



permedica
ORTHOPAEDICS



EXACTARS

Femoral Stem

SURGICAL TECHNIQUE



Both our Sales Representatives and Product Specialists are at Your complete disposal for any further information and/or explanation about the contents of this Surgical Technique



EXACTA^{RS}

FEMORAL STEM SYSTEM

EXACTA **RS** by permedica is a straight femoral stem for cementless application, available in Standard and Lateralized version, both with CCD angle of 132°. The Lateralized version has an offset increased of 6mm in the size range from 1 to 5 and 7mm in the size range from 6 to 12 allowing the lateralization without affecting the limb length.

The stem is designed with the aim of preserving bone and respecting the muscular structures: the design of the stem allows the introduction of the rasps with a curvilinear trajectory that follows the arch of the calcar, preserving the lateral region of the Greater Trochanter and therefore the insertion of the hip abductor muscles. The reduced length, in addition to making the stem particularly suitable for use with minimally invasive techniques (including those with anterior access), allows the implant to be centered without excessively engaging the femoral canal, thus preserving the shaft for any future interventions of revision. The triple conicity in all planes and the properties of the materials used ensure excellent primary stability of the implant while the bioactive coatings applied to the surface in contact with the bone favor long-term integration. The horizontal grooves in the proximal part of the stem are designed to reinforce axial stability. The tapered distal end allows to reduce the loads on the cortical walls. The trapezoidal section neck with a reduced diameter allows a wide range of movement of the joint, avoiding conflicts with the inner edge of the cup. The distal portion and the neck have a glossy finishing.

The seat for attaching the stem holder on the shoulder of the stem is inclined to facilitate insertion even with direct anterior access (DAA).

The threaded hole also allows the connection of extraction ends for eventual stem removal.



NOTE:

Further information are available in the section “Warnings, indication and contraindication for the implant” in the last page of this leaflet as well as in the Instruction for Use supplied in the packaging of each single device.

ATTENTION:

Good clinical results from a prosthetic intervention depends upon, other than the correct application of the surgical techniques, numerous factors of which good bone quality, wear values, and incision optimization.

INDICATION FOR USE

Use of the EXACTA **RS** stems is indicated in the following conditions:

- ✓ avascular necrosis of the femoral head;
- ✓ fractures of the femoral neck/head;
- ✓ rheumatoid arthritis;
- ✓ primary/secondary arthrosis;
- ✓ post-traumatic arthrosis;
- ✓ collagen diseases;
- ✓ displasies and congenital dislocation of the hip joint;
- ✓ epiphysiolisis.

SURGICAL PROCEDURE

ATTENTION:

*This Surgical Technique should be considered a guide or example to assist orthopaedic Surgeons already trained in Total Hip Arthroplasty. It's objective is to demonstrate the various instruments used for the implantation of the EXACTA **RS** stem by permedica. The knowledge and experience of the Surgeon will guide him throughout the steps of the implantation.*

✓ Pre-operative planning	page	3
✓ Surgical approach	page	4
✓ Joint exposure	page	4
✓ Femoral neck osteotomy	page	4
✓ Preparation of the medullary canal	page	5
✓ Broaching	page	5
✓ Trial evaluation	page	7
✓ Stem implantation - cementless	page	8
✓ Head implantation	page	8
✓ Stem removal	page	9
✓ Post-op care	page	9
✓ Instruments Set	page	10

PRE-OPERATIVE PLANNING 1

The aim of preoperative planning is to choose the most suitable prosthesis to implant, determine the ideal anchorage position, establish the correct positioning for good biomechanical reconstruction, correct eventual dysmetria and verify the size.

With these objectives in mind it is necessary to carry out a radiographical exam of the coxo-femoral joint (pelvis and proximal third of the femur) with projected Anterior-Posterior and Latero-Lateral images, with enough focal distance to obtain an enlargement of at least 15%.

In summary, a correct preoperative planning is advisable in order to carry out the following general characteristic evaluation:

CENTER OF ROTATION REPRODUCTION

From the A/P pelvis radiograph the controlateral femoral head center of rotation can be determined, when it is healthy, and the distance from the radiographic U is quantified.

EVALUATION OF EVENTUAL DYSMETRIA

Three horizontal lines are traced (**Fig. 1**): a Bi-ischiatic line (1), between the inferior margins of the ischium; an above acetabular line (2), between the upper margins of the acetabular cavity, and a bi-tronchanteric line (3), between the two lesser trochanters.

If these three lines are parallel amongst themselves, there is no dysmetria.

If lines (1) and (2) are parallel but line (3) is divergent, there is dysmetria due to a deformation of the femur.

If lines (2) and (3) are parallel but (1) is divergent, there is a dysmetria due to a cotyloid deformation.

In the case that all three lines are divergent amongst themselves, there is a combined dysmetria, determined by a cotyloid deformation as well as a femur deformation.

EVALUATION OF THE IMPLANT SIZE

After having studied and evaluated the above mentioned information via radiographic templates (with 15% magnification), choose the optimal size combination for the femoral component as well as the acetabular component (**Fig. 1b**).

It is possible to prepare a traced radiographic lucent of the hip by placing the template over the prosthesis to be implanted.

IMPORTANT!

Determine the correct level of the femoral neck osteotomy by placing the template of the better fitting size over the involved hip X-ray, aligning the line referring to the center of rotation to the top of the *Greater Trochanter*. The sinking mark for the precise resection level and the consequent sinking limit of the rasps is given by the line at the base of the neck, which identifies the limit of the stem coating.

ATTENTION

It would be advisable to evaluate, already in the pre-operative planning phase, the opportunity to use an EXACTA RS LATERAL stem.

Failing to execute accurate pre-operative planning could lead to poor results. The intervention should be carefully planned based upon X-Ray screening.

Before the operation it is furthermore necessary to investigate the possibility of any possible allergic reactions of the patient towards implantable device materials.

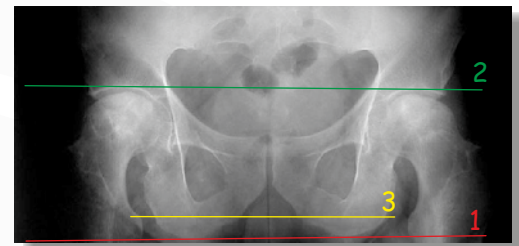

Fig. 1: Pre-operative planning

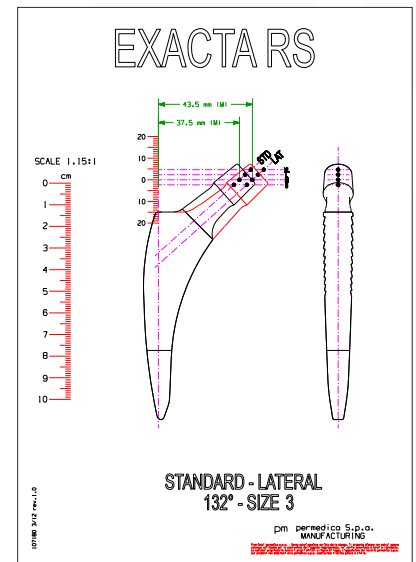
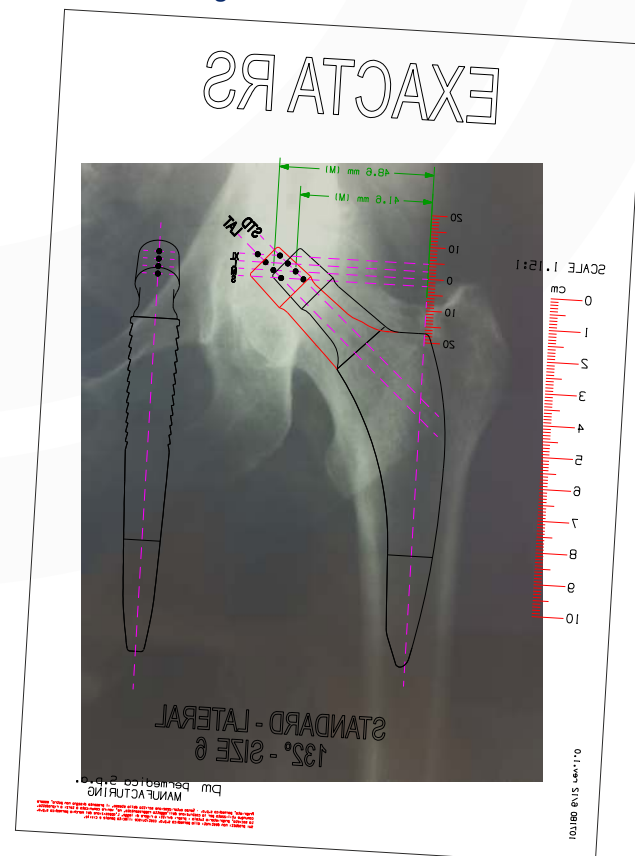

Fig. 1b: size evaluation



2 SURGICAL ACCESS

The initial exposure of the joint for the EXACTA **RS** stems implantation can be achieved by following any standard surgical approach, according to Surgeon's preferences and/or habits. For best surgical results it is always advisable use of most familiar surgical approach.

The following illustrated technique refers to an implant realized via a Postero-Lateral Approach.

3 JOINT EXPOSURE

The incision is centered on the posterior half of the *Greater Trochanter* and extended distally along the femoral diaphysis for 10 cm. and proximally following the direction of the *gluteus maximus* fibers.

The *Fascia Lata* is divided in line with the cutaneous incision. The *Gluteus Maximus* is divided longitudinally via a blunt dissection. Cauterize the bleeding points.

Expose the *Short External Rotators muscles* positioning a blunt retractor between the *Capsule* and the *Gluteus Medius*, putting them in tension via internal rotation of the joint. Pass a suturing thread into the *Piriformis Tendon* in order to evidence the position for successive reinsertion. Detach entirely or separately the *External Rotators muscles* by carrying out an incision as close as possible to the bone.

Cut the *Joint Capsule* starting from the Acetabular Cavity margin and going till the base of the *Femoral Neck*.

Dislocate the *Femoral Head* turning the joint internally with the knee flexed. In some cases it is necessary to section the Round ligament first.

Utilize a double pointed retractor in order to lift the femoral head thus providing optimal exposure.

4 FEMORAL NECK OSTEOTOMY

Before proceeding to the osteotomy of the femoral head, it is important to remove any osteophytes and periosteal tissues to allow clear vision of the head/neck limits.

The neck osteotomy is carried out using an oscillating saw, referring to the lesser trochanter and at the distance measured in the pre-operative planning (**Fig. 2**).

The femoral head is removed and preserved to be utilized for eventual bone grafts.

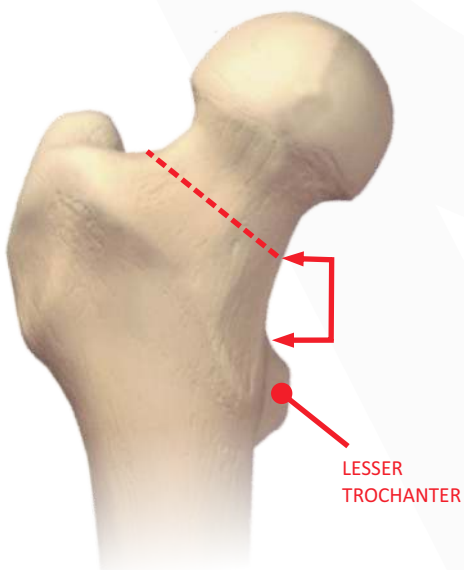

Fig. 2: resection level

PREPARATION OF THE MEDULLARY CANAL 5

The medullary canal is initiated utilizing the **Mouse Tail Starting Rasp (S13281)**. This instrument is inserted into the resected surface medially to the femoral neck centre (Fig. 3a) and pushed through the cancellous bone, towards the medullary canal, following the calcar arch to ensure the correct introduction of the first rasp (Fig. 3b).



S13281



Fig. 3a

Fig. 3b

Whenever desired it is also possible to use the **Moore Starting Chisel (S12022)** to create a rectangular slit in order to guide the insertion of the first rasp (Fig. 4a).

Also in this case the instrument must be inserted medially with respect to the center of the femoral neck (Fig. 4b).

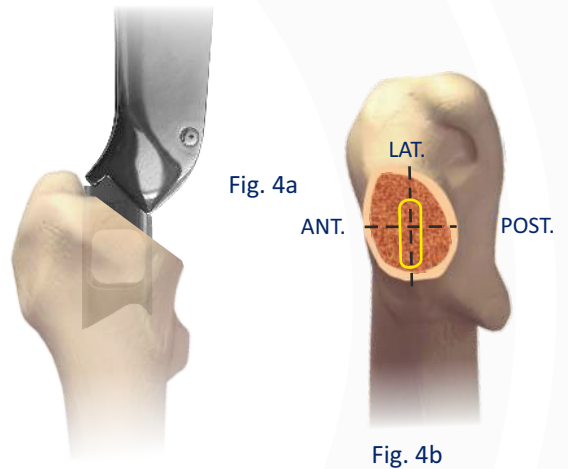

Fig. 4a

Fig. 4b

BROACHING 6

In addition to the **STRAIGHT Rasp Handle (S11601)** supplied as standard, it is also available a **CURVED Rasp Handle** and **Double Off-set Handles in LEFT and RIGHT version** (to be used with anterior approach).

S11644 Mark S Rasp Handle - Double Off-set LEFT



S11600 Mark S Rasp Handle - Curved



S11643 Mark S Rasp Handle - Double Off-set RIGHT

To lock/unlock the rasp onto the Handle (Fig. 5):

- ① open the locking system by pulling the lever **A**
- ② engage the broach in the connection **B**
- ③ lock the broach by pushing back the lever **A**



Fig. 5: rasp connection

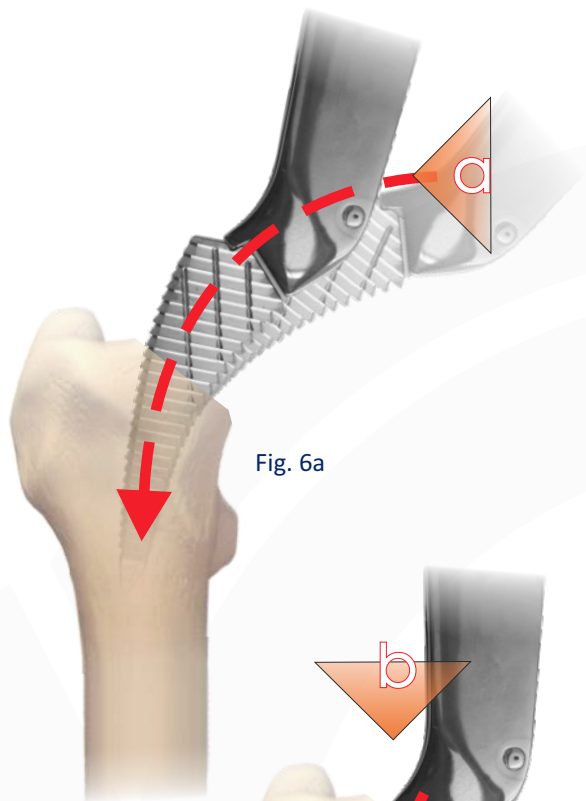

Fig. 6a

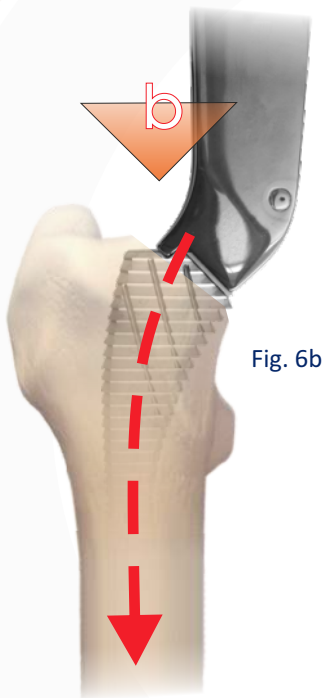

Fig. 6b

The smallest size broach is assembled onto the **Rasp Handle (S11601)** and inserted into the prepared track.

It is advisable to start with the **Starting Rasp S13250**, especially if a small size (1 to 3) has been planned from the preoperative planning.

The rasps must be inserted slightly medially (**Fig. 6a**) and then directed with mallet blows in order to follow the diaphyseal axis, by pushing the handle laterally (towards the *Greater Trochanter*), along the curvature of the calcar arch and avoiding varus positioning (**Fig. 6b**).

The rasps must be pushed until totally embedded. It may be necessary to repeat the extraction and reinsertion a few times to help removal of bony debris.

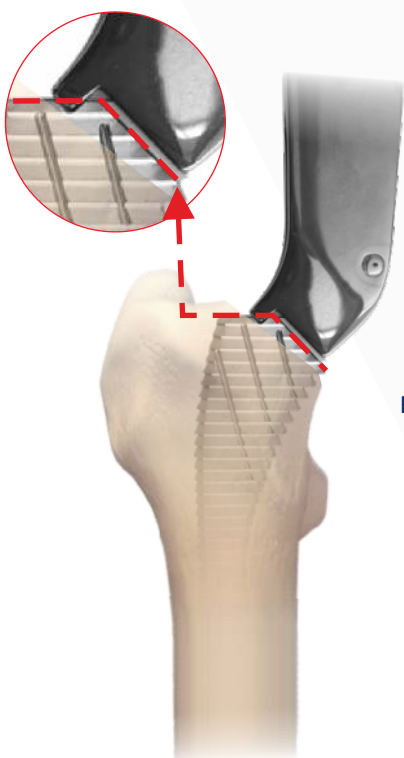

Fig. 7

Proceed inserting the next rasps, increasing the size until reaching the correct size determined in the pre-op planning (anyway the surgeon should feel the broach locking into the bone and not sinking any further, stable to torsion and opposing resistance to extraction).

If the osteotomy has been made accordingly to the pre-op planning, the Rasp Line mark should be leveled to the osteotomy (**Fig. 7**). If the broach sinks further, the next size is normally required.

Whenever the final rasp should be considerably smaller (two or more sizes) than that evaluated during the pre-operative planning it would be advisable to verify the correct insertion by X-Rays control and, if necessary, apply any corrections before inserting the final implant.

Having reached the desired fit, the last broach utilized is left in place. Inserting onto it the proper **Trial Neck** and a **Trial Head**, it will be possible to carry out a trial reduction.

ATTENTION:

The EXACTA RS trial necks are available in **STANDARD** and **LATERALIZED** version, fitting onto the rasps accordingly to the different sizes.

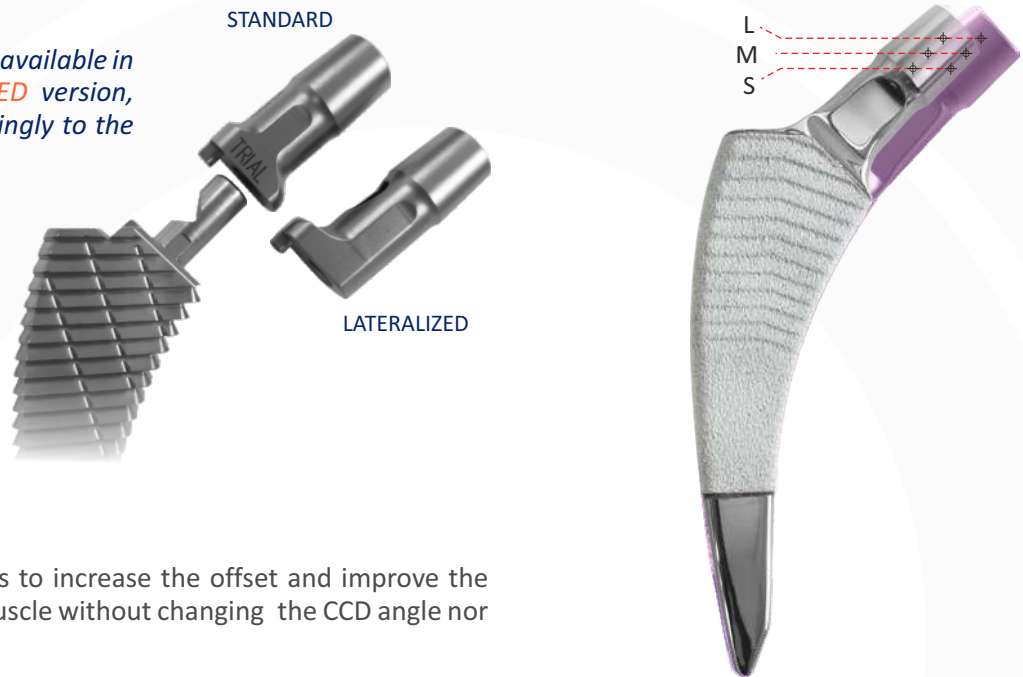

The Lateralized option allows to increase the offset and improve the tension of *Medius Gluteus* muscle without changing the CCD angle nor affecting the limb length.

After inserting a **Trial Head** compatible with the inner diameter of the implanted acetabular cup's liner (**Fig. 8**), reduce the hip to evaluate mobility and stability through a full range of motion (high flexion, external/internal rotation, abduction/adduction) and check for any impingement.

The appropriate neck length of the ball head to be used is determined as well. This is considered optimal if, by extending the limb and applying traction, an excursion of about 10mm is allowed. If the excursion should be different, evaluate the opportunity of using a Short or Long neck ball head.

The neck length of the Trial Heads is identifiable by a colour coding:

- GREEN** = SHORT Neck / XL-Neck (old type)
- BLUE** = MEDIUM Neck
- GREY** = LONG Neck
- YELLOW** = XL (Extra-Long) Neck

WARNINGS regarding use of ExtraLong ball-heads:
 Although the system foresees the use of Extralong ball heads, this could lead to an alteration of the correct biomechanics, with huge lever arms and high stresses on the implanted components. Therefore, use of this type of ball heads should be carefully evaluated, also considering the patient's weight and morphology.



Fig. 8

8

IMPLANTATION of the DEFINITIVE STEM

The definitive Stem to be implanted will be the same size of the last broach utilized.

Once drawn from the sterile packaging, the Stem is manually engaged into the previously prepared femoral site.

Screw the apposite Stem Impacting End (Straight S13282 o Curved S13283) onto the Universal Handle - Quick Fix (S19501).



Lodge the tip into the niche onto extreme top of the stem (Fig. 9) and impact with a hammer until complete seating (Fig. 10).



Fig. 9

Fig. 10

9

IMPLANTATION of the BALL HEAD

Once the stem is definitively seated it will be possible to repeat a trial, in case of any doubt, by using the Trial Heads. Once the correct ball head has been established, proceed to implante the definitive one.

Remove the plastic cap protecting the taper and manually insert the selected Ball Head onto the stem taper, applying axial pressure and torsion to achieve perfect locking.

After positioning, the Ball Head is impacted (Fig. 11) using the appropriate Impacting End (S19502) assembled on the Universal Handle - Quick Fix (S19501).



Fig. 11

WARNINGS:

- ☑ Ceramic Ball Heads should be gently impacted. NEVER hit them directly with metal instruments.
- ☑ Whenever replacment of a ceramic ball head should be necessary, an accurate investigation of the cone surface should be effected. Any visible damage (i.e. grooves/scratches) would compromise the geometrical/dimensional precision of the cone and use of a new ceramic ball head must be AVOIDED.

STEM REMOVAL 10

Whenever it should be necessary to remove the stem, the instruments set provides an apposite **Extraction Threaded End (S13284)** to be connected with the **Universal Handle - Quick Fix (S19501)** and screwed into the threaded hole on the top of the stem (**Fig. 12**).



Fig. 12

Alternatively an **Extraction Threaded Adapter** to be used with the **Sliding Hammer** is also available upon request.

In this case, connect the quick coupling **Extraction Adapter (S11012)** to the **Sliding Hammer Impactor/Extractor (S10012)** and screw it into the threaded hole in the top of the stem (**Fig. 12**).



POST-OPERATIVE CARE 11

Post-op care strategy is very important to allow the patient a correct recovery. The guidelines are established by the Surgeon and should consider several factors such as age, weight and bony structure of the patient.

In any case, it is necessary to avoid excessive load of the lower limb for a certain amount of time.

ATTENTION: the Surgeon is required to schedule regular check ups to verify the implant status.

S13200 EXACTA RS INSTRUMENTS SET

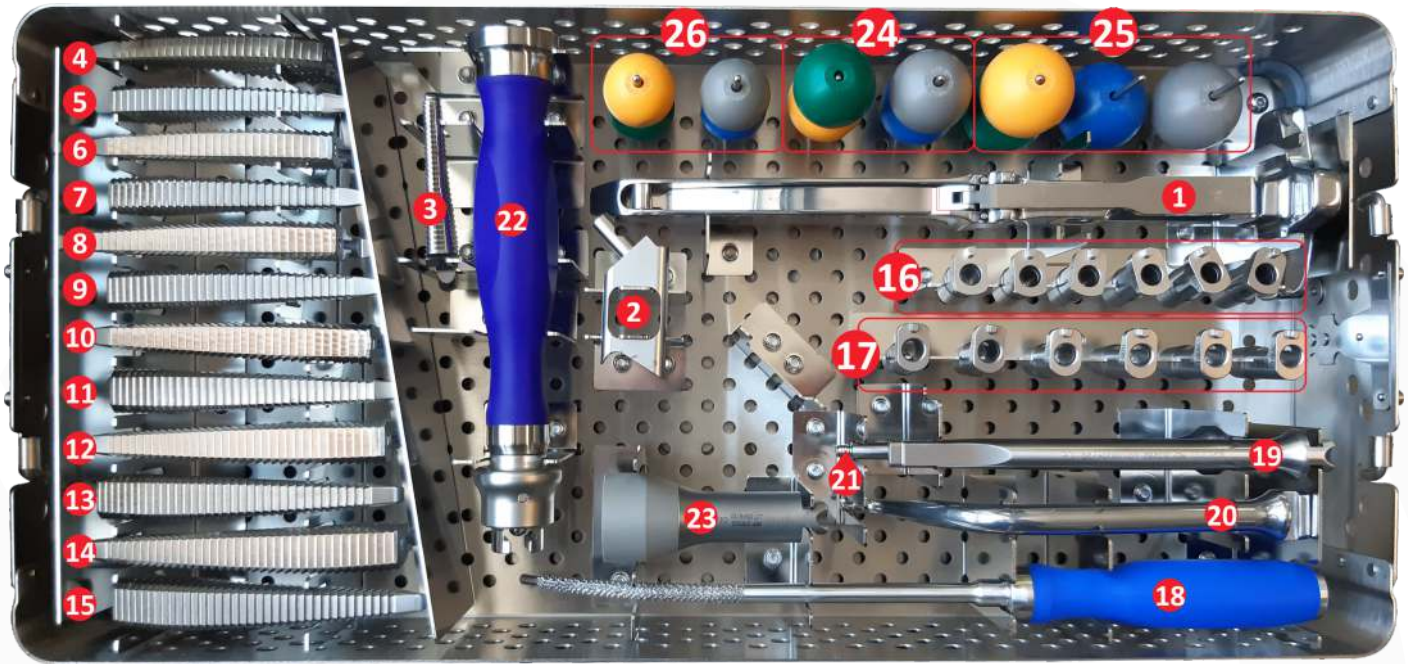

S13210 EXACTA RS STEM: Instruments Sterilization Case - Empty

- | | | | |
|---|--|-----------|--|
| 1 | S11601 RASP HANDLE Mark S - STRAIGHT | 18 | S13281 MOUSE TAIL STARTING RASP |
| 2 | S12022 MOORE STARTING CHISEL - Mark S | 19 | S13282 STEM IMPACTING END - Quick Fix - Straight |
| 3 | S13250 EXACTA RS: Mark S Starting Rasp | 20 | S13283 STEM IMPACTING END - Quick Fix - Curved |
| 4 | S13251 EXACTA RS: Mark S Rasp - Size 1 | 21 | S13284 STEM EXTRACTION THREADED END - Quick Fix |
| 5 | S13252 EXACTA RS: Mark S Rasp - Size 2 | 22 | S19501 UNIVERSAL HANDLE - Quick Fix |
| 6 | S13253 EXACTA RS: Mark S Rasp - Size 3 | 23 | S19502 HEAD IMPACTING END - Quick Fix |
| 7 | S13254 EXACTA RS: Mark S Rasp - Size 4 | 24 | S20131 TRIAL HEAD Ø 32mm - SHORT NECK |
| 8 | S13255 EXACTA RS: Mark S Rasp - Size 5 | | S20132 TRIAL HEAD Ø 32mm - MEDIUM NECK |
| 9 | S13256 EXACTA RS: Mark S Rasp - Size 6 | | S20133 TRIAL HEAD Ø 32mm - LONG NECK |
| 10 | S13257 EXACTA RS: Mark S Rasp - Size 7 | | S20134 TRIAL HEAD Ø 32mm - XL NECK |
| 11 | S13258 EXACTA RS: Mark S Rasp - Size 8 | 25 | S20137 TRIAL HEAD Ø 36mm - SHORT NECK |
| 12 | S13259 EXACTA RS: Mark S Rasp - Size 9 | | S20138 TRIAL HEAD Ø 36mm - MEDIUM NECK |
| 13 | S13260 EXACTA RS: Mark S Rasp - Size 10 | | S20139 TRIAL HEAD Ø 36mm - LONG NECK |
| 14 | S13261 EXACTA RS: Mark S Rasp - Size 11 | | S20140 TRIAL HEAD Ø 36mm - XL NECK |
| 15 | S13262 EXACTA RS: Mark S Rasp - Size 12 | 26 | S20181 TRIAL HEAD Ø 28mm - SHORT NECK |
| 16 | S13263 EXACTA RS: TRIAL NECK for Mark S Rasp, STD - Size 1 | | S20182 TRIAL HEAD Ø 28mm - MEDIUM NECK |
| | S13264 EXACTA RS: TRIAL NECK for Mark S Rasp, STD - Size 2-3 | | S20183 TRIAL HEAD Ø 28mm - LONG NECK |
| | S13265 EXACTA RS: TRIAL NECK for Mark S Rasp, STD - Size 4-5 | | S20184 TRIAL HEAD Ø 28mm - XL NECK |
| | S13266 EXACTA RS: TRIAL NECK for Mark S Rasp, STD - Size 6-7 | | |
| S13267 EXACTA RS: TRIAL NECK for Mark S Rasp, STD - Size 8-9 | | | |
| S13268 EXACTA RS: TRIAL NECK for Mark S Rasp, STD - Size 10-11-12 | | | |
| S13269 EXACTA RS: TRIAL NECK for Mark S Rasp, LAT - Size 1 | | | |
| S13270 EXACTA RS: TRIAL NECK for Mark S Rasp, LAT - Size 2-3 | | | |
| 17 | S13271 EXACTA RS: TRIAL NECK for Mark S Rasp, LAT - Size 4-5 | | |
| S13272 EXACTA RS: TRIAL NECK for Mark S Rasp, LAT - Size 6-7 | | | |
| S13273 EXACTA RS: TRIAL NECK for Mark S Rasp, LAT - Size 8-9 | | | |
| S13274 EXACTA RS: TRIAL NECK for Mark S Rasp, LAT - Size 10-11-12 | | | |

EXACTA RS cementless femoral stem

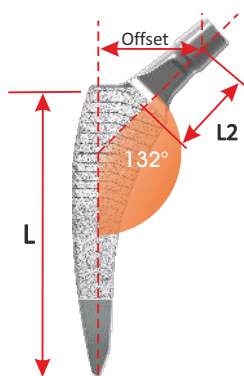

Standard - CCD 132°						Lateral - CCD 132°			
Size	L mm	Offset mm	L2 mm	HaX-Pore®	X-Pore	Offset mm	L2 mm	HaX-Pore®	X-Pore
				reference	reference			reference	reference
1	90	35,0	26,3	13211	13251*	41,0	30,5	13231	13271*
2	93	37,0	28,3	13212	13252*	43,0	32,5	13232	13272*
3	96	37,5	28,3	13213	13253*	43,5	32,5	13233	13273*
4	99	39,5	30,3	13214	13254*	45,5	34,5	13234	13274*
5	102	40,0	30,3	13215	13255*	46,0	34,5	13235	13275*
6	105	41,6	31,6	13216	13256*	48,6	36,6	13236	13276*
7	108	42,2	31,6	13217	13257*	49,2	36,6	13237	13277*
8	111	43,9	33,0	13218	13258*	50,9	37,9	13238	13278*
9	114	44,5	33,0	13219	13259*	51,5	37,9	13239	13279*
10	117	46,2	34,3	13220	13260*	53,2	39,3	13240	13280*
11	121	47,9	34,3	13221	13261*	54,0	39,3	13241	13281*
12	124	47,8	34,3	13222	13262*	54,7	39,3	13242	13282*

Information

INTENDED PURPOSE:

the **EXACTA RS** stems are intended for use in total or partial Hip Replacement procedures, combined with a femoral ball head (or a bi-articular head) and an acetabular cup. Indicated for primary hip arthroplasties in cases of serious joint degeneration, mainly due to arthrosis and post-traumatic degenerative factors. Device fixation is obtained by means of primary cementless press-fit stabilization.

MATERIALS:

Titanium Aluminium Niobium forged alloy (Ti6Al7Nb) ISO5832/11.

SURFACE FINISHING:

HaX-Pore®: double coating 300µm pure Titanium+50µm Hydroxyapatite $Ca_{10}(OH)_2(PO_4)_6$ plasma sprayed

X-Pore: coating 300µm pure Titanium plasma sprayed

STERILIZATION:

Method: Irradiation (Beta or Gamma rays - minimum dose 25 kGy) or vaporized Hydrogen Peroxide (VH2O2).

Validity: 5 years (Beta) - 10 years (Gamma-VH2O2).

CLASSIFICATION:

Class III as reported in Directive 2005/50/CE (and related D.lgs 26 april 2007 n.65) concerning re-classification of Hip, Knee and Shoulder joint prostheses which modifies classification criteria of Annex IX of Directive 93/42/CEE and next integrations and amendments.



permedica
ORTHOPAEDICS

*CHALLENGING EXCELLENCE
IN TECHNOLOGY*

www.permedica.it