

NexGen Pocket Profiler

Section 1 - Photos Needed

NexGen Stem Extension - Option Cemented (pg. 109)

NexGen Replacement Screws (pg. 127)

Section 2 - Photos Needed

NexGen MIS Femoral Finishing Instrument Kit - 00-5967-026-50 (pg. 128)

NexGen MIS Spacer Block/Notch Chamfer Troch Guide Kit - 00-5973-062-50 (pg. 175)

NexGen MIS Tibial Plate Instrument Kit - 00-5951-004, 00-5951-005-00, 00-5951-006-00 (pg. 216)

NexGen Rotating Hinge Knee Hinge Pin Servicing Instrument Kit - 00-5979-005-00 (pg. 229)

Zimmer Uni High Flex Tibial Resection/Instrument Kit - 00-5843-092-00 (pg. 223)

Zimmer Uni High Flex Tibial Provisional/Instrument Kit - 00-5843-093-00 (pg. 223)

Modified Fluted Mobile Tibial Plates and Provisional Japan Only (pg. 253)

NexGen CR/CR-Flex Articular Surface - Japan Only - 00-5952-008-01 (pg. 258)

NexGen CR-Flex Femoral and Articular Surface Provisionals - Japan Only - 00-5975-022-01 (pg. 259)

Disposables (pg. 275)



Zimmer®
NexGen®
Knee
Profiler



zimmer
Confidence in your hands®

INTRODUCTION

This condensed guide has been compiled to help you quickly obtain information or product specifications such as implant size, kit contents, and instrumentation usage for our entire line of knee implants. It's convenient to carry and provides easy access to *NexGen*[®] Knee, *Zimmer*[®] Uni High Flex Knee, *M/G*[®] Unicompartmental Knee, *MIS*[™] Instrumentation and *Prolong*[™] Highly Crosslinked Polyethylene product information whether you are on a sales call or in the O.R. Please refer your surgeon to the package insert for full product information.

TABLE OF CONTENTS

THE NEXGEN SYSTEM

Trademarks	8
NexGen System Chart	10
CR/CRA Color Key Chart	12
CR Micro Color Key Chart	13
LPS Color Key Chart	14
NexGen Legacy® Posterior Stabilized Flex Fixed Chart	16
LCKK Color Key Chart	17
NexGen RHK Sizing Chart and Dimensions	19
NexGen CR/CRA Femoral M/L-A/P Dimensions	18
NexGen LPS/LCKK Femoral M/L-A/P Dimensions	20
NexGen LPS-Flex Femoral M/L-A/P Dimensions	21
NexGen Tibial/Art Surf M/L-A/P Dimensions	22
All-Poly Tibial M/L-A/P Dimensions	23
M/G Unicompartmental M/L-A/P Dimensions	24
Femoral Notch Widths	25

FEMORAL IMPLANTS

CR Femoral Implants	26
LPS Femoral Implants	30
LPS-Flex Femoral Implants	32
CRA Femoral Implants	34
LCKK Femoral Implants	36
RHK Femoral Implants	40

ARTICULAR SURFACE IMPLANTS

CR/CRA Articular Surfaces	38
CR/CRA AC/AR Articular Surfaces	42
Prolong Highly Crosslinked Articular Surfaces	44
LPS Articular Surfaces	46
LPS-Flex Fixed Articular Surfaces	48
LCKK Articular Surfaces	50
RHK Articular Surfaces	58

TIBIAL IMPLANTS

NexGen CR Monoblock Tibia	60
NexGen LPS Monoblock Tibia	62
Stemmed Tibial Plates	52
Stemmed 3&7 Degree Fluted Tibial Plates	54
CR Pegged Tibial Plates	56
CR All-Poly Tibials	60
LPS All-Poly Tibials	64
RHK Tibial Plates	78

PATELLAS

All Polyethylene Patellas	66
Trabecular Metal Augmentation Patella	68

STEM EXTENSIONS

Stem Extensions	70
-----------------	----

MODULAR TIBIAL AUGMENTS

Precoat Tibial Augments	76
NexGen Tibial Augments	77
Legacy 3° Fluted Precoat Tibial Augments	78

FEMORAL AUGMENTS

Precoat Femoral Augments	80
RHK Femoral Augments	82
Titanium® Ti-6Al-4V Alloy Bone Screws	58

INSTRUMENTATION KITS

5973-01 Tibial Align/Resection Instr	82
5973-02 IM Tibial Milling	84
5973-03 Tibial/Femoral Gen Instr	86
5973-04 Stemmed Tibial Instr/Prov	88
5973-05 EM/IM Tibial Resector Instr	90
5973-06 CR Mono Block Tibial Instr/Prov	91
5973-07 Fluted 7° Stem Tibial	92
5973-08 Legacy 3° Instr	94
5973-09 Legacy 3° Instr	96
5973-10 A/P Wedge Tibial Plate Instr	100
5973-11 Femoral Sizing/Align Instr	102
5973-12 Femoral Milling Instr	104
5973-13 Femoral Resect/Fin Instr (5-in-1)	106
5973-14 Milling/5-IN-1 Micro Instrument	108
5973-19 Milling/5-IN-1 Macro Instr/Prov	110
5973-23 Sharp Fluted Stem Ext Prov	112
5973-24 Straight/Offset Stem Ext Prov	114
5878-09 Primary Porous Patella Instr/Prov	115
5973-30 Aug Patella Prov/Instr	116
5877-09 Continuum® Aug. Patella Prov/Instr Kit	117
5973-31 Patella/Spacer Blocks	118
5973-33 Micro Patella Prov	118
5973-35 Tibial Augment Instr/Prov	120
5973-36 Knee Reamers	124
5973-41 CR Provisional	126
5973-43 Micro CR Provisional	126
5930-43 CR Micro Provisional	127

TABLE OF CONTENTS

INSTRUMENTATION KITS CON'T

5973-47	CR AC Art Surface Prov	128
5973-48	Micro CR AC Art Surface Prov	128
5973-49	CR AR Art Surface Prov	130
5973-57	Notch/Chamfer Guide	134
5973-58	PS Milling Notch Guide	136
5973-59	TR/PS Milling Fin Guide	136
5973-50	5-in-1 Notch Guide	136
5973-60	EPI Femoral Instr	138
5973-61	EPI Femoral/Tibial Instr	140
5973-62	EPI Notch/Chamfer Guide	136
5973-63	Micro LPS Prov	142
5973-64	Macro LPS Fem Prov	142
5973-65	LPS Provisional	142
5930-63	LPS Micro Prov/Instr	143
5930-65	LPS Micro Prov/Instr	143
5973-67	Macro EPI Instr	144
5973-68	Micro EPI Instr	146
5973-70	CRA/LCCK Core Instr	148
5973-71	CRA Fem Prov/Cut Guide	150
5973-72	LCCK Fem Prov/Cut Guide	152
5973-73	LCCK Art Surf Prov	154
5973-74	LCCK Thick Art Surf Prov	154
5973-75	CRA/LCCK Rev Instr	156
5973-81	V-STAT® Variable Soft Tissue Alignment Tensor Instr	158
5973-82	4-in-1 Fem Instr	160
5973-83	4-in-1 Fem/Tib Instr	162
5973-84	Micro 4-in-1 Instr	164
5973-85	Macro 4-in-1 Instr	166
5973-90	IM Femoral Align/Resection	168
5973-91	IM Femoral Finishing Instr	170
5973-92	IM Fem/Tib Align/Finish	172
5973-93	Macro IM Instr	144
5973-94	Micro IM Instr	146
5973-99	MICRO-MILL® Instr System Driver Kit	174
5975-01	LPS-Flex Femoral Prov/Instr	176
5975-02	LPS-Flex Fixed Art Surf Prov/Instr	178
5975-04	Fluted Stem Mobile Tibial Prov/Instr	210
5979-01	RHK Femoral Instr	212
5979-03	RHK Tibial Prov/Instr	214
5979-04	RHK Articular Surface Prov	216
5979-05	RHK Pin Servicing Instr	218
5979-06	Milling/5-in-1 Femoral A/P Guide Instr	220

M/G UNICOMPARTMENTAL KNEE

5790-01	Femoral Implants	180
5790-07	Articular Surfaces	184
5790-04	Tibial Implants	182
5790-05	All-Poly Tibia	186
5789-52	MIS Tibial Instrument Kit	186
5789-50	MIS EM Instrument Kit	188
5789-53	MIS Femoral Instrument Kit	192

NEXGEN OSTEOTOMY

NexGen Osteotomy System	194
NexGen Osteotomy Instrumentation	196

DISPOSABLES

Disposable items	198
------------------	-----

SOFT TISSUE BALANCING GUIDE

NexGen Soft Tissue Balancing Guide	200
------------------------------------	-----

INSTRUMENT SUMMARY

Summary of NexGen Primary Femoral Instrument Options	202
--	-----

SALES SUPPORT

NexGen Sales Support Materials List	204
-------------------------------------	-----

INSTRUMENTATION KIT REFERENCE CHART

Instrumentation Procedure/Kit Reference Chart	214
---	-----

NexGen Knee
Cruciate Retaining CR-Flex Fixed

		Femoral Size					
		B	C/C-	D/D-	E/E-	F/F-	G/G-
M/L (mm)		58	60	64	68	72	76.5
A/P (mm)		48.5	53.5/51.5	57.5/55.5	61.5/59.5	65.5/63.5	70.5/68.5
A/P Box (mm)		36	38	42	46	50	54
Beating Spacing (mm)		36			44		

Tibial Size	B/1-2	CC-1-2	DD-1-2	EE-1-2	FF-1-2	GG-1-2
1-2	SOLID PURPLE	STRIPED PURPLE	STRIPED PURPLE	STRIPED PURPLE	STRIPED PURPLE	STRIPED PURPLE
3-4	B/3-4 STRIPED YELLOW	CC-3-4 SOLID YELLOW	DD-3-4 SOLID YELLOW	EE-3-4 SOLID YELLOW	FF-3-4 SOLID YELLOW	GG-3-4 SOLID YELLOW
5-6	B/5-6 STRIPED GREEN	CC-5-6 SOLID GREEN	DD-5-6 SOLID GREEN	EE-5-6 SOLID GREEN	FF-5-6 SOLID GREEN	GG-5-6 SOLID GREEN
7-10		CC-7-10 SOLID BLUE	DD-7-10 SOLID BLUE	EE-7-10 SOLID BLUE	FF-7-10 SOLID BLUE	GG-7-10 SOLID BLUE

Patella Size	Micro*	Standard
	26mm 5972-61-26 29mm 5972-61-29 32mm 5972-61-32 35mm 5972-61-35	26mm 5972-65-26† 29mm 5972-65-29† 32mm 5972-65-32† 35mm 5972-65-35

* 26mm Patella is for inseting only.
† Size A and B Femoral Components use Micro Patellas (5972-61-26, 29, 32, 35).
‡ 26, 29, 32mm Patellas not for use with G & H Femoral Components, unless used in an inset mode.
Note: When using the color coding scheme, match a solid color with a solid color; match a striped color with a striped color. Do not match a solid with a striped color. For example, it is not appropriate to match a solid green with a striped green.

NexGen Knee
Cruciate Retaining CR Trabecular Metal Monoblock

		Femoral Size					
		C	D	E	F	G	H
M/L (mm)		63	68	72	77	81	85
A/P (mm)		53.5	57.5	61.5	65.5	70.5	76
A/P Box (mm)		40	44	49	53	57	62
Beating Spacing (mm)		44		44		44	

Tibial Size	C/3-4	D/3-4	E/3-4	F/3-4	G/3-4	H/3-4
3-4	SOLID YELLOW	SOLID YELLOW	SOLID YELLOW	SOLID YELLOW	SOLID YELLOW	SOLID YELLOW
5-6	C/5-6 SOLID GREEN	D/5-6 SOLID GREEN	E/5-6 SOLID GREEN	F/5-6 SOLID GREEN	G/5-6 SOLID GREEN	H/5-6 SOLID GREEN
7-8	C/7-8 SOLID BLUE	D/7-8 SOLID BLUE	E/7-8 SOLID BLUE	F/7-8 SOLID BLUE	G/7-8 SOLID BLUE	H/7-8 SOLID BLUE

Primary Porous Patella Standard Size	32mm 5878-65-32*	35mm 5878-65-35	38mm 5878-65-38	41mm 5878-65-41

* 32mm Patella not for use with G & H Femoral Components.
Note: When using the color coding scheme, match a solid color with a solid color; match a striped color with a striped color. Do not match a solid with a striped color. For example, it is not appropriate to match a solid green with a striped green.

NexGen Legacy® Knee
Posterior Stabilized LPS Trabecular Metal Monoblock

		Femoral Size						
		C	D	E	F	G	H	
Tibial Size	3-4	CD/3-4 SOLID YELLOW		EF/3-4 STRIPED YELLOW				
	5-6	CD/5-6 STRIPED GREEN		EF/5-6 SOLID GREEN		GH/5-6 STRIPED GREEN		
	7-8			EF/7-8 STRIPED BLUE		GH/7-8 SOLID BLUE		
Patella Size		Use standard size Patellas with all LPS and LPS-Flex Femoral Components			26mm (inset only) 29mm†		32mm* 35mm	38mm 41mm

† For G & H Femoral Components, the 26, 29 and 32mm patellar components must be inset.

NexGen Legacy® Knee
Posterior Stabilized LPS and LPS-Flex Fixed

		Femoral Size							
		A*	B	C	D	E	F	G	H**
Tibial Size	1-2	AB/1-2 SOLID PURPLE		CD/1-2 STRIPED PURPLE					
	3-4	AB/3-4 STRIPED YELLOW		CD/3-4 SOLID YELLOW		EF/3-4 STRIPED YELLOW			
	5-6			CD/5-6 STRIPED GREEN		EF/5-6 SOLID GREEN		GH/5-6 STRIPED GREEN	
	7-10					EF/7-10 STRIPED BLUE		GH/7-10 SOLID BLUE	
Patella Size		Use standard size Patellas with all LPS and LPS-Flex Femoral Components			26mm (inset only) 29mm†		32mm* 35mm	38mm 41mm	

† For G & H Femoral Components, the 26, 29 and 32mm patellar components must be inset.

* Japan Only
** LPS Only

NexGen Legacy® Knee
Posterior Stabilized LPS-Mobile and LPS-Flex Mobile

		Femoral Size					
		AB	C	D	E	F	G
Fused Stem Mobile Tibial Size	1	AB/1-3					
	2	AB/1-3	C/2-4				
	3	AB/1-3	C/2-4	D/3-5			
	4		C/2-4	D/3-5	E/4-6		
	5			D/3-5	E/4-6	F/5-7	
	6				E/4-6	F/5-7	G/6-8
	7					F/5-7	G/6-8
	8						G/6-8
Patella Size		Use standard size Patellas with all LPS and LPS-Flex Femoral Components		26mm (inset only) [†]	32mm [†]	38mm	41mm

† For G & H Femoral Components, the 26, 29 and 32mm patellar components must be inset.

NexGen Legacy® Knee
Constrained Condylar LCCK

		Femoral Size					
		C	D	E	F	G	
Tibial Size	1-2	CD/1-2 STRIPED PURPLE	CD/1-2 STRIPED PURPLE				
	3-4	CD/3-4 SOLID YELLOW	CD/3-4 SOLID YELLOW	EF/3-4 STRIPED YELLOW	EF/3-4 STRIPED YELLOW		
	5-6	CD/5-6 STRIPED GREEN	CD/5-6 STRIPED GREEN	EF/5-6 SOLID GREEN	EF/5-6 SOLID GREEN	G/5-6 STRIPED GREEN	
	7-10			EF/7-10 STRIPED BLUE	EF/7-10 STRIPED BLUE	G/7-10 SOLID BLUE	
Patella Size		Use standard size Patellas with all LCCK Femoral Components		26mm (inset only) [†]	32mm [†]	38mm	
				29mm [†]	35mm	41mm	

† For G Femoral Components, the 26, 29 and 32mm patellar components must be inset.

NexGen® Knee
Rotating Hinge Knee (RH Knee)

		Femoral Size				
		B	C	D	E	F
Tibial Base Plate		1	B/1-6			
		2	B/1-6	C/2-6		
		3	B/1-6	C/2-6	D/3-6	
		4	B/1-6	C/2-6	D/3-6	E/4-6
		5	B/1-6	C/2-6	D/3-6	E/4-6
		6	B/1-6	C/2-6	D/3-6	E/4-6
Patella Size		Use <u>standard size</u> Patellas with RH Knee Femoral Components				
		26mm (inset only) [†] 29mm [†] 32mm [†] 35mm [†] 38mm [†] 41mm [†]				



MBK® – Mobile Bearing Knee

		Femoral Size					
		B	C	D	E	F	G
Tibial Size		1	B/1-3				
		2	B/1-3	C/2-4			
		3	B/1-3	C/2-4	D/3-5		
		4		C/2-4	D/3-5	E/4-6	
		5		D/3-5	E/4-6	F/5-7	
		6			E/4-6	F/5-7	G/6-8
		7				F/5-7	G/6-8
		8					G/6-8
Patella Size		Use <u>standard size</u> Patellas with all MBK Femoral Components					
		26mm (inset only) [†] 29mm [†] 32mm [†] 35mm [†] 38mm [†] 41mm [†]					



[†] Do not use 26, 29 or 32mm Patellas with size G Femoral Components.

NEXGEN CR/CRA FEMORAL DIMENSIONS

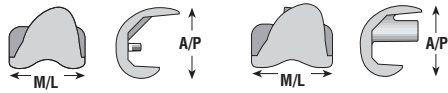

Size		CR		CRA	
		mm	mm	mm	mm
MICRO	A	55	44.5	-	-
	B	59	48.5	59	48.5
STANDARD	C	63	53.5	63	53.5
	D	68	57.5	68	57.5
	E	72	61.5	72	61.5
	F	77	65.5	77	65.5
	G	81	70.5	81	70.5
MACRO	H	85	76	-	-

NEXGEN CR-FLEX FEMORAL DIMENSIONS



Size		M/L	CR-FLEX	A/P
		mm		mm
MICRO	B	58		48.5
STANDARD	C	60		minus 51.5 53.5
	D	64		minus 55.5 57.5
	E	68		minus 59.5 61.5
	F	72		minus 63.5 65.5
	G	76.5		minus 68.5 70.5

NEXGEN LPS/LCCK FEMORAL DIMENSIONS

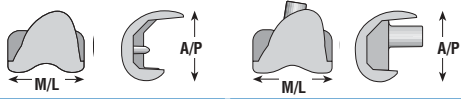

Size		LPS		LCCK	
		mm	mm	mm	mm
MICRO	A	54	45.5	-	-
	B	58	49.5	-	-
STANDARD	C	60	53.5	60	53.5
	D	64	57.5	64	57.5
	E	68	61.5	68	61.5
	F	72	65.5	72	65.5
	G	76.5	70.5	76.5	70.5
MACRO	H	81	76	-	-

NEXGEN LPS-FLEX FEMORAL DIMENSIONS



Size		LPS-FLEX	
		mm	mm
MICRO	A	54	46.5
	B	58	50.3
STANDARD	C	60	54.5
	D	64	58.6
	E	68	62.5
	F	72	66.5
	G	76.5	71.6

TIBIAL/ARTICULAR SURFACE DIMENSIONS

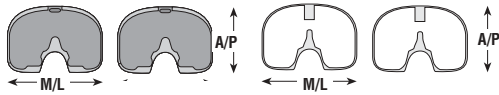

Size		PEGGED & STEMMED TIBIAL		ARTICULAR SURFACE	
MICRO	1	mm	mm	mm	mm
		2	58	40	58
STANDARD	3	62	41	58	40
	4	66	42	66	42
	5	66	46	66	42
	6	74	46	74	46
	7	74	50	74	46
	8	82	51	82	51
	9	82	54	82	51
	10	89	53	82	51

ALL-POLY TIBIAL DIMENSIONS

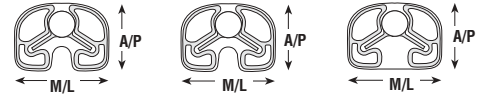

Size	CR		PS		LPS		
	M/L	A/P	M/L	A/P	M/L	A/P	
STANDARD	3	mm	mm	mm	mm	mm	
		66	42	66	42	66	42
	4	66	45	66	45	66	45
	5	74	46	66	46	74	46
	6	74	49	74	49	74	49
	7	82	50	82	50	82	50
	8	82	53	82	50	82	53

M/G UNICOMPARTMENTAL KNEE DIMENSIONS

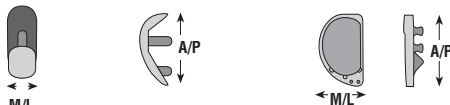

Size		M/G UNI FEMORAL		M/G UNI TIBIAL	
		mm	mm	mm	mm
SMALL	SMALL	21	42	SERIES 1	25 40
	SMALL PLUS	21	44	SERIES 2	27 44
REGULAR	REGULAR	24	47	SERIES 3	30 48
	REGULAR PLUS	25	50	SERIES 4	32 52
LARGE	LARGE	28	52	SERIES 5	35 56
	LARGE PLUS	28	56		
	LARGE PLUS PLUS	28	60		

ZIMMER UNICOMPARTMENTAL KNEE DIMENSIONS

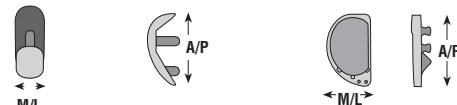

Size		ZIMMER UNI FEMORAL		ZIMMER UNI TIBIAL	
		mm	mm	mm	mm
SMALL	A	21	40	SIZE 1	23 41
	B	22	42.5	SIZE 2	25 44
REGULAR	C	22	45	SIZE 3	27 47
	D	23	48	SIZE 4	29 50
LARGE	E	24	51.5	SIZE 5	31 53
	F	25	55.5	SIZE 6	33 56
	G	26	60		

FEMORAL NOTCH WIDTHS (NARROWEST TOLERANCE)

NEXGEN CR, CR-FLEX, CRA Knee	WIDTH
SIZE A	11.9mm
SIZE B	12.1mm
SIZE C	12.2mm
SIZE D	12.5mm
SIZE E	12.8mm
SIZE F	12.9mm
SIZE G	13.3mm
SIZE H	13.4mm

NEXGEN PS Knee	WIDTH
SIZE A	13.7mm
SIZE B	13.7mm
SIZE C	16.6mm
SIZE D	16.6mm
SIZE E	17.8mm
SIZE F	17.8mm
SIZE G	21.2mm
SIZE H	21.2mm

NEXGEN LPS, LPS-FLEX Knee	WIDTH
SIZE A	13.7mm
SIZE B	13.7mm
SIZE C	16.6mm
SIZE D	16.6mm
SIZE E	17.8mm
SIZE F	17.8mm
SIZE G	21.2mm
SIZE H	21.2mm

NEXGEN CR FEMORAL IMPLANTS



OPTION

00-5966-001-00 NexGen CR Option Femoral Kit

Cat. No.	Description
00-5966-013-01	Fem Size C, Left (Str Purple/Yellow/Green/Blue)
00-5966-013-02	Fem Size C, Right (Str Purple/Yellow/Green/Blue)
00-5966-014-01	Fem Size D, Left (Str Purple/Yellow/Green/Blue)
00-5966-014-02	Fem Size D, Right (Str Purple/Yellow/Green/Blue)
00-5966-015-01	Fem Size E, Left (Str Purple/Yellow/Green/Blue)
00-5966-015-02	Fem Size E, Right (Str Purple/Yellow/Green/Blue)
00-5966-016-01	Fem Size F, Left (Str Purple/Yellow/Green/Blue)
00-5966-016-02	Fem Size F, Right (Str Purple/Yellow/Green/Blue)
00-5966-017-01	Fem Size G, Left (Str Purple/Yellow/Green/Blue)
00-5966-017-02	Fem Size G, Right (Str Purple/Yellow/Green/Blue)



PRECOAT

00-5970-001-00 NexGen CR Precoat Femoral Kit

Cat. No.	Description
00-5970-013-01	Fem Size C, Left (Str Purple/Yellow/Green/Blue)
00-5970-013-02	Fem Size C, Right (Str Purple/Yellow/Green/Blue)
00-5970-014-01	Fem Size D, Left (Str Purple/Yellow/Green/Blue)
00-5970-014-02	Fem Size D, Right (Str Purple/Yellow/Green/Blue)
00-5970-015-01	Fem Size E, Left (Str Purple/Yellow/Green/Blue)
00-5970-015-02	Fem Size E, Right (Str Purple/Yellow/Green/Blue)
00-5970-016-01	Fem Size F, Left (Str Purple/Yellow/Green/Blue)
00-5970-016-02	Fem Size F, Right (Str Purple/Yellow/Green/Blue)
00-5970-017-01	Fem Size G, Left (Str Purple/Yellow/Green/Blue)
00-5970-017-02	Fem Size G, Right (Str Purple/Yellow/Green/Blue)

* CR Femorals can be used with all CR Articular Surfaces (Machined, Net-Shape Molded and Prolong).

CONTINUED ON PAGE 32

NEXGEN CR FEMORAL IMPLANTS (CONT.)

00-5970-002-00 NexGen CR Macro Precoat Femoral Kit

Cat. No.	Description
00-5970-018-01	Fem Size H, Left (Str Purple/Yellow/Green/Blue)
00-5970-018-02	Fem Size H, Right (Str Purple/Yellow/Green/Blue)

00-5970-003-00 NexGen CR Micro Precoat Femoral Kit

Cat. No.	Description
00-5970-011-01	Fem Size A, Left (Purple/Str Yellow)
00-5970-011-02	Fem Size A, Right (Purple/Str Yellow)
00-5970-012-01	Fem Size B, Left (Purple/Str Yellow)
00-5970-012-02	Fem Size B, Right (Purple/Str Yellow)



POROUS

00-5972-001-00 NexGen CR Porous Femoral Kit

Cat. No.	Description
00-5972-013-01	Fem Size C, Left (Str Purple/Yellow/Green/Blue)
00-5972-013-02	Fem Size C, Right (Str Purple/Yellow/Green/Blue)
00-5972-014-01	Fem Size D, Left (Str Purple/Yellow/Green/Blue)
00-5972-014-02	Fem Size D, Right (Str Purple/Yellow/Green/Blue)
00-5972-015-01	Fem Size E, Left (Str Purple/Yellow/Green/Blue)
00-5972-015-02	Fem Size E, Right (Str Purple/Yellow/Green/Blue)
00-5972-016-01	Fem Size F, Left (Str Purple/Yellow/Green/Blue)
00-5972-016-02	Fem Size F, Right (Str Purple/Yellow/Green/Blue)
00-5972-017-01	Fem Size G, Left (Str Purple/Yellow/Green/Blue)
00-5972-017-02	Fem Size G, Right (Str Purple/Yellow/Green/Blue)

00-5972-002-00 NexGen CR Macro Porous Femoral Kit

Cat. No.	Description
00-5972-018-01	Fem Size H, Left (Str Purple/Yellow/Green/Blue)
00-5972-018-02	Fem Size H, Right (Str Purple/Yellow/Green/Blue)

00-5972-003-00 NexGen CR Micro Porous Femoral Kit

Cat. No.	Description
00-5972-011-01	Fem Size A, Left (Purple/Str Yellow)
00-5972-011-02	Fem Size A, Right (Purple/Str Yellow)
00-5972-012-01	Fem Size B, Left (Purple/Str Yellow)
00-5972-012-02	Fem Size B, Right (Purple/Str Yellow)

00-5972-003-99 NexGen HA/TCP CR Micro Porous Femoral Kit

Cat. No.	Description
65-5972-011-01	Fem Size A, Left (Purple/Str Yellow)
65-5972-011-02	Fem Size A, Right (Purple/Str Yellow)
65-5972-012-01	Fem Size B, Left (Purple/Str Yellow)
65-5972-012-02	Fem Size B, Right (Purple/Str Yellow)

00-5972-001-99 NexGen HA/TCP CR Porous Femoral Kit

Cat. No.	Description
65-5972-013-01	Fem Size C, Left (Str Purple/Yellow/Green/Blue)
65-5972-013-02	Fem Size C, Right (Str Purple/Yellow/Green/Blue)
65-5972-014-01	Fem Size D, Left (Str Purple/Yellow/Green/Blue)
65-5972-014-02	Fem Size D, Right (Str Purple/Yellow/Green/Blue)
65-5972-015-01	Fem Size E, Left (Str Purple/Yellow/Green/Blue)
65-5972-015-02	Fem Size E, Right (Str Purple/Yellow/Green/Blue)
65-5972-016-01	Fem Size F Left (Str Purple/Yellow/Green/Blue)
65-5972-016-02	Fem Size F, Right (Str Purple/Yellow/Green/Blue)
65-5972-017-01	Fem Size G Left (Str Purple/Yellow/Green/Blue)
65-5972-017-02	Fem Size G, Right (Str Purple/Yellow/Green/Blue)

NEXGEN CR-FLEX FEMORAL IMPLANTS



OPTION

00-5956-001-00 NexGen CR-Flex Option Implant Kit

Cat. No.	Description
00-5956-012-01	CR-Flex Option Fem Size B/L
00-5956-012-02	CR-Flex Option Fem Size B/R
00-5956-013-01	CR-Flex Option Fem Size C/L
00-5956-013-02	CR-Flex Option Fem Size C/R
00-5956-013-05	CR-Flex Option Fem Size -C/L
00-5956-013-06	CR-Flex Option Fem Size -C/R
00-5956-014-01	CR-Flex Option Fem Size D/L
00-5956-014-02	CR-Flex Option Fem Size D/R
00-5956-014-05	CR-Flex Option Fem Size -D/L
00-5956-014-06	CR-Flex Option Fem Size -D/R
00-5956-015-01	CR-Flex Option Fem Size E/L
00-5956-015-02	CR-Flex Option Fem Size E/R
00-5956-015-05	CR-Flex Option Fem Size -E/L
00-5956-015-06	CR-Flex Option Fem Size -E/R
00-5956-016-01	CR-Flex Option Fem Size F/L
00-5956-016-02	CR-Flex Option Fem Size F/R
00-5956-016-05	CR-Flex Option Fem Size -F/L
00-5956-016-06	CR-Flex Option Fem Size -F/R
00-5956-017-01	CR-Flex Option Fem Size G/L
00-5956-017-02	CR-Flex Option Fem Size G/R
00-5956-017-05	CR-Flex Option Fem Size -G/L
00-5956-017-06	CR-Flex Option Fem Size -G/R

- Indicates minus sizes

* CR-Flex Femorals can be used with Net-Shape Molded and Prolong articular surfaces.



PRECOAT

00-5950-001-00 NexGen CR-Flex Precoat Implant Kit

Cat. No.	Description
00-5950-012-01	CR-Flex Precoat Fem Size B/L
00-5950-012-02	CR-Flex Precoat Fem Size B/R
00-5950-013-01	CR-Flex Precoat Fem Size C/L
00-5950-013-02	CR-Flex Precoat Fem Size C/R
00-5950-013-05	CR-Flex Precoat Fem Size -C/L
00-5950-013-06	CR-Flex Precoat Fem Size -C/R
00-5950-014-01	CR-Flex Precoat Fem Size D/L
00-5950-014-02	CR-Flex Precoat Fem Size D/R
00-5950-014-05	CR-Flex Precoat Fem Size -D/L
00-5950-014-06	CR-Flex Precoat Fem Size -D/R
00-5950-015-01	CR-Flex Precoat Fem Size E/L
00-5950-015-02	CR-Flex Precoat Fem Size E/R
00-5950-015-05	CR-Flex Precoat Fem Size -E/L
00-5950-015-06	CR-Flex Precoat Fem Size -E/R
00-5950-016-01	CR-Flex Precoat Fem Size F/L
00-5950-016-02	CR-Flex Precoat Fem Size F/R
00-5950-016-05	CR-Flex Precoat Fem Size -F/L
00-5950-016-06	CR-Flex Precoat Fem Size -F/R
00-5950-017-01	CR-Flex Precoat Fem Size G/L
00-5950-017-02	CR-Flex Precoat Fem Size G/R
00-5950-017-05	CR-Flex Precoat Fem Size -G/L
00-5950-017-06	CR-Flex Precoat Fem Size -G/R

- Indicates minus sizes

* CR-Flex Femorals can be used with Net-Shape Molded and Prolong articular surfaces.

CONTINUED ON PAGE 36

NEXGEN CR-FLEX FEMORAL IMPLANTS (CONT.)



POROUS

00-5952-001-00 NexGen CR-Flex Porous Implant Kit

Cat. No.	Description
00-5952-012-01	CR-Flex Porous Fem Size B/L
00-5952-012-02	CR-Flex Porous Fem Size B/R
00-5952-013-01	CR-Flex Porous Fem Size C/L
00-5952-013-02	CR-Flex Porous Fem Size C/R
00-5952-013-05	CR-Flex Porous Fem Size -C/L
00-5952-013-06	CR-Flex Porous Fem Size -C/R
00-5952-014-01	CR-Flex Porous Fem Size D/L
00-5952-014-02	CR-Flex Porous Fem Size D/R
00-5952-014-05	CR-Flex Porous Fem Size -D/L
00-5952-014-06	CR-Flex Porous Fem Size -D/R
00-5952-015-01	CR-Flex Porous Fem Size E/L
00-5952-015-02	CR-Flex Porous Fem Size E/R
00-5952-015-05	CR-Flex Porous Fem Size -E/L
00-5952-015-06	CR-Flex Porous Fem Size -E/R
00-5952-016-01	CR-Flex Porous Fem Size F/L
00-5952-016-02	CR-Flex Porous Fem Size F/R
00-5952-016-05	CR-Flex Porous Fem Size -F/L
00-5952-016-06	CR-Flex Porous Fem Size -F/R
00-5952-017-01	CR-Flex Porous Fem Size G/L
00-5952-017-02	CR-Flex Porous Fem Size G/R
00-5952-017-05	CR-Flex Porous Fem Size -G/L
00-5952-017-06	CR-Flex Porous Fem Size -G/R

- Indicates minus sizes

* CR-Flex Femorals can be used with Net-Shape Molded and Prolong articular surfaces.

00-5952-001-99 NexGen HA/TCP CR-Flex Porous Femoral Kit

Cat. No.	Description
65-5952-012-01	CR-Flex HA/TCP Porous Fem Size B/L
65-5952-012-02	CR-Flex HA/TCP Porous Fem Size B/R
65-5952-013-01	CR-Flex HA/TCP Porous Fem Size C/L
65-5952-013-02	CR-Flex HA/TCP Porous Fem Size C/R
65-5952-013-05	CR-Flex HA/TCP Porous Fem Size -C/L
65-5952-013-06	CR-Flex HA/TCP Porous Fem Size -C/R
65-5952-014-01	CR-Flex HA/TCP Porous Fem Size D/L
65-5952-014-02	CR-Flex HA/TCP Porous Fem Size D/R
65-5952-014-05	CR-Flex HA/TCP Porous Fem Size -D/L
65-5952-014-06	CR-Flex HA/TCP Porous Fem Size -D/R
65-5952-015-01	CR-Flex HA/TCP Porous Fem Size E/L
65-5952-015-02	CR-Flex HA/TCP Porous Fem Size E/R
65-5952-015-05	CR-Flex HA/TCP Porous Fem Size -E/L
65-5952-015-06	CR-Flex HA/TCP Porous Fem Size -E/R
65-5952-016-01	CR-Flex HA/TCP Porous Fem Size F/L
65-5952-016-02	CR-Flex HA/TCP Porous Fem Size F/R
65-5952-016-05	CR-Flex HA/TCP Porous Fem Size -F/L
65-5952-016-06	CR-Flex HA/TCP Porous Fem Size -F/R
65-5952-017-01	CR-Flex HA/TCP Porous Fem Size G/L
65-5952-017-02	CR-Flex HA/TCP Porous Fem Size G/R
65-5952-017-05	CR-Flex HA/TCP Porous Fem Size -G/L
65-5952-017-06	CR-Flex HA/TCP Porous Fem Size -G/R

- Indicates minus sizes

* CR-Flex Femorals can be used with Net-Shape Molded and Prolong articular surfaces.

NEXGEN DISTAL FEMORAL SPACERS



SPACER

00-5950-007-00 NexGen Distal Femoral Spacer Implant Kit

Cat. No.	Description
00-5950-010-22	2mm NexGen Distal Femoral Spacer
00-5950-010-24	4mm NexGen Distal Femoral Spacer

00-5951-007-00 NexGen Distal Femoral Spacer Provisional Kit

Cat. No.	Description
00-5951-010-22	2mm NexGen Distal Femoral Spacer Provisional
00-5951-010-24	4mm NexGen Distal Femoral Spacer Provisional

NEXGEN LPS FEMORAL IMPLANTS



OPTION

Note: LPS Femoral components can be used with LPS, LPS-Flex Fixed or LPS-Flex Mobile Articular Surfaces.

00-5996-001-50 NexGen LPS Option Femoral Kit

Cat. No.	Description
00-5996-013-51	Fem Size C/Std, Left (Str Purple/Yellow/Str Green C,D)
00-5996-013-52	Fem Size C/Std, Right (Str Purple/Yellow/Str Green C,D)
00-5996-014-51	Fem Size D/Std, Left (Str Purple/Yellow/Str Green C,D)
00-5996-014-52	Fem Size D/Std, Right (Str Purple/Yellow/Str Green C,D)
00-5996-015-51	Fem Size E/Std, Left (Str Yellow E,F/Green/Str Blue)
00-5996-015-52	Fem Size E/Std, Right (Str Yellow E,F/Green/Str Blue)
00-5996-016-51	Fem Size F/Std, Left (Str Yellow E,F/Green/Str Blue)
00-5996-016-52	Fem Size F/Std, Right (Str Yellow E,F/Green/Str Blue)
00-5996-017-51	Fem Size G/Std, Left (Str Green/Blue)
00-5996-017-52	Fem Size G/Std, Right (Str Green/Blue)

00-5996-003-00 NexGen LPS Micro Option Femoral Kit

(Note: Use standard size patellas)

Cat. No.	Description
00-5996-011-01	Fem Size A/Micro, Left (Purple/Str Yellow A,B)
00-5996-011-02	Fem Size A/Micro, Right (Purple/Str Yellow A,B)
00-5996-012-01	Fem Size B/Micro, Left (Purple/Str Yellow A,B)
00-5996-012-02	Fem Size B/Micro, Right (Purple/Str Yellow A,B)

00-5996-002-50 NexGen LPS Macro Option Femoral Kit

Cat. No.	Description
00-5996-018-51	Fem Size H/Macro, Left (Blue)
00-5996-018-52	Fem Size H/Macro, Right (Blue)

Note: 51/52 suffixed femoral components are compatible with LPS-Flex Prolong as well as LPS, LPS-Flex Fixed or Mobile Articular Surfaces.

CONTINUED ON PAGE 40

NEXGEN LPS FEMORAL IMPLANTS (CONT.)



PRECOAT

00-5990-001-00 NexGen LPS Precoat Femoral Kit

Cat. No.	Description
00-5990-012-01	Fem Size B/Micro, Left (Purple/Str Yellow A,B)
00-5990-012-02	Fem Size B/Micro, Right (Purple/Str Yellow A,B)
00-5990-013-01	Fem Size C/Std, Left (Str Purple/Yellow/Str Green C,D)
00-5990-013-02	Fem Size C/Std, Right (Str Purple/Yellow/Str Green C,D)
00-5990-014-01	Fem Size D/Std, Left (Str Purple/Yellow/Str Green C,D)
00-5990-014-02	Fem Size D/Std, Right (Str Purple/Yellow/Str Green C,D)
00-5990-015-01	Fem Size E/Std, Left (Str Yellow E,F/Green/Str Blue)
00-5990-015-02	Fem Size E/Std, Right (Str Yellow E,F/Green/Str Blue)
00-5990-016-01	Fem Size F/Std, Left (Str Yellow E,F/Green/Str Blue)
00-5990-016-02	Fem Size F/Std, Right (Str Yellow E,F/Green/Str Blue)
00-5990-017-01	Fem Size G/Std, Left (Blue)
00-5990-017-02	Fem Size G/Std, Right (Blue)
00-5990-017-91	Fem Size H, Left (Str Green/Blue)
00-5990-017-92	Fem Size H, Right (Str Green/Blue)



POROUS

00-5992-001-00 NexGen LPS Porous Femoral Kit

Cat. No.	Description
00-5992-012-01	Fem Size B/Micro, Left (Purple/Str Yellow A,B)
00-5992-012-02	Fem Size B/Micro, Right (Purple/Str Yellow A,B)
00-5992-013-01	Fem Size C/Std, Left (Str Purple/Yellow/Str Green C,D)
00-5992-013-02	Fem Size C/Std, Right (Str Purple/Yellow/Str Green C,D)
00-5992-014-01	Fem Size D/Std, Left (Str Purple/Yellow/Str Green C,D)
00-5992-014-02	Fem Size D/Std, Right (Str Purple/Yellow/Str Green C,D)
00-5992-015-01	Fem Size E/Std, Left (Str Yellow E,F/Green/Str Blue)
00-5992-015-02	Fem Size E/Std, Right (Str Yellow E,F/Green/Str Blue)
00-5992-016-01	Fem Size F/Std, Left (Str Yellow E,F/Green/Str Blue)
00-5992-016-02	Fem Size F/Std, Right (Str Yellow E,F/Green/Str Blue)
00-5992-017-01	Fem Size G/Std, Left (Blue)
00-5992-017-02	Fem Size G/Std, Right (Blue)
00-5992-017-91	Fem Size G, Left (Blue)
00-5992-017-92	Fem Size G, Right (Blue)

NEXGEN LPS-FLEX FEMORAL IMPLANTS



OPTION

Note: LPS-Flex Femoral components can be used with LPS-Flex Fixed, LPS-Flex Prolong or LPS-Flex Mobile Articular Surfaces outside of the U.S.

00-5964-001-50 NexGen LPS-Flex Option Femoral Kit

Cat. No.	Description
00-5964-012-01	Fem Size B, Left
00-5964-012-02	Fem Size B, Right
00-5964-013-51	Fem Size C, Left
00-5964-013-52	Fem Size C, Right
00-5964-014-51	Fem Size D, Left
00-5964-014-52	Fem Size D, Right
00-5964-015-51	Fem Size E, Left
00-5964-015-52	Fem Size E, Right
00-5964-016-51	Fem Size F, Left
00-5964-016-52	Fem Size F, Right
00-5964-017-51	Fem Size G, Left
00-5964-017-52	Fem Size G, Right

00-5960-001-50 NexGen LPS-Flex Precoat Femoral Kit

Cat. No.	Description
00-5960-012-51	Fem Size B, Left
00-5960-012-52	Fem Size B, Right
00-5960-013-51	Fem Size C, Left
00-5960-013-52	Fem Size C, Right
00-5960-014-51	Fem Size D, Left
00-5960-014-52	Fem Size D, Right
00-5960-015-51	Fem Size E, Left
00-5960-015-52	Fem Size E, Right
00-5960-016-51	Fem Size F, Left
00-5960-016-52	Fem Size F, Right
00-5960-017-51	Fem Size G, Left
00-5960-017-52	Fem Size G, Right

NEXGEN CRA FEMORAL IMPLANTS



PRECOAT

Stem extensions are required when using CRA Femorals. CRA accepts femoral augments and all CR Articular Surfaces.

00-5976-001-00 NexGen CRA Precoat Femoral Kit

Cat. No.	Description
00-5976-012-01	Fem Size B, Left (Purple/Str Yellow)
00-5976-012-02	Fem Size B, Right (Purple/Str Yellow)
00-5976-013-01	Fem Size C, Left (Str Purple/Yellow/Green/Blue)
00-5976-013-02	Fem Size C, Right (Str Purple/Yellow/Green/Blue)
00-5976-014-01	Fem Size D, Left (Str Purple/Yellow/Green/Blue)
00-5976-014-02	Fem Size D, Right (Str Purple/Yellow/Green/Blue)
00-5976-015-01	Fem Size E, Left (Str Purple/Yellow/Green/Blue)
00-5976-015-02	Fem Size E, Right (Str Purple/Yellow/Green/Blue)
00-5976-016-01	Fem Size F, Left (Str Purple/Yellow/Green/Blue)
00-5976-016-02	Fem Size F, Right (Str Purple/Yellow/Green/Blue)
00-5976-017-01	Fem Size G, Left (Str Purple/Yellow/Green/Blue)
00-5976-017-02	Fem Size G, Right (Str Purple/Yellow/Green/Blue)

Note: Replacement CRA and LCCK Femoral Set Locking Screw 00-5988-090-00, 00-5987-071-00 Femoral Set Screwdriver required.

NEXGEN LCKK FEMORAL IMPLANTS



OPTION

Stem extensions are required when using LCKK Femorals.
LCKK accepts femoral augments.
LCKK Femoral Components can only be used with LCKK or LPS, LPS-Flex Fixed and LPS-Flex Mobile Articular Surfaces.

00-5994-001-00 NexGen LCKK Option Femoral Kit

Cat. No.	Description
00-5994-013-01	Fem Size C, Left (Yellow/Str Green, C, D)
00-5994-013-02	Fem Size C, Right (Yellow/Str Green, C, D)
00-5994-013-91	Fem Size C, Left (Yellow/Str Green, C, D)
00-5994-013-92	Fem Size C, Right (Yellow/Str Green, C, D)
00-5994-014-01	Fem Size D, Left (Yellow/Str Green, C, D)
00-5994-014-02	Fem Size D, Right (Yellow/Str Green, C, D)
00-5994-014-91	Fem Size D, Left (Yellow/Str Green, C, D)
00-5994-014-92	Fem Size D, Right (Yellow/Str Green, C, D)
00-5994-015-01	Fem Size E, Left (Green/Str Blue)
00-5994-015-02	Fem Size E, Right (Green/Str Blue)
00-5994-015-91	Fem Size E, Left (Green/Str Blue)
00-5994-015-92	Fem Size E, Right (Green/Str Blue)
00-5994-016-01	Fem Size F, Left (Green/Str Blue)
00-5994-016-02	Fem Size F, Right (Green/Str Blue)
00-5994-016-91	Fem Size F, Left (Green/Str Blue)
00-5994-016-92	Fem Size F, Right (Green/Str Blue)
00-5994-017-01	Fem Size G, Left (Blue)
00-5994-017-02	Fem Size G, Right (Blue)
00-5994-017-91	Fem Size G, Left (Blue)
00-5994-017-92	Fem Size G, Right (Blue)

Note: Replacement CRA and LCKK Femoral Set Screw
00-5988-090-00

NEXGEN ROTATING HINGE KNEE FEMORAL IMPLANTS



Rotating Hinge Knee Femoral Components are only used with Rotating Hinge Knee Tibial Base Plates and Rotating Hinge Knee Tibial Articular Surfaces.

00-5880-001-01 NexGen Rotating Hinge Knee Femoral Kit

Cat. No.	Description
00-5880-013-01	Fem Size C, Left
00-5880-013-02	Fem Size C, Right
00-5880-014-01	Fem Size D, Left
00-5880-014-02	Fem Size D, Right
00-5880-015-01	Fem Size E, Left
00-5880-015-02	Fem Size E, Right
00-5880-016-01	Fem Size F, Left
00-5880-016-02	Fem Size F, Right

Packaged with hinge mechanism assembled.

ZIMMER UNICOMPARTMENTAL HIGH FLEX FEMORAL IMPLANTS



00-5842-001-00 Zimmer Unicompartmental Precoat Femoral Kit

Cat. No.	Description
00-5842-011-01	Fem Size A, Left Medial / Right Lateral
00-5842-011-02	Fem Size A, Right Medial / Left Lateral
00-5842-012-01	Fem Size B, Left Medial / Right Lateral
00-5842-012-02	Fem Size B, Right Medial / Left Lateral
00-5842-013-01	Fem Size C, Left Medial / Right Lateral
00-5842-013-02	Fem Size C, Right Medial / Left Lateral
00-5842-014-01	Fem Size D, Left Medial / Right Lateral
00-5842-014-02	Fem Size D, Right Medial / Left Lateral
00-5842-015-01	Fem Size E, Left Medial / Right Lateral
00-5842-015-02	Fem Size E, Right Medial / Left Lateral
00-5842-016-01	Fem Size F, Left Medial / Right Lateral
00-5842-016-02	Fem Size F, Right Medial / Left Lateral
00-5842-017-01	Fem Size G, Left Medial / Right Lateral
00-5842-017-02	Fem Size G, Right Medial / Left Lateral

M/G UNICOMPARTMENTAL FEMORAL IMPLANTS



PRECOAT

00-5790-001-00 M/G Unicompartmental Precoat Femoral Kit

Cat. No.	Description
00-5790-020-00	Small Left Medial/Right Lateral
00-5790-021-00	Small Right Medial/Left Lateral
00-5790-022-00	Small Plus Left Medial/Right Lateral
00-5790-023-00	Small Plus Right Medial/Left Lateral
00-5790-024-00	Regular Left Medial/Right Lateral
00-5790-025-00	Regular Right Medial/Left Lateral
00-5790-026-00	Regular Plus Left Medial/Right Lateral
00-5790-027-00	Regular Plus Right Medial/Left Lateral
00-5790-028-00	Large Left Medial/Right Lateral
00-5790-029-00	Large Right Medial/Left Lateral
00-5790-030-00	Large Plus Left Medial/Right Lateral
00-5790-031-00	Large Plus Right Medial/Left Lateral
00-5790-032-00	Large Plus Plus Left Medial/Right Lateral
00-5790-033-00	Large Plus Plus Right Medial/Left Lateral

MG II FEMORAL IMPLANTS



00-5112-XXX-XX MG II Precoat Femoral Kit

Cat. No.	Description
00-5112-011-01	Fem Size 1, Left
00-5112-011-02	Fem Size 1, Right
00-5112-012-01	Fem Size 2, Left
00-5112-012-02	Fem Size 2, Right
00-5112-013-01	Fem Size 3, Left
00-5112-013-02	Fem Size 3, Right
00-5112-014-01	Fem Size 4, Left
00-5112-014-02	Fem Size 4, Right
00-5112-015-01	Fem Size 5, Left
00-5112-015-02	Fem Size 5, Right
00-5112-016-01	Fem Size 6, Left
00-5112-016-02	Fem Size 6, Right
00-5112-017-01	Fem Size 7, Left
00-5112-017-02	Fem Size 7, Right
00-5112-018-01	Fem Size 8, Left
00-5112-018-02	Fem Size 8, Right

MBK FEMORAL COMPONENTS



MBK FEMORAL

00-5940-001-00 MBK CR/CS Option Femoral Kit

Cat. No.	Description
00-5940-013-01	Fem Size C, Left
00-5940-013-02	Fem Size C, Right
00-5940-014-01	Fem Size D, Left
00-5940-014-02	Fem Size D, Right
00-5940-015-01	Fem Size E, Left
00-5940-015-02	Fem Size E, Right
00-5940-016-01	Fem Size F, Left
00-5940-016-02	Fem Size F, Right
00-5940-017-01	Fem Size G, Left
00-5940-017-02	Fem Size G, Right

00-5940-003-00 MBK CR/CS Micro Option Femoral Kit

Cat. No.	Description
00-5940-012-01	Femoral Size B, Left
00-5940-012-02	Femoral Size B, Right

00-5944-008-00 MBK CR/CS Porous Femoral Kit

Cat. No.	Description
00-5944-013-01	Fem Size C, Left
00-5944-013-02	Fem Size C, Right
00-5944-014-01	Fem Size D, Left
00-5944-014-02	Fem Size D, Right
00-5944-015-01	Fem Size E, Left
00-5944-015-02	Fem Size E, Right
00-5944-016-01	Fem Size F, Left
00-5944-016-02	Fem Size F, Right
00-5944-017-01	Fem Size G, Left
00-5944-017-02	Fem Size G, Right

NEXGEN CR/CR-FLEX/CRA ARTICULAR SURFACES (Net-Shape Molded)



REGULAR CONSTRAINT

90-5970-007-00 NexGen CR/CR-Flex/CRA Articular Surface Kit

Cat. No.	Description
90-5970-030-09*	Articular Surf, Yellow, 9mm (Fem C-H - Tib 3,4)
90-5970-030-10	Articular Surf, Yellow, 10mm (Fem C-H - Tib 3,4)
90-5970-030-12	Articular Surf, Yellow, 12mm (Fem C-H - Tib 3,4)
90-5970-030-14	Articular Surf, Yellow, 14mm (Fem C-H - Tib 3,4)
90-5970-030-17*	Articular Surf, Yellow, 17mm (Fem C-H - Tib 3,4)
90-5970-030-20*	Articular Surf, Yellow, 20mm (Fem C-H - Tib 3,4)
90-5970-040-09*	Articular Surf, Green, 9mm (Fem C-H - Tib 5,6)
90-5970-040-10	Articular Surf, Green, 10mm (Fem C-H - Tib 5,6)
90-5970-040-12	Articular Surf, Green, 12mm (Fem C-H - Tib 5,6)
90-5970-040-14	Articular Surf, Green, 14mm (Fem C-H - Tib 5,6)
90-5970-040-17*	Articular Surf, Green, 17mm (Fem C-H - Tib 5,6)
90-5970-040-20*	Articular Surf, Green, 20mm (Fem C-H - Tib 5,6)
90-5970-050-09*	Articular Surf, Blue, 9mm (Fem C-H - Tib 7-10)
90-5970-050-10	Articular Surf, Blue, 10mm (Fem C-H - Tib 7-10)
90-5970-050-12	Articular Surf, Blue, 12mm (Fem C-H - Tib 7-10)
90-5970-050-14	Articular Surf, Blue, 14mm (Fem C-H - Tib 7-10)
90-5970-050-17*	Articular Surf, Blue, 17mm (Fem C-H - Tib 7-10)
90-5970-050-20*	Articular Surf, Blue, 20mm (Fem C-H - Tib 7-10)

*9mm Articular Surface not included in U.S. kits

• 17mm and 20mm Articular Surfaces include a required locking screw to be used with the Taper Plug or NexGen Stem Extension and can only be used with stemmed tibial components that can include a stem extension.

90-5970-008-00 NexGen CR/CR-Flex/CRA Micro Articular Surface Kit

Cat. No.	Description
90-5970-020-09*	Articular Surf, Purple, 9mm (Fem A,B - Tib 1,2)
90-5970-020-10	Articular Surf, Purple, 10mm (Fem A,B - Tib 1,2)
90-5970-020-12	Articular Surf, Purple, 12mm (Fem A,B - Tib 1,2)
90-5970-020-14	Articular Surf, Purple, 14mm (Fem A,B - Tib 1,2)
90-5970-020-17*	Articular Surf, Purple, 17mm (Fem A,B - Tib 1,2)
90-5970-020-20*	Articular Surf, Purple, 20mm (Fem A,B - Tib 1,2)
90-5970-021-09*	Articular Surf, Str Purple, 9mm (Fem C-H - Tib 1,2)
90-5970-021-10	Articular Surf, Str Purple, 10mm (Fem C-H - Tib 1,2)
90-5970-021-12	Articular Surf, Str Purple, 12mm (Fem C-H - Tib 1,2)
90-5970-021-14	Articular Surf, Str Purple, 14mm (Fem C-H - Tib 1,2)
90-5970-021-17*	Articular Surf, Str Purple, 17mm (Fem C-H - Tib 1,2)
90-5970-021-20*	Articular Surf, Str Purple, 20mm (Fem C-H - Tib 1,2)
90-5970-031-09*	Articular Surf, Str Yellow, 9mm (Fem A,B - Tib 3,4)
90-5970-031-10	Articular Surf, Str Yellow, 10mm (Fem A,B - Tib 3,4)
90-5970-031-12	Articular Surf, Str Yellow, 12mm (Fem A,B - Tib 3,4)
90-5970-031-14	Articular Surf, Str Yellow, 14mm (Fem A,B - Tib 3,4)
90-5970-031-17*	Articular Surf, Str Yellow, 17mm (Fem A,B - Tib 3,4)
90-5970-031-20*	Articular Surf, Str Yellow, 20mm (Fem A,B - Tib 3,4)

Not Included in Kit (sold seperately)

Cat. No.	Description
90-5970-041-10	Articular Surf, Str Green, 10mm (Fem A,B - Tib 5,6)
90-5970-041-12	Articular Surf, Str Green, 12mm (Fem A,B - Tib 5,6)
90-5970-041-14	Articular Surf, Str Green, 14mm (Fem A,B - Tib 5,6)
90-5970-041-17*	Articular Surf, Str Green, 17mm (Fem A,B - Tib 5,6)
90-5970-041-20*	Articular Surf, Str Green, 20mm (Fem A,B - Tib 5,6)

*9mm Articular Surface not included in U.S. kits

• 17mm and 20mm Articular Surfaces include a required locking screw to be used with the Taper Plug or NexGen Stem Extension and can only be used with stemmed tibial components that can include a stem extension.

PROLONG CR/CR-FLEX HIGHLY CROSSLINKED POLYETHYLENE



PROLONG

00-5952-007-00 Prolong CR/CR-Flex Articular Surface Kit

Cat. No.	Description
00-5952-030-10	Articular Surf 3, 4/Yellow 10 mm (Fem C-H – Tib 3, 4)
00-5952-030-12	Articular Surf 3, 4/Yellow 12 mm (Fem C-H – Tib 3, 4)
00-5952-030-14	Articular Surf 3, 4/Yellow 14 mm (Fem C-H – Tib 3, 4)
90-5952-007-17*	Articular Surf 3, 4/Yellow 17 mm (Fem C-H – Tib 3, 4)
90-5952-007-20*	Articular Surf 3, 4/Yellow 20 mm (Fem C-H – Tib 3, 4)
00-5952-040-10	Articular Surf 5, 6/Green 10 mm (Fem C-H – Tib 5, 6)
00-5952-040-12	Articular Surf 5, 6/Green 12 mm (Fem C-H – Tib 5, 6)
00-5952-040-14	Articular Surf 5, 6/Green 14 mm (Fem C-H – Tib 5, 6)
90-5952-007-17*	Articular Surf 5, 6/Green 17 mm (Fem C-H – Tib 5, 6)
90-5952-007-20*	Articular Surf 5, 6/Green 20 mm (Fem C-H – Tib 5, 6)
00-5952-050-10	Articular Surf 7-10/Blue 10 mm (Fem C-H – Tib 7-10)
00-5952-050-12	Articular Surf 7-10/Blue 12 mm (Fem C-H – Tib 7-10)
00-5952-050-14	Articular Surf 7-10/Blue 14 mm (Fem C-H – Tib 7-10)
90-5952-007-17*	Articular Surf 7-10/Blue 17 mm (Fem C-H – Tib 7-10)
90-5952-007-20*	Articular Surf 7-10/Blue 20 mm (Fem C-H – Tib 7-10)

00-5952-008-00 Prolong Micro CR/CR-Flex Articular Surface Kit

Cat. No.	Description
00-5952-020-10	Articular Surf 1, 2/Purple 10 mm (Fem A,B – Tib 1,2)
00-5952-020-12	Articular Surf 1, 2/Purple 12 mm (Fem A,B – Tib 1,2)
00-5952-020-14	Articular Surf 1, 2/Purple 14 mm (Fem A,B – Tib 1,2)
90-5952-008-17*	Articular Surf 1, 2/Purple 17 mm (Fem A,B – Tib 1,2)
90-5952-008-20*	Articular Surf 1, 2/Purple 20 mm (Fem A,B – Tib 1,2)
00-5952-021-10	Articular Surf 1, 2/Str-Purple 10 mm (Fem C-H – Tib 1, 2)
00-5952-021-12	Articular Surf 1, 2/Str-Purple 12 mm (Fem C-H – Tib 1, 2)
00-5952-021-14	Articular Surf 1, 2/Str-Purple 14 mm (Fem C-H – Tib 1, 2)
90-5952-008-17*	Articular Surf 1, 2/Str-Purple 17mm (Fem C-H – Tib 1, 2)
90-5952-008-20*	Articular Surf 1, 2/Str-Purple 20 mm (Fem C-H – Tib 1, 2)
00-5952-031-10	Articular Surf 3, 4/Stripe-Yellow 10 mm (Fem A,B – Tib 3, 4)
00-5952-031-12	Articular Surf 3, 4/Stripe-Yellow 12 mm (Fem A,B – Tib 3, 4)
00-5952-031-14	Articular Surf 3, 4/Stripe-Yellow 14 mm (Fem A,B – Tib 3, 4)
90-5952-008-17*	Articular Surf 3, 4/Stripe-Yellow 17 mm (Fem A,B – Tib 3, 4)
90-5952-008-20*	Articular Surf 3, 4/Stripe-Yellow 20 mm (Fem A,B – Tib 3, 4)
00-5952-041-10	Articular Surf 1, 2/Stripe-Green 10 mm (Fem A,B – Tib 5, 6)
00-5952-041-12	Articular Surf 1, 2/Stripe-Green 12 mm (Fem A,B – Tib 5, 6)
00-5952-041-14	Articular Surf 1, 2/Stripe-Green 14 mm (Fem A,B – Tib 5, 6)
90-5952-008-17*	Articular Surf 3, 4/Stripe-Green 17 mm (Fem A,B – Tib 7,10)
90-5952-008-20*	Articular Surf 3, 4/Stripe-Green 20 mm (Fem A,B – Tib 7,10)

• 17mm and 20mm Articular Surfaces include a required locking screw to be used with the Taper Plug or NexGen Stem Extension and can only be used with stemmed tibial components that can include a stem extension.

• Optional- not included in kits- order separately.

NEXGEN CR/CRA ARTICULAR SURFACES[®]



ANTERIOR CONSTRAINED (AC)



ANATOMICALLY-ROTATED (AR)

00-5976-007-00 NexGen CR/CRA (AC) Articular Surface Kit

Cat. No.	Description
00-5976-030-10	Articular Surf, Yellow, 10mm (Fem C-H - Tib 3,4)
00-5976-030-12	Articular Surf, Yellow, 12mm (Fem C-H - Tib 3,4)
00-5976-030-14	Articular Surf, Yellow, 14mm (Fem C-H - Tib 3,4)
00-5976-030-17	Articular Surf, Yellow, 17mm (Fem C-H - Tib 3,4)
00-5976-030-20	Articular Surf, Yellow, 20mm (Fem C-H - Tib 3,4)
00-5976-030-23	Articular Surf, Yellow, 23mm (Fem C-H - Tib 3,4)
00-5976-040-10	Articular Surf, Green, 10mm (Fem C-H - Tib 5,6)
00-5976-040-12	Articular Surf, Green, 12mm (Fem C-H - Tib 5,6)
00-5976-040-14	Articular Surf, Green, 14mm (Fem C-H - Tib 5,6)
00-5976-040-17	Articular Surf, Green, 17mm (Fem C-H - Tib 5,6)
00-5976-040-20	Articular Surf, Green, 20mm (Fem C-H - Tib 5,6)
00-5976-040-23	Articular Surf, Green, 23mm (Fem C-H - Tib 5,6)
00-5976-050-10	Articular Surf, Blue, 10mm (Fem C-H - Tib 7-10)
00-5976-050-12	Articular Surf, Blue, 12mm (Fem C-H - Tib 7-10)
00-5976-050-14	Articular Surf, Blue, 14mm (Fem C-H - Tib 7-10)
00-5976-050-17	Articular Surf, Blue, 17mm (Fem C-H - Tib 7-10)
00-5976-050-20	Articular Surf, Blue, 20mm (Fem C-H - Tib 7-10)
00-5976-050-23	Articular Surf, Blue, 23mm (Fem C-H - Tib 7-10)

*Machined from molded bar stock.

00-5976-008-00 NexGen CR/CRA Micro (AC) Articular Surface Kit

Cat. No.	Description
00-5976-020-10	Articular Surf, Purple, 10mm (Fem A,B - Tib 1,2)
00-5976-020-12	Articular Surf, Purple, 12mm (Fem A,B - Tib 1,2)
00-5976-020-14	Articular Surf, Purple, 14mm (Fem A,B - Tib 1,2)
00-5976-020-17	Articular Surf, Purple, 17mm (Fem A,B - Tib 1,2)
00-5976-020-20	Articular Surf, Purple, 20mm (Fem A,B - Tib 1,2)
00-5976-020-23	Articular Surf, Purple, 23mm (Fem A,B - Tib 1,2)
00-5976-021-10	Articular Surf, Str Purple, 10mm (Fem C-H - Tib 1,2)
00-5976-021-12	Articular Surf, Str Purple, 12mm (Fem C-H - Tib 1,2)
00-5976-021-14	Articular Surf, Str Purple, 14mm (Fem C-H - Tib 1,2)
00-5976-021-17	Articular Surf, Str Purple, 17mm (Fem C-H - Tib 1,2)
00-5976-021-20	Articular Surf, Str Purple, 20mm (Fem C-H - Tib 1,2)
00-5976-021-23	Articular Surf, Str Purple, 23mm (Fem C-H - Tib 1,2)
00-5976-031-10	Articular Surf, Str Yellow, 10mm (Fem A,B - Tib 3,4)
00-5976-031-12	Articular Surf, Str Yellow, 12mm (Fem A,B - Tib 3,4)
00-5976-031-14	Articular Surf, Str Yellow, 14mm (Fem A,B - Tib 3,4)
00-5976-031-17	Articular Surf, Str Yellow, 17mm (Fem A,B - Tib 3,4)
00-5976-031-20	Articular Surf, Str Yellow, 20mm (Fem A,B - Tib 3,4)
00-5976-031-23	Articular Surf, Str Yellow, 23mm (Fem A,B - Tib 3,4)

00-5973-038-00 NexGen CR/CRA (AR) Articular Surface Kit

Cat. No.	Description
00-5973-038-10	Articular Surf, Yellow, Right, 10mm (Fem C-H - Tib 3,4)
00-5973-039-10	Articular Surf, Yellow, Left, 10mm (Fem C-H - Tib 3,4)
00-5973-038-12	Articular Surf, Yellow, Right, 12mm (Fem C-H - Tib 3,4)
00-5973-039-12	Articular Surf, Yellow, Left, 12mm (Fem C-H - Tib 3,4)
00-5973-038-14	Articular Surf, Yellow, Right, 14mm (Fem C-H - Tib 3,4)
00-5973-039-14	Articular Surf, Yellow, Left, 14mm (Fem C-H - Tib 3,4)
00-5973-048-10	Articular Surf, Green, Right, 10mm (Fem C-H - Tib 5,6)
00-5973-049-10	Articular Surf, Green, Left, 10mm (Fem C-H - Tib 5,6)
00-5973-048-12	Articular Surf, Green, Right, 12mm (Fem C-H - Tib 5,6)
00-5973-049-12	Articular Surf, Green, Left, 12mm (Fem C-H - Tib 5,6)
00-5973-048-14	Articular Surf, Green, Right, 14mm (Fem C-H - Tib 5,6)
00-5973-049-14	Articular Surf, Green, Left, 14mm (Fem C-H - Tib 5,6)
00-5973-058-10	Articular Surf, Blue, Right, 10mm (Fem C-H - Tib 7-10)
00-5973-059-10	Articular Surf, Blue, Left, 10mm (Fem C-H - Tib 7-10)
00-5973-058-12	Articular Surf, Blue, Right, 12mm (Fem C-H - Tib 7-10)
00-5973-059-12	Articular Surf, Blue, Left, 12mm (Fem C-H - Tib 7-10)
00-5973-058-14	Articular Surf, Blue, Right, 14mm (Fem C-H - Tib 7-10)
00-5973-059-14	Articular Surf, Blue, Left, 14mm (Fem C-H - Tib 7-10)

CR/CRA ARTICULAR SURFACES**



REGULAR CONSTRAINT

00-5972-007-00 NexGen CR/CRA Articular Surface Kit

Cat. No.	Description
00-5972-030-09	Articular Surf, Yellow, 9mm (Fem C-H - Tib 3,4)
00-5972-030-10	Articular Surf, Yellow, 10mm (Fem C-H - Tib 3,4)
00-5972-030-12	Articular Surf, Yellow, 12mm (Fem C-H - Tib 3,4)
00-5972-030-14	Articular Surf, Yellow, 14mm (Fem C-H - Tib 3,4)
00-5972-030-17	Articular Surf, Yellow, 17mm (Fem C-H - Tib 3,4)
00-5972-030-20	Articular Surf, Yellow, 20mm (Fem C-H - Tib 3,4)
00-5972-040-09	Articular Surf, Green, 09mm (Fem C-H - Tib 5,6)
00-5972-040-10	Articular Surf, Green, 10mm (Fem C-H - Tib 5,6)
00-5972-040-12	Articular Surf, Green, 12mm (Fem C-H - Tib 5,6)
00-5972-040-14	Articular Surf, Green, 14mm (Fem C-H - Tib 5,6)
00-5972-040-17	Articular Surf, Green, 17mm (Fem C-H - Tib 5,6)
00-5972-040-20	Articular Surf, Green, 20mm (Fem C-H - Tib 5,6)
00-5972-050-09	Articular Surf, Blue, 09mm (Fem C-H - Tib 7-10)
00-5972-050-10	Articular Surf, Blue, 10mm (Fem C-H - Tib 7-10)
00-5972-050-12	Articular Surf, Blue, 12mm (Fem C-H - Tib 7-10)
00-5972-050-14	Articular Surf, Blue, 14mm (Fem C-H - Tib 7-10)
00-5972-050-17	Articular Surf, Blue, 17mm (Fem C-H - Tib 7-10)
00-5972-050-20	Articular Surf, Blue, 20mm (Fem C-H - Tib 7-10)

**Machined from molded bar stock.

00-5972-008-00 NexGen CR/CRA Micro Articular Surface Kit

Cat. No.	Description
00-5972-020-09	Articular Surf, Purple, 9mm (Fem A,B - Tib 1,2)
00-5972-020-10	Articular Surf, Purple, 10mm (Fem A,B - Tib 1,2)
00-5972-020-12	Articular Surf, Purple, 12mm (Fem A,B - Tib 1,2)
00-5972-020-14	Articular Surf, Purple, 14mm (Fem A,B - Tib 1,2)
00-5972-020-17	Articular Surf, Purple, 17mm (Fem A,B - Tib 1,2)
00-5972-020-20	Articular Surf, Purple, 20mm (Fem A,B - Tib 1,2)
00-5972-021-09	Articular Surf, Str Purple, 09mm (Fem C-H - Tib 1,2)
00-5972-021-10	Articular Surf, Str Purple, 10mm (Fem C-H - Tib 1,2)
00-5972-021-12	Articular Surf, Str Purple, 12mm (Fem C-H - Tib 1,2)
00-5972-021-14	Articular Surf, Str Purple, 14mm (Fem C-H - Tib 1,2)
00-5972-021-17	Articular Surf, Str Purple, 17mm (Fem C-H - Tib 1,2)
00-5972-021-20	Articular Surf, Str Purple, 20mm (Fem C-H - Tib 1,2)
00-5972-031-09	Articular Surf, Str Yellow, 09mm (Fem A,B - Tib 3,4)
00-5972-031-10	Articular Surf, Str Yellow, 10mm (Fem A,B - Tib 3,4)
00-5972-031-12	Articular Surf, Str Yellow, 12mm (Fem A,B - Tib 3,4)
00-5972-031-14	Articular Surf, Str Yellow, 14mm (Fem A,B - Tib 3,4)
00-5972-031-17	Articular Surf, Str Yellow, 17mm (Fem A,B - Tib 3,4)
00-5972-031-20	Articular Surf, Str Yellow, 20mm (Fem A,B - Tib 3,4)

**Machined from molded bar stock.

NEXGEN LPS ARTICULAR SURFACES (Net-Shape Molded)



00-5996-007-00 NexGen LPS Articular Surface Kit

Cat. No.	Description
00-5996-030-09*	Articular Surf, Yellow, 9mm (Fem C,D - Tib 3,4)
00-5996-030-10	Articular Surf, Yellow, 10mm (Fem C,D - Tib 3,4)
00-5996-030-12	Articular Surf, Yellow, 12mm (Fem C,D - Tib 3,4)
00-5996-030-14	Articular Surf, Yellow, 14mm (Fem C,D - Tib 3,4)
00-5996-030-17	Articular Surf, Yellow, 17mm (Fem C,D - Tib 3,4)
00-5996-030-20	Articular Surf, Yellow, 20mm (Fem C,D - Tib 3,4)
00-5996-030-23	Articular Surf, Yellow, 23mm (Fem C,D - Tib 3,4)
00-5996-032-09*	Articular Surf, Str Yellow, 9mm (Fem E,F - Tib 3,4)
00-5996-032-10	Articular Surf, Str Yellow, 10mm (Fem E,F - Tib 3,4)
00-5996-032-12	Articular Surf, Str Yellow, 12mm (Fem E,F - Tib 3,4)
00-5996-032-14	Articular Surf, Str Yellow, 14mm (Fem E,F - Tib 3,4)
00-5996-032-17	Articular Surf, Str Yellow, 17mm (Fem E,F - Tib 3,4)
00-5996-032-20	Articular Surf, Str Yellow, 20mm (Fem E,F - Tib 3,4)
00-5996-032-23	Articular Surf, Str Yellow, 23mm (Fem E,F - Tib 3,4)
00-5996-040-09*	Articular Surf, Green, 9mm (Fem E,F - Tib 5,6)
00-5996-040-10	Articular Surf, Green, 10mm (Fem E,F - Tib 5,6)
00-5996-040-12	Articular Surf, Green, 12mm (Fem E,F - Tib 5,6)
00-5996-040-14	Articular Surf, Green, 14mm (Fem E,F - Tib 5,6)
00-5996-040-17	Articular Surf, Green, 17mm (Fem E,F - Tib 5,6)
00-5996-040-20	Articular Surf, Green, 20mm (Fem E,F - Tib 5,6)
00-5996-040-23	Articular Surf, Green, 23mm (Fem E,F - Tib 5,6)
00-5996-041-09*	Articular Surf, Str Green, 9mm (Fem C,D - Tib 5,6)
00-5996-041-10	Articular Surf, Str Green, 10mm (Fem C,D - Tib 5,6)
00-5996-041-12	Articular Surf, Str Green, 12mm (Fem C,D - Tib 5,6)
00-5996-041-14	Articular Surf, Str Green, 14mm (Fem C,D - Tib 5,6)
00-5996-041-17	Articular Surf, Str Green, 17mm (Fem C,D - Tib 5,6)
00-5996-041-20	Articular Surf, Str Green, 20mm (Fem C,D - Tib 5,6)
00-5996-041-23	Articular Surf, Str Green, 23mm (Fem C,D - Tib 5,6)
00-5996-042-10	Articular Surf, Str Green, 10mm (Fem G,H - Tib 5,6)
00-5996-042-12	Articular Surf, Str Green, 12mm (Fem G,H - Tib 5,6)
00-5996-042-14	Articular Surf, Str Green, 14mm (Fem G,H - Tib 5,6)
00-5996-042-17	Articular Surf, Str Green, 17mm (Fem G,H - Tib 5,6)
00-5996-042-20	Articular Surf, Str Green, 20mm (Fem G,H - Tib 5,6)
00-5996-042-23	Articular Surf, Str Green, 23mm (Fem G,H - Tib 5,6)

00-5996-007-00 NexGen LPS Articular Surface Kit (cont)

Cat. No.	Description
00-5996-050-09*	Articular Surf, Blue, 9mm (Fem G,H - Tib 7-10)
00-5996-050-10	Articular Surf, Blue, 10mm (Fem G,H - Tib 7-10)
00-5996-050-12	Articular Surf, Blue, 12mm (Fem G,H - Tib 7-10)
00-5996-050-14	Articular Surf, Blue, 14mm (Fem G,H - Tib 7-10)
00-5996-050-17	Articular Surf, Blue, 17mm (Fem G,H - Tib 7-10)
00-5996-050-20	Articular Surf, Blue, 20mm (Fem G,H - Tib 7-10)
00-5996-050-23	Articular Surf, Blue, 23mm (Fem G,H - Tib 7-10)
00-5996-051-09*	Articular Surf, Str Blue, 9mm (Fem E,F - Tib 7-10)
00-5996-051-10	Articular Surf, Str Blue, 10mm (Fem E,F - Tib 7-10)
00-5996-051-12	Articular Surf, Str Blue, 12mm (Fem E,F - Tib 7-10)
00-5996-051-14	Articular Surf, Str Blue, 14mm (Fem E,F - Tib 7-10)
00-5996-051-17	Articular Surf, Str Blue, 17mm (Fem E,F - Tib 7-10)
00-5996-051-20	Articular Surf, Str Blue, 20mm (Fem E,F - Tib 7-10)
00-5996-051-23	Articular Surf, Str Blue, 23mm (Fem E,F - Tib 7-10)

00-5996-008-00 NexGen LPS Micro Articular Surface Kit

Cat. No.	Description
00-5996-020-09*	Articular Surf, Purple, 9mm (Fem A,B - Tib 1,2)
00-5996-020-10	Articular Surf, Purple, 10mm (Fem A,B - Tib 1,2)
00-5996-020-12	Articular Surf, Purple, 12mm (Fem A,B - Tib 1,2)
00-5996-020-14	Articular Surf, Purple, 14mm (Fem A,B - Tib 1,2)
00-5996-020-17	Articular Surf, Purple, 17mm (Fem A,B - Tib 1,2)
00-5996-020-20	Articular Surf, Purple, 20mm (Fem A,B - Tib 1,2)
00-5996-020-23	Articular Surf, Purple, 23mm (Fem A,B - Tib 1,2)
00-5996-022-09*	Articular Surf, Str Purple, 9mm (Fem C,D - Tib 1,2)
00-5996-022-10	Articular Surf, Str Purple, 10mm (Fem C,D - Tib 1,2)
00-5996-022-12	Articular Surf, Str Purple, 12mm (Fem C,D - Tib 1,2)
00-5996-022-14	Articular Surf, Str Purple, 14mm (Fem C,D - Tib 1,2)
00-5996-022-17	Articular Surf, Str Purple, 17mm (Fem C,D - Tib 1,2)
00-5996-022-20	Articular Surf, Str Purple, 20mm (Fem C,D - Tib 1,2)
00-5996-022-23	Articular Surf, Str Purple, 23mm (Fem C,D - Tib 1,2)
00-5996-031-09*	Articular Surf, Str Yellow, 9mm (Fem A,B - Tib 3,4)
00-5996-031-10	Articular Surf, Str Yellow, 10mm (Fem A,B - Tib 3,4)
00-5996-031-12	Articular Surf, Str Yellow, 12mm (Fem A,B - Tib 3,4)
00-5996-031-14	Articular Surf, Str Yellow, 14mm (Fem A,B - Tib 3,4)
00-5996-031-17	Articular Surf, Str Yellow, 17mm (Fem A,B - Tib 3,4)
00-5996-031-20	Articular Surf, Str Yellow, 20mm (Fem A,B - Tib 3,4)
00-5996-031-23	Articular Surf, Str Yellow, 23mm (Fem A,B - Tib 3,4)

Warning: Do not interchange the LPS Articular Surfaces with the LPS-Flex femorals.

*Optional- not included in kits- order separately.

Size 9 (all Micro and Std sizes) are not available in the U.S.

NEXGEN LPS-FLEX FIXED ARTICULAR SURFACES (NET-SHAPE MOLDED)



LPS-FLEX FIXED

00-5964-007-00 NexGen LPS-Flex Fixed Bearing Articular Surface Kit

Cat. No.	Description
00-5964-020-09	Articular Surface AB 1-2, 9mm
00-5964-020-10	Articular Surface AB 1-2, 10mm
00-5964-020-12	Articular Surface AB 1-2, 12mm
00-5964-020-14	Articular Surface AB 1-2, 14mm
00-5964-020-17*	Articular Surface AB 1-2, 17mm
00-5964-020-20*	Articular Surface AB 1-2, 20mm
00-5964-020-23*	Articular Surface AB 1-2, 23mm
00-5964-022-09	Articular Surface CD 1-2, 9mm
00-5964-022-10	Articular Surface CD 1-2, 10mm
00-5964-022-12	Articular Surface CD 1-2, 12mm
00-5964-022-14	Articular Surface CD 1-2, 14mm
00-5964-022-17*	Articular Surface CD 1-2, 17mm
00-5964-022-20*	Articular Surface CD 1-2, 20mm
00-5964-022-23*	Articular Surface CD 1-2, 23mm
00-5964-031-09	Articular Surface AB 3-4, 9mm
00-5964-031-10	Articular Surface AB 3-4, 10mm
00-5964-031-12	Articular Surface AB 3-4, 12mm
00-5964-031-14	Articular Surface AB 3-4, 14mm
00-5964-031-17*	Articular Surface AB 3-4, 17mm
00-5964-031-20*	Articular Surface AB 3-4, 20mm
00-5964-031-23*	Articular Surface AB 3-4, 23mm
00-5964-030-09	Articular Surface CD 3-4, 9mm
00-5964-030-10	Articular Surface CD 3-4, 10mm
00-5964-030-12	Articular Surface CD 3-4, 12mm
00-5964-030-14	Articular Surface CD 3-4, 14mm
00-5964-030-17*	Articular Surface CD 3-4, 17mm
00-5964-030-20*	Articular Surface CD 3-4, 20mm
00-5964-030-23*	Articular Surface CD 3-4, 23mm
00-5964-032-09	Articular Surface EF 3-4, 9mm
00-5964-032-10	Articular Surface EF 3-4, 10mm
00-5964-032-12	Articular Surface EF 3-4, 12mm
00-5964-032-14	Articular Surface EF 3-4, 14mm

00-5964-007-00 NexGen LPS-Flex Fixed Bearing Articular Surface Kit (cont)

Cat. No.	Description
00-5964-032-17*	Articular Surface EF 3-4, 17mm
00-5964-032-20*	Articular Surface EF 3-4, 20mm
00-5964-032-23*	Articular Surface EF 3-4, 23mm
00-5964-041-09	Articular Surface CD 5-6, 9mm
00-5964-041-10	Articular Surface CD 5-6, 10mm
00-5964-041-12	Articular Surface CD 5-6, 12mm
00-5964-041-14	Articular Surface CD 5-6, 14mm
00-5964-041-17*	Articular Surface CD 5-6, 17mm
00-5964-041-20*	Articular Surface CD 5-6, 20mm
00-5964-041-23*	Articular Surface CD 5-6, 23mm
00-5964-040-09	Articular Surface EF 5-6, 9mm
00-5964-040-10	Articular Surface EF 5-6, 10mm
00-5964-040-12	Articular Surface EF 5-6, 12mm
00-5964-040-14	Articular Surface EF 5-6, 14mm
00-5964-040-17*	Articular Surface EF 5-6, 17mm
00-5964-040-20*	Articular Surface EF 5-6, 20mm
00-5964-040-23*	Articular Surface EF 5-6, 23mm
00-5964-042-09	Articular Surface GH 5-6, 9mm
00-5964-042-10	Articular Surface GH 5-6, 10mm
00-5964-042-12	Articular Surface GH 5-6, 12mm
00-5964-042-14	Articular Surface GH 5-6, 14mm
00-5964-042-17*	Articular Surface GH 5-6, 17mm
00-5964-042-20*	Articular Surface GH 5-6, 20mm
00-5964-042-23*	Articular Surface GH 5-6, 23mm
00-5964-051-09	Articular Surface EF 7-10, 9mm
00-5964-051-10	Articular Surface EF 7-10, 10mm
00-5964-051-12	Articular Surface EF 7-10, 12mm
00-5964-051-14	Articular Surface EF 7-10, 14mm
00-5964-051-17*	Articular Surface EF 7-10, 17mm
00-5964-051-20*	Articular Surface EF 7-10, 20mm
00-5964-051-23*	Articular Surface EF 7-10, 23mm
00-5964-050-09	Articular Surface GH 7-10, 09mm
00-5964-050-10	Articular Surface GH 7-10, 10mm
00-5964-050-12	Articular Surface GH 7-10, 12mm
00-5964-050-14	Articular Surface GH 7-10, 14mm
00-5964-050-17*	Articular Surface GH 7-10, 17mm
00-5964-050-20*	Articular Surface GH 7-10, 20mm
00-5964-050-23*	Articular Surface GH 7-10, 23mm

*Taper Plug 00-5960-099-00

*The 17mm, 20mm & 23mm Articulating Surfaces include a required locking screw to be used with the Taper Plug or NexGen Stem Extension, and can only be used with stemmed tibial components that can include a stem extension.

*Optional- not included in kits- order separately.

Size 9 (all Micro and Std sizes) are not available in the U.S.

NEXGEN LPS-FLEX PROLONG FIXED ARTICULAR SURFACES



LPS-FLEX PROLONG

00-5962-007-00 NexGen LPS-Flex Prolong Fixed Articular Surface Kit

Cat. No.	Description
00-5962-020-10	Articular Surface AB 1-2, 10mm
00-5962-020-12	Articular Surface AB 1-2, 12mm
00-5962-020-14	Articular Surface AB 1-2, 14mm
00-5962-020-17*	Articular Surface AB 1-2, 17mm
00-5962-020-20*	Articular Surface AB 1-2, 20mm
00-5962-020-23*	Articular Surface AB 1-2, 23mm
00-5962-022-10	Articular Surface CD 1-2, 10mm
00-5962-022-12	Articular Surface CD 1-2, 12mm
00-5962-022-14	Articular Surface CD 1-2, 14mm
00-5962-022-17*	Articular Surface CD 1-2, 17mm
00-5962-022-20*	Articular Surface CD 1-2, 20mm
00-5962-022-23*	Articular Surface CD 1-2, 23mm
00-5962-031-10	Articular Surface AB 3-4, 10mm
00-5962-031-12	Articular Surface AB 3-4, 12mm
00-5962-031-14	Articular Surface AB 3-4, 14mm
00-5962-031-17*	Articular Surface AB 3-4, 17mm
00-5962-031-20*	Articular Surface AB 3-4, 20mm
00-5962-031-23*	Articular Surface AB 3-4, 23mm
00-5962-030-10	Articular Surface CD 3-4, 10mm
00-5962-030-12	Articular Surface CD 3-4, 12mm
00-5962-030-14	Articular Surface CD 3-4, 14mm
00-5962-030-17*	Articular Surface CD 3-4, 17mm
00-5962-030-20*	Articular Surface CD 3-4, 20mm
00-5962-030-23*	Articular Surface CD 3-4, 23mm
00-5962-032-10	Articular Surface EF 3-4, 10mm
00-5962-032-12	Articular Surface EF 3-4, 12mm
00-5962-032-14	Articular Surface EF 3-4, 14mm
00-5962-032-17*	Articular Surface EF 3-4, 17mm
00-5962-032-20*	Articular Surface EF 3-4, 20mm
00-5962-032-23*	Articular Surface EF 3-4, 23mm

00-5962-007-00 NexGen LPS-Flex Fixed Bearing Articular Surface Kit (cont)

Cat. No.	Description
00-5962-041-10	Articular Surface CD 5-6, 10mm
00-5962-041-12	Articular Surface CD 5-6, 12mm
00-5962-041-14	Articular Surface CD 5-6, 14mm
00-5962-041-17*	Articular Surface CD 5-6, 17mm
00-5962-041-20*	Articular Surface CD 5-6, 20mm
00-5962-041-23*	Articular Surface CD 5-6, 23mm
00-5962-040-10	Articular Surface EF 5-6, 10mm
00-5962-040-12	Articular Surface EF 5-6, 12mm
00-5962-040-14	Articular Surface EF 5-6, 14mm
00-5962-040-17*	Articular Surface EF 5-6, 17mm
00-5962-040-20*	Articular Surface EF 5-6, 20mm
00-5962-040-23*	Articular Surface EF 5-6, 23mm
00-5962-042-10	Articular Surface GH 5-6, 10mm
00-5962-042-12	Articular Surface GH 5-6, 12mm
00-5962-042-14	Articular Surface GH 5-6, 14mm
00-5962-042-17*	Articular Surface GH 5-6, 17mm
00-5962-042-20*	Articular Surface GH 5-6, 20mm
00-5962-042-23*	Articular Surface GH 5-6, 23mm
00-5962-051-10	Articular Surface EF 7-10, 10mm
00-5962-051-12	Articular Surface EF 7-10, 12mm
00-5962-051-14	Articular Surface EF 7-10, 14mm
00-5962-051-17*	Articular Surface EF 7-10, 17mm
00-5962-051-20*	Articular Surface EF 7-10, 20mm
00-5962-051-23*	Articular Surface EF 7-10, 23mm
00-5962-050-10	Articular Surface GH 7-10, 10mm
00-5962-050-12	Articular Surface GH 7-10, 12mm
00-5962-050-14	Articular Surface GH 7-10, 14mm
00-5962-050-17*	Articular Surface GH 7-10, 17mm
00-5962-050-20*	Articular Surface GH 7-10, 20mm
00-5962-050-23*	Articular Surface GH 7-10, 23mm

*Taper Plug 00-5960-099-00

*The 17mm, 20mm & 23mm Articulating Surfaces include a required locking screw to be used with the Taper Plug or NexGen Stem Extension, and can only be used with stemmed tibial components that can include a stem extension.

*Optional- not included in kits- order separately.

*Metal clip for Flex Poly lock-down screw must always be inserted manually before implantation.

NEXGEN LCCK ARTICULAR SURFACES (Net-Shape Molded)



LCCK

00-5994-007-00 NexGen LCCK Articular Surface Kit

Cat. No.	Description
00-5994-022-10	Articular Surf, Str Purple, 10mm (Fem C,D - Tib 1,2)
00-5994-022-12	Articular Surf, Str Purple, 12mm (Fem C,D - Tib 1,2)
00-5994-022-14	Articular Surf, Str Purple, 14mm (Fem C,D - Tib 1,2)
00-5994-022-17	Articular Surf, Str Purple, 17mm (Fem C,D - Tib 1,2)
00-5994-022-20	Articular Surf, Str Purple, 20mm (Fem C,D - Tib 1,2)
00-5994-022-23	Articular Surf, Str Purple, 23mm (Fem C,D - Tib 1,2)
00-5994-030-10	Articular Surf, Yellow, 10mm (Fem C,D - Tib 3,4)
00-5994-030-12	Articular Surf, Yellow, 12mm (Fem C,D - Tib 3,4)
00-5994-030-14	Articular Surf, Yellow, 14mm (Fem C,D - Tib 3,4)
00-5994-030-17	Articular Surf, Yellow, 17mm (Fem C,D - Tib 3,4)
00-5994-030-20	Articular Surf, Yellow, 20mm (Fem C,D - Tib 3,4)
00-5994-030-23	Articular Surf, Yellow, 23mm (Fem C,D - Tib 3,4)
00-5994-032-10	Articular Surf, Str Yellow, 10mm (Fem E,F - Tib 3,4)
00-5994-032-12	Articular Surf, Str Yellow, 12mm (Fem E,F - Tib 3,4)
00-5994-032-14	Articular Surf, Str Yellow, 14mm (Fem E,F - Tib 3,4)
00-5994-032-17	Articular Surf, Str Yellow, 17mm (Fem E,F - Tib 3,4)
00-5994-032-20	Articular Surf, Str Yellow, 20mm (Fem E,F - Tib 3,4)
00-5994-032-23	Articular Surf, Str Yellow, 23mm (Fem E,F - Tib 3,4)
00-5994-041-10	Articular Surf, Str Green, 10mm (Fem C,D - Tib 5,6)
00-5994-041-12	Articular Surf, Str Green, 12mm (Fem C,D - Tib 5,6)
00-5994-041-14	Articular Surf, Str Green, 14mm (Fem C,D - Tib 5,6)
00-5994-041-17	Articular Surf, Str Green, 17mm (Fem C,D - Tib 5,6)
00-5994-041-20	Articular Surf, Str Green, 20mm (Fem C,D - Tib 5,6)
00-5994-041-23	Articular Surf, Str Green, 23mm (Fem C,D - Tib 5,6)

00-5994-007-00 NexGen LCCK Articular Surface Kit

Cat. No.	Description
00-5994-040-10	Articular Surf, Green, 10mm (Fem E,F - Tib 5,6)
00-5994-040-12	Articular Surf, Green, 12mm (Fem E,F - Tib 5,6)
00-5994-040-14	Articular Surf, Green, 14mm (Fem E,F - Tib 5,6)
00-5994-040-17	Articular Surf, Green, 17mm (Fem E,F - Tib 5,6)
00-5994-040-20	Articular Surf, Green, 20mm (Fem E,F - Tib 5,6)
00-5994-040-23	Articular Surf, Green, 23mm (Fem E,F - Tib 5,6)

00-5994-007-00 NexGen LCCK Articular Surface Kit (cont)

Cat. No.	Description
00-5994-042-10	Articular Surf, Str Green, 10mm (Fem G - Tib 5,6)
00-5994-042-12	Articular Surf, Str Green, 12mm (Fem G - Tib 5,6)
00-5994-042-14	Articular Surf, Str Green, 14mm (Fem G - Tib 5,6)
00-5994-042-17	Articular Surf, Str Green, 17mm (Fem G - Tib 5,6)
00-5994-042-20	Articular Surf, Str Green, 20mm (Fem G - Tib 5,6)
00-5994-042-23	Articular Surf, Str Green, 23mm (Fem G - Tib 5,6)
00-5994-051-10	Articular Surf, Str Blue, 10mm (Fem E,F - Tib 7-10)
00-5994-051-12	Articular Surf, Str Blue, 12mm (Fem E,F - Tib 7-10)
00-5994-051-14	Articular Surf, Str Blue, 14mm (Fem E,F - Tib 7-10)
00-5994-051-17	Articular Surf, Str Blue, 17mm (Fem E,F - Tib 7-10)
00-5994-051-20	Articular Surf, Str Blue, 20mm (Fem E,F - Tib 7-10)
00-5994-051-23	Articular Surf, Str Blue, 23mm (Fem E,F - Tib 7-10)
00-5994-050-10	Articular Surf, Blue, 10mm (Fem G - Tib 7-10)
00-5994-050-12	Articular Surf, Blue, 12mm (Fem G - Tib 7-10)
00-5994-050-14	Articular Surf, Blue, 14mm (Fem G - Tib 7-10)
00-5994-050-17	Articular Surf, Blue, 17mm (Fem G - Tib 7-10)
00-5994-050-20	Articular Surf, Blue, 20mm (Fem G - Tib 7-10)
00-5994-050-23	Articular Surf, Blue, 23mm (Fem G - Tib 7-10)

00-5994-007-01 NexGen LCCK Thick Articular Surface Kit

Cat. No.	Description
00-5994-022-28	Articular Surf, Str Purple, 28mm (Fem C,D - Tib 1,2)
00-5994-022-33	Articular Surf, Str Purple, 33mm (Fem C,D - Tib 1,2)
00-5994-030-28	Articular Surf, Yellow, 28mm (Fem C,D - Tib 3,4)
00-5994-030-33	Articular Surf, Yellow, 33mm (Fem C,D - Tib 3,4)
00-5994-032-28	Articular Surf, Str Yellow, 28mm (Fem E,F - Tib 3,4)
00-5994-032-33	Articular Surf, Str Yellow, 33mm (Fem E,F - Tib 3,4)
00-5994-041-28	Articular Surf, Str Green, 28mm (Fem C,D - Tib 5,6)
00-5994-041-33	Articular Surf, Str Green, 33mm (Fem C,D - Tib 5,6)
00-5994-040-28	Articular Surf, Green, 28mm (Fem E,F - Tib 5,6)
00-5994-040-33	Articular Surf, Green, 33mm (Fem E,F - Tib 5,6)
00-5994-042-28	Articular Surf, Str Green, 28mm (Fem G - Tib 5,6)
00-5994-042-33	Articular Surf, Str Green, 33mm (Fem G - Tib 5,6)
00-5994-051-28	Articular Surf, Str Blue, 28mm (Fem E,F - Tib 7-10)
00-5994-051-33	Articular Surf, Str Blue, 33mm (Fem E,F - Tib 7-10)
00-5994-050-28	Articular Surf, Blue, 28mm (Fem G - Tib 7-10)
00-5994-050-33	Articular Surf, Blue, 33mm (Fem G - Tib 7-10)

The LCCK Articulating Surfaces include a required locking screw, to be used with a NexGen Stem Extension.

LCCK components can only be used with Stemmed Tibial Components that include a Stem Extension.

NEXGEN ROTATING HINGE KNEE ARTICULAR SURFACES



Rotating Hinge Knee Articular Surfaces include a Hinge Post Extension in the package.

Rotating Hinge Knee Articular Surfaces are only used with Rotating Hinge Knee Femoral and Tibial Base Plate Components.

00-5880-007-01 NexGen Rotating Hinge Knee Articular Surface Kit

Cat. No.	Description
00-5880-030-12	Articular Surf, 12mm (Fem C - Tib 2-6)
00-5880-030-14	Articular Surf, 14mm (Fem C - Tib 2-6)
00-5880-030-17	Articular Surf, 17mm (Fem C - Tib 2-6)
00-5880-030-20	Articular Surf, 20mm (Fem C - Tib 2-6)
00-5880-030-23	Articular Surf, 23mm (Fem C - Tib 2-6)
00-5880-030-26	Articular Surf, 26mm (Fem C - Tib 2-6)
00-5880-040-12	Articular Surf, 12mm (Fem D - Tib 3-6)
00-5880-040-14	Articular Surf, 14mm (Fem D - Tib 3-6)
00-5880-040-17	Articular Surf, 17mm (Fem D - Tib 3-6)
00-5880-040-20	Articular Surf, 20mm (Fem D - Tib 3-6)
00-5880-040-23	Articular Surf, 23mm (Fem D - Tib 3-6)
00-5880-040-26	Articular Surf, 26mm (Fem D - Tib 3-6)
00-5880-050-12	Articular Surf, 12mm (Fem E - Tib 4-6)
00-5880-050-14	Articular Surf, 14mm (Fem E - Tib 4-6)
00-5880-050-17	Articular Surf, 17mm (Fem E - Tib 4-6)
00-5880-050-20	Articular Surf, 20mm (Fem E - Tib 4-6)
00-5880-050-23	Articular Surf, 23mm (Fem E - Tib 4-6)
00-5880-050-26	Articular Surf, 26mm (Fem E - Tib 4-6)
00-5880-060-12	Articular Surf, 12mm (Fem F - Tib 5-6)
00-5880-060-14	Articular Surf, 14mm (Fem F - Tib 5-6)
00-5880-060-17	Articular Surf, 17mm (Fem F - Tib 5-6)
00-5880-060-20	Articular Surf, 20mm (Fem F - Tib 5-6)
00-5880-060-23	Articular Surf, 23mm (Fem F - Tib 5-6)
00-5880-060-26	Articular Surf, 26mm (Fem F - Tib 5-6)

00-5880-008-01 NexGen Rotating Hinge Knee Micro Implant Kit

Cat. No.	Description
00-5880-012-01	Femoral Size B, Left
00-5880-012-02	Femoral Size B, Right
00-5880-020-12	Articular Surface, 12mm (Fem B - Tib 1-6)
00-5880-020-14	Articular Surface, 14mm (Fem B - Tib 1-6)
00-5880-020-17	Articular Surface, 17mm (Fem B - Tib 1-6)
00-5880-020-20	Articular Surface, 20mm (Fem B - Tib 1-6)
00-5880-020-23	Articular Surface, 23mm (Fem B - Tib 1-6)
00-5880-020-26	Articular Surface, 26mm (Fem B - Tib 1-6)
00-5880-001-02	Tibial Plate, Size 1, PMMA Precoat, Non Modular
00-5880-001-10	10mm Rotating Hinge Knee Full Block Tib. Aug, Size 1

NEXGEN LPS-FLEX MOBILE ARTICULAR SURFACES**



NEXGEN LPS-FLEX MOBILE

00-5946-008-00 NexGen LPS-Flex Mobile Articular Surface Kit

Cat. No.	Description
00-5946-020-09	Articular Surf, 9mm, (Fem A,B - Tib 1-3)
00-5946-020-10	Articular Surf, 10mm, (Fem A,B - Tib 1-3)
00-5946-020-12	Articular Surf, 12mm, (Fem A,B - Tib 1-3)
00-5946-020-14	Articular Surf, 14mm, (Fem A,B - Tib 1-3)
00-5946-020-17*	Articular Surf, 17mm, (Fem A,B - Tib 1-3)
00-5946-020-20*	Articular Surf, 20mm, (Fem A,B - Tib 1-3)
00-5946-030-09	Articular Surf, 9mm, (Fem C - Tib 1-3)
00-5946-030-10	Articular Surf, 10mm, (Fem C - Tib 2-4)
00-5946-030-12	Articular Surf, 12mm, (Fem C - Tib 2-4)
00-5946-030-14	Articular Surf, 14mm, (Fem C - Tib 2-4)
00-5946-030-17*	Articular Surf, 17mm, (Fem C - Tib 2-4)
00-5946-030-20*	Articular Surf, 20mm, (Fem C - Tib 2-4)
00-5946-040-09	Articular Surf, 9mm, (Fem D - Tib 3-5)
00-5946-040-10	Articular Surf, 10mm, (Fem D - Tib 3-5)
00-5946-040-12	Articular Surf, 12mm, (Fem D - Tib 3-5)
00-5946-040-14	Articular Surf, 14mm, (Fem D - Tib 3-5)
00-5946-040-17*	Articular Surf, 17mm, (Fem D - Tib 3-5)
00-5946-040-20*	Articular Surf, 20mm, (Fem D - Tib 3-5)
00-5946-050-09	Articular Surf, 9mm, (Fem E - Tib 4-6)
00-5946-050-10	Articular Surf, 10mm, (Fem E - Tib 4-6)
00-5946-050-12	Articular Surf, 12mm, (Fem E - Tib 4-6)
00-5946-050-14	Articular Surf, 14mm, (Fem E - Tib 4-6)
00-5946-050-17*	Articular Surf, 17mm, (Fem E - Tib 4-6)
00-5946-050-20*	Articular Surf, 20mm, (Fem E - Tib 4-6)

** Machined from molded bar stock.

* The 17mm and 20mm Articulating Surfaces include a required locking screw to be used with the Fluted Stem Mobile Tibial Plate.

00-5946-008-00 NexGen LPS-Flex Mobile Articular Surface Kit

Cat. No.	Description
00-5946-060-09	Articular Surf, 9mm, (Fem F - Tib 5-7)
00-5946-060-10	Articular Surf, 10mm, (Fem F - Tib 5-7)
00-5946-060-12	Articular Surf, 12mm, (Fem F - Tib 5-7)
00-5946-060-14	Articular Surf, 14mm, (Fem F - Tib 5-7)
00-5946-060-17*	Articular Surf, 17mm, (Fem F - Tib 5-7)
00-5946-060-20*	Articular Surf, 20mm, (Fem F - Tib 5-7)
00-5946-070-09	Articular Surf, 9mm, (Fem G - Tib 6-8)
00-5946-070-10	Articular Surf, 10mm, (Fem G - Tib 6-8)
00-5946-070-12	Articular Surf, 12mm, (Fem G - Tib 6-8)
00-5946-070-14	Articular Surf, 14mm, (Fem G - Tib 6-8)
00-5946-070-17*	Articular Surf, 17mm, (Fem G - Tib 6-8)
00-5946-070-20*	Articular Surf, 20mm, (Fem G - Tib 6-8)

** Machined from molded bar stock.

* The 17mm and 20mm Articulating Surfaces include a required locking screw to be used with the Fluted Stem Mobile Tibial Plate.

ZIMMER UNICOMPARTMENTAL HIGH FLEX ARTICULAR SURFACES



ZIMMER UNI

00-5842-007-00 Zimmer Uni High Flex Articular Surface Kit

Cat. No.	Description
00-5842-021-08	Articular Surf, Size 1, 8mm
00-5842-021-09	Articular Surf, Size 1, 9mm
00-5842-021-10	Articular Surf, Size 1, 10mm
00-5842-021-11	Articular Surf, Size 1, 11mm
00-5842-021-12	Articular Surf, Size 1, 12mm
00-5842-021-14	Articular Surf, Size 1, 14mm
00-5842-022-08	Articular Surf, Size 2, 8mm
00-5842-022-09	Articular Surf, Size 2, 9mm
00-5842-022-10	Articular Surf, Size 2, 10mm
00-5842-022-11	Articular Surf, Size 2, 11mm
00-5842-022-12	Articular Surf, Size 2, 12mm
00-5842-022-14	Articular Surf, Size 2, 14mm
00-5842-023-08	Articular Surf, Size 3, 8mm
00-5842-023-09	Articular Surf, Size 3, 9mm
00-5842-023-10	Articular Surf, Size 3, 10mm
00-5842-023-11	Articular Surf, Size 3, 11mm
00-5842-023-12	Articular Surf, Size 3, 12mm
00-5842-023-14	Articular Surf, Size 3, 14mm
00-5842-024-08	Articular Surf, Size 4, 8mm
00-5842-024-09	Articular Surf, Size 4, 9mm
00-5842-024-10	Articular Surf, Size 4, 10mm
00-5842-024-11	Articular Surf, Size 4, 11mm
00-5842-024-12	Articular Surf, Size 4, 12mm
00-5842-024-14	Articular Surf, Size 4, 14mm
00-5842-025-08	Articular Surf, Size 5, 8mm
00-5842-025-09	Articular Surf, Size 5, 9mm
00-5842-025-10	Articular Surf, Size 5, 10mm
00-5842-025-11	Articular Surf, Size 5, 11mm
00-5842-025-12	Articular Surf, Size 5, 12mm
00-5842-025-14	Articular Surf, Size 5, 14mm
00-5842-026-08	Articular Surf, Size 6, 8mm
00-5842-026-09	Articular Surf, Size 6, 9mm
00-5842-026-10	Articular Surf, Size 6, 10mm
00-5842-026-11	Articular Surf, Size 6, 11mm
00-5842-026-12	Articular Surf, Size 6, 12mm
00-5842-026-14	Articular Surf, Size 6, 14mm

M/G UNICOMPARTMENTAL ARTICULAR SURFACES



00-5790-007-00 M/G Unicompartamental Tibial Articular Surface Kit

Cat. No.	Description
00-5788-040-08	Series 1 – 8mm
00-5788-040-10	Series 1 – 10mm
00-5788-040-12	Series 1 – 12mm
00-5788-040-14	Series 1 – 14mm
00-5788-050-08	Series 2 – 8mm
00-5788-050-10	Series 2 – 10mm
00-5788-050-12	Series 2 – 12mm
00-5788-050-14	Series 2 – 14mm
00-5788-060-08	Series 3 – 8mm
00-5788-060-10	Series 3 – 10mm
00-5788-060-12	Series 3 – 12mm
00-5788-060-14	Series 3 – 14mm
00-5788-070-08	Series 4 – 8mm
00-5788-070-10	Series 4 – 10mm
00-5788-070-12	Series 4 – 12mm
00-5788-070-14	Series 4 – 14mm
00-5788-080-08	Series 5 – 8mm
00-5788-080-10	Series 5 – 10mm
00-5788-080-12	Series 5 – 12mm
00-5788-080-14	Series 5 – 14mm

MG II AP-LIP ARTICULAR SURFACES



MG II AP-LIP

00-5110-XXX-XX MG II AP-Lip Articular Surface Kit

Cat. No.	Description
00-5110-023-09	Articular Surf, Purple, 9mm, (Fem A,B)
00-5110-023-11	Articular Surf, Purple, 11mm, (Fem A,B)
00-5110-023-13	Articular Surf, Purple, 13mm, (Fem A,B)
00-5110-023-15	Articular Surf, Purple, 15mm, (Fem A,B)
00-5110-023-17	Articular Surf, Purple, 17mm, (Fem A,B)
00-5110-023-20	Articular Surf, Purple, 20mm, (Fem A,B)
00-5110-023-23	Articular Surf, Purple, 23mm, (Fem A,B)
00-5110-033-09	Articular Surf, Yellow, 9mm, (Fem C,D)
00-5110-033-11	Articular Surf, Yellow, 11mm, (Fem C,D)
00-5110-033-13	Articular Surf, Yellow, 13mm, (Fem C,D)
00-5110-033-15	Articular Surf, Yellow, 15mm, (Fem C,D)
00-5110-033-17	Articular Surf, Yellow, 17mm, (Fem C,D)
00-5110-033-20	Articular Surf, Yellow, 20mm, (Fem C,D)
00-5110-033-23	Articular Surf, Yellow, 23mm, (Fem C,D)
00-5110-043-09	Articular Surf, Green, 9mm, (Fem E,F)
00-5110-043-11	Articular Surf, Green, 11mm, (Fem E,F)
00-5110-043-13	Articular Surf, Green, 13mm, (Fem E,F)
00-5110-043-15	Articular Surf, Green, 15mm, (Fem E,F)
00-5110-043-17	Articular Surf, Green, 17mm, (Fem E,F)
00-5110-043-20	Articular Surf, Green, 20mm, (Fem E,F)
00-5110-043-23	Articular Surf, Green, 23mm, (Fem E,F)
00-5110-053-09	Articular Surf, Blue, 9mm, (Fem G,H,J,K)
00-5110-053-11	Articular Surf, Blue, 11mm, (Fem G,H,J,K)
00-5110-053-13	Articular Surf, Blue, 13mm, (Fem G,H,J,K)
00-5110-053-15	Articular Surf, Blue, 15mm, (Fem G,H,J,K)
00-5110-053-17	Articular Surf, Blue, 17mm, (Fem G,H,J,K)
00-5110-053-20	Articular Surf, Blue, 20mm, (Fem G,H,J,K)
00-5110-053-23	Articular Surf, Blue, 23mm, (Fem G,H,J,K)

MBK ARTICULAR SURFACES



00-5942-007-00 MBK CR/CS Articular Surface Kit

Cat. No.	Description
00-5942-031-09	Articular Surface, Size C, Left, 9mm
00-5942-031-10	Articular Surface, Size C, Left, 10mm
00-5942-031-12	Articular Surface, Size C, Left, 12mm
00-5942-031-14	Articular Surface, Size C, Left, 14mm
00-5942-031-17	Articular Surface, Size C, Left, 17mm
00-5942-031-20	Articular Surface, Size C, Left, 20mm
00-5942-032-09	Articular Surface, Size C, Right, 9mm
00-5942-032-10	Articular Surface, Size C, Right, 10mm
00-5942-032-12	Articular Surface, Size C, Right, 12mm
00-5942-032-14	Articular Surface, Size C, Right, 14mm
00-5942-032-17	Articular Surface, Size C, Right, 17mm
00-5942-032-20	Articular Surface, Size C, Right, 20mm
00-5942-041-09	Articular Surface, Size D, Left, 9mm
00-5942-041-10	Articular Surface, Size D, Left, 10mm
00-5942-041-12	Articular Surface, Size D, Left, 12mm
00-5942-041-14	Articular Surface, Size D, Left, 14mm
00-5942-041-17	Articular Surface, Size D, Left, 17mm
00-5942-041-20	Articular Surface, Size D, Left, 20mm
00-5942-042-09	Articular Surface, Size D, Right, 9mm
00-5942-042-10	Articular Surface, Size D, Right, 10mm
00-5942-042-12	Articular Surface, Size D, Right, 12mm
00-5942-042-14	Articular Surface, Size D, Right, 14mm
00-5942-042-17	Articular Surface, Size D, Right, 17mm
00-5942-042-20	Articular Surface, Size D, Right, 20mm
00-5942-051-09	Articular Surface, Size E, Left, 9mm
00-5942-051-10	Articular Surface, Size E, Left, 10mm
00-5942-051-12	Articular Surface, Size E, Left, 12mm
00-5942-051-14	Articular Surface, Size E, Left, 14mm
00-5942-051-17	Articular Surface, Size E, Left, 17mm
00-5942-051-20	Articular Surface, Size E, Left, 20mm
00-5942-052-09	Articular Surface, Size E, Right, 9mm
00-5942-052-10	Articular Surface, Size E, Right, 10mm
00-5942-052-12	Articular Surface, Size E, Right, 12mm
00-5942-052-14	Articular Surface, Size E, Right, 14mm
00-5942-052-17	Articular Surface, Size E, Right, 17mm
00-5942-052-20	Articular Surface, Size E, Right, 20mm

CONTINUED ON PAGE 74

MBK ARTICULAR SURFACES (CONT.)

00-5942-007-00 MBK CR/CS Articular Surface Kit (cont)

Cat. No.	Description
00-5942-061-09	Articular Surface, Size F, Left, 9mm
00-5942-061-10	Articular Surface, Size F, Left, 10mm
00-5942-061-12	Articular Surface, Size F, Left, 12mm
00-5942-061-14	Articular Surface, Size F, Left, 14mm
00-5942-061-17	Articular Surface, Size F, Left, 17mm
00-5942-061-20	Articular Surface, Size F, Left, 20mm
00-5942-062-09	Articular Surface, Size F, Right, 9mm
00-5942-062-10	Articular Surface, Size F, Right, 10mm
00-5942-062-12	Articular Surface, Size F, Right, 12mm
00-5942-062-14	Articular Surface, Size F, Right, 14mm
00-5942-062-17	Articular Surface, Size F, Right, 17mm
00-5942-062-20	Articular Surface, Size F, Right, 20mm
00-5942-071-09	Articular Surface, Size G, Left, 9mm
00-5942-071-10	Articular Surface, Size G, Left, 10mm
00-5942-071-12	Articular Surface, Size G, Left, 12mm
00-5942-071-14	Articular Surface, Size G, Left, 14mm
00-5942-071-17	Articular Surface, Size G, Left, 17mm
00-5942-071-20	Articular Surface, Size G, Left, 20mm
00-5942-072-09	Articular Surface, Size G, Right, 9mm
00-5942-072-10	Articular Surface, Size G, Right, 10mm
00-5942-072-12	Articular Surface, Size G, Right, 12mm
00-5942-072-14	Articular Surface, Size G, Right, 14mm
00-5942-072-17	Articular Surface, Size G, Right, 17mm
00-5942-072-20	Articular Surface, Size G, Right, 20mm

00-5942-008-00 MBK CR/CS Micro Articular Surface Kit

Cat. No.	Description
00-5942-021-09	Articular Surf, Size B, Left, 9mm
00-5942-021-10	Articular Surf, Size B, Left, 10mm
00-5942-021-12	Articular Surf, Size B, Left, 12mm
00-5942-021-14	Articular Surf, Size B, Left, 14mm
00-5942-021-17	Articular Surf, Size B, Left, 17mm
00-5942-022-09	Articular Surf, Size B, Right, 9mm
00-5942-022-10	Articular Surf, Size B, Right, 10mm
00-5942-022-12	Articular Surf, Size B, Right, 12mm
00-5942-022-14	Articular Surf, Size B, Right, 14mm
00-5942-022-17	Articular Surf, Size B, Right, 17mm

NEXGEN CR TRABECULAR METAL (TM) MONOBLOCK TIBIA



CR TM MONOBLOCK TIBIA

00-5886-004-00 NexGen CR TM Monoblock Tibial Kit

Cat. No.	Description
00-5886-043-10	Tibial, Yellow, Size 3 C/H, 10 mm
00-5886-043-12	Tibial, Yellow, Size 3 C/H, 12 mm
00-5886-043-14	Tibial, Yellow, Size 3 C/H, 14 mm
00-5886-043-17	Tibial, Yellow, Size 3 C/H, 17 mm
00-5886-044-10	Tibial, Yellow, Size 4 C/H, 10 mm
00-5886-044-12	Tibial, Yellow, Size 4 C/H, 12 mm
00-5886-044-14	Tibial, Yellow, Size 4 C/H, 14 mm
00-5886-044-17	Tibial, Yellow, Size 4 C/H, 17 mm
00-5886-045-10	Tibial, Green, Size 5 C/H, 10 mm
00-5886-045-12	Tibial, Green, Size 5 C/H, 12 mm
00-5886-045-14	Tibial, Green, Size 5 C/H, 14 mm
00-5886-045-17	Tibial, Green, Size 5 C/H, 17 mm
00-5886-046-10	Tibial, Green, Size 6 C/H, 10 mm
00-5886-046-12	Tibial, Green, Size 6 C/H, 12 mm
00-5886-046-14	Tibial, Green, Size 6 C/H, 14 mm
00-5886-046-17	Tibial, Green, Size 6 C/H, 17 mm
00-5886-047-10	Tibial, Blue, Size 7 C/H, 10 mm
00-5886-047-12	Tibial, Blue, Size 7 C/H, 12 mm
00-5886-047-14	Tibial, Blue, Size 7 C/H, 14 mm
00-5886-047-17	Tibial, Blue, Size 7 C/H, 17 mm
00-5886-048-10	Tibial, Blue, Size 8 C/H, 10 mm
00-5886-048-12	Tibial, Blue, Size 8 C/H, 12 mm
00-5886-048-14	Tibial, Blue, Size 8 C/H, 14 mm
00-5886-048-17	Tibial, Blue, Size 8 C/H, 17 mm

NEXGEN LPS TRABECULAR METAL (TM) MONOBLOCK TIBIA



LPS TM MONOBLOCK TIBIA
(Compatible with LPS-Flex Femorals)

00-5886-004-01 NexGen LPS TM Monoblock Tibial Kit

Cat. No.	Description
00-5886-053-10	Tibial, Yellow, Size 3 C/D, 10 mm
00-5886-053-12	Tibial, Yellow, Size 3 C/D, 12 mm
00-5886-053-14	Tibial, Yellow, Size 3 C/D, 14 mm
00-5886-053-17	Tibial, Yellow, Size 3 C/D, 17 mm
00-5886-054-10	Tibial, Yellow, Size 4 C/D, 10 mm
00-5886-054-12	Tibial, Yellow, Size 4 C/D, 12 mm
00-5886-054-14	Tibial, Yellow, Size 4 C/D, 14 mm
00-5886-054-17	Tibial, Yellow, Size 4 C/D, 17 mm
00-5886-063-10	Tibial, Str Yellow, Size 3 E/F, 10 mm
00-5886-063-12	Tibial, Str Yellow, Size 3 E/F, 12 mm
00-5886-063-14	Tibial, Str Yellow, Size 3 E/F, 14 mm
00-5886-063-17	Tibial, Str Yellow, Size 3 E/F, 17 mm
00-5886-064-10	Tibial, Str Yellow, Size 4 E/F, 10 mm
00-5886-064-12	Tibial, Str Yellow, Size 4 E/F, 12 mm
00-5886-064-14	Tibial, Str Yellow, Size 4 E/F, 14 mm
00-5886-064-17	Tibial, Str Yellow, Size 4 E/F, 17 mm
00-5886-055-10	Tibial, Green, Size 5 E/F, 10 mm
00-5886-055-12	Tibial, Green, Size 5 E/F, 12 mm
00-5886-055-14	Tibial, Green, Size 5 E/F, 14 mm
00-5886-055-17	Tibial, Green, Size 5 E/F, 17 mm
00-5886-056-10	Tibial, Green, Size 6 E/F, 10 mm
00-5886-056-12	Tibial, Green, Size 6 E/F, 12 mm
00-5886-056-14	Tibial, Green, Size 6 E/F, 14 mm
00-5886-056-17	Tibial, Green, Size 6 E/F, 17 mm
00-5886-057-10	Tibial, Blue, Size 7 G/H, 10 mm
00-5886-057-12	Tibial, Blue, Size 7 G/H, 12 mm
00-5886-057-14	Tibial, Blue, Size 7 G/H, 14 mm
00-5886-057-17	Tibial, Blue, Size 7 G/H, 17 mm

00-5886-004-01 NexGen LPS TM Monoblock Tibial Kit (cont.)

Cat. No.	Description
00-5886-058-10	Tibial, Blue, Size 8 G/H, 10 mm
00-5886-058-12	Tibial, Blue, Size 8 G/H, 12 mm
00-5886-058-14	Tibial, Blue, Size 8 G/H, 14 mm
00-5886-058-17	Tibial, Blue, Size 8 G/H, 17 mm
00-5886-065-10	Tibial, Str Green, Size 5 G/H, 10 mm
00-5886-065-12	Tibial, Str Green, Size 5 G/H, 12 mm
00-5886-065-14	Tibial, Str Green, Size 5 G/H, 14 mm
00-5886-065-17	Tibial, Str Green, Size 5 G/H, 17 mm
00-5886-066-10	Tibial, Str Green, Size 6 G/H, 10 mm
00-5886-066-12	Tibial, Str Green, Size 6 G/H, 12 mm
00-5886-066-14	Tibial, Str Green, Size 6 G/H, 14 mm
00-5886-066-17	Tibial, Str Green, Size 6 G/H, 17 mm
00-5886-067-10	Tibial, Str Blue, Size 7 E/F, 10 mm
00-5886-067-12	Tibial, Str Blue, Size 7 E/F, 12 mm
00-5886-067-14	Tibial, Str Blue, Size 7 E/F, 14 mm
00-5886-067-17	Tibial, Str Blue, Size 7 E/F, 17 mm
00-5886-068-10	Tibial, Str Blue, Size 8 E/F, 10 mm
00-5886-068-12	Tibial, Str Blue, Size 8 E/F, 12 mm
00-5886-068-14	Tibial, Str Blue, Size 8 E/F, 14 mm
00-5886-068-17	Tibial, Str Blue, Size 8 E/F, 17 mm
00-5886-075-10	Tibial, Str Green, Size 5 C/D, 10 mm
00-5886-075-12	Tibial, Str Green, Size 5 C/D, 12 mm
00-5886-075-14	Tibial, Str Green, Size 5 C/D, 14 mm
00-5886-075-17	Tibial, Str Green, Size 5 C/D, 17 mm
00-5886-076-10	Tibial, Str Green, Size 6 C/D, 10 mm
00-5886-076-12	Tibial, Str Green, Size 6 C/D, 12 mm
00-5886-076-14	Tibial, Str Green, Size 6 C/D, 14 mm
00-5886-076-17	Tibial, Str Green, Size 6 C/D, 17 mm

NEXGEN STEMMED TIBIAL PLATES



POROUS

Accepts Stem Extensions & 4 Bone Screws

00-5982-004-00 NexGen Porous Stemmed Tibial Plate Kit

Cat. No.	Description
00-5982-037-01	Tibial Plate, Size 3 (Yellow/Str Yellow)
00-5982-037-02	Tibial Plate, Size 4 (Yellow/Str Yellow)
00-5982-047-01	Tibial Plate, Size 5 (Green/Str Green)
00-5982-047-02	Tibial Plate, Size 6 (Green/Str Green)
00-5982-057-01	Tibial Plate, Size 7 (Blue/Str Blue)
00-5982-057-02	Tibial Plate, Size 8 (Blue/Str Blue)

00-5982-005-00 NexGen Macro Porous Stemmed Tibial Plate Kit

Cat. No.	Description
00-5982-057-03	Tibial Plate, Size 9 (Blue/Str Blue)
00-5982-057-04	Tibial Plate, Size 10 (Blue/Str Blue)

00-5982-006-00 NexGen Micro Porous Stemmed Tibial Plate Kit

Cat. No.	Description
00-5982-027-01	Tibial Plate, Size 1 (Purple/Str Purple)
00-5982-027-02	Tibial Plate, Size 2 (Purple/Str Purple)

00-5982-004-01 NexGen HA/TCP Porous Stemmed Tibial Plate Kit

Cat. No.	Description
65-5982-027-01	Tibial Plate, Size 1 (Purple/Str Purple)
65-5982-027-02	Tibial Plate, Size 2 (Purple/Str Purple)
65-5982-037-01	Tibial Plate, Size 3 (Yellow/Str Yellow)
65-5982-037-02	Tibial Plate, Size 4 (Yellow/Str Yellow)
65-5982-047-01	Tibial Plate, Size 5 (Green/Str Green)
65-5982-047-02	Tibial Plate, Size 6 (Green/Str Green)
65-5982-057-01	Tibial Plate, Size 7 (Blue/Str Blue)
65-5982-057-02	Tibial Plate, Size 8 (Blue/Str Blue)
65-5982-057-03	Tibial Plate, Size 9 (Blue/Str Blue)
65-5982-057-04	Tibial Plate, Size 10 (Blue/Str Blue)

Note: Replacement Stem Extension Locking Screw 00-5980-090-00



PRECOAT

Accepts Stem Extensions & Tibial Augments

00-5980-004-00 NexGen Precoat Stemmed Tibial Plate Kit

Cat. No.	Description
00-5980-037-01	Tibial Plate, Size 3 (Yellow/Str Yellow)
00-5980-037-02	Tibial Plate, Size 4 (Yellow/Str Yellow)
00-5980-047-01	Tibial Plate, Size 5 (Green/Str Green)
00-5980-047-02	Tibial Plate, Size 6 (Green/Str Green)
00-5980-057-01	Tibial Plate, Size 7 (Blue/Str Blue)
00-5980-057-02	Tibial Plate, Size 8 (Blue/Str Blue)

00-5980-006-00 NexGen Micro Precoat Stemmed Tibial Plate Kit

Cat. No.	Description
00-5980-027-01	Tibial Plate, Size 1 (Purple/Str Purple)
00-5980-027-02	Tibial Plate, Size 2 (Purple/Str Purple)

00-5980-005-00 NexGen Macro Precoat Stemmed Tibial Plate Kit

Cat. No.	Description
00-5980-057-03	Tibial Plate, Size 9 (Blue/Str Blue)
00-5980-057-04	Tibial Plate, Size 10 (Blue/Str Blue)

Note: Replacement Stem Extension Locking Screw 5980-90

CONTINUED ON PAGE 80

NEXGEN STEMMED TIBIAL PLATES (CONT.)



OPTION*

* Option Stemmed Tibial Components do not accommodate Stem Extensions or Taper Plugs, and are not to be used with the LCCK Articular Surfaces or 17mm and thicker Flex Articular Surfaces which require a lock-down screw.

00-5986-004-00 NexGen Option Stemmed Tibial Plate Kit

Cat. No.	Description
00-5986-037-01*	Tibial Plate, Size 3 (Yellow/Str Yellow)
00-5986-037-02*	Tibial Plate, Size 4 (Yellow/Str Yellow)
00-5986-047-01*	Tibial Plate, Size 5 (Green/Str Green)
00-5986-047-02*	Tibial Plate, Size 6 (Green/Str Green)
00-5986-057-01*	Tibial Plate, Size 7 (Blue/Str Blue)
00-5986-057-02*	Tibial Plate, Size 8 (Blue/Str Blue)



PRECOAT A/P WEDGE

Accepts Stem Extensions
& Tibial Augments

00-5988-001-00 NexGen Precoat A/P Wedge Stemmed Tibial Plate Kit

Cat. No.	Description
00-5988-003-00	Tibial Plate, Size 3 (Yellow/Str Yellow)
00-5988-004-00	Tibial Plate, Size 4 (Yellow/Str Yellow)
00-5988-005-00	Tibial Plate, Size 5 (Green/Str Green)
00-5988-006-00	Tibial Plate, Size 6 (Green/Str Green)
00-5988-007-00	Tibial Plate, Size 7 (Blue/Str Blue)
00-5988-008-00	Tibial Plate, Size 8 (Blue/Str Blue)

NEXGEN 3° AND 7° FLUTED TIBIAL PLATES



FLUTED 3° (OPTION)

Accepts Stem Extensions
& 3° Tibial Augments

00-5998-004-00 NexGen Legacy 3° Option Fluted Tibial Plate Kit

Cat. No.	Description
00-5998-028-01	3° Fluted Tibial Plate Sz. 1
00-5998-028-02	3° Fluted Tibial Plate Sz. 2
00-5998-038-01	3° Fluted Tibial Plate Sz. 3
00-5998-038-02	3° Fluted Tibial Plate Sz. 4
00-5998-048-01	3° Fluted Tibial Plate Sz. 5
00-5998-048-02	3° Fluted Tibial Plate Sz. 6
00-5998-058-01	3° Fluted Tibial Plate Sz. 7
00-5998-058-02	3° Fluted Tibial Plate Sz. 8

Note: Replacement Stem Extension Locking Screw 00-5980-090-00

CONTINUED ON PAGE 82

NEXGEN 3° AND 7° FLUTED TIBIAL PLATES (CONT.)



FLUTED 7° (OPTION)
Accepts Stem Extensions

00-5996-004-00 NexGen Fluted 7° Option Stem Tibial Plate Kit

Cat. No.	Description
00-5996-038-01	Fluted Tibial Plate, Size 3 (Yellow/Str Yellow)
00-5996-038-02	Fluted Tibial Plate, Size 4 (Yellow/Str Yellow)
00-5996-048-01	Fluted Tibial Plate, Size 5 (Green/Str Green)
00-5996-048-02	Fluted Tibial Plate, Size 6 (Green/Str Green)
00-5996-058-01	Fluted Tibial Plate, Size 7 (Blue/Str Blue)
00-5996-058-02	Fluted Tibial Plate, Size 8 (Blue/Str Blue)

00-5996-006-00 NexGen Micro Fluted 7° Option Stem Tibial Plate Kit

Cat. No.	Description
00-5996-028-01	Fluted Tibial Plate, Size 1 (Purple/Str Purple)
00-5996-028-02	Fluted Tibial Plate, Size 2 (Purple/Str Purple)

00-5996-005-00 NexGen Macro Fluted 7° Option Stem Tibial Plate Kit

Cat. No.	Description
00-5996-058-03	Fluted Tibial Plate, Size 9 (Blue/Str Blue)
00-5996-058-04	Fluted Tibial Plate, Size 10 (Blue/Str Blue)

Note: Replacement Stem Extension Locking Screw 00-5980-090-00

NEXGEN ROTATING HINGE KNEE TIBIAL BASE PLATES



Rotating Hinge Knee Tibial Base Plates are only used with Rotating Hinge Knee Femoral and Tibial Articular Surface Components.

00-5880-004-01 NexGen Rotating Hinge Knee Precoat Tibial Plate Kit

Cat. No.	Description
00-5880-002-00	Tibial Plate, Size 2
00-5880-002-02	Tibial Plate, Size 2, PMMA Precoat, Non Modular
00-5880-003-00	Tibial Plate, Size 3
00-5880-003-02	Tibial Plate, Size 3, PMMA Precoat, Non Modular
00-5880-004-00	Tibial Plate, Size 4
00-5880-005-00	Tibial Plate, Size 5
00-5880-006-00	Tibial Plate, Size 6

Packaged with a polyethelene bushing sleeve assembled.

NEXGEN CR PEGGED TIBIAL PLATES



CR POROUS*

00-5972-004-00 NexGen Porous Pegged Tibial Plate Kit

Cat. No.	Description
00-5972-035-01*	Tibial Plate, Size 3 (Yellow/Str Yellow)
00-5972-035-02*	Tibial Plate, Size 4 (Yellow/Str Yellow)
00-5972-045-01*	Tibial Plate, Size 5 (Green/Str Green)
00-5972-045-02*	Tibial Plate, Size 6 (Green/Str Green)
00-5972-055-01*	Tibial Plate, Size 7 (Blue/Str Blue)
00-5972-055-02*	Tibial Plate, Size 8 (Blue/Str Blue)

00-5972-006-00 NexGen Micro Porous Pegged Tibial Plate Kit

Cat. No.	Description
00-5972-025-01*	Tibial Plate, Size 1 (Purple/Str Purple)
00-5972-025-02*	Tibial Plate, Size 2 (Purple/Str Purple)

00-5972-005-00 NexGen Macro Porous Pegged Tibial Plate Kit

Cat. No.	Description
00-5972-055-03*	Tibial Plate, Size 9 (Blue/Str Blue)
00-5972-055-04*	Tibial Plate, Size 10 (Blue/Str Blue)

00-5972-004-01 NexGen HA/TCP Porous Pegged Tibial Plate Kit

Cat. No.	Description
65-5972-025-01*	Tibial Plate, Size 1 (Purple/Str Purple)
65-5972-025-02*	Tibial Plate, Size 2 (Purple/Str Purple)
65-5972-035-01*	Tibial Plate, Size 3 (Yellow/Str Yellow)
65-5972-035-02*	Tibial Plate, Size 4 (Yellow/Str Yellow)
65-5972-045-01*	Tibial Plate, Size 5 (Green/Str Green)
65-5972-045-02*	Tibial Plate, Size 6 (Green/Str Green)
65-5972-055-01*	Tibial Plate, Size 7 (Blue/Str Blue)
65-5972-055-02*	Tibial Plate, Size 8 (Blue/Str Blue)
65-5972-055-03*	Tibial Plate, Size 9 (Blue/Str Blue)
65-5972-055-04*	Tibial Plate, Size 10 (Blue/Str Blue)

* Pegged Tibial Plates are not recommended for use with LPS or LPS-Flex Components or 17mm and thicker CR-Flex Articular Surfaces which require a lock-down screw, and cannot be used with LCCK Components.



CR PRECOAT*

00-5970-004-00 NexGen Precoat Pegged Tibial Plate Kit

Cat. No.	Description
00-5970-035-01*	Tibial Plate, Size 3 (Yellow/Str Yellow)
00-5970-035-02*	Tibial Plate, Size 4 (Yellow/Str Yellow)
00-5970-045-01*	Tibial Plate, Size 5 (Green/Str Green)
00-5970-045-02*	Tibial Plate, Size 6 (Green/Str Green)
00-5970-055-01*	Tibial Plate, Size 7 (Blue/Str Blue)
00-5970-055-02*	Tibial Plate, Size 8 (Blue/Str Blue)

00-5970-006-00 NexGen Micro Precoat Pegged Tibial Plate Kit

Cat. No.	Description
00-5970-025-01*	Tibial Plate, Size 1 (Purple/Str Purple)
00-5970-025-02*	Tibial Plate, Size 2 (Purple/Str Purple)

00-5970-005-00 NexGen Macro Precoat Pegged Tibial Plate Kit

Cat. No.	Description
00-5970-055-03*	Tibial Plate, Size 9 (Blue/Str Blue)
00-5970-055-04*	Tibial Plate, Size 10 (Blue/Str Blue)

* Pegged Tibial Plates are not recommended for use with LPS or LPS-Flex Components or 17mm and thicker CR-Flex Articular Surfaces which require a lock-down screw, and cannot be used with LCCK Components.

NEXGEN MIS STEMMED TIBIAL PLATES



00-5950-003-00 *NexGen MIS Micro Precoat Stemmed Tibial Plate Kit*

Cat. No.	Description
00-5950-027-01	MIS Tibial Plate Precoat, Size 1
00-5950-027-02	MIS Tibial Plate Precoat, Size 2

00-5950-004-00 *NexGen MIS Precoat Stemmed Tibial Plate Kit*

Cat. No.	Description
00-5950-037-01	MIS Tibial Plate Precoat, Size 3
00-5950-037-02	MIS Tibial Plate Precoat, Size 4
00-5950-047-01	MIS Tibial Plate Precoat, Size 5
00-5950-047-02	MIS Tibial Plate Precoat, Size 6
00-5950-057-01	MIS Tibial Plate Precoat, Size 7
00-5950-057-02	MIS Tibial Plate Precoat, Size 8

00-5950-003-00 *NexGen MIS Macro Precoat Stemmed Tibial Plate Kit*

Cat. No.	Description
00-5950-057-03	MIS Tibial Plate Precoat, Size 9
00-5950-057-04	MIS Tibial Plate Precoat, Size 10



00-5950-004-00 *NexGen MIS Precoat Stemmed Tibial Plate Kit*

Cat. No.	Description
00-5950-067-00	MIS Drop Down Stem Plug
00-5950-067-45	MIS Drop Down Stem Extension, 45mm
00-5950-067-75	MIS Drop Down Stem Extension, 75mm
00-5950-090-00	MIS Flex Articular Surface Locking Screw

NEXGEN MIS MODULAR TIBIAL PLATES



00-5960-004-00 *NexGen MIS Modular Tibial Plate Implant Kit*

Cat. No.	Description
00-5960-037-01	MIS Modular Precoat Tibial Component, Size 3
00-5960-037-02	MIS Modular Precoat Tibial Component, Size 4
00-5960-047-01	MIS Modular Precoat Tibial Component, Size 5
00-5960-047-02	MIS Modular Precoat Tibial Component, Size 6
00-5960-057-01	MIS Modular Precoat Tibial Component, Size 7
00-5960-057-02	MIS Modular Precoat Tibial Component, Size 8
00-5960-037-00	Stemmmable Keel, Size 3-4
00-5960-037-10	Stemmmable Keel, Size 5-6
00-5960-047-10	Stemmmable Keel, Size 7-8
00-5960-057-10	Non-Stemmmable Keel, Size 3-4
00-5960-090-10	MIS Modular Articular Surface Locking Screw*

Optional Implants (Micro Size 2)

Cat. No.	Description
00-5960-027-02	MIS Modular Precoat Tibial Component, Size 2
00-5960-027-00	Stemmmable Keel, Size 1-2
00-5960-027-10	Non-Stemmmable Keel, Size 1-2

* For use with both Flex Articular Surfaces and LCCK Articular Surfaces.

NEXGEN CR ALL-POLY TIBIALS*



CR ALL-POLY*

00-5966-024-00 NexGen CR All-Poly Tibial Kit

Cat. No.	Description
00-5966-003-10	All-Poly Tibial, Yellow, Size 3, 10mm (Fem C-H)
00-5966-003-12	All-Poly Tibial, Yellow, Size 3, 12mm (Fem C-H)
00-5966-003-14	All-Poly Tibial, Yellow, Size 3, 14mm (Fem C-H)
00-5966-003-17	All-Poly Tibial, Yellow, Size 3, 17mm (Fem C-H)
00-5966-004-10	All-Poly Tibial, Yellow, Size 4, 10mm (Fem C-H)
00-5966-004-12	All-Poly Tibial, Yellow, Size 4, 12mm (Fem C-H)
00-5966-004-14	All-Poly Tibial, Yellow, Size 4, 14mm (Fem C-H)
00-5966-004-17	All-Poly Tibial, Yellow, Size 4, 17mm (Fem C-H)
00-5966-005-10	All-Poly Tibial, Green, Size 5, 10mm (Fem C-H)
00-5966-005-12	All-Poly Tibial, Green, Size 5, 12mm (Fem C-H)
00-5966-005-14	All-Poly Tibial, Green, Size 5, 14mm (Fem C-H)
00-5966-005-17	All-Poly Tibial, Green, Size 5, 17mm (Fem C-H)
00-5966-006-10	All-Poly Tibial, Green, Size 6, 10mm (Fem C-H)
00-5966-006-12	All-Poly Tibial, Green, Size 6, 12mm (Fem C-H)
00-5966-006-14	All-Poly Tibial, Green, Size 6, 14mm (Fem C-H)
00-5966-006-17	All-Poly Tibial, Green, Size 6, 17mm (Fem C-H)
00-5966-007-10	All-Poly Tibial, Blue, Size 7, 10mm (Fem C-H)
00-5966-007-12	All-Poly Tibial, Blue, Size 7, 12mm (Fem C-H)
00-5966-007-14	All-Poly Tibial, Blue, Size 7, 14mm (Fem C-H)
00-5966-007-17	All-Poly Tibial, Blue, Size 7, 17mm (Fem C-H)
00-5966-008-10	All-Poly Tibial, Blue, Size 8, 10mm (Fem C-H)
00-5966-008-12	All-Poly Tibial, Blue, Size 8, 12mm (Fem C-H)
00-5966-008-14	All-Poly Tibial, Blue, Size 8, 14mm (Fem C-H)
00-5966-008-17	All-Poly Tibial, Blue, Size 8, 17mm (Fem C-H)

*Not recommended for use with Flex Femorals.

*Machined from molded bar stock.

Cemented stem tibial hollow broaches are required for use with All-Poly Tibials.

NEXGEN LPS ALL-POLY TIBIALS*



LPS ALL-POLY*

00-5996-024-00 NexGen LPS All-Poly Tibial Kit

Cat. No.	Description
00-5996-003-10	All-Poly Tibial, Yellow, Size 3, 10mm (Fem C,D)
00-5996-003-12	All-Poly Tibial, Yellow, Size 3, 12mm (Fem C,D)
00-5996-003-14	All-Poly Tibial, Yellow, Size 3, 14mm (Fem C,D)
00-5996-003-17	All-Poly Tibial, Yellow, Size 3, 17mm (Fem C,D)
00-5996-004-10	All-Poly Tibial, Yellow, Size 4, 10mm (Fem C,D)
00-5996-004-12	All-Poly Tibial, Yellow, Size 4, 12mm (Fem C,D)
00-5996-004-14	All-Poly Tibial, Yellow, Size 4, 14mm (Fem C,D)
00-5996-004-17	All-Poly Tibial, Yellow, Size 4, 17mm (Fem C,D)
00-5996-005-10	All-Poly Tibial, Green, Size 5, 10mm (Fem E,F)
00-5996-005-12	All-Poly Tibial, Green, Size 5, 12mm (Fem E,F)
00-5996-005-14	All-Poly Tibial, Green, Size 5, 14mm (Fem E,F)
00-5996-005-17	All-Poly Tibial, Green, Size 5, 17mm (Fem E,F)
00-5996-015-10	All-Poly Tibial, Str Green, Size 5, 10mm (Fem C,D)
00-5996-015-12	All-Poly Tibial, Str Green, Size 5, 12mm (Fem C,D)
00-5996-015-14	All-Poly Tibial, Str Green, Size 5, 14mm (Fem C,D)
00-5996-015-17	All-Poly Tibial, Str Green, Size 5, 17mm (Fem C,D)
00-5996-006-10	All-Poly Tibial, Green, Size 6, 10mm (Fem E,F)
00-5996-006-12	All-Poly Tibial, Green, Size 6, 12mm (Fem E,F)
00-5996-006-14	All-Poly Tibial, Green, Size 6, 14mm (Fem E,F)
00-5996-006-17	All-Poly Tibial, Green, Size 6, 17mm (Fem E,F)

*Not recommended for use with Flex Femorals.

*Machined from molded bar stock.

Fluted Stem Tibial Instruments are required for LPS All-Poly Tibials.

CONTINUED ON PAGE 90

NEXGEN LPS ALL-POLY TIBIALS[®] (CONT.)

00-5996-024-00 NexGen LPS All-Poly Tibial Kit

Cat. No.	Description
00-5996-016-10	All-Poly Tibial, Str Green, Size 6, 10mm (Fem C,D)
00-5996-016-12	All-Poly Tibial, Str Green, Size 6, 12mm (Fem C,D)
00-5996-016-14	All-Poly Tibial, Str Green, Size 6, 14mm (Fem C,D)
00-5996-016-17	All-Poly Tibial, Str Green, Size 6, 17mm (Fem C,D)
00-5996-007-10	All-Poly Tibial, Blue, Size 7, 10mm (Fem G,H)
00-5996-007-12	All-Poly Tibial, Blue, Size 7, 12mm (Fem G,H)
00-5996-007-14	All-Poly Tibial, Blue, Size 7, 14mm (Fem G,H)
00-5996-007-17	All-Poly Tibial, Blue, Size 7, 17mm (Fem G,H)
00-5996-017-10	All-Poly Tibial, Str Blue, Size 7, 10mm (Fem E,F)
00-5996-017-12	All-Poly Tibial, Str Blue, Size 7, 12mm (Fem E,F)
00-5996-017-14	All-Poly Tibial, Str Blue, Size 7, 14mm (Fem E,F)
00-5996-017-17	All-Poly Tibial, Str Blue, Size 7, 17mm (Fem E,F)
00-5996-008-10	All-Poly Tibial, Blue, Size 8, 10mm (Fem G,H)
00-5996-008-12	All-Poly Tibial, Blue, Size 8, 12mm (Fem G,H)
00-5996-008-14	All-Poly Tibial, Blue, Size 8, 14mm (Fem G,H)
00-5996-008-17	All-Poly Tibial, Blue, Size 8, 17mm (Fem G,H)
00-5996-018-10	All-Poly Tibial, Str Blue, Size 8, 10mm (Fem E,F)
00-5996-018-12	All-Poly Tibial, Str Blue, Size 8, 12mm (Fem E,F)
00-5996-018-14	All-Poly Tibial, Str Blue, Size 8, 14mm (Fem E,F)
00-5996-018-17	All-Poly Tibial, Str Blue, Size 8, 17mm (Fem E,F)
00-5996-023-10	All-Poly Tibial, Str Yellow, Size 3, 10mm (Fem A,B)
00-5996-023-12	All-Poly Tibial, Str Yellow, Size 3, 12mm (Fem A,B)
00-5996-023-14	All-Poly Tibial, Str Yellow, Size 3, 14mm (Fem A,B)
00-5996-023-17	All-Poly Tibial, Str Yellow, Size 3, 17mm (Fem A,B)
00-5996-025-10	All-Poly Tibial, Str Green, Size 5, 10mm (Fem C,D)
00-5996-025-12	All-Poly Tibial, Str Green, Size 5, 12mm (Fem C,D)
00-5996-025-14	All-Poly Tibial, Str Green, Size 5, 14mm (Fem C,D)
00-5996-025-17	All-Poly Tibial, Str Green, Size 5, 17mm (Fem C,D)

*Not recommended for use with Flex Femorals.

*Machined from molded bar stock.

Fluted Stem Tibial Instruments are required for LPS All-Poly Tibials.

ZIMMER UNICOMPARTMENTAL HIGH FLEX ALL-POLY TIBIA



ZIMMER UNI

00-5842-008-00 Zimmer Uni All-Poly Tibia Implant Kit

Cat. No.	Description
00-5842-031-08	Zimmer Uni All-Poly Tibia, Size 1, Lt Med/Rt Lat
00-5842-031-10	Zimmer Uni All-Poly Tibia, Size 1, Lt Med/Rt Lat
00-5842-031-12	Zimmer Uni All-Poly Tibia, Size 1, Lt Med/Rt Lat
00-5842-031-14	Zimmer Uni All-Poly Tibia, Size 1, Lt Med/Rt Lat
00-5842-032-08	Zimmer Uni All-Poly Tibia, Size 1, Rt Med/Lt Lat
00-5842-032-10	Zimmer Uni All-Poly Tibia, Size 1, Rt Med/Lt Lat
00-5842-032-12	Zimmer Uni All-Poly Tibia, Size 1, Rt Med/Lt Lat
00-5842-032-14	Zimmer Uni All-Poly Tibia, Size 1, Rt Med/Lt Lat
00-5842-041-08	Zimmer Uni All-Poly Tibia, Size 2, Lt Med/Rt Lat
00-5842-041-10	Zimmer Uni All-Poly Tibia, Size 2, Lt Med/Rt Lat
00-5842-041-12	Zimmer Uni All-Poly Tibia, Size 2, Lt Med/Rt Lat
00-5842-041-14	Zimmer Uni All-Poly Tibia, Size 2, Lt Med/Rt Lat
00-5842-042-08	Zimmer Uni All-Poly Tibia, Size 2, Rt Med/Lt Lat
00-5842-042-10	Zimmer Uni All-Poly Tibia, Size 2, Rt Med/Lt Lat
00-5842-042-12	Zimmer Uni All-Poly Tibia, Size 2, Rt Med/Lt Lat
00-5842-042-14	Zimmer Uni All-Poly Tibia, Size 2, Rt Med/Lt Lat
00-5842-051-08	Zimmer Uni All-Poly Tibia, Size 3, Lt Med/Rt Lat
00-5842-051-10	Zimmer Uni All-Poly Tibia, Size 3, Lt Med/Rt Lat
00-5842-051-12	Zimmer Uni All-Poly Tibia, Size 3, Lt Med/Rt Lat
00-5842-051-14	Zimmer Uni All-Poly Tibia, Size 3, Lt Med/Rt Lat
00-5842-052-08	Zimmer Uni All-Poly Tibia, Size 3, Rt Med/Lt Lat
00-5842-052-10	Zimmer Uni All-Poly Tibia, Size 3, Rt Med/Lt Lat
00-5842-052-12	Zimmer Uni All-Poly Tibia, Size 3, Rt Med/Lt Lat
00-5842-052-14	Zimmer Uni All-Poly Tibia, Size 3, Rt Med/Lt Lat
00-5842-061-08	Zimmer Uni All-Poly Tibia, Size 4, Lt Med/Rt Lat
00-5842-061-10	Zimmer Uni All-Poly Tibia, Size 4, Lt Med/Rt Lat
00-5842-061-12	Zimmer Uni All-Poly Tibia, Size 4, Lt Med/Rt Lat
00-5842-061-14	Zimmer Uni All-Poly Tibia, Size 4, Lt Med/Rt Lat
00-5842-062-08	Zimmer Uni All-Poly Tibia, Size 4, Rt Med/Lt Lat
00-5842-062-10	Zimmer Uni All-Poly Tibia, Size 4, Rt Med/Lt Lat
00-5842-062-12	Zimmer Uni All-Poly Tibia, Size 4, Rt Med/Lt Lat
00-5842-062-14	Zimmer Uni All-Poly Tibia, Size 4, Rt Med/Lt Lat

CONTINUED ON PAGE 92

ZIMMER UNICOMPARTMENTAL HIGH FLEX ALL-POLY TIBIA (CONT.)

00-5842-008-00 Zimmer Uni All-Poly Tibia Implant Kit

Cat. No.	Description
00-5842-071-08	Zimmer Uni All-Poly Tibia, Size 5, Lt Med/Rt Lat
00-5842-071-10	Zimmer Uni All-Poly Tibia, Size 5, Lt Med/Rt Lat
00-5842-071-12	Zimmer Uni All-Poly Tibia, Size 5, Lt Med/Rt Lat
00-5842-071-14	Zimmer Uni All-Poly Tibia, Size 5, Lt Med/Rt Lat
00-5842-072-08	Zimmer Uni All-Poly Tibia, Size 5, Rt Med/Lt Lat
00-5842-072-10	Zimmer Uni All-Poly Tibia, Size 5, Rt Med/Lt Lat
00-5842-072-12	Zimmer Uni All-Poly Tibia, Size 5, Rt Med/Lt Lat
00-5842-072-14	Zimmer Uni All-Poly Tibia, Size 5, Rt Med/Lt Lat
00-5842-081-08	Zimmer Uni All-Poly Tibia, Size 6, Lt Med/Rt Lat
00-5842-081-10	Zimmer Uni All-Poly Tibia, Size 6, Lt Med/Rt Lat
00-5842-081-12	Zimmer Uni All-Poly Tibia, Size 6, Lt Med/Rt Lat
00-5842-081-14	Zimmer Uni All-Poly Tibia, Size 6, Lt Med/Rt Lat
00-5842-082-08	Zimmer Uni All-Poly Tibia, Size 6, Rt Med/Lt Lat
00-5842-082-10	Zimmer Uni All-Poly Tibia, Size 6, Rt Med/Lt Lat
00-5842-082-12	Zimmer Uni All-Poly Tibia, Size 6, Rt Med/Lt Lat
00-5842-082-14	Zimmer Uni All-Poly Tibia, Size 6, Rt Med/Lt Lat

M/G UNICOMPARTMENTAL ALL-POLY TIBIA



00-5790-005-00 M/G Unicompartmental All-Poly Tibial Components

Cat. No.	Description Series 1		
00-5790-040-08	Tibial Component	MRT/LLT	8mm
00-5790-040-10	Tibial Component	MRT/LLT	10mm
00-5790-040-12	Tibial Component	MRT/LLT	12mm
00-5790-040-14	Tibial Component	MRT/LLT	14mm
00-5790-041-08	Tibial Component	MLT/LRT	8mm
00-5790-041-10	Tibial Component	MLT/LRT	10mm
00-5790-041-12	Tibial Component	MLT/LRT	12mm
00-5790-041-14	Tibial Component	MLT/LRT	14mm

Cat. No.	Description Series 2		
00-5790-050-08	Tibial Component	MRT/LLT	8mm
00-5790-050-10	Tibial Component	MRT/LLT	10mm
00-5790-050-12	Tibial Component	MRT/LLT	12mm
00-5790-050-14	Tibial Component	MRT/LLT	14mm
00-5790-051-08	Tibial Component	MLT/LRT	8mm
00-5790-051-10	Tibial Component	MLT/LRT	10mm
00-5790-051-12	Tibial Component	MLT/LRT	12mm
00-5790-051-14	Tibial Component	MLT/LRT	14mm

Cat. No.	Description Series 3		
00-5790-060-08	Tibial Component	MRT/LLT	8mm
00-5790-060-10	Tibial Component	MRT/LLT	10mm
00-5790-060-12	Tibial Component	MRT/LLT	12mm
00-5790-060-14	Tibial Component	MRT/LLT	14mm
00-5790-061-08	Tibial Component	MLT/LRT	8mm
00-5790-061-10	Tibial Component	MLT/LRT	10mm
00-5790-061-12	Tibial Component	MLT/LRT	12mm
00-5790-061-14	Tibial Component	MLT/LRT	14mm

CONTINUED ON PAGE 94

M/G UNICOMPARTMENTAL ALL-POLY TIBIA (CONT.)

00-5790-005-00 M/G Unicompartmental All-Poly Tibial Components (cont)

Cat. No.	Description Series 4		
00-5790-070-08	Tibial Component	MRT/LLT	8mm
00-5790-070-10	Tibial Component	MRT/LLT	10mm
00-5790-070-12	Tibial Component	MRT/LLT	12mm
00-5790-070-14	Tibial Component	MRT/LLT	14mm
00-5790-071-08	Tibial Component	MLT/LRT	8mm
00-5790-071-10	Tibial Component	MLT/LRT	10mm
00-5790-071-12	Tibial Component	MLT/LRT	12mm
00-5790-071-14	Tibial Component	MLT/LRT	14mm

Cat. No.	Description Series 5		
00-5790-080-08	Tibial Component	MRT/LLT	8mm
00-5790-080-10	Tibial Component	MRT/LLT	10mm
00-5790-080-12	Tibial Component	MRT/LLT	12mm
00-5790-080-14	Tibial Component	MRT/LLT	14mm
00-5790-081-08	Tibial Component	MLT/LRT	8mm
00-5790-081-10	Tibial Component	MLT/LRT	10mm
00-5790-081-12	Tibial Component	MLT/LRT	12mm
00-5790-081-14	Tibial Component	MLT/LRT	14mm

NEXGEN FLUTED STEMMABLE MOBILE TIBIALS



00-5946-004-00 NexGen Fluted Stem Mobile Option Plate Kit

Cat. No.	Description
00-5946-010-00	Fluted Stem Mobile Option Plate, Size 1
00-5946-020-00	Fluted Stem Mobile Option Plate, Size 2
00-5946-030-00	Fluted Stem Mobile Option Plate, Size 3
00-5946-040-00	Fluted Stem Mobile Option Plate, Size 4
00-5946-050-00	Fluted Stem Mobile Option Plate, Size 5
00-5946-060-00	Fluted Stem Mobile Option Plate, Size 6
00-5946-070-00	Fluted Stem Mobile Option Plate, Size 7
00-5946-080-00	Fluted Stem Mobile Option Plate, Size 8

00-5946-004-01 NexGen Fluted Stem Mobile Precoat Stemtable Plate Kit

Cat. No.	Description
00-5946-010-01	Fluted Precoat Mobile Stemtable Plate, Size 1
00-5946-020-01	Fluted Precoat Mobile Stemtable Plate, Size 2
00-5946-030-01	Fluted Precoat Mobile Stemtable Plate, Size 3
00-5946-040-01	Fluted Precoat Mobile Stemtable Plate, Size 4
00-5946-050-01	Fluted Precoat Mobile Stemtable Plate, Size 5
00-5946-060-01	Fluted Precoat Mobile Stemtable Plate, Size 6
00-5946-070-01	Fluted Precoat Mobile Stemtable Plate, Size 7
00-5946-080-01	Fluted Precoat Mobile Stemtable Plate, Size 8

ZIMMER UNICOMPARTMENTAL HIGH FLEX TIBIAL PLATES



00-5842-004-00 Zimmer Uni Precoated Tibial Plate

Cat. No.	Description
00-5842-001-01	Zimmer Uni Precoated Plate, Size 1, Left
00-5842-001-02	Zimmer Uni Precoated Plate, Size 1, Right
00-5842-002-01	Zimmer Uni Precoated Plate, Size 2, Left
00-5842-002-02	Zimmer Uni Precoated Plate, Size 2, Right
00-5842-003-01	Zimmer Uni Precoated Plate, Size 3, Left
00-5842-003-02	Zimmer Uni Precoated Plate, Size 3, Right
00-5842-004-01	Zimmer Uni Precoated Plate, Size 4, Left
00-5842-004-02	Zimmer Uni Precoated Plate, Size 4, Right
00-5842-005-01	Zimmer Uni Precoated Plate, Size 5, Left
00-5842-005-02	Zimmer Uni Precoated Plate, Size 5, Right
00-5842-006-01	Zimmer Uni Precoated Plate, Size 6, Left
00-5842-006-02	Zimmer Uni Precoated Plate, Size 6, Right

M/G UNICOMPARTMENTAL TIBIAL IMPLANTS



PRECOAT



PRECOAT

00-5790-004-00 M/G Unicompartmental Tibial Precoat Fixation Plate Kit

Cat. No.	Description
00-5790-045-11	Series 1 – Right Medial/Left Lateral
00-5790-055-11	Series 2 – Right Medial/Left Lateral
00-5790-065-11	Series 3 – Right Medial/Left Lateral
00-5790-075-11	Series 4 – Right Medial/Left Lateral
00-5790-085-11	Series 5 – Right Medial/Left Lateral
00-5790-045-12	Series 1 – Left Medial/Right Lateral
00-5790-055-12	Series 2 – Left Medial/Right Lateral
00-5790-065-12	Series 3 – Left Medial/Right Lateral
00-5790-075-12	Series 4 – Left Medial/Right Lateral
00-5790-085-12	Series 5 – Left Medial/Right Lateral

MG II AUGMENT TIBIAL PLATES



MG II BLOCK

00-5114-XXX-XX MG II Augment Tibial Plates, Block

Cat. No.	Description
00-5114-054-31	MG II Block, Blue, 12mm, Size H+, Left
00-5114-054-32	MG II Block, Blue, 12mm, Size H+, Right

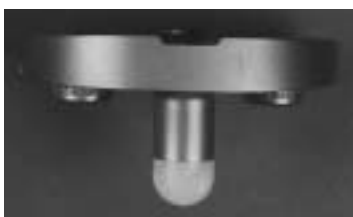

MG II FLAT

00-5114-XXX-XX MG II Augment Tibial Plates, Flat

Cat. No.	Description
00-5114-034-00	MG II Flat, Yellow, Size D+



MG II WEDGE

00-5114-XXX-XX MG II Augment Tibial Plates, 16° Wedge

Cat. No.	Description
00-5114-054-11	MG II 16° Wedge, Blue, Size H+, Left
00-5114-054-12	MG II 16° Wedge, Blue, Size H+, Right

MBK TIBIA PLATES



MBK PLATE

00-5942-004-00 MBK Precoat Fluted Stem Tibial Kit

Cat. No.	Description
00-5942-030-00	Fluted Tibial Plate, Size 3
00-5942-040-00	Fluted Tibial Plate, Size 4
00-5942-050-00	Fluted Tibial Plate, Size 5
00-5942-060-00	Fluted Tibial Plate, Size 6
00-5942-070-00	Fluted Tibial Plate, Size 7
00-5942-080-00	Fluted Tibial Plate, Size 8

00-5942-006-00 MBK Micro Precoat Fluted Stem Tibial Kit

Cat. No.	Description
00-5942-010-00	Fluted Tibial Plate, Size 1
00-5942-020-00	Fluted Tibial Plate, Size 2

00-5940-004-01 MBK Option Fluted Stem Tibial Plate Kit

Cat. No.	Description
00-5940-030-00	Tibial Plate, Size 3
00-5940-040-00	Tibial Plate, Size 4
00-5940-050-00	Tibial Plate, Size 5
00-5940-060-00	Tibial Plate, Size 6
00-5940-070-00	Tibial Plate, Size 7
00-5940-080-00	Tibial Plate, Size 8

00-5940-006-00 MBK Micro Option Fluted Stem Tibial Kit

Cat. No.	Description
00-5940-010-00	Tibial Plate, Size 1
00-5940-020-00	Tibial Plate, Size 2

NEXGEN ALL POLYETHYLENE PATELLAS**



NEXGEN ALL POLYETHYLENE

00-5972-009-00 NexGen All-Poly Patella Kit

Cat. No.	Description
00-5972-065-26*	All-Poly Patella, 26mm x 7.5mm
00-5972-065-29	All-Poly Patella, 29mm x 8.0mm
00-5972-065-32	All-Poly Patella, 32mm x 8.5mm
00-5972-065-35	All-Poly Patella, 35mm x 9.0mm
00-5972-065-38	All-Poly Patella, 38mm x 9.5mm
00-5972-065-41	All-Poly Patella, 41mm x 10mm

00-5972-009-01 NexGen Micro All-Poly Patella Kit

Cat. No.	Description
00-5972-061-26	Micro All-Poly Patella, 26mm x 7.5mm
00-5972-061-29	Micro All-Poly Patella, 29mm x 7.5mm
00-5972-061-32	Micro All-Poly Patella, 32mm x 7.7mm
00-5972-061-35	Micro All-Poly Patella, 35mm x 8.0mm

• 26mm not included in 00-5972-009-00 Kit and for inseting only.

**Machined from molded bar stock.

Note: 26mm, 29mm, and 32mm Patellas not for use with size G and H Femoral Components, unless used in inset mode.

Note: Do not use micro patellar components with standard femoral components. Do not use standard patellar components with micro femoral components, except with LPS & LPS Flex femorals.

Note: Size A and B Femoral Components use Micro Patellas (5972-61-26, 29, 32, 35), except with LPS & LPS Flex femorals.

NEXGEN TRABECULAR METAL PATELLAS*



NEXGEN PRIMARY

00-5878-009-00 NexGen Primary Porous Patella Kit ††

Cat. No.	Description
00-5878-065-32	Patella, 32mm x 10mm
00-5878-065-35	Patella, 35mm x 10mm
00-5878-065-38	Patella, 38mm x 10mm
00-5878-065-41	Patella, 41mm x 10mm

00-5878-009-01 NexGen Micro Primary Porous Patella Kit ††

Cat. No.	Description
00-5878-061-26	Patella, 26mm x 10mm
00-5878-061-29	Patella, 29mm x 10mm
00-5878-061-32	Patella, 32mm x 10mm
00-5878-061-35	Patella, 35mm x 10mm

††Indicated for use with bone cement in the U.S.



NEXGEN AUGMENTED

00-5876-009-00 NexGen Augmentation Patella Kit ††

Cat. No.	Description
00-5876-010-19*	Augmentation Patella, Medium, 32mm dia, 19.5mm thick
00-5876-010-22*	Augmentation Patella, Medium, 32mm dia, 22.5mm thick
00-5876-011-20**	Augmentation Patella, Large, 35mm dia, 20mm thick
00-5876-011-23**	Augmentation Patella, Large, 35mm dia, 23mm thick

*NexGen Poly Thickness 10.5mm

**NexGen Poly Thickness 11.0mm

††Indicated for use with bone cement in the U.S.

CONTINUED ON PAGE 102

NEXGEN TRABECULAR METAL PATELLAS* (CONT.)



CKS AUGMENTED

**00-5876-009-01 CKS® *Continuum*® †Augmentation Patella Kit ††

Cat. No.	Description
00-5876-036-19	Augmentation Patella, Medium, 32 mm dia, 19mm thick
00-5876-036-22	Augmentation Patella, Medium, 32 mm dia, 22mm thick
00-5876-039-19	Augmentation Patella, Large, 35 mm dia, 19mm thick
00-5876-039-22	Augmentation Patella, Large, 35 mm dia, 22mm thick

†Trademark of Implex Corp.

CKS Poly Thickness 10mm

*Manufactured by Implex Corp.

**The CKS *Continuum*® Augmentation Patella is not recommended for use with the *NexGen* Knee System

NEXGEN TRABECULAR CONE IMPLANTS



00-5450-001-00 *NexGen* Trabecular Metal Cone Implant Kit

Cat. No.	Description
00-5450-048-01	<i>Trabecular Metal</i> Cone Size 48-15mm Full, Extra Small
00-5450-052-01	<i>Trabecular Metal</i> Cone Size 52-15mm Full, Small
00-5450-059-01	<i>Trabecular Metal</i> Cone Size 59-15mm Full, Medium
00-5450-059-05	<i>Trabecular Metal</i> Cone Size 59-30mm Full, Medium
00-5450-059-20	<i>Trabecular Metal</i> Cone Size 59 Stepped, Medium, Height 30mm/15mm
00-5450-059-21	<i>Trabecular Metal</i> Cone Size 59 Stepped, Medium, Height 15mm/30mm
00-5450-067-01	<i>Trabecular Metal</i> Cone Size 67-15mm Full, Large
00-5450-067-05	<i>Trabecular Metal</i> Cone Size 67-30mm Full, Large
00-5450-067-20	<i>Trabecular Metal</i> Cone Size 67 Stepped, Large, Height 30mm/15mm
00-5450-067-21	<i>Trabecular Metal</i> Cone Size 67 Stepped, Large, Height 15mm/30mm

NEXGEN STEM EXTENSIONS



STRAIGHT

00-5988-097-00 NexGen Straight Stem Extension Kit

Cat. No.	Description
00-5988-012-12*	Straight Stem 12.7mm x 75mm (30mm)
00-5988-012-15	Straight Stem 15mm x 75mm (30mm)
00-5988-010-10	Straight Stem 10mm x 145mm (100mm)
00-5988-010-11	Straight Stem 11mm x 145mm (100mm)
00-5988-010-12	Straight Stem 12mm x 145mm (100mm)
00-5988-010-13	Straight Stem 13mm x 145mm (100mm)
00-5988-010-14	Straight Stem 14mm x 145mm (100mm)
00-5988-010-15	Straight Stem 15mm x 145mm (100mm)
00-5988-010-16	Straight Stem 16mm x 145mm (100mm)
00-5988-010-17	Straight Stem 17mm x 145mm (100mm)
00-5988-010-18	Straight Stem 18mm x 145mm (100mm)
00-5988-010-20	Straight Stem 20mm x 145mm (100mm)
00-5988-010-22	Straight Stem 22mm x 145mm (100mm)
00-5988-010-24	Straight Stem 24mm x 145mm (100mm)

00-5988-093-00 NexGen Straight Long Stem Extension Kit

Cat. No.	Description
00-5988-011-12	Straight Stem 12mm x 200mm (155mm)
00-5988-011-13	Straight Stem 13mm x 200mm (155mm)
00-5988-011-14	Straight Stem 14mm x 200mm (155mm)
00-5988-011-15	Straight Stem 15mm x 200mm (155mm)
00-5988-011-16	Straight Stem 16mm x 200mm (155mm)
00-5988-011-17	Straight Stem 17mm x 200mm (155mm)
00-5988-011-18	Straight Stem 18mm x 200mm (155mm)

* Not included in kit, order separately.

Note: Replacement Stem Extension Locking Screw 5980-90

NexGen Stem Extension Locking Screw is packaged with each NexGen stem extension.

I/B II Locking screw is included with the I/B II Femoral and Tibial Components.

Dia. x Comb. Lgth. (Actual Length)

Combined length is based on est. 45mm housing.



OFFSET

00-5988-094-00 NexGen Offset Stem Extension Kit

Cat. No.	Description
00-5988-020-11	Offset Stem, 11mm x 145mm (100mm)
00-5988-020-12	Offset Stem, 12mm x 145mm (100mm)
00-5988-020-13	Offset Stem, 13mm x 145mm (100mm)
00-5988-020-14	Offset Stem, 14mm x 145mm (100mm)
00-5988-020-15	Offset Stem, 15mm x 145mm (100mm)
00-5988-020-16	Offset Stem, 16mm x 145mm (100mm)
00-5988-020-17	Offset Stem, 17mm x 145mm (100mm)
00-5988-020-18	Offset Stem, 18mm x 145mm (100mm)

00-5988-095-00 NexGen Offset Long Stem Extension Kit

Cat. No.	Description
00-5988-021-12	Offset Stem, 12mm x 200mm (155mm)
00-5988-021-13	Offset Stem, 13mm x 200mm (155mm)
00-5988-021-14	Offset Stem, 14mm x 200mm (155mm)
00-5988-021-15	Offset Stem, 15mm x 200mm (155mm)
00-5988-021-16	Offset Stem, 16mm x 200mm (155mm)
00-5988-021-17	Offset Stem, 17mm x 200mm (155mm)
00-5988-021-18	Offset Stem, 18mm x 200mm (155mm)

Compatibility	I/B* II/CCK		NexGen	
	Femoral	Tibial	Femoral	Tibial
NexGen Stem Ext Straight, Offset, & Fluted	Yes	Yes	Yes	Yes
I/B* II/CCK Stem Extension	Yes	Yes	No	Yes

* Insall/Burstein® II Modular Knee System is a trademark of The Hospital for Special Surgery.

Note: Replacement Stem Extension Locking Screw 00-5980-090-00

NexGen Stem Extension Locking Screw is packaged with each NexGen stem extension.

I/B II Locking screw is included with the I/B II Femoral and Tibial Components.

Dia. x Comb. Lgth. (Actual Length)

Combined length is based on est. 45mm housing.

NEXGEN STEM EXTENSIONS & TAPER PLUG



SHARP FLUTED

00-5988-015-00 NexGen Sharp Fluted Stem Extension Kit

Cat. No.	Description
00-5988-015-10	Sharp Fluted Stem 10mm x 120mm (75mm)
00-5988-015-11	Sharp Fluted Stem 11mm x 120mm (75mm)
00-5988-015-12	Sharp Fluted Stem 12mm x 120mm (75mm)
00-5988-015-13	Sharp Fluted Stem 13mm x 120mm (75mm)
00-5988-015-14	Sharp Fluted Stem 14mm x 120mm (75mm)
00-5988-015-15	Sharp Fluted Stem 15mm x 120mm (75mm)
00-5988-015-16	Sharp Fluted Stem 16mm x 120mm (75mm)
00-5988-015-17	Sharp Fluted Stem 17mm x 120mm (75mm)
00-5988-015-18	Sharp Fluted Stem 18mm x 120mm (75mm)
00-5988-015-19	Sharp Fluted Stem 19mm x 120mm (75mm)
00-5988-015-20	Sharp Fluted Stem 20mm x 120mm (75mm)
00-5988-015-22	Sharp Fluted Stem 22mm x 120mm (75mm)
00-5988-015-24	Sharp Fluted Stem 24mm x 120mm (75mm)

Note: Replacement Stem Extension Locking Screw 00-5980-090-00 NexGen Stem Extension Locking Screw is packaged with each NexGen stem extension.

I/B II Locking screw is included with the I/B II Femoral and Tibial Components.

00-5988-016-00 NexGen Sharp Fluted Long Stem Extension Kit

Cat. No.	Description
00-5988-016-10	Sharp Fluted Stem 10mm x 175mm (130mm)
00-5988-016-11	Sharp Fluted Stem 11mm x 175mm (130mm)
00-5988-016-12	Sharp Fluted Stem 12mm x 175mm (130mm)
00-5988-016-13	Sharp Fluted Stem 13mm x 175mm (130mm)
00-5988-016-14	Sharp Fluted Stem 14mm x 175mm (130mm)
00-5988-016-15	Sharp Fluted Stem 15mm x 175mm (130mm)
00-5988-016-16	Sharp Fluted Stem 16mm x 175mm (130mm)
00-5988-016-17	Sharp Fluted Stem 17mm x 175mm (130mm)
00-5988-016-18	Sharp Fluted Stem 18mm x 175mm (130mm)
00-5988-016-19	Sharp Fluted Stem 19mm x 175mm (130mm)
00-5988-016-20	Sharp Fluted Stem 20mm x 175mm (130mm)
00-5988-016-22	Sharp Fluted Stem 22mm x 175mm (130mm)
00-5988-016-24	Sharp Fluted Stem 24mm x 175mm (130mm)

Compatibility	I/B* II/CCK		NexGen	
	Femoral	Tibial	Femoral	Tibial
NexGen Stem Ext Straight, Offset, & Fluted	Yes	Yes	Yes	Yes
I/B* II/CCK Stem Extension	Yes	Yes	No	Yes

* Insall/Burstein® II Modular Knee System is a trademark of The Hospital for Special Surgery.

Dia. x Comb. Lgth. (Actual Length)

Combined length is based on est. 45mm housing.

Note: Replacement Stem Extension Locking Screw 00-5980-090-00 NexGen Stem Extension Locking Screw is packaged with each NexGen stem extension.

I/B II Locking screw is included with the I/B II Femoral and Tibial Components.



FLEX TAPER PLUG

NexGen Flex Taper Plug

Cat. No.	Description
00-5960-099-00	Flex Taper Plug

NEXGEN STEM EXTENSIONS



EXTRA-LONG STRAIGHT

• NexGen Extra-Long Stem Extension

Cat. No.	Description
32-5988-012-12	Extra-Long Straight Stem Ext, 12mm x 245mm (200mm)
32-5988-012-13	Extra-Long Straight Stem Ext, 13mm x 245mm (200mm)
32-5988-012-14	Extra-Long Straight Stem Ext, 14mm x 245mm (200mm)
32-5988-012-15	Extra-Long Straight Stem Ext, 15mm x 245mm (200mm)
32-5988-012-16	Extra-Long Straight Stem Ext, 16mm x 245mm (200mm)
32-5988-012-17	Extra-Long Straight Stem Ext, 17mm x 245mm (200mm)
32-5988-012-18	Extra-Long Straight Stem Ext, 18mm x 245mm (200mm)
32-5988-012-20	Extra-Long Straight Stem Ext, 20mm x 245mm (200mm)
32-5988-012-22	Extra-Long Straight Stem Ext, 22mm x 245mm (200mm)
32-5988-012-24	Extra-Long Straight Stem Ext, 24mm x 245mm (200mm)



OPTION

• NexGen Curved Stem Extension

Cat. No.	Description
32-5988-152-11	Curved Tapered Stem Ext, 11mm x 197mm (152mm)
32-5988-152-13	Curved Tapered Stem Ext, 13mm x 197mm (152mm)
32-5988-152-15	Curved Tapered Stem Ext, 15mm x 197mm (152mm)

NOTE: No provisionals available for NexGen Curved Tapered Stem Extensions or Extra-Long Straight.

•Order separately.

Dia. x Comb. Lgth. (Actual Length)

Combined length is based on est. 45mm housing.

OPTION

• NexGen Cemented Stem Extension

Cat. No.	Description
00-5988-017-13	Cemented Stem, 13mm x 75mm (30mm)
00-5988-018-13	Cemented Stem, 13mm x 105mm (60mm)
00-5988-019-13	Cemented Stem, 13mm x 145mm (100mm)
00-5989-017-13	Cemented Stem Ext Prov, 13mm x 75mm
00-5989-018-13	Cemented Stem Ext Prov, 13mm x 105mm

NOTE: No provisionals available for NexGen Curved Tapered Stem Extensions or Extra-Long Straight.

•Order separately.

Dia. x Comb. Lgth. (Actual Length)

Combined length is based on est. 45mm housing.

NEXGEN TIBIAL AUGMENTS FOR PRECOAT STEMMED TIBIAL PLATES AND A/P WEDGE TIBIAL PLATES



HALF WEDGE-16°

00-5988-096-00 NexGen Precoat Tibial Augment Kit (1 of each)

Cat. No.	Description
00-5988-002-20*	16° Half Wedge Tibial Augment, Size 2
00-5988-003-20	16° Half Wedge Tibial Augment, Size 3
00-5988-004-20	16° Half Wedge Tibial Augment, Size 4
00-5988-005-20	16° Half Wedge Tibial Augment, Size 5
00-5988-006-20	16° Half Wedge Tibial Augment, Size 6
00-5988-007-20	16° Half Wedge Tibial Augment, Size 7
00-5988-008-20	16° Half Wedge Tibial Augment, Size 8,9



HALF WEDGE-26°

00-5988-096-00 NexGen Precoat Tibial Augment Kit (1 of each)

Cat. No.	Description
00-5988-002-21*	26° Half Wedge Tibial Augment, Size 2
00-5988-003-21	26° Half Wedge Tibial Augment, Size 3
00-5988-004-21	26° Half Wedge Tibial Augment, Size 4
00-5988-005-21	26° Half Wedge Tibial Augment, Size 5
00-5988-006-21	26° Half Wedge Tibial Augment, Size 6
00-5988-007-21	26° Half Wedge Tibial Augment, Size 7
00-5988-008-21	26° Half Wedge Tibial Augment, Size 8,9

Tibial Augments are packaged with two attaching screws.

- Replacement tibial augment screws (5988-91).
- Tibial Augments are medial, lateral, compatible.

* Not included in kits – order separately. (OPTIONAL)



THIRD WEDGE-22°

00-5988-096-00 NexGen Precoat Tibial Aug Kit (1 of each)

Cat. No.	Description
00-5988-002-22*	22° Third Wedge Tibial Augment, Size 2
00-5988-003-22	22° Third Wedge Tibial Augment, Size 3
00-5988-004-22	22° Third Wedge Tibial Augment, Size 4
00-5988-005-22	22° Third Wedge Tibial Augment, Size 5
00-5988-006-22	22° Third Wedge Tibial Augment, Size 6
00-5988-007-22	22° Third Wedge Tibial Augment, Size 7
00-5988-008-22	22° Third Wedge Tibial Augment, Size 8,9



FULL WEDGE-7°

00-5988-096-00 NexGen Precoat Tibial Aug Kit (1 of each)

Cat. No.	Description
00-5988-002-23*	7° Full Wedge Tibial Augment, Size 2
00-5988-003-23	7° Full Wedge Tibial Augment, Size 3
00-5988-004-23	7° Full Wedge Tibial Augment, Size 4
00-5988-005-23	7° Full Wedge Tibial Augment, Size 5
00-5988-006-23	7° Full Wedge Tibial Augment, Size 6
00-5988-007-23	7° Full Wedge Tibial Augment, Size 7
00-5988-008-23	7° Full Wedge Tibial Augment, Size 8
00-5988-009-23	7° Full Wedge Tibial Augment, Size 9

Tibial Augments are packaged with two attaching screws.

- Replacement tibial augment screws (5988-91).
- Tibial Augments are medial, lateral, compatible.

* Not included in kits – order separately. (OPTIONAL)

CONTINUED ON PAGE 112

NEXGEN TIBIAL AUGMENTS FOR PRECOAT STEMMED TIBIAL PLATES AND A/P WEDGE TIBIAL PLATES (CONT.)



HALF BLOCK-5mm

00-5988-096-00 *NexGen Precoat Tibial Aug Kit (1 of each)*

Cat. No.	Description
00-5988-001-26*	5mm Half Block Tibial Augment, Size 1
00-5988-002-26*	5mm Block Tibial Augment, Size 2
00-5988-003-26	5mm Block Tibial Augment, Size 3
00-5988-004-26	5mm Block Tibial Augment, Size 4
00-5988-005-26	5mm Block Tibial Augment, Size 5
00-5988-006-26	5mm Block Tibial Augment, Size 6
00-5988-007-26	5mm Block Tibial Augment, Size 7
00-5988-008-26	5mm Block Tibial Augment, Size 8,9



HALF BLOCK-10mm

00-5988-096-00 *NexGen Precoat Tibial Aug Kit (1 of each)*

Cat. No.	Description
00-5988-001-27*	10mm Half Block Tibial Augment, Size 1
00-5988-002-27*	10mm Block Tibial Augment, Size 2
00-5988-003-27	10mm Block Tibial Augment, Size 3
00-5988-004-27	10mm Block Tibial Augment, Size 4
00-5988-005-27	10mm Block Tibial Augment, Size 5
00-5988-006-27	10mm Block Tibial Augment, Size 6
00-5988-007-27	10mm Block Tibial Augment, Size 7
00-5988-008-27	10mm Block Tibial Augment, Size 8,9

Tibial Augments are packaged with two attaching screws.

-Replacement tibial augment screws (5988-91).

-Tibial Augments are medial, lateral, compatible.

• Not included in kits – order separately. (OPTIONAL)

NEXGEN TRABECULAR METAL TIBIAL AUGMENTS



00-5448-096-01 NexGen Trabecular Metal Tibial Aug 15,20 Kit (1 of each)

Cat. No.	Description
00-5448-002-28	15mm Tibial Augment Block,Rt Lat/Lt Med, Size 2
00-5448-002-29	20mm Tibial Augment Block,Rt Lat/Lt Med, Size 2
00-5448-002-38	15mm Tibial Augment Block,Lt Lat/Rt Med, Size 2
00-5448-002-39	20mm Tibial Augment Block,Lt Lat/Rt Med, Size 2
00-5448-003-28	15mm Tibial Augment Block,Rt Lat/Lt Med, Size 3
00-5448-003-29	20mm Tibial Augment Block,Rt Lat/Lt Med, Size 3
00-5448-003-38	15mm Tibial Augment Block,Lt Lat/Rt Med, Size 3
00-5448-003-39	20mm Tibial Augment Block,Lt Lat/Rt Med, Size 3
00-5448-004-28	15mm Tibial Augment Block,Rt Lat/Lt Med, Size 4
00-5448-004-29	20mm Tibial Augment Block,Rt Lat/Lt Med, Size 4
00-5448-004-38	15mm Tibial Augment Block,Lt Lat/Rt Med, Size 4
00-5448-004-39	20mm Tibial Augment Block,Lt Lat/Rt Med, Size 4
00-5448-005-28	15mm Tibial Augment Block,Rt Lat/Lt Med, Size 5
00-5448-005-29	20mm Tibial Augment Block,Rt Lat/Lt Med, Size 5
00-5448-005-38	15mm Tibial Augment Block,Lt Lat/Rt Med, Size 5
00-5448-005-39	20mm Tibial Augment Block,Lt Lat/Rt Med, Size 5
00-5448-006-28	15mm Tibial Augment Block,Rt Lat/Lt Med, Size 6
00-5448-006-29	20mm Tibial Augment Block,Rt Lat/Lt Med, Size 6
00-5448-006-38	15mm Tibial Augment Block,Lt Lat/Rt Med, Size 6
00-5448-006-39	20mm Tibial Augment Block,Lt Lat/Rt Med, Size 6
00-5448-007-28	15mm Tibial Augment Block,Rt Lat/Lt Med, Size 7
00-5448-007-29	20mm Tibial Augment Block,Rt Lat/Lt Med, Size 7
00-5448-007-38	15mm Tibial Augment Block,Lt Lat/Rt Med, Size 7
00-5448-007-39	20mm Tibial Augment Block,Lt Lat/Rt Med, Size 7

00-5448-096-02 NexGen Trabecular Metal Tibial Aug 30 Kit (1 of each)

Cat. No.	Description
00-5448-003-30	30mm Tibial Augment Block,Rt Lat/Lt Med, Size 3
00-5448-003-40	30mm Tibial Augment Block,Lt Lat/Rt Med, Size 3
00-5448-004-30	30mm Tibial Augment Block,Rt Lat/Lt Med, Size 4
00-5448-004-40	30mm Tibial Augment Block,Lt Lat/Rt Med, Size 4
00-5448-005-30	30mm Tibial Augment Block,Rt Lat/Lt Med, Size 5
00-5448-005-40	30mm Tibial Augment Block,Lt Lat/Rt Med, Size 5
00-5448-006-30	30mm Tibial Augment Block,Rt Lat/Lt Med, Size 6
00-5448-006-40	30mm Tibial Augment Block,Lt Lat/Rt Med, Size 6



00-5448-096-00 NexGen Trabecular Metal Tibial Aug 5/10mm Kit

Cat. No.	Description
00-5448-002-26	5mm Tibial Augment Block,Rt Lat/Lt Med, Size 2
00-5448-002-27	10mm Tibial Augment Block,Rt Lat/Lt Med, Size 2
00-5448-002-36	5mm Tibial Augment Block,Lt Lat/Rt Med, Size 2
00-5448-002-37	10mm Tibial Augment Block,Lt Lat/Rt Med, Size 2
00-5448-003-26	5mm Tibial Augment Block,Rt Lat/Lt Med, Size 3
00-5448-003-27	10mm Tibial Augment Block,Rt Lat/Lt Med, Size 3
00-5448-003-36	5mm Tibial Augment Block,Lt Lat/Rt Med, Size 3
00-5448-003-37	10mm Tibial Augment Block,Lt Lat/Rt Med, Size 3
00-5448-004-26	5mm Tibial Augment Block,Rt Lat/Lt Med, Size 4
00-5448-004-27	10mm Tibial Augment Block,Rt Lat/Lt Med, Size 4
00-5448-004-36	5mm Tibial Augment Block,Lt Lat/Rt Med, Size 4
00-5448-004-37	10mm Tibial Augment Block,Lt Lat/Rt Med, Size 4
00-5448-005-26	5mm Tibial Augment Block,Rt Lat/Lt Med, Size 5
00-5448-005-27	10mm Tibial Augment Block,Rt Lat/Lt Med, Size 5
00-5448-005-36	5mm Tibial Augment Block,Lt Lat/Rt Med, Size 5
00-5448-005-37	10mm Tibial Augment Block,Lt Lat/Rt Med, Size 5
00-5448-006-26	5mm Tibial Augment Block,Rt Lat/Lt Med, Size 6
00-5448-006-27	10mm Tibial Augment Block,Rt Lat/Lt Med, Size 6
00-5448-006-36	5mm Tibial Augment Block,Lt Lat/Rt Med, Size 6
00-5448-006-37	10mm Tibial Augment Block,Lt Lat/Rt Med, Size 6
00-5448-007-26	5mm Tibial Augment Block,Rt Lat/Lt Med, Size 7
00-5448-007-27	10mm Tibial Augment Block,Rt Lat/Lt Med, Size 7
00-5448-007-36	5mm Tibial Augment Block,Lt Lat/Rt Med, Size 7
00-5448-007-37	10mm Tibial Augment Block,Lt Lat/Rt Med, Size 7

00-5448-096-10 NexGen Trabecular Metal Tibial Aug Full Block Kit

Cat. No.	Description
00-5448-002-10	10mm Full Block Tibial Augment, Size 2
00-5448-003-10	10mm Full Block Tibial Augment, Size 3
00-5448-004-10	10mm Full Block Tibial Augment, Size 4
00-5448-005-10	10mm Full Block Tibial Augment, Size 5
00-5448-006-10	10mm Full Block Tibial Augment, Size 6
00-5448-007-10	10mm Full Block Tibial Augment, Size 7

NEXGEN TIBIAL AUGMENT BLOCKS



TIBIAL AUGMENT BLOCK

00-5988-096-01 NexGen Tibial Augment Kit (1 of each)

Cat. No.	Description
00-5988-001-28*	15mm Tibial Augment Block, Rt L/Lt M (Tapered), Size 1
00-5988-001-38*	15mm Tibial Augment Block, Lt L/Rt M (Tapered), Size 1
00-5988-002-28*	15mm Tibial Augment Block, Rt L/Lt M (Tapered), Size 2
00-5988-002-38*	15mm Tibial Augment Block, Lt L/Rt M (Tapered), Size 2
00-5988-003-28	15mm Tibial Augment Block, Rt L/Lt M (Tapered), Size 3
00-5988-003-38	15mm Tibial Augment Block, Lt L/Rt M (Tapered), Size 3
00-5988-004-28	15mm Tibial Augment Block, Rt L/Lt M (Tapered), Size 4
00-5988-004-38	15mm Tibial Augment Block, Lt L/Rt M (Tapered), Size 4
00-5988-005-28	15mm Tibial Augment Block, Rt L/Lt M (Tapered), Size 5
00-5988-005-38	15mm Tibial Augment Block, Lt L/Rt M (Tapered), Size 5
00-5988-006-28	15mm Tibial Augment Block, Rt L/Lt M (Tapered), Size 6
00-5988-006-38	15mm Tibial Augment Block, Lt L/Rt M (Tapered), Size 6
00-5988-007-28	15mm Tibial Augment Block, Rt L/Lt M (Tapered), Size 7
00-5988-007-38	15mm Tibial Augment Block, Lt L/Rt M (Tapered), Size 7
00-5988-008-28	15mm Tibial Augment Block, Rt L/Lt M (Tapered), Size 8
00-5988-008-38	15mm Tibial Augment Block, Lt L/Rt M (Tapered), Size 8
00-5988-001-29*	20mm Tibial Augment Block, Rt L/Lt M (Tapered), Size 1
00-5988-001-39*	20mm Tibial Augment Block, Lt L/Rt M (Tapered), Size 1
00-5988-002-29*	20mm Tibial Augment Block, Rt L/Lt M (Tapered), Size 2
00-5988-002-39*	20mm Tibial Augment Block, Lt L/Rt M (Tapered), Size 2

* Not included in kit, order separately.

00-5988-096-01 NexGen Tibial Augment Kit (1 of each)

Cat. No.	Description
00-5988-003-29	20mm Tibial Augment Block, Rt L/Lt M (Tapered), Size 3
00-5988-003-39	20mm Tibial Augment Block, Lt L/Rt M (Tapered), Size 3
00-5988-004-29	20mm Tibial Augment Block, Rt L/Lt M (Tapered), Size 4
00-5988-004-39	20mm Tibial Augment Block, Lt L/Rt M (Tapered), Size 4
00-5988-005-29	20mm Tibial Augment Block, Rt L/Lt M (Tapered), Size 5
00-5988-005-39	20mm Tibial Augment Block, Lt L/Rt M (Tapered), Size 5
00-5988-006-29	20mm Tibial Augment Block, Rt L/Lt M (Tapered), Size 6
00-5988-006-39	20mm Tibial Augment Block, Lt L/Rt M (Tapered), Size 6
00-5988-007-29	20mm Tibial Augment Block, Rt L/Lt M (Tapered), Size 7
00-5988-007-39	20mm Tibial Augment Block, Lt L/Rt M (Tapered), Size 7
00-5988-008-29	20mm Tibial Augment Block, Rt L/Lt M (Tapered), Size 8
00-5988-008-39	20mm Tibial Augment Block, Lt L/Rt M (Tapered), Size 8

00-5988-096-01 NexGen Full Augment Kit (1 of each)

Cat. No.	Description
00-5988-001-10	10mm Full Block Tibial Augment, Size 1
00-5988-002-10	10mm Full Block Tibial Augment, Size 2
00-5988-003-10	10mm Full Block Tibial Augment, Size 3
00-5988-004-10	10mm Full Block Tibial Augment, Size 4
00-5988-005-10	10mm Full Block Tibial Augment, Size 5
00-5988-006-10	10mm Full Block Tibial Augment, Size 6
00-5988-007-10	10mm Full Block Tibial Augment, Size 7
00-5988-008-10	10mm Full Block Tibial Augment, Size 8

ROTATING HINGE KNEE TIBIAL AUGMENTS



Designed to be used with Rotating Hinge Knee Tibial Base Plates only.

00-5880-096-01 NexGen Rotating Hinge Knee Tibial Augment Kit

Cat. No.	Description
00-5880-002-10	10mm Rotating Hinge Full Block Tib Augment, Size 2
00-5880-003-10	10mm Rotating Hinge Full Block Tib Augment, Size 3
00-5880-004-10	10mm Rotating Hinge Full Block Tib Augment, Size 4
00-5880-005-10	10mm Rotating Hinge Full Block Tib Augment, Size 5
00-5880-006-10	10mm Rotating Hinge Full Block Tib Augment, Size 6



00-5880-096-10 NexGen Trabecular Metal Rotating Hinge Knee Tibial Full Block Augment Kit

Cat. No.	Description
00-5880-022-10	10mm Rotating Hinge Full Block Tib Augment, Size 2
00-5880-023-10	10mm Rotating Hinge Full Block Tib Augment, Size 3
00-5880-024-10	10mm Rotating Hinge Full Block Tib Augment, Size 4
00-5880-025-10	10mm Rotating Hinge Full Block Tib Augment, Size 5
00-5880-026-10	10mm Rotating Hinge Full Block Tib Augment, Size 6

TIBIAL AUGMENTS FOR FLUTED TIBIAL PLATES



16° HALF WEDGE

00-5998-096-00 Legacy 3° Fluted Precoat Tibial Augment Kit (1 of each)

Cat. No.	Description
00-5998-002-20	16° Half Wedge Tibial Augment, Size 2
00-5998-003-20	16° Half Wedge Tibial Augment, Size 3
00-5998-004-20	16° Half Wedge Tibial Augment, Size 4
00-5998-005-20	16° Half Wedge Tibial Augment, Size 5
00-5998-006-20	16° Half Wedge Tibial Augment, Size 6
00-5998-007-20	16° Half Wedge Tibial Augment, Size 7
00-5998-008-20	16° Half Wedge Tibial Augment, Size 8,9



7° FULL WEDGE

00-5998-096-00 Legacy 3° Fluted Precoat Tibial Augment Kit (1 of each)

Cat. No.	Description
00-5998-002-23	7° Full Wedge Tibial Augment, Size 2
00-5998-003-23	7° Full Wedge Tibial Augment, Size 3
00-5998-004-23	7° Full Wedge Tibial Augment, Size 4
00-5998-005-23	7° Full Wedge Tibial Augment, Size 5
00-5998-006-23	7° Full Wedge Tibial Augment, Size 6
00-5998-007-23	7° Full Wedge Tibial Augment, Size 7
00-5998-008-23	7° Full Wedge Tibial Augment, Size 8

Tibial Augments are packaged with two attaching screws.
 -Replacement tibial augment screws (00-5988-091-00).
 -Tibial Augments are medial, lateral, compatible.

For use with 3° Tibial Plates.

CONTINUED ON PAGE 120

TIBIAL AUGMENTS FOR FLUTED TIBIAL PLATES [CONT.]



5mm BLOCK

00-5998-096-00 *Legacy 3° Fluted Precoat Tibial Augment Kit (1 of each)*

Cat. No.	Description
00-5998-002-26	5mm Blk Tibial Augment, Size 2
00-5998-003-26	5mm Blk Tibial Augment, Size 3
00-5998-004-26	5mm Blk Tibial Augment, Size 4
00-5998-005-26	5mm Blk Tibial Augment, Size 5
00-5998-006-26	5mm Blk Tibial Augment, Size 6
00-5998-007-26	5mm Blk Tibial Augment, Size 7
00-5998-008-26	5mm Blk Tibial Augment, Size 8,9



10mm BLOCK

00-5998-096-00 *Legacy 3° Fluted Precoat Tibial Augment Kit (1 of each)*

Cat. No.	Description
00-5998-002-27	10mm Blk Tibial Augment, Size 2
00-5998-003-27	10mm Blk Tibial Augment, Size 3
00-5998-004-27	10mm Blk Tibial Augment, Size 4
00-5998-005-27	10mm Blk Tibial Augment, Size 5
00-5998-006-27	10mm Blk Tibial Augment, Size 6
00-5998-007-27	10mm Blk Tibial Augment, Size 7
00-5998-008-27	10mm Blk Tibial Augment, Size 8,9

Tibial Augments are packaged with two attaching screws.
 -Replacement tibial augment screws (5988-91).
 -Tibial Augments are medial, lateral, compatible.

For use with 3° Tibial Plates

NEXGEN FEMORAL AUGMENTS



ANTERIOR

00-5990-031-00 *NexGen Precoat Anterior Femoral Augment Kit (1 of each)*

Cat. No.	Description
00-5990-033-31	Anterior Augment (Fem C)
00-5990-034-31	Anterior Augment (Fem D)
00-5990-035-31	Anterior Augment (Fem E)
00-5990-036-31	Anterior Augment (Fem F)
00-5990-037-31	Anterior Augment (Fem G)



DISTAL

00-5990-030-00 *NexGen Precoat CRA/LCCK/RHK Fem Aug Kit (2 of each)*

Cat. No.	Description
00-5990-033-10	5mm Distal Augment (Fem C)
00-5990-034-10	5mm Distal Augment (Fem D)
00-5990-035-10	5mm Distal Augment (Fem E)
00-5990-036-10	5mm Distal Augment (Fem F)
00-5990-037-10	5mm Distal Augment (Fem G)
00-5990-033-20	10mm Distal Augment (Fem C)
00-5990-034-20	10mm Distal Augment (Fem D)
00-5990-035-20	10mm Distal Augment (Fem E)
00-5990-036-20	10mm Distal Augment (Fem F)
00-5990-037-20	10mm Distal Augment (Fem G)

Femoral Augments are packaged with one attaching screw per augment.
 -Replacement screws available (00-5988-092-00).
 -Femoral Augments are medial, lateral, and right-left compatible.
 -Femoral Augments can be used with either LCCK, CRA or Rotating Hinge Knee Femoral Components.
 -Distal/Posterior Femoral Augments can be used with cement or screws.
 -Anterior Augments used with cement only.

CONTINUED ON PAGE 122

NEXGEN FEMORAL AUGMENTS (CONT.)



DISTAL-ONLY

00-5990-030-00 *NexGen* Precoat CRA/LCCK/Rotating Hinge Knee Femoral Augment Kit (2 of each)

Cat. No.	Description
00-5990-033-21	10mm Distal-only Augment (Fem C)
00-5990-034-21	10mm Distal-only Augment (Fem D)
00-5990-035-21	10mm Distal-only Augment (Fem E)
00-5990-036-21	10mm Distal-only Augment (Fem F)
00-5990-037-21	10mm Distal-only Augment (Fem G)



DISTAL-ONLY

00-5990-030-01 *NexGen* CRA/LCCK/Rotating Hinge Knee Femoral Augment 15,20 Kit (2 of each)

Cat. No.	Description
00-5990-033-23	15mm Distal-only Augment (Fem C)
00-5990-034-23	15mm Distal-only Augment (Fem D)
00-5990-035-23	15mm Distal-only Augment (Fem E)
00-5990-036-23	15mm Distal-only Augment (Fem F)
00-5990-037-23	15mm Distal-only Augment (Fem G)
00-5990-033-24	20mm Distal-only Augment (Fem C)
00-5990-034-24	20mm Distal-only Augment (Fem D)
00-5990-035-24	20mm Distal-only Augment (Fem E)
00-5990-036-24	20mm Distal-only Augment (Fem F)
00-5990-037-24	20mm Distal-only Augment (Fem G)

Femoral Augments are packaged with one attaching screw per augment.

- Replacement screws available (00-5988-092-00).
- Femoral Augments are medial, lateral, and right-left compatible.
- Femoral Augments can be used with either LCCK, CRA or Rotating Hinge Knee Femoral Components.
- Distal/Posterior Femoral Augments can be used with cement or screws.
- Anterior Augments used with cement only.



POSTERIOR

00-5990-030-00 *NexGen* Precoat CRA/LCCK/Rotating Hinge Knee Femoral Augment Kit (2 of each)

Cat. No.	Description
00-5990-033-01	5mm Posterior Augment (Fem C)
00-5990-034-01	5mm Posterior Augment (Fem D)
00-5990-035-01	5mm Posterior Augment (Fem E)
00-5990-036-01	5mm Posterior Augment (Fem F)
00-5990-037-01	5mm Posterior Augment (Fem G)
00-5990-033-02	10mm Posterior Augment (Fem C)
00-5990-034-02	10mm Posterior Augment (Fem D)
00-5990-035-02	10mm Posterior Augment (Fem E)
00-5990-036-02	10mm Posterior Augment (Fem F)
00-5990-037-02	10mm Posterior Augment (Fem G)



POSTERIOR-ONLY

00-5990-030-00 *NexGen* Precoat CRA/LCCK/Rotating Hinge Knee Femoral Augment Kit (2 of each)

Cat. No.	Description
00-5990-035-22	10mm Posterior-only Augment (Fem E)
00-5990-036-22	10mm Posterior-only Augment (Fem F)
00-5990-037-22	10mm Posterior-only Augment (Fem G)

Femoral Augments are packaged with one attaching screw per augment.

- Replacement screws available (00-5988-092-00).
- Femoral Augments are medial, lateral, and right-left compatible.
- Femoral Augments can be used with either LCCK, CRA or Rotating Hinge Knee Femoral Components.
- Distal/Posterior Femoral Augments can be used with cement or screws.
- Anterior Augments used with cement only.

NEXGEN TRABECULAR METAL AUGMENTS



00-5490-030-00 *NexGen Trabecular Metal Femoral Augment 5, 10 Kit (2 of each)*

Cat. No.	Description
00-5490-033-01	5mm Posterior Fem Augment, Size C
00-5490-033-02	10mm Posterior Fem Augment, Size C
00-5490-033-10	5mm Distal Fem Augment, Size C
00-5490-033-20	10mm Distal Fem Augment, Size C
00-5490-034-01	5mm Posterior Fem Augment, Size D
00-5490-034-02	10mm Posterior Fem Augment, Size D
00-5490-034-10	5mm Distal Fem Augment, Size D
00-5490-034-20	10mm Distal Fem Augment, Size D
00-5490-035-01	5mm Posterior Fem Augment, Size E
00-5490-035-02	10mm Posterior Fem Augment, Size E
00-5490-035-10	5mm Distal Fem Augment, Size E
00-5490-035-20	10mm Distal Fem Augment, Size E
00-5490-036-01	5mm Posterior Fem Augment, Size F
00-5490-036-02	10mm Posterior Fem Augment, Size F
00-5490-036-10	5mm Distal Fem Augment, Size F
00-5490-036-20	10mm Distal Fem Augment, Size F

00-5490-030-01 *NexGen Trabecular Metal Femoral Augment 15, 20 Kit (2 of each)*

Cat. No.	Description
00-5490-033-23	15mm Distal Only Fem Augment, Size C
00-5490-033-24	20mm Distal Only Fem Augment, Size C
00-5490-034-23	15mm Distal Only Fem Augment, Size D
00-5490-034-24	20mm Distal Only Fem Augment, Size D
00-5490-035-23	15mm Distal Only Fem Augment, Size E
00-5490-035-24	20mm Distal Only Fem Augment, Size E
00-5490-036-23	15mm Distal Only Fem Augment, Size F
00-5490-036-24	20mm Distal Only Fem Augment, Size F

SELF-TAPPING BONE SCREWS



00-5110-097-00 TIVANIUM Sterile Bone Screw Kit

Cat. No.	Description
00-5110-070-20	TIVANIUM Sterile, 6.5mm x 20mm
00-5110-070-25	TIVANIUM Sterile, 6.5mm x 25mm
00-5110-070-30	TIVANIUM Sterile, 6.5mm x 30mm
00-5110-070-35	TIVANIUM Sterile, 6.5mm x 35mm
00-5110-070-40	TIVANIUM Sterile, 6.5mm x 40mm
00-5110-070-45	TIVANIUM Sterile, 6.5mm x 45mm
00-5110-070-50	TIVANIUM Sterile, 6.5mm x 50mm
00-5110-070-55	TIVANIUM Sterile, 6.5mm x 55mm
00-5110-070-60	TIVANIUM Sterile, 6.5mm x 60mm
00-5110-070-70	TIVANIUM Sterile, 6.5mm x 70mm
00-5110-070-80	TIVANIUM Sterile, 6.5mm x 80mm

00-5110-099-00 TIVANIUM Nonsterile Bone Screw Kit

Cat. No.	Description
00-5110-075-20	TIVANIUM Nonsterile, 6.5mm x 20mm
00-5110-075-25	TIVANIUM Nonsterile, 6.5mm x 25mm
00-5110-075-30	TIVANIUM Nonsterile, 6.5mm x 30mm
00-5110-075-35	TIVANIUM Nonsterile, 6.5mm x 35mm
00-5110-075-40	TIVANIUM Nonsterile, 6.5mm x 40mm
00-5110-075-45	TIVANIUM Nonsterile, 6.5mm x 45mm
00-5110-075-50	TIVANIUM Nonsterile, 6.5mm x 50mm
00-5110-075-55	TIVANIUM Nonsterile, 6.5mm x 55mm
00-5110-075-60	TIVANIUM Nonsterile, 6.5mm x 60mm

WARNING: This device is not approved for screw attachment or fixation to the posterior elements (pedicles) of the cervical, thoracic, or lumbar spine.

NEXGEN REPLACEMENT SCREWS

NexGen Replacement Screw Kit

Cat. No.	Description
00-5980-090-00	NexGen Stem Extension Screw
00-5988-090-00	NexGen Femoral Set Screw
00-5988-091-00	NexGen Tibial Wedge Attachment Screw
00-5988-092-00	NexGen Femoral Augment Screw

NEXGEN MIS FEMORAL FINISHING INSTRUMENT KIT 00-5967-026-50

NEXGEN TIBIAL ALIGNMENT/RESECTION INSTRUMENT KIT 00-5973-001-00

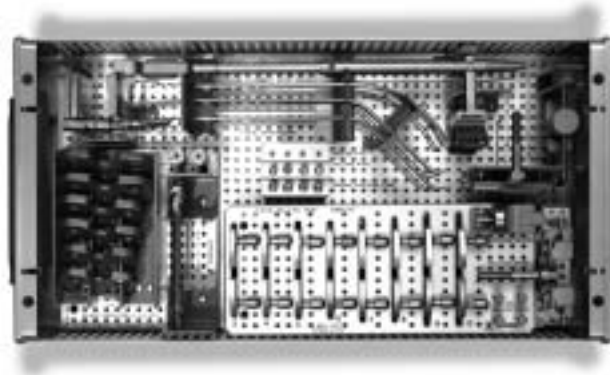

00-5967-026-50 NexGen MIS Femoral Finishing Instrument Kit

Cat. No.	Description
00-5965-090-00	Femoral Peg Drill Size A
00-5120-052-01	Patella/Femoral Drill 6.4mm Diameter
00-5965-099-00	Modular Peg
00-5967-049-00	Modular Boom Attachment
00-5967-069-00	Modular Shelf
00-5983-060-02	QS Notch Guide, Size B
00-5983-060-03	QS Notch Guide, Size C
00-5983-060-04	QS Notch Guide, Size D
00-5983-060-05	QS Notch Guide, Size E
00-5983-060-06	QS Notch Guide, Size F
00-5977-062-00	2mm Tibial Recutter
00-5977-095-00	2° Varus/Valgus Tibial Recutter
00-5967-009-03	Distal Femoral Recutting Guide
00-5983-042-00	Femoral Finishing Guide, Size B
00-5983-043-00	Femoral Finishing Guide, Size C
00-5983-044-00	Femoral Finishing Guide, Size D
00-5983-045-00	Femoral Finishing Guide, Size E
00-5983-046-00	Femoral Finishing Guide, Size F

00-5973-001-00 NexGen Tibial Alignment/Resection Instrument Kit

Cat. No.	Description
00-5061-063-00	Hex-head Holding Pin
00-5120-061-00	Tibial Retractor (2)
00-5120-067-00	Tibial Peg Drill
00-5120-069-00	Tibial Holding Pegs
00-5967-033-01	Spring Screws, Short
00-5977-001-00	Extramedullary Tibial Alignment Guide
00-5977-003-00	Tibial Cutting Head, 7° (for .050° Sawblade)
00-5977-015-03	Pegged Plate Prov/Drill Guide, Size 3
00-5977-015-04	Pegged Plate Prov/Drill Guide, Size 4
00-5977-015-05	Pegged Plate Prov/Drill Guide, Size 5
00-5977-015-06	Pegged Plate Prov/Drill Guide, Size 6
00-5977-015-07	Pegged Plate Prov/Drill Guide, Size 7
00-5977-015-08	Pegged Plate Prov/Drill Guide, Size 8
00-5977-096-00	Locking Tibial Tray Prov Handle
00-5977-032-00	Tibial Milling Depth Resection Gauge
00-5977-033-00	Tibial Long-threaded Spring Pins
00-5977-035-00	MICRO-MILL Tibial Milling Base, 7°

CONTINUED ON PAGE 130

NEXGEN TIBIAL ALIGNMENT/RESECTION INSTRUMENT KIT 00-5973-001-00 (CONT.)

00-5973-001-00 NexGen Tibial Alignment/Resection Instrument Kit (cont)

Cat. No.	Description
00-5977-036-03	MICRO-MILL Tibial Milling Template, Size 3
00-5977-036-04	MICRO-MILL Tibial Milling Template, Size 4
00-5977-036-05	MICRO-MILL Tibial Milling Template, Size 5
00-5977-036-06	MICRO-MILL Tibial Milling Template, Size 6
00-5977-036-07	MICRO-MILL Tibial Milling Template, Size 7
00-5977-036-08	MICRO-MILL Tibial Milling Template, Size 8
00-5977-036-09	MICRO-MILL Tibial Milling Template, Size 9
00-5977-036-10	MICRO-MILL Tibial Milling Template, Size 10
00-5977-037-00	Patella Tendon Retractor
00-5977-050-00	Tibial Depth Resection Gauge, 10mm
00-5977-056-01	Short-head Holding Pin
00-5977-081-00	Proximal Tibial Reference Guide
00-5991-027-00	Tibial Milling Tray
00-5991-028-00	Tibial Flat Provisional Tray
00-5991-025-55	Tibial Alignment/Resection Instrument Case

NEXGEN IM TIBIAL MILLING INSTRUMENT/PROVISIONAL KIT 00-5973-002-00

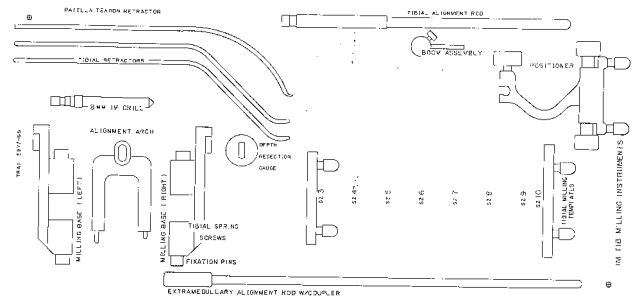

00-5973-002-00 NexGen IM Tibial Milling Instrument/Provisional Kit

Cat. No.	Description
00-5120-061-00	Tibial Retractor (2)
00-5785-080-00	Alignment Rod w/Coupler
00-5785-082-00	IM Drill, 8mm
00-5977-024-00	Extramedullary Alignment Arch
00-5977-032-00	Tibial Milling Depth Resection Gauge
00-5977-033-00	Tibial Long-Threaded Spring Screw
00-5977-036-03	Tibial Milling Template, Size 3
00-5977-036-04	Tibial Milling Template, Size 4
00-5977-036-05	Tibial Milling Template, Size 5
00-5977-036-06	Tibial Milling Template, Size 6
00-5977-036-07	Tibial Milling Template, Size 7
00-5977-036-08	Tibial Milling Template, Size 8
00-5977-036-09	Tibial Milling Template, Size 9
00-5977-036-10	Tibial Milling Template, Size 10
00-5977-037-00	Patella Tendon Retractor
00-5977-040-00	IM Tibial Boom, 7°
00-5977-044-00	IM Tibial Rod
00-5977-045-00	IM Tibial Milling Base Positioner
00-5977-047-01	IM Tibial Milling Base, Lt.
00-5977-047-02	IM Tibial Milling Base, Rt.
00-5978-013-00	Threaded Fixation Pins
00-5977-065-00	IM Tibial Milling Case

NEXGEN MIS TIBIAL/FEMORAL GENERAL INSTRUMENT KIT 00-5973-003-50

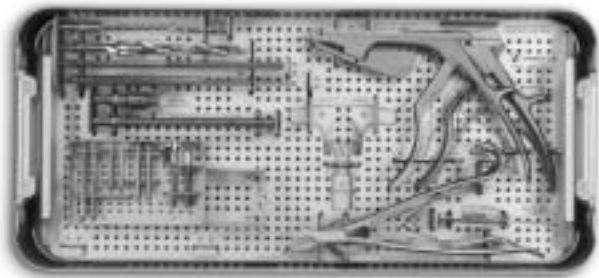

00-5973-003-50 MIS NexGen Tibial/Femoral General Instrument Kit

Cat. No.	Description
00-5983-099-00	Headless Pin Puller
00-5983-002-00	MIS Threaded Handle
00-5789-043-00	Holding Pin Pliers
00-5977-021-00	Articular Surface Removal Instrument
00-5977-020-00	Articular Surface Insertion Instrument
00-5061-088-00	Universal Femoral File
00-5120-085-00	3.2mm Bone Screw Drill
00-5120-087-00	Hex Head Screwdriver
00-5977-025-00	Tibial Impactor
00-5785-033-00	Femoral Impactor
00-5120-008-00	Universal Handle
00-5785-097-00	Slap Hammer Extractor
00-5967-002-00	Pin Driver/Extractor
00-5977-024-00	Alignment Arch

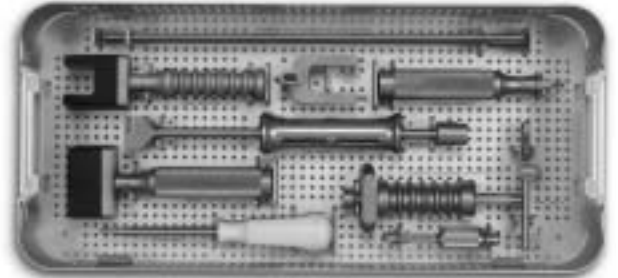

00-5973-003-50 MIS NexGen Tibial/Femoral General Instrument Kit

Cat. No.	Description
00-5785-079-00	Alignment Rod
00-5785-080-00	Alignment Rod/Coupler
00-5977-084-00	Resection Guide
00-5978-014-00	IM Step Drill, 8mm Dia.
00-5997-084-00	Gold Headless Pin
00-5061-063-00	Hex Head Holding Pin
00-5222-039-00	Headless Pin
00-5967-033-01	Short Spring Screw
00-5061-084-00	Cement Removal Tool
00-5791-049-00	Screw Inserter/Extractor
00-5983-092-00	MIS Femoral Impactor/Extractor
00-5983-049-00	MIS Screw Inserter/Extractor
00-5967-038-00	Blue Universal Lid
00-5967-056-00	Case

Optional (Sold Separately)

Cat. No.	Description
00-4301-004-00	Ratchet T-Handle
00-5978-001-00	Female Hex Screwdriver

NEXGEN TIBIAL/FEMORAL GENERAL INSTRUMENT KIT 00-5973-003-00

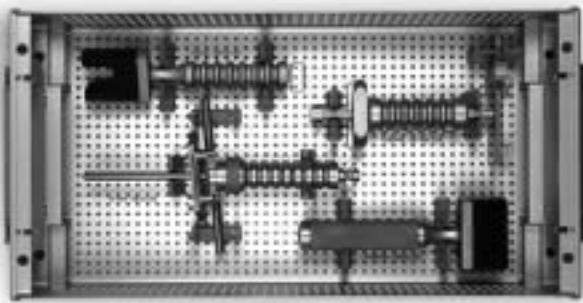
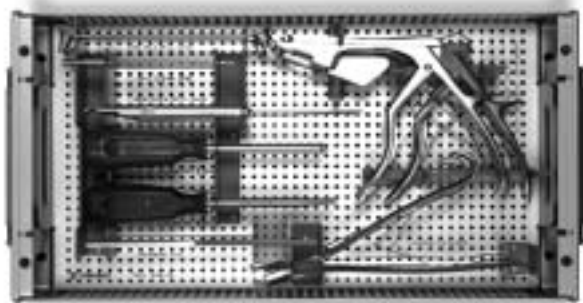

00-5973-003-00 NexGen Tibial/Femoral General Instrument Kit

Cat. No.	Description
00-5061-088-00	Universal Femoral File
00-5120-083-00	Bone Screw Depth Gauge
00-5120-084-00	Hand-held Drill Guide
00-5120-085-00	Bone Screw Drill
00-5120-087-00	Hex-head Screwdriver, 3.5mm
00-5785-033-00	IM Femoral Impactor
00-5789-043-00	Holding Pin Pliers
00-5977-020-00	Articular Surface Insertion Instrument
00-5977-021-00	Articular Surface Removal Instrument
00-5977-025-00	Tibial Impactor
00-5978-001-00	Female Hex Screwdriver
00-5978-020-00	Femoral Extractor
00-5991-030-55	Tibial/Femoral General Instrument Case

NEXGEN STEMMED TIBIAL INSTRUMENT/PROVISIONAL KIT 00-5973-004-00

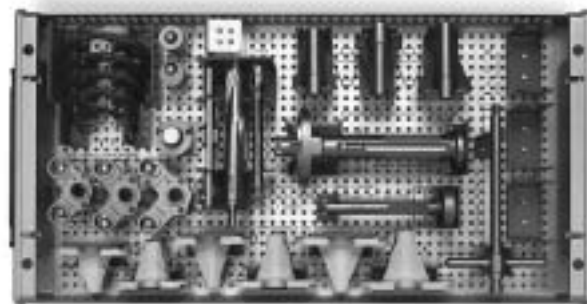

00-5973-004-00 NexGen Stemmed Tibial Instrument/Provisional Kit

Cat. No.	Description
00-5120-067-00	Stemmed Tibial Peg Drill
00-5977-009-00	Tibial Provisional Impactor
00-5977-010-00	Stemmed Tibial Drill
00-5977-010-01	Cemented Stem Drill
00-5977-011-00	Broach Impactor
00-5977-012-03	Sizing Plate, Size 3
00-5977-012-04	Sizing Plate, Size 4
00-5977-012-05	Sizing Plate, Size 5
00-5977-012-06	Sizing Plate, Size 6
00-5977-012-07	Sizing Plate, Size 7
00-5977-012-08	Sizing Plate, Size 8
00-5977-013-03	Tibial Broach, Size 3,4
00-5977-013-05	Tibial Broach, Size 5,6
00-5977-013-07	Tibial Broach, Size 7,8
00-5977-014-00	Cemented Stem Drill Guide
00-5977-096-00	Locking Tibial Tray Provisional Handle
00-5977-014-03	Drill Guide, Size 3,4
00-5977-014-05	Drill Guide, Size 5,6
00-5977-014-07	Drill Guide, Size 7,8
00-5977-017-00	Tibial Provisional Extractor
00-5977-026-03	Cemented Stemmed Tibial Hollow Broach, Size 3,4
00-5977-026-05	Cemented Stemmed Tibial Hollow Broach, Size 5,6
00-5977-026-07	Cemented Stemmed Tibial Hollow Broach, Size 7,8

CONTINUED ON PAGE 136

NEXGEN STEMMED TIBIAL INSTRUMENT/ PROVISIONAL KIT 00-5973-004-00 (CONT.)

00-5973-004-00 NexGen Stemmed Tibial Instrument/Provisional Kit (cont)

Cat. No.	Description
00-5977-056-01	Short-head Holding Pin
00-5977-096-00	Locking Tibial Tray Provisional Handle
00-5981-037-01	Stemmed Tibial Provisional, Size 3
00-5981-037-02	Stemmed Tibial Provisional, Size 4
00-5981-047-01	Stemmed Tibial Provisional, Size 5
00-5981-047-02	Stemmed Tibial Provisional, Size 6
00-5981-057-01	Stemmed Tibial Provisional, Size 7
00-5981-057-02	Stemmed Tibial Provisional, Size 8
00-5987-003-00	Straight Bushing
00-5987-004-00	Offset Bushing
00-5991-046-55	Stemmed Tibial Instrument/Prov Case

EM/IM TIBIAL RESECTOR INSTRUMENT KIT 00-5973-005-00

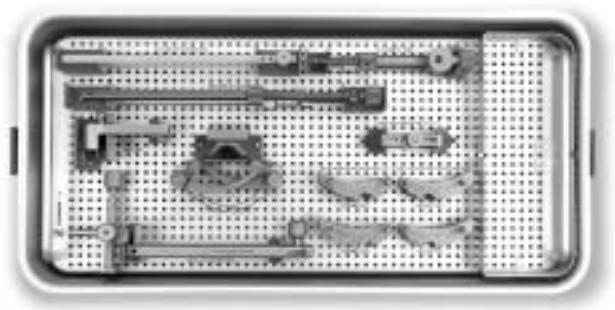

00-5973-005-00 EM/IM Tibial Resector Instrument Kit

Cat. No.	Description
00-5061-063-00	NexGen Hex Head Holding Pin
00-5120-061-00	Tibial Retractor (2)
00-5125-060-00	(0°) Augment Tibial Boom Tibial Boom Bushing (included w/Booms)
00-5222-039-00	Headless Pins, 48mm
00-5785-080-00	Alignment Rod with Coupler
00-5967-002-00	Female Hex Driver Bit
00-5967-033-01	Spring Screw, Short
00-5977-024-00	Extramedullary Alignment Arch
00-5977-037-00	Patella Tendon Retractor
00-5977-044-00	Tibial Milling IM Rod
00-5977-068-00	EM/IM Tibial Resector Case Assembly
00-5987-010-00	(7°) Revision Tibial Boom
00-5997-084-00	Headless Pin, 75mm

CONTINUED ON PAGE 138

EM/IM TIBIAL RESECTOR INSTRUMENT KIT 00-5973-005-00 (CONT.)

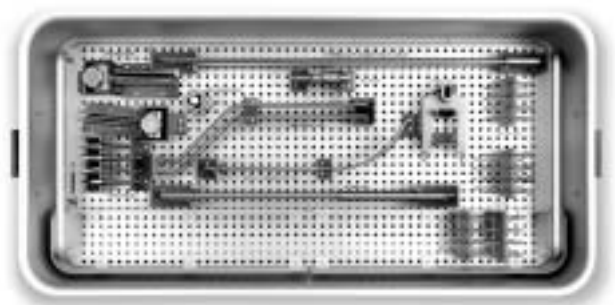

00-5973-005-00 EM/IM Tibial Resector Instrument Kit (cont)

Cat. No.	Description
00-5997-070-00	Ankle Clamp
00-5997-071-00	Distal Telescoping Rod
00-5997-072-00	Spike Arm Telescoping Rod
00-5997-073-00	Spike Arm
00-5997-074-00	Cut Guide Telescoping Rod
00-5997-075-00	0° Left Cut Guide
00-5997-076-00	0° Right Cut Guide
00-5997-079-00	7° Left Cut Guide
00-5997-080-00	7° Right Cut Guide
00-5997-081-00	Tibial Depth Resection Stylus
00-5997-083-00	IM Alignment Guide

NEXGEN TRABECULAR METAL CR/LPS MONOBLOCK TIBIAL INSTRUMENT KIT 00-5973-006-00

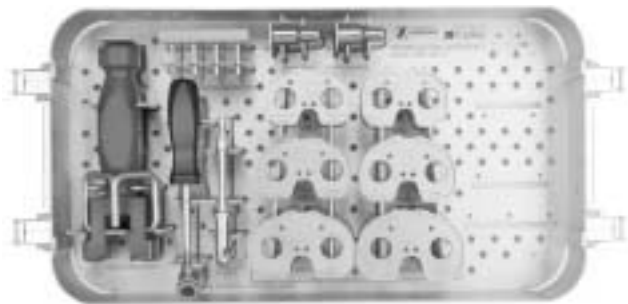

00-5973-006-00 NexGen Trabecular Metal CR/LPS Monoblock Tibial Instrument Kit

Cat. No.	Description
00-5887-043-00	Monoblock Tibial Prov./ Drill Guide, Size 3
00-5887-044-00	Monoblock Tibial Prov./ Drill Guide, Size 4
00-5887-045-00	Monoblock Tibial Prov./ Drill Guide, Size 5
00-5887-046-00	Monoblock Tibial Prov./ Drill Guide, Size 6
00-5887-047-00	Monoblock Tibial Prov./ Drill Guide, Size 7
00-5887-048-00	Monoblock Tibial Prov./ Drill Guide, Size 8
00-5887-051-00	Monoblock Tibial Drill Guide, 10.7 mm dia.
00-5887-052-00	Monoblock Tibial Drill w/Stop, 10.7 mm dia.
00-5887-055-00	Monoblock Tibial Peg Cement Mask
00-5887-056-00	Monoblock CR/LPS Tibial Impactor
00-5887-094-01	CR/LPS Tibial Instrument Case
00-5977-056-01	Short Head Holding Pin

NEXGEN FLUTED 7° STEM TIBIAL KIT 00-5973-007-00

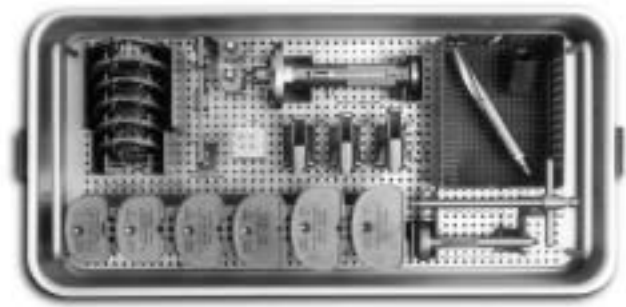

00-5973-007-00 NexGen Fluted 7° Stem Tibial Kit

Cat. No.	Description
00-5977-009-00	Stemmed Tibial Provisional Impactor
00-5977-010-02	Fluted Tibial Drill, 15mm
00-5977-011-00	Broach Impactor
00-5977-014-02	Tibial Drill Guide, 15mm
00-5977-096-00	Locking Tibial Tray Prov Handle
00-5977-017-00	Tibial Provisional Extractor
00-5977-056-01	Short-head Holding Pins
00-5987-003-00	Straight Bushing
00-5987-004-00	Offset Bushing
00-5997-038-01	Tibial Plate Prov, Size 3
00-5997-038-02	Tibial Plate Prov, Size 4
00-5997-048-01	Tibial Plate Prov, Size 5
00-5997-048-02	Tibial Plate Prov, Size 6
00-5997-058-01	Tibial Plate Prov, Size 7
00-5997-058-02	Tibial Plate Prov, Size 8
00-5997-060-03	Tibial Sizing Plate, Size 3
00-5997-060-04	Tibial Sizing Plate, Size 4
00-5997-060-05	Tibial Sizing Plate, Size 5
00-5997-060-06	Tibial Sizing Plate, Size 6
00-5997-060-07	Tibial Sizing Plate, Size 7
00-5997-060-08	Tibial Sizing Plate, Size 8
00-5997-061-03	Tibial Broach, Size 3,4
00-5997-061-05	Tibial Broach, Size 5,6
00-5997-061-07	Tibial Broach, Size 7,8
00-5991-070-00	Fluted Stem Tibial Case

NEXGEN LEGACY 3° FLUTED TIBIAL INSTRUMENT KIT 00-5973-008-00

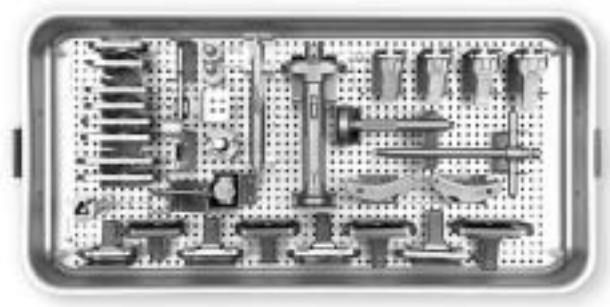

**00-5973-008-00 Nexgen Legacy 3° Fluted Tibial
Prov/Instrument Kit**

Cat. No.	Description
00-5977-005-00	3° Boom (IM) (Bushing Incl.)
00-5977-009-00	Stemmed Tibial Provisional Impactor
00-5977-010-02	Fluted Tibial Drill, 15mm
00-5977-011-00	Broach Impactor
00-5977-014-02	Tibial Drill Guide, 15mm
00-5977-017-00	Tibial Provisional Extractor
00-5977-056-01	Short-Head Holding Pins (BX)
00-5977-096-00	Locking Tib Tray Provisional Handle
00-5987-003-00	Straight Bushing
00-5987-004-00	Offset Bushing
00-5997-061-01	Tibial Broach; Size 1, 2
00-5997-061-03	Tibial Broach; Size 3, 4
00-5997-061-05	Tibial Broach; Size 5, 6
00-5997-061-07	Tibial Broach; Size 7, 8
00-5997-077-00	3° Left Cut Guide
00-5997-078-00	3° Right Cut Guide
00-5999-028-01	3° Fluted Tibial Plate Provisional; Size 1
00-5999-028-02	3° Fluted Tibial Plate Provisional; Size 2
00-5999-038-01	3° Fluted Tibial Plate Provisional; Size 3
00-5999-038-02	3° Fluted Tibial Plate Provisional; Size 4
00-5999-048-01	3° Fluted Tibial Plate Provisional; Size 5
00-5999-048-02	3° Fluted Tibial Plate Provisional; Size 6

CONTINUED ON PAGE 142

NEXGEN LEGACY 3° FLUTED TIBIAL INSTRUMENT KIT 00-5973-008-00 (CONT.)

00-5973-008-00 *Nexgen Legacy 3° Fluted Tibial* Prov/Instrument Kit (cont)

Cat. No.	Description
00-5999-058-01	3° Fluted Tibial Plate Provisional; Size 7
00-5999-058-02	3° Fluted Tibial Plate Provisional; Size 8
00-5999-060-01	3° Fluted Tibial Sizing Plate; Size 1
00-5999-060-02	3° Fluted Tibial Sizing Plate; Size 2
00-5999-060-03	3° Fluted Tibial Sizing Plate; Size 3
00-5999-060-04	3° Fluted Tibial Sizing Plate; Size 4
00-5999-060-05	3° Fluted Tibial Sizing Plate; Size 5
00-5999-060-06	3° Fluted Tibial Sizing Plate; Size 6
00-5999-060-07	3° Fluted Tibial Sizing Plate; Size 7
00-5999-060-08	3° Fluted Tibial Sizing Plate; Size 8
00-5999-091-00	3° Tibial Instr. Tray
00-5967-001-00	Generic Case Lid
00-5967-001-30	Generic Case Base, 3°

NEXGEN LEGACY 3° FLUTED TIBIAL AUGMENT/PROVISIONAL KIT 00-5973-009-00

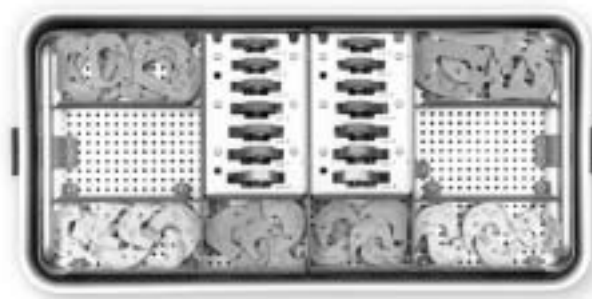

00-5973-009-00 *Nexgen Legacy 3° Fluted Tibial Augment* Prov/Instrument Kit

Cat. No.	Description
00-5999-002-20	16° Half Wedge Tibial Provisional; Size 2 (Rt/L, Lt/M)
00-5999-002-30	16° Half Wedge Tibial Provisional; Size 2 (Lt/L, Rt/M)
00-5999-003-20	16° Half Wedge Tibial Provisional; Size 3 (Rt/L, Lt/M)
00-5999-003-30	16° Half Wedge Tibial Provisional; Size 3 (Lt/L, Rt/M)
00-5999-004-20	16° Half Wedge Tibial Provisional; Size 4 (Rt/L, Lt/M)
00-5999-004-30	16° Half Wedge Tibial Provisional; Size 4 (Lt/L, Rt/M)
00-5999-005-20	16° Half Wedge Tibial Provisional; Size 5 (Rt/L, Lt/M)
00-5999-005-30	16° Half Wedge Tibial Provisional; Size 5 (Lt/L, Rt/M)
00-5999-006-20	16° Half Wedge Tibial Provisional; Size 6 (Rt/L, Lt/M)
00-5999-006-30	16° Half Wedge Tibial Provisional; Size 6 (Lt/L, Rt/M)
00-5999-007-20	16° Half Wedge Tibial Provisional; Size 7 (Rt/L, Lt/M)
00-5999-007-30	16° Half Wedge Tibial Provisional; Size 7 (Lt/L, Rt/M)
00-5999-008-20	16° Half Wedge Tibial Provisional; Size 8/9 (Rt/L, Lt/M)
00-5999-008-30	16° Half Wedge Tibial Provisional; Size 8/9 (Lt/L, Rt/M)
00-5999-002-23	7° Full Wedge Tibial Provisional; Size 2 (Rt/L, Lt/M)
00-5999-002-33	7° Full Wedge Tibial Provisional; Size 2 (Lt/L, Rt/M)
00-5999-003-23	7° Full Wedge Tibial Provisional; Size 3 (Rt/L, Lt/M)
00-5999-003-33	7° Full Wedge Tibial Provisional; Size 3 (Lt/L, Rt/M)
00-5999-004-23	7° Full Wedge Tibial Provisional; Size 4 (Rt/L, Lt/M)
00-5999-004-33	7° Full Wedge Tibial Provisional; Size 4 (Lt/L, Rt/M)
00-5999-005-23	7° Full Wedge Tibial Provisional; Size 5 (Rt/L, Lt/M)
00-5999-005-33	7° Full Wedge Tibial Provisional; Size 5 (Lt/L, Rt/M)
00-5999-006-23	7° Full Wedge Tibial Provisional; Size 6 (Rt/L, Lt/M)
00-5999-006-33	7° Full Wedge Tibial Provisional; Size 6 (Lt/L, Rt/M)
00-5999-007-23	7° Full Wedge Tibial Provisional; Size 7 (Rt/L, Lt/M)
00-5999-007-33	7° Full Wedge Tibial Provisional; Size 7 (Lt/L, Rt/M)

CONTINUED ON PAGE 144

NEXGEN LEGACY 3° FLUTED TIBIAL AUGMENT/ PROVISIONAL KIT 00-5973-009-00 (CONT.)

00-5973-009-00 Nexgen Legacy 3° Fluted Tibial Augment Prov/Instrument Kit (cont)

Cat. No.	Description
00-5999-008-23	7° Full Wedge Tibial Provisional; Size 8 (Rt/L, Lt/M)
00-5999-008-33	7° Full Wedge Tibial Provisional; Size 8 (Lt/L, Rt/M)
00-5999-002-26	5mm Block Tibial Aug. Provisional; Size 2 (Rt/L, Lt/M)
00-5999-002-36	5mm Block Tibial Aug. Provisional; Size 2 (Lt/L, Rt/M)
00-5999-003-26	5mm Block Tibial Aug. Provisional; Size 3 (Rt/L, Lt/M)
00-5999-003-36	5mm Block Tibial Aug. Provisional; Size 3 (Lt/L, Rt/M)
00-5999-004-26	5mm Block Tibial Aug. Provisional; Size 4 (Rt/L, Lt/M)
00-5999-004-36	5mm Block Tibial Aug. Provisional; Size 4 (Lt/L, Rt/M)
00-5999-005-26	5mm Block Tibial Aug. Provisional; Size 5 (Rt/L, Lt/M)
00-5999-005-36	5mm Block Tibial Aug. Provisional; Size 5 (Lt/L, Rt/M)
00-5999-006-26	5mm Block Tibial Aug. Provisional; Size 6 (Rt/L, Lt/M)
00-5999-006-36	5mm Block Tibial Aug. Provisional; Size 6 (Lt/L, Rt/M)
00-5999-007-26	5mm Block Tibial Aug. Provisional; Size 7 (Rt/L, Lt/M)
00-5999-007-36	5mm Block Tibial Aug. Provisional; Size 7 (Lt/L, Rt/M)
00-5999-008-26	5mm Block Tibial Aug. Provisional; Size 8/9 (Rt/L, Lt/M)
00-5999-008-36	5mm Block Tibial Aug. Provisional; Size 8/9 (Lt/L, Rt/M)
00-5999-002-27	10mm Block Tibial Aug. Provisional; Size 2 (Rt/L, Lt/M)
00-5999-002-37	10mm Block Tibial Aug. Provisional; Size 2 (Lt/L, Rt/M)
00-5999-003-27	10mm Block Tibial Aug. Provisional; Size 3 (Rt/L, Lt/M)
00-5999-003-37	10mm Block Tibial Aug. Provisional; Size 3 (Lt/L, Rt/M)
00-5999-004-27	10mm Block Tibial Aug. Provisional; Size 4 (Rt/L, Lt/M)
00-5999-004-37	10mm Block Tibial Aug. Provisional; Size 4 (Lt/L, Rt/M)
00-5999-005-27	10mm Block Tibial Aug. Provisional; Size 5 (Rt/L, Lt/M)
00-5999-005-37	10mm Block Tibial Aug. Provisional; Size 5 (Lt/L, Rt/M)
00-5999-006-27	10mm Block Tibial Aug. Provisional; Size 6 (Rt/L, Lt/M)
00-5999-006-37	10mm Block Tibial Aug. Provisional; Size 6 (Lt/L, Rt/M)
00-5999-007-27	10mm Block Tibial Aug. Provisional; Size 7 (Rt/L, Lt/M)
00-5999-007-37	10mm Block Tibial Aug. Provisional; Size 7 (Lt/L, Rt/M)
00-5999-008-27	10mm Block Tibial Aug. Provisional; Size 8/9 (Rt/L, Lt/M)
00-5999-008-37	10mm Block Tibial Aug. Provisional; Size 8/9 (Lt/L, Rt/M)

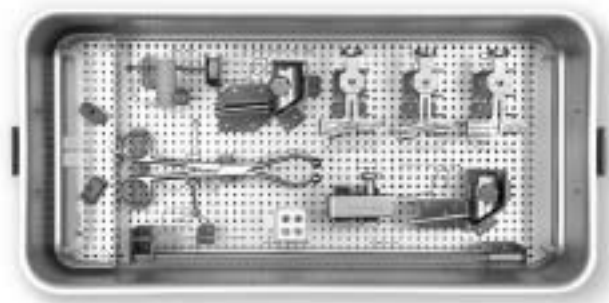

00-5973-009-00 Nexgen Legacy 3° Fluted Tibial Augment Prov/Instrument Kit (cont)

Cat. No.	Description
00-5061-063-00	Hex-Head Holding Pin (BX)
00-5125-081-00	Extramedullary Arch
00-5785-079-00	Alignment Rod
00-5785-080-00	Alignment Rod with Coupler
00-5977-030-00	Augment Assembly Clamp
00-5977-084-00	Resection Gauge
00-5987-015-00	Revision Half Wedge Cutter, 16°
00-5987-030-00	Revision Full Wedge Cutter 7°
00-5987-033-00	Revision Block Cutter, 5/10mm Block
00-5987-040-00	Revision Tibial/Depth Resection Gauge
00-5967-001-00	Generic Case Lid
00-5967-001-50	Generic Case Base, 5"
00-5999-096-00	3° Provisional Augment Tray
00-5999-097-00	3° Augment Instrumental Tray
00-5977-013-00	3° Offset Revision Tibial Boom
00-5987-017-01	7° Offset Revision Tibial Boom

NEXGEN A/P WEDGE TIBIAL PLATE INSTRUMENT KIT 00-5973-010-00

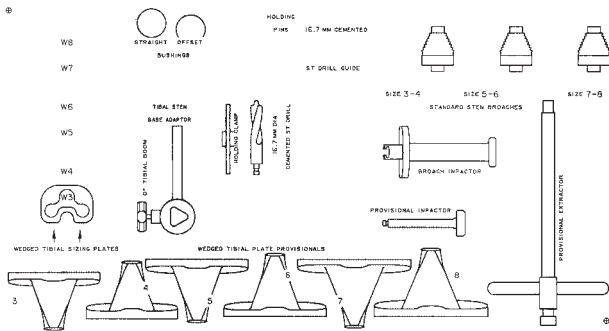

INSTRUMENT LAYOUT DIAGRAM

00-5973-010-00 NexGen A/P Wedge Tibial Plate Instrument Kit

Cat. No.	Description
00-5125-060-00	Tibial Boom, 0°
00-5977-009-00	Stemmed Tibial Prov Impactor
00-5977-010-01	Cemented Stem Drill
00-5977-011-00	Broach Impactor
00-5977-013-03	Tibial Broach, Size 3,4
00-5977-013-05	Tibial Broach, Size 5,6
00-5977-013-07	Tibial Broach, Size 7,8
00-5977-014-00	Cemented Stem Drill Guide
00-5977-096-00	Locking Tibial Tray Prov Handle
00-5977-017-00	Tibial Provisional Extractor
00-5977-056-01	Short-head Holding Pin
00-5987-003-00	Straight Bushing
00-5987-004-00	Offset Bushing
00-5987-006-00	Tibial Base Adaptor
00-5987-018-00	Offset Revision Tibial Boom, 0°
00-5987-043-00	Tibial Sizing Plate, Size 3
00-5987-044-00	Tibial Sizing Plate, Size 4
00-5987-045-00	Tibial Sizing Plate, Size 5
00-5987-046-00	Tibial Sizing Plate, Size 6
00-5987-047-00	Tibial Sizing Plate, Size 7
00-5987-048-00	Tibial Sizing Plate, Size 8
00-5989-003-00	Tibial Plate Prov, Size 3
00-5989-004-00	Tibial Plate Prov, Size 4
00-5989-005-00	Tibial Plate Prov, Size 5
00-5989-006-00	Tibial Plate Prov, Size 6
00-5989-007-00	Tibial Plate Prov, Size 7
00-5989-008-00	Tibial Plate Prov, Size 8
00-5987-095-55	A/P Wedge Tibial Plate Instrument Case

NEXGEN FEMORAL SIZING/ALIGNMENT INSTRUMENT KIT 00-5973-011-00

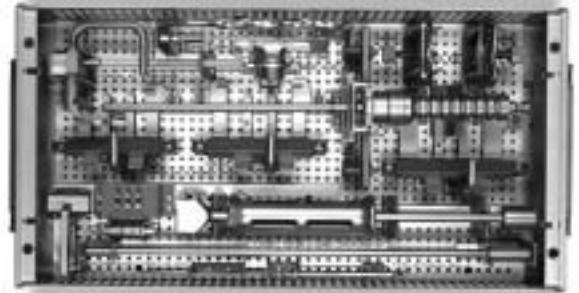

00-5973-011-00 NexGen Femoral Sizing/Alignment Instrument Kit

Cat. No.	Description
00-5120-052-01	Patellar/Femoral Drill
00-5120-085-00	Bone Screw Drill
00-5785-079-00	Alignment Rod
00-5785-080-00	Alignment Rod w/ Coupler
00-5785-097-00	Slaphammer Extractor
00-5967-002-00	Female Hex Driver Bit
00-5969-005-00	Standard Cut Spacer
00-5977-024-00	Extramedullary Alignment Arch
00-5977-084-00	Resection Guide
00-5978-003-00	IM Femoral A/P Sizing Guide
00-5978-004-00	MICRO-MILL Adjustable IM Guide
00-5978-006-00	MICRO-MILL 4-inch IM Guide
00-5978-007-03	A/P Placement Guide, Size C,D
00-5978-007-05	A/P Placement Guide, Size E,F
00-5978-007-07	A/P Placement Guide, Size G,H
00-5978-009-00	Downsizing Block
00-5978-009-03	Recutting Block, 3mm
00-5978-009-05	Recutting Block, 5mm
00-5978-011-01	MICRO-MILL Femoral Base, Left, Size C-H
00-5978-011-02	MICRO-MILL Femoral Base, Right, Size C-H
00-5978-012-00	Rotational Alignment Guide
00-5978-013-00	Threaded Fixation Pin
00-5978-014-00	IM Drill w/ Step, 8mm
00-5991-005-55	Femoral Sizing/Alignment Instrument Case

NEXGEN FEMORAL MILLING INSTRUMENT KIT 00-5973-012-00



00-5973-012-00 NexGen Femoral Milling Instrument Kit

Cat. No.	Description
00-5967-033-01	Spring Screws, Short
00-5978-031-03	Template, Size C
00-5978-031-04	Template, Size D
00-5978-031-05	Template, Size E
00-5978-031-06	Template, Size F
00-5978-031-07	Template, Size G
00-5978-035-03	Finishing Guide, Size C
00-5978-035-04	Finishing Guide, Size D
00-5978-035-05	Finishing Guide, Size E
00-5978-035-06	Finishing Guide, Size F
00-5978-035-07	Finishing Guide, Size G
00-5991-015-55	Femoral Milling Instrument Case

NEXGEN FEMORAL RESECTION/FINISHING INSTRUMENT (5-IN-1) KIT 00-5973-013-00

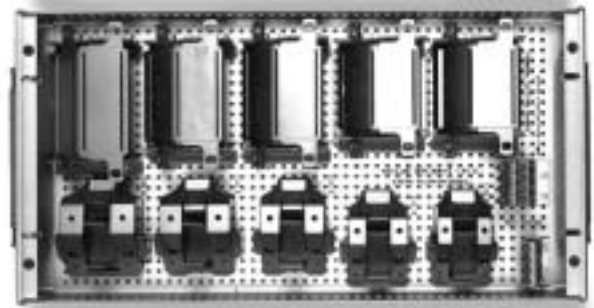

00-5973-013-00 NexGen Femoral Resection/Finishing Instr (5-in-1) Kit

Cat. No.	Description
00-5061-063-00	Hex-head Holding Pin
00-5967-033-01	Spring Screws, Short
00-5978-061-03	5-in-1 Femoral Cutting Guide, Size C
00-5978-061-04	5-in-1 Femoral Cutting Guide, Size D
00-5978-061-05	5-in-1 Femoral Cutting Guide, Size E
00-5978-061-06	5-in-1 Femoral Cutting Guide, Size F
00-5978-061-07	5-in-1 Femoral Cutting Guide, Size G
00-5991-010-55	Femoral Resection/Finishing Instrument (5-in-1) Case

See pages 175 - 178 for Notch Cutting Guide Options.

NEXGEN MILLING/5-IN-1 MICRO INSTRUMENT KIT 00-5973-014-00

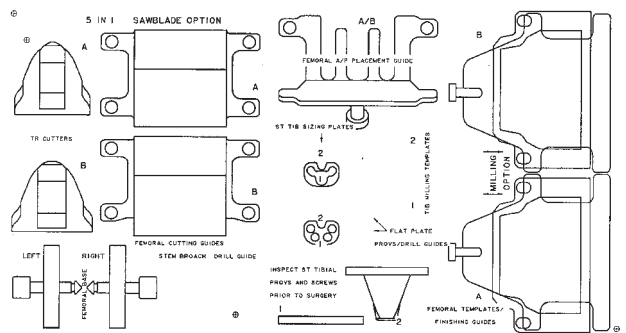
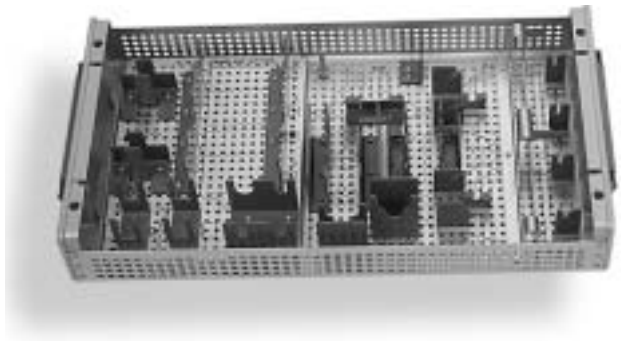

00-5973-014-00 NexGen Milling/5-in-1 Micro Instrument Kit

Cat. No.	Description
00-5977-012-01	Stemmed Tibial Sizing Plate, Size 1
00-5977-012-02	Stemmed Tibial Sizing Plate, Size 2
00-5977-013-01	Stemmed Tibial Broach, Size 1,2
00-5977-014-01	Stemmed Tibial Drill Guide, Size 1,2
00-5977-015-01	Flat Plate Provisional Drill Guide, Size 1
00-5977-015-02	Flat Plate Provisional Drill Guide, Size 2
00-5977-036-01	Tibial Milling Template, Size 1
00-5977-036-02	Tibial Milling Template, Size 2
00-5978-007-01	Femoral A/P Placement Guide, Size A,B
00-5978-010-01	Femoral Base, Left
00-5978-010-02	Femoral Base, Right

INSTRUMENT LAYOUT DIAGRAM

00-5973-014-00 NexGen Milling/5-in-1 Micro Instrument Kit (cont)

Cat. No.	Description
00-5978-031-01	Femoral Milling Template, Size A
00-5978-031-02	Femoral Milling Template, Size B
00-5978-035-01	Milling Finishing Guide, Size A
00-5978-035-02	Milling Finishing Guide, Size B
00-5978-064-01	5-in-1 Femoral Cutting Guide, Size A
00-5978-064-02	5-in-1 Femoral Cutting Guide, Size B
00-5978-071-01	TR Finishing Guide, Size A
00-5978-071-02	TR Finishing Guide, Size B
00-5981-027-01	Stemmed Tibial Provisional, Size 1
00-5981-027-02	Stemmed Tibial Provisional, Size 2
00-5991-090-55	Micro Instrument Case

NEXGEN MILLING/5-IN-1 MACRO INSTRUMENT/PROVISIONAL KIT 00-5973-019-00

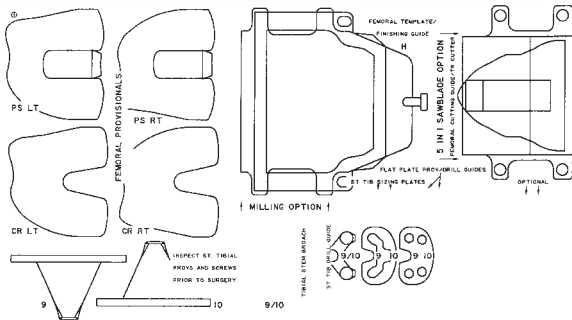
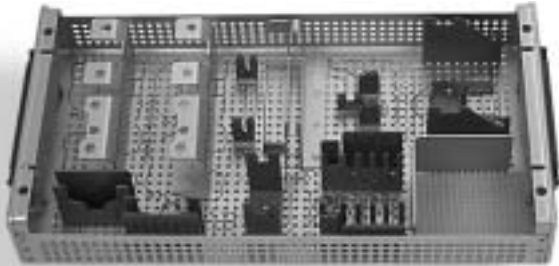

INSTRUMENT LAYOUT DIAGRAM

00-5973-019-00 NexGen Milling/5-in-1 Macro Instrument/Provisional Kit

Cat. No.	Description
00-5971-018-01	CR Femoral Provisional, Size H, Lt
00-5971-018-02	CR Femoral Provisional, Size H, Rt
00-5977-012-09	Stemmed Tibial Sizing Plate, Size 9
00-5977-012-10	Stemmed Tibial Sizing Plate, Size 10
00-5977-013-09	Stemmed Tibial Broach, Size 9,10
00-5977-014-09	Stemmed Tibial Drill Guide, Size 9,10
00-5977-015-09	Flat Plate Provisional/Drill Guide, Size 9
00-5977-015-10	Flat Plate Provisional/Drill Guide, Size 10
00-5978-031-08	Femoral Milling Template, Size H
00-5978-035-08	Milling Finishing Guide, Size H
00-5978-061-08	5-in-1 Femoral Cutting Guide, Size H
00-5978-064-08	5-in-1 Finishing Notch Guide, Size H
00-5981-057-03	Stemmed Tibial Provisional, Size 9
00-5981-057-04	Stemmed Tibial Provisional, Size 10
00-5997-018-01	LPS Femoral Provisional, Size H, Lt
00-5997-018-02	LPS Femoral Provisional, Size H, Rt
00-5991-020-55	Macro Instrument/Provisional Case

NEXGEN SHARP FLUTED STEM EXTENSION PROVISIONAL KIT 00-5973-023-00

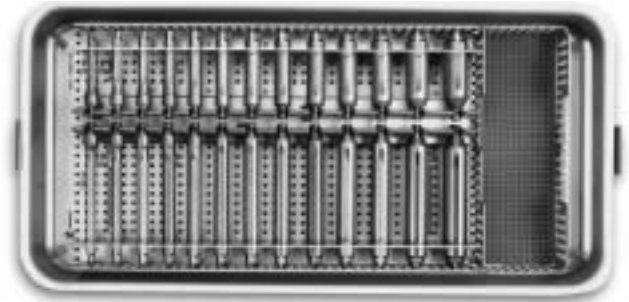

00-5973-023-00 NexGen Sharp Fluted Stem Extension Provisional Kit

Cat. No.	Description
00-5987-003-00	Straight Bushing
00-5989-012-12*	Stem Extension Provisional, 12.7mm x 75mm (30mm)
00-5989-015-10	Stem Extension Provisional, 10mm x 75mm
00-5989-015-11	Stem Extension Provisional, 11mm x 75mm
00-5989-015-12	Stem Extension Provisional, 12mm x 75mm
00-5989-015-13	Stem Extension Provisional, 13mm x 75mm
00-5989-015-14	Stem Extension Provisional, 14mm x 75mm
00-5989-015-15	Stem Extension Provisional, 15mm x 75mm
00-5989-015-16	Stem Extension Provisional, 16mm x 75mm
00-5989-015-17	Stem Extension Provisional, 17mm x 75mm
00-5989-015-18	Stem Extension Provisional, 18mm x 75mm
00-5989-015-19	Stem Extension Provisional, 19mm x 75mm
00-5989-015-20	Stem Extension Provisional, 20mm x 75mm
00-5989-015-22	Stem Extension Provisional, 22mm x 75mm
00-5989-015-24	Stem Extension Provisional, 24mm x 75mm
00-5989-016-10	Stem Extension Provisional, 10mm x 130mm
00-5989-016-11	Stem Extension Provisional, 11mm x 130mm
00-5989-016-12	Stem Extension Provisional, 12mm x 130mm
00-5989-016-13	Stem Extension Provisional, 13mm x 130mm
00-5989-016-14	Stem Extension Provisional, 14mm x 130mm
00-5989-016-15	Stem Extension Provisional, 15mm x 130mm
00-5989-016-16	Stem Extension Provisional, 16mm x 130mm
00-5989-016-17	Stem Extension Provisional, 17mm x 130mm
00-5989-016-18	Stem Extension Provisional, 18mm x 130mm
00-5989-016-19	Stem Extension Provisional, 19mm x 130mm
00-5989-016-20	Stem Extension Provisional, 20mm x 130mm
00-5989-016-22	Stem Extension Provisional, 22mm x 130mm
00-5989-016-24	Stem Extension Provisional, 24mm x 130mm
00-5967-001-00	Universal Case Lid
00-5967-001-25	Universal Base, 2.5in.
00-5969-086-00	Sharp Fluted Stem Extension Provisional Tray

*Not included in kit, order separately

NEXGEN STRAIGHT & OFFSET STEM EXTENSION PROVISIONAL KIT 00-5973-024-00

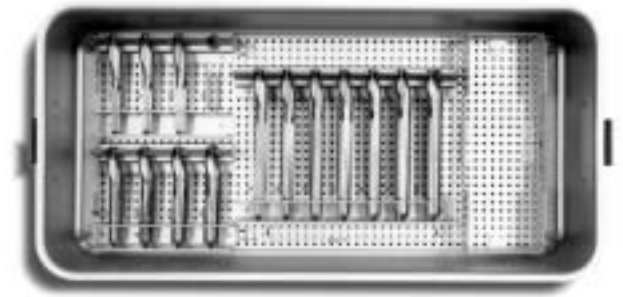
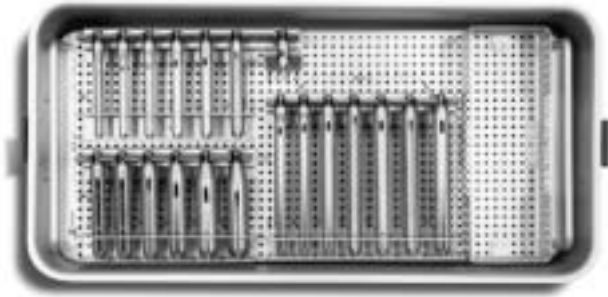

00-5973-024-00 NexGen Straight & Offset Stem Extension Prov Kit

Cat. No.	Description
00-5989-012-15	Straight Stem Extension Provisional, 15mm x 75mm
00-5989-010-10	Straight Stem Extension Provisional, 10mm x 145mm
00-5989-010-11	Straight Stem Extension Provisional, 11mm x 145mm
00-5989-010-12	Straight Stem Extension Provisional, 12mm x 145mm
00-5989-010-13	Straight Stem Extension Provisional, 13mm x 145mm
00-5989-010-14	Straight Stem Extension Provisional, 14mm x 145mm
00-5989-010-15	Straight Stem Extension Provisional, 15mm x 145mm
00-5989-010-16	Straight Stem Extension Provisional, 16mm x 145mm
00-5989-010-17	Straight Stem Extension Provisional, 17mm x 145mm
00-5989-010-18	Straight Stem Extension Provisional, 18mm x 145mm
00-5989-010-20	Straight Stem Extension Provisional, 20mm x 145mm
00-5989-010-22	Straight Stem Extension Provisional, 22mm x 145mm
00-5989-010-24	Straight Stem Extension Provisional, 24mm x 145mm
00-5989-011-12	Straight Stem Extension Provisional, 12mm x 200mm
00-5989-011-13	Straight Stem Extension Provisional, 13mm x 200mm
00-5989-011-14	Straight Stem Extension Provisional, 14mm x 200mm
00-5989-011-15	Straight Stem Extension Provisional, 15mm x 200mm
00-5989-011-16	Straight Stem Extension Provisional, 16mm x 200mm
00-5989-011-17	Straight Stem Extension Provisional, 17mm x 200mm
00-5989-011-18	Straight Stem Extension Provisional, 18mm x 200mm

X-Long Straight Stem Ext Provisionals (00-5993-012-12/18, 00-5993-012-20, 00-5993-012-22, 00-5993-012-24) are available only through Customer Service Loaner Program.

00-5973-024-00 NexGen Straight & Offset Stem Extension Prov Kit (cont)

Cat. No.	Description
00-5989-020-11	Offset Stem Extension Provisional, 11mm x 145mm
00-5989-020-12	Offset Stem Extension Provisional, 12mm x 145mm
00-5989-020-13	Offset Stem Extension Provisional, 13mm x 145mm
00-5989-020-14	Offset Stem Extension Provisional, 14mm x 145mm
00-5989-020-15	Offset Stem Extension Provisional, 15mm x 145mm
00-5989-020-16	Offset Stem Extension Provisional, 16mm x 145mm
00-5989-020-17	Offset Stem Extension Provisional, 17mm x 145mm
00-5989-020-18	Offset Stem Extension Provisional, 18mm x 145mm
00-5989-021-12	Offset Stem Extension Provisional, 12mm x 200mm
00-5989-021-13	Offset Stem Extension Provisional, 13mm x 200mm
00-5989-021-14	Offset Stem Extension Provisional, 14mm x 200mm
00-5989-021-15	Offset Stem Extension Provisional, 15mm x 200mm
00-5989-021-16	Offset Stem Extension Provisional, 16mm x 200mm
00-5989-021-17	Offset Stem Extension Provisional, 17mm x 200mm
00-5989-021-18	Offset Stem Extension Provisional, 18mm x 200mm
00-5967-001-00	Universal Case Lid
00-5967-001-50	Universal Base, 5in.
00-5969-087-00	Straight Stem Extension Prov Tray
00-5969-088-00	Offset Stem Extension Prov Tray

X-Long Straight Stem Ext Provisionals (00-5993-012-12/18, 00-5993-012-20, 00-5993-012-22, 00-5993-012-24) are available only through Customer Service Loaner Program.

NEXGEN PRIMARY POROUS PATELLA PROVISIONAL KIT 00-5973-034-00

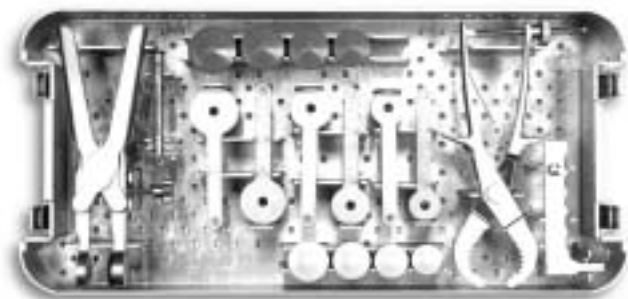

00-5973-034-00 *NexGen Primary Porous Patella Instrument Kit*

Cat. No.	Description
00-5879-065-32	Porous Patella Provisional, 32mm x 10mm
00-5879-065-35	Porous Patella Provisional, 35mm x 10mm
00-5879-065-38	Porous Patella Provisional, 38mm x 10mm
00-5879-065-41	Porous Patella Provisional, 41mm x 10mm
00-5879-061-26	Micro Porous Patella Provisional, 26mm x 10mm
00-5879-061-29	Micro Porous Patella Provisional, 29mm x 10mm
00-5879-061-32	Micro Porous Patella Provisional, 32mm x 10mm
00-5879-061-35	Micro Porous Patella Provisional, 35mm x 10mm
00-5879-067-26	Porous Patella Drill Guide, 26mm x 10mm
00-5879-067-29	Porous Patella Drill Guide, 29mm x 10mm
00-5879-067-32	Porous Patella Drill Guide, 32mm x 10mm
00-5879-067-35	Porous Patella Drill Guide, 35mm x 10mm
00-5879-067-38	Porous Patella Drill Guide, 38mm x 10mm
00-5879-067-41	Porous Patella Drill Guide, 41mm x 10mm
00-5879-052-00	Porous Patella Drill
00-3895-000-00	Townley Femoral Caliper
00-5781-062-00	Universal Patellar Saw Guide
00-5879-041-00	Porous Patella Clamp
00-5879-090-00	Porous Patella Instrument Case

NEXGEN AUGMENTATION PATELLA PROV/INSTRUMENT KITS 00-5973-030-00, 00-5877-009-00

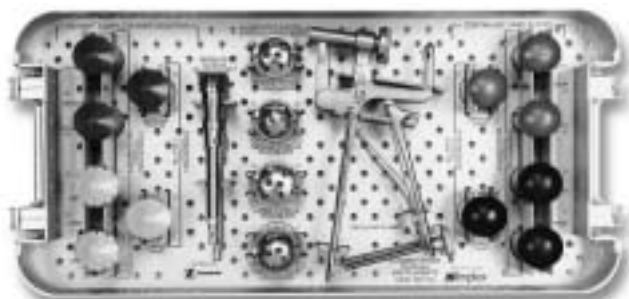

00-5973-030-00 *NexGen Augmentation Patella Provisional/Instrument Kit*

Cat. No.	Description
00-5877-010-19	Augmentation Patella Provisional, Medium, 19.5mm thick
00-5877-010-22	Augmentation Patella Provisional, Medium, 22.5mm thick
00-5877-011-20	Augmentation Patella Provisional, Large, 20mm thick
00-5877-011-23	Augmentation Patella Provisional, Large, 23mm thick
00-5877-010-10	All-Polyethylene Patella Provisional, Medium
00-5877-011-11	All-Polyethylene Patella Provisional, Large
00-5781-041-00	Patellar Clamp
00-5877-090-00	Augmentation Patella Instrument Case
00-5877-009-52	Reamer, 52mm
00-5877-012-38	Reamer, 38mm
00-5877-009-62	Reamer, 62mm
00-5877-012-44	Reamer, 44mm
00-5877-077-00	Shaft

*00-5877-009-00 *Continuum® †Augmentation Patella Prov/Instr Kit*

Cat. No.	Description
00-5877-036-19	Augmentation Patella Provisional, Medium, 19mm thick
00-5877-036-22	Augmentation Patella Provisional, Medium, 22mm thick
00-5877-039-19	Augmentation Patella Provisional, Large, 19mm thick
00-5877-039-22	Augmentation Patella Provisional, Large, 22mm thick
00-5877-036-10	All-Polyethylene Patella Provisional, Medium
00-5877-039-10	All-Polyethylene Patella Provisional, Large

†Trademark of Implex Corp.

*Manufactured by Implex Corp.

**The CKS *Continuum®* Augmentation Patella is not recommended for use with the *NexGen Knee System*

NOTE: Thickness includes both the patella and base.

NEXGEN PATELLA/SPACER BLOCK INSTRUMENT KITS 00-5973-031-00, 00-5973-033-00

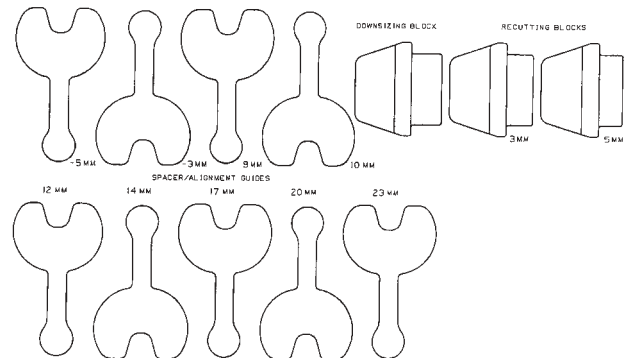
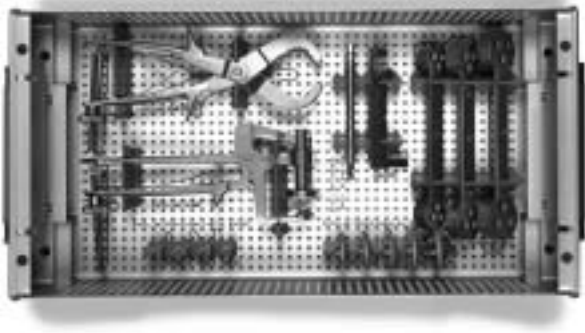

00-5973-031-00 NexGen Patella Spacer Block Instrument Kit

Cat. No.	Description
00-3895-000-00	Townley Femoral Caliper
00-5120-052-01	Patellar/Femoral Drill
00-5781-041-00	Patellar Clamp
00-5781-062-00	Universal Patellar Saw Guide
00-5971-065-29	Patellar Provisional, Size 29
00-5971-065-32	Patellar Provisional, Size 32
00-5971-065-35	Patellar Provisional, Size 35
00-5971-065-38	Patellar Provisional, Size 38
00-5971-065-41	Patellar Provisional, Size 41
00-5977-018-03	Spacer/Alignment Guide, 3mm
00-5977-018-05	Spacer/Alignment Guide, 5mm
00-5977-019-09	Spacer/Alignment Guide, 9mm
00-5977-019-10	Spacer/Alignment Guide, 10mm
00-5977-019-12	Spacer/Alignment Guide, 12mm
00-5977-019-14	Spacer/Alignment Guide, 14mm
00-5977-019-17	Spacer/Alignment Guide, 17mm
00-5977-019-20	Spacer/Alignment Guide, 20mm
00-5977-019-23	Spacer/Alignment Guide, 23mm
00-5979-001-26	Patellar Drill Guide, Sizes 26, 29mm
00-5979-001-32	Patellar Drill Guide, Sizes 32, 35mm
00-5979-001-38	Patellar Drill Guide, Sizes 38, 41mm
00-5991-035-55	Patella/Spacer Block Case
00-5991-037-50	Spacer Block Tray

00-5973-033-00 Micro Patella Provisional Kit

Cat. No.	Description
00-5971-061-26	Patella Provisional, Size 26
00-5971-061-29	Patella Provisional, Size 29
00-5971-061-32	Patella Provisional, Size 32
00-5971-061-35	Patella Provisional, Size 35

NEXGEN TIBIAL AUGMENT INSTRUMENT/PROVISIONAL KIT 00-5973-035-00

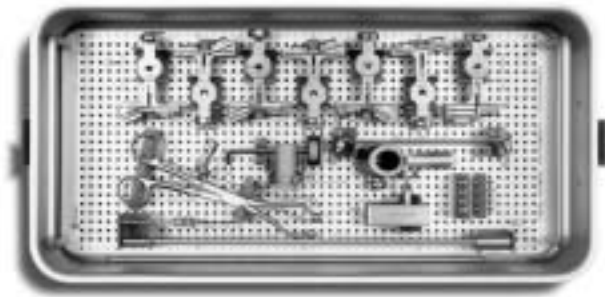

00-5973-035-00 NexGen Tibial Augment Instrument/Provisional Kit

Cat. No.	Description
00-5061-063-00	Hex-head Holding Pin
00-5125-081-00	Extramedullary Arch
00-5125-084-00	Hand-held Drill Guide
00-5785-080-00	Alignment Rod w/ Coupler
00-5977-030-00	Augment Assembly Clamp
00-5977-084-00	Resection Gauge
00-5987-010-00	Revision Tibial Boom, 7°
00-5987-015-00	Revision Half Wedge Cutter, 16°
00-5987-017-01	Offset Revision Tibial Boom, 7°
00-5987-020-00	Revision Half Wedge Cutter, 26°
00-5987-027-00	Revision Third Wedge Cutter, Size 3,4
00-5987-028-00	Revision Third Wedge Cutter, Size 5,6
00-5987-029-00	Revision Third Wedge Cutter, Size 7,8
00-5987-030-00	Revision Full Wedge Cutter, 7°
00-5987-033-01	Revision Block Cutter, 5, 10, 15, 20
00-5987-040-00	Revision Tibial/Depth Resection Gauge
00-5987-083-00	Femoral Sizing Template, E/F
00-5987-086-00	Augment Holding Clamp Head (2)
00-5989-002-10	Full Block Provisional, 10mm, Size 2
00-5989-003-10	Full Block Provisional, 10mm, Size 3
00-5989-003-20	Half Wedge Provisional, 16°, Size 3 (Rt/L, Lt/M)
00-5989-003-21	Half Wedge Provisional, 26°, Size 3 (Rt/L, Lt/M)
00-5989-003-22	Third Wedge Provisional, 22°, Size 3 (Rt/L, Lt/M)
00-5989-003-23	Full Wedge Provisional, 7°, Size 3 (Rt/L, Lt/M)
00-5989-003-26	Half Block Provisional, 5mm, Size 3 (Rt/L, Lt/M)
00-5989-003-27	Half Block Provisional, 10mm, Size 3 (Rt/L, Lt/M)
00-5989-003-28	Tapered Tib. Block, Prov., 15mm, Size 3 (Rt Lat/Lt Med)

00-5973-035-00 NexGen Tibial Augment Instrument/Provisional Kit (cont)

Cat. No.	Description
00-5989-003-29	Tapered Tib. Block, Prov., 20mm, Size 3 (Rt Lat/Lt Med)
00-5989-003-30	Half Wedge Provisional, 16°, Size 3 (Lt/L, Rt/M)
00-5989-003-31	Half Wedge Provisional, 26°, Size 3 (Lt/L, Rt/M)
00-5989-003-32	Third Wedge Provisional, 22°, Size 3 (Lt/L, Rt/M)
00-5989-003-33	Full Wedge Provisional, 7°, Size 3 (Lt/L, Rt/M)
00-5989-003-36	Half Block Provisional, 5mm, Size 3 (Lt/L, Rt/M)
00-5989-003-37	Half Block Provisional, 10mm, Size 3 (Lt/L, Rt/M)
00-5989-003-38	Tapered Tib. Block, Prov., 15mm, Size 3 (Lt Lat/Rt Med)
00-5989-003-39	Tapered Tib. Block, Prov., 20mm, Size 3 (Lt Lat/Rt Med)
00-5989-004-10	Full Block Provisional, 10mm, Size 4
00-5989-004-20	Half Wedge Provisional, 16°, Size 4 (Rt/L, Lt/M)
00-5989-004-21	Half Wedge Provisional, 26°, Size 4 (Rt/L, Lt/M)
00-5989-004-22	Third Wedge Provisional, 22°, Size 4 (Rt/L, Lt/M)
00-5989-004-23	Full Wedge Provisional, 7°, Size 4 (Rt/L, Lt/M)
00-5989-004-26	Half Block Provisional, 5mm, Size 4 (Rt/L, Lt/M)
00-5989-004-27	Half Block Provisional, 10mm, Size 4 (Rt/L, Lt/M)
00-5989-004-28	Tapered Tib. Block, Prov., 15mm, Size 4 (Rt Lat/Lt Med)
00-5989-004-29	Tapered Tib. Block, Prov., 20mm, Size 4 (Rt Lat/Lt Med)
00-5989-004-30	Half Wedge Provisional, 16°, Size 4 (Lt/L, Rt/M)
00-5989-004-31	Half Wedge Provisional, 26°, Size 4 (Lt/L, Rt/M)
00-5989-004-32	Half Wedge Provisional, 22°, Size 4 (Lt/L, Rt/M)
00-5989-004-33	Full Wedge Provisional, 7°, Size 4 (Lt/L, Rt/M)
00-5989-004-36	Half Block Provisional, 5mm, Size 4 (Lt/L, Rt/M)
00-5989-004-37	Half Block Provisional, 10mm, Size 4 (Lt/L, Rt/M)
00-5989-004-38	Tapered Tib. Block, Prov., 15mm, Size 4 (Lt Lat/Rt Med)
00-5989-004-39	Tapered Tib. Block, Prov., 20mm, Size 4 (Lt Lat/Rt Med)
00-5989-005-10	Full Block Provisional, 10mm, Size 5
00-5989-005-20	Half Wedge Provisional, 16°, Size 5 (Rt/L, Lt/M)
00-5989-005-21	Half Wedge Provisional, 26°, Size 5 (Rt/L, Lt/M)
00-5989-005-22	Third Wedge Provisional, 22°, Size 5 (Rt/L, Lt/M)
00-5989-005-23	Full Wedge Provisional, 7°, Size 5 (Rt/L, Lt/M)
00-5989-005-26	Half Block Provisional, 5mm, Size 5 (Rt/L, Lt/M)
00-5989-005-27	Half Block Provisional, 10mm, Size 5 (Rt/L, Lt/M)
00-5989-005-28	Tapered Tib. Block, Prov., 15mm, Size 5 (Rt Lat/Lt Med)
00-5989-005-29	Tapered Tib. Block, Prov., 20mm, Size 5 (Rt Lat/Lt Med)
00-5989-005-30	Half Wedge Provisional, 16°, Size 5 (Lt/L, Rt/M)

CONTINUED ON PAGE 162

NEXGEN TIBIAL AUGMENT INSTRUMENT/ PROVISIONAL KIT 00-5973-035-00 (CONT.)

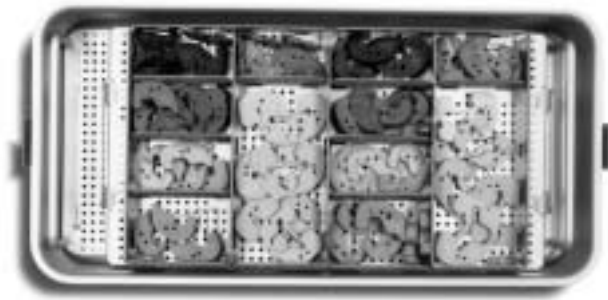

00-5973-035-00 NexGen Tibial Augment Instrument/Provisional Kit (cont)

Cat. No.	Description
00-5989-005-31	Half Wedge Provisional, 26°, Size 5 (Lt/L, Rt/M)
00-5989-005-32	Third Wedge Provisional, 22°, Size 5 (Lt/L, Rt/M)
00-5989-005-33	Full Wedge Provisional, 7°, Size 5 (Lt/L, Rt/M)
00-5989-005-38	Tapered Block, Prov., 15mm, Size 5 (Lt Lat/Rt Med)
00-5989-005-39	Tapered Block, Prov., 20mm, Size 5 (Lt Lat/Rt Med)
00-5989-005-36	Half Block Provisional, 5mm, Size 5 (Lt/L, Rt/M)
00-5989-005-37	Half Block Provisional, 10mm, Size 5 (Lt/L, Rt/M)
00-5989-006-10	Full Block Provisional, 10mm, Size 6
00-5989-006-20	Half Wedge Provisional, 16°, Size 6 (Rt/L, Lt/M)
00-5989-006-21	Half Wedge Provisional, 26°, Size 6 (Rt/L, Lt/M)
00-5989-006-22	Third Wedge Provisional, 22°, Size 6 (Rt/L, Lt/M)
00-5989-006-23	Full Wedge Provisional, 7°, Size 6 (Rt/L, Lt/M)
00-5989-006-26	Half Block Provisional, 5mm, Size 6 (Rt/L, Lt/M)
00-5989-006-27	Half Block Provisional, 10mm, Size 6 (Rt/L, Lt/M)
00-5989-006-28	Tapered Block, Prov., 15mm, Size 6 (Rt Lat/Lt Med)
00-5989-006-29	Tapered Block, Prov., 20mm, Size 6 (Rt Lat/Lt Med)
00-5989-006-30	Half Wedge Provisional, 16°, Size 6 (Lt/L, Rt/M)
00-5989-006-31	Half Wedge Provisional, 26°, Size 6 (Lt/L, Rt/M)
00-5989-006-32	Third Wedge Provisional, 22°, Size 6 (Lt/L, Rt/M)
00-5989-006-33	Full Wedge Provisional, 7°, Size 6 (Lt/L, Rt/M)
00-5989-006-36	Half Block Provisional, 5mm, Size 6 (Lt/L, Rt/M)
00-5989-006-37	Half Block Provisional, 10mm, Size 6 (Lt/L, Rt/M)
00-5989-006-38	Tapered Block, Prov., 15mm, Size 6 (Lt Lat/Rt Med)
00-5989-006-39	Tapered Block, Prov., 20mm, Size 6 (Lt Lat/Rt Med)
00-5989-007-10	Full Block Provisional, 10mm, Size 7
00-5989-007-20	Half Wedge Provisional, 16°, Size 7 (Rt/L, Lt/M)
00-5989-007-21	Half Wedge Provisional, 26°, Size 7 (Rt/L, Lt/M)

00-5973-035-00 NexGen Tibial Augment Instrument/Provisional Kit (cont)

Cat. No.	Description
00-5989-007-22	Third Wedge Provisional, 22°, Size 7 (Rt/L, Lt/M)
00-5989-007-23	Full Wedge Provisional, 7°, Size 7 (Rt/L, Lt/M)
00-5989-007-26	Half Block Provisional, 5mm, Size 7 (Rt/L, Lt/M)
00-5989-007-27	Half Block Provisional, 10mm, Size 7 (Rt/L, Lt/M)
00-5989-007-28	Tapered Block, Prov., 15mm, Size 7 (Rt Lat/Lt Med)
00-5989-007-29	Tapered Block, Prov., 20mm, Size 7 (Rt Lat/Lt Med)
00-5989-007-30	Half Wedge Provisional, 16°, Size 7 (Lt/L, Rt/M)
00-5989-007-31	Half Wedge Provisional, 26°, Size 7 (Lt/L, Rt/M)
00-5989-007-32	Third Wedge Provisional, 22°, Size 7 (Lt/L, Rt/M)
00-5989-007-33	Full Wedge Provisional, 7°, Size 7 (Lt/L, Rt/M)
00-5989-007-36	Half Block Provisional, 5mm, Size 7 (Lt/L, Rt/M)
00-5989-007-37	Half Block Provisional, 10mm, Size 7 (Lt/L, Rt/M)
00-5989-007-38	Tapered Block, Prov., 15mm, Size 7 (Lt Lat/Rt Med)
00-5989-007-39	Tapered Block, Prov., 20mm, Size 7 (Lt Lat/Rt Med)
00-5989-008-10	Full Block Provisional, 10mm, Size 8
00-5989-008-20	Half Wedge Provisional, 16°, Size 8 (Rt/L, Lt/M)
00-5989-008-21	Half Wedge Provisional, 26°, Size 8 (Rt/L, Lt/M)
00-5989-008-22	Third Wedge Provisional, 22°, Size 8 (Rt/L, Lt/M)
00-5989-008-23	Full Wedge Provisional, 7°, Size 8 (Rt/L, Lt/M)
00-5989-008-26	Half Block Provisional, 5mm, Size 8 (Rt/L, Lt/M)
00-5989-008-27	Half Block Provisional, 10mm, Size 8 (Rt/L, Lt/M)
00-5989-008-28	Tapered Block, Prov., 15mm, Size 8 (Rt Lat/Lt Med)
00-5989-008-29	Tapered Block, Prov., 20mm, Size 8 (Rt Lat/Lt Med)
00-5989-008-30	Half Wedge Provisional, 16°, Size 8 (Lt/L, Rt/M)
00-5989-008-31	Half Wedge Provisional, 26°, Size 8 (Lt/L, Rt/M)
00-5989-008-32	Third Wedge Provisional, 22°, Size 8 (Lt/L, Rt/M)
00-5989-008-33	Full Wedge Provisional, 7°, Size 8 (Lt/L, Rt/M)
00-5989-008-36	Half Block Provisional, 5mm, Size 8 (Lt/L, Rt/M)
00-5989-008-37	Half Block Provisional, 10mm, Size 8 (Lt/L, Rt/M)
00-5989-008-38	Tapered Block, Prov., 15mm, Size 8 (Lt Lat/Rt Med)
00-5989-008-39	Tapered Block, Prov., 20mm, Size 8 (Lt Lat/Rt Med)
00-5989-009-23	Full Wedge Provisional, 7°, Size 9 (Rt/L, Lt/M)
00-5989-009-33	Full Wedge Provisional, 7°, Size 9 (Lt/L, Rt/M)
00-5990-080-00	Tibial Augment Provisional Instrument Case
00-5222-039-00	Headless Pins, 48mm
00-5989-002-26	Tibial Block Prov., 5mm, Size 2 (Rt/L, Lt/M)
00-5989-002-27	Tibial Block Prov., 10mm, Size 2 (Rt/L, Lt/M)
00-5989-002-36	Tibial Block Prov., 5mm, Size 2 (Lt/L, Rt/M)
00-5989-002-37	Tibial Block Prov., 10mm, Size 2 (Lt/L, Rt/M)
00-5989-002-28	Tapered Block Provisional, 15mm, Size 2 (Rt L/Lt M)
00-5989-002-29	Tapered Block Provisional, 20mm, Size 2 (Rt L/Lt M)
00-5989-002-38	Tapered Block Provisional, 15mm, Size 2 (Lt L/Rt M)
00-5989-002-39	Tapered Block Provisional, 20mm, Size 2 (Lt L/Rt M)

CONTINUED ON PAGE 164

NEXGEN TIBIAL AUGMENT INSTRUMENT/ PROVISIONAL KIT 00-5973-035-00 (CONT.)

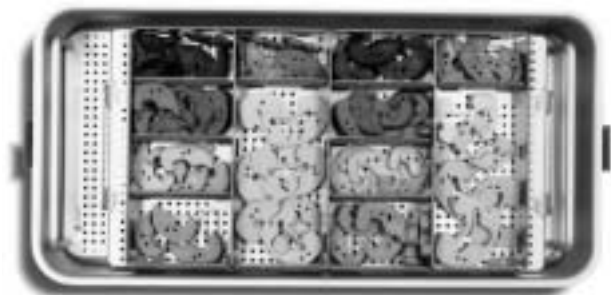

00-5973-035-00 *NexGen Tibial Augment Instrument/Provisional Kit (cont)*

Cat. No.	Description
00-5989-001-10*	Full Block Provisional, 10mm, Size 11
00-5989-001-26*	Half Block Provisional, 5mm, Size 1 (Rt L/Lt M)
00-5989-001-27*	Half Block Provisional, 10mm, Size 1 (Rt L/Lt M)
00-5989-001-28*	Tapered Block Provisional, 15mm, Size 1 (Rt L/Lt M)
00-5989-001-29*	Tapered Block Provisional, 20mm, Size 1 (Rt L/Lt M)
00-5989-001-36*	Half Block Provisional, 5mm, Size 1 (Lt L/Rt M)
00-5989-001-37*	Half Block Provisional, 10mm, Size 1 (Lt L/Rt M)
00-5989-001-38*	Tapered Block Provisional, 15mm, Size 1 (Lt L/Rt M)
00-5989-001-39*	Tapered Block Provisional, 20mm, Size 1 (Lt L/Rt M)
00-5989-002-20*	Half Wedge Prov., 16°, Size 2 (Rt/L/Lt/M)
00-5989-002-21*	Half Wedge Prov., 26°, Size 2 (Rt/L/Lt/M)
00-5989-002-22*	Third Wedge Prov., 22°, Size 2 ((Rt/L/Lt/M)
00-5989-002-23*	Full Wedge Prov., 7°, Size 2 (Rt/L/Lt/M)
00-5989-002-30*	Half Wedge Prov., 16°, Size 2 (Lt/L/Rt/M)
00-5989-002-31*	Half Wedge Prov., 26°, Size 2 (Lt/L/Rt/M)
00-5989-002-32*	Third Wedge Prov., 22°, Size 2 (Lt/L/Rt/M)
00-5989-002-33*	Full Wedge Prov., 7°, Size 2 (Lt/L/Rt/M)

*Not included in kit, order separately

NEXGEN REAMER KIT 00-5973-036-00

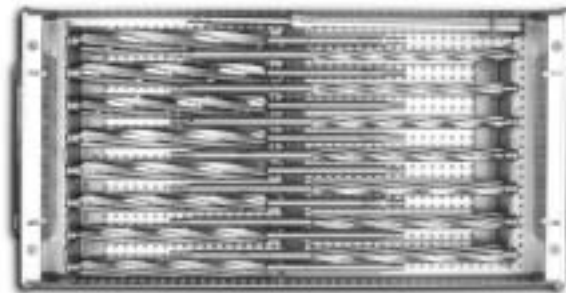

00-5973-036-00 *NexGen Reamer Kit*

Cat. No.	Description
00-5125-010-09	9mm Diameter Reamer
00-5125-011-10	10mm Diameter Reamer
00-5125-011-11	11mm Diameter Reamer
00-5125-011-12	12mm Diameter Reamer
00-5125-011-13	13mm Diameter Reamer
00-5125-011-14	14mm Diameter Reamer
00-5125-011-15	15mm Diameter Reamer
00-5125-011-16	16mm Diameter Reamer
00-5125-011-17	17mm Diameter Reamer
00-5125-011-18	18mm Diameter Reamer
00-5125-011-19	19mm Diameter Reamer
00-5125-011-20	20mm Diameter Reamer
00-5125-011-21	21mm Diameter Reamer
00-5125-011-22	22mm Diameter Reamer
00-5125-011-23	23mm Diameter Reamer
00-5125-011-24	24mm Diameter Reamer
00-5991-055-55	Reamer Case

NEXGEN CR PROVISIONAL KITS 00-5973-041-00, 00-5973-043-00

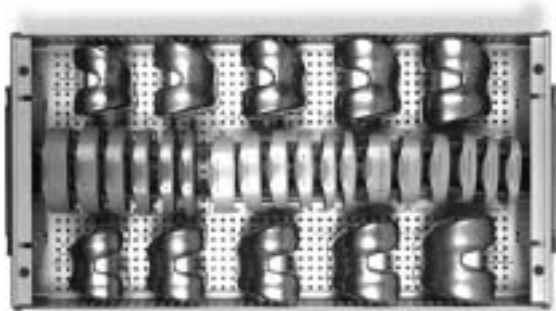

00-5973-041-00 NexGen CR Provisional Kit

Cat. No.	Description
00-5971-013-01	Femoral Prov, Size C, Lt
00-5971-013-02	Femoral Prov, Size C, Rt
00-5971-014-01	Femoral Prov, Size D, Lt
00-5971-014-02	Femoral Prov, Size D, Rt
00-5971-015-01	Femoral Prov, Size E, Lt
00-5971-015-02	Femoral Prov, Size E, Rt
00-5971-016-01	Femoral Prov, Size F, Lt
00-5971-016-02	Femoral Prov, Size F, Rt
00-5971-017-01	Femoral Prov, Size G, Lt
00-5971-017-02	Femoral Prov, Size G, Rt
00-5971-030-10	Articular Surf Prov, Yellow, 10mm (Fem C-H - Tib 3,4)
00-5971-030-12	Articular Surf Prov, Yellow, 12mm (Fem C-H - Tib 3,4)
00-5971-030-14	Articular Surf Prov, Yellow, 14mm (Fem C-H - Tib 3,4)
00-5971-030-17	Articular Surf Prov, Yellow, 17mm (Fem C-H - Tib 3,4)
00-5971-030-20	Articular Surf Prov, Yellow, 20mm (Fem C-H - Tib 3,4)
00-5971-040-10	Articular Surf Prov, Green, 10mm (Fem C-H - Tib 5,6)
00-5971-040-12	Articular Surf Prov, Green, 12mm (Fem C-H - Tib 5,6)
00-5971-040-14	Articular Surf Prov, Green, 14mm (Fem C-H - Tib 5,6)
00-5971-040-17	Articular Surf Prov, Green, 17mm (Fem C-H - Tib 5,6)
00-5971-040-20	Articular Surf Prov, Green, 20mm (Fem C-H - Tib 5,6)
00-5971-050-10	Articular Surf Prov, Blue, 10mm (Fem C-H - Tib 7-10)
00-5971-050-12	Articular Surf Prov, Blue, 12mm (Fem C-H - Tib 7-10)
00-5971-050-14	Articular Surf Prov, Blue, 14mm (Fem C-H - Tib 7-10)
00-5971-050-17	Articular Surf Prov, Blue, 17mm (Fem C-H - Tib 7-10)
00-5971-050-20	Articular Surf Prov, Blue, 20mm (Fem C-H - Tib 7-10)
00-5991-040-55	CR Provisional Case

00-5973-043-00 NexGen CR Micro Provisional Kit

Cat. No.	Description
00-5971-011-01	Femoral Prov, Size A, Lt
00-5971-011-02	Femoral Prov, Size A, Rt
00-5971-012-01	Femoral Prov, Size B, Lt
00-5971-012-02	Femoral Prov, Size B, Rt
00-5971-020-10	Articular Surf Prov, Purple, 10mm (Fem A,B - Tib 1,2)
00-5971-020-12	Articular Surf Prov, Purple, 12mm (Fem A,B - Tib 1,2)
00-5971-020-14	Articular Surf Prov, Purple, 14mm (Fem A,B - Tib 1,2)
00-5971-020-17	Articular Surf Prov, Purple, 17mm (Fem A,B - Tib 1,2)
00-5971-020-20	Articular Surf Prov, Purple, 20mm (Fem A,B - Tib 1,2)
00-5971-021-10	Articular Surf Prov, Str Purple, 10mm (Fem C-H - Tib 1,2)
00-5971-021-12	Articular Surf Prov, Str Purple, 12mm (Fem C-H - Tib 1,2)
00-5971-021-14	Articular Surf Prov, Str Purple, 14mm (Fem C-H - Tib 1,2)
00-5971-021-17	Articular Surf Prov, Str Purple, 17mm (Fem C-H - Tib 1,2)
00-5971-021-20	Articular Surf Prov, Str Purple, 20mm (Fem C-H - Tib 1,2)
00-5971-031-10	Articular Surf Prov, Str Yellow, 10mm (Fem A,B - Tib 3,4)
00-5971-031-12	Articular Surf Prov, Str Yellow, 12mm (Fem A,B - Tib 3,4)
00-5971-031-14	Articular Surf Prov, Str Yellow, 14mm (Fem A,B - Tib 3,4)
00-5971-031-17	Articular Surf Prov, Str Yellow, 17mm (Fem A,B - Tib 3,4)
00-5971-031-20	Articular Surf Prov, Str Yellow, 20mm (Fem A,B - Tib 3,4)
00-5991-080-55	CR Micro Provisional Case

NEXGEN CR/MICRO PROVISIONAL KIT 00-5930-043-00

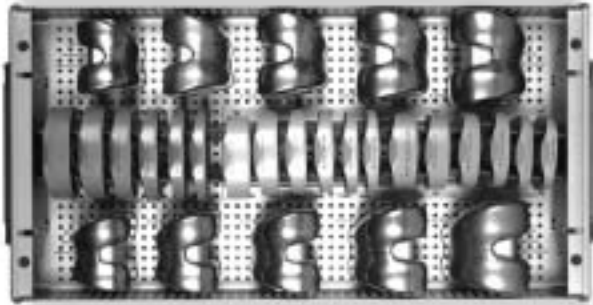

00-5930-043-00 NexGen CR Micro Provisional Kit

Cat. No.	Description
00-5971-011-01	Femoral Prov, Size A, Lt
00-5971-011-02	Femoral Prov, Size A, Rt
00-5971-012-01	Femoral Prov, Size B, Lt
00-5971-012-02	Femoral Prov, Size B, Rt
00-5971-020-09	Articular Surf Prov, Purple, 9mm (Fem A, B - Tib 1, 2)
00-5971-020-10	Articular Surf Prov, Purple, 10mm (Fem A, B - Tib 1, 2)
00-5971-020-12	Articular Surf Prov, Purple, 12mm (Fem A, B - Tib 1, 2)
00-5971-020-14	Articular Surf Prov, Purple, 14mm (Fem A, B - Tib 1, 2)
00-5971-020-17	Articular Surf Prov, Purple, 17mm (Fem A, B - Tib 1, 2)
00-5971-020-20	Articular Surf Prov, Purple, 20mm (Fem A, B - Tib 1, 2)
00-5971-021-09	Articular Surf Prov, Str Purple, 9mm (Fem C, H - Tib 1, 2)
00-5971-021-10	Articular Surf Prov, Str Purple, 10mm (Fem C, H - Tib 1, 2)
00-5971-021-12	Articular Surf Prov, Str Purple, 12mm (Fem C, H - Tib 1, 2)
00-5971-021-14	Articular Surf Prov, Str Purple, 14mm (Fem C, H - Tib 1, 2)
00-5971-021-17	Articular Surf Prov, Str Purple, 17mm (Fem C, H - Tib 1, 2)
00-5971-021-20	Articular Surf Prov, Str Purple, 20mm (Fem C, H - Tib 1, 2)
00-5971-031-09	Articular Surf Prov, Str Yellow, 9mm (Fem A, B - Tib 3, 4)
00-5971-031-10	Articular Surf Prov, Str Yellow, 10mm (Fem A, B - Tib 3, 4)
00-5971-031-12	Articular Surf Prov, Str Yellow, 12mm (Fem A, B - Tib 3, 4)
00-5971-031-14	Articular Surf Prov, Str Yellow, 14mm (Fem A, B - Tib 3, 4)
00-5971-031-17	Articular Surf Prov, Str Yellow, 17mm (Fem A, B - Tib 3, 4)
00-5971-031-20	Articular Surf Prov, Str Yellow, 20mm (Fem A, B - Tib 3, 4)
00-5971-041-09	Articular Surf Prov, Str Green, 9mm (Fem Am Em - Tib 5, 6)
00-5971-041-10	Articular Surf Prov, Str Green, 10mm (Fem Am Em - Tib 5, 6)
00-5971-041-12	Articular Surf Prov, Str Green, 12mm (Fem Am Em - Tib 5, 6)
00-5971-041-14	Articular Surf Prov, Str Green, 14mm (Fem Am Em - Tib 5, 6)
00-5971-041-17	Articular Surf Prov, Str Green, 17mm (Fem Am Em - Tib 5, 6)
00-5971-041-20	Articular Surf Prov, Str Green, 20mm (Fem Am Em - Tib 5, 6)
00-5971-041-23	Articular Surf Prov, Str Green, 23mm (Fem Am Em - Tib 5, 6)
00-5991-080-55	CR Micro Prov Case

NEXGEN CR-FLEX PROVISIONAL/INSTRUMENT KITS 00-5930-043-00, 00-5975-023-00, 00-5975-024-00

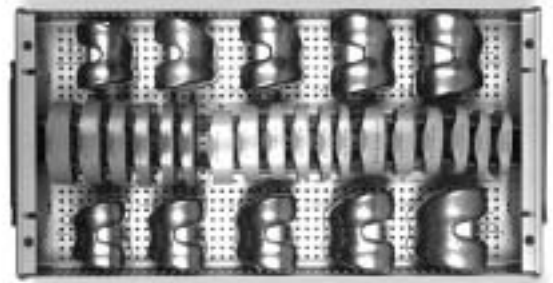

00-5975-022-00 NexGen CR-Flex Provisional/Instrument Kit

Cat. No.	Description
00-5955-013-01	CR-FLEX Femoral Prov Size C/L
00-5955-013-02	CR-FLEX Femoral Prov Size C/R
00-5955-014-01	CR-FLEX Femoral Prov Size D/L
00-5955-014-02	CR-FLEX Femoral Prov Size D/R
00-5955-015-01	CR-FLEX Femoral Prov Size E/L
00-5955-015-02	CR-FLEX Femoral Prov Size E/R
00-5955-016-01	CR-FLEX Femoral Prov Size F/L
00-5955-016-02	CR-FLEX Femoral Prov Size F/R
00-5955-017-01	CR-FLEX Femoral Prov Size G/L
00-5955-017-02	CR-FLEX Femoral Prov Size G/R
00-5971-030-10	CR Art Surf Prov, Yellow 10mm Tib 3-4
00-5971-030-12	CR Art Surf Prov, Yellow 12mm Tib 3-4
00-5971-030-14	CR Art Surf Prov, Yellow 14mm Tib 3-4
00-5971-030-17	CR Art Surf Prov, Yellow 17mm Tib 3-4
00-5971-030-20	CR Art Surf Prov, Yellow 20mm Tib 3-4
00-5971-040-10	CR Art Surf Prov, Green 10mm Tib 5-6
00-5971-040-12	CR Art Surf Prov, Green 12mm Tib 5-6
00-5971-040-14	CR Art Surf Prov, Green 14mm Tib 5-6
00-5971-040-17	CR Art Surf Prov, Green 17mm Tib 5-6
00-5971-040-20	CR Art Surf Prov, Green 20mm Tib 5-6
00-5971-050-10	CR Art Surf Prov, Blue 10mm Tib 7-10
00-5971-050-12	CR Art Surf Prov, Blue 12mm Tib 7-10
00-5971-050-14	CR Art Surf Prov, Blue 14mm Tib 7-10
00-5971-050-17	CR Art Surf Prov, Blue 17mm Tib 7-10
00-5971-050-20	CR Art Surf Prov, Blue 20mm Tib 7-10
00-5987-035-00	Deflection Beam Torque Wrench
00-5987-036-00	4.5mm Hex Driver Bit
00-5995-075-00	Art Surf Prov Locking Screw
00-5955-090-00	CR-FLEX Provisional Case

CONTINUED ON PAGE 170

NEXGEN CR-FLEX PROVISIONAL/INSTRUMENT KITS 00-5930-043-00, 00-5975-023-00, 00-5975-024-00 (CONT.)

Optional (Not Included in Kit)

Cat. No.	Description
00-5995-037-01	Tib Plate 3/4 Stem 10/13 Wrench
00-5995-037-02	Tib Plate 5/6 Stem 14/17 Wrench
00-5995-037-03	Tib Plate 7/8 Stem 18/20 Wrench
00-5995-037-04	Tib Plate 9/10 Stem 22/24 Wrench
00-5971-030-09	CR Art Surf Prov, Yellow 9mm Tib 3-4
00-5971-040-09	CR Art Surf Prov, Green 9mm Tib 5-6
00-5971-050-09	CR Art Surf Prof, Blue 9mm Tib 7-10

00-5975-023-00 NexGen CR-Flex Minus Provisional/Instrument Kit

Cat. No.	Description
00-5955-013-05	CR-FLEX Femoral Prov Size Minus C/L
00-5955-013-06	CR-FLEX Femoral Prov Size Minus C/R
00-5955-014-05	CR-FLEX Femoral Prov Size Minus D/L
00-5955-014-06	CR-FLEX Femoral Prov Size Minus D/R
00-5955-015-05	CR-FLEX Femoral Prov Size Minus E/L
00-5955-015-06	CR-FLEX Femoral Prov Size Minus E/R
00-5955-016-05	CR-FLEX Femoral Prov Size Minus F/L
00-5955-016-06	CR-FLEX Femoral Prov Size Minus F/R
00-5955-017-05	CR-FLEX Femoral Prov Size Minus G/L
00-5955-017-06	CR-FLEX Femoral Prov Size Minus G/R
00-5955-080-00	CR-FLEX Minus Size Prov Case

00-5975-024-00 NexGen CR-Flex Micro Provisional/Instrument Kit

Cat. No.	Description
00-5955-012-01	CR-Flex Femoral Prov Size B/L
00-5955-012-02	CR-Flex Femoral Prov Size B/R
00-5971-020-10	CR Articular Surf Prov, Purple, 10mm Tib 1, 2
00-5971-020-12	CR Articular Surf Prov, Purple, 12mm Tib 1, 2
00-5971-020-14	CR Articular Surf Prov, Purple, 14mm Tib 1, 2
00-5971-020-17	CR Articular Surf Prov, Purple, 17mm Tib 1, 2
00-5971-020-20	CR Articular Surf Prov, Purple, 20mm Tib 1, 2
00-5971-021-10	CR Articular Surf Prov, Str Purple, 10mm Tib 1, 2
00-5971-021-12	CR Articular Surf Prov, Str Purple, 12mm Tib 1, 2
00-5971-021-14	CR Articular Surf Prov, Str Purple, 14mm Tib 1, 2
00-5971-021-17	CR Articular Surf Prov, Str Purple, 17mm Tib 1, 2
00-5971-021-20	CR Articular Surf Prov, Str Purple, 20mm Tib 1, 2
00-5971-031-10	CR Articular Surf Prov, Str Yellow, 10mm Tib 1, 2
00-5971-031-12	CR Articular Surf Prov, Str Yellow, 12mm Tib 3, 4
00-5971-031-14	CR Articular Surf Prov, Str Yellow, 14mm Tib 3, 4
00-5971-031-17	CR Articular Surf Prov, Str Yellow, 17mm Tib 3, 4
00-5971-031-20	CR Articular Surf Prov, Str Yellow, 20mm Tib 3, 4
00-5955-060-00	CR-FLEX Micro Provisional Case

NEXGEN CR ANTERIOR CONSTRAINED (AC) ART SURF PROV KITS 00-5973-047-00, 00-5973-048-00

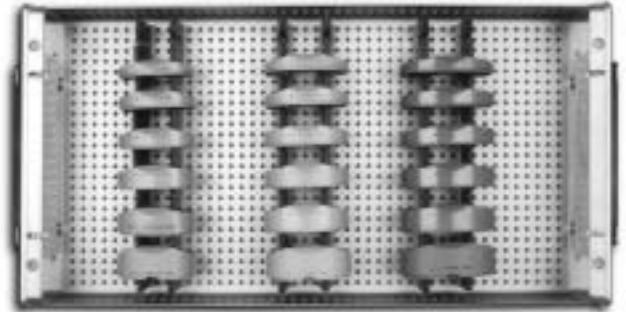

00-5973-047-00 NexGen CR (AC) Articular Surface Provisional Kit

Cat. No.	Description
00-5975-030-10	Articular Surf Prov, Yellow, 10mm (Fem C-F - Tib 3,4)
00-5975-030-12	Articular Surf Prov, Yellow, 12mm (Fem C-F - Tib 3,4)
00-5975-030-14	Articular Surf Prov, Yellow, 14mm (Fem C-F - Tib 3,4)
00-5975-030-17	Articular Surf Prov, Yellow, 17mm (Fem C-F - Tib 3,4)
00-5975-030-20	Articular Surf Prov, Yellow, 20mm (Fem C-F - Tib 3,4)
00-5975-030-23	Articular Surf Prov, Yellow, 23mm (Fem C-F - Tib 3,4)
00-5975-040-10	Articular Surf Prov, Green, 10mm (Fem C-F - Tib 5,6)
00-5975-040-12	Articular Surf Prov, Green, 12mm (Fem C-F - Tib 5,6)
00-5975-040-14	Articular Surf Prov, Green, 14mm (Fem C-F - Tib 5,6)
00-5975-040-17	Articular Surf Prov, Green, 17mm (Fem C-F - Tib 5,6)
00-5975-040-20	Articular Surf Prov, Green, 20mm (Fem C-F - Tib 5,6)
00-5975-040-23	Articular Surf Prov, Green, 23mm (Fem C-F - Tib 5,6)
00-5975-050-10	Articular Surf Prov, Blue, 10mm (Fem G,H - Tib 7-10)
00-5975-050-12	Articular Surf Prov, Blue, 12mm (Fem G,H - Tib 7-10)
00-5975-050-14	Articular Surf Prov, Blue, 14mm (Fem G,H - Tib 7-10)
00-5975-050-17	Articular Surf Prov, Blue, 17mm (Fem G,H - Tib 7-10)
00-5975-050-20	Articular Surf Prov, Blue, 20mm (Fem G,H - Tib 7-10)
00-5975-050-23	Articular Surf Prov, Blue, 23mm (Fem G,H - Tib 7-10)
00-5975-095-00	CR (AC) Articular Surface Prov Case

CONTINUED ON PAGE 172

NEXGEN CR ANTERIOR CONSTRAINED (AC) ART SURF PROV KITS 00-5973-047-00, 00-5973-048-00 (CONT.)

00-5973-048-00 NexGen CR Micro (AC) Articular Surface Provisional Kit

Cat. No.	Description
00-5975-020-10	Articular Surf Prov, Purple, 10mm (Fem A,B - Tib 1,2)
00-5975-020-12	Articular Surf Prov, Purple, 12mm (Fem A,B - Tib 1,2)
00-5975-020-14	Articular Surf Prov, Purple, 14mm (Fem A,B - Tib 1,2)
00-5975-020-17	Articular Surf Prov, Purple, 17mm (Fem A,B - Tib 1,2)
00-5975-020-20	Articular Surf Prov, Purple, 20mm (Fem A,B - Tib 1,2)
00-5975-020-23	Articular Surf Prov, Purple, 23mm (Fem A,B - Tib 1,2)
00-5975-021-10	Articular Surf Prov, Str Purple, 10mm (Fem C-F - Tib 1,2)
00-5975-021-12	Articular Surf Prov, Str Purple, 12mm (Fem C-F - Tib 1,2)
00-5975-021-14	Articular Surf Prov, Str Purple, 14mm (Fem C-F - Tib 1,2)
00-5975-021-17	Articular Surf Prov, Str Purple, 17mm (Fem C-F - Tib 1,2)
00-5975-021-20	Articular Surf Prov, Str Purple, 20mm (Fem C-F - Tib 1,2)
00-5975-021-23	Articular Surf Prov, Str Purple, 23mm (Fem C-F - Tib 1,2)
00-5975-031-10	Articular Surf Prov, Str Yellow, 10mm (Fem A,B - Tib 3,4)
00-5975-031-12	Articular Surf Prov, Str Yellow, 12mm (Fem A,B - Tib 3,4)
00-5975-031-14	Articular Surf Prov, Str Yellow, 14mm (Fem A,B - Tib 3,4)
00-5975-031-17	Articular Surf Prov, Str Yellow, 17mm (Fem A,B - Tib 3,4)
00-5975-031-20	Articular Surf Prov, Str Yellow, 20mm (Fem A,B - Tib 3,4)
00-5975-031-23	Articular Surf Prov, Str Yellow, 23mm (Fem A,B - Tib 3,4)
00-5975-090-00	CR Micro (AC) Articular Surface Prov Case

NEXGEN CR ANATOMICALLY-ROTATED (AR) ART SURF PROVISIONAL KIT 00-5973-049-00

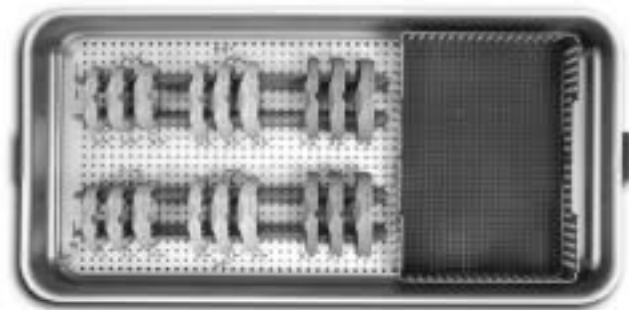

00-5973-049-00 NexGen CR (AR) Articular Surface Provisional Kit

Cat. No.	Description
00-5971-038-10	6° Rt Articular Surf Prov, Yellow, 10mm (Fem C-H - Tib 3,4)
00-5971-038-12	6° Rt Articular Surf Prov, Yellow, 12mm (Fem C-H - Tib 3,4)
00-5971-038-14	6° Rt Articular Surf Prov, Yellow, 14mm (Fem C-H - Tib 3,4)
00-5971-039-10	6° Lt Articular Surf Prov, Yellow, 10mm (Fem C-H - Tib 3,4)
00-5971-039-12	6° Lt Articular Surf Prov, Yellow, 12mm (Fem C-H - Tib 3,4)
00-5971-039-14	6° Lt Articular Surf Prov, Yellow, 14mm (Fem C-H - Tib 3,4)
00-5971-048-10	6° Rt Articular Surf Prov, Green, 10mm (Fem C-H - Tib 5,6)
00-5971-048-12	6° Rt Articular Surf Prov, Green, 12mm (Fem C-H - Tib 5,6)
00-5971-048-14	6° Rt Articular Surf Prov, Green, 14mm (Fem C-H - Tib 5,6)
00-5971-049-10	6° Lt Articular Surf Prov, Green, 10mm (Fem C-H - Tib 5,6)
00-5971-049-12	6° Lt Articular Surf Prov, Green, 12mm (Fem C-H - Tib 5,6)
00-5971-049-14	6° Lt Articular Surf Prov, Green, 14mm (Fem C-H - Tib 5,6)
00-5971-058-10	6° Rt Articular Surf Prov, Blue, 10mm (Fem C-H - Tib 7-10)
00-5971-058-12	6° Rt Articular Surf Prov, Blue, 12mm (Fem C-H - Tib 7-10)
00-5971-058-14	6° Rt Articular Surf Prov, Blue, 14mm (Fem C-H - Tib 7-10)
00-5971-059-10	6° Lt Articular Surf Prov, Blue, 10mm (Fem C-H - Tib 7-10)
00-5971-059-12	6° Lt Articular Surf Prov, Blue, 12mm (Fem C-H - Tib 7-10)
00-5971-059-14	6° Lt Articular Surf Prov, Blue, 14mm (Fem C-H - Tib 7-10)

NEXGEN MIS QUAD-SPARING SPACER BLOCK/NOTCH GUIDE KIT 00-5975-082-00

NEXGEN MIS SPACER BLOCK/NOTCH CHAMFER TROCH GUIDE KIT 00-5973-062-50

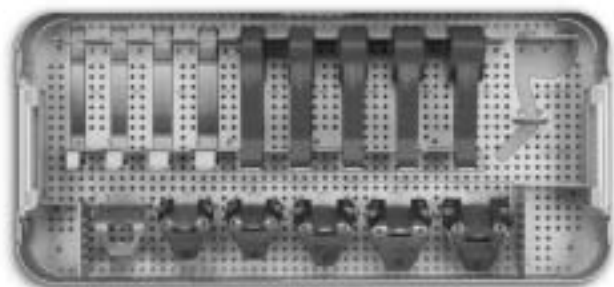

00-5975-082-00 NexGen MIS QS Spacer Block/Notch Guide Kit

Cat. No.	Description
00-5983-060-03	QS Notch Guide, Size C
00-5983-060-04	QS Notch Guide, Size D
00-5983-060-05	QS Notch Guide, Size E
00-5983-060-06	QS Notch Guide, Size F
00-5983-060-07	QS Notch Guide, Size G
00-5983-070-10	MIS Spacer Bolck, 10mm
00-5983-070-12	MIS Spacer Bolck, 12mm
00-5983-070-14	MIS Spacer Bolck, 14mm
00-5983-070-17	MIS Spacer Bolck, 17mm
00-5983-070-20	MIS Spacer Bolck, 20mm
00-5983-070-23	MIS Spacer Bolck, 23mm
00-5983-070-03	MIS Spacer Bolck Flex Adapter
00-5967-038-00	Blue Universal Lid
00-5983-097-00	Base

Optional (Not included in Kit)

Cat. No.	Description
00-5983-060-01	QS Notch Guide, Size A
00-5983-060-02	QS Notch Guide, Size B
00-5983-060-08	QS Notch Guide, Size H

00-5973-062-50 NexGen MIS Spacer Block/Notch Chamfer Troch Guide Kit

Cat. No.	Description
00-5983-053-00	MIS Trochlear Guide, Size C
00-5983-054-00	MIS Trochlear Guide, Size D
00-5983-055-00	MIS Trochlear Guide, Size E
00-5983-056-00	MIS Trochlear Guide, Size F
00-5983-057-00	MIS Trochlear Guide, Size G
00-5983-063-00	MIS Notch/Chamfer Guide, Size C
00-5983-064-00	MIS Notch/Chamfer Guide, Size D
00-5983-065-00	MIS Notch/Chamfer Guide, Size E
00-5983-066-00	MIS Notch/Chamfer Guide, Size F
00-5983-067-00	MIS Notch/Chamfer Guide, Size G
00-5983-070-10	MIS Spacer Bolck, 10mm
00-5983-070-12	MIS Spacer Bolck, 12mm
00-5983-070-14	MIS Spacer Bolck, 14mm
00-5983-070-17	MIS Spacer Bolck, 17mm
00-5983-070-20	MIS Spacer Bolck, 20mm
00-5983-070-23	MIS Spacer Bolck, 23mm
00-5983-070-03	MIS Spacer Block Flex Adapter
00-5967-022-00	Case Assy

Optional (Not included in Kit)

Cat. No.	Description
00-5983-051-00	MIS Trochlear Guide, Size A
00-5983-052-00	MIS Trochlear Guide, Size B
00-5983-058-00	MIS Trochlear Guide, Size H*
00-5983-061-00	MIS Notch/Chamfer Guide, Size A*
00-5983-062-00	MIS Notch/Chamfer Guide, Size B
00-5983-068-00	MIS Notch/Chamfer Guide, Size H*

NEXGEN NOTCH GUIDE KITS



NOTCH/CHAMFER GUIDE

00-5973-057-00 NexGen Notch/Chamfer Guide Kit

Cat. No.	Description
00-5978-072-01*	Notch/Chamfer Guide, Size A
00-5978-072-02*	Notch/Chamfer Guide, Size B
00-5978-072-03	Notch/Chamfer Guide, Size C
00-5978-072-04	Notch/Chamfer Guide, Size D
00-5978-072-05	Notch/Chamfer Guide, Size E
00-5978-072-06	Notch/Chamfer Guide, Size F
00-5978-072-07	Notch/Chamfer Guide, Size G
00-5978-072-08*	Notch/Chamfer Guide, Size H



PS MILLING NOTCH GUIDE

000-5973-058-00 NexGen PS Milling Notch Guide Kit

Cat. No.	Description
00-5978-034-01*	PS Milling Notch Guide, Size A, B
00-5978-034-03	PS Milling Notch Guide, Size C, D
00-5978-034-05	PS Milling Notch Guide, Size E, F
00-5978-034-07	PS Milling Notch Guide, Size G
00-5978-034-08*	PS Milling Notch Guide, Size H
00-5978-082-00	Posterior Femoral Retractor
00-5991-053-34	PS Milling Notch Guide Tray

*May order separately, not included in Kit.



TR/PS MILLING FINISHING GUIDE

00-5973-059-00 NexGen TR/PS Milling Finishing Guide Kit

Cat. No.	Description
00-5978-033-01*	TR/PS Milling Finishing Guide, Size A
00-5978-033-02*	TR/PS Milling Finishing Guide, Size B
00-5978-033-03	TR/PS Milling Finishing Guide, Size C
00-5978-033-04	TR/PS Milling Finishing Guide, Size D
00-5978-033-05	TR/PS Milling Finishing Guide, Size E
00-5978-033-06	TR/PS Milling Finishing Guide, Size F
00-5978-033-07	TR/PS Milling Finishing Guide, Size G
00-5978-082-00	Posterior Femoral Retractor
00-5991-053-33	TR/PS Milling Finishing Guide Tray



EPI NOTCH/CHAMFER GUIDE

00-5973-062-00 NexGen EPI Femoral Finishing Kit

Cat. No.	Description
00-5061-063-00	Hex-head Holding Pin
00-5967-072-01*	Notch/Chamfer Guide, Size A
00-5967-072-02*	Notch/Chamfer Guide, Size B
00-5967-072-03	Notch/Chamfer Guide, Size C
00-5967-072-04	Notch/Chamfer Guide, Size D
00-5967-072-05	Notch/Chamfer Guide, Size E
00-5967-072-06	Notch/Chamfer Guide, Size F
00-5967-072-07	Notch/Chamfer Guide, Size G

CONTINUED ON PAGE 178

NEXGEN NOTCH GUIDE KITS (CONT.)

00-5973-062-00 NexGen EPI Femoral Finishing Kit (con't)

Cat. No.	Description
00-5967-072-08*	Notch/Chamfer Guide, Size H
00-5967-073-34	Notch Slot Attachment, Size C, D
00-5967-073-56	Notch Slot Attachment, Size E, F
00-5967-073-78	Notch Slot Attachment, Size G, H
00-5967-090-00	EPI Femoral Finishing Instrument Case

*May order separately, not included in kit.



5-IN-1 FINISH PS NOTCH GUIDE

00-5973-050-00 NexGen 5-in-1 Finish PS Notch Guide Kit

Cat. No.	Description
00-5978-064-01*	Finish PS Notch Guide, Size A
00-5978-064-02*	Finish PS Notch Guide, Size B
00-5978-064-03	Finish PS Notch Guide, Size C
00-5978-064-04	Finish PS Notch Guide, Size D
00-5978-064-05	Finish PS Notch Guide, Size E
00-5978-064-06	Finish PS Notch Guide, Size F
00-5978-064-07	Finish PS Notch Guide, Size G
00-5978-064-08	Finish PS Notch Guide, Size H

*May order separately, not included in kit.

NEXGEN EPI FEMORAL INSTRUMENT KIT 00-5973-060-00

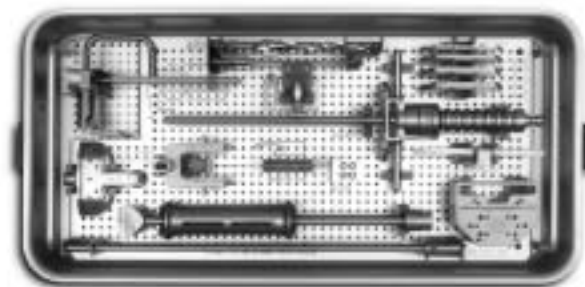

00-5973-060-00 NexGen EPI Femoral Instrument Kit

Cat. No.	Description
00-5061-063-00	Hex-head Holding Pin
00-5120-085-00	Bone Screw Drill
00-5785-079-00	Alignment Rod
00-5785-080-00	Alignment Rod w/ Coupler
00-5785-097-00	Slaphammer Extractor
00-5967-009-03	Distal Femoral Recutting Guide
00-5967-030-00	EPI Distal Femoral Cutting Guide
00-5967-032-00	Distal Placement Guide, 3°
00-5967-041-00	EPI Guide
00-5969-005-00	Standard Cutting Spacer
00-5969-005-02	Spacer, -2mm
00-5969-005-03	Spacer, -3mm
00-5969-005-04	Spacer, -4mm
00-5977-024-00	Extramedullary Alignment Arch
00-5977-084-00	Resection Guide
00-5978-003-00	IM Femoral A/P Sizing Guide
00-5978-004-00	MICRO-MILL Adjustable IM Guide
00-5978-006-00	MICRO-MILL 4-inch IM Guide
00-5978-014-00	IM Drill w/ Step, 8mm
00-5967-080-00	EPI/ 4-in-1 Femoral Instrument Case

NEXGEN EPI FEMORAL/TIBIAL INSTRUMENT KIT 00-5973-061-00

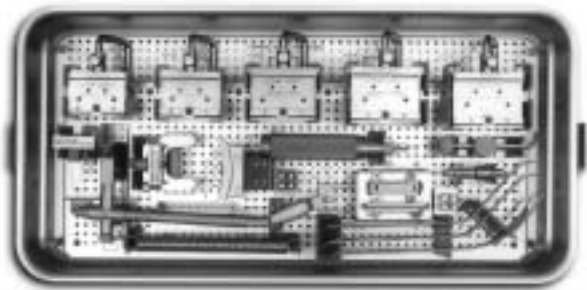

00-5973-061-00 NexGen EPI Femoral/Tibial Instrument Kit

Cat. No.	Description
00-5061-063-00	Hex-head Holding Pin
00-5061-082-00	Retractor Spring, 14cm
00-5120-008-00	Universal Handle
00-5120-061-00	Tibial Retractors (2)
00-5967-002-00	Female Hex Driver Bit
00-5967-011-00	Posterior Reference/Rotation Guide
00-5967-015-00	Posterior Resection Gauge
00-5967-033-01	Spring Screws, Short
00-5967-050-03	EPI A/P Cutting Guide, Size C
00-5967-050-04	EPI A/P Cutting Guide, Size D
00-5967-050-05	EPI A/P Cutting Guide, Size E
00-5967-050-06	EPI A/P Cutting Guide, Size F
00-5967-050-07	EPI A/P Cutting Guide, Size G
00-5967-060-00	Extramedullary Tibial Cutting Guide
00-5977-037-00	Patella Tendon Retractor
00-5977-050-00	Tibial Depth Resection Gauge, 10mm
00-5977-062-00	2° Varus/Valgus Tibial Recutter
00-5977-095-00	Tibial Recutter, 2mm
00-5967-085-00	EPI/4-in-1 Femoral/Tibial Instrument Case

NEXGEN LPS PROVISIONAL KITS 00-5973-065-00, 00-5973-063-00, 00-5973-064-00

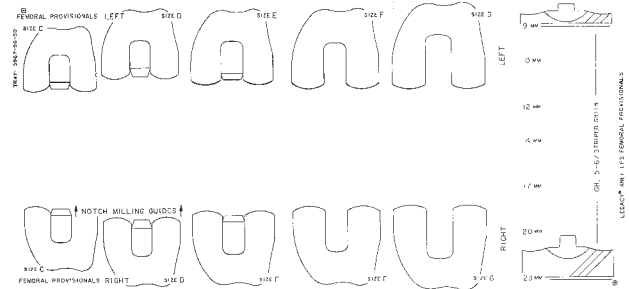

00-5973-065-00 NexGen LPS Provisional Kit

Cat. No.	Description
00-5995-075-00	Articular Surf Prov Locking Screw
00-5997-013-01	Femoral Provisional, Size C, Lt
00-5997-013-02	Femoral Provisional, Size C, Rt
00-5997-014-01	Femoral Prov, Size D, Lt
00-5997-014-02	Femoral Prov, Size D, Rt
00-5997-015-01	Femoral Prov, Size E, Lt
00-5997-015-02	Femoral Prov, Size E, Rt
00-5997-016-01	Femoral Prov, Size F, Lt
00-5997-016-02	Femoral Prov, Size F, Rt
00-5997-017-01	Femoral Prov, Size G, Lt
00-5997-017-02	Femoral Prov, Size G, Rt
00-5997-030-10	Articular Surf Prov, Yellow, 10mm (Fem C,D - Tib 3,4)
00-5997-030-12	Articular Surf Prov, Yellow, 12mm (Fem C,D - Tib 3,4)
00-5997-030-14	Articular Surf Prov, Yellow, 14mm (Fem C,D - Tib 3,4)
00-5997-030-17	Articular Surf Prov, Yellow, 17mm (Fem C,D - Tib 3,4)
00-5997-030-20	Articular Surf Prov, Yellow, 20mm (Fem C,D - Tib 3,4)
00-5997-030-23	Articular Surf Prov, Yellow, 23mm (Fem C,D - Tib 3,4)
00-5997-032-10	Articular Surf Prov, Str Yellow, 10mm (Fem E,F - Tib 3,4)
00-5997-032-12	Articular Surf Prov, Str Yellow, 12mm (Fem E,F - Tib 3,4)
00-5997-032-14	Articular Surf Prov, Str Yellow, 14mm (Fem E,F - Tib 3,4)
00-5997-032-17	Articular Surf Prov, Str Yellow, 17mm (Fem E,F - Tib 3,4)
00-5997-032-20	Articular Surf Prov, Str Yellow, 20mm (Fem E,F - Tib 3,4)
00-5997-032-23	Articular Surf Prov, Str Yellow, 23mm (Fem E,F - Tib 3,4)
00-5997-040-10	Articular Surf Prov, Green, 10mm (Fem E,F - Tib 5,6)
00-5997-040-12	Articular Surf Prov, Green, 12mm (Fem E,F - Tib 5,6)
00-5997-040-14	Articular Surf Prov, Green, 14mm (Fem E,F - Tib 5,6)
00-5997-040-17	Articular Surf Prov, Green, 17mm (Fem E,F - Tib 5,6)
00-5997-040-20	Articular Surf Prov, Green, 20mm (Fem E,F - Tib 5,6)
00-5997-040-23	Articular Surf Prov, Green, 23mm (Fem E,F - Tib 5,6)
00-5997-041-10	Articular Surf Prov, Str Green, 10mm (Fem C,D - Tib 5,6)
00-5997-041-12	Articular Surf Prov, Str Green, 12mm (Fem C,D - Tib 5,6)

CONTINUED ON PAGE 182

NEXGEN LPS PROVISIONAL KITS 00-5973-065-00, 00-5973-063-00, 00-5973-064-00 (CONT.)

00-5973-065-00 NexGen LPS Provisional Kit (cont)

Cat. No.	Description
00-5997-041-14	Articular Surf Prov, Str Green, 14mm (Fem C,D - Tib 5,6)
00-5997-041-17	Articular Surf Prov, Str Green, 17mm (Fem C,D - Tib 5,6)
00-5997-041-20	Articular Surf Prov, Str Green, 20mm (Fem C,D - Tib 5,6)
00-5997-041-23	Articular Surf Prov, Str Green, 23mm (Fem C,D - Tib 5,6)
00-5997-050-10	Articular Surf Prov, Blue, 10mm (Fem G,H - Tib 7-10)
00-5997-050-12	Articular Surf Prov, Blue, 12mm (Fem G,H - Tib 7-10)
00-5997-050-14	Articular Surf Prov, Blue, 14mm (Fem G,H - Tib 7-10)
00-5997-050-17	Articular Surf Prov, Blue, 17mm (Fem G,H - Tib 7-10)
00-5997-050-20	Articular Surf Prov, Blue, 20mm (Fem G,H - Tib 7-10)
00-5997-050-23	Articular Surf Prov, Blue, 23mm (Fem G,H - Tib 7-10)
00-5997-051-10	Articular Surf Prov, Str Blue, 10mm (Fem E,F - Tib 7-10)
00-5997-051-12	Articular Surf Prov, Str Blue, 12mm (Fem E,F - Tib 7-10)
00-5997-051-14	Articular Surf Prov, Str Blue, 14mm (Fem E,F - Tib 7-10)
00-5997-051-17	Articular Surf Prov, Str Blue, 17mm (Fem E,F - Tib 7-10)
00-5997-051-20	Articular Surf Prov, Str Blue, 20mm (Fem E,F - Tib 7-10)
00-5997-051-23	Articular Surf Prov, Str Blue, 23mm (Fem E,F - Tib 7-10)
00-5967-095-00	LPS Provisional Case

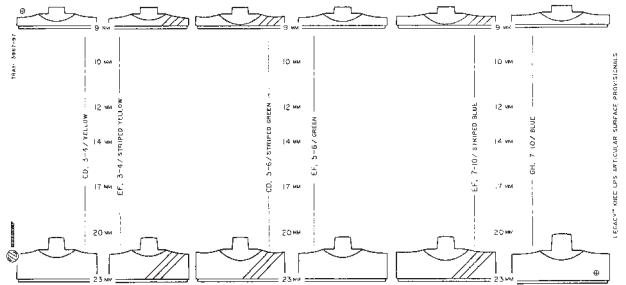

00-5973-063-00 NexGen LPS Micro Provisional Kit

Cat. No.	Description
00-5997-011-01	Femoral Prov, Size A, Lt
00-5997-011-02	Femoral Prov, Size A, Rt
00-5997-012-01	Femoral Prov, Size B, Lt
00-5997-012-02	Femoral Prov, Size B, Rt
00-5997-020-10	Articular Surf Prov, Purple, 10mm (Fem A,B - Tib 1,2)
00-5997-020-12	Articular Surf Prov, Purple, 12mm (Fem A,B - Tib 1,2)
00-5997-020-14	Articular Surf Prov, Purple, 14mm (Fem A,B - Tib 1,2)
00-5997-020-17	Articular Surf Prov, Purple, 17mm (Fem A,B - Tib 1,2)
00-5997-020-20	Articular Surf Prov, Purple, 20mm (Fem A,B - Tib 1,2)
00-5997-020-23	Articular Surf Prov, Purple, 23mm (Fem A,B - Tib 1,2)
00-5997-022-10	Articular Surf Prov, Str Purple, 10mm (Fem C,D - Tib 1,2)
00-5997-022-12	Articular Surf Prov, Str Purple, 12mm (Fem C,D - Tib 1,2)
00-5997-022-14	Articular Surf Prov, Str Purple, 14mm (Fem C,D - Tib 1,2)
00-5997-022-17	Articular Surf Prov, Str Purple, 17mm (Fem C,D - Tib 1,2)
00-5997-022-20	Articular Surf Prov, Str Purple, 20mm (Fem C,D - Tib 1,2)
00-5997-022-23	Articular Surf Prov, Str Purple, 23mm (Fem C,D - Tib 1,2)
00-5997-031-10	Articular Surf Prov, Str Yellow, 10mm (Fem A,B - Tib 3,4)
00-5997-031-12	Articular Surf Prov, Str Yellow, 12mm (Fem A,B - Tib 3,4)
00-5997-031-14	Articular Surf Prov, Str Yellow, 14mm (Fem A,B - Tib 3,4)
00-5997-031-17	Articular Surf Prov, Str Yellow, 17mm (Fem A,B - Tib 3,4)
00-5997-031-20	Articular Surf Prov, Str Yellow, 20mm (Fem A,B - Tib 3,4)
00-5997-031-23	Articular Surf Prov, Str Yellow, 23mm (Fem A,B - Tib 3,4)
00-5967-070-00	LPS Micro Provisional Case

00-5973-064-00 NexGen LPS Macro Provisional Kit

Cat. No.	Description
00-5997-018-01	Femoral Prov, Size H, Lt
00-5997-018-02	Femoral Prov, Size H, Rt

NEXGEN LPS PROVISIONAL KITS 00-5930-065-00, 00-5930-063-00

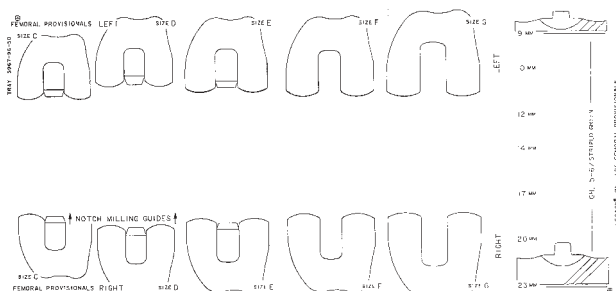

00-5930-065-00 NexGen LPS Provisional Kit

Cat. No.	Description
00-5995-075-00	Articular Surf Prov Locking Screw
00-5997-013-01	Femoral Provisional, Size C, Lt
00-5997-013-02	Femoral Provisional, Size C, Rt
00-5997-014-01	Femoral Provisional, Size D, Lt
00-5997-014-02	Femoral Provisional, Size D, Rt
00-5997-015-01	Femoral Provisional, Size E, Lt
00-5997-015-02	Femoral Provisional, Size E, Rt
00-5997-016-01	Femoral Provisional, Size F, Lt
00-5997-016-02	Femoral Provisional, Size F, Rt
00-5997-017-01	Femoral Provisional, Size G, Lt
00-5997-017-02	Femoral Provisional, Size G, Rt
00-5997-030-09*	Articular Surf Prov, Yellow, 9mm (Fem C, D - Tib 3, 4)
00-5997-030-10	Articular Surf Prov, Yellow, 10mm (Fem C, D - Tib 3, 4)
00-5997-030-12	Articular Surf Prov, Yellow, 12mm (Fem C, D - Tib 3, 4)
00-5997-030-14	Articular Surf Prov, Yellow, 14mm (Fem C, D - Tib 3, 4)
00-5997-030-17	Articular Surf Prov, Yellow, 17mm (Fem C, D - Tib 3, 4)
00-5997-030-20	Articular Surf Prov, Yellow, 20mm (Fem C, D - Tib 3, 4)
00-5997-030-23	Articular Surf Prov, Yellow, 23mm (Fem C, D - Tib 3, 4)
00-5997-032-09*	Articular Surf Prov, Str Yellow, 9mm (Fem E, F - Tib 3, 4)
00-5997-032-10	Articular Surf Prov, Str Yellow, 10mm (Fem E, F - Tib 3, 4)
00-5997-032-12	Articular Surf Prov, Str Yellow, 12mm (Fem E, F - Tib 3, 4)
00-5997-032-14	Articular Surf Prov, Str Yellow, 14mm (Fem E, F - Tib 3, 4)
00-5997-032-17	Articular Surf Prov, Str Yellow, 17mm (Fem E, F - Tib 3, 4)
00-5997-032-20	Articular Surf Prov, Str Yellow, 20mm (Fem E, F - Tib 3, 4)
00-5997-032-23	Articular Surf Prov, Str Yellow, 23mm (Fem E, F - Tib 3, 4)
00-5997-040-09*	Articular Surf Prov, Green, 9mm (Fem E, F - Tib 5, 6)
00-5997-040-10	Articular Surf Prov, Green, 10mm (Fem E, F - Tib 5, 6)

00-5930-065-00 NexGen LPS Provisional Kit (cont)

Cat. No.	Description
00-5997-040-12	Articular Surf Prov, Green, 12mm (Fem E, F - Tib 5, 6)
00-5997-040-14	Articular Surf Prov, Green, 14mm (Fem E, F - Tib 5, 6)
00-5997-040-17	Articular Surf Prov, Green, 17mm (Fem E, F - Tib 5, 6)
00-5997-040-20	Articular Surf Prov, Green, 20mm (Fem E, F - Tib 5, 6)
00-5997-040-23	Articular Surf Prov, Green, 23mm (Fem E, F - Tib 5, 6)
00-5997-041-09*	Articular Surf Prov, Str Green, 9mm (Fem C, D - Tib 5, 6)
00-5997-041-10	Articular Surf Prov, Str Green, 10mm (Fem C, D - Tib 5, 6)
00-5997-041-12	Articular Surf Prov, Str Green, 12mm (Fem C, D - Tib 5, 6)
00-5997-041-14	Articular Surf Prov, Str Green, 14mm (Fem C, D - Tib 5, 6)
00-5997-041-17	Articular Surf Prov, Str Green, 17mm (Fem C, D - Tib 5, 6)
00-5997-041-20	Articular Surf Prov, Str Green, 20mm (Fem C, D - Tib 5, 6)
00-5997-041-23	Articular Surf Prov, Str Green, 23mm (Fem C, D - Tib 5, 6)
00-5997-050-09*	Articular Surf Prov, Blue, 9mm (Fem G, H - Tib 7, 10)
00-5997-050-10	Articular Surf Prov, Blue, 10mm (Fem G, H - Tib 7, 10)
00-5997-050-12	Articular Surf Prov, Blue, 12mm (Fem G, H - Tib 7, 10)
00-5997-050-14	Articular Surf Prov, Blue, 14mm (Fem G, H - Tib 7, 10)
00-5997-050-17	Articular Surf Prov, Blue, 17mm (Fem G, H - Tib 7, 10)
00-5997-050-20	Articular Surf Prov, Blue, 20mm (Fem G, H - Tib 7, 10)
00-5997-050-23	Articular Surf Prov, Blue, 23mm (Fem G, H - Tib 7, 10)
00-5997-051-09*	Articular Surf Prov, Str Blue, 9mm (Fem E, F - Tib 7, 10)
00-5997-051-10	Articular Surf Prov, Str Blue, 10mm (Fem E, F - Tib 7, 10)
00-5997-051-12	Articular Surf Prov, Str Blue, 12mm (Fem E, F - Tib 7, 10)
00-5997-051-14	Articular Surf Prov, Str Blue, 14mm (Fem E, F - Tib 7, 10)
00-5997-051-17	Articular Surf Prov, Str Blue, 17mm (Fem E, F - Tib 7, 10)
00-5997-051-20	Articular Surf Prov, Str Blue, 20mm (Fem E, F - Tib 7, 10)
00-5997-051-23	Articular Surf Prov, Str Blue, 23mm (Fem E, F - Tib 7, 10)
00-5967-095-00	LPS Provisional Case

CONTINUED ON PAGE 186

NEXGEN LPS PROVISIONAL KITS 00-5930-065-00, 00-5930-063-00 (CONT.)

NEXGEN EPI/IM MACRO INSTRUMENT/PROVISIONAL KITS 00-5973-067-00, 00-5973-093-00

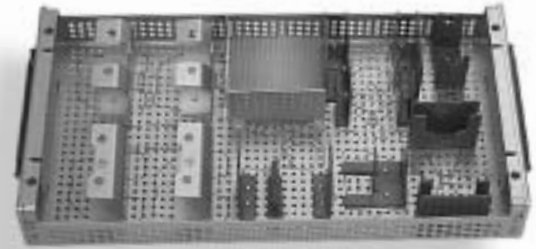
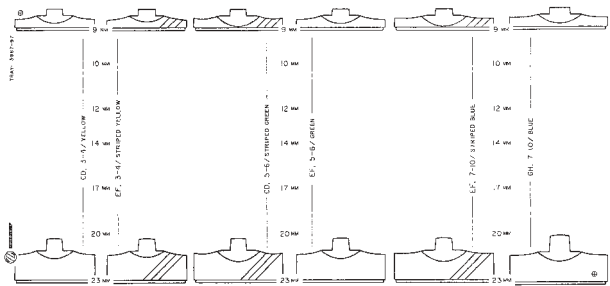

00-5930-063-00 NexGen LPS Micro Provisional Kit

Cat. No.	Description
00-5997-011-01	Femoral Prov, Size A, Lt
00-5997-011-02	Femoral Prov, Size A, Rt
00-5997-012-01	Femoral Prov, Size B, Lt
00-5997-012-02	Femoral Prov, Size B, Rt
00-5997-020-09*	Articular Surf Prov, Purple, 9mm (Fem A, B - Tib 1, 2)
00-5997-020-10	Articular Surf Prov, Purple, 10mm (Fem A, B - Tib 1, 2)
00-5997-020-12	Articular Surf Prov, Purple, 11mm (Fem A, B - Tib 1, 2)
00-5997-020-14	Articular Surf Prov, Purple, 12mm (Fem A, B - Tib 1, 2)
00-5997-020-17	Articular Surf Prov, Purple, 13mm (Fem A, B - Tib 1, 2)
00-5997-020-20	Articular Surf Prov, Purple, 14mm (Fem A, B - Tib 1, 2)
00-5997-020-23	Articular Surf Prov, Purple, 15mm (Fem A, B - Tib 1, 2)
00-5997-022-09*	Articular Surf Prov, Str Purple, 9mm (Fem C, D - Tib 1, 2)
00-5997-022-10	Articular Surf Prov, Str Purple, 10mm (Fem C, D - Tib 1, 2)
00-5997-022-12	Articular Surf Prov, Str Purple, 12mm (Fem C, D - Tib 1, 2)
00-5997-022-14	Articular Surf Prov, Str Purple, 14mm (Fem C, D - Tib 1, 2)
00-5997-022-17	Articular Surf Prov, Str Purple, 17mm (Fem C, D - Tib 1, 2)
00-5997-022-20	Articular Surf Prov, Str Purple, 20mm (Fem C, D - Tib 1, 2)
00-5997-022-23	Articular Surf Prov, Str Purple, 23mm (Fem C, D - Tib 1, 2)
00-5997-031-09*	Articular Surf Prov, Str Yellow, 9mm (Fem A, B - Tib 3, 4)
00-5997-031-10	Articular Surf Prov, Str Yellow, 10mm (Fem A, B - Tib 3, 4)
00-5997-031-12	Articular Surf Prov, Str Yellow, 12mm (Fem A, B - Tib 3, 4)
00-5997-031-14	Articular Surf Prov, Str Yellow, 14mm (Fem A, B - Tib 3, 4)
00-5997-031-17	Articular Surf Prov, Str Yellow, 17mm (Fem A, B - Tib 3, 4)
00-5997-031-20	Articular Surf Prov, Str Yellow, 20mm (Fem A, B - Tib 3, 4)
00-5997-031-23	Articular Surf Prov, Str Yellow, 23mm (Fem A, B - Tib 3, 4)
00-5967-070-00	LPS Micro Provisional Case

*These kits include the 9mm articular surface provisionals.

00-5973-067-00 NexGen EPI Macro Instrument/Provisional Kit

Cat. No.	Description
00-5061-063-00	Hex-head Holding Pins
00-5967-050-08	EPI A/P Cutting Guide, Size H
00-5967-072-08	EPI Notch/Chamfer Guide, Size H
00-5977-056-01	Short-head Holding Pins
00-5997-018-01	LPS Femoral Provisional, Size H, Lt
00-5997-018-02	LPS Femoral Provisional, Size H, Rt
00-5997-058-03	Fluted Stem Tibial Plate Provisional, Size 9
00-5997-058-04	Fluted Stem Tibial Plate Provisional, Size 10
00-5997-061-09	Fluted Stem Tibial Broach, Size 9,10

CONTINUED ON PAGE 188

NEXGEN EPI/IM MACRO INSTRUMENT/PROVISIONAL KITS 00-5973-067-00, 00-5973-093-00 (CONT.)

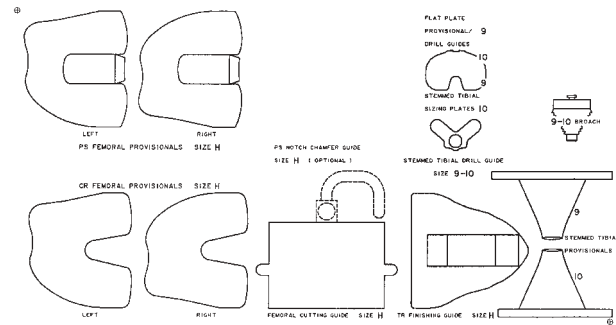

INSTRUMENT LAYOUT DIAGRAM

00-5973-093-00 NexGen IM Macro Instrument/Provisional Kit

Cat. No.	Description
00-5968-058-00	Femoral Finishing Guide, Size H
00-5971-018-01	CR Femoral Provisional, Size H, Lt
00-5971-018-02	CR Femoral Provisional, Size H, Rt
00-5977-012-09	Stemmed Tibial Sizing Plate, Size 9
00-5977-012-10	Stemmed Tibial Sizing Plate, Size 10
00-5977-013-09	Stemmed Tibial Broach, Size 9,10
00-5977-014-09	Stemmed Tibial Drill Guide, Size 9,10
00-5977-015-09	Flat Plate Provisional/Drill Guide, Size 9
00-5977-015-10	Flat Plate Provisional/Drill Guide, Size 10
00-5978-072-08	Notch/Chamfer Guide, Size H
00-5997-018-01	LPS Femoral Provisional, Size H, Lt
00-5997-018-02	LPS Femoral Provisional, Size H, Rt
00-5981-057-03	Stemmed Tibial Provisional, Size 9
00-5981-057-04	Stemmed Tibial Provisional, Size 10
00-5968-075-55	EPI/IM Macro Instrument/Provisional Case

NEXGEN EPI/IM MICRO INSTRUMENT/PROVISIONAL KITS 00-5973-068-00, 00-5973-094-00

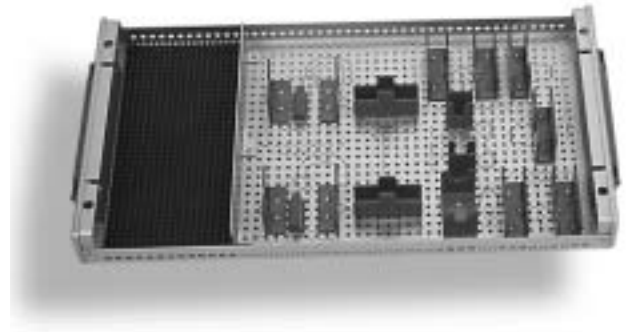

00-5973-068-00 NexGen EPI Micro Instrument/Provisional Kit

Cat. No.	Description
00-5061-063-00	Hex-head Holding Pin
00-5967-050-01	EPI A/P Cutting Guide, Size A
00-5967-050-02	EPI A/P Cutting Guide, Size B
00-5967-072-01	EPI A/P Notch Chamfer Guide, Size A
00-5967-072-02	EPI A/P Notch Chamfer Guide, Size B
00-5967-073-12	Notch Slot Attachment, Size A,B
00-5977-012-01	Stemmed Tibial Sizing Plate, Size 1
00-5977-012-02	Stemmed Tibial Sizing Plate, Size 2
00-5977-013-01	Stemmed Tibial Broach, Size 1,2
00-5981-027-01	Stemmed Tibial Plate Provisional, Size 1
00-5981-027-02	Stemmed Tibial Plate Provisional, Size 2
00-5977-056-01	Short-head Holding Pin

CONTINUED ON PAGE 190

NEXGEN EPI/IM MICRO INSTRUMENT/PROVISIONAL KITS 00-5973-068-00, 00-5973-094-00 (CONT.)

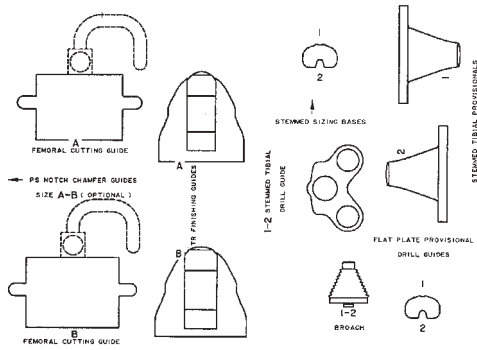

INSTRUMENT LAYOUT DIAGRAM

00-5973-094-00 NexGen IM Micro Instrument/Provisional Kit

Cat. No.	Description
00-5968-051-00	Femoral Finishing Guide, Size A
00-5968-052-00	Femoral Finishing Guide, Size B
00-5977-012-01	Stemmed Tibial Sizing Plate, Size 1
00-5977-012-02	Stemmed Tibial Sizing Plate, Size 2
00-5977-013-01	Stemmed Tibial Broach, Size 1, 2
00-5977-014-01	Stemmed Tibial Drill Guide, Size 1, 2
00-5977-015-01	Flat Plate Provisional/Drill Guide, Size 1
00-5977-015-02	Flat Plate Provisional/Drill Guide, Size 2
00-5978-072-01	Notch/Chamfer Guide, Size A
00-5978-072-02	Notch/Chamfer Guide, Size B
00-5981-027-01	Stemmed Tibial Provisional, Size 1
00-5981-027-02	Stemmed Tibial Provisional, Size 2
00-5968-080-55	EPI/IM Micro Instrument/Provisional Case

NEXGEN CRA/LCCK FEMORAL CORE INSTRUMENT KIT 00-5973-070-00

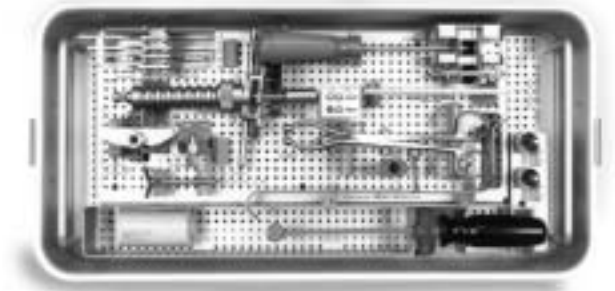

00-5973-070-00 NexGen CRA/LCCK Femoral Core Instrument Kit

Cat. No.	Description
00-5061-063-00	Hex-head Holding Pins
00-5222-039-00	Custom Tibial Wedge Provisional Pins
00-5967-030-00	Distal Femoral Cutting Guide
00-5967-031-00	Distal Placement Guide, 0°
00-5969-005-00	Standard Cutting Block
00-5969-005-06	Revision Cut Block, +3mm
00-5969-005-09	Revision Cut Block, Standard
00-5977-030-00	Augment Assembly Clamp
00-5978-082-00	Posterior Femoral Retractor
00-5987-051-01	Revision Rotational Alignment Guide
00-5987-060-00	Revision IM Guide
00-5987-071-00	Femoral Set Screw Hex Drivers, 2mm (2)
00-5987-081-00	Femoral Sizing Template, Size A,B
00-5987-082-00	Femoral Sizing Template, Size C,D
00-5987-083-00	Femoral Sizing Template, Size E,F
00-5987-084-00	Femoral Sizing Template, Size G,H
00-5987-086-00	Fem Aug Hold Clamp Heads, 5mm, Size E,G,H (2)
00-5987-089-00	Femoral Augment Screwdriver
00-5987-035-00	Deflection Beam Torque Wrench
00-5987-036-00	Hex Driver Bit, 4.5mm
00-5987-050-00	IM Hole Locator
00-5995-095-55	CRA/LCCK Femoral Core Instrument Case

NEXGEN CRA FEMORAL PROVISIONAL/CUTTING GUIDE KIT 00-5973-071-00

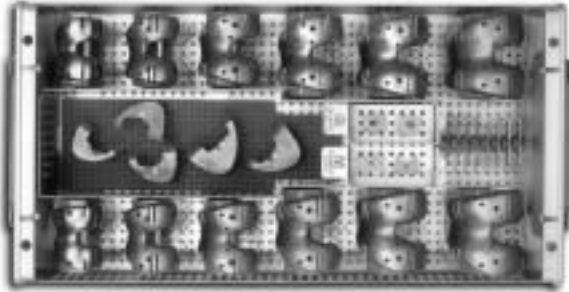

00-5973-071-00 NexGen CRA Femoral Provisional/Cutting Guide Kit

Cat. No.	Description
00-5222-039-00	Headless Pins, 48mm
00-5977-056-01	Short-head Holding Pins
00-5987-062-01	Femoral Prov/Cutting Guide, Size B, Lt
00-5987-062-02	Femoral Prov/Cutting Guide, Size B, Rt
00-5987-063-01	Femoral Prov/Cutting Guide, Size C, Lt
00-5987-063-02	Femoral Prov/Cutting Guide, Size C, Rt
00-5987-064-01	Femoral Prov/Cutting Guide, Size D, Lt
00-5987-064-02	Femoral Prov/Cutting Guide, Size D, Rt
00-5987-065-01	Femoral Prov/Cutting Guide, Size E, Lt
00-5987-065-02	Femoral Prov/Cutting Guide, Size E, Rt
00-5987-066-01	Femoral Prov/Cutting Guide, Size F, Lt
00-5987-066-02	Femoral Prov/Cutting Guide, Size F, Rt
00-5987-067-01	Femoral Prov/Cutting Guide, Size G, Lt
00-5987-067-02	Femoral Prov/Cutting Guide, Size G, Rt
00-5987-089-05	Posterior Augment Prov, 5mm Size C,D (2)
00-5987-089-10	Posterior Augment Prov, 10mm Size C,D (2)
00-5987-090-05	Distal Augment Prov, 5mm Size C,D (2)
00-5987-090-10	Distal Augment Prov, 10mm Size C,D (2)
00-5987-099-00	Patella Joint Line Gauge
00-5995-090-55	CRA Femoral Prov/Cutting Guide Case

Optional (order separately)

Cat. No.	Description
00-5989-033-31	Anterior Augment Prov, Size C
00-5989-034-31	Anterior Augment Prov, Size D
00-5989-035-31	Anterior Augment Prov, Size E
00-5989-036-31	Anterior Augment Prov, Size F
00-5989-037-31	Anterior Augment Prov, Size G

NEXGEN LCCK FEMORAL PROVISIONAL/CUTTING GUIDE KIT 00-5973-072-00

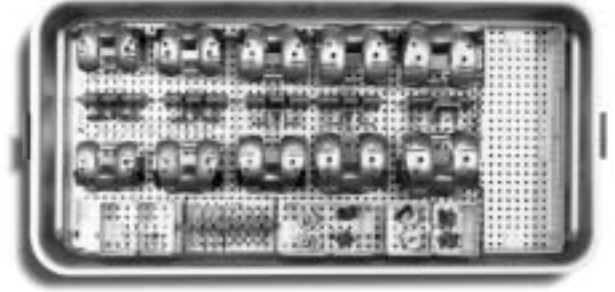

00-5973-072-00 NexGen LCCK Femoral Provisional/Cutting Guide Kit

Cat. No.	Description
00-5222-039-00	Headless Pins, 48mm
00-5977-056-01	Short-head Holding Pins
00-5987-089-05	Posterior Augment Prov., 5mm, Size C,D (2)
00-5987-089-10	Posterior Augment Prov., 10mm, Size C,D (2)
00-5987-090-05	Distal Augment Prov., 5mm, Size C,D (2)
00-5987-090-10	Distal Augment Prov., 10mm, Size C,D (2)
00-5987-090-15	Distal Augment Prov., 15mm, Size C/D (2)
00-5987-090-20	Distal Augment Prov., 20mm, Size C/D (2)
00-5987-091-05	Posterior Augment Prov., 5mm, Size E,F (2)
00-5987-091-10	Posterior Augment Prov., 10mm, Size E,F (2)
00-5987-092-05	Distal Augment Prov., 5mm, Size E,F (2)
00-5987-092-10	Distal Augment Prov., 10mm, Size E,F (2)
00-5987-092-15	Distal Augment Prov., 15mm, Size E/F (2)
00-5987-092-20	Distal Augment Prov., 20mm, Size E/F (2)
00-5987-093-05	Posterior Augment Prov., 5mm, Size G (2)
00-5987-093-10	Posterior Augment Prov., 10mm, Size G (2)
00-5987-094-05	Distal Augment Prov., 5mm, Size G (2)
00-5987-094-10	Distal Augment Prov., 10mm, Size G (2)
00-5987-094-15	Distal Augment Prov., 15mm, Size G (2)
00-5987-094-20	Distal Augment Prov., 20mm, Size G (2)
00-5995-013-00	Modular Box Prov, Size C
00-5995-014-00	Modular Box Prov, Size D
00-5995-015-00	Modular Box Prov, Size E
00-5995-016-00	Modular Box Prov, Size F
00-5995-017-00	Modular Box Prov, Size G
00-5995-013-91	Femoral Prov/Cutting Guide, Size C, Lt
00-5995-013-92	Femoral Prov/Cutting Guide, Size C, Rt
00-5995-014-91	Femoral Prov/Cutting Guide, Size D, Lt

CONTINUED ON PAGE 194

NEXGEN LCCK FEMORAL PROVISIONAL/CUTTING GUIDE KIT 00-5973-072-00 (CONT.)

00-5973-072-00 NexGen LCCK Femoral Prov/Cutting Guide Kit (cont)

Cat. No.	Description
00-5995-014-92	Femoral Prov/Cutting Guide, Size D, Rt
00-5995-015-91	Femoral Prov/Cutting Guide, Size E, Lt
00-5995-015-92	Femoral Prov/Cutting Guide, Size E, Rt
00-5995-016-91	Femoral Prov/Cutting Guide, Size F, Lt
00-5995-016-92	Femoral Prov/Cutting Guide, Size F, Rt
00-5995-017-01	Femoral Prov/Cutting Guide, Size G, Lt
00-5995-017-02	Femoral Prov/Cutting Guide, Size G, Rt
00-5995-085-55	LCCK Prov/Cut Guide Instrument Case

Optional (order separately)

Cat. No.	Description
00-5989-033-31	Anterior Augment Prov., Size C
00-5989-034-31	Anterior Augment Prov., Size D
00-5989-035-31	Anterior Augment Prov., Size E
00-5989-036-31	Anterior Augment Prov., Size F
00-5989-037-31	Anterior Augment Prov., Size G

NOTE: Replacement Modular Box Provisional Screws 00-5987-085-00 are not included in the kit.

NEXGEN LCCK ARTICULAR SURFACE PROVISIONAL/ INSTRUMENT KITS 00-5973-073-00, 00-5974-074-00

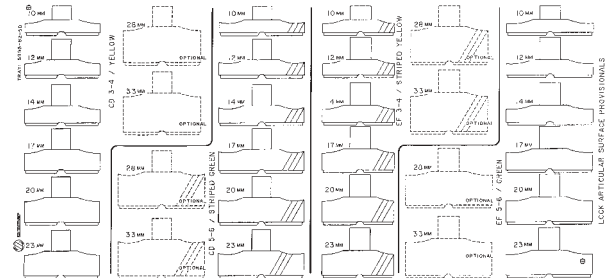

00-5973-073-00 NexGen LCCK Articular Surface Prov/Instr Kit

Cat. No.	Description
00-5995-030-10	Articular Surf Prov, Yellow, 10mm (Fem C,D - Tib 3,4)
00-5995-030-12	Articular Surf Prov, Yellow, 12mm (Fem C,D - Tib 3,4)
00-5995-030-14	Articular Surf Prov, Yellow, 14mm (Fem C,D - Tib 3,4)
00-5995-030-17	Articular Surf Prov, Yellow, 17mm (Fem C,D - Tib 3,4)
00-5995-030-20	Articular Surf Prov, Yellow, 20mm (Fem C,D - Tib 3,4)
00-5995-030-23	Articular Surf Prov, Yellow, 23mm (Fem C,D - Tib 3,4)
00-5995-041-10	Articular Surf Prov, Str Green, 10mm (Fem C,D - Tib 5,6)
00-5995-041-12	Articular Surf Prov, Str Green, 12mm (Fem C,D - Tib 5,6)
00-5995-041-14	Articular Surf Prov, Str Green, 14mm (Fem C,D - Tib 5,6)
00-5995-041-17	Articular Surf Prov, Str Green, 17mm (Fem C,D - Tib 5,6)
00-5995-041-20	Articular Surf Prov, Str Green, 20mm (Fem C,D - Tib 5,6)
00-5995-041-23	Articular Surf Prov, Str Green, 23mm (Fem C,D - Tib 5,6)
00-5995-051-10	Articular Surf Prov, Str Blue, 10mm (Fem E,F - Tib 7-10)
00-5995-051-12	Articular Surf Prov, Str Blue, 12mm (Fem E,F - Tib 7-10)
00-5995-051-14	Articular Surf Prov, Str Blue, 14mm (Fem E,F - Tib 7-10)
00-5995-051-17	Articular Surf Prov, Str Blue, 17mm (Fem E,F - Tib 7-10)
00-5995-051-20	Articular Surf Prov, Str Blue, 20mm (Fem E,F - Tib 7-10)
00-5995-051-23	Articular Surf Prov, Str Blue, 23mm (Fem E,F - Tib 7-10)
00-5995-040-10	Articular Surf Prov, Green, 10mm (Fem E,F - Tib 5-6)
00-5995-040-12	Articular Surf Prov, Green, 12mm (Fem E,F - Tib 5-6)
00-5995-040-14	Articular Surf Prov, Green, 14mm (Fem E,F - Tib 5-6)
00-5995-040-17	Articular Surf Prov, Green, 17mm (Fem E,F - Tib 5-6)
00-5995-040-20	Articular Surf Prov, Green, 20mm (Fem E,F - Tib 5-6)
00-5995-040-23	Articular Surf Prov, Green, 23mm (Fem E,F - Tib 5-6)
00-5995-050-10	Articular Surf Prov, Blue, 10mm (Fem G - Tib 7-10)
00-5995-050-12	Articular Surf Prov, Blue, 12mm (Fem G - Tib 7-10)
00-5995-050-14	Articular Surf Prov, Blue, 14mm (Fem G - Tib 7-10)
00-5995-050-17	Articular Surf Prov, Blue, 17mm (Fem G - Tib 7-10)
00-5995-050-20	Articular Surf Prov, Blue, 20mm (Fem G - Tib 7-10)
00-5995-050-23	Articular Surf Prov, Blue, 23mm (Fem G - Tib 7-10)

CONTINUED ON PAGE 196

NEXGEN LCCK ARTICULAR SURFACE PROVISIONAL/ INSTRUMENT KITS 00-5973-073-00, 00-5974-074-00 (CONT.)

00-5973-073-00 *NexGen* LCCK Articular Surface Prov/Instr Kit (cont)

Cat. No.	Description
00-5987-038-00	Stem Protector Sleeve
00-5995-075-00	Articular Surf Prov Locking Screw
00-5995-080-55	LCCK Articular Surface Prov/Instr Case

00-5973-074-00 *NexGen* LCCK Thick Articular Surface Prov/Instr Kit

Cat. No.	Description
00-5995-030-28	Articular Surf Prov, Yellow, 28mm (Fem C,D - Tib 3,4)
00-5995-030-33	Articular Surf Prov, Yellow, 33mm (Fem C,D - Tib 3,4)
00-5995-040-28	Articular Surf Prov, Green, 28mm (Fem E,F - Tib 5,6)
00-5995-040-33	Articular Surf Prov, Green, 33mm (Fem E,F - Tib 5,6)
00-5995-041-28	Articular Surf Prov, Str Green, 28mm (Fem C,D - Tib 5,6)
00-5995-041-33	Articular Surf Prov, Str Green, 33mm (Fem C,D - Tib 5,6)
00-5995-050-28	Articular Surf Prov, Blue, 28mm (Fem G - Tib 7-10)
00-5995-050-33	Articular Surf Prov, Blue, 33mm (Fem G - Tib 7-10)
00-5995-051-28	Articular Surf Prov, Str Blue, 28mm (Fem E, F - Tib 7-10)
00-5995-051-33	Articular Surf Prov, Str Blue, 33mm (Fem E, F - Tib 7-10)

NEXGEN CRA/LCCK REVISION INSTRUMENT KIT 00-5973-075-00

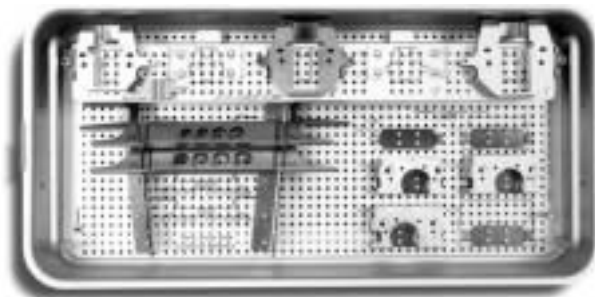

00-5973-075-00 *NexGen* CRA/LCCK Revision Instrument Kit

Cat. No.	Description
00-5061-063-00	Hex Head Holding Pins
00-5987-010-01	Femoral Stem Drill, 18mm
00-5987-011-03	Fem Stem Base/ Cutting Block, Size C
00-5987-011-04	Fem Stem Base/ Cutting Block, Size D
00-5987-011-05	Fem Stem Base/ Cutting Block, Size E
00-5987-011-06	Fem Stem Base/ Cutting Block, Size F
00-5987-011-07	Fem Stem Base/ Cutting Block, Size G
00-5987-012-00	Femoral Base Guide Flange
00-5987-013-01	Femoral Guide Bushing, Size 9, 10
00-5987-013-02	Femoral Guide Bushing, Size 11, 12
00-5987-013-03	Femoral Guide Bushing, Size 13-15
00-5987-013-04	Femoral Guide Bushing, Size 16-18
00-5987-013-05	Femoral Guide Bushing, Size 19-21
00-5987-014-00	Femoral Offset Bushing
00-5987-016-00	Stem Provisional Adapter

CONTINUED ON PAGE 198

NEXGEN CRA/LCCK REVISION INSTRUMENT KIT 00-5973-075-00 (CONT.)

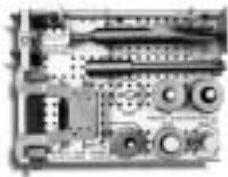

00-5973-075-00 NexGen CRA/LCCK Revision Instrument Kit (cont)

Cat. No.	Description
00-5987-019-00	Posterior Saw Guide Attachment
00-5987-070-00	LCCK Stem Extension Bushing
00-5987-079-00	Offset Stem Wrench
00-5987-080-00	Offset Stem Locknut
00-5987-097-03	LCCK Notch Chamfer Guide, Size C
00-5987-097-04	LCCK Notch Chamfer Guide, Size D
00-5987-097-05	LCCK Notch Chamfer Guide, Size E
00-5987-097-06	LCCK Notch Chamfer Guide, Size F
00-5987-097-07	LCCK Notch Chamfer Guide, Size G
00-5987-037-00*	LCCK Tibial Plate Wrench, Size 1, 2
00-5995-037-01	LCCK Tibial Plate Wrench, Size 3,4
00-5995-037-02	LCCK Tibial Plate Wrench, Size 5,6
00-5995-037-03	LCCK Tibial Plate Wrench, Size 7, 8
00-5995-037-04	LCCK Tibial Plate Wrench, Size 9,10
00-5995-070-00	CRA/LCCK Revision Instrument Case

*May order separately, not included in kit.

V-STAT INSTRUMENT KIT 00-5973-081-00

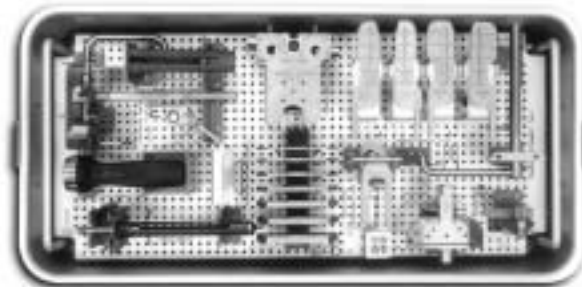

00-5973-081-00 V-STAT Variable Soft Tissue Alignment Tensor Instrument Kit

Cat. No.	Description
00-5061-063-00	Hex-head Holding Pins
00-5967-030-00	EPI Distal Femoral Cutting Guide
00-5967-031-00	Distal Placement Guide, 0°
00-5969-001-00	Tensor, 0°
00-5969-002-00	In-line Torque Wrench
00-5969-003-00	Ratcheting Handle
00-5969-004-01	Spacer Block, +1mm
00-5969-004-02	Spacer Block, +2mm
00-5969-005-00	Spacer Block, Standard Cut
00-5969-005-01	Spacer Block, -1mm
00-5969-005-02	Spacer Block, -2mm
00-5969-005-03	Spacer Block, -3mm
00-5969-005-04	Spacer Block, -4mm
00-5969-005-05	Spacer Block, -5mm
00-5969-006-00	Valgus Angle Reference Guide
00-5969-011-00	Posterior Femoral Rough Cutter & Alignment Guide
00-5969-012-00	Femoral Sizer
00-5969-013-00	Poly Sizer
00-5969-044-00	Anterior Femoral Mark Guide
00-5969-095-00	V-STAT Instrument Case

Optional (order separately)

Cat. No.	Description
00-5969-011-01	Femoral Rough Cutter Handle
00-5969-043-01	Macro Paddle Assy
00-5969-043-02	Macro Paddle Assy
00-5969-001-03	Tensor-3° Flexed Distal Cut
00-5969-005-06	Rev Cut Spacer Block, +3mm

NEXGEN MULTI-REFERENCE 4-IN-1 FEMORAL INSTRUMENT KIT 00-5973-082-00

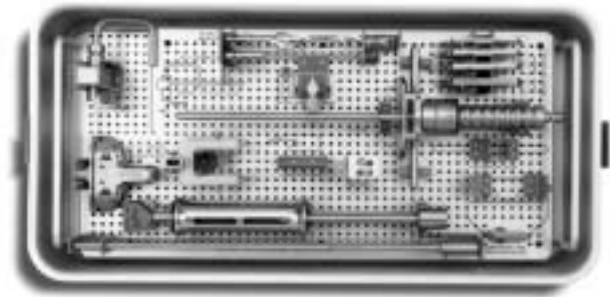

00-5973-082-00 *NexGen Multi-Reference 4-in-1
Femoral Instrument Kit*

Cat. No.	Description
00-5977-084-00	Resection Guide
00-5061-063-00	Hex-head Holding Pins
00-5120-085-00	Bone Screw Drill, 3.2mm
00-5785-079-00	Alignment Rod
00-5785-080-00	Alignment Rod w/ Coupler
00-5785-097-00	Slaphammer Extractor
00-5967-030-00	EPI Distal Femoral Cutting Guide
00-5967-032-00	3° Distal Placement Guide
00-5967-031-00	0° Distal Placement Guide
00-5967-053-00	4-in-1 A/P Sizing Guide
00-5969-005-00	Standard Cut Spacer
00-5969-005-02	Spacer, -2mm
00-5969-005-03	Spacer, -3mm
00-5969-005-04	Spacer, -4mm
00-5977-024-00	Alignment Arch
00-5978-004-00	<i>MICRO-MILL</i> Adjustable IM Guide
00-5978-014-00	IM Step Drill w/ Step, 8mm diameter
00-5967-051-82	<i>Multi-Reference</i> Femoral Instrument ID Tag
00-5967-080-00	EPI Femoral Instrument Case

NEXGEN MIS MULTI-REFERENCE 4-IN-1 INSTRUMENT KIT 00-5973-082-50

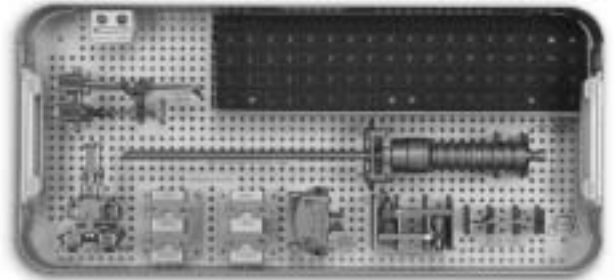

00-5973-082-50 *NexGen MIS Multi-Reference 4-in-1
Femoral Instrument Kit*

Cat. No.	Description
00-5967-055-00	Mini A/P Sizer
00-5967-055-11	Modular Plate Varus Left 0,3
00-5967-055-12	Modular Plate Varus Right 0,3
00-5967-055-13	Modular Plate Varus Left 5,7
00-5967-055-14	Modular Plate Varus Right 5,7
00-5983-028-00	Locking Boom*
00-5967-036-00	Distal Femoral Cutting Guide
00-5967-042-00	Mini Adjustable IM Guide - Long
00-5967-045-00	Mini IM Guide Spacer Standard
00-5967-046-00	<i>MIS</i> Threaded Handles
00-5967-032-00	3° Distal Placement Guide
00-5967-031-00	0° Distal Placement Guide
00-5987-089-00	Male Hex Screwdriver, 3.5mm
00-5967-049-00	Locking Boom Attachment
00-5967-038-00	Blue Universal Lid
00-5967-007-00	Base

Optional (order separately)

Cat. No.	Description
00-5967-043-00	Mini Adjustable IM Guide - Short

*Will be replaced by Q4

NEXGEN MIS MINI FEMORAL FINISHING INSTRUMENT KIT 00-5973-083-50

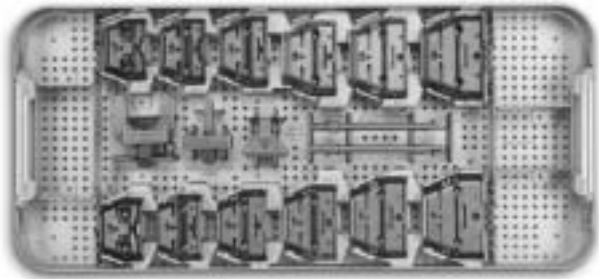

00-5973-083-50 NexGen MIS Mini Femoral Finishing Instrument Kit

Cat. No.	Description
00-5967-011-00	Posterior Reference/Rotation Guide
00-5967-015-00	Posterior Resection Gauge
00-5120-052-01	Patellar Femoral Drill
00-5967-069-00	Modular Shelf
00-5967-038-00	Blue Universal Lid
00-5967-026-00	Base

00-5973-083-01 Optional Sub-Kit

Cat. No.	Description
00-5983-033-00	MIS Femoral Finishing Guide Std. Size C
00-5983-034-00	MIS Femoral Finishing Guide Std. Size D
00-5983-035-01	MIS Femoral Finishing Guide Std. Size E
00-5983-036-00	MIS Femoral Finishing Guide Std. Size F
00-5983-037-00	MIS Femoral Finishing Guide Std. Size G

00-5973-083-02 Optional Sub-Kit

Cat. No.	Description
00-5983-043-00	MIS Femoral Finishing Guide Flex Size C
00-5983-044-00	MIS Femoral Finishing Guide Flex Size D
00-5983-045-01	MIS Femoral Finishing Guide Flex Size E
00-5983-046-00	MIS Femoral Finishing Guide Flex Size F
00-5983-047-00	MIS Femoral Finishing Guide Flex Size G

Optional Single Items

Cat. No.	Description
00-5965-009-00	LPS-Flex Femur Peg Drill, Size A,B
00-5983-031-00	MIS Femoral Finishing Guide Std. Size A
00-5983-032-01	MIS Femoral Finishing Guide Std. Size B
00-5983-038-00	MIS Femoral Finishing Guide Std. Size H
00-5983-042-00	MIS Femoral Finishing Guide Flex Size B
00-5983-048-00	MIS Femoral Finishing Guide Flex Size H

NEXGEN MULTI-REFERENCE 4-IN-1 FEMORAL/TIBIAL INSTRUMENT KIT 00-5973-083-00

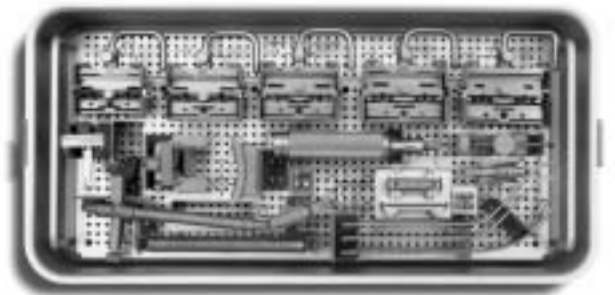

00-5973-083-00 NexGen Multi-Reference Femoral/Tibial Instrument Kit

Cat. No.	Description
00-5061-063-00	Hex-head Holding Pin
00-5061-082-00	Retractor Spring, 14cm
00-5120-008-00	Universal Handle
00-5120-061-00	Tibial Retractor (2)
00-5222-039-00	Tibial Wedge Provisional Pins
00-5967-002-00	Female Hex Driver Bit
00-5967-011-00	Posterior Reference/Rotation Guide
00-5967-015-00	Posterior Resection gauge
00-5967-033-01	Short Spring Screw
00-5967-051-03	4-in-1 Femoral Cutting Guide, Size C
00-5967-051-04	4-in-1 Femoral Cutting Guide, Size D
00-5967-051-05	4-in-1 Femoral Cutting Guide, Size E
00-5967-051-06	4-in-1 Femoral Cutting Guide, Size F
00-5967-051-07	4-in-1 Femoral Cutting Guide, Size G
00-5967-060-00	Extramedullary Tibial Cutting Guide
00-5977-037-00	Patella Tendon Retractor
00-5977-050-00	Tibial Depth Resection Gauge, 10mm
00-5977-062-00	2° varus/valgus Tibial Recutter
00-5977-095-00	Tibial Recutter, 2mm
00-5967-085-00	EPI Femoral/Tibial Instrument Case
00-5967-051-83	Multi-Reference Femoral/Tibial Instrument ID Tag

NEXGEN MULTI-REFERENCE 4-IN-1 MICRO INSTRUMENT KIT 00-5973-084-00

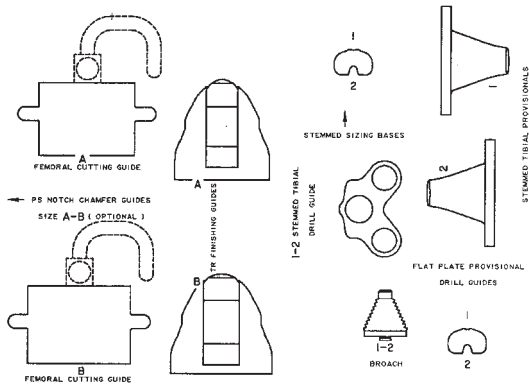
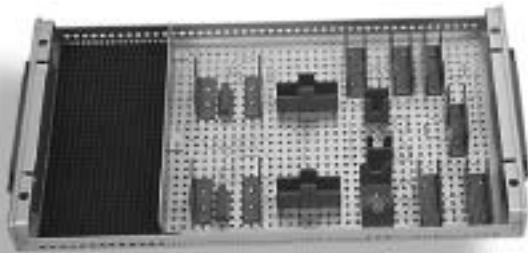

INSTRUMENT LAYOUT DIAGRAM

00-5973-084-00 *NexGen Multi-Reference 4-in-1
Micro Instrument Kit*

Cat. No.	Description
00-5061-063-00	Hex-head Holding Pins
00-5967-051-01	4-in-1 Femoral Cutting Guide, Size A
00-5967-051-02	4-in-1 Femoral Cutting Guide, Size B
00-5977-012-01	Tibial Sizing Plate, Size 1
00-5977-012-02	Tibial Sizing Plate, Size 2
00-5977-013-01	Stemmed Tibial Broach, Size 1, 2
00-5977-056-01	Grooved Short-head Holding Pins
00-5981-027-01	Stemmed Tibial Prov., Size 1
00-5981-027-02	Stemmed Tibial Prov., Size 2
00-5967-072-01	EPI Notch Chamfer Guide, Size A
00-5967-072-02	EPI Notch Chamfer Guide, Size B
00-5967-073-12	Notch Slot Attachment, Size A, B
00-5967-051-84	ID Tag <i>Multi-Reference</i> Micro Instrument
00-5968-080-55	EPI/IM Micro Instrument Case

NEXGEN MULTI-REFERENCE 4-IN-1 MACRO INSTRUMENT KIT 00-5973-085-00

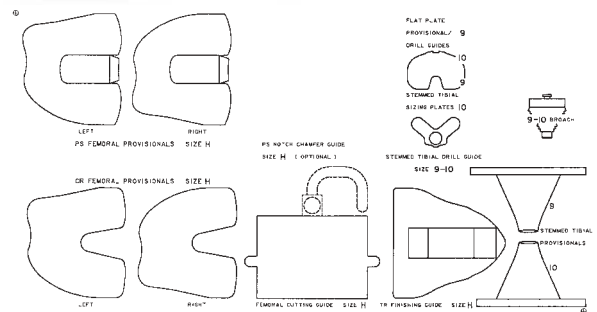
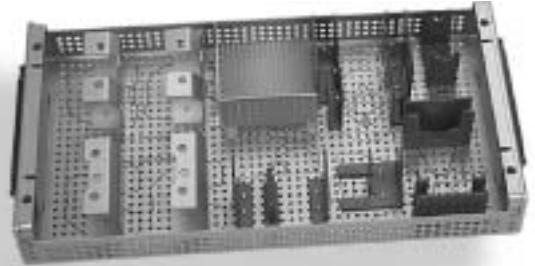

INSTRUMENT LAYOUT DIAGRAM

00-5973-085-00 *NexGen Multi-Reference 4-in-1
Macro Instrument Kit*

Cat. No.	Description
00-5061-063-00	Hex Head Holding Pins
00-5967-051-08	4-in-1 Femoral Cutting Guide, Size H
00-5977-056-01	Short Head Holding Pins
00-5997-018-01	LPS Femoral Prov., Comp, Size H-L
00-5997-018-02	LPS Femoral Prov., Comp, Size H-R
00-5981-057-03	Stemmed Tibial Provisional, Size 9
00-5981-057-04	Stemmed Tibial Provisional, Size 10
00-5977-013-09	Stemmed Tibial Broach, Size 9,10
00-5977-012-09	Stemmed Tibial Sizing Plate, Size 9
00-5977-012-10	Stemmed Tibial Sizing Plate, Size 10
00-5967-072-08	EPI Notch Chamfer Guide, Size H
00-5967-073-78	Notch Slot Attachment, Size G, H
00-5967-051-85	ID Tag, <i>Multi-Reference</i> Macro Instrument
00-5968-075-55	EPI/IM Macro Instrument/Provisional Case

NEXGEN MIS MINI-INCISION IM INSTRUMENT KIT 00-5973-090-50

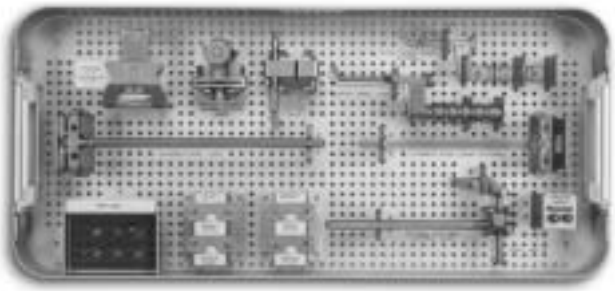

00-5973-090-50 NexGen MIS Mini-Incision IM Instrument Kit

Cat. No.	Description
00-5967-062-00	Mini IM Alignment Guide (9 in.)
00-5967-065-00	Mini IM Primary Anterior Cut Guide
00-5967-065-10	Mini Offset Boom
00-5967-066-00	Mini IM Distal Cut Block
00-5967-067-00	Mini IM External Rotation Guide
00-5967-055-11	Modular Plate Varus Left 0,3
00-5967-055-12	Modular Plate Varus Right 0,3
00-5967-055-13	Modular Plate Valgus Left 5,7
00-5967-055-14	Modular Plate Valgus Right 5,7
00-5968-040-00	Femoral A/P Measuring Guide
00-5967-046-00	Threaded Handles
00-5967-084-00	MIS Mini Instrument Base
00-5967-038-00	Blue Universal Lid

Optional (order separately)

Cat. No.	Description
00-5967-063-00	Mini IM Alignment Guide Short (6.5 in.)
00-5120-008-00	Universal Handle
00-5061-063-00	Hex Head Holding Pins
00-5222-039-00	Headless Holding Pins
00-5997-084-00	Gold Headless Pins
00-5967-069-00	MIS Modular Shelf

NEXGEN IM FEMORAL ALIGNMENT/RESECTION KIT 00-5973-090-00

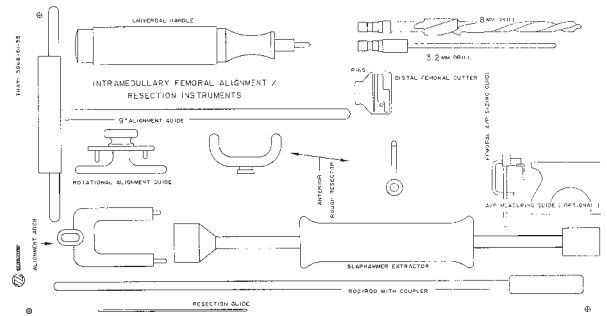

INSTRUMENT LAYOUT DIAGRAM

00-5973-090-00 NexGen IM Femoral Alignment/Resection Kit

Cat. No.	Description
00-5061-063-00	Hex-head Holding Pins
00-5120-008-00	Universal Handle
00-5120-015-00	Rotational Alignment Guide
00-5120-085-00	Bone Screw Drill
00-5785-079-00	Alignment Rod
00-5785-080-00	Alignment Rod w/ Coupler
00-5785-097-00	Slaphammer Extractor
00-5968-010-00	IM Alignment Guide, 9in.
00-5968-011-00	IM Alignment Guide, 4in.
00-5968-020-00	Anterior Femoral Cutting Guide
00-5968-030-00	Distal Femoral Cutting Guide
00-5968-040-00	Femoral A/P Measuring Guide
00-5977-024-00	Extramedullary Alignment Guide
00-5977-084-00	Resection Guide
00-5978-003-00	IM Femoral A/P Sizing Guide
00-5978-014-00	IM Drill w/ Step, 8mm
00-5968-060-55	IM Femoral Alignment/Resection Case

NEXGEN IM FEMORAL FINISHING INSTRUMENT KIT 00-5973-091-00

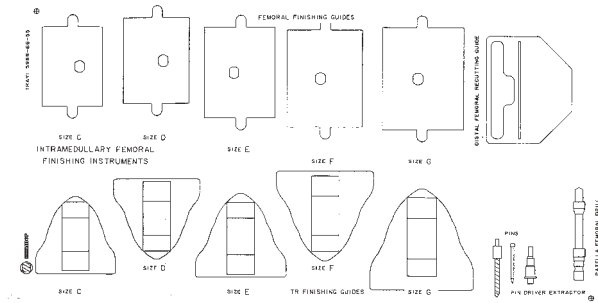

00-5973-091-00 NexGen IM Femoral Finishing Instrument Kit

Cat. No.	Description
00-5120-052-01	Patellar/Femoral Drill
00-5967-002-00	Female Hex Driver Bit
00-5967-009-03	Distal Femoral Recutting Guide
00-5967-033-01	Spring Screw, Short
00-5968-053-00	Femoral Finishing Guide, Size C
00-5968-054-00	Femoral Finishing Guide, Size D
00-5968-055-00	Femoral Finishing Guide, Size E
00-5968-056-00	Femoral Finishing Guide, Size F
00-5968-057-00	Femoral Finishing Guide, Size G
00-5977-056-01	Short-head Holding Pin
00-5968-065-55	IM Femoral Finishing Instrument Case

See pages 175-178 for Notch-Cutting Guide Options.

NEXGEN IM FEMORAL/TIBIAL ALIGNMENT/FINISHING KIT 00-5973-092-00

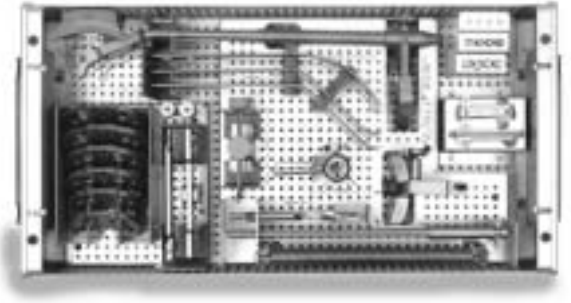

00-5973-092-00 NexGen IM Femoral/Tibial Alignment/ Finishing Kit

Cat. No.	Description
00-5061-063-00	Hex-head Holding Pins
00-5061-082-00	Retractor Spring, 14cm
00-5120-061-00	Tibial Retractor (2)
00-5120-067-00	Tibial Peg Drill
00-5120-069-00	Tibial Holding Pegs
00-5785-082-00	IM Knee Drill, 8mm
00-5967-033-01	Short Spring Screw
00-5967-060-00	Extramedullary Tibial Cutting Guide
00-5977-015-03	Flat Plate Provisional/Drill Guide, Size 3
00-5977-015-04	Flat Plate Provisional/Drill Guide, Size 4
00-5977-015-05	Flat Plate Provisional/Drill Guide, Size 5
00-5977-015-06	Flat Plate Provisional/Drill Guide, Size 6
00-5977-015-07	Flat Plate Provisional/Drill Guide, Size 7
00-5977-015-08	Flat Plate Provisional/Drill Guide, Size 8
00-5977-096-00	Locking Tibial Tray Provisional Handle
00-5977-037-00	Patella Tendon Retractor
00-5977-050-00	Tibial Depth Resection Gauge, 10mm
00-5977-056-01	Short-head Holding Pins
00-5977-062-00	2° Varus/Valgus Tibial Recutter
00-5977-083-00	IM Tibial Resector
00-5977-095-00	Tibial Recutter, 2mm
00-5968-070-55	IM Femoral/Tibial Alignment/Finishing Case

MICRO-MILL DRIVER KIT-5973-99

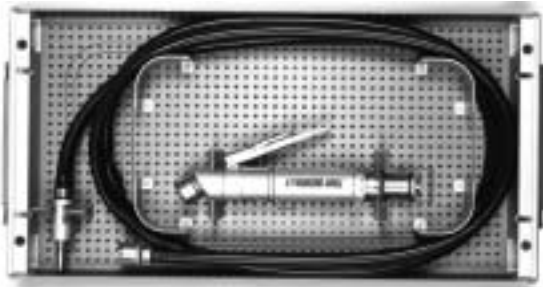

00-5973-099-00 MICRO-MILL Driver

Cat. No.	Description
00-5052-010-00	Universal Hose,10ft.
00-5978-060-00	MICRO-MILL Driver
00-5991-095-55	Milling Driver Case

NEXGEN LPS-FLEX FEMORAL PROVISIONAL/INSTRUMENT KIT 00-5975-001-00

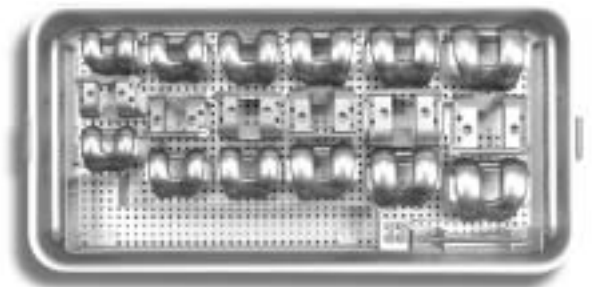

00-5975-001-00 NexGen LPS-Flex Femoral Instrument Kit

Cat. No.	Description
00-5961-012-01	LPS-Flex Femoral Provisional, Size B, Left
00-5961-012-02	LPS-Flex Femoral Provisional, Size B, Right
00-5961-013-01	LPS-Flex Femoral Provisional, Size C, Left
00-5961-013-02	LPS-Flex Femoral Provisional, Size C, Right
00-5961-014-01	LPS-Flex Femoral Provisional, Size D, Left
00-5961-014-02	LPS-Flex Femoral Provisional, Size D, Right
00-5961-015-01	LPS-Flex Femoral Provisional, Size E, Left
00-5961-015-02	LPS-Flex Femoral Provisional, Size E, Right
00-5961-016-01	LPS-Flex Femoral Provisional, Size F, Left
00-5961-016-02	LPS-Flex Femoral Provisional, Size F, Right
00-5961-017-01	LPS-Flex Femoral Provisional, Size G, Left
00-5961-017-02	LPS-Flex Femoral Provisional, Size G, Right
00-5965-002-00	LPS-Flex Posterior Re-Cut Guide, Size B
00-5965-003-00	LPS-Flex Posterior Re-Cut Guide, Size C
00-5965-004-00	LPS-Flex Posterior Re-Cut Guide, Size D
00-5965-005-00	LPS-Flex Posterior Re-Cut Guide, Size E
00-5965-006-00	LPS-Flex Posterior Re-Cut Guide, Size F
00-5965-007-00	LPS-Flex Posterior Re-Cut Guide, Size G
00-5965-009-00	LPS-Flex Femur Peg Drill, Size A,B
00-5965-095-00	LPS-Flex Femoral Prov/Instr Case
00-5965-099-00	Re-Cut Guide Modular Pegs (4)

NEXGEN LPS-FLEX FIXED ARTICULAR SURFACE PROVISIONAL/INSTRUMENT KIT 00-5975-002-00

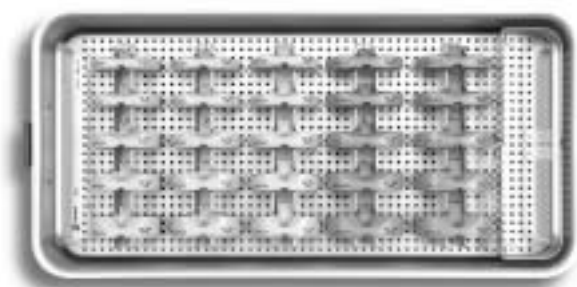
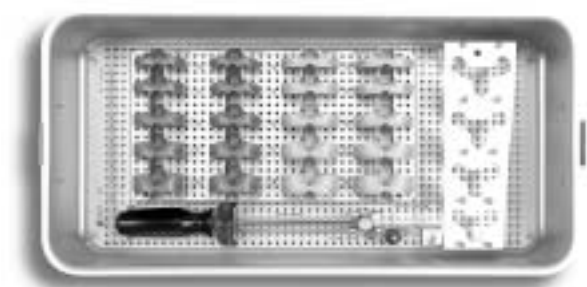

**00-5975-002-00 NexGen LPS-Flex Fixed Articular Surface
Prov/Instr Kit**

Cat. No.	Description
00-5961-020-10	LPS-Flex Fixed Art. Surf. Provisional AB/1-2, 10mm
00-5961-020-12	LPS-Flex Fixed Art. Surf. Provisional AB/1-2, 12mm
00-5961-020-14	LPS-Flex Fixed Art. Surf. Provisional AB/1-2, 14mm
00-5961-020-17	LPS-Flex Fixed Art. Surf. Provisional AB/1-2, 17mm
00-5961-020-20	LPS-Flex Fixed Art. Surf. Provisional AB/1-2, 20mm
00-5961-022-10	LPS-Flex Fixed Art. Surf. Provisional CD/1-2, 10mm
00-5961-022-12	LPS-Flex Fixed Art. Surf. Provisional CD/1-2, 12mm
00-5961-022-14	LPS-Flex Fixed Art. Surf. Provisional CD/1-2, 14mm
00-5961-022-17	LPS-Flex Fixed Art. Surf. Provisional CD/1-2, 17mm
00-5961-022-20	LPS-Flex Fixed Art. Surf. Provisional CD/1-2, 20mm
00-5961-030-10	LPS-Flex Fixed Art. Surf. Provisional CD/3-4, 10mm
00-5961-030-12	LPS-Flex Fixed Art. Surf. Provisional CD/3-4, 12mm
00-5961-030-14	LPS-Flex Fixed Art. Surf. Provisional CD/3-4, 14mm
00-5961-030-17	LPS-Flex Fixed Art. Surf. Provisional CD/3-4, 17mm
00-5961-030-20	LPS-Flex Fixed Art. Surf. Provisional CD/3-4, 20mm
00-5961-032-10	LPS-Flex Fixed Art. Surf. Provisional EF/3-4, 10mm
00-5961-032-12	LPS-Flex Fixed Art. Surf. Provisional EF/3-4, 12mm
00-5961-032-14	LPS-Flex Fixed Art. Surf. Provisional EF/3-4, 14mm
00-5961-032-17	LPS-Flex Fixed Art. Surf. Provisional EF/3-4, 17mm
00-5961-032-20	LPS-Flex Fixed Art. Surf. Provisional EF/3-4, 20mm
00-5961-040-10	LPS-Flex Fixed Art. Surf. Provisional EF/5-6, 10mm
00-5961-040-12	LPS-Flex Fixed Art. Surf. Provisional EF/5-6, 12mm
00-5961-040-14	LPS-Flex Fixed Art. Surf. Provisional EF/5-6, 14mm
00-5961-040-17	LPS-Flex Fixed Art. Surf. Provisional EF/5-6, 17mm
00-5961-040-20	LPS-Flex Fixed Art. Surf. Provisional EF/5-6, 20mm
00-5961-041-10	LPS-Flex Fixed Art. Surf. Provisional CD/5-6, 10mm
00-5961-041-12	LPS-Flex Fixed Art. Surf. Provisional CD/5-6, 12mm

**00-5975-002-00 NexGen LPS-Flex Fixed Articular Surface
Prov/Instr Kit (cont)**

Cat. No.	Description
00-5961-041-14	LPS-Flex Fixed Art. Surf. Provisional CD/5-6, 14mm
00-5961-041-17	LPS-Flex Fixed Art. Surf. Provisional CD/5-6, 17mm
00-5961-041-20	LPS-Flex Fixed Art. Surf. Provisional CD/5-6, 20mm
00-5961-042-10	LPS-Flex Fixed Art. Surf. Provisional G/5-6, 10mm
00-5961-042-12	LPS-Flex Fixed Art. Surf. Provisional G/5-6, 12mm
00-5961-042-14	LPS-Flex Fixed Art. Surf. Provisional G/5-6, 14mm
00-5961-042-17	LPS-Flex Fixed Art. Surf. Provisional G/5-6, 17mm
00-5961-042-20	LPS-Flex Fixed Art. Surf. Provisional G/5-6, 20mm
00-5961-050-10	LPS-Flex Fixed Art. Surf. Provisional G/7-10, 10mm
00-5961-050-12	LPS-Flex Fixed Art. Surf. Provisional G/7-10, 12mm
00-5961-050-14	LPS-Flex Fixed Art. Surf. Provisional G/7-10, 14mm
00-5961-050-17	LPS-Flex Fixed Art. Surf. Provisional G/7-10, 17mm
00-5961-050-20	LPS-Flex Fixed Art. Surf. Provisional G/7-10, 20mm
00-5961-051-10	LPS-Flex Fixed Art. Surf. Provisional EF/7-10, 10mm
00-5961-051-12	LPS-Flex Fixed Art. Surf. Provisional EF/7-10, 12mm
00-5961-051-14	LPS-Flex Fixed Art. Surf. Provisional EF/7-10, 14mm
00-5961-051-17	LPS-Flex Fixed Art. Surf. Provisional EF/7-10, 17mm
00-5961-051-20	LPS-Flex Fixed Art. Surf. Provisional EF/7-10, 20mm
00-5965-090-00	LPS-Flex Fixed Art. Surf. Prov/Instr Case
00-5987-035-00	Deflection Beam Torque Wrench
00-5987-036-00	Hex Driver Bit, 4.5mm
00-5995-075-00	Articular Surf. Prov. Locking Screw

NEXGEN LPS-FLEX MOBILE ARTICULAR SURFACE PROVISIONAL/INSTRUMENT KIT 00-5975-003-00

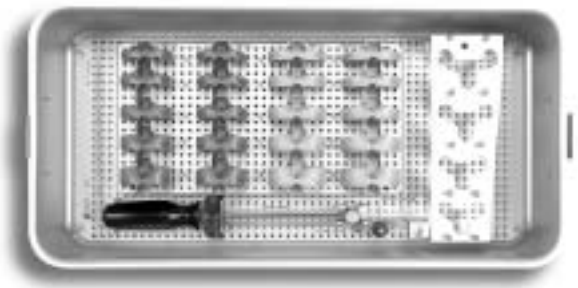

**00-5975-003-00 NexGen LPS-Flex Mobile Articular Surf
Prov/Inst Kit**

Cat. No.	Description
00-5945-020-09	Articular Surf Prov. A,B/1,2,3 9mm
00-5945-020-10	Articular Surf Prov. A,B/1,2,3 10mm
00-5945-020-12	Articular Surf Prov. A,B/1,2,3 12mm
00-5945-020-14	Articular Surf Prov. A,B/1,2,3 14mm
00-5945-020-17	Articular Surf Prov. A,B/1,2,3 17mm
00-5945-020-20	Articular Surf Prov. A,B/1,2,3 20mm
00-5945-030-09	Articular Surf Prov. C/2,3,4 9mm
00-5945-030-10	Articular Surf Prov. C/2,3,4 10mm
00-5945-030-12	Articular Surf Prov. C/2,3,4 12mm
00-5945-030-14	Articular Surf Prov. C/2,3,4 14mm
00-5945-030-17	Articular Surf Prov. C/2,3,4 17mm
00-5945-030-20	Articular Surf Prov. C/2,3,4 20mm
00-5945-040-09	Articular Surf Prov. D/3,4,5 9mm
00-5945-040-10	Articular Surf Prov. D/3,4,5 10mm
00-5945-040-12	Articular Surf Prov. D/3,4,5 12mm
00-5945-040-14	Articular Surf Prov. D/3,4,5 14mm
00-5945-040-17	Articular Surf Prov. D/3,4,5 17mm
00-5945-040-20	Articular Surf Prov. D/3,4,5 20mm
00-5945-050-09	Articular Surf Prov. E/4,5,6 9mm
00-5945-050-10	Articular Surf Prov. E/4,5,6 10mm
00-5945-050-12	Articular Surf Prov. E/4,5,6 12mm

**00-5975-003-00 NexGen LPS-Flex Mobile Articular Surf
Prov/Inst Kit (cont)**

Cat. No.	Description
00-5945-050-14	Articular Surf Prov. E/4,5,6 14mm
00-5945-050-17	Articular Surf Prov. E/4,5,6 17mm
00-5945-050-20	Articular Surf Prov. E/4,5,6 20mm
00-5945-060-09	Articular Surf Prov. F/5,6,7 9mm
00-5945-060-10	Articular Surf Prov. F/5,6,7 10mm
00-5945-060-12	Articular Surf Prov. F/5,6,7 12mm
00-5945-060-14	Articular Surf Prov. F/5,6,7 14mm
00-5945-060-17	Articular Surf Prov. F/5,6,7 17mm
00-5945-060-20	Articular Surf Prov. F/5,6,7 20mm
00-5945-070-09	Articular Surf Prov. G/6,7,8 9mm
00-5945-070-10	Articular Surf Prov. G/6,7,8 10mm
00-5945-070-12	Articular Surf Prov. G/6,7,8 12mm
00-5945-070-14	Articular Surf Prov. G/6,7,8 14mm
00-5945-070-17	Articular Surf Prov. G/6,7,8 17mm
00-5945-070-20	Articular Surf Prov. G/6,7,8 20mm
00-5965-085-00	LPS-Flex Mobile Art Surface Prov./Inst. Case
00-5987-035-00	Deflection Beam Torque Wrench
00-5987-036-00	Hex Driver Bit, 4.5mm

NEXGEN MIS TIBIAL PLATE INSTRUMENT KIT

00-5951-004-00, 00-5951-005-00, 00-5951-006-00

00-5951-006-00 NexGen MIS Micro Tibial Plate Instrument Kit

Cat. No.	Description
00-5951-012-01	MIS Tibial Plate Sizer, Size 1
00-5951-012-02	MIS Tibial Plate Sizer, Size 2
00-5951-026-01	MIS Cemented Broach, Sizes 1,2
00-5951-027-01	MIS Tibial Plate Provisional Size 1
00-5951-027-02	MIS Tibial Plate Provisional Size 2
00-5951-084-00	MIS Micro Tibial Plate Instrument Case

00-5951-004-00 NexGen MIS Tibial Plate Instrument Kit

Cat. No.	Description
00-5951-067-45	MIS Extension Provisional, 45mm
00-5951-067-75	MIS Extension Provisional, 75mm
00-5951-037-01	MIS Tibial Plate Provisional Size 3
00-5951-037-12	MIS Tibial Plate Provisional Size 4
00-5951-047-01	MIS Tibial Plate Provisional Size 5
00-5951-047-02	MIS Tibial Plate Provisional Size 6
00-5951-057-01	MIS Tibial Plate Provisional Size 7
00-5951-057-02	MIS Tibial Plate Provisional Size 8
00-5951-075-00	MIS Provisional Surface Locking Screw
00-5951-012-03	MIS Tibial Plate Sizer, Size 3
00-5951-012-04	MIS Tibial Plate Sizer, Size 4
00-5951-012-05	MIS Tibial Plate Sizer, Size 5
00-5951-012-06	MIS Tibial Plate Sizer, Size 6
00-5951-012-07	MIS Tibial Plate Sizer, Size 7
00-5951-012-08	MIS Tibial Plate Sizer, Size 8

00-5951-004-00 NexGen MIS Tibial Plate Instrument Kit (cont.)

Cat. No.	Description
00-5951-026-03	MIS Cemented Broach, Sizes 3,4,4+
00-5951-026-05	MIS Cemented Broach, Sizes 5,6,6+
00-5951-026-07	MIS Cemented Broach, Sizes 7-8
00-5951-003-00	Drill Bushing
00-5951-090-00	Tibial Broach Impactor Assembly
00-5951-009-00	Locking Plate Inserter
00-5951-009-01	Flex Countertorque
00-5951-096-00	MIS Sizing Plate Handle
00-5951-017-00	MIS Tibial Provisional Extractor
00-5951-036-00	MIS 6mm Hex Driver
00-5951-036-02	MIS 6mm Hex Screwdriver
00-5951-011-00	Small Hexhead Driver
00-5977-010-00	NexGen Stemmed Tibial Drill
00-5987-035-00	Deflection Beam Torque Wrench
00-5983-049-00	MIS Screw Inserter/Extractor
00-5977-056-01	Shorthead Holding Pin
00-5222-039-00	Headless Pin
00-5951-081-00	MIS Stemmed Tibial Plate Instrument Case

00-5951-005-00 NexGen MIS Macro Tibial Plate Instrument Kit

Cat. No.	Description
00-5951-012-09	MIS Tibial Plate Sizer, Size 9
00-5951-012-10	MIS Tibial Plate Sizer, Size 10
00-5951-026-09	MIS Cemented Broach, Sizes 9,10
00-5951-057-03	MIS Tibial Plate Provisional Size 9
00-5951-057-04	MIS Tibial Plate Provisional Size 10
00-5951-087-00	MIS Macro Tibial Plate Instrument Case

NEXGEN MIS MODULAR TIBIAL PLATE INSTRUMENT KIT 00-5961-004-00

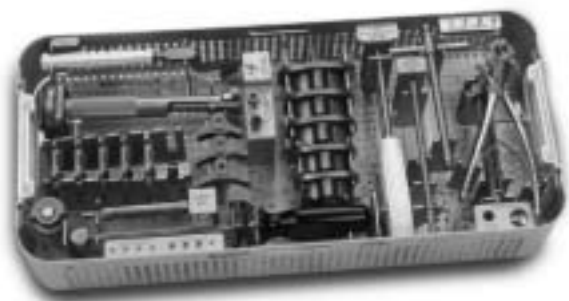

00-5961-004-00 NexGen MIS Modular Tibial Plate Instrument Kit

Cat. No.	Description
00-5961-001-00	MIS Modular Keel Holder
00-5961-002-00	Taper Seating Tool
00-5961-037-01	MIS Modular Tib Plate Provisional, Size 3
00-5961-037-02	MIS Modular Tib Plate Provisional, Size 4
00-5961-047-01	MIS Modular Tib Plate Provisional, Size 5
00-5961-047-02	MIS Modular Tib Plate Provisional, Size 6
00-5961-057-01	MIS Modular Tib Plate Provisional, Size 7
00-5961-057-02	MIS Modular Tib Plate Provisional, Size 8
00-5961-037-10	Stemtable Keel Provisional, Size 3-4
00-5961-047-10	Stemtable Keel Provisional, Size 5-6
00-5961-057-10	Stemtable Keel Provisional, Size 7-8
00-5961-037-00	Non-Stemtable Keel Provisional, Size 3-4
00-5961-037-00	18mm Modular Stemmed Tibial Drill
00-5931-007-00	18mm Tibial Stem Drill Guide
00-5951-009-00	MIS Locking Plate Inserter
00-5951-009-01	MIS Flex Countertorque Tool
00-5951-011-00	MIS Sizing Plate Screwdriver
00-5951-012-03	MIS Tibial Sizing Plate, Size 3
00-5951-012-04	MIS Tibial Sizing Plate, Size 4
00-5951-012-05	MIS Tibial Sizing Plate, Size 5
00-5951-012-06	MIS Tibial Sizing Plate, Size 6
00-5951-012-07	MIS Tibial Sizing Plate, Size 7
00-5951-012-08	MIS Tibial Sizing Plate, Size 8
00-5951-096-00	MIS Sizing Plate Handle
00-5951-090-00	MIS Tibial Broach Impactor Assembly
00-5977-013-03	Size 3-4 Broach
00-5977-013-05	Size 5-6 Broach
00-5977-013-07	Size 7-8 Broach
00-5983-049-00	MIS Screw Inserter/Extractor

00-5961-004-00 NexGen MIS Modular Tibial Plate Instrument Kit (cont.)

Cat. No.	Description
00-5987-035-00	Deflection Beam Torque Wrench
00-5995-075-00	A/S Provisional Locking Screw
00-5881-026-00	4.5mm Hex Driver Bit
00-5120-087-00	Hex Head Screwdriver, 3.5mm
00-5977-017-00	Tibial Provisional Extractor
00-5987-071-00	2mm Set Screw Hex Driver (x2)
00-5222-039-00	Headless Pin
00-5977-056-01	Shorthead Holding Pin
00-5961-080-00	MIS Modular Tibial Plate Instrument Case
Optional Instruments (Revision)	
00-5961-017-00	MIS Offset Revision Tibial Boom, 7"
00-5987-003-00	Straight Bushing
00-5987-004-00	Offset Bushing
Optional Instruments (Micro Size 2)	
00-5961-027-02	MIS Modular Tibial Plate Provisional, Size 2
00-5961-027-10	Stemtable Keel Provisional, Size 1-2
00-5961-027-00	Non-Stemtable Keel Provisional, Size 1-2
00-5951-012-02	MIS Tibial Sizing Plate, Size 2
00-5977-013-01	Size 1-2 Broach

NEXGEN FLUTED STEM MOBILE TIBIAL PROV/INSTR KIT 00-5975-004-00

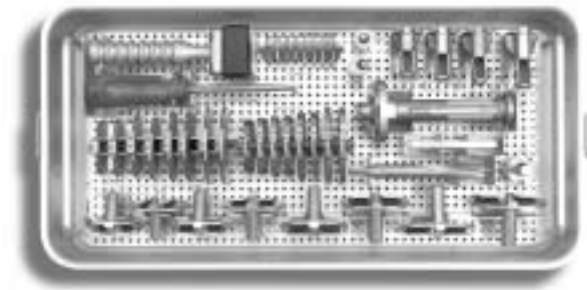

00-5975-004-00 NexGen Fluted Stem Provisional Kit

Cat. No.	Description
00-5120-087-00	Hex Head Screwdriver, 3.5mm
00-5941-003-00	MBK Tibial Holding Clamp
00-5941-004-00	MBK Tibial Impactor
00-5941-006-00	Small Head Holding Pins
00-5945-010-00	Fluted Stem Mob. Plate Provisional, Size 1
00-5945-011-00	Fluted Stem Mob. Tib. Sizing/Positioning Plate, Size 1
00-5945-020-00	Fluted Stem Mob. Plate Provisional, Size 2
00-5945-021-00	Fluted Stem Mob. Tib. Sizing/Positioning Plate, Size 2
00-5945-030-00	Fluted Stem Mob. Plate Provisional, Size 3
00-5945-031-00	Fluted Stem Mob. Tib. Sizing/Positioning Plate, Size 3
00-5945-040-00	Fluted Stem Mob. Plate Provisional, Size 4
00-5945-041-00	Fluted Stem Mob. Tib. Sizing/Positioning Plate, Size 4
00-5945-050-00	Fluted Stem Mob. Plate Provisional, Size 5
00-5945-051-00	Fluted Stem Mob. Tib. Sizing/Positioning Plate, Size 5
00-5945-060-00	Fluted Stem Mob. Plate Provisional, Size 6
00-5945-061-00	Fluted Stem Mob. Tib. Sizing/Positioning Plate, Size 6
00-5945-070-00	Fluted Stem Mob. Plate Provisional, Size 7
00-5945-071-00	Fluted Stem Mob. Tib. Sizing/Positioning Plate, Size 7
00-5945-080-00	Fluted Stem Mob. Plate Provisional, Size 8
00-5945-081-00	Fluted Stem Mob. Tib. Sizing/Positioning Plate, Size 8
00-5965-080-00	LPS-Flex Fluted Stem Mobile Tibial Prov/Instr Case
00-5977-010-02	Fluted Stem Tibial Drill, 15mm

00-5975-004-00 NexGen Fluted Stem Provisional Kit (cont)

Cat. No.	Description
00-5977-011-00	Broach Impactor
00-5977-014-02	Fluted Stem Tibial Drill Guide, 15mm
00-5977-056-01	Grooved Short Head Holding Pin
00-5987-003-00	Straight Bushing
00-5987-004-00	Offset Bushing
00-5997-060-01	Fluted Stem Tibial Broaching Plate Size 1
00-5997-060-02	Fluted Stem Tibial Broaching Plate Size 2
00-5997-060-03	Fluted Stem Tibial Broaching Plate Size 3
00-5997-060-04	Fluted Stem Tibial Broaching Plate Size 4
00-5997-060-05	Fluted Stem Tibial Broaching Plate Size 5
00-5997-060-06	Fluted Stem Tibial Broaching Plate Size 6
00-5997-060-07	Fluted Stem Tibial Broaching Plate Size 7
00-5997-060-08	Fluted Stem Tibial Broaching Plate Size 8
00-5997-061-01	Fluted Stem Tibial Broach Size 1-2
00-5997-061-03	Fluted Stem Tibial Broach Size 3-4
00-5997-061-05	Fluted Stem Tibial Broach Size 5-6
00-5997-061-07	Fluted Stem Tibial Broach Size 7-8

NEXGEN MIS QUAD-SPARING MEDIAL FEMORAL/RETRACTOR KIT 00-5975-080-00

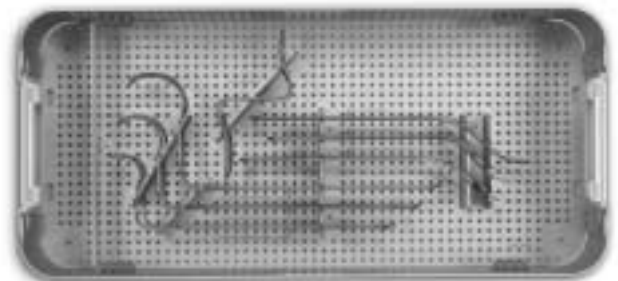
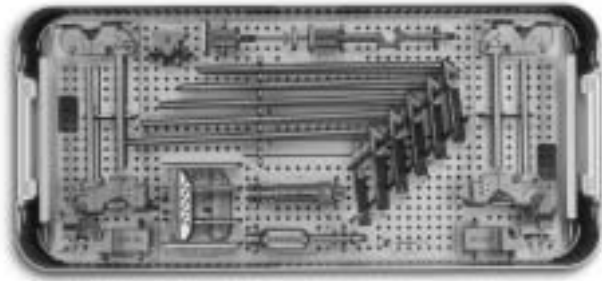

00-5975-080-00 MIS Q-S Medial Femoral/Retractor Kit

Cat. No.	Description
00-5983-004-93	IM Alignment Guide, Medial 3 Degree (229mm)
00-5983-004-94	IM Alignment Guide, Medial 4 Degree (229mm)
00-5983-004-95	IM Alignment Guide, Medial 5 Degree (229mm)
00-5983-004-96	IM Alignment Guide, Medial 6 Degree (229mm)
00-5983-004-97	IM Alignment Guide, Medial 7 Degree (229mm)
00-5983-006-01	Medial IM Distal Cut Guide
00-5983-006-03	Medial IM Distal Cut Guide, +3mm
00-5983-029-00	A/P Tower
00-5983-027-01	Ext Rotation Cut Block, Left Med/Right Lat
00-5983-027-02	Ext Rotation Cut Block, Right Med/Left Lat
00-5983-039-01	Pin Placer, Left Med/Right Lat
00-5983-039-02	Pin Placer, Right Med/Left Lat
00-5983-030-01	3 degree Medial Base, Left Small
00-5983-040-01	3 degree Medial Base, Left
00-5983-030-02	3 degree Medial Base, Right Small
00-5983-040-02	3 degree Medial Base, Right
00-5983-028-00	MIS Locking Boom
00-5983-002-00	MIS Threaded Handle
00-5983-081-00	Collateral Soft Tissue Protector
00-5983-082-00	Collateral Retractor
00-5983-083-00	PCL Retractor
00-5983-084-00	Dual Z Retractor
00-5967-038-00	Blue Universal Lid
00-5983-017-00	Base

Optional (Order Separately)

Cat. No.	Description
00-5967-069-00	Modular Shelf
00-5983-004-64	IM Alignment Guide, Medial 4 degree (165mm)
00-5983-004-66	IM Alignment Guide, Medial 6 degree (165mm)
00-5983-080-01	Collateral Retractor, small
00-5983-080-02	Collateral Retractor, medium
00-5983-080-03	Collateral Retractor, large

NEXGEN MIS QUAD-SPARING TIBIAL INSTRUMENT KIT 00-5975-084-00

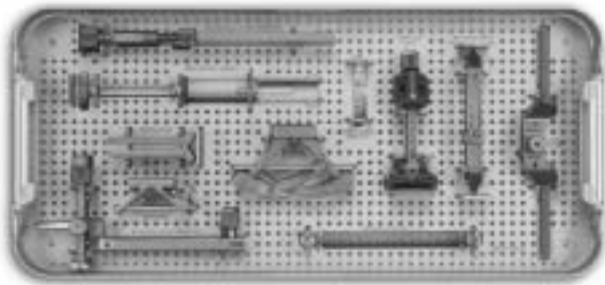

00-5975-084-00 MIS Quad-Sparing Tibial Instrument Kit

Cat. No.	Description
00-5983-010-00	Tibial Cut Guide
00-5983-011-07	Tibial Boom 7 Degree
00-5983-012-00	MIS Proximal Telescoping Rod
00-5983-014-00	MIS Distal Telescoping Rod
00-5983-015-00	Tubercle Arm
00-5983-016-00	MIS Tibial Depth Resection Stylus
00-5997-070-00	Ankle Clamp
00-5967-038-00	Blue Universal
00-5983-026-00	Base

Optional (Order Separately)

Cat. No.	Description
00-5977-011-00	Tibial Broach Impactor
00-5983-013-00	Ankle Bar
00-5061-082-00	Spring
00-5983-011-03	Tibial Boom 3 Degree

NEXGEN ROTATING HINGE KNEE FEMORAL INSTRUMENT KIT 00-5979-001-00

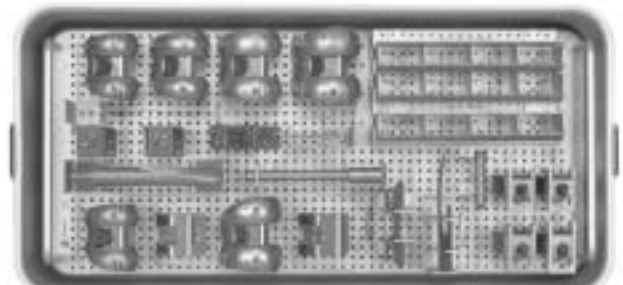

00-5979-001-00 NexGen Rotating Hinge Knee Femoral Instrument Kit

Cat. No.	Description
00-5881-026-00	Locking Screw Driver
00-5881-027-00	130 in-lb. Torque Wrench
00-5881-028-00	Spanner Wrench
00-5881-010-01	Femoral Stem Base Drill
00-5881-013-10	Femur Notch/Chamfer Guide, Size C
00-5881-014-10	Femur Notch/Chamfer Guide, Size D
00-5881-015-10	Femur Notch/Chamfer Guide, Size E
00-5881-016-10	Femur Notch/Chamfer Guide, Size F
00-5881-013-01	Femoral Prov/Cutting Guide, Size C, Left
00-5881-013-02	Femoral Prov/Cutting Guide Size C, Right
00-5881-014-01	Femoral Prov/Cutting Guide Size D, Left
00-5881-014-02	Femoral Prov/Cutting Guide Size D, Right
00-5881-015-01	Femoral Prov/Cutting Guide Size E, Left
00-5881-015-02	Femoral Prov/Cutting Guide Size E, Right
00-5881-016-01	Femoral Prov/Cutting Guide Size F, Left
00-5881-016-02	Femoral Prov/Cutting Guide Size F, Right
00-5881-011-00	Hinge Post Extension Provisional
00-5881-013-00	Modular Box Insert Prov, Size C
00-5881-014-00	Modular Box Insert Prov, Size D
00-5881-015-00	Modular Box Insert Prov, Size E
00-5881-016-00	Modular Box Insert Prov, Size F
00-5987-089-05	Posterior Augment, 5mm Size C, D (2)

CONTINUED ON PAGE 226

NEXGEN ROTATING HINGE KNEE FEMORAL INSTRUMENT KIT 00-5979-001-00 (CONT.)

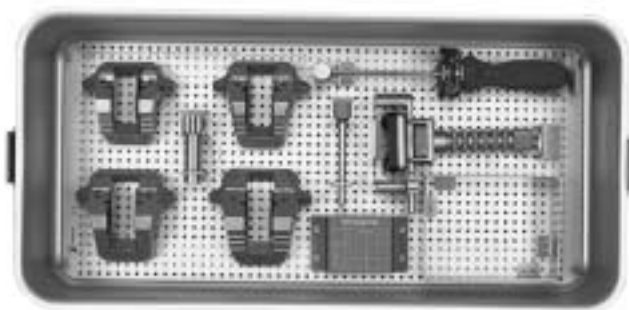

00-5979-001-00 *NexGen Rotating Hinge Knee Femoral Instrument Kit (cont)*

Cat. No.	Description
00-5987-089-10	Posterior Augment, 10mm Size C, D (2)
00-5987-090-05	Distal Augment, 5mm Size C, D (2)
00-5987-090-10	Distal Augment, 10mm Size C, D (2)
00-5987-090-15	Distal Augment, 15mm Size C, D (2)
00-5987-090-20	Distal Augment, 20mm Size C, D (2)
00-5987-091-05	Posterior Augment, 5mm Size E, F (2)
00-5987-091-10	Posterior Augment, 10mm Size E, F (2)
00-5987-092-05	Distal Augment, 5mm Size E, F (2)
00-5987-092-10	Distal Augment, 10mm Size E, F (2)
00-5987-092-15	Distal Augment, 15mm Size E, F (2)
00-5987-092-20	Distal Augment, 20mm Size E, F (2)
00-5061-063-00	Hex Head Holding Pin (4/set)
00-5977-056-01	Short Holding Pins (4/set)
00-5222-039-00	Headless Holding Pins (4/set)
00-5987-070-00	LCCK Stem Extension Bushing
00-5977-084-00	Resector Guide
00-5987-016-00	Stem Provisional Adapter
00-5987-099-00	Patella Joint Line Gauge
00-5969-004-01	+1 Spacer Block
00-5978-014-00	8mm IM Drill with Stop
00-5990-050-00	Femoral General Instrument Case

NEXGEN ROTATING HINGE KNEE TIBIAL INSTRUMENT/PROVISIONAL KIT 00-5979-003-00

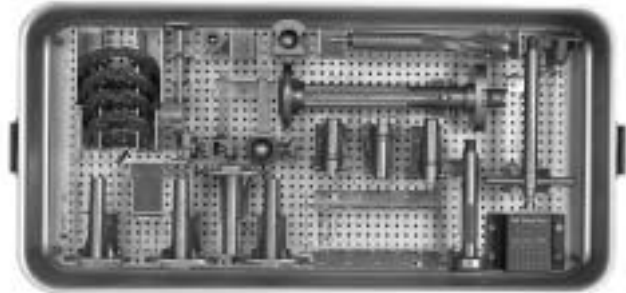

00-5979-003-00 *NexGen Rotating Hinge Knee Tibial Prov/Instr Kit*

Cat. No.	Description
00-5881-080-00	Tibial Broach Impactor
00-5881-081-00	Tibial Stem Base Drill
00-5881-082-00	Tibial Stem Base Drill Bushing
00-5881-084-00	Tibial Provisional Impactor
00-5881-085-00	Tibial Provisional Extractor
00-5881-086-00	Revision Tibial Boom, 0 degrees
00-5881-087-00	Sizing Plate Extractor
00-5881-042-00	Tibial Sizing Plate Provisional, Size 2
00-5881-043-00	Tibial Sizing Plate Provisional, Size 3
00-5881-044-00	Tibial Sizing Plate Provisional, Size 4
00-5881-045-00	Tibial Sizing Plate Provisional, Size 5
00-5881-046-00	Tibial Sizing Plate Provisional, Size 6
00-5881-002-00	Tibial Prov, Size 2, Provisional
00-5881-003-00	Tibial Prov, Size 3, Provisional
00-5881-004-00	Tibial Prov, Size 4, Provisional
00-5881-005-00	Tibial Prov, Size 5, Provisional
00-5881-006-00	Tibial Prov, Size 6, Provisional
00-5881-002-10	Full Block Tibial Prov Augment, 10mm, Size 2
00-5881-003-10	Full Block Tibial Prov Augment, 10mm, Size 3
00-5881-004-10	Full Block Tibial Prov Augment, 10mm, Size 4
00-5881-005-10	Full Block Tibial Prov Augment, 10mm, Size 5
00-5881-006-10	Full Block Tibial Prov Augment, 10mm, Size 6
00-5977-013-01	Tibial Broach, Size 1, 2
00-5977-013-03	Tibial Broach, Size 3, 4
00-5977-013-05	Tibial Broach, Size 5, 6
00-5125-060-00	Tibial Boom, 0 degree
00-5977-096-00	Locking Tibial Tray Provisional Handle
00-5941-006-00	Small Head Holding Pin (4/bx)
00-5987-003-00	Straight Bushing
00-5990-055-00	Tibial General Instrument Case

NEXGEN ROTATING HINGE KNEE ARTICULAR SURFACE PROVISIONAL KIT 00-5979-004-00

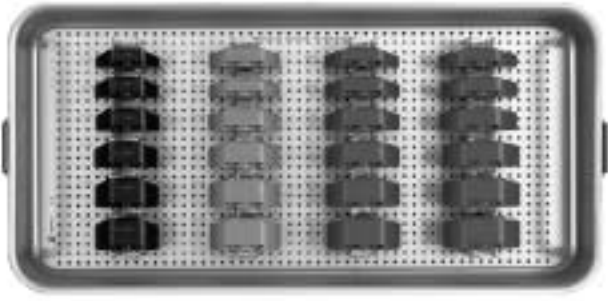

00-5979-004-00 *NexGen Rotating Hinge Knee Articular Surface Prov Kit*

Cat. No.	Description
00-5881-030-12	Articular Surf Prov 12mm (Fem C - Tib 2-6)
00-5881-030-14	Articular Surf Prov 14mm (Fem C - Tib 2-6)
00-5881-030-17	Articular Surf Prov 17mm (Fem C - Tib 2-6)
00-5881-030-20	Articular Surf Prov 20mm (Fem C - Tib 2-6)
00-5881-030-23	Articular Surf Prov 23mm (Fem C - Tib 2-6)
00-5881-030-26	Articular Surf Prov 26mm (Fem C - Tib 2-6)
00-5881-040-12	Articular Surf Prov 12mm (Fem D - Tib 3-6)
00-5881-040-14	Articular Surf Prov 14mm (Fem D - Tib 3-6)
00-5881-040-17	Articular Surf Prov 17mm (Fem D - Tib 3-6)
00-5881-040-20	Articular Surf Prov 20mm (Fem D - Tib 3-6)
00-5881-040-23	Articular Surf Prov 23mm (Fem D - Tib 3-6)
00-5881-040-26	Articular Surf Prov 26mm (Fem D - Tib 3-6)
00-5881-050-12	Articular Surf Prov 12mm (Fem E - Tib 4-6)
00-5881-050-14	Articular Surf Prov 14mm (Fem E - Tib 4-6)
00-5881-050-17	Articular Surf Prov 17mm (Fem E - Tib 4-6)
00-5881-050-20	Articular Surf Prov 20mm (Fem E - Tib 4-6)
00-5881-050-23	Articular Surf Prov 23mm (Fem E - Tib 4-6)
00-5881-050-26	Articular Surf Prov 26mm (Fem E - Tib 4-6)
00-5881-060-12	Articular Surf Prov 12mm (Fem F - Tib 5-6)
00-5881-060-14	Articular Surf Prov 14mm (Fem F - Tib 5-6)
00-5881-060-17	Articular Surf Prov 17mm (Fem F - Tib 5-6)
00-5881-060-20	Articular Surf Prov 20mm (Fem F - Tib 5-6)
00-5881-060-23	Articular Surf Prov 23mm (Fem F - Tib 5-6)
00-5881-060-26	Articular Surf Prov 26mm (Fem F - Tib 5-6)
00-5990-060-00	Articular Surface Prov Case

NEXGEN ROTATING HINGE KNEE HINGE PIN SERVICING INSTRUMENT KIT 00-5979-005-00

00-5979-005-00 *NexGen Rotating Hinge Knee Pin Servicing Instrument Kit*

Cat. No.	Description
00-5888-012-51*	Drill Guide, Size B, L
00-5888-012-52*	Drill Guide, Size B, R
00-5881-013-51	Drill Guide, Size C, L
00-5888-013-52	Drill Guide, Size C, R
00-5881-014-51	Drill Guide, Size D, L
00-5881-014-52	Drill Guide, Size D, R
00-5881-015-51	Drill Guide, Size E, L
00-5881-015-52	Drill Guide, Size E, R
00-5881-016-51	Drill Guide, Size F, L
00-5881-016-52	Drill Guide, Size F, R
00-5881-050-00	Trephine
00-5881-051-00	Hand Rasp
00-5881-053-00	Hex Cap Removal Tool
00-5881-054-00	Wrench
00-5881-055-00	Tibial Bushing Remover
00-5888-000-03	Generic Full 3.0 Case
00-5990-065-00	Hinge Pin Servicing Instrument Case

*Not included in kit.

NEXGEN STEMMED FEMORAL MILLING/5-IN-1 A/P GUIDE INSTR KIT 00-5979-006-00

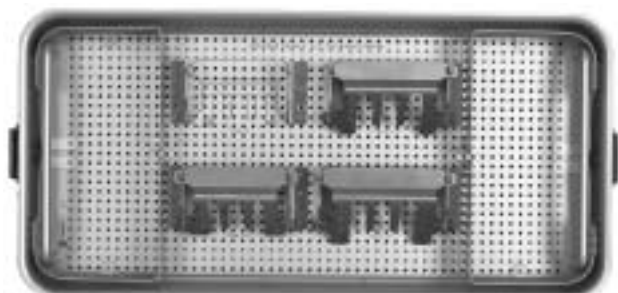

00-5979-006-00 *NexGen* Milling/5-in-1 Stemmed Fem A/P Placement Guide Instr Kit

Cat. No.	Description
00-5978-007-11*	A/P Placement Guide, Size B
00-5978-007-13	A/P Placement Guide, Size C/D
00-5978-007-15	A/P Placement Guide, Size E/F
00-5978-007-17	A/P Placement Guide, Size G
00-5990-070-00	Stemmed Femoral A/P Placement Guide Instrument Case

*May order separately, not included in kit.

ZIMMER UNICOMPARTMENTAL HIGH FLEX FEMORAL PROVISIONAL/INSTRUMENT KIT 00-5843-091-00

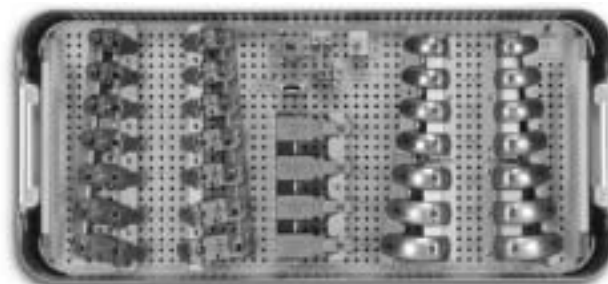

00-5843-091-00 *Zimmer Uni Femoral Provisional/Instrument Kit*

Cat. No.	Description
00-1336-028-00	Driver/Impactor, Femoral
00-5785-072-00	Universal Handle/Peg Driver
00-5785-082-00	IM Knee Drill, 8mm Dia
00-5785-097-00	Slaphammer Exttractor
00-5789-046-00	M/G Uni Knee Fem Holding Peg
00-5789-021-00	Right I/M Femoral Resect Guide, 9"
00-5791-021-04	Right I/M fem Resect Guide, 4"
00-5791-022-00	Left I/M Femoral Resect Guide, 9"
00-5791-022-04	Left I/M fem Resect Guide, 4"
00-5791-023-00	Distal Femoral Resect Block
00-5791-023-01	Lateral Distal Femoral Resect Block
00-5791-025-00	M/G Uni I/M Patellar Retractor
00-5841-050-00	Femoral Instrument Case
00-5843-011-01	Femoral Cut Guide Sz A Lt Med/Rt Lat
00-5843-011-02	Femoral Cut Guide Sz A Rt Med/Lt Lat
00-5843-012-01	Femoral Cut Guide Sz B Lt Med/Rt Lat
00-5843-012-02	Femoral Cut Guide Sz B Rt Med/Lt Lat
00-5843-013-01	Femoral Cut Guide Sz C Lt Med/Rt Lat
00-5843-013-02	Femoral Cut Guide Sz C Rt Med/Lt Lat
00-5843-014-01	Femoral Cut Guide Sz D Lt Med/Rt Lat
00-5843-014-02	Femoral Cut Guide Sz D Rt Med/Lt Lat
00-5843-015-01	Femoral Cut Guide Sz E Lt Med/Rt Lat
00-5843-015-02	Femoral Cut Guide Sz E Rt Med/Lt Lat
00-5843-016-01	Femoral Cut Guide Sz F Lt Med/Rt Lat
00-5843-016-02	Femoral Cut Guide Sz F Rt Med/Lt Lat
00-5843-017-01	Femoral Cut Guide Sz G Lt Med/Rt Lat
00-5843-017-02	Femoral Cut Guide Sz G Rt Med/Lt Lat
00-5843-018-00	Precoat Femoral Drill w/Stop

CONTINUED ON PAGE 232

ZIMMER UNICOMPARTMENTAL HIGH FLEX FEMORAL PROVISIONAL/INSTRUMENT KIT 00-5843-091-00 (CONT.)

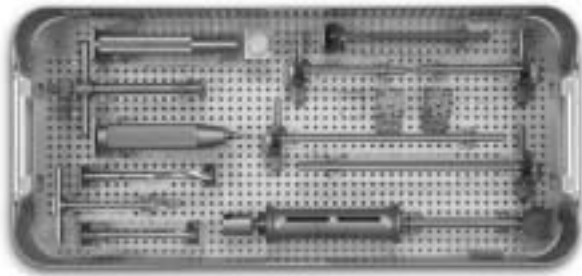

00-5843-091-00 Zimmer Uni Femoral Provisional/Instrument Kit (cont.)

Cat. No.	Description
00-5843-051-00	Femoral Reamer
00-5843-054-00	Insertion Handle
00-5841-011-01	Femoral Provisional Sz A Lt Med/Rt Lat
00-5841-011-02	Femoral Provisional Sz A Rt Med/Lt Lat
00-5841-012-01	Femoral Provisional Sz B Lt Med/Rt Lat
00-5841-012-02	Femoral Provisional Sz B Rt Med/Lt Lat
00-5841-013-01	Femoral Provisional Sz C Lt Med/Rt Lat
00-5841-013-02	Femoral Provisional Sz C Rt Med/Lt Lat
00-5841-014-01	Femoral Provisional Sz D Lt Med/Rt Lat
00-5841-014-02	Femoral Provisional Sz D Rt Med/Lt Lat
00-5841-015-01	Femoral Provisional Sz E Lt Med/Rt Lat
00-5841-015-02	Femoral Provisional Sz E Rt Med/Lt Lat
00-5841-016-01	Femoral Provisional Sz F Lt Med/Rt Lat
00-5841-016-02	Femoral Provisional Sz F Rt Med/Lt Lat
00-5841-017-01	Femoral Provisional Sz G Lt Med/Rt Lat
00-5841-017-02	Femoral Provisional Sz G Rt Med/Lt Lat

Optional Spacer Block Instruments (Not Included in Kit)

Cat. No.	Description
00-5843-030-08	Spacer block 8mm 5 degree
00-5843-030-10	Spacer block 10mm 5 degree
00-5843-030-12	Spacer block 12mm 5 degree
00-5843-030-14	Spacer block 14mm 5 degree
00-5843-032-00	Spacer block alignment tower
00-5843-033-02	Spacer block Distal Femoral Resector

Disposables (Ordered Separately)

Cat. No.	Description
00-5791-041-00	Headed Screw, 48mm (1/Bx)
00-5791-042-00	Headless Screw, 48mm (1/Bx)
00-5791-044-00	Headed Screw, 33mm (1/Bx)
00-5791-054-00	Collapsing Holding Pin (1/Bx)
00-5843-052-01	Articular Surface Inserter Tip

ZIMMER UNICOMPARTMENTAL HIGH FLEX TIBIAL RESECTION/INSTRUMENT KIT 00-5843-092-00

00-5843-092-00 Zimmer Uni Tibial Resection/Instrument Kit

Cat. No.	Description
00-5061-063-00	Hex Head Holding Pin (4/Bx)
00-5061-084-00	Cement Remover
00-5120-087-00	Hex Head Screwdriver, 3.5 mm
00-5785-079-00	Tibial Alignment Rod
00-5785-080-00	Alignment Rod with Coupler
00-5789-038-00	Tibial Articular Surface Remover
00-5789-043-00	Holding Pin Pliers
00-5789-049-00	Tibial Drill w/Stop, 9mm Dia
00-5791-049-00	Screw Inserter/Extractor
00-5791-071-00	Drill Blue, 3.2mm
00-5841-055-00	Tibial Instrument Case
00-5843-021-00	Tibial Resector Lt Med/Rt Lat, 5 Deg
00-5843-021-02	Tibial Resector Base Lt Med/Rt Lat
00-5843-022-00	Tibial Resector Rt Med/Lt Lat, 5 Deg
00-5843-022-02	Tibial Resector Base Rt Med/Lt Lat
00-5843-023-00	Tibial Resector Stem, Short
00-5843-024-00	Tibial Resector Stem, Long
00-5843-025-00	Removal Hook
00-5843-026-00	Distal Telescoping Rod
00-5843-028-00	Targeting Guide
00-5843-029-00	Tibial Depth Resection Stylus, 2/4
00-5843-052-00	Tray/Art Surface Inserter
00-5977-056-01	Short Head Holding Pin (4/Bx)
00-5977-084-00	Resection Guide
00-5983-080-01	Collateral Retractor, Small
00-5983-084-00	Dual Z Retractor
00-5997-070-00	Ankle Clamp
00-5997-084-00	Headless Gold Pin, 75mm (4/Bx)
00-5977-056-00	Short Head Holding Pin, 17mm (4/Bx)
00-5977-056-02	Short Head Holding Pin, 17mm (4/Bx)
00-5791-035-00	Tibial Plate Impactor

CONTINUED ON PAGE 234

ZIMMER UNICOMPARTMENTAL HIGH FLEX TIBIAL RESECTION/INSTRUMENT KIT 00-5843-092-00 (CONT.)

Optional EM Instruments (Not included in kit)

Cat. No.	Description
00-5843-025-01	EM Distal Femoral Resector, 4.5mm Short, -2mm
00-5843-025-02	EM Distal Femoral Resector, 6.5mm Short, Std.
00-5843-025-04	EM Distal Femoral Resector, 4.5mm Long, -2mm
00-5843-025-05	EM Distal Femoral Resector, 6.5mm Long, Std.
00-5843-025-09	Distal Femoral Resector Holding Peg

ZIMMER UNICOMPARTMENTAL HIGH FLEX TIBIAL PROVISIONAL/INSTRUMENT KIT 00-5843-093-00

00-5843-093-00 Zimmer Uni Tibial Provisional/Instrument Kit

Cat. No.	Description
00-5789-071-00	Tension Gauge
00-5841-001-01	Tibial Drill Guide S1, Lt Med/Rt Lat
00-5841-001-02	Tibial Drill Guide S1, Rt Med/Lt Lat
00-5841-002-01	Tibial Drill Guide S2, Lt Med/Rt Lat
00-5841-002-02	Tibial Drill Guide S2, Rt Med/Lt Lat
00-5841-003-01	Tibial Drill Guide S3, Lt Med/Rt Lat
00-5841-003-02	Tibial Drill Guide S3, Rt Med/Lt Lat
00-5841-004-01	Tibial Drill Guide S4, Lt Med/Rt Lat
00-5841-004-02	Tibial Drill Guide S4, Rt Med/Lt Lat
00-5841-005-01	Tibial Drill Guide S5, Lt Med/Rt Lat
00-5841-005-02	Tibial Drill Guide S5, Rt Med/Lt Lat
00-5841-006-01	Tibial Drill Guide S6, Lt Med/Rt Lat
00-5841-006-02	Tibial Drill Guide S6, Rt Med/Lt Lat
00-5841-021-08	Art Surf Provisional Size 1, 8mm
00-5841-021-09	Art Surf Provisional Size 1, 9mm
00-5841-021-10	Art Surf Provisional Size 1, 10mm
00-5841-021-11	Art Surf Provisional Size 1, 11mm
00-5841-021-12	Art Surf Provisional Size 1, 12mm
00-5841-021-14	Art Surf Provisional Size 1, 14mm
00-5841-022-08	Art Surf Provisional Size 2, 8mm
00-5841-022-09	Art Surf Provisional Size 2, 9mm
00-5841-022-10	Art Surf Provisional Size 2, 10mm
00-5841-022-11	Art Surf Provisional Size 2, 11mm
00-5841-022-12	Art Surf Provisional Size 2, 12mm
00-5841-022-14	Art Surf Provisional Size 2, 14mm
00-5841-023-08	Art Surf Provisional Size 3, 8mm
00-5841-023-09	Art Surf Provisional Size 3, 9mm
00-5841-023-10	Art Surf Provisional Size 3, 10mm
00-5841-023-11	Art Surf Provisional Size 3, 11mm
00-5841-023-12	Art Surf Provisional Size 3, 12mm
00-5841-023-14	Art Surf Provisional Size 3, 14mm

CONTINUED ON PAGE 236

ZIMMER UNICOMPARTMENTAL HIGH FLEX TIBIAL PROVISIONAL/INSTRUMENT KIT 00-5843-093-00

00-5843-093-00 Zimmer Uni Tibial Provisional/Instrument Kit

Cat. No.	Description
00-5841-024-08	Art Surf Provisional Size 4, 8mm
00-5841-024-09	Art Surf Provisional Size 4, 9mm
00-5841-024-10	Art Surf Provisional Size 4, 10mm
00-5841-024-11	Art Surf Provisional Size 4, 11mm
00-5841-024-12	Art Surf Provisional Size 4, 12mm
00-5841-024-14	Art Surf Provisional Size 4, 14mm
00-5841-025-08	Art Surf Provisional Size 5, 8mm
00-5841-025-09	Art Surf Provisional Size 5, 9mm
00-5841-025-10	Art Surf Provisional Size 5, 10mm
00-5841-025-11	Art Surf Provisional Size 5, 11mm
00-5841-025-12	Art Surf Provisional Size 5, 12mm
00-5841-025-14	Art Surf Provisional Size 5, 14mm
00-5841-026-08	Art Surf Provisional Size 6, 8mm
00-5841-026-09	Art Surf Provisional Size 6, 9mm
00-5841-026-10	Art Surf Provisional Size 6, 10mm
00-5841-026-11	Art Surf Provisional Size 6, 11mm
00-5841-026-12	Art Surf Provisional Size 6, 12mm
00-5841-026-14	Art Surf Provisional Size 6, 14mm
00-5841-060-00	Tibial/Instrument Provisional Case
00-5843-035-08	Flexion/Extension Gap Spacer, 8mm
00-5843-035-10	Flexion/Extension Gap Spacer, 10mm
00-5843-035-12	Flexion/Extension Gap Spacer, 12mm
00-5843-035-14	Flexion/Extension Gap Spacer, 14mm
00-5843-041-01	Tibial Sizer Size 1
00-5843-041-02	Tibial Sizer Size 2
00-5843-041-03	Tibial Sizer Size 3
00-5843-041-04	Tibial Sizer Size 4
00-5843-041-05	Tibial Sizer Size 5
00-5843-041-06	Tibial Sizer Size 6
00-5843-042-00	Tibial Sizing Slider
00-5791-060-08	Concave Tibial Spacer, 8mm
00-5791-060-10	Concave Tibial Spacer, 10mm
00-5791-060-12	Concave Tibial Spacer, 12mm
00-5791-060-14	Concave Tibial Spacer, 14mm
00-5789-049-00	Tibial Drill w/Stop, 9mm Dia

M/G MIS TIBIAL INSTRUMENT KIT* 00-5789-052-00

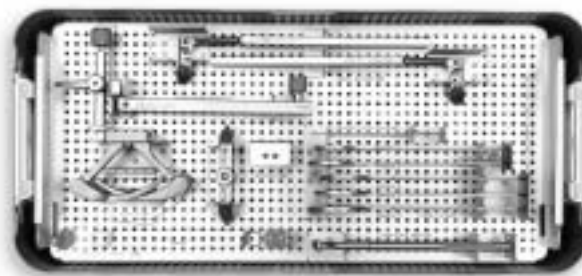

00-5789-052-00 M/G MIS Tibial Prov/Instr Kit

Cat. No.	Description
00-5222-039-00	Headless Smooth Pin, 48mm
00-5789-015-00	Series 1 – Tibial Sizer
00-5789-016-00	Series 2 – Tibial Sizer
00-5789-017-00	Series 3 – Tibial Sizer
00-5789-018-00	Series 4 – Tibial Sizer
00-5789-051-00	Series 5 – Tibial Sizer
00-5789-038-00	Tibial Articular Surface Remover
00-5789-040-08	Tibial Articulating Surf Prov Series 1 – 8mm
00-5789-040-10	Tibial Articulating Surf Prov Series 1 – 10mm
00-5789-040-12	Tibial Articulating Surf Prov Series 1 – 12mm
00-5789-040-14	Tibial Articulating Surf Prov Series 1 – 14mm
00-5789-050-08	Tibial Articulating Surf Prov Series 2 – 8mm
00-5789-050-10	Tibial Articulating Surf Prov Series 2 – 10mm
00-5789-050-12	Tibial Articulating Surf Prov Series 2 – 12mm
00-5789-050-14	Tibial Articulating Surf Prov Series 2 – 14mm
00-5789-060-08	Tibial Articulating Surf Prov Series 3 – 8mm
00-5789-060-10	Tibial Articulating Surf Prov Series 3 – 10mm
00-5789-060-12	Tibial Articulating Surf Prov Series 3 – 12mm
00-5789-060-14	Tibial Articulating Surf Prov Series 3 – 14mm
00-5789-070-08	Tibial Articulating Surf Prov Series 4 – 8mm
00-5789-070-10	Tibial Articulating Surf Prov Series 4 – 10mm
00-5789-070-12	Tibial Articulating Surf Prov Series 4 – 12mm

CONTINUED ON PAGE 238

M/G MIS TIBIAL INSTRUMENT KIT* 00-5789-052-00 (CONT.)

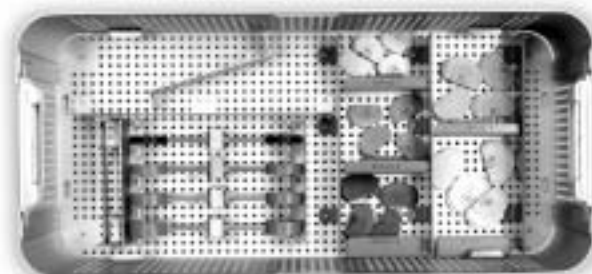
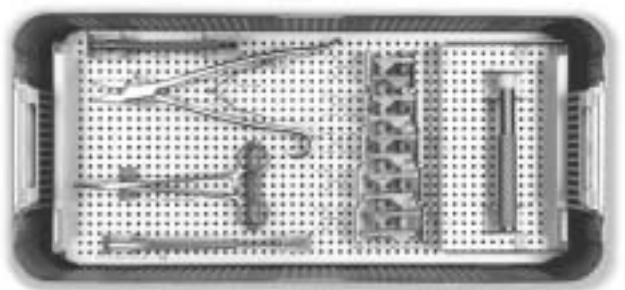

00-5789-052-00 M/G MIS Tibial Prov/Instr Kit (cont)

Cat. No.	Description
00-5789-070-14	Tibial Articulating Surf Prov Series 4 – 14mm
00-5789-080-08	Tibial Articulating Surf Prov Series 5 – 8mm
00-5789-080-10	Tibial Articulating Surf Prov Series 5 – 10mm
00-5789-080-12	Tibial Articulating Surf Prov Series 5 – 12mm
00-5789-080-14	Tibial Articulating Surf Prov Series 5 – 14mm
00-5789-043-00	Holding Pin Pliers
00-5789-044-00	Tibial Holding Peg (Not Shown)
00-5789-045-01	Tibial Fixation Plate, Right Medial/Left Lateral – Series 1
00-5789-045-02	Tibial Fixation Plate, Left Medial/Right Lateral – Series 1
00-5789-055-01	Tibial Fixation Plate, Right Medial/Left Lateral – Series 2
00-5789-055-02	Tibial Fixation Plate, Left Medial/Right Lateral – Series 2
00-5789-065-01	Tibial Fixation Plate, Right Medial/Left Lateral – Series 3
00-5789-065-02	Tibial Fixation Plate, Left Medial/Right Lateral – Series 3
00-5789-075-01	Tibial Fixation Plate, Right Medial/Left Lateral – Series 4
00-5789-075-02	Tibial Fixation Plate, Left Medial/Right Lateral – Series 4
00-5789-085-01	Tibial Fixation Plate, Right Medial/Left Lateral – Series 5
00-5789-085-02	Tibial Fixation Plate, Left Medial/Right Lateral – Series 5
00-5789-047-00	Tibial Holding Clamp
00-5789-049-00	Tibial Drill With Stop
00-5789-071-00	Tension Gauge
00-5791-031-00	Left Medial/Right Lateral Tibial Resector
00-5791-032-00	Right Medial/Left Lateral Tibial Resector

*To be used with the M/G Unicompartmental Knee.

00-5789-052-00 M/G MIS Tibial Prov/Instr Kit (cont)

Cat. No.	Description
00-5061-084-00*	Cement Remover
00-5791-035-00	Tibial Plate Impactor
00-5791-060-08	Concave Tibial Spacer, 8mm
00-5791-060-10	Concave Tibial Spacer, 10mm
00-5791-060-12	Concave Tibial Spacer, 12mm
00-5791-060-14	Concave Tibial Spacer, 14mm
00-5997-070-00	Ankle Clamp
00-5997-071-00	Distal Telescoping Rod
00-5997-081-00	Depth Resection Stylus
00-5977-084-00	Resection Guide
00-1336-028-00	Femoral Impactor
00-5791-054-00	Slotted Holding Pin (Disposable/Sterile)*
00-5791-091-00	UNI MIS Tibial Prov/Inst Base
00-5791-092-00	UNI MIS Tibial Prov/Inst Top Tray
00-5791-093-00	UNI MIS Tibial Prov/Inst Bottom Tray
00-5791-099-00	UNI MIS Generic Lid
00-5997-084-00*	Gold Headless Pins, 75mm

*Not included in kit.

*To be used with the M/G Unicompartmental Knee.

M/G MIS EM* KIT 00-5789-050-00



00-5789-050-00 M/G MIS EM Instrument Kit

Cat. No.	Description
00-5793-015-00	Adjustable Alignment Block (L-Med/R-Lat)
00-5793-016-00	Adjustable Alignment Block (R-Med/L-Lat)
00-5793-023-03	3° Tibial Cut Block
00-5793-023-05	5° Degree Tibial Cut Block
00-5793-023-07	7° Degree Tibial Cut Block
00-5793-025-00	Alignment Tower (Not shown)
00-5793-029-00	Square Alignment Rod (Not shown)
00-5987-089-00	Femoral Augment Screwdriver (Not shown)
00-5791-098-00	MIS EM Instrument Tray

EM Disposables

Cat. No.	Description
00-5793-017-00*	Minus 2mm Distal Femoral Spacer (Not shown)
00-5793-030-00*	Targeting Guide (Not shown)

*Not included in kit.

*To be used with the M/G Unicompartmental Knee.

M/G MIS FEMORAL INSTRUMENT KIT* 00-5789-053-00

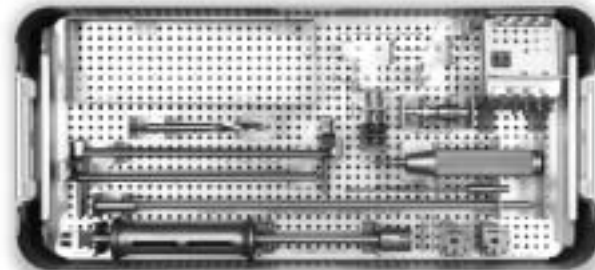

00-5789-053-00 M/G MIS Femoral Provisional/Instrument Kit

Cat. No.	Description
00-5061-063-00	Hex Head Holding Pins (4)
00-5061-088-00	Femoral File
00-5120-085-00	Q/C Drill 3.2 mm
00-5785-072-00	Universal Handle Driver
00-5785-079-00	Alignment Rod
00-5785-080-00	Alignment Rod w/ Coupler
00-5785-082-00	Q/C Femoral IM Drill 8mm
00-5785-097-00	Slaphammer Extractor
00-5789-042-00	Unicompartmental Femoral Drill w/Stop
00-5789-046-00	Femoral Holding Peg
00-5791-001-00	Femoral Sizer/Finishing Guide Small Left Medial/Right Lateral
00-5791-002-00	Femoral Sizer/Finishing Guide Small Right Medial/Left Lateral
00-5791-003-00	Femoral Sizer/Finishing Guide Small + Left Medial/Right Lateral
00-5791-004-00	Femoral Sizer/Finishing Guide Small + Right Medial/Left Lateral
00-5791-005-00	Femoral Sizer/Finishing Guide Regular Left Medial/Right Lateral
00-5791-006-00	Femoral Sizer/Finishing Guide Regular Right Medial/Left Lateral
00-5791-007-00	Femoral Sizer/Finishing Guide Regular + Left Medial/Right Lateral
00-5791-008-00	Femoral Sizer/Finishing Guide Regular + Right Medial/Left Lateral
00-5791-009-00	Femoral Sizer/Finishing Guide Large Left Medial/Right Lateral
00-5791-010-00	Femoral Sizer/Finishing Guide Large Right Medial/Left Lateral
00-5791-011-00	Femoral Sizer/Finishing Guide Large + Left Medial/Right Lateral
00-5791-012-00	Femoral Sizer/Finishing Guide Large + Right Medial/Left Lateral
00-5791-013-00	Femoral Sizer/Finishing Guide Large ++ Left Medial/Right Lateral
00-5791-014-00	Femoral Sizer/Finishing Guide Large ++ Right Medial/Left Lateral
00-5792-020-00	Femoral Provisional Small Left Medial/Right Lateral
00-5792-021-00	Femoral Provisional Small Right Medial/Left Lateral
00-5792-022-00	Femoral Provisional Small + Left Medial/Right Lateral
00-5792-023-00	Femoral Provisional Small + Right Medial/Left Lateral
00-5792-024-00	Femoral Provisional Regular Left Medial/Right Lateral

*Not included in kit.

*To be used with the M/G Unicompartmental Knee.

CONTINUED ON PAGE 242

M/G MIS FEMORAL INSTRUMENT KIT* 00-5789-053-00 (CONT.)

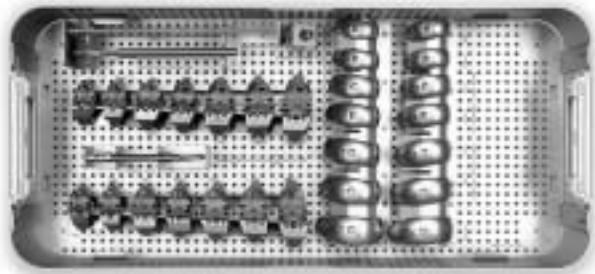

00-5789-053-00 M/G MIS Femoral Provisional/Instrument Kit (cont)

Cat. No.	Description
00-5792-025-00	Femoral Provisional Regular Right Medial/Left Lateral
00-5792-026-00	Femoral Provisional Regular + Left Medial/Right Lateral
00-5792-027-00	Femoral Provisional Regular + Right Medial/Left Lateral
00-5792-028-00	Femoral Provisional Large Left Medial/Right Lateral
00-5792-029-00	Femoral Provisional Large Right Medial/Left Lateral
00-5792-030-00	Femoral Provisional Large + Left Medial/Right Lateral
00-5792-031-00	Femoral Provisional Large + Right Medial/Left Lateral
00-5792-032-00	Femoral Provisional Large ++ Left Medial/Right Lateral
00-5792-033-00	Femoral Provisional Large ++ Right Medial/Left Lateral
00-5967-002-00	Female Hex Driver/Bit
00-5967-033-01	Spring Screws Short
00-5977-056-01	Grooved Short Head Holding Pins
00-5791-021-00	Right Medial/Left Lateral IM Femoral Resector Guide (9")
00-5791-021-04	Right IM Femoral Resect Guide 4" (Not Shown)
00-5791-022-00	Left Medial/Right Lateral IM Femoral Resector Guide (9")
00-4301-004-00*	Ratchet T-Handle
00-5791-022-04	Left IM Femoral Resect Guide 4" (Not Shown)
00-5791-023-00	Distal Femoral Resector Block – Medial
00-5791-023-01	Lateral Distal Femoral Resector Block – Lateral
00-5791-025-00	IM Patellar Retractor
00-5791-026-00	T-Handle
00-5791-041-00*	Headed Screw, 48mm (1 each)
00-5791-042-00*	Headless Screw, 48mm (1 each)
00-5791-043-00*	Headless Screw, 27mm (1 each)
00-5791-049-00	Screw Inserter/Extractor
00-5791-054-00	Slotted Holding pin
00-5791-096-00	MIS Fem Prov/Inst Base
00-5791-097-00	MIS Fem Prov/Inst Tray
00-5791-099-00	MIS Generic Lid

*Not included in kit.

*To be used with the M/G Unicompartmental Knee.

MBK CR/CS FEM/ART SURFACE PROV KIT, LEFT 00-5973-096-00

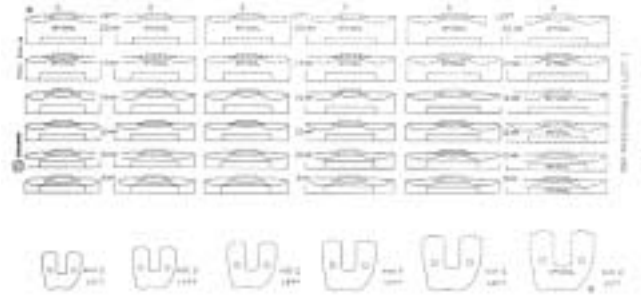

00-5973-096-00 MBK CR/CS Femoral/Articular Surface Provisional Kit, Left

Cat. No.	Description
00-5941-013-01	Femoral Prov, Size C, Lt
00-5941-014-01	Femoral Prov, Size D, Lt
00-5941-015-01	Femoral Prov, Size E, Lt
00-5941-016-01	Femoral Prov, Size F, Lt
00-5941-017-01	Femoral Prov, Size G, Lt
00-5941-031-09	Articular Surf Prov, Size C, Lt, 9mm
00-5941-031-10	Articular Surf Prov, Size C, Lt, 10mm
00-5941-031-12	Articular Surf Prov, Size C, Lt, 12mm
00-5941-031-14	Articular Surf Prov, Size C, Lt, 14mm
00-5941-031-17	Articular Surf Prov, Size C, Lt, 17mm
00-5941-031-20	Articular Surf Prov, Size C, Lt, 20mm
00-5941-041-09	Articular Surf Prov, Size D, Lt, 9mm
00-5941-041-10	Articular Surf Prov, Size D, Lt, 10mm
00-5941-041-12	Articular Surf Prov, Size D, Lt, 12mm
00-5941-041-14	Articular Surf Prov, Size D, Lt, 14mm
00-5941-041-17	Articular Surf Prov, Size D, Lt, 17mm
00-5941-041-20	Articular Surf Prov, Size D, Lt, 20mm
00-5941-051-09	Articular Surf Prov, Size E, Lt, 9mm
00-5941-051-10	Articular Surf Prov, Size E, Lt, 10mm
00-5941-051-12	Articular Surf Prov, Size E, Lt, 12mm
00-5941-051-14	Articular Surf Prov, Size E, Lt, 14mm
00-5941-051-17	Articular Surf Prov, Size E, Lt, 17mm
00-5941-051-20	Articular Surf Prov, Size E, Lt, 20mm

CONTINUED ON PAGE 244

MBK CR/CS FEM/ART SURFACE PROV KIT, LEFT 00-5973-096-00 (CONT.)

00-5973-096-00 MBK CR/CS Femoral/Articular Surface Provisional Kit, Left (cont.)

Cat. No.	Description
00-5941-061-09	Articular Surf Prov, Size F, Lt, 9mm
00-5941-061-10	Articular Surf Prov, Size F, Lt, 10mm
00-5941-061-12	Articular Surf Prov, Size F, Lt, 12mm
00-5941-061-14	Articular Surf Prov, Size F, Lt, 14mm
00-5941-061-17	Articular Surf Prov, Size F, Lt, 17mm
00-5941-061-20	Articular Surf Prov, Size F, Lt, 20mm
00-5941-071-09	Articular Surf Prov, Size G, Lt, 09mm
00-5941-071-10	Articular Surf Prov, Size G, Lt, 10mm
00-5941-071-12	Articular Surf Prov, Size G, Lt, 12mm
00-5941-071-14	Articular Surf Prov, Size G, Lt, 14mm
00-5941-071-17	Articular Surf Prov, Size G, Lt, 17mm
00-5941-071-20	Articular Surf Prov, Size G, Lt, 20mm
00-5941-091-00	Fem/Articular Surf Prov Tray, Left
00-5967-001-30	Generic Base, 3 in.
00-5967-001-00	Generic Lid, Aluminum

MBK CR/CS FEM/ART SURFACE PROV KIT, RIGHT 00-5973-097-00

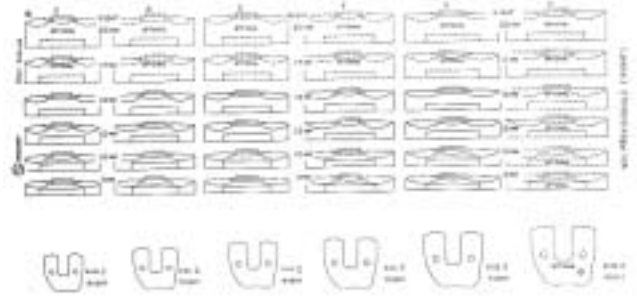

00-5973-097-00 MBK CR/CS Femoral Articular Surface Provisional Kit, Right

Cat. No.	Description
00-5941-013-02	Femoral Prov, Size C, Rt
00-5941-014-02	Femoral Prov, Size D, Rt
00-5941-015-02	Femoral Prov, Size E, Rt
00-5941-016-02	Femoral Prov, Size F, Rt
00-5941-017-02	Femoral Prov, Size G, Rt
00-5941-032-09	Articular Surf Prov, Size C, Rt, 9mm
00-5941-032-10	Articular Surf Prov, Size C, Rt, 10mm
00-5941-032-12	Articular Surf Prov, Size C, Rt, 12mm
00-5941-032-14	Articular Surf Prov, Size C, Rt, 14mm
00-5941-032-17	Articular Surf Prov, Size C, Rt, 17mm
00-5941-032-20	Articular Surf Prov, Size C, Rt, 20mm
00-5941-042-09	Articular Surf Prov, Size D, Rt, 9mm
00-5941-042-10	Articular Surf Prov, Size D, Rt, 10mm
00-5941-042-12	Articular Surf Prov, Size D, Rt, 12mm
00-5941-042-14	Articular Surf Prov, Size D, Rt, 14mm
00-5941-042-17	Articular Surf Prov, Size D, Rt, 17mm
00-5941-042-20	Articular Surf Prov, Size D, Rt, 20mm
00-5941-052-09	Articular Surf Prov, Size E, Rt, 9mm
00-5941-052-10	Articular Surf Prov, Size E, Rt, 10mm
00-5941-052-12	Articular Surf Prov, Size E, Rt, 12mm
00-5941-052-14	Articular Surf Prov, Size E, Rt, 14mm
00-5941-052-17	Articular Surf Prov, Size E, Rt, 17mm
00-5941-052-20	Articular Surf Prov, Size E, Rt, 20mm

CONTINUED ON PAGE 246

MBK CR/CS FEM/ART SURFACE PROV KIT, RIGHT 00-5973-097-00 (CONT.)

00-5973-097-00 MBK CR/CS Femoral Articular Surface Provisional Kit, Right (cont)

Cat. No.	Description
00-5941-062-09	Articular Surf Prov, Size F, Rt, 9mm
00-5941-062-10	Articular Surf Prov, Size F, Rt, 10mm
00-5941-062-12	Articular Surf Prov, Size F, Rt, 12mm
00-5941-062-14	Articular Surf Prov, Size F, Rt, 14mm
00-5941-062-17	Articular Surf Prov, Size F, Rt, 17mm
00-5941-062-20	Articular Surf Prov, Size F, Rt, 20mm
00-5941-072-09	Articular Surf Prov, Size G, Rt, 9mm
00-5941-072-10	Articular Surf Prov, Size G, Rt, 10mm
00-5941-072-12	Articular Surf Prov, Size G, Rt, 12mm
00-5941-072-14	Articular Surf Prov, Size G, Rt, 14mm
00-5941-072-17	Articular Surf Prov, Size G, Rt, 17mm
00-5941-072-20	Articular Surf Prov, Size G, Rt, 20mm
00-5941-092-00	Fem/Articular Surf Prov Tray, Right
00-5967-001-30	Generic Base, 3"
00-5967-001-00	Generic Lid, Aluminum

MBK TIBIAL GENERAL INSTRUMENT KIT 00-5973-098-00

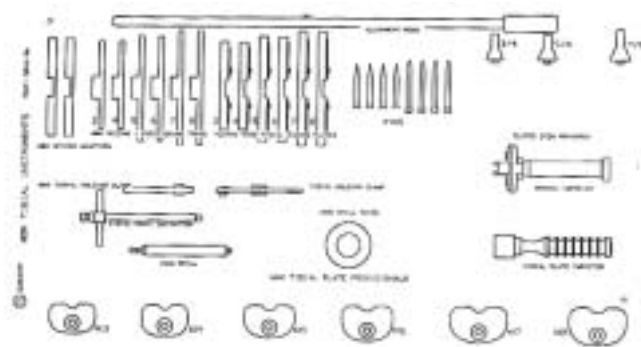

00-5973-098-00 MBK Tibial/General Instrument Kit

Cat. No.	Description
00-5941-003-00	Tibial Holding Clamp
00-5941-004-00	Tibial Plate Impactor
00-5941-006-00	Small Head Holding Pins
00-5941-009-00	Spacer Adaptor
00-5941-030-00	Tibial Plate Prov, Size 3
00-5941-031-00	Tibial Sizing/Positioning Tray, Size 3
00-5941-040-00	Tibial Plate Prov, Size 4
00-5941-041-00	Tibial Sizing/Positioning Tray, Size 4
00-5941-050-00	Tibial Plate Prov, Size 5
00-5941-051-00	Tibial Sizing/Positioning Tray, Size 5
00-5941-060-00	Tibial Plate Prov, Size 6
00-5941-061-00	Tibial Sizing/Positioning Tray, Size 6
00-5941-070-00	Tibial Plate Prov, Size 7
00-5941-071-00	Tibial Sizing/Positioning Tray, Size 7
00-5941-080-00	Tibial Plate Prov, Size 8
00-5941-081-00	Tibial Sizing/Positioning Tray, Size 8
00-5941-096-00	Tibial Instrument Tray
00-5967-001-00	Generic Lid, Aluminum
00-5967-001-35	Generic Base, 3.5 in.
00-5969-004-01	Plus 1mm Spacer
00-5977-010-02	15mm Fluted Stem Tibial Drill
00-5977-011-00	NexGen Broach Impactor
00-5977-014-02	NexGen 15mm Fluted Stemmed Tibial Drill Guide

CONTINUED ON PAGE 248

MBK TIBIAL GENERAL INSTRUMENT KIT 00-5973-098-00 (CONT.)

00-5973-098-00 MBK Tibial/General Instrument Kit (cont)

Cat. No.	Description
00-5977-017-00	NexGen Tibial Prov. Extractor
00-5977-056-01	NexGen Short Head Holding Pins
00-5977-096-00	NexGen Locking Tibial Tray Prov. Handle
00-5997-060-03	Fluted Stem Tibial Sizing Plate, Size 3
00-5997-060-04	Fluted Stem Tibial Sizing Plate, Size 4
00-5997-060-05	Fluted Stem Tibial Sizing Plate, Size 5
00-5997-060-06	Fluted Stem Tibial Sizing Plate, Size 6
00-5997-060-07	Fluted Stem Tibial Sizing Plate, Size 7
00-5997-060-08	Fluted Stem Tibial Sizing Plate, Size 8
00-5997-061-03	Fluted Stem Tibial Broach, Size 3-4
00-5997-061-05	Fluted Stem Tibial Broach, Size 5-6
00-5997-061-07	Fluted Stem Tibial Broach, Size 7-8
00-5785-079-00	Alignment Rod
00-5785-080-00	Alignment Rod w/ Coupler
00-5941-002-00*	Articular Surface Extractor
00-5941-008-00*	Distal Femoral Cut Guide

*Items are OPTIONAL instruments and are not included in kit.

NEXGEN OSTEOTOMY IMPLANTS



NexGen OS L-Plates

Cat. No.	Description
00-5250-004-01	Left L-Plate, 4mm Offset
00-5250-004-02	Right L-Plate, 4mm Offset
00-5250-008-01	Left L-Plate, 8mm Offset
00-5250-008-02	Right L-Plate, 8mm Offset
00-5250-012-01	Left L-Plate, 12mm Offset
00-5250-012-02	Right L-Plate, 12mm Offset

NexGen OS Specific Cortical Bone Screws*

Cat. No.	Description
00-5250-045-24	4.5mm Bone Screw, 24mm Length
00-5250-045-26	4.5mm Bone Screw, 26mm Length
00-5250-045-28	4.5mm Bone Screw, 28mm Length
00-5250-045-30	4.5mm Bone Screw, 30mm Length
00-5250-045-32	4.5mm Bone Screw, 32mm Length
00-5250-045-34	4.5mm Bone Screw, 34mm Length
00-5250-045-36	4.5mm Bone Screw, 36mm Length
00-5250-045-38	4.5mm Bone Screw, 38mm Length
00-5250-045-40	4.5mm Bone Screw, 40mm Length
00-5250-045-42	4.5mm Bone Screw, 42mm Length
00-5250-045-44	4.5mm Bone Screw, 44mm Length
00-5250-045-46	4.5mm Bone Screw, 46mm Length
00-5250-045-48	4.5mm Bone Screw, 48mm Length
00-5250-045-50	4.5mm Bone Screw, 50mm Length
00-5250-045-52	4.5mm Bone Screw, 52mm Length
00-5250-045-54	4.5mm Bone Screw, 54mm Length
00-5250-045-56	4.5mm Bone Screw, 56mm Length
00-5250-045-58	4.5mm Bone Screw, 58mm Length
00-5250-045-60	4.5mm Bone Screw, 60mm Length

* WARNING: This device is not approved for screw attachment or fixation to the posterior elements (pedicles) or of the cervical, thoracic, or lumbar spine.

CONTINUED ON PAGE 250

NEXGEN OSTEOTOMY IMPLANTS (CONT.)

NexGen OS Specific Cancellous Bone Screws*

Cat. No.	Description
00-5250-065-45	6.5mm Bone Screw, 45mm Length
00-5250-065-50	6.5mm Bone Screw, 50mm Length
00-5250-065-55	6.5mm Bone Screw, 55mm Length
00-5250-065-60	6.5mm Bone Screw, 60mm Length
00-5250-065-65	6.5mm Bone Screw, 65mm Length
00-5250-065-70	6.5mm Bone Screw, 70mm Length
00-5250-065-75	6.5mm Bone Screw, 75mm Length
00-5250-065-80	6.5mm Bone Screw, 80mm Length
00-5253-090-00	Screw Case

* **WARNING:** This device is not approved for screw attachment or fixation to the posterior elements (pedicles) or of the cervical, thoracic, or lumbar spine.

NEXGEN OSTEOTOMY INSTRUMENTATION



NexGen OS Instrumentation

Cat. No.	Description
00-5253-003-00	Break Away Pins (Qty. 3/Box)
00-5253-004-00	3° Cutter
00-5253-013-00	Pin Placement Guide
00-5253-015-00	Alignment Guide
00-5253-016-00	Compression Clamp
00-5253-017-00	Cutting Block (Qty needed - 2)
00-5253-095-00	Instrument Case

NexGen OS General Instruments

Cat. No.	Description
00-2237-053-00	Wire Grip T-Handle
00-2305-017-00	3.5mm Hex Screwdriver Q-C
00-2305-025-00	Hexhead Screwdriver, Large
00-2313-005-00	Depth Gauge, Large
00-2345-045-00	ECT Drill Guide, 4.5mm
00-2346-004-00	T-Handle Q-C
00-2346-047-00	4.5mm Tap Q-C
00-2346-066-00	6.5mm Tap Q-C
00-2410-032-00	3.2mm Drill Q-C
00-0186-004-53	Keith Needles, Style 5 (Qty 6/Box)

NEXGEN LPS-FLEX & CR MICRO FEMORAL IMPLANTS JAPAN ONLY



OPTION

00-5960-001-00 NexGen LPS-Flex Co-Nidium/Precoat Femoral Kit

Cat. No.	Description
00-5960-011-31	Fem Size A, Left
00-5960-011-32	Fem Size A, Right
00-5960-012-31	Fem Size B, Left
00-5960-012-32	Fem Size B, Right
00-5960-013-31	Fem Size C, Left
00-5960-013-32	Fem Size C, Right
00-5960-014-31	Fem Size D, Left
00-5960-014-32	Fem Size D, Right
00-5960-015-31	Fem Size E, Left
00-5960-015-32	Fem Size E, Right
00-5960-016-31	Fem Size F, Left
00-5960-016-32	Fem Size F, Right
00-5960-017-31	Fem Size G, Left
00-5960-017-32	Fem Size G, Right

NexGen CR Micro Porous Femorals- JAPAN ONLY

Cat. No.	Description
00-5972-013-03	Fem Size C, Left
00-5972-013-04	Fem Size C, Right
00-5972-014-03	Fem Size D, Left
00-5972-014-04	Fem Size D, Right
00-5972-015-03	Fem Size E, Left
00-5972-015-04	Fem Size E, Right

NexGen HA/TCP CR Micro Femorals- JAPAN ONLY

Cat. No.	Description
65-5972-013-33	Fem Size C, Left
65-5972-013-34	Fem Size C, Right
65-5972-014-33	Fem Size D, Left
65-5972-014-34	Fem Size D, Right
65-5972-015-33	Fem Size E, Left
65-5972-015-34	Fem Size E, Right

MODIFIED FLUTED MOBILE TIBIAL PLATES AND PROVISIONALS JAPAN ONLY

Modified Fluted Mobile Tibial Plate Provisionals - JAPAN ONLY

Cat. No.	Description
00-5945-010-02	Modified Fluted Mobile Tibial Plate Prov., Size 1
00-5945-020-02	Modified Fluted Mobile Tibial Plate Prov., Size 2

Modified Fluted Mobile PCT Plate - JAPAN ONLY

Cat. No.	Description
00-5946-010-03	Modified Fluted Mobile Tibial Plate, Size 1
00-5946-020-03	Modified Fluted Mobile Tibial Plate, Size 2

Reduced Stem Base Adaptor - JAPAN ONLY

Cat. No.	Description
00-5977-011-01	Modified Fluted Mobile Tibial Plate Prov., Size 1

NEXGEN CR C,D,E MICRO PROVISIONAL KITS

00-5930-043-01, 00-5930-043-00 JAPAN ONLY

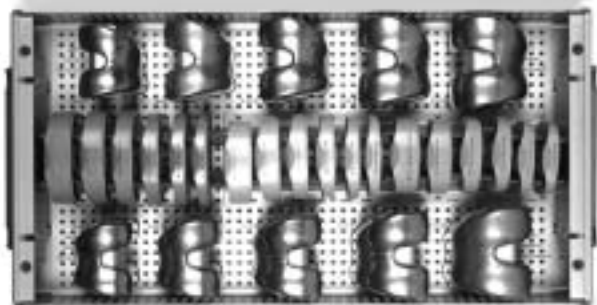

00-5930-043-01 NexGen CR Provisional Kit

Cat. No.	Description
00-5971-013-03	Femoral Prov, Size C, Lt
00-5971-013-04	Femoral Prov, Size C, Rt
00-5971-014-03	Femoral Prov, Size D, Lt
00-5971-014-04	Femoral Prov, Size D, Rt
00-5971-015-03	Femoral Prov, Size E, Lt
00-5971-015-04	Femoral Prov, Size E, Rt

00-5930-043-00 NexGen CR Micro Provisional Kit

Cat. No.	Description
00-5971-011-01	Femoral Prov, Size A, Lt
00-5971-011-02	Femoral Prov, Size A, Rt
00-5971-012-01	Femoral Prov, Size B, Lt
00-5971-012-02	Femoral Prov, Size B, Rt
00-5971-020-09	Articular Surf Prov, Purple, 9mm (Fem A, B - Tib 1, 2)
00-5971-020-10	Articular Surf Prov, Purple, 10mm (Fem A, B - Tib 1, 2)
00-5971-020-12	Articular Surf Prov, Purple, 12mm (Fem A, B - Tib 1, 2)
00-5971-020-14	Articular Surf Prov, Purple, 14mm (Fem A, B - Tib 1, 2)
00-5971-020-17	Articular Surf Prov, Purple, 17mm (Fem A, B - Tib 1, 2)
00-5971-020-20	Articular Surf Prov, Purple, 20mm (Fem A, B - Tib 1, 2)
00-5971-021-09	Articular Surf Prov, Str Purple, 9mm (Fem C, H - Tib 1, 2)
00-5971-021-10	Articular Surf Prov, Str Purple, 10mm (Fem C, H - Tib 1, 2)
00-5971-021-12	Articular Surf Prov, Str Purple, 12mm (Fem C, H - Tib 1, 2)
00-5971-021-14	Articular Surf Prov, Str Purple, 14mm (Fem C, H - Tib 1, 2)
00-5971-021-17	Articular Surf Prov, Str Purple, 17mm (Fem C, H - Tib 1, 2)
00-5971-021-20	Articular Surf Prov, Str Purple, 20mm (Fem C, H - Tib 1, 2)

5930-43 NexGen CR Micro Provisional Kit (cont)

Cat. No.	Description
00-5971-031-09	Articular Surf Prov, Str Yellow, 9mm (Fem A, B - Tib 3, 4)
00-5971-031-10	Articular Surf Prov, Str Yellow, 10mm (Fem A, B - Tib 3, 4)
00-5971-031-12	Articular Surf Prov, Str Yellow, 12mm (Fem A, B - Tib 3, 4)
00-5971-031-14	Articular Surf Prov, Str Yellow, 14mm (Fem A, B - Tib 3, 4)
00-5971-031-17	Articular Surf Prov, Str Yellow, 17mm (Fem A, B - Tib 3, 4)
00-5971-031-20	Articular Surf Prov, Str Yellow, 20mm (Fem A, B - Tib 3, 4)
00-5971-041-09	Articular Surf Prov, Str Green, 9mm (Fem Am Em - Tib 5, 6)
00-5971-041-10	Articular Surf Prov, Str Green, 10mm (Fem Am Em - Tib 5, 6)
00-5971-041-12	Articular Surf Prov, Str Green, 12mm (Fem Am Em - Tib 5, 6)
00-5971-041-14	Articular Surf Prov, Str Green, 14mm (Fem Am Em - Tib 5, 6)
00-5971-041-17	Articular Surf Prov, Str Green, 17mm (Fem Am Em - Tib 5, 6)
00-5971-041-20	Articular Surf Prov, Str Green, 20mm (Fem Am Em - Tib 5, 6)
00-5971-041-23	Articular Surf Prov, Str Green, 23mm (Fem Am Em - Tib 5, 6)
00-5991-080-55	CR Micro Prov Case

Misc. NexGen Micro Instruments

Cat. No.	Description
00-5978-005-00	MICRO-MILL Adj. IM Guide
00-5978-008-01	MICRO-MILL Std. Cut Block

NEXGEN CR/CR-FLEX/CRA MICRO ARTICULAR SURFACE KIT (NET-SHAPE MOLDED) JAPAN ONLY



90-5970-007-01 *NexGen CR/CR-Flex/CRA Micro Articular Surface Kit - JAPAN ONLY*

Cat. No.	Description
90-5970-020-09	Articular Surf, Purple, 9mm (Fem A, B – Tib 1, 2)
90-5970-020-10	Articular Surf, Purple, 10mm (Fem A, B – Tib 1, 2)
90-5970-020-12	Articular Surf, Purple, 12mm (Fem A, B – Tib 1, 2)
90-5970-020-14	Articular Surf, Purple, 14mm (Fem A, B – Tib 1, 2)
90-5970-020-17*	Articular Surf, Purple, 17mm (Fem A, B – Tib 1, 2)
90-5970-020-20*	Articular Surf, Purple, 20mm (Fem A, B – Tib 1, 2)
90-5970-021-09	Articular Surf, Str Purple, 9mm (Fem C-H – Tib 1, 2)
90-5970-021-10	Articular Surf, Str Purple, 10mm (Fem C-H – Tib 1, 2)
90-5970-021-12	Articular Surf, Str Purple, 12mm (Fem C-H – Tib 1, 2)
90-5970-021-14	Articular Surf, Str Purple, 14mm (Fem C-H – Tib 1, 2)
90-5970-021-17*	Articular Surf, Str Purple, 17mm (Fem C-H – Tib 1, 2)
90-5970-021-20*	Articular Surf, Str Purple, 20mm (Fem C-H – Tib 1, 2)
90-5970-031-09	Articular Surf, Str Yellow, 9mm (Fem A, B – Tib 3, 4)
90-5970-031-10	Articular Surf, Str Yellow, 10mm (Fem A, B – Tib 3, 4)
90-5970-031-12	Articular Surf, Str Yellow, 12mm (Fem A, B – Tib 3, 4)
90-5970-031-14	Articular Surf, Str Yellow, 14mm (Fem A, B – Tib 3, 4)
90-5970-031-17*	Articular Surf, Str Yellow, 17mm (Fem A, B – Tib 3, 4)
90-5970-031-20*	Articular Surf, Str Yellow, 20mm (Fem A, B – Tib 3, 4)
90-5970-041-09	Articular Surf, Str Green, 9mm (Fem A, B – Tib 5, 6)
90-5970-041-10	Articular Surf, Str Green, 10mm (Fem A, B – Tib 5, 6)
90-5970-041-12	Articular Surf, Str Green, 12mm (Fem A, B – Tib 5, 6)
90-5970-041-14	Articular Surf, Str Green, 14mm (Fem A, B – Tib 5, 6)
90-5970-041-17*	Articular Surf, Str Green, 17mm (Fem A, B – Tib 5, 6)
90-5970-041-20*	Articular Surf, Str Green, 20mm (Fem A, B – Tib 5, 6)

* 17mm and 20mm Articular Surfaces include a required locking screw to be used with the Taper Plug or NexGen Stem Extension and can only be used with stemmed tibial components that can include a stem extension.

NEXGEN CR/CRA MICRO ARTICULAR SURFACE KIT JAPAN ONLY



00-5972-008-01 *NexGen CR/CRA Micro Articular Surface Kit - JAPAN ONLY*

Cat. No.	Description
00-5972-020-09	Articular Surf, Purple, 9mm (Fem A, B – Tib 1, 2)
00-5972-020-10	Articular Surf, Purple, 10mm (Fem A, B – Tib 1, 2)
00-5972-020-12	Articular Surf, Purple, 12mm (Fem A, B – Tib 1, 2)
00-5972-020-14	Articular Surf, Purple, 14mm (Fem A, B – Tib 1, 2)
00-5972-020-17	Articular Surf, Purple, 17mm (Fem A, B – Tib 1, 2)
00-5972-020-20	Articular Surf, Purple, 20mm (Fem A, B – Tib 1, 2)
00-5972-021-09	Articular Surf, Str Purple, 9mm (Fem C-H – Tib 1, 2)
00-5972-021-10	Articular Surf, Str Purple, 10mm (Fem C-H – Tib 1, 2)
00-5972-021-12	Articular Surf, Str Purple, 12mm (Fem C-H – Tib 1, 2)
00-5972-021-14	Articular Surf, Str Purple, 14mm (Fem C-H – Tib 1, 2)
00-5972-021-17	Articular Surf, Str Purple, 17mm (Fem C-H – Tib 1, 2)
00-5972-021-20	Articular Surf, Str Purple, 20mm (Fem C-H – Tib 1, 2)
00-5972-031-09	Articular Surf, Str Yellow, 9mm (Fem A-B – Tib 3, 4)
00-5972-031-10	Articular Surf, Str Yellow, 10mm (Fem A, B – Tib 3, 4)
00-5972-031-12	Articular Surf, Str Yellow, 12mm (Fem A, B – Tib 3, 4)
00-5972-031-14	Articular Surf, Str Yellow, 14mm (Fem A, B – Tib 3, 4)
00-5972-031-17	Articular Surf, Str Yellow, 17mm (Fem A, B – Tib 3, 4)
00-5972-031-20	Articular Surf, Str Yellow, 20mm (Fem A, B – Tib 3, 4)
00-5972-041-09	Articular Surf, Str Green, 9mm (Fem A, B – Tib 5, 6)
00-5972-041-10	Articular Surf, Str Green, 10mm (Fem A, B – Tib 5, 6)
00-5972-041-12	Articular Surf, Str Green, 12mm (Fem A, B – Tib 5, 6)
00-5972-041-14	Articular Surf, Str Green, 14mm (Fem A, B – Tib 5, 6)
00-5972-041-17	Articular Surf, Str Green, 17mm (Fem A, B – Tib 5, 6)
00-5972-041-20	Articular Surf, Str Green, 20mm (Fem A, B – Tib 5, 6)

NEXGEN PROLONG CR MICRO ARTICULAR SURFACE KIT

JAPAN ONLY

00-5952-008-01 NexGen Prolong CR Micro Articular Surface Kit - JAPAN ONLY

Cat. No.	Description
00-5952-020-10	CR Articular Surf, Purple 10mm, (Fem A,B - Tib 1,2)
00-5952-020-12	CR Articular Surf, Purple 12mm, (Fem A,B - Tib 1,2)
00-5952-020-14	CR Articular Surf, Purple 14mm, (Fem A,B - Tib 1,2)
00-5952-020-17	CR Articular Surf, Purple 17mm, (Fem A,B - Tib 1,2)
00-5952-020-20	CR Articular Surf, Purple 20mm, (Fem A,B - Tib 1,2)
00-5952-021-10	CR Articular Surf, Str Purple 10mm, (Fem C,H - Tib 1,2)
00-5952-021-12	CR Articular Surf, Str Purple 12mm, (Fem C,H - Tib 1,2)
00-5952-021-14	CR Articular Surf, Str Purple 14mm, (Fem C,H - Tib 1,2)
00-5952-021-17	CR Articular Surf, Str Purple 17mm, (Fem C,H - Tib 1,2)
00-5952-021-20	CR Articular Surf, Str Purple 20mm, (Fem C,H - Tib 1,2)
00-5952-031-10	CR Articular Surf, Str Yellow 10mm, (Fem A,B - Tib 3,4)
00-5952-031-12	CR Articular Surf, Str Yellow 12mm, (Fem A,B - Tib 3,4)
00-5952-031-14	CR Articular Surf, Str Yellow 14mm, (Fem A,B - Tib 3,4)
00-5952-031-17	CR Articular Surf, Str Yellow 17mm, (Fem A,E - Tib 3,4)
00-5952-031-20	CR Articular Surf, Str Yellow 20mm, (Fem A,B - Tib 3,4)
00-5952-041-10	CR Articular Surf, Str Green 10mm, (Fem A,B - Tib 5,6)
00-5952-041-12	CR Articular Surf, Str Green 12mm, (Fem A,B - Tib 5,6)
00-5952-041-14	CR Articular Surf, Str Green 14mm, (Fem A,B - Tib 5,6)
00-5952-041-17	CR Articular Surf, Str Green 17mm, (Fem A,B - Tib 5,6)
00-5952-041-20	CR Articular Surf, Str Green 20mm, (Fem A,B - Tib 5,6)

NEXGEN CR-FLEX PROVISIONAL/INSTRUMENT KIT

00-5975-022-01 JAPAN ONLY

00-5975-022-01 NexGen CR-Flex Provisional/Instrument Kit - JAPAN ONLY

Cat. No.	Description
00-5955-095-00	CR-FLEX Femoral & Articular Surface Provisionals (Japan)
00-5955-012-01	CR-FLEX Femoral Provisional Size B/L
00-5955-012-02	CR-FLEX Femoral Provisional Size B/R
00-5955-013-01	CR-FLEX Femoral Provisional Size C/L
00-5955-013-02	CR-FLEX Femoral Provisional Size C/R
00-5955-014-01	CR-FLEX Femoral Provisional Size D/L
00-5955-014-02	CR-FLEX Femoral Provisional Size D/R
00-5955-015-01	CR-FLEX Femoral Provisional Size E/L
00-5955-015-02	CR-FLEX Femoral Provisional Size E/R
00-5955-016-01	CR-FLEX Femoral Provisional Size F/L
00-5955-016-02	CR-FLEX Femoral Provisional Size F/R
00-5965-002-00	CR-FLEX Recut Guide, Size B
00-5965-003-00	CR-FLEX Recut Guide, Size C
00-5965-004-00	CR-FLEX Recut Guide, Size D
00-5965-005-00	CR-FLEX Recut Guide, Size E
00-5965-006-00	CR-FLEX Recut Guide, Size F
00-5965-009-00	CR-FLEX Femoral Peg Drill, Size A,B
00-5965-099-00	Re-Cut Guide Modular Pegs (4)
00-5971-020-09	CR Articular Surf Prov, Purple, 9mm, Fem B-Tib1-2
00-5971-020-10	CR Articular Surf Prov, Purple, 10mm, Fem B-Tib1-2
00-5971-020-12	CR Articular Surf Prov, Purple, 12mm, Fem B-Tib1-2
00-5971-020-14	CR Articular Surf Prov, Purple, 14mm, Fem B-Tib1-2
00-5971-020-17	CR Articular Surf Prov, Purple, 17mm, Fem B-Tib1-2
00-5971-020-20	CR Articular Surf Prov, Purple, 20mm, Fem B-Tib1-2
00-5971-021-09	CR Articular Surf Prov, Str Purple, 9mm, Fem C-G-Tib1-2
00-5971-021-10	CR Articular Surf Prov, Str Purple, 10mm, Fem C-G-Tib1-2
00-5971-021-12	CR Articular Surf Prov, Str Purple, 12mm, Fem C-G-Tib1-2
00-5971-021-14	CR Articular Surf Prov, Str Purple, 14mm, Fem C-G-Tib1-2
00-5971-021-17	CR Articular Surf Prov, Str Purple, 17mm, Fem C-G-Tib1-2
00-5971-021-20	CR Articular Surf Prov, Str Purple, 20mm, Fem C-G-Tib1-2

CONTINUED ON PAGE 260

NEXGEN CR-FLEX PROVISIONAL/INSTRUMENT KIT 00-5975-022-01 (CONT.) JAPAN ONLY

00-5975-022-01 NexGen CR-Flex Provisional/Instrument Kit (cont.) - JAPAN ONLY

Cat. No.	Description
00-5971-030-09	CR Articular Surf Prov, Yellow, 9mm, Fem C-G-Tib 3-4
00-5971-030-10	CR Articular Surf Prov, Yellow, 10mm, Fem C-G-Tib 3-4
00-5971-030-12	CR Articular Surf Prov, Yellow, 12mm, Fem C-G-Tib 3-4
00-5971-030-14	CR Articular Surf Prov, Yellow, 14mm, Fem C-G-Tib 3-4
00-5971-030-17	CR Articular Surf Prov, Yellow, 17mm, Fem C-G-Tib 3-4
00-5971-030-20	CR Articular Surf Prov, Yellow, 20mm, Fem C-G-Tib 3-4
00-5971-031-09	CR Articular Surf Prov, Str Yellow, 9mm, Fem B-Tib 3-4
00-5971-031-10	CR Articular Surf Prov, Str Yellow, 10mm, Fem B-Tib 3-4
00-5971-031-12	CR Articular Surf Prov, Str Yellow, 12mm, Fem B-Tib 3-4
00-5971-031-14	CR Articular Surf Prov, Str Yellow, 14mm, Fem B-Tib 3-4
00-5971-031-17	CR Articular Surf Prov, Str Yellow, 17mm, Fem B-Tib 3-4
00-5971-031-20	CR Articular Surf Prov, Str Yellow, 20mm, Fem B-Tib 3-4
00-5971-040-09	CR Articular Surf Prov, Green, 9mm, Fem C-G-Tib 5-6
00-5971-040-10	CR Articular Surf Prov, Green, 10mm, Fem C-G-Tib 5-6
00-5971-040-12	CR Articular Surf Prov, Green, 12mm, Fem C-G-Tib 5-6
00-5971-040-14	CR Articular Surf Prov, Green, 14mm, Fem C-G-Tib 5-6
00-5971-040-17	CR Articular Surf Prov, Green, 17mm, Fem C-G-Tib 5-6
00-5971-040-20	CR Articular Surf Prov, Green, 20mm, Fem C-G-Tib 5-6
00-5971-041-10	CR Articular Surf Prov, Str Grn, 10mm, Fem B-Tib 5-6
00-5971-041-12	CR Articular Surf Prov, Str Grn, 12mm, Fem B-Tib 5-6
00-5971-041-14	CR Articular Surf Prov, Str Grn, 14mm, Fem B-Tib 5-6
00-5971-041-17	CR Articular Surf Prov, Str Grn, 17mm, Fem B-Tib 5-6
00-5971-041-20	CR Articular Surf Prov, Str Grn, 20mm, Fem B-Tib 5-6
00-5971-050-09	CR Articular Surf Prov, Blue, 9mm, Fem C-G-Tib 7-10
00-5971-050-10	CR Articular Surf Prov, Blue, 10mm, Fem C-G-Tib 7-10
00-5971-050-12	CR Articular Surf Prov, Blue, 12mm, Fem C-G-Tib 7-10
00-5971-050-14	CR Articular Surf Prov, Blue, 14mm, Fem C-G-Tib 7-10
00-5971-050-17	CR Articular Surf Prov, Blue, 17mm, Fem C-G-Tib 7-10
00-5971-050-20	CR Articular Surf Prov, Blue, 20mm, Fem C-G-Tib 7-10
00-5987-035-00	Torque Wrench
00-5987-036-00	Hex Driver Bit, 4.5mm
00-5995-075-00	Locking Screw

NEXGEN LPS-FLEX FEMORAL PROV/INSTR KIT 00-5975-005-01 JAPAN ONLY

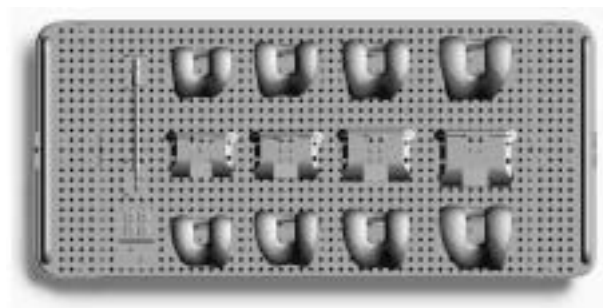

00-5975-005-01 NexGen LPS-Flex Femoral Prov/ Instr Surface Kit - JAPAN ONLY

Cat. No.	Description
00-5961-012- 01	LPS-Flex Femoral Provisional, Size B,L
00-5961-012- 02	LPS-Flex Femoral Provisional, Size B,R
00-5961-013- 01	LPS-Flex Femoral Provisional, Size C,L
00-5961-013- 02	LPS-Flex Femoral Provisional, Size C,R
00-5961-014- 01	LPS-Flex Femoral Provisional, Size D, L
00-5961-014- 02	LPS-Flex Femoral Provisional, Size D,R
00-5961-015- 01	LPS-Flex Femoral Provisional, Size E,L
00-5961-015- 02	LPS-Flex Femoral Provisional, Size E,R
00-5965-002-00	LPS-Flex Re-Cut Guide, Size B
00-5965-003-00	LPS-Flex Re-Cut Guide, Size C
00-5965-004-00	LPS-Flex Re-Cut Guide, Size D
00-5965-005-00	LPS-Flex Re-Cut Guide, Size E
00-5965-009-00	Flex Femur Peg Drill, Size A,B
00-5965-060-00	LPS-Flex Femoral Prov/Instr Case
00-5965-099-00	Re-cut Guide Modular Peg (4)

NEXGEN LPS-FLEX MOBILE ART SURF PROV/INSTR KIT 00-5975-006-01 JAPAN ONLY

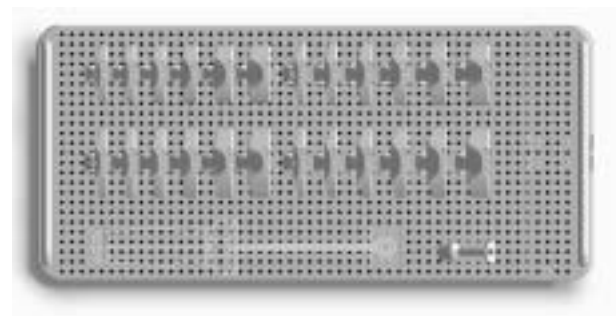

00-5975-006-01 NexGen LPS-Flex Mobile Articular Surf Prov/Instr Kit - JAPAN ONLY

Cat. No.	Description
00-5945-020-09	LPS-Flex Mob Prov Art Surf A,B/1,2,3, 9mm
00-5945-020-10	LPS-Flex Mob Prov Art Surf A,B/1,2,3, 10mm
00-5945-020-12	LPS-Flex Mob Prov Art Surf A,B/1,2,3, 12mm
00-5945-020-14	LPS-Flex Mob Prov Art Surf A,B/1,2,3, 14mm
00-5945-020-17	LPS-Flex Mob Prov Art Surf A,B/1,2,3, 17mm
00-5945-020-20	LPS-Flex Mob Prov Art Surf A,B/1,2,3, 20mm
00-5945-030-09	LPS-Flex Mob Prov Art Surf C/2,3,4, 9mm
00-5945-030-10	LPS-Flex Mob Prov Art Surf C/2,3,4, 10mm
00-5945-030-12	LPS-Flex Mob Prov Art Surf C/2,3,4, 12mm
00-5945-030-14	LPS-Flex Mob Prov Art Surf C/2,3,4, 14mm
00-5945-030-17	LPS-Flex Mob Prov Art Surf C/2,3,4, 17mm
00-5945-030-20	LPS-Flex Mob Prov Art Surf C/2,3,4, 20mm
00-5945-040-09	LPS-Flex Mob Prov Art Surf D/3,4,5, 9mm
00-5945-040-10	LPS-Flex Mob Prov Art Surf D/3,4,5, 10mm
00-5945-040-12	LPS-Flex Mob Prov Art Surf D/3,4,5, 12mm
00-5945-040-14	LPS-Flex Mob Prov Art Surf D/3,4,5, 14mm
00-5945-040-17	LPS-Flex Mob Prov Art Surf D/3,4,5, 17mm
00-5945-040-20	LPS-Flex Mob Prov Art Surf D/3,4,5, 20mm
00-5945-050-09	LPS-Flex Mob Prov Art Surf E/4,5,6, 9mm
00-5945-050-10	LPS-Flex Mob Prov Art Surf E/4,5,6, 10mm
00-5945-050-12	LPS-Flex Mob Prov Art Surf E/4,5,6, 12mm
00-5945-050-14	LPS-Flex Mob Prov Art Surf E/4,5,6, 14mm
00-5945-050-17	LPS-Flex Mob Prov Art Surf E/4,5,6, 17mm
00-5945-050-20	LPS-Flex Mob Prov Art Surf E/4,5,6, 20mm
00-5965-061-00	Mob Art Surf Prov Case Assembly
00-5987-035-00	Deflection Beam Torque Wrench
00-5987-036-00	Hex Driver Bit, 4.5mm

NEXGEN LPS-FLEX FLUTED STEM MOBILE TIBIAL PROV/INSTR KIT 00-5975-007-01 JAPAN ONLY

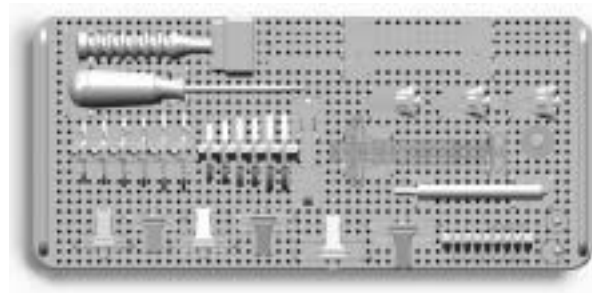

00-5975-007-01 NexGen LPS-Flex Mobile Provisional Kit - JAPAN ONLY

Cat. No.	Description
00-5120-087-00	Hex Head Screwdriver, 3.5mm
00-5941-003-00	MBK Tibial Holding Clamp
00-5941-004-00	MBK Tibial Impactor
00-5941-006-00	Small Head Holding Pins
00-5945-010-00	Fluted Stem Mob. Plate Provisional, Size 1
00-5945-011-00	Fluted Stem Mob. Tib. Sizing/Positioning Plate, Size 1
00-5945-020-00	Fluted Stem Mob. Plate Provisional, Size 2
00-5945-021-00	Fluted Stem Mob. Tib. Sizing/Positioning Plate, Size 2
00-5945-030-00	Fluted Stem Mob. Plate Provisional, Size 3
00-5945-031-00	Fluted Stem Mob. Tib. Sizing/Positioning Plate, Size 3
00-5945-040-00	Fluted Stem Mob. Plate Provisional, Size 4
00-5945-041-00	Fluted Stem Mob. Tib. Sizing/Positioning Plate, Size 4
00-5945-050-00	Fluted Stem Mob. Plate Provisional, Size 5
00-5945-051-00	Fluted Stem Mob. Tib. Sizing/Positioning Plate, Size 5
00-5945-060-00	Fluted Stem Mob. Plate Provisional, Size 6
00-5945-061-00	Fluted Stem Mob. Tib. Sizing/Positioning Plate, Size 6
00-5965-062-00	LPS-Flex Fluted Stem Mobile Tibial Prov/Instr Case
00-5977-010-02	Fluted Stem Tibial Drill, 15mm
00-5977-011-00	Broach Impactor
00-5977-014-02	Fluted Stem Tibial Drill Guide, 15mm
00-5977-056-01	Grooved Short Head Holding Pin
00-5987-003-00	Straight Bushing

CONTINUED ON PAGE 264

NEXGEN LPS-FLEX FLUTED STEM MOBILE TIBIAL PROV/ INSTR KIT 00-5975-007-01 (CONT.) JAPAN ONLY

00-5975-007-01 NexGen LPS-Flex Mobile Provisional Kit - JAPAN ONLY (cont)

Cat. No.	Description
00-5987-004-00	Offset Bushing
00-5995-037-00	LCCK Tibial Plate Wrench, Size 1-2 (not shown)
00-5995-037-01	LCCK Tibial Plate Wrench, Size 3-4 (not shown)
00-5995-037-02	LCCK Tibial Plate Wrench, Size 5-6 (not shown)
00-5997-060-01	Fluted Stem Tibial Sizing Plate Size 1
00-5997-060-02	Fluted Stem Tibial Sizing Plate Size 2
00-5997-060-03	Fluted Stem Tibial Sizing Plate Size 3
00-5997-060-04	Fluted Stem Tibial Sizing Plate Size 4
00-5997-060-05	Fluted Stem Tibial Sizing Plate Size 5
00-5997-060-06	Fluted Stem Tibial Sizing Plate Size 6
00-5997-061-01	Fluted Stem Tibial Broach Size 1-2
00-5997-061-03	Fluted Stem Tibial Broach Size 3-4
00-5997-061-05	Fluted Stem Tibial Broach Size 5-6

NEXGEN LPS-FLEX FEMORAL PROV/INSTR SIZE A KIT 00-5975-008-01 JAPAN ONLY

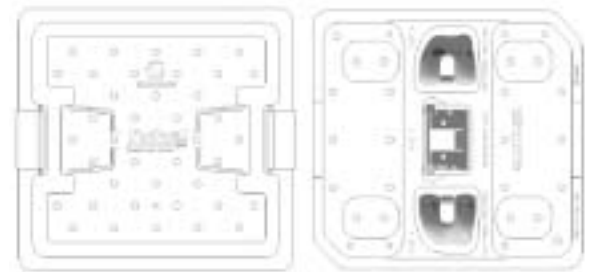

00-5975-008-01 NexGen LPS-Flex Femoral Prov/inst Size A Kit - JAPAN ONLY

Cat. No.	Description
00-5961-011-01	LPS-Flex Femoral Provisional, Size A-L
00-5961-011-02	LPS-Flex Femoral Provisional, Size A-R
00-5965-001-00	Posterior re-cut Guide, Size A
00-5965-065-00	LPS-Flex Femoral Provisional instrument Case, Size A

**NEXGEN LPS-FLEX PROV/INSTR KIT, SIZE F/7-
00-5975-009-01 JAPAN ONLY**

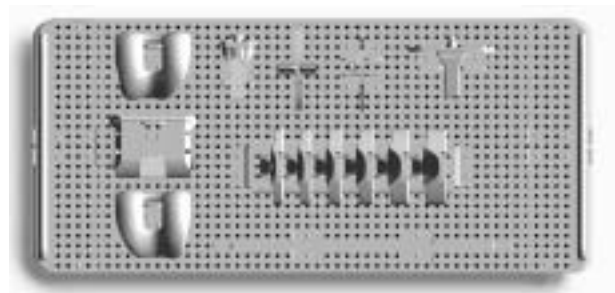

**00-5975-009-01 NexGen LPS-Flex Prov/Instr Kit, Size F/7
- JAPAN ONLY**

Cat. No.	Description
00-5945-060-09	LPS-Flex Mob. Prov. Art. Surface F/5,6,7, 9mm
00-5945-060-10	LPS-Flex Mob. Prov. Art. Surface F/5,6,7, 10mm
00-5945-060-12	LPS-Flex Mob. Prov. Art. Surface F/5,6,7, 12mm
00-5945-060-14	LPS-Flex Mob. Prov. Art. Surface F/5,6,7, 14mm
00-5945-060-17	LPS-Flex Mob. Prov. Art. Surface F/5,6,7, 17mm
00-5945-060-20	LPS-Flex Mob. Prov. Art. Surface F/5,6,7, 20mm
00-5945-070-00	Fluted Stem Mob. Plate Provisional Size 7
00-5945-071-00	Fluted Stem Mob. Tib. Sizing/Positioning Plate, Size 7
00-5961-016-01	LPS-Flex Femoral Provisional, Size F, L
00-5961-016-02	LPS-Flex Femoral Provisional, Size F, R
00-5965-006-00	Posterior Re-Cut Guide, Size F
00-5965-063-00	Large LPS Flex Fluted Stem Mobile Tibial Prov/Instr Case
00-5995-037-03	LCCK Tibial Plate Wrench, Size 7-8 (not shown)
00-5997-060-07	Fluted Stem Tibial Sizing Plate, Size 7
00-5997-061-07	Fluted Stem Tibial Broach Size 7-8

**NEXGEN LPS-FLEX PROV/INSTR KIT, SIZE G/8-
00-5975-010-01 JAPAN ONLY**

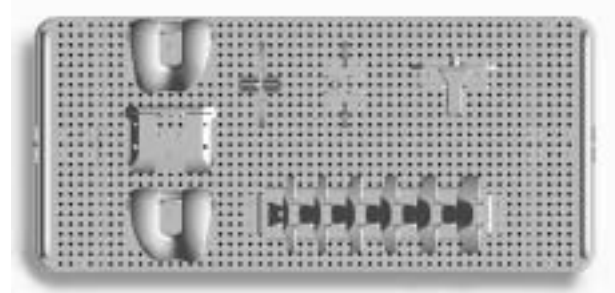

**00-5975-010-01 NexGen LPS-Flex Prov/Instr Kit, Size G/8
- JAPAN ONLY**

Cat. No.	Description
00-5945-070-09	LPS-Flex Mob. Art. Surface Prov. G/6,7,8, 9mm
00-5945-070-10	LPS-Flex Mob. Art. Surface Prov. G/6,7,8, 10mm
00-5945-070-12	LPS-Flex Mob. Art. Surface Prov. G/6,7,8, 12mm
00-5945-070-14	LPS-Flex Mob. Art. Surface Prov. G/6,7,8, 14mm
00-5945-070-17	LPS-Flex Mob. Art. Surface Prov. G/6,7,8, 17mm
00-5945-070-20	LPS-Flex Mob. Art. Surface G/6/8, 20mm
00-5945-080-00	Fluted Stem Mob. Plate Provisional, Size 8
00-5945-081-00	Fluted Stem Mob. Tib. Sizing/Positioning Plate, Size 8
00-5961-017-01	LPS-Flex Femoral Provisional, Size G, L
00-5961-017-02	LPS-Flex Femoral Provisional, Size G, R
00-5965-007-00	Posterior Re-Cut Guide, Size G
00-5965-064-00	Extra-Large LPS-Flex Prov/Instr Case
00-5997-060-08	Fluted Stem Tibial Sizing Plate, Size 8

MBK CR/CS FEM/ART SURFACE PROV KITS

00-5973-096-00 AND 00-5973-097-00 JAPAN ONLY

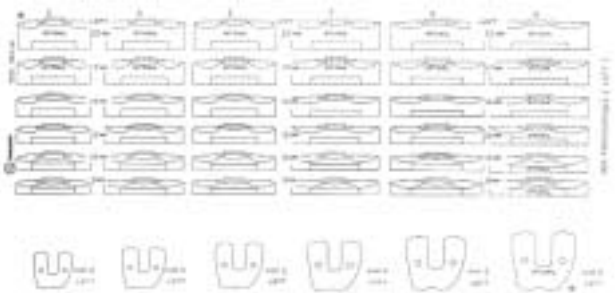

00-5973-096-00 MBK CR/CS Femoral/Articular Surface Provisional Kit, Left

Cat. No.	Description
00-5941-012-01	Femoral Prov, Size B, Lt
00-5941-013-01	Femoral Prov, Size C, Lt
00-5941-014-01	Femoral Prov, Size D, Lt
00-5941-015-01	Femoral Prov, Size E, Lt
00-5941-016-01	Femoral Prov, Size F, Lt
00-5941-017-01	Femoral Prov, Size G, Lt
00-5941-021-09	Articular Surf Prov, Size B, Lt, 9mm
00-5941-021-10	Articular Surf Prov, Size B, Lt, 10mm
00-5941-021-12	Articular Surf Prov, Size B, Lt, 12mm
00-5941-021-14	Articular Surf Prov, Size B, Lt, 14mm
00-5941-021-17	Articular Surf Prov, Size B, Lt, 17mm
00-5941-021-20	Articular Surf Prov, Size B, Lt, 20mm
00-5941-031-09	Articular Surf Prov, Size C, Lt, 9mm
00-5941-031-10	Articular Surf Prov, Size C, Lt, 10mm
00-5941-031-12	Articular Surf Prov, Size C, Lt, 12mm
00-5941-031-14	Articular Surf Prov, Size C, Lt, 14mm
00-5941-031-17	Articular Surf Prov, Size C, Lt, 17mm
00-5941-031-20	Articular Surf Prov, Size C, Lt, 20mm
00-5941-041-09	Articular Surf Prov, Size D, Lt, 9mm
00-5941-041-10	Articular Surf Prov, Size D, Lt, 10mm
00-5941-041-12	Articular Surf Prov, Size D, Lt, 12mm
00-5941-041-14	Articular Surf Prov, Size D, Lt, 14mm
00-5941-041-17	Articular Surf Prov, Size D, Lt, 17mm
00-5941-041-20	Articular Surf Prov, Size D, Lt, 20mm

00-5973-096-00 MBK CR/CS Femoral/Articular Surface Provisional Kit, Left

Cat. No.	Description
00-5941-051-09	Articular Surf Prov, Size E, Lt, 9mm
00-5941-051-10	Articular Surf Prov, Size E, Lt, 10 mm
00-5941-051-12	Articular Surf Prov, Size E, Lt, 12 mm
00-5941-051-14	Articular Surf Prov, Size E, Lt, 14 mm
00-5941-051-17	Articular Surf Prov, Size E, Lt, 17mm
00-5941-051-20	Articular Surf Prov, Size E, Lt, 20mm
00-5941-061-09	Articular Surf Prov, Size F, Lt, 9mm
00-5941-061-10	Articular Surf Prov, Size F, Lt, 10mm
00-5941-061-12	Articular Surf Prov, Size F, Lt, 12mm
00-5941-061-14	Articular Surf Prov, Size F, Lt, 14mm
00-5941-061-17	Articular Surf Prov, Size F, Lt, 17mm
00-5941-061-20	Articular Surf Prov, Size F, Lt, 20mm
00-5941-071-09	Articular Surf Prov, Size G, Lt, 9mm
00-5941-071-10	Articular Surf Prov, Size G, Lt, 10mm
00-5941-071-12	Articular Surf Prov, Size G, Lt, 12mm
00-5941-071-14	Articular Surf Prov, Size G, Lt, 14mm
00-5941-071-17	Articular Surf Prov, Size G, Lt, 17mm
00-5941-071-20	Articular Surf Prov, Size G, Lt, 20mm
00-5941-091-00	Fem/Articular Surf Prov Tray, Left
00-5967-001-30	Generic Base, 3"
00-5967-001-00	Generic Lid, Aluminum

CONTINUED ON PAGE 270

**MBK CR/CS FEM/ART SURFACE PROV KITS 00-5973-096-00
AND 00-5973-097-00 JAPAN ONLY (CONT.)**

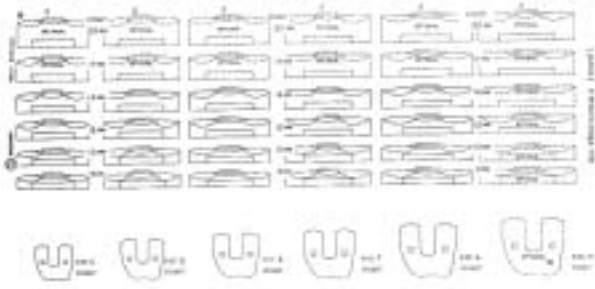

00-5973-097-00 MBK CR/CS Femoral Articular Surface Provisional Kit, Right

Cat. No.	Description
00-5941-012-02	Femoral Prov, Size B, Rt
00-5941-013-02	Femoral Prov, Size C, Rt
00-5941-014-02	Femoral Prov, Size D, Rt
00-5941-015-02	Femoral Prov, Size E, Rt
00-5941-016-02	Femoral Prov, Size F, Rt
00-5941-017-02	Femoral Prov, Size G, Rt
00-5941-022-09	Articular Surf Prov, Size B, Rt, 9mm
00-5941-022-10	Articular Surf Prov, Size B, Rt, 10mm
00-5941-022-12	Articular Surf Prov, Size B, Rt, 12mm
00-5941-022-14	Articular Surf Prov, Size B, Rt, 14mm
00-5941-022-17	Articular Surf Prov, Size B, Rt, 17mm
00-5941-022-20	Articular Surf Prov, Size B, Rt, 20mm
00-5941-032-09	Articular Surf Prov, Size C, Rt, 9mm
00-5941-032-10	Articular Surf Prov, Size C, Rt, 10mm
00-5941-032-12	Articular Surf Prov, Size C, Rt, 12mm
00-5941-032-14	Articular Surf Prov, Size C, Rt, 14mm
00-5941-032-17	Articular Surf Prov, Size C, Rt, 17mm
00-5941-032-20	Articular Surf Prov, Size C, Rt, 20mm
00-5941-042-09	Articular Surf Prov, Size D, Rt, 9mm
00-5941-042-10	Articular Surf Prov, Size D, Rt, 10mm
00-5941-042-12	Articular Surf Prov, Size D, Rt, 12mm
00-5941-042-14	Articular Surf Prov, Size D, Rt, 14mm

00-5973-097-00 MBK CR/CS Femoral Articular Surface Provisional Kit, Right (cont)

Cat. No.	Description
00-5941-042-17	Articular Surf Prov, Size D, Rt, 17mm
00-5941-042-20	Articular Surf Prov, Size D, Rt, 20mm
00-5941-052-09	Articular Surf Prov, Size E, Rt, 9mm
00-5941-052-10	Articular Surf Prov, Size E, Rt, 10mm
00-5941-052-12	Articular Surf Prov, Size E, Rt, 12mm
00-5941-052-14	Articular Surf Prov, Size E, Rt, 14mm
00-5941-052-17	Articular Surf Prov, Size E, Rt, 17mm
00-5941-052-20	Articular Surf Prov, Size E, Rt, 20mm
00-5941-062-09	Articular Surf Prov, Size F, Rt, 9mm
00-5941-062-10	Articular Surf Prov, Size F, Rt, 10mm
00-5941-062-12	Articular Surf Prov, Size F, Rt, 12mm
00-5941-062-14	Articular Surf Prov, Size F, Rt, 14mm
00-5941-062-17	Articular Surf Prov, Size F, Rt, 17mm
00-5941-062-20	Articular Surf Prov, Size F, Rt, 20mm
00-5941-072-09	Articular Surf Prov, Size G, Rt, 9mm
00-5941-072-10	Articular Surf Prov, Size G, Rt, 10mm
00-5941-072-12	Articular Surf Prov, Size G, Rt, 12mm
00-5941-072-14	Articular Surf Prov, Size G, Rt, 14mm
00-5941-072-17	Articular Surf Prov, Size G, Rt, 17mm
00-5941-072-20	Articular Surf Prov, Size G, Rt, 20mm
00-5941-092-00	Fem/Articular Surf Prov Tray, Right
00-5967-001-30	Generic Base, 3 in.
00-5967-001-00	Generic Lid, Aluminum

MBK TIBIAL GENERAL INSTRUMENT KIT 00-5973-098-00

JAPAN ONLY

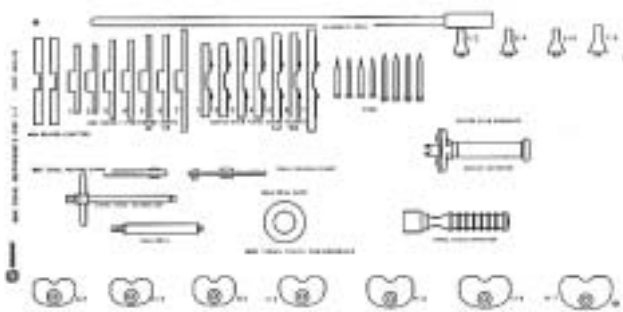

00-5973-098-00 MBK Tibial/General Instrument Kit

Cat. No.	Description
00-5941-003-00	Tibial Holding Clamp
00-5941-004-00	Tibial Plate Impactor
00-5941-006-00	Small Head Holding Pins
00-5941-009-00	Spacer Adaptor
00-5941-010-00	Tibial Plate Prov, Size 1
00-5941-011-00	Tibial Sizing/Positioning Tray, Size 1
00-5941-020-00	Tibial Plate Prov, Size 2
00-5941-021-00	Tibial Sizing/Positioning Tray, Size 2
00-5941-030-00	CR Tibial Plate Prov, Size 3
00-5941-031-00	Tibial Sizing/Positioning Tray, Size 3
00-5941-040-00	CR Tibial Plate Prov, Size 4
00-5941-041-00	Tibial Sizing/Positioning Tray, Size 4
00-5941-050-00	CR Tibial Plate Prov, Size 5
00-5941-051-00	Tibial Sizing/Positioning Tray, Size 5
00-5941-060-00	CR Tibial Plate Prov, Size 6
00-5941-061-00	Tibial Sizing/Positioning Tray, Size 6
00-5941-070-00	CR Tibial Plate Prov, Size 7
00-5941-071-00	Tibial Sizing/Positioning Tray, Size 7
00-5941-080-00	CR Tibial Plate Prov, Size 8
00-5941-081-00	Tibial Sizing/Positioning Tray, Size 8
00-5941-096-00	Tibial Instrument Tray
00-5967-001-00	Generic Lid, Aluminum
00-5967-001-35	Generic Base, 3.5"

00-5973-098-00 MBK Tibial/General Instrument Kit (cont)

Cat. No.	Description
00-5969-004-01	Plus 1mm Spacer
00-5977-010-02	15mm Fluted Stem Tibial Drill
00-5977-011-00	NexGen Broach Impactor
00-5977-014-02	NexGen 15mm Fluted Stemmed Tibial Drill Guide
00-5977-017-00	NexGen Tibial Prov. Extractor
00-5977-056-01	NexGen Short Head Holding Pins
00-5977-096-00	NexGen Locking Tibial Tray Prov. Handle
00-5997-060-01	Fluted Stem Tibial Sizing Plate, Size 1
00-5997-060-02	Fluted Stem Tibial Sizing Plate, Size 2
00-5997-060-03	Fluted Stem Tibial Sizing Plate, Size 3
00-5997-060-04	Fluted Stem Tibial Sizing Plate, Size 4
00-5997-060-05	Fluted Stem Tibial Sizing Plate, Size 5
00-5997-060-06	Fluted Stem Tibial Sizing Plate, Size 6
00-5997-060-07	Fluted Stem Tibial Sizing Plate, Size 7
00-5997-060-08	Fluted Stem Tibial Sizing Plate, Size 8
00-5997-061-01	Fluted Stem Tibial Broach, Size 1-2
00-5997-061-03	Fluted Stem Tibial Broach, Size 3-4
00-5997-061-05	Fluted Stem Tibial Broach, Size 5-6
00-5997-061-07	Fluted Stem Tibial Broach, Size 7-8
00-5785-079-00	Alignment Rod
00-5785-080-00	Alignment Rod w/ Coupler
00-5941-002-00*	Articular Surface Extractor
00-5941-008-00*	Distal Femoral Cut Guide

*(Items are OPTIONAL instruments and are not included in kit.)

NEXGEN PINS & SCREWS



1 2 3 4 5 6 7 8 9 10 11 12 13

Cat. No.	Description
1. 00-5997-084-00	Headless Gold Pin, 75mm (4/Bx)
2. 00-5791-054-00	Collapsing Holding Pin
3. 00-5061-063-00	Hex Head Holding Pin (4/Bx)
4. 00-5967-033-01	Spring Screw, Short
5. 00-5791-041-00	48mm Headed Screw
6. 00-5791-042-00	48mm Headless Screw
7. 00-5791-044-00	33mm Headed Screw
8. 00-5791-043-00	27mm Headed Screw
9. 00-5222-039-00	NexGen Headless Pins, 48mm
10. 00-5977-056-00	Short Headed Holding Pin 52mm (4 each)
11. 00-5977-056-01	Short Head Holding Pin (4/Bx)
12. 00-5977-056-02	Short Headed Holding Pin 17mm (2 each)
13. 00-6250-065-35	Bone Screw 6.5 x 35 Self-Tap

DISPOSABLES

Cat. No.	Description
00-0186-004-53	Keith Needles
00-5052-058-00	Reciprocator Saw Blade, 12.5 x 89mm
00-5052-179-00	Reciprocator Saw Blade, 12.5 x 76
00-5052-291-00	Reciprocator Saw Blade, 12.5 x 76 x 1.27mm
00-5052-202-00	Milling Cutter, 12mm (Micro)
00-5052-204-00	Milling Cutter, 19mm
00-5071-161-00	Oscillating Saw Blade, 25.4 x 90 x 1.27
00-5071-180-00	Oscillating Saw Blade, 10 x 85 x 1.27mm
00-5071-181-00	Oscillating Saw Blade w/etch line, 19.5 x 86 x 1.27mm
00-5071-201-00	Oscillating Brazol Saw Blade, 19.5 x 86 x 1.27mm
00-5253-003-00	Breakaway Pins (3/bx)
00-5793-030-00	Targeting Guide
00-5791-041-00	Headed Screw, 48mm (1 each)
00-5791-042-00	Headless Screw, 48mm (1 each)
00-5791-043-00	Headless Screw, 27mm (1 each)
00-5791-044-00	Headed Screw, 33mm (1 each)
00-5791-054-00	Slotted Holding Pin (1 each)
00-5793-017-00	Minus 2mm Distal Femoral Resector
00-5977-002-00	Ankle Strap (1/box)
00-5977-034-07	Milling Drape
00-5843-052-01	Articular Surface Inserter Tip
00-5983-040-27	MIS Quad-Sparing Total Knee Headed Screw, 27mm
00-5983-040-33	MIS Quad-Sparing Total Knee Headed Screw, 33mm

SOFT TISSUE BALANCE GUIDE

		EXTENSION		
		TIGHT	OK	LOOSE
FLEXION	TIGHT	1	2	3
	OK	4	5	6
	LOOSE	7	8	9

BALANCING FLEXION/EXTENSION GAPS

After the flexion gap has been established and the appropriate size femoral component applied, extend the knee. A symmetrical and balanced extension gap should be created. This is sometimes difficult as it often requires elevation or lowering of the joint line. The patella helps determine the appropriate position of the joint line.

It is important to remember that adjustments to the femoral side of the arthroplasty can affect the knee in either flexion or extension, while any change to the tibia affects both flexion and extension. This is part of the rationale for reconstructing the tibial side first. The matrix to the left suggests the nine situations that can occur during a trial reduction in a revision knee. It is worth reviewing these options and some of their potential solutions.

1.

If a knee is too tight in both flexion and extension, reducing the height of the tibial articular surface may be sufficient to balance the construct.

2.

If the knee is tight in flexion but acceptable in extension, two options exist. An augment may be used with the distal femur. This will drop the joint line lower, and allow the use of a thinner tibial component. Another option is to use a smaller femoral component.

3.

If the joint is loose in extension and tight in flexion, augmentation of the distal femur should provide a good arthroplasty with a thinner polyethylene component if the joint line is at its proper location. Another option is to use a smaller femoral component possibly with a thicker polyethylene component.

4.

If the joint is acceptable in flexion but tight in extension, several options exist. One is to release the posterior capsule from the femur. Another alternative is to resect more distal femoral bone. This moves the femoral component proximally on the femur at the expense of elevating the joint line.

5.

Obviously, if both components are acceptable, no further modification is necessary.

6.

If the joint is acceptable in flexion and loose in extension, the probable solution is augmentation of the distal femur while using the same polyethylene component. This will drop the joint line and tighten the extension gap. Another option is to downsize the femoral component and use a thicker polyethylene component. This will probably raise the joint line.

7.

If the joint is loose in flexion and acceptable in extension, a larger femoral component, may suffice. A second option is a thicker tibial articular surface with a more proximal femoral position.

8.

If the joint is loose in flexion and acceptable in extension, increasing the femoral size may equalize the gaps. Alternatively, moving the femoral component proximally and applying a thicker tibial articular surface will equalize the gaps. As a less desirable solution, one may choose to accept this situation if it is only of a mild degree, particularly in a highly constrained component.

9.

If the joint is symmetrically loose in both flexion and extension, a thicker tibial articular surface will solve both problems.

In situations where two options exist to help solve the soft tissue mismatch, the position of the patella or the joint line help the surgeon decide which option to select.

Note: After applying one of these solutions, perform another trial reduction. This will identify any new problem or a variation of the initial problem that now may exist.

The Zimmer [Revision Knee Arthroplasty Surgical Guidelines](#) is strongly recommended for a more complete discussion on revision total knee arthroplasty technique. (This booklet can be ordered through Zimmer, reference catalog number 97-5224-03).

SUMMARY OF NEXGEN PRIMARY FEMORAL INSTRUMENT OPTIONS

	5-in-1	Milling
Reference for femoral A/P position	Anterior reference	Anterior reference
Number of setups	1	1
Bone cuts	Saw blade	Milling burr/
Distal Cut first	No	No
Distal Cut angle	0°	0°
Femoral rotation	3° off posterior condyles	3° off posterior condyles
Varus/valgus alignment	Primary: IM Secondary: EM	Primary: IM Secondary: EM
Valgus cut angles	0-11° in 1° increments	0-11° in 1° increments

IM	EPI	4-in-1
Anterior reference	Anterior or posterior reference	Anterior or posterior reference
3	3	2
Saw Blade	Saw Blade	Saw Blade
Yes (after preliminary anterior cut)	Yes	Yes
0°	0° or 3°	0° or 3°
3° off posterior condyles	Based on epicondyles or variable based on posterior condyles	3°, 5° and 7° off posterior condyles or variable based on posterior condyles
Primary: IM Secondary: EM	Primary: IM Secondary: EM	Primary: IM Secondary: EM
2-11° in 1° increments	0-11° in 1° increments	0-11° in 1° increments

KNEE SALES SUPPORT MATERIAL

Journal Reprints:

Relating to Knee Products

<u>Cat. Number</u>	<u>Description</u>	<u>Price</u>
97-5994-09	A Practical Approach to Dealing with Bone Loss in Revision Total Knee Arthroplasty Lucey SD, Scuderi GR, Kelly MA, Insall JN. Orthopedics Tips & Techniques, Oct, 2000	\$.40
97-5973-11	Anatomy of the Tibial Intramedullary Canal. Hicks CA, Noble P, Tullos H. Clin Orthop, 1995	\$1.10
97-5964-15	Continuous Passive Motion with Accelerated Flexion after Total Knee Arthroplasty. Yashar AA, Venn-Watson E, Welsh T, et al. Clin Orthop Rel Res, 1997	\$1.20
97-5250-12	Current Role for High Tibial Osteotomy. Dunn HK. Current Concepts in Total Knee Arthroplasty, 1992	
97-5973-08	Cutting Errors in Preparation of Femoral Components in Total Knee Arthroplasty. Otani T, Whiteside LA, White SE. J of Arthroplasty, 1993	
97-5964-14	Early Flexion Routine. Jordan LR, Siegal JL, Olive JL. Clin Orthop Rel Res, 1995	\$1.40
97-5972-19	Effect of Patellar Button Placement and Femoral Component Design on Patellar Tracking in Total Knee Arthroplasty. Yoshii I, Whiteside LA, Anouchi YS. Clin Orthop Rel Res, 1992	\$1.75
97-2100-11	Effect of Polyethylene Quality on Wear in Total Knee Arthroplasty. Tanner MG, Whiteside LA, White SE. Clin Orthop, 1995.	
97-5220-08	Effect of Screw Fixation on Initial Rigidity of Tibial Knee Components. Wyatt RWB, Alpert JP, Daniels AU, et al. J of Appl Biomat, 1991.	
97-5973-10	Effect of the Tibial Cut on Subsidence Following Total Knee Arthroplasty. Hofmann AA, Bachus KN, Wyatt RW. Clin Orthop, 1991.	
97-5110-115	Effects of Inaccurate Bone Cuts on Femoral Component Position in Total Knee Arthroplasty. Lennox DW, Cohn BT, Eschenroeder HC. Orthop, 1988	\$0.35
97-5973-16	Factors Influencing the Longevity of UHMWPE Tibial Components. Greenwald Meeting Synopsis, Orthopaedic Research Laboratories, 1996	\$0.95
97-2100-511	Hugh Downs: Joint Replacement Helps a Television Icon Step into an Active Future. Vim & Vigor Magazine Article, 1997 (25/pkg)	\$10.00
97-5946-13	The Influence of Mobile Bearing Geometry on the Wear of UHMWPE Tibial Inserts III: A Finite Element Study. Greenwald Meeting Synopsis, Orthopaedic Research Laboratories, 2000	\$1.00
97-5970-15*	The Insall Legacy in Total Knee Arthroplasty. Scuderi GR. Clin Orthop Rel Res, 2001	\$1.65
97-5970-15-01	The Insall Legacy in Total Knee Arthroplasty. Scuderi GR. Clin Orthop Rel Res, 2001	\$1.65
97-5972-11	Kinematics of the Knee Joint in Deep Flexion: A Radiographic Assessment. Hefzy MS, Kelly BP, Cooke TD. Medical Eng & Physics	\$1.30

Journal Reprints cont:

<u>Cat. Number</u>	<u>Description</u>	<u>Price</u>
97-5970-11	Malrotation Causing Patellofemoral Complications after Total Knee Arthroplasty. Berger RA, Crossett LS, Jacobs JJ, Rubash HE. Clin Orthop Rel Res, 1998	\$1.95
97-5940-15	Mechanical Evaluation of Mobile Bearing Knees. Menchetti PP, Walker PS. Am Jnl of Knee Surg, Spring 1997	\$0.60
97-5973-14	Modular Tibial Insert Micromotion. Parks NL, Engh GA, Topoleski LDT, et al. Clin Orthop Rel Res, 1998	\$1.20
97-5972-10	On Geographical Variations in the Normal Range of Joint Motion. Ahlberg A, Moussa M, Al-Nahdi M. Clin Orthop Rel Res, 1988	\$0.65
97-5900-08	Patella Considerations in Total Knee Replacement. The Patella, Chapter 16, Springer-Verlag, 1995	\$3.75
97-5972-15	Patellofemoral Contact Area: The NexGen® in Comparison to the Duracon, the PFC and the Natural Knees. McLean, Eng, Ahmed, 1996	
97-5900-07	Patellofemoral Pain After Total Knee Arthroplasty. Scuderi GR, Insall JN, Scott WN. JAAOS, 1994	\$0.75
97-5973-17	Polyethylene Wear on the Distal Tibial Insert Surface in Total Knee Arthroplasty. Gabriel SM, Dennis DA, Honey MJ, et al. The Knee, Elsevier, 1998	\$1.75
97-5110-07	Prospective Randomized Comparison of Cemented and Uncemented MG II® Replacements Reconstruction of the Knee Joint, pp 250-259, Springer-Verlag, 1997	\$1.50
97-5250-15	Proximal Tibial Osteotomy: A Critical Long-Term Study of 87 Cases. Coventry MB, Ilstrup DM, Wallrichs SL, et al. JBJS, 1993	
97-5970-14	Range of Motion after Total Knee Surgery. Dennis DA, Komistek RD, Stiehl JB, et al. J of Arthro, 1998	\$0.75
97-5220-07	Retention of the Posterior Cruciate in Total Knee Arthroplasty. Andriacchi TP, Galante JO. J of Arthroplasty, 1988	
97-5994-07	Revision Total Knee Arthroplasty: A Surgical Technique. Insall JN, Scuderi GR. Surgical Technology International VIII, 1999	\$1.50
97-5994-15	Revision Total Knee Arthroplasty. Current Rationale and Techniques for Femoral Component Revision. Hoeffel DP, Rubash HE. Clin Orthop Rel Res, 2000	\$2.65
97-5224-15	Revision Total Knee Arthroplasty with Cemented Fixation. Scuderi GR, Insall JN. Techniques Orthop, 1993	\$1.60
97-5973-05	Rigidity of Initial Fixation with Uncemented Tibial Knee Implants. Branson PJ, Steege JW, Wixson RL, et al. J of Arthroplasty, 1989	
97-5791-01	Role of Unicompartmental Knee Arthroplasty. Schwartz TD, Battish R, Latke PA. Seminars in Arthroplasty, 2000	\$0.75
97-5964-13	Squatting Following Total Knee Arthroplasty. Kim J-M, Moon M-S. Clin Orthop Rel Res, 1995	\$1.65
97-5220-11	Substitute the PCL for Long-Term Success with TKA. Scuderi GR, Scott WN. Ortho Today, 1996.	

KNEE SALES SUPPORT MATERIAL

Journal Reprints cont:

Cat. Number	Description	Price
97-5973-07	Surface Characteristics Following Tibial Preparation During Total Knee Arthroplasty. Toksvig-Larsen S, Ryd L. <i>J of Arthroplasty</i> , 1994.	
97-5220-15	Survivorship of Cemented Knee Replacements. Scuderi GR, Insall JN, Windsor RE, et al. <i>JBIS Br</i> , 1989	\$0.40
97-5973-03	Temperature Elevation During Knee Arthroplasty. Toksvig-Larsen S, Ryd L. <i>Acta Orthop Scand</i> , 1989.	
97-5972-06	Tibial Plateau Coverage in Total Knee Arthroplasty. Incavo SJ, Ronchetti PJ, Howe JG, et al. <i>Clin Orthop</i> , 1994.	
97-5220-10	Total Condylar Prosthesis: 10- to 12-Year Results of a Cemented Knee Replacement. Vince KG, Insall JN, Kelly MA. <i>JBIS Br</i> , 1989.	
97-2100-36	Total Knee Replacement in Young, Active Patients. Diduch DR, Insall JN, Scott WN, et al. <i>JBIS</i> , 1997.	
97-5790-07	Unicompartmental Knee Arthroplasty. Berger RA, Nedeff DD, Barden RN, et al. <i>Clin Orthop Rel Res</i> , 1999	\$1.65
97-5250-17	Upper Tibial Osteotomy. Coventry MB. <i>Clin Orthop</i> , 1984.	
97-5110-15	Wear and Deformation of Patella Component in Total Knee Arthroplasty. Hsu HP, Walker PS, <i>Clin Orthop</i> , 1989	\$0.35

Relating to Polyethylene

Cat. Number	Description	Price
97-2100-11	Effect of Polyethylene Quality on Wear in Total Knee Arthroplasty. Tanner MG, Whiteside LA, White SE. <i>Clin Orthop</i> , 1995	\$1.25
97-2100-13	Comparison of Polyethylene Wear in Machined vs Molded Polyethylene. Bankston AB, Keating EM, Ranawat C. et al, <i>Clin Orthop</i> , 1995	
97-2100-58	Polyethylene: Can it be made Better? Li S, Furman BD, Gillis AM, <i>Sem in Arthro</i> , 1998	\$0.90
97-5110-206	Conformity & Polyethylene Damage in Total Knee Replacement. Andriacchi TP, Nataranjan RN. 1997.	
97-5110-15	Wear and Deformation of Patella Component in Total Knee Arthroplasty. Hsu HP, Walker PS. <i>Clin Orthop</i> , 1989	\$0.35
97-5900-06	Correlation Between Fusion Defects and Damage in Tibial Polyethylene Bearings. Wrona M, Mayor MB, Collier JP, et al. <i>Clin Orthop</i> , 1994	\$1.00
97-5973-16	Factors Influencing the Longevity of UHMWPE Tibial Components. Heim CS, Postak PD, Greenwald AS. <i>AAOS</i> 1996	\$0.95

Relating to Trabecular Metal

Cat. Number	Description	Price
97-7255-18•	Biomechanics of Femoral Head Osteonecrosis: Natural History and Head-Preserving Surgical Management. Brown TD, Brand RA, et al, <i>AAOS</i> , 1999	\$1.00
97-7255-16	Characteristics of Bone Ingrowth and Interface Mechanics of a New Porous Tantalum Biomaterials. Bobyn JD, Stackpool GJ, Hacking SA, et al. <i>JBIS, Br.</i> , 1999	\$1.00

Journal Reprints cont:

Cat. Number	Description	Price
97-7255-17	Characterization of a New Porous Tantalum Biomaterial for Reconstructive Orthopaedics. Bobyn JD, Jo Miller Orthopaedic Research Laboratory, 1999	\$3.50
97-7255-19•	Flexural Rigidity of Laboratory and Surgical Substitutes for Human Fibular Bone Grafts. Heiner AD, Poggie RA, Brown TD, <i>Jof Musculoskeletal Res.</i> , 1998	\$2.00
97-7255-15	Tissue Response to Porous Tantalum Acetabular Cups. Bobyn JD, Toh, K-K, Hocking SA, et al. <i>J of Arthroplasty</i> , 1999.	\$8.50
97-7255-14	UHMWPE: The Good, Bad, & Ugly Fixation and Bearing Surfaces for the Next Millennium. Bobyn JD. <i>Orthopedics</i> , 1999.	\$7.75

Technical Whitepapers:

Relating to Knee Products

Cat. Number	Description
97-2100-09	Bone Cut Accuracy and Flatness from Milling and Sawing. Dueringer K, Stalcup G, 1996
97-2000-148	Cobalt-Chromium-Molybdenum Alloy Fiber Metal for <i>MGII®</i> and <i>NexGen®</i> Knees. Shetty R, 1996
97-5110-206	Conformity & Polyethylene Damage in Total Knee Replacement. Andriacchi TP, Nataranjan RN, 1997
97-2100-26	Design and Manufacture Solutions in Total Knee Arthroplasty. Beckman A, 1997
97-2000-147	Dynamic Evaluation of Metal Backed Patella Interface Strength. Gilbertson L, Hodorek R, 1995
97-2100-05	Effect of Material Stiffness on the Function of Cemented Tibial Trays: Ti-6Al-4V versus CoCr Alloy. Levine D, 1995
97-2100-20	Effect of Patellar Thickness on Patellar Tracking and Loading After Total Knee Arthroplasty. Miller MC, Zhang AX, Crossett LS, et al, 1996
97-5972-16	<i>NexGen</i> Total Knee Arthroplasty Design Rationale and Early Clinical Results. Bertin KC, 1996
97-2100-08	Thermal Effects in Bone from Milling and Sawing. Dueringer K, Stalcup G, Lintner P, 1996
97-2000-144	Wear Issues in Knees: Part I: Literature Review and Knee Simulator Study. Shetty R, Laurent M, 1993
97-2000-145	Wear Issues in Knees: Knee Design. Aikins JL, 1995
97-2000-151	Wear Properties of Nitrogen Diffusion Hardened <i>Titanium®</i> Ti-6Al-4V Alloy in <i>MGII</i> Knees. Shetty R, Ottersberg W, 1995

NEXGEN SALES SUPPORT MATERIAL

Technical Whitepapers cont:

Relating to Polyethylene

Cat. Number	Description	Price
97-2100-22	Comparative Aging Behavior of Polyethylene Acetabular Components Extended Chain Versus Surgical Grade. King R, Kirkpatrick L, Devanathan D, 1996	
97-5110-206	Conformity and Polyethylene Damage in Total Knee Replacement	
97-2100-31	UHMWPE Design Considerations. Steffensmeier S, Stalcup G, 1997	
97-2100-25	Zimmer Polyethylene Overview. Gsell R, Johnson T, King R, et al, 1997.	
97-2100-27	Quality Indicators of UHMWPE. Gsell R, King R, Swarts D, 1997	
97-2100-28	Nitrogen Packaging & Gamma-Irradiation Sterilization of UHMWPE. Johnson T, Gsell R, Taylor G, 1997	
97-2100-29	Benefits of Gamma-Radiation Sterilization for UHMWPE Wear. King R, Gsell R, 1997	
97-2100-30	Compression Molding of UHMWPE. Pletcher T, Swarts D, 1997	
97-2000-144	Wear Issues in Knees: Part I: Literature Review and Knee Simulator Study. Shetty R, Laurent M, 1993	
97-2000-145	Wear Issues in Knees: Knee Design. Aikins JL, 1995	
97-2000-143	Wear of Polyethylene in Total Hip Replacement. Gilbertson L, 1995	

P3[®] Practice Assistance Program Materials:

General Program Materials

Cat. Number	Description	Price
97-2100-533	P3 Letterhead Stationery, 8.5x11 (50/pkg)	\$1.75
97-2100-534	P3 Letterhead Stationery, 11x17 (50/pkg)	\$2.00
97-2100-506	P3 Pocket Tips Card	
97-2100-508	P3 Pocket Folder	
97-2100-512	Public Relations Guidebook	\$8.00
97-2100-542	P3 Newsletter Vol. 1, No. 1 (25/pkg)	\$7.50
97-2100-543	P3 Newsletter Vol. 1, No. 2 (25/pkg)	\$7.50
97-2100-544	P3 Newsletter Vol. 1, No. 3 (25/pkg)	\$7.50
97-2100-545	P3 Newsletter Vol. 1, No. 4 (25/pkg)	\$7.50
97-2100-551	P3 Pathways to Success Brochure	
97-2100-548	P3 The Search: Your 1st Job in Orthopaedic Surgery (includes cd)	\$7.00
97-2100-553	P3 Program Sales Presentation CD	

Videos/CDs:

Cat. Number	Description	Price
97-2100-521	Agility & Mobility: An Introduction To Joint Replacement Video	\$6.00
97-2100-514	Biomechanics and Biomaterials CD-ROM	\$5.00
97-2100-520	Patient Education Professional Overview Video	\$6.00
97-2100-538	Polyethylene in Orthopaedics CD-ROM	\$5.00

Patient-Oriented Flyers/Reprints:

Cat. Number	Description	Price
97-2100-511	Hugh Downs Journal Article—Vim & Vigor 1998 (25/pkg)	\$10.00
97-5970-09	Knee Replacement Patient Education Brochure —featuring Hugh Downs (25/pkg)	\$3.25
97-5970-09-01	Knee Replacement Patient Education Brochure—featuring Hugh Downs, Spanish (25/pkg)	\$3.25
97-2100-550	Minimally Invasive Surgery Patient Education for Miller/Galante Uni Knee (25/pkg)	\$3.50
97-2100-554	NexGen LPS-Flex Fixed Knee Patient Brochure (25/pkg)	\$5.00
97-2100-549	No Bones About It: What You Need to Know About Osteoporosis	\$2.70
97-2100-510	OUCH! Managing Pain Caused by Arthritis (25/pkg)	\$4.10
97-2100-510-01	OUCH! Managing Pain Caused by Arthritis, Spanish (25/pkg)	\$4.10
97-2100-509	Questions and Answers About Joint Replacement (25/pkg)	\$2.70
97-2100-509-01	Questions and Answers About Joint Replacement, Spanish (25/pkg)	\$2.70
97-2100-504	Those Achy, Breaky Joints—Exercise & Arthritis (25/pkg)	\$2.95
97-2100-504-01	Those Achy, Breaky Joints—Exercise & Arthritis, Spanish (25/pkg)	\$2.95
97-2100-505	You Are What You Eat—Diet & Arthritis (25/pkg)	\$2.70
97-2100-505-01	You Are What You Eat—Diet & Arthritis, Spanish (25/pkg)	\$2.70
97-2100-503	Understanding Arthritis (25/pkg)	\$3.40
97-2100-503-01	Understanding Arthritis, Spanish (25/pkg)	\$3.40

Patient ID Cards:

Cat. Number	Description	Price
97-2100-541	Miller/Galante Unicompartmental Knee (8 cards/sheet)	\$0.96
97-2100-517	NexGen CR Knee (8 cards/sheet)	\$0.96
97-2100-518	NexGen Legacy LPS Knee (8 cards/sheet)	\$0.96
97-2100-519	NexGen Legacy LCKK Knee (8 cards/sheet)	\$0.96

Case Layouts:

Knee Systems

Cat. Number	Description
97-5791-06	Minimally Invasive Miller/Galante Uni Femoral/Tibial Provisionals
97-5946-07	NexGen LPS-Flex Mobile Articular Surface Provisionals/Instruments
97-5964-06	NexGen LPS-Flex Fluted Stem Mobile Tibial Provisionals/Instruments
97-5976-06	NexGen AC Articular Surface Provisionals
97-5997-07	NexGen EM/IM Tibial Resectors
97-5997-06	NexGen Fluted Stemmed Tibial Instruments/Provisionals
97-5977-06	NexGen General, MICRO-MILL, 5-in-1 Instruments & CR Provisionals
97-5996-06	NexGen Legacy LPS Provisionals
97-5998-06	NexGen Legacy 3°

KNEE SALES SUPPORT MATERIAL

Case Layouts cont:

Cat. Number	Description
□ 97-5988-106	NexGen Sharp Fluted Stem Extensions
□ 97-5981-06	NexGen Stemmed Tibial Instrumentation
□ 97-5988-06	NexGen Tibial Augment & Stem Extension Instruments/Provisionals
□ 97-5967-06	NexGen EPI Instrumentation
□ 97-5973-06	NexGen IM Instrumentation
□ 97-5977-106	NexGen IM Tibial Milling
□ 97-5964-07	NexGen LPS-Flex Fixed Articular Surface Provisionals/Instruments
□ 97-5964-06	NexGen LPS-Flex Femoral Provisionals/Instruments
□ 97-5973-406	NexGen Multi-Reference 4-in-1 Femoral/Tibial
□ 97-5980-06	NexGen PS Provisionals
□ 97-5994-06	NexGen Revision Instrumentation CRA/Legacy LCCK
□ 97-5969-06	NexGen V-Stat Tensor Instrumentation

Relating to Polyethylene

Cat. Number	Description
□ 97-7255-10	Augmentation Patella
□ 97-7255-32	NexGen Primary Porous Patella
□ 97-7255-37	Monoblock Tibial

Knee Product Literature:

General Knee Product Information

Cat. Number	Description	Price
□ 97-5110-209	Femoral Size Conversion Chart	
□ 97-6000-788	Goniometer, w/ Blue Logo, Navy Case w/ White Logo	\$5.00
□ 97-7000-645	Goniometer (12in. size, Ultem; autoclavable)	\$23.00
□ 97-2100-511	Hugh Downs: Joint Replacement Helps a Television Icon Step into an Active Future. Vim & Vigor Magazine Article, 1997 (25/pkg)	\$10.00
□ 97-5968-101	Joint Ruler Surgical Technique/Brochure	
□ 97-5224-03	Rev.1 Revision Knee Arthroplasty: Surgical Guidelines	\$3.00
□ 97-5994-08	Revision Algorithm Matrix Flip Chart	\$2.00
□ 97-5970-09	Total Knee Replacement Patient Education Brochure (w/Hugh Downs comments) (25/pkg)	\$3.25
□ 97-5220-06	When to Use a Posterior Stabilized Prosthesis in a Total Knee Replacement	
□ 97-5120-05	Zimmer Adjustable Tibial Resector Data Sheet	
□ 97-5120-402	Zimmer Adjustable Tibial Resector Surgical Technique	
□ 97-5120-02	Zimmer Patella Reamer Surgical Technique	
□ 97-5973-04	Zimmer Total Knee Sterilization Case Labels (2pp set)	\$3.00

Knee Product Literature cont:

Distinctive Kit Tools

Cat. Number	Description	Price
□ 97-5970-12	Internal/External Rotation Tool Card	\$5.75
□ 97-5972-12	NexGen Anatomically-Rotated Articulating Surface Tool Card	\$10.00
□ 97-5970-19	NexGen Cam/Spine Hologram w/Rockers	\$5.00
□ 97-5964-12	NexGen LPS-Flex Design Considerations Tool Card	\$1.50
□ 97-5970-10	NexGen Offset Stem Demo Card	\$7.00
□ 97-5970-05	NexGen Range-of-Motion Tool Card	\$10.50
□ 97-5994-08	Revision Algorithm Matrix Flip Chart	\$2.00

Insall/Burstein®† II Total Knee System

Cat. Number	Description
□ 97-5220-101	Rev.5 Insall/Burstein II System Brochure
□ 97-5220-103	Rev.1 Insall/Burstein II System Insert
□ 97-5224-102	Rev.1 Insall/Burstein II CCK Surgical Technique
□ 97-5220-102	Rev.2 Insall/Burstein II PS Surgical Technique
□ 97-5226-102	Insall/Burstein II System Revision Surgical Technique
□ 97-6000-46	Insall/Burstein II PS Instrumentation Order Form
□ 97-7000-192	Insall/Burstein II System Implant & Provisional Order Form (40 sheets/pad)

†Insall/Burstein® Total Knee System is a trademark of The Hospital for Special Surgery

MG II® Total Knee System

Cat. Number	Description
□ 97-5110-301	Rev.2 MG II System Brochure
□ 97-5110-303	Rev.1 MG II System Brochure Insert
□ 97-5110-202	Rev.4 MG II System Surgical Technique
□ 97-5110-109	Rev.1 MG II System Wall Chart
□ 97-6000-49	MG II System Instrument Order Form

M/G™ Unicompartmental Knee System

Cat. Number	Description
□ 97-5780-02	Rev. 2 Miller/Galante Primary Knee Surgical Technique
□ 97-5790-101	Rev. 1 Miller/Galante Unicompartmental Knee Brochure
□ 97-5790-102	Miller/Galante Unicompartmental Knee Surgical Technique
□ 97-5791-02	M/G Unicompartmental Knee Surgical Technique
□ 97-5790-03	M/G Unicompartmental Knee Implant & Instrumentation Order Form
□ 97-5791-06	Minimally Invasive M/G Uni Femoral/Tibial Provisional Case Layouts
□ 97-5791-08	Rev.1 Minimally Invasive EM/IM Brochure for the M/G Unicompartmental Knee
□ 97-5791-05	Minimally Invasive EM Surgical Technique for M/G Unicompartmental Knee

KNEE SALES SUPPORT MATERIAL

Knee Product Literature cont:

Cat. Number	Description	Price
□ 97-5791-09	Minimally Invasive EM Technique Wall Chart for M/G Unicompartmental Knee (5/pkg)	\$9.50
□ 97-5791-03	Minimally Invasive IM Technique/Brochure for M/G Unicompartmental Knee	
□ 97-5791-04	Minimally Invasive IM Technique Wall Chart for M/G Unicompartmental Knee (5/pkg)	\$9.50
□ 97-2100-550	Minimally Invasive Patient Education for M/G Unicompartmental Knee(25/pkg)	\$3.50

Mobile Bearing Knee Systems

Cat. Number	Description
□ 97-5946-01	Zimmer Mobile Bearing Knee Systems Brochure (includes LPS-Flex Mobile, LPS Mobile, LCCK Mobile, and MBK Knees)

MBK® Mobile Bearing Knee Systems

Cat. Number	Description	Price
□ 97-5940-101	MBK System Brochure	
□ 97-5944-102	MBK System EPI Surgical Technique	
□ 97-5942-102	MBK System IM Surgical Technique	
□ 97-5940-102	MBK System MICRO-MILL Surgical Technique	
□ 97-5940-03	MBK System Implant and Instrumentation Order Form	
□ 97-5940-09	Rev.1 MBK System Size Interchangeability Chart	\$1.00

NexGen LPS-Flex Mobile Knee System*

Cat. Number	Description	Price
□ 97-5946-02	Rev.1 NexGen LPS-Flex Mobile Bearing Knee Surgical Technique	
□ 97-5946-08	NexGen LPS-Flex Mobile Alphanumeric Code Chart	\$0.40
□ 97-5946-07	NexGen LPS-Flex Mobile Articular Surface Provisional/Instrument Case Layout	
□ 97-5946-06	NexGen LPS-Flex Fluted Stem Mobile Tibial Provisional/Instrument Case Layout	
□ 97-5964-01	NexGen LPS-Flex Systems Brochure	
□ 97-5964-03	NexGen LPS-Flex Systems Design Rationale	\$1.25

NexGen Complete Knee Solution

Cat. Number	Description	Price
□ 97-5970-07	NexGen System Color-Code Exercises	
□ 97-5972-103	NexGen System Design Rationale	\$10.00
□ 97-5972-113	NexGen System Design Rationale Reference Article Summaries	
□ 97-5972-205	NexGen System Implant Brochure	
□ 97-5972-104	NexGen System Instrumentation Brochure	
□ 97-5972-109	NexGen System Product Profiler	

Knee Product Literature cont:

Cat. Number	Description	Price
□ 97-5972-509*	NexGen System Product Profiler, International Version	
□ 97-5980-17	NexGen System Sales Planning Worksheet (50/pad)	
□ 97-5970-08	NexGen System Template Portfolio Label (to be inserted into Template Portfolio—97-2100-23)	
□ 97-5976-06	NexGen AC Articular Surface Provisional Case Layouts	
□ 97-5970-202	NexGen CR/CRA Surgical Technique	
□ 97-5997-02	NexGen EM/IM Tibial Resector Surgical Technique	
□ 97-5997-07	NexGen EM/IM Tibial Resector Case Layouts	
□ 97-5997-06	NexGen Fluted Stemmed Tibial Instrument/Provisional Case Layout	
□ 97-5977-06	NexGen General, MICRO-MILL, 5-in-1 Instruments, & CR Provisionals Case Layouts	
□ 97-5970-169	NexGen Legacy LPS & Legacy LCCK Color Key Chart for Articulating Surfaces & Patellas	\$0.50
□ 97-5996-06	NexGen Legacy LPS Provisional Case Layouts	
□ 97-5998-06	NexGen Legacy 3-degree Case Layouts	
□ 97-5970-168	NexGen PS & CR/CRA Color Key Chart for Articulating Surfaces & Patellas	\$0.50
○ 97-5988-106	NexGen Sharp Fluted Stem Extension Case Layout	
○ 97-5981-06	NexGen Stemmed Tibial Instrumentation Case Layout	
○ 97-5988-06	NexGen Tibial Augment & Stem Extension Instrument/Provisionals Case Layout	
○ 97-5988-102	Rev.1 NexGen Tibial Stemmed & Augmented Surgical Technique	
○ 97-5967-06	NexGen EPI Instrumentation Case Layouts	
○ 97-5967-102	NexGen EPI Instrumentation Surgical Technique for use with CR & Legacy LPS—Detailed	
○ 97-5967-103	NexGen EPI Instrumentation Surgical Technique for use with CR & Legacy LPS—Abbreviated	
○ 97-5967-30*	NexGen EPI Instrumentation Self-Study Guide	
○ 97-5973-06	NexGen IM Instrumentation Case Layouts	
○ 97-5973-102	Rev.1 NexGen IM Instrumentation Surgical Technique for use with CR & Legacy LPS—Detailed	
○ 97-5973-103	NexGen IM Instrumentation Surgical Technique for use with CR & Legacy LPS—Abbreviated	
○ 97-5973-30*	NexGen IM Instrumentation Self-Study Guide	
○ 97-5977-106	NexGen IM Tibial Milling Case Layouts	
○ 97-5977-102	NexGen IM Tibial Milling Surgical Technique	
○ 97-2100-554	NexGen LPS-Flex Fixed Patient Brochures (25/pkg)	\$5.00
○ 97-5964-101	NexGen LPS-Flex Fixed Systems Brochure	
○ 97-5964-103***	NexGen LPS-Flex Fixed Systems Design Rationale	\$1.25
○ 97-5964-02	NexGen LPS-Flex Fixed Bearing Knee Surgical Technique	

***Items on hold

KNEE SALES SUPPORT MATERIAL

Knee Product Literature cont:

Cat. Number	Description	Price
□ 97-5964-08	NexGen LPS-Flex Fixed Alphanumeric Code Chart	\$0.40
□ 97-5964-07	NexGen LPS-Flex Fixed Articular Surface Provisional/Instrument Case Layout	
□ 97-5964-06	NexGen LPS-Flex Fixed Femoral Provisional/Instrument Case Layout	
□ 97-5996-02	NexGen Legacy LPS Surgical Technique	
□ 97-5970-102	Rev.1 NexGen MICRO-MILL & 5-in-1 Instrumentation Surgical Technique for use with CR—Detailed	
□ 97-5980-102	NexGen MICRO-MILL & 5-in-1 Instrumentation Surgical Technique for use with Legacy LPS—Detailed	
□ 97-5970-103	NexGen MICRO-MILL & 5-in-1 Instrumentation Surgical Technique for use with CR & Legacy LPS—Abbreviated	
□ 97-5977-30*	NexGen MICRO-MILL & 5-in-1 Instrumentation Self-Study Guide	
□ 97-5973-406	Rev.1 NexGen Multi-Reference 4-in-1 Femoral/Tibial Case Layouts	
□ 97-5973-402	Rev.1 NexGen Multi-Reference 4-in-1 Surgical Technique for use with CR & Legacy LPS—Detailed	
□ 97-5973-403	Rev.1 NexGen Multi-Reference 4-in-1 Surgical Technique for use with CR & Legacy LPS—Abbreviated	
□ 97-5250-101	Rev.1 NexGen OS System Brochure	
□ 97-5250-102	Rev.2 NexGen OS Surgical Technique	
□ 97-5980-101	Rev.1 NexGen PS Brochure	
□ 97-5980-06	NexGen PS Provisionals Case Layouts	
□ 97-5976-07	NexGen Revision CRA Surgical Case Studies by Dr. K Bertin	
□ 97-5994-06	Rev.1 NexGen Revision Instrumentation CRA/Legacy LCKK Case Layout	
□ 97-5976-102	Rev.1 NexGen Revision Instrumentation Surgical Technique for use with CRA	
□ 97-5994-202	NexGen Revision Instrumentation Surgical Technique for use with Legacy LCKK	
□ 97-5880-01	NexGen RHK System Brochure	
□ 97-5880-02	NexGen RHK System Surgical Technique	
□ 97-5880-03	NexGen RHK System Design Rationale	\$1.50
□ 97-5880-06	NexGen RHK System Instrumentation/Provisionals Case layouts	
□ 97-5880-08	NexGen RHK System Sizing Wallchart	
□ 97-5880-09	NexGen RHK System Pocket Reference Guide	
□ 97-5969-09	NexGen V-STAT Tensor Flexion/Extension Alignment Chart (crack-n-peel)	
□ 97-5969-06	NexGen V-STAT Tensor Instrumentation Case Layout	
□ 97-5969-102	NexGen V-STAT Tensor Instrumentation Surgical Technique	
□ 97-5969-08	NexGen V-STAT Tensor Slide Ruler/Reference Guide	\$2.25

Knee Product Literature cont:

Polyethylene		
Cat. Number	Description	Price
□ 97-6305-01	Longevity® Crosslinked Polyethylene Brochure	
□ 97-6305-03	Longevity Crosslinked Polyethylene Puzzle	\$5.25
□ 97-6305-08	Longevity Crosslinked Polyethylene Design Rationale	\$1.50
□ 97-5952-01	Prolong Highly Crosslinked Polyethylene Brochure	
□ 97-5952-08	Prolong Highly Crosslinked Polyethylene Design Rationale	\$1.50
□ 97-2100-32	Zimmer 5-Point Polyethylene Brochure	
□ 97-2100-33	Rev.1 Zimmer 5-Point Polyethylene Design Rationale	\$1.75

Trabecular Metal Literature:

General		
Cat. Number	Description	
□ 97-7255-13 ^Δ	Presentation Folder	
□ 97-7255-01 ^Δ	Technology Overview Brochure	
Knee Systems		
Cat. Number	Description	
□ 97-7255-05 ^Δ	Augmentation Patella Data Sheet	
□ 97-7255-04 ^Δ	Augmentation Patella Surgical Technique	
□ 97-7255-10 ^Δ	Augmentation Patella Case Layouts	
□ 97-7255-37 ^Δ	Monoblock Tibial Case Layouts	
□ 97-7255-33 ^Δ	NexGen CR & Legacy LPS Trabecular Metal Monoblock Tibia Brochure	
□ 97-7255-34 ^Δ	NexGen CR & Legacy LPS Trabecular Metal Monoblock Tibia Surgical Technique	
□ 97-7255-32 ^Δ	NexGen Primary Porous Patella Case Layouts	
□ 97-7255-11 ^Δ	NexGen Primary Porous Patella Data Sheet	
□ 97-7255-12 ^Δ	NexGen Primary Porous Patella Surgical Technique	

Knee Templates

Cat. Number	Description	Price
□ 97-2100-23	Template Portfolio (to be ordered with appropriate label insert)	\$7.75
□ 97-5970-08	NexGen Knee Template Portfolio Label (to be inserted into Template Portfolio)	
□ 97-6000-209	X-Ray Template Envelopes (pkg of 25)	\$3.75

^ΔManufactured by Implex Corp.

KNEE SALES SUPPORT MATERIAL

Knee Templates cont:

Insall/Burstein II Knee Templates

Cat. Number	Description	Price
97-5224-50	Insall/Burstein II CCK Femoral (59,64,69 mm)	\$1.00
97-5224-51	Insall/Burstein II CCK Femoral Line Extension (54 mm/74 mm)	\$1.00
97-5220-50	Insall/Burstein II PS Femoral (54,59,64 mm)	\$1.00
97-5220-51	Insall/Burstein II PS Femoral (69,74 mm)	\$1.00
97-5220-52	Insall/Burstein II PS Tibial Tray (54 mm)	\$1.00
97-5220-53	Insall/Burstein II PS Tibial Tray (59 mm)	\$1.00
97-5220-54	Insall/Burstein II PS Tibial Tray (64 mm)	\$1.00
97-5220-55	Insall/Burstein II PS Tibial Tray (69 mm)	\$1.00
97-5220-56	Insall/Burstein II PS Tibial Tray (74 mm)	\$1.00
97-5220-57	Insall/Burstein II Knee Curved Stem Extensions	\$1.00
97-5220-58	Insall/Burstein II All-Poly Tibial (54 mm)	\$1.00
97-5220-59	Insall/Burstein II All-Poly Tibial (59 mm)	\$1.00
97-5220-60	Insall/Burstein II All-Poly Tibial (64 mm)	\$1.00
97-5220-61	Insall/Burstein II All-Poly Tibial (69 mm)	\$1.00
97-5220-62	Insall/Burstein II All-Poly Tibial (74 mm)	\$1.00

MG II Knee System Templates

Cat. Number	Description	Price
97-5116-01	MG II All-Poly Tibial, C Yellow	\$1.00
97-5116-02	MG II All-Poly Tibial, D Yellow	\$1.00
97-5116-03	MG II All-Poly Tibial, E Green	\$1.00
97-5116-04	MG II All-Poly Tibial, F Green	\$1.00
97-5116-05	MG II All-Poly Tibial, G Blue	\$1.00
97-5116-06	MG II All-Poly Tibial, H Blue	\$1.00
97-5110-50	MG II Knee Femoral (1, 2 Micro)	\$1.00
97-5110-51	MG II Knee Femoral (3, 4)	\$1.00
97-5110-52	MG II Knee Femoral (5, 6)	\$1.00
97-5110-53	MG II Knee Femoral (7, 8)	\$1.00
97-5110-54	MG II Knee Tibial (A, B Micro)	\$1.00
97-5110-55	MG II Knee Tibial (C, D, E)	\$1.00
97-5110-56	MG II Knee Tibial (F, G, H)	\$1.00
97-5110-57	MG II Knee Tibial (I, K)	\$1.00
97-5110-58	MG II Porous Augmented Tibial (B+)	\$1.00
97-5110-59	MG II Porous Augmented Tibial (D+)	\$1.00
97-5110-60	MG II Porous Augmented Tibial (E+)	\$1.00
97-5110-61	MG II Porous Augmented Tibial (F+)	\$1.00
97-5110-62	MG II Porous Augmented Tibial (H+)	\$1.00

Templates:

Miller/Galante Knee System Templates

Cat. Number	Description	Price
97-5782-51	Miller/Galante Stemmed Tibial—Sizes A, B, C (Set of 3)	\$3.00
97-5790-50	Miller/Galante Uni Femorals	\$1.00
97-5790-51	Miller/Galante Uni Tibials	\$1.00

MBK Mobile Bearing Knee Templates*

Cat. Number	Description	Price
97-5940-50*	MBK Femoral Set—Sizes c/d, e/f, g (Set of 3)	\$3.00
97-5940-55*	MBK Tibial Set—Sizes 3-8 (Set of 3)	\$3.00
97-5940-51*	MBK Femoral/Tibial Micro—Sizes 1,2,B (Set of 2)	\$3.00

NexGen Knee System Template Sets

Cat. Number	Description	Price
97-5988-50	NexGen A/P Wedge Tibial Set—Sizes 3-8 (Set of 6)	\$6.00
97-5970-50	NexGen CR Knee Femoral Set—Sizes A-H (Set of 4)	\$3.00
97-5976-50	NexGen CRA Femoral Set—Sizes B-G (Set of 6)	\$6.00
97-5994-50	NexGen LCCK Femoral Set—Sizes C-G (Set of 5)	\$3.00
97-5996-50	NexGen LPS Femoral Set—Sizes A-H (Set of 4)	\$3.00
97-5964-50	NexGen LPS-Flex Femoral Set—Sizes A-G (Set of 4)	\$3.00
97-5998-55	NexGen Legacy 3° Fluted Metal Tibial and Stem Extensions (Set of 8)	\$13.50
97-5998-56	NexGen Legacy 3° Fluted Metal Tibial Augments (Set of 2)	\$7.00
97-5980-50	NexGen PS Femoral—Sizes A & B	\$1.00
97-5980-51	NexGen PS Femoral—Sizes C & D	\$1.00
97-5980-52	NexGen PS Femoral—Sizes E & F	\$1.00
97-5980-53	NexGen PS Femoral—Sizes G & H	\$1.00
97-5988-53	NexGen Curved, Tapered Stem Extension (11mm, 13mm, 15mm x 152mm)	\$1.50
97-5988-54	NexGen Extra Long Straight Stem Extension (12/24mmx200mm)	\$1.50
97-5996-55	NexGen Fluted Stem Tibial Plate Set—Sizes 1-10 (Set of 10)	\$10.00
97-5946-50*	NexGen Fluted Stem Mobile Tibial Component Set—Sizes 1-8 (Set of 4)	\$3.00
97-5988-51	NexGen Offset Stem Extension	\$1.50
97-5988-52	NexGen Sharp Fluted Stem Extension Template	\$1.00
97-5970-55	NexGen Stemmed Tibial Plate, Wedge, and Stem Set—Sizes 1-10 (Set of 10)	\$7.00
97-5970-66	NexGen Stemmed Tibial Plate Augmented Set—Sizes 2-9 (Set of 3)	\$3.50
97-5880-51	NexGen RHK Femoral Set—Sizes C-F (Set of 4)	TBD
97-5880-50	NexGen RHK Tibial Set—Sizes 2-6 (Set of 5)	TBD

Knee Templates—Other

97-5785-50	Zimmer Intramedullary Instrumentation (angle of correction)	\$3.00
------------	---	--------

*Available outside the U.S. only

KNEE SALES SUPPORT MATERIAL

CD-ROMs:

Cat. Number	Description	Price
97-5970-104	NexGen Knee Surgical Techniques for Cruciate Retaining and Legacy Posterior Stabilized Knees CD-ROM (PC & Mac Cross-platform)—Featuring MICRO-MILL Instrumentation (Milling option), MICRO-MILL Instrumentation (5-in-1 Saw blade option), Multi-Reference 4-in-1 Femoral Instrumentation, Intramedullary Instrumentation, V-STAT Variable Soft Tissue Alignment Tensor, and Patella Instrumentation	\$5.00
97-2100-514	Biomechanics and Biomaterials CD-ROM	\$3.00
97-2100-540	Calcium Phosphate Ceramic Coating of Titanium Fiber Metal Implants CD-ROM	\$5.00
97-2555-23	Perioperative Autotransfusion for Total Joint Replacement. Dearborn J. CD-ROM	\$3.00
97-2100-538	Polyethylene in Orthopaedics CD-ROM	\$5.00
97-2227-23	Stayfuse™ Interdigital Fusion Presentation CD-ROM	\$3.00

Stayfuse™ is a trademark of Pioneer Surgical Technologies

DVDs:

Cat. Number	Description	Price
97-7255-23	Augmentation Patella Surgical Technique DVD	\$2.00
97-8106-123	Coonrad/Morrey Surgical Technique DVD	\$2.00
97-5791-27	MIS EM Surgical Approach for the M/G Unicompartamental Knee	\$2.00

Videos:

Note: All videos available in VHS format unless otherwise noted. Can duplicate to other formats upon request through video department; pricing varies.

General Information Videos

Cat. Number	Description	Price
97-2100-521	Agility & Mobility: An Introduction to Joint Replacement Video	\$6.00
97-2100-51	Biomechanics of the Fracture Union Kit (Includes Self-Study Guide)	\$6.00
97-2100-35	Introduction to the Zimmer Mobile Learning Center (MLC)	\$6.00
97-2100-520	Patient Education Professional Overview Video	\$6.00
97-2100-50	Proximal Femur Fractures Class. & Trmt. Opt. (Incl. Self-Study Guide)	\$6.00
97-2100-49	X-Ray Interpretation of the Pelvis and Knee Kit (Incl. Self-Study Guide)	\$6.00

Videos cont:

Knee Product Videos

Cat. Number	Description	Price
97-7255-21	Augmentation Patella Surgical Technique	\$6.00
97-5224-21	Insall/Burstein II CCK System Surgical Technique	\$6.00
97-5220-21	Insall/Burstein II PS Knee System Technique	\$6.00
97-2000-130	Insall/Burstein II PS Knee Primary Surgical Technique	\$6.00
97-5226-21	Insall/Burstein II CCK Intramedullary Revision Surgical Technique	\$6.00
97-5940-21	MBK Mobile Bearing Knee Overview	\$6.00
97-5780-21	Miller/Galante Total Knee System Overview	\$6.00
97-5790-21	Miller/Galante Uni Knee System Surgical Technique	\$6.00
97-5791-21	Minimally Invasive IM Technique for the Miller/Galante Unicompartamental Knee	\$6.00
97-5791-26	Minimally Invasive EM Technique for the Miller/Galante Unicompartamental Knee	\$6.00
97-5967-21	NexGen EPI Instrumentation Surgical Technique for use with Legacy LPS	\$6.00
97-5967-20*	NexGen EPI Instrumentation Surgical Technique In-Service Kit for use with CR & Legacy LPS (Kit includes—videos: 97-5967-21, 97-5967-22; support materials: 97-5967-30, 97-5972-07, 97-5972-08, 97-5970-68, 97-5970-69, 97-5972-04, 97-5972-05, 97-5967-102, 97-5967-06, 97-5977-06, 97-5980-06, 97-5988-06, 97-5981-06, 97-5996-06)	\$18.00
97-5967-23	NexGen EPI Instrumentation Surgical Technique In-Service Kit for use with CR & Legacy LPS—PAL (Kit includes—see listing above)	\$18.00
97-5967-24	NexGen EPI Instrumentation Surgical Technique In-Service Kit for use with CR & Legacy LPS—SECAM (Kit includes—see listing above)	\$18.00
97-5973-21	NexGen IM Instrumentation Surgical Technique for use with CR	\$6.00
97-5973-20*	NexGen IM Instrumentation In-Service Kit for use with CR & Legacy LPS—VHS (Kit includes—videos: 97-5973-22, 97-5973-21; support materials: 97-5970-68, 97-5972-04, 97-5972-05, 97-5973-102, 97-5973-30, 97-5972-07, 97-5972-08, 97-5981-06, 97-5988-06, 97-5973-06, 97-5977-06, 97-5980-06, 97-5976-06)	\$18.00
97-5973-23	NexGen IM Instrumentation In-Service Kit for use with CR & Legacy LPS—PAL (Kit includes—see listing above)	\$18.00
97-5973-24	NexGen IM Instrumentation In-Service Kit for use with CR & Legacy LPS—SECAM (Kit includes—see listing above)	\$18.00
97-5964-21	NexGen Legacy LPS-Flex Fixed Surgical Technique	\$6.00
97-5946-21*	NexGen Legacy LPS-Flex Mobile Bearing Knee Surgical Technique	\$6.00
97-5970-21	NexGen MICRO-MILL Instrumentation Surgical Technique for use with CR	\$6.00
97-5980-21	NexGen MICRO-MILL Instrumentation Surgical Technique for use with Legacy LPS	\$6.00

KNEE SALES SUPPORT MATERIAL

Videos cont:

Cat. Number	Description	
97-5970-20*	NexGen MICRO-MILL Instrumentation In-Service Kit for use with CR & Legacy LPS—VHS (Kit includes—videos: 97-5970-22, 97-5970-21; support materials: 97-5970-68, 97-5970-102, 97-5980-102, 97-5977-30, 97-5972-04, 97-5972-05, 97-5972-07, 97-5972-08, 97-5977-06, 97-5977-106, 97-5976-06, 97-5980-06, 97-5981-06, 97-5988-06)	\$25.00
97-5970-23	NexGen MICRO-MILL Instrumentation In-Service Kit for use with CR & Legacy LPS—PAL(Kit includes—see listing above)	\$25.00
97-5970-24	NexGen MICRO-MILL Instrumentation In-Service Kit for use with CR & Legacy LPS—SECAM (Kit includes—see listing above)	\$25.00
97-5973-421	NexGen Multi-Reference 4-in-1 Surgical Technique for use with CR & Legacy LPS	\$6.00
97-5250-21	NexGen OS Surgical Technique	\$6.00
97-5969-21	NexGen V-STAT Tensor Surgical Technique	\$6.00
97-2000-128	Revision Total Knee Arthroplasty Surgical Technique	\$6.00
97-5785-121	Zimmer IM Knee Instrumentation Surgical Technique	\$6.00
97-5120-21	Zimmer Patella Reamer Surgical Technique	\$6.00

Promotional Merchandise:

Models/Plastic Samples

NexGen Knee System Models/Plastics

Cat. Number	Description	
97-5970-347	Anatomically Correct Knee Model w/Display Stand	\$50.00
97-5791-350	Miller/Galante Unicompartmental Knee Model w/ Display Stand	\$100.00
97-5970-346	NexGen System Knee Model/Sawbones Display Stand	\$15.00
97-5970-349	NexGen CR Knee Model w/Stand	\$100.00
97-5970-353	NexGen CR Size D Femoral Chrome Finish Plastic	\$11.00
97-5970-357	NexGen CR Regular Articulating Surface Plastic	\$5.50
97-5970-355**	NexGen CRA Size D Femoral Plastic	\$5.00
97-5964-350	NexGen Flex Knee Model w/ Display Stand	\$100.00
97-5970-344	NexGen Legacy LPS Knee Model w/Stand	\$100.00
97-5970-374	NexGen Legacy LPS Size D Femoral Chrome Finish Plastic	\$11.00
97-5970-375	NexGen Legacy LPS Articular Surface Plastic	\$5.50
97-5970-356	NexGen Legacy LCCK Size D Femoral Chrome Finish Plastic	\$11.00
97-5970-360**	NexGen Legacy LCCK Articular Surface Plastic	\$5.50
97-5970-383	NexGen Legacy LPS-Flex Size D Femoral Chrome Finish with Articulating Surface Plastic	\$10.00
97-5970-354**	NexGen PS Size D Femoral Plastic	\$10.00
97-5970-359**	NexGen PS Articular Surface Plastic	\$5.50
97-5970-361	NexGen Pegged Tibial Plate Chrome Finish Plastic, Size 4	\$9.00
97-5970-362	NexGen Stemmed Tibial Plate Chrome Finish Plastic, Size 4	\$9.00
97-5970-372**	NexGen 11mm Offset Stem Extension Chrome Finish Plastic	\$4.50
97-5970-373	NexGen 35mm All-Poly Patella Plastic	\$3.00
97-5791-349	X-ray Bag, w/ M.I.S. Embroidered Logo, white papers and template included	\$58.00



zimmer
Confidence in your hands®