











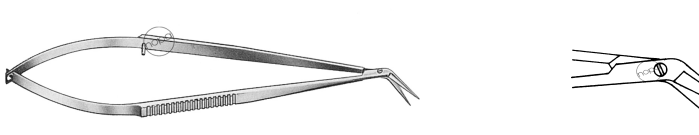
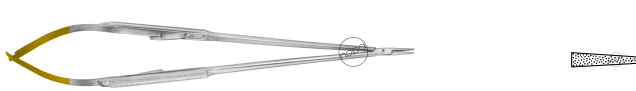

Pos.	Cat.-no.	Quantity	Description
1	AC 870/04	4,00	MICRO SCISSORS 18,0 CM, 90°
			
2	AC 870/05	4,00	MICRO SCISSORS 18,0 CM, 125°
			
3	AC 870/02	4,00	MICRO SCISSORS 18,0 CM, 45°
			
4	KS 082/21	2,00	DIAMOND NEEDLE HOLDER, STRAIGHT, 21,0 CM
			
5	KS 080/23	2,00	DIAMOND NEEDLE HOLDER, STRAIGHT, 23,0 CM
			

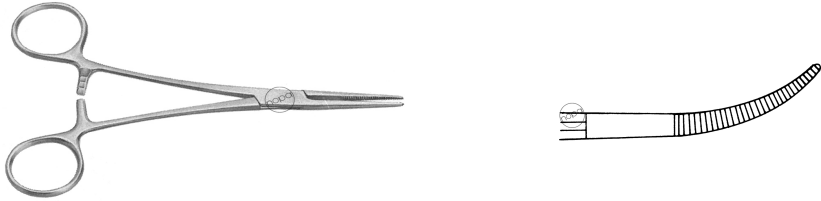
Pos.	Cat.-no.	Quantity	Description
6	AA 157/18	5,00	HALSTED ARTERY FCPS.CVD 18.0 CM
			
7	AA 320/02	5,00	HEISS FORCEPS SLIGHTLY CVD 20.0CM
			
8	AA 173/16	60,00	KELLY-RANKIN ARTERY FORCEPS CVD 16,0 CM
			
9	AA 177/14	40,00	COLLER FORCEPS CURVED 14.0 CM
			
10	AA 200/16	60,00	ROCHESTER-PEAN ARTERY FCPS STR 16.0 CM
			

Pos.	Cat.-no.	Quantity	Description
11	KA 273/17	4,00	WIRE FORCEPS 17,0 CM TUC
			
12	AE 552/18	4,00	WIRE TWISTING FORCEPS TUC 18.5 CM
			
13	KK 489/25	3,00	DE BAKEY ATRAUMA-KLEMME 25,0CM
			
14	AC 247/17	10,00	TOENNIS-ADSON DISS.SCS CVD 17.5.CM
			
15	AC 971/28	2,00	METZENBAUM-DELICATE SCS TUC CVD BL28.0CM
			

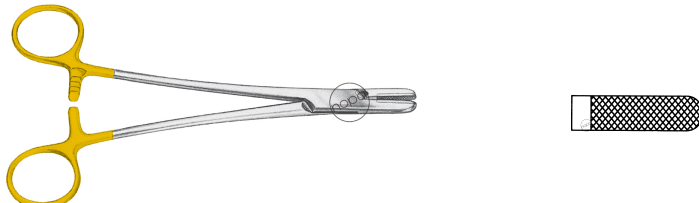
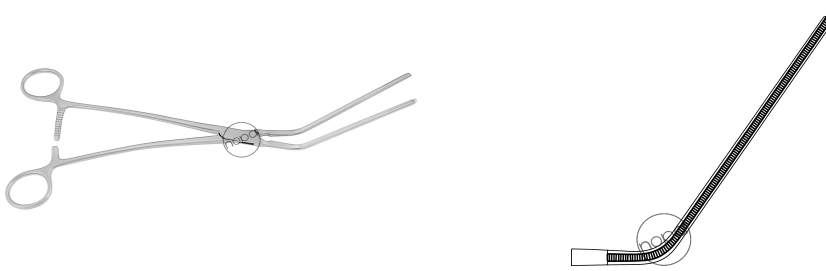
Pos.	Cat.-no.	Quantity	Description
16	AK 565/16	2,00	CONE RETRACTOR BLUNT 16.5 CM



17	XK 556/03	11,00	L-HOOK ELECTRODE W/O SUCTION,5MM,32,0 CM
----	-----------	-------	--

18	XK 556/50	11,00	HANDLE
----	-----------	-------	--------



19	XP 722/93	32,00	LAPAROSCOPES, 10MM, 30°, AUTOCLAVABLE
----	-----------	-------	---------------------------------------

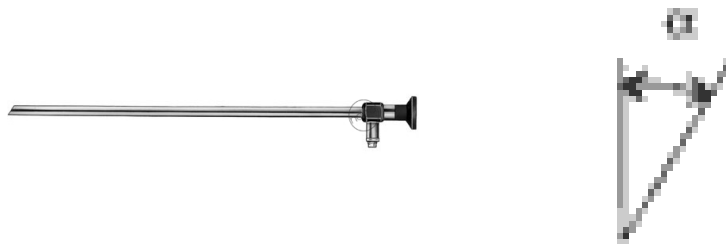

20	XM 1153/45K	32,00	ENDO-SCISSORS, CURVED, 450MM
----	-------------	-------	------------------------------



Pos.	Cat.-no.	Quantity	Description
21	XK 556/03	32,00	L-HOOK ELECTRODE W/O SUCTION,5MM,32,0 CM

22	XK 662/05	26,00	SUCTION/IRRIGATION TUBE, 5MM
----	-----------	-------	------------------------------



23	XK 662/01	26,00	HANDLE WITH 2 TRUMPET VALVES, 10MM
----	-----------	-------	------------------------------------

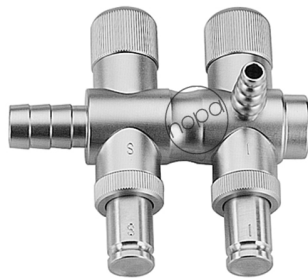







24	XK 657/09	15,00	NEEDLE Ø1,4MM
----	-----------	-------	---------------





25	XP 701/40	5,00	OPTIC F. ARTHROSCOPY/SINUSCOPY 4,0MM 0°
----	-----------	------	---

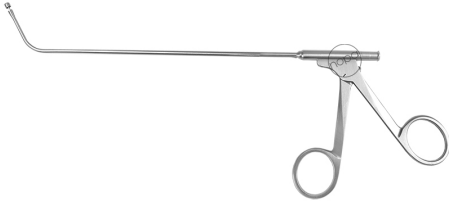

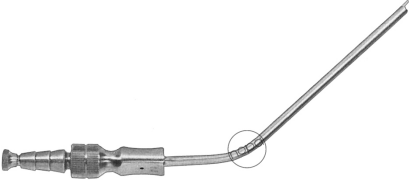
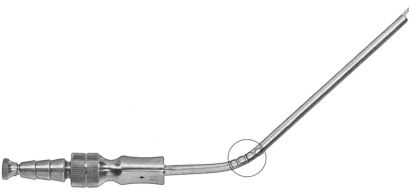



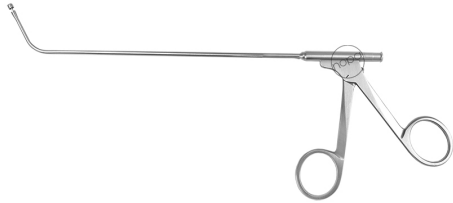
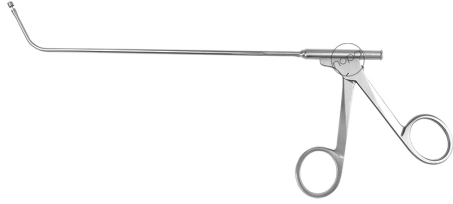
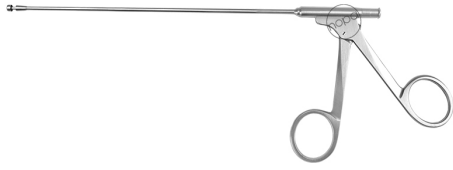

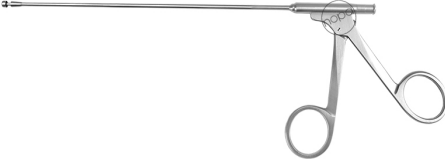

Pos.	Cat.-no.	Quantity	Description
26	XP 701/45	5,00	OPTIC F. ARTHROSCOPY/SINUSCOPY 4,0MM 45°
			
27	XP 701/47	5,00	OPTIC F. ARTHROSCOPY/SINUSCOPY 4,0MM 70°
			
28	KO 171/03	4,00	WEIL-BLAKESLEY SINUSCOPY FCPS 3,5MM 0°
			
29	KA 702/19	5,00	FREER SEPTUM ELEVATOR BLUNT 19,0 CM
			
30	KO 492/55	3,00	KUHN BOLGER ANTRUM CURETTE, 55°
			

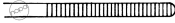
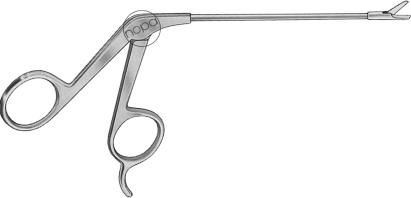
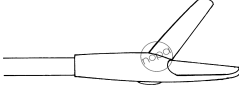
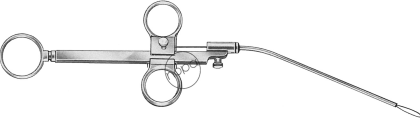
Pos.	Cat.-no.	Quantity	Description
31	KO 177/03	4,00	CIRCULAR PUNCH, FULL 360° BITE, Ø 3.5 MM,
			
32	AO 436/03	5,00	EICKEN-KILLIAN SUCTION TUBE, 13,0 CM,
			
33	AO 436/04	4,00	EICKEN-KILLIAN SUCTION TUBE,
			
34	AO 430/06	4,00	FRAZIER SUCTION TUBE CHARR 6/WL 9 CM
			
35	AO 430/08	4,00	FRAZIER SUCTION TUBE CHARR 8/ WL 9 CM
			

Pos.	Cat.-no.	Quantity	Description
36	KO 492/90	2,00	KUHN BOLGER ANTRUM CURETTE, 90° 
37	KO 483/21	3,00	MACKAY ANTRUM CURETTE, 5.0X2.5 MM, 
38	KO 177/04	3,00	CIRCULAR PUNCH, FULL 360° BITE, Ø 4.5 MM, 
39	KO 177/03	4,00	CIRCULAR PUNCH, FULL 360° BITE, Ø 3.5 MM, 
40	KO 177/02	4,00	CIRCULAR PUNCH, FULL 360° BITE, Ø 4.5 MM, 

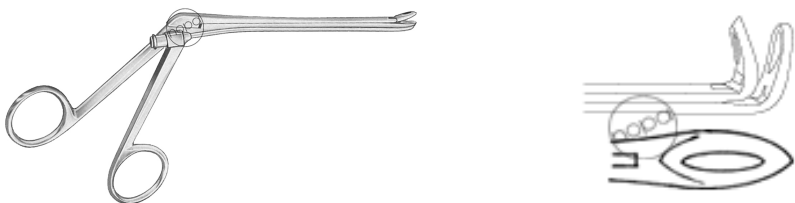

Pos.	Cat.-no.	Quantity	Description
41	KO 177/01	4,00	CIRCULAR PUNCH, FULL 360° BITE, Ø 3.5 MM,
			
42	KO 489/21	2,00	MACKAY SICKLE KNIFE, STRAIGHT, 21.0 CM
			
43	AB 690/20	5,00	GRUENWALD NASAL TAMPON FORCEPS 20,0 CM
 			
44	KO 180/01	2,00	SINUSCOPY SCISSOR SMOOTH 12CM STRAIGHT
 			
45	KO 100/00	3,00	KRAUSE NASAL SNARE WITH 1 TIP
			

Pos.	Cat.-no.	Quantity	Description
46	KO 171/08	3,00	WEIL-BLAKESLEY SINUSCOPY FCPS 3,5MM 45°
			
47	KO 170/23	3,00	WEIL-BLAKESLEY SINUSCOPY FCPS 3,5MM 90°
			
48	XK 100/15	24,00	SPECIAL NEEDLES, 2,00 X 150 MM VERRES
			
49	XM 1452/33	30,00	CLIP APPLYING FORCEPS, 330MM
			
50	XM 570/00	8,00	LIVER RETRACTOR, 10MM, 33,0CM / 13 1/4"
			

Pos.	Cat.-no.	Quantity	Description
51	XM 516/01	11,00	KNOT GUIDE



52	XM 590/00	6,00	FASCIA SEWING GUIDE, 140MM
----	-----------	------	----------------------------



53	XM 585/40	6,00	PALPATION PROBE, 400MM
----	-----------	------	------------------------





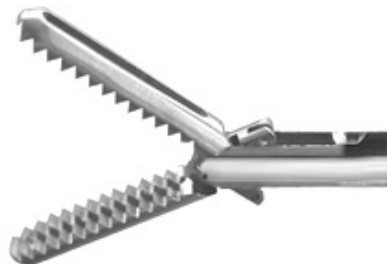







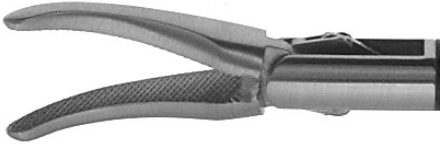





54	XM 1163/33KS	32,00	GRASPING FORCEPS, 330MM
----	--------------	-------	-------------------------



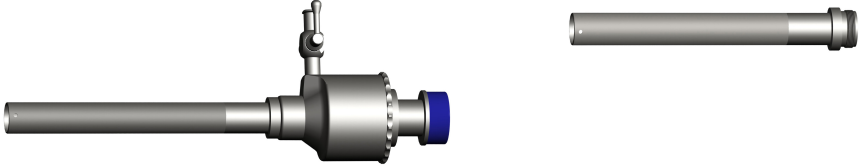

55	XM 1166/33KS	32,00	HUNTER GRASPING FORCEPS, 330MM
----	--------------	-------	--------------------------------

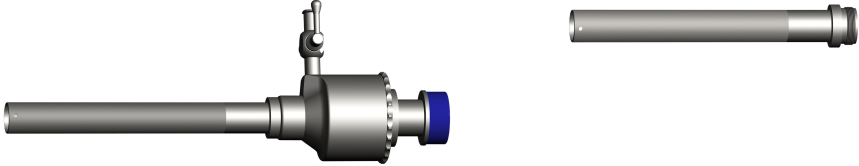

Pos.	Cat.-no.	Quantity	Description
56	XM 1162/33K	32,00	MIKRO GRASPING FORCEPS, 330MM
  			
57	XM 1221/33K	32,00	MARYLAND DISSECTING FORCEPS, 330MM
  			
58	XM 1170/33K	14,00	CROCE-OLMI GRASPING FORCEPS, 330MM
  			
59	XM 1422/33	12,00	NEEDLE HOLDER TC, 330MM
 			
60	XM 1420/33	2,00	NEEDLE HOLDER TC, 330MM
 			

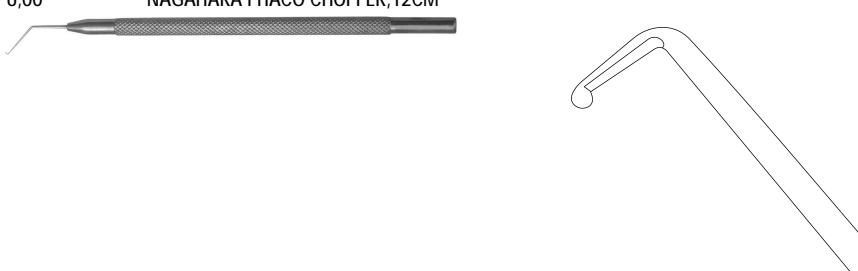
Pos.	Cat.-no.	Quantity	Description
61	XK 770/03	35,00	REDUCING SLEEVE DIA 10MM TO 5MM
			
62	XK 603/03	73,00	TROCAR SLEEVE, 101MM
			
63	XK 761/11	48,00	TROCAR, POINTED, 11,0MM
			
64	XK 761/06	42,00	TROCAR, POINTED, 5,5 MM
65	XK 603/02	76,00	TROCAR SLEEVE, 95MM
			
66	AC 775/10	10,00	CASTROVIEJO IRIS SCISSORS 10.0 CM BL
			

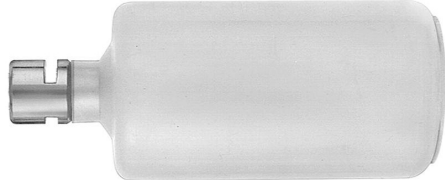
Pos.	Cat.-no.	Quantity	Description
67	KP 498/90	6,00	ROSEN PHACO SPLITTER,12CM
			
68	KP 497/30	6,00	NAGAHARA PHACO CHOPPER,12CM
			
69	KP 769/40	15,00	MC INTYRE LACRIMAL CANNULA
			
70	KP 701/50	15,00	BISHOP-HARMON SILICONE BULB A. LL-CONN.
			
71	AE 572/14	6,00	CASTROVIEJO NH TUC STR RA SERRATED 14 CM
