



Technical Publications

Vivid™ S70N / Vivid S60N

Version 206



User Manual

BD092160-1EN — English

Rev. 04

GENERAL USER DOCUMENTATION.
COPYRIGHT GENERAL ELECTRIC COMPANY.
GE PROPRIETARY. REPRODUCTION AND/OR DISTRIBUTION IS
PROHIBITED.

© GE, 2021-2023.

Regulatory requirement

This product complies with regulatory requirements of the following European Regulation 2017/745 concerning medical devices.



This manual is a reference for the Vivid S70N and Vivid S60N ultrasound systems and covers the following models: Vivid S70N v206 and Vivid S60N v206. It applies to all revisions of the 206 software for the Vivid S70N and Vivid S60N ultrasound systems, which will hereafter be listed as Vivid S70N / S60N. All information in this manual is relevant for the two systems unless otherwise specified.



GE Vingmed Ultrasound AS
Strandpromenaden 45
3191 Horten, Norway
Tel: (+47) 3302 1100
www.gehealthcare.com

Revision History

Reason for change

REV	DATE (YYYY-MM-DD)	REASON FOR CHANGE
Rev. 01	2021-10-08	Draft
Rev. 02	2021-11-30	Initial version
Rev. 03	2022-08-10	Updates according to feedback <ul style="list-style-type: none"> • Device labels • Automated Function Imaging • Pre/Post • Probes • Remote Viewing • eDelivery • Measurement accuracy • Contrast Imaging • DICOM Viewer
Rev. 04	2023-03-27	<ul style="list-style-type: none"> • Symbols • Optimizing 2D • 4D-Mode • AI Auto Measure – 2D • Probes overview • Cleaning and disinfecting the system • CartoSound • Electromagnetic Compatibility (EMC)

List of Effective Pages

PAGE NUMBER	REV
All pages	Rev. 04

Please verify that you are using the latest revision of this document. Information pertaining to this document is maintained on ePDM (GE electronic Product Data Management). If you need to know the latest revision, contact your distributor, local GE Sales Representative or in the USA call the GE Ultrasound Clinical Answer Center at 1 800 682 5327 or 1 262 524 5698.

Regulatory Requirements

Conformance Standards

The GE Healthcare product families are tested to meet all applicable requirements and relevant standards per the countries in which the product will be sold. Any changes to accessories, peripheral units, or any other part of the system must be approved by the manufacturer: GE Vingmed Ultrasound AS. Ignoring this advice may compromise the regulatory approvals obtained for the product.

This product complies with the regulatory requirements of the following:

Standard/Directive/Regulation	Scope
Regulation (EU) 2017/745	Medical Device Regulation (MDR)
2006/42/EC	Machinery Directive (MD)
2012/19/EU	Waste Electrical and Electronic Equipment (WEEE)
2011/65/EU	Directive on the restriction of the use of certain hazardous substances in electrical and electronic equipment (ROHS)
2014/53/EC	Council Directive concerning Radio equipment (RED) Note: Only relevant when equipped with optional Wireless communication
IEC/EN 60601-1 ANSI/AAMI ES60601-1 CAN/CSA-C22.2 No. 60601-1	Medical Electrical Equipment - Part 1. General requirements for basic Safety and essential performance
IEC/EN 60601-2-37	Medical electrical equipment - Part 2-37. Particular requirements for the basic safety and essential performance of ultrasonic medical diagnostic and monitoring equipment
IEC/EN 60601-1-2	Medical Electrical Equipment - Part 1-2. General requirements for basic safety and essential performance - Collateral standard: Electromagnetic disturbances - Requirements and tests
IEC/EN 60601-1-6	Medical Electrical Equipment - Part 1-6. General requirements for basic safety and essential performance - Collateral standard: Usability
IEC/EN 62304	Medical Device Software - Software life-cycle processes

Standard/Directive/ Regulation	Scope
IEC/EN 62366-1	Medical Devices - Application of usability engineering to medical devices
ISO 10993-1	Biological evaluation of medical devices Note: The standard is in scope only to accessories of this device that are applied parts intended for patient contact.

Clarification related to the CE marking of upgraded devices

The Vivid S v203/v204/v205 to v206 upgrade kit consists of complete new device software.

The upgrade to v206 complies with the regulatory requirements identified in this user manual and bears the CE mark in accordance to Regulation (EU) 2017/745, Medical Device Regulation (MDR).

Unmodified content of the original Vivid S70N/S60N v203/v204/v205 complies with the regulatory requirements identified in the user manual originally provided with the Vivid S70N/S60N and retains the CE mark in accordance to 93/42/EEC, Medical Devices Directive (MDD).

Certifications

- GE Vingmed Ultrasound AS, Horten is ISO 13485 certified.
- GE Medical Systems (China) Co., Ltd. is ISO 13485 certified.

Importer information

- TURKEY

Türkiye İthalatçısı / Turkish Importer	GE Medical Systems Türkiye Ltd. Şti. Esentepe Mah. Harman Sok. No: 8 34394 Şişli İstanbul Türkiye
---	---

Directives/Regulations

The GE ultrasound product families are tested to meet all applicable requirements in relevant EU Directives/Regulations and European/International standards.

- Regulation (EU) 2017/745 concerning MDR (Medical Device Regulation): the CE label affixed to the product testifies compliance to this Regulation.
- The location of the CE marking is specified in 'Device labels' on *page 2-27*.
- Year of first CE mark: 2015

Classifications

The ultrasound console and related ultrasound probes are Active Diagnostic Medical Devices belonging to Class IIa per the MDR 2017/745 regulation for use on human patients.

The following classifications are in accordance with the IEC/EN 60601-1:

Type of protection against electric shock:

- Class I Equipment

Degree of protection against electric shock:

- Type BF Applied part (for Probes marked with BF symbol)
- Type CF Applied part (for ECG, and probes marked with CF symbol)
- The ECG applied part input is defibrillation proof.

Continuous Operation

System is IPX0.

Footswitch is IPX8.

Transducers are IPX7.

ICE catheters are IPX8.

Class I Equipment

EQUIPMENT in which protection against electric shock does not rely on BASIC INSULATION only, but also includes an earth ground. This additional safety precaution prevents exposed metal parts from becoming LIVE in the event of an insulation failure.

Type BF Applied part

TYPE BF APPLIED PART providing a specified degree of protection against electric shock with particular regard to allowable LEAKAGE CURRENT.

	Patient leakage current	
	Normal condition	Single fault condition
d.c.	<10 microA	<50 microA
a.c.	<100 microA	<500 microA

Type CF Applied part

TYPE CF APPLIED PART providing a degree of protection higher than that for Type BF Applied Part against electric shock particularly regarding allowable LEAKAGE CURRENT.

	Patient leakage current	
	Normal condition	Single fault condition
d.c.	<10 microA	<50 microA
a.c.	<10 microA	<50 microA

Original Documentation

The original document was written in English.

Software License Acknowledgements

WindowBlinds™ OCX © Stardock ®



Table of Contents

Conformance Standards	i-2
Clarification related to the CE marking of upgraded devices	i-3
Certifications	i-3
Importer information	i-3
Directives/Regulations	i-4
Classifications	i-4
Class I Equipment	i-4
Type BF Applied part	i-5
Type CF Applied part	i-5
Original Documentation	i-5
Software License Acknowledgements	i-5

Table of Contents

Chapter 1 — Introduction

Overview

Attention	1-2
Documentation	1-3
Conventions used in this manual	1-4
Principles of operation	1-4
Indications for use	1-5
Intended Users	1-7
Patient population (system and probes)	1-8
Clinical benefit (system and probes)	1-8
Contraindications	1-8
Prescription device	1-8
Reporting	1-8
Safety	1-9

Contact Information

Contacting GE Ultrasound	1-10
Manufacturer	1-17

Chapter 2 — Safety

Safety Precautions

Precaution Levels	2-2
-------------------	-----

Owner responsibility

Notice against user modification	2-3
----------------------------------	-----

Acoustic output

Definition of the acoustic output parameters	2-4
Acoustic output and display on the Vivid S70N / S60N	2-5
ALARA	2-7
Safety statement	2-7

System controls affecting acoustic output	2-8
OB Exam	2-10
Important safety considerations	
Patient safety	2-11
Personnel and equipment safety	2-14
Electromagnetic Compatibility (EMC)	2-20
Environmental protection	2-26
Device labels	
Symbols	2-27
For China only	2-32
Chapter 3 — Prepare the System for Use	
Site requirements	
Power requirements	3-2
Operating Environment	3-3
Environmental requirements	3-3
Electromagnetic interferences	3-3
Connecting the system	3-4
System Overview	
Getting to know the system	3-9
Probe cable hook	3-10
Removable media	3-11
Physiological traces	3-14
Peripheral/accessory connector panel	3-19
Wired Footswitch (Option)	3-21
Switching On/Off	
Switch on the system	3-23
Scanning without Log In	3-23
Log In	3-24
Switch off the system	3-24
Connect and disconnect probes	
Connect the probe	3-27
Activate the probe	3-29
Deactivate the probe	3-31
Disconnect the probe	3-31
Intra Cardiac Ultrasound Catheters	3-32
The Scanning screen	
The Title bar	3-34
Parameters window	3-35
Clipboard	3-35
Control Panel	
Control Panel overview	3-36
Trackball area	3-38
Touch Panel	3-39
The alphanumeric keyboard (option)	3-44
Main display adjustment	
Lock/unlock the main display	3-45
Image Adjustment	3-46

Moving and transporting the system	
Wheels -----	3-49
Moving the system -----	3-49
Using Transportation mode -----	3-51
Transporting the system -----	3-52
Reinstalling at a new location -----	3-53
Preparing Vivid S70N / S60N for scanning -----	3-53
Chapter 4 — Start an Examination	
Perform exams without logging in	
Unsaved images from previous session -----	4-2
Starting an examination after logging in	
Creating a new patient record -----	4-5
Selecting an existing patient record -----	4-6
Ending an examination -----	4-6
Cineloop	
Cineloop overview -----	4-9
Using cineloop -----	4-10
Zoom	
Display zoom -----	4-12
HR zoom -----	4-12
Annotations	
To insert an annotation -----	4-13
Editing annotations -----	4-15
To erase text annotations -----	4-16
Bodymark -----	4-16
Annotation and bodymark configuration -----	4-17
Chapter 5 — Image Optimization	
2D-Mode	
2D-Mode overview -----	5-3
Using 2D-Mode -----	5-5
Optimizing 2D- -----	5-5
M-Mode	
M-Mode overview -----	5-7
Using M-Mode -----	5-9
Optimizing M-Mode -----	5-10
Color Mode	
Color 2D Mode overview -----	5-12
Color M-Mode overview -----	5-14
Using Color Mode -----	5-16
Optimizing Color Mode -----	5-16
PW and CW Doppler	
PW and CW Doppler overview -----	5-19
Using PW/CW Doppler modes -----	5-21
Optimizing PW/CW Doppler modes -----	5-21
Tissue Velocity Imaging (TVI)	
TVI overview -----	5-23
Using TVI -----	5-25

Optimizing TVI	5-25
Tissue Tracking	
Tissue Tracking overview	5-26
Using Tissue Tracking	5-28
Optimizing Tissue Tracking	5-28
Strain rate	
Strain rate overview	5-29
Using Strain rate	5-31
Optimizing Strain rate	5-31
Strain	
Strain overview	5-32
Using Strain	5-34
Optimizing Strain	5-34
Tissue Synchronization Imaging (TSI)	
TSI overview	5-35
Using TSI	5-37
Contrast Imaging	
Data acquisition	5-39
Contrast Echocardiography Box	5-46
Strain Elastography	
Description	5-47
Using Strain Elastography	5-47
Using Strain Elastography (in steps)	5-49
Strain Elastography Controls	5-49
Elastography Analysis	
Overview	5-51
Using Elastography Analysis	5-51
Additional scanning features	
LogiqView	5-54
Compound	5-55
Virtual Convex	5-55
B-Flow	5-55
Blood Flow Imaging	5-56
Image controls	
Control panel	5-57
Touch panel and rotaries	5-57
Scan Assist Pro	
Scan Assist Pro overview	5-67
Setting up Scan Assist Pro	5-69
Using Scan Assist Pro	5-71
Pre/Post	5-73
Chapter 6 — 4D and Multi-plane Modes	
4D-Mode	
Real-time, single beat 4D imaging	6-2
Real-time, multi beat 4D imaging	6-2
4D-Mode	6-3
4D Color Flow mode	6-16

HD Color	6-20
Flexi-Slice	6-21
Basic operations	6-24
4D-Mode controls	6-35
Multi-plane mode	
Bi-plane mode screen	6-42
Tri-plane mode screen	6-44
Using Multi-plane mode	6-46
Bi-plane prepare	6-46
Basic operations	6-48
Multi-plane mode controls	6-50
FlexiViews	
Chapter 7 — Stress Echo	
Introduction	
Selection of a stress test protocol template	
Image acquisition	
Starting acquisition	7-5
Continuous capture mode	7-9
Stress Echo analysis	
Image selection for analysis	7-16
Wall motion scoring	7-18
Quantitative TVI Stress echo analysis	
Accessing QTVI Stress analysis tools	7-22
Vpeak measurement	7-22
Tissue Tracking	7-25
Quantitative analysis	7-25
References	7-25
Editing/creating a Stress Echo protocol template	
Entering the Template editor screen	7-26
Editing/Creating a template	7-27
Chapter 8 — Measurements and Analysis	
Introduction	
General recommendations about measurements	8-4
About Measurement results display	8-4
Assign and Measure modality	
Measure and Assign modality	
Measurements on volume renderings	8-9
Measurements on protocol images	
Example results	8-10
AI Auto Measure – Spectrum Recognition	
Configuration for AI Auto Measure – Spectrum Recognition	8-14
Restrictions for AI Auto Measure – Spectrum Recognition	8-15
Advanced cardiac measurements and analysis	
Event timing measurements	8-16
TSI Measurements	8-17
Automated Function Imaging	8-23

AutoEF measurements for the Left Ventricle (Auto EF 3.0, Easy Auto EF) - -	
8-74	
Cardiac Auto Doppler - - - - -	8-83
AI Auto Measure – 2D - - - - -	8-87
Pediatric Z-score measurements - - - - -	8-91
4D/Multi-plane LV	
4D/multi-plane LV analysis tools - - - - -	8-92
4D Auto LVQ - - - - -	8-92
Manual left ventricular volume measurements - - - - -	8-103
TSI surface model - - - - -	8-108
4D Auto RVQ	
Requirements - - - - -	8-110
Starting 4D Auto RVQ - - - - -	8-111
Align Views - - - - -	8-112
Set Landmarks - - - - -	8-113
Review - - - - -	8-113
Results - - - - -	8-115
Approval - - - - -	8-115
4D Auto MVQ	
Requirements - - - - -	8-116
Starting 4D Auto MVQ - - - - -	8-117
Align Views - - - - -	8-118
Set Landmarks - - - - -	8-119
Review - - - - -	8-121
Results - - - - -	8-122
Approval - - - - -	8-124
4D Auto AVQ	
Requirements - - - - -	8-125
Starting the 4D Auto AVQ tool - - - - -	8-127
Slice alignment - - - - -	8-128
LVOT segmentation - - - - -	8-128
Measurements - - - - -	8-130
Approval - - - - -	8-131
Running Apps	
Launchpad - - - - -	8-132
Apps - - - - -	8-132
Activating an App - - - - -	8-133
Starting an App from the launchpad - - - - -	8-133
Storing measurements - - - - -	8-135
Advanced vascular measurements and analysis	
Intima-Media Thickness - - - - -	8-136
Vascular Auto Doppler - - - - -	8-139
OB measurements	
OB graphs - - - - -	8-142
Measurement result table	
Minimizing the Measurement result table - - - - -	8-148
Moving the Measurement result table - - - - -	8-148
Deleting measurements - - - - -	8-148

Worksheet	
Overview - - - - -	8-149
Using the Worksheet- - - - -	8-150
Measurement accuracy	
General - - - - -	8-152
Sources of error - - - - -	8-152
Optimizing Measurement Accuracy - - - - -	8-154
Measurement Uncertainties - - - - -	8-154
Chapter 9 — Quantitative Analysis	
Introduction	
Q Analysis overview	
Starting Q Analysis - - - - -	9-3
Q Analysis screen- - - - -	9-4
Using Q Analysis	
Generation of a trace - - - - -	9-9
Saving/retrieving Q Analysis - - - - -	9-13
Frame disabling - - - - -	9-13
Optimization- - - - -	9-15
Switching modes or traces- - - - -	9-19
Anatomical M-Mode - - - - -	9-20
Chapter 10 — Archiving	
Introduction	
The dataflow concept	
Dataflows available - - - - -	10-3
Storing images and cineloops	
Storing an image - - - - -	10-7
Storing a cineloop- - - - -	10-8
Saving images and cineloops to a standard format - - - - -	10-9
DICOM Viewer - - - - -	10-11
Retrieving and editing archived information	
Searching for a patient record - - - - -	10-14
Editing data in the archive - - - - -	10-17
Deleting archived information- - - - -	10-25
Moving examinations - - - - -	10-27
Review images in archive	
Review the images from a selected examination - - - - -	10-29
Review images from a selected patient record- - - - -	10-31
Connectivity	
The dataflow concept - - - - -	10-36
Dataflow selection- - - - -	10-39
Transfer of patient records/examinations	
Transfer patient records/examinations between archives - - - - -	10-41
Transferring patient records/examinations- - - - -	10-42
Disk management	
Configuring the Disk management function - - - - -	10-50
Running the Disk management function - - - - -	10-53

Data Backup and restore	
Backup procedure- - - - -	10-58
Restore procedure - - - - -	10-62
Tricefy Uplink	
To register a Tricefy account - - - - -	10-65
Configuration of Tricefy storage - - - - -	10-66
Configuration of Tricefy QR - - - - -	10-72
Data streaming	
Streaming in process - - - - -	10-73
Remote Viewing	
Using Remote Viewing - - - - -	10-75
Chapter 11 — Report	
Introduction	
Creating a report	
Working with the report function	
To open a report- - - - -	11-4
To choose another report template- - - - -	11-6
To change patient information - - - - -	11-6
Images in the report - - - - -	11-6
To print a report - - - - -	11-7
To store a report- - - - -	11-7
Retrieving an archived report- - - - -	11-8
Retrieving a DICOM PDF report- - - - -	11-8
Deleting an archived report - - - - -	11-8
Structured Findings	
Prerequisite - - - - -	11-10
Starting Structured Findings- - - - -	11-11
Using Structured Findings - - - - -	11-13
Structured Findings configuration- - - - -	11-15
Direct report	
Creating comments- - - - -	11-26
Creating pre-defined text inputs - - - - -	11-27
Report designer	
Accessing the Report designer- - - - -	11-28
Report designer overview - - - - -	11-29
Designing a report template- - - - -	11-31
Saving the report template- - - - -	11-43
To exit the Report designer - - - - -	11-43
Report templates management	
Configuration of the Template selection menu- - - - -	11-45
Export/Import of Report templates - - - - -	11-46
Chapter 12 — Customize Configuration	
Customize System Settings	
About system Configuration- - - - -	12-3
General system settings - - - - -	12-6
Touch Panel	
Shortcuts - - - - -	12-8

Users and Security

Local System Users	12-10
User Policies	12-14
LDAP	12-15
System password	12-17
Login Banner	12-17
Storage Encryption	12-20

Global imaging settings

Global imaging settings	12-21
-------------------------------	-------

Measurement Package

Basic operations	12-23
Measurement package configuration - example	12-25
User-defined formulas	12-27
Advanced settings	12-35
Normal values	12-42
Transfer of user-defined measurements transfer in DICOM SR	12-43
Advanced Quantification	12-44
Circumference and area (spline trace) measurement	12-45

Connectivity configuration

System in a network environment	12-48
System in a network environment with a DICOM server	12-53
Wireless Network Setup	12-76
Data Streaming	12-80
Relocated features from v201 - v205	12-85

Archive

Configuration of the archiving functions	12-88
Network configuration	12-89
Dataflow	12-89
Default remote path setting	12-93
XML Export configuration	12-94
Patient ID	12-95
Other	12-97

Scan Assist Pro Creator

Overview	12-100
Protocol export from Vivid S70N / S60N and off-system installation of the Scan Assist Pro Creator	12-100
Starting Scan Assist Pro Creator	12-102
File handling	12-103
Creating new Protocols	12-104
Saving Protocols	12-105
Views	12-106
Step attributes	12-108

Stress Echo

Application Presets List

Generating a new preset	12-115
Deleting an application preset	12-118

6VT-D TEE Probe	
Image View	
Chapter 13 — Probes	
Probe overview	
Supported probes / accessories	13-2
Modes of Operation for probes	13-7
Additional Functionality	13-8
Probe presets	13-10
Maximum probe temperature	13-12
Probe orientation	13-13
Probe labeling	13-14
Intracardiac Ultrasound Catheters	13-15
Care and Maintenance	
Planned maintenance	13-19
Inspecting the probe	13-20
Safety tests	13-20
Environmental conditions	13-21
Cleaning and disinfecting probes	13-21
Coupling gels	13-61
Disposal	13-62
Probe safety	
Electrical hazards	13-63
Mechanical hazards	13-63
Biological hazards	13-64
Restricted Areas	13-65
Leakage of Silicon Grease	13-66
Biopsy	
User qualification for biopsy	13-67
Biopsy capability for probes	13-67
Precaution concerning the use of biopsy procedures	13-68
Preparing the Biopsy guide attachment - Convex, Sector and Linear probes	13-71
Preparing the Biopsy guide attachment - endocavity probe	13-75
Displaying the Guide zone	13-78
Biopsy needle path verification	13-79
Starting the biopsy procedure	13-79
Cleaning, disinfection and disposal	13-79
Probe Check	
Introduction	13-80
Supported probes	13-81
Probe Test Activation	13-81
Auto Trigger interval configuration	13-83
Manual Trigger	13-87
Chapter 14 — Peripherals	
Introduction	
Printing	
To print an image	14-4

Printing configuration	
P1 button configuration -----	14-5
Printer setup-----	14-6
Flexible Video Out	
Connect external monitor-----	14-7
Select region to show on the external monitor -----	14-8
Full Screen video out region -----	14-8
Image video out region -----	14-9
View-X	
TCP/IP Configuration for View-X -----	14-12
View-X Direct -----	14-14
Adjust Cropping of the Video Stream -----	14-17
CartoSound	
CartoSound/SoundStar -----	14-19
Chapter 15 — Maintenance	
System Care and Maintenance	
Overview -----	15-2
Expected Service Life Description -----	15-2
Maintenance schedule -----	15-3
Cleaning and disinfecting the system -----	15-4
Prevention of static electricity interference-----	15-13
System self-test	
System malfunction-----	15-14
Bookmarking a system malfunction -----	15-15
Generating a log file -----	15-15
Advanced log options -----	15-16
eDelivery - Software update	
Introduction -----	15-18
Software update via Remote Service Platform (RSvP) -----	15-18
Software download and installation-----	15-19
Software update via End-User Portal -----	15-27
Loading the Software -----	15-29
Reload Software-----	15-31
Index	



Chapter 1

Introduction

The Vivid S70N / S60N is a high performance digital ultrasound imaging system with total data management.

The system provides image generation in 4D (option on Vivid S70N), 2D (B) Mode, Color Doppler, Power Doppler (Angio), M-Mode, Color M-Mode, PW and CW Doppler spectral, Tissue Velocity imaging, advanced Strain and Contrast applications.

The fully digital architecture of the Vivid S70N / S60N system allows optimal usage of all scanning modes and probe types, throughout the full spectrum of operating frequencies.

This chapter provides information concerning indications for use/contraindications, contact information, and how this documentation is organized.

Attention

This manual contains necessary and sufficient information to operate the ultrasound system safely.

Read and understand all instructions in the User Manual before attempting to use the ultrasound system.

Keep this manual with the equipment at all time. Periodically review the procedures for operation and safety precautions.

Disregarding information on safety is considered abnormal use.

Not all features or products described in this document may be available or cleared for sale in all markets. Please contact your local GE Healthcare representative to get the latest information.

NOTE: Please note that orders are based on the individually agreed upon specifications and may not contain all features listed in this manual.

NOTE: All references to standards / regulations and their revisions are valid at the time of publication of the user manual.

Documentation



CAUTION

Safety instructions must be reviewed before operating the system.

Vivid S70N / S60N documentation consists of various manuals:

- The User Manual and Onboard Help (TRANSLATED) provides information needed by the user to operate the system safely. It describes the basic functions of the system, safety features, operating modes, measurements/ calculations, probes, and user care and maintenance.
- The Advanced Reference Manual (ENGLISH ONLY) contains data tables, such as measurements and calculations, OB, and Acoustic Output.
- The Privacy and Security Manual (TRANSLATED) describes privacy and security considerations, privacy and security capabilities, and how they are configured and used appropriately.
- The Service Manual (ENGLISH ONLY) supplies block diagrams, lists of spare parts, descriptions, adjustment instructions, or similar information which helps qualified technical personnel in repairing those parts of the system which have been defined as repairable.
- Medical Ultrasound Safety publication from American Institute of Ultrasound in Medicine (AIUM) (ENGLISH ONLY). Provided as ALARA Educational Program, to comply with US FDA Track 3 - Not available in all countries.

NOTE: *The eDocumentation kit provides instructions on how to read the user documentation via electronic media. All user manuals are provided in electronic format. The eDocumentation media includes English and all other translations.*

The Vivid S70N / S60N manuals are written for users who are familiar with basic ultrasound principles and techniques. They do not include sonographic training or detailed clinical procedures.

NOTE: *The screen graphics in this manual are only for illustrational purposes. Actual screen output may differ.*

Conventions used in this manual

Bold type describes button names on the screen.

Italic type describes program windows, screens and dialogue boxes.

Icons highlight safety issues as described in 'Safety' on *page 2-1*.

Principles of operation

Medical ultrasound images are created by computer and digital memory from the transmission and reception of mechanical high-frequency waves applied through a probe. The mechanical ultrasound waves spread through the body, producing an echo where density changes occur. For example, in the case of human tissue, an echo is created where a signal passes from an adipose tissue (fat) region to a muscular tissue region. The echoes return to the probe where they are converted back into electrical signals.

These echo signals are highly amplified and processed by several analog and digital circuits that use filters with many frequency and time response options to transform the high-frequency electrical signals into a series of digital image signals which are stored in memory. Once in memory, the image can be displayed in real-time on the image monitor.

A probe is an accurate, solid-state device, providing multiple image formats. The digital design and use of solid-state components provides highly stable and consistent imaging performance with minimal required maintenance.

Indications for use

Vivid S70N / S60N is a general-purpose ultrasound system, specialized for use in cardiac imaging. It is intended for use by, or under the direction of a qualified and trained physician for ultrasound imaging, measurement, display and analysis of the human body and fluid. The device is intended for use in a hospital environment including echo lab, other hospital settings, operating room, Cath lab and EP lab or in private medical offices. The systems support the following clinical applications: Fetal/Obstetrics, Abdominal (including renal, GYN), Pediatric, Small Organ (breast, testes, thyroid), Neonatal Cephalic, Adult Cephalic, Cardiac (adult and pediatric), Peripheral Vascular, Musculo-skeletal Conventional, Musculo-skeletal Superficial, Urology (including prostate), Transesophageal, Transvaginal, Transrectal, Intra-cardiac and Intra-luminal, Interventional Guidance (including Biopsy, Vascular Access), Thoracic/Pleural, and Intraoperative (vascular). Modes of operation include: 3D/4D Imaging mode, B, M, PW Doppler, CW Doppler, Color Doppler, Color M Doppler, Power Doppler, Harmonic Imaging, Coded Pulse and Combined modes: B/M, B/Color M, B/PWD or CWD, B/Color/PWD or CWD, B/Power/PWD.

Probe applications/indications table

Clinical Application <i>Anatomy/ Region of Interest</i>	Probe																									
	M5Sc-D	3Sc-RS	6S-D	12S-D	4Vc-D	9L-D	11L-D	C1-5-D	C1-6-D	C2-9-D	C3-10-D	6VT-D	6Tc-RS	9T-RS	10T-D	iC5-9-D	2D (P2D)	6D (P6D)	L8-18i-D	ML6-15-D	AcuNav 10F	AcuNav 8F	SoundStar 3D 10F	SoundStar eco 10F	SoundStar eco 8F	
Ophthalmic																										
Fetal/Obstetrics	+	+	+		+			+	+	+						+										
Abdominal (including renal, GYN)	+	+	+	+	+	+		+	+	+	+															
Thoracic/Pleural	+	+	+		+	+	+	+	+																	
Pediatric	+	+	+	+	+	+	+			+	+															
Small Organ (including breast/ testes/thyroid)						+	+												+	+						
Neonatal Cephalic			+	+							+															
Adult Cephalic	+	+			+																					
Cardiac (Pediatric)	+	+	+	+	+									+	+		+	+								
Cardiac (Adult)	+	+	+	+	+							+	+	+	+		+	+								
Peripheral Vascular	+	+		+		+	+	+	+	+	+						+	+	+	+	+					
Musculo-skeletal Conventional						+	+				+								+	+						
Musculo-skeletal Superficial						+	+				+								+							
Urology (including prostate)	+				+			+	+	+							+									
<i>Exam type, Means of Access:</i>																										
Transesophageal												+	+	+	+											
Transrectal																	+									

Clinical Application <i>Anatomy/ Region of Interest</i>	Probe																											
	M5Sc-D	3Sc-RS	6S-D	12S-D	4Vc-D	9L-D	11L-D	C1-5-D	C1-6-D	C2-9-D	C3-10-D	6VT-D	6Tc-RS	9T-RS	10T-D	iC5-9-D	2D (P2D)	6D (P6D)	L8-18i-D	ML6-15-D	AcuNav 10F	AcuNav 8F	SoundStar 3D 10F	SoundStar eco 10F	SoundStar eco 8F			
Transvaginal																	+											
Transurethral																												
Intra-cardiac and Intra-luminal																						+	+	+	+	+	+	
Intraoperative (vascular)																				+								
Intraoperative Neurological																												
Intravascular																												
<i>Interventional Guidance:</i>																												
Tissue Biopsy	+	+			+	+	+	+	+	+							+				+							
Vascular Access (IV, PICC)						+	+				+	+					+				+							

Frequency of use

Daily (Typically 8 hours)

Intended Users

The systems are intended for use by qualified and trained physicians or sonographers.

Operator profile

- Qualified and trained physicians or sonographers with at least basic ultrasound knowledge.
- The operator must have read and understood the user manual.

Patient population (system and probes)

- Age: all ages (including embryos and fetuses)
- Location: worldwide
- Sex: male and female
- Weight: all weight categories, see note below
- Height: no limitations

NOTE: Minimum weight apply for TEE probes (see TEE Probe User Manual).

NOTE: Extreme obesity may affect operation of the device.

Clinical benefit (system and probes)

The clinical benefit of a diagnostic ultrasound device is to help healthcare professionals provide accurate diagnostic information (visualize human tissue/internal structure) that enhances the diagnostic and treatment care pathways of the patient for a variety of diseases and conditions.

Contraindications

The Vivid S70N / S60N is not intended for ophthalmic use or any use causing the acoustic beam to pass through the eye.

NOTE: Vivid S70N / S60N should be used in compliance with law. Some jurisdictions restrict certain uses, such as gender determination.

Prescription device

NOTE: For USA only: Federal law restricts this device to sale or use by or on the order of a physician.

Reporting

In case a serious incident occurred in relation to Vivid S70N / S60N ultrasound products or GE Healthcare ultrasound probes, this should be reported to GE Healthcare and the competent Authority.

Safety

All information in Chapter 'Safety' on *page 2-1*, should be read and understood before operating the ultrasound system.

Contact Information

Contacting GE Ultrasound

For additional information or assistance, please contact your local distributor or the appropriate support resource listed on the following pages:

INTERNET

<https://www.gehealthcare.com>

<https://cleaning.gehealthcare.com>

Clinical Questions

For information in the United States, Canada, Mexico, and parts of the Caribbean, call the Customer Answer Center.

TEL: (1) 800-682-5327 or (1) 262-524-5698

In other locations, contact your local Applications, Sales, or Service Representative.

Service Questions

For service in the United States, call GE CARES.

TEL: (1) 800-437-1171

In other locations, contact your local Service Representative.

Information Requests

To request technical product information in the United States, call GE.

TEL: (1) 800-643-6439

In other locations, contact your local Applications, Sales, or Service Representative.

Placing an Order

To order accessories, supplies, or service parts in the United States, call the GE Technologies Contact Center.

TEL: (1) 800-558-5102

In other locations, contact your local Applications, Sales, or Service Representative.

AMERICAS

ARGENTINA

GE Healthcare TEL: 11-5298-2400
Nicolas Vedia 3616, piso 5
Buenos Aires

BRAZIL

GE Healthcare do Brasil Comércio e Serviços para
Equipamentos Médico- Hospitalares Ltda
Av. Magalhães de Castro, 4800 – Andar 10 Conj. 101 e 102,
Andar 11 Conj. 111 e 112, Andar 12 Conj. 121 e 122, Torre 3 -
Cidade Jardim - CEP: 05676-120 - São Paulo/SP – Brasil
C.N.P.J.: 00.029.372/0001-40
TEL: 3004 2525 (Capitais e regiões metropolitanas) /
08000 165 799 (Demais regiões)

CANADA

GE Healthcare
Ultrasound Service Engineering
9900 Innovation Drive
Wauwatosa, WI 53226
TEL: (1) 800-668-0732
Customer Answer Center TEL: (1) 262-524-5698

LATIN & SOUTH AMERICA

GE Healthcare
Ultrasound Service Engineering
9900 Innovation Drive
Wauwatosa, WI 53226
TEL: (1) 262-524-5300
Customer Answer Center TEL: (1) 262-524-5698

MEXICO

GE Sistemas Medicos de Mexico S.A. de C.V.
Rio Lerma #302, 1º y 2º Pisos
Colonia Cuauhtemoc FAX: (5) 211-4631
06500-Mexico, D.F.
TEL: (5) 228-9600

USA

GE Healthcare
Ultrasound Service Engineering
9900 Innovation Drive
Wauwatosa, WI 53226
TEL: (1) 800-437-1171 FAX: (1) 414-721-3865

ASIA

ASIA PACIFIC

JAPAN

GE Healthcare Asia Pacific
4-7-127, Asahigaoka
Hinoshi, Tokyo
191-8503, Japan
TEL: +81 42 585 5111

AUSTRALIA

GE Healthcare
32 Philip Street
Parramatta, NSW 2150
TEL: 1800 659 465

CHINA

GE Healthcare - China
No. 1, Yongchang North Road
Beijing Economic & Technology Development Area
Beijing 100176, China
TEL: (8610) 5806 8888 FAX: (8610) 6787 1162

INDIA

Wipro GE Healthcare Pvt Ltd
No. 4, Kadugodi Industrial Area
Sadaramangala, Whitefiled
Bangalore, 56067
TEL: +(91) 1-800-425-8025

KOREA

GE Healthcare Korea
15F, 416 Hangang Dae ro, Chung-gu
Seoul, 04637, Korea
TEL: +82 1544 6119

NEW ZEALAND

Level 7 Vero Centre
48 Shortland St, Auckland 1010
New Zealand
TEL: 0800 659 465

SINGAPORE

GE HEALTHCARE PTE ASEAN (Singapore)
11 North Buona Vista Drive
#11-07 The Metropolis Tower 2
Singapore 138589
TEL: +65 6291 8528 FAX: +65 6291 7006

AFRICA

EGYPT

GE Healthcare
32 Philip Street
Parramatta, NSW 2150
TEL: 1800 659 465

KENYA

GE East Africa Services Limited
General Mathenge Drive, Courtyard Building
Westlands
Nairobi 30, 00100 KE
TEL: +254 719 093 044

NIGERIA

GE International Operations (Nig) Ltd
Bishop Aboyade Cole Street No. 927/928
Mansard Place, PO Box 54255
Victoria Island, Lagos LA, NG
TEL: +234 (01) 4607101, +234 (01) 4607102

**KINGDOM OF
SAUDI ARABIA**

GE Healthcare Arabia Co. Ltd
Platinum Centre, Building 1
Salahuddin Ayoubi Road
Riyadh-12811, Kingdom of Saudi Arabia
TEL: +966 (11) 494 5779, FAX: +966 (11) 207 3946

SOUTH AFRICA

General Electric South Africa (Pty) Ltd.
60 Glenhove Road
Green on Glenhove Customer Innovation Centre
Johannesburg GP, 2196 ZA
TEL: +27 0100725000, FAX: +27 0862958385

EUROPE and MIDDLE EAST

For all other European countries not listed, please contact your local GE Healthcare distributor or the appropriate support resource listed on www.gehealthcare.com.

AUSTRIA

GE Healthcare Austria GmbH & Co OG
EURO PLAZA, Gebäude E
Technologiestr. 10, A-1120 Wien
TEL: (+43) 1 97272 0 FAX: (+43) 1 97272 2222

BELGIUM & LUXEMBURG

GE Healthcare BVBA
Eagle Building
Kouterveldstraat 20
1831 DIEGEM
TEL: (+32) 2 719 7204 FAX: (+32) 2 719 7205

CZECH REPUBLIC

GE Medical Systems Česká Republika, s.r.o.
Bucharova 2641/14
158 00 Praha 5
Česká Republika
TEL: (+420) 224 446 162, FAX: (+420) 224 446 161

DENMARK

GE Medical Systems Ultrasound
Park Alle 295, 2605 Brøndby
TEL: (+45) 43 295 400 FAX: (+45) 43 295 399

ESTONIA & FINLAND

GE Healthcare Finland Oy
Kuortaneenkatu 2, 000510 Helsinki
P.O.Box 330, 00031 GE Finland
TEL: (+358) 10 39 48 220 FAX: (+358) 10 39 48 221

FRANCE

GE Medical Systems SCS
24 Avenue de l'Europe - CS20529
78457 Velizy Villacoublay Cedex
TEL: (+33) 13 449 50 00 FAX: (+33) 13 44 95 202

GERMANY

GE Healthcare GmbH
Beethovenstrasse 239
42655 Solingen
TEL: (+49) 212-28 02-0 FAX: (+49) 212-28 02 380

GREECE

GE Healthcare
8-10 Sorou Str. Marousi
Athens 15125 Hellas
TEL: (+30) 210 8930600 FAX: (+30) 210 9625931

HUNGARY

GE Hungary Zrt.
Bence utca 3
Budapest BU, 1138 HU
TEL: (+36) 23 410 314, FAX: (+36) 23 410 390

IRELAND

GE Healthcare
3050 Lake Drive, Citywest Business Campus
Dublin 24
TEL: (+353) 1 4605500

ITALY

GE Medical Systems Italia spa
Via Galeno, 36, 20126 Milano
TEL: (+39) 02 2600 1111 FAX: (+39) 02 2600 1599

NETHERLANDS

GE Healthcare B.V.
De Wel 18, 3871 MV Hoevelaken
PO Box 22, 3870 CA Hoevelaken
TEL: (+31) 33-25 41 222

NORWAY

GE Healthcare
Vitaminveien 1A, 0485 Oslo
TEL: (+47) 23 18 50 50

GE Healthcare
Strandpromenaden 45,
P.O. Box 141, 3191 Horten
TEL: (+47) 33 02 11 16

POLAND

GE Medical Systems Polska
Sp. z o.o., ul. Woloska 9
02-583 Warszawa, Poland
TEL: (+48) 22 330 83 00 FAX: (+48) 22 330 83 83

PORTUGAL

General Electric Portuguesa SA
SA. Avenida do Forte, n° 6-6A
Edificio Ramazzotti, 2790-072 Carnaxide
TEL: (+351) 21 425 1300 FAX: (+351) 21 425 1343

RUSSIA

GE Healthcare
12th floor, 10C, Presnenskaya nab.
Moscow 123317 Russia
TEL: (+7) 495 739 69 31 FAX: (+7) 495 739 69 32

SPAIN

GE Healthcare España
C/ Gobelos 35-37
28023 Madrid
TEL: (+34) 91 663 2500 FAX: (+34) 91 663 2501

SWEDEN

GE Healthcare Sverige AB
FE 314, SE-182 82 Stockholm, Sweden
TEL: (+46) 8 559 50010

SWITZERLAND

GE Medical Systems (Schweiz) AG
Europastrasse 31,
8152 Glattbrugg
TEL: (+41) 1 809 92 92 FAX: (+41) 1 809 92 22

TURKEY

GE Healthcare Türkiye
Istanbul Office
Levent Ofis
Esentepe Mah. Harman Sok.
No:8 Sisli-Istanbul
TEL: +90 212 398 07 00 FAKS: +90 212 284 67 00

**UNITED ARAB
EMIRATES (UAE)**

GE Healthcare Holding ME SA
Dubai Internet City, Building No. 18
P. O. Box # 11549, Dubai
U.A.E
TEL: (+971) 4 429 6161
FAX (+971) 4 429 6200/01/02

UNITED KINGDOM

GE Medical Systems Ltd
Pollards Wood
Nightingales Lane
Chalfont St Giles, Buckinghamshire HP8 4SP
TEL: (+44) 1494 544000, FAX: (+44) 1707 289742

Manufacturer



GE Vingmed Ultrasound AS
Strandpromenaden 45
3191 Horten, Norway
Tel.: (+47) 3302 1100

Chapter 2

Safety

Describes the safety and regulatory information pertinent to operating this ultrasound system as well as procedures for simple care and maintenance of the system.

'Safety Precautions' on page 2-2

'Owner responsibility' on page 2-3

'Acoustic output' on page 2-4

'Important safety considerations' on page 2-11

'Device labels' on page 2-27.

Safety Precautions

Precaution Levels

Icon description

Various levels of safety precautions may be found on the equipment, and different levels of severity are identified by one of the following icons that precede precautionary statements in the text.



Indicates that a specific hazard is known to exist which through inappropriate conditions or actions may cause:

- Severe or fatal personal injury



Indicates that a specific hazard is known to exist which through inappropriate conditions or actions may cause:

- Severe personal injury



Indicates that a potential hazard may exist which through inappropriate conditions or actions may cause:

- Minor injury or discomfort

NOTE: *Indicates precautions or recommendations that should be used in the operation of the ultrasound system, specifically:*

- Maintaining an optimum system environment
- Using this Manual
- Notes to emphasize or clarify a point

Owner responsibility

NOTE: *For USA only: Federal law restricts this device to sale by or on the order of a physician.*

It is the responsibility of the owner to ensure that anyone operating the system reads and understands this section of the manual. However, there is no representation that the act of reading this manual renders the reader qualified to operate, inspect, test, align, calibrate, troubleshoot, repair, or modify the system. The owner should make certain that only properly trained, fully-qualified service personnel undertake the installation, maintenance, troubleshooting, calibration, and repair of the equipment.

The owner of the ultrasound system should ensure that only properly trained, fully qualified personnel are authorized to operate the system. Before authorizing anyone to operate the system, it should be verified that the person has read, and fully understands, the operating instructions contained in this manual. It is advisable to maintain a list of authorized operators.

Should the system fail to operate correctly, or not respond to the commands described in this manual, the operator should contact GE Service.

For information about specific requirements and regulations applicable to the use of electronic medical equipment, consult local, state, and federal agencies.

Notice against user modification

Never modify this product, including system components, software, cables, etc. User modification may cause safety hazards and degradation in system performance. All modification must be done by a GE qualified person.

Acoustic output

Definition of the acoustic output parameters

Thermal Index

TI is an estimate of the temperature increase of soft tissue or bone. There are three thermal index categories:

- TIS: Soft tissue thermal index. The main TI category. Used for applications that do not image bone.
- TIB: Bone thermal index (bone located in a focal region). Used for fetal application.
- TIC: Cranial bone thermal index (bone located close to the surface). Used for transcranial application.

The Vivid S70N / S60N has an internal limit of 3.0 on TI for the chosen index category.

Mechanical Index

MI is the estimated likelihood of tissue damage due to cavitation. The absolute maximum regulatory limit of the MI is 1.9 as set by the FDA 510(k) guidance of June 27, 2019.

The maximum MI values obtainable with Vivid S70N / S60N in relevant operating modes, and with available ultrasound probes, are found in the Reference manual.

Ispta

The Ispta is the Spatial Peak Temporal Average Intensity. The absolute maximum regulatory limit of Ispta is 720 mW/cm^2 as set by the FDA 510(k) guidance of June 27, 2019.

Acoustic output and display on the Vivid S70N / S60N

In the title bar, two fields are allocated for the display of power values as shown in Figure 2-1.



1. Title bar
2. MI
3. TI

Figure 2-1. The display of MI and TI on the screen

The Vivid S70N / S60N chooses the correct category based on mode of operation and chosen application, and presents the relevant TI category to the operator. It is therefore important that the operator chooses the correct application. The system also provides the ability to select the display of any of the TI categories regardless of the current application.

The British Medical Ultrasound Society has suggested some maximum scanning times relative to displayed TI as follows:

Obstetric scanning		
TI	time	Note
0.0–0.7	Unlimited	Monitor TIS up to 10 weeks post LMP, TIB thereafter
0.7–1.0	< 60 min	
1.0–1.5	< 30 min	
1.5–2.0	< 15 min	
2.0–2.5	< 4 min	
2.5–3.0	< 1 min	

Neonatal trans-cranial & spinal scanning		
TI	time	Note
0.0–0.7	Unlimited	Monitor TIC. MI>0.7 should be used with caution in the presence of contrast agents.
0.7–1.0	< 60 min	
1.0–1.5	< 30 min	
1.5–2.0	< 15 min	
2.0–2.5	< 4 min	
2.5–3.0	< 1 min	

Neonatal general and cardiac scanning		
TI	time	Note
0.0–1.0	Unlimited	Monitor TIB. MI>0.7 should be used with caution in the presence of contrast agents.
1.0–1.5	< 120 min	
1.5–2.0	< 60 min	
2.0–2.5	< 15 min	
2.5–3.0	< 4 min	

Adult trans-cranial scanning		
TI	time	Note
0.0–1.0	Unlimited	Monitor TIC. MI>0.7 should be used with caution in the presence of contrast agents.
1.0–1.5	< 30 min	
1.5–2.0	< 15 min	
2.0–2.5	< 4 min	
2.5–3.0	< 1 min	

General Abdominal, Peripheral Vascular and other scanning (excluding the eye)		
TI	time	Note
0.0–1.0	Unlimited	Monitor TIB or TIC if bone closer than 1 cm, TIS if no bone is in the image. MI>0.7 should be used with caution in the presence of contrast agents.
1.0–1.5	< 120 min	
1.5–2.0	< 60 min	
2.0–2.5	< 15 min	
2.5–3.0	< 4 min	

NOTE: *The Vivid S70N / S60N does not monitor the duration of thermal exposure.*

References

- The British Medical Ultrasound Society. Guidelines for the safe use of diagnostic ultrasound equipment.
- American Institute of Ultrasound in Medicine Consensus Report on Potential Bioeffects of Diagnostic Ultrasound.

The maximum possible MI and Ispta on the Vivid S70N / S60N is within the limits set in Track 3 in the FDA 510(k) guide of June 27, 2019, MI < 1.9 and Ispta < 720 mW/cm².

ALARA

Ultrasound procedures should be performed using output levels and exposure times As Low As Reasonably Achievable (ALARA) while acquiring clinical information.

Training

During each ultrasound examination the user is expected to weigh the medical benefit of the diagnostic information that would be obtained against the risk of potentially harmful effects. Once an optimal image is achieved, the need for increasing acoustic output or prolonging the exposure cannot be justified. It is recommended that all users receive proper training in applications before performing them in a clinical setting. Contact the GE sales representative for training assistance.

Safety statement

GE safety statement

Although no harmful biological effects have been demonstrated for ultrasound frequencies, intensities, or exposure times used in examination with the GE system, GE recommends using the lowest acoustic output settings which will produce diagnostically acceptable information.

System controls affecting acoustic output

The operator controls that directly affect the acoustic output are discussed in the Acoustic Output Data Tables in the Reference Manual. These tables show the highest possible acoustic intensity for a given mode, obtainable only when the maximum combination of control settings is selected. Most settings result in a much lower output. It is important to note the following:

- The duration of an ultrasound examination is as important as the acoustic output, since patient exposure to output is directly related to the exposure time.
- Better image quality yields faster clinical results, making it possible to complete the relevant ultrasound examination more rapidly. Therefore, any control that improves the quality of the examination can help to reduce patient exposure, even though it may not directly affect acoustic output.

Probe selection

As long as the appropriate application is available, any probe can be used with the knowledge that the intensities fall at, or below, those stated in the Acoustic Output Data Tables. The duration of patient exposure is most likely minimized with the use of a probe that is optimized to provide resolution and focal depth, appropriate to the examination.

Application selection

Selecting the probe and application preset appropriate to a particular ultrasound examination automatically provides acoustic output limits within FDA guidelines for that application. Other parameters which optimize performance for the selected application are also set automatically, and should assist in reducing the patient exposure time. See 'Connect and disconnect probes' on *page 3-27*, for information on selecting probes and application presets.

Changing imaging modes

Acoustic output depends on the imaging mode selected. The choice of mode (2D, M-Mode, Doppler or Color Flow) determines whether the ultrasound beam is stationary or in motion. This greatly affects the energy absorbed by the tissue.

See 'Image Optimization' on *page 5-1*, for complete information on changing imaging modes.

When operating in a combined mode, such as 2D and M-Mode, the total acoustic output comprises contributions from each individual mode. Depending on the modes in use, either or both output indices may be affected.

The user can override the default settings, but care should be taken to observe the displayed MI and TI values.

Power

It is possible to change the power in all operating modes so that the operator can use the ALARA principle.

OB Exam

Exam Preparation

Prior to an ultrasound examination, the patient should be informed of the clinical indication, specific benefits, potential risks, and alternatives, if any. In addition, if the patient requests information about the exposure time and intensity, it should be provided. Patient access to educational materials regarding ultrasound is strongly encouraged to supplement the information communicated directly to the patient. Furthermore, these examinations should be conducted in a manner and take place in a setting which ensures patient dignity and privacy:

- Prior material knowledge and approval of the presence of nonessential personnel with the number of such personnel kept to a minimum.
- An intent to share with the parents per the physician's judgment, either during the examination or shortly hereafter, the information derived.
- An offer of choice about viewing the fetus.
- An offer of choice about learning the sex of the fetus, if such information becomes available.

Ultrasound examinations performed solely to satisfy the family's desire to know the fetal sex, to view the fetus, or to obtain a picture of the fetus should be discouraged.

Important safety considerations

This section includes considerations for the following:

- 'Patient safety' on *page 2-11*
- 'Personnel and equipment safety' on *page 2-14*
- 'Electromagnetic Compatibility (EMC)' on *page 2-20*
- 'Environmental protection' on *page 2-26*

The information contained in this section is intended to familiarize the user with the hazards associated with the use of the system, and to alert them to the extent to which injury and damage may occur if the precautions are not observed.

Users are obligated to familiarize themselves with these safety considerations and to avoid conditions that could result in injury or damage.

Patient safety

Patient identification



The concerns listed in this section can seriously affect the safety of the patient undergoing a diagnostic ultrasound examination.

Always include proper identification with all patient data and verify the accuracy of the patient's name and/or identity number when entering such data. Ensure that the correct patient ID is provided on all recorded data and hard copy prints. Identification errors could result in an incorrect diagnosis.

Diagnostic information

The images and calculations provided by the system are intended as a diagnostic tool for competent users. They are explicitly not to be regarded as the sole, irrefutable basis for clinical diagnosis. Users are encouraged to study the literature and reach their own professional conclusions regarding the clinical utility of the system.



The system provides calculations (e.g. estimated fetal weight) and charts based on published scientific literature. The selection of the appropriate chart and clinical interpretation of calculations and charts is the sole responsibility of the user. The user must consider contraindications for the use of a calculation or chart as described in the scientific literature. The diagnosis, decision for further examinations, and medical treatment must be performed by qualified personnel following good clinical practice.

The user should be aware of the product specifications and system accuracy and stability limitations. These limitations must be considered before making any decision based on quantitative values. If in doubt, consult the nearest GE Ultrasound Service Office.

Equipment malfunction or incorrect settings can result in measurement errors or failure to detect details in the image. The user must become thoroughly familiar with the operation of the system in order to optimize its performance and to recognize possible malfunctions. Application training is available through the sales representative.

NOTE: Be certain to ensure the privacy of patient information.

Mechanical hazards



Damaged probes or improper use and manipulation of the transesophageal probe may result in injury or increased risk of infection. Inspect probes frequently for sharp, pointed, or rough surface damage that could cause injury or tear protective barriers (gloves and sheaths). Never use excessive force when manipulating intracavity probes. Become familiar with all instructions and precautions provided with special purpose probes.



Observe probe immersion levels (see Figure 13-6 on page 13-29).

Inspect probes for sharp edges or rough surfaces that could injure sensitive tissue.

DO NOT bend or pull the cable forcefully, to avoid mechanical shock or impact to the probe.



Ultrasound transducers are sensitive instruments which can easily be damaged by rough handling. Take extra care not to drop transducers and avoid contact with sharp or abrasive surfaces. A damaged housing, lens, or cable can result in patient injury or serious impairment of operation.

Transesophageal probe safety



Never use excessive force when manipulating intracavity probes. Become familiar with all instructions and precautions provided with special purpose probes.

Electrical Hazard



A damaged probe may increase the risk of electric shock if conductive solutions come in contact with internal live pads. Inspect probes often for cracks or openings in the housing and holes in and around the acoustic lens, or other damage that could allow moisture to enter. Become familiar with the probe's use and care precautions outlined in 'Probes' on page 13-1.



Ultrasound can produce harmful effects in tissue and potentially result in patient injury. Always minimize exposure time and keep ultrasound levels low when there is no medical benefit. Use the principle of ALARA (As Low As Reasonably Achievable), increasing output only when needed to obtain diagnostic image quality. Observe the acoustic output display and be familiar with all controls affecting the output level. See the Bioeffects section of the Acoustic Output chapter in the Advanced Reference Manual for more information.

The system and Electrosurgical units



This equipment provides no special means of protection from high frequency (HF) burns that may result from using an electrosurgical unit (ESU). To reduce the risk of HF burns, avoid contact between the patient and ultrasound transducer or ECG electrodes while operating the ESU. Where contact cannot be avoided, as in the case of TEE monitoring during surgery, make sure the transducer or ECG electrodes are not located between the ESU active and dispersive electrodes and keep the ESU cables away from the transducer or ECG cables

Defibrillation



Make sure that nobody touches the connector of any probe remaining in the patient during defibrillation and that the connector is not in direct contact with any conductive material during defibrillation.



Remove any sensors on the patient other than the ECG before defibrillation.



Disconnect probes remaining in the patient from the system before defibrillation.

System malfunction



Any electronic device can fail without warning signs, therefore the user is advised to follow local clinical practice guidelines for having a backup imaging plan when performing time-critical image-guided examinations and interventions.

Personnel and equipment safety

The hazards listed below can seriously affect the safety of personnel and equipment during a diagnostic ultrasound examination.

General hazard



Only approved and recommended peripherals and accessories should be used.

All peripherals and accessories must be securely placed to avoid fall damage, and must not be placed within reach of the patient.



Do not use this equipment if a safety problem is known to exist. Have the system repaired and performance verified by qualified service personnel before returning to use.



In certain settings, the system may emit a low volume high pitched noise from the electronics which a small subset of users may be able to sense and which may cause discomfort, headache and/or hearing sensations. To reduce this, consider modifying the settings, moving the scanner further away from the user, and using hearing protection.

Explosion hazard



Never operate the equipment in the presence of flammable or explosive liquids, vapors, or gases. Malfunctions in the system or sparks generated by fan motors can electrically ignite these substances. Operators should be aware of the following points to prevent such explosion hazards.

- If flammable substances are detected in the environment, do not plug in or turn on the system.
- If flammable substances are detected after the system has been turned on, do not attempt to turn off the system, or to unplug it.
- If flammable substances are detected, evacuate and ventilate the area before turning off the system.

Electrical hazard



The internal circuits of the system use high voltages, capable of causing serious injury or death by electrical shock.

NOTE: *Any rest energy within our scanners or their components will be below 60 V DC or 2 mJ.*

To avoid injury

- Do not remove the system's protective covers. No user-serviceable parts are inside. If servicing is required, contact qualified technical personnel.
- Connect the attachment plug to a hospital-grade grounding outlet to ensure adequate grounding.
- Do not place liquids on or above the system. Conductive fluids seeping into the active circuit components may cause short circuiting, which could result in an electrical fire.
- An electrical hazard may exist if any light, monitor, or visual indicator remains on after the system is turned off.

Fuses blown within 36 hours of being replaced may indicate a malfunctioning electrical circuit within the system. In this event, the system must be checked by GE Ultrasound service personnel. No attempt should be made to replace the fuses with others of a higher rating.

Moving hazard



The ultrasound system weighs approximately 75 Kg (165 lb.).

Special care must be used to avoid injury when moving or transporting the system.

- Always be sure the pathway is clear.
- Limit the speed of movement to a careful walk.
- Use at least two people when moving the system on inclines.

Ensure that the system is well prepared before transporting. Refer to 'Moving and transporting the system' on *page 3-49* for more information.

Biological hazard



CAUTION

For patient and personnel safety, beware of biological hazards while performing transesophageal procedures. To avoid the risk of disease transmission:

- Use protective barriers (gloves and probe sheaths) whenever necessary. Follow sterile procedures as required.
- Thoroughly clean and disinfect probes after each patient examination. Refer to Chapter 'Probes' on *page 13-1*, for probe use and care instructions.
- Reusable accessories should be cleaned and disinfected or sterilized as stated by the manufacturer, after each patient.
- Follow all in-house infection control policies as they apply to personnel and equipment.

Pacemaker hazard

The possibility of the system interfering with pacemakers is minimal. However, as this system generates high frequency electrical signals, the operator should be aware of the potential hazard this could cause.

Electrical safety

Device classifications

See 'Classifications' on *page i-4* for more information.

Peripheral devices



DANGER

If externally powered equipment supplied by GEHC is electrically connected to the scanner ME Equipment, an ME System is formed. Only items that have been specified as part of the ME System or have been specified as compatible with the ME System should be connected.

All GEHC supplied equipment which is externally powered and connects to the scanner shall be placed outside the patient environment (as defined by IEC/EN60601-1 Clause 16.2.c).



DANGER

Use only GE Healthcare approved internal equipment when replacing an *internal* peripheral.

External peripheral equipment must be in compliance with related IEC/EN standards for safety. The electrical medical systems conformance to IEC/EN60601-1 Clause 16 must be verified.

All non-medical electrical equipment must be kept outside of the patient environment, as defined in IEC/EN60601-1, unless it is equipped with additional protective earth or extra separating transformer. Commercial devices such as laser cameras, printers, VCRs and external monitors, usually exceed allowable leakage current limits per IEC/EN60601-1 and, when plugged into separate AC outlets, are in violation of patient safety standards. Suitable electrical isolation of such external AC outlets, or providing the device with extra protective earth, will be required in order to meet IEC/EN60601-1 Clause 16 standards for electrical leakage currents.

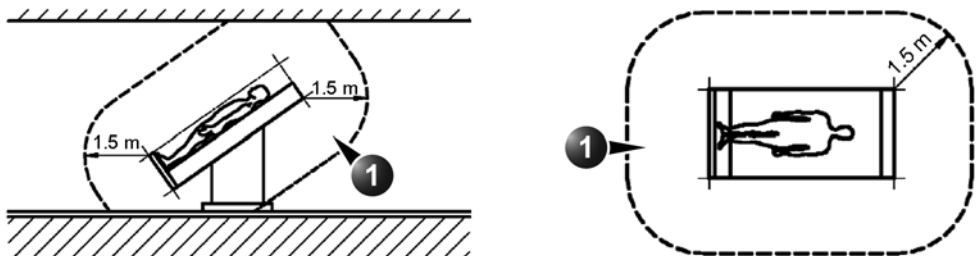

1. Patient environment

Figure 2-2. Example of patient environment

Internally connected peripheral devices

The system, together with peripheral devices, such as video printer, meets ANSI AAMI ES60601-1 and IEC/EN 60601-1 standards for electrical isolation and safety. These standards are applicable only when the specified peripheral devices are plugged into the AC outlets provided on the system.

External Connection of other peripheral devices



DANGER

External devices can be used only if CE marked and in compliance with related IEC or ISO Safety standards. Conformance to IEC/EN60601-1 Clause 16 requirements for Medical Electrical systems must be verified.

Accessory equipment connected to the analog and digital interfaces must be certified according to the respective IEC or ISO Safety standards (e.g. IEC/EN62368-1 or IEC/EN60950-1 for data processing equipment or IEC/EN60601-1 for medical equipment). Furthermore all complete configurations shall comply with the requirements for Medical Electrical systems of IEC/EN60601-1. Anybody connecting additional equipment to the signal input part or signal output part of the ultrasound system configures a medical electrical system, and is therefore responsible that the system complies with the requirements of the IEC/EN60601-1 Clause 16. If in doubt, consult the technical service department or your local GE representative.



WARNING

Any devices or cables, other than those sold with the ultrasound system, connected to the Peripheral /accessory connector panel or to an USB port on the system may result in an increase of the electromagnetic emission from the system, or a decrease of the electromagnetic immunity of the system.



CAUTION

When using peripheral device, observe all warnings and cautions given in peripheral operator manuals.

Allergic reactions to latex-containing medical devices



CAUTION

Contact with natural rubber latex may cause a severe anaphylactic reaction in persons sensitive to the natural latex protein. Sensitive users and patients must avoid contact with these items.

Due to reports of severe allergic reactions to medical devices containing latex (natural rubber), the FDA advises healthcare professionals to identify latex-sensitive patients, and be prepared to treat allergic reactions promptly. Latex is a component of many medical devices, including surgical and examination gloves, catheters, incubation tubes, anesthesia

masks, and dental dams. Patient reaction to latex has ranged from contact urticaria to systemic anaphylaxis.

For more details regarding allergic reaction to latex, refer to *FDA Medical Alert MDA91-1*, March 29.

Electromagnetic Compatibility (EMC)

NOTE: *This system carries the CE mark. It complies with regulatory requirements of the European Regulation 2017/745 concerning medical devices. It also complies with emission limits for a Group 1, Class A Medical Device as stated in EN 60601-1-2 (IEC 60601-1-2).*

NOTE: *The emissions characteristics of this equipment make it suitable for use in industrial areas and hospitals, e.g. professional healthcare environment (CISPR 11 class A). If it is used in a residential environment (for which CISPR 11 class B is normally required) this equipment might not offer adequate protection to radio-frequency communication services. The user might need to take mitigation measures, such as relocating or re-orienting the equipment.*

Electrical medical equipment requires special precautions regarding EMC and must be installed and implemented according to the EMC information provided in this manual.

All types of electronic equipment may characteristically cause electromagnetic interference with other equipment, transmitted either through air or connecting cables. The term Electromagnetic Compatibility (EMC) indicates the capability of the equipment to curb electromagnetic influence from other equipment, while at the same time not affecting other equipment with similar electromagnetic radiation.

Radiated or conducted electromagnetic signals can cause distortion, degradation, or artifacts in the ultrasound image which may impair the ultrasound system's essential performance (see page 2-26).

There is no guarantee that interference will not occur in a particular installation. If this equipment is found to cause or

respond to interference, attempt to correct the problem by one or more of the following measures:

- Re-orient or re-locate the affected device.
- Increase the separation between the system and the affected device.
- Power the equipment from a source other than that of the affected device.
- Consult your service representative for further suggestions.

The manufacturer is not responsible for any interference or response caused by the use of interconnecting cables other than those recommended or by unauthorized changes or modifications to this system. Unauthorized changes or modifications could void the user's authority to operate the equipment.

To comply with the regulations on electromagnetic interference, all interconnecting cables to peripheral devices must be shielded and properly grounded. Use of cables not properly shielded and grounded may result in the equipment causing or responding to radio frequency interference, in violation of the European Union Medical Device Regulation and FCC regulations.

Interference caution



CAUTION

Use of devices that transmit radio waves near the system could cause it to malfunction.

Before installing or using the system, be aware of the proximity of known radio frequency (RF) sources, such as:

- Radio and TV stations
- Portable and mobile RF communication devices (cell phones including 5G communication, two-way radios)
- Fixed RF communication devices including RFID (Radio-frequency identification), EAS (electronic article surveillance), and Wireless power transfer (WPT)
- High-frequency surgical units, such as diathermy, electrocautery, argon beam coagulators, etc.
- X-ray, CT, or MRI devices

These devices are also possible sources of interference as they may emit higher levels of electromagnetic radiation.

Devices which intrinsically transmit radio waves, such as cellular phones, radio transceivers, mobile radio transmitters, radio-controlled toys, etc., should preferably not be operated near the system.

Medical staff in charge of the system are required to instruct technicians, patients, and other people who may be around the system to fully comply with the above recommendations.

Any electrical device can unintentionally emit electromagnetic waves. However, minimum device separation distances cannot be calculated for such unspecified radiation. When the ultrasound system is used adjacent to or in close proximity to other equipment the user should be attentive to unexpected device behavior which may be caused by such radiation.

The ultrasound system is intended for use in the electromagnetic environment specified in the tables below.

The user of the ultrasound system should ensure that the device is used in such an environment.



The use of accessories, transducers and cables other than those specified, with the exception of transducers and cables sold by the manufacturer of the Vivid S70N / S60N as replacement parts for internal components, may result in increased electromagnetic emissions or decreased electromagnetic immunity of the Vivid S70N / S60N.



The Vivid S70N / S60N should not be used adjacent to or stacked with other equipment and that if adjacent or stacked use is necessary, the Vivid S70N / S60N should be observed to verify normal operation in the configuration in which it will be used.



Portable RF communications equipment (including peripherals such as antenna cables and external antennas) should be used no closer than 30 cm (12 inches) to any part of the Vivid S70N / S60N series system, including cables specified by the manufacturer. Otherwise, degradation of the performance of this equipment could result.

Electromagnetic emissions

The Vivid S70N / S60N is intended for use in the electromagnetic environment specified below. The customer or the user of the Vivid S70N / S60N should ensure that it is used in such an environment.

Guidance and manufacturer's declaration – electromagnetic emissions.		
Emissions test	Compliance	Electromagnetic environment - guidance
RF emission CISPR 11	Group 1	The ultrasound system uses RF energy only for its internal function. Therefore, its RF emissions are very low and are not likely to cause any interference in nearby electronic equipment.
RF emission CISPR 11 EN55011	Class A	This system is suitable for use in all establishments, other than domestic establishments and those directly connected to the public low-voltage power supply network that supplies buildings used for domestic purposes, provided the following warning is heeded: Warning: This system is intended for use by healthcare professionals only. This system may cause radio interference or disrupt the operation of nearby equipment. It may be necessary to take mitigating measures, such as re-orienting or relocating the system or shielding the location.
Harmonic emission IEC 61000-3-2	Class A	
Voltage fluctuations/flicker emissions IEC 61000-3-3	Without additional conditions	

Electromagnetic immunity

The Vivid S70N / S60N is intended for use in the electromagnetic environment specified below. The customer or the user of the Vivid S70N / S60N should ensure that it is used in such an environment,

Guidance and manufacturer's declaration - electromagnetic immunity.			
Immunity test	IEC 60601-1-2 test level	Compliance level	Electromagnetic environment - guidance
Electrostatic discharge (ESD) IEC 61000-4-2	±8 kV contact ±15 kV air (max)	±8 kV contact ±15 kV air (max)	Floors should be wood, concrete or ceramic tile. If floors are covered with synthetic material, the relative humidity should be at least 30%.

Guidance and manufacturer's declaration - electromagnetic immunity.			
Immunity test	IEC 60601-1-2 test level	Compliance level	Electromagnetic environment - guidance
Electrical transients/ bursts IEC 61000-4-4	± 2 kV for power-supply lines ± 1 kV for input/output lines 100 kHz Repetition Frequency	± 2 kV for power-supply lines ± 1 kV for input/output lines 100 kHz Repetition Frequency	Mains power quality should be that of a typical commercial or hospital environment
Surge IEC 61000-4-5	± 1 kV line(s) to line(s) ± 2 kV line(s) to earth 0, 90, 180, 270 phase angles	± 1 kV line(s) to line(s) ± 2 kV line(s) to earth 0, 90, 180, 270 phase angles	Mains power quality should be that of a typical commercial or hospital environment.
Voltage dips, short interruptions, and voltage variations on power supply input lines IEC 61000-4-11	0 % U_T ; 0,5 cycle At 0°, 45°, 90°, 135°, 180°, 225°, 270°, and 315° 0 % U_T ; 1 cycle 70% U_T ; 25/30 cycles Single phase: at 0° 0 % U_T ; 250/300 cycles	Compliance for all test levels. Controlled shutdown with return to pre-disturbance condition after operator's intervention. (Power-on switch)	Mains power quality should be that of a typical commercial or hospital environment. If the user of the ultrasound system requires continued operation during power mains interruptions, it is recommended that the ultrasound system is powered from an uninterruptible power supply or a battery.
Power frequency (50/60 Hz) magnetic field IEC 61000-4-8	30 A/m 50 Hz or 60 Hz	30 A/m 50 and 60Hz	Power frequency magnetic fields should be at levels characteristic of a typical location in a typical commercial or hospital environment.
NOTE: U_T is the a. c. mains voltage prior to application of the test level.			

Guidance and manufacturer's declaration - electromagnetic immunity.		
Immunity test	IEC 60601-1-2 test level	Compliance level
Conducted RF IEC 61000-4-6	3 Vrms 150 kHz to 80 MHz	3 Vrms 150 kHz to 80 MHz
Radiated RF and Proximity fields from RF wireless communications equipment IEC 61000-4-3	3 V/m; 80 MHz to 2.7 GHz 80% AM at 1 kHz	3 V/m; 80 MHz to 2.7 GHz 80% AM at 1 kHz
	385 MHz (18 Hz Pulse Modulation)	27 V/m
	450 MHz (FM +/- 5 kHz deviation 1 kHz sine or 18 Hz Pulse Modulation)	28 V/m
	710 MHz (217 Hz PM)	9 V/m
	745 MHz (217 Hz PM)	9 V/m
	780 MHz (217 Hz PM)	9 V/m
	810 MHz (18 Hz PM)	28 V/m
	870 MHz (18 Hz PM)	28 V/m
	930 MHz (18 Hz PM)	28 V/m
	1720 MHz (217 Hz PM)	28 V/m
	1845 MHz (217 Hz PM)	28 V/m
	1970 MHz (217 Hz PM)	28 V/m
	2450 MHz (217 Hz PM)	28 V/m
	5240 MHz (217 Hz PM)	9 V/m
	5500 MHz (217 Hz PM)	9 V/m
5785 MHz (217 Hz PM)	9 V/m	
NOTE: Electromagnetic propagation is affected by absorption and reflection from structures, objects and people.		

Essential performance

The essential performance of the ultrasound system is:

- the ability to display physiological images as input for diagnosis by trained physician.
- the ability to display physiological traces as aid for diagnosis by trained physician.
- the ability to display quantified data as input for diagnosis by trained physician.
- the display of ultrasound indexes as aid for safe use of the system.
- the display of probe surface temperature as aid for safe use of the system (Probe dependent).

Environmental protection

System and battery disposal

The USER/SERVICE staff should dispose of all the waste properly, per federal, state, and local waste disposal regulations.

Regulations vary for different countries. Dispose of a used battery in accordance with local regulations.





NOTE: Used batteries should not be placed with common household waste products. Contact local authorities for the location of a chemical waste collection program nearest you.













Please contact the manufacturer or other authorized disposal company to decommission your equipment.











Device labels

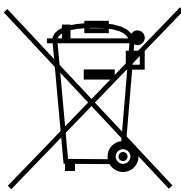







The following table describes the purpose and location of safety labels and other important information provided on the equipment.

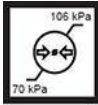

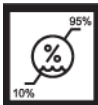
Symbols

Label	Purpose	Location	Standard
Identification Plate	Manufacturer's name and address Model Device Listing/Certification Labels	Rear	N/A- by GE Healthcare
	GE Logo	Various	N/A- by GE Healthcare
	On/off button Warning: System shutdown using the On/Off button does not disconnect the ultrasound system from mains voltage. For disconnecting the ultrasound system from mains voltage after system shutdown, please set the circuit breaker close to the mains inlet to OFF as described on page 3-23.	Control panel	IEC 60417-5010
	Equipment Type BF, in which protection against electric shock does not rely on basic insulation only. Provides additional safety precautions such as double insulation or reinforced insulation, because there is no provision for protective earthing or reliance upon installation conditions.	Probes / Rear of system	IEC 60417-5333
	Defibrillator-proof Type CF equipment.	ECG connector	IEC 60417-5336

Label	Purpose	Location	Standard
	Indicates that the product is in compliance with all relevant European Directives and Regulations, and under surveillance by Notified Body 0123.	Rear of system	N/A- by certification body
	For USA only: Caution: Federal law restricts this device to sale by or on the order of a physician.	Rear of system	N/A- by GE Healthcare
	TUV SÜD NRTL Certification Mark.	Rear of system	N/A- by certification body
	GOST-R Mark: per Law of the Russian Federation No. 184-FZ.	Rear of system	N/A- by certification body
	Non-ionizing electromagnetic radiation.	Rear of system	IEC 60417-5140
	Alternating current	Various	IEC 60417-5032
	Protective earth (ground)	Internal	IEC 60417-5019
	Equipotentiality: Indicates terminal to be used for connecting equipotential conductors when interconnecting (grounding) with other equipment as described in IEC/EN 60601-1.	Rear of system	IEC 60417-5021
	Follow instructions for use. Read and understand all instructions in the User's Manual before attempting to use the ultrasound system.	Rear of system	ISO 7010-M002
	Symbol indicating that the Instructions for Use are supplied in electronic form and visually displayed on the console.	Rear of system	N/A- by GE Healthcare
	CAUTION - Dangerous voltage: Used to indicate electric shock hazards.	Rear of system	ISO 7010-W012
	Attention - Consult accompanying documents: Alerts the user to refer to the user documentation when complete information cannot be provided on the label.	Various	ISO 7010-W001
	The system is not designed for use with flammable anesthetic gases.	Rear of system	N/A- by GE Healthcare

Label	Purpose	Location	Standard
	CAUTION - Do not push the system sideways when casters are in break position. Instability may occur.	Top console (both sides)	ISO 7010-P017
	DO NOT place objects on the surface of the rear of the main display while folded.	Display rear panel	ISO 7010-P012
	This symbol indicates that the waste of electrical and electronic equipment must not be disposed as unsorted municipal waste and must be collected separately. Please contact the manufacturer or other authorized disposal company to decommission your equipment.	Rear of system Probes (Identification plate)	EN 50419
	System weight	Rear of system	N/A- by GE Healthcare
	Date of manufacture: The date could be a year, year and month, or year, month and day, as appropriate. See ISO 8601 for date formats.	Rear of system	ISO 7000-2497
	Manufacturer name and address	Rear of system	ISO 7000-3082
	Serial number	Rear of system	ISO 7000-2498
	Brand and model identifier	Rear of system	ISO 7000-2493
	Unique Device Identification (UDI). Every system has a unique marking for identification. Scan or enter the UDI information into the patient health record as required by governing laws.	Rear of system	ISO 15223-1
	Device part number identifier	Rear of system	N/A- by GE Healthcare
	Symbol indicates the item is a medical device.	Rear of system Probes	ISO 15223-1
IPX7	Protected against the effects of temporary immersion in water.	Applied parts of probes	IEC 60529
IPX8	Protected against the effects of continuous immersion in water.	Tri-pedal footswitch	IEC 60529

Label	Purpose	Location	Standard
Assembled in XXXXX (XXXXX represents the country name)	Identify the Customs Country of Origin of the materials.	Rear of system	N/A- by GE Healthcare
	To indicate the acceptable upper and lower limits of atmospheric pressure for transport and storage.	Package labeling	ISO 7000-2621
	To identify the temperature limits, for example on transport packaging to indicate limits within which the package has to be kept and handled. The temperature values may be shown adjacent to the symbol.	Package labeling	ISO 7000-0632
	To indicate the acceptable upper and lower limits of relative humidity for transport and storage.	Package labeling	ISO 7000-2620
	On transport packaging. To indicate that the items are not to be vertically stacked.	Package labeling	ISO 7000-2402
	On transport packaging. To indicate the correct upright position.	Package labeling	ISO 7000-0623
	On transport packaging. To indicate that the content of the package is fragile and that the package must be handled with care.	Package labeling	ISO 7000-0621
	On transport packaging. To indicate that the the package must be handled with care.	Package labeling	N/A
	On transport packaging. To indicate that the package must be kept in dry conditions.	Package labeling	ISO 7000-0626
	SGS INMETRO	Rear of system and package labeling	N/A- by certification body

Label	Purpose	Location	Standard
	WARNING - The system is MR Unsafe and should remain outside the MRI scanner room.	Rear of system	ASTM F2503
	This symbol indicates the authorised representative in Switzerland.	Rear of system Probe box labels	Swiss Medical Devices Ordinance 812.213
XDclear™	Product Marketing indicator information	Probes	N/A- by GE Healthcare
	To indicate that the marked item or its material is part of a recovery or recycling process.	Probe packaging boxes and probe box labels.	ISO 7000-1135

For China only

电子信息产品污染控制标志说明 Explanation of Pollution Control Label

根据 SJ/T11364-2014 《电子电气产品有害物质限制使用标识要求》特提供如下有关污染控制方面的信息。

The following product pollution control information is provided according to SJ/T11364-2014 *Marking for Restriction of Hazardous Substances caused by electrical and electronic products*.

标签	说明
	<p>该标志表明本产品含有超过中国标准 GB/T 26572 《电子电气产品中限用物质的限量要求》中限量的有害物质。标志中的数字为本产品的环保使用期，表明本产品在正常使用的条件下，有毒有害物质不会发生外泄或突变，用户使用本产品不会对环境造成严重污染或对其人身、财产造成严重损害的期限。单位为年。</p> <p>为保证所声明的环保使用期限，应按产品手册中所规定的环境条件和方法进行正常使用，并严格遵守产品维修手册中规定的定期维修和保养要求。</p> <p>产品中的消耗件和某些零部件可能有其单独的环保使用期限标志，并且其环保使用期限有可能比整个产品本身的环保使用期限短。应到期按产品维修程序更换那些消耗件和零部件，以保证所声明的整个产品的环保使用期限。</p> <p>本产品在使用寿命结束时不可作为普通生活垃圾处理，应被单独收集妥善处理。</p> <p>This symbol indicates the product contains hazardous materials in excess of the limits established by the Chinese standard GB/T 26572 Requirements of concentration limits for certain restricted substances in electrical and electronic products. The number in the symbol is the Environment-friendly Use Period (EFUP), which indicates the period during which the hazardous substances contained in electrical and electronic products will not leak or mutate under normal operating conditions so that the use of such electrical and electronic products will not result in any severe environmental pollution, any bodily injury or damage to any assets. The unit of the period is "Year".</p> <p>In order to maintain the declared EFUP, the product shall be operated normally according to the instructions and environmental conditions as defined in the product manual, and periodic maintenance schedules specified in Product Maintenance Procedures shall be followed strictly.</p> <p>Consumables or certain parts may have their own label with an EFUP value less than the product. Periodic replacement of those consumables or parts to maintain the declared EFUP shall be done in accordance with the Product Maintenance Procedures.</p> <p>This product must not be disposed of as unsorted municipal waste, and must be collected separately and handled properly after decommissioning.</p>

产品中有害物质的名称及含量 - Vivid S60N / S70N

Table 2-1: Table of Hazardous Substances' Name and Concentration

部件名称 Component Name	有害物质 Hazardous Substances' Name					
	铅 (Pb)	汞 (Hg)	镉 (Cd)	六价铬 (Cr ⁶⁺)	多溴联苯 (PBB)	多溴二苯醚 (PBDE)
超声探头 Ultrasound Probes	X	O	O	X	O	O
TEE 探头 TEE Probes	X	O	O	O	O	O
主显示器 Main display	O	O	O	O	O	O
控制柜 Console Cabinet	X	O	O	X	O	X
卡架 Card Rack	X	O	O	O	O	O
操作板 Operator Panel	X	O	O	O	O	O
数据存储设备 / 打印机 Data Storage Device/Printer	O	O	O	O	O	O
<p>本表格依据 SJ/T 11364 的规定编制。 This table is prepared according to SJ/T 11364.</p> <p>O: 表示该有害物质在该部件所有均质材料中的含量均在 GB/T 26572 规定的限量要求以下 X: 表示该有害物质至少在该部件的某一均质材料中的含量超出 GB/T 26572 规定的限量要求</p> <ul style="list-style-type: none"> • 此表所列数据为发布时所能获得的最佳信息 • 由于缺少经济上或技术上合理可行的替代物质或方案，此医疗设备运用以上一些有毒有害物质来实现设备的预期临床功能，或给人员或环境提供更好的保护效果。 <p>O: Indicates that hazardous substance contained in all of the homogeneous materials for this part is below the limit requirement in GB/T 26572. X: Indicates that t hazardous substance contained in at least one of the homogeneous materials used for this part is above the limit requirement in GB/T 26572.</p> <ul style="list-style-type: none"> • Data listed in the table represents best information available at the time of publication • Applications of hazardous substances in this medical device are required to achieve its intended clinical uses, and/or to provide better protection to human beings and/or to environment, due to lack of reasonably (economically or technically) available substitutes. 						

Chapter 3

Prepare the System for Use

Describes the site requirements, system overview, powering on the system, system positioning/transporting, operator controls, probes, and adjusting the main display.

'Site requirements' on page 3-2

'System Overview' on page 3-9

'Switching On/Off' on page 3-23

'Connect and disconnect probes' on page 3-27

'The Scanning screen' on page 3-33.

'Control Panel' on page 3-36.

'Main display adjustment' on page 3-45.

'Moving and transporting the system' on page 3-49.

Site requirements

Only qualified physicians or ultrasound sonographers should perform scans of patients for medical diagnostic reasons. Request training, if needed. Ensure that unauthorized personnel do not tamper with the system.

Service representatives authorized by GE Ultrasound will unpack and install the system. Do not attempt to install the system alone.



All the warnings in Chapter 'Safety' on *page 2-1*, should be read and understood before operating the system.

To carry out regular preventative maintenance refer to Chapter 'System Care and Maintenance' on *page 15-2*.

Maintain a clean environment. Turn off the circuit breaker before cleaning the system. Refer to 'System Care and Maintenance' on *page 15-2* for cleaning instructions.

The ultrasound system must operate within the proper environment and in accordance with the requirements described in this section. Before using the system, ensure that the requirements are met.

Optimal operation of the system can be obtained by implementing the following requirements:

Power requirements

The ultrasound system uses a separate power outlet for 100–240 VAC, 50/60 Hz.



Operating the system with the wrong voltage range causes damages, voiding the factory warranty.

Operating Environment

Ensure that there is sufficient air flow around the ultrasound system when installed or operated.

Environmental requirements

The ultrasound system requires constant maintenance of its operational environment. Different temperature and humidity requirements are specified for operation, storage and transportation.

Requirement	Temperature	Humidity	Air Pressure
Operational	10–35 °C	30–85%	700–1060 hPa
Storage	-20–60 °C	10–95%	700–1060 hPa
Transport	-20–60 °C	10–95%	700–1060 hPa

NOTE: System may be operated at an altitude of up to 3000 meters.

Electromagnetic interferences

The ultrasound system is approved for use in hospitals, clinics, and other environmentally qualified facilities, in terms of the prevention of radio wave interference. Operation of the system in an inappropriate environment can cause electronic interference to radios and television sets situated near the medical equipment.

Ensure that the system is protected from electromagnetic interferences as follows:

- Operate the system at least 4.5 meters (15 feet) away from equipment that emits strong electromagnetic radiation.
- Shield the system when operating it in the vicinity of radio broadcasting equipment, if necessary.

Connecting the system

A GE-qualified person should perform the initial system installation.

Connecting the ultrasound system involves preliminary checks of the power cord, voltage level, and compliance with electrical safety requirements.

Use only power supply cords, cables, and plugs provided by or designated by GE.

Ensure that the power plug is the proper hospital-grade type (where required).



Ensure that the power cord and plug are intact before use.



The system should be connected to a fixed power socket which has the protective grounding connector. Never use an extension cord or adapter plug.



Failure to provide an adequate earth circuit can cause electrical shock, resulting in serious injury.



Connection of additional protective earth conductors or potential equalization conductors is not necessary in most cases and is only recommended for situations involving multiple equipment in a high-risk patient environment to provide assurance that all equipment is at the same potential and operates within acceptable leakage current limits. An example of a high-risk patient would be a special procedure during which the patient has an accessible conductive path to the heart such as exposed cardiac pacing leads.

Voltage level check

Check the rating label on the rear side of the system (see Figure 3-1).



Check the voltage range indicated on the label:

- 100–240 VAC, 50/60 Hz, 500 VA

At 110 V: 6.4 A

At 115 V: 6.0 A

At 230 V: 3.0 A

Figure 3-1. The rating label location



If the mains supply is not within the specified range, do not connect the system to the power source. Contact your local distributor or the appropriate support resource.

Connecting to the electrical outlet



POWER OUTAGE MAY OCCUR. The ultrasound system requires a dedicated single branch circuit. To avoid circuit overload and possible loss of critical care equipment, make sure you **DO NOT** have other equipment operating on the same circuit.

The system's power must be supplied from a separate, properly rated outlet to avoid risk of fire. Refer to 'Power requirements' on *page 3-2* for rating information.

The power cord should not, under any circumstances, be altered to a configuration rated less than that specified for the current.

Do not use an extension cord or adapter plug.

1. Ensure that the wall outlet is of appropriate type, and that the power switch is turned off.
2. Uncoil the power cable, allowing sufficient slack so that the system can be moved slightly.
3. Attach the power plug to the system and secure it in place by using the retaining clamp.
4. Secure the power plug to the wall outlet.

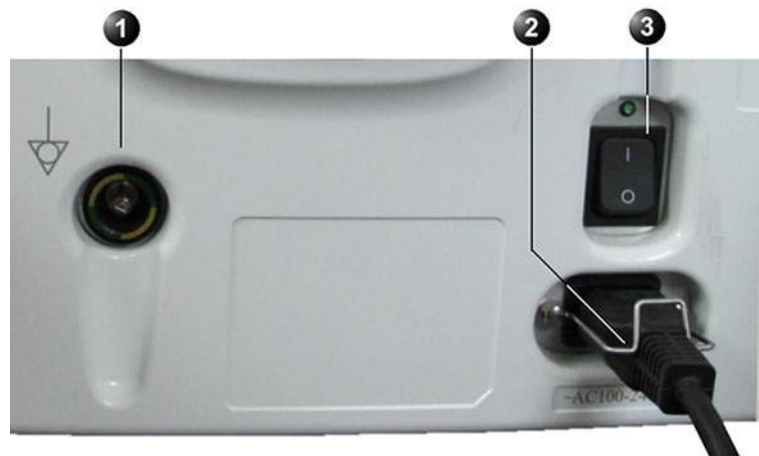

1. Ground socket
2. Retaining clamp for power plug
3. Circuit breaker

Figure 3-2. Power plug



To avoid risk of fire, the system power must be supplied from a separate, properly rated outlet.

Under no circumstances should the AC power plug be altered, changed, or adapted to a configuration rated less than specified. Never use an extension cord or adapter plug.



Ensure that the retaining clamp for the power plug is fixed firmly.



Use caution to ensure that the power cable does not disconnect during system use. If the system is accidentally unplugged and the optional battery is not installed, data may be lost.

To help ensure grounding reliability, connect to a "hospitalgrade" or "hospital only" grounded power outlet.

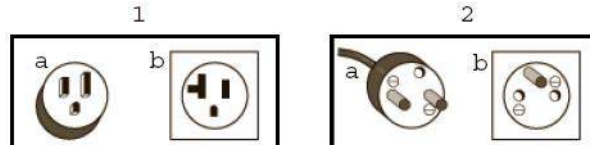

1. 100-120 VAC, 1200 VA Plug and Outlet Configuration
2. 220-240 VAC, 1200 VA Plug and Outlet Configuration

Figure 3-3. Example Plug and Outlet Configurations

Battery

The System contains an internal battery (optional), which is not user-accessible. The internal battery acts as a limited alternative power source, which becomes active when the AC power fails or AC cable is abruptly pulled out.

Display turns off and no scanning is possible while in battery mode.

Battery technology

The lithium ion technology used in the system's battery is significantly less hazardous to the environment than the lithium

metal technology used in some other batteries (such as watch batteries). Used batteries should not be placed with common household waste products. Contact local authorities for the location of a chemical waste collection program nearest you.



NOTE: *The battery may only be disassembled and re-assembled by an authorized field-service engineer.*

NOTE: *The batteries should be replaced every 2 years, or earlier if the system informs that the battery needs replacement.*

Viewing Current Battery Status

When the system is running, a status icon is displayed in the system *Status* bar to indicate the current battery status.

Table 3-1: Battery status icons

Icon	Status Description
	Battery is fully charged (80%-100%)
	Battery is partially charged (40%-80%)
	Battery is almost empty (10%-40%)

NOTE: *The % values mentioned above may fluctuate by up to +/- 3% points.*

View Detailed Battery Status

The status of the battery charge (% charge) appears on the touch panel during **Transportation** mode.

System Overview

Getting to know the system



- | | |
|--|---|
| 1. Main display monitor | 9. Probe connector (RS type for TEE probe) |
| 2. Touch Panel | 10. ECG cable connector |
| 3. Probe and gel holder on both sides of Control Panel | 11. Doppler Pencil Probe Connector |
| 4. Pull-out alphanumeric Keyboard (option) | 12. Probe-cable hooks |
| 5. Front handle | 13. Up/Down & Left/right swivel release lever |
| 6. Probe connectors (DLP type) | 14. Front USB port |
| 7. Probe-cable management tray (removable) | 15. Control Panel |
| 8. Front-wheel with foot-break | 16. Articulated arm for display monitor |

Figure 3-4. Vivid S70N / S60N (front)

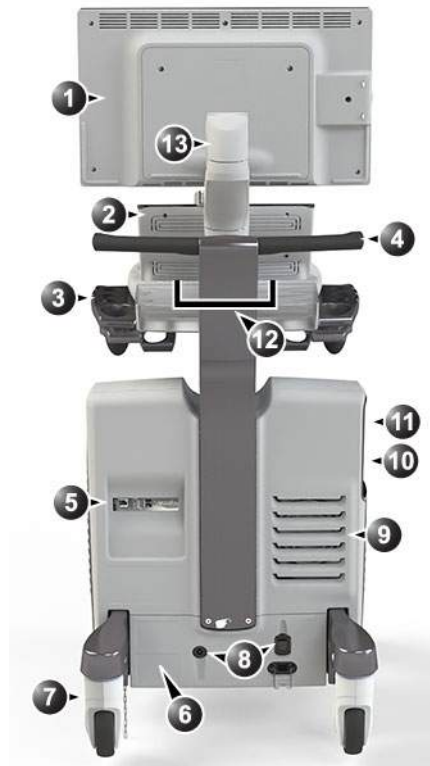

- | | |
|--|---|
| 1. Main display monitor | 8. Circuit-breaker, power and ground connectors |
| 2. Touch Panel | 9. Ventilation port |
| 3. Probe and gel holder on both sides of Control Panel | 10. Black and white video printer (optional) |
| 4. Rear handle | 11. CD/DVD drive (option) |
| 5. Rear I/O connectors panel | 12. Doppler speakers |
| 6. System labels | 13. Articulated arm for display monitor |
| 7. Swivel rear wheels | |

Figure 3-5. Vivid S70N / S60N (rear)

Probe cable hook

The two probe cable hooks located below the Control Panel are intended to keep the probe cables away from the floor and the wheels. Do not use the hooks for other purposes.

Removable media

Intended use

Removable media can be used for the following purposes:

- Long-term image storage: The final destination of the images, after they are moved out of the system harddisk by using the Disk Management feature (see page 10-49).
- Backup of patient database and system configuration presets (see page 10-57)
- Patient archive sneakernet: Copy a set of patient records between a system and EchoPAC Software Only using the Transfer feature (see page 10-41) with removable media.
- DICOM transfer to copy a set of patient records to/from a third party DICOM review station.
- XML export: Exports demographics, measurements, and reporting data from the system to a third party reporting application using removable media (see page 10-41).
- Copy of system configuration presets between two units using the Backup/Restore feature (see page 10-57).
- Save images as JPEG, MPEG, AVI, DICOM, or RawDICOM for review on a regular computer.

Supported removable media

The following removable media are supported:

- CD-R (option)
- DVD-R (option)
- USB Flash card

NOTE: *Archive removable media written from a Vivid S70N / S60N using the 206 software cannot be read by a Vivid S70N / S60N using older software.*

NOTE: *Depending on the system configuration, USB mass storage may be disabled on the system. Enabling/disabling of USB mass storage can only be done by users with administrator rights: Sys Admin or GE Admin users (see 'Local System Users' on page 12-10). When USB mass storage is disabled, the following icon is shown on the status bar:* 



CAUTION

USB Flash card:

- Use only shielded USB Flash cards that are verified for EMC performance according to EN55011/EN55022. The use of other USB Flash cards may cause interference on the system itself or on other electronic devices.

Recommendation concerning CD and DVD handling

To avoid data loss, never touch the recordable surface of a disk. Handle the disk only by the outer edge. Do not place it face down on a hard surface. Fingerprints or scratches will make the disk unusable. Before usage, verify that the disk surface has no visible scratches. If there are any scratches, do NOT use the disk.

Formatting removable media

To format removable media:

1. Insert the media in the drive.
2. Press **Utility/Config** on the Touch Panel.
3. If required, log on to the system.
4. Select the category **Connectivity** and select the sheet **Tools** (Figure 3-6).

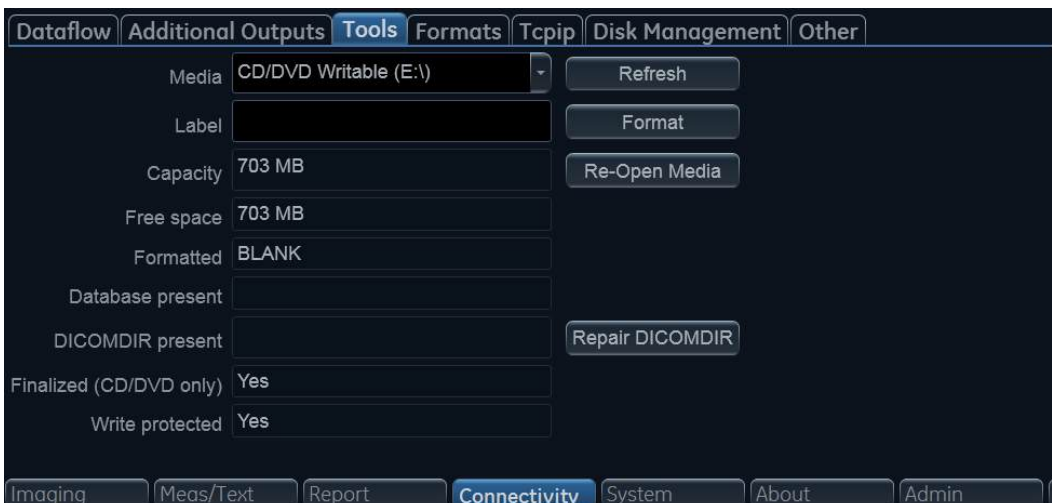

Figure 3-6. The Tools sheet

5. Select the removable media from the *Media* drop-down menu (CD-R, DVD-R or USB device).

NOTE: Select **Refresh** if the media does not appear on the list.

6. Enter a name for the removable media in the *Label* field.

NOTE: Only the following characters and signs can be used when labeling a media: A - Z, a - z, 0 - 9, “_” and “-”. Do not use more than 11 characters or signs. Do not use space.

7. Select **Format**.

A confirmation window is displayed.



The formatting process will erase any data present on the media.

8. Select **OK** to continue.
9. Wait for the display of the *Information* window indicating that the formatting process is completed.
10. Select **OK**.
11. Eject the media as described below.

NOTE: Removable media used during *Disk space management, Backup, Export, or Save as* do not need to be formatted in advance as the formatting process is part of these procedures if required.

Ejecting removable media

1. Press **Utility/Eject** on the Touch Panel.

NOTE: Do not eject CD/DVD using the button on the CD/DVD drive.

The *Eject device* menu is displayed (Figure 3-7).

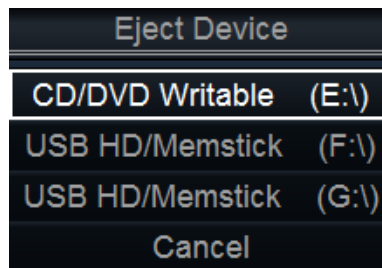

Figure 3-7. The Eject device menu

2. Select the relevant media.

Wait for the display of the *Information* window indicating that the device can be safely removed before removing the media.

Physiological traces

The physiological module consists of two channels: ECG and Respiration. The scanned image that is displayed is synchronized with the ECG and respiration traces. In M-Mode or Doppler, the traces are synchronized to that particular mode's sweep.



CAUTION

Use only GE Healthcare accessories.

Conductive parts of electrodes and associated connectors for applied parts, including neutral electrodes should not contact other conductive parts, including earth.

Simultaneous use of two or more applied parts will cause summation of patient leakage currents.

NOTE: Heart rate may be adversely affected by cardiac arrhythmias or the operation of cardiac pacemaker pulses.

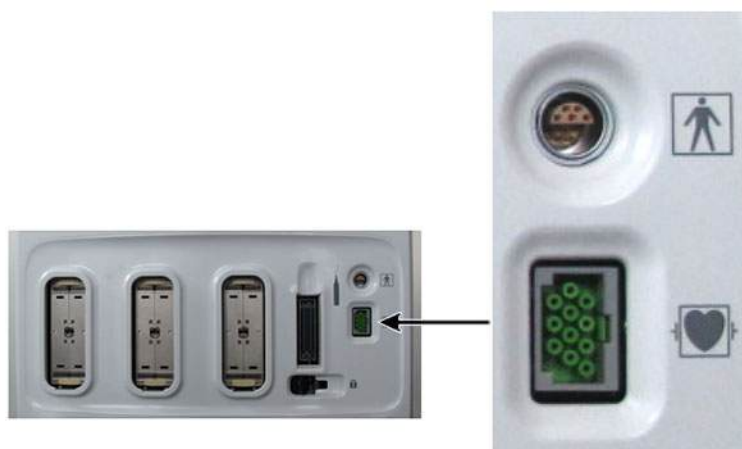

Figure 3-8. The patient (I/O) connection panel

ECG/Respiration

NOTE: Only use ECG cables provided with your Vivid S70N / S60N, or cables that GE Healthcare offer as accessory to your particular device. Details on the appropriate ECG cables are identified in the service manual.

NOTE: Refer to the ECG cables manufacturer instructions for use for cleaning and disinfection information.

The ECG cable is a modular cable consisting of two distinct parts:

- **The Trunk:** A single cable connecting to the system at one end, providing a cable splitter device at the other end (see Figure 3-9).
- **The triple color-coded electrode cable:** To be inserted in the splitter device. Each electrode cable hooks up to the appropriate stick-on electrode by a color-coded clip type connector.

The color-coding of the electrodes follows one of two standards that are common in different parts of the world. The cable splitter device illustrates the color codes, names, and body locations for the two standard color codes (see Figure 3-9).

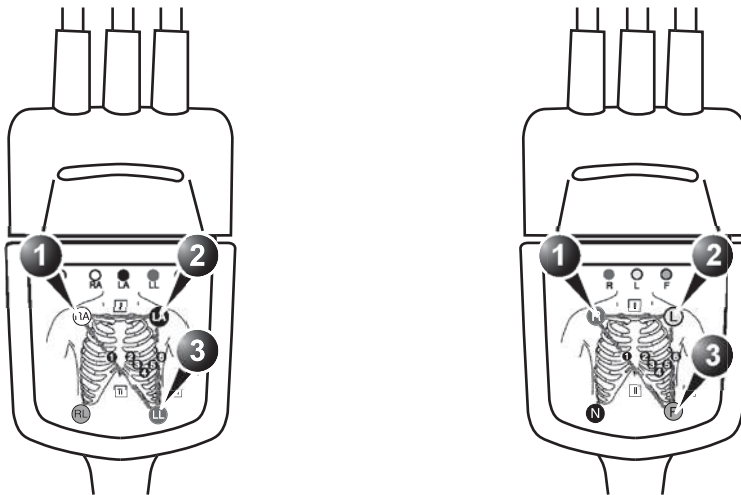

AHA (USA)

1. RA: White
2. LA: Black
3. LL: Red

IEC (Europe, Asia, ROW)

1. R: Red
2. L: Yellow
3. F: Green

Figure 3-9. The cable splitter device with electrode placement conventions

To connect the internal ECG

1. Connect the ECG trunk cable to the rectangular socket marked ECG on the patient trace (I/O) panel. The patient trace (I/O) panel is located at the front left of the ultrasound system (see Figure 3-8).
2. Hook up the electrode cables to the electrodes, following the appropriate convention (see Figure 3-9).

Using Physio



The use of respiratory sensing might interfere with impedance-based rate-responsive pacemakers, potentially resulting in upper-rate pacing. Turning off the respiratory trace on the system will block off the respiratory sensing signals which might interfere with the pacemaker.

NOTE: *The ECG functionality of the Patient I/O module is not intended for patient monitoring nor to support alarm functionality. This input is intended as a tool for easier synchronization of images and cineloop control during ultrasound examinations.*

Display ECG trace



Figure 3-10. ECG controls

1. The ECG is displayed by default in all cardiac applications. For all other applications, press the tab **Physio** on the Touch Panel. and press **ECG** (Figure 3-10).

NOTE: *The ECG button shows/hides the ECG trace. It does not turn off the ECG.*

2. The following controls can be adjusted:
 - **Horiz. Sweep:** Adjusts the sweep speed stepwise (1, 2, 3, 4, 6, 8, 12, and 16 sec. The default setting is 4 sec.)
 - **Gain:** Adjusts the trace amplitude.
 - **Position:** Moves the trace vertically.
 - **ECG Lead:** Selects the desired lead:
 - Lead 1: RA (-) to LA (+) (right, left, or lateral)
 - Lead 2: RA (-) to LL (+) (superior inferior)
 - Lead 3: LA (-) to LL (+) (superior inferior)
 - **QRS visible:** Show/Hide the QRS marker on the ECG.

Removing/adding Triggers

In case of a noisy ECG the system could generate an erroneous QRS marker which produces a heart cycle loop in a wrong location. The user can correct this manually by adjusting the actual location of the relevant QRS marker.

To remove a QRS marker on a replayed loop:

1. Press **QRS visible** to display the QRS markers and identify any extra QRS marker to be removed.
2. Press **Pause** to stop the cineloop and use the trackball to place the small red bar in the vicinity of the QRS marker to be removed.
3. Press **Remove Trig.**

To add a trigger:

1. Place the small red bar on the place where a QRS marker is missing.
2. Press **Add Trig.**
The new QRS marker is added.
3. Press **Pause** and store a copy of the cineloop with the new QRS markers.

Display respiratory trace

1. Press the **Physio** tab on the Touch Panel.
2. Press **Respiratory.**
The respiratory signal appears in addition to the ECG signal.
3. The following controls can be adjusted:

- **Lead selection:** Select the one that provides a stronger signal
- **Horiz. Sweep:** Adjusts the sweep speed.
- **Gain:** Adjusts the trace amplitude.
- **Position:** Moves the trace vertically.

Peripheral/accessory connector panel

The Peripheral/accessory connector panel is located at the rear of the system (see Figure 3-11).

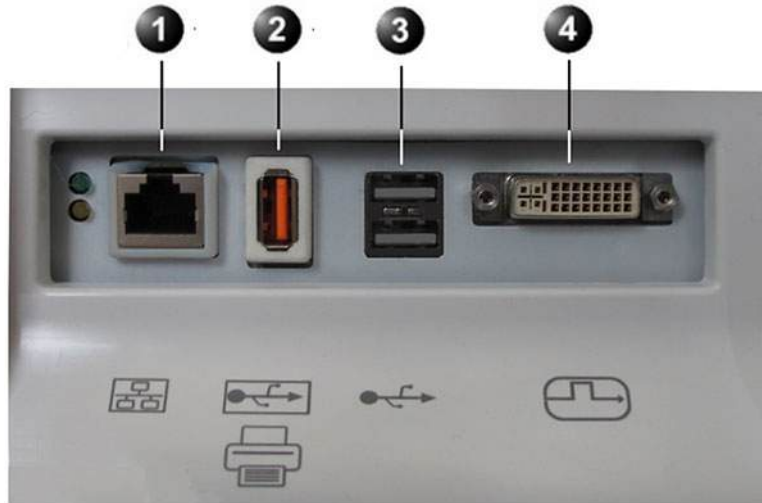

1. Ethernet LAN connector
2. Insulated USB connector (supporting USB 1.0)
3. Dual USB connector (supporting USB 2.0)
4. DVI display-out connector

Figure 3-11. Peripheral/accessory connector panel



Accessory equipment connected to the analog and digital interfaces must be certified according to the respective IEC or ISO Safety standards (e.g. IEC/EN62368-1 or IEC/EN 60950 for data processing equipment and IEC/EN 60601-1 for medical equipment). Any person connecting additional equipment to the signal input part or output part of the ultrasound system configures the medical system and is therefore responsible that the system complies with the requirements of the medical electrical systems of IEC/EN 60601-1 Clause 16. If in doubt, consult the technical service department or your local representative.

Do not touch the conducting parts of the USB or Ethernet cables when connecting equipment to the system.



Any devices or cables, other than those sold with the ultrasound system, connected to the Peripheral /accessory connector panel, or to an USB port on the system may result in an increase in the electromagnetic emission from the system, or a decrease in the electromagnetic immunity of the system.

Socket	Signal type	Device type	Note
Insulated USB 	Universal serial bus supporting USB 1.0	Printer	Printers with external power supply will connect here
USB - Dual socket 	Universal serial bus supporting USB 2.0	Memory devices	Devices <u>without</u> external power supply will connect here
DVI 	Digital signals only	Digital monitor	This is a DVI-I connector, but there is no analog signal transmission. Only digital monitors can be connected.
Ethernet 	1000 Base-TX Ethernet IEEE 802.3	Network device	

Wired Footswitch (Option)

You can attach this Footswitch to the system by connecting it to one of the USB port on the rear of the system.



To avoid damage of the cable, keep the cable away from the wheels. Disconnect the Footswitch before moving the system.

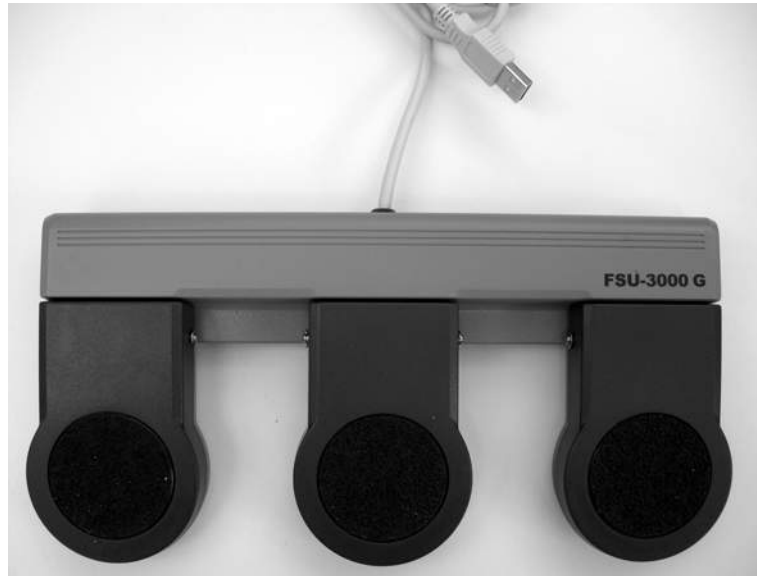

Figure 3-12. Footswitch and USB Cable

This is a 3-pedal Footswitch. You can configure its functionality from the **Config/Imaging/Application** (see page 12-26).

The graphic on the bottom of the main screen can be configured to show the functional assignment of the different pedals. See the example in Figure 3-13.

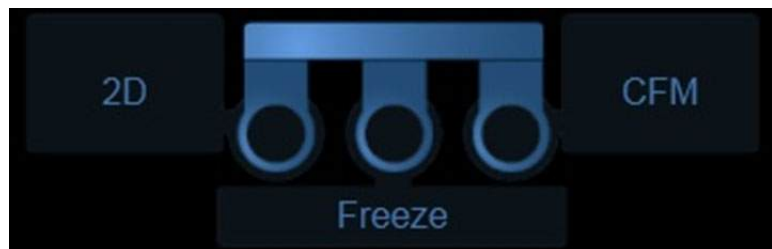

Figure 3-13. Footswitch functional assignment

NOTE: When using the Footswitch, DO NOT hold down the footswitch pedal. Press and release the Footswitch pedal. Pushing and holding down the pedal behaves the same way as pushing and holding down a key on the keyboard.

Switching On/Off

Switch on the system

1. Switch on the circuit breaker at the rear of the system (see Figure 3-14).
2. Press the on/off button on the top left of the control panel (see Figure 3-14).

After initialization the default scanning screen is displayed.

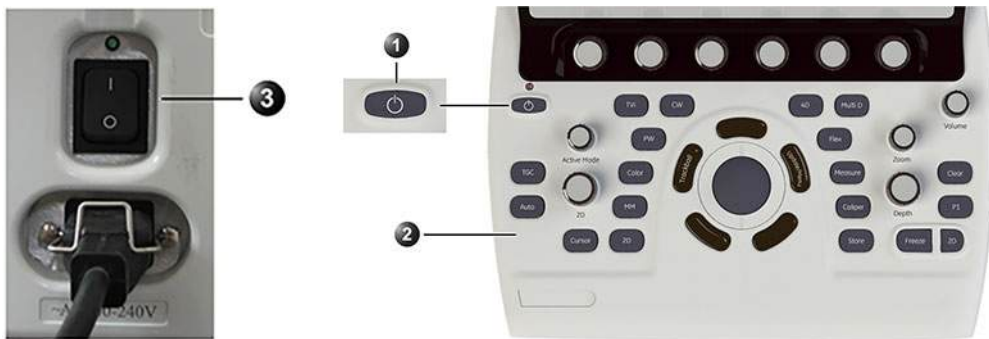

1. On/Off switch
2. Control Panel
3. Circuit breaker

Figure 3-14. The Circuit breaker and On/Off button

Scanning without Log In

Some emergency type of situation requires immediate access to the system and its functionality after switched on and powered up. The Vivid S70N / S60N give the user full access to its scanning and diagnostic functionality without the user having to log in. See 'Perform exams without logging in' on *page 4-2 for more information.*

Log In

To access images and data stored on the system, and to do configuration changes to the system, the user has to log in.

The *Operator Login* window lets the user enter user ID and password, see Figure 3-15.

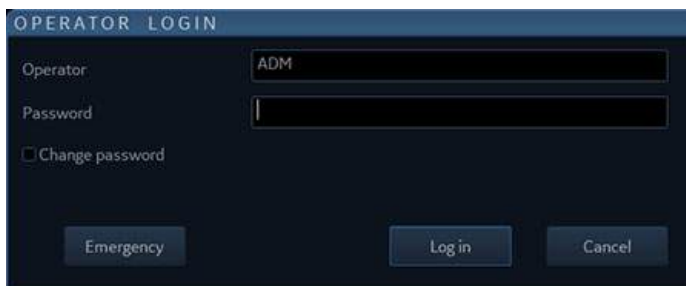

Figure 3-15. Operator Login window

Pressing **Emergency** or **Cancel** will let the user continue operating the system without logging in. See 'Perform exams without logging in' on *page 4-2 for more information*.

Personal user accounts can be configured in the Vivid S70N / S60N ('Users and Security' on *page 12-10*).

If "Use Auto Logon" ('Auto logon' on *page 12-13*) is enabled, the system will automatically log in with the specified user account, and the *Operator Login* window will not be shown.

NOTE: *By factory **LogIn** default, the Operator ID is USR and there is no need to enter a password.*

Switch off the system

When the ultrasound system is switched off, the system performs an automatic shutdown sequence. It is recommended to perform a full shutdown at least once per week. This will prevent extreme memory fragmentation, which might cause some computer slowdown.

Shutdown

1. Press the on/off button on the top left of the control panel. The *Exit dialogue* window is displayed.

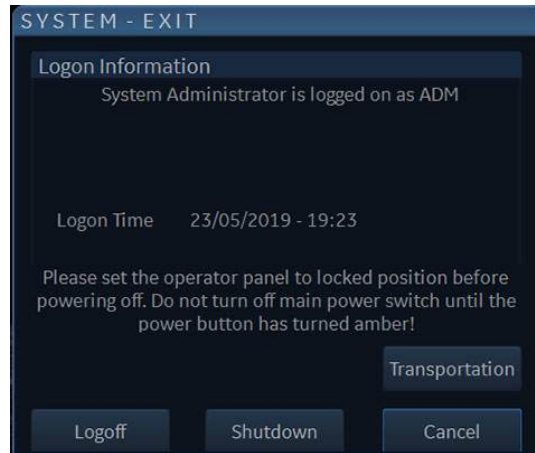

Figure 3-16. The Exit dialogue window

The system can be switched off into one of the two states:

- **Shutdown:** the entire system is shut down. Full shutdown is recommended if the system is not intended to be used for a whole day or longer.
- **Transportation/Standby mode:** most of the system is powered down, but a certain portion of the system remains energized. This mode allows a shorter reboot time when the system moved from one place to another. Also, when AC power is interrupted, the main screen and keyboard are powered down. The touch panel and the rest of the system is still powered by an internal battery. When AC power is resumed, the system will turn ON in less than 5 seconds ('Using Transportation mode' on page 3-51).

NOTE: *Battery performance may degrade over time and limit the use of transportation mode. In case the battery can not be fully charged, or can not support transportation mode for more than 20 minutes please arrange for service of the battery.*

NOTE: *In case of total lockup of the system, hold the on/off button down a few seconds to turn the system off.*

2. Select **Shutdown**.

The shutdown process takes a few seconds and is completed when the color of the on/off button changes from green to amber.

3. Select **Transportation**.

The systems enters the Transportation mode.

Booting up from this mode takes less than a minute.

NOTE: After switching off the system, wait at least ten seconds before turning it on again.

NOTE: Whenever the system is fully shut down or put in Standby mode, the system automatically performs "End-Exam" to save all data and images of the current patient into the archiving system.

When switching the system off to move it, follow the additional steps below:

1. Wait until the on/off button has turned amber and set the circuit breaker to **OFF**.
2. Remove the plug from the mains power socket.
3. Secure the system power cable around the cable storage hooks at the rear of the system.

Connect and disconnect probes

Connect the probe

Probes can be connected at any time, whether the system is on or off.

The system has two types of probe ports: one RS probe port and three DLP probe ports (Figure 3-17).

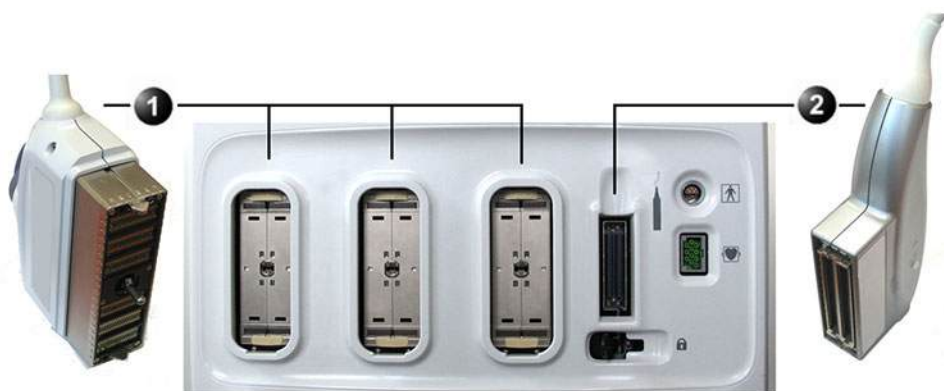

1. DLP Probe port
2. RS Probe port

Figure 3-17. Probe ports

1. Before connecting the probe:
 - Inspect the probe and the probe cable for any damage.
 - Do a visual check of the probe pins and system sockets. Remove any dust or foam remains from the probe pins.
2. Hold the probe connector vertically with the cable pointing upward.
3. Turn the connector locking handle counterclockwise.
4. Align the connector with the probe port and carefully push into place.
5. Turn the locking handle clockwise to the full vertical position to lock in place.
6. Position the probe cable so that it is not resting on the floor.



CAUTION

Do not allow the probe head to hang freely. Impact to the probe head may result in irreparable damage.



CAUTION

Take the following precautions with the probe cables:

- Keep free from the wheels.
- Do not bend.
- Do not cross cables between probes.



DANGER

Do NOT touch the patient and any of the connectors on the ultrasound system simultaneously, including ultrasound probe connectors.

NOTE: Further information on handling of ICE and TEE probes is located in the particular user manuals supplied with these probes.

Connect the 6Tc-RS or the 9T-RS TEE probe



CAUTION

Transesophageal probes require a special handling. Refer to the user documentation enclosed with these probes.

The 6Tc-RS and the 9T-RS probes are equipped with a Vivid *i* connector. To connect these probes to the ultrasound system, use the RS probe port (see Figure 3-17).

To connect a probe (Small connector - type RS)

1. Hold the probe connector vertically with the cable pointing upward.
2. Push the connector locking handle to the right-most position.
3. Align the connector with the probe port and carefully push into place.
4. Push the connector locking handle to the left-most position.
5. Position the probe cable so that it is not resting on the floor.



Figure 3-18. RS Probe Connection Locking Lever



CAUTION

Handle the probes gently while connecting and disconnecting



WARNING

Do NOT touch the patient and any of the connectors on the ultrasound unit simultaneously, including ultrasound probe connectors.

Activate the probe

When a probe is connected to the system it is automatically detected.

Selecting a probe and an application

1. Press **Probe** on the Control Panel. A list of the connected probes and application presets is displayed.



Figure 3-19. Probe selection

2. Select the desired probe application preset to start scanning.



CAUTION

Make sure that the probe and application names displayed on the screen correspond to the actual probe and application selection.

Check that the correct TI category is displayed. TIB must be displayed when a fetal application is selected.

Switching Application Preset using QuickApps

QuickApps provides an easy access to specific imaging settings, such as coronary or contrast imaging, without leaving the selected imaging preset.

QuickApps keeps the current scanning mode and image geometry parameters (such as 2D Depth, 2D Width, Color ROI size and position) as adjusted by the user, while optimizing imaging parameters for that selected scanning situation.

The Vivid S70N / S60N comes with a set of factory QuickApps presets for most supported probes and Application Presets.

Factory QuickApps cannot be modified, but user-defined QuickApps presets can be created as needed.

QuickApps can be managed on the fly as described below:



1. **New:** To create a new QuickApps preset based on the currently active QuickApps preset or Imaging preset. Press **New** and name the new QuickApps preset as desired.
2. **Reload:** Has two different functions:
 - If a factory QuickApp is active, **Reload** will restore the default factory settings.
 - If a user-defined QuickApp is active, **Reload** will restore the most recently saved settings on that QuickApp.
3. **Save:** To overwrite the currently active QuickApps preset. It is only possible to use **Save** when working with a user defined QuickApps preset (**Save** is not available for factory QuickApps presets).
4. **Delete:** To delete a user defined QuickApps preset. Press **Delete** and select the QuickApp that should be eliminated.

Figure 3-20. Manage QuickApps

Deactivate the probe

Press the **Freeze** key to deactivate the probe. When deactivating the probe, the probe is automatically placed in *Standby* mode.

Disconnect the probe

Probes can be disconnected at any time. It is recommended that the probe should not be active when being disconnected.

To disconnect a probe (Small connector - type RS):

1. Freeze the image by pressing **Freeze**.
2. Press the connector locking lever *towards the left* to unlock the connector.
3. Pull the probe and connector straight out of the probe port.
4. Carefully slide the probe and connector away from the probe port and around the right side of the keyboard.
5. Ensure the cable is free.
6. Be sure that the probe head is clean before placing the probe in its storage case.

To disconnect a probe (Large connector - type DLP):

1. Rotate the lock handle counter-clockwise to the horizontal position to unlock the connector.
2. Pull the connector straight out of the probe port.

Transporting probes

When transporting a probe a long distance, store it in its carrying case.

Storing probes

It is recommended that all probes be stored in the carrying case provided.

- First place the probe connector into the carrying case.
- Carefully wind the cable into the carrying case.
- Carefully place the probe head into the carrying case. **DO NOT** use excessive force or impact the probe face.

Intra Cardiac Ultrasound Catheters

See 'Intracardiac Ultrasound Catheters' on *page 13-15* for information.

The Scanning screen



- | | |
|--|--|
| <ol style="list-style-type: none"> 1. Title bar <ul style="list-style-type: none"> - Current patient data - Institution - Operator ID - Probe - Application - Mechanical & Thermal Index 2. Measurement result table 3. Depth scale 4. Physiological traces, ECG, Phono, Resp 5. Probe orientation marker 6. Measurement 7. Scanplane indicator (TEE probe/4D probe) 8. Greyscale/Color bar | <ol style="list-style-type: none"> 9. Parameter window 10. Clipboard 11. Prompt/Status information 12. - Trackball assignment <ul style="list-style-type: none"> - Footswitch pedal assignments - TEE probe button assignments 13. - Caps lock on/off <ul style="list-style-type: none"> - Access to service platform - Network status 14. Frame counter and timer 15. Probe surface temperature indicator (only appears when a TEE probe is selected) 16. Current, real-time display of Heart-rate, Date and time |
|--|--|

Figure 3-21. The scanning screen (composite)

The scanning screen is divided in several areas as follows:

The Title bar

NOTE: The patient information displayed on the Title bar is configurable ('Global imaging settings' on page 12-21).

From the left:

Patient Information

Displays the information that uniquely identifies the patient, such as patient name, identification number and birth date. This information is entered in the *New patient window* ('Creating a new patient record' on page 4-5).

Institution name

The institution name is entered from the configuration package ('General system settings' on page 12-6).

Operator ID

Identification code of the operator ('Users and Security' on page 12-10).

Date and time

Displays the current date and time or for a retrieved image, the date and time at which it was stored.

Probe and Application

Displays the currently selected probe and application or for retrieved image the probe and application that were used ('Selecting a probe and an application' on page 3-29).

Live scanning related information

Displays, if available, the current values for

- Mechanical Index (MI), for the current active image
- Thermal Index (TI), for the current active image
- Probe temperature (for TEE probe)
- Heart rate (HR)

Archive Information

Displays the currently selected patient and image archives.

Parameters window

Displays scan mode or application specific parameters. In scanning mode the parameters for the active mode are highlighted. This window also displays zoom information, stress template, and image groups in image browser.

Clipboard

Displays the thumbnail images representing the acquired data during the current examination.

Control Panel

Control Panel overview



- | | |
|---|---|
| 1. Touch Panel with adjustment Softkey rotaries (see page 3-43) | 10. 4D & Multi D controls (Vivid S70N only) |
| 2. On/Off button (see page 3-23) | 11. Loudspeaker volume control |
| 3. Active mode gain | 12. Flex - programmable button |
| 4. TGC Screen activation | 13. Zoom |
| 5. 2D Gain | 14. Clear |
| 6. Auto (Auto-tissue, ASO) | 15. Depth |
| 7. Cursor | 16. Print, capture |
| 8. Scan mode selection | 17. Freeze, 2D Freeze |
| 9. Trackball and related buttons (see page 3-38) | 18. Measurement, Caliper |
| | 19. Store |

Figure 3-22. The Control Panel

Key illumination

The keys on the Control Panel are illuminated according to their availability:

- **Illumination in green:** The key function is currently active.
- **Illumination in yellow:** The key function is available (but not active) in the current state of the system.
- **No illumination:** The key is not available in the current state of the system.

Adjust the Control Panel

The system Control Panel can be freely adjusted to swivel or move up/down. There are two brake handles located under the Control Panel.

To swivel the Control Panel left or right

1. Pull and hold the left brake handle, located under the Control Panel.
The Control Panel can now be freely rotated left or right.
2. When reaching the desired swivel angle, release the swivel-brake handle.

The Control Panel will remain at the set angle.

NOTE: *The main display will swivel together with the control-panel. In addition the main display may be swiveled independently of the control-panel.*

To move the Control Panel up or down

1. Pull and hold the right-hand handle, located under the Control Panel.
The Control Panel can now be freely adjusted up or down.
2. When reaching the desired height, release the height-adjust handle.

The Control Panel will remain at the set height.

NOTE: *When the Control Panel is lowered it moves towards the operator. When panel is raised it also moves away from the operator.*

NOTE: *When preparing the system to be moved, pull the left handle and bring the Control Panel to a center position. Swivel it slightly till a locking click is heard.*

Trackball area

Different functions can be assigned to the trackball.

The trackball functions are organized in functional groups which are displayed below the image area of the screen. The **Trackball** key (Figure 3-23, [3]) is used to toggle between the functional groups.

Each functional group can have one or more functions. The **Select** key (Figure 3-23, [2]) is used to toggle between the functions within the active group.

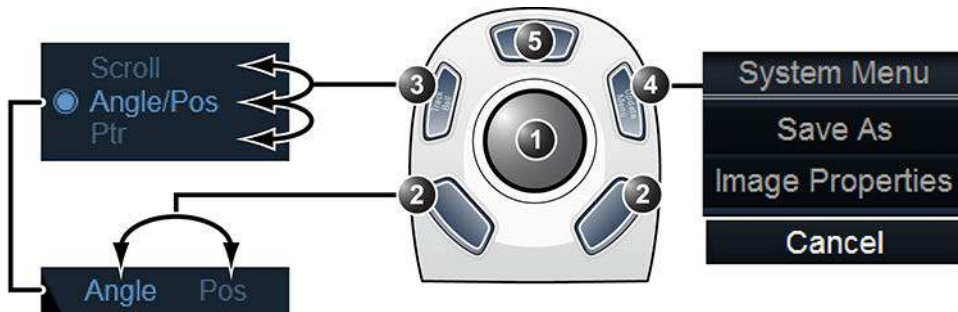

1. Trackball:
 - Adjusts the selected control.
 - Moves the pointer.
2. Select keys:
 - Toggles between the functions within the active group.
 - Performs the selected control or highlighted menu item.
3. Trackball key: Toggles between trackball functional groups.
4. Update/Menu key:
 - In Freeze: Displays a pop-up System menu.
 - In Live duplex mode (Doppler or M-mode): Toggles Live/Freeze between the 2D image and the spectrum image.
5. Upper key: Configurable as either a select key, a pointer, an Image store button, or an Image cursor (see page 12-21).

Figure 3-23. The Trackball area

The current active state of the trackball is displayed on the bottom of the display (Figure 3-24).



Figure 3-24. Trackball assignment graphical display

Touch Panel

The Touch Panel enables access to modality driven controls and functionality.

The function controls are accessed from a configurable *Shortcut* bar at the top of the Touch Panel.

The scanning mode controls are organized in tab pages. For each tab, two pages may be accessed by swiping laterally anywhere on the Touch Panel.

At the bottom of the Touch Panel there are six rotary/push buttons. The functionality of these buttons changes based on the active mode/function.



1. *Shortcut* bar: Quick access to different functions on the system.
2. Scanning modes tab: Select the tab to activate scanning mode.
3. Main body with touch controls.
4. Rotary/Push buttons with mode/function specific controls.
5. Swipe the screen to change page.

Figure 3-25. Touch Panel

Shortcut bar



Figure 3-26. The shortcut bar

The *Shortcut* bar gives quick access to different functions on the system. The default functions available on the *Shortcut* bar depend on the examination category selected. Additional functions are available by pressing the **More** button.

The *Shortcut* bar can be customized to the user's needs (see 'Touch Panel' on page 12-8).

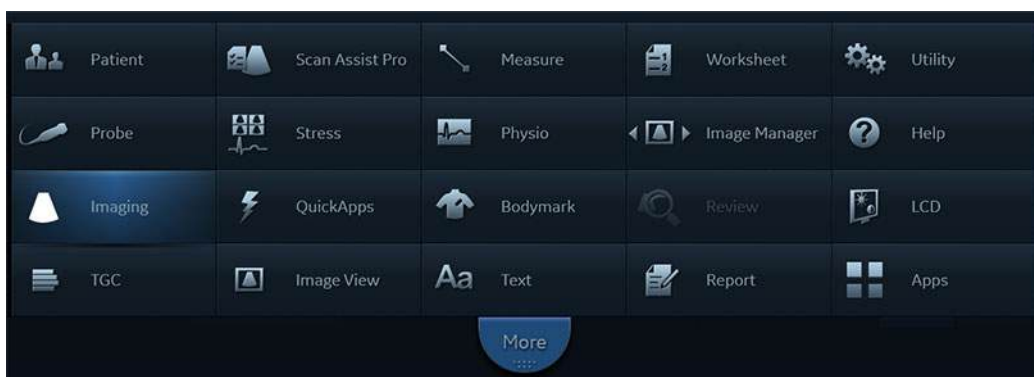

- **Patient:** Access the *Archive* screen.
- **Scan Assist Pro:** Start Scan Assist Pro.
- **Measure:** Start the Measurement package.
- **Worksheet:** Display the measurement worksheet.
- **Utility:** Access system Configuration package, DICOM spooler, Media and Direct Report.
- **Probe:** Select probe and preset.
- **Stress:** Access Stress Echo package.
- **Physio:** Access physiological traces.
- **Image manager:** Review images in the selected patient record.
- **Help:** Display the user documentation.
- **Imaging:** Access the scan mode controls.
- **QuickApps:** Access QuickApps function.
- **Bodymark:** Access bodymarks.
- **Review:** Review images in selected examination.
- **LCD:** Access LCD controls (Contrast, Brightness etc.).
- **Image View:** Display the image area on the touch panel.
- **TGC:** Access TGC (Time Gain Compensation).
- **Text:** Access the annotation function.
- **Report:** Access the report function.
- **Apps:** Open a new window listing all compatible Apps already installed on the system.

Figure 3-27. Additional shortcuts

Tab pages

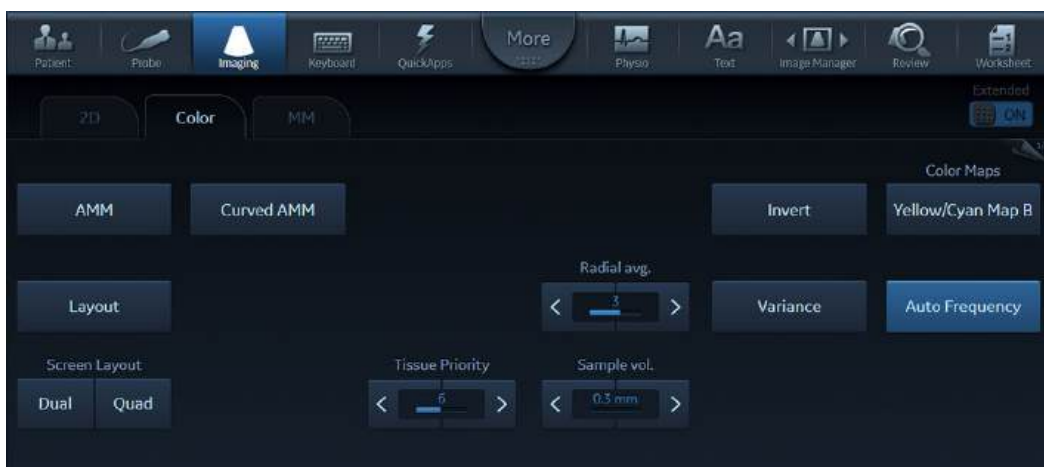

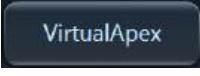
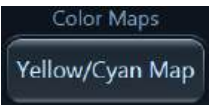
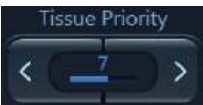



Figure 3-28. The Tab folders

The scanning mode controls are organized in Tab pages. The active mode can be changed by pressing the corresponding tab. For each tab, two pages may be accessed by swiping laterally anywhere on the Touch Panel.

There are different types of control buttons.

Button	Description
 On  Off	Push button: Toggles the control between on and off states. <ul style="list-style-type: none"> • Light blue = On • Dark blue = Off Note: The button may turn black for a short time while being toggled.
	Menu push button: Opens a menu on screen. The selection in the menu is done using the trackball and the Select Key. The current selection from the menu is displayed inside the button.
	Variable button: Control with variable adjustment
	Dual button: Combines two controls that exclude each other mutually (e.g. toggling between Dual and Quad screen display)

Other feature	Description
	Page indicator: Swipe laterally anywhere on the Touch panel to toggle display of page 1 and 2.

The Rotary/Push buttons

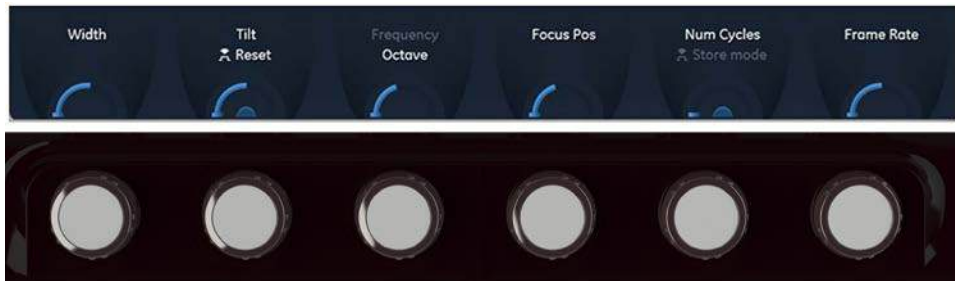







Figure 3-29. The Rotary/Push buttons

At the bottom of the Touch Panel, there are six rotary/push buttons. The functionality of these buttons changes, based on the active mode/function.

Rotary/Push button	Description
	Rotate/Push Reset control: <ul style="list-style-type: none"> • Rotate the knob to adjust the upper parameter (e.g. Tilt) • Press the knob reset the upper parameter to its default (preset) value. The parameter value appears only during adjustment.  : Gauge indicating that the control can be adjusted within a pre-defined range.
	Rotate/Push Toggle control: Press the knob to toggle the selection of the two parameters and rotate the knob to adjust the selected parameter.  : Gauge indicating that the control has no pre-defined range.
	Rotate/Push Swap control <ul style="list-style-type: none"> • Rotate the knob to adjust the upper parameter (e.g. Num Cycles) • Press the knob to swap the upper control (e.g. Num Cycles vs. Timespan).

The alphanumeric keyboard (option)

A touch alphanumeric keyboard can be activated on the Touch Panel by the user. Additionally, a physical alphanumeric keyboard can be optionally installed on the system. In this case the keyboard is situated under the Control Panel, in a drawer which can open and close.



Figure 3-30. Extendable physical alphanumeric keyboard (optional)

Main display adjustment

The main display position can be adjusted for easy viewing:

- Rotate left/right around its central pivot point.
- Tilt forward/backward for the optimum viewing angle.
- Raise or lower for the best viewing height.



To avoid injury or damage, make sure nothing is within the range of motion before moving the display and display arm. This includes both objects and people.

Lock/unlock the main display



DO NOT place a finger, hand or any object on the joint of the monitor or monitor arm to avoid injury when moving the monitor and monitor arm.

Unlock and move the main display

1. Turn the release knob clockwise to unlock the main display (Figure 3-32).
The main display can be moved freely in all directions.
2. Grab the bottom of the main display to adjust the position of the display (Figure 3-31).



Figure 3-31. Positioning the main display

NOTE: *When flipping up the display from the flip down state, you can grab the upper corner of the display.*

Lock the main display

1. Turn the release knob counter-clockwise to raise the lock.
2. Move the main display sideways to lock the arm's joints.
3. Push the display down into parked position.



1. Unlocked main display
2. Locked main display
3. Release knob

Figure 3-32. Main display locking mechanism

Image Adjustment

Adjusting the monitor's contrast and brightness is one of the most important factors for proper image quality. If these controls are set incorrectly, the Gain, TGC, Dynamic Range and even Power Output may have to be changed more often than necessary to compensate.

To select different image size, see 'Flexible Video Out' on *page 14-7*

Using monitor adjustment Touch panel Controls

1. Activate the main menu on the Touch Panel.
2. Tap the LCD setup tab. The Touch Panel will display several screen adjustments controls (Figure 3-33).

These screen controls allow the user to optimize the screen settings.

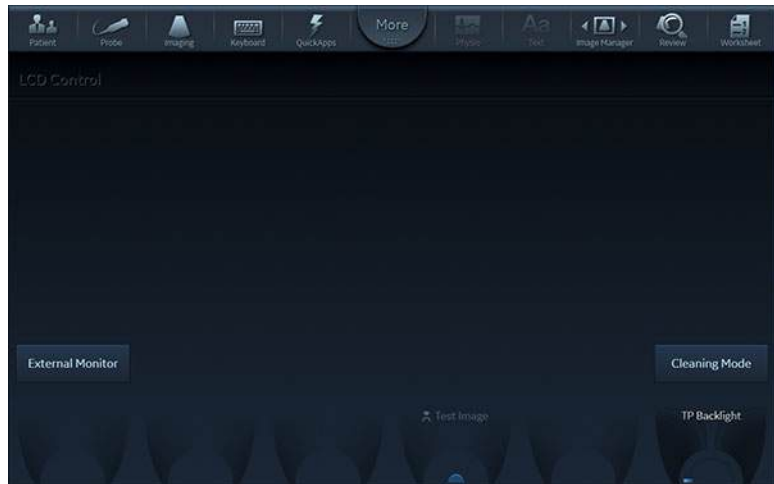

Figure 3-33. LCD adjustment utility

Brightness Rotary

This is the main control to adjust screen brightness to compensate for different ambient light.

In a totally dark room it is recommended to set brightness down all the way.

Cleaning the touch panel

In order to allow cleaning the Touch Panel without affecting the system operation, press **Cleaning Mode**. The Touch Panel will become blank allowing you to use a soft cloth with glass cleaning solution to clean the panel. Press **Freeze** or click **Exit** on main display to return to normal operation. Click the **Bright** button on the display to convert the Touch Panel to white background for different visibility.

External Monitor button

Activate this button when connecting the system to an external display. It will allow you to optimize Contrast / Brightness and blue-tint to suit the particular external display.

NOTE: *At this state, a rotary selector will appear allowing to optimize for the monitor type used: sRGB, GSDP or CRT.*

When the button is de-activated, the previous settings that were optimized for the internal display will be restored.

Touch Panel Brightness setting

The Touch Panel setup screen contains a rotary controller to adjust the brightness of touch panel. It is also possible to let the

automatic light-sensor take over and control the brightness constantly adjusting it to the ambient light.

Test pattern

When adjusting an external display or any peripheral hard-copy device, you may turn this function ON to generate a screen-calibration pattern to assist in exact callibration.

Moving and transporting the system

Wheels

The front wheels and the right rear wheel of the system are controlled by gray brake pedals situated above each wheel.

The left rear wheel is controlled by a green directional-lock pedal above the wheel.

The rear and front wheels of the system are free-swivel wheels (Figure 3-5)

Examine the wheels frequently for defects to avoid breaking or jamming.

Moving the system

To prepare the system to be moved

1. Turn system Off to **Full shut-down** or *Standby* mode.
2. Remove the AC plug from the power outlet.
3. Wrap the AC power cord to ensure cord is not hanging in the wheel area or beyond the sides of the system.
4. Pull the left handle and swivel the keyboard so it will lock in its central position ('Main display adjustment' on *page 3-45*).
5. Disconnect all external cables linking the system to any off-board peripheral devices and network. (Note the marks on each cable to reconnect them later).
6. Place all probes securely in proper probe holders. Ensure that the probe cables do not protrude from the side of the system or interfere with the wheels, or foot area. Hang the cords on respective hooks provided, ensuring cords are secure and out of lower portion of the system and do not extend beyond the sides of system.
7. Ensure that no loose items are placed on the system.
8. If intending to travel over bumpy surface or if more visibility is required during transportation, fold the main display forward to a horizontal position ('Main display adjustment' on *page 3-45*).

9. Unlock the front and rear brakes and engage the right front wheel lock.

Once all cables and cords are wrapped and secure out of the lower portion of the system, not extending beyond sides of system, you are ready for transport.

To ensure safety while moving the system

1. Ensure that the keyboard console is in central-locked position.



Ensure that the hands of the patient are away from the console while moving the system or keyboard console.



The system weight approximately 75 Kg. To avoid possible injury or equipment damage mobilizing handles are provided.

2. Proceed cautiously when crossing door or elevator thresholds. Grasp the front handle grips and push or pull, or use the rear handle bar for pushing the system. Do not attempt to move the system using cables or probe connectors. Take extra care while moving the system on inclines. Do not hang or lean body weight on the handles.



The rear handle should only be used for pushing the system, not for pulling, The system might become unstable when hitting an obstacle while pulled with the rear handle.

3. Ensure that the system does not strike the walls or door frames.
4. Ensure that the pathway is clear, and probe cables are secure not to catch onto anything in the path (including wheels and feet)..
5. Move the system slowly and carefully. Limit the movement to slow careful walk.



To minimize the risk of system tipping and avoid possible injury and equipment damage, make sure to follow these recommendations when moving the system on inclines:

- Avoid ramps that are steeper than 10 degrees.
- Utilize additional care and personnel when moving on a steep incline (>5 degrees).
- Ensure the main display arm and Control panel are in locked position.



Probe cables may get caught on external devices, such as doors, medical devices in the transporting path, wheels, or feet. Please ensure cords are wrapped properly, not extended beyond sides of system and out of the way for portables.

Using Transportation mode

With Transportation mode, the system power is maintained by the battery. Transportation mode is either activated by the user, or automatically activated if there is an AC power failure or the power cable is unplugged in preparation for transportation. Transportation mode can be used to reduce system startup time for portable exams. While in Transportation mode, the system maintains the current patient and scan settings. As a result, when power is restored, the current patient's details, scan settings and stored images are readily available.

To enter Transportation mode

1. When the Exit dialogue window is displayed, select **Transportation**.

The main display turns off.

The *Ready for Transportation* screen appears on the Touch Panel, indicating the system is ready for transportation.



Figure 3-34. Ready for transportation

2. Disconnect the AC cable from the power socket and transport the system to a different location.
3. When ready to use the system, plug the AC cable to a power socket.

The system turns ON and is ready to use within a few seconds.

Transportation mode following abrupt power interruption

If the system is operating and the AC power is interrupted or AC power plug is disconnected, the system enters Transportation mode as described above.

Transporting the system

Take extra care when transporting the system by vehicle. In addition to the moving precautions listed under 'Moving the system' on *page 3-49*, follow the procedure described below.

1. Disconnect all probes and secure them in their boxes.
2. Lower the system's keyboard to its minimum height.
3. Park the vehicle on a level surface for loading and unloading.
4. Secure the system while it is on the lift, to prevent rolling. Do not attempt to hold it in place by hand. Cushion the system and strap the lower part so that it does not break loose.
5. Ensure that the system is secured inside the vehicle. Secure it with straps to prevent movement while in transit.
6. Drive cautiously to prevent vibration damage.

Reinstalling at a new location

1. When the system is in place at a new location, lock the wheel brakes.
2. Follow the installation procedure described in 'Connecting the system' on page 3-4.

Acclimation time

Following transport, allow the system to acclimate before switching it on. Acclimation will take one hour for each 2.5 °C increment when the system's temperature is below 10 °C or above 35 °C.

°C	-20	-15	-10	-5	0	5	10	35	40	45	50	55	60
°F	-4	5	14	23	32	41	50	95	104	113	122	131	140
Hours	12	10	8	6	4	2	0	0	2	4	6	8	10

Preparing Vivid S70N / S60N for scanning

1. Lock front Wheel brakes
2. Un-Wrap the AC power cord and plug into power source.
3. Lift the main display to the fully open position. Secure the Monitor at full upright position.
4. Turn the system on.
5. Connect external cables if needed (LAN, USB, etc.).
6. Probe being used to scan should be ready, with cables clear of foot area and wheels by wrapping un-used portion of the cord on respective hooks provided.
7. Adjust keyboard's height and swivel ('Main display adjustment' on page 3-45).

NOTE: *Ensure that the probe cables do not protrude from the system or interfere with the wheels, or foot area. The Hanging cords may cause damage to system if lodged or hooked onto nearby items. By ensuring cords are secure and out of lower portion of the system, this may provide a more secure atmosphere and avoid unnecessary damage.*

Avoiding possible hazards

- Avoid dragging cables on the floor. In cases where the wheel rolls over cable or person pushing the system steps on cables, it may generate severe force to break the cable or the connector.
- Avoid hanging cables beyond sides of the system. When system is moved, these cables may be caught in door-knobs or other medical equipment and apply severe forces that may break probe cables or connectors.

Chapter 4

Start an Examination

'Perform exams without logging in' on page 4-2

'Starting an examination after logging in' on page 4-5

'Cineloop' on page 4-9.

'Zoom' on page 4-12

'Annotations' on page 4-13

Perform exams without logging in

The Vivid S70N / S60N gives the user full access to scanning and diagnostic functionality without having to log in. The user can switch on the system, start scanning and do diagnostics immediately as soon the system is powered up.

In this mode, the user will not have access to images and data stored on the system. The user will not be able to do any configuration changes to the system.

If pressing the **Patient** button to enter the *Patient* screen, the *Operator Login* dialog will be shown.

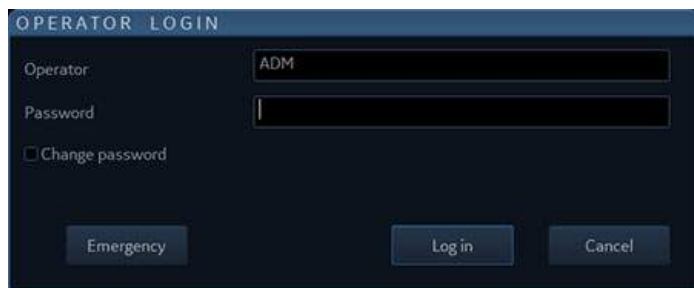

Figure 4-1. Operator Login dialog

The user can continue without logging in. Click **Emergency** button to start in Emergency mode or **Cancel** to return to scanning screen.

In Emergency mode, the user can create one patient record and enter patient demographics for one patient.

Unsaved images from previous session

When having completed a session without logging in to the system (by use of Emergency mode or operating the system without logging in) there might be images and data stored in the temporary storage. If so, the *Operator Login* dialog will be shown at next startup of the system.

The user can still choose between logging in, use Emergency mode or cancel the log in to enter the scanning screen.

Storing data to a dataflow

Unsaved data from a previous session can be assigned to a new or existing patient when a user logs in to the system. The procedure differs dependent of the presence of a patient record from the previous session, or if it's just images without a patient record.

Images are stored without a patient record

When data are stored without a patient record the images are not assigned to an exam or a patient.

When logging in to the scanner the user is asked to keep or discard the unsaved images, see Figure 4-2.

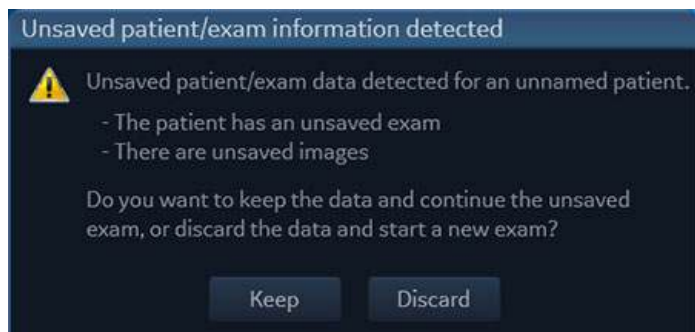

Figure 4-2. Unsaved patient/exam information

Next, when creating a new patient or opening an existing patient, the user will be asked to add the unsaved images to the patient record.

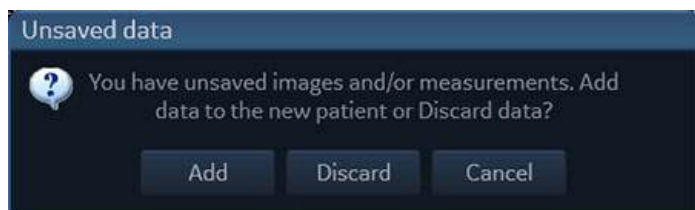

Figure 4-3. Unsaved data window

Patient record created in Emergency mode

When a patient record is created in Emergency mode, it is temporarily stored to the “NoArchive” dataflow. When there are unsaved patient record(s) in NoArchive when a user logs in, the user is asked if he/she want to transfer the patient record from “NoArchive” to another dataflow for permanent storage.

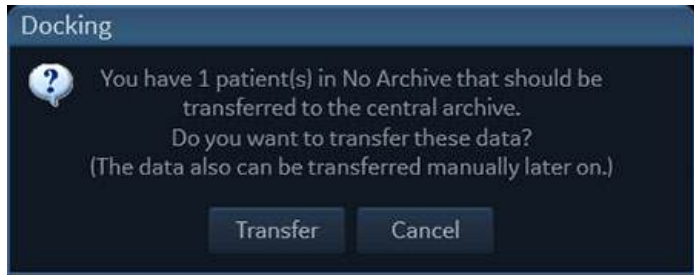

Figure 4-4. Docking dialog

Select **Transfer** to enter *Transfer* screen and to copy the patient record from NoArchive to another dataflow.

Starting an examination after logging in

in

Creating a new patient record

1. Press **Patient** on the Touch Panel.
If required, log on by typing the user ID and password.
The *Archive* screen is displayed (Figure 4-6 on page 4-7).
2. In the *Archive* screen select the desired dataflow.
3. Type the patient **Last Name**, and/or **ID**.

NOTE: *The system can be configured to automatically generate a patient ID (see page 12-89).*

With the default configuration, the system automatically checks whether the patient is already in the archive. The result of this search is displayed in the *Patient* list.

Verify that the patient to be created is not already in the *Patient* list.

4. To create a new patient record, press **New Patient**.
The *Create new patient record* window is displayed.

The screenshot shows a dark-themed window titled "Create new patient record". It is divided into three sections: "Patient data", "Physical", and "Details".
- **Patient data:** Last name: Doe; Middle name: (empty); First name: Joe; Gender: (dropdown menu); Patient ID: Auto generated; Birthdate: (calendar icon); Age: (empty).
- **Physical:** Height: (empty) cm (selected) m; Weight: (empty) g (selected) kg; BSA: (empty).
- **Details:** BP: (empty).
At the bottom are "Create" and "Cancel" buttons.

Figure 4-5. The Create new patient record window

5. Enter additional patient information if required and press **Create**.

The system is ready for scanning or the *Patient info and exam* screen is displayed (Figure 4-7 on page 4-8), depending on the system configuration (see page 12-89).

If the system is configured to display the *Patient info and exam* screen, follow the steps below:

1. Fill in the additional information in the *Patient info and exam* screen if required.

NOTE: *The information displayed on screen can be adjusted from the list of available information on lower part of the screen (see Figure 4-7 on page 4-8).*

2. Press **Patient** or any active scanning key on the Control Panel to start the examination.

Selecting an existing patient record

1. Press **Patient** on the Touch Panel.
If required, log on by typing the user ID and password.
The *Archive* screen is displayed (Figure 4-6 on page 4-7).
2. In the *Archive* screen select the desired dataflow.
3. Type the patient **Last Name**, and/or **ID** or another query that identifies the patient.

When default configured, the system automatically searches to see if the patient is already in the archive. The result of this search is displayed in the *Patient* list.

4. Highlight the patient record in the *Patient* list.

NOTE: *Select the **Exams** tab to display a list of examinations instead of the patient records.*

5. To start a new examination, press **Add Exam**.

NOTE: *If an examination with the current date already exists you will be asked whether to continue the existing examination or create a new examination.*

Ending an examination

1. Press **Patient** on the Touch Panel.
2. Press one of the following on the Touch Panel.
 - **Archive:** The examination is finished and the *Archive* screen is displayed. Any search criteria previously entered are remembered.
 - **End Exam:** The examination is finished and the *Archive* screen is displayed ready for a new search.



1. Select archive and other pre-defined services.
2. Change user.
3. Advanced search filters
4. Press one of the headings to sort the list accordingly (ascending/descending).
5. Display either patient or examination list.

The *Archive* screen may be slightly different depending on the Dataflow selected

Figure 4-6. The Archive screen



- 1. Patient information
- 2. Examination information
- 3. Clipboard with images for the selected examination
- 4. List of examinations
- 5. List of available information to display on screen

Figure 4-7. The Patient info and exam screen

CineLoop

When the scan mode is frozen, the system automatically displays cineLoop boundary markers on either side of the last detected heart cycle. The cineLoop boundaries can be adjusted using the cineLoop controls on the Touch Panel to cover one or more heart cycles.

CineLoop overview



- | | |
|---------------------------------|--------------------------------|
| 1. Left marker (cineLoop start) | 3. Right marker (cineLoop end) |
| 2. Current frame | 4. Cine speed |

Figure 4-8. CineLoop display

Using cineloop

Selection of a cineloop

1. Press **Freeze**.
The left and right markers are displayed on either side of the last detected heart cycle on the ECG trace.
2. Press **2D Freeze**.
The selected heart beat is played back.
3. Press **2D Freeze** to freeze the cineloop.
4. Use the trackball to scroll through the acquisition and find the sequence of interest.
5. Adjust **Cycle select** to move from heart beat to heart beat and select the heart cycle of interest.
6. Adjust **Num cycles** to select the number of heart beats to play back.
7. In Freeze, press **Set left** or **Set right** to set the corresponding cineloop boundary to the current frame.
8. Adjust **Left marker** and **Right marker** to trim or expand the cineloop boundaries.
9. Press **2D Freeze** to run the cineloop and **Image Store** to store the cineloop ('Storing a cineloop' on page 10-8) or **Freeze** to return to live scanning.

NOTE: Cineloop storage can be configured to store heart cycles with additional time before and after the R-wave and to display a preview before storage ('Global imaging settings' on page 12-21).

Adjustment of cineloop playback

1. Use the trackball or adjust **Speed** to set the speed of the cineloop playback.
The speed factor (%) is displayed on the right side of the ECG.

To view a cineloop frame by frame

1. In freeze, use the trackball or adjust **Frame** to scroll through the cineloop frame by frame.

To synchronize playback of several cineloops

1. Press **Sync** to synchronize playback of several cineloops running on the screen.

NOTE: For synchronization to work as expected in DICOM images, they must fulfill one of the below requirements:

- Images are acquired with ECG on a scanner that supports DICOM with R Wave Time Vector (see the DICOM conformance statement for the scanner type being used.)
- Images are single cycle loops where the first image frame corresponds to the R wave.

Storage of a cineloop

See 'Storing a cineloop' on *page 10-8*.

The system supports two types of zoom:

- Display zoom: Magnifies the image display of a selected area.
- High resolution (HR) zoom: Concentrates the image processing on a selected area of the image, resulting in improved image quality and a higher frame rate in the chosen region of interest (ROI).

Display zoom

1. Rotate the **Zoom** knob clockwise on the Control Panel.
The resulting magnified image appears in the acquisition window. An un-magnified image is displayed in the right corner showing the outlined zoomed region.
2. Use the trackball to position the zoom area over the desired portion of the image.
3. To turn off the Display zoom, rotate the **Zoom** knob counterclockwise.

HR zoom

1. Press the **Zoom** knob.
2. Use the trackball to position the zoom area over the desired portion of the image.
3. Increase size as desired by turning the **Zoom** knob clockwise.
4. Press **Zoom** one more time to turn off the HR zoom.

Annotations

Text annotations may be inserted anywhere in the image area. The annotation can be free text or a pre-defined text from an application-specific annotation library displayed on the Touch Panel.

Annotations can be done on two separate layers to enable selective display of annotations.



Annotations (text, arrow, and bodymark) are created on separate layers. When viewing annotated images on a different system or when zooming the image, the position of the annotations on the image may be slightly changed.

To insert an annotation

Free text

1. Type the desired text using the alphanumeric keyboard.
To change/add line press **Enter**.
2. Trackball the text entered to the insertion position.
3. Press **Select** to add the annotation.

Pre-defined text

1. Press **Text** on the Touch Panel.

NOTE: You may need to press **More** first on the Touch Panel to have access to the **Text** button.

The **Text** folder with annotations specific to the current application is displayed on the Touch Panel.

NOTE: To select annotations from another application, press the button under the label **Library...** and select the desired application library.

2. On the Touch Panel, press the pre-defined text to insert.
The word is displayed on the screen.

NOTE: Some buttons toggle between two or three related annotation texts (e.g. pressing the annotation **Left** will insert the text “Left” and toggle the button to the annotation **Right**). Annotation buttons with toggle functionality are marked with a circular arrow.

3. Position the text on the screen with the trackball.
4. Press **Select** to add the annotation.



1. Selects application specific library
2. Displays Bodymarks
3. Inserts Arrow
4. Creates layered annotations
5. Adjustment tools
6. Button with toggle function

Figure 4-9. Annotation Touch Panel

Layered annotations

Annotations can be entered on two different layers (called Text 1 and Text 2). This function enables the user to show/hide different annotations on the same image.

1. Press **Text 1** on the Touch Panel. The Text 1 layer is displayed. Enter an annotation.

2. Press **Text 2**. The Text 2 layer is displayed (the Text 1 layer is hidden). Enter an annotation.

Editing annotations

To move annotations

1. While in Annotation mode, move the text marker over the annotation to move and press **Select**.
2. Move the selected annotation with the trackball to a new location and press **Select**.

NOTE: An annotation is tied to the view where it was placed. For example: If an annotation is moved from the 2D view and into the doppler view, the annotation will disappear when switching to a mode which does not show the doppler view.

To edit annotations

Replacing text

1. Press **Highlight** on the Touch Panel to browse through the annotations entered word by word until the word to edit is selected.

*NOTE: To browse backward, press and hold down **Shift** while pressing **Highlight**.*

2. To select several words, rotate **Grab Word** on the Touch Panel.
3. Type a new text to replace the selected text or press **Delete word** on the Touch Panel (or **Backspace**) to delete the selection.

Adding text

1. Move the text marker over the annotation to edit and press **Select**.
2. The text in the selected annotation can be edited using the following alphanumeric keys:
 - **Right arrow**: Moves the text cursor forward.
 - **Left arrow**: Moves the text cursor backward.
 - **Tab**: Moves the text cursor forward word by word.
 - **Shift + Tab**: Moves the text cursor backward word by word.
 - **Enter**: Moves the cursor to the next line.
 - **Backspace**: Deletes backward.

- **Delete:** Deletes forward.
- **Insert:** Toggles the text entry state from overwrite to insert mode.

To erase text annotations

1. Press **Clear** on the Control Panel. The text annotation is erased.

If text annotation contains a yellow portion, typed previously, and a green portion which is the currently typed text, the first press on Clear erases yellow text. A second press erases the yellow text.

To erase all text annotations

To erase all annotations:

1. Press **Page erase** on the Touch Panel.
If using layered annotations, all texts from both layers are deleted.

Bodymark

Bodymarks are small graphic images that represent the examined anatomy. By using bodymarks, the user can indicate the position that the probe was in during the examination.

Inserting a bodymark

1. Press **Bodymark** on the Touch Panel.
The bodymarks specific to the current application are displayed.
2. Press the bodymark to insert.
The selected bodymark with a probe marker is displayed on the scanning screen.
3. Using the trackball, adjust the position of the probe marker.
4. Adjust **Rotate probe marker** to set the probe marker orientation.
5. To move the bodymark:
 - Press **Move pattern**.

*NOTE: To select bodymarks from another application, press the button under the label **Library...** and select the desired application library.*

- Move the bodymark to a new location with the trackball.
 - Press **Move pattern** to anchor the bodymark to the new location.
6. Press **Select**.

To erase a bodymark

1. Press **Clear** on the Control Panel.

Annotation and bodymark configuration

Annotation and bodymark configuration enable the user to:

- Create new application specific text and bodymark libraries.
- Edit existing application specific text and bodymark libraries.
- Delete user-defined libraries.

A library is a list of up to 30 text inputs accessible from the Touch Panel (two pages).

To access to the Annotation and bodymark configuration screen:

1. Press **Utility/Config** on the Touch Panel and log on as administrator if required.
2. Select the **Meas/Text** category and **Text** or **Bodymark** subgroup.

The corresponding screen is displayed (Figure 4-10, Figure 4-11).



Figure 4-10. The Text sheet

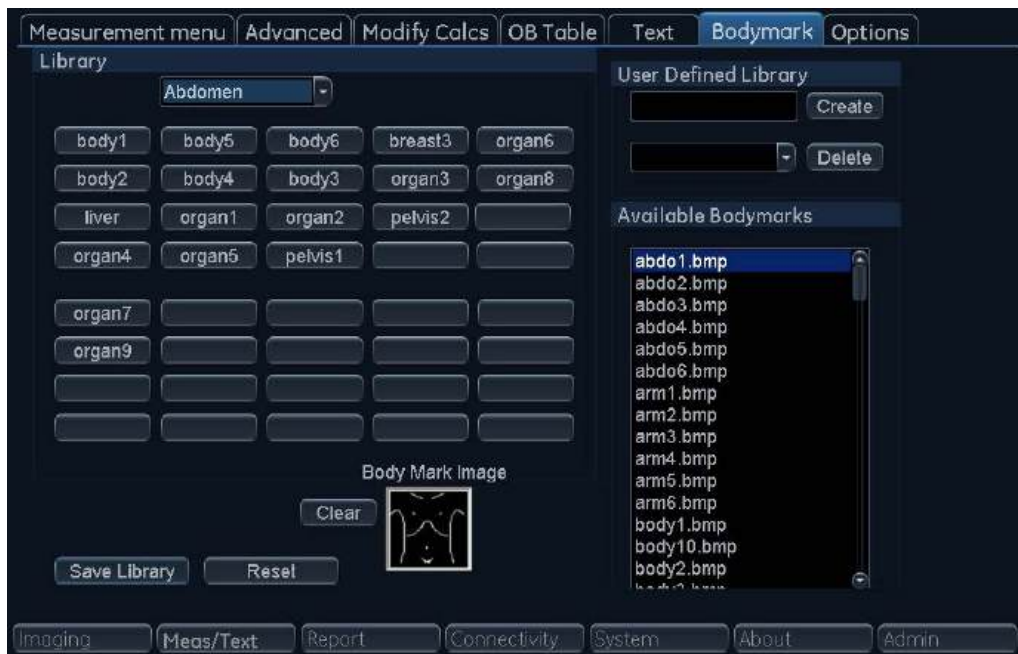

Figure 4-11. The Bodymark sheet

To edit an existing library

1. In the *Library* field, select the library to edit.
2. To change or add a pre-defined text, select the text entry or a blank location and do one of the following.

Annotation library:

- Type a text.
- Select a text from the *Copy from existing* list.

Bodymark library:

- Select a bodymark form the *Bodymark available* field.

3. Press **Save library**.

NOTE: *If a factory library is edited, the original library can be restored by pressing **Reset**.*

Toggling pre-defined annotations

It is possible to assign up to three related texts to one location enabling the user to toggle between the text entries when pressing the button on the Touch Panel (e.g. pressing the toggling annotation **Left** will insert the text “Left” and toggle the button to the annotation **Right**). Annotation buttons with toggle functionality are marked with a circular arrow.

To create a toggling annotation:

1. Enter up to three text entries separated by a colon in the desired location (e.g. “Left:Right”).

To create a library

1. In the *User-defined library* field, type a name for the library to be created, then select **Create**.
2. Enter pre-defined texts as described in step 2 above.
3. Press **Save library**.

Automatically enter Bodymark

Annotation has the ability to configure Active Function at freeze in 2D and Color flow modes as: None, Body Mark or Text.

If Body Mark is selected, the default bodymark will appear automatically at “Home” position. See bottom left in Figure 4-12. The default bodymark is the first in the list, see Figure 4-13.

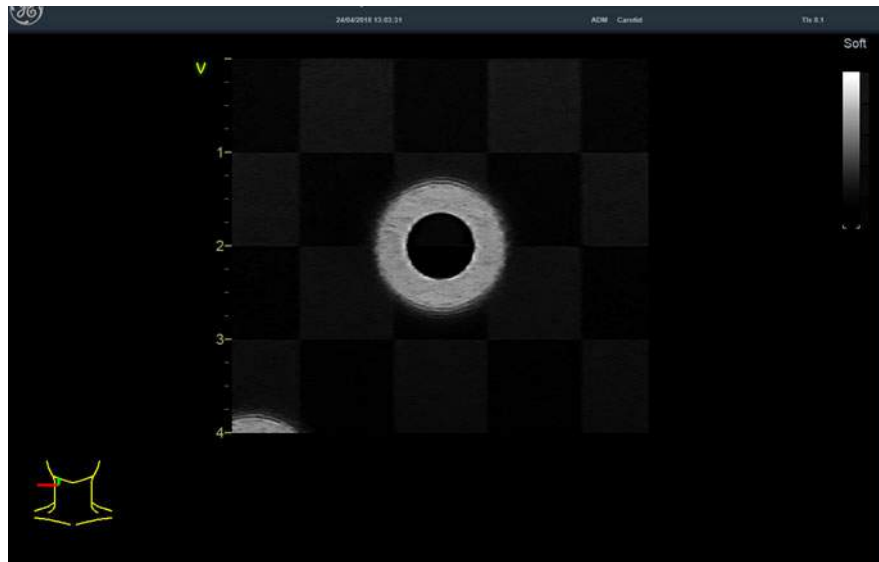

Figure 4-12. Home position

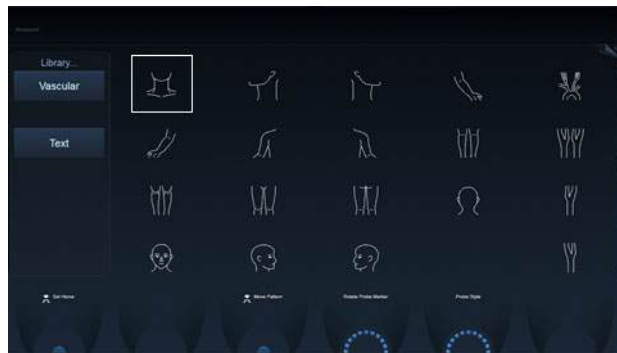

Figure 4-13. Default bodymark

When Bodymark is activated, Probe Mark position is moving by default. The left “Set” key can be used to switch between Probe Mark Move and Body Mark Move. The system will stay in Bodymark or text mode after Probe Mark position is adjusted. In Freeze, “Depth” control can be used to rotate Probe Mark when Bodymark is active.

The system will stay in Bodymark or text mode when Active side is changed.

General options

Text, bodymark, and arrow default options can be specified from the *Option* category.

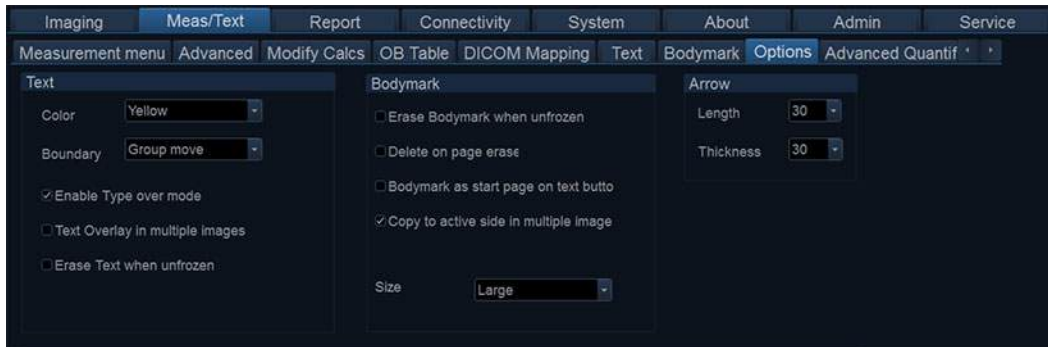

Figure 4-14. The Options sheet

Parameter	Description
Text color	Select the color for annotation text.
Text boundary	Select Group Move or Word Wrapping
Enable type over mode	When selected, the user can place the cursor in an existing annotation and start typing to insert new text.
Text overlay in multiple images	When selected, if in dual mode, hides annotations in both images when toggling Text 1/Text 2 . If unchecked, hides annotations in the active image only.
Erase text when unfrozen	Deletes annotations when unfreezing the image.
Erase Bodymark when unfrozen	Deletes bodymark when unfreezing the image.
Delete Bodymark on page erase	The Bodymark inserted is deleted when applying Page erase .
Bodymark as start page on text button	Sets the Bodymark Touch Panel as default page when pressing Text on the Control Panel.
Arrow length	Select the default arrow length.
Arrow thickness	Select the default arrow thickness.
Text and bookmark library	Set availability for up to six libraries for the current application and select the default library. Reset reloads the factory default setting.
Bodymark size	Select Normal or Large bodymark size. Default is Large.
Copy Bodymark to active side	Copies bodymark to active side in dual or quad screen.

Chapter 5

Image Optimization

Describes how to adjust the image. This chapter describes acquisition modes and scanning features.

'2D-Mode' on page 5-3

'M-Mode' on page 5-7

'Color Mode' on page 5-12

'PW and CW Doppler' on page 5-19

'Tissue Velocity Imaging (TVI)' on page 5-23

'Tissue Tracking' on page 5-26

'Strain rate' on page 5-29

'Strain' on page 5-32

'Tissue Synchronization Imaging (TSI)' on page 5-35

'Contrast Imaging' on page 5-39

'Strain Elastography' on page 5-47

'Elastography Analysis' on page 5-51

'Additional scanning features' on page 5-54

'Image controls' on page 5-57

'Scan Assist Pro' on page 5-67

2D-Mode

2D-Mode overview



1. Probe orientation marker
2. Parameter window

Figure 5-1. The 2D screen (cardiac)



Figure 5-2. 2D Touch panel (4D probe Live) page 1 and 2

Using 2D-Mode

The 2D-Mode is the system's default mode.

1. Press **2D** on the Control panel to access 2D mode.
2. Optimize the image by adjusting the image controls (see below).

Optimizing 2D

The use of preset gives optimum performance with minimum adjustment. If necessary, the following controls can be adjusted to further optimize the 2D image:

- Press either **Soft** or **Sharp** Auto Tissue setting on the Touch panel.
 - **Soft**: optimizes the radial and lateral uniformity and brightness of the tissue continuously in real-time.
The mention "Soft" is displayed on the upper right corner of the image area
 - **Sharp**: further enhances the image display by optimizing the grayscale curve.
The mention "Sharp" is displayed on the upper right corner of the image area

The Auto Tissue setting (Soft or Sharp) can be turned on/off by pressing **Auto** on the Control panel. The last used setting is then applied.

The Auto Tissue settings are only available in live scanning and cannot be turned off when the image is stored.

- If available, press **Virtual Apex** (probe dependent) to improve near field imaging, allowing increased visibility up to the width of the full probe aperture close to the surface.
- Use the **Gain** and **TGC** controls to optimize the overall image.

Gain increases or decreases the amount of echo information displayed. TGC compensates for depth-related attenuation in the image.

- Use the **Depth** control to adjust the range to be imaged.
- Use the **Frequency** control (move to higher frequencies) or the **Frame rate** control (move to lower frame rate) to increase resolution in image.
- Use the **Frequency** control (move to lower frequency) to increase penetration.
- Use the **DDP** control to optimize imaging in the blood flow regions and make a cleaner, less noisy image.
- Adjust **Compress** to further optimize the display.
- Use **UD Clarity** (Cardiac) or **UD Speckle reduce** (non-cardiac) to reduce image speckle. Extra care must be taken to select the optimal Speckle reduction level, as too much filtering of speckle can mask or obscure desired image detail.
- Adjust **Octave** to toggle between Fundamental and Harmonic mode.
- Press **Color maps** and select a gray map from the menu on screen.
- Use **HD** (High Definition) to smooth out the speckle and reduce the noise in the image.
- If using a 4D probe:
 - Adjust the **Quick Rotate** control on the Touch panel or press **Angle** on the Control panel to rotate the scan plane to pre-defined angles.
 - Adjust the **Rotate** rotary of the Touch panel to fine tune the angle adjustment.

A scan plane indicator is displayed showing the angle position of the scan plane.



Always use the minimum power required to obtain acceptable images in accordance with applicable guidelines and policies.

M-Mode

M-Mode overview

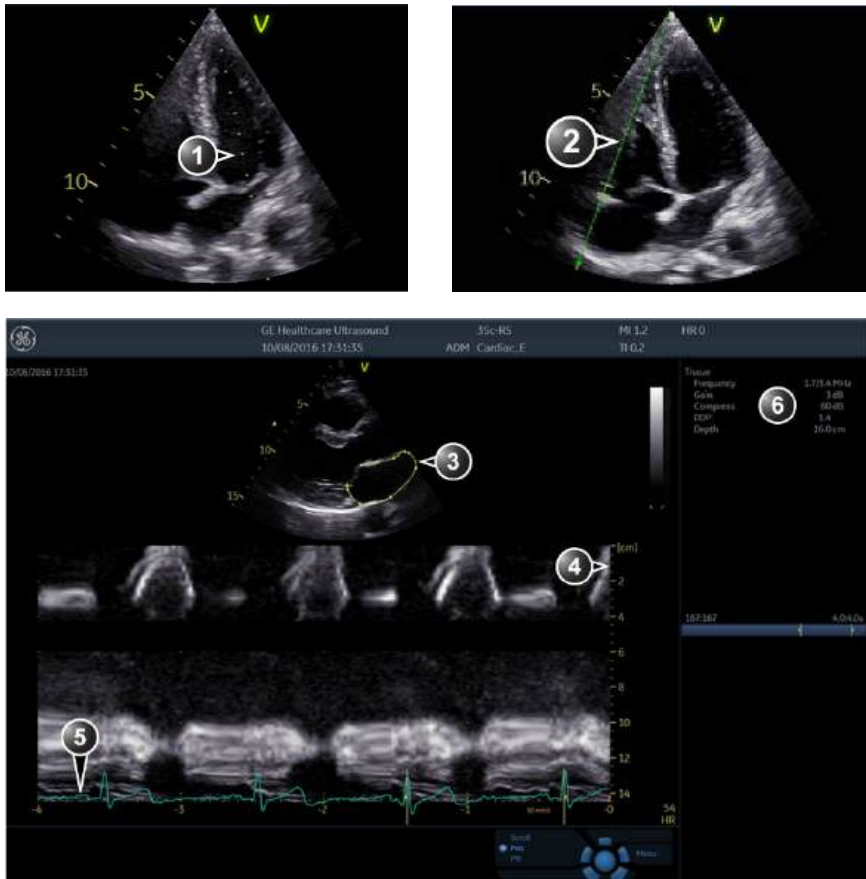

- | | |
|--|---------------------|
| 1. Time motion cursor conventional M-Mode | 4. Depth scale |
| 2. Time motion cursor anatomical M-Mode | 5. Time scale |
| 3. Time motion cursor curved anatomical M-Mode | 6. Parameter window |

Note: The sweep speed information displayed in the bottom right corner of the image represents the user selected sweep speed and should be used only as a reference to confirm that the image was acquired at the selected sweep speed. It is not to be used for measurements or analysis. This is not an absolute value, but simply a reference number. Users performing studies using standardized protocols may find this sweep speed information useful for reading studies from other institutions.

Figure 5-3. The M-Mode screen (composite)

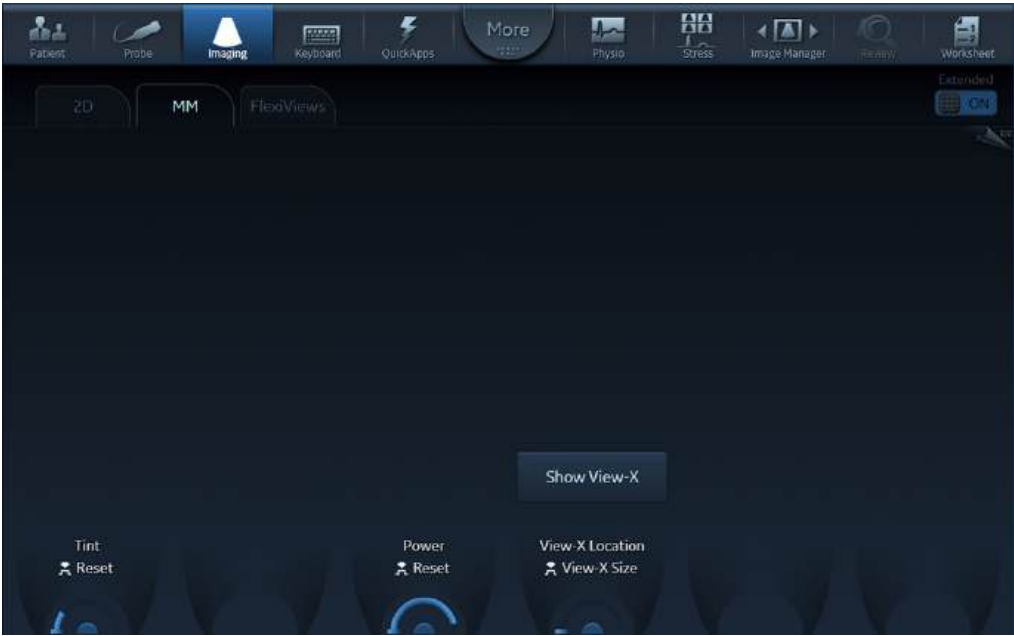

Figure 5-4. M-Mode Touch panel page 1 and 2

This system has three types of M-Mode:

- Conventional M-Mode (MM): displays a distance/time plot of a cursor line in the axial plane of the 2D-image.
- Anatomical M-Mode (AMM): displays a distance/time plot from a cursor line, which is independent from the axial plane. AMM is available in grayscale, color, TVI, Tissue Tracking, Strain rate and Strain modes.
- Curved Anatomical M-Mode (CAMM): displays a distance/time plot from a free-drawn cursor line. CAMM is available in grayscale, color, TVI, Tissue Tracking, Strain rate and Strain modes.

Conventional M-Mode can be combined with Color Mode.

Using M-Mode

Conventional M-Mode

1. To access M-Mode from any other scan mode, press **MM** on the Control panel.
2. Use the trackball to position the cursor over the required area of the image.
3. Press **Freeze**.
4. Use the trackball to scroll through the data acquired.

Anatomical M-Mode

1. In M-Mode or 2D-Mode Freeze, press **AMM** on the Touch panel.

NOTE: Anatomical M-Mode can also be used with previously acquired digitally stored 2D images. More than one heart cycle should be stored if performing M-Mode in post processing.

2. Use the trackball (assigned function: *Pos*) to position the cursor over the required area of the image.
3. Press **Trackball** to allow free rotation of the solid full-length cursor line throughout the 2D image (trackball assigned function: *Angle*).
4. Rotate the solid cursor line to the desired direction.

Curved Anatomical M-Mode

1. In M-Mode, press **Curved AMM**.
2. Use the trackball (assigned function: *Pos*) to position the starting point of the time motion curve.
3. Press **Select** to anchor the starting point of the time motion curve.
4. Use the trackball to position the next point of the time motion curve.
5. Press **Select** to anchor the point of the time motion curve.
6. Repeat step 4 and 5 up to draw a complete time motion curve.

NOTE: The time motion curve can be edited by following the curve back to the desired point and redraw.

7. On the last point, press **Select** twice to terminate the curve.

NOTE: To edit the time motion curve, select a point, move it to a new position and press **Select**.

Optimizing M-Mode

The use of preset gives optimum performance with minimum adjustment. If necessary, the following controls can be adjusted to further optimize the M-Mode display:

NOTE: Refer to 'Generating a new preset' on page 12-115 about creating presets.

- Adjust **Horizontal sweep** to optimize the display resolution.
- Adjust **Gain** and **TGC** controls to adjust the range to be imaged.
- Use the **Frequency** (move to higher frequencies) or the **Frame rate** control (move to lower frame rate) to increase resolution in image.
- Adjust **Dynamic range** to optimize the useful range of incoming echoes to the available grayscale.
- Adjust **Compress** and **Edge Enhance** to further optimize the display.
- Adjust **Reject** to reduce noise while taking care not to eliminate significant low-level diagnostic information.
- Press **Octave** to toggle between fundamental and Harmonic mode.
- Use the **Focus Pos** control to center the focal point around the region of interest.
- Adjust **Power** to obtain an acceptable image using the lowest setting possible.

NOTE: *The Power setting affects all other operating modes.*

Color Mode

Color 2D Mode overview



1. Probe orientation marker
2. Color bar
3. Color sector marker
4. Parameter window

Figure 5-5. The Color Mode screen

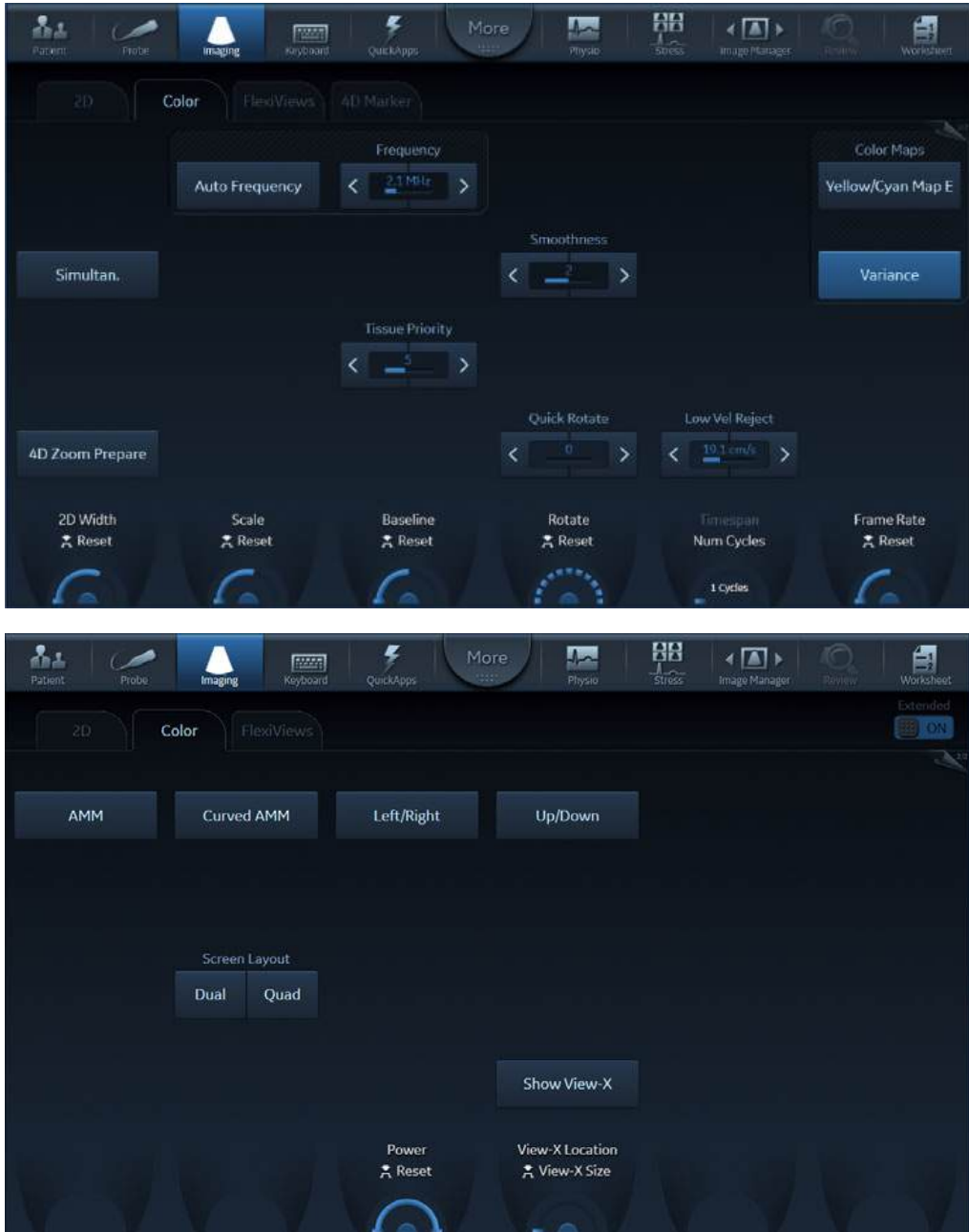
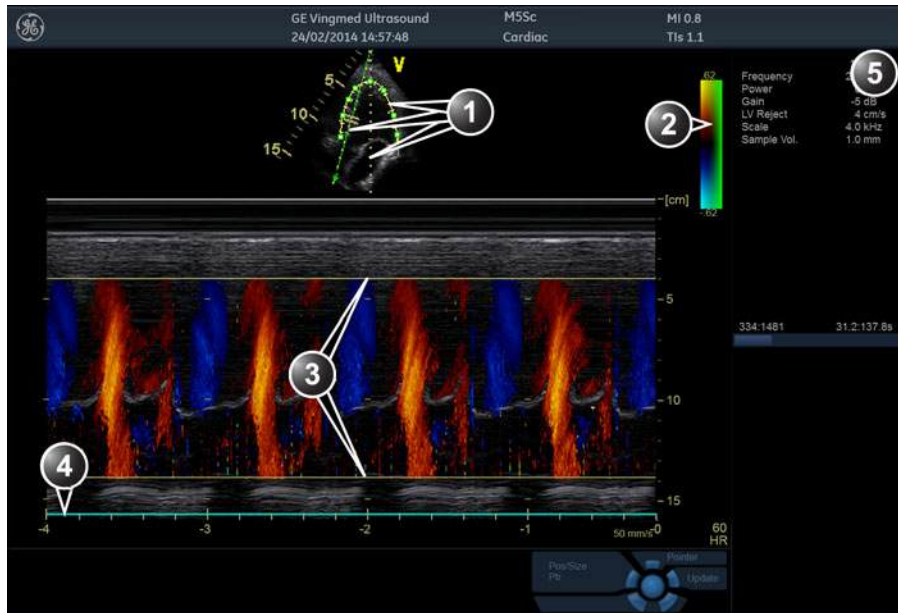

Figure 5-6. Color 2D Touch panel page 1 and 2

Color M-Mode overview



1. Time motion cursors (M-Mode, AMM and Curved AMM)
2. Color bar
3. Flow sector marker
4. Time scale
5. Parameter window

Figure 5-7. The Color M-Mode screen (composite)

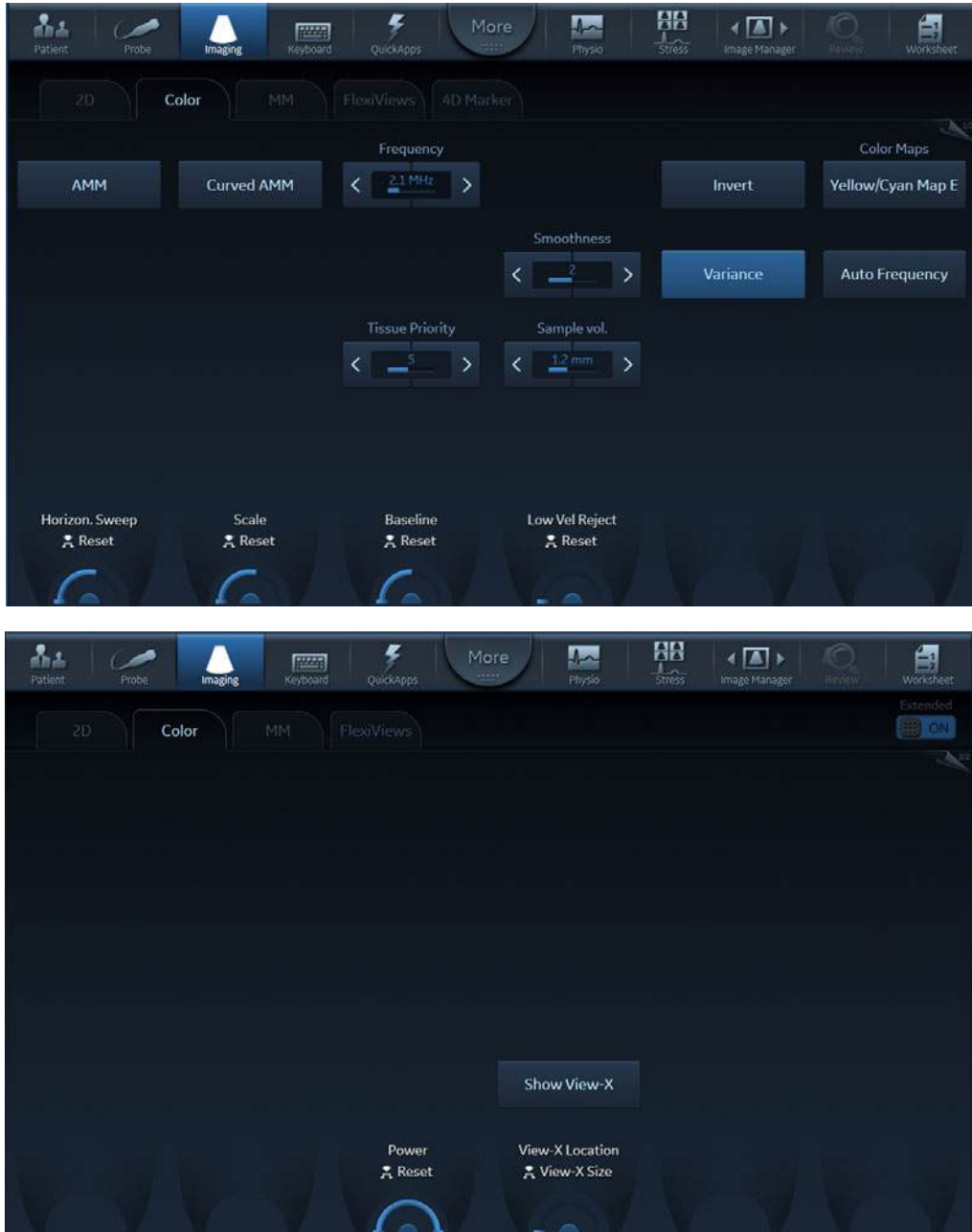

Figure 5-8. Color M-Mode Touch panel page 1 and 2 (Color controls)

Using Color Mode

Color 2D

1. From an optimized 2D image, press **Color**.
2. Use the trackball (assigned function: *Pos*) to position the ROI frame over the area to be examined.
3. Press **Select**. The instruction *Size* should be highlighted in the trackball status bar.

*NOTE: If the trackball control Pointer is selected, press **Trackball** to be able to select between Position and Size controls.*

4. Use the trackball to adjust the dimension of the ROI.

Color M-Mode

1. From M-Mode press **Color**.
2. Use the trackball (assigned function: *Pos*) to position the color area in the M-Mode display.
3. Press **Select**. The instruction *Size* should be highlighted in the trackball status bar.

*NOTE: If the trackball control Pointer is selected, press **Trackball** to be able to select between Position and Size controls.*

4. Use the trackball to adjust the dimension of the color area.

Optimizing Color Mode

The use of preset gives optimum performance with minimum adjustment. If necessary, the following controls can be adjusted to further optimize the Color Mode display:

NOTE: Refer to 'Generating a new preset' on page 12-115 about creating presets.

- Adjust the **Active mode gain** to set the gain in the color flow area.
- Adjust **Scale** to the highest setting that provides adequate flow detection.

NOTE: The scale value may affect FPS, Low Velocity Reject, and Sample Volume.

- Adjust **Low Velocity Reject** to remove low velocity blood flow and tissue movement that reduces image quality.
- Adjust **Variance** to detect flow disturbances.
- Adjust **Sample volume (SV)** to a low setting for better flow resolution, or a higher setting to more easily locate disturbed flows.
- Adjust **Frequency** to optimize the color flow display. Higher settings improve resolution. Lower settings improve depth penetration and sensitivity. This does not affect the frequency used for 2D and M-Mode.

NOTE: Frequency setting may affect FPS, SV and Low Velocity Reject.

In certain selected applications when entering color flow imaging (CF), there is a button available called **AutoFrequency**. If this button is depressed, the application will automatically select for the user a frequency appropriate for the depth of the ROI. When the feature is enabled, the frequency control is no longer available to the user until the AutoFrequency button is released again. And while the AutoFrequency feature is active the scale control is controlling velocity and not PRF as indicated on the Touch panel rotary itself. If the user turns the desired velocity control to a higher value than what is achievable at the maximum PRF attainable at the current depth, the feature will automatically lower the frequency to still attempt to achieve the requested velocity, if this is possible within the range of frequencies supported. Moving the ROI between different depths, the user may experience that the system selects a different frequency if that is more suitable, as is displayed on the screen, but will attempt where possible to retain the velocity span requested from the user interface. Releasing the AutoFrequency button will again make the manual frequency selection rotary available to the user and the scale button will again be controlling the PRF directly.

- Adjust **Power** to obtain an acceptable image using the lowest setting possible.

NOTE: The Power setting affects all other operating modes.

Adjust the following settings to further optimize display of the image:

- Use **Invert** to reverse the color assignments in the color flow area of the display.
- Use **Tissue priority** to emphasize either the color flow overlay, or the underlying greyscale tissue detail.
- Use **Baseline** to emphasize flow either toward or away from the probe.

NOTE: Push the **Baseline** control button to reset the baseline.

- Use **Radial Averaging** and **Lateral Averaging** (not available to all probes) to reduce noise in the color flow area. Radial and Lateral Averaging smooths the image by averaging collected data along the same horizontal line. An increase of the lateral averaging will reduce noise, but this will also reduce the lateral resolution.
- For **Select probes:** Use **Color Smoothness** to adjust the degree of averaging in order to achieve a smooth or less smooth color presentation.



Use all noise reduction controls with care. Excessive application may obscure low level diagnostic information.

PW and CW Doppler

PW and CW Doppler overview



1. Sample volume (PW only)
2. Angle correction marker
3. Velocity scale
4. Low velocity reject
5. Nyquist velocity
6. Doppler baseline
7. Frequency scale (configurable, see page 12-21)
8. Parameter window

Note: the sweep speed information displayed in the bottom right corner of the image represents the user selected sweep speed and should be used only as a reference to confirm that the image was acquired at the selected sweep speed. It is not to be used for measurements or analysis. This is not an absolute value, but simply a reference number. Users performing studies using standardized protocols may find this sweep speed information useful for reading studies from other institutions.

Figure 5-9. The PW/CW Doppler Mode screen

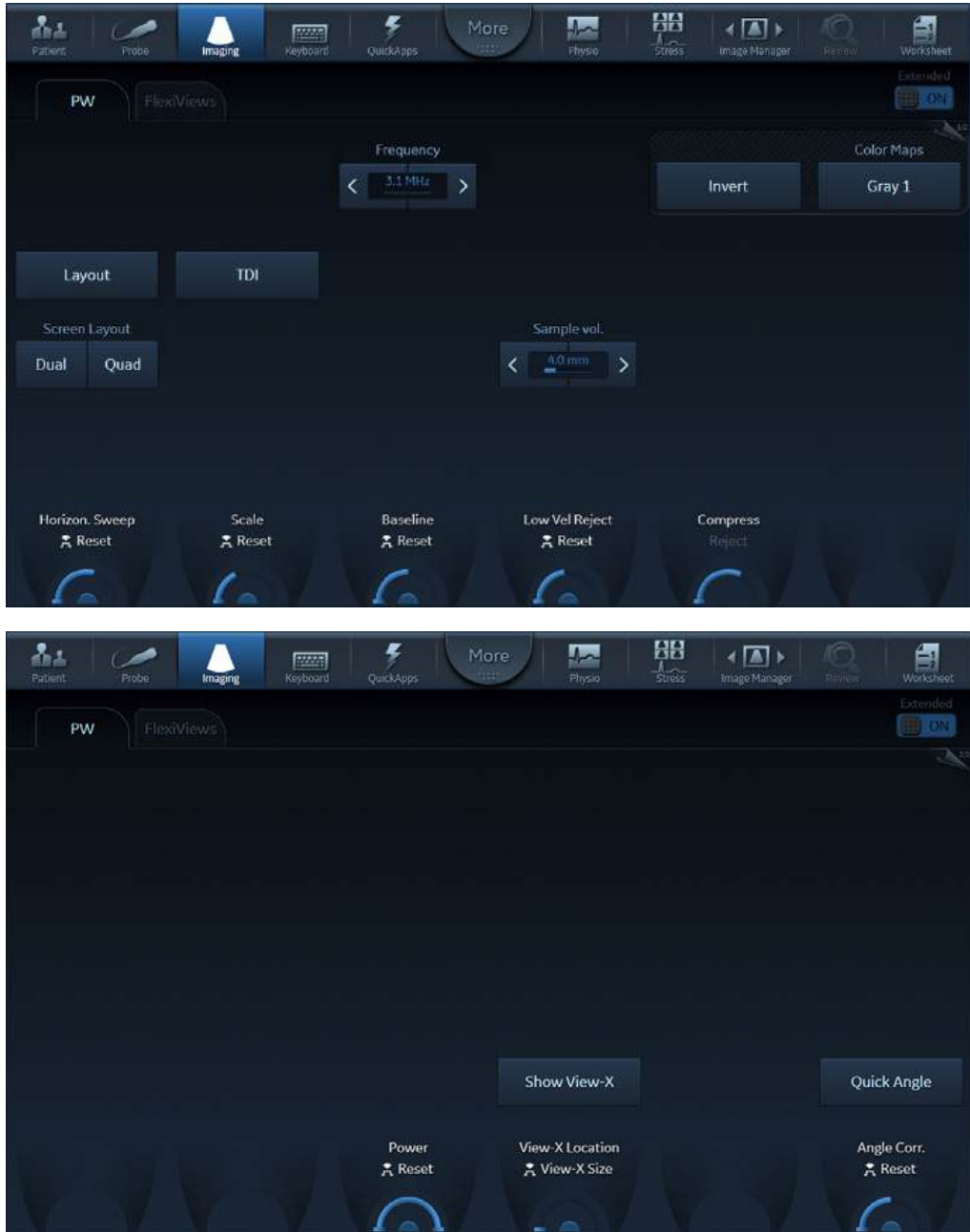

Figure 5-10. The PW Doppler Touch Panels page 1 and 2

Using PW/CW Doppler modes

Alternative 1

1. Press **PW** or **CW**. A scanning screen is displayed with a Doppler cursor on the 2D mode image and a Doppler spectrum in the lower part of the screen.
2. Use the trackball to position the Doppler cursor line and in PW the sample volume location over the area of interest.
3. In PW, adjust the **Sample Volume**.

NOTE: Sample Volume adjustment may affect the Scale, Frame rate and LV rej. settings.

Alternative 2

1. Press **Cursor** on the Control Panel. A cursor line is displayed on the 2D image.
2. Select the cursor type on the Touch Panel.
3. With the trackball adjust the position of the cursor line.
4. Press **PW** or **CW**.

Optimizing PW/CW Doppler modes

The use of preset gives optimum performance with minimum adjustment. If necessary, the following controls can be adjusted to further optimize the PW/CW modes display:

NOTE: Refer to 'Generating a new preset' on page 12-115 about creating presets

- Adjust the **Active mode gain** to set the gain in the spectral Doppler area.
- Adjust **Low velocity reject** to reduce unwanted low velocity blood flow and tissue movement.
- In PW mode, adjust **Sample volume** to low setting for better resolution, or higher setting to more easily locate the disturbed flows. Adjustment of the Sample volume may affect the PRF (Nyquist limit) settings.
- Adjust the **Compress** setting to balance the effect of stronger and weaker echoes and obtain the desired intensity display.

- Adjust **Frequency** to optimize flow display. Higher setting will improve resolution and the lower setting will increase the depth penetration.
- Adjust **Frame rate** to a higher setting to improve motion detection, or to a lower setting to improve resolution.

NOTE: Frequency and Frame rate settings may affect the Low Velocity Reject.

- Adjust **Power** to obtain an acceptable image using the lowest setting possible. This is particularly important in CW mode, as the energy duty cycle is 100% (constant).

NOTE: The Doppler Power setting affects only Doppler operating modes.



CAUTION

Use all noise reduction controls with care. Excessive application may obscure low level diagnostic information.

Adjust the following settings to further optimize the display of the image.

- Use the **Horizontal sweep** to optimize the sweep speed.
- To view signal detail, adjust **Scale** to enlarge the vertical spectral Doppler trace. Velocity range directly controls the pulse repetition frequency, which is responsible for the setting of the Nyquist limit (the ability to detect maximum velocity without aliasing).
- Use **Invert** to reverse the vertical component of the spectral Doppler area of the display.
- Use **Quick angle** and **Angle correction** to steer the ultrasound beam to the blood flow to be measured (Not typically required during cardiac studies).
- Adjust **LPRF** (PW Doppler mode only) to toggle between high and low Pulse Repetition Frequency (PRF). When the Doppler PRF is raised beyond a certain limit, more than one Doppler gate is displayed on the screen.
- Press **Auto** on the Control Panel to activate Automatic Spectrum Optimization (ASO). ASO is used to automatically adjust baseline and scale of the PW/CW spectrum to optimize the spectral display. It will avoid the display of a folded spectrum and stretch the spectrum vertically as large as possible. ASO optimization is not continuous but performed instantaneously each time **Auto** is pressed.

Tissue Velocity Imaging (TVI)

TVI overview

Tissue Velocity Imaging (TVI) calculates and color-codes the velocities in tissue. The tissue velocity information is acquired by sampling of tissue Doppler velocity values at discrete points. The information is stored in a combined format with grayscale imaging during one or several cardiac cycles with high temporal resolution.

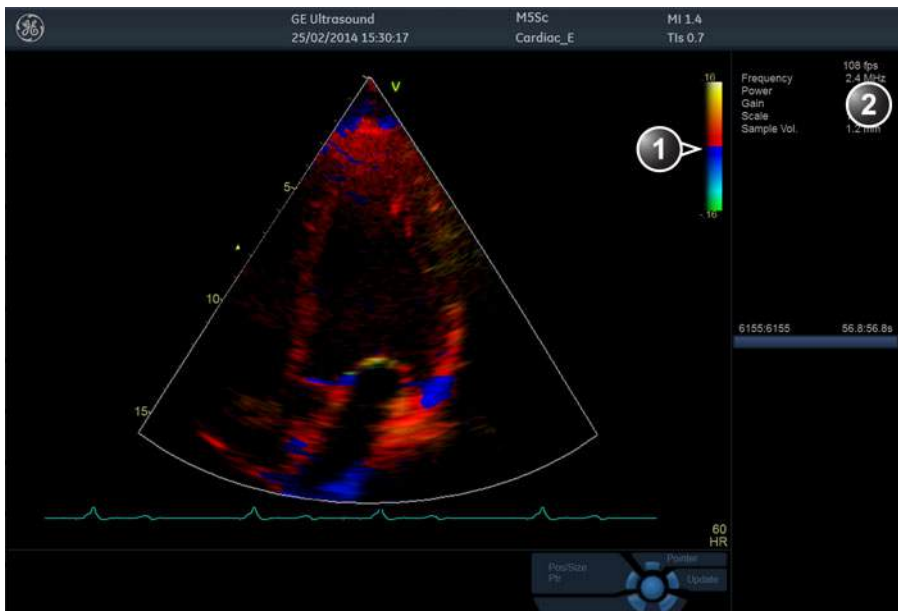

1. TVI color bar
2. Parameter window

Figure 5-11. The TVI Mode screen

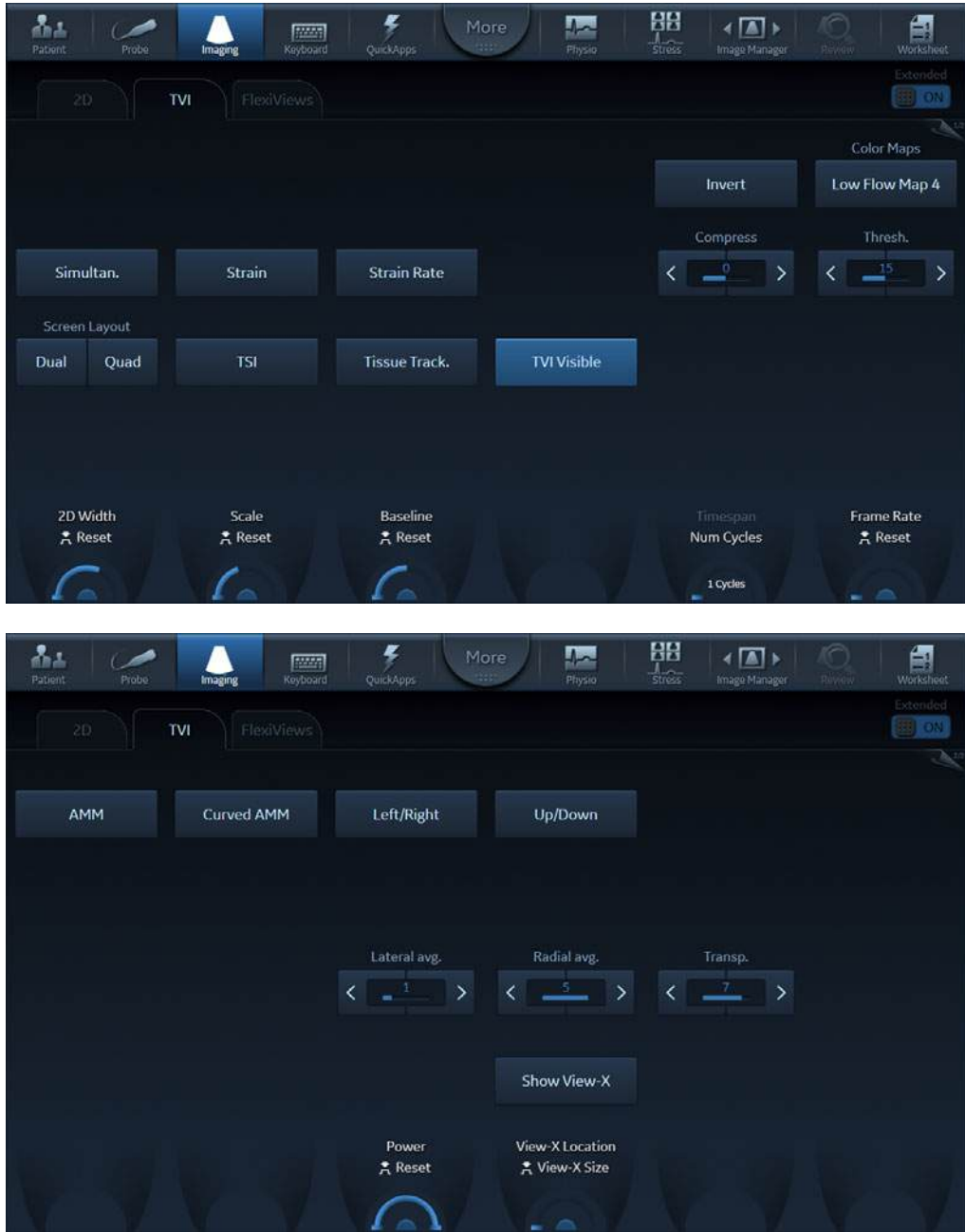

Figure 5-12. TVI Touch Panel page 1 and 2

Using TVI

1. While in 2D mode press **TVI** on the Control Panel.
2. Use the trackball (assigned function: *Pos*) to position the ROI frame over the area to be examined.
3. Press **Select**. The instruction *Size* should be highlighted in the trackball status bar.

NOTE: If the trackball control *Pointer* is selected, press **Trackball** to be able to select between *Position* and *Size* controls.

4. Use the trackball to adjust the dimension of the ROI.

Optimizing TVI

The use of presets gives optimum performance with minimum adjustment. If necessary, the following controls can be adjusted to further optimize the TVI display:

NOTE: Refer to 'Generating a new preset' on page 12-115 about creating presets.

- To reduce quantification noise (variance), the Nyquist limit should be as low as possible, without creating aliasing. To reduce the Nyquist limit: reduce the **Scale** value.

NOTE: The *Scale* value also affects the frame rate. There is a trade off between the frame rate and quantification noise.

- TVI provides velocity information only in the beam direction. The apical view typically provides the best window since the beams are then approximately aligned to the longitudinal direction of the myocardium (except near the apex). To obtain radial or circumferential tissue velocities, a parasternal view must be used. However, from this window the beam cannot be aligned with the muscle for all the parts of the ventricle.

NOTE: *PW* will be optimized for *Tissue Velocities* when activated from inside TVI.

Tissue Tracking

Tissue Tracking overview

Tissue Tracking calculates and color-codes the displacement in the tissue over a given time interval, typically the systole. The displacement is defined as the distance the tissue moves during this time interval. The displacement is found as the time integral (sum) of the tissue velocities during this interval.

Only displacements in the beam direction are found. Only positive (systolic) displacements are mapped into colors, negative displacements are mapped into greyscale.

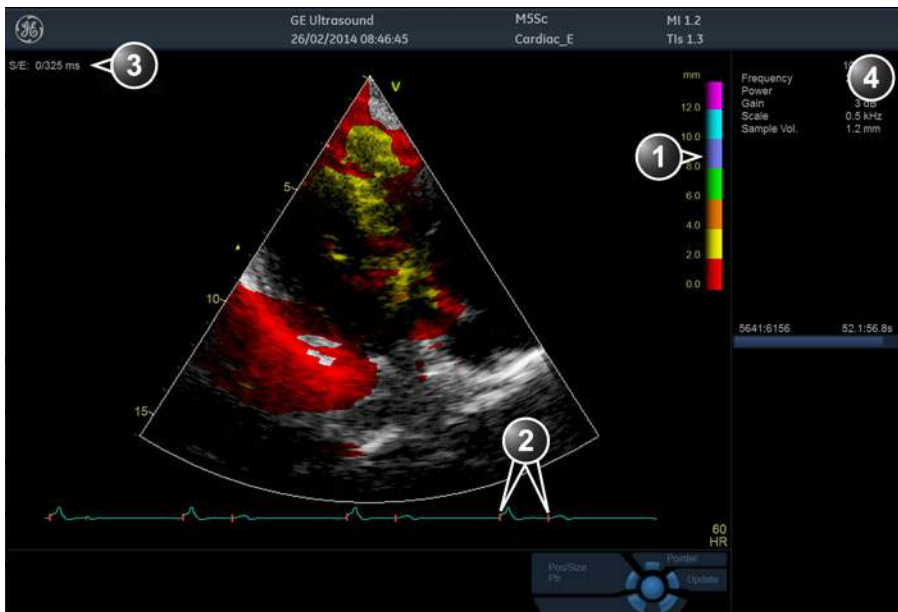

1. Tissue Tracking color bar
2. Track start and track end markers
3. Tracking start and end from detected QRS
4. Parameter window

Figure 5-13. The Tissue Tracking Mode screen

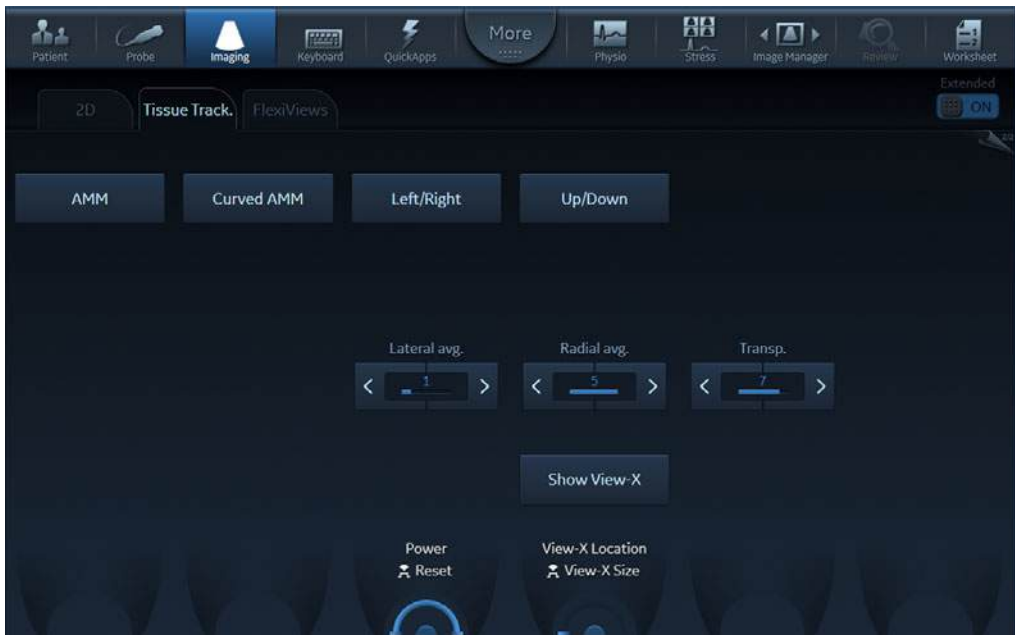
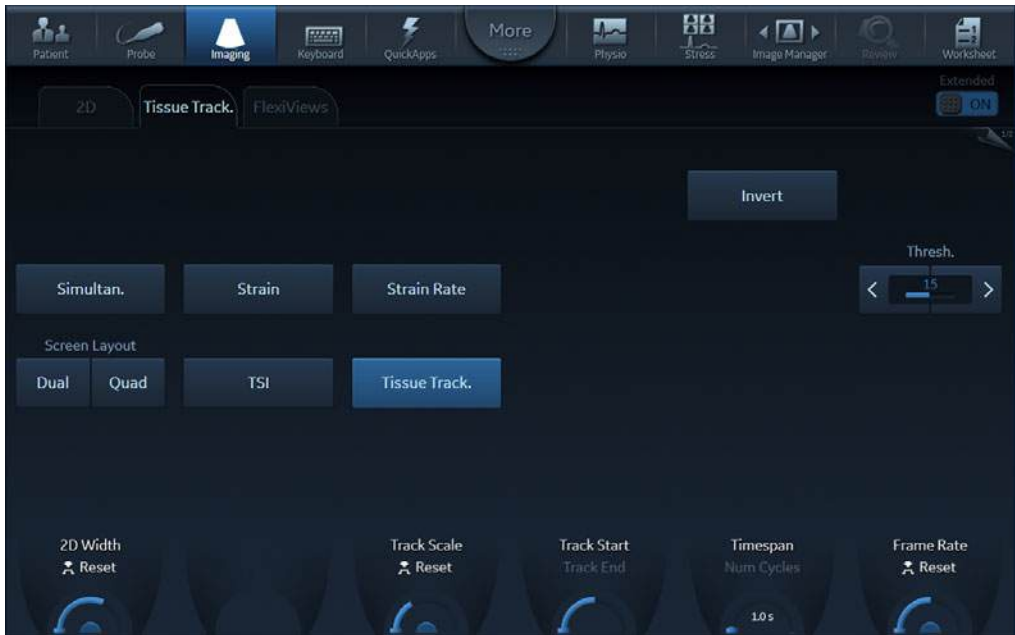

Figure 5-14. The Tissue Tracking Touch Panel page 1 and 2

Using Tissue Tracking

1. From TVI Mode, press **Tissue Tracking**.
2. Adjust **Tracking start** close to the R-peak.
3. Adjust **Tracking end** to end systole.
4. Use the trackball to position the ROI frame over the area to be examined.
5. Press **Select**. The instruction **Size** should be highlighted in the trackball status bar.

*NOTE: If the trackball control Pointer is selected, press **Trackball** to be able to select between Position and Size controls.*

6. Use the trackball to adjust the dimension of the ROI.

Optimizing Tissue Tracking

- To reduce quantification noise (variance), the Nyquist limit should be as low as possible, without creating aliasing. To reduce the Nyquist limit, reduce the scale while in TVI.
- To check for aliasing, freeze the loop and apply velocity trace (Press **Freeze** and **Q-Analysis**), see also 'Quantitative Analysis' on page 9-1).
- The main use of Tissue Tracking is to map positive systolic displacements. This means that **Tracking start** and **Tracking end** controls should be adjusted to pick out the systolic phase of the cardiac cycle. Adjust **Tracking start** close to the R-Peak. Adjust **Tracking end** to end systole, typically near the T-wave.

*NOTE: Tissue Tracking on TEE acquisitions displays negative displacements. Make sure **Invert** is selected to display positive displacements.*

- Negative displacement can be mapped by pressing **Invert**. **Tracking start** and **Tracking end** must then be adjusted to pick out the diastolic phase of the cardiac cycle.
- The maximum displacement that is color-coded can be adjusted using **Tracking scale**. If set too low, most of the wall will show the color indicating maximum displacement. If set too high, the maximum displacement color is never reached.
- Tissue Tracking provides velocity information only in the beam direction. The apical view typically provides the best window since the beams are then approximately aligned to the longitudinal direction of the myocardium (except near the apex).

Strain rate

Strain rate overview

Strain rate calculates and color-codes the deformation per system time i.e the speed at which the tissue deformation occurs.

Strain rate is calculated as the spatial gradient of velocity data.

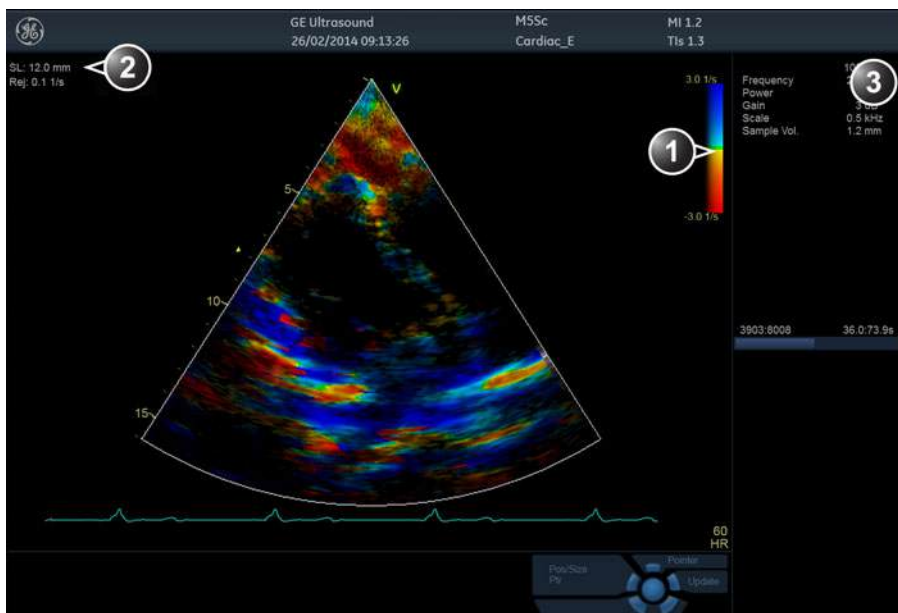

1. Strain rate color bar
2. Strain length and Strain rate reject
3. Parameter window

Figure 5-15. The Strain rate mode screen



Figure 5-16. The Strain rate Touch Panel page 1 and 2

Using Strain rate

1. From TVI Mode, press **Strain rate**.
2. Use the trackball to position the ROI frame over the area to be examined.
3. Press **Select**. The instruction *Size* should be highlighted in the trackball status bar.

NOTE: If the trackball control *Pointer* is selected, press **Trackball** to be able to select between *Position* and *Size* controls.

4. Use the trackball to adjust the dimension of the ROI.

Optimizing Strain rate

- To reduce quantification noise (variance), the Nyquist limit should be as low as possible, without creating aliasing. To reduce the Nyquist limit, reduce the scale while in TVI.
- To check for aliasing, freeze the loop and apply velocity trace (Press **Freeze** and **Q-Analysis**), see also 'Quantitative Analysis' on page 9-1).
- Strain rate provides information only in the beam direction. The apical view typically provides the best window since the beams are then approximately aligned to the longitudinal direction of the myocardium (except near the apex).
- There is a trade-off between noise and spatial resolution controlled by the **Strain length** control. To minimize noise the **Strain length** should be maximized.
- The maximum Strain rate that is color-coded can be adjusted using the **SRI scale** control. If set too low, most of the wall will show the color indicating maximum Strain rate. If set too high, the maximum Strain rate color is never reached.
- Low strain rates may be masked out with a green color using the **SRI Reject** control.

Strain overview

Strain calculates and color-codes the extent of tissue deformation (lengthening or shortening) relative to the original size over a given time interval, typically the systole.

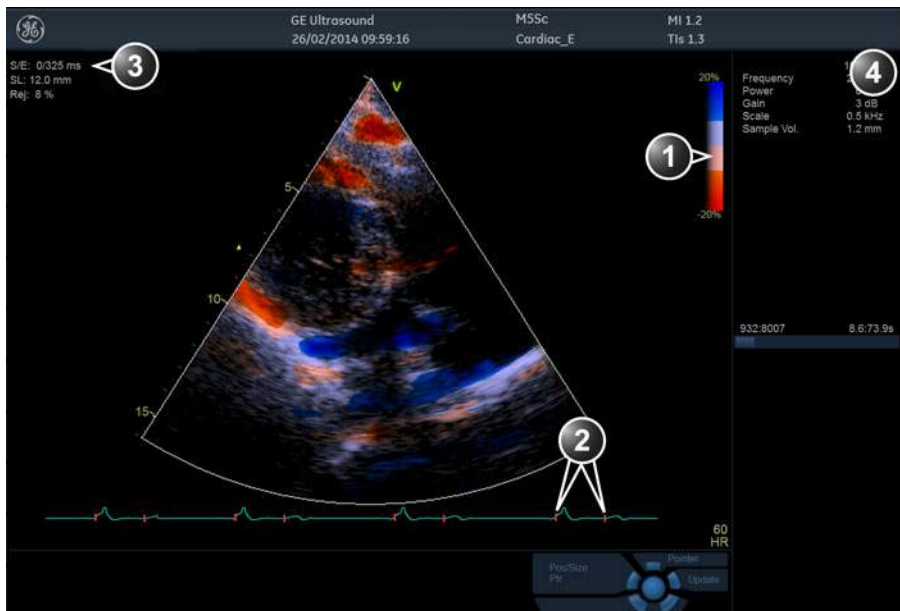

1. Strain color bar
2. Strain start and end markers
3. Strain start and end from detected QRS and Strain sample size
4. Parameter window

Figure 5-17. The Strain mode screen

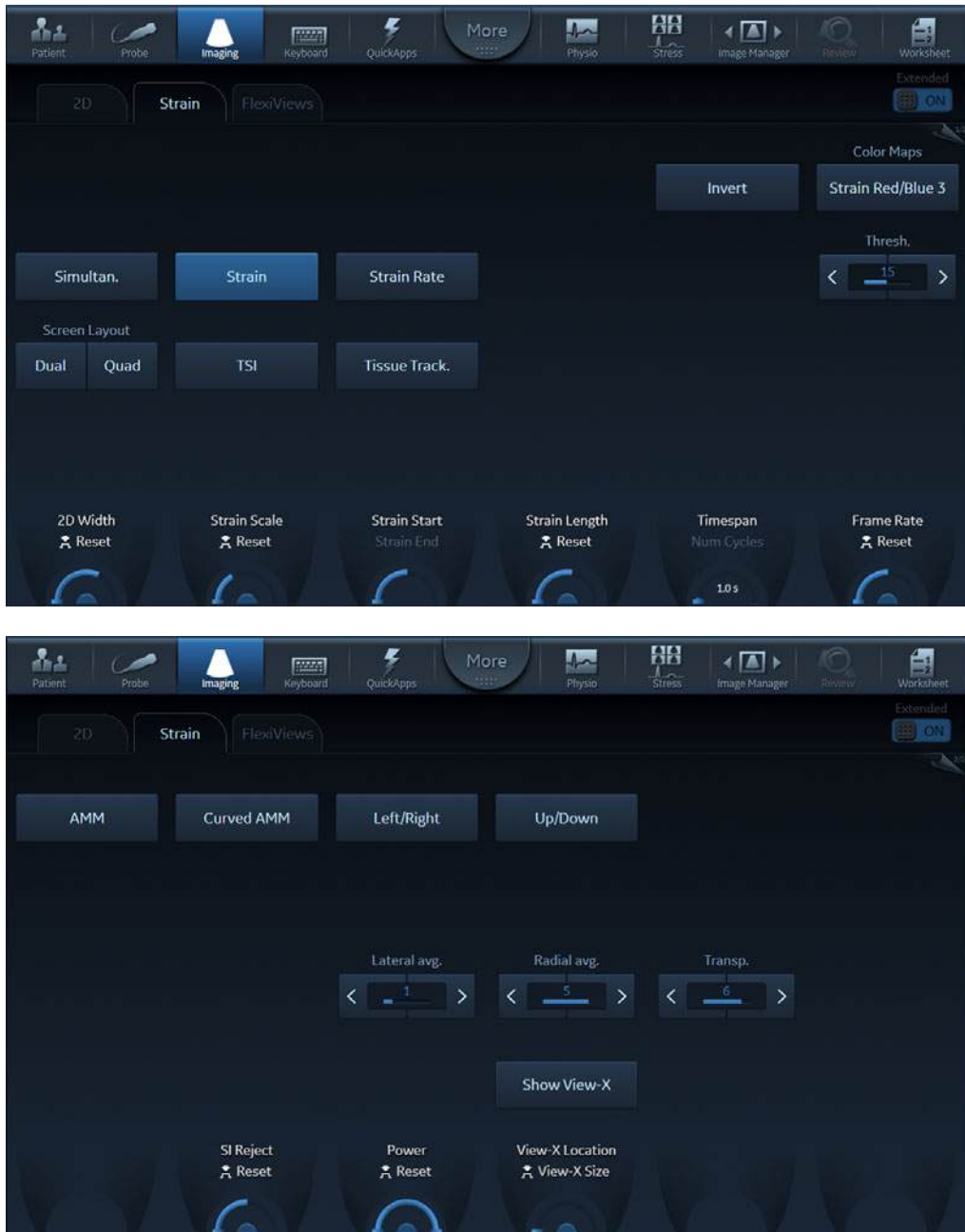

Figure 5-18. The Strain Touch panel page 1 and 2

Using Strain

1. From TVI Mode, press **Strain**.
2. Adjust **Strain Start** close to the R-peak.
3. Adjust **Strain end** to end systole, typically near the T-wave.
4. Use the trackball to position the ROI frame over the area to be examined.
5. Press **Select**. The instruction **Size** should be highlighted in the trackball status bar.

*NOTE: If the trackball control Pointer is selected, press **Trackball** to be able to select between Position and Size controls.*

6. Use the trackball to adjust the dimension of the ROI.

Optimizing Strain

- From an optimized Strain rate display adjust strain tracking to pick out the systolic phase.
- The main use of Strain is to map negative systolic deformation. This means that **Strain start** and **Strain end** should be adjusted to pick out the systolic phase of the cardiac cycle: Adjust **Strain start** close to the R-Peak. Adjust **Strain end** to end systole, typically near the T-wave.
- The maximum deformation that is color-coded can be adjusted using the **Strain scale** control. If set too low, most of the wall will show the color indicating maximum deformation. If set too high, the maximum deformation color is never reached.
- Strain provides information only in the beam direction. The apical view typically provides the best window since the beams are then approximately aligned to the longitudinal direction of the myocardium (except near the apex).
- Low strain values may be masked out with a different color using the **SI Reject** control.

Tissue Synchronization Imaging (TSI)

TSI overview

TSI calculates and color-codes the time from detected QRS to a detected event, typically the time to peak systolic velocity.

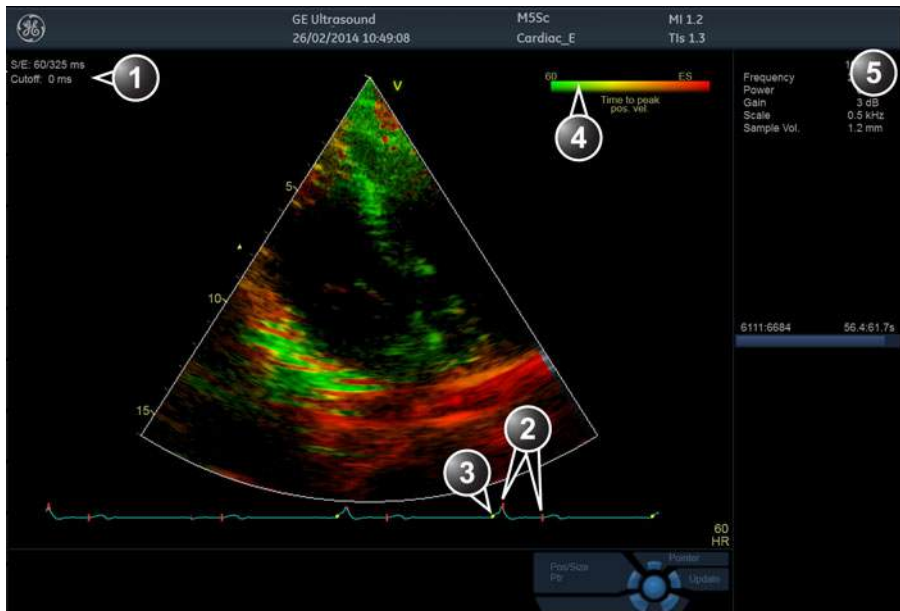

1. TSI start/end and TSI Cut-off
2. TSI start and end markers
3. QRS marker
4. TSI color bar
5. Parameter window

Figure 5-19. The TSI mode screen

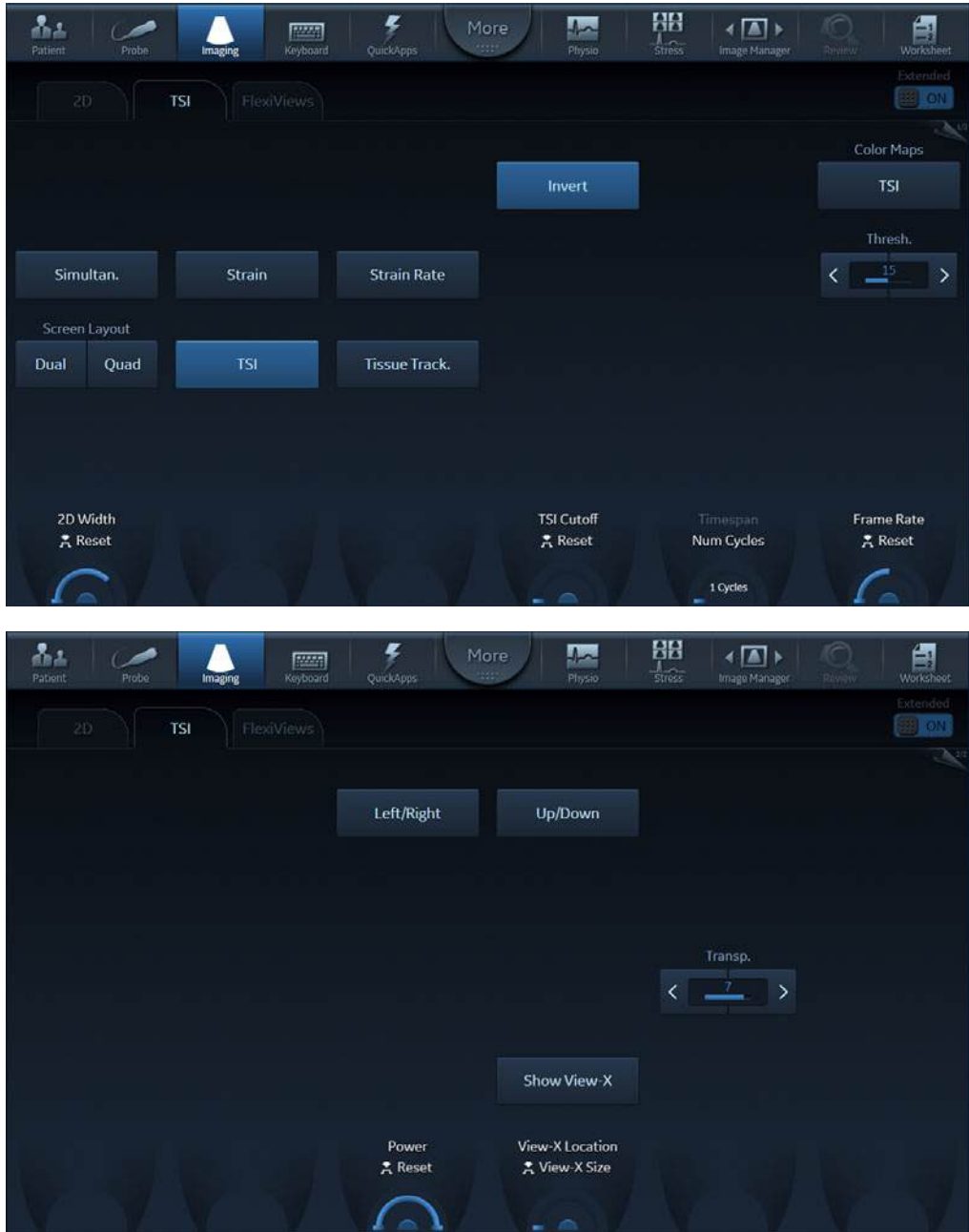

Figure 5-20. The TSI Touch panel page 1 and 2

NOTE: TSI is only recommended for adult cardiac images acquired with the following probes: M5Sc-D, 6Tc-RS or 6VT-D. The measurement accuracies of the TSI time-to-peak values reported in the 'Measurement accuracy' on page 8-152 are verified with these probes.

Using TSI



TSI requires correct QRS detection to function properly. Therefore always check that the yellow circle markers on the ECG are positioned correctly on each QRS complex before proceeding with the analysis.

1. Ideally, perform the AVO and AVC Event Timing measurements prior to starting TSI. See 'Event timing measurements' on page 8-16.
2. From TVI, Tissue Tracking, Strain or Strain rate mode, select **TSI**.
3. Use the trackball to position the ROI frame over the area to be examined.
4. Press **Select**. The instruction *Size* should be highlighted in the trackball status bar.

NOTE: If the trackball control *Pointer* is selected, press **Trackball** to be able to select between *Position* and *Size* controls.

5. Use the trackball to adjust the dimensions of the ROI.

TSI markers adjustments

The default TSI markers settings are:

- **TSI start:** The time of the Event Timing measurement Aortic Valve Opening (AVO). (If no AVO measurement is available, 60 ms from the detected QRS is used.)
- **TSI end:** The time of the Event Timing measurement Aortic Valve Closure (AVC). (If no AVC measurement is available, an estimated time of end systole is used.)

The system can be configured to not use AVO and AVC for TSI start and end, or to use other events.

The configuration alternatives are:

- **TSI start:** AVO, 60, 80, 100, 120 ms, or Manual control
- **TSI end:** AVC, AVC - 200 ms, AVC - 150 ms, AVC - 100 ms, AVC - 50 ms, AVC, AVC + 50 ms, AVC + 100 ms, AVC + 150 ms, AVC + 200 ms, MVO, MVO + 100 ms,

MVO + 160 ms, MVO + 200 ms, MVO + 260 ms,
ES - 200 ms, ES - 150 ms, ES - 100 ms, ES - 50 ms,
ES + 50 ms, ES + 100 ms, ES + 150 ms, ES + 200 ms or
Manual control.

NOTE: *Manual adjustment of TSI start and TSI end markers is available in Q Analysis. To store the modified marker settings, press **Store** and choose the configuration setting **Manual control** to avoid automatic adjustment of the markers.*

To configure TSI markers:

1. Press **Utility/Config** on the Touch panel and select the category **Meas/Text**.
2. In the *Measure category*, select the sheet **Advanced**.
3. In the *Application specific parameters section* adjust TSI start and TSI end parameters by selecting a new value from the combo menu displayed upon selection.

Contrast Imaging

The two basic steps of contrast imaging are data acquisition and quantification. Data acquisition is described in this chapter. Quantification is further described in 'Quantitative Analysis' on page 9-1.



Misdiagnosis based on image artifacts

Misdiagnosis in ultrasound contrast images may be caused by several artifacts, most importantly:

Motion artifacts: gives rise to signals independently of contrast presence. This may be caused by patient movement; including respiration, or by probe movement influenced by the operator.

Regional drop outs: caused by unintentional destruction of the contrast agent, too low concentration of contrast agent, poor acoustic penetration due to rib/lung shadows or system failing to detect the contrast agent due to erroneous settings induced by the operator.

Tissue harmonics: gives contrast-like signals independently of the presence of contrast agent.

Data acquisition

NOTE: *This system is designed for compatibility with commercially available contrast agents. Because the availability of these agents is subject to government regulation and approval, product features intended for use with these agents may not be commercially marketed nor made available before the contrast agent is approved for use. Advanced contrast features are only enabled on systems for delivery in countries or regions where the agents are approved for use or for investigational or research use.*



Appropriate training

Only physicians or echo technicians who have received appropriate training can use the Contrast applications.



Always read and follow carefully the manufacturer instructions on the contrast agent label.



Cardiac rhythm disturbances during cardiac studies using gas ultrasound contrast agents have been observed in the diagnostic range of Mechanical Index (MI) values. See the specific package insert for the contrast agent being used for further details.

Cardiac imaging

- **Left Ventricular Contrast imaging:** The LV Contrast and LVO Stress applications are optimized for endocardial border detection and assessment of wall motion and wall thickening. LVO Stress is optimized for higher heart rates. Both applications require the LVO Contrast option enabled.
- **Contrast Low MI imaging:** The Contrast Low MI application is optimized for improved assessment of perfusion of the myocardium. The application requires the Advanced Contrast option enabled.

Non-cardiac imaging

- **Vascular Contrast imaging:** optimized to visualize contrast in larger vessels, for example carotid artery. Requires the Vascular/Abdominal Contrast option enabled.
- **Abdominal Contrast imaging:** optimized to visualize contrast agents in abdominal organs.

NOTE: Vascular / Abdominal and Advanced Contrast Imaging application availability is subject to government regulation and approval and might not be available in your regions. Vascular/Abdominal and Advanced Contrast Imaging is not available in the U.S.

Left Ventricular Contrast Imaging

The Left Ventricular (LV) Contrast application has an optimized system preset for optimal resolution of endocardial borders and for optimal assessment of wall motion and wall thickening.

The LV Contrast application may help to identify LV thrombus and evaluate wall motion.



1. Parameter window

Figure 5-21. The LV Contrast acquisition screen



Figure 5-22. The LV Contrast Touch Panel

LV Contrast

The LV Contrast application works with the M5Sc-D, 3Sc-RS, 4Vc-D, 6VT-D, and 6Tc-RS probes.

1. From a Cardiac application (U, E, A, I), press **Quick Apps** on the Touch Panel. A list of the available Quick Apps is displayed.
2. Select **LV Contrast** application.

Contrast Low MI

Contrast Low MI application works with the M5Sc and 4Vc-D probes.

1. From a Cardiac application (U, E, A), press **Quick Apps** on the Touch Panel. A list of the available Quick Apps is displayed.
2. Select **Contrast Low MI** application.

NOTE: *If the orientation of the image has been lost, Tissue Visualization or Simultaneous Contrast Imaging (Simultan.) can be used to re-orient the probe after the application has been selected.*



Always read and follow carefully the manufacturer instructions on the contrast agent label.

Optimizing Cardiac Contrast Imaging

If a swirling pattern is observed and persists after the LV cavity has been filled with contrast agent, the MI Desired should be reduced until homogenous opacification is obtained.



An MI Desired setting, which is too high, will destroy the contrast agent in the LV cavity.

NOTE: *If the amount of contrast injected is too high, you may press **Flash** to destroy some of the contrast. Some applications may limit how often Flash can be activated due to probe temperature restrictions. The **Flash** control will be grayed out during this time.*

NOTE: *Flash is not available on TEE probes.*

The MI and TI values transmitted during the Flash sequence is displayed parenthetically in the title bar along with the current imaging MI and TI values.

Supplementary controls

The following controls can be used during contrast imaging from the **Contrast** tab on the Touch Panel.

- NOTE:**
- **Power [MI]:** adjust the desired MI while imaging.
The actual MI may be higher than the desired MI due to limitations of the probe's electronics.
 - **Focus Position:** adjust the focal depth of the transmitted pulse of the 2D image.
 - **Flash Duration:** adjust the length of the Flash specified in number of frames. The current value is displayed in the info window. The duration of the Flash is independent of the 2D imaging frame rate.
 - **Flash MI Limit:** adjust the maximum desired MI of the Flash. An MI of 0.8 is default. If the maximum desired MI is not being achieved during Flash, adjust **Flash Duration** and/or **Position/Size** of the Flash ROI. The achievable MI during flash (and the MI Limit) is displayed in the information

window. The MI during flash is displayed in the Status bar at the bottom of the screen.

- **Timers T1 and T2:** press **T1** or **T2** once to start a timer, press again to stop the timer.

NOTE: To flash in a region of interest only, modify the position and size of the ROI with the trackball

Vascular/Abdominal Contrast Imaging

NOTE: *This system is designed for compatibility with commercially available contrast agents. Because the availability of these agents is subject to government regulation and approval, product features intended for use with these agents may not be commercially marketed nor made available before the contrast agent is approved for use. Advanced contrast features are only enabled on systems for delivery in countries or regions where the agents are approved for use or for investigational or research use.*

Vascular Contrast is intended for visualization of ultrasound contrast agents in large vessels (for example carotid artery and femoral artery).

The Vascular Contrast application works with the 9L-D probe.

Abdominal Contrast optimized to visualize contrast agents in abdominal organs.

The Abdominal Contrast application works with the C1-6-D and C1-5-D probes.

1. From a Vascular application (Abdominal, Carotid, Vascular), press **Quick Apps** on the Touch Panel. A list of the available Quick Apps is displayed.
2. Select the **Contrast** application.

NOTE: *If the orientation of the image has been lost, Tissue Visualization can be used to re-orient the probe after the application has been selected.*

NOTE: *The Vascular and Abdominal Contrast applications require the Vascular/Abdominal Contrast option enabled.*

NOTE: *If the amount of contrast injected is too high, you may press **Flash** to destroy some of the contrast. Some applications may limit how often Flash can be activated due to probe temperature restrictions. The **Flash** control will be grayed out during this time.*

The MI and TI values transmitted during the Flash sequence is displayed parenthetically in the title bar along with the current imaging MI and TI values.

Supplementary controls

The following controls can be used during contrast imaging from the **Contrast** tab on the Touch Panel.

- **Power [MI]:** adjust the desired MI while imaging.

NOTE: *The actual MI may be higher than the desired MI due to limitations of the probe's electronics.*

- **Focus Position:** adjust the focal depth of the transmitted pulse of the 2D image.
- **Flash Duration:** adjust the length of the Flash specified in number of frames. The current value is displayed in the info window. The duration of the Flash is independent of the 2D imaging frame rate.
- **Flash MI Limit:** adjust the maximum desired MI of the Flash. An MI of 1.2 is default. If the maximum desired MI is not being achieved during Flash, adjust **Flash Duration** and/or **Position/Size** of the Flash ROI. The achievable MI during flash (and the MI Limit) is displayed in the information window. The MI during flash is displayed in the Status bar at the bottom of the screen.
- **Timers T1 and T2:** press **T1** or **T2** once to start a timer, press again to stop the timer.

Contrast Echocardiography Box

Contrast Echocardiography Box: the European Society of Cardiology provides useful information on contrast echocardiography on the Internet here: <https://www.escardio.org/Education/Practice-tools/EACVI-toolboxes/Contrast-Echo/Contrast-Echocardiography-Box>

Strain Elastography

Description

Strain Elastography shows the spatial distribution of tissue elasticity properties in a region of interest by estimating the strain before and after tissue distortion caused by external or internal forces. The strain estimation is filtered and scaled to provide a smooth presentation when displayed.

Below is an example of Strain Elastography. The image is displayed in dual mode with the color map/bar of the Strain Elastography on the one side of the display and the imaging parameters on the other.

You can activate Elastography via the button on the Touch panel or the **Flex** button on the Control panel.

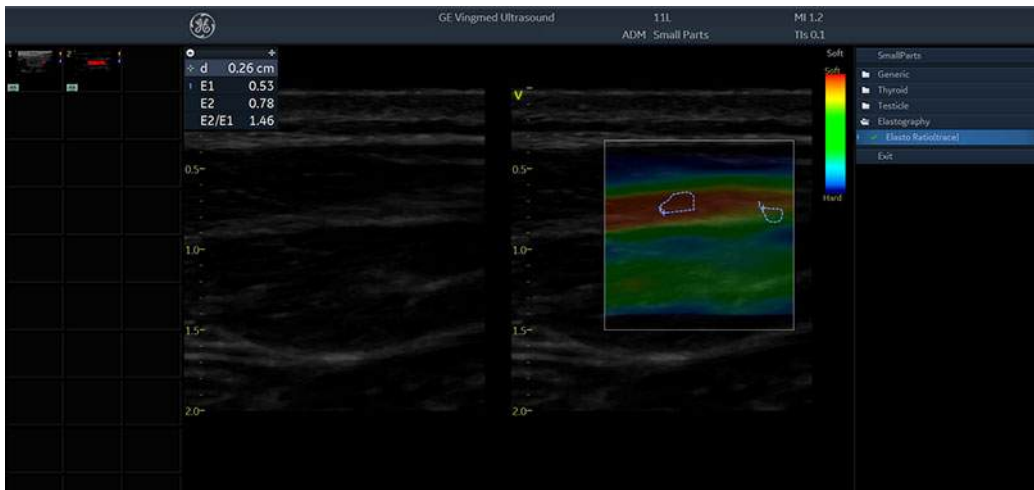

Figure 5-23. Elastography Example

Using Strain Elastography

The Elastography image is achieved by pulsating the probe while you are scanning the anatomy of interest. Here are some criteria to use:

Handheld elasticity imaging can be very dynamic as the size of distortion depends on the movement of the hand-held probe. To maintain stable and consistent displayed strains, pay attention to the Quality graph and its feedback. An ideal manual compression is indicated by a high-value feedback. In addition, apply the following post-processing controls: Smoothing, Window, Scaling, and Frame Averaging.

Strain Elastography displays firmer tissue in blue and softer tissue in red. To enhance Blue, increase Hard Compress; to enhance Red, increase Soft Compress on the Touch Panel. To enhance strain elastography contrast, reselect the Color Map.

If you need a higher resolution, reduce Smoothing, increase Frequency, or reduce Window.

If you need a smoother image, increase Window or Smoothing.

If the images seem too flashy, decrease Frame Reject to 1.0 and Noise Reject to have consistent imaging throughout.

Using Strain Elastography (in steps)

Table 5-1: Strain Elastography

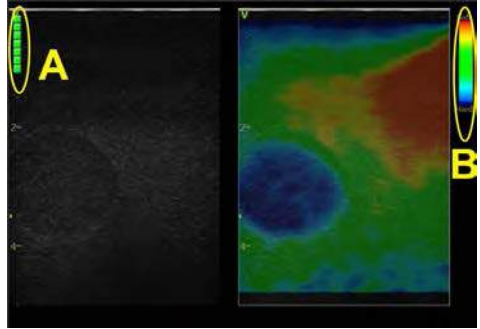
Using Strain Elastography	
<p>Manual Compression:</p> <ol style="list-style-type: none"> 1. Press the Elastography virtual button on the Touch panel to activate. 2. Adjust the position of the ROI to place the suspicious area at the center. 3. Adjust the size to include surrounding tissue (sample area size is 3 times the dimension of the lesion per axis). <p>Manual compression depends on the type of the probe.</p> <ol style="list-style-type: none"> 1. Linear probes: Perform slight compressions keep the transducer perpendicular to the skin. Duration: 5 sec or 10 compressions. 2. Convex probes: Turn the patient on the left side more than 90 deg. Press the probe above the lesion — this will allow the heart and lungs to create compressions. <p><i>Note 1: Any soft (vessel, cyst, air) or stiff (bone) tissue above the lesion or reference area may cause interference with compressions. In that case, try the same operation from a different angle.</i></p> <p><i>Note 2: Keep the lesion within the image and keep the quality indicator remaining green for more than 2 seconds.</i></p>	<p>Select a frame to analyze:</p> <ol style="list-style-type: none"> 1. Press Freeze. 2. Use the trackball or “frame by frame” knob, select a frame when the quality bar reaches its high peak.  <p>Elastography image , quality indicator (A) and elasto color bar (B)</p> <p>The relation between elastography colors and area's stiffness is displayed at the elastography color bar (B in the image above).</p>

Strain Elastography Controls

Table 5-2: Strain Elastography Touch Panel Description

Parameter	Description
AxSmoothing	Controls the smoothness of the strain elastography image in the axial direction. A higher value means a smoother image.
LaSmoothing	Controls the smoothness of the strain elastography image in the lateral direction. A higher value means a smoother image.
WindowLength	Controls the RF data segment size for the motion tracking. A higher Window value gives a better signal to noise ratio (SNR) at the cost of axial resolution.
Color Map	Controls the strain elastography maps. Six different maps are available with various contrast and color schemes, including a grayscale map. Selections: E1-5, E-Gray, and E-Invert.
Frame Average	Controls the persistence of the strain elastography images.
Frequency	Controls the transmit frequency.

Table 5-2: Strain Elastography Touch Panel Description

Parameter	Description
Soft Compress	Individually controls the image enhancement for the softer than average tissues.
Hard Compress	Individually controls the image enhancement for the harder than average tissues.
Scale	Controls the time interval between consecutive firings. A lower value dictates a higher sensitivity to weak manual motion.
Transp.	High values bring out the tissue behind the strain elastography data. You adjust via the Color Gain control; this imaging parameter appears as a "T" on the right-hand portion of the display.
Frame Reject	Controls how many frames get rejected due to low quality vertical motion. A higher value means more frames get rejected. A rejected frame has a completely transparent ROI with the B-Mode background showing through.
Noise Reject	Controls how many frames get rejected due to lateral and elevational motion. A higher value means more frames get rejected. A rejected frame has a completely transparent ROI with the B-Mode background showing through.
Frame Rate	Optimizes B-Mode frame rate or spatial resolution for the best possible image.

Elastography Analysis

Overview

The Elastography Mode detects strains by correlating the echo amplitudes of the tissue when compressed and uncompressed. Different displacement of echoes is an indicator for different stiffness (strain) of the tissue. High strain means that the tissue is softer, low strain means that it is stiffer. Zero is absolutely stiff without any elasticity. Elastography Analysis is a strain ratio comparative tool that enables users to compare the strain of one tissue to the surrounding tissue.

Using Elastography Analysis

1. Activate Elastography from the Touch panel.
2. Perform the scan. Proper manual compression/decompression is indicated by a fully green quality indicator.
3. Press **Freeze** and scroll the Trackball for a frame with high quality according to the quality indicator for Elastography analysis.
4. Enter *Measurement*, in the application of *SmallParts*, choose *Elasto Ratio(trace)* in the folder of Elastography.
5. Activate the cursor and move it over the Elastography image. Press **Set**, then a manual trace will appear. It will be the reference sample area and should be placed in the normal tissue. Move the Trackball to draw the trace and then press **Set** the second time to end the first trace.
6. After completing the first trace, the cursor is ready to draw the second trace. Press **Set** and move the Trackball again. A new sample area appears which should be placed on the abnormal area.
7. After pressing **Set** to end the second trace, the *Elasto Index* and the *Elasto ratio* will be displayed together. The ratio value indicates how many times the tissue of an abnormal area is harder or softer than the tissue of the reference sample area.

NOTE: **Elasto Index** represents the mean elasticity value inside one specific trace. *Elasto Index* provides relative measurement, so these values themselves are not providing a value in kPa (Young's Modulus). **Elasto Ratio** is the ratio between *Elasto Index* of two drawn traces.

Additional Notes for Elastography Analysis

NOTE: Use the Trackball to scroll the Cineloop quickly.

NOTE: The maximum strain value in human tissue can be up to 2%.

NOTE: The ratio value indicates how many times the tissue of a sample area is harder or softer than the tissue of the Reference sample area.

Limitations

- This is a relative quantification tool based on freehand manual palpation technology. It cannot show the stiffness by the kPa (kilopascal).
- There is no compatibility among manufacturers regarding the value. It depends on their strain imaging technology and definition of the value.
- Colors indicate degree of stiffness and do not directly correlate to a specific tissue type. Interpretation of what the tissues are and how to apply these ratios clinically is at the discretion of the user.
- Elastography physics dictates that cystic structures will be displayed with a three-layer pattern. This three-layer pattern will start with blue on the factory default map (which corresponds to hard), then progresses to green and then to red (which corresponds to soft). The posterior displacement of elastography patterns also may cause the B-Mode cyst to consist primarily of blue with the green to red being posterior to the B-Mode cyst. You need to be aware of the three-layer pattern of a cyst in elastography. Utilizing Elastography Analysis and setting the sample area in the blue portion of the three-layer pattern on the cyst and then setting the sample area in the "normal" tissue may cause you to misinterpret the Elastography Analysis ratio as the cyst to be hard as compared to the "normal" tissue.



CAUTION

Elastography images can only be provided as a tool to assist the physicians or sonographers in making a clinical diagnosis. It is recommended to compare images scanned with other systems or use other non-ultrasound means for diagnosis determination.

Additional scanning features

LogiqView

LogiqView provides the ability to construct and view a static 2D image which is wider than the field of view of a given transducer. This feature allows viewing and measurements of anatomy that is larger than what would fit in a single image.

LogiqView constructs the extended image from individual image frames as the operator slides the transducer along the surface of the skin in the direction of the scan plane.

LogiqView is available with all linear array probes.

Using LogiqView

1. Perform a detailed examination of the anatomy/pathology. Optimize parameters for tissue texture and visible window prior to activating LogiqView.
2. Press **LogiqView**.
3. To start acquiring the image, press **2D freeze** key. Scan slowly and in a uniform motion lengthwise.
 - Continuous contact is required throughout the length of the extended image.
 - Always keep the transducer perpendicular to the skin surface.
 - Keep the motion within the same scan plane.
 - Do not make abrupt changes in speed of motion.
4. If required, press **2D freeze** again to restart LogiqView.
5. To complete the scan, press **Freeze**.
6. Adjust **LogiqView rotate** to rotate the acquisition.

NOTE: The quality of the resulting image is somewhat user-dependent and requires some additional skill and practice to develop proper technique.

Compound

Compound is a process of combining three (default) or five frames from different steering angles into a single frame. The combined single image has the benefits of reduced speckle noise, reduced clutter, and continuity of specular reflectors. Therefore, this technique can improve contrast resolution.

Compound is available with all curved and flat linear probes. Compound is on by default.

Using compound

1. Press **Compound**.
A three frames compounded image is produced.
2. To change the number of compounded frames, adjust **Compound frames** on the Touch panel. Three or five frames can be selected.

Virtual Convex

Virtual Convex allows a wider field of view (FOV) in the depth and aims to enhance image quality, in particular on linear probes.

B-Flow

B-Flow provides an intuitive representation of non quantitative hemodynamics in vascular structures. B-Flow enables visualization of complex hemodynamics and highlights moving blood and tissue. There are no artifacts such as bleeding, blooming, or aliasing.

B-Flow is available with all probes except TEE probes.

Using B Flow

1. While in Color flow, press **B-Flow**.
2. Adjust **Flow speckle**. Increased Flow speckle enhances hemodynamics.

The greater the speed, the better the image scatter density and size. If the scan direction is the same as the flow direction, then the image scatter is elongated; if the scan direction is the opposite as the flow direction, then the image scatter is tighter. Therefore, have the scan direction opposite to that of flow direction. Switch the way you hold the probe, with the probe

orientation marker inferior to maintain correct orientation on the monitor. Flow starts from where the focal zone is located.

Blood Flow Imaging

Blood flow imaging (BFI) is a Color flow mode with added speckle information for vascular use. The speckle information visualizes the blood flow direction.

NOTE: When scanning in BFI triplex mode it is normal to have a time delay between the Doppler display / Doppler audio and the BFI color display.

BFI is available with linear and curved linear probes.

Using Blood Flow Imaging

1. While in Color flow, press **BFI**.
2. Adjust **Flow speckle**. Increased Flow speckle enhances hemodynamics.

Image controls

Control panel

	2D Gain
2D	When rotated clockwise, increases the overall gain applied to the received echo signals equally for all depth.

	Time Gain Compensation TGC
2D	Compensates for depth-related attenuation in an image. The sliders nearest the operator affect the far field. TGC amplifies returning signals to correct for the attenuation caused by tissue at increasing depths.

	Auto
2D	Turns Auto Tissue setting on/off (see 'Auto Tissue' on <i>page 5-59</i>).

	Depth
2D	Sets the maximum (far field) distance that will be imaged. Decreasing the depth may allow higher frame rates.

Touch panel and rotaries

	Line Density
2D (non-cardiac)	Controls the spatial resolution of the image versus the image update rate.

	HD (High Definition)
2D	Smoothens the speckle and reduces the noise in the image.

	Width/2D width
2D, CF, TVI, TT, SRI, SI, TSI	Controls the size or angular width of the 2D image. A smaller angle generally produces an image with a higher frame rate.

	Frequency
2D, M-Mode	Rotate to adjust the probe's operating frequency. The selected frequency is displayed in the <i>Parameter</i> window. For some probes/applications the lowest frequency settings will be Octave imaging settings. Push to turn Octave imaging on/off.
CF, Doppler, TVI, SRI	Enables the adjustment of the transmission frequency to control the sensitivity or the level of penetration. The selected frequency is displayed in the <i>Parameter</i> window. Adjusting Frequency may affect Sample Volume and LVR settings.

	Frame rate
2D, CF, Doppler, TVI, TT, SR, SRI, TSI	Adjusts frame rate (FPS). The relative setting of the frame rate is displayed in the <i>Parameter</i> window. When adjusting frame rate, there is a trade off between spatial and temporal resolution.

	Up/Down
2D, M-Mode, CF	Up/Down: enables the 2D image to be flipped 180 degrees.

	Left/Right
2D, CF	Left/Right: enables a mirror image of the 2D image to be created. The left/right reference marker V moves to the other side of the image.

	Compress
2D, M-Mode	Controls the amount of contrast in the 2D image. An index number is displayed on the control to indicate the relative level of compression.
Doppler	Enables control over the contrast of the Doppler spectrum. When compression is raised, the spectrum image becomes softer and some low level background noise may appear. Compress is available in both Live and Freeze.
TVI, SRI	Controls the amount of color compression. The color bar is adjusted accordingly.

	Reject
2D, M-Mode	Adjusts the rejection level. When this control is increased, low-level echoes are rejected and appear darker in the 2D image. An index number is displayed on the control to indicate the relative level of rejection.
Doppler	Enables undesirable background noise to be removed from the Doppler spectrum resulting in a darker background. Reject is available in both Live and Freeze.

	Data Dependent Processing (DDP)
2D	Performs a temporal processing which reduces random noise without affecting the motion of significant tissue structures. An index number is displayed on the control to indicate the relative DDP level.

	Tilt
2D, TVI, TT	Enables the axis of the 2D image to be tilted to the left or right. By default the axis of symmetry of a 2D image is vertical.

	View-X
2D	Enable picture-in-picture view via streaming box. Screen position can be adjusted using rotary control.

	Auto Tissue
2D	<p>Two settings are available:</p> <ul style="list-style-type: none"> • Soft: optimizes the radial and lateral uniformity and brightness of the tissue continuously in real-time. • Sharp: further enhances the image display by optimizing the gray scale curve. <p>The Auto Tissue setting (Soft or Sharp) can be turned on/off by pressing Auto on the Control panel. The last used setting is then applied. The Auto Tissue setting is preserved when switching to 2D duplex mode.</p> <p>The Auto Tissue settings are only available in live scanning and cannot be turned off when the image is stored.</p>

	Smart Depth
2D, M-Mode	<p>For every setting of scan-depth there is an optimal Frequency/Transmit Pattern setting.</p> <p>With Smart Depth turned ON, the system will optimize the Frequency/Transmit Pattern setting for the currently selected depth. The Frequency control value displayed on screen will be modified to display the updated value with every change of depth setting by the operator.</p> <p>With Smart Depth turned OFF, the Frequency control setting will remain unchanged when depth setting is changed.</p>

	UD Clarity
2D (Cardiac)	<p>Reduces the unwanted effects of speckle in the ultrasound image. Image speckle usually appears as a grainy texture in otherwise uniform areas of tissue. Its appearance is related to image system characteristics, rather than tissue characteristics, so that changes in system settings, such as probe type, frequency, depth, and others, can change the appearance of the speckle. Too much speckle can impair image quality and make it difficult to see the desired detail in the image. Likewise, too much filtering of speckle can mask or obscure desired image detail. Extra care must be taken to select the optimal Speckle reduction level.</p> <p>A decrease of UD Clarity creates a smoother image, though keeping boundaries sharp. An increase of UD Clarity creates a crisper image.</p>

	UD Speckle reduce
2D (non-Cardiac)	Reduces the unwanted effects of speckle in the ultrasound image. Image speckle usually appears as a grainy texture in otherwise uniform areas of tissue. Its appearance is related to image system characteristics, rather than tissue characteristics, so that changes in system settings, such as probe type, frequency, depth, and others, can change the appearance of the speckle. Too much speckle can impair image quality and make it difficult to see the desired detail in the image. Likewise, too much filtering of speckle can mask or obscure desired image detail. Extra care must be taken to select the optimal Speckle reduction level.
	Virtual Apex
2D (Cardiac)	Improves near field imaging, allowing increased visibility up to the width of the full probe aperture close to the surface.
	Virtual Convex
2D, CF, Doppler	Virtual Convex extends the field of view for linear probes. Enable/disable independently for each mode.
	Compound
2D	Combines three or five frames from different steering angles into a single frame, reducing speckle noise and clutter, and providing continuity of specular reflectors.
	Edge Enhance
2D, M-Mode (non-cardiac)	Controls image processing related to the extent of edge enhancement applied to an image.
	PRF
2D	Affects the level of reverberations in the image. When turned on, the frame rate (or the number of focal zones) will decrease, while the reverberations will be attenuated.
	Power
2D, M-Mode, CF, Doppler, TVI, TT, SRI, SI, TSI	Controls the amount of acoustic power applied in all modes. When power is set to maximum, it is equal to or less than the maximum acoustic power permitted by the FDA. The Thermal Index (TI) and the Mechanical Index (MI) are displayed on the screen. When power is reduced, it reduces the signal-to-noise ratio, so that the image may become noisier.
	Horizontal sweep
M-Mode, Doppler	Adjusts the horizontal refresh rate of the M-Mode or Doppler area of the display. Horizontal sweep is available in live and cine replay.

	Scale
CF, TVI	Adjusts the repetition rate of the Doppler pulses transmitted to acquire the data for color flow mapping. The Scale (Nyquist limit) should be adjusted so that no aliasing occurs, while still having good resolution of velocities. The Nyquist limit should be somewhat above the maximum velocity found in the data.
Doppler	Enables the vertical scale of the Doppler spectrum and the maximal detectable velocity to be modified. Velocity range directly controls the pulse repetition frequency, which is responsible for the setting of the Nyquist limit (the ability to detect maximum velocity without aliasing).

	Baseline
CF	Adjusts the color map to emphasize flow either toward or away from the probe. Baseline is available in both Live and Freeze.
Doppler	Enables the Doppler baseline to be shifted up and down. The default Doppler baseline is set at the center of the vertical aspect of the Doppler display, dividing evenly the flow toward and away from the probe. By adjusting the baseline a larger portion of the analysis is assigned to the flow direction present. Baseline is available in Live and Freeze, including CW.
TVI	Adjusts the color map to emphasize tissue motion either toward or away from the probe. Baseline is available in both Live and Freeze.

	Invert
CF	Enables the color scheme assigned to positive and negative velocities to be inverted. Invert is available in live and cine replay.
Doppler	Enables the Doppler spectrum to be flipped 180 degrees, so that negative velocities are displayed above the baseline and positive velocities below the baseline. Invert is available in live and cine replay.
TVI	Enables the color scheme assigned to positive and negative tissue velocities to be inverted. Invert is available in live and cine replay.
TT	Enables the color scheme assigned to the tissue displacements to be inverted. Invert is available in live and cine replay.
SRI	Enables the color scheme assigned to strain rate to be inverted. Invert is available in live and cine replay.
SI	Enables the color scheme assigned to shortening and elongation tissue deformation to be inverted. Invert is available in live and cine replay.

	Variance
CF	Controls the amount of variance data added to a color display. Variance enables computer-aided detection of turbulent flow (e.g. jets or regurgitation). Variance is available in live and cine replay.

	Color Maps
All modes	Displays the <i>Color</i> menu for selection of different color maps.

	Tissue priority
CF	Emphasizes either the color of the color mode or the grey scale tissue detail of the 2D image. Tissue priority is available in both Live and Freeze.

	Sample volume
CF	Adjusts the size of the color flow Doppler sampling area. Lower setting gives better flow resolution while a higher setting increases sensitivity and helps to locate turbulent flows.

	Low Velocity Rejection (LVR)
CF	LVR, also called Wall motion filter, enables the extent of low velocity removal to be adjusted. Color data produced by very low flow may cause interference.
Doppler	Enables the low velocity portions of the spectrum to be filtered, since the Doppler spectrum and audio may contain strong wall-motion signals. The amount of Low Velocity Reject is indicated by the green vertical bar at the right end of the baseline.

	Lateral averaging
CF, TVI, TT, SRI, SI	Smooths the image by averaging collected data along the same horizontal line. An increase of the lateral averaging will reduce noise, but this will also reduce the lateral resolution.

	Radial averaging
CF, TVI, TT, SRI, SI	Smooths the image by averaging collected data along the same radial line. An increase of the radial averaging will reduce noise, but this will also reduce the radial resolution.

	Smoothness control
Selected probes	Smoothness, available on selected probes, controls the radial averaging, which in turn affects the noise level as well as resolution.

	LPRF
PW Doppler	Sets the Pulse Repetition Frequency (PRF) for the PW Doppler acquisition of flow data. Enables toggling between high and low Pulse Repetition Frequency (PRF). When the Doppler PRF is raised beyond a certain limit, more than one Doppler gate is displayed on the screen.

Angle correction and Quick angle	
Doppler	Enables correction of the Doppler velocity scale by defining the angle between the Doppler beam and the investigated blood vessel or blood flow. A thin cross bar on the Doppler cursor will rotate as the control is adjusted. Angle correction is available in both Live and Freeze. Angle correction adjusts the angle between zero and 90 degrees with one degree increment. Quick angle adjusts the angle by 60 degrees.

Sample volume	
PW Doppler	In PW mode, sets the longitudinal size of the region to be sampled for measurement. Adjusting Sample volume may affect the PRF (Nyquist limit) settings. SV does not apply to CW mode, where the volume sampled is the full length of the area indicated by the cursor line.

	Tissue Track.	Strain Rate
TVI, TT, SRI, SI	Starts Tissue Tracking mode.	Starts Strain Rate mode.

	Strain	TSI
TVI, TT, SRI, SI	Starts Strain mode.	Starts TSI mode.

	AMM	Curved AMM
M-Mode, TVI, TT, SRI, SI	Starts Anatomical M-Mode.	Starts Curved Anatomical M-Mode.

Simultaneous	
CF, TVI, TT, SRI, SI, TSI	Enables simultaneous display of a 2D image and a 2D image with color coded mode.

Simultan.	
Contrast	Enables simultaneous display within contrast with tissue visualization on one side for reference and orientation, and contrast visualization on the other.

TVI visible	
TVI	Turns TVI display on/off.

Q Analysis	
TVI, TT, SRI, SI, TSI (In Freeze)	Starts the Quantitative analysis application.

	Threshold
TVI, TT, SRI, SI, TSI	Controls the level of greyscale intensity that is used as a threshold for color.

	Transparency
TVI, TT, SRI, SI, TSI	Controls the degree of transparency of the color display.

	Track start
TT	Controls the time after ECG R-peak when the integration should start.

	Track end
TT	Controls the time after tracking start when the integration should end.

	Tracking scale
TT	Controls the color cut-off value of max displacement displayed. The chosen values are shown on the color bar.

	SRI scale
SRI	Defines the scale for the color coding of the strain rate.

	Strain length
SRI, SI	Determines the strain sample volume size. There is a trade-off between noise and spatial resolution controlled by the Strain length. To minimize noise the Strain length should be maximized. A value of 12mm is typical for adult cardiac patients.

	SRI reject
SRI	Adjusts the cut-off level of the low Strain rate to be discarded when generating the color image. Rejected values are displayed in green.

	Strain start
SI	Controls the time after ECG R-peak when the strain calculation should start. The strain start time is displayed on the screen and is represented on the ECG by a red marker.

	Strain end
SI	Controls the time after strain start when the strain calculation should end. The strain end time is displayed on the screen and is represented on the ECG by a red marker.

Strain scale	
SI	Defines the scale for the color coding of the tissue deformation.

Strain reject (SI reject)	
SI	Adjusts the cut-off level of the low tissue deformation to be discarded when generating the color image. Rejected values are uncolored.

Cine compound	
TT, SRI, SI, TSI (Freeze only)	Calculates and displays cineloops generated from a temporal averaging of multiple consecutive heart cycles. The number of cycles averaged is user adjustable. The number of averaged cycles is displayed on the top left corner.

TSI Cut-off	
TSI	Controls the cut-off time: using this control it is possible to color all parts of the TSI image that has a time to peak less than a certain cut-off time.

T1/T2 (Timer)	
Stress echo	Starts a timer.

ECG Trig 1	
All modes	Specifies the delay (ms) from R-wave to the triggered frame.

Dual Trig Delay	
All modes	Specifies the delay (ms) from the first triggered frame (ECG Trig 1) to the second triggered frame. Only active when Dual Trig is turned on.

ECG Trig Interval	
All modes	Controls the number of cardiac cycles between triggered images.

ECG Trig	
All modes	Enables intermittent imaging based on the ECG.

Persistence	
Vascular Contrast	Enables the adjustment of color images, so that the current frame retains some color information from previous frames, in order to minimize noise.

	Num Cycle / Time span
2D, CF, TVI, TT, SRI, SI, TSI	<p>Cineloop storage adjustment. Press the rotary to toggle between Num Cycle and Time span.</p> <ul style="list-style-type: none">• Num Cycle: adjust number of heart cycles to store.• Time span: adjust the storage length in seconds.

Scan Assist Pro

Scan Assist Pro provides an automated examination script that guides you through an examination step-by-step. The system automatically invokes the correct mode and imaging parameters, advances to the next step in an examination, annotates the image, initiates measurements, and assigns the measurements to the worksheet/report.

Scan Assist Pro overview



1. Protocol name
Completed steps/number of steps
2. Step instruction area
3. Protocol steps
Check mark: completed step
Frame: current step (The frame is green when the Protocol is active or yellow when it is paused.)
4. This column indicates the scanning mode or when a measurement needs to be made.
5. This column indicates the action to move the Protocol to the next step.
6. Navigation: Stop, Pause/Continue the Protocol.

Figure 5-24. Scan Assist Pro window



1. **Category:** the Protocols are grouped according to the exam categories (e.g. Cardiac, Abdominal... etc)
Config: display Scan Assist Pro config sheet (Figure 5-28 on page 5-72).
2. Protocols available for the selected category.
3. Stop, Pause/Continue and restart Protocol.
4. Change current step.
Change position and size of the Scan Assist Pro window.

Figure 5-25. Scan Assist Pro Touch panel

Setting up Scan Assist Pro

Scan Assist Pro is ready to use with factory Protocols. However user-defined Protocols customized to better suit the user's needs can be added to the list of available Protocols on the Vivid S70N / S60N.

User-defined Protocols are created using the Scan Assist Pro Creator program, either on-system or off-system (see 'Scan Assist Pro Creator' on *page 12-100*).

To set up Scan Assist Pro with user-defined Protocols you need to:

- Import the user-defined Protocol that was created using the Scan Assist Pro Creator.

NOTE: You do not need to import the user-defined Protocol if it was created with the on system Scan Assist Pro Creator program.

- Add the Protocol to the Protocol selection so that it is available from the Touch panel.

Importing a Protocol

1. Insert the media with the saved Protocol from the Scan Assist Pro Creator or exported Protocol from another Vivid S70N / S60N.

Refer to 'Scan Assist Pro Creator' on *page 12-100* for more information on how to create a Protocol.

2. Press **Utility/Config** on the Touch panel and log on if required.
3. Select **Imaging/Scan Assist Pro**.

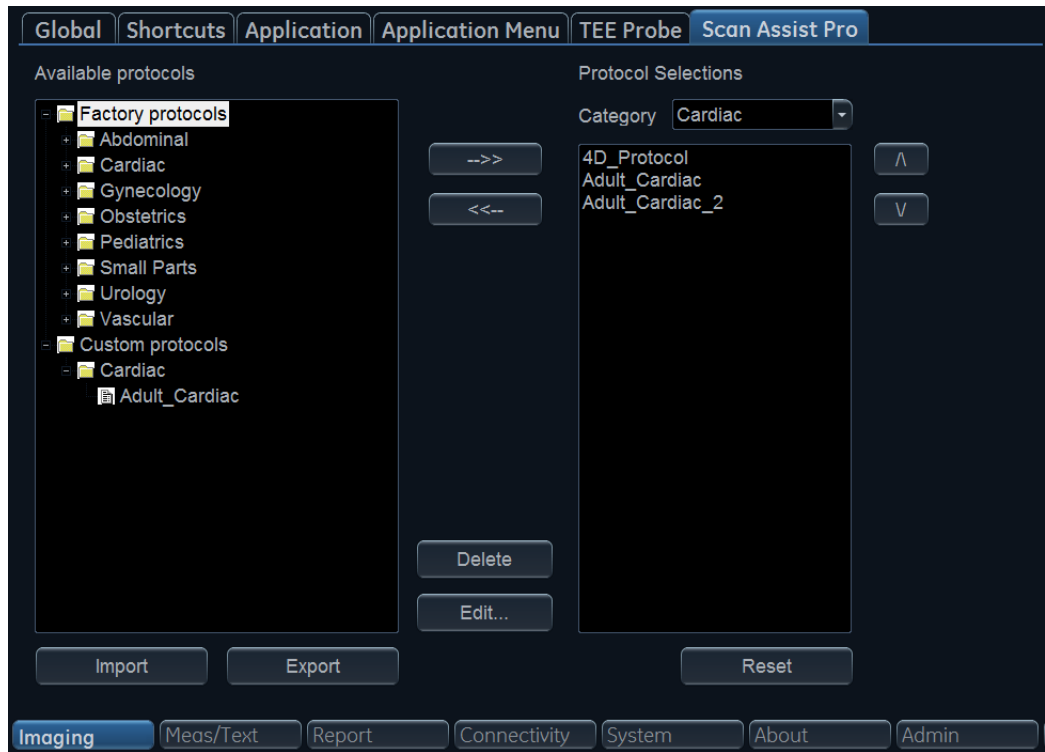

Figure 5-26. The Scan Assist Pro sheet

4. Select **Import** from the *Scan Assist Pro* sheet. The *Import Protocols* window is displayed.

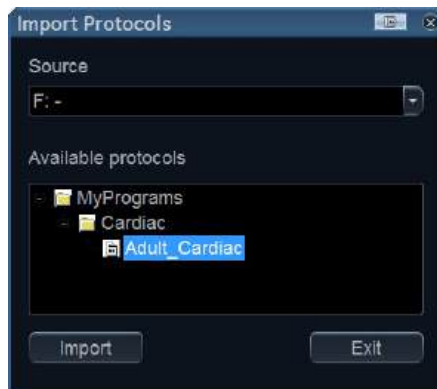

Figure 5-27. Import Protocols

5. In the *Source* field, select the media that the Protocol is stored on.
6. Highlight the Protocol(s) to be imported. If a folder is highlighted, all Protocols in the folder are selected.

7. Select **Import**. The Protocol(s) are stored to the Vivid S70N / S60N.

NOTE: *If the Protocol(s) already exist a confirmation dialog is displayed asking the user to confirm the replacement of the existing Protocol(s).*

Add the imported Protocol to the Protocol selection

The imported Protocol(s) must be added to the Protocol selection to be available on the Scan Assist Pro Touch panel.

1. Select the desired **Category** under Protocol Selections on the right-hand side of the *Scan Assist Pro* sheet (Figure 5-26 on page 5-70).
2. Select the imported Protocol from Available Protocols/ Custom Protocols on the left-hand side of the *Scan Assist Pro* sheet. Press the **Right arrow** button to add the imported Protocol to the selected exam category.

NOTE: *Use the **Up** and **Down arrow** buttons to move the Protocol up and down in the list that will be displayed on the Scan Assist Pro Touch panel.*

Using Scan Assist Pro

1. Press **Protocol** on the Control panel and select the Protocol to run on the Touch panel.

NOTE: *The Protocols displayed on the Touch panel correspond to the current exam category. To use a Protocol from another exam category, Press **Category** on the Touch panel and select a Protocol from a different category.*

The *Scan Assist Pro* window is displayed on screen with the first step active. In the example below the annotation for the first step has been automatically added on the image, ready for you to scan the specified anatomy.

NOTE: *You can change the size and position of the Scan Assist Pro window using the rotary button under the Touch panel.*

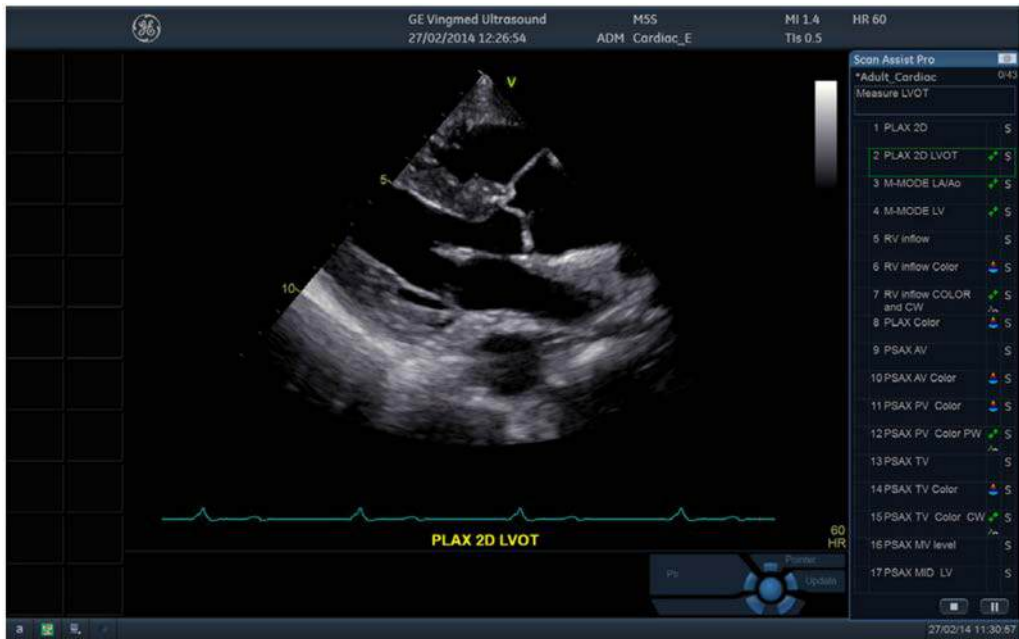

Figure 5-28. Scan Assist Pro screen

2. Follow the steps indicated in the Protocol: image/measure the appropriate anatomy.
3. Perform the indicated trigger to move to the next step in the Protocol (e.g Store, Unfreeze... etc).
4. To pause or unpause Scan Assist Pro, press the **Pause** button either in the *Scan Assist Pro* window or on the Touch panel. You can also press the **Left/Right arrow** key on the keyboard.
5. To stop a Protocol, press the **Stop** button either in the *Scan Assist Pro* window or on the Touch panel. A dialog is displayed to confirm the operation.
6. To restart a Protocol, press **Restart** on the Touch panel. A dialog is displayed to confirm the operation.
7. To skip a step or move to a certain step, press the **Up/Down arrow** key on the keyboard or select the step you want to move to using the trackball.

Pre/Post

Pre-Post Compare is a workflow enhancement feature that allows the user to indicate the state, **Pre** or **Post**, such that all acquired images and all measurements performed within that state will be tagged with either *Pre* or *Post*. When performing interventional procedures or other specific exams implied by an event, it may be useful for the user to acquire images and take measurements before and after the event/procedure to compare them.



Figure 5-29. LA Area measurement and image tagged with “Pre”

NOTE: *Pre/Post is not applicable for generic measurement and is not applicable for recall images.*

Pre/Post measurement label is also indicated in the worksheet. In the worksheet, Pre and Post measurements are displayed separately and transferred to the report as two distinguished measurements. Measurements also have the Pre/Post modifiers in the DICOM SR and this info is available for external reporting tools.

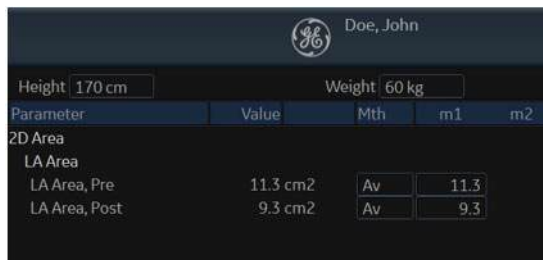

The screenshot shows a software interface with a dark background. At the top right, there is a GE logo and the name "Doe, John". Below this, there are two input fields: "Height 170 cm" and "Weight 60 kg". A table with the following structure is displayed:

Parameter	Value	Mth	m1	m2
2D Area				
LA Area				
LA Area, Pre	11.3 cm ²	Av	11.3	
LA Area, Post	9.3 cm ²	Av	9.3	

Figure 5-30. Worksheet showing “Pre” and “Post” measurements separately

Using Pre/Post

1. Go to Scan Assist Pro to start the feature.
2. Switch the **Pre/Post** button on. The *Pre* label will appear on the screen.
3. Toggle the **Pre** or **Post** button on the Touch Panel according to the stage you are in. The label on the screen will change accordingly. The label will also be applied to measurements and will be stored with the image.

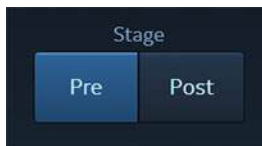

Figure 5-31. User control to select “Pre” or “Post” stage

4. To exit labeling, go to the Scan Assist Pro and switch the **Pre/Post** button off.

Chapter 6

4D and Multi-plane Modes

'4D-Mode' on page 6-2

'Multi-plane mode' on page 6-42

'FlexiViews' on page 6-53

4D-Mode

4D mode is an option available on Vivid S70N.

Real-time, single beat 4D imaging

The 4D transesophageal probe on Vivid S70N enables real-time, single beat 4D tissue and color imaging. The volume data is displayed in real-time with volume rendering techniques for visualization of valves and structures.

Real-time, multi beat 4D imaging

The 4D transesophageal probe on Vivid S70N enables the acquisition of larger tissue/color volumes with ECG gated acquisition. The data acquired is displayed in real-time so that the user can control the quality of the data acquired throughout the scanning process.

4D-Mode

Volume rendering screen

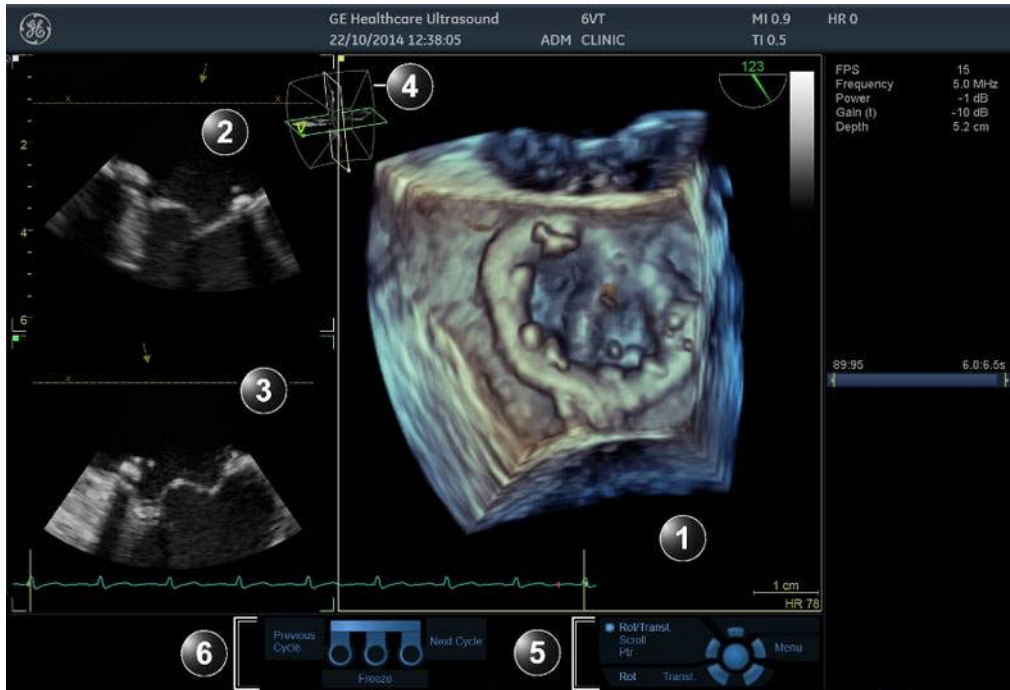

1. Volume rendering.
2. 2D image in the azimuth plane. The arrow indicates the viewing direction onto the volume rendering relative to the azimuth plane.
3. 2D image in the elevation plane. The arrow indicates the viewing direction onto the volume rendering relative to the elevation plane.
The brown line with X indicates the cropping applied to the Volume rendering.
4. Orientation window: displays a three-dimensional scene with acquisition sector and 2D image positions.
5. Trackball functions
6. Footswitch functions (option)

Figure 6-1. The 4D-Mode screen (Volume rendering)



Figure 6-2. 4D Touch Panel (4D probe Live) page 1 and 2

4D-Mode acquisition

Real time single beat 4D acquisition

1. Select a 4D probe, and an application.
2. Enter 4D either by pressing the **4D** button on the Control Panel or by selecting a 4D acquisition preset on the Touch Panel: **Medium** (medium size sector with top-down view), **Large** (large sector more suited for acquisition of the complete LV), or **Bird's view** on page 2 (small sector seen from the side). If 4D was previously used, the **Back to 4D** button is available which restores the last used 4D settings.

NOTE: 4D acquisition may also be done in Multi-Slice mode ('Multi-Slice acquisition' on page 6-8) and 4D Zoom prepare mode ('4D Zoom prepare acquisition' on page 6-11).

The volume acquisition is started.

3. The following parameters may be adjusted during acquisition:
 - **Volume size:** adjust the volume size. An increase of the volume size will reduce the volume rate.
 - **Volume shape:** adjust the ratio between the elevation and azimuth widths. Changing the volume shape from default will increase the volume rate.
 - **Frame rate:** adjust the frame rate. There is a trade-off between the frame rate and the image quality.
 - **Elevation tilt:** tilt the volume in the elevation plane and change the viewing direction accordingly.
 - Other parameters: Frequency and Octave.
 - **Angle:** display different rendering views.
 - **Layout:** display different layout alternatives.
4. Optimize the image quality as necessary (2D Gain, 4D Gain, Volume Optimize and UD Clarity).
 - Turn on **HD Live** display to simulate light propagation and scattering through tissue.
 - Turn off **HD Live** and if desired, select a **Color map** to colorize the volume rendering. The Depth color maps use a combination of colors to improve depth perception.

Press **Red** or **Color Laser lines** on the Touch Panel (page 2) to visualize the 2D image locations in the volume rendering. The 2D image locations are shown as overlaying red or color coded lines following the surface in the volume rendering. The color of the laser lines corresponds to the color coding used for the 2D images.

5. Press **Store** to store the acquisition.



The lower the volume rate, the longer is the delay between acquisition of the different parts of the image. So settings with low volume rate may introduce geometrical distortions on fast moving structures.

Real time multi beat 4D acquisition

Real time multi beat 4D acquisition is based on ECG gated acquisition of at least two sub-volumes. This technique enables the acquisition of a larger volume without compromising the spatial and/or temporal resolution, by combining sub-volumes acquired over several heart cycles. When all sub-volumes have been recorded, the process is repeated replacing the oldest sub-volumes.



ECG gated acquisition may by nature contain artifacts.

Artifacts may be caused by:

- Movements of the probe caused by the operator during acquisition.
- Movements of the patient during acquisition, including movements caused by respiration.
- Irregular heart rate during acquisition.

To validate the acquisition, press **Multi-Slice** and perform a visual inspection. Stitching artifacts are shown as visible transitions between the sub-volumes (Figure 6-3).



The lower the volume rate, the longer is the delay between acquisition of the different parts of the image. So settings with low volume rate may introduce geometrical distortions on fast moving structures.

To avoid spatial artifacts, make sure that the probe and the patient are not moving during the acquisition. The patient should, if possible hold his/her breath. The ECG trace should be stable.

1. Connect the ECG device and make sure to obtain a stable ECG trace.
2. Select a 4D probe, and an application.
3. Enter 4D either by pressing the **4D** button on the Control Panel or by selecting a 4D acquisition preset on the Touch Panel: **Medium** (medium size sector with top-down view) or

NOTE:

Large (large sector more suited for acquisition of the complete LV). If 4D was previously used, the **Back to 4D** button is available which restores the last used 4D settings.

4D acquisition may also be done in Multi-Slice mode ('Multi-Slice acquisition' on page 6-8) and 4D Zoom prepare mode ('4D Zoom prepare acquisition' on page 6-11).

The volume acquisition is started.

4. The following parameters may be adjusted during acquisition:
 - **Volume size:** adjust the volume size. An increase of the volume size will reduce the volume rate.
 - **Volume shape:** adjust the ratio between the elevation and azimuth widths. Changing the volume shape from default will increase the volume rate.
 - **Elevation tilt:** tilt the volume in the elevation plane and change the viewing direction accordingly.
 - Other parameters: Frame rate, Frequency and Octave.
 - **Angle** (on the Touch Panel): display different rendering views.
 - **Layout** (on the Touch Panel): display different layout alternatives.
5. You may adjust **Num Beats** to change the number of heart beats the acquisition should be based on.
6. Press **Multi beat** on the Touch Panel.

The gated acquisition is started. Ask the patient to hold her/his breath at end expiration. Keep the probe steady and look for stitching artifacts in both the volume rendering and the elevation plane in the lower left window of the screen, or use Multi-Slice (page 6-8) to better assess the stitching quality. Attention should be brought on stitching quality during acquisition rather than volume rendering quality.
7. You may adjust **Angle** to get different rendering views. The default top/down view is best for stitching quality assessment.
8. Optimize the image quality as necessary (2D Gain, 4D Gain and UD Clarity).
 - Turn on **HD Live** display to simulate light propagation and scattering through tissue.
 - Turn off **HD Live** and If desired, select a **Color map** to colorize the volume rendering. The Depth color maps use a combination of colors to improve depth perception.

Press **Red** or **Color Laser lines** on the Touch Panel (page 2) to visualize the 2D image locations in the volume rendering. The 2D image locations are shown as overlaying red or color coded lines following the surface in the volume rendering. The color of the laser lines corresponds to the color coding used for the 2D images.

9. Press **Store** to store the acquisition.

NOTE: *It is recommended to acquire several heart cycles and use **Cycle select** to select the best one.*

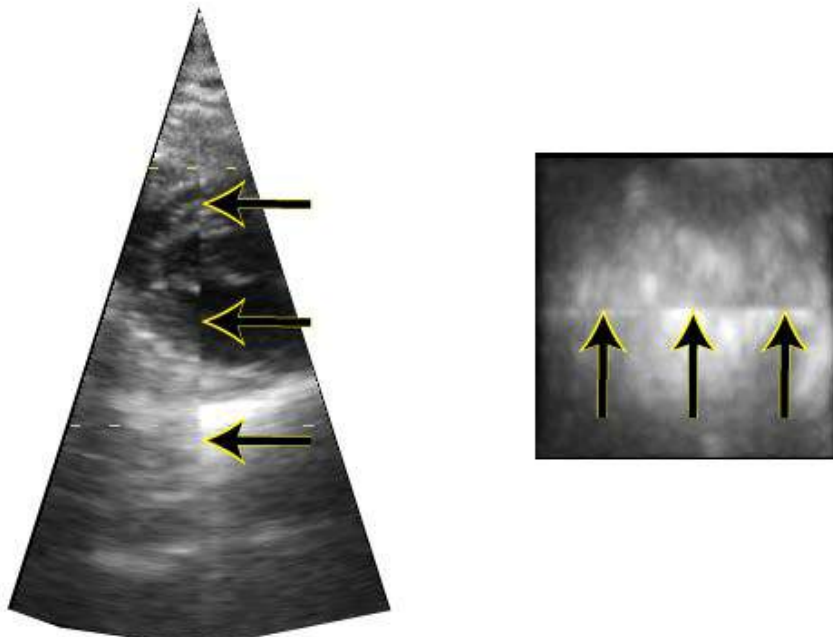

Figure 6-3. Stitching artifacts

Multi-Slice acquisition

Multi-Slice acquisition provides full volume data acquisition in the same way as regular 4D single-beat or multi-beat acquisition.

When using Multi-Slice acquisition the volume rendering display is replaced by equidistant short axis views. The two Apical views displayed on the left are for probe orientation purpose, while the short axis views are used to ensure that the entire chamber is included in the volume and to evaluate presence of stitching artifacts (Figure 6-4).

1. While in 4D Live, press **Multi-Slice** on the Touch Panel.

The *Multi Slice* screen is displayed showing equidistant short axis views (Figure 6-4). The short axis views are evenly distributed and maximized in size for best assessment (e.g image quality, presence and visibility of all walls, stitching artifacts when using real time multi beat acquisition). Apical views are displayed on the left side for orientation purpose.

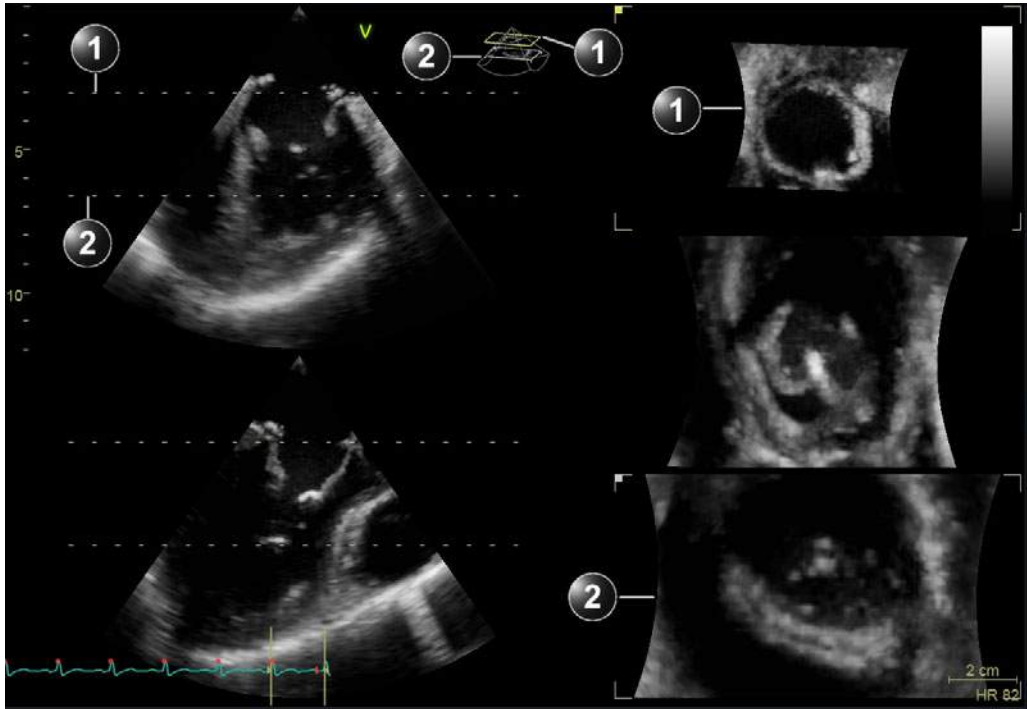

1. Upper slice
2. Lower slice

Figure 6-4. Multi Slice screen

NOTE: Press **Layout** on the Touch Panel or use the dedicated buttons on the Touch Panel to get the following display alternatives.

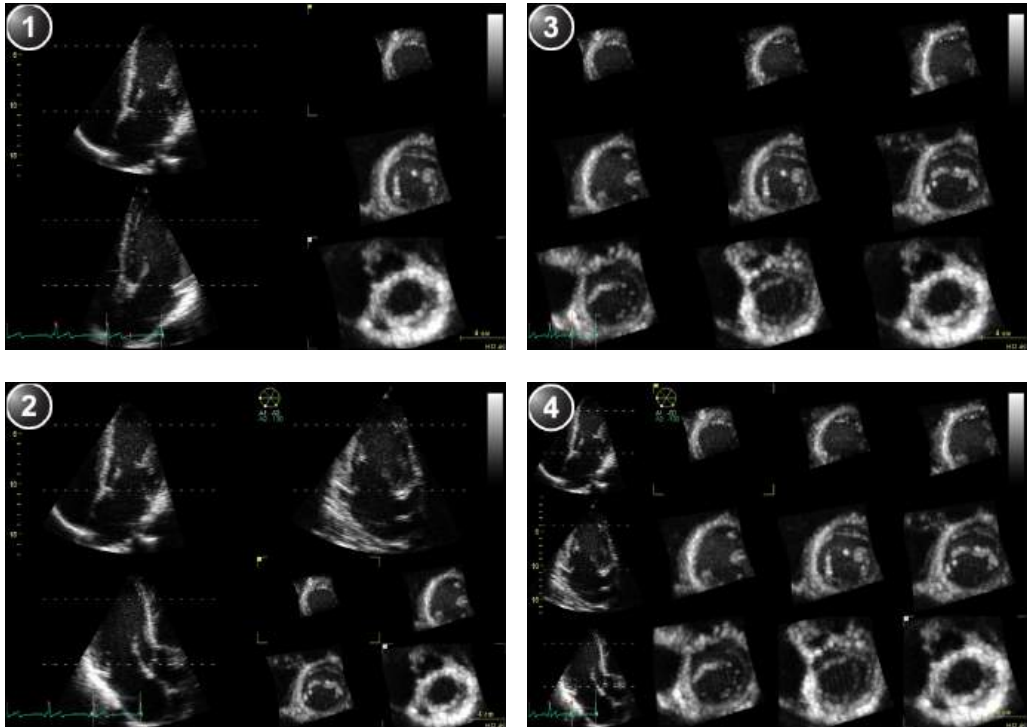

- 1. 5 Slice
- 2. 7 Slice

- 3. 9 Slice
- 4. 12 Slice

Figure 6-5. Multi Slice alternative displays

If required, apply zoom. All short axis views are zoomed in simultaneously.

NOTE: *Multi-Slice is also available in replay.*

2. The following adjustments can be done:

- Place the cursor in the middle section of the top or bottom slice intersection line in one of the apical views. The cursor is changed to . Drag to change the slicing area.

Alternatively, adjust **Top** and **Bottom** controls on the Control Panel.

- Place the cursor at one of the extremities of the top or bottom slice intersection line in one of the apical views. The cursor is changed to . Drag to rotate the slices backward/forward and sideways, to align the slices with the anatomical structure.

Alternatively, adjust the **Axis 1** and **Axis 2** controls on the Touch Panel (page 2).

- Adjust **Translate** to move all slices up or down.

NOTE: *The default position can be displayed again by pressing **Clear** on the Control Panel.*

3. Press **Multi-Slice** to exit.

4D Zoom prepare acquisition

4D Zoom prepare acquisition is used to acquire real-time data of isolated structures at a higher frame rate than what can be obtained with a full volume acquisition. It is also useful because acquisition is restricted to the structure of interest, reducing the need for post processing.

4D Zoom prepare is available from 2D, Color Flow, 4D, 4D Color Flow and Multi-plane modes.

4D Zoom acquisition is done in two steps:

- Prepare step: positioning of the probe for optimal acquisition and adjustment of the zoom ROI in biplane mode.
- Acquisition step: Acquisition of zoomed 4D data.

1. To start 4D Zoom prepare:

- From 4D or 4D Color Flow mode: press the **Zoom** button on the Control Panel.
- From 2D, Color Flow or Bi-plane mode: press **4D Zoom prepare** on the Touch Panel.

A biplane screen is displayed showing a ROI in the azimuth and elevation planes.

NOTE: *Transesophageal acquisition: press **Mitral valve**, **AV SAX**, **AV LAX** or **Top Down** on the Touch Panel to acquire a volume rendering of the corresponding view.*

2. Using the trackball adjust the position, size, width and tilt of the ROI so that the ROI is correctly covering the structure of interest in both planes.

- Press **Select** to toggle the trackball function between ROI position (**Pos**) and ROI size (**Size**).
- Press **Ref. plane** on the Touch Panel to toggle the trackball function between **Pos/Size** and **Width/Tilt**.
- Press **Select** to toggle the trackball function between ROI width (**Width**) and ROI tilt (**Tilt**). The Width and Tilt controls affect the ROI in the elevation plane only.

3. Press **4D** on the Control Panel to acquire 4D data in the defined zoom area.

NOTE: You can do a single beat (see page 6-5) or a multi beat (see page 6-6) acquisition.

NOTE: The tissue sector is slightly increased if entering 4D Color Flow mode.

4. Press **Store** to store the acquisition.

4D Markers

4D Markers is a tool where one can place annotations on structures/objects of interest. Placement can be done on 2D and Multi-plane slices, on slices derived from 4D datasets, or on the rendered datasets themselves.

4D markers have defined coordinates in image space. They will rotate/translate/zoom when the 4D image is rotated/translated/zoomed. Therefore, they always stay in the correct position relative to the anatomical structures which are annotated as long as the probe is not moved. When switching from 4D to 2D or to Multi-plane, the 4D markers are maintained in the same position with respect to the probe. A legend with marker names is always shown if 4D Markers are present in the image.

The markers are shown as 3D-objects when a rendering is shown, and as circumferences in slices. In 2D slices derived from 4D, the markers will only be visible if there is an intersection between the slice and the marker (Figure 6-6).

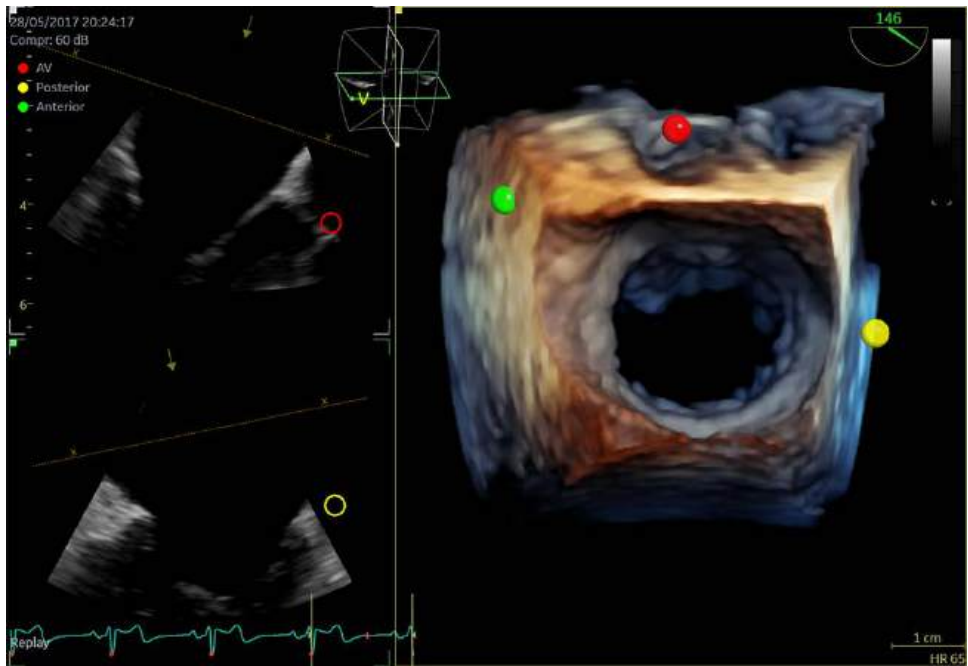



Figure 6-6. Image with 4D Markers

Inserting a 4D Marker

Select the **4D Marker** tab on the Touch Panel when in 4D, 2D, or Multi-plane mode. (Figure 6-7). Select one of the pre-defined markers, or click **Free Text..** if you want to define your own text. The cursor changes to the *cross* symbol:  cross.

Place the marker either on a slice or directly on the 3D rendering by clicking. While positioning the marker, the legend displays the active marker being placed.

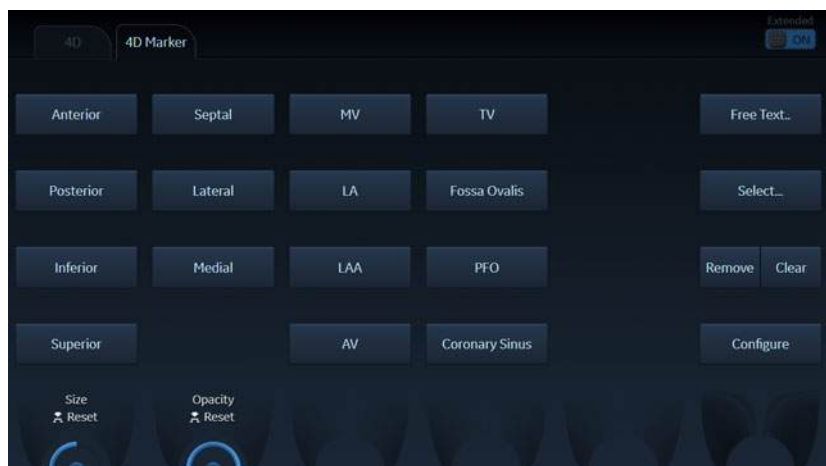

Figure 6-7. 4D Marker tab is available in 4D-mode.

Removing a 4D Marker

Press **Remove** to delete the last placed marker or **Clear** to delete all markers.

Changing size of 4D Markers

Use the **Size** rotary (other applications have sliders) to change the radius of the 4D markers. The selected size is applied to the 4D Marker which will be placed next. It does not influence the size of the remaining markers which are already placed.

Changing opacity of 4D Markers

Use the **Opacity** rotary (other applications have sliders) to change the opacity of the 4D markers. The selected opacity level is applied to all 4D Markers unless a particular marker is selected, in which case it affects only the selected marker.

Editing a placed 4D Marker

To edit an existing marker, press **Select...** on the Touch Panel, move the cursor to the marker and click. Move the marker to the desired location and click again to place it.

NOTE: A selected marker is marked as Active in the legend. It is possible to change the size and opacity of an active marker by using the size and opacity controls, respectively.

Configuring the pre-defined 4D Markers

To customize the set of predefined 4D Markers, press **Configure**. The current configuration of markers in use is shown in the *Enabled 4D Markers* list (Figure 6-8). Select any item and use the up and down arrow buttons to reorder the list. Press **Remove** to remove a selected item. Alternatively, use the left and right arrow buttons to move the selected item to and from the *Available 4D Markers* list. This allows to remove a 4D Marker and re-introduce it later if needed. Use the empty text box field to define a custom marker name. Press **Factory** to reset the list to the default factory setting.

This configuration screen can be accessed at any time. Press **Utility** on the Touch Panel followed by **Config...**, and then select the **Imaging** category and **4D Marker** tab.

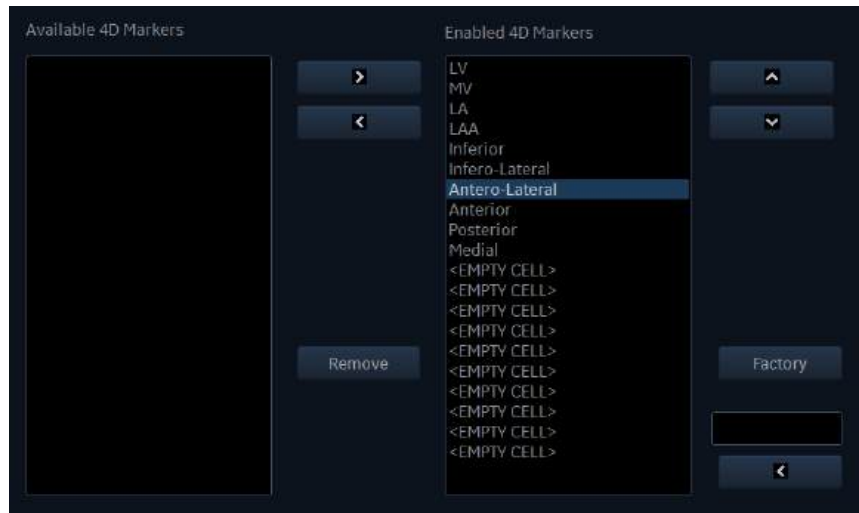
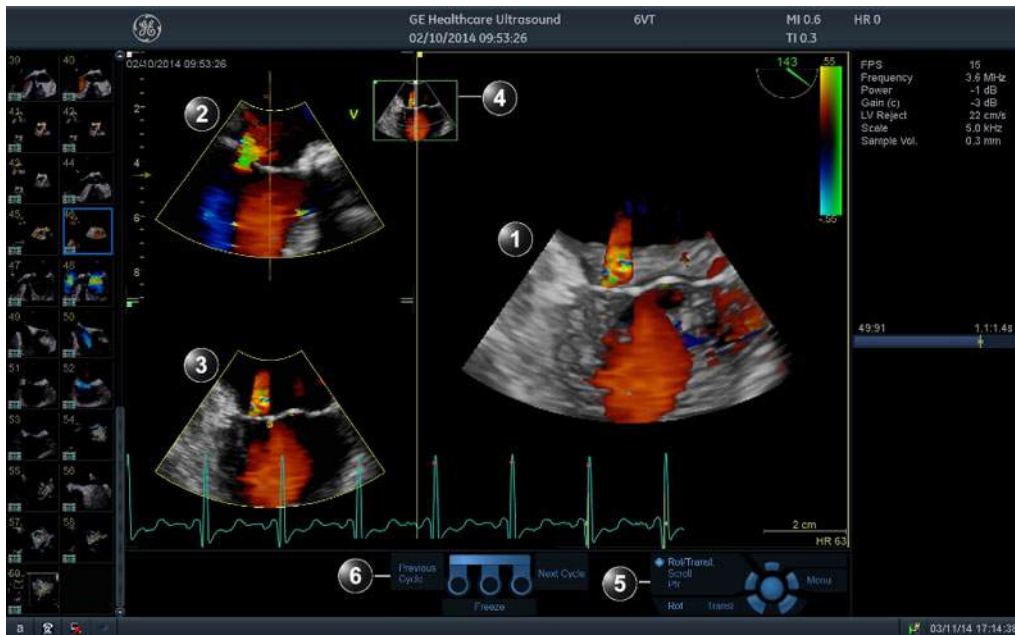

Figure 6-8. Configuration of predefined 4D Markers

4D Color Flow mode

Volume rendering screen



1. Volume rendering display with Color Flow
2. 2D Color Flow image in the azimuth plane. The arrow indicates the viewing direction onto the volume rendering relative to the azimuth plane.
3. 2D Color Flow image in the elevation plane. The arrow indicates the viewing direction onto the volume rendering relative to the elevation plane.
4. Orientation window: displays a three-dimensional scene with acquisition sector and 2D image positions.
5. Trackball functions
6. Footswitch functions (option)

Figure 6-9. 4D Color Flow screen (Volume rendering)



Figure 6-10. The 4D Color Flow mode Touch panel

4D Color Flow acquisition

NOTE: *The 4D Color Flow acquisition can also be started using the 4D Zoom prepare acquisition mode (see '4D Zoom prepare acquisition' on page 6-11).*

Real time single beat 4D Color flow acquisition

Color Flow can be enabled in 2D mode before entering 4D mode or when in 4D mode.

1. Select a 4D probe and a cardiac application.
2. While in 2D, press **Color**.
3. Optimize the image quality (Gain, Depth, TGC... etc.).
4. Use the trackball to adjust the position and size of the color ROI as necessary. Alternatively,
5. Press **4D** on the Control panel.

NOTE: *If the color ROI position is not optimal, press **MultiD** on the Control Panel.*

6. Press **Store**.



CAUTION

Tissue structures may obscure relevant flow information. If required, increase Tissue transparency setting.

Color flow data may obscure other relevant color flow information (e.g. jet). If required adjust Flow transparency setting.

In some settings the volume rate can be less than 10 volumes per second. This may lead to small display mismatch between the color and tissue data. This is because of the rapid movement of structures (e.g. valves) compared to the time lag between the tissue and the color volume acquisitions. Tissue data should only be used as guidance for the localization of the flow data.

Real time multi beat 4D Color Flow acquisition

Real time gated 4D Color Flow acquisition is based on ECG gated sub-volume acquisitions of color flow data.



ECG gated acquisition may by nature contain artifacts. The triggering works by acquiring the whole tissue volume during the first heart beat, followed by several color sub-volumes that are stitched together. Consequently, the tissue volume is not updated for every heart beat, and only the color data may have stitching artifacts.

Artifacts may be caused by:

- Movements of the probe caused by the operator during acquisition.
- Movements of the patient during acquisition, including movements caused by respiration.
- Irregular heart rate during acquisition.

To validate the acquisition, perform a visual inspection in both the volume rendering and the elevation plane. Stitching artifacts are shown as visible transitions between the sub-volumes in the color flow data. The Multi-Slice mode is also well suited for evaluating the presence of stitching artifacts while in live acquisition (see Figure 6-3).

1. Connect the ECG device and make sure to obtain a stable ECG trace.
2. Select a 4D probe and a cardiac application.
3. While in 2D, press **Color**.
4. Use the trackball to adjust the position and size of the color ROI as necessary. Alternatively, perform this step in Biplane where it's possible to adjust the position and the size on both azimuth and elevation plane.
5. Press **4D** on the Control panel.
6. You may adjust **Num Beats** to change the number of heart beats the acquisition should be based on.
7. On the Touch panel, press **Multi beat**. The gated acquisition is started. Ask the patient to hold her/his breath at end expiration. Keep the probe steady and look for stitching artifacts in the color flow data in both the volume rendering and the elevation plane in the lower left window of the screen.
8. Press **Freeze**.

In 2D Freeze, look for stitching artifacts in the color flow data in both the volume rendering and the elevation plane in the lower left window of the screen.

9. Rotate the volume to check the result. Use Cycle select to select the best heart cycle.
10. Press **Store**.

4D Zoom prepare acquisition (Color Flow)

See '4D Zoom prepare acquisition' on page 6-11.

4D Color Flow volume rendering



Volume rendering of 4D Color flow data acquired with **Variance** set to off may be visually different when using data acquired on software versions 204 and newer versus data acquired on software versions 203 and older. High bandwidth regions may be visualized with higher opacity and high bandwidth jets may therefore appear more opaque with data acquired on software versions 204 and newer.

HD Color

HD Color is a 4D Color Flow visualization mode available by pressing **HD Color** while in 4D Color Flow mode. **HD Color** applies reflections and shadowing to the 4D Color Flow Volume to enhance the 3D depth perception when visualized on a 2D monitor. A transparency control, **HD Color Strength**, is available to visualize selectable degrees or strengths of turbulent blood flow within the transparent outline of the non-turbulent flow.

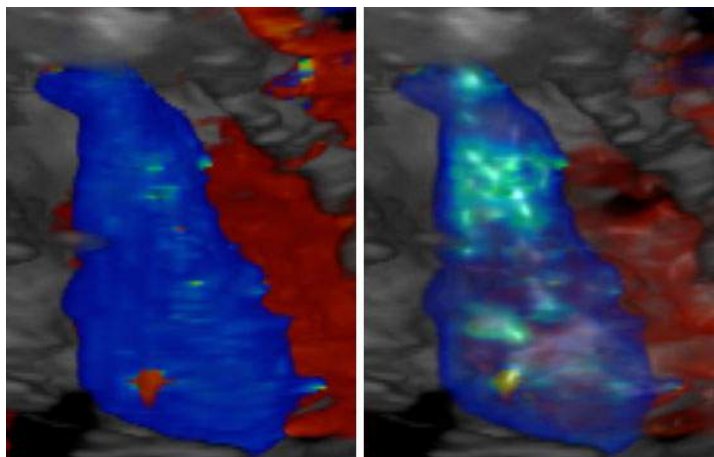

Figure 6-11. On the left: Conventional 4D Color Flow without HD Color, on the right: 4D Color Flow with HD Color enabled.

Flexi-Slice

The Flexi-Slice mode is used to extract 2D cut-planes from 4D data sets. The Flexi-Slice mode displays several cut-planes and a volume rendering. The cut-planes can be rotated and translated independently of each other, or in combination (see page 6-24). Flexi-Slice mode is available from 4D and 4D Color Flow mode in live and replay.

To start the Flexi-Slice mode press **Flexi-Slice** while in 4D or 4D Color Flow mode.

Flexi-Slice mode screen

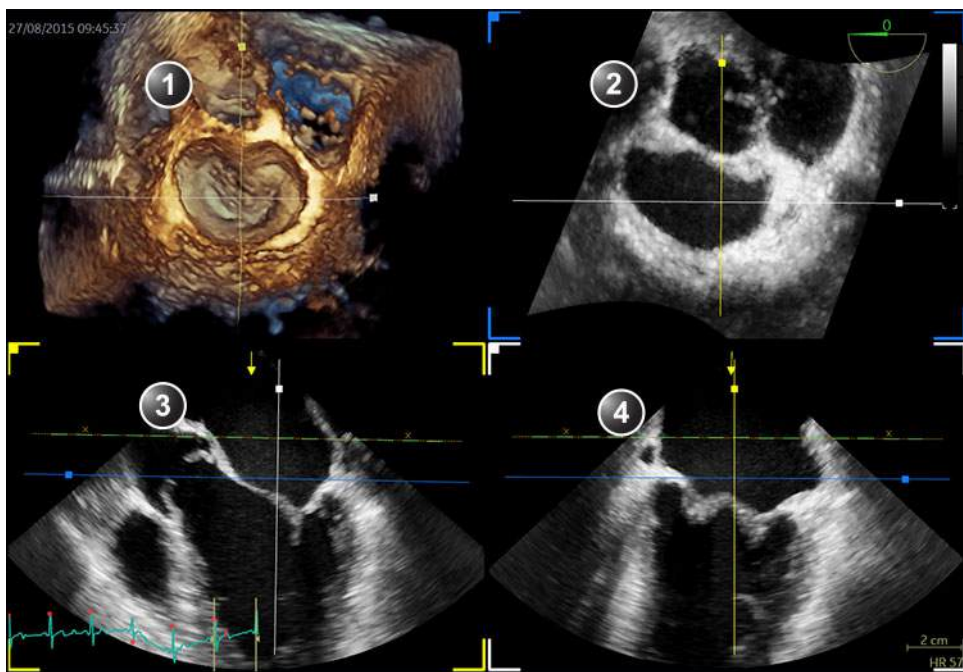

1. Volume rendering
2. Cut-plane 1 (blue)
3. Cut-plane 2 (yellow)
4. Cut-plane 3 (white)

Figure 6-12. The 4D screen (Flexi-Slice mode)

Flexi-Slice mode screen (Color flow)

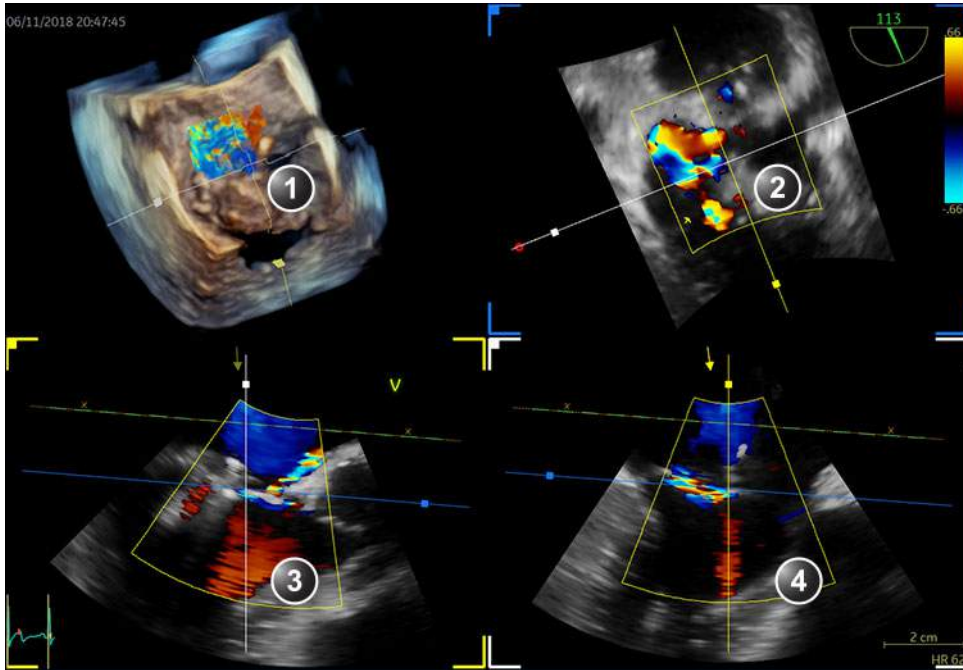

1. Volume rendering
2. Cut-plane 1 (blue)
3. Cut-plane 2 (yellow)
4. Cut-plane 3 (white)

Figure 6-13. 4D Color Flow screen (Flexi-Slice mode)



Figure 6-14. The Flexi-Slice mode Touch panel

Flexi-Slice preset layouts

In Flexi-Slice mode, several cut-planes are displayed as well as their location and the location of the crop plane. At least one cut-plane is parallel to the crop plane. Several preset layouts are available to the user that can be selected on the Touch Panel.

NOTE: *On some layouts, two lines parallel to the crop plane are visible. These planes are used to obtain extra slices on the volumes. The views corresponding to these planes display distance values on the lower left corner. The reference plane shows "0mm", while the other shows the absolute distance between the current plane and the reference plane.*

Basic operations

Rotating/Translating the view plane or crop plane

Rotation and translation can be performed in either Volume rendering or Flexi-Slice mode. Press **Flexi-Slice** to toggle between the two modes.

Volume rendering mode

In Volume rendering mode, rotation applies to the viewing direction onto the volume rendering. When **View Crop** on the Touch Panel is selected, the viewing direction and the crop plane rotate together. When **View crop** is deselected rotation applies only to the viewing direction.

Translation applies to a crop plane into the volume (see 'Crop tool' on *page 6-31* for more information about cropping).

1. Press **Select** to toggle between **Rotate** and **Translate**.

Rotation:

- Rotation with **View crop** selected: use the trackball to rotate the active crop plane together with the viewing direction. The viewing direction always coincides with the crop plane.
- Rotation with **View crop** deselected: use the trackball to rotate the viewing direction around the volume rendering. The crop plane does not rotate.

Translation:

- Use the trackball to translate the crop plane into the volume.

The default position can be displayed again by pressing **Clear**.

Flexi-Slice mode



In Flexi-Slice, there are two modes to interact with the slices: Drag & Drop and Click-To-Move. Drag & Drop mode requires the user to click an item and move it to the desired location while keeping the button pressed. Click-To-Move requires the user to click and release on an item to initiate the interaction, and then click and release to terminate it. Mode selection can be performed by entering **Config...**, selecting **Imaging** and then the **Global** tab, under the item **4D Interactions**.

In Flexi-Slice mode, each cut-plane may be rotated independently (or simultaneously if "Lock Slices" is selected on

the Touch Panel) and translated (independently only) using the Trackball:

1. Press **Yellow**, **White** or **Green** on the Touch Panel to select the Reference plane and change the orientation of the volume rendering accordingly.

The volume rendering is updated accordingly.

2. Place the cursor at one of the extremities of a cut-plane intersection line in one of the cut-planes. The cursor is changed to . Drag (or click) to rotate the cut-plane.
3. Place the cursor in the middle section of a cut-plane intersection line. The cursor is changed to . Drag (or click) to translate the cut-plane.
4. Place the cursor at the intersection between two cut-plane lines. The cursor is changed to . Both cut-planes are translated simultaneously.
5. Click on a point in the volume rendering to move the intersection of the two other cut-planes to that location.
 - If **Depth Mode** is turned on: the reference plane is also moved inside the volume rendering to the corresponding selected depth.
 - If **Depth Mode** is turned off: the reference plane is kept at the current depth.

6. Place the cursor at the outer area of one of the cut-planes. The cursor is changed to . Drag to rotate the cut-plane image. The cut-plane lines remain fixed.

7. Place the cursor in the inner area of one of the cut-planes. The cursor is changed to . Drag (or click) to pan the cut-plane image. The cut-plane lines remain fixed.

In Flexi-Slice, change trackball mode to **Rot** to start interacting with the 3D rendering in the same way as Volume rendering mode. The trackball will change the viewing angle of the rendering.

Zooming

1. Rotate the **Zoom** knob clockwise on the Control Panel.
The volume rendering is magnified.

4D Views

4D Views enables quick access to standard 2D and 4D views. 4D Views requires slice alignment before standard views can be selected.

4D Views is available in Freeze and replay.

1. Press **4D Views** on the Touch Panel.
The *Slice alignment* screen is displayed.

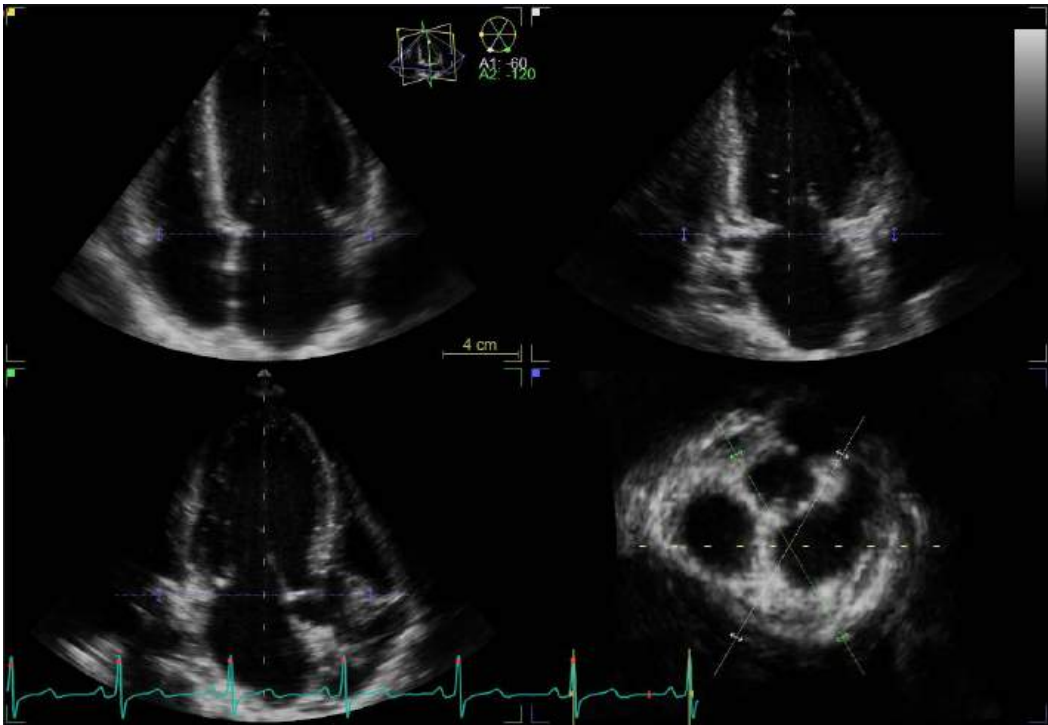

Figure 6-15. Slice alignment screen

Alignment – Transthoracic acquisition

1. Press **Auto Align** on the Touch Panel (or **Auto** on the Control Panel).

The standard views are displayed with the left ventricle centered to the center axis.

Further adjustment of the alignment can be done using the slice alignment controls on the Touch Panel or using the trackball.

From the Touch Panel, adjust as required:

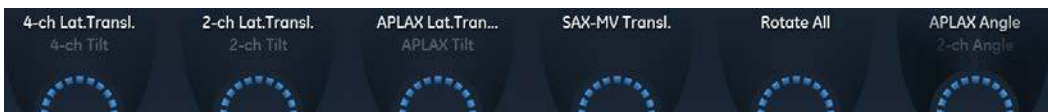







Figure 6-16. Slice alignment controls

From the Trackball, adjust as required:

- Place the cursor outside one of the extremities of the slice intersection lines in the Apical short axis view. The cursor is changed to . Drag to rotate all apical views around the main axis.
- Place the cursor at one of the extremities of the Apical 2 chamber slice intersection line (white) in the Apical short axis view. The cursor is changed to . Drag to rotate the Apical 2 chamber slice around the main axis.
- Place the cursor at one of the extremities of the Apical long axis slice intersection line (green) in the Apical short axis view. The cursor is changed to . Drag to rotate the Apical long axis slice around the main axis.
- Place the cursor at one of the extremities of a slice intersection line in one of the apical views. The cursor is changed to . Drag to tilt all slices around a perpendicular axis to the apical view.
- Place the cursor in the middle section of a slice intersection line in one of the apical views. The cursor is changed to . Drag to pan all slices.
- Place the cursor on the blue intersection lines in one of the apical views. The cursor is changed to . Drag to translate the short axis plane.

NOTE: Press **Clear** on the Touch Panel to remove the alignment and display the original probe position or previously approved alignment.

2. Press **Approve** when alignment is done.

NOTE: Pressing **Delete** on the Touch Panel will remove any previously approved alignments and exit the Slice alignment function.

3. Select the desired standard view on the Touch Panel.



Figure 6-17. The 4D Views Touch Panel (Transthoracic acquisition)



Alignment – Transesophageal acquisition



1. Perform slice alignment using the slice alignment controls on the Touch Panel or using the trackball.
From the Touch Panel, adjust as required:



Figure 6-18. Slice alignment controls

From the trackball, adjust as required:

- Place the cursor outside one of the extremities of the slice intersection lines in the short axis view. The cursor is changed to . Drag (or click) to rotate all views around the main axis.
- Place the cursor at one of the extremities of the 2 chamber slice intersection line (white) in the short axis view. The cursor is changed to . Drag (or click) to rotate the 2 chamber slice around the main axis.
- Place the cursor at one of the extremities of the Mid-esophageal (ME) long axis slice intersection line (green) in the short axis view. The cursor is changed to . Drag (or click) to rotate the ME long axis slice around the main axis.

- Place the cursor at one of the extremities of a slice intersection line in one of the long axis views. The cursor is changed to . Drag (or click) to tilt all slices around a perpendicular axis to the view.
- Place the cursor in the middle section of a slice intersection line in one of the long axis views. The cursor is changed to . Drag (or click) to pan all slices.
- Place the cursor on the blue intersection lines in one of the long axis views. The cursor is changed to . Drag (or click) to translate the short axis plane.

NOTE: Pressing **Clear** on the Touch Panel will remove the alignment and display the original probe position or previously approved alignment.

2. Press **Approve** when alignment is done.

NOTE: Pressing **Delete** on the Touch Panel will remove any previously approved alignments and exit the Slice alignment function.

3. Select the desired standard view on the Touch Panel.



Figure 6-19. The 4D Views Touch Panel (Transesophageal acquisition)

Dynamic

Dynamic is a tissue tracking tool. When Dynamic is on the cropping plane applied to the volume rendering is moving

together with the tissue structure through the entire heart cycle. Only longitudinal displacements relative to the basal LV are detected. Dynamic tool may enable a better visualization of anatomical structures (e.g. MV annulus) through the entire heart cycle.

Dynamic is only available with transthoracic acquisitions.

NOTE: When Dynamic is on the icon  is displayed on screen.



CAUTION

Use Dynamic only on apical greyscale acquisitions.

Do not compare measurements performed on static and dynamic slices.

2-click cropping

2-click crop enables to quickly extract any views for visualization of 4D structures. Two crop planes are created by clicking twice in one of the 2D images or in the volume rendering.

1. Press **2-Click Crop** on the Touch Panel.
2. Place the cursor in one of the 2D views (or the volume rendering) and press **Select** to create the first crop plane.
3. Move the cursor to a new location. The volume rendering is updated simultaneously showing the cropped view.
4. Press **Select** to create the second crop plane.

NOTE: *If desired repeat the procedure to create a new cropped view.*

5. Press **2-Click Crop** to go back to the *Volume rendering* screen.
6. To remove 2-click crop, press **Clear** on the Touch Panel.

Dual cropping

Dual Crop enables to quickly display the 4D data from opposite views using two renderings. To enable this visualization, two crop planes are created by clicking twice in one of the 2D slices or in the volume rendering.

1. Press **Dual Crop** on the Touch panel.
2. Place the cursor in one of the 2D slices (or the volume rendering) and press **Select** to create the first crop plane.
3. Move the cursor to a new location. The volume rendering is updated simultaneously showing the cropped view.

4. Press **Select** to create the second crop plane and to enter Dual Crop visualization.
5. Press **Layout** to toggle dual crop layouts. The volume rendering can be freely rotated.
6. Press **Dual Crop** to go back to the *Volume rendering* screen.
7. To remove crop planes, press **Clear** on the Touch panel.

Parallel cropping

Parallel cropping applies two parallel crop planes in the volume rendering. This setting can be useful for valves and shunts renderings.

When using **Parallel Crop**, both crop planes move together, when translating and rotating. The thickness of the parallel crop is adjusted using the **Thickness** control.

To remove parallel cropping, press **Parallel Crop** again.

Crop tool

The volume rendering can be cropped to only display the structure of interest.

There are two crop planes that can be adjusted in each of the azimuth, elevation, and short axis planes.

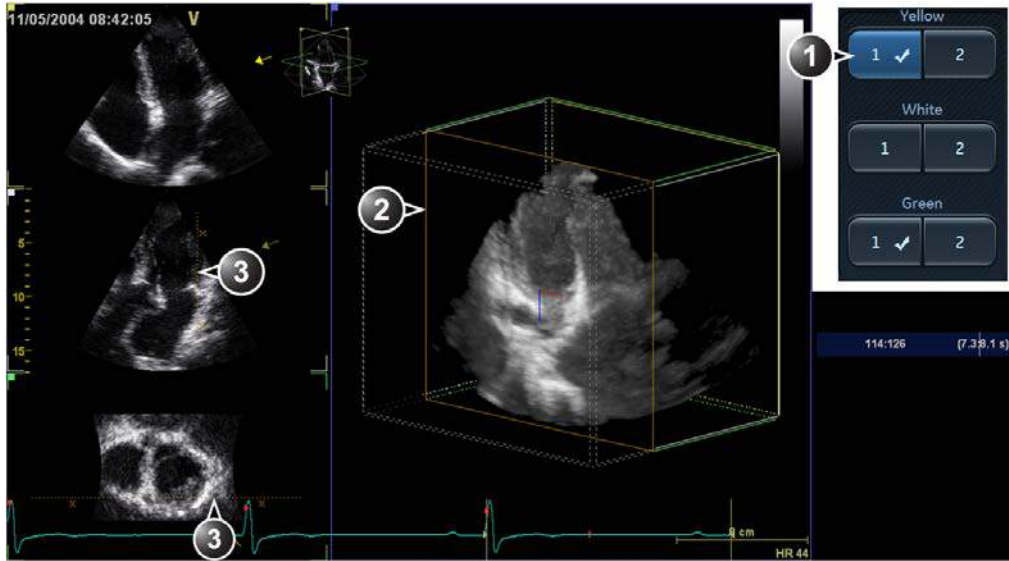

1. Depressed button: active crop plane.
Check mark: cropping is applied.
2. Active crop plane in the volume rendering.
3. Crop plane intersection. The X symbols indicate the cropped side.

Figure 6-20. Crop plane 1 in the azimuth plane

1. Press **Crop tool** on the Touch Panel (page 2).
2. On the Touch Panel, select the crop plane to adjust.
3. The adjustment of the crop plane is done with the trackball. Press **Select** to toggle the trackball function between translation (**Transl**) and rotation (**Rot**).
 - **Transl**: translates the crop plane into the volume.
 - **Rot**: rotates the view plane around the volume rendering.

To rotate the crop plane, press **Rotate crop** on the Touch Panel and use the trackball to apply rotation. Press **Rotate crop** again when done.
4. Use the **Rotate red** and **Rotate blue** controls on the Touch Panel to fine tune the adjustment of the crop plane. The **Rotate Red** control rotates the crop plane about the red indicator in the center of the crop plane. Similarly, the **Rotate Blue** control rotates the crop plane about the blue indicator. The **Spin Red&Blue** control changes the orientation of the red and blue indicators, to facilitate cropping in oblique angles.
5. Other possible adjustments:

- Press **Flip crop** to remove the data on the other side of the current crop plane. The viewing direction is flipped 180 degrees.
- Press **Parallel crop** to add a crop plane parallel to the current crop plane. This setting can be useful for valves and shunts renderings.

When using **Parallel Crop**, both crop planes move together, when translating and rotating. The thickness of the parallel crop is adjusted using the **Thickness** control.

To remove parallel cropping, press **Parallel Crop** again.

Press **Reset Active** to undo the adjustments made on the current active crop plane.

Press **En face view** to display a straight forward view of the active crop plane.

6. On the Touch Panel, select another crop plane and make the required adjustments as described above.

NOTE: Pressing down a button containing a check mark will make the corresponding existing crop plane active. Pressing a button without a check mark will introduce a new crop plane, and make it active.

7. To remove crop planes:
 - To remove the active crop plane (indicated by a depressed button with check mark), press the corresponding button again.
 - To remove a crop plane that is defined (indicated by a check mark) but not active, press the corresponding button twice.
 - To remove all crop planes, press **Angle** or **Clear** on the Touch Panel.
8. Press **Crop tool** to exit the cropping mode.

Stereo vision

4D Stereo Vision is a display technique that enhances the perception of depth in the 3D renderings. This is achieved by mixing two different volume renderings with slightly separated viewing angle and presenting them separately to the user's left and right eyes.

Stereo vision is based on Anaglyph stereo vision. It can be displayed on any monitor and requires anaglyph stereo glasses (glasses with one red and one cyan lens).

Stereo vision is started by pressing **Stereo vision** on the Touch Panel while in 4D mode.

Make sure to use the correct glasses.



Figure 6-21. 3D anaglyph glasses

NOTE: Not all users may be able to perceive depth using stereoscopic display techniques.

4D-Mode controls

Control panel

4D Gain (Active Gain rotary)	
4D, 4D Color	Affects the transparency of the volume rendering. Too much 4D Gain applied will take away structures, too little will leave opaque "Gray clouds" in the ventricle.

Zoom (4D Zoom prepare)	
4D, 4D Color	<p>Enters 4D Zoom prepare acquisition:</p> <p>Enables 4D Zoom prepare acquisition displaying a biplane screen with an adjustable zoom ROI in the azimuth and elevation planes. After adjustment of the ROI, press 4D to acquire 4D data for the defined ROI (see page 6-11).</p>

Layout	
4D, 4D Color	Toggles the display between different screen layouts.

Update Menu	
4D, 4D Color	<p>Depending on the situation:</p> <ul style="list-style-type: none"> • Toggles between 4D Color Flow Prepare mode and 4D Color Flow acquisition. • Toggles between 4D/4D Color Flow Zoom mode and 4D/4D Color Zoom prepare mode.

	Trackball
4D, 4D Color	<p>The trackball has multiple functions. The trackball functions are organized in several functional groups. The function selected is displayed in the lower part of the screen.</p> <ul style="list-style-type: none"> • Press Select to toggle between the trackball functions within the active functional group. Groups with several functions are marked with a + symbol. • Press Trackball to toggle between the functional groups. <p>The functions available are:</p>
	<p>Volume rendering mode: Group 1:</p> <ul style="list-style-type: none"> • Rotate: rotates the viewing direction onto the volume rendering. The active crop plane is also rotated if View crop is selected on the Touch panel. • Translate: translates a crop plane into the volume rendering. <p>Group 2:</p> <ul style="list-style-type: none"> • Speed: adjusts cine replay speed. • Scroll: scrolls through a cinelooop (in Freeze).
	<p>Volume rendering, cropping mode: Group 1:</p> <ul style="list-style-type: none"> • Translate: translates the current crop plane. • Rotate: <ul style="list-style-type: none"> • Rotates the viewing direction onto the volume rendering. • Rotates the crop plane if Rotate is selected on the Touch panel.
	<p>Flexi-Slice mode: Group 1:</p> <ul style="list-style-type: none"> • Rotate: rotates the viewing direction onto the volume rendering. <p>Group 2:</p> <ul style="list-style-type: none"> • Adjust: rotates and translates the selected cut-plane or the data. <p>Group 3:</p> <ul style="list-style-type: none"> • Speed: adjusts cine replay speed. • Scroll: scrolls through a cinelooop (in Freeze).

	Angle
4D, 4D Color	Sets the cut-planes and crop planes to pre-defined positions.

	Clear
4D, 4D Color	Sets the cut-planes and crop planes to the default position.

Touch panel and rotaries

	Volume size
4D	Controls simultaneously the azimuth and elevation widths. An increase generates a bigger volume with a lower volume rate. A decrease generates a smaller volume with a higher volume rate.

	Volume shape
4D	Adjusts the ratio between the elevation and azimuth widths. Changing the volume shape from default will increase the volume rate.

	Volume optimize
4D	Optimizes the volume rendering by adjusting several display controls simultaneously (e.g Shading, Smoothness, etc.).

	Medium / Large
4D, 4D Color	4D Acquisition presets: sets the volume size for the 4D acquisition. <ul style="list-style-type: none"> • Medium: medium size sector with top-down view, more suited for mitral valve acquisition. • Large: large sector more suited for acquisition of the complete LV.

	4D Zoom prepare
4D, 4D Color	4D Acquisition preset that enables to acquire real-time data of isolated structures at a higher frame rate than what can be obtained with a full volume acquisition.

	Acquire volume
4D Color	Toggles between Prepare mode and 4D Color flow acquisition.

	Multi Beat
4D, 4D Color	Toggles ECG gated 4D acquisition on and off.

	Num Beats
4D, 4D Color	Adjusts the number of heart beats the multi beat acquisition is based on.

	View Crop
4D, 4D Color	Crop mode where the view plane and the crop plane always coincide.

Flip Crop	
4D, 4D Color	Sets the crop plane so that the opposite volume is cropped and the viewing direction is flipped 180 degrees.

2-Click Crop	
4D, 4D Color	Crop mode where two parallel crop planes are applied in the volume rendering. The position and viewing direction are defined by clicking in two locations either in the 2D reference images or in the volume rendering. 2-click crop enables to quickly extract any views for visualization of 4D structures.

Dual Crop	
4D, 4D Color	Dual Crop enables to quickly display the 4D data from opposite views using two renderings. To enable this visualization, two crop planes are created by clicking twice in one of the 2D slices or in the volume rendering.

Flexi-Slice	
4D, 4D Color	Toggles the display between Volume rendering (Figure 6-1 on page 6-3) and Slice mode (Figure 6-12 on page 6-21).

Multi Slice	
4D, 4D Color	Enables simultaneous display of equidistant short axis views generated from a volume acquisition. Alternative displays are available from the Touch panel or by pressing Layout on the Touch panel.

Depth/Color maps	
4D, 4D Color	<ul style="list-style-type: none"> • Adjusts the volume rendering color from a color map menu. • Depth color maps: these color maps use colors to improve the perception of depth. Selecting the Depth bronze/blue color map will display structures that are close to the view plane with a bronze color. Structures that are farther behind will be colored with a gray color, while the structures that are farthest behind will be colored in blue. Very bright colors are almost white, independent of the depth.
4D	Depth Illumination map: this color map creates shadows to improve the perception of depth. Rotate the Light source rotary on the Touch panel to adjust the light angle.

Stereo Vision	
4D, 4D Color	Stereo Vision: 4D Stereo vision is a display technique that enhances the perception of depth in 3D renderings. This is achieved by mixing two different volume renderings with slightly separated viewing angles and presenting them separately to the user's left and right eyes.

4D Views	
4D, 4D Color	Enables quick access to standard 2D and 4D views. 4D Views is available in Freeze and replay.
Dynamic	
4D	Dynamic is a tissue tracking tool. When Dynamic is on the cropping plane applied to the volume rendering is moving together with the tissue structure through the entire heart cycle. Available only for transthoracic acquisitions.
HD Live	
4D	HD Live is an advanced visualization method that simulates light propagation and scattering through tissue. The end result is rendered images with realistic looking soft shadows.
Bird's View	
4D, 4D Color	4D Acquisition preset displaying a small sector seen from the side.
Back to 4D	
4D, 4D Color	Start 4D scanning by restoring the last used 4D settings.
Elevation tilt (Front/Back)	
4D	Tilts the volume in the elevation plane and change the viewing direction accordingly.
Laser Lines	
4D, 4D Color	Enables the visualization of the 2D image locations in the volume rendering. The 2D image locations are shown as overlaying red or color coded lines following the surface in the volume rendering. The color of the laser lines (white or green) corresponds to the color coding used for the 2D images.
Up/Down	
4D, 4D Color	Flips the volume upside-down. Not available when alignment has been approved.
Parallel Crop	
4D, 4D Color	Crop mode where two parallel crop planes are applied (see page 6-31).

	Crop Tool
4D, 4D Color	When in Freeze, enters the crop mode (see page 6-31).

	Navigation Abs/Rel
4D, 4D Color	<p>Abs: rotation of the volume about the probe axis. The volume rendering can be tilted.</p> <p>Rel: Rotation of the volume about x and y axis. Left/right movement rotates about the y-axis, up/down about the x-axis.</p>

	DDP (Data Dependent Processing)
4D, 4D Color	Performs temporal processing which reduces random noise without affecting the motion of significant tissue structures.

	Cine rotate
4D, 4D Color	In Replay mode, displays the volume rendering of a cardiac cycle that rotates continuously back and forth.

	Smoothness
4D, 4D Color	Affects continuity of structures and image noise in the volume rendering. Too much smoothness will blur the image, too little will leave too much noise.

	Shading
4D, 4D Color	Adjusts the shading effect on the volume rendering. Shading may improve three dimensional perception.

	Gamma
4D	Adjusts the brightness of midtone values. A higher gamma value produces an overall darker image, a lower gamma value a brighter image.

	Tissue Transparency
4D, 4D Color	Adjusts the display transparency of tissue data. An increase of Tissue Transparency may help bring out tissue structures or flow information behind obscuring tissue structures.

	Color Transparency
4D Color	Adjusts the display transparency of color data. An increase of Color Transparency may help bring out relevant color flow information (e.g. jet).

	Biplane prepare
4D	Bi-plane prepare is a 4D scanning mode intended to be used for entering bi-plane from within a 4D acquisition. The trackball is used to position two cut-planes according to structures that are visualized in the volume rendering. Pressing Biplane on the Touch panel enters the biplane acquisition mode, keeping the cut-planes shown in the 4D mode, but with higher resolution and frame rate.

	Depth Mode
4D, 4D Color	In Flexi-Slice mode, affects the position of the reference plane in the volume rendering. <ul style="list-style-type: none"> • Depth Mode on: when clicking in the volume rendering the reference plane is moved inside the volume to the corresponding depth. • Depth Mode off: the reference plane is kept at the current depth.

Multi-plane mode

Multi-plane mode is an option available on Vivid S70N.

Bi-plane mode screen

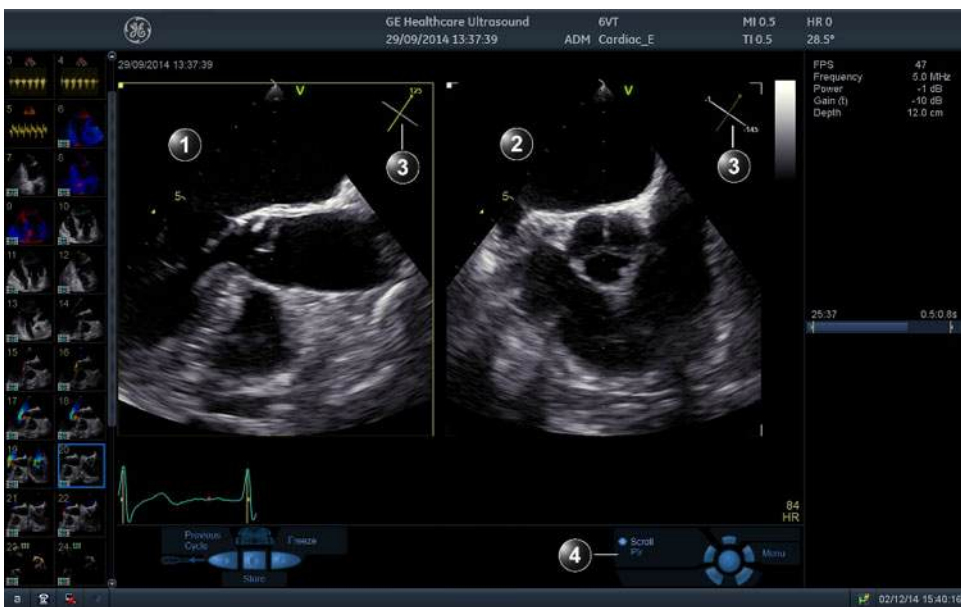

1. Scan plane 1 (yellow): default reference scan plane. This scan plane can be rotated together with scan plane 2, but it cannot be tilted.
2. Scan plane 2 (white): this scan plane is by default perpendicular to scan plane 1 along the scanning axis. This scan plane can be tilted and rotated.
3. Navigator: displays the position of both scan planes as seen from the probe. The rotation angle for scan plane 1 and the rotation and tilt angles for scan plane 2 are indicated in the corresponding view.
4. Trackball functions

Figure 6-22. The Bi-plane imaging mode screen

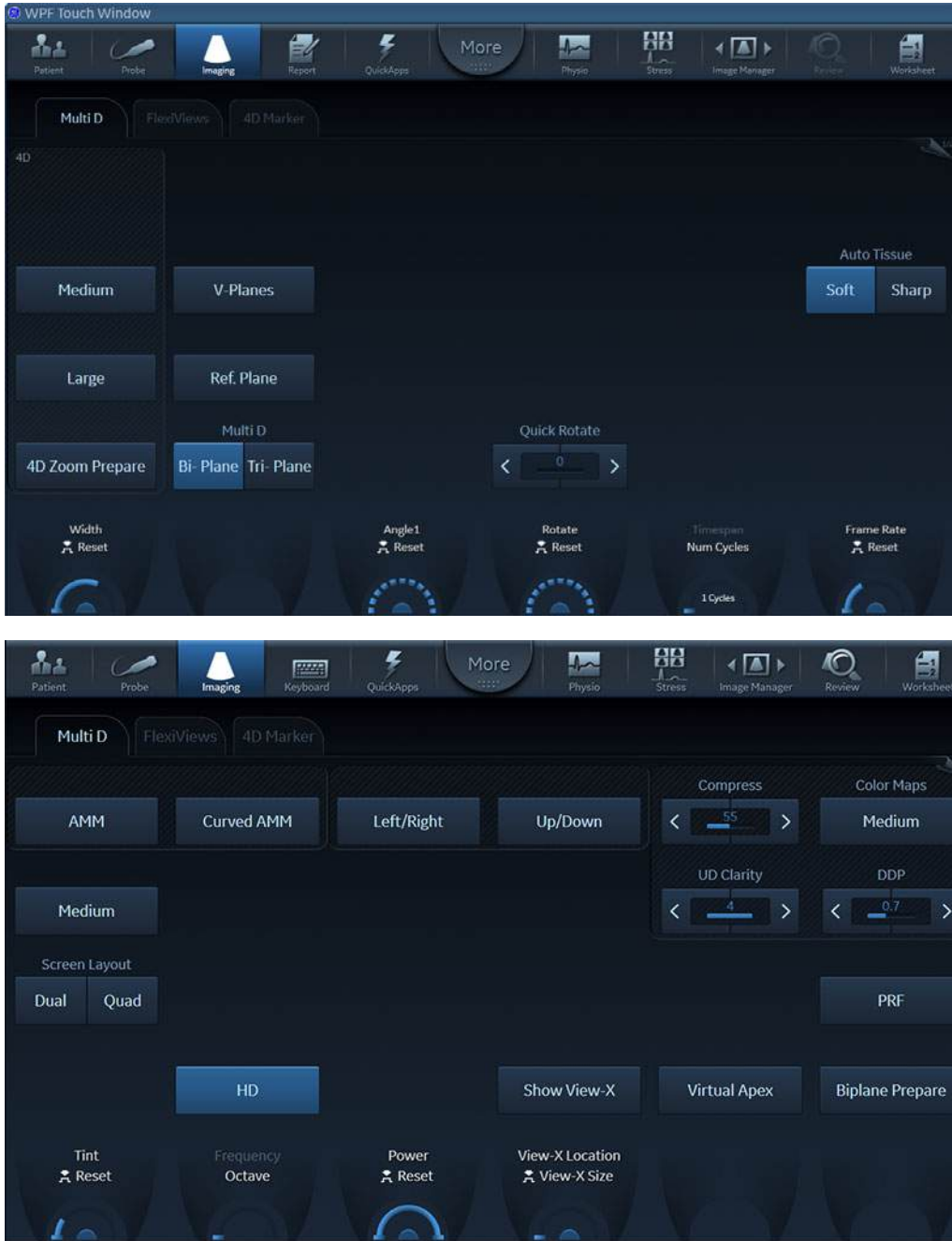
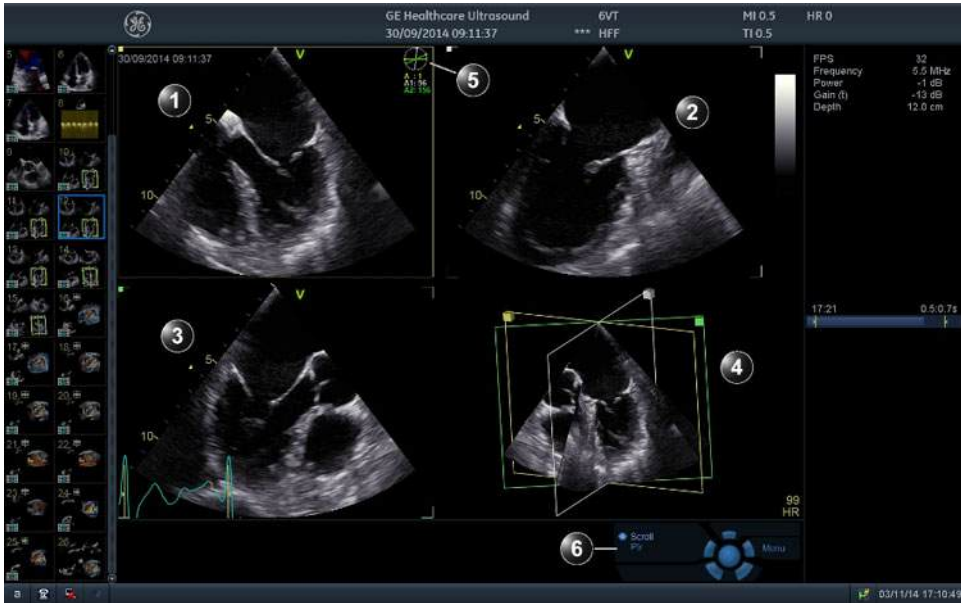

Figure 6-23. The Bi-plane mode Touch panel (page 1 and 2)

Tri-plane mode screen



1. Scan plane 1 (yellow): default reference scan plane. This scan plane can be rotated together with scan planes 1 and 2.
2. Scan plane 2 (white): this scan plane can be rotated separately.
3. Scan plane 3 (green): this scan plane can be rotated separately.
4. Orientation window: displays all the scan planes in a projection.
5. Navigator: displays rotation angle values for the scan planes 1 (A) if rotated, 2 (A1) and 3 (A2).
6. Trackball functions

Figure 6-24. The Tri-plane imaging mode screen

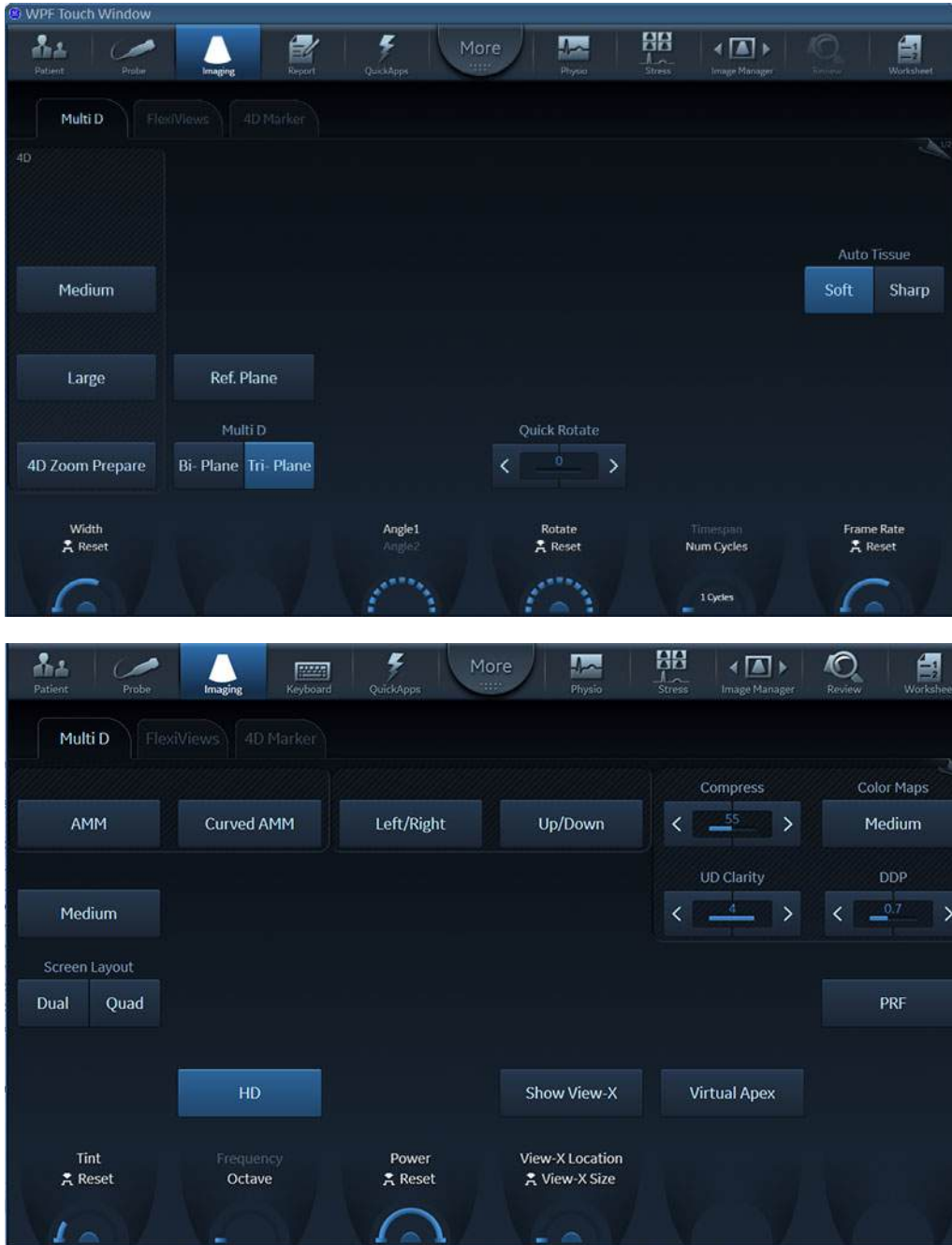

Figure 6-25. The Tri-plane mode Touch panel (page 1 and 2)

Using Multi-plane mode

1. Select a 4D probe and a cardiac application.
2. Press **Multi D** on the Control panel.
The *Bi-plane* screen is displayed.
3. Press **Tri-plane** or **Bi-plane** on the Control panel to activate the corresponding mode.
4. Adjust the angle increment between the scan planes, or the overall rotation (see page 6-48).
5. If in Bi-plane mode, adjust the scan plane 2 tilt angle (see page 6-49).
6. To activate another scanning mode:
 - Press **Color** to activate CF mode.
 - Press **TVI** to activate TVI mode.
 - In TVI mode, press either **TSI**, **Tissue Tracking**, **Strain** or **Strain rate** to activate alternative tissue Doppler modes.

NOTE: To start 4D acquisition, select one of the 4D acquisition presets on the Touch panel (**Medium**, **Large** or **4D Zoom prepare**).

7. Zoom in the structure of interest (see page 6-49).

NOTE: Scan plane rotation or tilting cannot be done when in zoom mode.

8. Press **Store** to save the acquisition.

Bi-plane prepare

Bi-plane prepare is a 4D scanning mode intended to be used for entering Bi-plane from within a 4D acquisition. The trackball is used to position two cut-planes according to structures that are visualized in the volume rendering. Pressing **Bi-plane** on the Touch panel enters the Bi-plane acquisition mode, keeping the cut-planes shown in the 4D mode, but with higher resolution and frame rate.

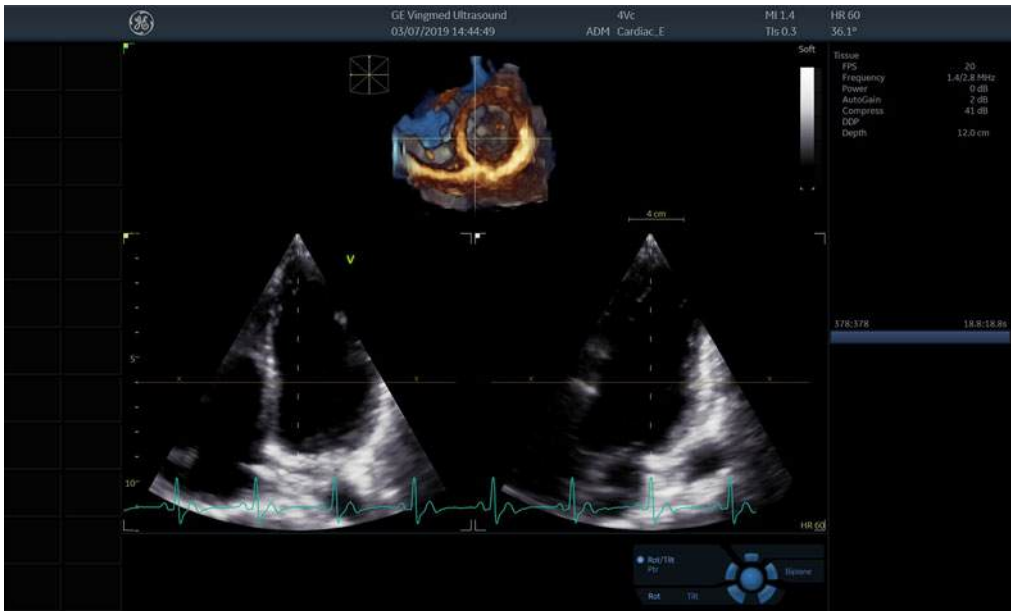

Figure 6-26. The Bi-plane prepare screen

1. In 4D live press **Bi-plane prepare** on the Touch Panel.
The *Bi-plane prepare* screen is displayed showing two perpendicular cut-planes and a smaller volume rendering with Laser-Lines visualizing the position of the cut-planes.
2. Using the trackball, rotate and/or tilt the cut-planes until the cut-planes of interest are displayed.
Alternatively, adjust **Tilt** and **Rotate** rotary controls.
3. Press **Bi-plane** on the Touch panel (or **Multi D** on the Control Panel) to start high resolution and high frame rate bi-plane acquisition.
4. Press **Store** to save the acquisition.

Basic operations

Scan plane rotation

Simultaneous scan plane rotation

Transesophageal acquisition

1. If using the default configuration for the buttons on the 6VT-D probe, use Buttons 1 and 3 to rotate all scan planes simultaneously (see Figure 6-27).

NOTE: To configure the 6VT-D probe buttons, see '6VT-D TEE Probe' on page 12-119.

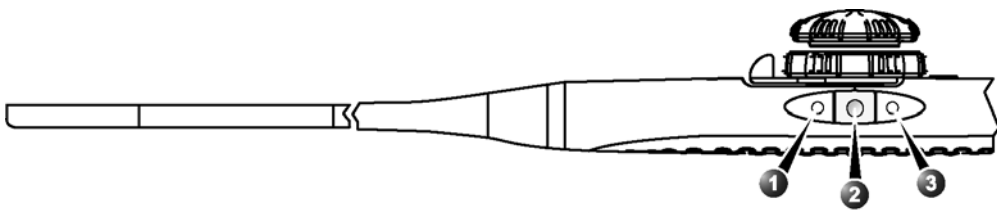

1. Button 1 (closest to the probe tip): counterclockwise scan plane rotation
2. Button 2: Image store
3. Button 3: clockwise scan plane rotation

Figure 6-27. 6VT-D default buttons configuration (Live mode)

Alternatively, adjust the **Rotate** rotary on the Control panel to rotate all scan planes simultaneously.

2. Press **Quick Rotate** on the Touch panel to rotate all scan planes to pre-defined angles.

Single scan plane rotation

Scan plane 2 and 3 can be rotated separately. The rotation is done around the crossing line between the scan planes. Scan plane rotation is not available in zoom mode.

1. Press **Select** until the desired trackball function is selected:
 - **Angle 1**: rotation of scan plane 2 (white)
 - **Angle 2**: rotation of scan plane 3 (green, Tri-plane only)
2. Use the trackball to rotate the corresponding scan plane around the probe center axis.

NOTE: Rotation of scan plane 2 and 3 can also be done using the **Angle 1** and **Angle 2** rotary buttons.

3. In Bi-plane mode only, press **V-planes** to rotate scan plane 2, so that it has the same angle as scan plane 1. The

scan plane 2 can then be tilted using the **Tilt** rotary or the trackball (see below)

4. To reset the scan planes to the original default position, press **Clear**.

Tilting scan plane 2

In Bi-plane mode, the scan plane 2 can be tilted around the top of the scanning sector using the trackball. Tilting is not available in zoom mode.

1. In Bi-plane mode, press **Select** until the trackball function **Pos** is selected.
2. Use the trackball to tilt the scan plane 2.

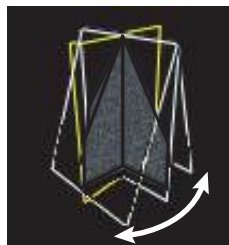

Figure 6-28. Tilting of scan plane 2 (Bi-plane mode)

3. To reset the scan planes to the original default position, press **Clear**.

Zooming

1. Rotate the **Zoom** knob clockwise on the Control panel.
All scan plane images are zoomed in. A *Navigation* window is displayed with a frame highlighting the zoomed area.
The zoomed area can be moved within the sector or resized.
1. In zoom mode, press **Select** to toggle the trackball function to **Pos** and use the trackball to freely move the zoomed area within the scan plane.
2. Press **Select** to toggle the trackball function to **Size** and use the trackball to adjust the size of the zoomed area (2D mode only).

Multi-plane mode controls

Control panel

	Multi D
	Starts/exits Multi-plane mode.

	Zoom
	<p>Activated and adjusted by rotating the Zoom rotary (🔍). An orientation preview showing the outlined magnified area is displayed in the upper right corner of the screen. The position and size of the magnified area are adjusted with the trackball when in B mode.</p> <p>HR zoom concentrates the image processing to a magnified user selectable portion of the image, resulting in an improved image quality in the selected image portion.</p> <p>HR zoom is activated and adjusted by pressing and rotating the Zoom rotary (🔍). An orientation preview showing the outlined magnified area is displayed in the upper right corner of the screen. The position and size of the magnified area are adjusted with the trackball.</p>

	Clear
	Resets all scan planes to the default position.

	Angle
	Toggles the position of scan plane 2 between the default position and a pre-defined angle relatively to scan plane 1.

	Layout
	<ul style="list-style-type: none"> • In Bi-plane mode, toggles the display between the default Bi-plane dual screen and a single screen showing the selected scan plane. • In Tri-plane mode, toggles the display between the default Tri-plane quad screen, a quad screen with enlarged <i>Geometric model</i> and a single screen showing the selected scan plane.

	Trackball
	<p>The trackball has multiple functions. The trackball functions are organized in several functional groups.</p> <p>The function selected is displayed in the lower right corner of the screen.</p> <ul style="list-style-type: none"> • Press Select to toggle between the trackball functions within the active functional group. Groups with several functions are marked with a + symbol. • Press Trackball to toggle between the functional groups. <p>The functions available are:</p> <p>Group 1 (Live):</p> <ul style="list-style-type: none"> • Pos: in Bi-plane, tilts the scan plane 2 (white) around the top of the sector. • Angle 1: adjusts the angle between the scan planes 2 (white) and scan plane 1 (yellow). Scan plane 2 is rotated around the crossing line between the scan planes. Scan plane 1 is fixed. • Angle 2: adjusts the angle between the scan planes 3 (green) and scan plane 1 (yellow). Scan plane 1 is fixed. Available in Tri-plane only. <p>Group 1 (Zoom):</p> <ul style="list-style-type: none"> • Pos: moves the zoom area. • Size: resizes the zoom area. <p>Group 2 (Color/TVI modes):</p> <ul style="list-style-type: none"> • Pos: moves the color sector. In Bi-plane CFM mode, if scan plane 1 (yellow) is selected as reference scan plane, both color sectors are moved. If scan plane 2 (white) is selected as reference scan plane its color sector is moved independently. In Tri-plane CFM mode, all ROI are moved at the same time. • Size: resizes the color ROI. All sectors are resized at the same time. <p>Group 1 (Freeze/Replay):</p> <ul style="list-style-type: none"> • Speed: adjusts cine replay speed. • Scroll: scrolls through a cinelooop (in Freeze).

	4D & MP
	<p>The 4D and MP buttons can be used as arrows '<' and '>' to toggle between the left and right halves of Dual Screen. This works for all probes except 4D - 6VT and 6VT-D.</p>

Touch panel and rotaries

This section describes only the Multi-plane mode controls. See 'Image controls' on *page 5-57* for 2D, Color and TVI modes image controls

	Bi-plane / Tri-plane
	Toggles between Bi-plane and Tri-plane mode.

	Reference Plane
	Toggles the reference plane between the scan planes. The reference plane may also be selected using the trackball when the Pointer trackball tool selected.

	V-Planes
	In Bi-plane mode, rotates scan plane 2, so that it has the same angle as scan plane 1. The scan plane 2 can then be tilted.
	Quick Rotate
	Rotates all scan planes to pre-defined angles.
	Angle 1 / Angle 2
	<ul style="list-style-type: none"> • Angle 1: adjusts the angle between the scan planes 2 (white) and scan plane 1 (yellow). Scan plane 2 is rotated around the crossing line between the scan planes. • Angle 2: adjusts the angle between the scan planes 3 (green) and scan plane 1 (yellow). Scan plane 3 is rotated around the crossing line between the scan planes. <p>These controls are identical to the Trackball controls Angle 1 and Angle 2.</p>
	Rotate
	Rotates all scan planes around the crossing line between the scan planes.
	Bird's View / Medium / Large
	Starts 4D Acquisition: sets the volume size for the 4D acquisition (see page 6-5).
	4D Zoom prepare
	Enables 4D Zoom prepare acquisition displaying a biplane screen with an adjustable zoom ROI in the azimuth and elevation planes. After adjustment of the ROI, press 4D to acquire 4D data for the defined ROI (see page 6-11).
	Right Invert
	In Transesophageal Bi-plane mode Live only: mirrors the image on the right hand side.

FlexiViews

FlexiViews provides a quick access to standard or user-defined views when scanning with 4D TEE probes. This feature stores image geometry and a selected number of scanning parameters, such as 4D Gain and Multibeat.

Vivid S70N with 4D option come with a set of factory defined views. Users can create their own defined views as needed.

Storing FlexiViews while in zoom is limited to 4D modes and 4D Zoom Prepare.

FlexiViews can be managed on the fly according to Figure 6-29.

Press the *FlexiViews* tab and select any of the available FlexiViews. The name of the view is displayed in the button together with the scanning mode for that view. Factory default FlexiViews are identified with a "GE" mark on the top right corner of the button.



- **Replace:** To replace an existing factory FlexiView. It is only possible to replace a FlexiView with a new setting working in the same scanning mode as predefined.
- **New:** To create a new user defined FlexiView. Press **New** and name the new FlexiView as desired.
- **Reset To Factory:** To reset a modified FlexiView to its predetermined factory settings. Press **Reset To Factory** and select the FlexiView that you want to restore to factory settings.
- **Reset All:** To restore all FlexiViews to the factory default values.
- **Configure:** To configure the order and visibility of the FlexiViews.
- **Delete:** To delete a user defined FlexiView. Press **Delete** and select the FlexiView to be deleted.
- **Lock:** To keep the FlexiViews tab open after selecting one of the available FlexiViews. If the Lock button is set to **OFF**, the Touch panel will return to the active imaging mode tab after selecting a FlexiView.

Figure 6-29. The FlexiViews tab



Displayed images may not accurately reflect the user-defined name of the selected FlexiView.

The **Configure** button opens the configuration screen which allows showing/hiding FlexiViews, and sorting the Enabled FlexiViews as described in Figure 6-30.

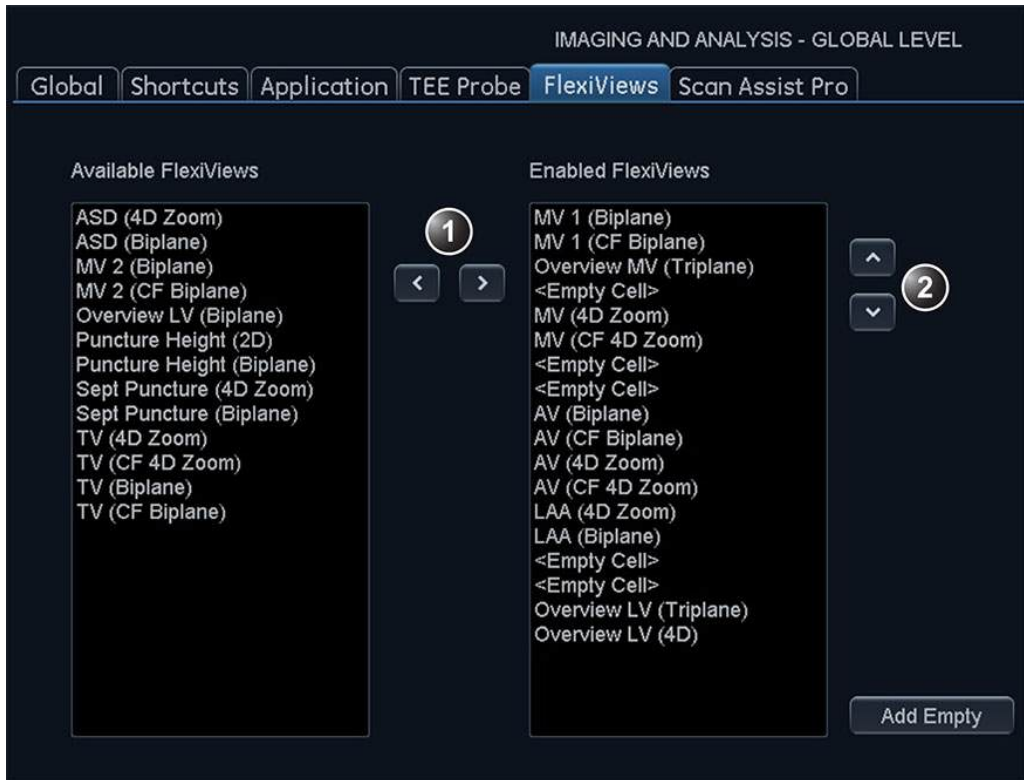

1. Use the arrows to move FlexiViews from *Available FlexiViews* to *Enabled FlexiViews*. The FlexiViews in the *Enabled FlexiViews* will be visible under the *FlexiViews* tab.
2. The arrows allow ordering the enabled FlexiViews according to user preferences. The *Enabled FlexiViews* are divided in columns of 4 elements each. Empty cells may be added to customize the layout of the buttons within the *FlexiViews* tab.

Figure 6-30. FlexiViews configuration

Chapter 7

Stress Echo

The ultrasound system provides an integrated stress echo package, with the ability to perform image acquisition, review, image optimization, and wall segment scoring and reporting for a complete, efficient stress echo examination.

'Selection of a stress test protocol template' on page 7-3

'Image acquisition' on page 7-4

'Stress Echo analysis' on page 7-16

'Quantitative TVI Stress echo analysis' on page 7-20

'Editing/creating a Stress Echo protocol template' on page 7-26

Introduction

The ultrasound system provides an integrated stress echo package, with the ability to perform image acquisition, review, image optimization, and wall segment scoring and reporting for a complete, efficient stress echo examination.

The stress package provides protocol templates for exercise, as well as pharmacological stress examinations. In addition to preset factory protocol templates, templates can be created or modified to suit users' needs. Users can define various quad screen review groups, in any order and combination, that will suit their normal review protocol. When reviewing stress examination images, the images are viewed at their original image quality, and different post-processing and zoom factors may be applied to the images under review for effective image optimization. The protocol template may be configured for Continuous capture. In addition to standard wall motion scoring analysis, the user can perform quantitative stress analysis based on tissue velocity information (TVI), see page 7-20.

A stress echo examination consists of three steps:

- Selection of a stress test protocol template (page 7-3)
- Image acquisition (page 7-4)
- Stress analysis (page 7-16)

Selection of a stress test protocol template

1. Press **Stress** on the Touch panel.
The *Protocol* screen is displayed (see Figure 7-1) showing the default stress protocol for the current probe and application.
2. Turn freeze off to initiate scanning using the current template.

To use another template, press **Template** and select the desired template from the template list. Turn freeze off to initiate scanning.

NOTE: To create or edit a template see page 7-26.

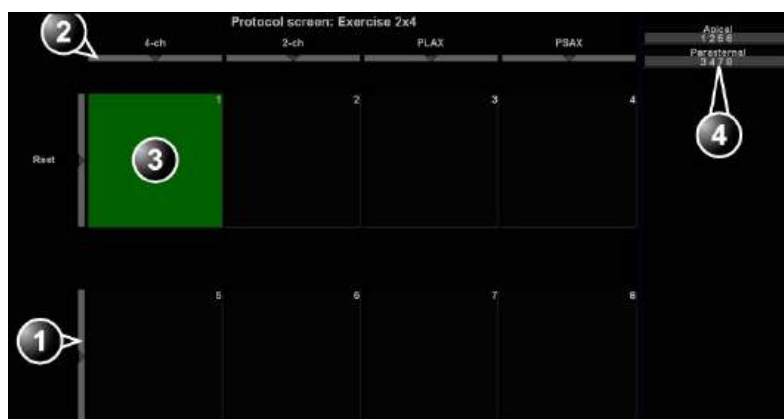

1. Level selection
2. Projection selection
3. Current acquisition
4. Group of views

Figure 7-1. The Protocol screen

Image acquisition

Images are acquired in a pre-defined order, according to the selected template. The highlighted cell (green) of the matrix, displayed in the *Clipboard* window indicates which view is currently being acquired (see Figure 7-2). The names of both the view and the level for the current cell is displayed on the top corner of the image area and under the template matrix.

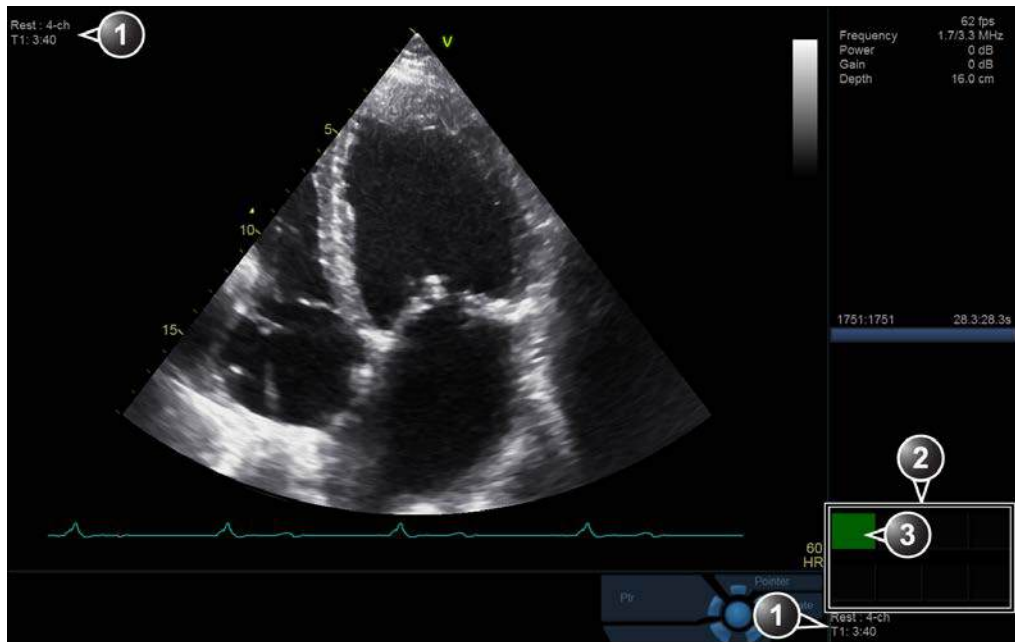

1. Current view, level and timers
2. Template matrix view and level
3. Current view (Green cell)

Figure 7-2. The stress mode acquisition screen

Starting acquisition

1. Turn **Freeze** off to initiate scanning.

NOTE: To use the *Timer*, see page 7-8.

2. Perform a scan that conforms with the view that is highlighted in the template matrix on the *Clipboard* window. If the selected template has the option **Smart Stress** turned on (see page 7-28), a subset of the image acquisition settings for each view in the baseline level will be stored and automatically reused in the corresponding views in the next levels.

NOTE: *Smart Stress* is turned on by default in factory templates.

3. Press **Store**.
 - If the actual stress level is configured to preview cineloop before storing, use the cineloop controls to select the most appropriate heart cycle and, if desired adjust the loop markers (see 'Cineloop' on page 4-9 for further information). Press **Store** to save the selected cineloop.
 - If the actual stress level is not configured to preview cineloop before storing, the system will automatically store the last cardiac cycle.

NOTE: For further information on stress test configuration, see page 7-26.

When storage of the cineloop is completed, the actual highlighted cell in the template matrix is filled with dark blue color indicating that the view has been acquired. After storing the loop, the system automatically highlights the next view in the matrix to be acquired.

Stress levels can be configured for side-by-side display/ comparison of the reference loop from baseline or previous level and the loop to acquire (see Figure 7-3).

4. Repeat previous steps until all required views are completed.



CAUTION

If using DICOM Server dataflow for stress-echo acquisition, images should not be saved to permanent archive before the complete protocol exam is acquired.

The template used can be configured so that analysis is automatically started, displaying the first protocol group. The wall segment scoring diagrams for each view is displayed in the

Parameters window on the right side of the screen (see Figure 7-8 on page 7-18).

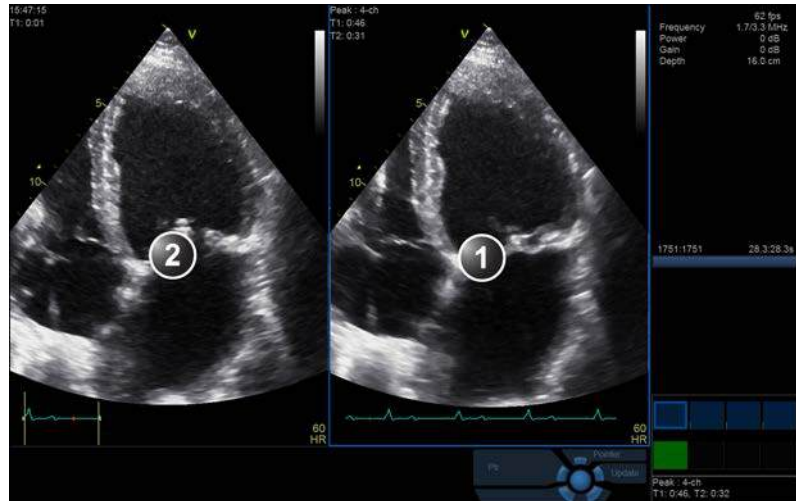

1. Current acquisition loop
2. Corresponding reference loop

Figure 7-3. Display of the Reference loop during acquisition

Protocol Pause function

During the stress acquisition it is possible to temporarily exit the protocol acquisition mode to acquire images in any mode outside the stress protocol.

1. To temporarily exit the protocol mode, press **Protocol Pause** on the Touch panel.
2. Acquire the desired images outside the protocol.
3. Press **Protocol Pause** to restart the protocol acquisition mode and resume the stress acquisition.

Selecting a view during acquisition

A fixed protocol is provided for scanning, based on the selected template. The system automatically highlights the next view to be acquired in the template matrix, as images are stored. However, the order of scanning may be changed manually as follows.

Manual selection of a view during acquisition

1. Use the arrow keys on the alphanumeric keyboard to highlight the cell that represents the view that is to be acquired.

The selected cell in the template matrix is highlighted in red, indicating non-default position and is blinking if it contains a previously stored acquisition.

2. Scan and save the selected loop as explained in the previous section.

After storage the system automatically highlights the next available view to be acquired.

Replacing an acquired image

1. Use the arrow keys on the alphanumeric keyboard to highlight the cell that represents the view that is to be replaced.

The selected cell in the template matrix is blinking red, indicating non-default position.

2. Scan and save the selected loop as explained in the previous section.

3. Select in the dialog window if you want to **Replace** or **Keep** the existing loop.

- **Replace:** the original image is deleted from the examination and replaced by the acquired image.
- **Keep:** the original image is replaced by the acquired image, but it is not deleted from the examination.

NOTE:

When selecting Keep, both the new and the old image will be associated with the current protocol cell and you may later perform Wall Motion Scoring for this level in the protocol using either the new or the old image. The new image may be opened from the protocol, while the old image may be opened manually from the clipboard.

After storage the system automatically highlights the next available view to be acquired.

Moving an acquired image

An Image can be moved from one cell to another during acquisition. There are two ways to move images.

Procedure 1

1. In the *Protocol* screen, press **Move image**.
2. Trackball to the image to move (source cell).
3. Press **Select**.
4. Trackball to the destination cell.
5. Press **Select**.

The image is moved from the source cell to the destination cell.

Procedure 2

1. In the *Protocol* screen, trackball to the cell containing the image to move (source cell).
2. Press and hold down **Select**.
3. With the **Select** key still depressed, trackball to the destination cell.
4. Release the **Select** key.

The image is moved from the source cell to the destination cell.

If the destination cell contains an image, the images from the source and destination cells will be exchanged when moving an acquired image.

Timers

Two timers can be displayed in the *Stress mode acquisition* screen, beside the template matrix.

- **T1** displays the elapsed time from the start of the stress examination.
- **T2** starts when entering live scanning on the second stress level

Press Protocol T2 on the Touch panel to stop/start the T2 timer. Timers restart always at zero.

The display of T1 and T2 is user-configurable (see page 7-26).

Continuous capture mode

Continuous capture mode enables the user to perform acquisition continuously for several views at any level depending on the selected template configuration. Continuous capture consists of temporarily saving images acquired in a storage buffer. To enable best possible use of the limited storage buffer capacity, a Pause/Capture mode is provided, as opposed to the normal Freeze/Scan mode. The Pause mode enables scanning and live display on the screen, without any capture, thereby leaving the buffer available.

To run Continuous capture, the user has to select a template where this feature is activated (see page 7-26 about template configuration).

The buffer bar

When entering a cell with Continuous capture enabled, a *Buffer bar* is displayed in the *Info* window (Figure 7-4). The *Buffer bar* displays the following information:

- The scanning state:
 - **PAUSE**: live scanning without storing
 - **CAPTURE**: live scanning with storing to buffer
- The percentage of the buffer that is filled
- The buffer filling progression showed by a filling gauge

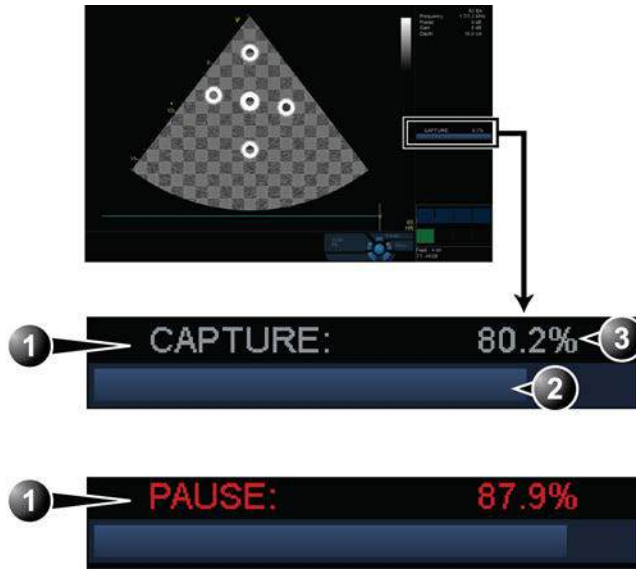

1. Scanning state
2. Buffer gauge
3. Percentage of filled buffer

Figure 7-4. The buffer bar in Continuous capture

Controlling the capture process

When entering a cell with Continuous capture enabled, the system is automatically set in Pause mode.

1. Press **Store** or **2D Freeze** to start image capture.
“Capture” is displayed in the buffer bar, the gauge starts filling and the percentage of filled memory buffer increases (Figure 7-4).
2. Press **Image Store** or **2D Freeze** again to stop capture.
“Pause” is displayed in the buffer bar.

When 90% of the memory buffer is filled up, the text display in the buffer bar turns red.

The system enters Freeze mode automatically once the buffer is full. The captured recording is stored on disk and the captured loops are displayed in the *Continuous capture selection* screen (see below).

Running Continuous capture

1. Do all your pre-stress acquisitions in the Cardiac application.
2. Press **Stress** on the Touch panel to enter the stress echo mode.
The *Protocol* screen is displayed (Figure 7-1 on page 7-3).
3. Press **Template**.
The template list is displayed.
4. Select the template **Exercise 2x4**.
5. Press **Begin/Cont**.
6. Acquire the resting loops in all four views.
7. Once the fourth loop is acquired the system enter into a waiting mode where Continuous Capture is in pause state awaiting the patient to exercise.
8. When the patient is back on the bed, press **Store** or **2D Freeze**. The Continuous capture acquisition is started.
9. Acquire all your views. You may pause the acquisition when moving the probe between parasternal and apical position.
The memory buffer gauge increases (Figure 7-4). When memory filling exceeds 90%, the percent number turns red.
10. Press **Freeze** to finish.
11. Press **Select Cycles**.
The *Continuous capture selection* screen is displayed (see Figure 7-5 on page 7-14).
If the buffer is filled up the system will automatically display the *Continuous capture selection* screen.
Refer to the next section if additional image acquisition is necessary after the buffer is filled up.
12. Assign the cineloops to the four views (see page 7-13).
The continuous capture acquisition was stored on disk before the *Continuous capture selection* screen was displayed. At end exam, a dialogue is displayed asking whether this file should be kept or not. To avoid unnecessary data storage, it is recommended to delete this file at end exam when the cycles have been selected and stored.
13. Press **Done** if you are finished selecting or want to do the selection later.
OR
Press **Select later** if you want to return to the scanning screen. If there are more rows in the protocol template, the

active cell will move to the next row. To later select loops from the Continuous Capture, enter Protocol screen and click on the Continuous capture thumbnail in the lower left corner.

OR

Press **New capture** to start a new Continuous capture acquisition at this stress level.

14. While on a row with Continuous Capture, press **Next Level** to store the data acquired during Continuous Capture and progress to the next row (this will exit the Protocol if Continuous Capture was on the final row).
15. Perform Analysis and scoring (see page 7-16).

Continuous capture with additional image acquisition

After acquiring Continuous capture, additional images can be stored to the clipboard before the patient's heart rate decreases toward recovery level. These additional images may be acquired with other scanning modes (using the same probe and application), before doing image assignment to the views. The following procedure applies if the Continuous Capture is on the final row:

1. Perform Continuous capture as described above (steps 1 to 10).
2. If the buffer is not filled up: press **Finish Level** on the control panel. The Continuous Capture recording is stored for later selection and live scanning is activated outside the stress protocol.
If the buffer is filled up: press **Select later**. Scanning is activated outside the stress protocol.
3. Perform the additional acquisition (e.g. Color flow, Doppler). Images will be stored outside the protocol.
4. In order to resume the stress echo exam and assign loops for the views from the Continuous capture buffer, press **Protocol**.
5. Select the **Continuous capture** thumbnail on the lower left corner of the *Protocol* screen.
The *Continuous capture selection* screen is displayed.
6. Assign the cineloops to the views (see page 7-13).
7. Press **Done** when you are finished selecting.
8. Perform Analysis and scoring (see page 7-16).

Postponed image assignment

The assignment of the cineloops to the views can be done on a later stage on a stored Continuous capture acquisition.

1. Perform Continuous capture as described in 'Running Continuous capture' on page 7-11 (steps 1 to 11).
2. When entering *Continuous capture selection* screen (step 11), the continuous capture acquisition is stored on disk before the *Continuous capture selection* screen is displayed. At end exam, a dialogue is displayed asking whether this file should be kept or not. To avoid unnecessary data storage, it is recommended to delete this file at end exam when the cycles have been selected and stored.
3. Re-open the examination if necessary.
4. Press **Protocol**.
The *Protocol* screen is displayed.
5. Press on the **Continuous capture** thumbnail on the lower left corner of the *Protocol* screen.
The *Continuous capture selection* screen is displayed.
6. Assign the cineloops to the views (see page 7-13).
7. Press **Done** when finished.
8. Perform Analysis and scoring (see page 7-16).
9. When exiting this patient a dialogue window is displayed asking whether the remaining continuous capture images should be deleted.
 - Press **Yes** to delete the remaining continuous capture images
OR
 - Press **No** to keep the entire continuous capture acquisition.

The normal procedure is to delete the remaining images as they take a lot of disk space.

New capture from the Continuous capture selection screen

1. Press **New Capture**.
The scanning screen is activated.
2. Press **Freeze** to start live acquisition.
3. Press **Store** to start capture.

Assigning and storing the loops

The cineloops captured in the buffer are assigned to the stress protocol views and stored from the *Continuous capture selection* screen (see Figure 7-5).

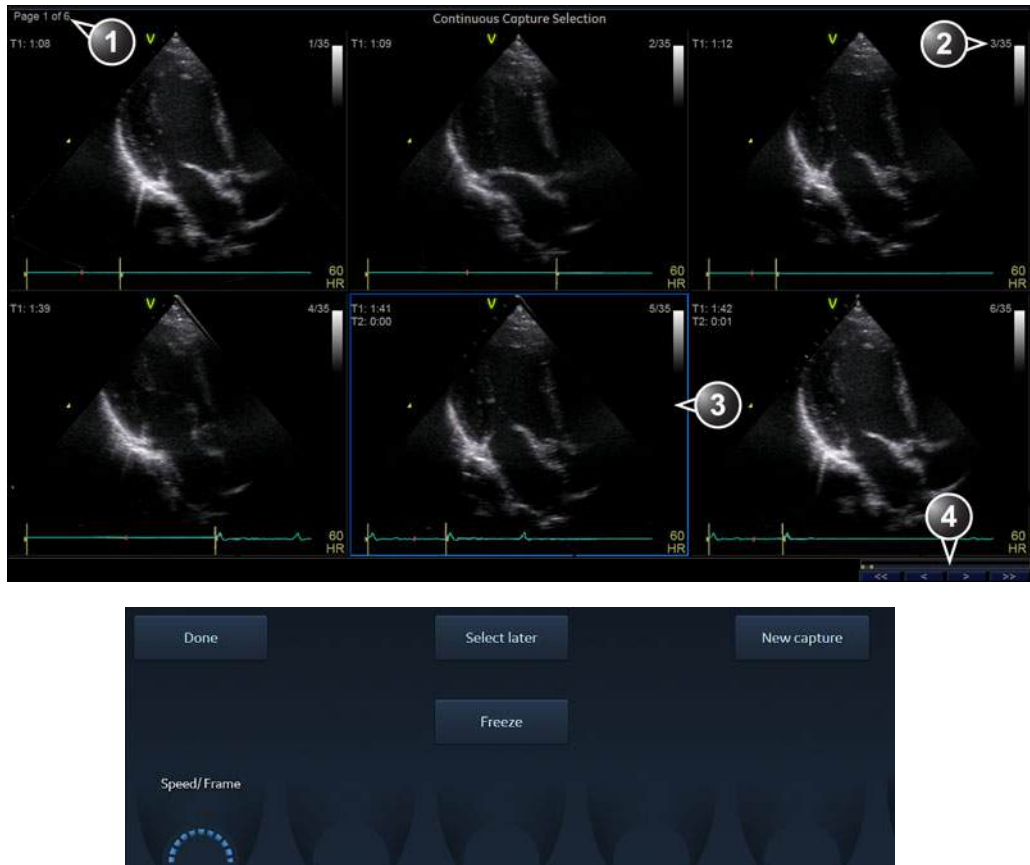

1. Rotate Review Page to display other pages.
2. Cycle number and total number of cycles
3. Highlighted loop
4. Buffer bar: to browse through the acquisition, select an area in the buffer bar to display the corresponding page or select the first, last, previous or next page buttons.

Figure 7-5. The Continuous capture selection screen

Assigning a cineloop to a view

1. Trackball to the desired loop in order to assign it to a particular view of the stress template.
The frame of the loop is highlighted.
2. Press **Select**.
A pop-up menu is displayed with the view names of the template (see Figure 7-6).
3. Trackball to the required view name.
4. Press **Select**.
The name of the view is displayed above the timers in the loop window.
5. Repeat steps 1 through 4 to assign loops to the other views of the level.
6. Press **Done** when completed.

NOTE: *The continuous capture acquisition was stored on disk before the Continuous capture screen was displayed. At end exam, a dialogue is displayed asking whether this file should be kept or not. To avoid unnecessary data storage, it is recommended to delete this file at end exam if the cycles have been selected and stored.*

1. Assigned loop
2. Highlighted loop
3. Already assigned view
4. Highlighted views

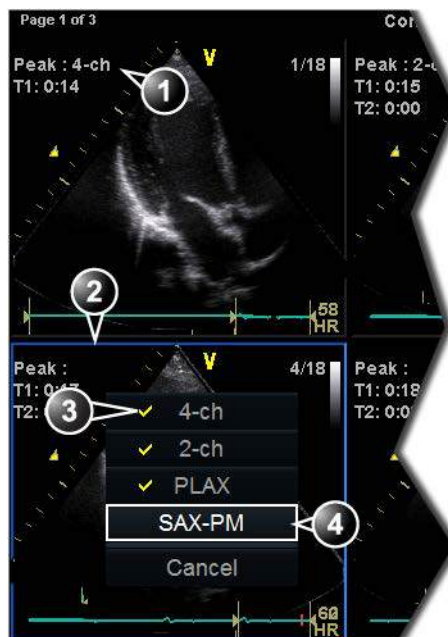

Figure 7-6. Loop assignment in Continuous capture

Stress Echo analysis

Stress Echo analysis consists of viewing previously saved loops and assigning scores to each cardiac segment, in order to quantify the function of the muscle, or wall motion.

Depending on the protocol configuration, the analysis stage can be started automatically after completion of the stress test or it can be started manually. In this case, the usual procedure consists of sequentially opening all image groups (if defined) and perform scoring from image to image.

The quad screen is the standard display for comparing heart cycles (Figure 7-8). The heart cycle loops in the display are synchronized to enable comparison. Each loop in the quad screen can be magnified, using the zoom control.

Image selection for analysis

Images can be selected manually or from a pre-defined group in the *Protocol* screen.

Selection of images from a group

If groups of images have been defined in the protocol template (page 7-29), the user can select a group of images for analysis and sequentially analyze all images from all groups from within the *Analysis* screen (Figure 7-8 on page 7-18).

1. In a stress examination, press **Protocol**.
A preview of the acquisitions is displayed.
2. Trackball to a group in the *Group list*.
The frame of the images belonging to the group are highlighted.

NOTE: Pressing **Analyze** (while no images are selected in *Protocol* screen) will automatically open the first group of images in *Analyze* screen.

3. Press **Select** to open images in the *Analyze* screen (see page 7-18).

1. **Select a Projection**
2. Select an image
3. Select and open an Image group

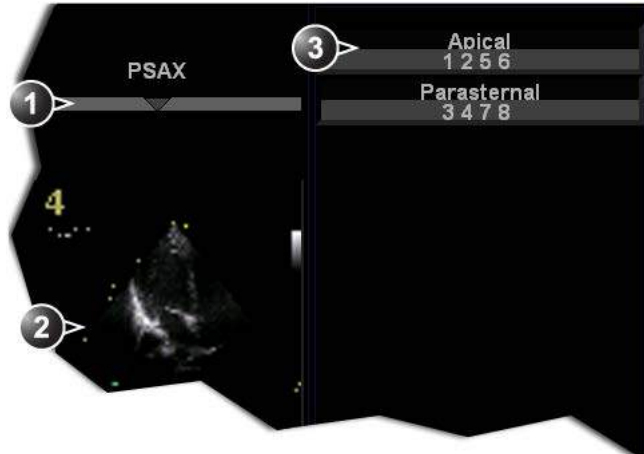

Figure 7-7. Image selection from the Protocol screen

Manual selection of images in the Analysis screen

1. When currently in protocol analysis in the *Stress analysis* screen (Figure 7-8), hold down **Shift** while selecting the images from the stress template matrix in the lower right corner of the screen.

Manual selection of images in the Protocol screen

1. In a stress examination, press **Protocol**.
A preview of the acquisitions is displayed.
2. Trackball to the first image to select.
3. Press **Select**.
The frame of the selected loop is highlighted.
4. Repeat steps 2 and 3 to select other images.
5. Press **Analyze** to open images in the *Analyze* screen (see page 7-18).

NOTE: *Alternative: Double click on the last selected image to open images.*

Wall motion scoring

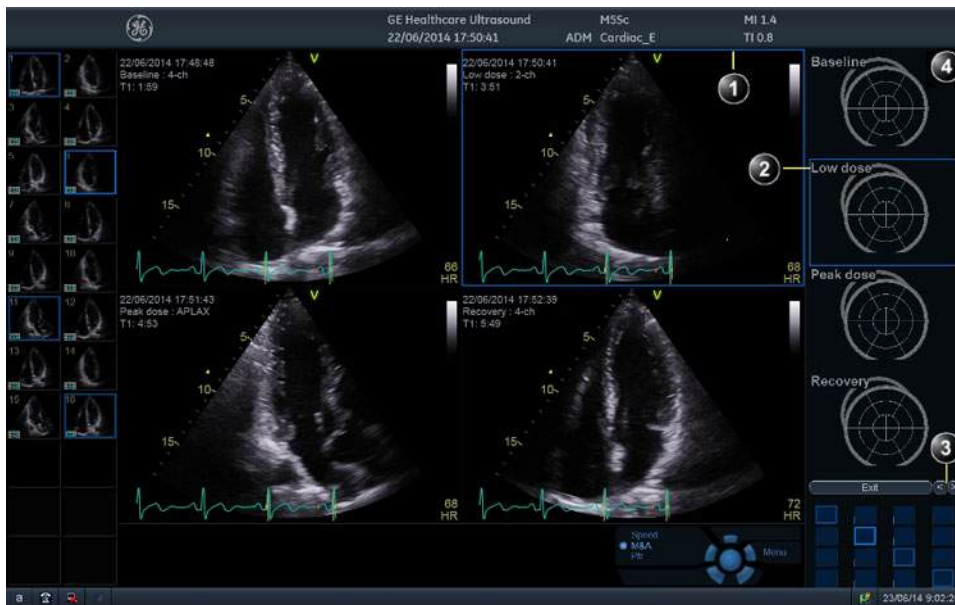

1. Selected loop (highlighted frame)
2. Highlighted segment name (see pointer)
3. Change page or enter next image group
4. Display Bull's eye diagram

Figure 7-8. The stress echo analysis screen

Wall motion scoring is used to evaluate wall motion in each cardiac segment. The left ventricle myocardium is divided into a number of segments (e.g. 16 or 18), and each segment is assigned a score based on visual evaluation/"eye-balling". The wall motion scoring results are linked to the stress level of the image being evaluated. This means that for instance when scoring a short axis projection and a long axis projection from the same stress level, then common segments with the same scoring value will be shown in the respective scoring diagrams.



CAUTION

The wall motion scoring result is assigned to the stress level of the image, but will not be updated if the image is moved to another stress level in the protocol at a later time. Images should be correctly placed in the protocol when performing wall motion scoring.

NOTE: *The number of segments (WMS segment model), the range of scoring values (WMS scoring legend) and the initial scoring*

value (WMS initial scoring) may be configured in Config/Meas Text/Advanced under the Cardiac M&A category.

1. In the *Stress Echo Analysis* screen, trackball to a segment in one of the scoring diagrams and press **Select**.
The *Score pop-up list* is displayed (see Figure 7-9).
2. Trackball to a score.
3. Press **Select**.
The score is displayed in the relevant segment area in the diagram (see Figure 7-9).
4. Repeat steps 1 through 3 to score relevant segments.
5. Rotate **Review page** to display next group of images.
6. Repeat steps 1 through 3 to score relevant segments on the new loops.

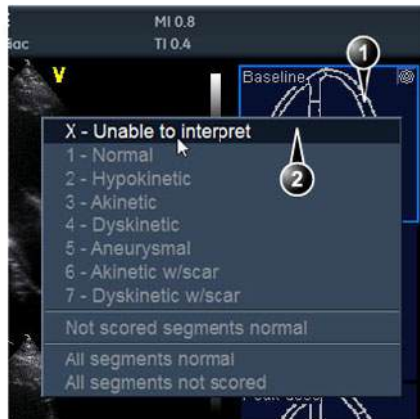

1. Selected segment
2. Selected score

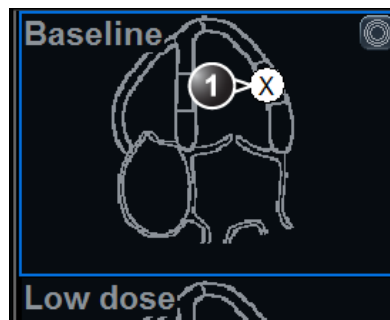

1. Scored segment

Figure 7-9. Segment scoring

Quantitative TVI Stress echo analysis



QTVI Stress analysis is meant as a guide to wall motion scoring.

Diagnosis must not be based on results achieved by QTVI Stress analysis only.

The ultrasound system provides a Quantitative TVI (QTVI) Stress analysis package based on Tissue velocity information (TVI). The TVI data is stored in a combined format with grey scale imaging during stress examination.

When selecting a template supporting TVI data acquisition, the ultrasound system will automatically store TVI information, generally for the apical views of the stress examination.

The QTVI Stress analysis option currently applies only to Dobutamine stress-echo.

Wall Motion Scoring remains the basis for the diagnosis of CAD in stress echocardiography. QTVI Stress may be used as a guidance tool to check this interpretation.

The current version of QTVI Stress is based on the assessment of peak velocity at peak Dobutamine stress (see reference 1 on page 7-25). The normal ranges have been validated in the “average” patient presenting for stress testing. The velocity cutoff values for the V_{peak} measurement will not work in the following cases:

- Submaximal stress (<85% predicted max HR)
- Patients at extremes of age (<40 or >70)
- Previous myocardial infarction / revascularization
- Previous heart-failure / cardiomyopathy / hypertrophy / arrhythmia / aortic regurgitation

The velocity cutoff values are based on placing the sample volume at center of each cardiac segment at start of systole, the left ventricle myocardial segments are defined by the American

Society of Echocardiography 16 segments model. However, the velocity cutoff model does not cover the apical segments (due to low velocities and segment orientation), (see note).

NOTE: *Velocity measurements in mid and basal segments of the myocardium will contain contributions from the apical region of the myocardium. E.g. if measured value in a mid segment is below the cutoff value for this segment then this might relate to a reduced function in the mid or apical region.*

Tissue Doppler does not have perfect site-specificity because of tethering by adjacent segments. Thus, although an ischemic segment has little thickening (and therefore could be expected to show low velocity), measured velocity may be influenced by local tethering, reflecting contraction in surrounding segments. Conversely, a normal segment may have its velocity reduced by an adjacent segment with reduced velocity. This tethering effect may decrease the sensitivity for single vessel disease, but nonetheless the sensitivity and specificity of the cut-offs are approximately 80% (see reference 1 on page 7-25).

Three different analysis tools based on TVI data are available:

- **‘Vpeak measurement’ on page 7-22**, enables the display of a tissue velocity trace for a selected region of a previously scored segment through the entire heart cycle. In addition Vpeak is color-coded on the 2D image. From the velocity trace, the user can estimate the peak systolic velocity (see reference 1 on page 7-25).

This tool is available in views from peak levels only and only when a segment has been scored in one of these views.

- **‘Tissue Tracking’ on page 7-25**, enables visualization of the systolic contraction of the heart by color-coding the myocardial displacement through the systole.
- **‘Quantitative analysis’ on page 7-25**, enables further quantitative analysis based on multiple tissue velocity traces.

The quantitative analysis is described in Chapter ‘Quantitative Analysis’ on page 9-1.

Accessing QTVI Stress analysis tools

The three QTVI Stress analysis tools are entered by pressing a dedicated button on the scoring diagram (Figure 7-10) of the selected view. Only views with TVI data acquired will display QTVI Stress tools buttons on the respective diagrams.

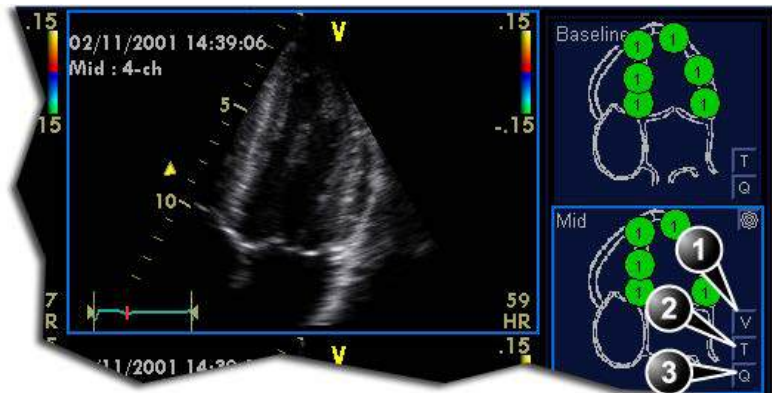

1. Vpeak measurement (V-peak measurement is displayed in views from peak levels and only after scoring.)
2. Tissue Tracking
3. Quantitative analysis

Figure 7-10. QTVI Stress tools buttons

Vpeak measurement

This tool enables the user to generate a tissue velocity profile for a given wall segment through the entire heart cycle and display color-coded Vpeak in tissue.

From the velocity trace, the user can determine whether the systolic Vpeak is over or under a clinically determined velocity threshold (see reference 1 on page 7-25) to confirm the wall motion scoring.



QTVI Stress can be used only in conjunction with wall motion scoring analysis, as a guiding tool.

When activating QTVI Stress, the measurement applies only to the currently highlighted segment for the current level and projection view.

To display a Vpeak measurement

1. Perform segment scoring as described on page 7-18.
When performing scoring in a view from a peak level, the Vpeak measurement button (**V**) is displayed in the corresponding diagram.
2. In the *Scoring* diagram, press **V**.
The cursor is changed to sampling area and the scored peak views are updated showing:
 - A diagram with the current segment highlighted (scoring bullet with a ring) and the segment's velocity cutoff (Figure 7-11).
 - Color-coded velocity in tissue. The color-coding convention is as follow:
 - **Green**: Velocities above threshold value + 5%
 - **Yellow**: Velocities near threshold (+/- 5% interval)
 - **White**: Velocities below threshold value - 5%
 - A result window to display tissue velocity profile, shown when moving the sampling area in the view.
3. In the 2D sector, place the sampling point over the wall area corresponding to the current segment (shown as the highlighted segment in the diagram).
A tissue velocity profile for the actual segment is generated in the *Result* window (Figure 7-11).
4. Use **Segment Select** to analyze the other segments in the peak view,

Or
Select another scoring bullet in the diagram in one of the peak views.

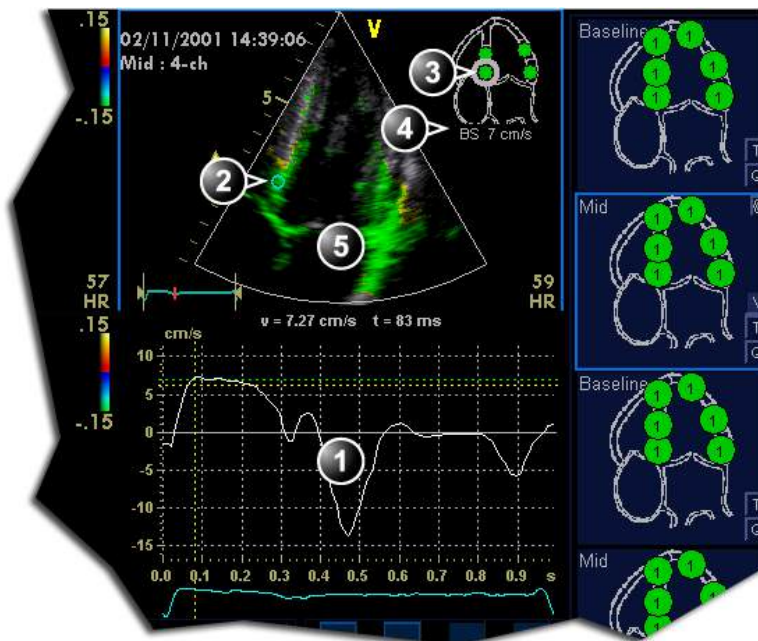

1. Tissue velocity profile
2. Sampling point
3. Current segment
4. Vpeak threshold for current segment
5. Color-coded tissue velocity:

Color-coding (velocity thresholds and tissue):

- **Green:** velocities above threshold value
- **Yellow:** velocities near threshold (0 to -10% interval)
- **White:** velocities below threshold value - 10%

Figure 7-11. Vpeak QTVI Stress display

Turn-off the Vpeak measurement tool

1. Select the **V** button in the peak view scoring diagrams.

V-peak measurement interpretation

The systolic Vpeak in the tissue velocity profile is automatically detected and highlighted by a vertical bar (Figure 7-11). The automatically detected Vpeak should be visually verified by the user. In addition Vpeak thresholds are displayed as color-coded horizontal lines (Figure 7-11). These thresholds represent statistical guideline values for peak velocity at peak stress level (Dobutamine stress procedure) for the three apical views. Only threshold values for basal and mid-segments for each apical view are defined (see reference 1 on page 7-25). The result is highlighted by a color-coding of the thresholds lines, the

color-coding in the 2D image and the scoring bullet (Figure 7-11).

Tissue Tracking

Tissue Tracking calculates and color-codes the displacement in tissue over a given time interval. The displacement is found as the time integral (sum) of the tissue velocities during the given time interval. The color-coded displacements calculated in the myocardium are displayed as color overlay in the respective acquisition window.

By studying the color patterns generated in the different segments, the user can confirm the standard segmental wall motion scoring at peak levels.

To display Tissue Tracking

1. Press **T** in one of the *Wall segment diagram* field (usually an apical view at peak level).
The Tissue Tracking color overlay is displayed in the *Acquisition* window.

Quantitative analysis

Quantitative analysis enables further analysis based on multiple tissue velocity traces. Quantitative analysis is performed using the Quantitative analysis package described in Chapter 'Quantitative Analysis' on page 9-1.

To start quantitative analysis

1. Press **Q** in one of the *Wall segment diagram* field (usually an apical view at peak level) to launch the Quantitative analysis package (page 9-1).

References

1. **Application of Tissue Doppler to Interpretation of Dobutamine Echocardiography and Comparison With Quantitative Coronary Angiography.** Cain P, Baglin T, Case C, Spicer D, Short L. and Marwick T H. *Am. J. Cardiol.* 2001; 87: 525-531

Editing/creating a Stress Echo protocol template

The stress package provides protocol templates for exercise as well as pharmacological stress examinations. The user can create new templates or modify existing templates to suit the individual needs. Up to ten projections and fourteen stress levels can be created in a template.

Templates created may be temporary, used only during the current examination, or saved as new templates, for future use and reference.

Templates are edited/created from the *Template editor* screen.

Entering the Template editor screen

1. Press **Stress** on the Touch panel to enter the stress echo mode.
2. Press **Template**.
The *Template* menu is displayed.
3. Select **Template Editor**.
The *Template editor* screen is displayed (see Figure 7-12).

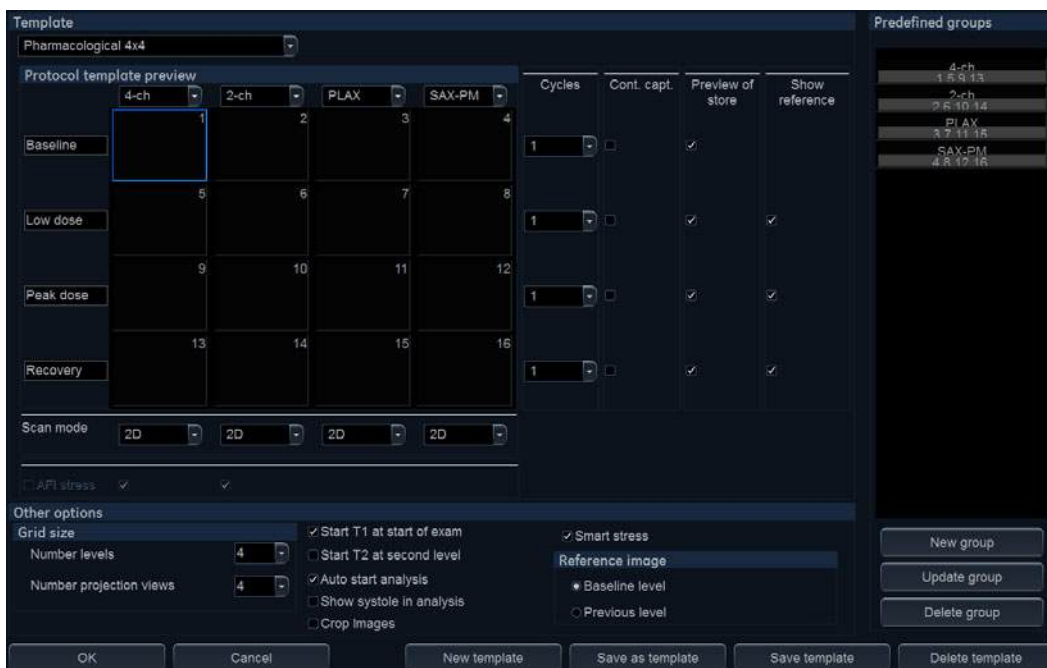

Figure 7-12. The Template editor screen

Editing/Creating a template

Selecting a base template to edit

1. From the *Template* drop-down menu on the upper left corner of the *Template editor* screen select a base template to edit.

NOTE:

Determine the required number of projections and levels you need and select the most appropriate foundation template.

The selected template is displayed in the *Protocol template preview* field, showing the levels and projections and their labels.

Adding/deleting levels and projections

1. Enter the number of levels and projections in the *Grid size* field (see Figure 7-12).
The new grid size is displayed in the *Protocol template preview* field.
2. Press **New Template** to create a new template.
Or
Press **Save Template** to update the base template.

NOTE: *Factory templates cannot be changed.*

Scan mode selection

1. From the **Scan mode** drop-down menu, select a scan mode to be associated to the actual column (projection).

Display timer(s)

1. Check the box(es) to display timer(s) as specified (see Figure 7-12).

Start analysis automatically

1. Check **Auto start analysis** to display the Stress Echo Analysis screen when the last acquisition is performed.

Crop images

1. Check **Crop images** to enable display cropping of images recorded as part of the protocol.
Cropping can be turned off for individual cells of the protocol acquisition by using the **Crop** button on Touch panel.

Smart stress

Check **Smart stress** to store a subset of the image acquisition settings (e.g. geometry, zoom, gain, compress, reject, power...etc) for each view in the protocol. Smart Stress enables to set image acquisition settings for each view at baseline level and automatically get the same image settings in the corresponding views in the next levels. If you want to use Smart stress in Continuous capture, you need to use the arrow buttons to indicate to the system when you are switching views.

Assigning new labels to levels and projections

1. Select a label from the *Label* drop-down menu or type a new label.

Configuring levels

The following options can be set up for each level:

Number of cycles to be stored in the cineloop

1. Enter the desired number in the *Cycles* field.
Up to four cycles/cineloop can be stored.

NOTE: *Even if you store more than one cycle, while in analysis of the Stress echo images the system will by default only display the last cycle.*

Continuous capture

1. Check **Continuous capture** if continuous image acquisition throughout the level is desired.

When Continuous capture is selected, preview of cineloop and reference display (see below) during acquisition are not possible.

Preview of store

1. Check **Preview of store** if review and adjustment of cineloops before storage is desired.

Show reference

1. Check **Show reference** if the display of the corresponding reference loop is desired during acquisition (dual screen mode).

Adding a group

1. In the *Protocol template preview* field select the cells to be part of the group.
2. In the *Pre-defined group* field, press **New group**.
A dialogue box is displayed asking the user to enter a name for the new group.
3. Enter the group name.
4. Press **OK**.

The new group is displayed in the *Pre-defined group* field.

Updating an existing group

1. In the *Pre-defined group* field, select the group to edit.
2. Either select (a) new cell(s) to add to the group or deselect (an) existing cell(s) to remove from the group.
3. Press **Update group** in the *Pre-defined group* field.

The display in the *Protocol template preview* field is updated accordingly.

Deleting a group

1. In the *Pre-defined group* field, select the group to delete.
2. Press **Delete group**.

The group is removed from the list in the *Pre-defined group* field.

Chapter 8

Measurements and Analysis

'Assign and Measure modality' on page 8-6

'Measure and Assign modality' on page 8-8

'Measurements on protocol images' on page 8-10

*'AI Auto Measure – Spectrum Recognition' on
page 8-11*

*'Advanced cardiac measurements and analysis' on
page 8-16*

'4D/Multi-plane LV' on page 8-92

'4D Auto RVQ' on page 8-110

'4D Auto MVQ' on page 8-116

'4D Auto AVQ' on page 8-125

'Running Apps' on page 8-132

*'Advanced vascular measurements and analysis' on
page 8-136*

'OB measurements' on page 8-142

'Measurement result table' on page 8-148

'Worksheet' on page 8-149.

'Measurement accuracy' on page 8-152

Introduction

The ultrasound system provides functionality for two measurement conventions:

- **Assign and Measure:** the user activates the **Measure** mode, selects and then performs a pre-labeled measurement.
 - The user is guided through the study: an auto-sequence functionality automatically selects the next measurement in a study.
 - The selected measurement is highlighted in the *Measurement* menu.
 - The performed measurement is indicated in the *Measurement* menu.

The studies and their parameters are user-configurable. The user can create own studies containing the relevant measurements (see page 12-23).

- **Measure and Assign:** the user activates the **Measure** or **Caliper** mode, then selects and performs a generic measurement. After completion, the user assigns a label to the measurement.



Only assigned measurements are saved when ending the examination.

After doing measurements, the system automatically makes the calculations related to the measurements performed. Measurements and calculations are displayed in the *Measurements result* table (see page 8-148).

Assigned measurements and calculations are automatically gathered into a *Worksheet* and used to populate the patient report.

General recommendations about measurements

- When doing time-measurements in Doppler or M-Mode, it is recommended to freeze the 2D image during acquisition.
- Distance and area measurements should be done on greyscale 2D images or slice mode images if in 4D, not on color flow or TVI-based images. Similarly, in M-Mode, distance measurements should be done on greyscale M-mode images and not on color M-mode images. If doing Color M-Mode measurements of propagation of flow, please refer to your specific laboratory protocols.

About Measurement results display

Be aware of the following:

- Measurement results display
By default the system always displays absolute values for parameters measured in Doppler. This means that values from above and below baseline will all be displayed as positive results.
For Cardiac this behavior cannot be changed. For non-Cardiac the Absolute Value setting can be turned off in **Config -> Meas/Text -> Advanced**, by setting the attribute **Absolute Value** to **Off**.
- Calculated parameters
For calculated parameters the system uses signed values in calculation formulas, and displays the absolute value of the result.
- When a parameter is measured several times the individual values for the parameter will be listed in the m1, m2... columns in the worksheet. The *Value* column in the worksheet will contain a derived value for the parameter, e.g. the average of the individual values (Figure 8-1).
When calculating formula derived parameters, the m1, m2... columns in the worksheet contain calculated values based on the individual input parameter values in the same column (Figure 8-1). The *Value* column contains calculated values based on the input parameter values in the *Value* column.

A		B				
Parameter	Value	Mth	m1	m2	m3	
2D Dimension						
LVIDd	5.0 cm	Av	5.0	5.2	4.8	
EDV(Teich)	117 ml		119	128	105	
LVIDs						
LVIDs	3.0 cm	Av	3.0			
ESV(Teich)	36 ml		36			
EF(Teich)	69 %		70			
ESV(Cube)	28 ml		28			
EF(Cube)	77 %		78			
%FS	39 %		39			
SV(Teich)	83 ml		83			
SV(Cube)	95 ml		97			

Figure 8-1. Measurement result window (A) and Worksheet (B)

The *Measurement result* window always displays values from the m1, m2... columns. It is therefore recommended to consult the worksheet (see page 8-149) to get an overview of measured and calculated parameters.

Assign and Measure modality



1. Measurement category for the current application
2. Study
3. Opened study
4. Performed measurement
5. Pre-selected measurement
6. Access to other studies for the current measurement category.
7. Controls for the current measurement
8. General controls for the measurement application

Figure 8-2. Example of a measurement study

1. Press **Measure** on the Control panel.
The *Measurement* menu is displayed, showing the measurement category for the current application (Figure 8-2).

To change Measurement category:

1. Select the heading in the *Measurement* menu and choose another category.

NOTE: *This can also be done from the Touch panel.*

To perform measurements from a study:

1. Select the study (folder) in the *Measurement* menu.

NOTE: *This can also be done from the Touch panel.*

The study folder is opened and the first measurement is selected.

2. Perform the measurement. Follow the instructions displayed on screen.

Make sure to follow the current medical practices when placing the specific points on the image.

If the folder is configured with auto-sequence measurement (see page 12-24), the next measurement in the study is pre-selected. To skip a pre-selected measurement, select another measurement.

Completed measurements are marked with a check mark.

Measure and Assign modality

1. Press **Caliper** on the Control panel and select the desired measurement tool.
Or
Press **Measure** and select the desired measurement tool in the *Generic* folder in *Measurement* menu.

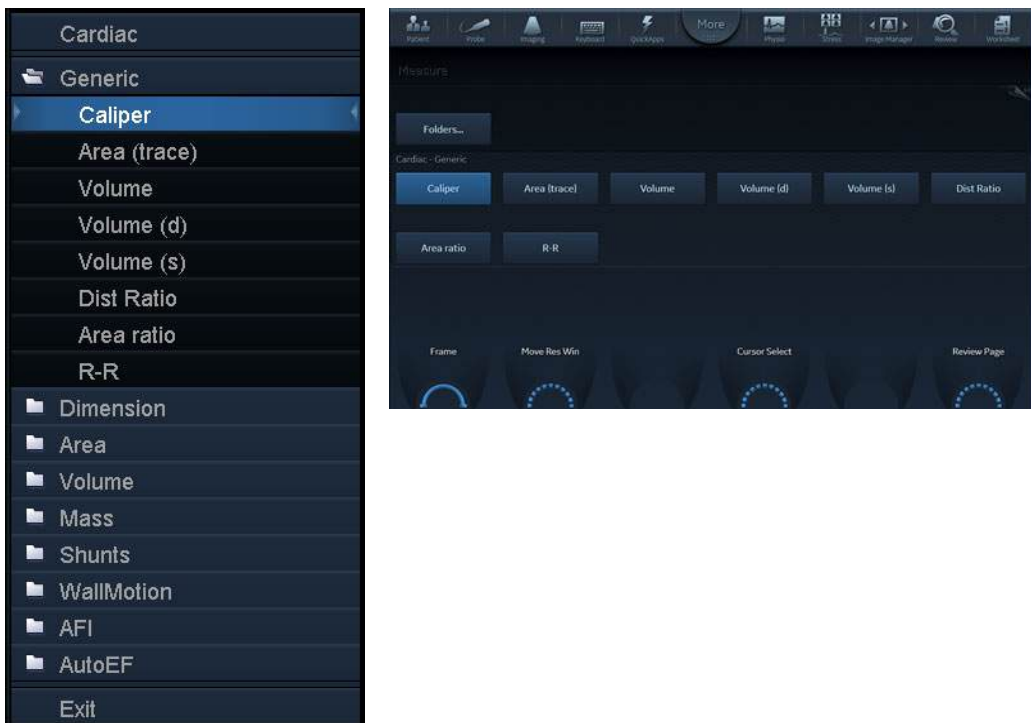

Figure 8-3. Measurement tools

2. Perform the measurement. Follow the instructions displayed on screen.
Make sure to follow the current medical practices when placing the specific points on the image.

NOTE: *The system supports up to 15 separate measurements per M&A session. When exceeding this limit the measurements*

are still correct but will no longer have unique labeling for the tool graphics and results.

3. To assign a label, select the measurement in the *Measurement result* table and select the required label.

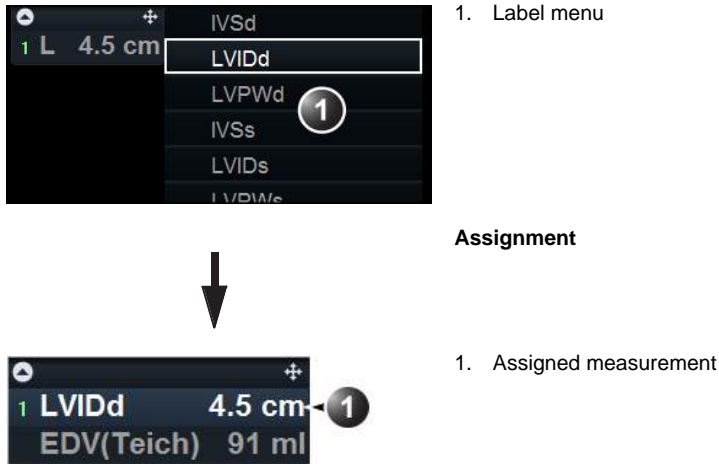

Figure 8-4. Measurement assignment

Measurements on volume renderings

Distance and area measurements can be done on 4D volume renderings from a 4D acquisition.

1. Perform a distance or area measurement on a 4D acquisition by selecting either **Distance (Crop plane)** or **Area (Crop plane)** measurement tool.



When measuring on a volume rendering, the measurement is actually performed on the displayed crop plane and the depth information is NOT taken into account.

It is recommended to use parallel crop (see 'Parallel cropping' on *page 6-31*) with a short distance between the crop planes.

Be aware that the Gain adjustment (2D and 4D Gain) may impact the display of the anatomical structures to measure.

Measurements on protocol images

When performing measurements on images acquired in a protocol, the measurement results will be associated with the protocol level of the image. Average values will be calculated for each protocol level.

For example you may measure LVOT Diam for images acquired outside protocol and for images on each level of an Exercise 2x4 protocol, leading to the following results in worksheet:

Example results

Parameter	Value	Method	m1	m2
LVOT Diam	1.0 cm	Average	1.1	0.9
LVOT Diam, Rest	1.1 cm	Average	1.0	1.2
LVOT Diam, Peak	1.2 cm	Average	1.2	



WARNING

Measurement results associated with a stress level will not be updated if the image is moved to another stress level at a later time. Images should be correctly placed in the protocol before performing measurements.

AI Auto Measure – Spectrum Recognition

AI Auto Measure – Spectrum Recognition provides semi-automatic AI based navigation through the Doppler part of the Measure menu. This workflow feature is activated by the **Freeze** button or the **Measure** button, depending on the configuration, when a Doppler spectrum is active on screen.

When a given class is recognized, and an associated measurement is enabled, this measurement will be invoked. If the measurement has associated Cardiac Auto Doppler functionality, this will be activated automatically, and tracing or points will be visible. If the default measurement is enabled but does not have an associated Cardiac Auto Doppler functionality, the appropriate folder will open.

The algorithm predicts the appropriate measurement for the spectrum based on a baseline shift up/down and the cursor location. If the default measurement is not enabled (in **Config > Meas/Text**), a supplementary measurement will, where available, be performed. A list of supported measurements is provided in Table 8-1.

NOTE: AI Auto Measure – Spectrum Recognition does not perform any measurements, it only sends a command for the system to initiate a specific measurement. The measurement itself is either performed by Cardiac Auto Doppler (see ‘Cardiac Auto Doppler’ on page 8-83) or manually.

Table 8-1: Supported measurements and classes

Network Class	Spectrum Class**	Default measurements	Additional measurements
Aortic Valve	Aortic Regurgitation (AR)***	AR Pressure Half time	AR Trace, AR Vmax
	Aortic Valve Outflow (AVO)	*AV Trace	*AV Vmax
	Aortic undecided (ARAVO)	None. Aortic folder opened. User has to select.	
	Left Ventricle Outflow Tract (LVOT)	*LVOT Trace	*LVOT Vmax
Mitral Valve	Mitral Regurgitation (MR)***	MR Trace	MR Vmax, MR dP/dT
	Mitral Valve Inflow (MVI) Trace	*MV Trace	
	Mitral undecided (MRMvtrace)	None. Mitral folder opened. User has to select.	
	Mitral Valve Inflow (MVI) Velocity	*MV E/A Velocity	MV E/A Ratio, MV E Vel, MV A Vel, MV DecT
Pulmonary Valve	Pulmonary Regurgitation (PR)***	PRend, Vmax	RAP
	Pulmonary Outflow (PVO)	*PV Trace	*PV Vmax
	Pulmonary undecided (PRPVO)	None. Pulmonary folder opened. User has to select.	
	Right Ventricle Outflow Tract (RVOT)	*RVOT Trace	*RVOT Vmax
Tricuspid Valve	Tricuspid Regurgitation (TR)***	*TR Vmax	TR Trace, TR dP/dT
	Tricuspid Valve Inflow (TVI) Velocity	TV E/A Vel	TV E Vel, TV A Vel, TV DecT

Table 8-1: Supported measurements and classes

Network Class	Spectrum Class**	Default measurements	Additional measurements
Pulmonary Vein	Pulmonary Vein (P Vein)	P Vein S	P Vein D, P Vein A, P Vein A Dur
Tissue Doppler	Lateral Wall – Left Ventricle	*LV E'	*E'
	Septal Wall	*Sep E'	*E'
	Lateral Wall – Right Ventricle	RV S'	
<p>* Cardiac Auto Doppler – supported measurements (see 'Cardiac Auto Doppler' on page 8-83)</p> <p>** AI Auto Measure – Spectrum Recognition – supported classes</p> <p>*** These labels refer to the intention to measure regurgitation through the given valve, however this does not imply the presence of regurgitation and thus does not correspond to a diagnosis.</p>			

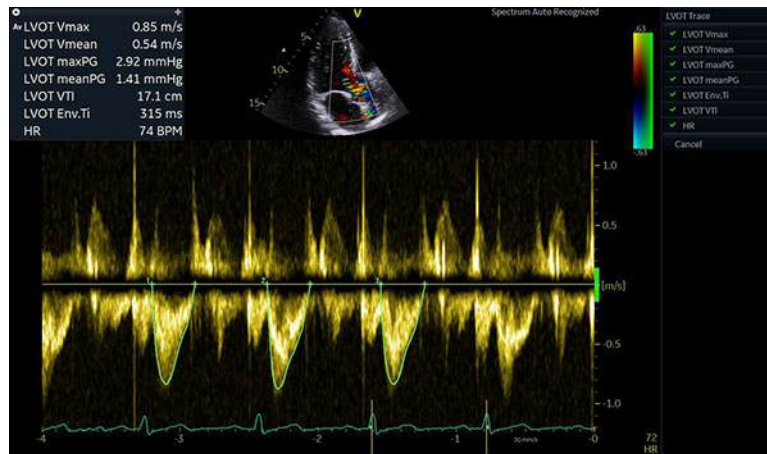

Figure 8-5. AI Auto Measure – Spectrum Recognition

The AI Auto Measure – Spectrum Recognition algorithm was trained, verified and validated on adult cardiac images. Algorithm was able to provide a classification in 93 % of cases and had accuracy of 98 % for the cases where classification was provided. The algorithm for AI Auto Measure – Spectrum Recognition will only consider the complete visible cardiac cycles on display when **Freeze/Measure** is pressed. Cycles that are incomplete or not visible will not be considered. Measurements for individual cycles can be excluded/approved on

a cycle-by-cycle basis by hovering mouse pointer over each cycle, see 'Review and Approve' on page 8-85.



AI Auto Measure – Spectrum Recognition uses AI based computer algorithms to determine the spectrum type. There is an inherent risk that these algorithms may sometimes give suboptimal or incorrect results. Verify that the semi-automatically selected measurements are appropriate for the displayed spectrum type before approving the measurements.

Configuration for AI Auto Measure – Spectrum Recognition

1. Go to **Config** and select the **Meas/Text** tab.
2. Select **Advanced**.
3. In the drop-down options of the *M&A category*, select **Cardiac**.
4. Set *Automated Doppler Measurements* to *on*.
5. Set *AI Auto Measure – Spectrum Recognition* to *on*.

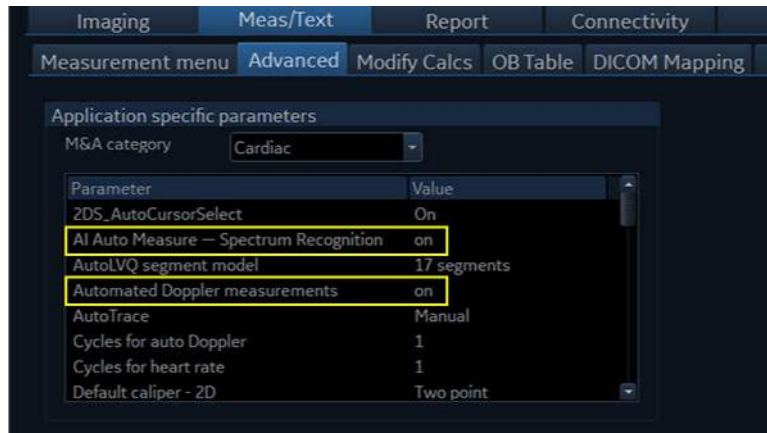

Figure 8-6. Enabling AI Auto Measure – Spectrum Recognition and Automated Doppler Measurements

6. Set *Start M&A on freeze PW* to *on*.



Figure 8-7. Enabling Start M&A on freeze PW

If *Start M&A on freeze PW* is set to *off* when pressing **Freeze**, the preferred complete cycles must be on screen before pressing **Measure**.

Restrictions for AI Auto Measure – Spectrum Recognition

AI Auto Measure – Spectrum Recognition is only available under the M&A category *Cardiac* for Doppler Spectrums acquired with cardiac Adult TTE probes. Spectrum type with no associated auto measurements will open the measure menu at the suitable location for manual measurements. A list of supported spectrum classes is provided in Table 8-1.

Advanced cardiac measurements and analysis

Event timing measurements

Event timing enables the time measurement for opening and closure of the Aortic and Mitral valves, as referred to the automatically detected QRS marker, which normally is on the rising slope of the R-wave.

Event timing can be performed on a Doppler spectrum or an M-Mode acquisition showing the corresponding valves. The procedure is similar in both modes. In addition event timing can be done on traces in Q Analysis. The measurements are shown as dashed lines in the *Analysis* window and *Anatomical M-Mode* window in Q Analysis.

The measurements can be used as default start and end times for TSI.

1. Generate the spectrum or M-Mode image to be measured.
2. Press **Freeze** to stop the cineloop.
3. Press **Measure** on the Control Panel.
4. Select **Event Timing** in the *Measurement* menu.

The following event timing measurements are available (with the first measurement on the list selected):

- **AVO**: Aortic Valve Opening
- **AVC**: Aortic Valve Closure
- **MVO**: Mitral Valve Opening
- **MVC**: Mitral Valve Closure

5. Place the cursor to the corresponding point on the spectrum for the selected measurement.
6. Press **Select** to anchor the point.

The event timing measurement (ms) is displayed in the *Measurement result* table.

When an event timing measurement is performed, the QRS markers are displayed on the ECG trace and correct QRS

marker position should be verified before the Event Timing measurements are performed.

TSI Measurements

Each sample in the TSI image represents the time to the maximum velocity within the chosen TSI search interval from TSI Start to TSI End (page 5-37).

There are two automatic TSI time to peak measurement tools:

- **Generic TSI Time to peak measurement:** displays the TSI value at the location point set by the user.
- **Segmental TSI Time to peak measurement:** measures the time to peak velocity in specific wall segments and gets automatically calculated TSI indexes based on these measurements. The measurements may be presented in a color coded Bull's eye diagram.

Alternatively, time to peak measurement can be done in Q Analysis by manually measuring the time between the QRS marker and the peak velocity on the velocity trace.

Generic Time to peak measurement

1. Acquire a TSI apical loop.
2. Press **Measure**.
3. In the *Measurement* menu, select **Generic** and **Time to peak** (see Figure 8-8).

The TSI loop freezes at the TSI end frame.

4. Place a point in the middle of a basal or mid-level myocardial segment in the TSI image.

The Time to peak and Peak velocity values for the segment are displayed in the *Measurement result* window.

NOTE:

To judge the quality of your data at the measuring point in the 2D image the TSI trace may be used (see 'TSI trace' on page 8-19). See also the Caution text on page 8-22.

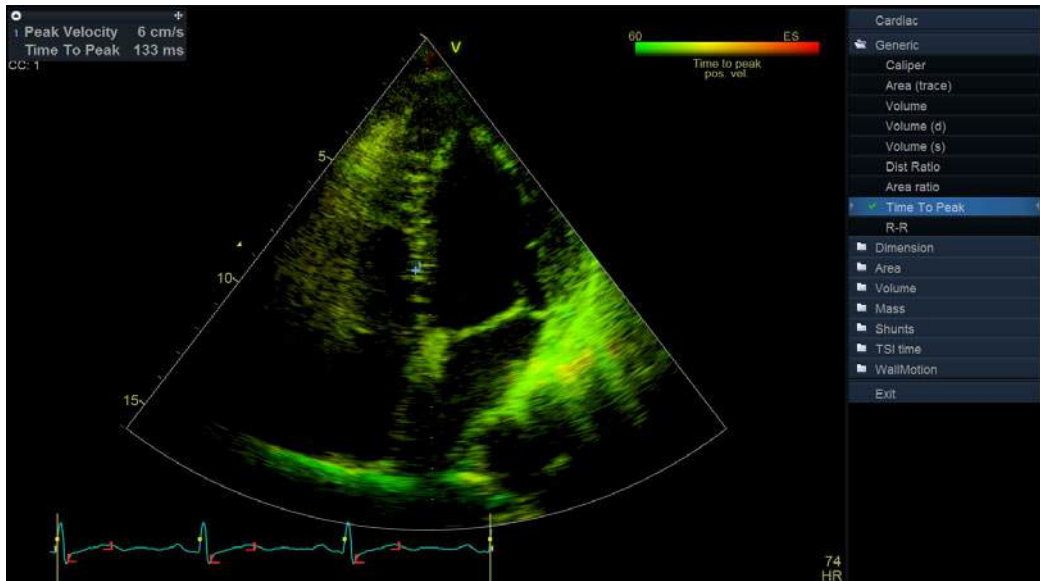

Figure 8-8. TSI Generic Time to peak measurement screen

Segment Time to peak measurements

1. Acquire TSI loops from all three apical views.
2. Press **Measure** and select the **TSI time** study.
The TSI loop freezes at the TSI end frame.
The first measurement in the study is automatically selected (see Figure 8-9).
3. Place a point in the middle of the corresponding segment in the TSI image.
The Time to peak value for the segment is displayed in the *Measurement result* window.
4. Perform a measurement for all basal and mid-level segments in all three apical views.
In addition to the Time to peak value for each segment, the following TSI indexes are calculated:
 - *Septal lateral delay*: difference in Time to peak velocity in the basal lateral wall and basal septum.
 - *Septal posterior delay*: difference in Time to peak velocity in the basal posterior wall and the basal antero-septum.
 - *Basal seg. max diff.*: difference between the maximum and minimum time to peak measurements in the six basal segments. Requires at least four of the six basal segment measurements.

- **Basal standard deviation:** the standard deviation of the time to peak measurements in the six basal segments. Requires at least four of the six basal segment measurements.
- **All seg. max diff.:** difference between the maximum and minimum time to peak measurements in all the measured basal and mid level segments. Requires at least eight of the twelve segmental measurements.
- **All segments standard deviation:** the standard deviation of the time to peak measurements in all measured basal and mid level segments. Requires at least eight of the twelve segmental measurements.

The TSI indexes indicate degrees of asynchrony in time to peak velocity.

5. Select **TSI Bull's eye report** in the *Measurement* menu.

The measurements are displayed in a color coded bull's eye diagram together with a list of the calculated TSI indexes.

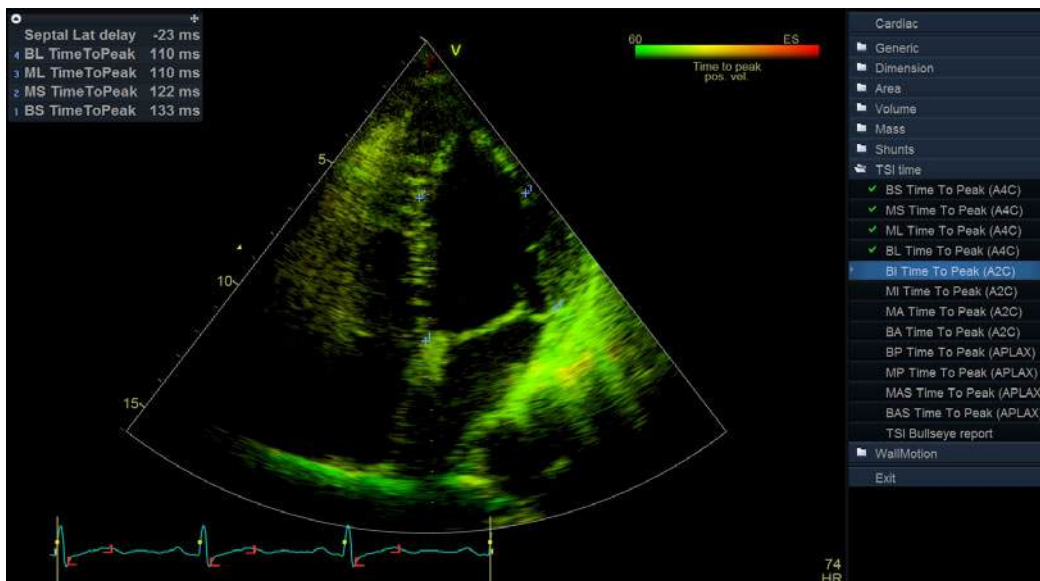

Figure 8-9. Segment Time to peak measurements screen

TSI trace

The TSI Time to peak measurement can be verified and eventually manually changed from the TSI trace.

1. Double click on the measurement point.
The ROI and the corresponding TSI curve are displayed (see Figure 8-10).

2. Press **Select** to anchor the ROI and trace.
3. If required, select a new peak location in the trace.
4. Click in the acquisition window to exit the TSI trace.

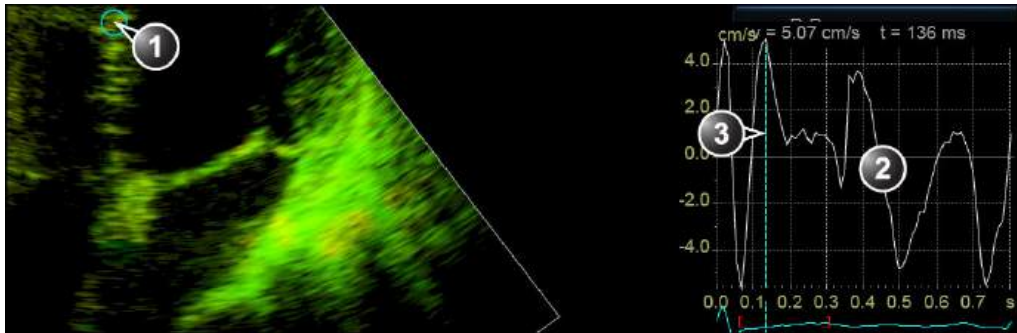

1. TSI ROI
2. TSI trace
3. TSI Time to peak marker

Figure 8-10. TSI trace

Time to peak measurement in Q Analysis

1. From a TSI apical loop, press **Q Analysis** on the Touch panel.
2. Place a sample area in a myocardial segment.
A velocity trace is displayed in the *Analysis* window (see Figure 8-11).
3. Press **Measure**.
4. In the *Measurement* menu, select **Generic** and **Time**.

NOTE: *If **Time** is not available in the Generic folder, Press **Active Mode** on the Control panel.*

5. In the *Analysis* window, measure the time from the yellow QRS marker to the peak velocity of the velocity trace.

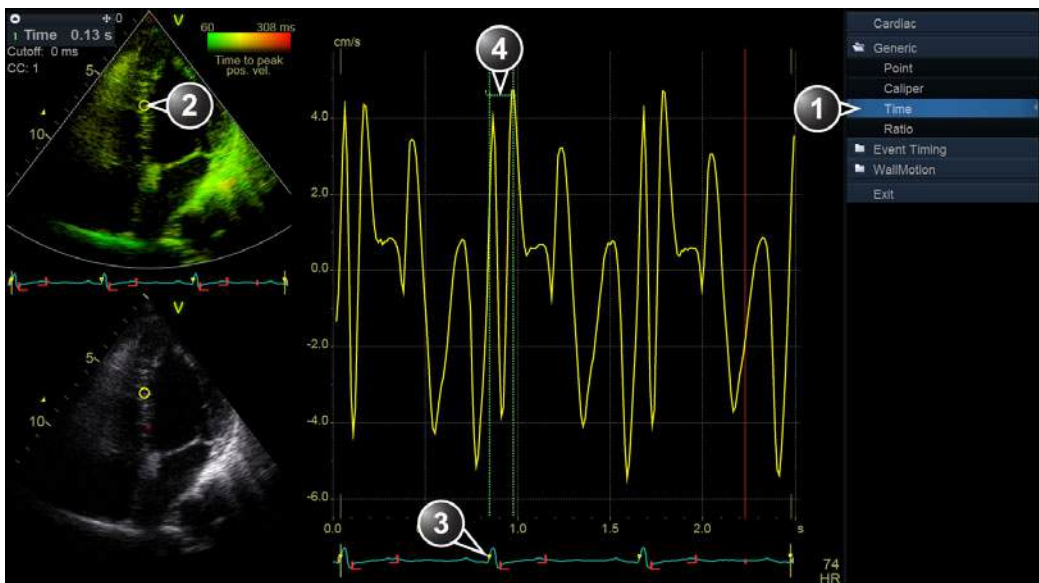

1. Time measurement tool
2. Sample area
3. QRS marker
4. Time to peak measurement

Figure 8-11. Manual TSI Time to peak measurement in Q Analysis

NOTE: *It is possible to do a Generic or a Segment Time to peak measurement from within Q Analysis and compare the result with a manual Time to peak measurement. To access the corresponding measurement tool in Q Analysis you may have to press **Active mode** to display the relevant Measurement menu.*



CAUTION

The Time to peak measurement in Q Analysis may differ from the TSI Time to peak measurements due to the following considerations:

- The TSI Time to peak measurements find the maximum velocity only within the TSI search interval. If the desired peak on the velocity trace is outside the TSI search interval, the TSI Time to peak measurements will return a different result than the manual Time to peak measurement.
- If the maximum velocity is at one of the ends of the TSI search interval, the TSI time to peak measurements return the time of the end of the TSI search interval. In some cases the falling flank of an iso-volumic contraction peak at the time of TSI Start or the rising flank of a post-systolic contraction peak at the time of TSI End may be detected. In a manual measurement the time to a peak within the TSI search interval with a lower velocity than the velocity at the end of the interval may be measured instead. The color map *TSI Trace* may be used to identify regions in the image where the peak detection is near the ends of the TSI search interval. The TSI Trace tool should be used to verify TSI measurements in the identified regions.
- If there are two or more peaks of comparable velocity within the TSI search interval, or a poor signal quality, the TSI Time to peak measurements may return the time to a different peak than what a manual method would do. Typically in these situations, the TSI image will show a wide range of colors over a small spatial region.

Automated Function Imaging

Automated Function Imaging (AFI) is a decision support tool for global and regional assessment of the systolic function of the left ventricle (LV), right ventricle (RV), and left atrium (LA). AFI calculates the myocardial tissue deformation based on feature tracking on 2D grey scale loops.

Content in this section:

- 'AFI on the Left Ventricle (AFI 3.0, Easy AFI LV)' on *page 8-23*
- 'AFI on the Right Ventricle' on *page 8-49*
- 'AFI on the Left Atrium' on *page 8-63*

AFI on the Left Ventricle (AFI 3.0, Easy AFI LV)

AFI is performed on the standard TTE apical views, apical long-axis (APLAX), 4-chamber (A4CH) and 2-chamber (A2CH), as well as on the standard mid-esophageal views acquired with a TEE probe.

Data Requirements

Data types

All AFI analyses are available on raw data, which also is the recommended data format for all AFI processing.

Analysis on multi-frame DICOM files is only possible for AFI on LV. The DICOM files must have a calibration region.

One click workflow (available with Easy AFI LV option only) is only available for AFI LV analysis on Adult TTE raw data images. (One click workflow is not supported for AFI stress.)

When running AFI on DICOM multiframe data, it is advised to optimize the acquisition to provide well visible speckle patterns in the tissue.

Views

Automated Function Imaging of the Left Ventricle can be performed on one or three of the standard views.

If a complete analysis of all three views is performed, the result is presented as a Bull's Eye display showing color-coded and numerical values for peak systolic longitudinal strain, PSS (Peak Systolic Strain), TTP (Time To Peak global longitudinal strain) and traces.

If the analysis of one view alone is performed, the result is presented as a *Quad* layout, with two screens to evaluate the ROI and tracking, a strain curves graph and a Color Anatomical M-Mode (CAMM).

Recommended Probes

Table 8-2: Recommended probes - AFI on LV

	Probes
Cardiac	M5Sc-D, 3Sc-RS, 4Vc-D, 6Tc, 6VT-D
Pediatric	6S-D, 12S-D

NOTE: *AFI 3.0 is only recommended for the probes in Table 8-2. Easy AFI LV is only available for adult TTE. The measurement accuracies of the longitudinal strain values reported in 'Measurement accuracy' on page 8-152 are verified with these probes.*

Image characteristics

- A frame rate higher than 40 frames per second is recommended. Lower frame rates are accepted by the tool (37 fps for raw data and 30 fps for DICOM). Higher frame rates will benefit the workflow by making it easier to achieve satisfactory speckle tracking. A higher frame rate is recommended for high heart rates.
- The entire myocardium should be visible.
- A depth range that includes the entire heart chamber of interest (LV) should be used.
- Acquisitions must be made without the use of contrast agents.

Acquisition

Create an exam, connect the ECG device and make sure to obtain a stable ECG trace.

The apical views may be acquired sequentially in 2D mode, or simultaneously in Tri-plane mode.

Sequential acquisition

Acquire 2D grey scale cineloops of an APLAX, A4CH and A2CH view.

NOTE: It is recommended to acquire all three apical views sequentially to get similar heart rates in all views.

If TTE view recognition is enabled during the acquisition and the views are successfully recognized by the AI, the detected view label is saved in the file during Image Store.

Heart rate and cycles

- Heart rate variability between the recordings should not exceed 30%.
- If the acquisition has more than one heart cycle, the analysis will by default be done on the second to last heart cycle.
- The system should be configured to store 100 ms before and after each heart cycle.

Configuring the tool

It is possible to configure some of the AFI controls and analysis settings.

To access the configuration menu, press **Utility/Config** on the Touch panel, select the category **Meas/Text**, and the **Advanced Quantification** subgroup.

Select **AFI** to configure the AFI tool designed for analysis on the Left Ventricle.

Configurable workflow controls



Figure 8-12. AFI configuration

- *Autoprocessing timeout* – The time the operator must keep the trackball still before tracking automatically starts.
- *YoYo* – When adjusting the ROI, select whether a limited number of frames around the selected ROI frame should be looped back and forth to ease ROI adjustment.
- *ROI Method* – Select fully automatic or 3-Click ROI as default tool.
- *AVC Stage mode* – Select whether to always open the AVC Selection stage. If *Auto* is selected, upon analysis of the APLAX view, the user is taken to the Results stage after the ROI stage. "Auto" AVC or Event timing will be used by default. It will still be possible for the user to re-visit the AVC Selection stage to edit the chosen AVC.
- *Prioritize event timing* – Select *Yes* to use Event Timing values for AVC if there are some in the current exam and AVC Stage mode is on *Auto*.
- *BE Mode* – Colormaps that shall be available for the Bull's Eye.
- *EF reminder* – Select *Yes* to be reminded to visit the EF layout on A4CH and A2CH views analysis. Visiting the EF layout is mandatory to obtain EF values in Worksheet while using AFI for the analysis of the Left Ventricle.
- *Positive Peak Rule* – If *On*, then a positive strain value will be shown if the maximum positive peak exceeds 30% of the maximum negative peak, resulting in a blue segment in the

Bull's Eye. If *Off*, then the negative strain value will be shown regardless of the size of the positive peak.

- *One click workflow* (available with Easy AFI LV option only) – If *Off*, then processing stops for user input for each view. If *On*, then processing will attempt to proceed automatically through all views and present the user with the aggregated results of all views. One click workflow is only available for Adult TTE raw data images. If for some reason one click workflow is attempted but cannot be performed, the system will revert back to the manual step-by-step workflow.

Configurable analysis settings

- *BE Segment model* – Select the preferred Bull's Eye standard (ASE/AFI, 17/18 segment models).
- *Strain reference layer* – Select whether the strain values shall be calculated based on endocardial or full wall tracking.

Reference layer for strain

The tool supports calculation of strain parameters based on either endocardial deformation or myocardial/full wall deformation.



CAUTION

Measurements based on endocardial and myocardial analysis are not comparable.

- Endocardial deformation is assessed by performing analysis of the endocardial part of the ROI trace. Measurements derived from endocardial deformation are suffixed *Endo*, such as for instance `GPeakSysSL(Avg)_Endo`
- Myocardial/full wall deformation is assessed by performing analysis of the whole ROI trace. Measurements derived from myocardial deformation are suffixed *Full*, such as for instance `GPeakSysSL(Avg)_Full`

NOTE: *If attempting to reprocess an analysis using a different reference layer a warning will be shown informing that the values in the analysis will change.*

Starting the tool

Starting AFI from sequential acquisition (raw data)

1. Open the exam for which you want to perform AFI analysis and select one of the apical images you would like to use for the analysis.

2. Press **Measure** on the Control Panel and select the **AFI** study.

If the images are acquired with a transthoracic probe, the system will try to identify a triplet of apical views suitable for the analysis. If a triplet is identified, a message will be displayed in the lower part of the screen "AFI starting with images selected by AI" and the tool will start up in the *Define ROI* stage with one of the selected views. Or, if feasible and one click enabled, the tool will proceed to the results stage showing results from all the three views. The selected triplet is highlighted in the clipboard, with a thicker border around the current view being analyzed.

If the identification of a suitable triplet failed, or if the probe is a transesophageal probe, the tool will start up in the *Select View* stage.

NOTE: *Automatic identification of the suitable triplets is based on view recognitions stored in the files (during Image Store), clipboard location, frame rate and heart rate proximities. The View Recognition algorithm was trained, verified and validated on adult resting cardiac TTE images. Algorithm was able to provide a classification in 98 % of cases and for these cases had accuracy of 99 %.*

Starting AFI from simultaneous acquisition (Tri-plane acquisition)

1. Open a Tri-plane acquisition.
2. Press **Measure** on the Control panel and select **AFI**. The AFI application is started displaying the APLAX view.



CAUTION

When performing AFI on all three apical views, the user is recommended to start with the APLAX view. This allows manual adjustment of the Aortic Valve Closure (AVC) event timing that is used in the calculation of the longitudinal systolic strain in all apical views.

Starting AFI on DICOM data

1. Open an exam to perform the AFI analysis on and select the DICOM multi-frame image of a suitable apical view.
2. Press **Measure** and select the **AFI** study.

NOTE: *DICOM files do not usually provide the complete ECG trace as usable data. It is present on the image; and will be displayed as part of the image data. However, if the DICOM file contains R-wave information (DICOM tag 0018, 6060 "R Wave Time Vector), the AFI tool will automatically detect cycles in a multicycle acquisition. See Figure 8-13 for an illustration of the ECG on AFI analysis of DICOM files with and without the*

DICOM tag. It is still possible to perform AFI on DICOM data without a defined “R Wave Time Vector”, but a single cycle must be identified in the view stage of the tool. To do so, drag the vertical bars marking the cycle boundary on the ECG trace to frames that correspond to the cycle you wish to perform the analysis on.

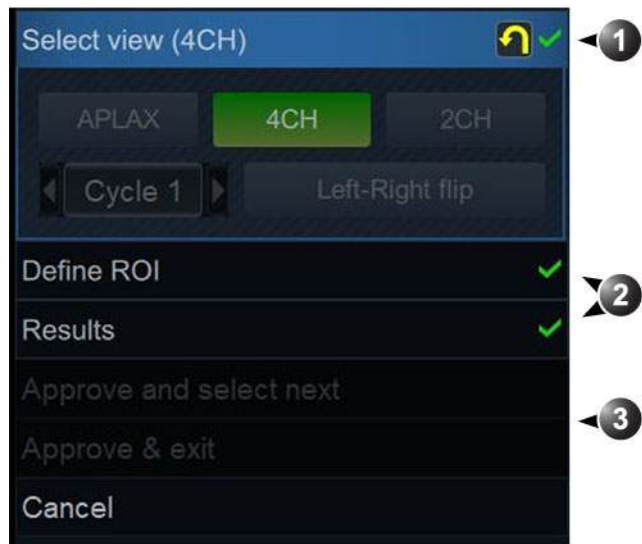

Figure 8-13. ECG representation in AFI when performed on DICOM data. If the required tag was found, cycle starts will be displayed as yellow dots on the ECG line.

Navigating the tool

If one click workflow is enabled (available with Easy AFI LV option only), the tool will proceed automatically to the result screen which shows the results for all views combined. However, by clicking on any view in the result screen (see Figure 8-19 on page 8-45), the tool will provide navigation as described in this section. One click operation is only available for AFI LV for Adult TTE raw data images.

Perform the analysis by following an on-screen guided workflow (see Figure 8-14).



1. Active stage
2. Stages previously visited
3. Stages not yet accessible

Figure 8-14. A typical AFI workflow menu

The *Workflow* menu (or stage menu) is located on the right side of the tool. It contains a set of stages the user should visit sequentially. It is possible to re-visit already viewed stages. Click on their title to navigate to any available stage. Stages that are not accessible given the tool's state are greyed out.

The stages of an AFI analysis on the left ventricle are:

- *Select View* – where the user indicates to the tool which view will be analyzed (skipped for images acquired with automatic TTE view recognition).
- *Define ROI* – where the user draws the ROI where speckle tracking will take place.
- *Set AVC (APLAX only)* – where the user defines the AVC time when processing the APLAX view.
- *Results* – where the user examines the results of the analysis.

Most stages require interaction with the user, and hints on what is expected are given below the stage title (see Figure 8-15).



- If a stage is labeled , the stage is complete and nothing more needs to be done in that tool stage.
- Click the  (reset) button to reset the stage and clear all user-entered information in that stage.



Figure 8-15. AFI Workflow menu

When available, press **Approve and select next** to return to the *Select View* stage and perform the analysis for a new view.

When available, press **Approve & Exit** to approve the analysis and store the reviewed measurements to worksheet. See 'Measurements available after complete analysis' on *page 8-48* for the list of stored measurements after performing AFI of the LV.

At any time, click **Cancel** to exit the tool without saving any analysis.

AFI on the APLAX view

TTE data acquired with View Recognition

1. When in *Define ROI* stage:

Verify that the view annotation shown to the upper left of the screen is correct. If it is not, either:

 - Click the **Select View** stage button to reannotate to the correct view and proceed analyzing that image.
 - Click on an **APLAX** image in the clipboard. This will discard analysis of the current loop and replace it with the one selected from clipboard. The tool will start in the *Select view* stage where it should be annotated as APLAX.

Pay attention to the left/right orientation of the image by comparing the LV wall names with a visual inspection of the image. If the image orientation is wrong:

- go back to the *Select view* stage.
- press **Left-Right Flip**.
- verify the view by annotating it as *APLAX* again.

NOTE: *You may alternatively exit AFI, invert the image and start AFI again.*

2. An automatic ROI is generated when entering the Define ROI stage. The ROI may be edited by clicking and dragging on the endocardial and epicardial contours. See 'ROI adjustment' on page 8-36 for more information.

NOTE: *If AFI is performed on pediatric exams with 9T-RS, 6S-D and 12S-D, the automatic ROI is disabled. See section about 3-click ROI in 'To create a new ROI' on page 8-38*

3. When satisfied with the ROI, either stop moving the cursor and wait for automatic processing to start or click on the **Process** button, **Results** for A4CH/A2CH, or **Set AVC** for APLAX. Now the system performs feature tracking to get a temporal ROI trace. On completion, it proceeds to the next stage.
4. (APLAX only) After the *ROI* edit stage, the system enters the *Set AVC* stage. Select one of the AVC setting strategies to verify AVC time. See section 'Event timing' on page 8-60. On completion, the AFI tool now proceeds to the *Results* stage.
5. The AFI tool is now displaying the *Results* stage in a *Quad layout*. Now the tracking quality must be inspected and verified. The tracked ROI is divided into segments. The tracking quality for each segment is automatically evaluated and applied to reject segments for which the tracking is assumed to be not reliable. Segments that have been rejected do not have values in the segmental result ROI to the lower left in the *Quad* view, but instead show an X. The strain trace (upper right), Curved Anatomic M-mode section (lower right) and parametric overlay on the dynamic ROI (upper left) are disabled for rejected segments. By clicking on a segment in the segmental result ROI it is possible to override the automatic quality assessment to either show or hide segmental values. The tracking for each segment must be visually controlled and validated as described below.

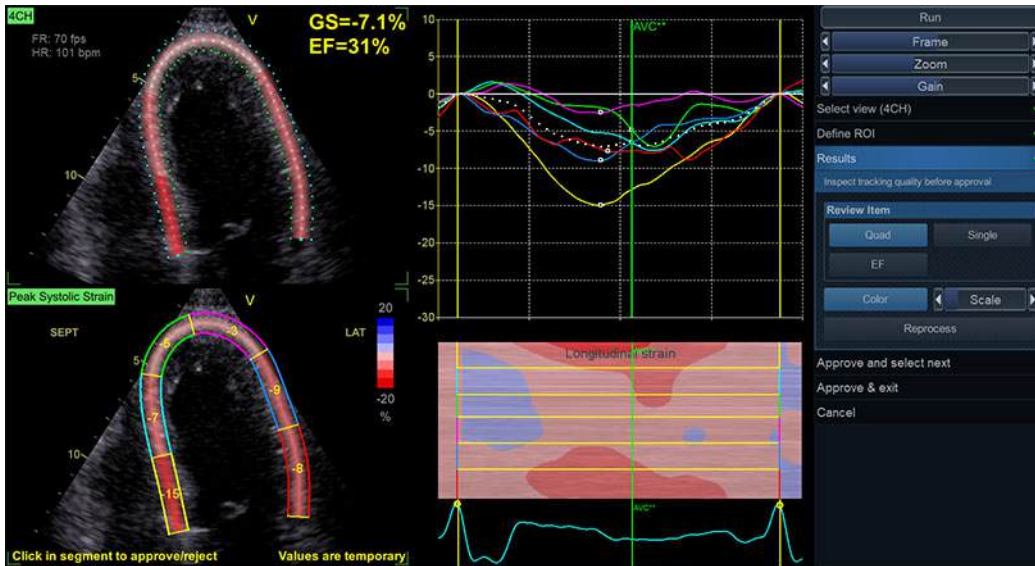

Figure 8-16. Results stage in Quad layout

Once the tracking quality has been controlled for all segments, you may choose to click:

- Reprocess – To completely reprocess the view currently being reviewed. This will take the user back to "Define ROI" stage of the workflow.
- Approve and Select Next – To proceed analyzing the next view in order to achieve a complete Bull's eye.
- Approve and Exit – To exit the tool and store performed measurements. No segmental strain results are stored in this case.

NOTE: *In case of a multi-cycle recording, the system automatically launches the second to last cycle for analysis. If during analysis, the operator wants to switch to another cycle, that is possible by entering the Select View stage and change cycle using the Cycle button. Also, the CineStart and CineEnd markers may be adjusted by clicking and dragging the markers on the ECG for precise edition of the selected cycle.*

TTE data without view recognition or TEE data

The workflow for data without view recognition is very similar to the workflow with view recognition. The differences are:

- The first stage when launching the tool, will be the *Select View* stage. The user should then:
 - Perform any Left-Right flip corrections.

- Select Cycle and adjust Cine markers as appropriate.
- Annotate the view by clicking one of the view labeling buttons (**A4CH**, **A2CH**, **APLAX**).
- When clicking **Approve and Select Next**, the tool will proceed to the *Select View stage*, and the operator has to manually select the next view to process from the clipboard.

NOTE: *If AFI is performed on TEE exams, the automatic ROI is disabled. See section about 3-click ROI in 'To create a new ROI' on page 8-38.*

For simultaneous acquisition (Tri-plane acquisition)

The procedure for AFI on Tri-plane acquisition is very similar to the one used for sequential views with pre-annotated views.

- The tool opens in the *ROI edit* stage with the APLAX view.
- When clicking **Approve and Select Next**, the tool will proceed to the *ROI edit* stage of the next view (A4CH, A2CH).
- If the operator wants to perform the analysis in a different order, it is possible to go to the *Select View* stage and select the preferred view for analysis.

AFI on A4CH and A2CH views

The procedure for AFI on Apical 4-chamber and 2-chamber views is similar to the one used in the APLAX view.

TTE data acquired with View Recognition

Perform the steps 1, 2, 3, and 5 from the APLAX procedure, but make sure the view is correctly annotated as *A4CH/A2CH* and that wall names in the *Roi Adjustment* stage are as expected.

Perform the tracking validation (page 8-35) and, optionally, ROI adjustment (page 8-36) procedures.



If the APLAX view was not analyzed first, the strain values displayed in the Quad screen for the A4CH/A2CH are labeled temporary and may be different after APLAX have been analyzed. The reason for this is that for the A4CH and A2CH views, the AVC time is automatically set based on strain curve peaks (Auto mode). If the user, during APLAX analysis, selects to use Event Timing or manually sets the AVC time, the globally applied AVC time will become different, causing segmental results to change.



If AVC mode is set to Auto, the final value of AVC time is not available before all three views have been analyzed. Thus, strain values displayed in Quad screen of the two views analyzed first are labeled temporary. The reason for this is that the Auto-AVC calculation derived from all three views is most accurate and may be different from the intermediate AVC calculations used for each view

EF by AFI

The AFI tool also provides EF values which fully correspond to the values provided by the dedicated AutoEF tool. In the AFI result screens, the green endocardial border corresponds to the contours used for the EF calculation. Thus, users should be reviewing correctness of these contours (and EF values displayed on screen) before approval. If further details on EF are needed, clicking the EF button will provide the same information as within the AutoEF tool.

NOTE: If both A4CH and A2CH have been analyzed, the system also calculates biplane Simpson EF, SV, CO and volumes.

NOTE: The EF values (including volume values) provided by running the AFI tool will appear in the Worksheet, Report and in DicomSR in exactly the same way as EF values provided by running the dedicated AutoEF tool. If first AutoEF is performed and then AFI, there will be two instances of the EF values in the Worksheet.

Tracking

The accuracy of the measurements provided by AFI rely on good tracking quality.



Poor tracking quality may lead to incorrect measurement results. The tracking for each segment must be visually controlled and validated.

Poor tracking quality could result from a variety of causes. The most common causes for bad tracking are:

- Erroneous placement of the basal points when defining the ROI. If the basal points are placed too far from the annular region, the ROI segments at the annular base will not move together with the underlying 2D image throughout the entire heartbeat.
- Erroneous placement of the apex when defining the ROI. The point should be placed so that the resulting ROI covers

mainly the myocardium. If the apex point is placed too high, the ROI will mainly cover the epicardium, resulting in poor tracking.

- Too narrow ROI width. Narrowing the ROI too much will result in poor tracking due to lack of tissue data in the ROI.
- Too much clutter. Images with too much static clutter will result in poor tracking.

Inspect each segment and make sure that the center line is moving together with the underlying 2D image. Use the various results layouts to examine the tracking quality (e.g. Quad layout).

The following can help examining the tracking quality:

- Turn off the color overlay by clicking **Color** button.
- Reduce playback speed by using the **Speed** slider (or the rotary on the touch panel).
- Use the *Single* layout to get a larger view of the dynamic mesh (especially in difficult cases).

If the tracking needs to be improved for some segments, the user can modify the ROI or create a new ROI.

ROI adjustment

Automatic ROI based on AI segmentation (available with Easy AFI LV option only) is only available for adult TTE raw cardiac images and only when the appropriate options are enabled. This algorithm was trained, verified and validated on adult TTE cardiac raw data images. Accuracy of running with Automatic AI ROI is reported in 'Measurement accuracy' on *page 8-152* as "accuracy w/o editing".

If the automatic ROI is not optimal (resulting in poor tracking), the user can either adjust the ROI or create a new ROI as described below.

General ROI remarks

The calculations performed on the tracked ROI aim to find the longitudinal deformation along the cardiac muscle from base to apex. For an AFI analysis on the Left Ventricle, these calculations assume the ventricle to have a horse-shoe shape.



If the ROI does not have a horse-shoe shape, the calculated measurements may not be accurate.

To adjust the ROI

The following adjustments can be done in the Define ROI stage:

- Adjust *ROI width* by clicking the **ROI Width** slider (or use the touch panel rotary).
- Click-and-drag (or click, move the mouse, click to release) on the endocardial part of the ROI. Endocardial editing edits the whole ROI (Figure 8-17, upper part).
- Click-and-drag (or click, move the mouse, click to release) the anchor points on the epicardial ROI (highlighted in red on mouse hovering). Epicardial editing edits the epicardial part only (Figure 8-17, lower part).

A pictogram in the upper right corner of the screen indicates the core feature of a good ROI for the current view the user is analyzing.



Figure 8-17. ROI Editing Options

To create a new ROI

Selecting the correct frame

The system automatically displays a frame where the endocardial border is usually visible. To use another frame, while in *Define ROI* stage, pause the playback by pressing **Stop**. Then, use the **Frame** slider (or rotary on the Touch panel) to select a different frame for ROI definition.

Creating a new automatic ROI

To create a new automatic ROI, click the **Reset** stage symbol . This relaunches the automatic segmentation.

Creating a new manual ROI

Sometimes, the automatic ROI may fail to capture the correct ROI. In this case, a 3-Point ROI alternative is provided. To generate a ROI by this method, when in *Define ROI* stage, click on the **3-Click** button. The AFI tool will now prompt to place 3 landmarks. Take care to place the landmarks in the correct location according to the hints displayed close to the mouse pointer.

NOTE: The 3-Point ROI is the default ROI method for TEE data and Pediatric exams with raw data.

When the third landmark is placed, a ROI is generated and can optionally be edited as for the automatic ROI (Figure 8-18).

NOTE: If the ROI needs to be adjusted, make sure to make the changes immediately after the ROI is displayed, before the auto processing of the ROI begins.

*NOTE: Auto processing of the ROI will start after a given time delay that is configurable (from **Config**).*

NOTE: The YoYo function is turned on to help find the correct location of the landmarks.

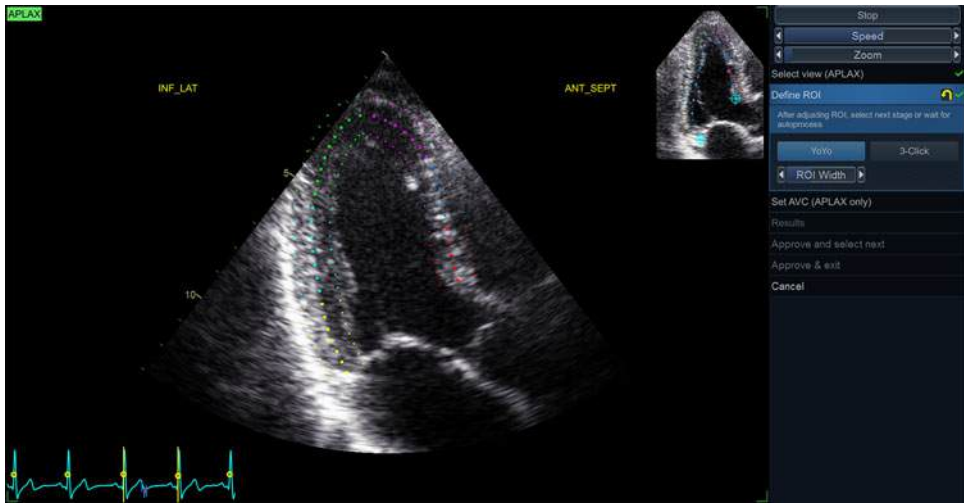

Figure 8-18. Defining a ROI

Guidelines for optimal ROI placing



Correct ROI definition is crucial to get good tracking. By not following the ROI definition guidelines, the tool accuracy may be reduced. See use cases below for common pitfalls.

Tip: Make sure to follow the recommendations when placing the three points (see below).

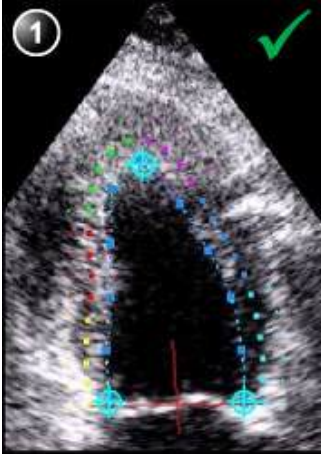
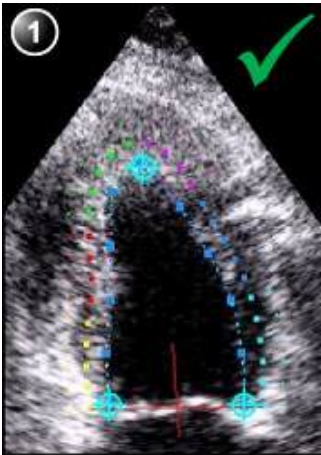
Base	Correct	Wrong
<ol style="list-style-type: none"> 1. Correct position of the base points. 2. The ROI extends into the aortic tract. 		

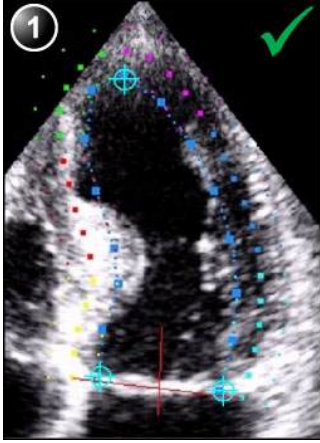
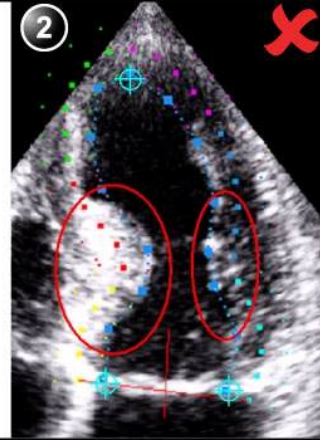
Apex	Correct	Wrong
<ol style="list-style-type: none">1. Correct position of the Apex point.2. The apex point is placed too high. The ROI is extending beyond the epicardium.	 A grayscale echocardiogram showing a heart cross-section. A red dashed line indicates the apex point, which is correctly positioned at the lowest point of the heart. A green checkmark is in the top right corner. A circular '1' is in the top left corner. A region of interest (ROI) is outlined in cyan, following the heart's contour.	
<ol style="list-style-type: none">1. Correct position of the Apex point.2. The upper right border of the ROI is way too much into the chamber cavity.	 A grayscale echocardiogram showing a heart cross-section. A red dashed line indicates the apex point, which is correctly positioned. A red 'X' is in the top right corner. A circular '2' is in the top left corner. The ROI (cyan outline) is incorrectly placed, extending significantly into the chamber cavity.	

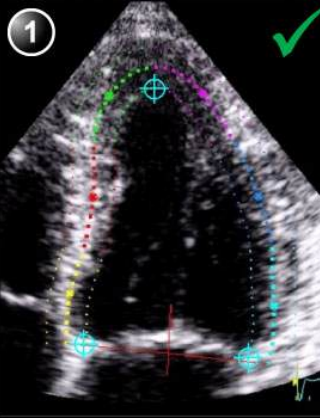
Bulges	Correct	Wrong
<ol style="list-style-type: none"> 1. Correct ROI. 2. ROI should not be bulging or follow the papillary muscle. To edit the ROI, see 'ROI adjustment' on page 8-36. 	 <p>Figure 1: A parasternal short-axis echocardiogram showing a correct ROI (Region of Interest) for strain analysis. The ROI is a smooth, curved line along the left ventricular wall, marked with a green checkmark. The ROI follows the contour of the ventricle without bulging or following the papillary muscle.</p>	 <p>Figure 2: A parasternal short-axis echocardiogram showing an incorrect ROI placement. The ROI is marked with a red 'X' and consists of two separate, bulging loops that do not follow the natural contour of the ventricle, indicating an error in measurement.</p>

General	Correct	Wrong
<p>The left ventricle must be visible through the entire cycle.</p> <ol style="list-style-type: none"> 1. End systole frame: the entire left ventricle is displayed. 2. End diastole frame: the annulus is not displayed. 	 <p>Figure 1: A parasternal short-axis echocardiogram showing correct frame selection. The end systole frame (top) shows the entire left ventricle, and the end diastole frame (bottom) shows the annulus. A green checkmark indicates this is the correct setup.</p>	 <p>Figure 2: A parasternal short-axis echocardiogram showing incorrect frame selection. The end diastole frame (bottom) shows the annulus, but the end systole frame (top) does not show the entire left ventricle. A red 'X' indicates this is an incorrect setup.</p>

Event timing

Timing information may be crucial to accurate diagnosis. The most important event timing is the aortic valve closure (AVC), since it is part of the definition of the end systolic strain parameter.

Determination of the AVC timing by the system is as follows, depending on the situation:

- If event timing is not available, an automatic AVC estimate is used, determined by the temporal contraction of all LV segments (Strain curves).
- From the APLAX view, the user can adjust the estimated AVC timing. The adjusted AVC timing will then be used in the other apical views when running AFI on these views.

AVC timing adjustment (APLAX only)

After tracking is performed, the system enters the Set AVC stage. The following options for AVC settings are provided:

- *Automatic:* AVC is set automatically based on the ROI tracking using the time of peak negative strain.
- *Event timing:* AVC is taken from the event timing measurements.

NOTE: This option is only available if the operator performed event timing measurement prior to running AFI, see page 8-16. If "AVC stage mode" is configured to be automatic (see 'Configurable workflow controls' on page 8-26 for more information), this stage will be skipped and the tool will proceed to the Results stage.

- *Manual:* Use the provided frame sliders and locate the AVC time manually before approving with the **Manual** button (or rotary on the Touch Panel).

Inspecting the results

After completed tracking, the system displays the *Quad* screen layout for tracking validation and inspection of results for the currently processed view.

The screen contains the following result displays:

- *Tracked ROI:* A dynamic display of the tracked ROI to be used for tracking validation. The tracked ROI has a texture overlay indicating strain values according to the colormap. The overlay may be turned off/on by clicking the **Color** button.

NOTE: Rejected segments will not have texture overlay.

- *Segmental result ROI:* A static display indicating the peak strain value per segment. Rejected segments are displayed with an X instead of a value. Clicking a segment changes its

rejection status (See 'Tracking' on page 8-35 for more information.)

- **Strain traces:** A static display indicating the segmental and global strain traces with time. The peak values are indicated.

NOTE: *The peak values can be adjusted by clicking and dragging the peak markers with the mouse.*



CAUTION

Segments and peak detection should be checked to make sure that non-physiological traces are excluded in the calculation of indices.

- **Curved anatomic M-mode:** A static display indicating a curved anatomic M-mode along the center of the ROI. The M-mode has a parametric overlay indicating peak strain values.

NOTE: *Rejected segments will not have texture overlay.*

NOTE: *The Segmental result ROI, Strain traces and Curved anatomic M-mode are using color codes to link the different segments.*

Peak detection

The peak systolic strain detection for each segment can be verified and manually adjusted as required. To adjust the peak detection:

1. Press **BE+Traces**. The *Bull's Eye and Traces* screen is displayed (see Figure 8-21)
2. To change the peak marker position on a curve:
 - Click on the peak marker (square point) on one of the curves, move the peak marker to a new position and click again to fix the point.
 - Place the cursor on a segment in the Bull's Eye. The corresponding curve is highlighted. Click on the segment to select the corresponding peak marker and move it to a new position.

The peak type is determined by the selected color map (systolic for PSS, global for PSI and TTP). The position of the AVC marker can also be checked in the *Bull's Eye and Traces* screen. If needed, the APLAX view should be reprocessed to change the AVC time.

When using one click workflow (available with Easy AFI LV option only), several automatically processed elements should be inspected before approval. These items can be visually

inspected from the result screen (see Figure 8-19 on page 8-45).

What to inspect?	How to inspect?	How to edit if wrong?
View and wall names are correct	Check that the three looping B-mode images correspond to the respective view labels as visible in the top left corner of each image and the wall names as visible at each side of the ultrasound sector.	If view label is wrong: Double click on the B-mode which is not corresponding to the view label. Then click the <i>Select View</i> stage in the menu and select a new image from clipboard. If wall names are Left-Right flipped: Double click the relevant B-mode, then click Select View and Left-Right Flip .
Tracking is correct (and thus implicitly the ROI is correct)	For each of the three looping B-mode images, check that the tracked ROI corresponds to the underlying motion as visible in the B-mode. See 'Tracking' on page 8-35 for details on evaluating tracking.	Double click on the B-mode with bad tracking. Adjust the ROI. Then click Process or wait for auto process. If tracking of a segment cannot be improved by adjusting the ROI, click on the segment to reject it.
EF	Inspect the EF values as visible above the Bull's eye and to the right of 4CH and 2CH views and compare with the LV motion. Also inspect the green endocardial contours (which are used for the EF calculation). To inspect volume values and/or the EF ED/EF ES frames specifically, click Review Item – EF . This will provide the same information as when running the dedicated AutoEF tool.	If ED or ES frames are wrong, click the Review Item - EF button and edit the frames using the available controls as described for AutoEF. If the EF is wrong due to the tracking being wrong, follow the above process for fixing the tracking/ROI delineation.
AVC	Inspect the green AVC mark on ECG of the APLAX view and compare with aortic valve closure as visible in the B-mode. Use Speed , Zoom , Stop , and Frame controls if necessary.	If AVC is wrong, click the Edit AVC button visible on the APLAX view. Click Set AVC - Manual and position AVC at the correct time point according to the valve closure as visible in the image.

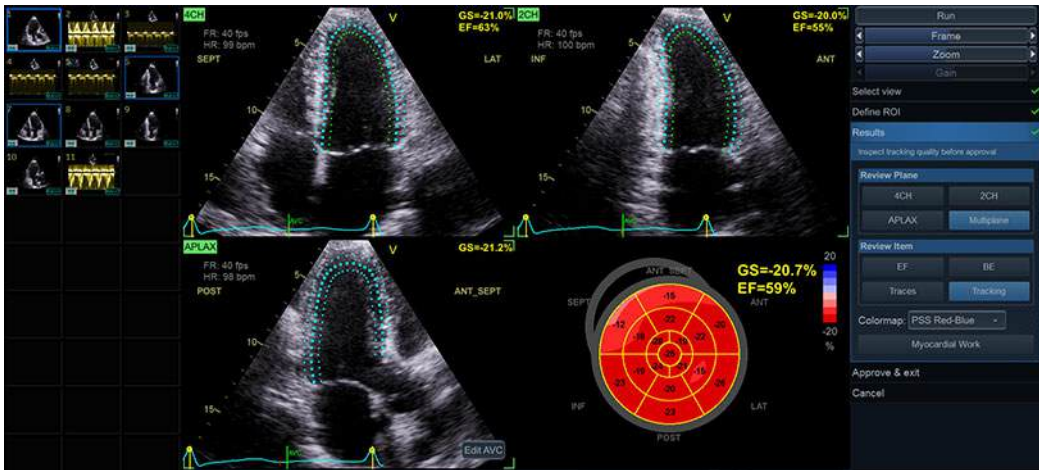

Figure 8-19. AFI result screen

Exiting AFI

When in the *Results* stage the operator may click the **Approve and Exit** button. The behavior depends on the number of views analyzed:

- If all three views were analyzed the tool will go to the Bull's eye only layout and prompt the operator whether the results should be stored. If **Yes** is selected, measurements are transferred to the worksheet, and a result file with a screenshot of the Bull's Eye will be generated. See also the section 'Reprocessing Data' on page 8-47.
- If only one or two views were analyzed, the tool will enter the Quad layout of the most recently processed view and prompt the operator whether the results should be stored. If **Yes** is selected, measurements are transferred to the worksheet and a result file with a screenshot of the Quad screen is generated. See also the section 'Reprocessing Data' on page 8-47.

Completed analysis results

When all three apical views have been analyzed, the result screen provides three new Layouts to inspect global function.

- *BE Only*. Bull's eye presentation with segmental full wall Peak systolic strain color coding and segmental Peak systolic strain values.
- *BE+Traces*. In addition to the Bull's eye, also displays the strain traces for all three views. In this view, it is possible to correct trace peaks by clicking and dragging peak markers

or clicking the corresponding segment in the Bull's eye (Figure 8-21).

- *BE+Review*. In addition to the Bull's eye, also displays the cineloops for all three views.

Bull's eye standards

The Bull's eye can be configured to display either 18 or 17 segments using either the AFI or the ASE standard (from **Config**). Consult the Vivid S70N / S60N Reference Manual for more information regarding Bull's Eye segmentation formats.



If reprocessing a file with a different Bull's Eye standard, the segmental values will change. The system will warn the operator if attempting to reanalyze a stored loop with a different Bull's eye standard.

Bull's eye colormaps

The tool provides a set of different colormaps for the Bull's Eye. The different colormaps are available from the *Colormap* dropdown menu in the *Result stage* menu.

The system can be configured to display other color maps (**Config**). The following colormaps are available:

- *PSS Red-Blue*: Peak systolic strain in a red-blue color coding.
- *PSS-Green-Yellow-Red*: Peak systolic strain in a green-yellow-red color coding.
- *PSI*: Post Systolic Index (PSI) color coding and segmental PSI values in the Bull's eye
- *TTP*: Time-to-peak strain (TTP) color coding and segmental TTP values in the Bull's eye

NOTE: *PSI and TTP color maps are based on the global peaks (as supposed to systolic peaks).*

Rejected segments in the Bull's Eye are identified by the peak values being replaced by a X, and that the segment is greyed out in the colorimetric display, see Figure 8-20.

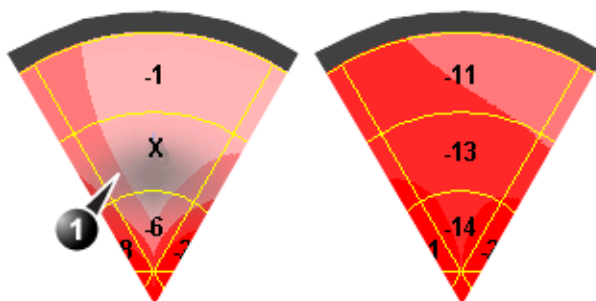

1. Segment with tracking quality scored as Not acceptable (**X**).

Figure 8-20. Colorimetric display

About the results

Be aware of the following:

- Clinical assessments should be made based on both color and segmental full wall Peak systolic strain values.
- No values shown in any *Result* screen will be transferred to the *Worksheet* unless either **Approve and Exit** or **Approve and select next** is pressed.
- All results shown (curves, colors, and values) are based on drift compensated values. Any strain drifting is linearly compensated throughout the cycle. If the drift compensation in a given segment is too high, the segment is automatically rejected.
- If more than one segment is rejected, the Global Strain value is not calculated.

Reprocessing Data

The data from one or several views from a saved AFI analysis may be reprocessed.

NOTE: When doing reprocessing, if the operator chooses to store the results, the results will be treated as new analysis with new measurements in the worksheet and a new thumbnail in the clipboard.

Incomplete analysis (AFI on LV with not all 3 views)

1. Double-click on the thumbnail showing the AFI Quad screen result layout. Depending on the number of views analyzed, either a dual or a quad screen is displayed, showing the last Quad view result screen and the cineloops processed in that analysis.

2. Launch **AFI**. The tool will proceed to the *Results* stage of the last analyzed view. The user may choose to reprocess the views already analyzed or to complete the analysis by processing the missing view(s).

Complete analysis (3 views)

1. Double-click on the thumbnail showing the AFI Bull's Eye layout. A quad screen is displayed, showing the Bull's Eye and the 3 cine-loops processed in that analysis.
2. Launch **AFI**. The tool will proceed to the final *Results* stage. The user may choose to reprocess the views already analyzed or even replace earlier processed views.

NOTE: A result file can only be reprocessed with the same AFI tool as it was originally processed. It is not possible to reprocess an AFI on LV result file with any other tool of the Vivid suite.

Measurements available after complete analysis

The following parameters are also available after completed analysis:

- Global Strain (GS) values for all three apical views. In a given view the Global Strain (GS), also called Global Longitudinal Peak Strain (GLPS), is defined as the percentage of maximal contraction over the whole cardiac cycle of the entire myocardial wall relative to its end diastolic length.
- Average Global Strain value from all three apical views. Global strain per view is not the average of the 6 segmental values. It is calculated as if the whole ventricular view is one large segment, from base to base. If more than two segments are rejected, no global view strain is shown. The global strain for the left ventricle is calculated as the arithmetic average of the three global view strain values.
- AVC measurement (either automatic, event timing measurement or manual, see page 8-60).
- PSD: Peak Strain Dispersion is an index that displays variability in time-to-peak (TTP) longitudinal strain. The index is the standard deviation of the TTP strain (of all segments) over the whole cycle. The TTP bulls-eye is useful in association with PSD as the color scheme uses green color to indicate normal contraction with a peak around AVC, blue color to indicate early contraction, and yellow to red color to indicate late contraction.



CAUTION

Rejection of non-physiological traces and correct peak detection (see also 'Inspecting the results' on page 8-42) is particularly important when using the TTP color map, as wrong peaks will influence the PSD index significantly. Peaks detected in very early systole and late diastole should be checked, and traces rejected if they are considered non-physiological.

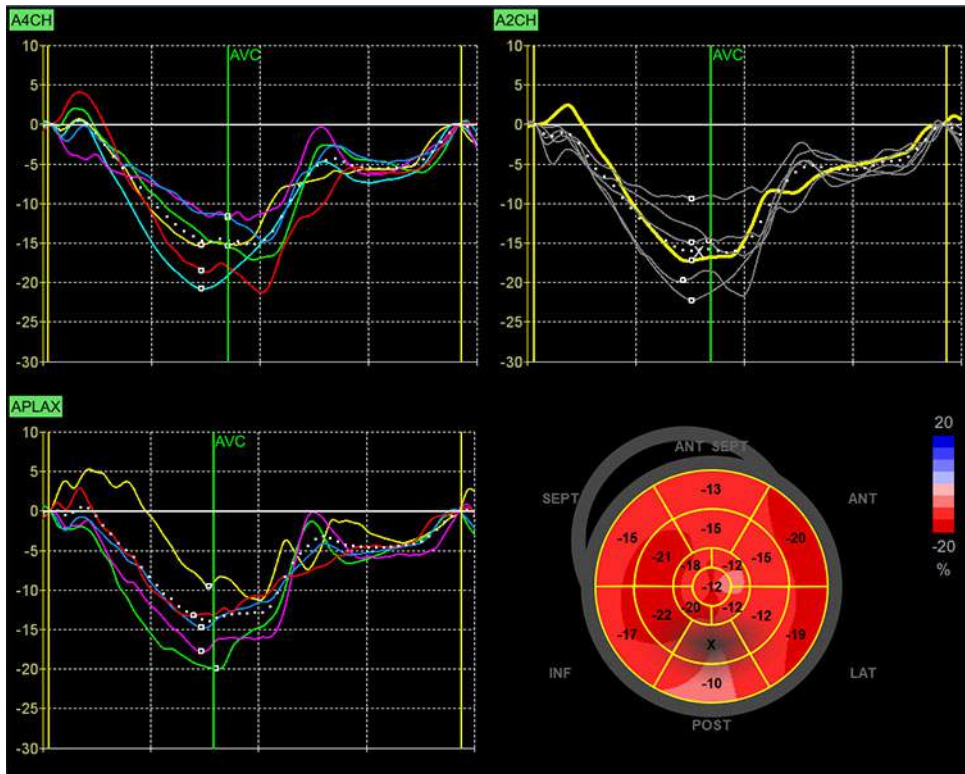

Figure 8-21. Bull's Eye and Traces screen

AFI on the Right Ventricle

Automated Functional Imaging of the Right Ventricle should be performed on a RV focused view. It is important that the free-wall (FW) is well visible throughout the heart cycle.

Data Requirements

Data types

AFI of the RV is only available for raw data.

Views

AFI of the RV should be performed on RV focused apical 4-chamber (A4CH) images.

Recommended Probes

Table 8-3: Recommended probes - AFI on RV

	Probes
Cardiac	M5Sc-D, 3Sc-RS, 4Vc-D
Pediatric	6S-D, 12S-D

NOTE: *AFI is only recommended for the probes in Table 8-3. The measurement accuracies of the longitudinal strain values reported in 'Measurement accuracy' on page 8-152 are verified with these probes.*

Image characteristics

- A frame rate higher than 40 frames per second is recommended. A lower frame rate is accepted by the tool (37 fps). Higher frame rates will benefit the workflow by making it easier to achieve satisfactory speckle tracking. A higher frame rate is recommended for high heart rates.
- The entire myocardium should be visible.
- A depth range that includes the entire heart chamber of interest (RV) should be used.
- Acquisitions must be made without the use of contrast agents.

Acquisition

Create an exam, connect the ECG device and make sure to obtain a stable ECG trace.

Heart rate and cycles

- If the acquisition has more than one heart cycle, the analysis will by default be done on the second to last heart cycle.
- The system should be configured to store 100 ms before and after each heart cycle.

Configuring the tool

It is possible to configure some of the AFI controls and analysis settings.

To access the configuration menu, press **Utility/Config** on the Touch Panel, select the category **Meas/Text**, and the **Advanced Quantification** subgroup.

Select **AFI RV** to configure the AFI tool designed for analysis on the Right Ventricle.

Configurable workflow controls

- *Autoprocessing timeout* – The time the operator must keep the trackball still before tracking automatically starts.
- *YoYo* – When adjusting the ROI, select whether a limited number of frames around the selected ROI frame should be looped back and forth to ease ROI adjustment.

Configurable analysis settings

- *Strain reference layer* – Select whether the strain values shall be calculated based on endocardial or full wall tracking.

Reference layer for strain

The tool supports calculation of strain parameters based on either endocardial deformation or myocardial/full wall deformation.



Measurements based on endocardial and myocardial analysis are not comparable.

- Endocardial deformation is assessed by performing analysis of the endocardial part of the ROI trace. Measurements derived from endocardial deformation are suffixed Endo.
- Myocardial/full wall deformation is assessed by performing analysis of the whole ROI trace. Measurements derived from myocardial deformation are suffixed Full.

NOTE: *If attempting to reprocess an analysis using a different reference layer a warning will be shown informing that the values in the analysis will change.*

Starting AFI on RV

1. Open the exam for which you want to perform AFI on RV analysis and select the A4CH image you would like to use for the analysis.
2. Press **Measure** on the Control Panel and select **AFI RV**. The tool will launch in the *Define ROI* stage with the

selected view. Use the **Cycle** slider to select the heart cycle to perform the analysis on (if more than one is available).

Navigating the tool

Perform the analysis by following an on-screen guided workflow (see Figure 8-22).

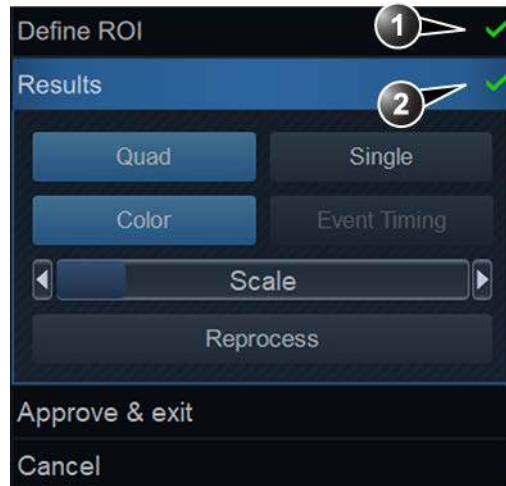

1. Stage previously visited
2. Active stage

Figure 8-22. A typical AFI workflow menu

The *Workflow* menu (or stage menu) is located on the right side of the tool. It contains a set of stages the user should visit sequentially. It is possible to re-visit already viewed stages. Click on their title to navigate to any available stage. Stages that are not accessible given the tool's state are greyed out.

The stages of an AFI analysis on the right ventricle are:

- Define ROI – where the user draws the ROI where speckle tracking will take place.
- Results – where the user examines the results of the analysis.

Most stages require interaction with the user, and hints on what is expected are given below the stage title (see Figure 8-23).



- If a stage is labeled , the stage is complete and nothing more needs to be done in that tool stage.
- Click the  (reset) button to reset the stage and clear all user-entered information in that stage.



Figure 8-23. AFI Workflow menu

When available, press **Approve & Exit** to approve the analysis and store the reviewed measurements to worksheet. See 'Measurements available after complete analysis' on page 8-63 for the list of stored measurements after performing AFI of the RV.

At any time, click **Cancel** to exit the tool without saving any analysis.

Tracking

The accuracy of the measurements provided by AFI rely on good tracking quality.



Poor tracking quality may lead to incorrect measurement results. The tracking for each segment must be visually controlled and validated.

Poor tracking quality could result from a variety of causes. The most common causes for bad tracking are:

- Erroneous placement of the basal points when defining the ROI. If the basal points are placed too far from the annular region, the ROI segments at the annular base will not move together with the underlying 2D image throughout the entire heartbeat.
- Erroneous placement of the apex when defining the ROI. The point should be placed so that the resulting ROI covers mainly the myocardium. If the apex point is placed too high, the ROI will mainly cover the epicardium, resulting in poor tracking.
- Too narrow ROI width. Narrowing the ROI too much will result in poor tracking due to lack of tissue data in the ROI.
- Too much clutter. Images with too much static clutter will result in poor tracking.

Inspect each segment and make sure that the center line is moving together with the underlying 2D image. Use the various results layouts to examine the tracking quality (e.g. Quad layout).

The following can help examining the tracking quality:

- Turn off the color overlay by clicking **Color** button.
- Reduce playback speed by using the **Speed** slider (or the rotary on the touch panel).
- Use the *Single* layout to get a larger view of the dynamic mesh (especially in difficult cases).

If the tracking needs to be improved for some segments, the user can modify the ROI or create a new ROI.

ROI segments

The ROI used in AFI RV includes both the intraventricular septum and the right ventricle Free wall.

For each of these walls, strain is calculated in three segments: base, mid and apex (see Figure 8-24)

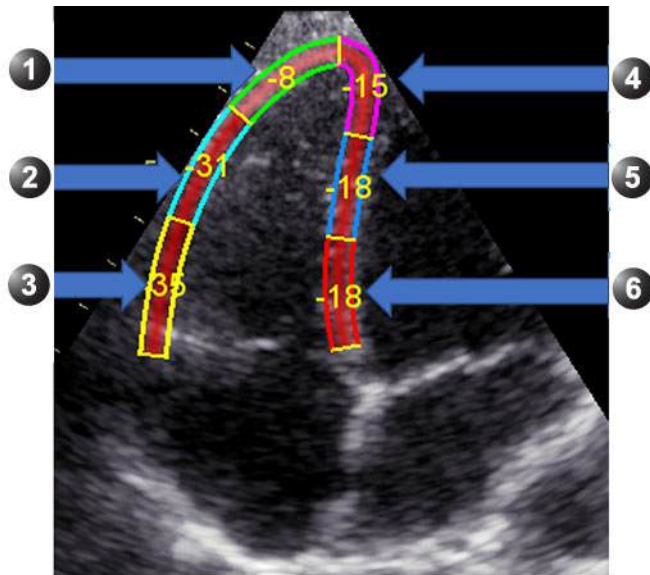

- | | |
|-------------|--------------|
| 1. Apex FW | 4. Apex IVS |
| 2. Mid FW | 5. Mid IVS |
| 3. Basal FW | 6. Basal IVS |

Figure 8-24. Segments on AFI on RV ROI

ROI adjustment

If the automatic ROI is not optimal (resulting in poor tracking), the user can either adjust the ROI or create a new ROI as described below.

General ROI remarks

The calculations performed on the tracked ROI aim to find the longitudinal deformation along the cardiac muscle from base to apex. For an AFI analysis of the Right Ventricle, these calculations assume the ventricle to show a hinge at the apex.



If the ROI does not have a hinge in the apex, the calculated measurements may not be accurate.

To adjust the ROI

The following adjustments can be done in the Define ROI stage:

- Adjust *ROI width* by clicking the **ROI Width** slider (or use the Touch Panel rotary).
- Click-and-drag (or click, move the mouse, click to release) on the endocardial part of the ROI. Endocardial editing edits the whole ROI (Figure 8-25, upper part).
- Click-and-drag (or click, move the mouse, click to release) the anchor points on the epicardial ROI (highlighted in red on mouse hovering). Epicardial editing edits the epicardial part only (Figure 8-25, lower part).

A pictogram in the upper right corner of the screen indicates the core feature of a good ROI for the current view the user is analyzing.

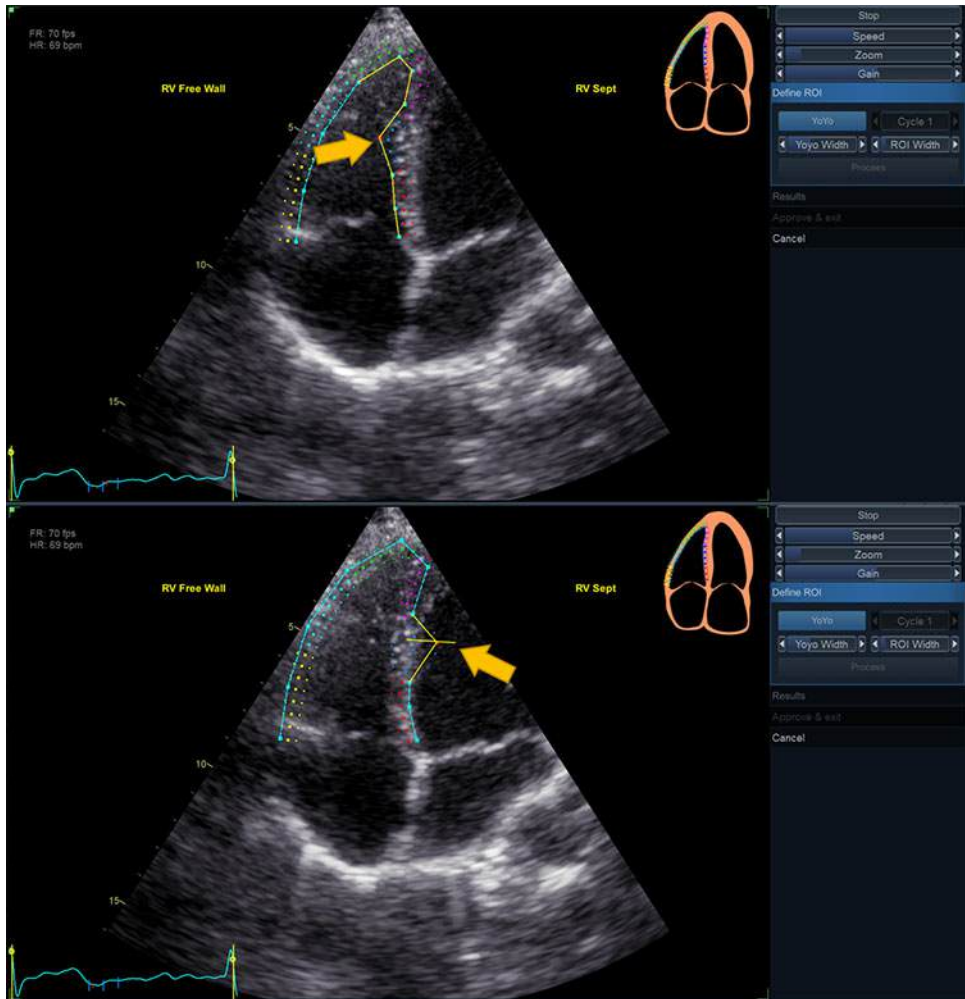



Figure 8-25. ROI Editing Options

To create a new ROI

Selecting the correct frame

The system automatically displays a frame where the endocardial border is usually visible. To use another frame, while in *Define ROI* stage, pause the playback by pressing **Stop**. Then, use the **Frame** slider (or rotary on the Touch Panel) to select a different frame for ROI definition.

Creating a new ROI

While in *Define ROI* stage, use the **Reset**  button to remove the previous ROI.

The AFI tool will now prompt to place 3 landmarks. Take care to place the landmarks in the correct location according to the hints displayed close to the mouse pointer.



CAUTION

Faulty landmark selection may cause segment values to be swapped in the final results.

When the third landmark is placed, a ROI is generated and can optionally be edited (Figure 8-26).

NOTE: *If the ROI needs to be adjusted, make sure to make the changes immediately after the ROI is displayed, before the auto processing of the ROI begins.*

NOTE: *Auto processing of the ROI will start after a given time delay that is configurable (from **Config**).*

NOTE: *The YoYo function is turned on to help find the correct location of the landmarks.*

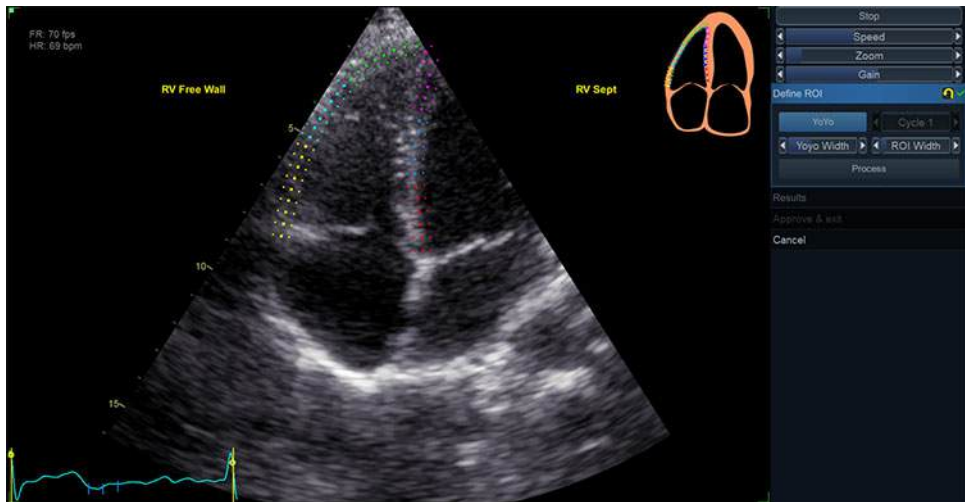



Figure 8-26. Defining a ROI



Guidelines for optimal ROI placing

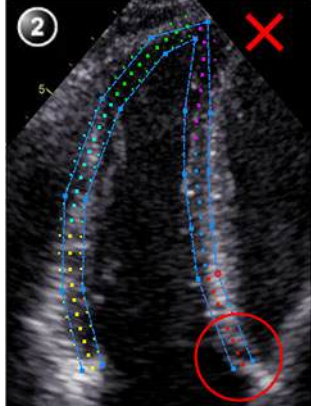
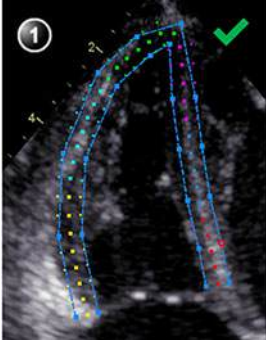
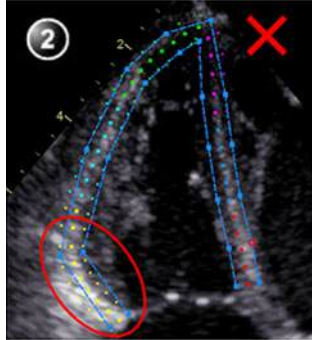

Please refer to the current official recommendations on Right Ventricle strain analysis on 2D images for state-of-the-art ROI placement guidelines. Unless current guidelines state otherwise, it is not recommended to include the whole interventricular septum in the AFI RV ROI. Instead, the ROI width in the interventricular septum should be kept similar to that of the free wall.

Measurements and Analysis

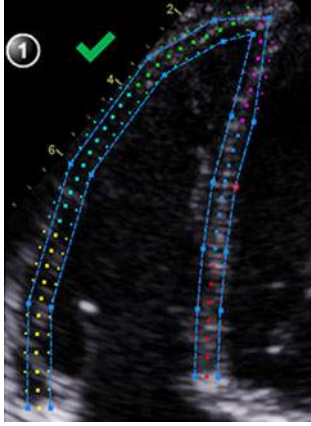
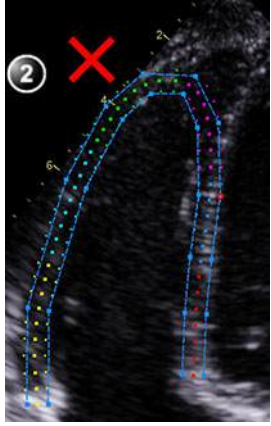
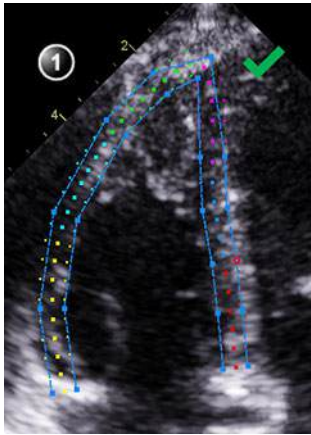
Correct ROI definition is crucial to get good tracking. By not following the ROI definition guidelines, the tool accuracy may be reduced. See use cases below for common pitfalls.

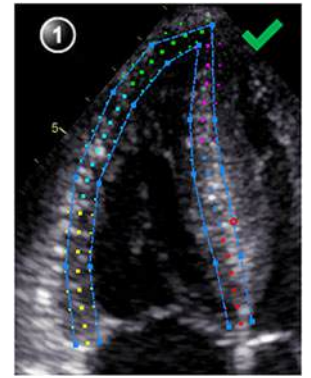
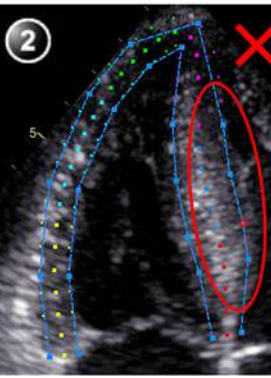
Base	Correct	Wrong
<ol style="list-style-type: none">1. Correct position of the base points, at the tricuspid leaflet insertion level.2. The ROI goes to the level of the mitral annulus.	 <p>Figure 1: Correct ROI definition. The ROI (blue dashed line) is correctly positioned at the tricuspid leaflet insertion level (marked with a green checkmark) and extends to the level of the mitral annulus. The ROI is straight at the base.</p>	 <p>Figure 2: Wrong ROI definition. The ROI (blue dashed line) is incorrectly positioned at the tricuspid leaflet insertion level (marked with a red X) and extends to the level of the mitral annulus. The ROI is curved at the base, which is circled in red.</p>
<ol style="list-style-type: none">1. Correct position of the base point.2. The ROI is curved at base level.	 <p>Figure 1: Correct ROI definition. The ROI (blue dashed line) is correctly positioned at the tricuspid leaflet insertion level (marked with a green checkmark) and is curved at the base level.</p>	 <p>Figure 2: Wrong ROI definition. The ROI (blue dashed line) is incorrectly positioned at the tricuspid leaflet insertion level (marked with a red X) and is curved at the base level, which is circled in red.</p>

Apex	Correct	Wrong
<ol style="list-style-type: none"> 1. Correct shape at apex. 2. The ROI does not show a sharp angle at apex. 	 <p>Figure 1: A parasternal long-axis echocardiogram showing a correctly defined region of interest (ROI) for the left ventricle. The ROI is outlined with a blue dashed line and contains several colored dots (green, yellow, red, purple). The apex is clearly defined with a sharp angle, indicated by a green checkmark and the number 1 in a circle.</p>	 <p>Figure 2: A parasternal long-axis echocardiogram showing an incorrectly defined ROI for the left ventricle. The ROI is outlined with a blue dashed line but has a rounded apex, indicated by a red X and the number 2 in a circle.</p>
<ol style="list-style-type: none"> 1. Correct placement of apex. 2. The apex is too low. 	 <p>Figure 1: A parasternal long-axis echocardiogram showing a correctly placed ROI for the left ventricle. The ROI is outlined with a blue dashed line and contains several colored dots. The apex is correctly placed and indicated by a green checkmark and the number 1 in a circle.</p>	 <p>Figure 2: A parasternal long-axis echocardiogram showing an incorrectly placed ROI for the left ventricle. The ROI is outlined with a blue dashed line but is positioned too low, indicated by a red X and the number 2 in a circle.</p>
Septum	Correct	Wrong
<ol style="list-style-type: none"> 1. Correct septum ROI. 2. The ROI includes the left ventricular part of the septum. 	 <p>Figure 1: A parasternal long-axis echocardiogram showing a correctly defined ROI for the septum. The ROI is outlined with a blue dashed line and contains several colored dots. The ROI is correctly placed and indicated by a green checkmark and the number 1 in a circle.</p>	 <p>Figure 2: A parasternal long-axis echocardiogram showing an incorrectly defined ROI for the septum. The ROI is outlined with a blue dashed line but includes the left ventricular part of the septum, indicated by a red X and the number 2 in a circle.</p>

Bulges	Correct	Wrong
<ol style="list-style-type: none"> 1. Correct ROI. 2. ROI should not be bulging or follow the papillary muscle (to edit ROI, see 'ROI adjustment' on page 8-55.) 		

Event timing

The peak strain measured on the Right Ventricle is measured between the start of the cycle and the Pulmonic Valve Closure (PVC) time.

If PVC has been measured in the current exam using Event Timing, the AFI RV tool will use this value to determine the time range in which the peak systolic strains have to be found.

Unselect the **Event Timing** button to use PVC calculated from the tracking results (see Figure 8-27). In this case, PVC will be calculated based on the time of the peak negative strain.

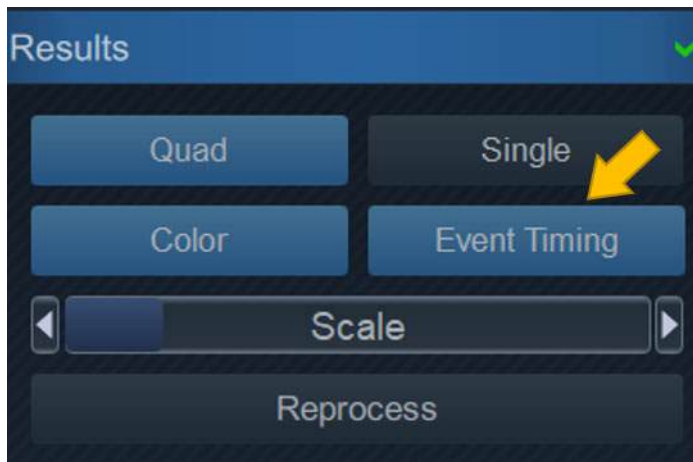

Figure 8-27. Event Timing button

Inspecting the results

After completed tracking, the system displays the *Quad* screen layout for tracking validation and inspection of results for the currently processed view.

The screen contains the following result displays:

- *Tracked ROI*: A dynamic display of the tracked ROI to be used for tracking validation. The tracked ROI has a texture overlay indicating strain values according to the colormap. The overlay may be turned off/on by clicking the **Color** button.

NOTE: *Rejected segments will not have texture overlay.*

- *Segmental result ROI*: A static display indicating the peak strain value per segment. Rejected segments are displayed with an X instead of a value. Clicking a segment changes its rejection status (See 'Tracking' on page 8-53 for more information.)
- *Strain traces*: A static display indicating the segmental and global strain traces with time. The peak values are indicated.

NOTE: *The peak values can be adjusted by clicking and dragging the peak markers with the mouse.*



Segments and peak detection should be checked to make sure that non-physiological traces are excluded in the calculation of indices.

- *Curved anatomic M-mode*: A static display indicating a curved anatomic M-mode along the center of the ROI. The M-mode has a parametric overlay indicating peak strain values.

NOTE: *Rejected segments will not have texture overlay.*

NOTE: *The Segmental result ROI, Strain traces and Curved anatomic M-mode are using color codes to link the different segments.*

Peak detection

The peak systolic strain detection for each segment can be verified and manually adjusted as required. To adjust the peak detection:

1. Go to *Results* stage. The quadrant view is displayed.
2. To change the peak marker position on a curve, click on the peak marker (square point) on one of the curves, move the peak marker to a new position and click again to fix the point.

The peak type is determined by the selected color map (systolic for PSS, global for PSI and TTP). The position of the PVC can also be checked on the curves graph.

Exiting AFI

When in the *Results* stage, the operator may click the **Approve and Exit** button. The tool will prompt the operator whether the results should be stored. If **Yes** is selected, measurements are transferred to the worksheet, and a result file with a screenshot of the *Results* stage will be generated. See also 'Reprocessing Data' on page 8-62.

Completed analysis results

A completed AFI analysis on the right ventricle is a single view analysis that can be stored in a result file.

Relevant strain data can be observed at the *Results* stage screen.

Peak systolic strain values per segment can be observed on the lower left quadrant, inside the ROI mesh.

Strain values per segment during the chosen analyzed cycle can be observed on the graph on the upper right quadrant. It is also visible on the color anatomical M-Mode (CAMM) on the lower right quadrant.

Global values are displayed as text on the lower left quadrant.

About the results

Be aware of the following:

- All results shown (curves, colors, and values) are based on drift compensated values. Any strain drifting is linearly compensated throughout the cycle. If the drift compensation in a given segment is too high, the segment is automatically rejected.
- No values shown in any *Result* screen will be transferred to the Worksheet unless **Approve and Exit** is pressed.
- If more than one segment is rejected, the Global Strain is not calculated.
- If more than one segment of the Free wall is rejected, the Free Wall Strain is not calculated.

Reprocessing Data

The data from a saved AFI analysis on the RV may be reprocessed.

NOTE: *When doing reprocessing, if the operator chooses to store the results, the results will be treated as new analysis with new measurements in the worksheet and a new thumbnail in the clipboard.*

1. Double-click on the thumbnail showing the AFI RV *Results* stage.
2. Launch **AFI RV**. The tool will proceed to the *Results* stage. You may choose to reprocess the view already analyzed, after the ROI or segments' approval.

NOTE: *A result file can only be reprocessed with the same AFI tool as it was originally processed. It is not possible to reprocess an AFI on RV result file with any other tool of the Vivid suite.*

Measurements available after complete analysis

After a complete analysis has been performed, the following measurements can be transferred to the worksheet:

- Tricuspid Annular Plane Systolic Excursion (TAPSE)
- Global Peak strain on the entire Right Ventricle wall is defined as the percentage of maximal contraction over the whole cardiac cycle of the entire myocardial wall, relative to its end diastolic length
- Global Peak Systolic strain on the Right Ventricle Freewall is defined as the percentage of maximal contraction of the right ventricle free wall, relative to its end diastolic length
- The peak systolic strains calculated on each of the segments

AFI on the Left Atrium

Automated Functional Imaging of the Left Atrium should be performed on a LA focused 4-Chamber and 2-Chamber view. It is important to avoid foreshortening of the LA chamber.

Data Requirements

Data types

Automated Function Imaging of the Left Atrium is only available for raw data.

Views

AFI of the LA should be performed on LA focused apical 4-chamber (A4CH) and apical 2-chamber images.

Recommended Probes

Table 8-4: Recommended probes - AFI on LA

	Probes
Cardiac	M5Sc-D, 3Sc-RS, 4Vc-D
Pediatric	6S-D, 12S-D

NOTE: *AFI on LA is only recommended for the probes in Table 8-4. The measurement accuracies of the longitudinal strain values reported in 'Measurement accuracy' on page 8-152 are verified with these probes.*

Image characteristics

- A frame rate higher than 40 frames per second is recommended. A lower frame rate is accepted by the tool (37 fps). Higher frame rates will benefit the workflow by making it easier to achieve satisfactory speckle tracking. A higher frame rate is recommended for high heart rates.
- The entire left atrium should be visible. Measurements are not reliable if images are foreshortened.
- A depth range that includes the entire heart chamber of interest (LA) should be used.
- Acquisitions must be made without the use of contrast agents.

Acquisition

Create an exam, connect the ECG device and make sure to obtain a stable ECG trace.

Heart rate and cycles

- If the acquisition has more than one heart cycle, the analysis will by default be done on the second to last heart cycle unless a different cycle was selected before starting AFI.
- The system should be configured to store 100ms before and after each heart cycle.

Configuring the tool

It is possible to configure some of the AFI controls and analysis settings.

To access the configuration menu, press **Utility/Config** on the Touch Panel, select the category **Meas/Text**, and the **Advanced Quantification** subgroup.

Select **AFI LA** to configure the AFI tool designed for analysis on the Left Atrium.

Configurable workflow controls

- *Autoprocessing timeout* – The time the operator must keep the trackball still before tracking automatically starts.
- *YoYo* – When adjusting the ROI, select whether a limited number of frames around the selected ROI frame should be looped back and forth to ease ROI adjustment.
- *EF reminder* – Select **Yes** to be reminded to visit the EF layout on A4CH and A2CH views analysis. Visiting the EF layout is mandatory to obtain EF values in Worksheet while using AFI for the analysis of the Left Atrium.

Starting AFI on LA

1. Open the exam for which you want to perform AFI LA analysis and select one of the apical LA focused image to use for the analysis.
2. Press **Measure** on the Control Panel and select **AFI LA**. The tool will launch in the Select View stage. If more than one heart cycle is available, use the **Cycle** slider to select which heart cycle to perform the analysis on.

Navigating the tool

Perform the analysis by following an on-screen guided workflow (see Figure 8-28).

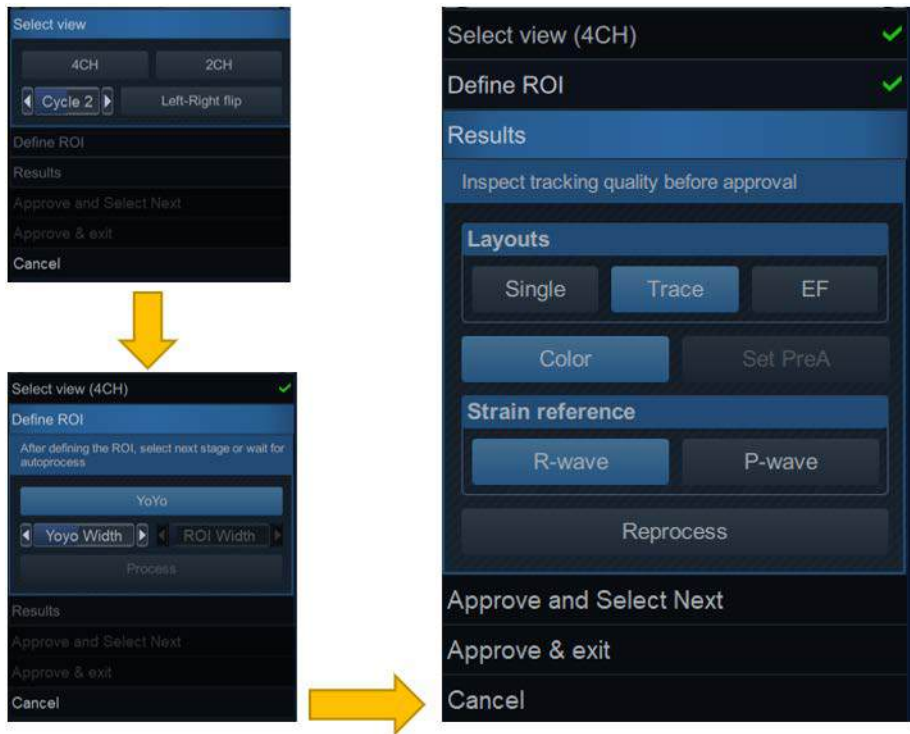



Figure 8-28. A typical AFI LA workflow menu

The workflow menu (or stage menu) is located on the right side of the tool. It contains a set of stages the user should visit sequentially. It is possible to re-visit already viewed stages. Click on their title to navigate to any available stage. Stages that are not accessible given the tool's state are greyed out.

The stages of an AFI analysis of the left atrium are:

- Select View – where the user indicates to the tool which view will be analyzed
- Define ROI – Where the ROI is drawn, speckle tracking will take place.
- Results – Examination of the analysis' results.

Most stages require interaction with the user, and hints on what is expected are given below the stage title.

- If a stage is labeled , the stage is complete and nothing more needs to be done in that tool stage.
- Click the  (reset) button to reset the stage and clear all user-entered information in that stage.

When available, press **Approve and select next** to return to the Select view stage and perform the analysis for a new view.

When available, press **Approve & Exit** to approve the analysis and store the reviewed measurements to worksheet. See 'Measurements available after complete analysis' on page 8-73 for the list of stored measurements after performing AFI of the LA.

At any time, click **Cancel** to exit the tool without saving any analysis.

Tracking

The accuracy of the measurements provided by AFI rely on good tracking quality.



Poor tracking quality may lead to incorrect measurement results.

Poor tracking quality could result from a variety of causes. The most common causes are:

- Erroneous placement of the basal points when defining the ROI. If the basal points are placed too far from the annular region, the ROI segments at the annular base will not move together with the underlying 2D image throughout the entire heartbeat.
- Erroneous placement of the atrial roof when defining the ROI. The point should be placed so that the resulting ROI covers mainly the myocardium. If the atrial roof point is placed too deep, the ROI will mainly cover the epicardium, resulting in poor tracking.
- Too narrow ROI width. Narrowing the ROI width too much will result in poor tracking due to lack of tissue data in the ROI.

Inspect tracking ROI closely and make sure that the center line in each region is moving together with the underlying 2D image. Use the various results layouts to examine the tracking quality (e.g. Single layout).

The following can help examining the tracking quality:

- Turn off the color overlay by clicking on the **Color** button.
- Reduce playback speed by using the **Speed** slider (or the rotary on the Touch Panel).
- Use the *Single layout* to get a larger view of the dynamic mesh (especially in difficult cases).

If the tracking needs to be improved for some regions, the user can modify the ROI or create a new ROI.

ROI adjustment

If the ROI is not optimal (resulting in poor tracking), the user can either adjust the ROI or create a new ROI as described below.

General ROI remarks

The calculations performed on the tracked ROI aim to find the longitudinal deformation along the cardiac muscle from base to atrial roof. For an AFI analysis of the Left Atrium, these calculations assume the atrium to have a horse-shoe shape.



If the ROI does not have a horse-shoe shape, the calculated measurements may not be accurate.

To adjust the ROI

The following actions can be done in the Define ROI stage:

- Adjust the ROI width by clicking the **ROI Width** slider (or use the Touch Panel rotary).
- Click-and-drag (or click, move the mouse, click to release) on the endocardial part of the ROI. Endocardial editing edits the whole ROI (see Figure 8-29, upper part).
- Click-and-drag (or click, move the mouse, click to release) the anchor points on the epicardial ROI (highlighted in red on mouse hovering). Epicardial editing edits the epicardial part only (see Figure 8-29, lower part).

A pictogram in the upper right corner of the screen indicates the core feature of a good ROI for the current view the user is analyzing.

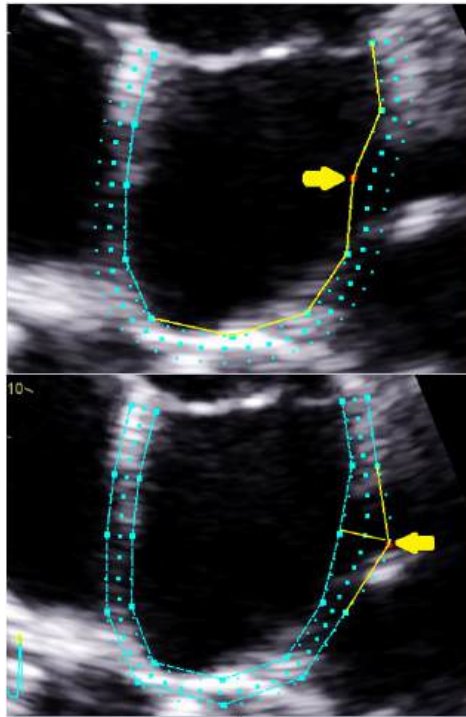



Figure 8-29. ROI editing options

To create a new ROI

Selecting the correct frame

The system automatically displays a frame where the endocardial border is usually visible. To use another frame, while in *Define ROI* stage, pause the playback by pressing **Stop**. Use the **Frame** slider (or rotary on the Touch Panel) to select a different frame for ROI definition.

Creating a new ROI

While in Define ROI stage use the Reset () button to remove the previous ROI.

The AFI tool will now prompt to place three landmarks. Take care to place the landmarks in the correct location according to the hints displayed close to the mouse pointer.

When the third landmark is placed, a ROI is generated and can optionally be edited (Figure 8-30).

NOTE: *If the ROI needs to be adjusted, make sure to make the changes immediately after the ROI is displayed, before the auto processing of the ROI begins.*

NOTE: Auto processing of the ROI will start after a given time delay that is configurable (from **Config**).

NOTE: The YoYo function is turned on to help find the correct location of the landmarks.

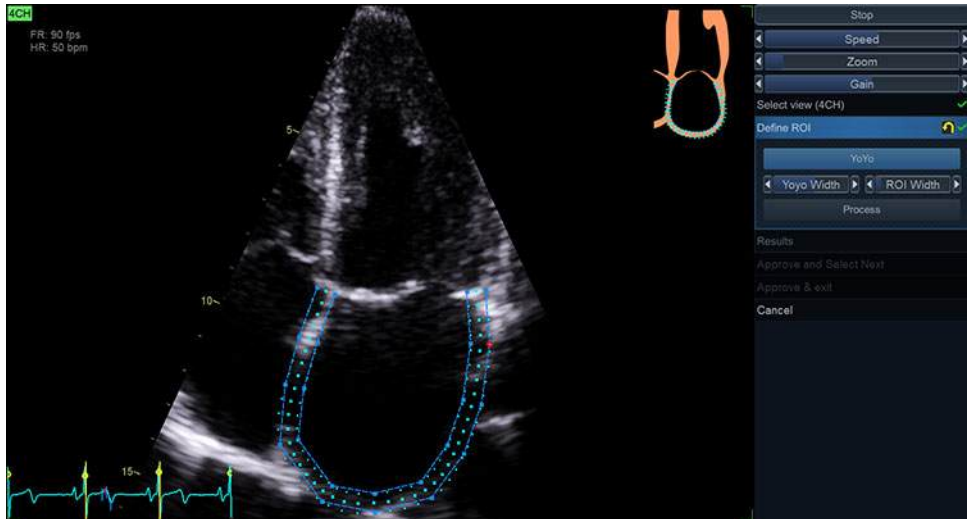
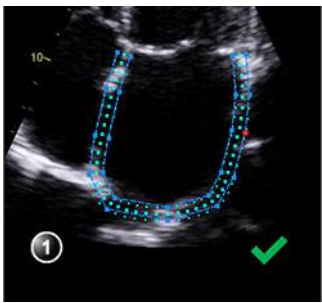
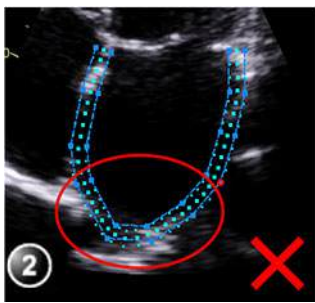

Figure 8-30. Defining a ROI

Guidelines for optimal ROI placing

Correct ROI definition is crucial to get good tracking. By not following the ROI definition guidelines, the tool accuracy may be reduced. See use cases below for common pitfalls.

Base	Correct	Wrong
<ol style="list-style-type: none"> 1. ROI should be bounded by mitral valve plane from top. 2. ROI goes above mitral valve plane. 		

Atrial roof	Correct	Wrong
1. Correct shape in atrial roof. 2. ROI is too sharp in atrial roof.		

Inspecting the results

After completed tracking, the system presents a dynamic display of tracked ROI for tracking validation and results inspection.

The screen contains the following result displays:

- Tracked ROI: A dynamic display of the tracked ROI to be used for tracking validation. The tracked ROI has a texture overlay indicating stretching with blue and contraction with red color. The overlay may be turned off/on by clicking the Color button.
- Strain trace: A static display indication the global strain trace with time.
- Measurements: Left atrium strain values during three phases of LA cycle: Reservoir strain (S_R), Conduit strain (S_CD) and contractile strain (S_CT), as well as the max LA volume for the processed view. Maximum LA volume for 4CH and 2CH views are displayed with LAV/max 4CH and LAV/max 2CH respectively.

NOTE: Clicking S_R, S_CD or S_CT from Measurement menu show corresponding (time, strain) pair on the stain trace with a red double arrow.

NOTE: Zero strain reference can be set either at R-wave (default) or P-wave. This can be configured on the stage menu by selecting R-wave or P-wave button under Strain reference.

NOTE: After completing processing the second view, the system displays the Biplane layout by default which contains the tracked ROI and strain trace for each view.

PreA time

PreA or the time before start of left atrium contraction is automatically calculated based on LA volume curve over entire LA cycle. However, user can edit this time by pressing Stop

button and use frame slider to select the desired frame time as PreA and then press Set PreA button. This is also possible by dragging PreA marker on ECG curve. Setting new PreA time updates PreA dependent LA measurement: S_CD, S_CT and LAVPreA.

Emptying fraction layout

The results screen for each view also has an Emptying Fraction (EF) layout. In this layout, the system presents automatically generated traces of the LA endocardium at minimum and maximum volume times used to calculate LA emptying fraction (LAEF), LA emptying volume (LAEV), maximum LA volume (LAVmax), minimum LA volume and LA volume at PreA time (LAVprea). Biplane volumes are calculated by Simpson MOD.

NOTE: Maximum and minimum volume time are calculated in proximity of LV end systolic and end diastolic frame times respectively.

NOTE: If the user does not open the EF layout while processing each view, the EF measurements generated in the AFI tool will not be considered as validated by the user. Therefore, they will not be transferred to the Worksheet.

Exiting AFI

When in the Results stage, the operator may click the **Approve and Exit** button. The behavior depends on the number of views analyzed:

- If only one was analyzed, the tool will enter the *Trace* layout of the processed view and prompt the operator whether the results should be stored. If **Yes** is selected, measurements are transferred to worksheet and a result file with a screenshot of the *Trace* screen is generated. See also the section 'Reprocessing Data' on page 8-73.
- If both views were analyzed, the tool will go to the *Biplane* layout and prompt the operator whether the result should be stored. If **Yes** is selected, measurements are transferred to worksheet and a result file with a screenshot of the *Biplane* screen is generated. See also the section 'Reprocessing Data' on page 8-73.

Completed analysis results

A completed AFI analysis on the left atrium is a two-view analysis that can be stored in a result file.

Relevant left atrium strain data at each phase of LA cycle can be observed at the *Results* stage screen.

Emptying fraction and all relevant volumes are displayed in the *Measurement* table.

About the results

Be aware of the following:

- All results shown (curve, and values) are based on a drift compensated strain curve. Any strain drifting is linearly compensated throughout the cycle. If the drift compensation is too high, a warning message is shown to the user.
- No values shown in any *Result* screen will be transferred to the Worksheet unless **Approve and select next** and finally, **Approve and Exit** is pressed.

Reprocessing Data

The data from a saved AFI analysis on the LA may be reprocessed.

NOTE: When doing reprocessing, if the operator chooses to store the results, the results will be treated as a new analysis with new measurements in the worksheet and a new thumbnail in the clipboard.

1. Double-click on the thumbnail showing the AFI LA *Results* stage.
2. Launch **AFI LA**. The tool will proceed to the Results stage. You may choose to reprocess the view already analyzed or alter the ROI.

NOTE: A result file can only be reprocessed with the same AFI tool as it was originally processed. It is not possible to reprocess an AFI on LA result file with any other tool of the Vivid suite.

Measurements available after complete analysis

All strain measurements are calculated as differences of two measurements on the strain curve, where the strain curve is defined as percentage contraction of the entire myocardial wall relative to the length at either the R-wave or P-wave. After a

complete analysis has been performed, the following measurements can be transferred to the worksheet:

- R-wave and P-wave referenced left atrium strain values at reservoir phase for each view. Defined as the difference of strain values at end and onset of the reservoir phase.
- R-wave and P-wave referenced left atrium strain values at conduit phase for each view. Defined as the difference of strain values at end and onset of the conduit phase.
- R-wave and P-wave referenced left atrium strain values at contractile phase for each view. Defined as the difference of strain values at end and onset of the contractile phase.
- Left atrium emptying fraction and volume for each view.
- Minimum and maximum left atrium volumes for each view as well as volume at PreA time.

AutoEF measurements for the Left Ventricle (Auto EF 3.0, Easy Auto EF)

Automated Ejection Fraction (AutoEF) is a semi-automatic measurement tool used for measurement of the global EF (Ejection fraction). The AutoEF tool is used as an optional decision support tool.

The AutoEF tool is derived from a 2D speckle tracking algorithm, which tracks and calculates the myocardial tissue deformation based on feature tracking on 2D grey scale loops.

AutoEF is performed on either one or both apical 4-chamber or 2-chamber views, in any order.

The result is presented as Ejection Fraction value, calculated by Simpson MOD for each view and MOD Bi-plane Ejection Fraction for the whole LV. All values are stored to the worksheet when approved.

NOTE: AutoEF is only recommended for the probes in Table 8-5. Easy AutoEF is only available for adult TTE. The measurement accuracies of the 2D Auto EF measurement values reported in 'Measurement accuracy' on page 8-152 are verified with these probes.

Table 8-5: Recommended probes - AutoEF

	Probes
Cardiac	M5Sc-D, 3Sc-RS, 4Vc-D, 6Tc, 6VT-D
Pediatric	6S-D, 12S-D

Acquisition

Acquisition with ECG and stored files

1. Create an exam, connect the ECG device and make sure to obtain a stable ECG trace.
2. Acquire 2D grey scale cineloops of an Apical 4 chamber view and an Apical 2 chamber view.

Acquisition without ECG

1. Create an adult Transthoracic Echocardiography (TTE) exam, start scanning.
2. Acquire and store 2D grey scale cineloops of Apical 4-chamber view or Apical 2-chamber view with length at least 3 seconds.

NOTE: In order to run the “AutoEF without ECG” feature, the Easy AutoEF and the “AutoEFwoECG” option keys must be enabled.

Acquisition requirements

- A frame rate higher than 40 frames per second is recommended. Lower frame rates are accepted by the tool (37 fps for raw data and 30 fps for DICOM). Higher frame rates will benefit the workflow by making it easier to achieve satisfactory speckle tracking. A higher frame rate is recommended for high heart rates.
- The system should be configured to store 100 ms before and after each heart cycle.
- If the acquisition has more than one heart cycle, the analysis will by default be done on the second to last heart cycle.
- The entire myocardium should be visible.
- A depth range that includes the entire left ventricle should be used.
- Acquisitions must be made without the use of contrast agents.
- There should be no foreshortening of the myocardium in the recording.
- One click workflow (available with Easy AutoEF option only) is only available for Adult TTE raw data images.

Additional requirements for AutoEF when no ECG connected

- AutoEF without ECG is only supported for Adult TTE exams with raw data.
- AutoEF without ECG requires at least 3 seconds of data to detect cycle information.
- The acquisition has to represent a stable sinus rhythm for AutoEF without ECG to work.
- The left ventricle should not translate during the acquisition.
- Any intermittent artifact appearing in the recording (e.g. lung shadow) will degrade the results.
- The **Easy AutoEF** and **AutoEFwoECG** option keys must be enabled.

NOTE: Accuracy of running AutoEF without ECG compared to AutoEF with ECG is detailed in the "2D AutoEF when Adult TTE raw data without ECG" section of the table at the end of 'Measurement accuracy' on page 8-152. AutoEF accuracy when manual edits are performed is detailed in the table section "2D Auto EF". Finally, the table section named "2D AutoEF when Adult TTE raw data with ECG" adds a column describing accuracy w/o editing (within 95% confidence interval) compared to with manual editing.

Starting AutoEF

Launching AutoEF in live

1. Create an exam, start scanning with or without ECG.
2. Acquire 2D grey scale 4 chamber or 2 chamber view.
3. Select *AutoEF* either in *Measure* menu or on the touch panel.

*NOTE: To start AutoEF without storing files, the **Easy AutoEF** and **AutoEFwoECG** option keys must be enabled. The system will only allow user to perform the analysis on one view (either 4 chamber or 2 chamber). To combine both views, please launch AutoEF from stored files.*

Launching AutoEF from stored files

1. Open any one of the stored apical views and press **Measure**.
2. Select *AutoEF* either in *Measure* menu or on the touch panel.

If View Recognition was enabled during acquisition, the system will try to identify a suitable pair of apical views for the analysis. If this succeeded and one click workflow is possible, the tool will

launch and proceed to the result screen. If one click workflow is not possible, the tool will start up in the *Define ROI* stage with the selected apical view. If no suitable pair of apical images were found, the tool will launch and start up in the *Select View* stage. (See Figure 8-31).

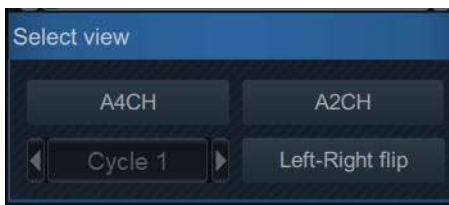

Figure 8-31. Select View stage

AutoEF on the A4CH view

If one click workflow is enabled (available with Easy AutoEF option only), the tool will proceed automatically to the result screen which shows the results for all views combined (if available). However, by clicking on any of the views in the result screen, the tool will provide the usual navigation between the stages of the AutoEF analysis. One click workflow is only available for Adult TTE raw data images.

1. When in *Define ROI* stage:
 - Annotate the view by clicking one of the view labeling buttons (**A4CH**, **A2CH**).
 - Pay attention to the left/right orientation of the image by comparing the LV wall names with a visual inspection of the image. If the image orientation is wrong:
 - Go back to the *Select view* stage.
 - Press **Left-Right Flip**.
 - Verify the view by annotating it as *A4CH* again

NOTE: You may alternatively exit AutoEF, invert the image and start AutoEF again.

2. An automatic endocardial border is generated when entering the *Define ROI* stage. The endocardial border may be edited by clicking and dragging the points of the contours. See section 'ROI adjustment' on page 8-36.
3. When satisfied with the endocardial border, either stop moving the cursor and wait for automatic processing or click on the **Process** button. Now the system tracks the endocardium with time. On completion, it proceeds to show the results in the *EF result* screen. The endocardial border

tracking must be visually controlled and validated as described below.

EF results

The *Results* stage opens with a multi frame EF result layout.

- The running loop is shown on the left. A green dotted line marks the inner border of the chamber. In case the system detects poor endocardial border tracking, the system automatically displays parts of the border in red.
- The maximal volume (ED) and minimal volume (ES) are displayed on the right side.

NOTE: Press **Go to ED** or **Go to ES** to display the ED and ES frames.

- The End Diastolic volume (EDV), the End Systolic Volume (ESV), and the resulting Ejection Fraction (EF), as well as the results for each view, are summarized in a table on the right side.

Tracking Validation

- Inspect the endocardial border tracking for the end systole and end diastole.
- If the results are visually correct, you may press **Approve and exit** to exit the tool and store the values to the worksheet, so they can be used in a report, or continue with **Approve and next view**.

Tracking correction

The following can be done if the endocardial tracking needs correction:

- Click **2CH** or **4CH** and then adjust **ES frame** and **ED frame** controls if different frames need to be selected for ES and ED.
- Edit misaligned points on the endocardial border trace as described on 'Editing the endocardial border trace' on *page 8-79*.
- Create a new endocardial border trace (See 'To create a new endocardial border trace' on *page 8-80*)

Possible causes of poor tracking

- Erroneous placement of the basal points when defining the border. If the basal points are placed too far from the annular region, the borders at the annular base will not move together with the underlying 2D image throughout the entire heartbeat.
- Erroneous placement of the apex point when defining the border. The point should be placed so that the resulting border trace covers mainly the endocardium. If the apex point is placed too high, the border trace will mainly cover the epicardium resulting in poor tracking.

Trace adjustment of the endocardial border

If the automatic endocardial border detection is not optimal the user can either adjust the trace or create a new trace as described below.

NOTE: *Automatic endocardial border is based on an AI segmentation algorithm (available with Easy AutoEF option only) and is exclusively available for Adult TTE raw data images. This algorithm was trained, verified and validated on adult TTE cardiac raw data images. Note that in septal bulge cases, the automatic ROI will cut through the bulge. Unedited automatic ROI border on septal bulge cases may therefore overestimate volumes compared to manual tracing. Accuracy of running with Automatic ROI compared to manual ROI is reported in "Measurement accuracy" on page 8-152 as "accuracy w/o editing". The dataset used had recordings both with and without septal bulge cases.*



Poor tracking quality may lead to incorrect measurement results. The automatic endocardial border must be visually controlled and validated.

Editing the endocardial border trace

- Enter the Define ROI stage.
- Adjust the trace by moving the cursor over the endocardial border trace, select an anchor point and drag it to a new location. The shape of the endocardial border trace is updated accordingly.

In the upper right of the screen there is a pictogram indicating the core features of a good AutoEF ROI.

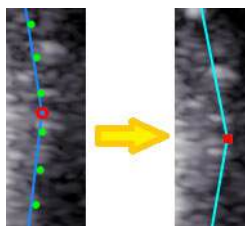



Figure 8-32. Moving an anchor on the trace

To create a new endocardial border trace

The system automatically displays a frame where the endocardial border is usually clearly visible. To use another frame, while in Define ROI stage, pause the playback by pressing Stop. Then, use the Frame slider (or rotary) to select a different frame for endocardial border definition.

To create a new automatic endocardial border trace, click the Reset stage symbol . This relaunches the automatic segmentation.

Sometimes the automatic endocardial border detection algorithm may fail to capture the correct border. In this case, a 3-Point alternative is provided.

To generate an endocardial border by this method, when in *Define ROI* stage, click on the button **3-Click**. The AutoEF tool will now prompt to click 3 landmarks. Follow the indications displayed on the screen when placing the three points.

When the third landmark is selected, an endocardial border is generated and can optionally be edited as for the automatic endocardial border.

NOTE: *If the endocardial border needs to be adjusted make sure to make the changes immediately after it is displayed, before the auto processing begins.*

NOTE: *The timing when auto processing will start is configurable (from Config).*

NOTE: *The Yo-yo function is turned on to help find correct location for the points.*

Reviewing results when using one click workflow

When using one click workflow (available with Easy AutoEF option only), several automatically processed elements should be inspected before final approval. Following items can be visually inspected from the AutoEF result screen (see Figure 8-33 on page 8-82).

What to inspect?	How to inspect?	How to edit if wrong?
View labels are correct	Check that the B-mode images correspond to the respective view labels as visible in the top left corner of each image.	Double click on the B-mode which is not corresponding to the view label. Then click the <i>Select View</i> stage in the menu and select a new image from clipboard. Continue the workflow with the new image.
ED and ES frames are correct	Check that ED and ES frames represent largest and smallest LV volume as visible in B-mode.	Double click on the B-mode with the problem or click on the 2CH/4CH button. Adjust ED/ES by using the frame sliders in the right-hand side menu or by dragging the ED/ES markers on the lower left ECG. Click Biplane Review to go back to the screen showing both views in ED/ES.
Tracking is correct (and thus implicitly the ROI and resulting EF is correct)	For each of the B-mode images, check that the ED and ES endocardial contours are anatomically correct with respect to the B-mode images.	Click 2CH to edit the 2CH contour or click 4CH to edit the 4CH contour. Adjust the ROI in the upper two images. Click Biplane review to go back to the screen showing both views in ED/ES.



Figure 8-33. AutoEF result screen with biplane (BiP) results

Problem solving

Problem	Background	Suggestions
BiP EF value is not shown in the result screen.	The AutoEF tool contains a consistency check between the EF for each view. If the individual view EF results are not compatible, no BiP EF value will be shown.	Check that contours are correctly placed with respect to the ventricular walls. If still no BiP EF, one or both recordings could be foreshortened. Try other recordings if available or acquire new ones.

Exiting AutoEF

At any time, the tool can be cancelled by pushing the **Cancel** button. The plugin will close and any unsaved data will be lost.

When in the *Results* stage, the operator may click the **Approve and exit** button. Upon clicking this, the measurements are transferred to the worksheet and a result file with a screenshot of the result layout will be stored to clipboard. See also 'Reprocessing Data' on page 8-47.

Reprocessing data

The data from a saved AutoEF analysis may be reprocessed.

NOTE: *When doing reprocessing, if the operator chooses to store the results, the results will be treated as new analysis with new measurements in the worksheet and a new thumbnail in the clipboard.*

1. Single view analysis stored
 - Double-click on the thumbnail showing the AutoEF result layout. A dual screen is displayed showing the view result screen and the cineloop processed in that analysis.
 - Launch AutoEF. The tool will proceed to the *Results* stage. You may choose to reprocess the view already analyzed or to complete the analysis adding the missing view to the analysis.
2. Both views analysis stored
 - Double-click on the thumbnail showing the AutoEF result layout. A quad screen is displayed, showing the view result screen of the last processed view and the cineloops processed in the analysis.
 - Launch AutoEF. The tool will automatically proceed to the *Results* stage of the last processed view. You may choose to reprocess the views already analyzed or even replace the cineloops used in earlier processed views.

Cardiac Auto Doppler

Some cardiac and pediatric Doppler measurements are available in the measurements menu with an **Auto** button, enabling automatic measurements on Doppler spectrums.

NOTE: *The Cardiac Auto Doppler algorithm output is not affected by spectrum display settings like Compress and Reject. If these settings are modified, the trace/peak values might not appear to align with the spectrum on screen the same as it did before the modification. Thus, after adjusting spectrum display settings, you may want to readjust the tracing sensitivity to improve the fit between the displayed spectrum and the trace/peak values.*

When automatic measurement is available, the Auto button is visible in the Measurement menu, see Figure 8-34.

1. Select **Auto** to initiate automatic measurement detection.

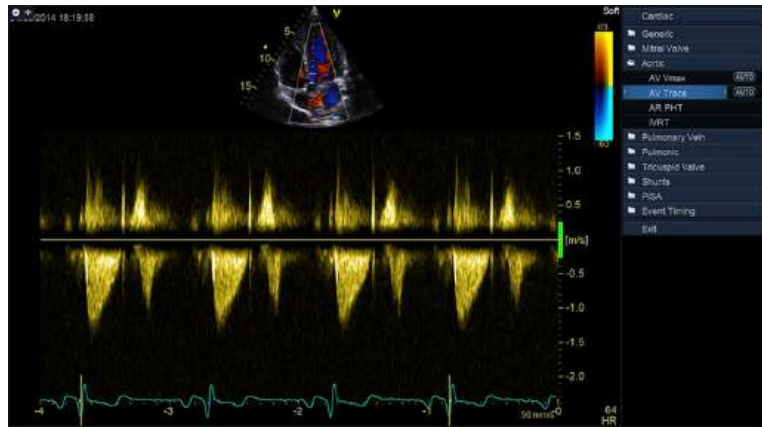

Figure 8-34. Ready to start Cardiac Auto Doppler

2. The generated trace is created and average measurement values are displayed, see Figure 8-35.

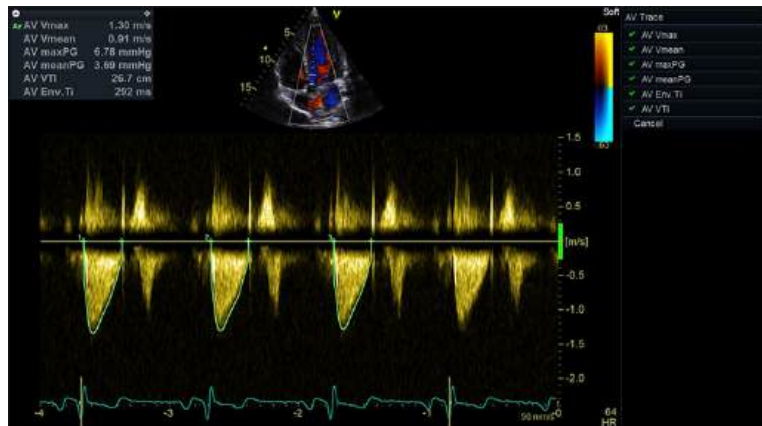

Figure 8-35. Cardiac Auto Doppler Measurement screen

NOTE: *The Cardiac Auto Doppler algorithm uses the QRS trig points from the ECG, and will run analysis on all full heart cycles displayed on screen.*

3. The **Sensitivity** rotary can be adjusted to align the automated measurement as needed. Parameters in the list can be toggled on/off.

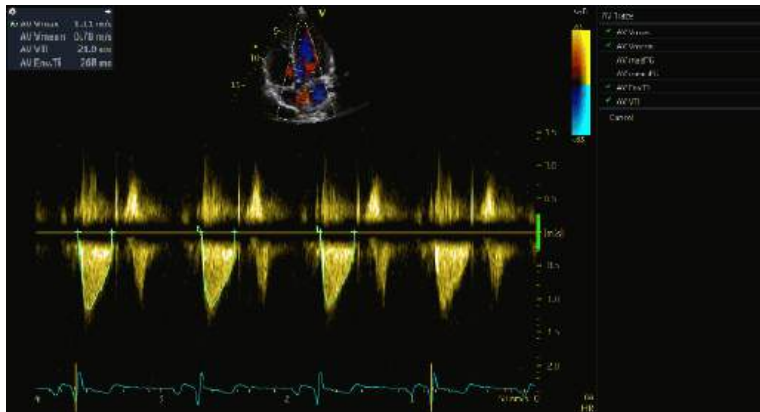

Figure 8-36. Toggle parameters on/off

NOTE: The Sensitivity changes apply only to non-rejected cycles.

Review and Approve

4. When hovering over a cycle, the cycle can be rejected or exclusively kept by selecting the corresponding symbol, see Figure 8-37. Press the **Recalc** button to restore rejected cycles.

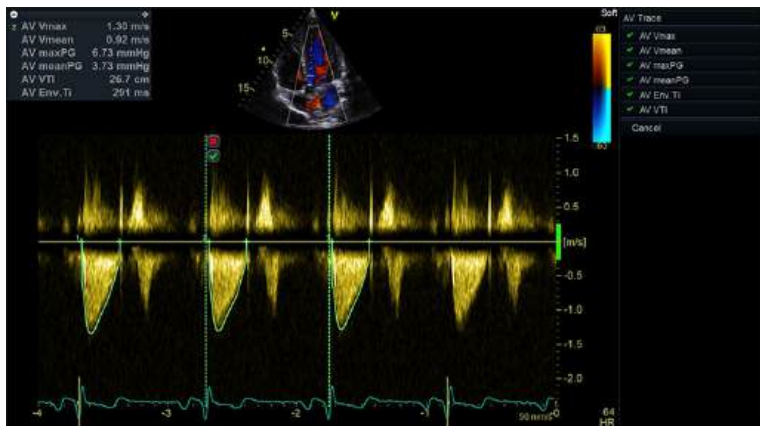

Figure 8-37. Reject or keep cycles

NOTE: When hovering over a specific cycle, the measurements will reflect only that specific cycle, indicated by the number of the cycle.



The Cardiac Auto Doppler measurements use computer algorithms for envelope detection and recognition of points of interest. There is an inherent risk that these algorithms may sometimes give suboptimal or incorrect results. Verify the correctness of the displayed points and traces before storing them. All specific Cardiac Auto Doppler measurements listed in Table 8-1 on page 8-12 are based on the same underlying Cardiac Auto Doppler algorithm. Please see note in 'Measurement Uncertainties' on page 8-154 explaining the expected accuracy of Cardiac Auto Doppler when unadjusted.

- When satisfied with all the displayed cycles, press **Approve without image store** or **Store** to approve them.

NOTE: By pressing **Store**, the result values of auto measurements are approved and an image is stored to clipboard. By pressing **Approve without image store**, the result values of auto measurements are approved, but no image is stored to clipboard. After **Approve without image store** is pressed, additional measurements may be performed. If **Store** is pressed after these additional measurements are performed, an image showing both the results and the additional manual measurements will be stored to clipboard.

Results

- After **Store** or **Approve without image store** is pressed, the results for each cycle are split into separate measurements and displayed as seen below.

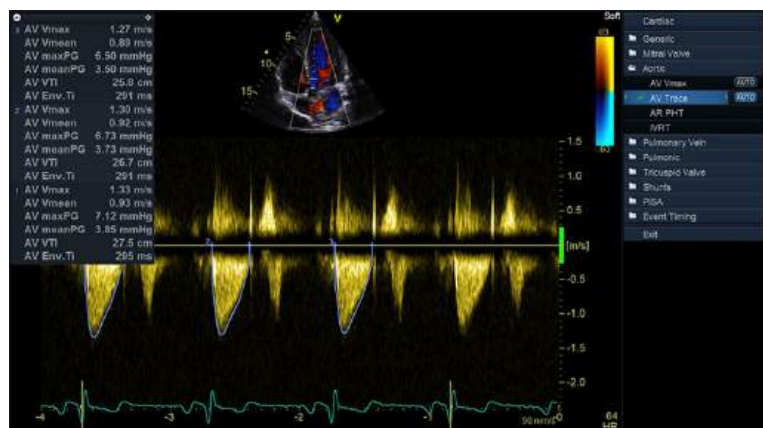

Figure 8-38. Approved measurement results

AI Auto Measure – 2D

Some Cardiac measurements are available in the measurement menu with an **Auto** button, enabling semi-automatic measurements on B-mode images (AI Auto Measure).

On Parasternal Long Axis (PLAX) images recorded on adults using a Transthoracic Echocardiography (TTE) probe, the following auto 2D measurements are available: IVSd, LVIDd, LVPWd, IVSs, LVIDs, LVPWs. Parameters derived from these six measurements, including ESV, EDV, SV, EF, and %FS will be automatically calculated once the measurements have been approved.

NOTE: *The Auto buttons will only start the tool if certain conditions are fulfilled:*

- *Adult cardiac TTE simplex B-mode image loop*
- *Depth <18 cm*
- *Contains at least one complete cardiac cycle R-R*
- *Not using a contrast application*
- *Not using write zoom*
- *Automatic view recognition identifies the loop as PLAX*

NOTE: *B-mode display settings like Compress and Gain, or any post process user adjustments, do not affect output from the AI Auto Measure – 2D algorithm.*

Initiating automatic measurements on B-mode images

1. Before pressing **Auto**, position the ECG marker in the cardiac cycle to be analyzed.
2. Select **Auto** to initiate the automatic measurements.

The **Auto** buttons indicate which B-mode measurements are available, see Figure 8-39. By clicking any **Auto** button, all the available automatic B-mode measurements are performed.



Figure 8-39. Automatic B-mode measurements

3. The display will switch to a Dual screen layout where an End Diastolic frame is shown to the left and an End Systolic frame is shown to the right, see Figure 8-40.

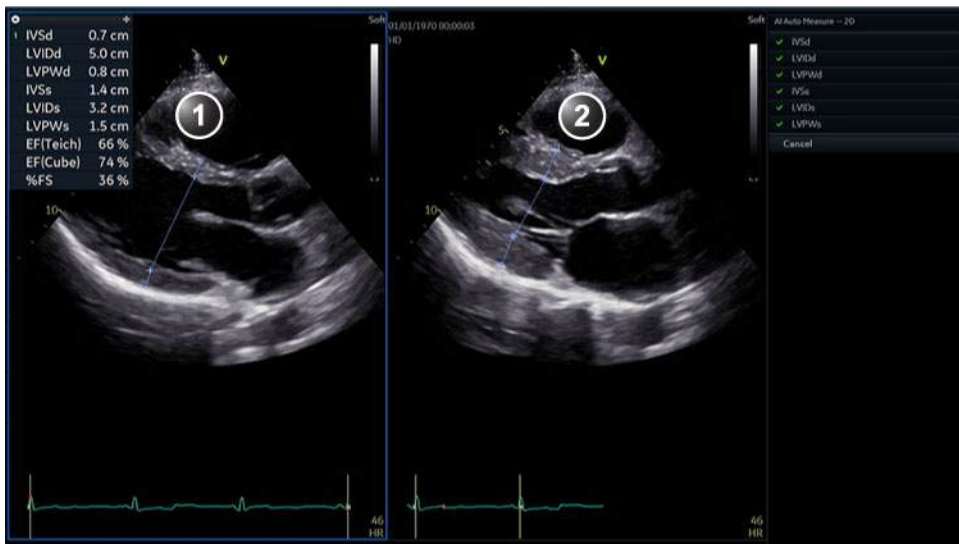

1. End Diastolic frame with automatically generated calipers
2. End Systolic frame with automatically generated calipers

Figure 8-40. AI Auto Measure – 2D calipers



The AI Auto Measure – 2D measurements use AI based computer algorithms for estimating the caliper end points. There is an inherent risk that these algorithms may sometimes give suboptimal or incorrect results, see the table below. Bulging septum, sigmoidal septum, foreshortened or tilted PLAX images were not used in training the algorithm. Automatic measurements on such images may not necessarily be useful. Verify the correctness of the displayed calipers, and manually adjust the caliper positions if needed, as described in ‘Adjust caliper positions’ on page 8-90, before storing them. If correctness cannot be achieved, even with manual adjustment, do not store the measurements. Note that, as an alternative, all the measurements provided by the AI Auto Measure – 2D tool can be obtained based on manual measurements in other views. The AI Auto Measure – 2D end point caliper placement algorithm was trained, verified and validated on adult cardiac images. Accuracy of running this algorithm without edits is provided in ‘Measurement accuracy’ on page 8-152.

Expected performance of the six individual measurements provided by the AI Auto Measure – 2D tool:

	IVSd	LVIDd	LVPWd	IVSs	LVIDs	LVPWs
Success rate	94%	93%	98%	98%	93%	87%

- When satisfied with the displayed calipers, press **Approve without image store** or **Store** to approve them.

*NOTE: By pressing **Store**, the results of auto measurements are approved and transferred to Worksheet. Also, an image is stored to clipboard. By pressing **Approve without image store**, the result values of auto measurements are approved and transferred to Worksheet, but no image is stored to clipboard.*

Adjust time frame

NOTE: The AI Auto Measure – 2D algorithm uses the QRS trig point to determine End Diastole. End Systole is calculated based on End Diastole and heart rate.

- To choose a different time frame for End Diastole, turn the **ED Frame** rotary.

2. To choose a different time frame for End Systole, turn the **ES Frame** rotary.
3. After modifying a frame, click **Reprocess** to rerun automatic algorithm with the chosen frames as input.

NOTE: When turning the **ED Frame** or **ES Frame** rotaries, the calipers will not update or change unless the **Recalc** button is pressed. Caliper brightness will be reduced the further away a frame is from the frame used for estimating the caliper.

Adjust caliper positions

1. Double-click on any caliper end point to move it.
2. Click once to set the new position.

Discarding calipers

1. Select a caliper name in the measurement menu to discard individual caliper measurements.
2. Click **Cancel** to discard all automatic measurements.

Figure 8-41 shows an example where LVPW is discarded in the menu and thus corresponding caliper is not visible.

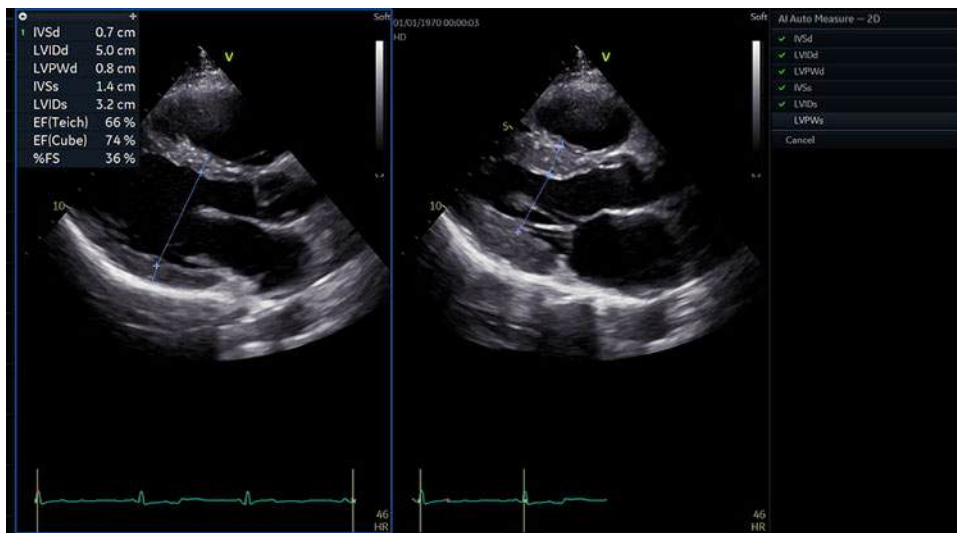

Figure 8-41. Example of discarded caliper

Pediatric Z-score measurements

Several publications exist on the relation between the size / age / sex of a patient, and measured values for different pediatric heart measurements. The most typical approach is to normalize measured values against body surface area, BSA.

NOTE: *When entering the patient's height and weight in the Patient info and exam screen (Figure 4-7 on page 4-8), BSA will automatically be calculated.*

When BSA for a patient is known, these relations make it possible to calculate the expected value, Z0, for a given measurement. And after performing a measurement, a Z-score can be calculated, describing the relationship between Z0 and the observed value:

- The sign of the Z-score shows whether the observed value is higher or lower than expected. Values above Z0 give positive Z-scores, values below Z0 give negative Z-scores.
- The magnitude of the Z-score quantifies how many standard deviations the observed value is away from Z0, and thus quantifies normality/abnormality.

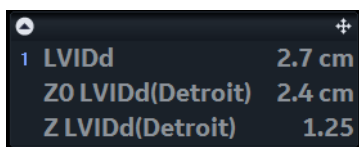

1 LVIDd	2.7 cm
Z0 LVIDd(Detroit)	2.4 cm
Z LVIDd(Detroit)	1.25

Figure 8-42. Example: Result window after measuring LVIDd.

In the example shown in Figure 8-42, the measured value is higher than the Z0 value predicted by the Detroit publication, leading to a positive Z-score.

A list of supported publications and related measurements for Z-score calculations can be found in the Reference Manual. To select which of these should be used, select **Config -> Meas/Text -> Measurement menu**. Under *Pediatric Heart*, press the **Z-score** button to display a dialog where it is possible to select what publication to use. It is also possible to select/deselect individual Z-score parameters by enabling/disabling them as described under 'Configuration of the Measurement menu' on page 12-25.

4D/Multi-plane LV

4D/multi-plane LV analysis tools

Depending on the data set, the following 4D/multi-plane LV analysis tools are available on the Vivid S70N:

Tool	Data set		
	4D	Tri-plane	Tri-plane TSI
4D Automated LV Quantification	page 8-92	-	-
Tri-plane LV Volume measurement	page 8-103	page 8-103	-
Bi-plane LV Volume measurement	-	page 8-106	-
TSI surface model	-	-	page 8-108

4D Auto LVQ

The 4D Auto LVQ (Automated Left Ventricular Quantification) tool enables the estimation of the left ventricular volumes and the ejection fraction in 4D data sets based on automatic border detection. The automatic border detection is created after placing two points in an end-diastolic apical view, one at the center of the LV base and one at the apex.

Requirements

The 4D Auto LVQ tool is available on 4D tissue data sets in replay mode only.



The tool cannot be used on 4D acquisitions with volume rate equal or lower than 12 vps.



Do not use the 4D Auto LVQ tool in these cases:

- For volume measurements: The acquisition has a volume rate lower than 20% of the heart rate, e.g., 12 vps at 60 bpm, 20 vps at 100 bpm and 30 vps at 150 bpm.
- The image quality is poor.
- The acquisition has stitching artifacts (see page 6-6 on how to avoid stitching artifacts).
- The acquisition has significant reverberation artifacts.
- A significant part (more than 25%) of the left ventricular walls or the detected contours are outside the ultrasound sector.
- Segments are outside the image sector.
- The lateral resolution is low.



The tool must not be used on other chambers than the human adult left ventricle.

NOTE: *When the 4D Auto LVQ tool is used on Vivid S70N / S60N, it is possible to store the traces, bullseye, 3D model, and measurements shown as part of the user interface to images files by pressing the **Store** button. However, if such image files are to be sent to a DICOM server using a dataflow with RAW data disabled, DICOM title bar must be enabled on the Vivid S70N / S60N in order for the images to contain traces, bullseye, 3D model, and measurements as part of the stored DICOM Multiframe/Singleframe files.*

Starting the 4D Auto LVQ tool

1. Open a Full volume acquisition.
2. Press **Measure**.
3. Select **Volume/4D Auto LVQ** (Figure 8-43).

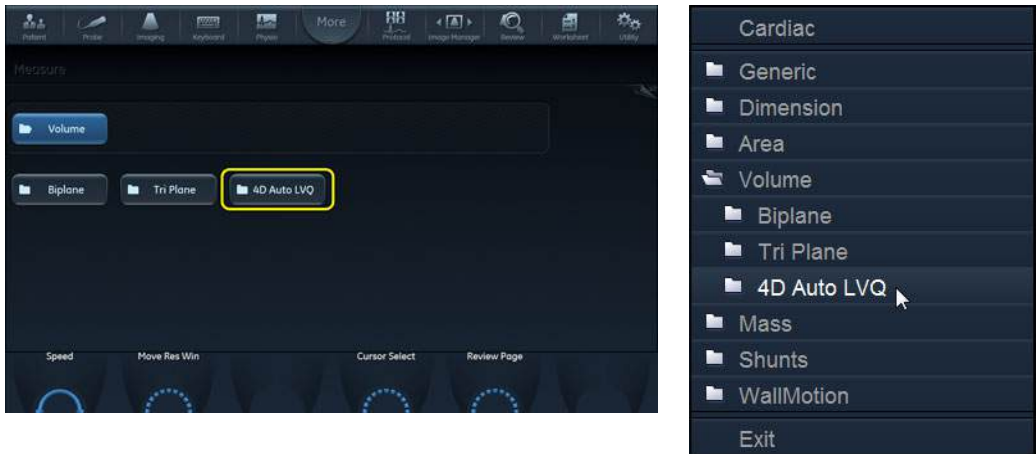

Figure 8-43. 4D Auto LVQ measurement selection

The *Measurement* menu is displayed with the Alignment tool selected (Figure 8-44).



Figure 8-44. Measurement menu

The main screen displays three apical and a short axis views (Figure 8-45).

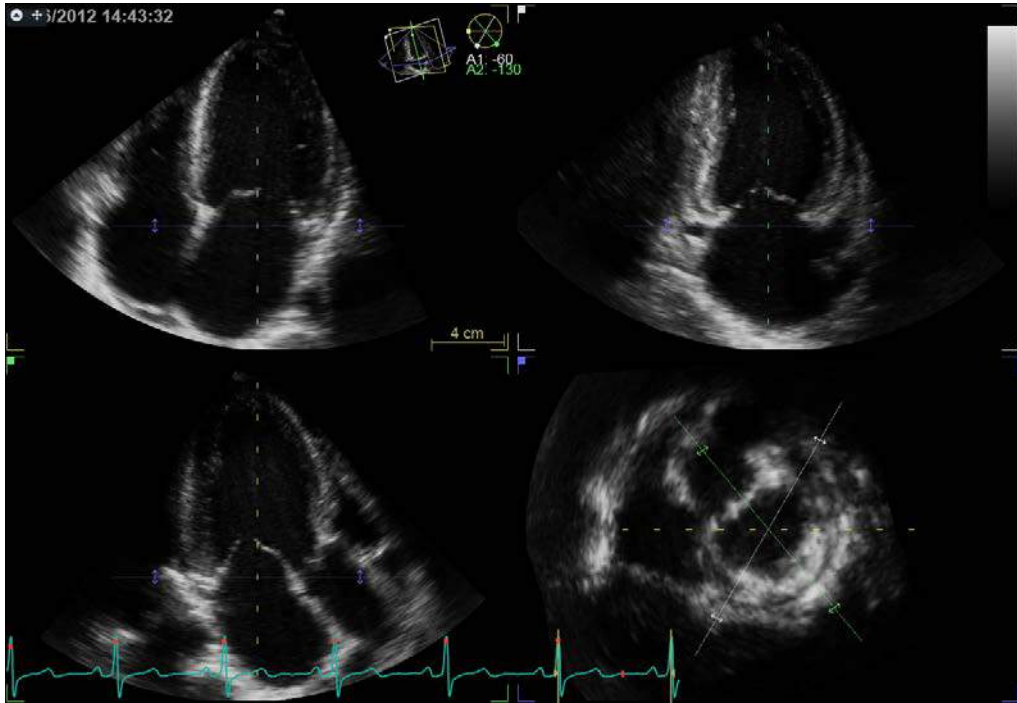

Figure 8-45. Slice alignment screen

Slice alignment

Slice alignment is used to identify the long axis of the left ventricle, the three standard apical views and the atrio-ventricular plane. Slice alignment performed and approved before running 4D Auto LVQ is used by default, otherwise the slice alignment is performed automatically. If necessary the auto alignment can be further adjusted as follows:

1. Tilt and/or translate the apical views using the controls on the panel or the trackball until the left ventricle is centered to the center axis.
2. Rotate the apical views using the controls on the panel or the trackball until the standard views are displayed.

NOTE: *Auto alignment is not available with transesophageal acquisitions, only manual alignment as described in 'Alignment – Transesophageal acquisition' on page 6-28.*

See page 6-25 for more information on Slice alignment.

End-diastolic volume contour detection

1. Select **EDV** (End-Diastolic Volume).
The default screen displays three apical views, three short axis views and an interactive view (Figure 8-46).
The system automatically displays the loops at the estimated end diastolic frame.
2. If the automatic end diastolic frame detection is not optimal, use the **Move ED** control to set the new end diastolic frame.
3. In one of the apical views, place two points: one at the center of the LV base and one at the apex.

A contour is automatically drawn in all views (see Figure 8-46).

NOTE: *Alternative methods for doing contour detection: press **Auto** on the Control panel to draw the contour automatically without placing any points, or press **Manual** on the control panel and place two basal and one apical point in all three apical views.*



Erroneous contour detection of the left ventricle may lead to incorrect measurement results. The contour detection should be visually checked and edited if required.

NOTE: The contour detection should be checked in all slices.
*Press **Layout** several times on the control panel to display the apical slices in large size one by one.*

The contour detection quality can be visualized by moving the cursor through the LV and observe the contour detection in the interactive view. The position of the interactive view updates according to the cursor position in the other views.

To lock the interactive view, press **Lock view**. When the interactive view is locked the position can be controlled using the **Move view** control.

Adjust **Contour visibility** to change the display intensity of the contour (or hide it).

To run the cine loop, press **2D Freeze** on the Control panel or the rotary button **Run** on the Touch panel.

To stop the cine loop, press **2D Freeze** on the Control panel or the rotary button **Go To ED** on the Touch panel. The end diastolic frame is displayed.

To edit the contours, see 'Contour adjustment' on page 8-99.

To reset the contours and start over, press **Reset**.

The following measurements are available:

- End diastolic volume
- Sphericity Index

NOTE: You can press **Store** at any point during the procedure.

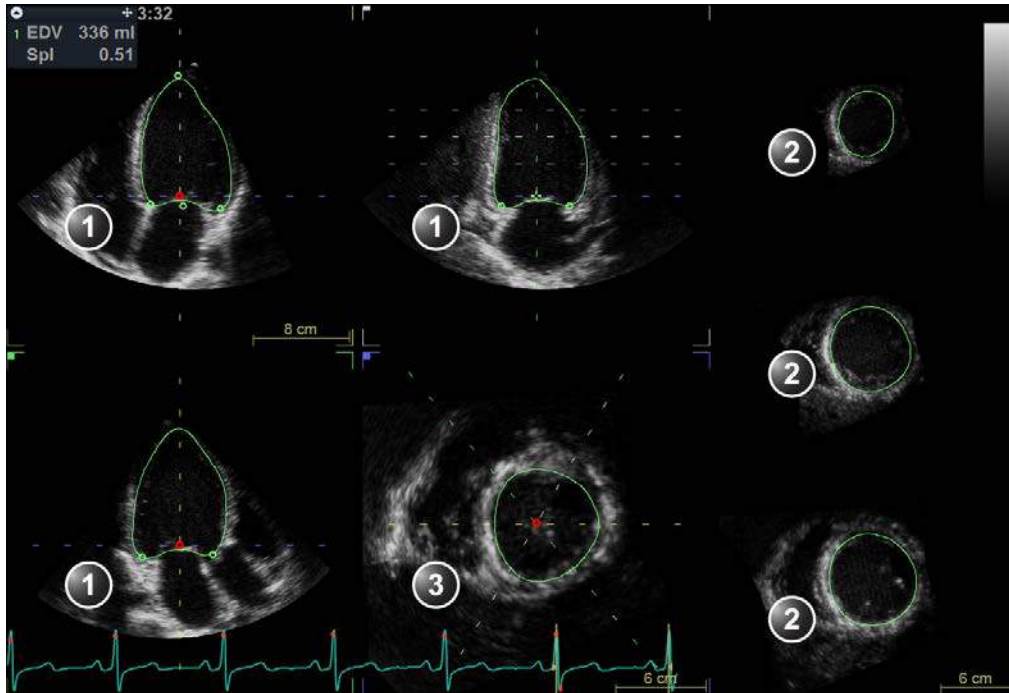

1. Apical views
2. Short axis views
3. Interactive view

Figure 8-46. Left ventricle contour detection (end-diastole)

End-systolic Volume contour detection

1. Select **ESV** (End-Systolic Volume).
The system automatically displays the loop at the estimated end systolic frame within the same heart cycle.
2. If the automatic end systolic frame detection is not optimal, use the **Move ES** control to set the new end systolic frame.
3. In one of the apical views, place two points: one at the center of the LV base and one at the apex.

A contour is drawn in all views.

NOTE: *If the Auto or Manual contour detection method was used to define the EDV contour (see step 3 on page 8-96) the same method is used for the ESV contour detection.*



Erroneous contour detection of the left ventricle may lead to incorrect measurement results. The contour detection should be visually checked and edited if required.

NOTE: *The contour detection should be checked in all slices. Press **Layout** several times on the Control panel to display the apical slices in large size one by one.*

The contour detection quality can be visualized by moving the cursor through the LV and observe the contour detection in the interactive view. The position of the interactive view updates according to the cursor position in the other views.

To lock the interactive view, press **Lock view**. When the interactive view is locked the position can be controlled using the **Move view** control.

Adjust **Contour visibility** to change the display intensity of the contour (or hide it).

To run the cine loop, press **2D Freeze** on the Control panel or the rotary button **Run** on the Touch panel.

To stop the cine loop, press **2D Freeze** on the Control panel or the rotary button **Go To ES** on the Touch panel. The end systolic frame is displayed.

To edit the contours, see 'Contour adjustment' on page 8-99.

To reset the contours and start over, press **Reset**.

The following measurements are available:

- End diastolic volume
- End systolic volume
- Ejection Fraction
- Sphericity Index
- Cardiac Output
- Stroke Volume
- Heart Rate

Contour adjustment

The contour detection should be checked. If the contour detection is not optimal, it can be adjusted by adding attracting points to the contour. An attracting point will pull the contour toward that point.

NOTE:

1. Place the cursor at the location where to add a point.
Attracting points can be added in any slice. Make sure to lock the interactive view if adding attractive points in the interactive view.
2. Press **Select**.
A point is added and the contour is modified (Figure 8-47).
3. To delete an attracting point, double click on the point or press **Undo**.

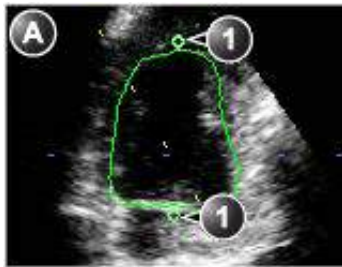

a. Original contour

1. Original attracting points



b. Modified contour

2. Added attracting point

Figure 8-47. Contour adjustment

Volume waveform

Display and adjustment

1. Press **Volume waveform**.
The data is processed and the *Result* screen is displayed (Figure 8-48) showing:
 - The four running views with dynamic contours
 - A volume waveform curve with end diastolic and end systolic markers
 - A dynamic LV surface model
 - The Measurement result table

NOTE: Press **Layout** on the Control panel to display a large LV surface model.

2. Press **Go to ED** on the Touch panel to display the end diastolic frame.
Press **Go to ES** on the Touch panel to display the end systolic frame.
3. The contour detection may still be adjusted:
 - Press **2D Freeze** or press **Select** on any view to stop the cineloops. Scroll to correct frame.
 - Add or remove attracting points to modify the contour as described in 'Contour adjustment' on page 8-99.
 - Press **Volume waveform** to reprocess the data.
4. The end diastolic and end systolic markers on the volume waveform curve can be adjusted:
 - Adjust **Move ED** and **Move ES** controls to move the end diastolic and end systolic markers on the curve.

The measurement results are updated.

The following measurements are available:

- End diastolic volume
- End systolic volume
- Ejection Fraction
- Sphericity Index
- Cardiac Output
- Stroke Volume
- Heart Rate

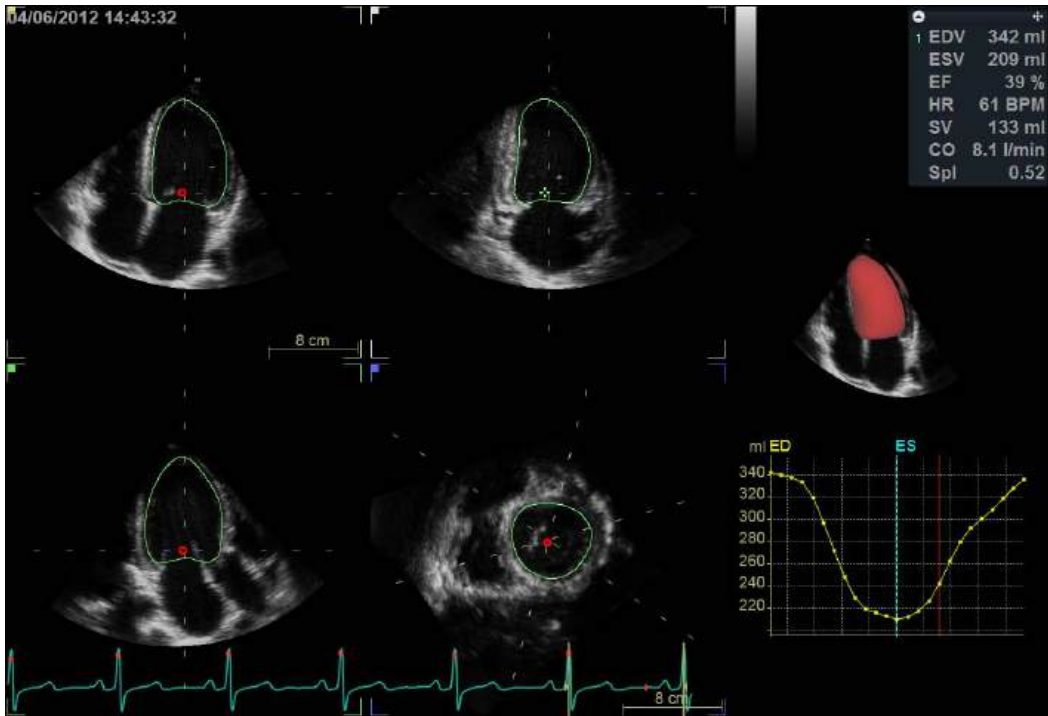

Figure 8-48. The Volume waveform screen

Approval



The 4D Auto LVQ tool involves partly automated steps. There is an inherent risk that these steps may fail. Verify the correctness using the displayed verification graphics in the tool before approving.

1. Press **Approve & Exit** to store the measurements shown in the *Measurement result* table.

The measurements are transferred to the Worksheet.

To exit without approving, press **Cancel**.

NOTE: *Measurements that are not approved will not be saved.*



The measurement should not be approved if a significant part (more than 25%) of the left ventricular wall or the detected contours are outside the ultrasound sector.

Calculation formula and measurement accuracy

Refer to the Reference manual for calculation formula and 'Measurement accuracy' on *page 8-152* for measurement accuracy information.

Manual left ventricular volume measurements

Tri-plane acquisition

This procedure describes the calculation and reconstruction of the left ventricular volume from a Tri-plane acquisition. The Tri-plane acquisition should be a Tri-plane greyscale acquisition, not a Tri-plane color acquisition.

1. In Tri-plane mode, acquire an Apical 4 chamber view in scan plane 1 (yellow).
2. Rotate scan plane 2 and 3 to display an Apical 2 chamber view in scan plane 2 (white) and an Apical long axis view in scan plane 3 (green).
3. Press **Freeze** (**2D Freeze** if on a stored image).
4. Press **Measure**.

The *Measurement* menu is displayed.

5. In the *Measurement* menu select **Volume** and **Tri-plane**.
The *Measurement* screen is displayed with the *Ejection fraction tool* selected (see Figure 8-49).

The end diastolic frame of the current cardiac cycle is displayed and the cursor is moved to the reference scan plane.

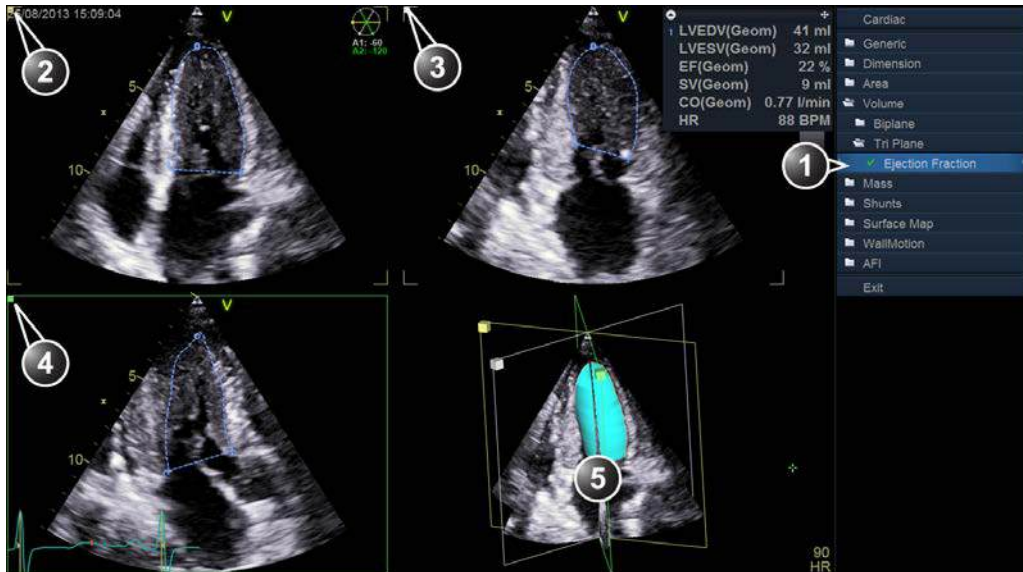

1. Ejection fraction tool for Tri-plane
2. Scan plane 1 (yellow): Apical 4 chamber view
3. Scan plane 2 (white): Apical 2 chamber view
4. Scan plane 3 (green): Apical long axis view
5. Volume reconstruction

Figure 8-49. The Tri-plane measurement screen

6. If desired, press **Layout** twice to display the reference scan plane in a single screen.
7. Place the cursor to the start point for the trace.
8. Press **Select** and draw a contour of the left ventricle.
To edit the contour while drawing:
 - Follow the contour backward to erase it and redraw.
 - Press **Undo** or **Backspace** to erase the contour stepwise and redraw.
 - Press **Delete** to remove the entire contour and redraw.
9. Press **Select** to complete the contour.
The cursor is automatically moved to the next scan plane.
The crossing point of the trace done in the first scan plane is marked in the second scan plane.
10. Draw a contour of the left ventricle in scan plane 2 and 3 following the same procedure.
When the last end-diastolic contour is drawn, an end-systolic frame is automatically displayed. The system automatically enters scroll mode. Using the trackball, ensure that the correct end-systolic frame is displayed.

Press **Select** to leave scroll mode.

11. Repeat steps 7 to 10 to draw a contour of the left ventricle at end-systole in all the scan planes.

The measurement results, including end-diastolic and end-systolic volumes and the left ventricular ejection fraction, are displayed in the *Measurement result* table.

NOTE: *Other measurements may be displayed by configuring the Measurement menu, refer to the system's or workstation's User manual for more information about Measurement menu configuration.*

12. If in single screen mode, press **Layout** to display the Volume reconstruction of the left ventricle in the *Geometric model*.
13. Press **Layout** again to display an enlarged *Geometric model*.

The Volume reconstruction can be rotated in all directions (see page 8-106).

Multi beat 4D acquisition

This procedure describes the calculation and reconstruction of the left ventricular volume from a Multi beat 4D acquisition.



CAUTION

ECG gated acquisition may by nature contain artifacts, that may have impact on the measurements.

See the recommendations on page 6-6 to avoid stitching artifacts during Multi-beat 4D acquisition.

1. Using the Multi beat 4D acquisition mode (see page 6-6), acquire a 4D Apical 4 chamber image.
2. Press **Freeze**.
3. Orientate the reference cut-plane to display an Apical 4 chamber.
4. Press **Measure**.
The *Measurement* menu is displayed.
5. In the *Measurement* menu select **Volume** and **Tri-plane**.
The *Measurement* screen is displayed with the *Ejection fraction tool* selected.
6. Follow the procedure described in 'Tri-plane acquisition' on page 8-103 from step 7.

Rotation of the Volume reconstruction

The volume reconstruction displayed in the *Geometric model* can be rotated in any directions.

1. Place the pointer in the *Geometric model*.
2. Press and hold down **Select** and use the trackball to rotate the volume reconstruction.

Bi-plane acquisition

This procedure describes the calculations of the left ventricular volume from a Bi-plane acquisition. The volume calculation is based on the Method of disk.

1. In Bi-plane mode, acquire an Apical 4 chamber view in scan plane 1 (yellow).
2. If required, rotate scan plane 2 to display an Apical 2 chamber view.
3. Press **Freeze**.
4. Using the trackball, scroll through the cineloop to display the end-diastolic frame.
5. Press **Measure**.
The *Measurement* menu is displayed.
6. In the *Measurement* menu select **Volume** and **Bi-plane**.
The *Trace tool* for the Left ventricular end-diastolic volume for the Apical 4 chamber view is selected (see Figure 8-50).

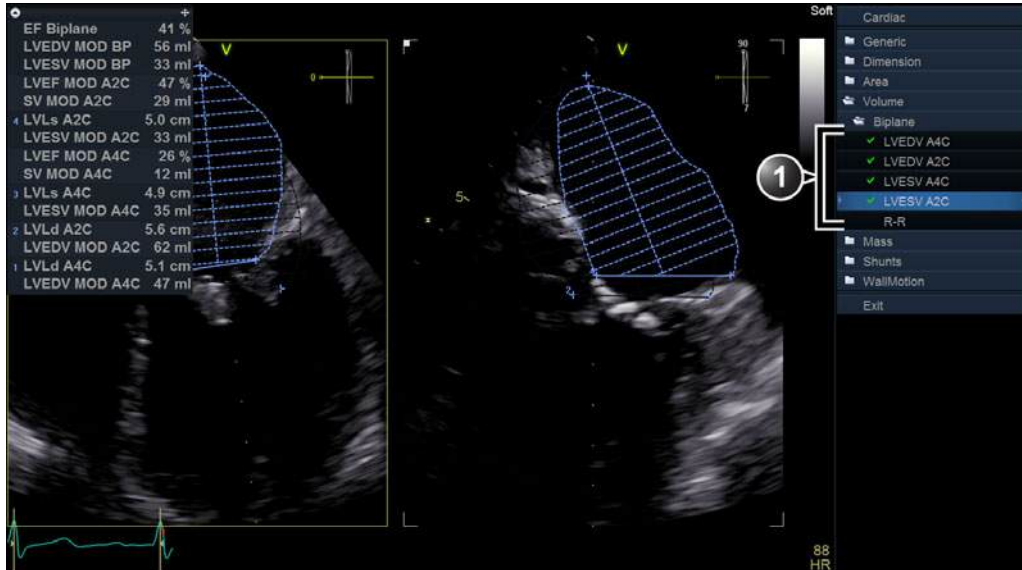

1. Trace tools

Figure 8-50. The Volume measurement screen (Bi-plane)

7. In scan plane 1 (yellow), place the cursor to the start point for the trace.
8. Press **Select** and draw a contour of the left ventricle.
9. Move the cursor to the apex and press **Select** to measure the length.
The trace tool for the Left ventricular end-diastolic volume for the Apical 2 chamber view is selected.
10. Repeat steps 8 and 9 in the scan plane 2 (measurement in the Apical 2 chamber view).
The trace tool for the Left ventricular end-systolic volume for the Apical 4 chamber view is selected.
11. Using the trackball, scroll through the cineloop to display the end-systolic frame in the same heart cycle.
12. Press **Trackball** to activate the **M&A** tool.
13. Repeat steps 7 to 10 to perform the end-systolic measurements in the Apical 4 chamber and 2 chamber views.

The Ejection fraction (Bi-plane) and the end-diastolic and end-systolic left ventricular volumes are calculated.

TSI surface model

A Surface model representation of the left ventricle with TSI color coding can be generated from a TSI Tri-plane acquisition by applying a sampling path in the myocardium. The sampling path is created by placing control points in the myocardium.

1. In Tri-plane TSI mode, acquire an Apical 4 chamber view in scan plane 1 (yellow).
2. If required rotate scan plane 2 and 3 to display an Apical 2 chamber view in scan plane 2 (white) and an Apical long axis view in scan plane 3 (green).
3. Press **Freeze**.
4. Press **Measure**.
The *Measurement* menu is displayed.
5. In the *Measurement* menu select **Surface Map**.
The *Mapping tool* is selected (see Figure 8-51).

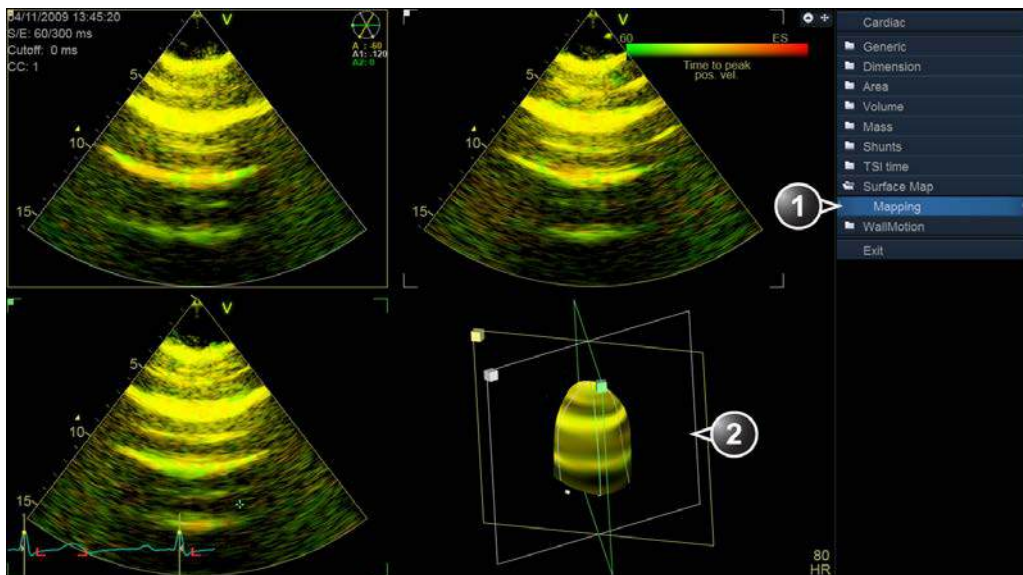

1. Mapping tool for Geometry model
2. TSI surface model

Figure 8-51. The Measurement screen (Geometry model)

6. In scan plane 1 (yellow), place the cursor to the start point for the sampling path starting in the myocardium.
7. Move the cursor following the myocardium and press **Select** to place new points.

By creating several control points the sampling path can be bent to follow the myocardium.

8. Press **Select** twice to end the sampling path.
9. Create a sampling path in scan plane 2 and 3.
A TSI color coded surface model is displayed in the *Geometric model*.
10. To create a dynamic model, scroll to another frame in the same heart cycle and create a sampling path in each scan plane.
11. Press **2D Freeze** to run the model.

To edit the sampling path

1. Place the cursor over a control point.
2. Press **Select** twice (double-click) and move the control point to a new position using the trackball.
3. Press **Select** to place the control point to its new position.

4D Auto RVQ

The 4D Auto RVQ (Automated Right Ventricle Quantification) tool enables the segmentation of the right ventricle (RV) in 4D data sets based on automatic border detection. Upon completion of the segmentation the tool will provide metrics for the RV volume, ejection fraction, stroke volume and diameters.

The 4D Auto RVQ tool is an option for the Vivid S70N when 4D is enabled.

Requirements

The 4D Auto RVQ tool is available on 4D transthoracic (TTE) tissue data sets in replay mode only.



The tool cannot be used on 4D acquisitions with volume rate lower than 12 vps.



Do not use the 4D Auto RVQ tool if:

- The image quality is poor.
- The acquisition has stitching artifacts (see page 6-6 on how to avoid stitching artifacts).
- The acquisition has significant reverberation artifacts.
- The lateral resolution is low.



The results of the tool should not be approved if more than 25% of the right ventricular walls or the detected contours are outside the ultrasound sector or otherwise poorly visualized.



The tool must not be used on other structures than the right ventricle.

Starting 4D Auto RVQ

1. Open a 4D dataset with a good RV acquisition.
2. Press **Measure**.
3. Select **Volume > 4D Auto RVQ** (Figure 8-52)

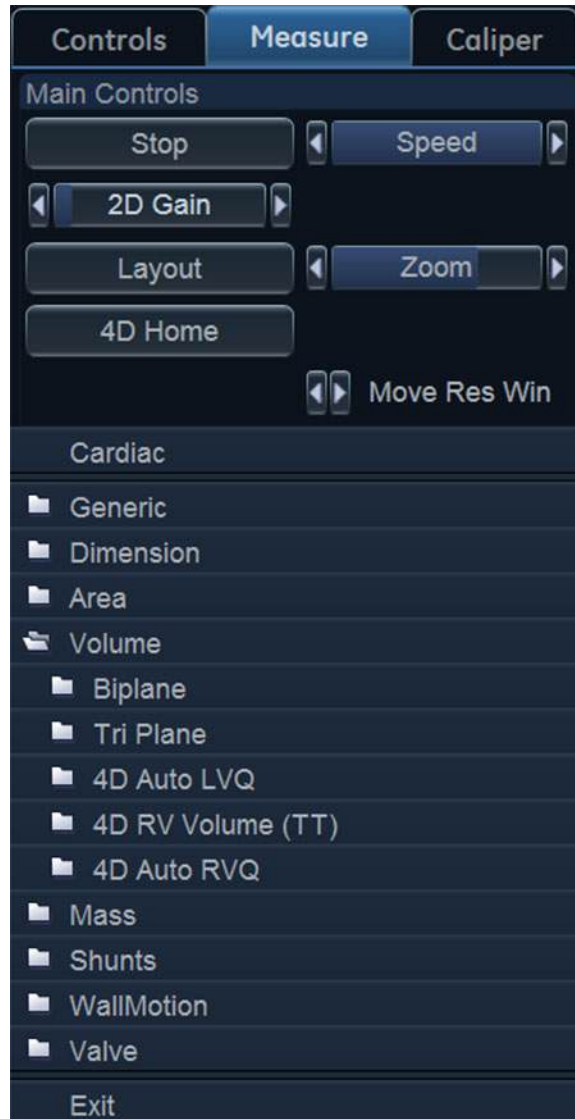

Figure 8-52. Selecting the 4D Auto RVQ tool.

The *Workflow* menu is displayed with the *Align Views* tool selected (Figure 8-53).



Figure 8-53. Workflow menu

Align Views

The Align Views stage displays two long axis slices (rotated 90 degrees with respect to each other) and two short axis view at base and apical RV (Figure 8-54).

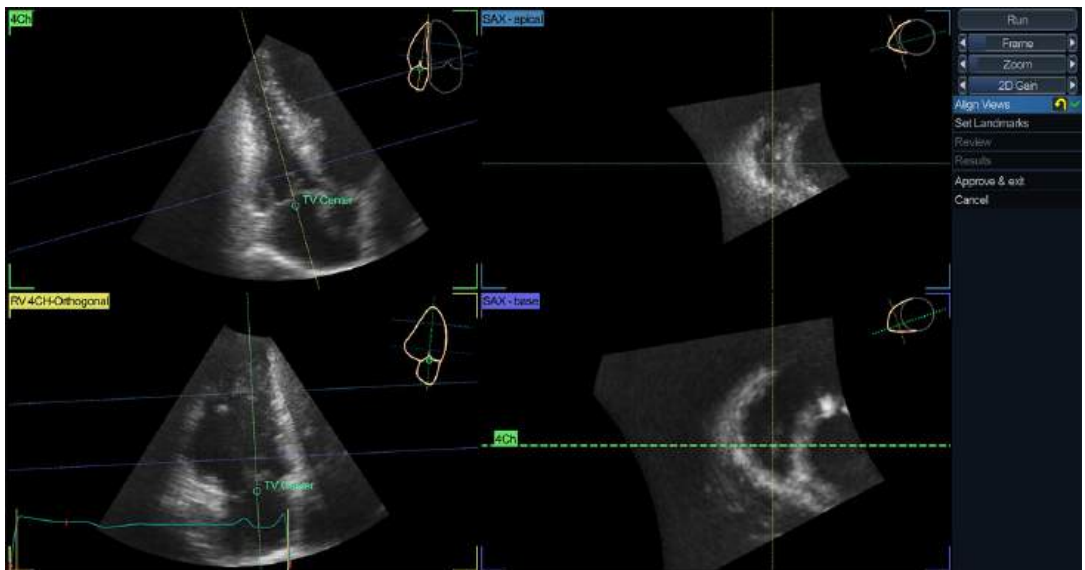

Figure 8-54. Align View Stage

The alignment of the data must be performed in order to identify RV long axis from tricuspid valve (TV) center to RV apex in RV-4-chambers view and on its orthogonal view. Care must be taken to avoid RV foreshortening (Figure 8-39).

1. To select another frame, adjust the Frame control.
2. The alignment can be modified by rotating any of the views and by moving TV center.

Set Landmarks

1. Select **Set Landmarks**.
The screen displays 4-chamber and short axis views of the RV (Figure 8-55).
2. In the 4-chamber view, place the three landmarks:
 - The RV apex.
 - The Tricuspid Annulus on the free wall (TA free wall)
 - The Tricuspid Annulus on the septal wall (TA septal)
3. In the short axis view, place landmarks on:
 - The RV endocardial border corresponding to LV/RV posterior junction.
 - The RV endocardial border corresponding to LV/RV anterior junction.
 - The RV endocardial border corresponding to any RV free wall point.
4. When the final landmark is placed, segmentation automatically launches.



Figure 8-55. The Set Landmarks stage.

Review

When segmentation completes, the Review stage is automatically entered.

The default screen displays nine (9) slices on the 3D data in a 3x3 grid (Figure 8-56):

- First row shows 4-chambers view playing (1st column), at End Diastole (ED) (2nd column) and at End Systole (ES) (3rd column).
 - Second row shows mid short axis view (SAX-mid) playing (1st column), at ED (2nd column) and at ES (3rd column).
 - Third row shows base short axis view (SAX-base) playing (1st column), at ED (2nd column) and at ES (3rd column).
1. The RV segmentation should be checked in all slices. To visualize the RV segmentation in all slices, rotate and translate the reference slices (dotted lines) and observe the segmentation in the interactive view.
 2. The RV segmentation may be adjusted by clicking and dragging contours in 2D views.
 3. The contours should be checked for the entire cycle.

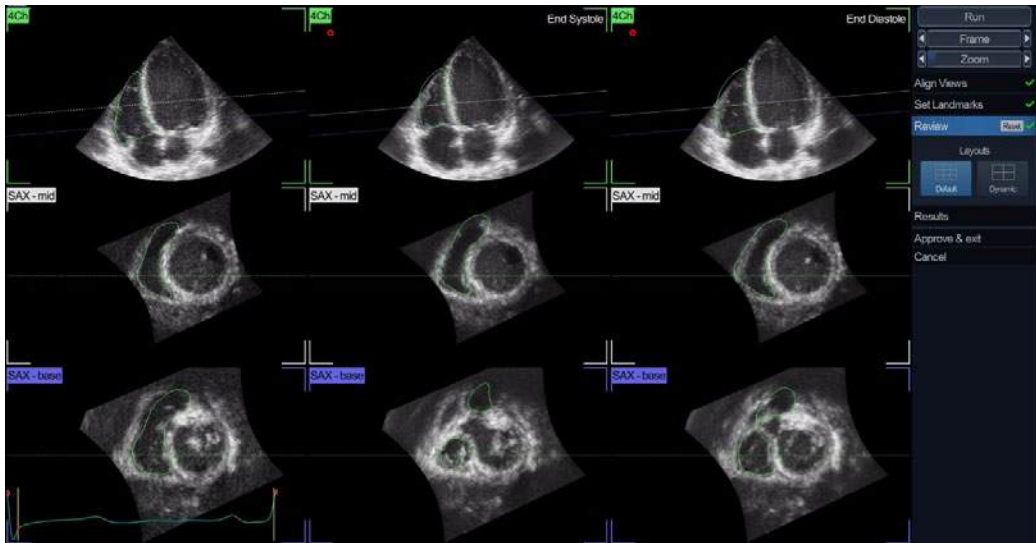

Figure 8-56. The Review stage.

Results

1. Select **Results** stage.

The final segmentation result is shown as contour on 2D slices and as a 3D model in 3D rendering. A dedicated panel reports computed measurements.

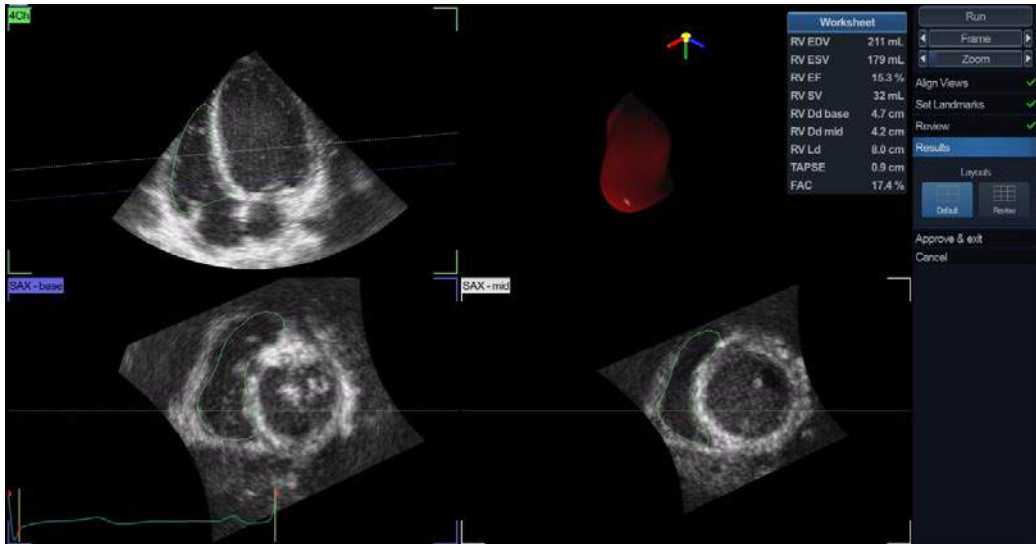

Figure 8-57. The Results stage.

Approval



The 4D Auto RVQ tool involves partly automated steps (automatic segmentation of RV). There is an inherent risk that these steps may fail. Verify the correctness of the borders and 3D model using the displayed verification graphics in the tool before approving.

- Press **Approve and exit** to store the measurements.

The measurements are transferred to the Worksheet. To exit without approving, press **Cancel**.

NOTE: *Measurements that are not approved will not be saved.*

4D Auto MVQ

The 4D Auto MVQ (Automated Mitral Valve Quantification) tool allows the user to perform computer assisted identification and segmentation of 4D TEE images of the Mitral Valve (MV). Upon completion of the segmentation the tool will provide metrics for the MV annulus and leaflet during systole.

The 4D Auto MVQ tool is only on the Vivid S70N with 4D option available when 4D is enabled.

Requirements

4D Auto MVQ is available on 4D transesophageal echocardiographic (TEE) tissue data sets in replay mode only.



The results may be inaccurate when the tool is used on loops with volume rate lower than 12 vps.



Do not use the 4D Auto MVQ tool if:

- The image quality is poor.
- The acquisition has stitching artifacts (see page 6-6 on how to avoid stitching artifacts).
- The acquisition has significant reverberation artifacts.



The results of the tool should not be approved if any part of the valve or annulus is outside the ultrasound sector or otherwise poorly visualized.



The tool must not be used on other structures than the mitral valve.

Starting 4D Auto MVQ

1. Open a 4D TEE acquisition. The acquisitions should be made from mid-esophagus centered on the mitral valve either from the full view or using 4D Zoom.
2. Press **Measure**.
3. Select **Valve > 4D Auto MVQ** (Figure 8-58)



Figure 8-58. Selecting the 4D Auto MVQ tool.

The *Workflow* menu is displayed with the *Align Views* tool selected (Figure 8-59).



Figure 8-59. Workflow menu

Align Views

Align Views stage presents two long axis slices (rotated 90 degrees with respect to each other) and short axis 3D view at the annulus plane (Figure 8-60).



Figure 8-60. Align Views screen

The alignment of the data must be performed in order to identify standard views: Mitral-Commissural view (MC, top left), Antero-Posterior Long Axis view (APLAX, top right) and short axis 3D view aligned with MV annulus (Figure 8-60).

To perform optimal alignment:

- Translate and tilt SAX plane so that it is aligned and just above MV (on atrium side) in APLAX and MC views.
- In APLAX and MC views, translate and tilt the SAX plane so that their intersection is in the center of MV.
- Adjust the center line in APLAX And MC so that their intersection is in the center of MV.

MC, APLAX, and SAX are always orthogonal in all views.

The user must identify in the sequence the frames corresponding to end-diastole (ED) and end-systole (ES). To perform optimal alignment, rotate any of the views and move the annulus plane.

1. ED and ES are automatically estimated and **Set ED** and **Set ES** buttons can be used to modify and correctly mark ED and ES frames.
2. To select another frame, adjust the **Frame** control.

Set Landmarks

1. Select **Set Landmarks**.
The default screen displays two long axis views (MC and APLAX) and short axis 3D view at the annulus plane aligned according to surgical view (the 3D looking from atrium to MV and with aortic valve on top) (Figure 8-61).
2. Place landmarks on: In MC view, mark the two mitral annulus hinge points (MA1 and MA2); on APLAX view mark the Posterior annulus hinge (P), Anterior annulus hinge (A), Coaptation (Coap), and Right Sinus Aortic Annulus (Ao) points.
3. When the final landmark is placed, segmentation is automatically launched.

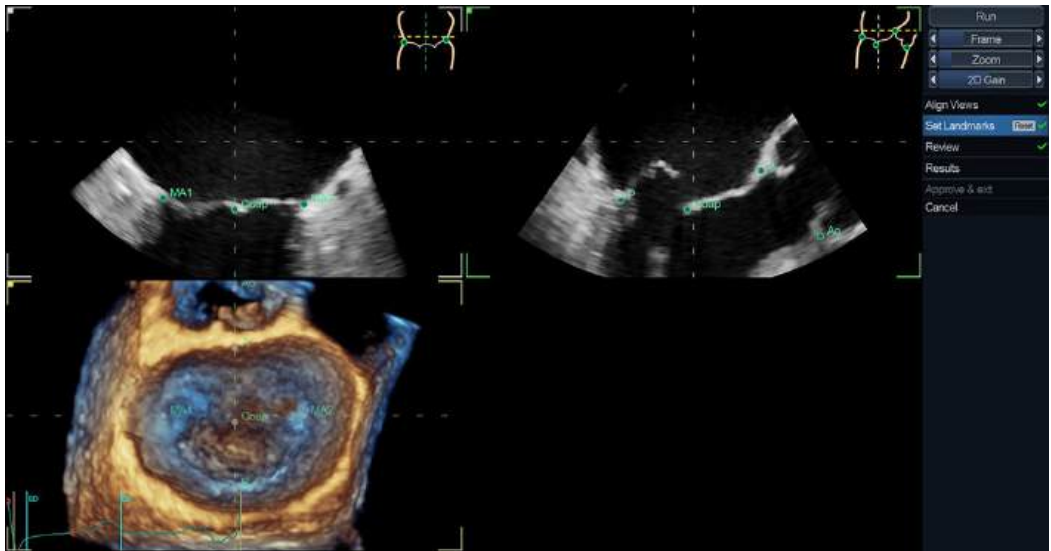

Figure 8-61. Set Landmark stage

Review

1. The *Review* stage is automatically entered.
The default screen displays two long axis views (MC and APLAX), short axis 3D view at the annulus plane aligned according to surgical view (the 3D looking from atrium to MV and with aortic valve on top) and an interactive 3D view of segmented MV (Figure 8-62).



Figure 8-62. The Review stage

2. The MV segmentation should be checked in all slices. To visualize the MV segmentation in all slices, rotate the reference slices in short axis view (dotted lines) and observe the segmentation in the interactive view. In 3D interactive view the model laser lines update according to slice position in the 3D short axis view. The segmentation is correct when segmented model overlaps MV leaflets.

NOTE: *Erroneous contour detection of the mitral valve may lead to incorrect measurement results. The contour detection should be visually checked and edited if required.*

3. The MV segmentation may be adjusted by clicking and dragging leaflet contours in 2D views or by clicking and dragging handles (dots on annulus and on leaflet free edges).
4. In commissure layout the user can modify commissure points. On left 3D image the user can place mouse cursor on one of the commissures while loop is playing and click.

Computation is launched and after few seconds the modified MV model is displayed.

Results

Select the **Results** stage.

The final segmentation result is shown along with panel reporting *Worksheet*, *Annulus* and *Leaflets* measurements. By selecting **Dynamic Layout**, a graph showing selected measurement values during systole is shown. By clicking a measurement the corresponding plot is displayed in **Dynamic Layout**, while in other layouts a 3D annotation showing the measured entity is displayed in the 3D interactive view.



Figure 8-63. The Results screen, showing MV measurements.

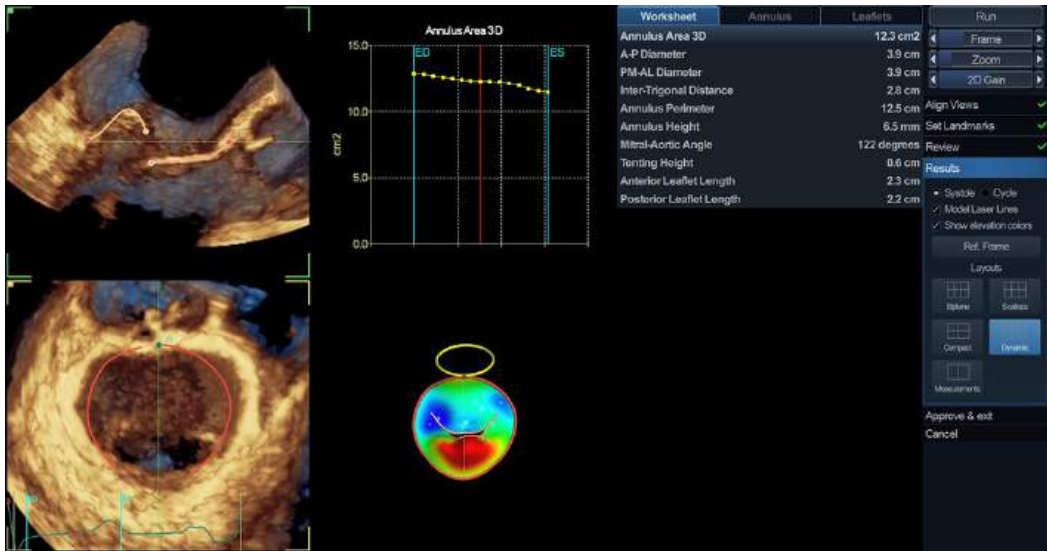

Figure 8-64. The Results screen, showing Dynamic Layout



Figure 8-65. The Results screen, showing Measurement layout

Approval



The 4D Auto MVQ tool involves partly automated steps (automatic segmentation of MV). There is an inherent risk that these steps may fail. Verify the correctness of the borders, tracked points and 3D model using the displayed verification graphics in the tool before approving.

Press **Approve and exit** to store the measurements shown in the *Worksheet* tab of the measurement table.

The measurements are transferred to the Worksheet.

To exit without approving, press **Cancel**.

NOTE: *Measurements that are not approved will not be saved.*

4D Auto AVQ

The 4D Auto AVQ (4D Automated Aortic Valve Quantification) tool allows the user to perform computer assisted alignment of 4D TEE images of the Left Ventricular Outflow Tract (LVOT) as well as segmentation of the LVOT and aortic root. Upon completion of the segmentation the tool will provide metrics for the aortic annulus diameter and area.

The 4D Auto AVQ tool is only available on Vivid S70N.

Requirements

The 4D Auto AVQ tool is available on 4D transesophageal echocardiographic (TEE) tissue data sets in replay mode only.



The tool cannot be used on acquisitions with volume rate lower than 12 vps.



Do not use the 4D Auto AVQ tool if:

- The image quality is poor.
- The acquisition has stitching artifacts (see page 6-6 on how to avoid stitching artifacts).
- The acquisition has significant reverberation artifacts.
- The lateral resolution is low.
- Segments are outside the image sector.



The results of the tool should not be approved if more than 25% of the aortic annulus walls or the detected contours are outside the ultrasound sector or otherwise poorly visualized.



WARNING

The tool must not be used on other structures than the aortic valve.

Starting the 4D Auto AVQ tool

1. Open a 4D TEE acquisition. The acquisitions should be made from mid-esophagus roughly centered on the aortic valve using 4D Zoom.
2. Press **Measure**.
3. Select **Valve > 4D Auto AVQ** (Figure 8-66).



Figure 8-66. Selection of the 4D Auto AVQ tool

The *Workflow* menu is displayed with the *Alignment* tool selected (Figure 8-67).

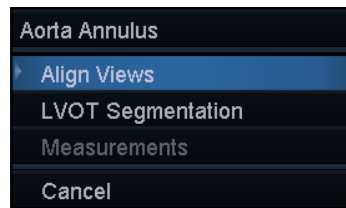

Figure 8-67. Workflow menu

The main screen displays two long axis slices (rotated 90 degrees with respect to each other), a short axis view at the annulus plane and a free view (Figure 8-68).

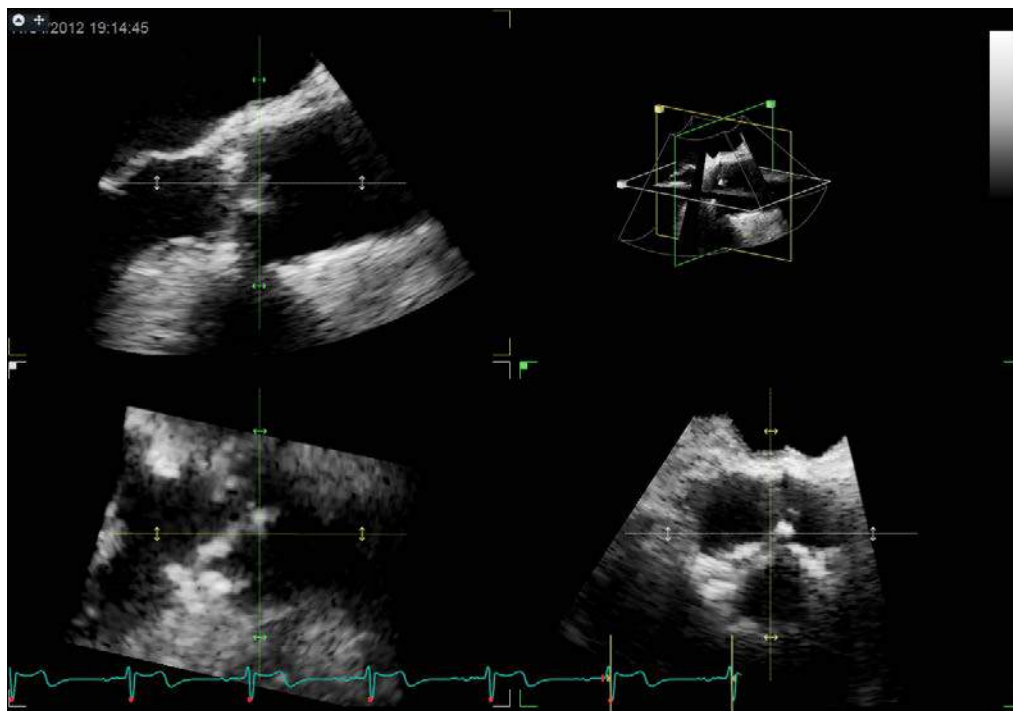

Figure 8-68. Slice alignment screen

Slice alignment

The alignment of the LVOT is done automatically, presenting to the user two long axis slices (rotated 90 degrees with respect to each other) and short axis view at the annulus plane (Figure 8-68).

1. To select another frame adjust the **Frame** control.
2. If necessary the auto alignment can be further adjusted by rotating any of the views and by moving the annulus plane.

LVOT segmentation

1. Select **LVOT segmentation**.

The default screen displays two long axis views, one short axis view, an interactive view and a surface model (Figure 8-69).

The LVOT is automatically segmented and the result is presented in the mid-systolic frame (defined as 15% of the R-R interval). The segmentation is shown as curves where the 3D LVOT boundary intersects the 2D slices as well as a surface model.

2. The LVOT segmentation should be checked in all slices. To visualize the LVOT segmentation in all slices, move the blue line through the LVOT in one of the long axis views and observe the segmentation in the interactive view. The position of the interactive view updates according to the blue line position in the long axis view.
3. The LVOT segmentation may be adjusted by adding attracting points in the interactive view.
 - Press **Lock view** to lock the interactive view.
 - Place the cursor at the location where to add a point.
 - Press **Select**.
A point is added and the segmentation is modified.
 - To delete an attracting point, double click on the point.

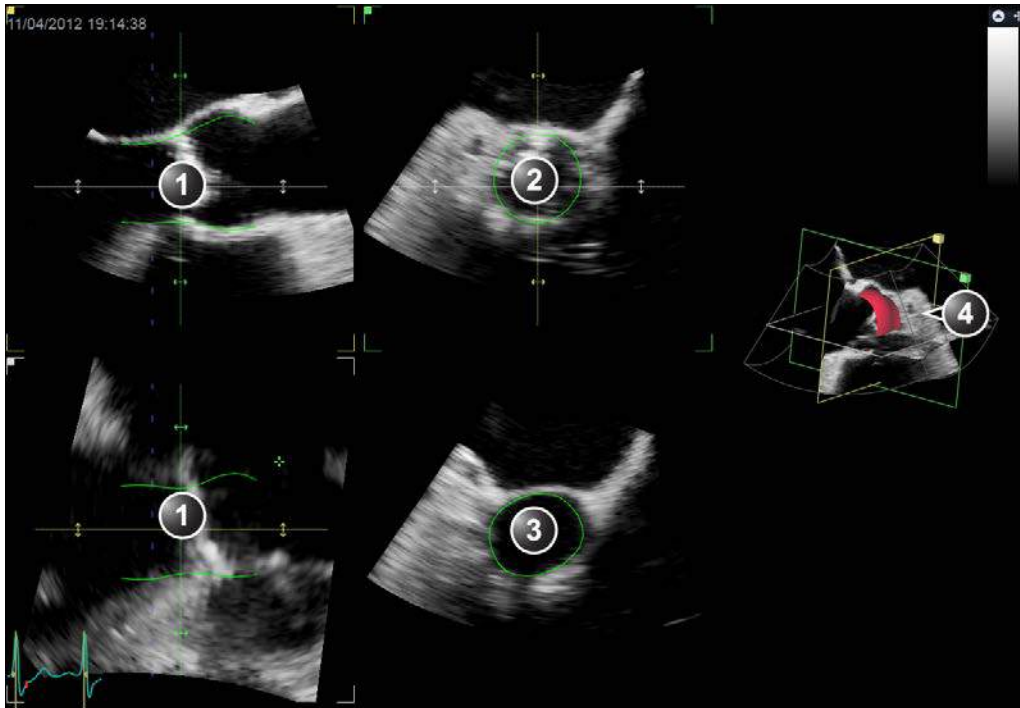

1. Long axis view
2. Short axis view
3. Interactive view
4. 3D surface model

Figure 8-69. LVOT segmentation

Measurements

1. Select **Measurements**.

The final segmentation result is shown along with a graph showing the aortic annulus area in relation to the SAX plane lateral position (distance from aortic valve).

Two layouts are available by use of the Layout button on the Vivid S70N / S60N control panel and the Layout button in the user interface on EchoPAC Software Only (see Figure 8-70).

The user can freeze the loop and navigate the frames. A green vertical line will appear at the measurement frame (see Figure 8-70).

The following measurements are available:

- AA diameter: diameter calculated based on the perimeter of the segmentation in the aortic annulus plane at mid-systole
- AA max diameter: length of the major semi-axis of an ellipse fit to the aortic annulus at mid-systole.
- AA min diameter: length of the minor semi-axis of an ellipse fit to the aortic annulus at mid-systole
- AA area: area of the detected aortic annulus at mid-systole



1. Measurement frame indicator
2. Layout button

Figure 8-70. Aortic valve measurement screen

Approval



WARNING

The 4D Auto AVQ tool involves partly automated steps (automatic view alignment, automatic segmentation of left ventricular outflow tract and aortic root). There is an inherent risk that these steps may fail. Verify the correctness of the alignment, displayed contours and 3D model using the displayed verification graphics in the tool before approving.

1. Press **Approve and exit** to store the measurements shown in the *Measurement result* table.
The measurements are transferred to the Worksheet.
To exit without approving, press **Cancel**.

NOTE: *Measurements that are not approved will not be saved.*

Running Apps

Launchpad

Apps is the button that lists third-party apps together in a panel. This panel is called Launchpad and it displays third-party software apps installed for use with the Vivid S70N / S60N software as buttons in a grid view. The launchpad lets the user launch an app and do measurements and analysis the app supports.

Apps

An app is a separate software application having a particular intended use and performance as designed and offered by its legal manufacturer. Qualified apps are separately purchased through the GE Healthcare Marketplace website and installed. The offered apps are designed and manufactured by a responsible third-party legal manufacturer, and verified to be compatible with Vivid S70N / S60N. In the Vivid S70N / S60N Launchpad the installed apps are represented by app name, name of the legal manufacturer, license information, and the logo of the legal manufacturer on the app buttons. For the user instructions, please check the user manuals of the third-parties.

The user can explore more apps that are verified to be compatible with Vivid S70N / S60N, and thus offered through the GE Healthcare Marketplace website. Apps are available on the subscription-based model and can be ordered from the webpage. Orders must be made by an individual with a user account that is enabled to purchase software on behalf of the organization. The app will download and install automatically after completing an order on the webpage, provided that the ultrasound system is connected to the internet. A working internet connection is necessary to acquire license when an app is activated. The Vivid S70N / S60N may ask for internet connection in regular basis to check the user's subscriptions.

Activating an App

After the first purchase, a code is provided to the user via email. This code is used to connect the Vivid S70N / S60N to the user's account on the GE Healthcare Marketplace.

1. Go to **Config -> Admin -> System Admin**
2. Add the code in the text box *License Server Id*
3. Press **Refresh**

The list of Apps currently installed on the Vivid S70N / S60N is visible under *Installed App* (see Figure 8-71) and their license status is updated after pressing Refresh (with a new License Server Id) or when the Vivid S70N / S60N is restarted.

NOTE: *Internet access is required for the license activation to be successful.*



Figure 8-71. App License fields in Config

Starting an App from the launchpad

While in the Imaging tab:

1. Press **More -> Apps** on the Touch Panel (see Figure 8-72)



Figure 8-72. Accessing the Launchpad

All compatible Apps that are already installed on the Vivid S70N / S60N will be visible on the Touch Panel. Apps without a valid license will be greyed out.

NOTE: Only Apps compatible with the chosen image mode will be visible.

Figure 8-73 presents example apps for illustrative purposes only.



Figure 8-73. Example Apps with various license statuses

2. Press on the desired available App to start it.

Storing measurements

By default, all apps have read-only access to measurements stored in an exam. Only apps that were RA approved can create and store their own measurements. Measurements that were stored by an app are also displayed on the Worksheet alongside with other measurements performed with Vivid tools.

NOTE: *Measurements received from third-party applications are displayed on the Worksheet as one page per application.*

Height	Weight	BSA						BP		Page 1/2			
Parameter	Value	Mth	m1	m2	m4	m5	m6	m7	n8	m9	m10	m12	m1
Third party company													
Approved_OutOfProcess													
MT_MEANING	1.2 cm	Av	1.1	1.2									

Figure 8-74. Storing measurements

Advanced vascular measurements and analysis

Intima-Media Thickness

The Intima-Media Thickness (IMT) is calculated based on automatic contour detection of the Intima and Media layers on a user-defined search region along the vessel wall. Multiple IMT measurements are made between pairs of intima and adventitia points along the wall (Figure 8-75). IMT can be measured both on the posterior and the anterior walls of the vessel. IMT should be done on 2D mode images, not on Color mode images.

The IMT measurement is available with linear probes only.

NOTE: Due to the physical properties of ultrasound imaging, the posterior IMT measurement is generally more accurate than the anterior IMT measurement.

The following parameters are calculated:

- Average IMT
- Maximum IMT
- Minimum IMT
- Standard deviation of IMT measurements
- Number of successful IMT measurements

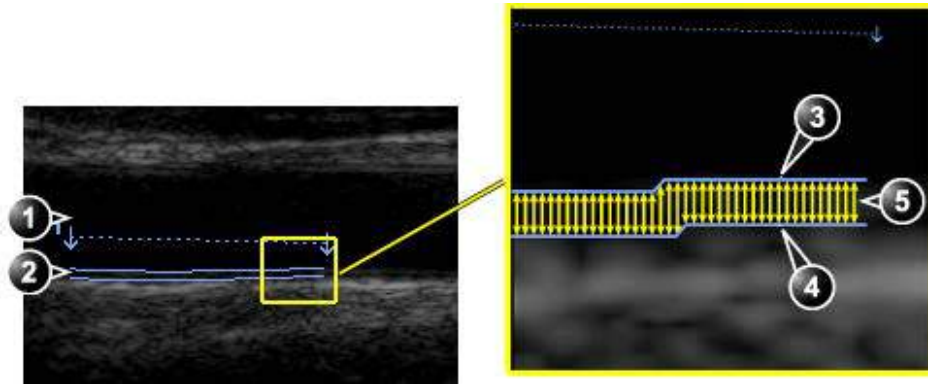

1. Vessel lumen
2. Vessel wall

3. Lumen-Intima boundary
4. Media-Adventitia boundary
5. Multiple IMT measurements

Figure 8-75. IMT measurement (Posterior wall)

IMT Measurement procedure

The following procedure describes the posterior IMT measurement.

1. Acquire a longitudinal scan of the carotid artery and optimize the image.
2. Press **Freeze**.
3. Scroll to an end-diastolic frame where the intima layer is clearly visible.
4. Press **Measure**.
5. Select the appropriate IMT measurement. If measuring the IMT of the posterior wall of the right common carotid select **Rt** and **CCA IMT Post** (Figure 8-76).

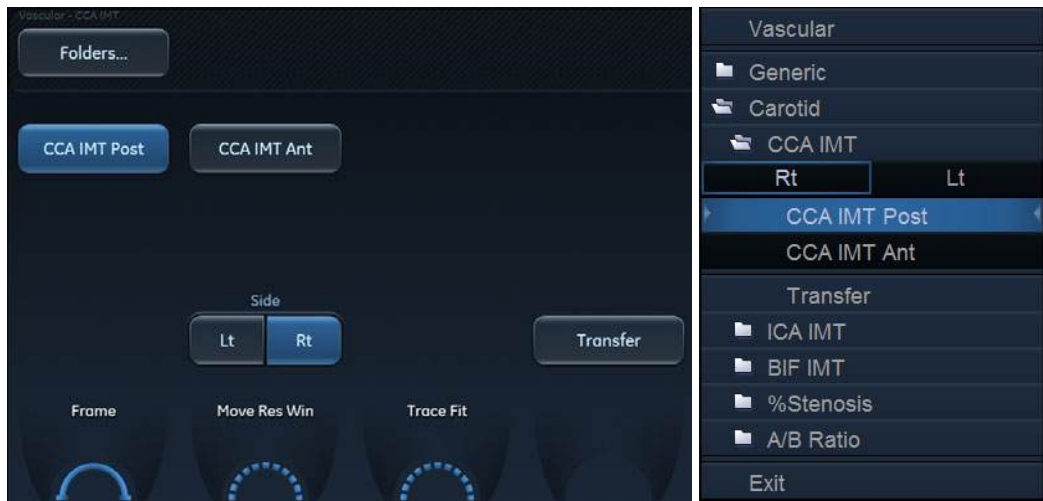

Figure 8-76. IMT Measurement menu (Right Common Carotid Posterior IMT measurement tool)

6. Place the cursor in the artery closer to the posterior wall and press **Select** to anchor the start of the search region (Figure 8-77, left).
7. Move the cursor parallel to the artery to define the end point of the search region. Make sure the Intima and Media layers are within the search region (indicated by the lower dotted line in Figure 8-77, left).

Press **Select** to anchor the point. For the posterior wall the contour detector searches for the leading of the edges of the intima and adventitia layers. The detected contours are drawn in the image (Figure 8-77, right).

The measurement calculations are displayed in the *Measurement result* table.

NOTE: *If the Intima and Media layers are not within the search region, the contour is not drawn. Select (double click) and move the anchored points closer to the Intima layer.*

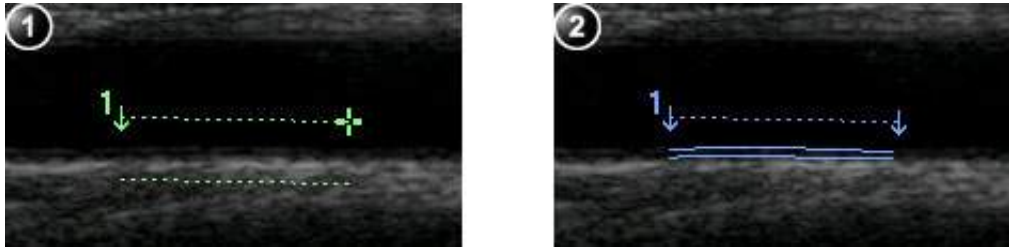

1. Measurement segment

2. IMT trace

Figure 8-77. IMT Measurement segment and traces

8. If the contour is not optimal, adjust **Trace Fit** to modify the traces according to different threshold values.

If the contour is still not optimal, try to perform the IMT measurement on another frame, preferably close to the end diastole.

IMT trace approval

NOTE: *Erroneous contour detection of the Intima and Media layers may lead to incorrect measurement results. The contour detection should be visually checked and edited if required.*

Since the IMT measurements are done semi-automatically, the operator has to approve the detection by visual inspection before storing the results in worksheet and report.

1. If the traces fit both layers of the posterior wall, approve the measurement by selecting **Transfer** in the *Measurement* menu.

Once transferred, the calculations can be viewed in the worksheet and report.

NOTE: *Measurements that are not approved will not be saved.*

NOTE: *Any image adjustments (e.g Gain or zoom) on approved (transferred) measurements will unassign the measurements. Press **Transfer** to approve the measurements again.*

Vascular Auto Doppler

Vascular Auto Doppler enables the Vivid S70N / S60N to detect and identify a cardiac cycle, and allows measurements and calculations during live timeline imaging while the image is frozen or in cine.

During cardiac cycle detection, the system identifies the cardiac cycle using calipers, vertical bars, and/or highlighting of timeline data. Use of identifiers is based on measurements and calculations selected by an operator for the current application. The system may place calipers at early systolic peak, peak systole, minimum diastole and end diastole. For Venous flow, calipers are placed at peak values. Vertical bars may also be placed to indicate the beginning and end of the cardiac cycle. The peak and/or mean trace may be highlighted. You can edit the cardiac cycle identified by the system or select a different cardiac cycle.



1. Auto/Manual measurement
2. Cardiac cycle indicators
3. Calipers

Figure 8-78. Vascular Auto Doppler screen

Use the Modify Calculation sheet to select the calculations to be displayed in the *M&A Result* window. These calculations are displayed at the top of the *M&A Result* window located adjacent to the image. The calculations are presettable by application, which means you can set up the default calculations to be displayed for each application. See 'The Modify calculations sheet' on page 12-36 for more information.



The automated vascular doppler measurements use computer algorithms for envelope detection and recognition of points of interest. There is an inherent risk that these algorithms may sometimes give suboptimal or incorrect results. Verify the correctness of the displayed points and traces before approving them.

OB measurements

1. From an obstetric exam on a scan in Freeze, press **Measure**.
2. Select the desired study.
3. Perform the required measurements from the selected study.

Follow the on-screen indications when performing measurements.

OB graphs

OB Graphs allow you to assess fetal growth compared to a normal growth curve. When a patient has completed two or more ultrasound exams, you can also use the graphs to look at fetal trending. For multi-gestational patients you can show curves for all fetuses and compare the growth on the graphs. The Vivid S70N / S60N provides the following two basic types of graphs:

- **Fetal Growth Curve graphs** – shows one measurement per graph. These graphs show the normal growth curve, positive and negative standard deviations or applicable percentiles, and ultrasound age of the fetus using the current measurement. For multi-gestational pregnancies, you can show curves for all fetuses. If previous exam data is available, the graph can show fetal trending.
- **Fetal Growth Bar graph** – shows the ultrasound age and the gestational age based on patient data. Plots all measurements on one graph.



The system provides calculations (e.g. estimated fetal weight) and charts based on published scientific literature. The selection of the appropriate chart and clinical interpretation of calculations and charts are the sole responsibility of the user. The user must consider contraindications for the use of a calculation or chart as described in the scientific literature. The diagnosis, decision for further examinations and medical treatment must be performed by qualified personnel following good clinical practice.

To view OB graphs

1. Press **Worksheet**.
2. Press **Graph**.

The Fetal growth curve graph is displayed (Figure 8-79). The horizontal axis shows the fetal age in weeks. The system determines this age from the data entered in the *Patient info and exam* screen. Depending on the measurement selected the vertical axis displays measurements (mm or cm), ratios (%) or fetal weight (g).

The Fetal growth curve graph shows the following information for the selected measurement:

- The normal growth curve
- The standard deviations or relevant percentiles
- The gestational age of the fetus, using patient data (vertical dotted line)
- Using the current ultrasound measurement data, where the fetus is on the growth curve

From the OB graphs screen, the user can enter relevant information in the *Fetus position* and *Placenta* fields.

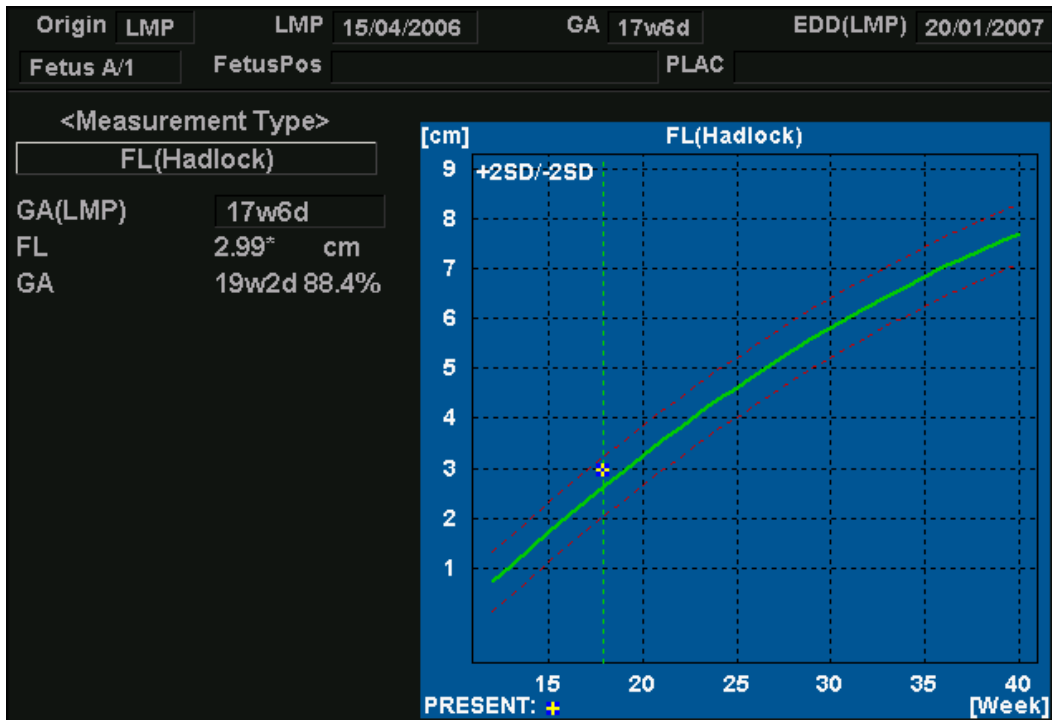

Figure 8-79. Fetal growth curve graph

To select the measurement

1. Select the measurement in the *Measurement type* field.
A list of available measurements is displayed.
2. Select the measurement to display.
To scroll through all Fetal growth curve graphs, adjust **Graph change**.

To select the age to use

1. Adjust **Select GA**.
The plot displays either gestational age (GA) from the LMP, or the composite ultrasound age (CUA).
When selected, the gestational age may be changed by the user.
 1. Select the **GA (LMP)** value.
An editing window is displayed.
 2. Enter a new value and select **OK**.
The GA (LMP) label is changed to GA(GA) showing the new value entered. This information is also updated in the

Patient info and exam screen. In addition the EDD (LMP) is updated to EDD (GA) with new calculated value.

To view single or quad screen

1. Press **Quad** to display four graphs simultaneously.
2. To select the measurements to display in the quad screen, select the drop-down button on the left of each graph and select the desired measurement.
3. Press **Single** to display single graph screen again.

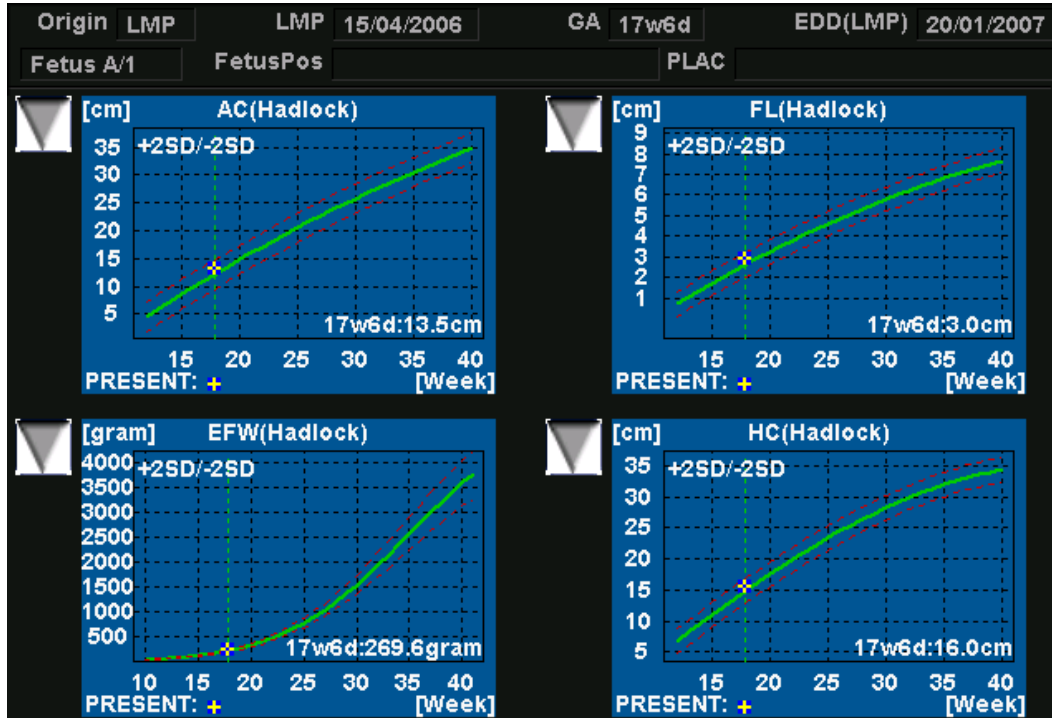

Figure 8-80. Fetal growth curve graph: quad screen

Fetal trending

When you have ultrasound data from more than one exam of a patient, you can use the data to look at fetal trending on the Fetal growth curve graphs. Fetal trending requires that a LMP value is entered in the *Patient info and exam* screen.

1. Press **Worksheet**.
2. Press **Graphs** and select the desired measurement to display.
3. Press **Plot both**.

The system automatically finds the data from previous ultrasound exams, and displays it on the graph with the present data.

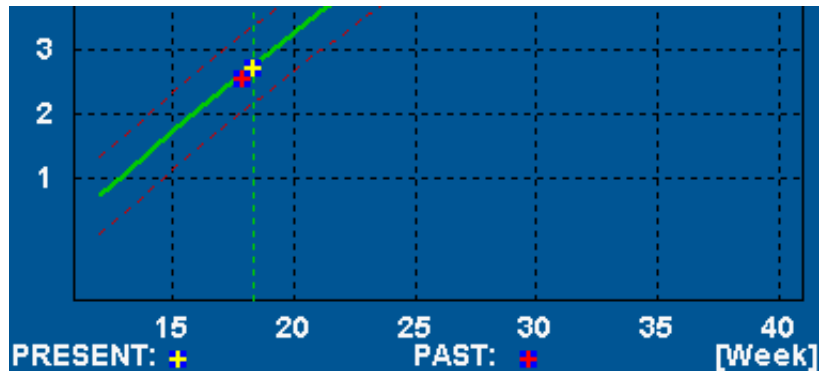

Figure 8-81. Fetal trending graph

Fetal growth bar graph

The fetal growth bar graph shows current exam measurements and the normal growth range based on the gestational age. It shows all measurements on one graph.

1. Press **Worksheet**.
2. Press **Graph**.
3. Press **Bar**.

The fetal growth bar graph is displayed.

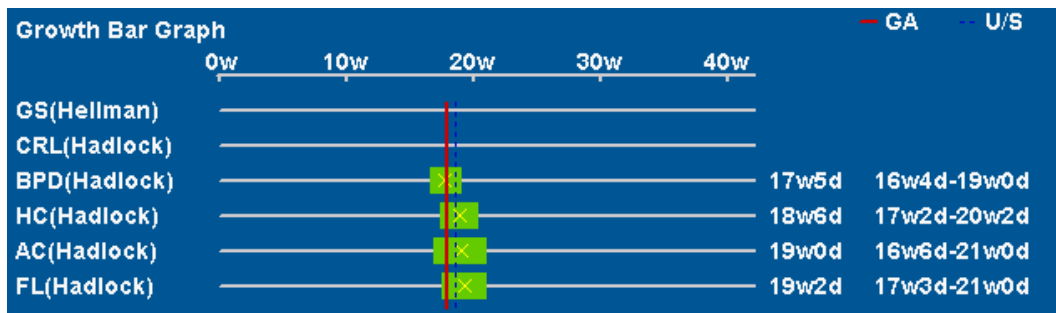



Figure 8-82. Fetal growth bar graph

- The horizontal axis shows the gestational weeks.
- The red vertical line shows the gestational age using the patient data.
- The blue dotted vertical line shows the ultrasound age using the current measurements.
- The yellow x shows the ultrasound age for each measurement.
- The green rectangle shows the normal age range for the measurement.

Measurement result table

The display of the *Measurement result* table can be minimized and moved to prevent the table obscuring parts of the ultrasound image.

Minimizing the Measurement result table

1. Select  on the heading of the *Measurement result* table. The *Measurement result* table is minimized to the heading bar.
Repeat step 1 to maximize the *Measurement result* table.

Moving the Measurement result table

1. Adjust **Move Result Win** on the Control panel to move the *Measurement result* table around the screen.

NOTE: *Alternative: select the heading of the Measurement result table, move the table to a new location and press **Select** to anchor the table.*

Deleting measurements

1. Select the measurement to delete in the *Measurement result* table.
2. Select **Delete measurement** in the context menu.

Worksheet

The worksheet function enables the user to review, edit, delete or print data independently of a report. All measurements and calculations taken during the examination can be viewed at any time using the worksheet.

Overview

Height	Weight		BSA					BP				Page 1/1	
Parameter	Value	Mth	m1	m2	m3	m4	m5	m6	m7	m8	m9	m10	m11
Biplane													
A4C													
LVLd A4C	5.1 cm	Av	5.1										
LVEDV MOD A4C	47 ml	Av	47										
LVI MOD A4C													
LVEF MOD A4C	26 %		26										
SV MOD A4C	12 ml		12										
A2C													
LVLd A2C	5.6 cm	Av	5.6										
LVEDV MOD A2C	62 ml	Av	62										



1. Measurement type
2. Measurement parameter
3. Value calculated according to the value type selected.
4. Measured / calculated values
5. Value type: Averaging, Max, Min or Last

Figure 8-83. Worksheet screen

Using the Worksheet

1. Press **Worksheet** on the Control panel.
2. Select the Measurement type.
3. To browse through the measurements, select **Page Up** or **Page Down** or adjust **Page Change**.

To select a type of value

1. Select the relevant cell in the *Mth (Method)* column.
A pop-up menu is displayed showing the different options available.

1. Average of the measurements taken
2. Maximum measurement
3. Minimum measurement
4. Last measurement that was taken



Figure 8-84. Value options

2. Select the required option.
The value is updated accordingly.

To exclude or include measurements

One or more measurement values from a set of measurements for a parameter can be excluded when doing average calculation.

1. Place the cursor over the measurement to exclude.
2. Press **Update Menu**.
3. Select **Exclude value/Include value** from the context menu.

To delete measurements

1. Place the cursor over the measurement to delete.
2. Press **Update Menu**.
3. Select:
 - **Delete value** to delete the current value
 - **Delete set** to delete the current set of values
 - **Delete all** to delete all values from the Worksheet.

To change a measurement value

1. Select the measurement to change.
2. Enter a new value.

NOTE: *Changed measurements are marked with an asterisk (*).*

Measurement accuracy

General

When using the Measurement and Analysis (M&A) package, it is important to keep in mind the different aspects that affect the accuracy of the measurements. These include acoustical properties, patient echogenicity, measurement tools and algorithms, system setup (especially Field-of-view or Range settings), probe type used, and operator inputs.

Sources of error

Image Quality

The accuracy of each measurement is highly dependent on image quality. Image quality is highly dependent on system design, operator variability, and patient echogenicity. The operator variability and patient echogenicity are independent of the ultrasound system.

Operator variability

One of the largest potential sources of error is operator variability. A skilled operator can reduce this by optimizing the image quality for each type of measurement. Clear identification of structures, good probe alignment and correct cursor placement is important. Because of pixel resolution, the accuracy of a measurement decreases with decreasing distance on screen. Therefore it is important when scaling the object on the screen to avoid measuring objects that are too small.

NOTE: See also 'Optimizing Measurement Accuracy' on page 8-154 for recommended techniques.

Image measurement

The accuracy in lateral direction is limited by the beam width and the beam positioning. The radial accuracy is mainly limited by the acoustic pulse length.

Doppler alignment

Errors in velocity measurements increase with the cosine of the angle between the measured flow and the ultrasound beam. For example, an alignment error of 20 degrees, will give a 6% under-estimation of the velocities, while an error of 40 degrees will cause the under-estimation to be 24%. It is highly recommended to optimize transducer position to align the ultrasound beam with the flow direction.

NOTE: If alignment is not possible, you may use the Angle Correction control to compensate if the flow direction is known.

Screen pixel resolution

The display screen is composed of an array of square picture elements (pixels). The smallest resolvable unit is +/- 1 pixel. This pixel error is only significant when measuring short distances on the screen. By observing good scanning practices, the settings of the field of view should be such that the measured distance is significant with respect to the full size of the screen. When such scaling is impossible, the pixel error may come into play. The pixel error is +/- 0.2% of the full ultrasound area in the User Screen.

Algorithms

Some formulae used in clinical calculations are based on assumptions or approximations. For example the volume calculations from 2D or M mode assume a certain, 'ideal' shape of the heart chamber, while the actual shape can vary quite much between individuals. Also, formulae taking several "raw" measurements as inputs are prone to increased errors, depending on the combination of input variable accuracies. For example, the Cardiac Output formula from Doppler is sensitive to errors in the entered Diameter, since this parameter will be squared in the formula.

Speed of Sound in Tissue

The average speed of sound value of 1540 meters / second is used for all calculations. Depending on the tissue structures, this generalization may give errors from 2% (typical) to 5% (much fatty tissue layers present).

Optimizing Measurement Accuracy

Probe selection

Select a transducer appropriate for the application, and optimize the transducer frequencies used. Higher imaging frequencies provide better resolution, but less penetration than lower frequencies. Lower Doppler frequencies can measure higher max velocities, and at greater depths, but with less velocity resolution than higher Doppler frequencies.

Field of View

All display modes should be adjusted so that the area of interest covers as large portion of the display as possible. Use **Depth**, **Angle**, **Zoom**, **Horizontal Sweep** and **Velocity** controls to optimize the different modes.

Cursor Placement

All measurements are dependent on the accuracy of their “input” data. Consistency and precision in placing cursors and drawing traces correctly on the images are important.

NOTE: Avoid placement of the cursor near the top of the image, close to the transducer, when using convex or linear probes.

Measurement Uncertainties

The accuracy percentages reported below are based on data taken with optimum control settings, using calibrated phantoms and test equipment.

The calibration was done for the basic measurable parameters: Distance, Time and Velocity.

Independent sources of uncertainty contribute to a total uncertainty by a RMS (Root Mean Square) combination of the sources. Refer to the discussions above regarding measurement accuracy and sources of error when reading the table below.

NOTE: In Cardiac, several Doppler measurements have an auto feature (CAD – Cardiac Auto Doppler). Cardiac Auto Doppler uses automatic algorithms to analyze a Doppler spectrum over multiple heart cycles, and then displays a set of suggested landmarks. Adjust – if needed – and approve these landmarks before they are extracted and used for initialization of existing

manual Doppler measurement tools. These Doppler tools then calculate and deliver numeric results, using exactly the same calculations as when landmarks are defined by purely manual user input. Be aware that due to potential variations in the automatically placed landmarks when using Cardiac Auto Doppler, any calculation based on unadjusted landmarks may give a deviation in numeric results - typically up to 10% compared to when the landmarks are optimized and placed manually.



The AFI, AFI LA, AFI RV, and AutoEF tools use automated algorithms to do segmentation and speckle tracking. There is an inherent risk that these algorithms may sometimes provide suboptimal or incorrect results. Please verify the correctness of the displayed points and traces before approving them.



4D Auto RVQ, 4D Auto AVQ, and 4D Auto MVQ tools use automated segmentation algorithms to initiate 3D models that the tool measurements are calculated from. There is an inherent risk that these automated segmentation algorithms may give inaccurate 3D models.



The AI Auto Measure – 2D measurements use computer algorithms for estimating the caliper end points. There is an inherent risk that these algorithms may sometimes give suboptimal or incorrect results.

NOTE: *Values reported in the Accuracy column in the table below are based on measurements where the user has, if necessary, edited the 3D model before approval of the results. As recommended in this manual, the result should not be approved without review, and, if necessary, editing of the 3D model. If the tools are used without review and editing, the expected accuracy will be negatively affected. The expected accuracy of measurements when the 3D tools are used without review and editing are added in the Comments column below labeled as "Accuracy w/o editing".*

Measurement	Range	Accuracy	Comments
2D Calipers			
Depth	20 - 105 mm	max (5.0%, 1.0 mm)	
Vertical distance	0.25 - 110 mm	max (5.0%, 1.0 mm)	
Horizontal distance	10 - 110 mm	max (5.0%, 1.0 mm)	

Measurements and Analysis

Measurement	Range	Accuracy	Comments
Area	0.5 – 150 cm ²	10%	
Circumference	5 - 30 cm	10%	
M-mode Calipers			
Depth	20 - 105 mm	max (5.0%, 1.0 mm)	
dt	10 - 10000 ms	max (5.0%, 1 ms)	With optimal sweep speed setting
Spectrum Calipers			
Velocity	0.2 – 2.0 m/s	10%	
dt	10 - 1000ms	max (0.5%, 5 ms)	With optimal sweep speed setting
	1000 - 10000ms	1.5%	
Spectrum Doppler AutoCalc			
Velocity	5 - 110 cm/s	10%	
dt	10 - 200 ms	max (2%, 4 ms)	
Acceleration	250 - 1300 cm/s ²	12%	
Volume Flow	60 - 1600 ml/min	20%	
Heart Rate	55 - 115 bpm	10%	
TSI Caliper			
dt	65 - 400 ms	max (2 frames, 25 ms)	
Velocity	2.6 - 7.5 cm/s	10%	
ECG Caliper			
dt	10 - 10000 ms	max (5.0%, 1 ms)	
Heart Rate	40 - 250 bpm	5%	The heart rate displayed on screen while scanning, estimated based on the eight last heart beats acquired by ECG.
Event timing			
Time	130 - 650 ms	max (5.0%, 1 ms)	
Q Analysis			
Velocity from TVI data	1 - 45 cm/s	3 cm/s	
Strain rate from TVI data	-6 - +2 s ⁻¹	max (2 s ⁻¹ , 20%)	
Strain from TVI data	-45 - +65%	7 percentage points	

Measurement	Range	Accuracy	Comments
Displacement from TVI data	3 - +15 mm	2 mm	
Grayscale intensity difference from 2D data	12 dB	10%	
Velocity from color flow data	25 - 75 cm/s	7 cm/s	
dt	10 -10000 ms	max (2 frames, 25 ms)	
2D Auto EF			
EF (single view)	25 – 65%	15 percentage points	The given Range and Accuracy has been validated both for GE DICOM and raw data formats (raw data with ECG), as well as for 3rd party DICOM data from Philips and Siemens, but for no other vendors. Note that separate table sections are provided for 2D Auto EF on Adult TTE raw data with ECG and 2D AutoEF on Adult TTE raw data without ECG.
ESV (single view)	19 – 140 ml	40 ml	
EDV (single view)	65 – 240 ml	40 ml	
Ls and Ld	5 – 9 cm	2 cm	
EF_BiP	25 –65%	15 percentage points	
ESV_BiP	19 – 140 ml	20 ml	
EDV_BiP	65 – 240 ml	20 ml	
2D AutoEF when Adult TTE Raw data with ECG (see “accuracy w/o editing” for Easy Auto EF)			
EF (single view)	25 – 65%	15 percentage points	Accuracy w/o editing: 15 percentage points (within 95% confidence interval)
ESV (single view)	19 – 140 ml	40 ml	Accuracy w/o editing: 50 ml (within 95% confidence interval)
EDV (single view)	65 – 240 ml	40 ml	Accuracy w/o editing: 50 ml (within 95% confidence interval)
Ls and Ld	5 – 9 cm	2 cm	Accuracy w/o editing: 2 cm (within 95% confidence interval)
EF_BiP	25 –65%	15 percentage points	Accuracy w/o editing: 15 percentage points (within 95% confidence interval)
ESV_BiP	19 – 140 ml	20 ml	Accuracy w/o editing: 50 ml (within 95% confidence interval)

Measurement	Range	Accuracy	Comments
EDV_BiP	65 – 240 ml	20 ml	Accuracy w/o editing: 50 ml (within 95% confidence interval)
2D AutoEF when Adult TTE raw data without ECG			
EF (single view)	25 – 65%	15 percentage points	Accuracy was calculated as maximum allowed difference between running tool on recording with ECG and with ECG removed.
ESV (single view)	19 – 140 ml	40 ml	
EDV (single view)	65 – 240 ml	40 ml	
Ls and Ld	5 – 9 cm	2 cm	
EF_BiP	25 – 65%	15 percentage points	
ESV_BiP	19 – 140 ml	20 ml	
EDV_BiP	65 – 240 ml	20 ml	
HeartRate	47 – 111 bpm	8 bpm	
AFI/Triplane AFI			
Global Longitudinal Strain	-20 – -5%	3 percentage points	Accuracy for Global Longitudinal Strain is 5 percentage points for TEE probes The given Range and Accuracy has been validated both for GE DICOM and raw data formats, as well as for 3rd party DICOM data from Philips and Siemens, but for no other vendors. Note that a separate table section is provided specifically for AFI when Adult TTE raw data as this data type allows more automation.
Regional Longitudinal Strain	-20 – +2%	9 percentage points	
Longitudinal Endocardial strain	-25 – -2%	9 percentage points	
AFI/triplane AFI when Adult TTE Raw data (see “accuracy w/o editing” for Easy AFI LV)			
Global Longitudinal Strain	-22 – -5%	3 percentage points	Accuracy w/o editing: 3 percentage points (within 95% confidence interval)
Regional Longitudinal Strain	-22 – +2%	9 percentage points	Accuracy w/o editing: 9 percentage points (within 95% confidence interval)

Measurement	Range	Accuracy	Comments
AFI on the Right Ventricle			
G peak SL Full/Endo (A4C_RV)	-23 – -5%	3 percentage points	
G peak SL Full/Endo (A4C_RVFW)	-29 – -10%	6 percentage points	
Apical/ Mid/ Basal FW/IVS PSSL Full/Endo	-29 – -5%	9 percentage points	
TAPSE	17 – 24mm	≤ 5 mm	
AFI on the Left Atrium			
LASr R-Wave/P-Wave (A4C/A2C/Avg)	5 – 31%	5 percentage points	
LAScd R-Wave/P-Wave (A4C/A2C/Avg)	-18 – -5%	5 percentage points	
LASct R-Wave/P-Wave (A4C/A2C/Avg)	-15 – 0%	5 percentage points	
LA Vmax (A2C/A4C)	19 – 131 ml	≤ 25 ml	
LA Vmin (A2C/A4C)	6 – 80 ml	≤ 20 ml	
LA VpreA (A2C/A4C)	11 – 98 ml	≤ 23 ml	
LA Vmax (BiP)	19 – 131 ml	≤ 20 ml	
LA Vmin (BiP)	6 – 80 ml	≤ 15 ml	
LA VpreA (BiP)	15 – 300 ml	≤ 18 ml	
AI Auto Measure – 2D			
IVSd	5 – 130 mm	max (5.0%, 1.0 mm)	Range, Accuracy w/o editing (mean absolute difference to reference): 5 – 12 mm, 16%. Algorithm will refuse to provide estimates in 12% of PLAX images.
LVIDd	5 – 130 mm	max (5.0%, 1.0 mm)	Range, Accuracy w/o editing (mean absolute difference to reference): 33 – 77 mm, 5%. Algorithm will refuse to provide estimates in 12% of PLAX images.

Measurements and Analysis

Measurement	Range	Accuracy	Comments
LVPWd	5 – 130 mm	max (5.0%, 1.0 mm)	Range, Accuracy w/o editing (mean absolute difference to reference): 5 – 13 mm, 18%. Algorithm will refuse to provide estimates in 12% of PLAX images.
IVSs	5 – 130 mm	max (5.0%, 1.0 mm)	Range, Accuracy w/o editing (mean absolute difference to reference): 7 – 17 mm, 11%. Algorithm will refuse to provide estimates in 12% of PLAX images.
LVIDs	5 – 130 mm	max (5.0%, 1.0 mm)	Range, Accuracy w/o editing (mean absolute difference to reference): 23 – 72 mm, 6%. Algorithm will refuse to provide estimates in 12% of PLAX images.
LVPWs	5 – 130 mm	max (5.0%, 1.0 mm)	Range, Accuracy w/o editing (mean absolute difference to reference): 8 – 17 mm, 15%. Algorithm will refuse to provide estimates in 12% of PLAX images.
4D Auto LVQ			
Volumes (EDV, ESV)	5 – 20 ml 20 – 210 ml	3 ml 10 ml	The tool should not be used on collapsing ventricles
ED Mass	43 – 200 g	20 g	
ES Mass	43 – 200 g	20 g	
Sphericity Index	0.27 – 0.98	0.2	
4D Strain Segmental strain (Longitudinal, Circumferential, Area, Radial)	-35 – +53%	9 percentage points	
Rotation	2.1 – 37.4°	5°	
4D Auto MVQ			
Annulus Area 2D	4.1 - 22.8 cm ²	10%	Accuracy w/o editing: 15%

Measurement	Range	Accuracy	Comments
Annulus Area 3D	4.6 - 25.3 cm ²	10%	Accuracy w/o editing: 15%
Annulus Height / MV Annulus Height	1.7 - 10.5 mm	max (10%, 3 mm)	Accuracy w/o editing: 5 mm
Annulus perimeter / MV Annulus Perimeter	7.8 - 17.7 cm	10%	Accuracy w/o editing: 15%
Anterior/Posterior Leaflet Billowing	0.0 - 7.8 mm	max (10%, 3 mm)	Accuracy w/o editing: 5 mm
Anterior Closure Line Length 3D	2.6 - 5.9 cm	20%	Accuracy w/o editing: 25%
Anterior Leaflet Angle	4 - 30°	10°	Accuracy w/o editing: 15°
Anterior Leaflet Area	2.5 - 12.1 cm ²	max (10%, 1.0 cm ²)	Accuracy w/o editing: 20%
Anterior Leaflet Length / MV Ant Leaflet Len	1.4 - 3.6 cm	max (10%, 3 mm)	Accuracy w/o editing: 20%
A-P Diameter / MV A-P Diam	1.8 - 5.0 cm	10%	Accuracy w/o editing: 15%
Commissural Diameter	2.9 - 5.7 cm	10%	Accuracy w/o editing: 15%
Inter-Trigonal Distance / Inter-Trigonal Dist	1.9 - 4.1 cm	10%	Accuracy w/o editing: 20%
Mitral Annular Excursion	1.9 - 14.1 mm	max (10%, 3 mm)	Accuracy w/o editing: 5 mm
Mitral-Aortic Angle	120 - 139°	10%	Accuracy w/o editing: 20°
Non-Planar Angle	126 - 171°	10%	Accuracy w/o editing: 20°
Orifice Area	0.0 - 1.4 cm ²	max (10%, 0.2 cm ²)	Accuracy w/o editing: 1.0 cm ²
PM-AL Diameter / MV PM-AL Diam	2.9 - 5.9 cm	10%	Accuracy w/o editing: 15%
Posterior Closure Line Length 3D	2.6 - 6.4 cm	20%	Accuracy w/o editing: 25%
Posterior Leaflet Angle	5 - 56°	10°	Accuracy w/o editing: 15°
Posterior Leaflet Area	2.6 - 16.7 cm ²	max (10%, 1.0 cm ²)	Accuracy w/o editing: 20%
Posterior Leaflet Length / MV Post Leaflet Len	0.8 - 2.5 cm	max (10%, 3 mm)	Accuracy w/o editing: 20%

Measurements and Analysis

Measurement	Range	Accuracy	Comments
Tenting Area	0.3 - 4.1 cm ²	max (10%, 0.5 cm ²)	Accuracy w/o editing: 1.0 cm ²
Tenting Height / MV Tenting Height	0.2 - 1.4 cm	max (10%, 3 mm)	Accuracy w/o editing: 5 mm
Tenting Volume	0.2 - 11.1 ml	max (10%, 1 ml)	Accuracy w/o editing: 1.5 ml
4D Auto RVQ			
EDV	73 – 82 ml	15 mL	Accuracy w/o editing: max (20%, 20ml)
ESV	30 – 94 ml	10 ml	Accuracy w/o editing: max (20%, 20ml)
Dd base	29 – 47 mm	max (10%, 3 mm)	Accuracy w/o editing: max (25%, 6 mm)
Dd mid	20 – 39 mm	max (10%, 3 mm)	Accuracy w/o editing: max (25%, 6 mm)
Ld	66 – 88 mm	max (10%, 4 mm)	Accuracy w/o editing: max (15%, 4 mm)
FAC	36 – 55 %	10 percentage points	Accuracy w/o editing: max (25%, 15 percentage points)
TAPSE	6 – 27 mm	max (10%, 3 mm)	Accuracy w/o editing: max (20%, 4 mm)
4D Auto AVQ (Aortic Annulus)			
Area	3.3 - 5.2 cm ²	10%	Accuracy w/o editing: 30%
Diameter	2.1 - 2.7 cm	10%	Accuracy w/o editing: 15%
IMT			
Distance	0.49 – 1.07 mm	0.13 mm	

Chapter 9

Quantitative Analysis

'Q Analysis overview' on page 9-3

'Using Q Analysis' on page 9-9.

Introduction

The quantitative analysis (Q Analysis) software package is designed for analysis of TVI related (Tissue Tracking, Strain, Strain rate, TSI) and Contrast related raw data.

NOTE: Q Analysis is only recommended for adult cardiac images acquired with the following probes: M5Sc-D, 6Tc-RS, or 6VT-D. The measurement accuracies of the quantitative values reported in the 'Measurement accuracy' on page 8-152 are verified with these probes.

The main features of these options are:

- Multiple Time-mode specific trace display from selected points in the myocardium.
- Arbitrary Curved anatomical M-Mode

Q Analysis overview

Starting Q Analysis

Starting Q Analysis in replay mode

1. Open an examination and select a TVI or a contrast loop.
2. Press **Q Analysis**.

The *Quantitative Analysis* screen is displayed (see Figure 9-1).

Starting Q Analysis in live

1. Press **Freeze**.
2. Press **Q Analysis**.

The *Quantitative Analysis* screen is displayed (see Figure 9-1).

Q Analysis screen

Overview

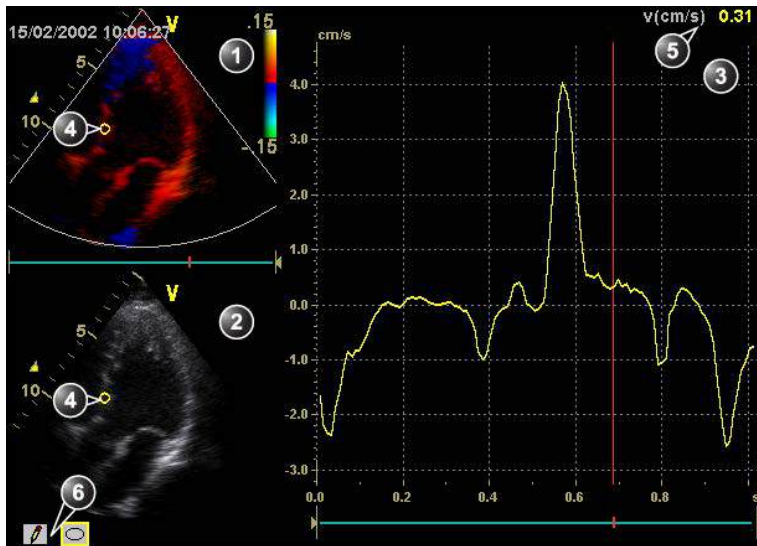



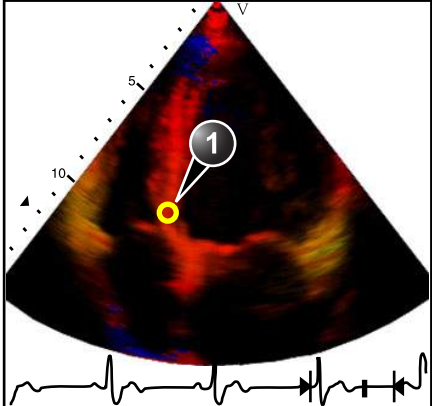
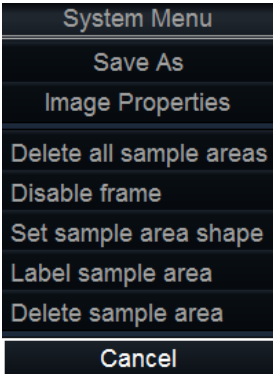

1. Color cineloop window
2. Tissue cineloop window
3. Analysis window
4. Sample area
5. Time and velocity at cursor position
6. Sample area tools

Figure 9-1. Quantitative analysis window (here with TVI data)

The Color cineloop window

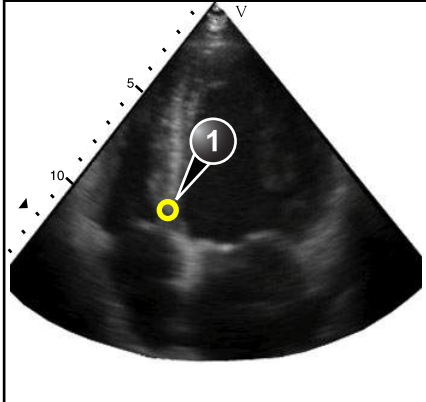
	<p>Displays TVI, Tissue Tracking, Strain, Strain rate or Angio color-coded data.</p> <p>Sample area (1): Indicates sampling position of the velocity (TVI), displacement (Tissue Tracking), percent deformation (Strain), deformation rate (Strain rate) or intensity (Contrast) trace. The sample area is color-coded: the first sample area is yellow, the second blue...etc.</p>
 <p>a) Shown only when a sample area is selected (pointed at).</p> <p>b) With Contrast data only.</p> <p>c) Shown only when pointing at an anchored sample area.</p>	<p>The cineloop windows system menu</p> <p>This menu is displayed by pressing Update menu when the cursor is placed over a sample volume in one of the <i>Cineloop</i> windows.</p> <ul style="list-style-type: none"> • Delete all Sample areas: removes all traces at once. • Disable frame^b: the current frame is excluded from the cineloop display. • Set Sample area Shape^a: enables resizing of a selected sample area by setting height, width and tilt angle. The trackball marker must be pointed at an anchored sample area. • Label Sample area...^a: sets a descriptive name to the sample area. The label is useful for identification of the sample area when exporting data. • Delete Sample area^c: deletes the selected sample area. • Delete anchor^c: removes anchoring from a dynamic sample area (see also page 9-9 and page 9-11). • Cancel: exits the <i>System</i> menu.

The Tissue cineloop window

	<p>Displays 2D data</p> <p>Sample area (1): Indicates sampling position of the velocity (TVI), displacement (Tissue Tracking), percent deformation (Strain), deformation rate (Strain rate) or intensity (Contrast) trace. The sample area is color-coded: the first sample area is yellow, the second blue...etc.</p>
	<p>Sample area tools:</p> <ul style="list-style-type: none"> : creates a sample area based on freehand drawing. : creates a sample area with a pre-defined circular/elliptical shape (configurable, see page 9-15)

The analysis window

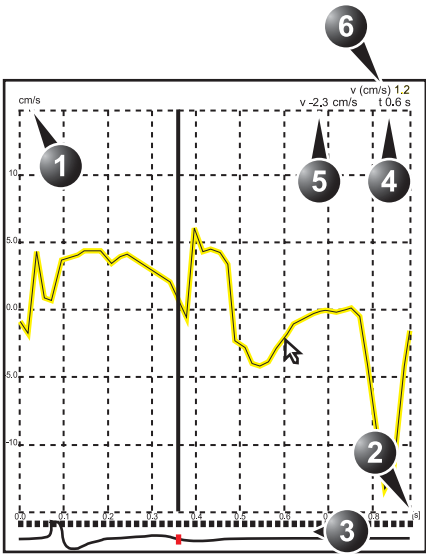
	<p>TVI: Displays velocity trace</p> <ol style="list-style-type: none"> Y axis: velocity scale (cm/s) X axis: Time (s) ECG Time at cursor position Velocity at cursor position Velocity at frame marker position (color coded) <p>Tissue Tracking: Displays tissue displacement trace</p> <ol style="list-style-type: none"> Y axis: displacement scale (mm) X axis: time (s) ECG with Tracking start and Tracking end markers Time at cursor position Displacement at cursor position Displacement at frame marker position (color coded) <p>Strain rate: Displays Strain rate trace (rate of deformation (s^{-1}))</p> <ol style="list-style-type: none"> Y axis: s^{-1} X axis: time (s) ECG Time at cursor position Strain rate at cursor position Strain rate at frame marker position
--	---

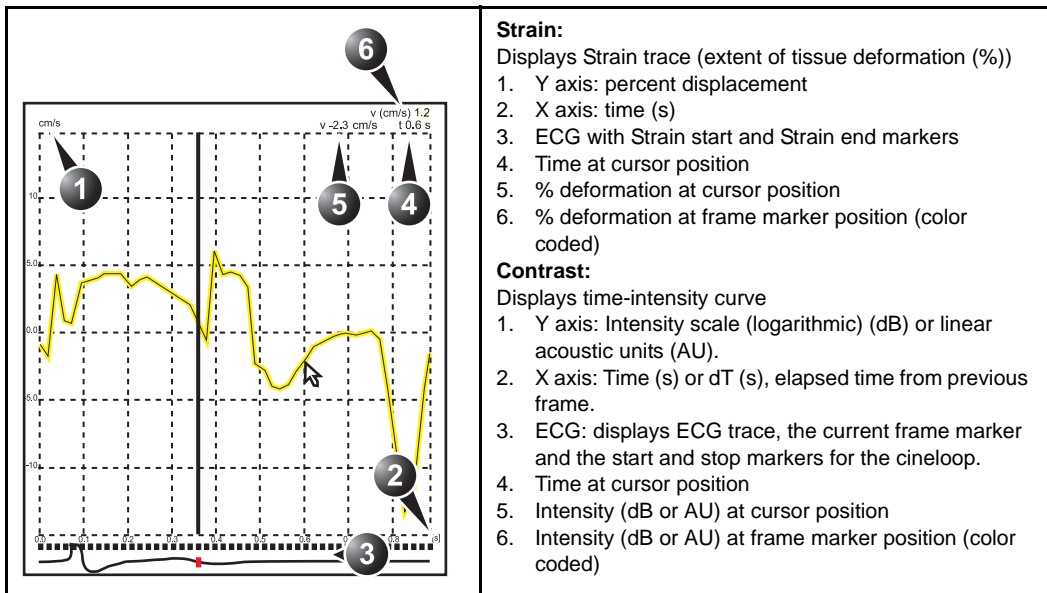

<p>System Menu</p> <ul style="list-style-type: none"> Save As Image Properties Delete all sample areas Vertical auto-scaling ▶ Vertical unit ▶ Line style ▶ Smoothing ▶ Curve fitting ▶ Export traces Unzoom Cancel 	<p>The analysis window System menu:</p> <p>This menu is displayed by pressing Update menu when the cursor is in the Analysis window.</p> <ul style="list-style-type: none"> • Delete all Sample areas: removes all traces at once. • Analysis signal: toggles trace display between velocity, displacement, strain rate, stain or greyscale intensity curves. • Drift compensation: compensates drifting of strain or Tissue Tracking curves by either resetting the curve to zero at the tracking start point (cycle resetting) or by linear compensation throughout the cycle (linear compensation) • Vertical auto-scaling: selects between full unit range or a range according to the maximum and minimum values of the displayed trace(s). • Vertical unit^a: toggles between logarithmic (dB) and linear acoustical units (AU). • Line style: selects between solid line only or solid line with square markers at each data point. • Smoothing: smooths the trace displayed by applying a filter over a defined time window. Both the filter type and time window are user-selectable. The type of filter available is depending on the analysis signal displayed. • Export traces: saves trace data in ASCII format, readable in spreadsheet programs. If present, trace data for physiological traces are also exported. • Curve fitting^a: toggles between Wash-in, Wash-out and off. • Unzoom^b: restores full analysis window display when in zoom mode. • Cancel: exits the System menu.
--	--

a) With contrast data only.
b) Shown only in zoom mode.

The Trackball assignments

 A screenshot of a software interface showing trackball assignments. On the left, a list of options is displayed: 'QA' (selected with a blue circle), 'Scroll', and 'Ptr'. On the right, a trackball is shown with four directional buttons labeled 'Pointer' (top), 'Menu' (right), and two unlabeled buttons (bottom and left).	<p>QA: Pointing tool in Quantitative analysis mode.</p> <p>Scroll/Speed:</p> <ul style="list-style-type: none">• When the cineloop is stopped, enables scrolling through the cineloop.• When the cineloop is running, enables control of the cine replay speed. <p>Press the Trackball key to toggle the trackball assignment between QA and Scroll/Speed.</p>
--	--

Using Q Analysis

Generation of a trace

Up to eight traces can be generated.

About the sample area

The sample area can be in three different states:

- **Free sample area:** freely moving sample area (QA cursor) before anchoring.

NOTE: The free sample area disappears when the QA cursor is moved over a static sample area.

- **Static sample area:** the free sample area is anchored by pressing **Select**.
- **Dynamic anchored sample area:** the sample area is anchored in two or more frames (see Manual tracking below). In these particular frames, the sample area is displayed with an anchor. The sample area moves smoothly between the anchored positions when playing/scrolling the cineloop.

To generate a trace

Trace from a pre-defined sample area

The shape of the pre-defined sample area is configurable (see page 9-15).

1. If the Trackball assignment is not on QA, press **Trackball** until **QA** is highlighted.
2. If necessary, select the sample area **Shape button** .
3. Place the cursor in one of the *Cineloop* windows.
The cursor is changed to a sample area (white circle).
A preview of the trace is displayed in the *Analysis* window.
4. Press **Select** to anchor the sample area.

In this frame the sample area is marked with an anchor.

If the cineloop has more than one heart cycle a sample area will also be anchored in the corresponding frame in the next heart cycles.

The trace is updated accordingly in the *Analysis* window.

NOTE: *The trace and sample area are color-coded. First generated trace is yellow, second blue...etc.*

The Strain cursor

In Strain and Strain rate modes, the sample area displays a Strain cursor showing the segment along the beam direction that is used for Strain and Strain rate calculations. Make sure that the Strain cursor is within the myocardium when anchoring the sample area.

Trace from a freehand sample area

1. Select the **Pencil button** .
2. Place the cursor in one of the *Cineloop* windows.
The cursor is changed to a cross.
3. Press and hold down **Select** while drawing a sample area with the trackball.
4. Release **Select**.

The sample area is automatically closed.

The trace is updated accordingly in the *Analysis* window.

Manual tracking of the sample area (dynamic anchored sample area)

The sample area can be moved within the loop to ensure that data in the trace is generated from the same anatomical location during the cyclic motion of the heart.

1. Freeze the image and set a sample area over a region of interest.

Note the anatomical location of the sample area.

2. Press **Trackball** until the **Scroll** trackball assignment is selected. Select a new frame.
3. Press **Trackball** until the **QA** trackball assignment is selected.
4. Drag the sample area to the corresponding anatomical location in the new frame.

When the sample area is anchored in more than one frame, linear interpolation is performed, so that the sample area is smoothly moved between the anchored positions in the selected frames when running the cineloop.

NOTE: In the original frame and this particular frame the sample area is marked with an anchor.

5. Press **Trackball** until the **Scroll** trackball assignment is selected.
6. Scroll through the cineloop and control that the sample area follows the moving anatomical structure.
7. Add anchored sample areas in several frames to obtain a more accurate displacement of the sample area.

To move a dynamic anchored sample area

1. Freeze the image.
2. Press **Trackball** until the **Scroll** trackball assignment is selected.
3. Scroll through the cineloop to display one of the frames where the sample area was anchored.

NOTE: In these frames the sample area is marked with an anchor.

4. Press **Trackball** until the **QA** trackball assignment is selected.
5. Place the cursor on the sample area to move, in one of the *Cineloop* windows.
6. Press **Select**.
The sample area is unanchored.
7. Drag the sample area to a new location.
8. Press **Select** to anchor the sample area to the new location.

Zooming in the Analysis window

1. In the *Analysis* window, press and hold down the **Select** key while dragging the trackball cursor to define the zooming area.
2. Release the **Select** key.

The selected area is displayed in the *Analysis* window.

To unzoom

1. In the *Analysis* window, press **Update menu**.
The *System* menu is displayed.
2. Select **Unzoom**.

Deletion of a trace

The user can delete all traces at once or one at a time.

To delete all traces

1. If necessary, press **Trackball** until the **QA** trackball assignment is selected.
2. With the cursor in one of the *Cineloop* windows, press **Update menu**.
The *System* menu is displayed.
3. Select **Delete all sample areas**.

To delete one specific trace

1. If necessary, press **Trackball** until the **QA** trackball assignment is selected.
2. Place the cursor on the sample area to delete.
3. Press **Update menu**.
The *System* menu is displayed.
4. Select **Delete sample area**.

Saving/retrieving Q Analysis

1. Press **Store** to save the quantitative analysis session.
2. To recall the Quantitative analysis session, select the icon on the clipboard, and press **Q Analysis**.

Frame disabling

Frame disabling excludes the actual frame from the cineloop display. Frame disabling is available only with contrast data.

Disabling frames

1. Place the cursor on the frame marker of the frame to disable beneath the *Analysis* window (see Figure 9-2).
2. Press **Select** to disable the frame.

The frame marker turns red.

NOTE: To re-enable a frame: Press **Select** on the corresponding frame marker.

Disabling successive frames at a time

1. Press and hold down **Select** while dragging the cursor over the frame markers of the frames to disable.

The frame markers turn red.

NOTE: To re-enable successive frames: press and hold down **Select** while dragging the cursor over the frame markers.

ECG triggered frame disabling

In a multi-cycle acquisition, the user may deselect all frames in all heart cycles but a selected one. This function can be used for example to select a particular systolic frame for each heart cycle.

1. Scroll through the cineloop to identify the cardiac phase to analyze or identify the cardiac phase on the ECG trace.
2. Place the cursor on the frame marker of the frame of interest in one of the heart cycles (see Figure 9-2).

3. Press **Update menu**.

The *System* menu is displayed.

4. Select **ECG triggering**.

All frames in all heart cycles are disabled except for the selected and corresponding frames in the other heart cycles.

Re-enabling all frames

1. Place the cursor on the *Frame marker axis*.
2. Press **Update menu** in the trackball area on the Control panel.

The *System* menu is displayed.

3. Select **Enable all frames**.

All previously disabled frames are re-enabled.

1. Analysis window
2. Frame marker axis
3. Enabled frame (green marker)
4. Disabled frame (red marker)
5. ECG
6. Current frame

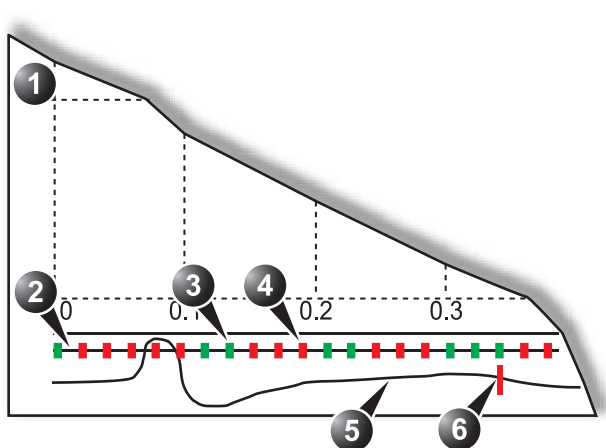

Figure 9-2. Frame disabling

Optimization

Optimizing the sample area

The sample area can be reshaped and labeled.

Reshaping a sample area

1. If necessary, press **Trackball** until the **QA** trackball assignment is selected.
2. Place the cursor on the sample area to reshape.
3. Press **Update menu**.

The *System* menu is displayed.

4. Select **Set Sample area shape**.

A *Dialogue* window is displayed where the user can adjust the height, the width and the angle of the sample area (see Figure 9-3).

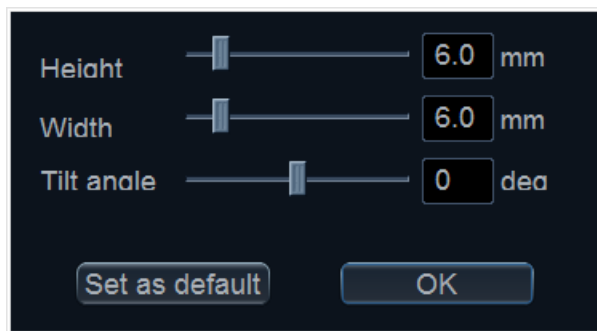

Figure 9-3. The sample area reshaping window

5. Drag the sliders to adjust the shape of the sample area as desired.
6. Press **OK** to return to the *Quantitative analysis* window and use the settings for the current analysis only.

OR

Press **Set as default** to return to the *Quantitative analysis* screen and keep the settings as default.

NOTE: *The sample area can also be reshaped using the **Sample Width**, **Sample Height** and **Sample Angle** controls on the Touch panel.*

Labeling a sample area

The sample area label is used to identify data associated to the sample area when exporting to a spreadsheet program.

1. If necessary, press **Trackball** until the **QA** trackball assignment is selected.
2. Place the cursor on the sample area to label.
3. Press **Update menu**.
The *System* menu is displayed.
4. Select **Label Sample area**.
A *Dialogue* window with a free text field is displayed (see Figure 9-4).
5. Type a name for the sample area.
6. Press **OK** to return to the *Quantitative analysis* screen.

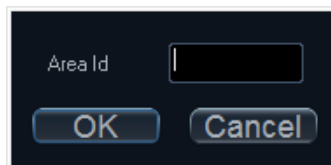

Figure 9-4. The sample area labeling window

Trace display

Y-axis

Auto-scaling

The system can be configured to display the full unit range or a range according to the maximum and minimum values of the displayed trace(s) (auto-scaling function). In addition, the auto-scaling function can be set to be live update (updates while the sample area is moved) or delayed (updated when the sample area is anchored).

1. If necessary, press **Trackball** until the **QA** trackball assignment is selected.
2. With the cursor in the *Analysis* window, press **Update menu**.
The *System* menu is displayed.
3. Select **Vertical auto-scaling**.
The *Vertical auto-scaling* menu is displayed.

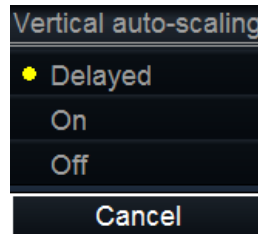

Figure 9-5. The Vertical Auto-scaling menu

4. Select the desired option:
 - **Delayed:** auto-scaling takes place after anchoring the sample area.
 - **On:** auto-scaling while moving the sample area.
 - **Off:** displays full scale.

Vertical units

When analyzing contrast data, the Y-axis can be set to display either logarithmic scale (dB) or linear, acoustical units (AU) for both tissue intensity (2D) or Angio intensity data.

1. If necessary, press **Trackball** until the **QA** trackball assignment is selected.
2. With the cursor in the *Analysis* window, press **Update menu**.
The *System* menu is displayed.
3. Select **Vertical unit**.
The *Vertical unit* menu is displayed.

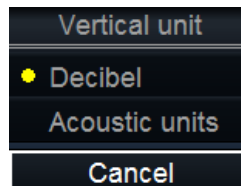

Figure 9-6. The Vertical unit menu

4. Select the desired option.

Trace smoothing

The system can smooth the traces displayed by applying a filter over a defined time window. The type of filter available is depending on the analysis signal displayed.

1. If necessary, press **Trackball** until the **QA** trackball assignment is selected.
2. With the cursor in the *Analysis* window, press **Update menu**.

The *System* menu is displayed.

3. Select **Smoothing**.
The *Smoothing* menu is displayed.
4. Select a smoothing filter.
The trace display is updated.

Cine compound

Cine compound calculates and displays cineloops generated from a temporal averaging of multiple consecutive heart cycles. The number of averaged cycles is displayed on the top left corner.

To apply cine compound:

1. Adjust **Cine compound** to set the number of heart cycles to average.
The traces are updated showing averaged data. The number of heart cycles averaged is displayed on the top left corner.
2. Press **CC Zoom** to display the last recorded heart cycle.
3. Press **CC Zoom** again to unzoom.

Switching modes or traces

The user can toggle between TVI, Tissue Tracking, Strain rate or Strain modes to access to the mode specific controls or display alternative traces from within a selected mode.

To switch mode

1. Select the desired mode (TVI, Tissue Tracking, Strain rate, Strain or TSI).

The *Analysis* window is updated with the corresponding trace.

Anatomical M-Mode

M-Mode applied to TVI, Tissue Tracking, Strain rate, Strain or intensity data (Contrast) calculates and color/codes data accordingly along a path drawn by the operator.

Using Anatomical M-Mode

1. Press **Curved AMM**.
2. In one of the *Cineloop* windows, place the first point of the path.
3. Move the cursor to the location for the next anchoring point of the path and press **Select**.

A path with two anchor points will give a straight anatomical M-Mode profile. By creating more than two anchor points, the user can bend the path and obtain a curved anatomical M-Mode profile.

NOTE: To edit a path under construction, move the cursor backward and retrace the path.

4. To end the trace press **Select** twice (double clicking).

The color-coded display of the corresponding data calculated along the path is shown in the *Analysis* window.

NOTE: Adjust **Horiz. Sweep** and scroll through the *cineloop* to optimize the display to the portion of interest.

Optimizing Anatomical M-Mode

Edition of the curve

The drawn Anatomical M-Mode path can be edited by moving the anchor points.

To move an anchor point

1. Select the anchor point to move.
2. Move the anchor point to a new position.
3. Press **Select** to anchor the point to its new location.

Chapter 10

Archiving

'The dataflow concept' on page 10-3

'Storing images and cineloops' on page 10-7

'Retrieving and editing archived information' on page 10-14

'Review images in archive' on page 10-29

'Connectivity' on page 10-36

'Transfer of patient records/examinations' on page 10-41

'Disk management' on page 10-49

'Data Backup and restore' on page 10-57

'Tricify Uplink' on page 10-65

'Data streaming' on page 10-73

'Remote Viewing' on page 10-75

Introduction

During an examination, the operator stores data, images and cineloops for immediate purposes. The Vivid S70N / S60N ultrasound system includes an integrated patient archiving system for data and image storage.

The Vivid S70N / S60N ultrasound system also enables storing of data and images to external databases (Network Server, removable media).

The dataflow concept

Communication between the Vivid S70N / S60N ultrasound system and other information providers on the network takes the form of dataflows. Each dataflow defines the transfer of patient information and images from an input source to the system, and from the system to one or several output sources.

A dataflow is a set of pre-configured settings. Selecting a dataflow will automatically customize the system to work according to the settings associated with this dataflow.

Dataflows available

A set of pre-defined dataflows is available on the system as listed in the table below.

NOTE: Not all dataflow listed below are visible by default.

NOTE: The list of dataflow available is configurable (see 'Dataflow adjustments' on page 12-89).

Dataflow	Description
LocalArchive	The local database is used for patient archiving. Images are stored to internal harddrive.
LocalArchive / DICOM Server	The local archive is used for patient archiving. Images are stored to the internal hard drive and to a DICOM server. Some of the measurements are stored if DICOM SR is turned on (see page 12-68 for more information about DICOM SR and supported measurements).
EchoPAC Archive / DICOM Storage Image Vault Archive / DICOM Storage	A remote database (either on EchoPAC Software Only or a server) is used for patient archiving. Images are stored to a network image volume (either internal HD on EchoPAC Software Only or a server).

Dataflow	Description
EchoPAC Archive / DICOM Storage Image Vault Archive / DICOM Storage	A remote database is used for patient archiving. Images are stored to a network image volume and to a DICOM server. Some of the measurements are stored if DICOM SR is turned on (see page 12-68 for more information about DICOM SR and supported measurements).
Worklist / Local Archive / DICOM Storage	Search in a DICOM Modality Worklist, the patient found is copied into local database. The patient information and the examination results are stored to the local database. Images are stored to a DICOM server and to an image volume on the local harddrive. Some of the measurements are stored if DICOM SR is turned on (see page 12-68 for more information about DICOM SR and supported measurements).
Worklist / Local Archive / DICOM Storage Worklist / Image Vault Archive / DICOM Storage	Search in a DICOM Modality Worklist, the patient found is copied into a remote database. The patient information and the examination results are stored to a remote database. Images are stored to a DICOM server and to an image network volume. Some of the measurements are stored if DICOM SR is turned on (see page 12-68 for more information about DICOM SR and supported measurements).
Worklist / Local Archive	Search in a DICOM Modality Worklist, the patient found is copied into the local database. The patient information and the examination results are stored to the local database. Images are stored to an image volume on the local harddrive.
Worklist / EchoPAC Archive Worklist / Image Vault Archive	Search in a DICOM Modality Worklist, the patient found is copied into a remote database. The patient information and the examination results are stored to a remote database. Images are stored to an image network volume.
DICOM DVD Read Only	Read DICOM images from the CD/DVD-drive. Read only dataflow, no data can be stored.
DICOM Storage	Store pure DICOM images to a DICOM device. Raw data may also be saved depending on the dataflow configuration. Some of the measurements are stored if DICOM SR is turned on (see page 12-68 for more information about DICOM SR and supported measurements).
DICOM Query Retrieve	Retrieve images from a DICOM server based on query parameters.

Dataflow	Description
Worklist - DICOM Storage	Search in the DICOM Modality Worklist. Images are stored to a DICOM Server. Some of the measurements are stored if DICOM SR is turned on (see page 12-68).
DICOM Query Retrieve / DICOM Storage	Retrieve images from a DICOM server based on query parameters. Images are stored to a DICOM server. Some of the measurements are stored if DICOM SR is turned on (see page 12-68 for more information about DICOM SR and supported measurements).
Worklist / DICOM Query Retrieve - DICOM Storage	Search in a DICOM Modality Worklist, retrieve images from a DICOM server based on query parameters. Images are stored to a DICOM server. Some of the measurements are stored if DICOM SR is turned on (see page 12-68 for more information about DICOM SR and supported measurements)
DICOM USB Read Only	Read DICOM data from an USB storage device. Read only dataflow, no data can be stored.
No Archive	Enables to perform an examination without storing the data to any archive.
Local Archive / Tricefy Store	The local archive is used for patient archiving. Images are stored to the local archive and to Tricefy. If DICOM SR is enabled, measurements are also sent to Tricefy.
Tricefy Store	Store images to Tricefy. If DICOM SR is enabled, measurements are also sent to Tricefy.
Local Archive / Tricefy Patient Share	The local archive is used for patient archiving. Images are stored to the local archive and to Tricefy. Images are also shared with the patient. If DICOM SR is enabled, measurements are also sent to Tricefy.
Tricefy Patient Share	Store images to Tricefy and share them with the patient. If DICOM SR is enabled, measurements are also sent to Tricefy.
Tricefy QR / Tricefy Store	Search in Tricefy patients and examinations. Retrieve images from Tricefy. Images are stored to Tricefy. If DICOM SR is enabled, measurements are also sent to Tricefy.
Tricefy QR / Tricefy Patient Share	Search in Tricefy patients and examinations. Retrieve images from Tricefy. Images are stored to Tricefy and shared with the patient. If DICOM SR is enabled, measurements are also sent to Tricefy.

Dataflow	Description
Worklist/Tricefy QR ®C Tricefy Store	Search in a DICOM Modality Worklist, retrieve images from Tricefy. Images are stored to Tricefy. If DICOM SR is enabled, measurements are also sent to Tricefy.
Worklist/Local Archive ®C Tricefy Store	Search in a DICOM Modality Worklist, the patient found is copied into the local archive. The patient information and the examination results are stored to the local database. Images are stored to Tricefy and to the local archive. If DICOM SR is enabled, measurements are also sent to Tricefy

Transfer sources and destinations available

NOTE: Not all items listed below may be visible by default.

Transfer source/destination	Description
DICOM USB	USB device defaulted to store DICOM data, but can also be configured to include raw data images as well as DICOM SR. No support for inclusion of other patient data.
DICOM DVD	DVD (or CD) device defaulted to store DICOM data, but can also be configured to include raw data images as well as DICOM SR. No support for inclusion of other patient data.
Export as XML	Media or remote path support from transfer of measurements and other parameters in XML format
DICOM Print	Support for printing of images on a DICOM printer
Raw Data USB	USB device defaulted to store raw data but can also be configured to include DICOM images as well as DICOM SR. Support for inclusion of other patient data included for database transfer.
DICOM Raw data DVD	DVD (or CD) device defaulted to store raw data but can also be configured to include DICOM images as well as DICOM SR. Support for inclusion of other patient data included for database transfer.

Storing images and cine-loops

Images and cine-loops that are stored during a current examination are displayed as thumbnails on the clipboard. When an image is stored, all the additional information that is displayed is saved with it (e.i. probe and application selected, image setting, annotations or measurements).

The image archive is set by the dataflow selected (see page 10-3 about available dataflows).



Do not use the internal harddrive for long-term image storage. External storage media or network-based server solution is recommended for image long-term archive.



If working off-line with a dataflow pointing to a DICOM server, the images stored during the examination may have to be manually resent in the DICOM spooler when reconnecting the system. Resend all jobs that are failed.

In addition, stored images and cine-loops can be saved to a removable media in the standard formats JPEG, MPEG, H.264 (mp4), HDF and DICOM (see page 10-9).

Storing an image

Images are displayed chronologically on the clipboard.

1. While scanning in any mode, press **Freeze**.
2. With the trackball, scroll through the cine-loop and select the required image.
3. Press **Store**.

The image is stored and a thumbnail is displayed on the clipboard.

Storing a cineloop

A cineloop is a sequence of images recorded over a certain time frame. The time frame can be adjusted to cover one or more heart cycles. The stored cineloops are displayed chronologically on the clipboard. Cineloops can be stored at any time during the scanning session.

The system can be configured to perform either

- Retrospective storage: while scanning press **Store** to store the last elapsed defined number of cycles/seconds.
- Prospective storage: while scanning press **Store** to start storage of the forthcoming defined number of cycles/seconds.

The user can also configure the system to preview the cineloop before storage or save the cineloop directly as described in the sections below.

See 'Global imaging settings' on *page 12-21* for configuration of cineloop storage.

Direct storage of a cineloop

Depending on whether the system has been configured to enable or disable the **Preview Loop before store** function (see 'Global imaging settings' on *page 12-21*), the following procedures enable the cineloop to be stored directly.

Storing cineloop without preview

The function **Preview Loop before store** is disabled (see *page 12-21*).

1. Press **Store mode** rotary/push button on the Touch panel to select between cycles and time storage and adjust **Num Cycles** or **Timespan** to define the number of cycles or seconds to store.
2. While scanning, press **Store**.
 - If **Retrospective storage** is selected (see 'Global imaging settings' on *page 12-21*), the last elapsed defined number of cycles/seconds are stored.
 - If **Prospective storage** is selected (see 'Global imaging settings' on *page 12-21*), the forthcoming defined number of cycles/seconds are stored.

A thumbnail is displayed on the clipboard and scanning resumes immediately.

NOTE: *Cine-loop storage can be configured to store heart cycles with additional time before and after the R-wave (see 'Global imaging settings' on page 12-21).*

Storing cine-loop with preview

The function **Preview Loop before store** is enabled (see page 12-21).

1. Press **Store mode** rotary/push button on the Touch panel to select between cycles and time storage and adjust **Num Cycles** or **Timespan** to define the number of cycles or seconds to store.
2. While scanning, press **Store**.
 - If **Retrospective storage** is selected (see page 12-21), the last elapsed defined number of cycles/seconds are displayed on the screen (but not stored).
 - If **Prospective storage** is selected (see page 12-21), the forthcoming defined number of cycles/seconds are displayed on the screen (but not stored).
3. If desired, select and adjust the cine-loop to store using the cine-loop controls (see 'Cine-loop' on page 4-9).
4. Press **Store** to save the cine-loop.

A thumbnail is displayed on the clipboard and scanning resumes immediately.

Saving images and cine-loops to a standard format

Images and cine-loops can be saved to a removable media or a shared network folder in the following standard formats:

- **Still images:** JPEG, MPEG, DICOM and RawDICOM (Raw data + DICOM), VolDicom and HDF
 - **Cine-loops:** H.264 (mp4), MPEG, DICOM and RawDICOM (Raw data + DICOM), VolDicom and HDF
1. In live: press **Freeze**.
In replay: select an image thumbnail on the clipboard.
 2. Press **Update menu** on the Control panel.
The *System* menu is displayed.

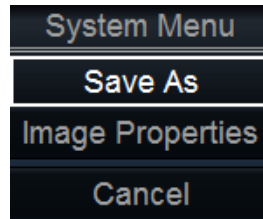

Figure 10-1. The System menu

3. Select **Save as**.

The Save as menu is displayed.

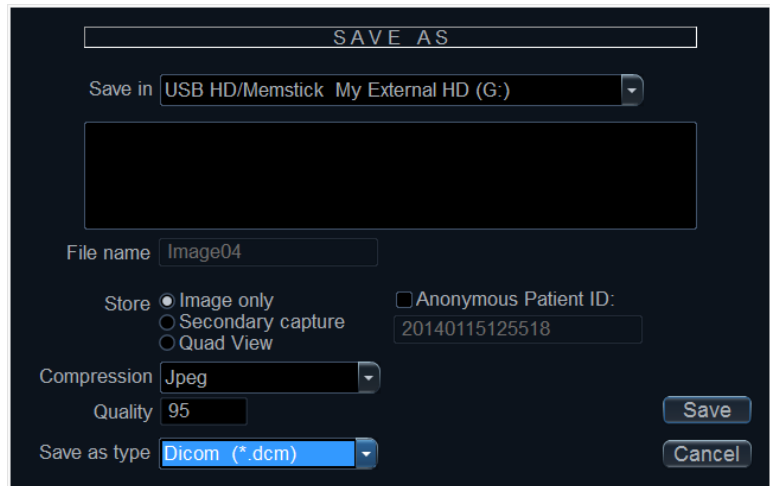

Figure 10-2. The Save as window

4. Select the desired destination from the *Save in archive* pull-down menu.
5. Enter a file name in the *File name* field.
If the image or cinelooop is saved as DICOM or RawDICOM the file name is automatically generated to follow the DICOM standard.
6. Select between:
 - Store **Image only**: saves the active image or cinelooop only.
 - Store **Secondary capture**: creates a screen capture of the entire screen.
 - Store **Quad view**: saves all images or cinelooop when in quad view.

NOTE: Store Secondary capture and Quad view are not available when storing RawDICOM.

- Check **Anonymous Patient ID** to anonymize the file (only available for DICOM formats).
7. Select the image compression type (JPEG or RIe) or no compression.
 8. Enter in the desired **Image quality** (between 10 and 100). A high quality setting will give a lower compression.
 9. In the *Save as type* field select one of the following formats:
 - **RawDICOM:** saves the still image or cine-loop in both GE raw format and DICOM format.
 - **DICOM:** saves the still image or cine-loop in pure DICOM format.
 - **JPEG:** saves a still image in JPEG format.
 - **MPEG:** saves the still image or cine-loop in MPEG format.
 - **H.264 (mp4):** saves the cine-loop in mp4 format.
 - **HDF:** saves the image or cine-loop in HDF (Hierarchical Data Format). HDF is a portable data format for exchange of scientific numerical and graphical data. More information about HDF format at: <http://www.hdfgroup.org/>.

A tool for viewing HDF files can be downloaded from <http://www.hdfgroup.org/hdf-java-html/hdfview/>.
 10. Press **Save**.

A file is saved in the selected archive.

DICOM Viewer

This feature is an option that enables to export a self-contained DICOM viewer to a removable media along with the selected images when transferring images to a DICOM removable media.

NOTE: The exported DICOM Viewer software can be either EZ DICOM CD Viewer or GE Healthcare developed DICOM Viewer. It is a standalone software to display ultrasound images exported from GE Healthcare Vivid™ Ultrasound systems.

NOTE: *This viewer is NOT intended to be a diagnostic tool. It is only meant to be used for reference. See further explanation in the "DICOM Viewer Instructions for Use."*

Details of DICOM Viewer

When the Vivid S70N / S60N system includes the DICOM Viewer option, it allows the user to transfer examinations to DICOM removable media together with a DICOM viewer.

Placing the media in any PC automatically starts-up the DICOM viewer to allow users to view images and loops contained in the examinations available on that media. There is no need to perform any installation on the viewing PC station, as the DICOM viewer is self-contained on the inserted media.

NOTE: *Minimal requirements for the Viewing PC are Windows 10.*

The self-contained DICOM viewer contains a built-in Instructions for Use. Read this instruction to learn more about the different functions of the viewer. Translations of the instruction to different languages are available to the user.

Refer to DICOM Viewer Instructions for Use to set User Interface in different languages.

Configuring the DICOM Viewer

The user can configure the system to enable or disable the embedding of the DICOM viewer on the media.

1. Make sure the DICOM Viewer option is installed.
2. Press **Utility/Config** on the Touch Panel.
3. Select the **Connectivity** category and the **Transfer** subgroup.
The *Transfer* sheet is displayed.
4. Select a dataflow for a DICOM removable media (i.e DICOM USB or DICOM DVD)

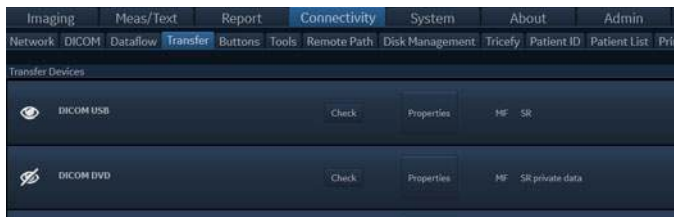

Figure 10-3. Transfer sheet

5. Select **Properties**.
The *DICOM Media Properties* window is displayed.
6. Check the option **Add DICOM Viewer**.

The DICOM Viewer will be exported when transferring examination to the corresponding DICOM removable media.

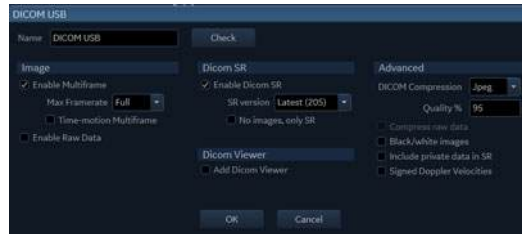

Figure 10-4. DICOM Media Properties window

Retrieving and editing archived information

Searching for a patient record

1. Press **Patient** on the Control panel.
If required, log on by typing the user ID and password.
The *Archive* screen is displayed (Figure 10-5).
2. In the *Archive* screen select the desired dataflow.
3. Type the patient **Last Name**, and/or **ID** or another query that identifies the patient.

When default configured, the system automatically searches to see if the patient is already in the archive. The result of this search is displayed in the *Patients* list.

4. Highlight the patient record in the *Patients* list.

NOTE: Select the **Exams** tab to display a list of examinations instead of the patient records.

5. Press **Open Patient**.

The *Patient info and exam* screen for the actual patient is displayed (refer to Figure 10-7).



1. Select archive and other pre-defined services.
2. Change user.
3. Advanced search filters
4. Display either patient or examination list.
5. Clear current search criteria
6. Create new patient record
7. Open the selected patient record.
8. Load patient record and start new examination.
9. Transfer patient records between archives (see page 10-41)
10. Delete selected patient record or examination (see page 10-25).
11. Manage hard disk space (see page 10-49)

Figure 10-5. The Archive screen

Advanced search

To restrain the search to a specific patient group, one or more additional filters may be applied to the search. The table below shows the filters available from the *Patient* list and *Exam* list.

NOTE: *Filters available are dependent of the dataflow selected. Search criteria for DICOM Worklist or Query/Retrieve dataflows are set when configuring the DICOM device (see 'Adjusting the Search Criteria' on page 12-67).*

Advanced searching filters	
Patient list	Exam list
Last name	Last name
First name	First name
Patient ID	Patient ID
Date of birth	Category
Born before and/or after	Today's examinations
Gender	Diagnosis codes
	Examination before and/or after
	Stress
	No reports
	Images
	Diagnosing physician
	Exam ID
	Exam description
	Location

Editing data in the archive

After selecting a patient record and pressing **Open Patient**, the *Patient info and exam* screen is displayed (Figure 10-7) showing patient information, examinations and diagnosis information for the selected patient.

From this screen the user can enter or modify the patient information, examination results and diagnostic codes using the alphanumeric keyboard and pre-defined text input tools.

Once done a window is displayed asking the user to save the information entered.

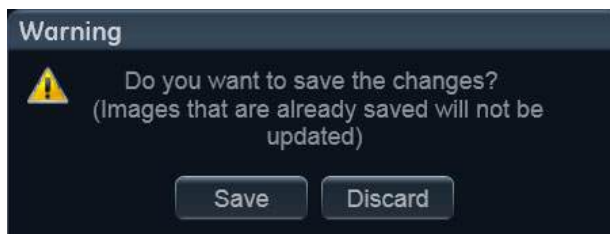
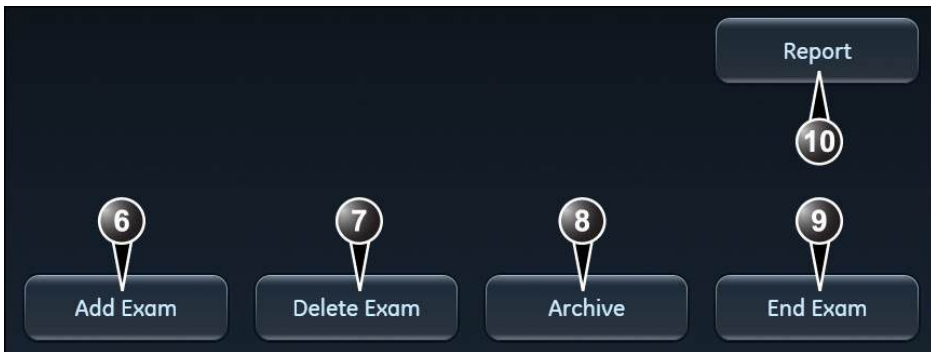
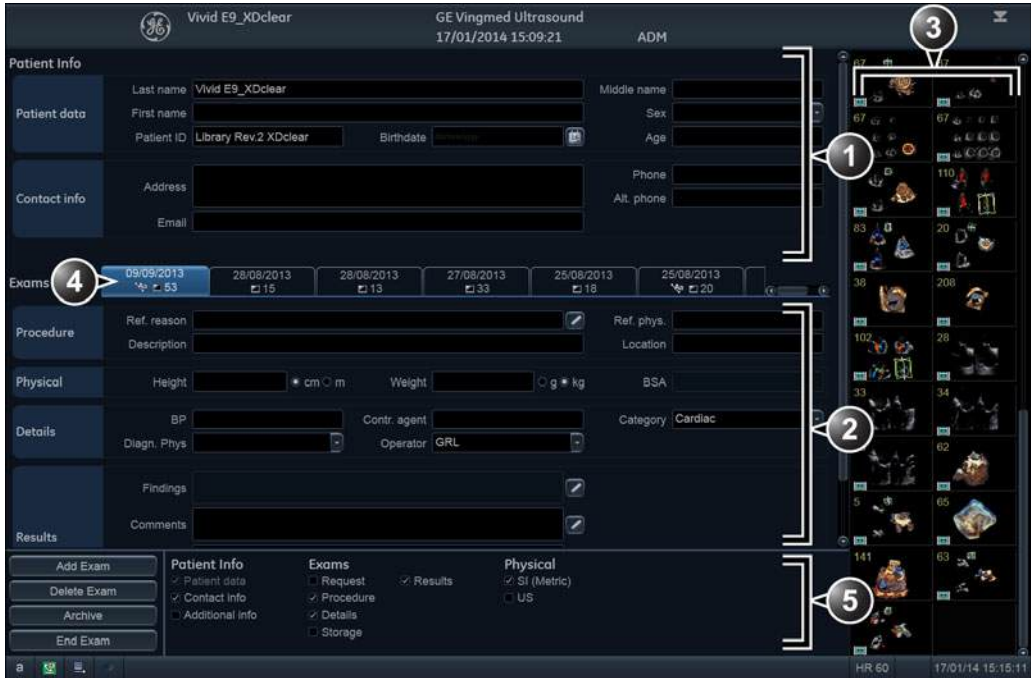

Figure 10-6. Save patient data window



CAUTION

The user is responsible for patient demographic data, diagnostic information or any other patient related information entered in the database.



1. Patient information
2. Examination information
3. Clipboard with images for the selected examination
4. List of examinations
5. List of available information to display on screen
6. Create a new examination.
7. Delete the selected examination.
8. Close the patient record and display the *Archive* screen.
9. End current examination and display the *Archive* screen.
10. Create a report.

Figure 10-7. The Patient info and exam screen

Additional Patient ID

The Vivid S70N / S60N system supports an additional field for Patient ID number.

To create/remove an additional Patient ID

1. In the *Patient info and exam* screen, make sure the option **Additional info** is checked in order to display the *Patient IDs* field.



Figure 10-8. The Patient IDs field

2. To create an additional Patient ID, press **Add**.
The *Add Patient ID* window is displayed.
3. Enter a Patient ID and your identifier as issuer and press **OK**.
The new Patient ID is displayed in the *Patient IDs* field.
To make this new Patient ID the primary ID, select the **Primary** radio button next to the ID. A confirmation window is displayed. Press **OK** to confirm.
4. To remove an additional Patient ID, select the Patient ID and press **Remove**. A confirmation window is displayed. Press **OK** to confirm.

NOTE: *A Primary Patient ID cannot be removed.*

Editing Referral reasons, Comments and Diagnosis information

The user can edit the actual text in the *Patient info and exam* screen using the alphanumeric keyboard and by inserting pre-defined text input.

Editing text

1. In the *Patient info and exam* screen (Figure 10-7), place the cursor in the required field.
2. Using the alphanumeric keyboard, edit the information.

Inserting pre-defined text input

1. In the *Patient info and exam* screen, press  next to the field to edit.

The *Insert text* window is displayed (see Figure 10-9).

The pre-defined text list is organized in a three level hierarchy. Selecting one item in the first column displays pre-defined text entries related to the selected text in the second and third columns.

2. Navigate through the pre-defined text list by selecting items in the columns and double-click on the desired pre-defined text to be inserted. If an entry in the third column is inserted, the selected text in the second column is also inserted.

Press **More>>** to display the full text for the selected entry.

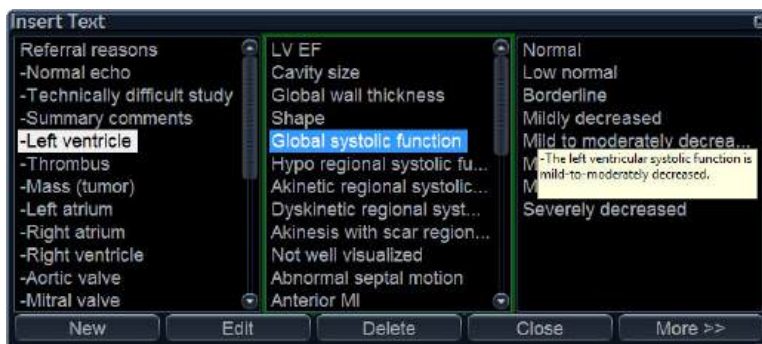

Figure 10-9. The Insert text window

Creating, editing and deleting text input

1. Press **Utility/Config** on the Touch panel to access the configuration package.
2. In the Configuration package, select the category **Report** and the Tab sheet **Comment texts**.

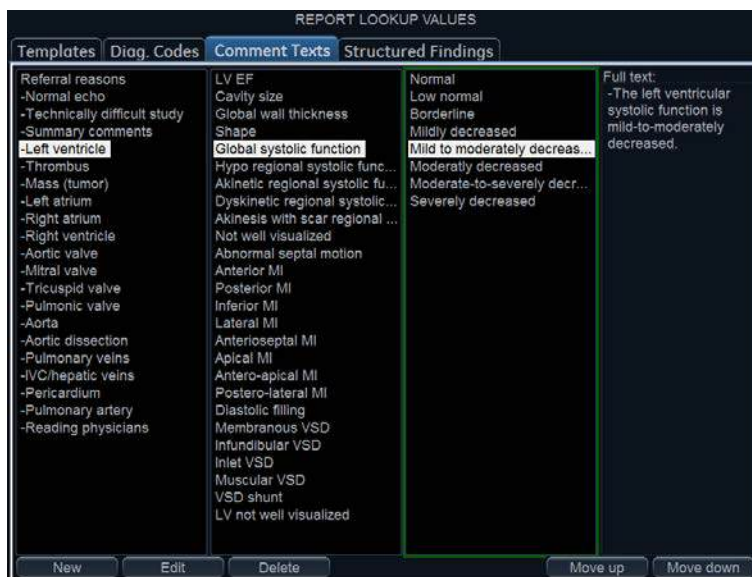

Figure 10-10. The Comment texts sheet

The pre-defined text list is organized in a three level hierarchy. Selecting one item in the first column displays pre-defined text entries related to the selected text in the second and third column.

To create a new text input in the first level:

1. Select the first level and press **New**.
The *Enter new text* window is displayed.

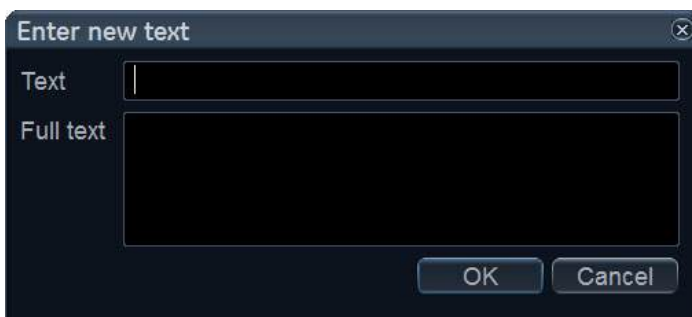

Figure 10-11. The Enter new text window

2. Enter a title in the *Text* field and a pre-defined text in the *Full text* field.
3. Select **OK**.

To create a new text input in the second and third level:

1. Select an item in the first column, then select either the second or third column and press **New**.
The *Enter new text* window is displayed.
The pre-defined text input to be created in the second and third column will be related to this selection only.
2. Enter a title in the *Text* field and a pre-defined text in the *Full text* field.
3. Press **OK**.

To edit a pre-defined text input:

1. Select the term to edit in one of the columns.
2. Press **Edit**.
The *Edit text* window is displayed.
3. Edit the text in both the *Text* and *Full text* fields.
4. Press **OK**.

To delete a pre-defined text input:

1. Select the item to delete in one of the columns.
2. Press **Delete**.
A *Confirmation* window is displayed.
3. Press **Yes**.
The selected text input is deleted including the belonging text inputs in the sub-levels.

Diagnosis code

Adding Diagnosis codes

1. In the *Patient info and exam* screen, press  next to the *Code* field.
The *Code* list is displayed.
2. Select the codes to enter.
The codes selected are displayed in the *Patient info and exam* screen.

Removing entered Diagnosis codes

1. In the *Patient info and exam* screen, press  next to the *Code* field.
The *Code* list is displayed.
2. Uncheck the codes to remove.

Creating a Diagnosis code

1. In the *Patient info and exam* screen, press  next to the *Code* field.
The *Code* list is displayed.
2. Select **New code**.
The *New code* window is displayed.
3. Enter the new code.
4. Press **OK** to exit.

Diagnostic codes can also be created and deleted from the configuration package:

1. Press **Utility/Config** on the Touch panel to access the configuration package.
2. In the Configuration package, select the category **Report** and the Tab sheet **Diag. Codes**.

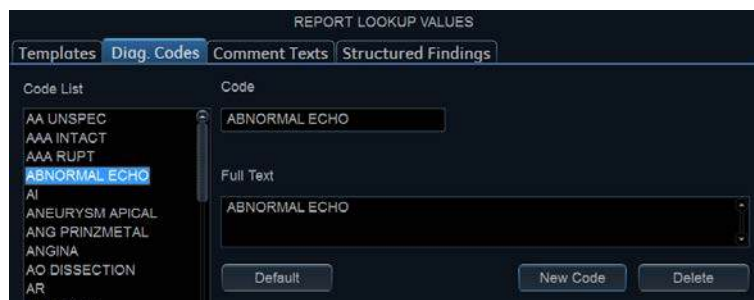

Figure 10-12. The Diagnostic codes sheet

To create a diagnostic code:

1. Select **New code**.
2. In the *Code* field, enter a name for the diagnostic code.
3. In the *Full text* field, enter the code text.

To delete a diagnostic code:

1. In the *Code list* field, select the diagnostic code to delete.
2. Select **Delete**.

Editing patient information

Patient information (name, contact information and patient IDs) can be edited from the *Patient info and exam* screen.

1. Select a patient record and press **Open patient** on the Touch panel.
The *Patient info and exam* screen is displayed (refer to Figure 10-7 on page 10-18).
2. Edit the patient information using the alphanumeric keyboard.



CAUTION

Do NOT use '\ ' or '^' in patient information fields, as these characters might cause problems with some DICOM devices.

Deleting archived information

Only users belonging to the user groups Cardiologist, Sys Admin and GE admin are allowed to delete patient records or examinations (see 'Users and Security' on page 12-10 for further information).

To delete a patient record

1. Press **Patient** on the Control panel.
The *Archive* screen is displayed (Figure 10-5 on page 10-15).
2. Search and highlight the patient record to delete.
NOTE: Press and hold down **Shift** or **Ctrl** to select several patient records.
3. Press **Delete** on the Touch panel.
A warning message is displayed asking the user to confirm the action to perform.
4. Select **OK**.

To delete an examination

1. Press **Patient** on the Control panel.
The *Archive* screen is displayed (Figure 10-5 on page 10-15).
2. Search and highlight the patient record with the examination to delete.
3. Press **Open patient** on the Touch panel.
The *Patient info and exam* screen is displayed (Figure 10-7 on page 10-18).
4. Highlight the examination to delete.
5. Press **Delete exam** to delete the examination.
A warning message is displayed asking the user to confirm the action to perform.
6. Select **OK**.
The examination is deleted.

NOTE: Examinations can also be deleted from the *Archive* screen when displaying the *Exam list*. Search and highlight the examination(s) to delete and press **Delete**.

To delete an image

1. Press **Patient** on the Control panel.
The *Archive* screen is displayed (Figure 10-5 on page 10-15).
2. Search and highlight the patient record with the image to delete.
3. Press **Open Patient** on the Touch panel.
The *Patient info and exam* screen is displayed (Figure 10-7 on page 10-18).
4. Highlight the examination with the image to delete and press **Review** on the Touch panel.
The images for the selected examination are displayed on the *Review screen* (Figure 10-15 on page 10-30).

NOTE: You may also press **Image manager** on the Touch panel and select the examination with the image(s) to delete on the Touch panel.

5. Select the image to delete.
6. Press **Delete**.
A warning message is displayed asking the user to confirm the action to perform.
7. Select **Yes**.

To delete an image from the clipboard

1. If in live, press **Freeze**.
2. Press **Trackball** until the Pointer tool is selected.
3. Move the pointer over the image to delete in the clipboard.
4. Press **Update/Menu** on the Control panel.
5. Select **Delete clipboard cell** from the context menu.
A warning message is displayed asking the user to confirm the action to perform.
6. Select **Yes**.

NOTE: *Delete from the clipboard* is also available from the *Patient info and exam* screen.

Moving examinations

An examination can be moved from one patient record to another. This feature should only be used if an examination was performed and stored to a wrong patient record.

1. In the *Archive* screen select the **Exam** tab to display the examination list (see Figure 10-5 on page 10-15).
2. Search for the examination to move.
3. Move the trackball marker over the examination to move and press **Update/Menu** on the Control panel.
4. Select **Move Exam From Patient** in the context menu.

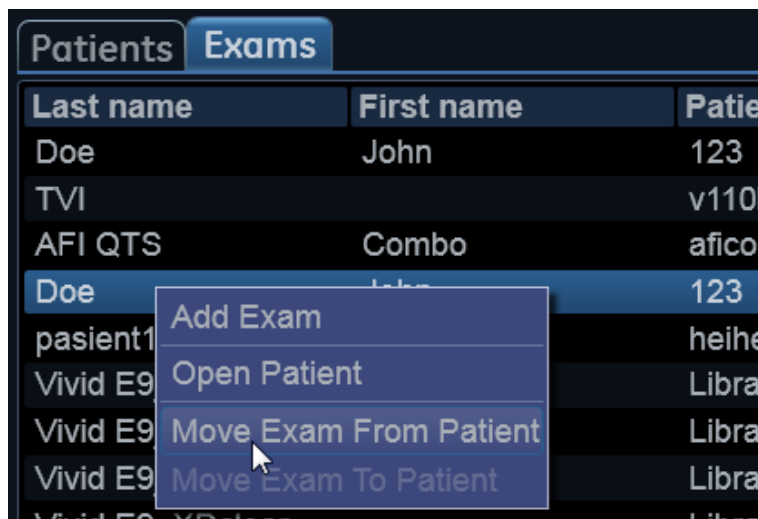

Figure 10-13. Context menu - Move exam from patient

5. Select the **Patient** tab to display the patient list.
6. Search the target patient record.
7. Move the trackball marker over the target patient record and press **Update/Menu** on the Control panel.
8. Select **Move Exam To Patient** in the context menu.

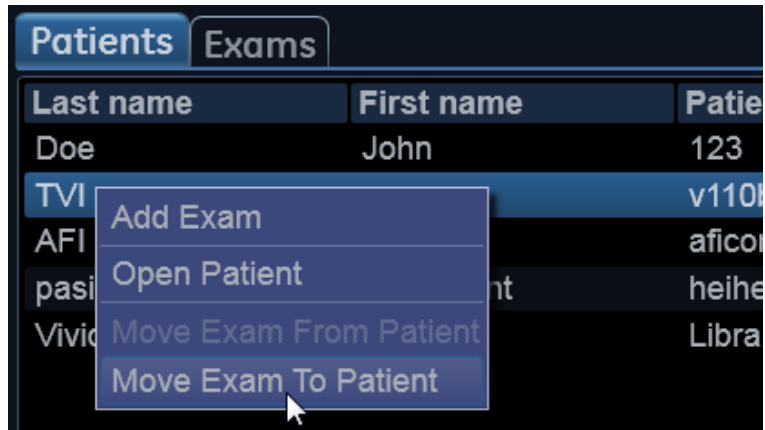

Figure 10-14. Context menu - Move exam to patient

A warning message is displayed asking the user to confirm the action to perform.

9. Select **OK**.

When moving an exam from one patient record to another on a remote server, the operation may take a long time depending on the amount of data. A dialog may appear showing a potential lock-up. Press **Ignore** and the move will proceed. If possible, perform the move locally on the server instead.

Review images in archive

There are two ways to review archived images:

- Review the images from a selected examination.
- Review images from a selected patient record, enabling the analysis of images belonging to different examinations for the selected patient record.

Review the images from a selected examination

1. In the *Patient info and exam* screen (see Figure 10-7 on page 10-18), highlight the examination with images to review.
2. Press **Review** on the Touch panel.

The stored images for the selected examination are displayed in the *Review* screen (see Figure 10-15).

To analyze images:

1. Select the images to analyze.
2. Press **Analyze**.



1. Selected image*.
2. Select all images in the examination.
3. Select all images in the current page.
4. Start analysis of selected images.
5. Save selected images.
6. Delete selected images.
7. Freeze/unfreeze cineloops.
8. Selected images will be sent to DICOM server in raw data format in addition to DICOM multiframe**.
9. Selected images will not be sent to DICOM server in raw data format in addition to DICOM multiframe**.

10. Adjust cineloop speed or select a frame.
11. Scroll through the Review screen pages.

* Images with raw data have a *R* in the top right corner.

** This setting overrides raw data settings (**Utility -> Config -> Connectivity -> Dataflow -> Properties** for selected dataflow with DICOM Server).

**These buttons are only available when images have been acquired in a dataflow with a DICOM server not in Direct Store mode.

Figure 10-15. The Review screen

Review images from a selected patient record

The procedure described below enables the analysis of images belonging to different examinations for a selected patient record. If images are stored on multiple removable media, they have to be restored to the local hard drive prior to review as described below.

1. While in the *Patient info and exam* screen press **Image manager** on the Touch panel.

The *Image manager* is displayed on the Touch panel showing thumbnails for the stored images sorted by examination for the actual patient record (see Figure 10-18).

If the images are stored on a removable media that is not mounted, the image thumbnail is replaced by a symbol.

2. Select the images to analyze or press **Analyze** to review all images.
 - If all images are available the images are displayed for review.
 - If some of the images are not available locally the *Restore images* window is displayed.



Figure 10-16. The Restore Images window

3. Select between:
 - **Restore only the selected images:** only selected images that are not available locally are restored.

- **Restore all images of the selected exam:** all images that are not available locally in the exams where an image was selected are restored.
 - **Restore current patient:** restores all images in all examinations.
4. Press **OK**.
The *Insert media* window is displayed.



Figure 10-17. The Insert Media window

5. Insert the required media.
6. Select between:
- **OK:** the images on the mounted media are restored on the local hard drive. If not all the required images are on the inserted media, the user is prompted to insert another media until all required images are restored on the hard drive.
 - **Skip media:** the images stored on the inserted media are not restored. If not all the required images are on the inserted media, the user is prompted to insert another media until all required images are restored on the hard drive.
 - **Cancel:** no images are restored.

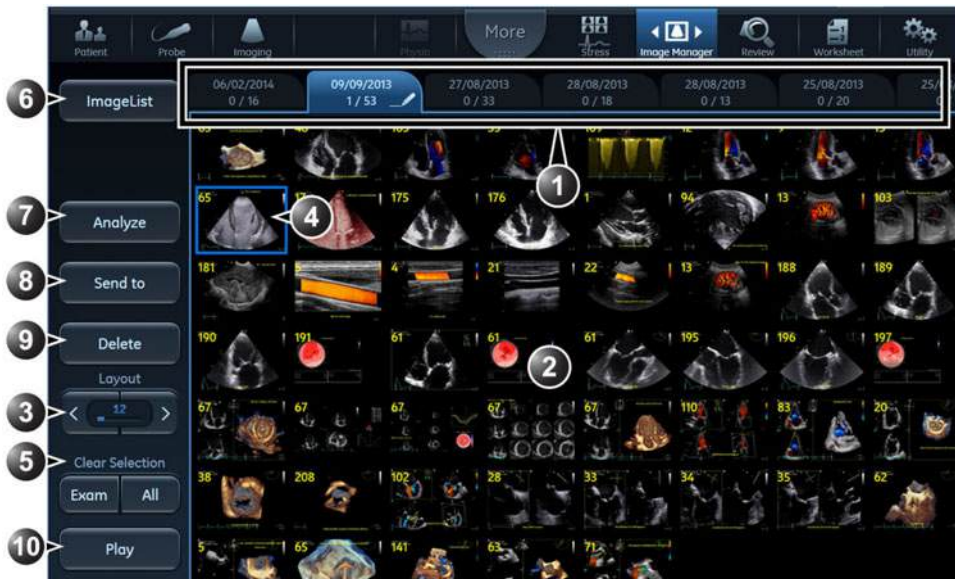

1. Each examination is displayed on a tab.
The tab for the active examination is marked with a pencil symbol.
2. Image thumbnails for the selected examination. Swipe vertically to scroll through images.
3. Adjust **Layout** to change the number of image thumbnails to display on the Touch panel.
4. Touch an image thumbnail to select/deselect an image. Selected images are marked with a blue frame. Images can be selected from multiple examinations.
The number of images selected and the total number of images in the examination is displayed on the tab.
5. Image selection tool: select/deselect all images from an examination or all images from the patient record.
6. Press **Image list** to toggle the display of examinations as a list or as tabs.
7. Press **Analyze** to display up to four selected images on the main screen.
8. Press **Send to** to save images to a removable media.
9. Press Archive to save selected images.
10. Play/Pause cineloops

Figure 10-18. The Image Manager Touch Panel

Additional features for the Image manager

Change the active examination

The active examination is identified by a pencil symbol on the examination tab in the *Image manager* Touch Panel. To make another examination active, follow the steps below:

1. In the *Image manager* Touch Panel, select the examination tab to make the active one.
2. Press **Activate Exam** on the Touch Panel.

The examination tab is marked with a pen symbol.



1. Active examination (marked with a pen symbol).
2. Displayed examination.
3. Press **Image list** to toggle the display of examinations as a list or as tabs.
4. Press **Activate Exam** to make the displayed examination the active one.

Figure 10-19. The Active Exam

Print or save image to a standard format

1. Connect a removable media to the system (if applicable).
2. Select images in the *Image manager* on the Touch Panel and press **Send to** (see Figure 10-18 on page 10-33).

The *Send images to external device* window is displayed.

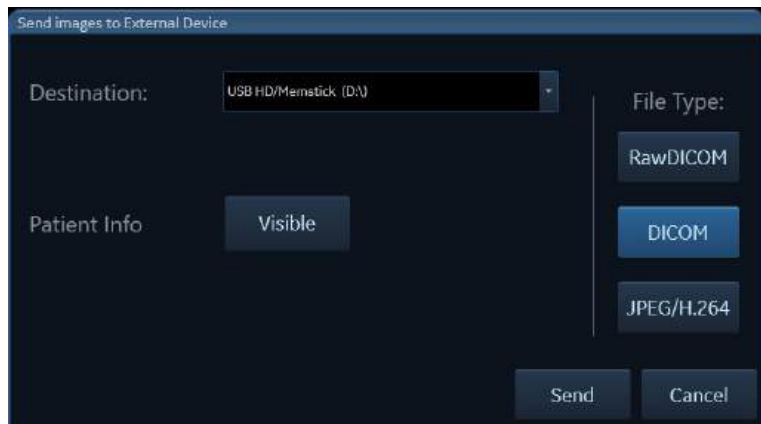

Figure 10-20. The Send images to external device window

3. Select the *Destination* and *File type*. Images can be sent to a printer, to a removable media, or to a DICOM server. The *Destination* list shows the available removable media and the DICOM servers that have been set up on the system (see 'DICOM devices configuration' on page 12-55). Depending on the *Destination*, a *File type* must be selected. **RawDicom** gives a DICOM file that holds the Vivid raw data. **DICOM** gives a DICOM Single-frame or Multi-frame

file. **JPEG/H.264** means that still images are converted to JPEG and loops to H.264. **JPEG/H.264** means that still images are converted to JPEG and loops to MPEG.

The folder name for DICOM files is by default called *GEMS_IMG* (cannot be changed).

The folder name for all other files is by default the current date (YYYYMMDD). The folder name can be changed.

4. To anonymize the images, press **Visible**.

This section describes the communication and connection options for the Vivid S70N / S60N ultrasound system with other devices in the hospital information system. This section covers the procedures for configuration and optimal data management from a Vivid S70N / S60N in the following scenarios:

- A stand-alone Vivid S70N / S60N
- A Vivid S70N / S60N and workstation in a network
- A Vivid S70N / S60N and a DICOM server in a network.
- A Vivid S70N / S60N and an EchoPAC Software Only in a direct connect environment.

The dataflow concept

Communication between the Vivid S70N / S60N ultrasound system and other information providers on the network takes the form of dataflows. Selecting a dataflow will automatically customize the ultrasound system to work according to the services associated with this dataflow. Each dataflow defines the location and format of patient information. Patient information can include demographic data and images, as well as reports, measurement and analysis data. By utilizing dataflows, the user can configure the Vivid S70N / S60N ultrasound system to optimally meet the connectivity needs of the facility, while keeping the user interface unchanged. The dataflow concept allows the flexibility of data to be obtained from various sources and allows data to flow to various output sources.

Dataflow examples

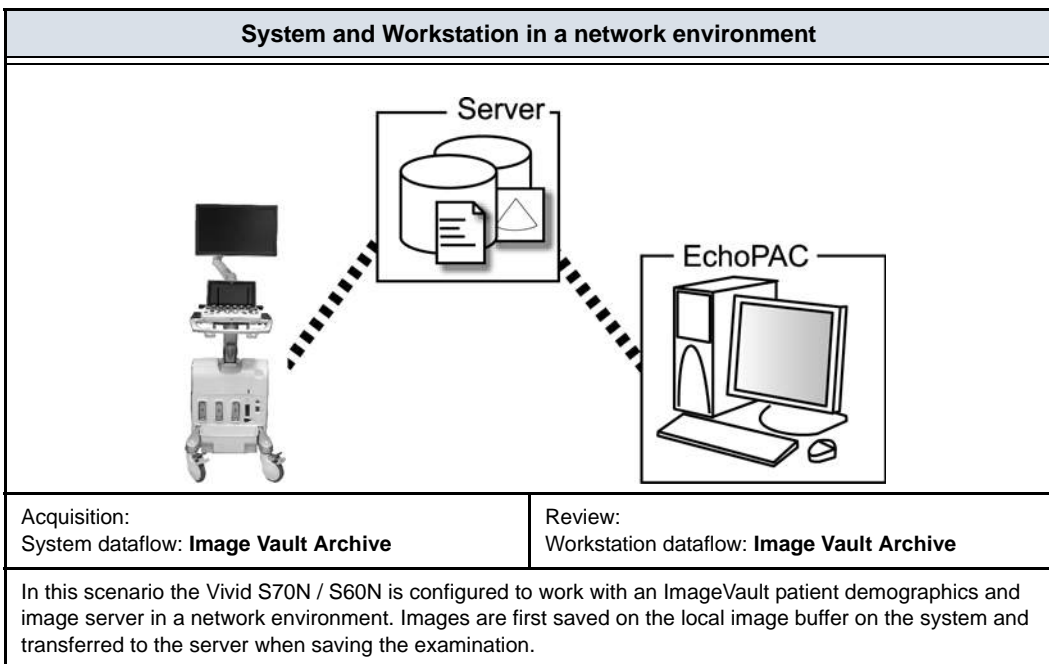
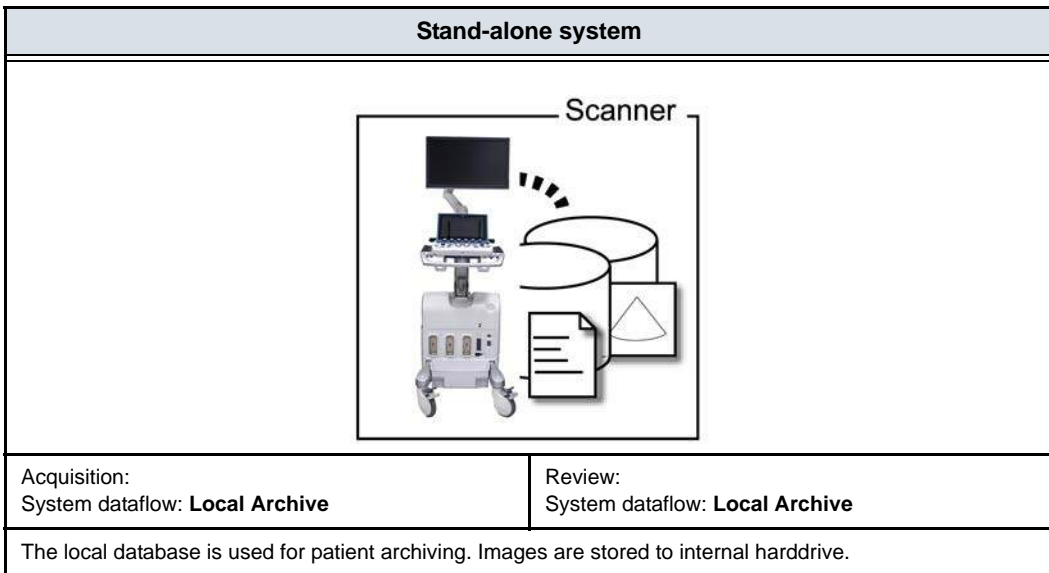

System and DICOM server in a Network

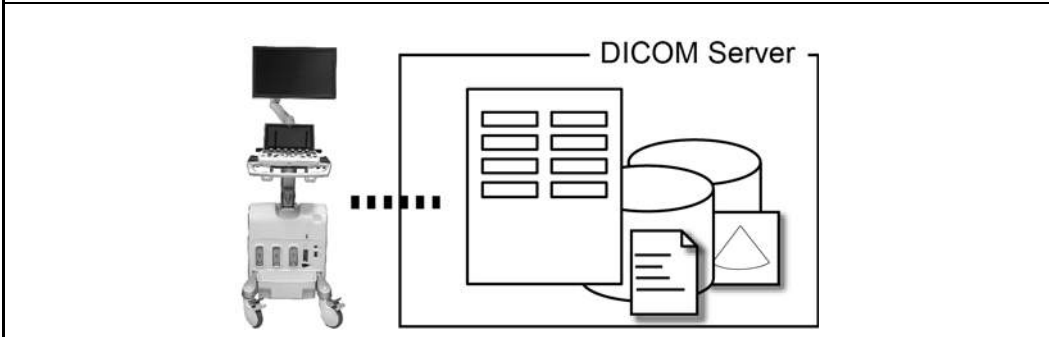

System DICOM dataflows:

- **DICOM Storage:** images are stored to a DICOM server.
- **Local Archive / DICOM Storage:** the local archive is used for patient archiving. Images are stored to the internal harddrive and to a DICOM server.
- **EchoPAC Archive / DICOM Storage, Image Vault Archive / DICOM Storage:** a remote database is used for patient archiving. Images are stored to a network image volume and to a DICOM server.
- **Worklist / Local Archive / DICOM Storage:** search in a DICOM Modality Worklist, the patient found is copied into local database. The patient information and the examination results are stored to the local database. Images are stored to a DICOM server and to an image volume on the local harddrive.
- **Worklist / EchoPAC Archive / DICOM Storage, Worklist / Image Vault Archive / DICOM Storage:** search in a DICOM Modality Worklist, the patient found is copied into a remote database. The patient information and the examination results are stored to a remote database. Images are stored to a DICOM server and to an image network volume.
- **DICOM Query Retrieve:** retrieve images from a DICOM server based on query parameters.
- **Worklist / DICOM Query Retrieve / DICOM Storage:** search in a DICOM Modality Worklist and retrieve images from a DICOM server based on query parameters. Images are stored to a DICOM server.
- **DICOM Query Retrieve - DICOM Storage:** retrieve images from a DICOM server based on query parameters. Images are stored to a DICOM server.

System and EchoPAC Software Only in a direct connect environment

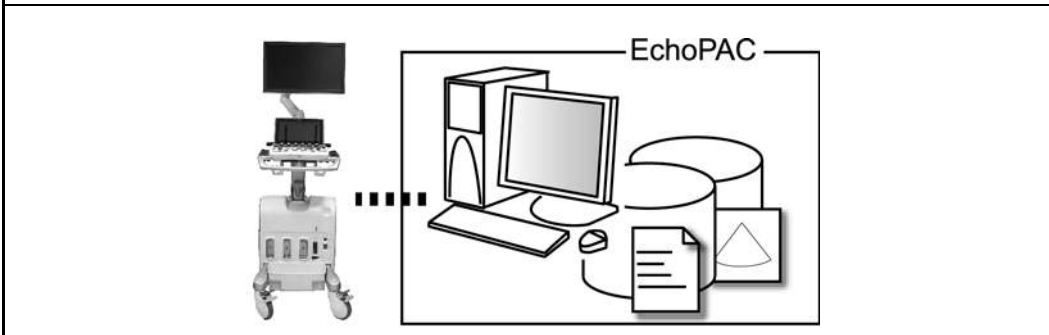

Acquisition:

System dataflow: **EchoPAC Archive - EchoPAC**

HD

Review:

Workstation dataflow: **EchoPAC Shared**

System and EchoPAC Software Only in a direct connect environment

In this scenario the data is transferred from the Vivid S70N / S60N to a dedicated EchoPAC Software Only workstation over the Ethernet (either in a peer-to-peer connection with a crossover cable, or in a network). The database from the EchoPAC Software Only is used as the master and images are stored directly to the EchoPAC Software Only internal harddrive. In this configuration the system is just an intermediate acquisition system which after completion of a study, will not contain any patient information, measurements or images.

Up to four systems can be connected to one EchoPAC Software Only if the workstation has the EchoPAC Share option enabled. A Vivid S70N / S60N using the 206 software can only connect to an EchoPAC Software Only also using the 206 software. Older version Vivid S70N / S60N can connect via EchoPAC Share if compatible with Sybase 16. Please contact your local GE representative to update software for Sybase 16 compatibility if required.

Dataflow selection

Select a dataflow from the *Archive* screen (see Figure 10-5 on page 10-15) or configure the system with a **default** dataflow from the Configuration management package as described below.

Default dataflow selection

1. Press **Utility/Config** on the Touch panel and log on as administrator if required.
2. Select the **Connectivity** category and **Dataflow** subgroup. The *Dataflow* sheet is displayed (see Figure 10-22).

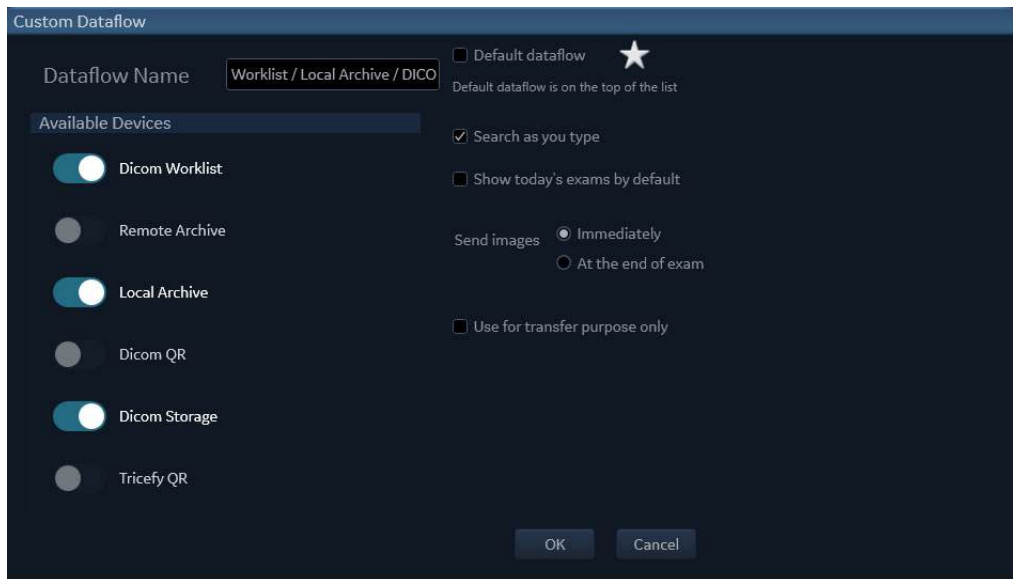

Figure 10-21. Dataflow Sheet

3. Select the desired dataflow in the *Dataflow* pull-down menu and check the option **Default**.
4. Press **Config** to exit the Configuration management package.



1. Select a dataflow
2. Default option for the selected dataflow

Figure 10-22. Default Dataflow

Transfer of patient records/ examinations

Transfer patient records/examinations between archives

The Transfer function on Vivid S70N / S60N enables transfer of patient records/examinations between archives as listed below:

Transfer			
	From	To	Note
1.	Local archive	Removable media	Perform transfer 1 and 2 to transfer data between systems via a removable media (CD/DVD or USB storage device).
2.	Removable media	Local archive	
3.	Local archive	Image Vault Archive or EchoPAC Archive, or DICOM server	Transfer data from the local archive to an ImageVault server, a DICOM server or EchoPAC Software Only.
4.	Image Vault Archive or EchoPAC Archive or DICOM server	Local archive	Transfer data from an ImageVault server, a DICOM server or EchoPAC Software Only to the local archive.
5.	Image Vault Archive or EchoPAC Archive or DICOM server	Removable media	Transfer data from an ImageVault server, a DICOM server or EchoPAC Software Only to a removable media (CD/DVD or USB storage device).
6.	Removable media	Image Vault Archive or EchoPAC Archive or DICOM server	Transfer data from a removable media (CD/DVD or USB storage device) to an ImageVault server, a DICOM server or EchoPAC Software Only.
7.	Image Vault Archive or EchoPAC Archive or DICOM server	Image Vault Archive or EchoPAC Archive or DICOM server	Transfer data between remote archives (ImageVault server, DICOM server or EchoPAC)



CAUTION

If an examination is opened, it must be closed before performing transfer of patient records/examinations.



CAUTION

Information from system with 206 software can only be read on a system with equivalent software version.

Transferring patient records/examinations

NOTE: *In order to retain measurements from user-defined formulas when transferring between systems, for instance between a Vivid S70N / S60N and an EchoPAC review station, the user-defined formulas must first be exported to the transfer destination before transferring exam data. To transfer user-defined formulas, see 'Data Backup and restore' on page 10-57*

1. If transferring data from/to a removable media, insert the media in the drive.
2. Press **Patient**.
The *Archive* screen is displayed (see Figure 10-5 on page 10-15).
3. Press **Transfer**.
The *Transfer* screen is displayed.

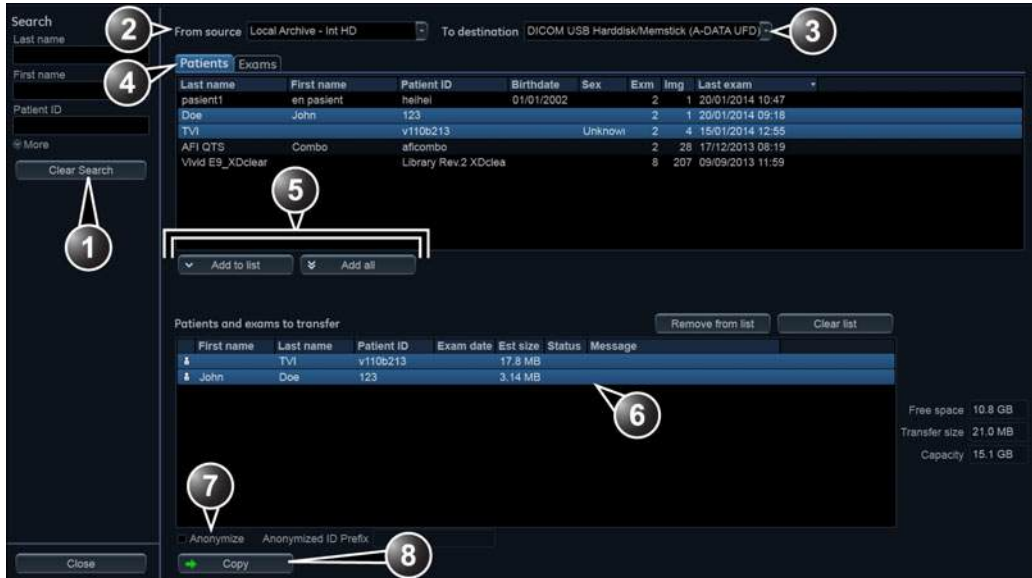

1. Search for the data to transfer.
2. Transfer from.
3. Transfer to.
4. Transfer either patient records or examinations.
5. Add selected/all items to the transfer list.
6. List of data to transfer.
7. Additional functions:
 - **Anonymize:** remove patient information to the transferred items (only available for DICOM data transfer to removable media).
 - **Delete after copy:** remove transferred items after transfer (not available with all services).
8. Perform data transfer.

Figure 10-23. The Transfer screen

4. If a search for patient records or examinations was performed in the *Archive* screen before entering the *Transfer* screen, the found items are displayed in the *Transfer* screen.

If no search was performed before entering the *Transfer* screen, select a source archive from the *Source* drop-down menu and search for the patients records or examinations to transfer.

NOTE: *Note that both sources and destinations can be hidden from showing up in the Transfer screen. This can be changed in the Dataflow and Transfer tab in Connectivity configuration by clicking on the "Eye" icon to hide/unhide.*

The following source archives are available:

- **Local Archive:** Transfer data from the local archive.

- **Image Vault Archive or EchoPAC Archive:** Transfer data from the configured remote archive.
- **DICOM DVD:** Transfer DICOM data only from a CD/DVD-R.
- **DICOM USB:** Transfer DICOM data from an USB storage device. Only available when an USB storage device is mounted.
- **DICOM Query retrieve:** Transfer DICOM data from a Query/Retrieve DICOM server.
- **Raw Data USB:** Transfer data from an USB storage device. Only available when an USB storage device is mounted.
- **Raw Data DVD:** Transfer data from a CD/DVD.
- **Tricefy QR:** Transfer images and SR files from Tricefy.

NOTE: *If the removable media contains data from various imaging sources, some data may not be available at first attempt. Use Config -> Connectivity -> Tools -> Repair DICOMDIR on the correct media to fix availability of supported DICOM files. This process may require some time depending on the size of the data on the media.*

NOTE: *Repair DICOMDIR is only supported for media with a size less than 200GB.*

5. Select one of the following available destinations from the *Destination* drop-down menu:

- **DICOM CD/DVD:** Transfer DICOM data only to a CD/DVD-R.

Check **Anonymize** and enter a **Prefix** if you want to remove all patient related information to the transferred data. Patient name and ID are replaced by the prefix followed by an increasing number. The prefix should not contain any patient identifying data.

NOTE: *Anonymization is only available for DICOM data transfer to removable media. Annotations or other visible patient information in the images will not be anonymized.*

- **DICOM USB Harddisk/Memstick:** Transfer DICOM data only to an USB storage device. Only available when an USB storage device is mounted.

Check **Anonymize** and enter a **Prefix** if you want to remove all patient related information to the transferred data. Patient name and ID are replaced by the prefix followed by an increasing number. The prefix should not contain any patient identifying data.

- **DICOM Print:** Prints images to a DICOM printer via DICOM spooler.
 - **DICOM Storage:** Transfer DICOM data only to a DICOM server via DICOM spooler.
 - **Export to XML:** Transfer demographics, measurements and reporting data to XML file. The export destination must be configured (see page 12-94).
 - **Remote Archive - Remote HD:** Transfer raw and DICOM data to an ImageVault server or EchoPAC Software Only.
 - **USB Harddisk/Memstick:** Transfer data to an USB storage device. Only systems using Sybase 16 are able to read this data. Only available when an USB storage device is mounted.
 - **CD/DVD Archive:** Transfer data to a CD/DVD. Only systems using Sybase 16 are able to read this data.
 - **Tricefy Store:** Transfer images to Tricefy. If DICOM SR is enabled, measurements are also sent to Tricefy.
 - **Tricefy Patient Share:** Transfer images to Tricefy and share them with the patient. If DICOM SR is enabled, measurements are also sent to Tricefy.
6. The following situations may occur if the destination media is a CD/DVD:
- If the destination media needs to be formatted the following window is displayed asking the user whether to format the media.



Figure 10-24. Media formatting window

NOTE: Enter a new label and select **OK**.
Only the following characters and signs can be used when labeling a media: A - Z, a - z, 0 - 9, “_” and “-”. Do not use more than 11 characters or signs. Do not use space.

The media is formatted and ready to use.

- If the CD/DVD is not empty, the *Add files* window is displayed.

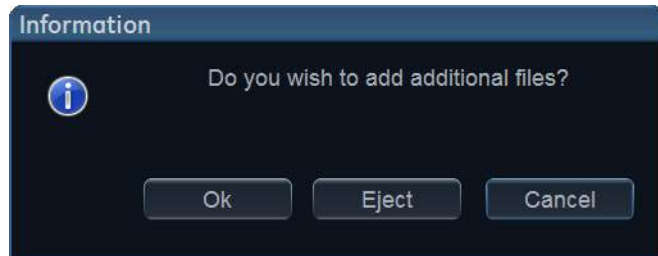

Figure 10-25. Add additional files window

Select **OK**.

The system is preparing the media to allow addition of new files.

NOTE:

*If **Eject** is selected, the user is prompted to insert another media. If **No** is selected, the Transfer window is displayed (Figure 10-23), where the user can select another destination.*

7. Press **Add to list** to make the selected items ready for transfer, or press **Add all** to make all available items ready for transfer.

Depending on the source and destination selected the following may be available:

- **Delete after copy:** the item selected will be deleted from the source archive after transfer to the destination archive.
- **Anonymize:** remove patient related information from the items transferred. You may enter a **Prefix** to replace the patient name and ID with the prefix followed by an increasing number. The prefix should not contain any patient identifying data.

8. Press **Copy**.

NOTE:

*If **Delete after copy** is selected the user will be asked to confirm the action.*

9. If one or more patient records or examinations are already present in the destination archive, the *Matching patient/exam data* window is displayed.

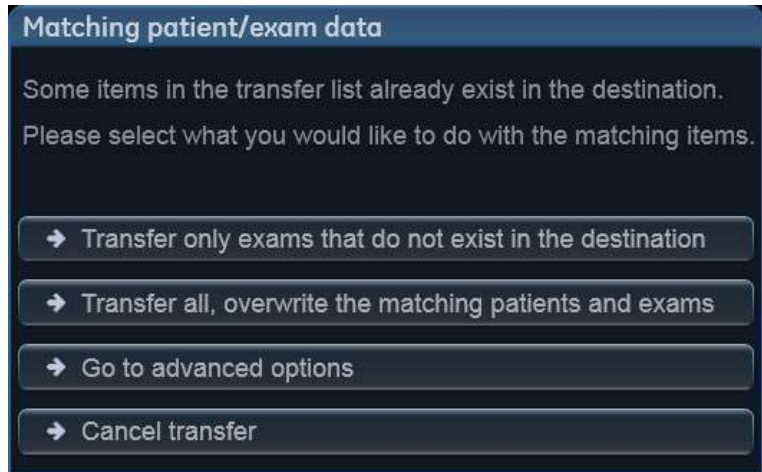

Figure 10-26. The Matching patient/exam data window

10. Select between:

- **Transfer only exams that are not in the destination**
- **Transfer all, overwrite the matching patients and exams**
- **Go to advanced options**
- **Cancel transfer**

The *Advanced option* window is displayed.

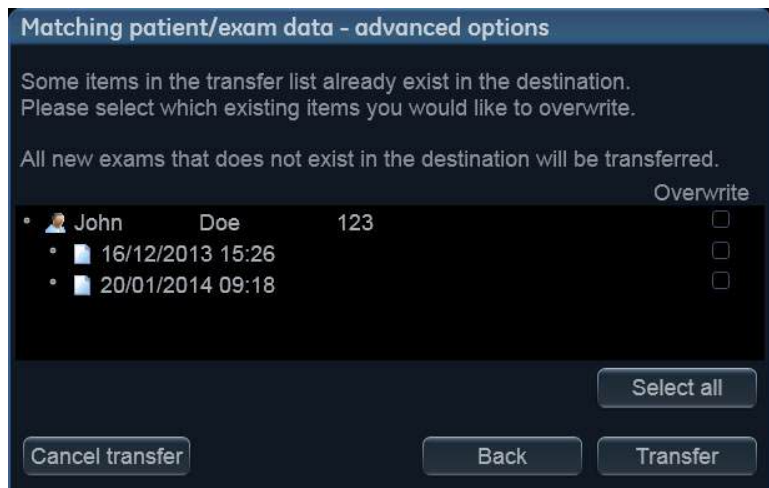





Figure 10-27. The Advanced option window

Select the items to overwrite.

	Overwrite patient information. The exams are not overwritten.
	Overwrite examinations. The patient information is not overwritten.
	Overwrite both patient information and examinations.

Press **Transfer**.

The transfer operation is started. The *Copying patients* window is displayed showing the progression of the transfer.

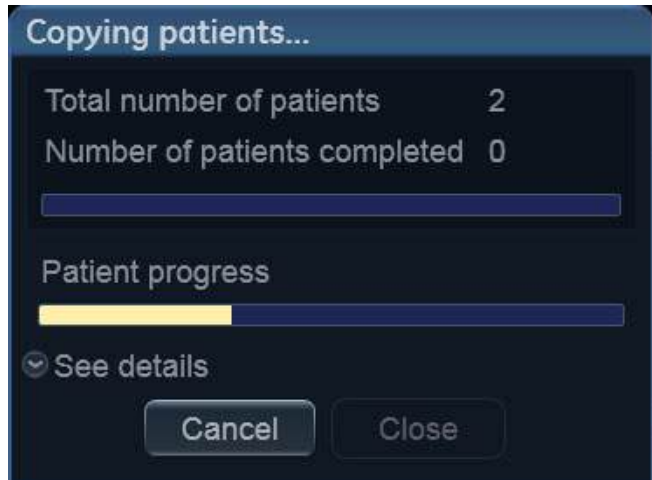

Figure 10-28. The Copying patients window

Each successfully transferred item is marked with a check mark in the transfer list.



	First name	Last name	Patient ID	Exam date	Est size	Status
	John	Doe	123		9.03 MB	✓
		TVI	v110b213		27.5 MB	✓

Figure 10-29. List of transferred items

NOTE: Press **Clear transferred** to clear the list of transferred items.

11. Press **Close** to return to the *Archive* screen.

Disk management

The Disk management function allows the user to manage hard disk space while maintaining the patient database on the system. The Disk management function can be used to move, copy or delete images and move or copy reports from the oldest patient records. The Disk management function has also an auto-purge feature that will automatically delete images and reports that have already been copied if the local hard disk is getting full.

Three different disk management scenarios are possible depending on the system configuration:

- Disk management is set to **move** files: the user runs the Disk management function on a regular basis to move images and reports from older patient records to removable media or to a network volume. Using this setting, moved images and reports are deleted from the local hard drive and copied to the specified destination. This scenario prevents the local disk to fill up and keeps images and reports from the most recent patient records on the local disk. Using this scenario, the user can control what should remain on the system while keeping the disk free space at an operational level.
- Disk management is set to **copy** files: the user runs the Disk management function on a regular basis to copy images and reports from older patient records to removable media or to a network volume. To prevent the local disk to fill up, the auto-purge function automatically deletes files that were previously copied when the disk free space has reached the minimum allowed limit (**15 GB**). This scenario lets the system automatically manage the disk space on the system.

NOTE: When using this setting, the original images will be retrieved from the local hard drive as long as they are available there. When the images are deleted from the local hard drive by the auto-purge function, the copied images will be retrieved.

- Disk management is set to **delete** files: the user runs the Disk management function on a regular basis to delete images from older patient records.

NOTE: *Ensure that you have established a data management protocol for your office/institution. The user MUST manage the removable media used when running Disk management by keeping a log and by creating a media filing system.*

A person should be in charge of performing the process. The Disk management system can be set up so that a reminder is displayed at regular intervals.

It is always highly recommended to take a backup of moved/copied files, which is the responsibility of the customer. The system does not offer functionality for taking backup of images and reports saved on long-term storage media.

NOTE: *Computerized Tomography exams are not handled by Disk Management. The user is responsible for manually deleting these exams when needed.*

Configuring the Disk management function

Configuration of the Disk management system can only be done by user with administration rights.

1. Press **Utility/Config** on the Touch panel.
If required log on as administrator.
2. Select the category **Connectivity**.
3. In the *Connectivity* category, select the sheet **Disk management**.



1. Sets the reminder time interval for running Disk management.
2. Sets the files to be managed based on the examination dates.
3. Sets the Disk management to copy, move or delete images.
4. Sets the destination device.
5. Starts Disk management.

Figure 10-30. The Disk management sheet

Disk management schedule setting

1. Next to **Reminder interval**, specify the number of days/ weeks you want the system to prompt you to perform disk management.

This setting should be set based on the activity of your office/institution.

Data management settings

1. Select a number of days, weeks or months next to **Manage files older than**. Only files older than the specified setting will be copied, moved or deleted.
If **Today (all files)** is selected, all files will be copied or moved.
2. Next to **Operation** check:
 - **Copy**: the images and reports from the examinations older than the specified setting defined in step 1 are copied to the specified destination. Using this setting,

the files will exist in two locations, the local hard drive and the destination.

- **Move:** the images and reports from the examinations older than the specified setting defined in step 1 are copied to the specified destination, verified and then deleted from the local hard drive. Using this setting, the files will exist in one location, the destination media. They are removed from the local hard drive.
- **Delete:** the images from the examinations older than the specified setting defined in step 1 are deleted from the hard drive.

Destination device setting

1. Next to **Destination device**, select a removable media or a network share folder.

NOTE: When a network share folder is selected the path to the folder must be entered. Press **Check** to verify the connection.



CAUTION

If using removable media, it is recommended to use dedicated media to the Disk management process. Removable media used for data backup must not be used when performing Disk management.

Do not use the same removable media on several systems.

Running the Disk management function

The Disk management function can be run at any time. In addition, the user may be prompted to run Disk management if the time since the last Disk management operation performed has reached the setting for the Reminder interval (see page 10-51), or if the local hard drive is about to be full.

Disk management can be run from the *Archive* screen (see below) or from **Config/Connectivity/Disk management** (Figure 10-30 on page 10-51).

Manual start of Disk management

1. Press **Patient**.
The *Archive* screen is displayed.
2. Press **Disk management**.
The *Disk management* window is displayed (Figure 10-31).

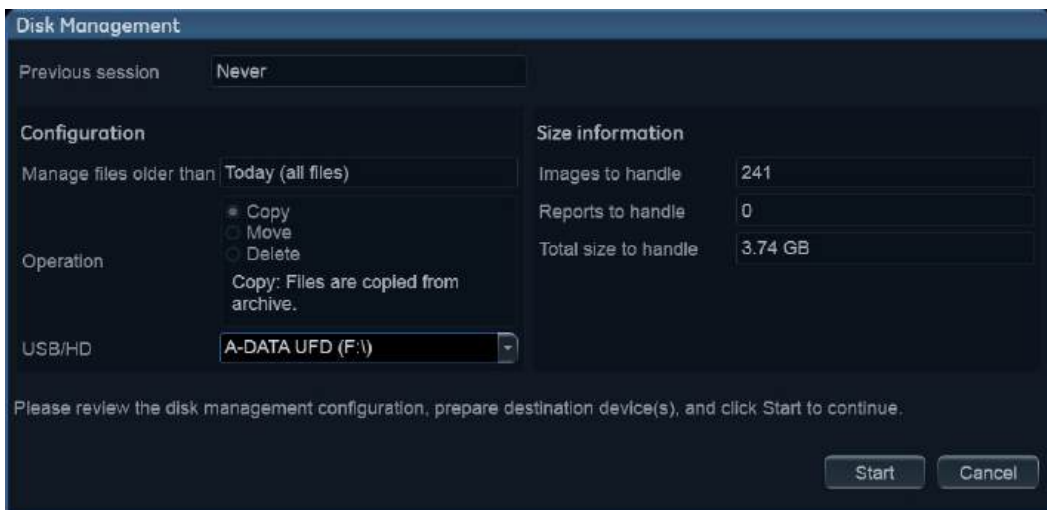

Figure 10-31. The Disk management window

The Disk management operation will either copy, remove or delete files from the local archives depending on the Disk management configuration (see page 10-50). Make sure the correct configuration is set.

Prepare the destination device(s). If a connected USB device is used, make sure the correct device is selected.

If using CD/DVD, the operation may require several disks as specified in the *Disk management* window. Make sure that the specified number of disks are available.

NOTE: *CD/DVD do not need to be formatted.*

3. Press **Start**.

The *Disk management processing files* window is displayed showing progression of the process (Figure 10-32).



Figure 10-32. The Copying files window

If using CD/DVD as destination device, the system automatically formats the disks if required. If the media is formatted the user will be asked to enter a label for the media.

NOTE: *The media label should have an identification of the system the Disk management is run from.*

NOTE: *Disk management is aborted if the destination device contains a database backup or exported patient data.*

The information displayed on the *Disk management processing files* window is updated while the files are being copied.

4. If more than one media is necessary a dialogue window is displayed asking the user to insert a new media.

Press **OK** after the new media is inserted.

The operation is resumed.

5. When all the files are copied, the *Disk management completed* window is displayed (Figure 10-33), showing the list of processed examinations, the media used and a detailed log.

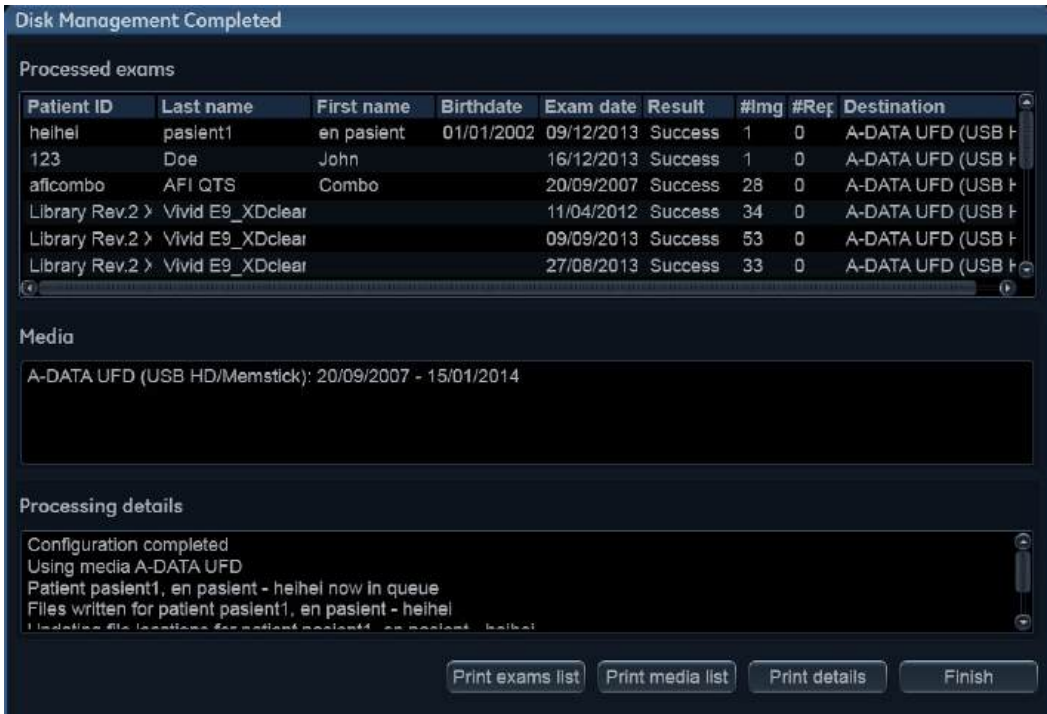

Figure 10-33. The Disk management completed window

- Select **Print exam list** to print the list of processed examinations.
 - Select **Print media list** to print the list of media.
 - Select **Print details** to print the detailed log.
6. Make sure all media are physically labeled according to the list displayed in the *Disk management completed* window. The media label should also have an identification of the system the Disk management was run from.
 7. Press **Finish** to complete the Disk management operation and file the media.
A backup reminder window is displayed.

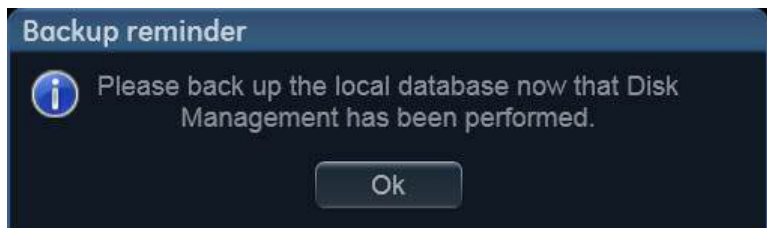

Figure 10-34. The Backup reminder window

8. Press **OK**.

See page 10-57 to perform a database backup.

Data Backup and restore

The Backup/Restore function enables the user to:

- Copy/Restore the patient archive.
- Copy/Restore the system configuration. The Copy/Restore system configuration feature enables the user to configure several units with identical presets, providing that the units have the same software version.

To minimize accidental loss of data, perform backup of the patient archive stored on the local harddrive at least **once a week**.



GE Healthcare is not responsible for lost data if the suggested backup procedures are not followed and will not aid in the recovery of lost data.

There is no backup function for the images or reports (no creation of a safety copy). For long-term storage, images and reports should be moved to a USB HD or to a network shared folder using the Disk management procedure (see page 10-49).



DO NOT use the local harddrive for long-term image storage.

Only users with administration rights have access to the backup/Restore function.

Backup procedure

1. Press **Patient**.
2. In the *Archive* screen, select the dataflow **Local Archive - Int. HD**.
3. Press **Utility/Config** on the Touch panel.
4. Select the category **Admin**.
5. Select the **Backup** sheet.

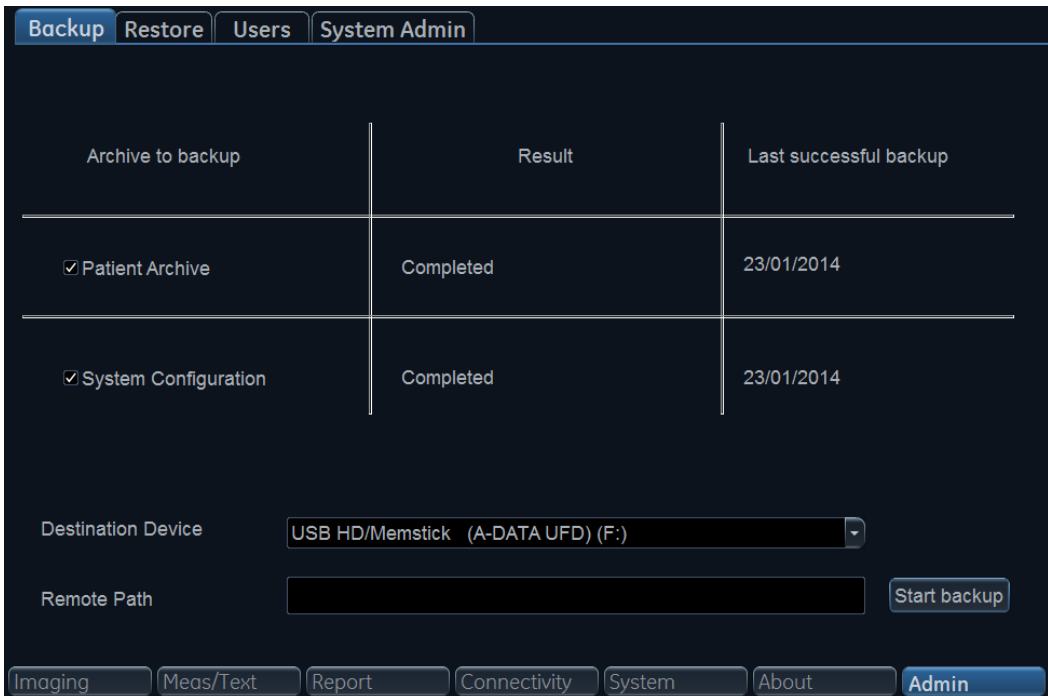

Figure 10-35. The Backup sheet

6. In the *Backup* sheet select as needed:
 - **Patient archive** to backup the patient records.
 - **System configuration** to copy system settings and user presets.
7. Select a removable media or a shared network folder as destination.

NOTE: *To be able to select a network share folder, the path (of type: \\server-name\share-name) must have been entered in the Remote path field.*

8. If the backup is done to a removable media, insert a dedicated media in the drive.
9. Select **Start backup**.

The following situations may occur:

- The system is checking that the removable media is inserted. If not, a dialogue window is displayed prompting the user to insert a media.



Figure 10-36. The Insert media window

Insert the media and select **OK**.

- If using a CD/DVD, the system is checking if the media needs to be formatted. If yes, a dialogue window is displayed prompting the user to enter a media label.

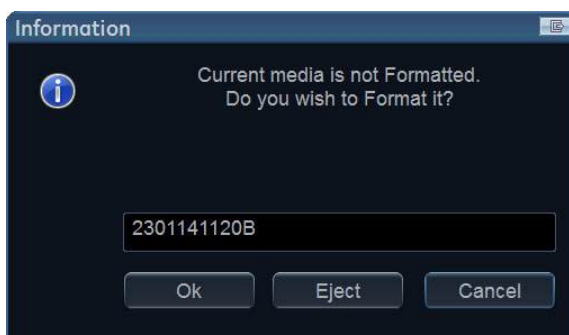

Figure 10-37. The Enter media label window

Type in a label for the media and select **OK**.

NOTE: *Only the following characters and signs can be used when labeling a media: A - Z, a - z, 0 - 9, “_” and “-”. Do not use more than 11 characters or signs. Do not use space.*

NOTE: *If you select **Eject** you can perform the backup using another removable media. If you select **Cancel** the backup operation is stopped.*

- The system is checking if there is already a backup or a Disk management copy on the media. If the following error message is displayed, the disk is ejected and the

user is asked to use a new media that does not contain any backup or Disk management data.



Figure 10-38. The Replace current media window

NOTE: Insert a new media and select **OK**.
To reuse a Backup CD/DVD when performing a new archive backup, the media has to be re-formatted first.

10. During backup, progress windows are displayed showing the current operation being performed.

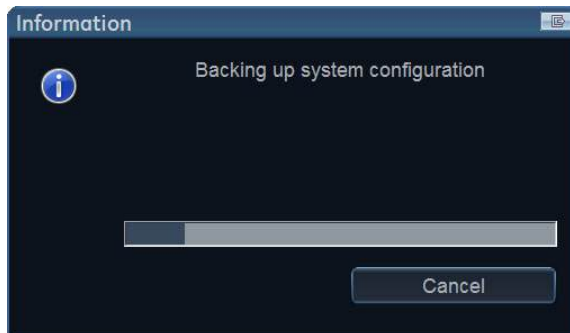

Figure 10-39. The Backup progress window

11. At the end of the process, the *Backup completed* window is displayed.

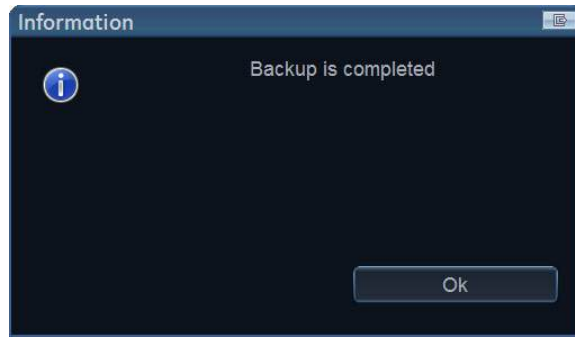

Figure 10-40. The Backup completed window

Select **OK**.

The Backup result is displayed on the *Backup* sheet.

12. Make sure to physically label the media. An identification of the system should also be noted on the media and a backup log should be kept.

File the media in a safe place.

Restore procedure

1. Press **Utility/Config** from the Touch panel.
2. Select the category **Admin**.
3. Select the **Restore** sheet.

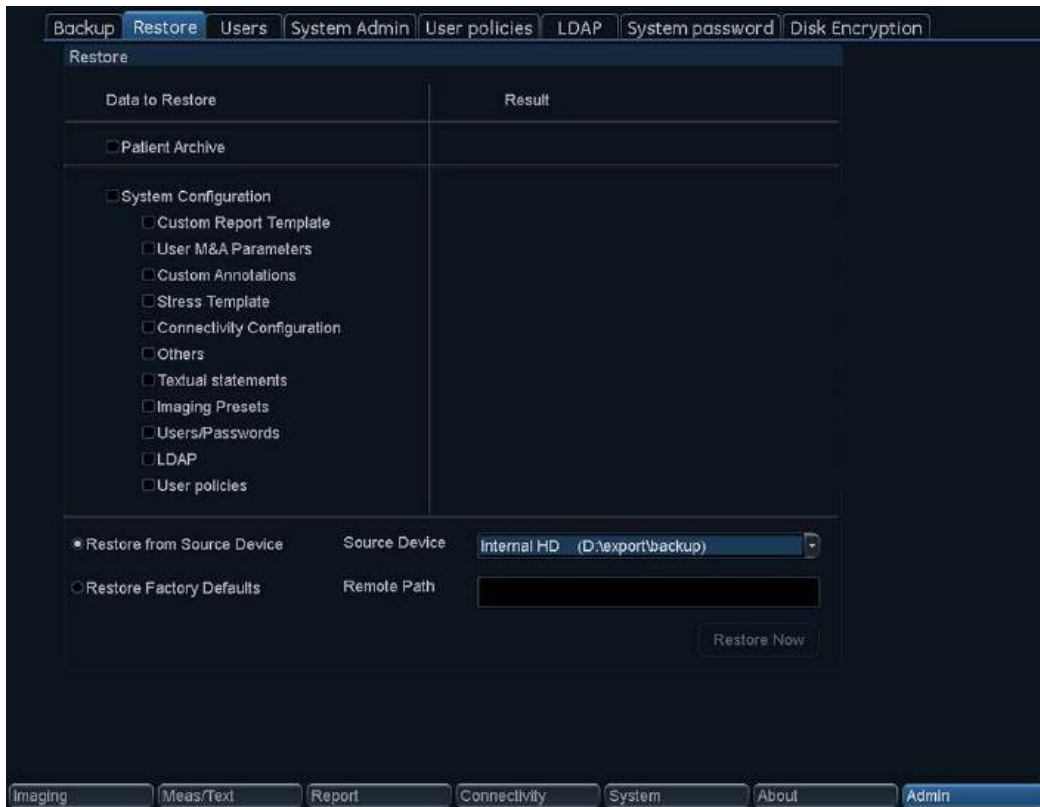

Figure 10-41. The Restore sheet

4. In the *Restore* sheet select as needed:
 - **Patient archive** to restore the patient archive.
 - **System configuration** to restore all system settings and user presets.
OR
 - One or several **system configuration items** to restore parts of the system settings and user presets (see Figure 10-41).
5. If restore is done from a backup on a removable media, insert the media in the drive. Make sure that **Restore from Source Device** is selected.
6. Select the appropriate **Source device**.



CAUTION

The Restore procedure will **OVERWRITE** the existing data on the local harddrive. Make sure to insert the correct media and select the correct source device.

7. Select **Restore now**.

Depending on the selection of items to be restored, one or two restore confirmation windows are displayed:

A

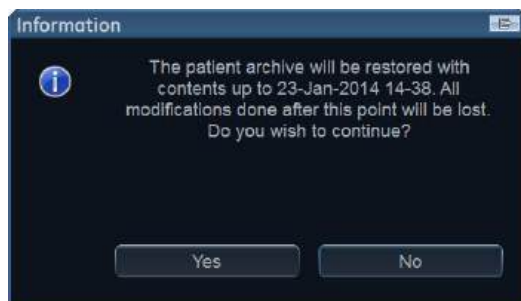

a. Displayed if the patient archive is to be restored.

B

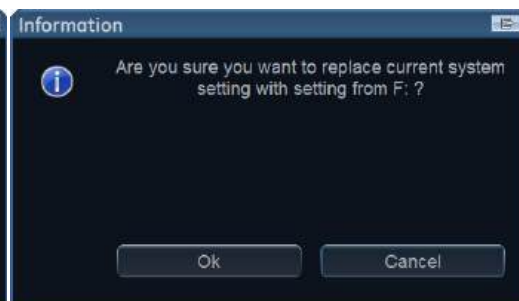

b. Displayed if any of the system settings are to be restored.

Figure 10-42. The Restore confirmation window

8. Ensure that the correct source is selected and select **OK**. The selected items are copied to the systems.
9. If connectivity configuration settings are restored the following information window is displayed.

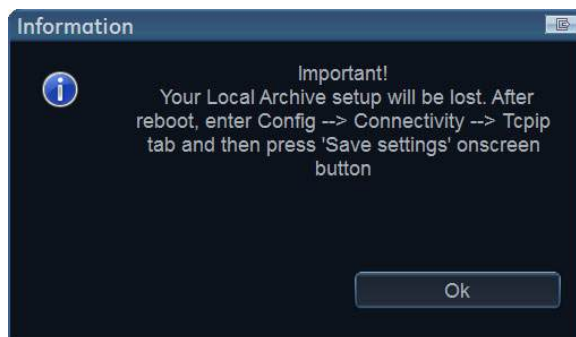

Figure 10-43. Information window

10. Select **OK**.

The *System shutdown* window is displayed.

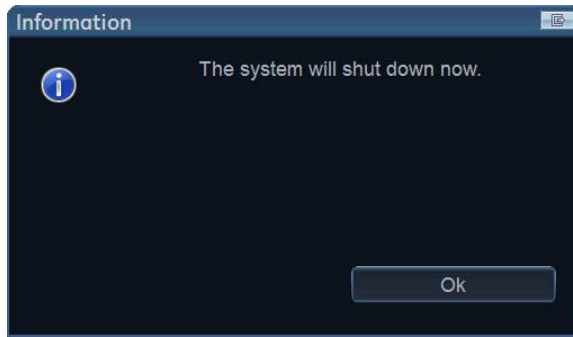

Figure 10-44. The System shutdown window

11. Select **OK** to shut down the system.
12. Restart the system.

If connectivity configuration settings have been restored, make sure to save the TCP/IP settings: select **Config/Connectivity/TCPIP** and select **Save settings**. The system needs to be restarted again.

Tricefy Uplink

Tricefy Uplink, an online platform for sharing and distributing medical images, enables physicians to archive, collaborate and share exam data with patients and colleagues. After registration, the studies can be archived and viewed in the cloud.



1. Archive securely in the cloud.
2. Access anytime from any device.
3. Share with patients instantly.
4. Collaborate with colleagues easily.

Figure 10-45. How the Tricefy server works.

To register a Tricefy account

1. Press **Utility/Config**.
2. If required, log on to the system.
3. Select the **Connectivity** category and the **Tricefy** subgroup. The *Tricefy* screen is displayed (see Figure 10-46).
4. Check the button **Enable Tricefy**. A registration text field is displayed.
5. Type e-mail address and press **Activate account**.
At first connection, a registration letter will be sent to the provided e-mail address. Follow the instructions to complete the Tricefy Uplink registration.

- After the account is successfully registered, press the **Test Connection** button. The account information is displayed, indicating account name, customer name and account status (see Figure 10-46).

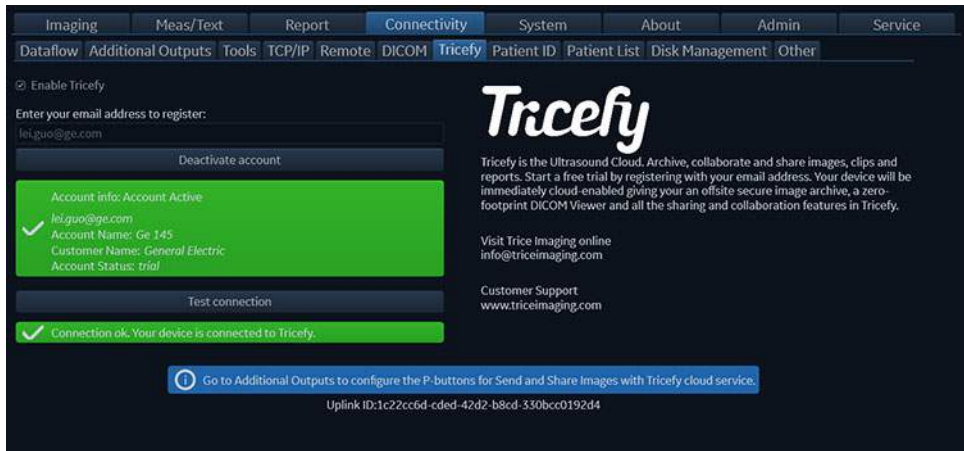



Figure 10-46. The Tricefy Screen

NOTE: An icon in the bottom left corner of the title bar shows the Tricefy connection status.

The icon  indicates that Tricefy Uplink is successfully connected.

The icon  indicates that registration is incomplete.

The icon  indicates that Tricefy Uplink is disconnected.

Configuration of Tricefy storage

The following dataflows are available for transferring images from the ultrasound system to the Tricefy cloud server:

Dataflow	Description
Local Archive / Tricefy Store	The local archive is used for patient archiving. Images are stored to the local archive and to Tricefy Uplink. If DICOM SR is enabled, measurements are also sent to Tricefy Uplink.
Tricefy Store	Store images to Tricefy Uplink. If DICOM SR is enabled, measurements are also sent to Tricefy Uplink.

Dataflow	Description
Local Archive / Tricefy Patient Share	The local archive is used for patient archiving. Images are stored to the local archive and to Tricefy. Images are also shared with the patient. If DICOM SR is enabled, measurements are also sent to Tricefy Uplink.
Tricefy Patient Share	Store images to Tricefy and share them with the patient. If DICOM SR is enabled, measurements are also sent to Tricefy Uplink.
Tricefy QR / Tricefy Store	Search in Tricefy Uplink patients and examinations. Retrieve images from Tricefy Uplink. Images are stored to Tricefy Uplink. If DICOM SR is enabled, measurements are also sent to Tricefy Uplink.
Tricefy QR / Tricefy Patient Share	Search in Tricefy Uplink patients and examinations. Retrieve images from Tricefy Uplink. Images are stored to Tricefy Uplink and shared with the patient. If DICOM SR is enabled, measurements are also sent to Tricefy Uplink.
Worklist / Tricefy QR / Tricefy Store	Search in a DICOM Modality Worklist, retrieve images from Tricefy Uplink. Images are stored to Tricefy Uplink. If DICOM SR is enabled, measurements are also sent to Tricefy Uplink.
Worklist / Local Archive / Tricefy Store	Search in a DICOM Modality Worklist, the patient found is copied into the local archive. The patient information and the examination results are stored to the local database. Images are stored to Tricefy Uplink and to the local archive. If DICOM SR is enabled, measurements are also sent to Tricefy Uplink.

Configure as follows before storing exams to Tricefy Uplink:

1. Press **Utility/Config**.
2. If required, log on to the system as **ADM**.
3. Select the **Connectivity** category and the **Dataflow** subgroup.

The *Dataflow sheet* is displayed (see Figure 10-47 on page 10-68)

4. Select the dataflow **Local Archive - Tricefy Store**.

NOTE: *Dataflows listed in the above table can also be selected as needed.*

5. Uncheck the **Hidden** button.

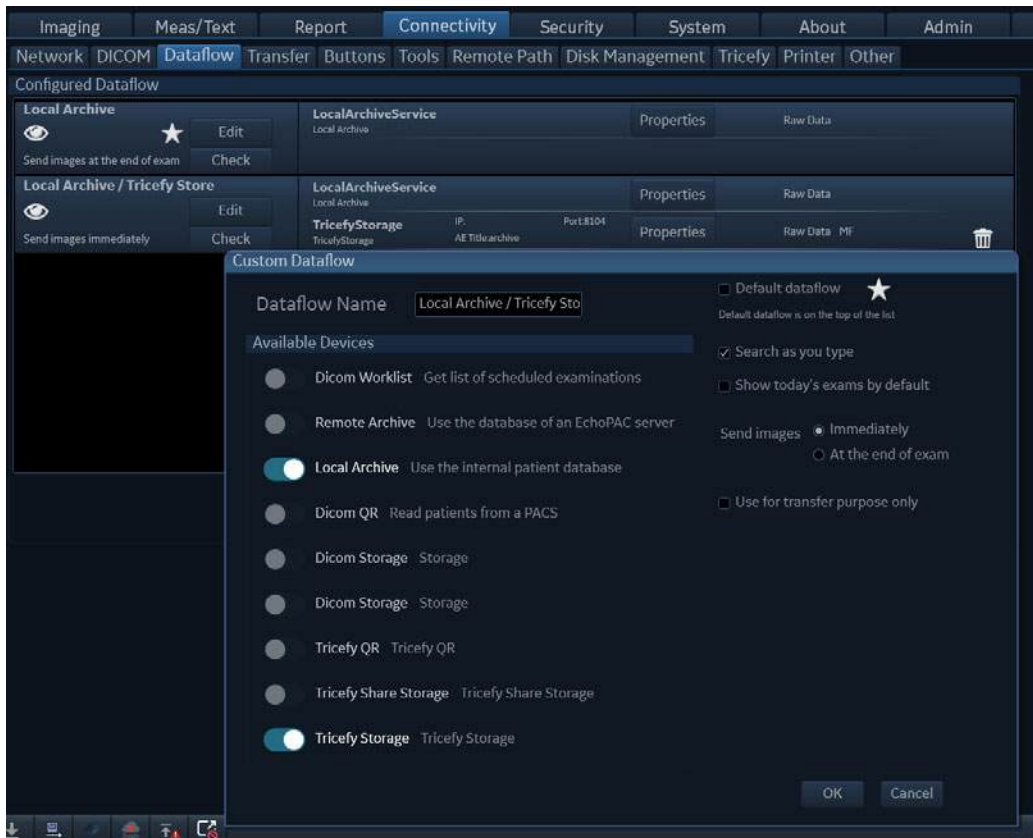

Figure 10-47. The Dataflow sheet

Storing an exam to Tricefy Uplink (Example 1)

1. In the Patients/Exams list, select dataflow **Local Archive - Tricefy Storage**.
2. Get back to the scan and press **Store** key. The image is stored in the clipboard.
3. End the exam. The exam data will be sent to the Tricefy website (https://tricefy4.com/users/sign_in) in addition to the local archive.

Storing an exam to Tricefy Uplink (Example 2)

1. In the Patients/Exams list, select dataflow **Local Archive - TricefyPatientShare**.

NOTE: *If TricefyPatientShare is selected as dataflow, the patient telephone number must be entered under patient data so*

that the patient will be informed automatically when images are uploaded to Tricefy Uplink.

NOTE: To share the exam results with more than one person, type several telephone numbers separated by semicolon.

2. Get back to scan and press **Store** key. The image is stored in the clipboard.
3. End the exam. The exam data will be sent to the Tricefy website (https://tricefy4.com/users/sign_in) in addition to the local archive.

NOTE: If the **Direct Store** checkbox is checked in the Dataflow sheet, the selected image will be directly sent to the Tricefy website when pressing the **Store** key.

How to export an existing exam from local archive to Tricefy Uplink

1. Press **Transfer** from the Patients/Exams list (Figure 10-48). The *Transfer* screen is displayed (Figure 10-49)
2. Select **Local Archive** from the the *Source* drop-down menu. Select **Tricefy Storage** from the *Destination* drop-down menu.
3. Press **Add to list** to make the selected items ready for transfer.
4. Press **Copy** (Figure 10-49). The exam data is sent to the Tricefy website (https://tricefy4.com/users/sign_in).

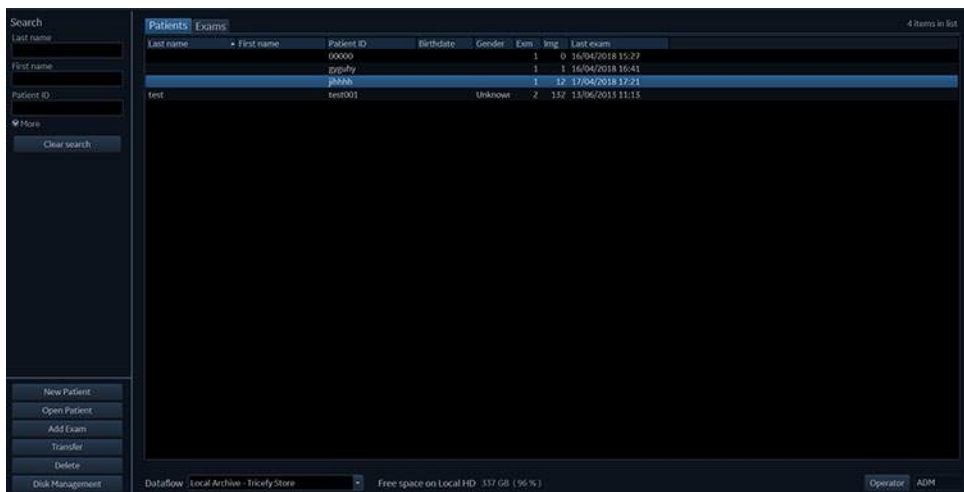

Figure 10-48. The Patients/Exams list

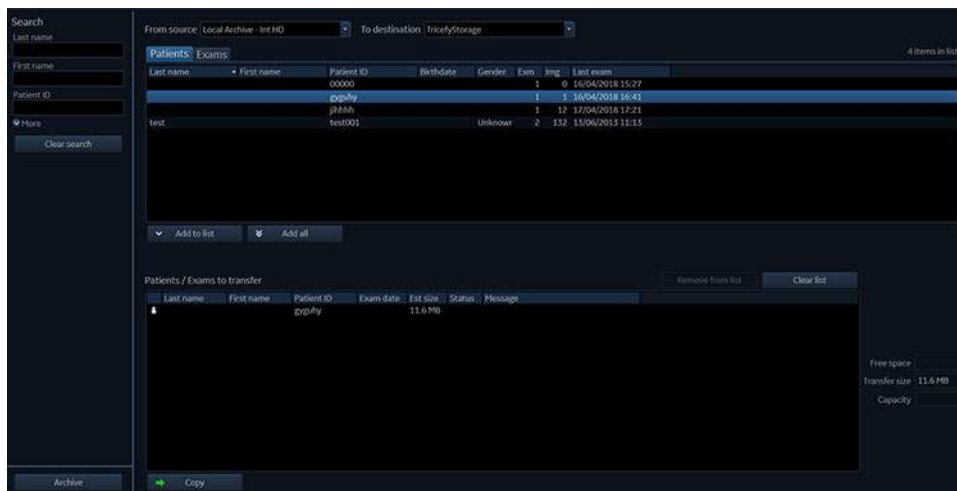

Figure 10-49. The Transfer screen

Accessing exams on the Tricify website

Open the Tricify website (https://tricify4.com/users/sign_in). Log in with user credentials and access the exam results in the *Studies* tab.

Configuration of the P1 button

The P1 button can also be configured to store images directly to the Tricify website. With this method one can send selected images instead of the whole exam, like shown in the two previous examples.

Configure P1 button as TricifyStorage

1. Press **Utility/Config** on the Touch Panel.
2. If required, log on to the system.
3. Select the Connectivity category and the Buttons subgroup. The *Buttons sheet* is displayed (See Figure 10-50)
4. In *Button* field, select **P1**.
5. Select **TricifyStorage** from the *Available output* field and press the **Right arrow** button to assign it to the *Selected Output* field.

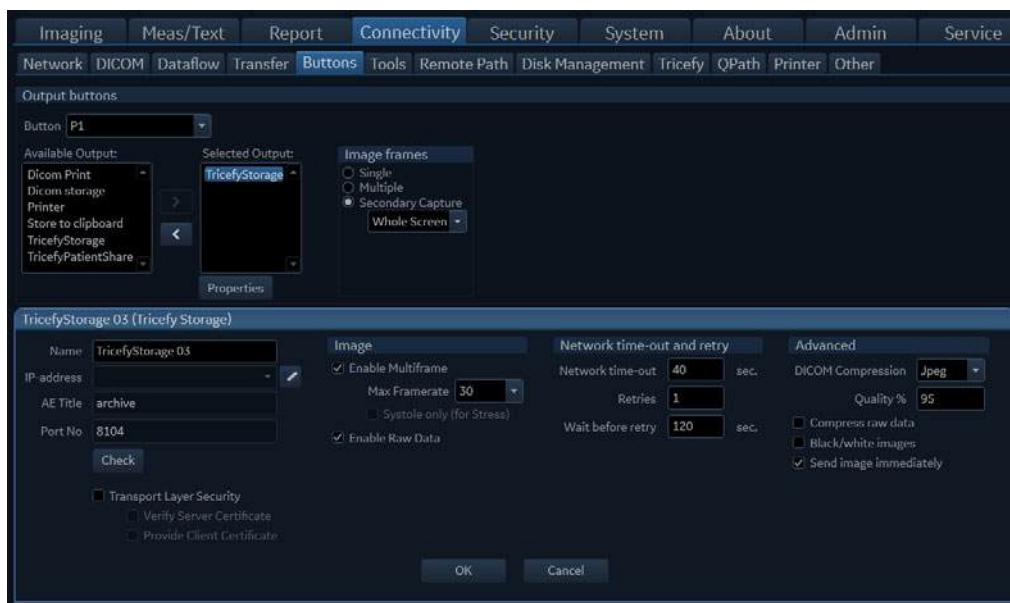

Figure 10-50. Buttons Sheet

6. Get back to scan and press **P1** button. The exam data will be sent to the spooler and kept there. (Press **Spooler** on the *Control panel* or press the *Spooler* icon to see the data).
7. End the exam. The exam data will be sent to the Tricefy website (https://tricefy4.com/users/sign_in)

NOTE: If the **Single Association** button is unchecked in the *Additional outputs sheet*, the exam data will be directly uploaded to the Tricefy website when pressing **P1** button, without being held on the spooler page.

NOTE: List of exam results sent to the Tricefy server will be displayed on the spooler page. (Press **Spooler** on the *Control Panel* or press the *Spooler* icon to see the data).

Configure P1 button as TricefyPatientShare

1. Press **Utility/Config**.
2. If required, log on to the system.
3. Select the **Connectivity** category and **Buttons** subgroup. The *Buttons sheet* is displayed.
4. In the *Button* field select **P1**.
5. Select **TricefyPatientShare** in the *Available output* field and press the **Right arrow** button to assign it to the *Selected Output* field.

NOTE: *The patient telephone number must be entered under patient data so that the patient will be informed automatically when images are uploaded to Tricefy Uplink.*

NOTE: *To share the exam results with more than one person, type several telephone numbers seperated by semicolon.*

6. Get back to scan and press **P1** button. The exam data will be held on the spooler page.
7. End the exam. The exam data will be sent to the Tricefy website (https://tricefy4.com/users/sign_in).

Configuration of Tricefy QR

Tricefy QR, similar to DICOM Query Retrieve, enables users to check exam results which are stored in the Tricefy website via scanner.

1. Log in to the Tricefy website (https://tricefy4.com/users/sign_in).
2. Enable Q/R for corresponding IP address matched with your ultrasound system from the *Uplinks* tab of the website.

NOTE: *Contact your Tricefy Uplink representative to get support for any Tricefy website questions.*

3. Press **Utility/Config** and log on to the system as **ADM**.
4. Select the **Connectivity** category and the **Dataflow** subgroup.
5. Select the dataflow **Tricefy QR -Tricefy Storage**.
6. Uncheck the **Eye** icon and connect with Internet.
7. Go to patient page and select **Tricefy QR -Tricefy Storage**.

The exam results stored in the Tricefy website will be displayed in the *Patients/Exams* list.

NOTE: *Disable Q/R on the Tricefy website to prevent exam data being used by any other person logging in to the system with the same IP address.*

Data streaming

NOTE: *Data streaming is currently not generally available.*

NOTE: *The **StreamServer** option key should be installed to enable streaming live ultrasound data.*

The system has the capability to stream live ultrasound image data (both 2D and 3D) over the network connection to enabled devices. The data stream will contain gray scale and color data, geometry and physio traces. No patient information will be transferred with the streamed data. To configure this capability, see 'Data Streaming' on page 12-80.

Streaming in process

The streaming is initiated and terminated from an enabled device (e.g. a smart phone / tablet or PC connected to the same network – capable of receiving the streamed data over a custom protocol). An enabled device can only receive data when streaming has been enabled on the system, see 'Enable data streaming' on page 12-80.

Active streaming is marked with a red label: *STREAMING*.

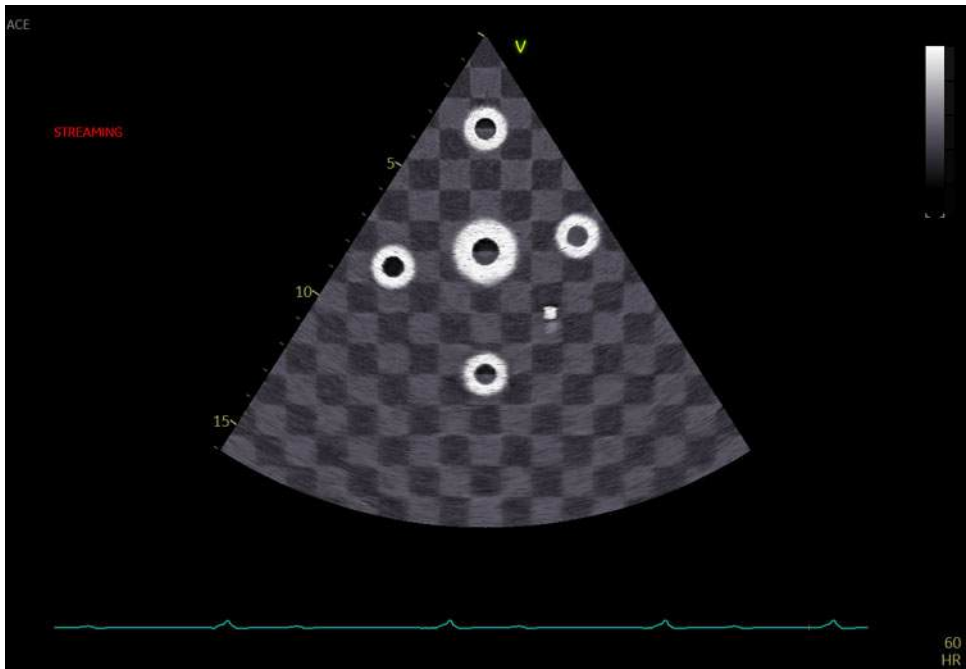

Figure 10-51. Active streaming window (example)

Data streaming can be stopped by pressing **More > Utility > Stop Data Streaming** on the control panel.

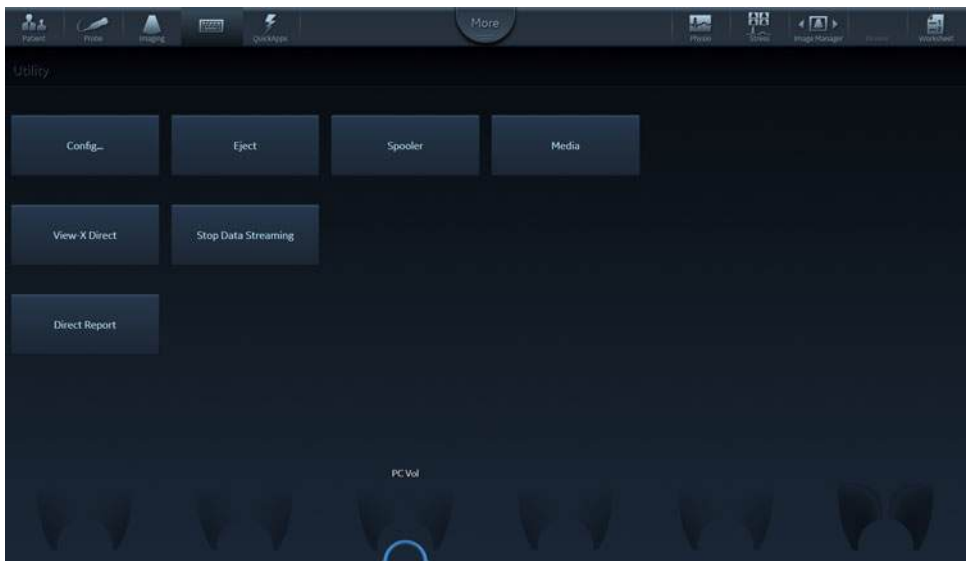

Figure 10-52. Stop Data Streaming

Remote Viewing

The system has the capability to stream the main screen over the network. The remote user can view the streamed screen from a device/computer on the same network as the system, using a web client application that can reproduce MPEG4 video streams, such as a modern web browser. Remote Viewing allows non-diagnostic remote image viewing, image review, consultation, guidance, support, and education in real time. For instance, the remote user can learn from images streamed during an intervention or routine exam. Additionally, the remote user can view the scanner screen and provide support to the local user by suggesting how to modify the system settings (such as acquisition depth or frequency, display layout, etc.) or which images should be acquired and stored before ending the exam. Remote Viewing does not enable two-way remote access to the system and does not allow remote control of the system.

NOTE: *To enable remote viewing of the screen, the corresponding option key must be installed.*



WARNING

Remote Viewing is not intended for diagnostic use.

Using Remote Viewing

To start Remote Viewing:

1. Press **More** on the Touch Panel, then **Utility**.
2. Press **Remote Viewing** on the Touch Panel (see Figure 10-53 below).



Figure 10-53. Remote Viewing on the Touch Panel

An icon on the status bar shows that the system is ready to stream the screen (see Figure 10-54 below).

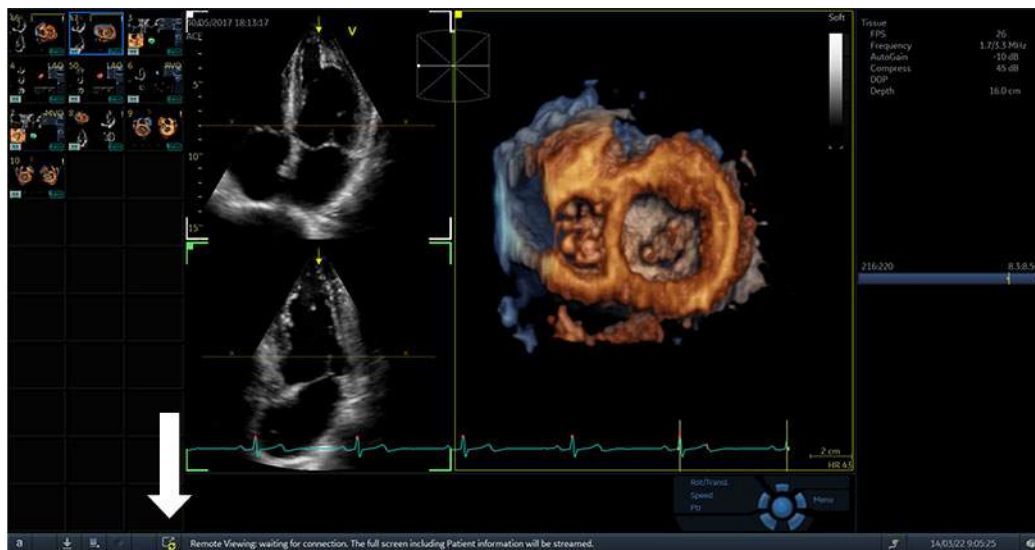

Figure 10-54. Icon on the status bar

3. On the remote device/computer start a web client application that can reproduce MPEG4, such as a modern web browser, insert the IP address of the ultrasound system

and connect to the port 443, followed by “/remotewebviewing”. (E.g. type https://192.168.1.100:443/remotewebviewing in the web browser address bar, where 192.168.1.100 must be replaced with the IP of the ultrasound system).

NOTE: *When connecting to the scanner from the web client, the user may be asked to explicitly allow the unsafe connection since the security certificate is not trusted on the device.*

NOTE: *To see the IP address of the ultrasound system, press **More** on the Touch Panel, then **Utility**, then **Connectivity** and then **Network**.*

4. Insert Username and Password in the client application on the remote device/computer.

NOTE: *Only a user that is a member of the group “ConsultingPhys” will have permission to remote view the system. If LDAP authentication is enabled, at least one of the LDAP groups that the user belongs to must be mapped to the group “ConsultingPhys” to allow the user to remote view the system. See Figure 12-71 on page 12-82 and Figure 12-72 on page 12-83 for details).*

After successful login, the communication is setup and the ultrasound main screen will be displayed on the client application on the remote device.

An icon on the status bar shows that connection has been established and that remote viewing of the screen is ongoing (see Figure 10-55 below).

It is not possible for the remote user to interact with the system from the web browser.



When Remote Viewing connection is established, the full screen including patient information is displayed on the remote browser.

5. Close the web browser to terminate the Remote Viewing session.



Figure 10-55. Icon showing that remote viewing is ongoing



Image quality on the Remote Viewing system may be sub-optimal compared to the scanner monitor.

To stop Remote Viewing using scanner controls:

1. Press **More** on the Touch Panel, then **Utility**.
2. Toggle **Remote Viewing** on the Touch Panel so that it becomes unselected.

Chapter 11

Report

'Creating a report' on page 11-3

'Working with the report function' on page 11-4

'Structured Findings' on page 11-10

'Direct report' on page 11-26

'Report designer' on page 11-28

'Report templates management' on page 11-44.

Introduction

The system enables the creation of patient and examination reports containing measurements, images and analysis that were made during the examination. The layout of the reports is defined by generic templates delivered with the system. Custom templates can also be made.

Saved reports are *read-only*. Therefore it is recommended that the data is carefully reviewed before the report is saved. Use the worksheet (see page 8-149) to facilitate the review and adjustment of data before generating a report. The final report can be printed on a regular printer.

Creating a report

Reports summarize data obtained in the examination. They can contain data and images.

Once generated, the report can be viewed, images can be added, wall segment diagrams can be assigned and text can be entered in the free text fields. All other information must be changed from the *Patient info and exam* screen, the *Worksheet* screen or the *Structured Findings* screen.

Working with the report function

To open a report

1. Press **Report** (available from the *Patient info and exam* screen, *Worksheet* screen or from the *Utility* Tab sheet on the Touch panel).

The default template for the current examination is displayed (see Figure 11-1). The information entered during the examination is automatically filled in (e.g. Demographic, Diagnosis, Comments...etc.).

To choose another report template

1. Press **Template**.

The *Template selection* menu is displayed showing the available report templates organized by application.

NOTE: The Template selection menu can be configured to display only the templates of interest (see page 11-45).

2. Do one of the following:

- Select a template from the current application template list.
- Select another application and select the desired template from the sub-menu displayed.

The selected template is displayed on the screen.

NOTE: The five last used templates can be selected directly from the Touch panel.

To change patient information

1. Select the heading of the information to change.
The *Patient info and exam* screen is displayed.
2. Change the information as required.
3. Press **Report** when completed.
The user is asked to confirm the changes.
4. Select **OK** to confirm or **Cancel** to abort.

Images in the report

1. To add an image to the report, place the pointer over an image in the clipboard and double-click the **Select** key.
The image is inserted into the first free image container in the report.
2. To move an image in the report, select and drag the image to move it to a new image container.
3. To replace an image in the report, select and drag an image from the clipboard over the image to replace in the report.
4. To remove an image from the report, select and drag the image to remove outside the report page.

To print a report

Only members of the user group “Cardiologist” are allowed to print a report (see ‘Users and Security’ on page 12-10).

1. Press **Print**.

The report is printed on the default printer. A status window is displayed showing the printing process.

For printer configuration, see page 14-5.

To store a report

Only members of the user group “Cardiologist” are allowed to store a report (see ‘Users and Security’ on page 12-10).

1. Press **Store**.

The report is stored in the Report archive.

Alternative storage

Reports can also be saved in a user-defined location in the following formats:

- **Compiled HTML (.CHM) files:** readable from Internet Explorer.
- **Portable Document Format (.PDF) files:** readable with Adobe Acrobat reader.
- **Text (.TXT) files:** only text data is saved; readable with a text editor.

1. Press **Save as**.

The *Save as dialog* window is displayed.

2. Select the destination folder from the *Save in archive* pull down menu.

NOTE: *To configure the default remote path, see ‘Default remote path setting’ on page 12-93.*

3. Select **PDF**, **CHM** or **TXT** format.
4. Press **Save**.

Retrieving an archived report

1. Press **Retrieve**.

A list of the available reports for the actual examination is displayed.

The default name for a report is of type:

<template type>_<store date>_<store time>.

2. Select the report to retrieve.

NOTE: To display the current report, select **Show active exam**.

Retrieving a DICOM PDF report

The system supports read-only access to DICOM PDF reports created on a DICOM server.

1. To select patients containing DICOM PDF reports, use the **DICOM Query retrieve – DICOM server** dataflow.

2. To view the report, select **Report** and press **Retrieve**.

A list of the available reports for the actual examination is displayed, including DICOM PDF reports.

3. Select the report to retrieve.

The retrieved DICOM PDF report is read-only and is shown in a separate window.

NOTE: The report will be automatically closed if the user selects any other screen than **Analysis**.

The patient containing DICOM PDF reports can be transferred from DICOM Server to Local Archive. Use **DICOM Query retrieve** as source and **Local Archive Int. HD** as destination.

NOTE: If the patient containing DICOM PDF report is transferred to any dataflow except **Local Archive Int. HD**, the report will not be available when the patient is opened in the destination dataflow.

Deleting an archived report

Only members of the user group “Cardiologist” are allowed to delete a report (see ‘Users and Security’ on page 12-10).

1. Press **Delete**.

A list of the available reports for the actual examination is displayed.

The default name for a report is of type:

<template type>_<store date>_<store time>.

2. Select the report to delete.

NOTE: DICOM PDF reports cannot be deleted.

Structured Findings

Structured Findings is a feature that enables the user to insert pre-configured structured diagnostic statements and codes (e.g Billing, Accreditation) in the patient report and create a conclusion based on the inserted statements.

Prerequisite

To be able to insert structured diagnostic statements and create a conclusion in a patient record, the report template used must have assigned fields for the structured findings, the codes and the conclusion.

NOTE: Factory templates have Findings and Conclusion fields.

To create the assigned fields in a user-defined report template:

1. Press **Report** (available from the *Patient, Worksheet or Utility* Tab sheet on the Touch panel).
2. Press **Template** and select the desired report template.
3. Press **Designer**.
The *Report designer* screen is displayed.
4. Select the location in the report template where to insert the Structured findings fields.
5. Select **Insert** and **Archive Information**.
The *Archive information* box is displayed (Figure 11-2).
6. Double-click on **Select All** under all three parameter fields in the *Archive information* box to deselect all parameters.
7. Select **Structured findings, Findings conclusion Indication codes** and **Billing codes** in the *Exam Information* field (Figure 11-2).
8. Select **OK**.
9. Save the Report template and exit the Report designer.

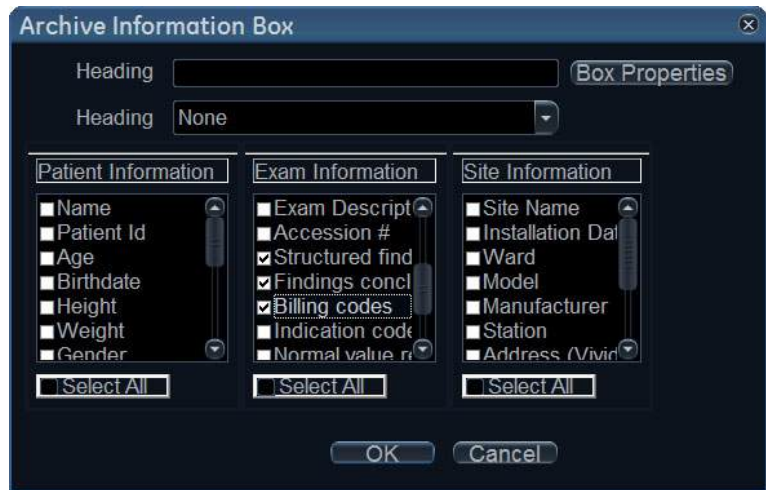

Figure 11-2. The Archive information box

Starting Structured Findings

1. Press **Report**.
Make sure the current template has a Structured Findings field and a Conclusion field defined or select another template if necessary.
2. Press **Findings** or select the header of the Findings box in the report.

The *Structured Findings* window is displayed (Figure 11-5).

Structured Findings structure

The diagnostic statements are organized in tab pages (see Figure 11-3). Each tab page may contain:

- Underlying tab pages that contain Tab sheets.
- Tab sheets that contain diagnostic statements.

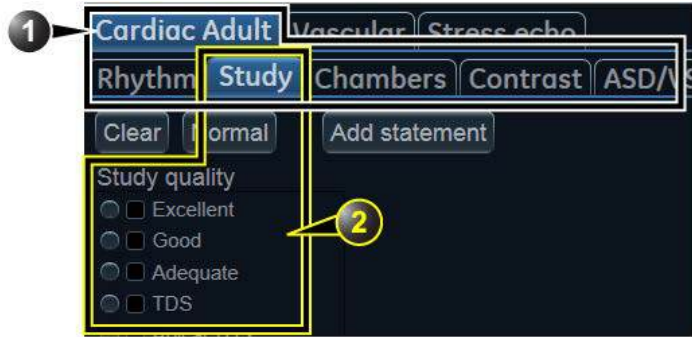

1. Tab page with underlying tab sheets
2. Tab sheet

Figure 11-3. Structured findings structure

There are three types of diagnostic statements (see Figure 11-4):

- Check box statement: when selected the statement is included in the report.
- Combo box statement: create a statement by selecting one alternative text among several choices.
- Statement group: create several statements by selecting multiple check box statements.

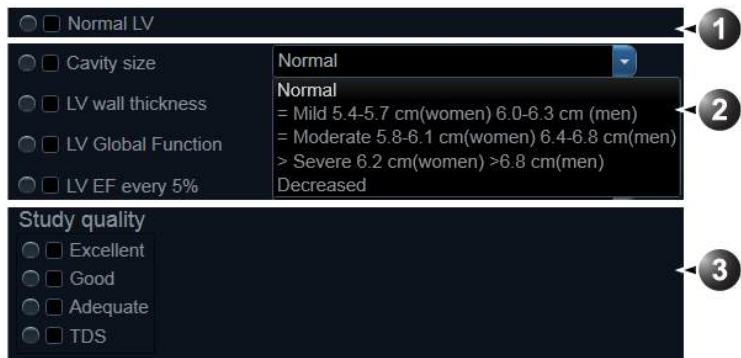

1. Check box statement
2. Combo box statement
3. Statement group

Figure 11-4. Diagnostic statement types

Using Structured Findings

1. Start Structured Findings (see page 11-11).
2. Browse to the tab sheet containing the statements of interest.
3. To insert a statement in the report (Findings field):
 - Check box statement: select the statement.
 - Combo box statement: select an alternative text in the combo box next to the statement.
 - Statement group: select the statements of interest within the group.

A preview of the selected statement(s) is displayed in the *Findings preview* field (see Figure 11-5). The statement text in the preview field can be edited. This will apply only for the current report.

Once a statement is selected an asterisk is displayed on the tab of the current sheet and pages.

NOTE: Select **Normal** to select only normal statements from the current tab sheet (see page 11-19 for more information on how to define normal statements).

NOTE: Select **Clear** to deselect all statements from the current tab sheet.

To insert a conclusion statement in the report:

- Press the **Conclusion** button in front of the statement of interest.

NOTE: Pressing the **Conclusion** button in front of a statement that was not previously selected results in simultaneously inserting the finding statement and create the conclusion.

A preview of the selected conclusion statement is displayed in the *Conclusion preview* field (see Figure 11-5).

Conclusion statements are displayed in a numbered list.

The list can be reordered: triple-click on the conclusion statement to move in the *Conclusion preview* field and use the **Arrow up** or **Arrow down** key to move the statement up or down.

The conclusion text in the preview field can be edited. This will apply only for the current report.

To display the changes in the report, select **Refresh report**.

4. Press **Close**.

The report for the current patient is displayed with the selected findings, conclusion statement(s) and associated codes (if any).

NOTE: *Some diagnostic statements have measurements values in the body text referred by a tag (e.g the {EF} tag refers to EF measurement). These statements require that the actual measurement is done to display correctly in the report.*

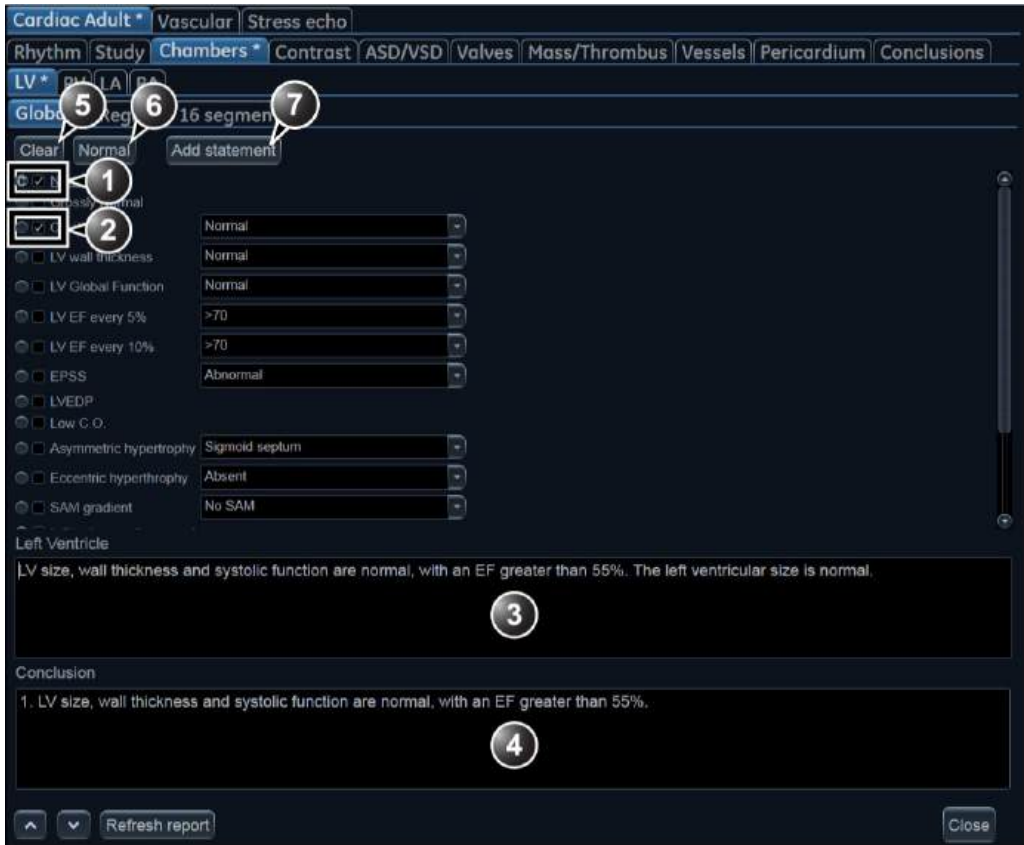

1. Statement inserted in the Conclusion and Findings field.
2. Statement inserted in the Findings field only.
3. Findings preview field
4. Conclusion preview field
5. Remove all selections.
6. Insert normal findings for the current tab sheet.
7. Create and add a statement. The statement will be available only for the current examination.

Figure 11-5. Structured Findings window

Global selection of normal statements

It is possible to select all normal statements from all tab sheets belonging to the current top tab sheet.

1. Place the cursor in the *Statement* field, press **Update/menu** on the Control panel and select **Normal**.

All statements defined as normal are selected from all the tab sheets. An asterisk is displayed on the tab of all the tab sheets that contain normal statements.

NOTE: *This operation will remove any other “non-normal” previously selected statements.*

2. To remove all statements at once, place the cursor in the *Statement* field, press **Update menu** and select **Clear**.

Structured Findings configuration

Structured Findings configuration is used to:

- Create, edit or delete finding statements, conclusion statements and codes.
- Organize the diagnostic statements in the *Structured Findings* screen.
- Define the normal diagnostic statements.

Accessing the Structured Findings configuration screen

1. Press **Utility/Config** on the Touch panel and select the **Report** category.
2. Select the **Structured Findings** tab.

The *Structured Findings* configuration screen is displayed (Figure 11-6).

Or from within Structured Findings:

1. Press **Update menu** on the Control panel and select **Config**.



1. Structured Findings structure tree:
 - Tab page
 - Tab sheet
 - Check box statement
 - Combo box statement
 - Statement group
2. Tab or statement label
3. Findings text
4. Conclusion text
5. Codes for the selected statement
6. Create, move, copy or delete statement
7. Create page, Combo box or statement groups
8. Enter a variable in statement or conclusion text
9. Hide selected tab or statement from the Structured Finding window
10. Set the selected statement as normal
11. Reset factory default findings
12. Export/import findings.

Figure 11-6. Structured Findings configuration screen

Creation of a tab page

The following procedure describes how to create a new top level tab page.

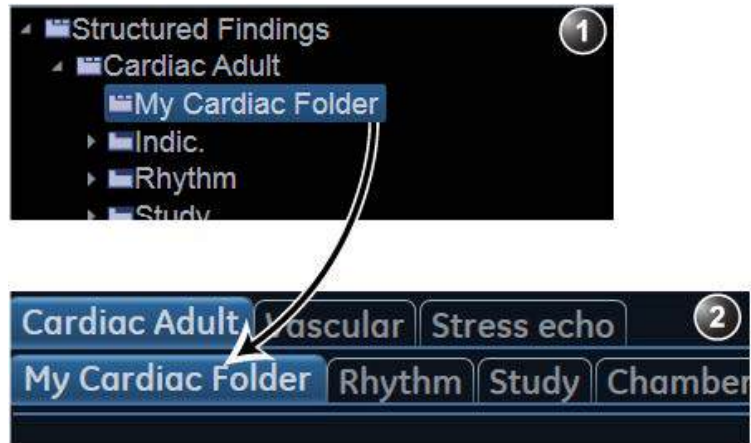

1. Configuration window
2. Structured findings window

Figure 11-7. New tab page

1. In the *Structured Findings* configuration window (Figure 11-6), select the Structured Findings tab page.
 2. Select **Add**.
A new entry is created in the Structured Findings tab page. The new entry is by default a tab sheet (📁).
 3. Select **Enable one more tab level** to change the new entry to a tab page (📁).
 4. With the new entry selected, follow the following steps:
 - Enter a name in the *Label* field (tab name).
 - Enter a description in the *Findings text* field. The description will be displayed in the report as a heading when selecting a statement from the underlying tab sheets. The system is always using the Findings text from the highest item in the structure as a heading for the selected underlying statements.
 - Enter the appropriate codes.
- NOTE:** *To enter several codes separate each code by a space.*
5. Press **Up** or **Down** to move the tab in the structure tree (or do drag and drop).

Creation of a tab sheet

The following procedure describes how to create a tab sheet in a tab page.

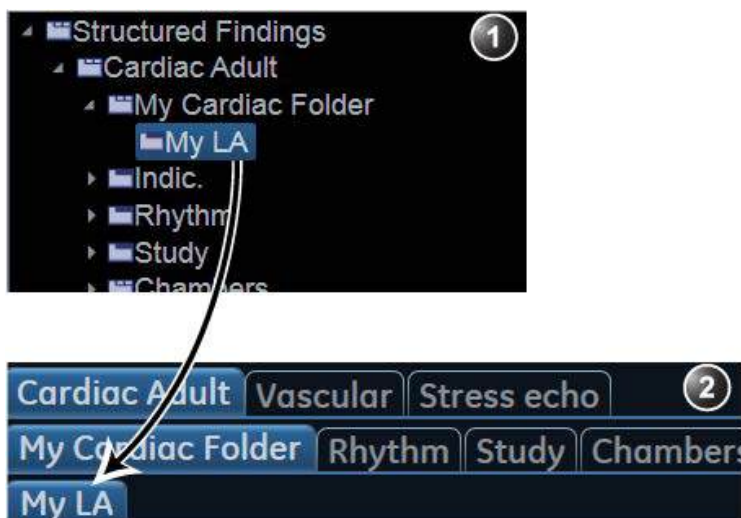

1. Configuration window
2. Structured findings window

Figure 11-8. New tab sheet

1. Make sure the tab page is selected and press **Add**.
A new entry is created in the tab page. The new entry is by default a tab sheet (📁).
2. With the new entry selected, follow the following steps:
 - Enter a name in the *Label* field (tab name).
 - Enter a description in the *Findings text* field.

If required:

- Enter the appropriate codes.

NOTE: To enter several codes, separate each code by a space.

Adding statements in the tab sheet

Check box statement

The following procedure describes how to create a check box statement.

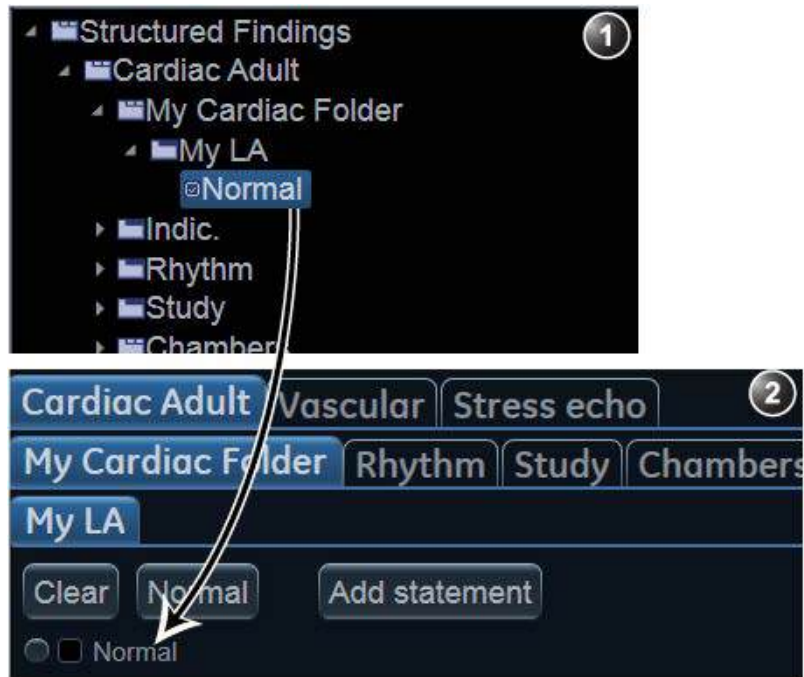

1. Configuration window
2. Structured findings window

Figure 11-9. New check box statement

1. Make sure the tab sheet is selected and press **Add**.
A new entry is created in the tab sheet. The new entry is by default a check box statement (☑).
2. With the new entry selected, follow the following steps:
 - Enter a name in the *Label* field (statement name).
 - Enter the full statement in the *Findings text* field.
 - Enter a conclusion in the *Conclusion text* field (optional).

NOTE: *If the Conclusion text field is empty, the statement text will be used as conclusion when selected.*

If required:

- Enter the appropriate codes.

NOTE: To enter several codes, separate each code by a space.

- Check **Include findings in normal report** to define the statement as normal.

All statements within the selected tab sheet that have this option checked will be included in the report when **Normal** is selected in the *Structured Findings* window (see 'Using Structured Findings' on page 11-13).

Combo box statement

The following procedure describes how to create a combo box statement.

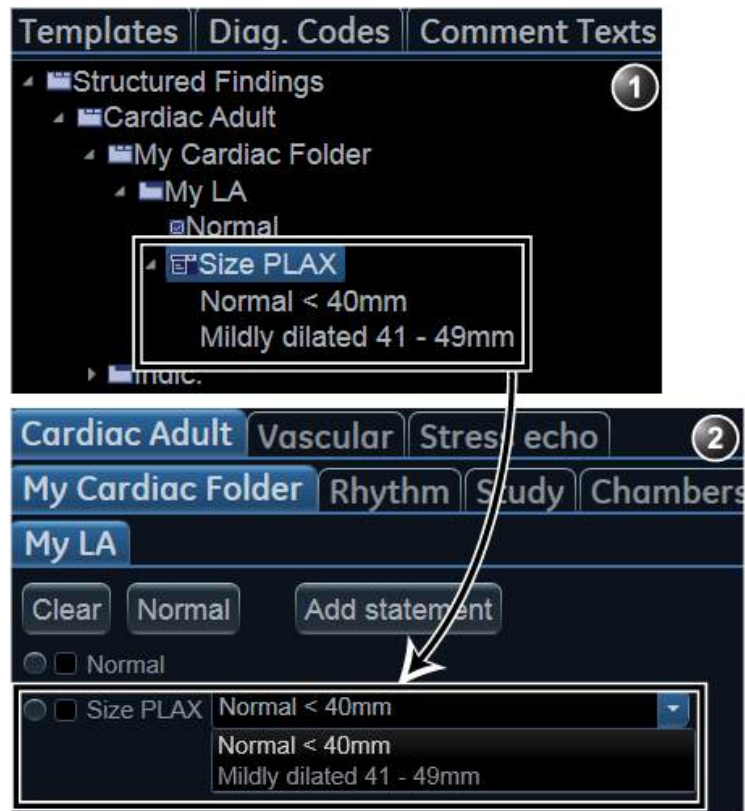

1. Configuration window
2. Structured findings window

Figure 11-10. New combo box statement

1. Create a new statement as described above. A check box statement is created by default.
2. With the new statement selected, press **Add**.

A new underlying entry is created and the parent statement is changed to a Combo box statement (E).

3. With the new underlying entry selected, follow the following steps:
 - Enter a name in the *Label* field.
 - Enter a text in the *Findings text* field.
 - Enter a conclusion in the *Conclusion text* field (optional).
4. Repeat the procedure from step 2 to create as many underlying statements as necessary. Each underlying statement will be a selectable entry in the combo box.

Statement group

Statement groups are created by changing a combo statement to a statement group.

1. Create a combo box statement as described above.
2. Make sure the combo box statement is selected and deselect the option **Enable pull-downs**.

The combo box statement is changed to a statement group (E). Each underlying entries are changed to check box statements.

Editing a statement

Tab label, statements and statement alternative texts can be edited.

1. In the *Structured Findings* configuration window (Figure 11-6), select the item to edit.
2. Make the required changes.

Inserting variable parameters in a statement

Variable parameters such as patient name, institution name, measurement values...etc can be inserted in a statement as tagged information.

To insert variable parameters in a statement:

1. Place the cursor at the required position in the *Findings text* field (or *Conclusion text* field).
2. Press **Insert parameter**.

The *Insert parameter* window is displayed (see Figure 11-11).

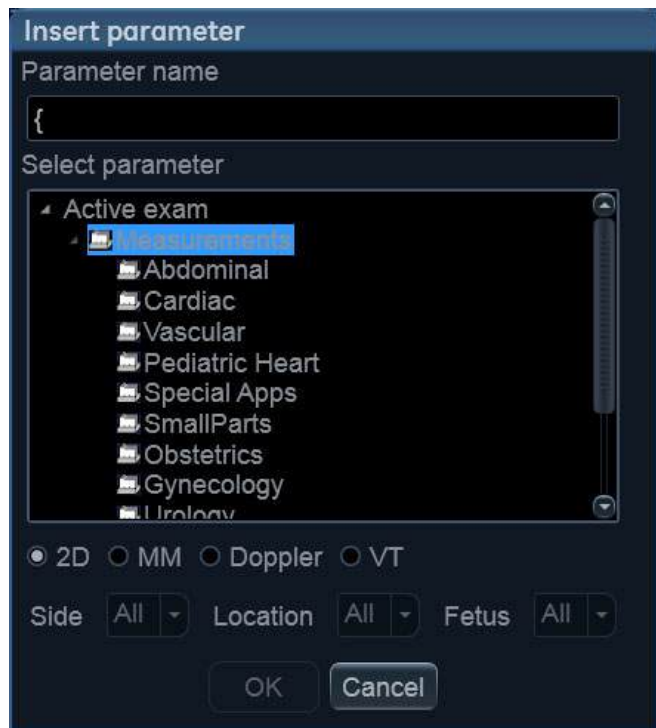

Figure 11-11. Insert parameter window

3. Browse and select the actual parameter to insert.

NOTE: For measurement values, select first the scanning mode.

4. Press **OK**.

NOTE: To display correctly in the report, the actual parameter value must exist, e.g. if a measurement value is included in a statement as a variable parameter, a measurement value must exist for the current patient, otherwise the parameter name is displayed.

5. If the selected parameter can be measured/calculated by different methods, the user is asked to select the preferred parameter to insert (Figure 11-12). Move the preferred parameter as first item in the list displayed and select **OK**.

The selected parameter is inserted in the statement as a tag (e.g. the {EF} tag refers to EF measurement)



Figure 11-12. The parameter list

Copy of a statement

Tab pages, tab sheets and statements can be copied from one location to another. The word “Copied” is added to the copied item name.

1. In the *Structured Findings* configuration window (Figure 11-6), select the item to copy.
2. Select **Copy**.
3. Select the item to contain the copy.
4. Select **Paste**.

NOTE: If the item to copy cannot be copied in the selected location, the operation is ignored.

NOTE: Copy can be done by drag-and-drop, while holding **Ctrl** depressed.

Deletion of a statement

Tab pages, tab sheets and statements can be deleted.



CAUTION

Deletion cannot be undone.

1. In the *Structured Findings* configuration window (Figure 11-6), select the item to delete.
2. Select **Delete**.

The selected item is deleted.

Factory reset

All statements can be reset back to the factory default.



CAUTION

Factory reset cannot be undone.

1. Select **Reset**.
The *Reset statements* window is displayed.
2. Select:
 - **Yes** to reset all statement to the factory default (No undo).
 - **No** to cancel the operation.

Exporting/Importing statements

Diagnostic statements can be exported from one system and imported on another system.

Exporting statements

1. In the *Structured Findings* configuration window (Figure 11-6), select **Export**.
A browsing window is displayed.
2. Browse to a destination and select **Save**.

Importing statements

1. In the *Structured Findings* configuration window (Figure 11-6), select **Import**.
A browsing window is displayed.
2. Browse to a destination and select **Open**.
3. Select one of the following options:
 - **Insert**: the statements are imported in a new top tab sheet, keeping the current statements in place.
 - **Replace**: the imported statements replace the existing ones.
 - **Cancel**: cancel the import.

Direct report

Direct report enables the user to insert comments at any time during the examination that will be part of the final report.

Direct report provides also an overview over the measurements completed.

Creating comments

1. Press **Freeze**.
2. Press **Utility**.
3. Select **Direct Report**.
4. In the *Direct report* screen, select the comment type.
5. Type your comments in the *Text* field.
6. To add a measurement in the comment, double-click a measurement in the *Measurement overview* field.

1. Select the type of information
2. Create/insert pre-defined text
3. Text field
4. List of measurements completed
5. Exits the Direct report



Figure 11-13. The Direct report

Inserting pre-defined text input

1. Select the insertion point in the *Text* field.
2. Select **Insert text**.

The *Insert text* window is displayed (see Figure 11-14).



Figure 11-14. The Insert text window

The pre-defined text list is organized in a three level hierarchy. Selecting one item in the first column displays pre-defined text entries related to the selected text in the second and third column.

3. Navigate through the pre-defined text list by selecting items in the columns and double-click on the desired pre-defined text to be inserted. If an entry in the third column is inserted, the selected text in the second column is also inserted.

Press **More>>** to display the full text for the selected entry.

Creating pre-defined text inputs

This feature is described in 'Creating, editing and deleting text input' on *page 10-20*.

Report designer

The Report designer software package enables the user to create report templates that best suit its needs.

Designing a report template consists of choosing the information to display in the report (e.g. header, footer, logo, patient information, images, measurements...etc.) and arrange it in the report viewer.

The Report designer function is based on the information container concept: each type of information is included within a container with parameters that can be configured (size, color, font properties, information to display...etc.).

Accessing the Report designer

1. Press **Report** on the Touch panel.
The *Report* screen is displayed.
2. Press **Designer**.

The *Report designer* screen is displayed with the selected template in the *Report template design area* (see Figure 11-15).

Report designer overview

The Report designer screen

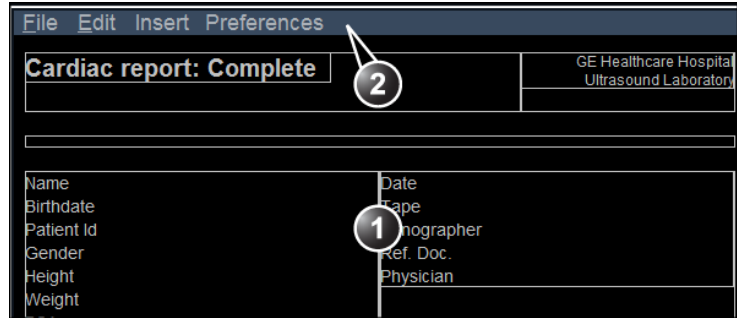

1. Report template design area
2. Menu bar

Figure 11-15. The Report designer screen

The menu bar

Menu	Description
File	<ul style="list-style-type: none"> • New: start working on a new template. • Save: save the template using the same name. Factory report templates cannot be overwritten. • Save as: save the template using a new name. • Page setup: define printing orientation and header/footer for the printed report. • Print Preview: display a print preview of the report template. • Exit: exit the Report designer and returns to the report function. The user can choose whether to save the updates or restore the original template.

Menu	Description
Edit	<ul style="list-style-type: none"> • Delete: remove the selected object from the report template. • Undo: restore the previous state of the report template.

Menu	Description
Insert	<ul style="list-style-type: none"> • Page Break: insert a new page in the report template. • Table: configure and insert a table in the report template. • Logo: select and insert a logo to the report template. • Archive info: select and insert data from the following categories: Patient information Exam information Site information • Anatomical graphics: select and insert an anatomical graphic (cardiac, vascular or TEE). • Image: create a container for the display of ultrasound images. • Wall motion analysis: insert a container for the display of Stress Echo analysis results (cut planes Bull's eye and scoring table). • OB/GYN: insert OB graph. • Measurements: insert a container for the display of measurements and calculations. When creating a measurement container, the user is prompted through a configuration procedure enabling the selection of mode specific measurements and/or calculations. • Text field: insert a container where the user can write in the report. • Fixed text: insert a container with static text. The text typed during the creation of the container will be displayed in the report.

Menu	Description
Preferences	<ul style="list-style-type: none"> • Page Color: sets the default background color for the template page.

Designing a report template

Starting template designing

1. Start the Report designer (see page 11-28).
2. Press **File** and select **New** to display a blank page or use the current report template as basis template.

Setting the layout preferences

Adjusting the report page color background

1. Press **Preferences** and select **Page Color**.
The *Color selection* window is displayed.
2. Select the desired color.
3. Press **OK**.

Header and footer in the printed report

This function is described on page 11-41.

Inserting an information container in the report template body

The different types of information to be included in a report are grouped in information containers. Designing a report template consists in inserting and configuring the different information containers in the template page in an ordered manner.

Information containers can be inserted either:

- Directly into the report template body: this procedure does not allow side-by-side insertion, the information container will normally cover the width of the report template page.
- Within a table: this procedure allows side-by-side insertion of several information containers.

Inserting a table

1. Place the cursor at the desired insertion point in the *Report template design area*.
2. Press **Insert** and select **Table**.
The *Container properties* window is displayed (see Figure 11-16).
3. Adjust the parameters as desired.
4. Press **OK**.

The table is displayed in the template.

NOTE: *To modify an inserted table, double-click in an empty area in the table. A selection menu is displayed where the user can add, delete a row or a column or open the Table properties window.*

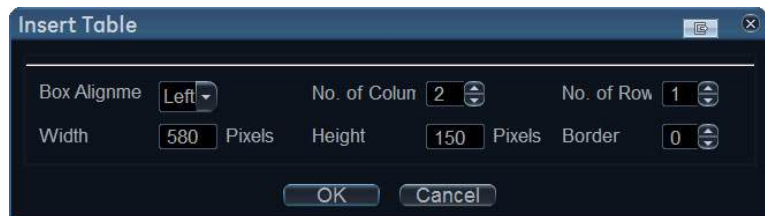

Figure 11-16. The Table properties window

Inserting a logo

1. Provide the hospital logo in JPEG or Bitmap format onto a removable media.
2. Select the location where to insert the logo (a table cell or directly in the report template).
3. Select **Insert** and **Logo**.
The *Logo* box is displayed.



Figure 11-17. The logo box

4. Select a logo, or if not available, select **Import logo**.
Browse and select the logo and select **OK**.
5. Specify the appearance.
6. Select **OK**.

Inserting fixed text

Fixed text is an entry that cannot be changed in the report (e.g. hospital information).

1. Select the location where to insert the fixed text (a table cell or directly in the report template).
2. Select **Insert** and **Fixed text**.
The *Fixed text* box is displayed.

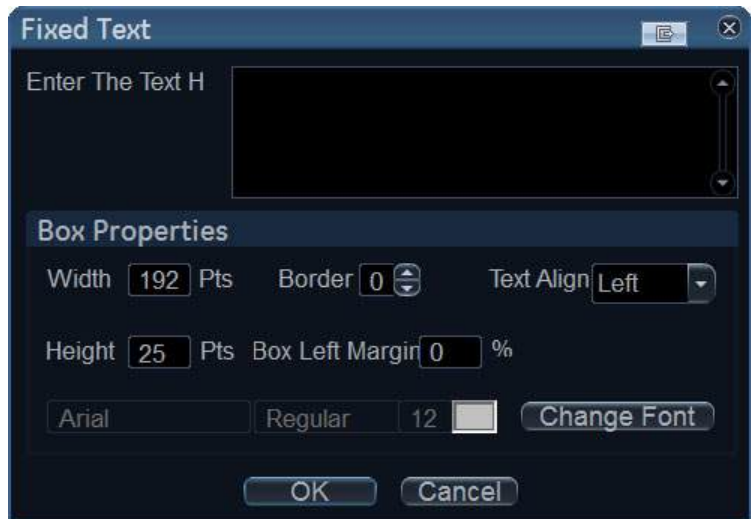

Figure 11-18. The Fixed text box

3. Enter the text and specify the appearance.
4. Select **OK**.

Inserting archive information

Archive information contains all the objects of the different information menus (Patient, Exam, Study and Site Information).

You may display the archive information over two columns using a table container as described below.

1. Insert a table for the archive information to the desired location (a table cell or directly in the report template).
2. Select the first table cell.
3. Select **Insert** and **Archive information**.
The *Archive information* box is displayed.

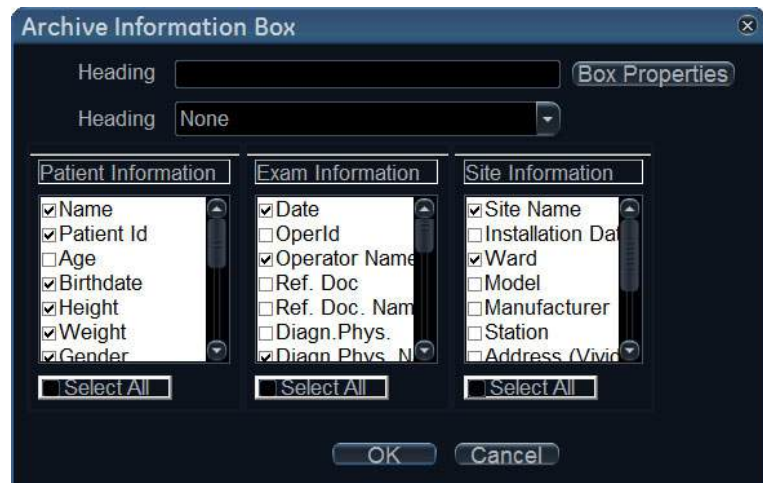

Figure 11-19. The Archive information box

4. If desired, enter a heading and select a heading link from the pull-down menu.
5. Select the Information parameters to be displayed in the first cell.
Select **Box properties** to change the font, alignment, appearance, etc.
6. Select **OK**.
7. Select the next table cell and repeat steps 3 to 6 to enter the remaining archive information.

Inserting an Image container

- Select the location where to insert the fixed text (a table cell or directly in the report template).
- Select **Insert** and **Image**.
The *Ultrasound image* box is displayed.

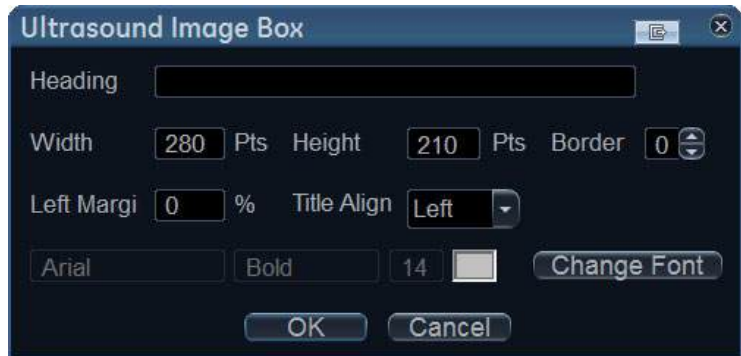

Figure 11-20. The Ultrasound image box

- If desired, enter a heading, set the container size and specify the text appearance.
- Select **OK**.

Inserting a measurement container

You may display the measurements over several columns using a table container as described below.

1. Insert a table for the measurements to the desired location.
2. Select the first table cell.
3. Select **Insert** and **Measurements**.
The *Measurements* box is displayed.

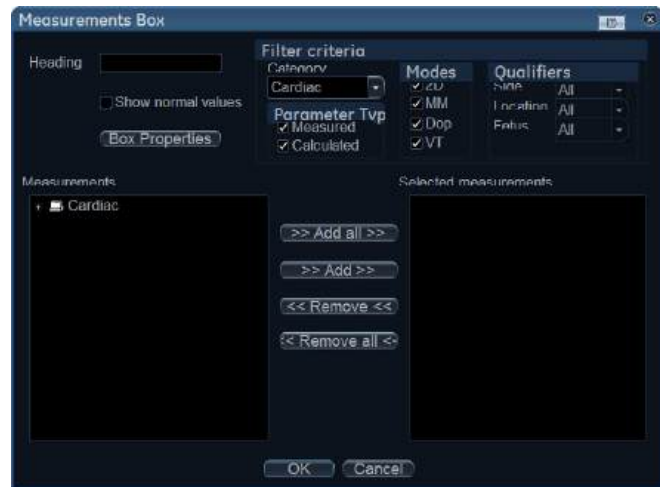

Figure 11-21. The Measurements box

4. Enter a heading (e.g. 2D).
5. Using the *Filter criteria*, define the type of measurements to be displayed (e.g. Cardiac, 2D, measured and calculated). Select **Show normal value** to display user-defined Normal value next to the measurements in the Report (see 'Normal values' on page 12-42 for more information).

NOTE: *References for the normal values can be displayed in the report by checking **Normal value references** from **Insert -> Archive Info** (see page 11-35).*

The *Measurement* list on the left side is updated.

6. From the measurement list, select the measurement to insert and press **Add**. Both single measurements or a folder may be added.
7. The list of the inserted measurements is displayed in the *Selected measurement* list on the right side.
8. Press **OK**.
9. Select the next table cell and repeat steps 3 to 8 to insert several measurements.

Inserting Text fields

Text fields are:

- Containers for Referral reasons, Comments and Diagnosis information.
- Containers for free text, where the user can type information in the report.

1. Select the location where to insert the text field container (a table cell or directly in the report template).
2. Select **Insert** and **Text field**.
The *Text field* box is displayed.

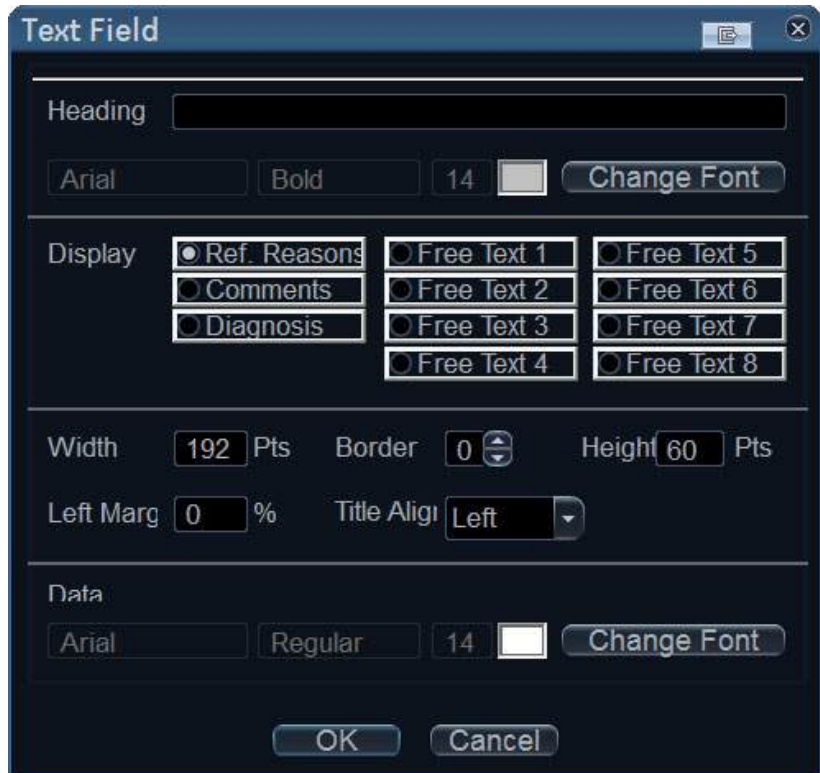

Figure 11-22. The Text field box

3. Enter a heading.
4. From the *Display* field, select between:
 - **Referral reasons:** displays the information entered in the *Patient info and exam* window.
 - **Comments:** displays the information entered in the *Patient info and exam* window.
 - **Diagnosis:** displays the information entered in the *Patient info and exam* window.
 - **Free text 1-8:** creates an empty free text container.
5. If desired, adjust the font settings for the header and data.

Inserting Wall motion scoring analysis containers

Two different containers must be inserted for the Wall motion scoring analysis:

- A Wall motion scoring diagrams container (Cut planes or Bull's eyes)
- A Wall motion scoring table

Inserting Wall motion scoring diagrams container

1. Select the location where to insert the free text container (a table cell or directly in the report template).
2. Select **Insert, Wall motion analysis** and select between **Cut planes** and **Bull's eye**.

The corresponding *Wall motion score* box is displayed.

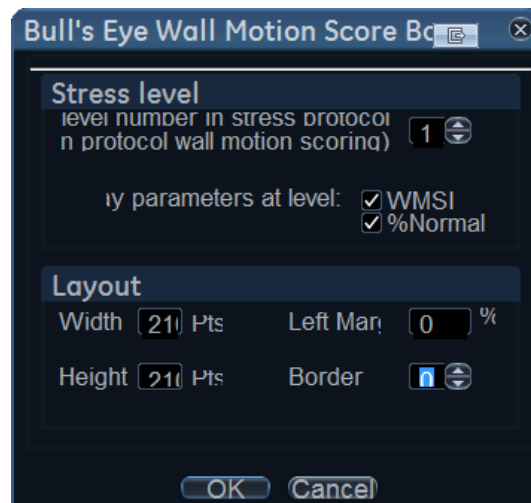

Figure 11-23. The Wall motion score box (Cut planes)

3. Adjust the parameters and select **OK**:
The scoring diagrams are inserted in the report template

Inserting Wall motion scoring table container

1. Place the cursor below the *Wall motion scoring diagrams* container.
2. Select **Insert, Wall motion analysis** and select **Score table** box.

The *Score table* box is displayed.

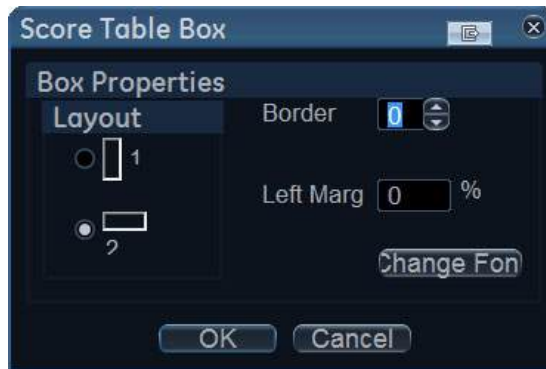



Figure 11-24. The Score table box

3. Adjust the layout parameters in the *Score table* box and select **OK**.

The Score table is inserted in the report template.

Editing the information container

Resizing the information container

1. Move the cursor over the border of the container to resize. The mouse cursor is changed to a cross .
2. Press **Select**. The container is displayed with anchor squares on the sides and at the corners.
3. Resize the container by dragging from the anchor points.

Editing the information container properties

1. Double-click in the container to edit and select **Properties**. The *Properties* window is displayed.
2. Adjust the parameters specific to the selected container.

NOTE: Some information containers have additional parameters that may be adjusted by selecting **Box properties**.

Inserting a new page

1. Place the cursor at the desired insertion point in the *Report template design area*.
2. Press **Insert** and select **Page Break**.

Inserting header and footer

Header and footer may be defined to be displayed in the printed report. The header and footer are not visible in the on screen report.

To insert header and footer in the printed report:

1. Select **File** and **Page setup**.

The Page setup box is displayed.

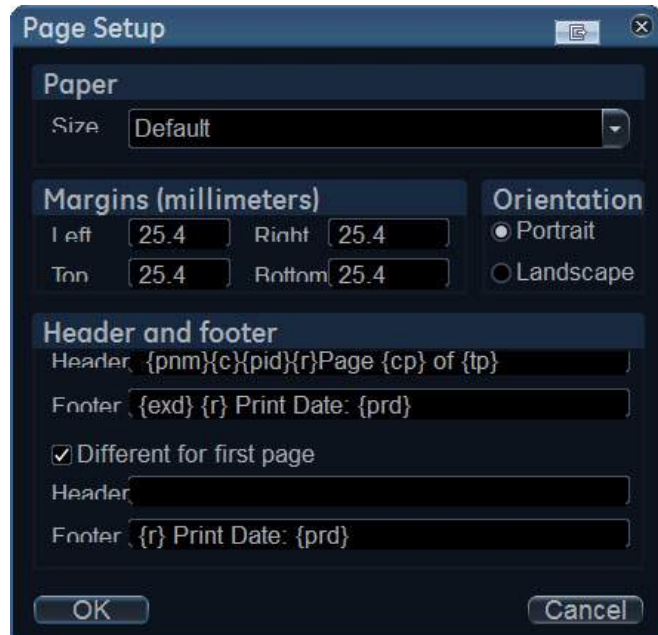

Figure 11-25. The Page setup box

2. Adjust the printing orientation.
3. Define the header and footer for the printed report, by typing text and entering the required variables listed in the table below.

Check **Different on first page** and create a specific header/footer for the first page.

4. Select **OK**.

To check the display of the header and footer, select **File** and **Print preview**.

Variable	Description
{pid}	Patient ID
{pnm}	Patient name

Variable	Description
{pdb}	Patient date of birth
{exd}	Examination date
{prd}	Current date (printing date)
{prt}	Current time (printing time)
{cp}	Current page
{tp}	Page count
{c}	Subsequent entries are centered
{r}	Subsequent entries are right aligned

Saving the report template

Replace an existing template

Factory templates cannot be overwritten.

1. Press **File** and select **Save**.
A dialogue window is displayed asking for confirmation.
2. Select:
 - **Yes** to save the report template
 - **No** to discard the report template
 - **Cancel** to go back to the Report designer without saving the report template.

Save existing template with a new name

1. Press **File** and select **Save as**.
The *Save template as* window is displayed.

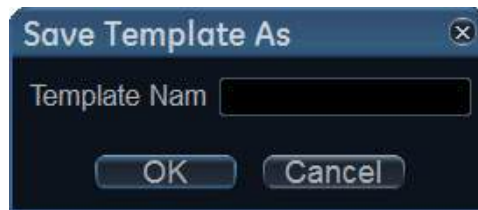

Figure 11-26. The Save template as window

2. Enter a name for the template.
3. Press **OK**.

The template is saved.

To exit the Report designer

1. Select **File** and **Exit**.
The *Exit* window is displayed.
2. In the *Exit* window, select:
 - **Yes**: to save the report template and exit the application.
 - **No**: to exit the application without saving the changes made in the report template.
 - **Cancel**: to return to the application.

Report templates management

This section describes:

- Configuration of the *Template selection* menu.
- Deletion of user-defined report templates.
- Export/import of user-defined report templates.

The report templates management is done from the *Report templates* sheet in the system configuration package.

To access to the *Report templates* sheet:

1. Press **Utility/Config** on the Touch panel and select the **Report** category.

The *Report category* sheet is displayed.

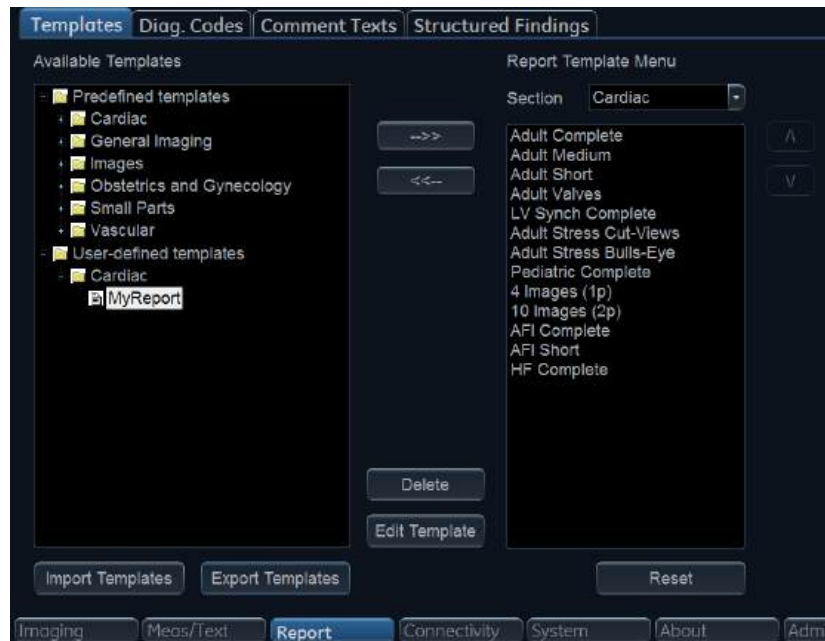



Figure 11-27. The Report templates sheet

Configuration of the Template selection menu

The *Template* selection menu displays the application specific report templates that can be selected when creating a report. The *Template* selection menu can be configured to display only the templates of interest.

Inserting a template in the Template selection menu

1. Press **Utility/Config** on the Touch panel and select **Report**. The *Report templates* sheet is displayed (Figure 11-27)
2. In the *Available templates* field (left field), select the template to insert in the *Template* selection menu.
3. Next to *Section*, select the appropriate application.
4. Press the **Right arrow button** .

The selected template is inserted in the *Template* selection menu.

NOTE: Double-clicking on a template in the *Available template* field will also insert the template in the *Template* menu.



Removing a template from the Template selection menu

1. In the *Report template menu* field (right field), select the template to remove.
2. Press the **Left arrow button** .

The selected template is removed from the *Template* selection menu.

NOTE: Double-clicking on a template in the *Report template menu* field will also remove the template from the *Template* menu.

Sorting the templates in the Template selection menu

1. In the *Report template menu* field, select the template to move.
2. Press the **Up** or **Down arrow buttons**  .

The selected template is moved accordingly in the *Template* selection menu.

Deleting a report template from the system

Only user-defined report templates can be deleted from the system.

1. In the *Available templates* field (left field), select the report to delete (Figure 11-27).
2. Press **Delete**.
A Confirmation window is displayed.
3. Select **Yes** to delete the report template.

Export/Import of Report templates

User-defined report templates can be exported to a removable media and imported from the removable media into another system.

Export of Report templates

1. Insert a removable media in the drive.
2. Press **Utility/Config** on the Touch panel and select **Report**.
The *Report templates* sheet is displayed (Figure 11-27 on page 11-44).
3. Select **Export Templates**.
The available user-defined templates are displayed in the *Export templates* window.

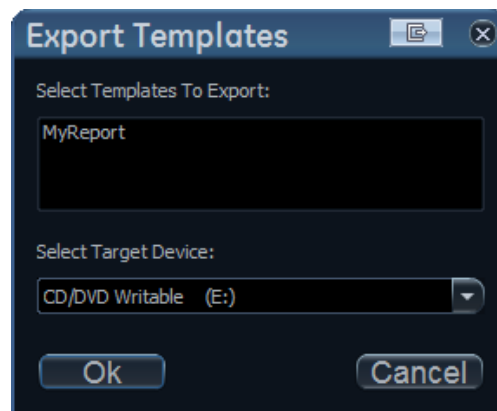

Figure 11-28. The Export templates window

4. Select the template(s) to export. Multiple selection can be done using the **Shift** or **Ctrl** key.

5. Select the desired removable media under *Select target device*.
- NOTE:** *To export to a shared folder on a network, a remote path must be defined (see 'Default remote path setting' on page 12-93).*
6. Press **OK**.
A Confirmation window is displayed.
 7. Press **OK**.
The selected template(s) are exported to the removable media.
 8. Press **Utility/Eject** on the Touch panel and select the media to eject.

Import of Report templates

1. Insert the removable media with the report template(s) to import.
2. Press **Utility/Config** on the Touch panel and select **Report**.
The *Report templates* sheet is displayed (Figure 11-27 on page 11-44).
3. Select **Import Templates**.
The *Import templates* window is displayed.

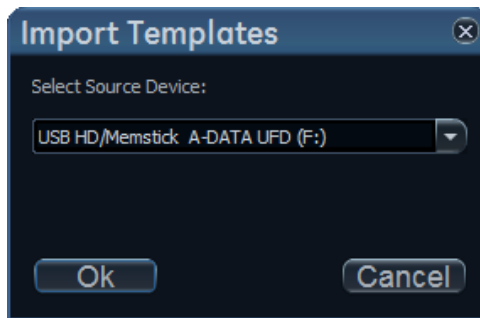

Figure 11-29. The Import template window

4. Select the source device from the pull-down menu.
5. Press **OK**.
A Confirmation window is displayed.
6. Press **OK**.
The templates are imported into the system.
7. Press **Utility/Eject** on the Touch panel and select the media to eject.

Chapter 12

Customize Configuration

Describes how to customize configuration of the system:

'Customize System Settings' on page 12-3

'Touch Panel' on page 12-8

'Users and Security' on page 12-10

'Global imaging settings' on page 12-21.

'Measurement Package' on page 12-23.

'Connectivity configuration' on page 12-48

'Archive' on page 12-88.

'Scan Assist Pro Creator' on page 12-100.

'Stress Echo' on page 12-113.

'Application Presets List' on page 12-114.

'6VT-D TEE Probe' on page 12-119.

'Image View' on page 12-121

Customize System Settings

About system Configuration

The configuration package enables customization of the global configuration of the system, application-specific settings, system connectivity, and data management settings.

The configuration management package is divided into different setup categories with subgroups.

Only users with administrative rights have access to all the subgroups.

Setup category	Description	Subgroup	Access
Imaging	Global imaging, shortcuts for touch panel buttons, scan information, application settings, TEE probe button assignment, probe test intervals, FlexiViews configuration, 4D Markers setup and Scan Assist configuration	Global	All
		Shortcuts	All
		Scan Info	All
		Probe buttons	All
		Probe test	All
		FlexiViews	All
		Scan Assist Pro	Admin
Meas/Text	Measurements and Annotation configuration	Measurement menu	All
		Advanced	All
		Modify Calcs	All
		OB Tables	All
		Text	All
		DICOM Mapping	Admin
		Bodymark	All
		Options	All
		Advanced Quantification	All

Setup category	Description	Subgroup	Access
Report	Report configuration	Template	All
		Diagnostic Codes	All
		Comment Texts	All
		Structured Findings	All
		Options	All
Connectivity	System connectivity configuration	Network	Admin
		DICOM	Admin
		Dataflow	Admin
		Transfer	Admin
		Buttons	All
		Tools	All
		Remote Path	Admin
		Disk management	Admin
		Tricefy	Admin
		Printer	Admin
		Other	All
Security	General system settings and system test	Users	Admin
		User Policies	Admin
		LDAP	Admin
		System Password	Admin
System	General system settings and system test	Settings	Admin
		Test	Admin
About	System information	System Version	All
		SW version	All
		Firmware Version	All
		HW Version	All
		Probes	All
Admin	Data management and user account	Backup	Admin
		Restore	Admin
		Licenses	Admin
		Activity report	Admin

Setup category	Description	Subgroup	Access
Service	Service	Service	Admin

General system settings

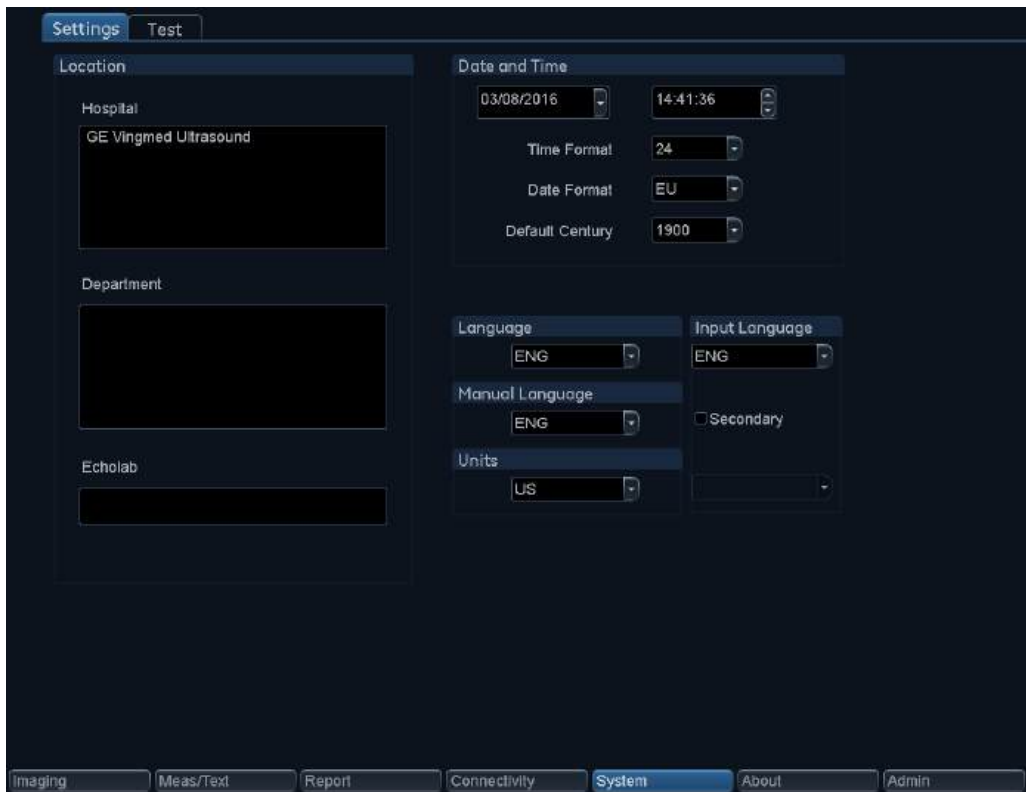

Figure 12-1. The Settings sheet

1. Press **Utility/Config** on the Touch panel and log on as administrator if required.
2. Select the **System** category and **Settings** subgroup.
The *Settings* sheet is displayed.

Location

1. **Hospital:** Enter the hospital name. This information is displayed on the scanning screen's *Title bar* and on the image properties of all saved images.
2. **Department:** Enter the department name. This information is displayed on the image properties of all saved images.

Date and time

Changes will be effective only after rebooting the system.

1. **Date:** Select the correct date from the pop-up window.
2. **Time:** Select either hour, minute or second, and then press the arrow head buttons to set the time.
3. **Time Format:** Select the desired format (24 or 12 AM/PM) from the pop-up menu.
4. **Date Format:** Select the desired format (EU or US) from the pop-up menu.

Language, units and video settings

Changes will be effective only after rebooting the system.

- **Language:** Select the desired language for the system from the drop-down menu.
- **Manual Language:** Select the desired language for the Online manual from the drop-down menu. If not available the English manual will be displayed as default.
- **Input Language:** Select the default alphanumeric keyboard language configuration on the Touch panel.

NOTE: The display of the alphanumeric keyboard on the Touch panel may be turned off. To turn on the display of the alphanumeric keyboard, see 'Touch Panel' on page 12-8.

To define a secondary language configuration for the alphanumeric keyboard on the Touch panel, check the **Secondary** option and select a language from the drop-down menu.

After reboot of the system, press **Lang** on the alphanumeric keyboard on the Touch panel to toggle between the two language configurations.

- **Units:** Select the desired units (Metric or US) from the drop-down menu.

Shortcuts

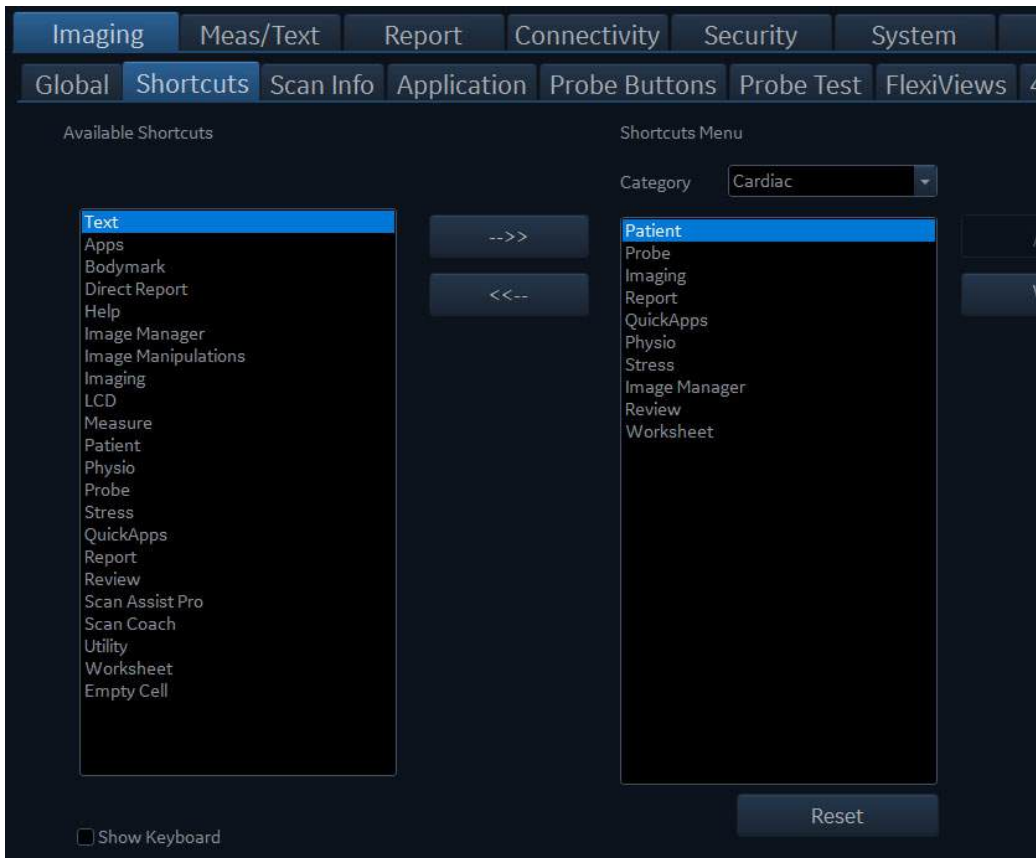

Figure 12-2. The Shortcuts sheet





The *Shortcut* bar on the Touch panel can be configured by the user, so that the most used functions are readily available on the top bar of the Touch panel.

1. Press **Utility/Config** on the Touch panel and log on as administrator if required.
2. Select the **Imaging** category and **Shortcuts** subgroup.
The *Shortcuts* sheet is displayed.

3. The *Shortcut* bar is configured according to the examination categories. Select the desired *Shortcut* bar to configure from the *Category* drop-down menu.

NOTE: Up to ten shortcuts can be added to the *Shortcut* bar.

NOTE: Shortcuts marked with an asterisk (*) cannot be removed from the *Shortcut* bar.

4. To replace a shortcut in the *Shortcut* bar:
 - Select the shortcut to insert in the *Available shortcuts* list.
 - Select the shortcut to replace in the *Shortcuts menu* list.
 - Press the **Right arrow** button .
5. To remove a shortcut and create an empty cell in the *Shortcut* bar:
 - Select the shortcut to remove in the *Shortcuts menu* list.
 - Press the **Left arrow** button .
6. To add a shortcut in the *Shortcut* bar:
 - Select an **Empty cell** in the *Shortcuts menu* list.
 - Press the **Right arrow** button .
7. To sort the shortcuts in the *Shortcut* bar:
 - Select the shortcut to move in the *Shortcuts menu* list.
 - Press the **Up** or **Down arrow** buttons   to move the shortcut accordingly.
8. To reset the *Shortcut* bar to the factory default settings, press **Reset** and press **Yes** in the *Confirmation* window.
9. Select **Show keyboard** to show the alphanumeric keyboard on the Touch panel.

Users and Security

Local System Users

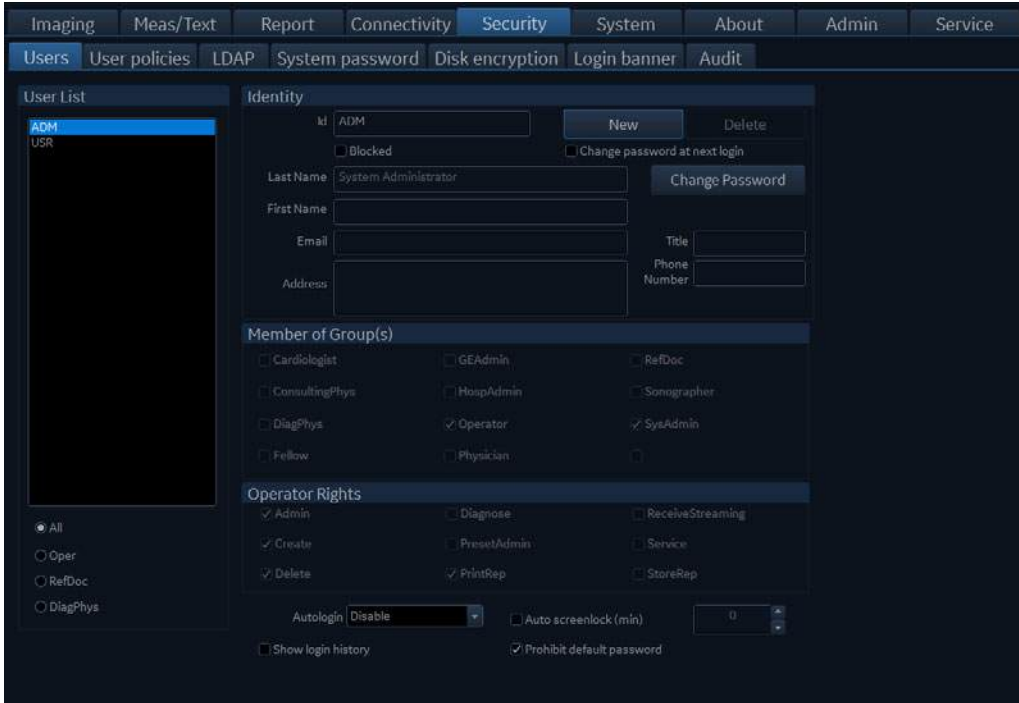

Figure 12-3. The Users sheet

The ultrasound system requires operator registration. The users are divided in groups with different rights as shown below.

Groups	Rights (see definitions below)								Service
	Create	Delete	Diagnose	Preset admin	Print report	Store report	Admin	Receive streaming	
Cardiologist	+	+			+	+			Activated with a Dongle
Consulting physician								+	
Diagnosing physician			+						
Fellow	+				+				
GE admin	+	+			+			+	
Hosp admin				+	+				
Operator									
Physician	+				+				
Referring doctor									
Sonographer	+				+				
Sys Admin	+	+			+			+	

The rights associated to the user groups are:

Rights	Definitions
Create	Create and update patient record, examination, user and referring members. Transfer patient records and examinations. Move examinations.
Delete	Delete patient record, examination, user and referring members.
Diagnose	Make the Diagnosing physician available in the <i>Patient info and exam</i> screen. Sign off report.
Preset admin	Make application presets protected. Delete protected application presets.
Print report	• Print a report
Store report	• Store reports, sign and unsign reports
Admin	• System administration

Rights	Definitions
Receive streaming	The user will be allowed receiving Vivid images on a remote client, streamed from the system by the Data streaming feature.
Service	• Access to the service platform

NOTE: When adding or modifying local users, the changes will not take effect until the system is restarted.

1. Press **Utility/Config** on the Touch Panel and log on as administrator if required.
2. Select the **Security** category and **Users** subgroup.
The *Users* sheet is displayed.

Creating a user or a referring member

1. Press **New**.
2. Enter username and password, then press **OK**.
3. Enter additional user information.
4. Select the type of user/referring member in *Member of Group(s)*.



To be able to login on the system, the group Operator **MUST** be selected.

Editing a user configuration

1. Select the actual user in the *User list*.
2. Make the desired changes.
3. Press **Config** or any active scanning key to exit the Configuration management package.

Deleting a user

1. Select the actual user in the *User list*.
 2. Press **Delete**.
- The user is removed from the *User list*.

Auto logon and auto screen lock

Auto logon

1. Select the desired logon setup from the pull down menu:
 - **Disabled:** No default user is selected when logging on.
 - **Last user:** The last user is selected automatically when logging on.
 - **A specific user:** Select one of the users to be the default user when logging on.

Auto screen lock

1. Set the time span (from 10 min.) for the system to automatically get locked when not in use. When the system is locked, the current user may either log on again or the system may be restarted by a different user.

Manual screen lock

The user can invoke screen lock manually by pressing <ALT> + L at any time.

Last Login Information

Check off **Show login History** to display the last login attempt for this user ID. When enabled, the information is displayed to the user after a successful log in.

Prohibit default password

If **Prohibit default password** is selected, a warning message is displayed at startup if the passwords of the ADM and USR user IDs are not changed from the default values.

User Policies

The screenshot shows a web-based configuration interface for user policies. At the top, there is a navigation bar with tabs for Imaging, Meas/Text, Report, Connectivity, Security (selected), System, About, Admin, and Ser. Below this is a sub-navigation bar with tabs for Users, User policies (selected), LDAP, System password, Disk encryption, Login banner, and Audit. The main content area is titled 'Enable policies' with a checkbox that is currently unchecked. Below this, there are three sections: 'User policy', 'User name policy', and 'Password policy'. Each section contains several configuration options with spinners or checkboxes.

Section	Configuration Option	Value
User policy	Block user after consecutive failing login attempts	3
	Blocking time	10 minutes
User name policy	Minimum user name length	6
Password policy	Minimum password length	8
	Minimum number of character sets required in the password	3
	Upper case characters	0
	Lower case characters	0
	Digits (0-9)	0
	Non-alphanumeric characters (e.g. !\$#%)	0
	Maximum password age (days)	365
	Minimum password age (hours)	1
Password history (no reuse of the last n used password)	10	
Password cannot contain user name	<input checked="" type="checkbox"/>	

Figure 12-4. The User Policies sheet

User Policies can be enabled to enforce user account policies for all users on the system. The rules can be configured to set requirements for user name length, password complexity and for blocking of users. By default users policies are disabled.

LDAP

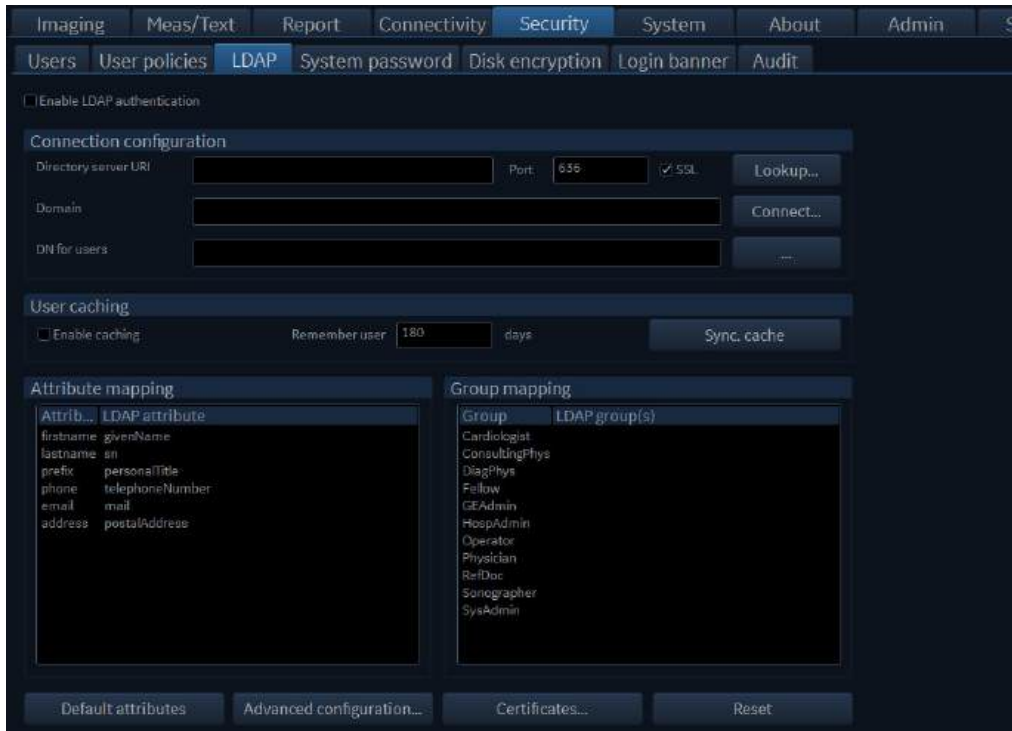

Figure 12-5. The LDAP sheet

Enable "LDAP authentication" to utilize services from an external Directory Server for authenticating users when logging in to the system. If enabled it will not be possible to login to the system with users defined as local users on the system, except for the ADM user.

NOTE: *If LDAP is configured, the log-in dialog indicates the log-in domain.*

The system can be configured to use authentication services from a Microsoft Active Directory server or from another LDAP compatible Directory Server.

	Definition
Connection configuration	Set directory server, domain, and DN for users.
User caching	Set number of days user will be remembered without needing to log in with network access. When disabling this option, the cached user data will be deleted
Field mapping	Map LDAP attributes to system user attributes.

	Definition
Group mapping	Map LDAP groups to system groups. An LDAP group can be mapped to zero or more system groups. Several LDAP groups can be mapped to the same system group.

To define the LDAP properties:

1. Enter the configuration properties.
2. Press **Connect** to test the connection and enter a valid user name and password for the LDAP server in the dialog that appears.
3. Define group mapping for the LDAP user groups that shall be grant users access to the system.

The user will be assigned one or more system groups according to the group mapping and which of these LDAP groups the user is a member of.

Advanced LDAP configuration

Default naming context attribute: defaultNamingContext

User search filter: (sAMAccountType=805306368)

Account name attribute: sAMAccountName

Group search filter: (sAMAccountType=268435456)

Group name attribute: cn

Member Of attribute: memberOf

Search timeout (s): 60

Search page size (objects): 1,000

Two step authentication

Enabled

User distinguished: []

User password: []

Load default settings OK Cancel

Figure 12-6. The Advanced LDAP configuration screen of the LDAP sheet

If the Directory Server does not support anonymous connection for the authentication service, two step authentication is needed. Then valid user credentials for a user with access to the Directory Server must be entered here.

NOTE: *The user credentials will be stored on the system.*

System password

Figure 12-7. The System Password sheet

The System Password is the password for the underlying Windows OS user running this application. Do not change this password unless you are the system administrator of the device. This password is not needed for users of the system. It will only be needed for GEHC service in special situations. If you change the password, be sure to keep the new password secured and available if needed by GEHC service.

Login Banner

The Login Banner provides an option to display information to the user when logging in to the system. When enabled, the user is required to accept the message to complete the login process. The login banner is configurable for an administrator of the system.

Enable the Login Banner

1. Press **Utility/Config** on the Touch Panel as administrator.
2. Select **Admin** category and the **Login banner** subgroup.
3. Check off the **Enable login banner**.

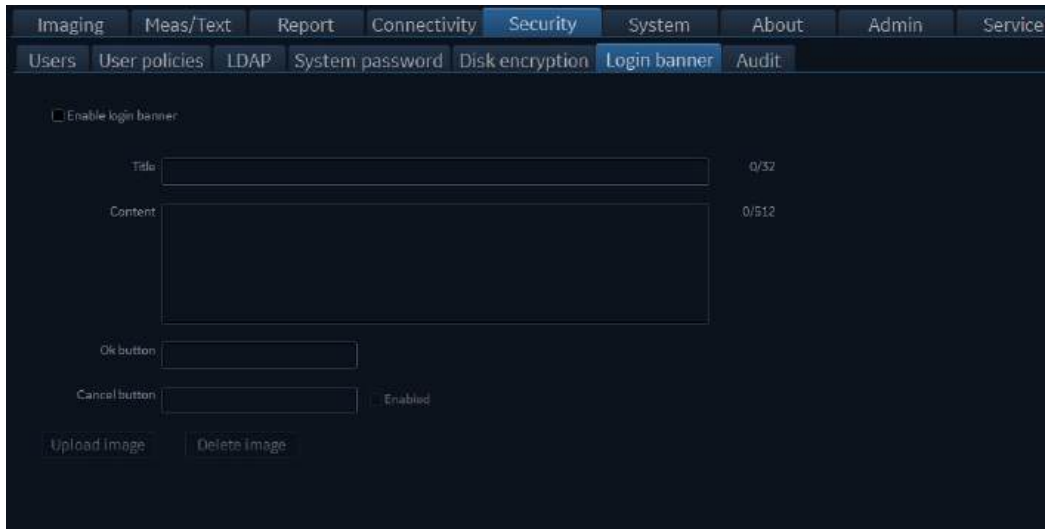

Figure 12-8. Login banner window

4. Enter the title text to be displayed into *Title* field.
5. Enter the text to be displayed into *Content* field.
6. Enter text to be displayed on the **Ok** button into the *Ok button* field.
7. (Optionally) Check off *Enable* for showing a Cancel button and enter the text to be displayed on the **Cancel** button.
8. (Optionally) Upload an image to be displayed on the Login Banner. Insert the USB Flash Drive with the image file to use. Select **Upload image**.

NOTE: *Acceptable image formats are .jpg, .jpeg, .png and .bmp.*

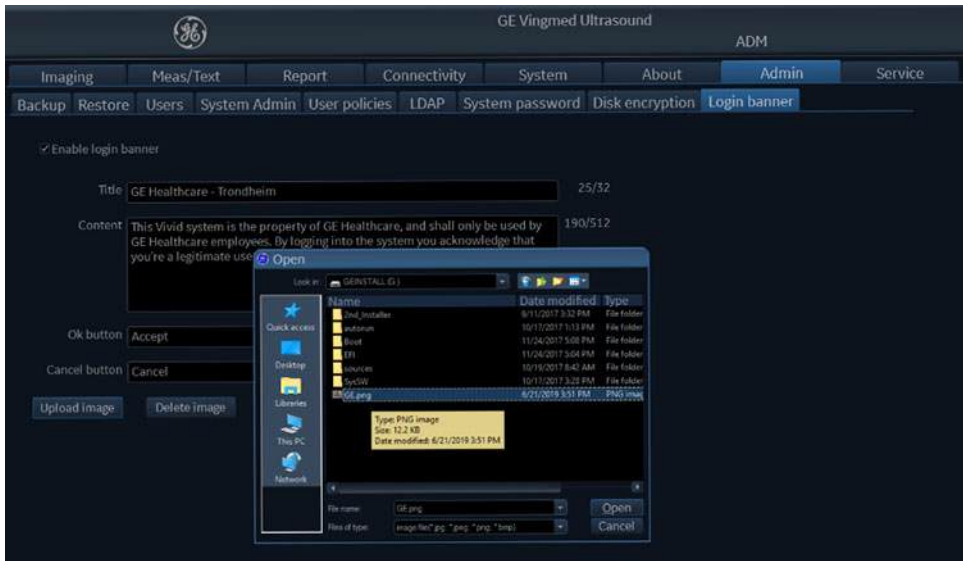

Figure 12-9. Upload image to login banner

At next login to the system, the login banner is shown to the authenticated user. Press the **OK** button to complete the login.

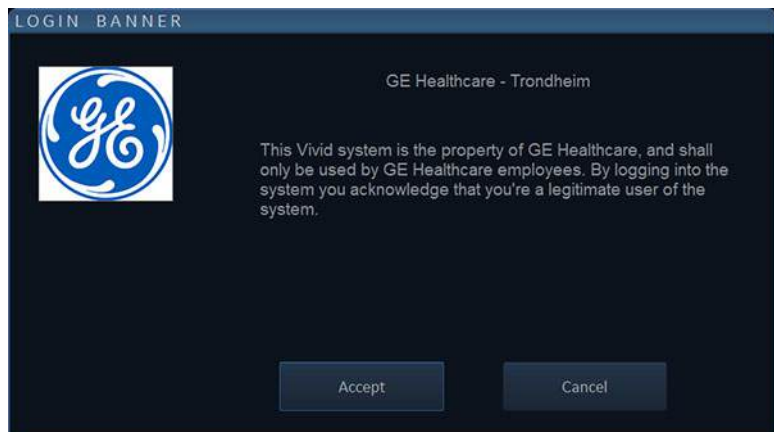

Figure 12-10. Example of Login banner

Storage Encryption



Figure 12-11. The Disk Encryption sheet

Disk encryption can be enabled for patient data stored on the system. By default, Disk encryption is disabled.

When enabling disk encryption you will be prompted to choose an encryption password as well as a storage location for the recovery key.

NOTE: *While the system is undergoing encryption, it will not be available for use. We highly recommend performing disk encryption overnight or when the system is not needed for use for an extended period of time.*

NOTE: *Should the system power down during disk encryption or otherwise cease to function, a prompt will appear when restarting the system to continue disk encryption.*

When starting up the system, the encrypted disk must be unlocked for the users to access images, local archive, and other patient information. The disk can be unlocked in one of the following ways:

- Enter the previously chosen Encryption Password
- Insert a USB memory stick with the stored recovery key in the system at start-up or when the *Unlock* dialog is presented.
- Enter the recovery key manually.



WARNING

Without the Encryption Password or Recovery Key it will not be possible to access the patient information, images, or local archive. GE has no access to this information or the ability to undo encryption in the event that the Encryption Password and Recovery Key are lost. Maintaining the Encryption Password and Recovery Key are solely the user's responsibility.

Global imaging settings

1. Press **Utility/Config** on the Touch panel and log on if required.
2. Select **Imaging/Global**.

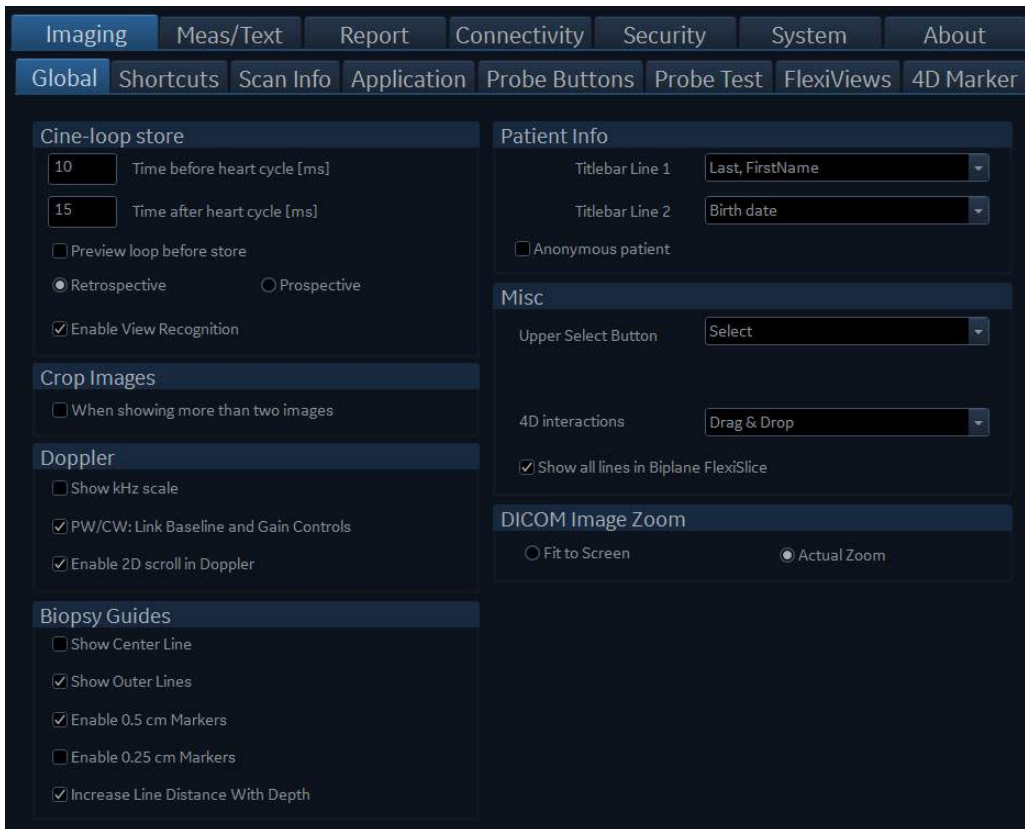

Figure 12-12. The Global sheet

Global imaging settings

The followings settings can be configured:

Parameter	Description
Cineloop store	<ul style="list-style-type: none"> • Time before/after heart cycle: sets the total storage time span of the cineloop in ECG mode. • Preview loop before store: when selected enable review of cineloops before storage. • Retrospective / Prospective <ul style="list-style-type: none"> • Retrospective: store the last elapsed defined number of cycles/seconds. • Prospective: store the forthcoming defined number of cycles/seconds. • Enable View Recognition: Certain views are automatically recognized and labeled for later use.
Crop images	In the <i>Analysis screen</i> , removes top and bottom of the image when more than two images have been selected.
Doppler	<ul style="list-style-type: none"> • Show KHz scale: when selected, displays the KHz scale on the left side of the Doppler spectrum (see Figure 5-10 on page 5-20). • PW/CW: Link baseline and gain controls: when selected, baseline and gain settings are preserved when toggling between PW and CW Doppler modes.
Biopsy Guides	Configure the biopsy guide zone display
Patient Info	<ul style="list-style-type: none"> • Title bar Line 1 & 2: selects from the drop-down menu the patient information to display on the <i>Title bar</i>. • Anonymous patient: when checked, no patient information is displayed on the <i>Title bar</i>.
Upper Select button	The upper button on the Trackball area can be configured as: <ul style="list-style-type: none"> • a Select key • a pointer • an Image store button • an image cursor
4D Interactions	<ul style="list-style-type: none"> • Drag & Drop: hold down the Select button and drag the pointer • Click and move: click once, then drag the pointer. Use for one-handed operation of the trackball..
DICOM image zoom	For use when reviewing DICOM images on a scanner: <ul style="list-style-type: none"> • Fit to screen - adjusts image size according to the screen size/ resolution • Actual zoom - keeps the original file size

Measurement Package

There are many more measurements and parameters in the measurement package than shown in the default *Measurement* menu. Use the configuration system to set up the measurements that should be available in the *Measurement* menu and which parameters should be calculated.

A list of all cardiac calculations with needed measurements and location in the Measurement package can be found in the Reference manual.

Basic operations

Opening the Measurement configuration package

1. Press **Utility/Config** on the Touch panel and select the category **Measure/Text**.

The *Measurement menu* sheet is displayed (Figure 12-13).

Display of the Measurement categories



1. Press **M&A categories** in the *Configuration* window.
The M&A categories are displayed in a pop-up window.
2. Check the categories to be displayed.

Uncheck the categories to hide.

To select a Measurement category in the *Measurement* menu:

1. Select the heading of the *Measurement* menu.
The measurement categories are displayed in a sub-menu.
2. Select the Measurement category to display.

Moving an item in the Measurement menu

1. Select an entry in the *Measurement* menu.
2. Press  or  to move the selection up or down inside the *Measurement* menu.

Deleting an item in the Measurement menu

Only user-created items can be deleted.

1. Select an entry to delete in the *Measurement* menu.
2. Press  to delete the item.

Display/hide a folder or a measurement in the Measurement menu

The Measurement menu (Folders and Measurements) can be configured to display only the entries (folders and measurements) of interest.

To hide a folder or a measurement:

1. Uncheck the actual folder or measurement in the *Folder* or *Measurement* field in the *Configuration* window.

To display a hidden folder or measurement:

1. Check the actual folder or measurement in the *Folder* or *Measurement* field in the *Configuration* window.

Auto-sequence of measurements within a folder

1. In the *Measurement menu* sheet, select a folder in the *Measurement* menu.
2. Check **Auto sequence**.

When performing the first measurement in the folder, the next measurement is automatically selected.

Creating a user-defined folder

1. If the folder is to be inside another folder, select the actual folder in the *Measurement* menu.
2. Press **Add folder**.
The *Measurement* menu is updated.
3. Enter the folder name in the *Name text* field.

Measurement package configuration - example

The following example based on calculation of AV CO (Cardiac Output by Aortic Flow) describes how to configure the measurement package so that necessary measurements and the resulting calculations are displayed on screen.

Calculation of Cardiac Output by Aortic Flow requires the measurement of:

- AV diameter located in the folder *Dimension* (2D mode)
- AV VTI located in the folder *Aortic* (Doppler AV Trace).
- Heart rate

If a calculated parameter (e.g. AV CO in AV Trace measurement) requires another parameter to be calculated (e.g. AV Diam) the user must first measure the required parameter (e.g. AV Diam) before the dependent parameter (e.g. AV CO in AV Trace) gets calculated.

Configuration of the Measurement menu

If the AV diameter measurement is not present in the folder *Dimension* in the *Measurement* menu, follow the following procedure:

1. Press **Utility/Config** on the Touch panel and select the category **Measure/Text**.
The *Measurement menu* sheet is displayed (Figure 12-13).
2. AV Diam is a 2D measurement, make sure that **2D** is checked in the *Measurement* sheet.
3. Select folder **Dimension** in the *Measurement* menu.
A list of all available measurements for the selected folder is displayed in the *Measurement menu* sheet.
4. Check the box in front of **AV Diam**.
The AV Diam measurement is displayed in the folder *Dimension* in the *Measurement* menu.
5. For the AV VTI measurement, check **Doppler** in the *Measurement menu* sheet and select the folder **Aortic** in the *Measurement* menu.
6. Check the box in front of **AV Trace**.
The AV Trace measurement is displayed in the folder *Aortic* in the *Measurement* menu.

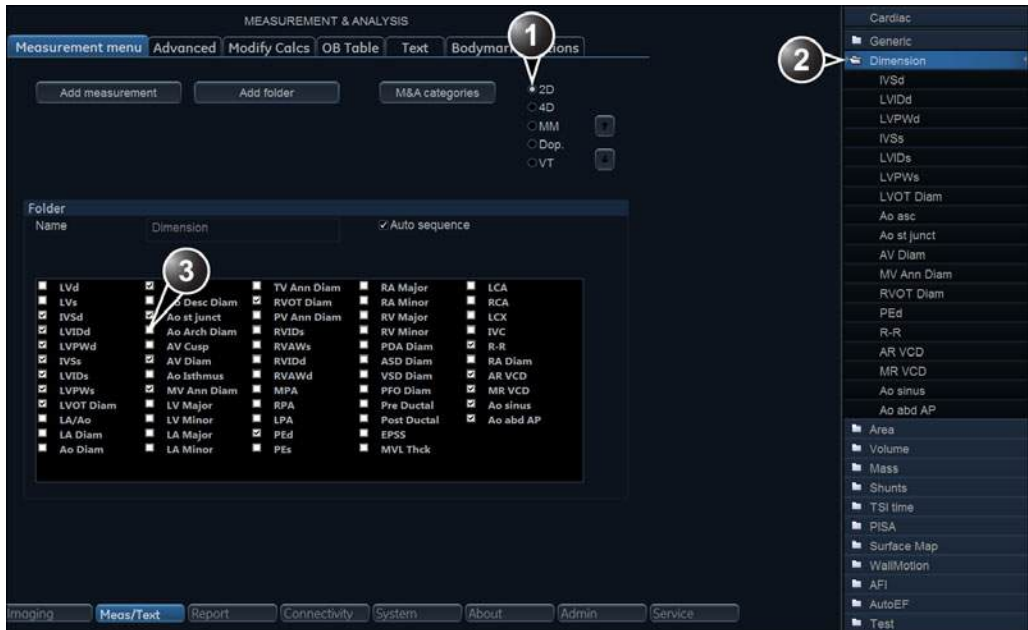

1. Select the scanning mode for the measurement to add to the Measurement menu.
2. Select the folder for the measurement to add.
3. Select the measurement to add.

Figure 12-13. Configuration of the Measurement menu

Configuration of the Measurement result table

If AV CO calculation is not displayed in the *Measurement result* table, follow the following procedure:

1. Press **Utility/Config** on the Touch panel and select the Config category **Measure/Text**.

The *Measurement menu* sheet is displayed.

2. The AV CO calculation is based on Doppler AV Trace measurement in the folder *Aortic*, check **Doppler** in the *Measurement menu* sheet and select the folder **Aortic**.

A list of all available measurements and calculations for the selected folder is displayed in the *Measurement menu* sheet.

NOTE: *Entries in green are calculated measurements.*

3. In the *Measurement menu* sheet, double-click on the **AV Trace** measurement.

A list of all available output parameters for the AV Trace measurement is displayed in the *Measurement menu* sheet.

4. Check the box in front of **AV CO**.

The AV CO calculation will be displayed in the *Measurement result* table.

User-defined formulas

User-defined formulas can be created using existing measurements or by defining new measurements. The following example describes the creation of a formula based on existing measurements.



GE Healthcare does not take any responsibility for the correctness of the user-defined studies, parameters or functions.

In order to retain measurements from user-defined formulas when transferring between system, for instance between a Vivid S70N / S60N and an EchoPAC review station, the user-defined formulas must first be exported to the transfer destination before transferring the exam data.

To transfer user-defined formulas, see 'Data Backup and restore' on page 10-57

User-defined formula - example

The workflow for user-defined formula is:

- If the user-defined formula is based on several measurements of different types, create a user-defined folder in the *Measurement* menu so that all measurements and the formula are grouped together. If the formula is based on a single measurement you may select an existing appropriate folder.
- Add the measurement(s) needed for the formula to the user-defined (or existing) folder.
- Create the formula based on the added measurements.

The following procedure describes the creation of user-defined LIMP formula as follows: My LIMP = (MCO-AV ET)/AV ET.

Creation of a user-defined folder

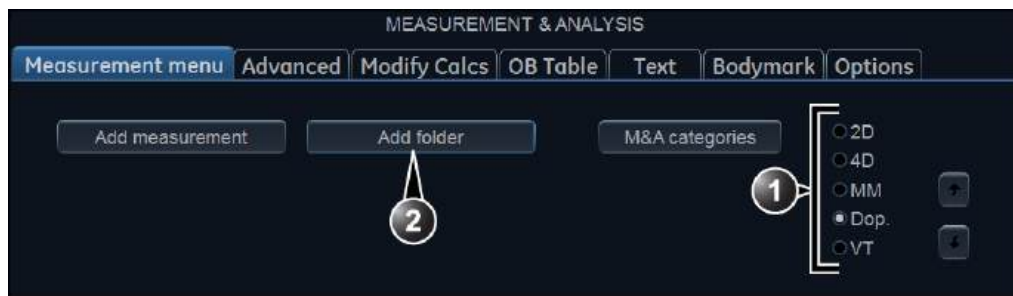

1. Select the appropriate scanning mode.
2. Create a folder in the Measurement menu.

Figure 12-14. The Measurement menu sheet (Add folder)

1. Press **Utility/Config** on the Touch panel and select the category **Measure**.
2. MCO and AV ET are Doppler measurements, select **Doppler** in the *Measurement menu* sheet.
3. Select **Add folder**.
4. Give the folder a name (e.g. "My Folder").

Adding measurements

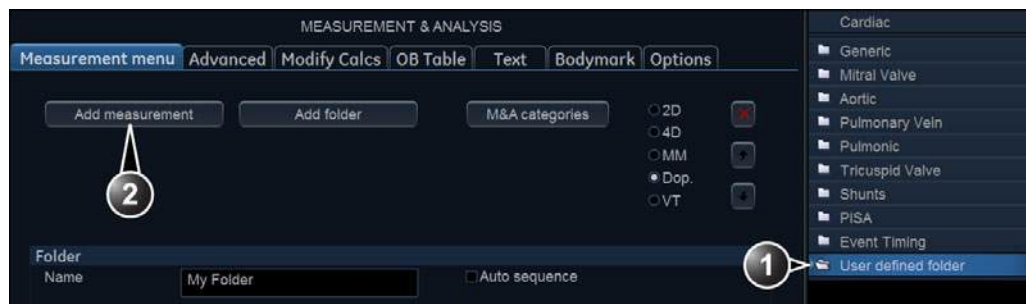

1. Select the user-defined folder.
2. Press Add measurement.

Figure 12-15. The Measurement menu sheet (Add measurement)

1. Select the user-defined folder (e.g. "My Folder") in the *Measurement menu*.
2. Press **Add Measurement** in the *Measurement menu* sheet. The *Add measurement* window is displayed.

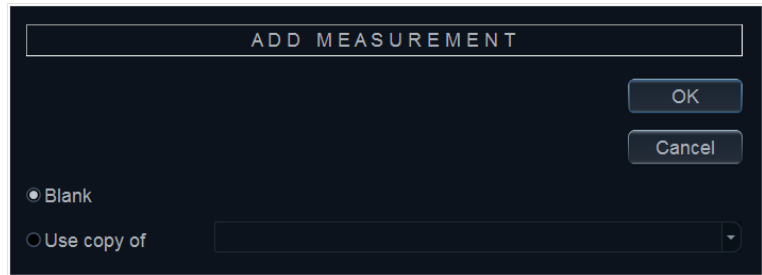
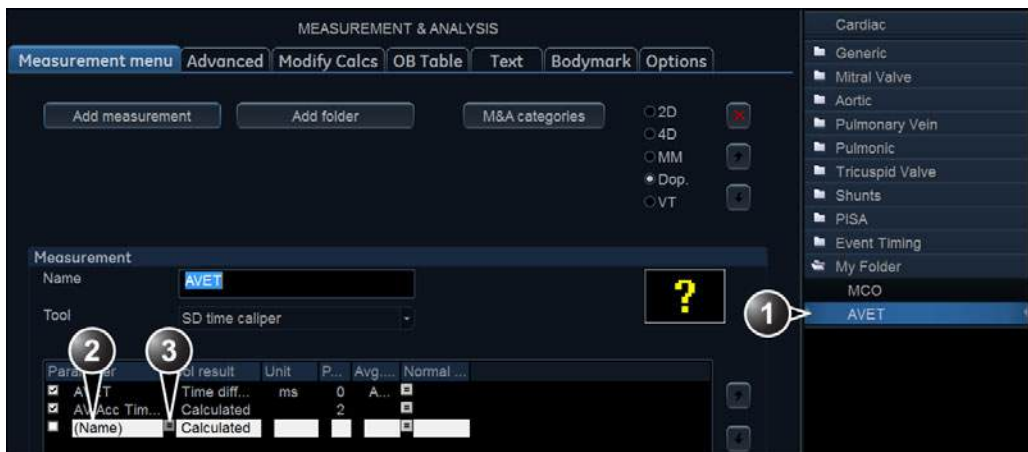

Figure 12-16. The Add measurement window

3. MCO and AV ET are measurements that already exist on the system, check **Use copy of** and select **MCO** from the drop down menu.
4. Select **OK** to add the MCO measurement.
5. Repeat steps 2 to 4 to add the AV ET measurement.

Creation of the formula



1. Select the last measurement.
2. Double click and enter the formula name.
3. Select “=” to create the formula.

Figure 12-17. The Measurement menu sheet

The formula for this example is as follows:

$$\text{My LIMP} = (\text{MCO} - \text{AV ET}) / \text{AV ET}$$

1. In the user-defined folder (e.g. “My folder”), select the last measurement created (e.g. AV ET).
2. Click beneath the last line in the *Parameter list* in the *Measurement menu* sheet to add a new line.

3. Double-click (Name) and enter the name for the formula (e.g. My LIMP).
 4. Select .
- The *Edit formula* window is displayed.

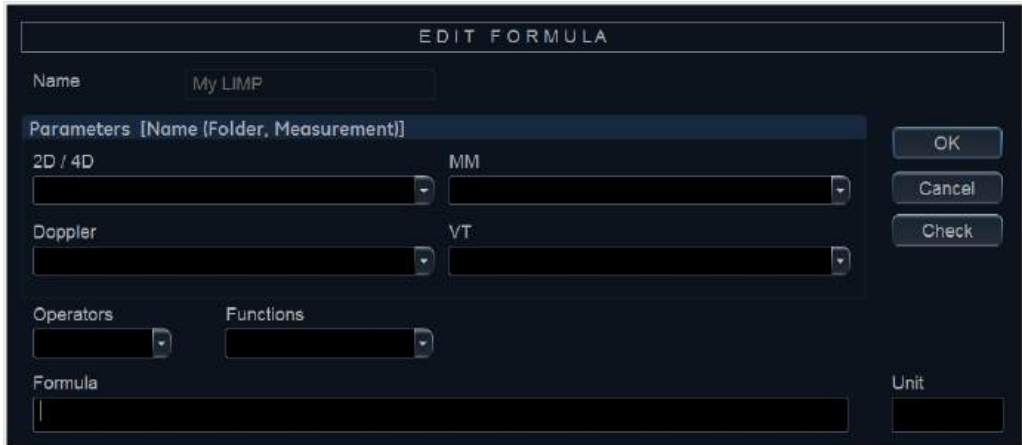
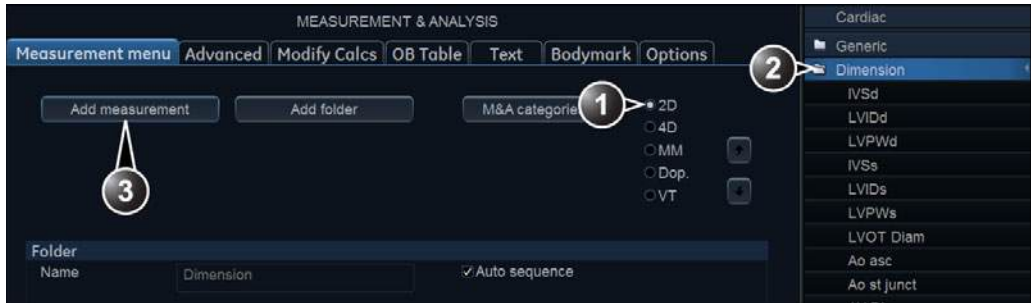

Figure 12-18. The Edit formula window

5. Select "(" from the *Operators* drop-down menu.
 6. In the *Doppler* drop-down list, select **MCO [My Folder, MCO]**.
Make sure to select the measurement located in the user-defined folder (e.g. "My Folder").
 7. Select "-" from the *Operators* drop-down menu.
 8. In the *Doppler* drop-down list, select **AV ET [My Folder, AVET]**.
 9. Select ")" from the *Operators* drop-down menu.
 10. Select "/" from the *Operators* drop-down menu.
- NOTE:** *Operators may also be entered using the alphanumeric keyboard.*
11. In the *Doppler* drop-down list, select **AV ET [My Folder, AVET]**.
The Formula line should display: $\{MCO\}-\{AVET\}/\{AVET\}$.
No units are necessary since the formula is a ratio ('About units' on page 12-33).
 12. Press **Check** to make sure that the syntax for the formula is correct.

User-defined measurements

Some user-defined formula may require measurements that do not exist on the system. The following example based on a generic distance measurement illustrates how to create user-defined measurements.



1. Select the appropriate scanning mode.
2. Select the appropriate folder.
3. Press Add measurement.

Figure 12-19. The Measurement menu sheet

1. Press **Utility/Config** on the Touch panel and select the category **Measure**.
2. In the *Measurement menu* sheet, select the appropriate scanning mode for the measurement to be created (e.g. 2D).
3. Select the appropriate folder in the *Measurement menu* (e.g. Dimension).
4. Press **Add Measurement** in the *Measurement menu* sheet. The *Add measure* window is displayed.

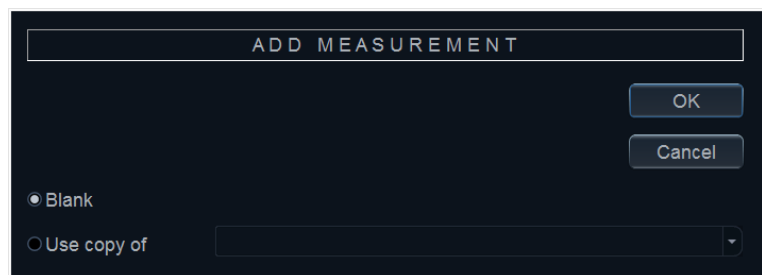
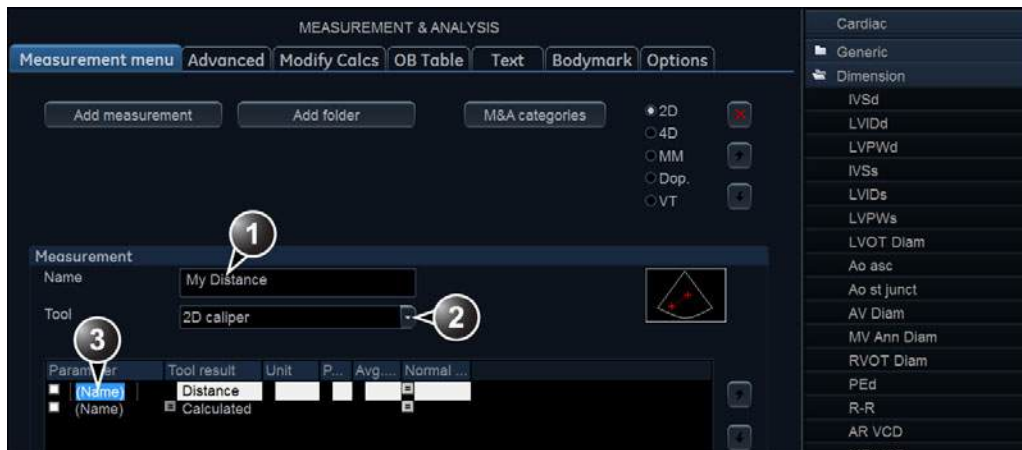

Figure 12-20. The Add measure window

5. Check **Blank** and press **OK**. The *Measurement menu* sheet is updated.



1. Enter a name for the measurement.
2. Select the appropriate measurement tool.
3. Double click and enter the formula name.

Figure 12-21. The Measurement menu sheet

6. In the *Measurement menu* sheet, enter the name for the measurement (e.g. My Distance).
7. Select the appropriate measurement tool in the drop-down menu, next to **Tool** (e.g. 2D Caliper).
8. Double-click **(Name)** in the appropriate parameter (e.g. Distance) and enter a name for the parameter (e.g. My Length).

If desired change the system and the number of decimals for the measurement by double clicking the values under *Unit* and *Precision* (see also 'About units' on page 12-33).

About units

Be aware of the following:

- All formulas are calculated in SI units (see table below).
- If no unit is specified in the *Edit formula* window when defining a formula, the displayed value will be in SI unit.

To define a different unit

1. When creating a formula, enter the unit to use when displaying the formula output. E.g. if Y in the formula $Y=f(x)$ is to be displayed in cm, enter cm in the *Unit* field (see Figure 12-18 on page 12-30).

The *Unit* field is case sensitive, make sure to enter the exact unit as shown in the table below (Alternative unit column).

2. The output of a formula must always be in an SI unit (see table below). Conversion to the specified display unit is then done automatically.

Example: an user wants to add a regression formula for estimating a length **B** from a measured length **A**, both in cm.

The formula is: $B = 2.4 + 1.1 \cdot A$.

- As **A** is a measurement value the system will enter the formula in the SI unit for length (m). The formula expects A in cm, and to get that, **A** must be multiplied by 100:

$$B = 2.4 + 1.1 \cdot A \cdot 100$$

- The formula now gives **B** in cm. Converting the output from cm to the SI unit (m), is done by dividing by 100:

$$B = (2.4 + 1.1 \cdot A \cdot 100) / 100$$

The output is now in m, and by entering this formula into the system the user gets the expected result. Measuring an **A** of 2 cm gives: $B = (2.4 + 1.1 \cdot 0.02 \cdot 100) / 100 = 0.046$ m.

Before display of the value it is converted according to the specified display unit (cm), and the system displays 4.6 cm. If the selected display unit was set to mm the formula would give the exact same output, 0.046 m, but the automatic unit conversion would now instead give a displayed value of 46 mm.

Customize Configuration

Calculation	SI	Alternative unit
Time	s	ms - msec - min - h
Ratio	%	
Frequency	bpm	
Angle	rad	deg - grad
Distance	m	cm - dm - cm - mm - inch - feet- pixels
Velocity	m/s	dm/s - cm/s - mm/s - inch/s
Acceleration	m/s ²	dm/s ² - cm/s ² - mm/s ² - inch/s ²
Area	m ²	dm ² - cm ² - mm ² - inch ²
Volume	m ³	dm ³ - cm ³ - l - dl - cl - ml - gallon - quart
Volume flow	m ³ /s	dm ³ /s - cm ³ /s - l/s dl/s - cl/s - ml/s - m ³ /min dm ³ /min - cm ³ /min - l/min - dl/min - cl/min ml/min - ml/m ²
Pressure	mm Hg*	Pa - kPa - bar - torr - atm - psi
Pressure/time	mm Hg/s	mmHg/s
Mass	kg	g - ounce - pound
Other		mmHG - Date - WeekDay - Day - NoUnit l/minm ² - g/m ² - cm/m ²
* The correct SI unit for pressure is Pa, but here mm Hg was used as base unit as it is a standard pressure unit to use in medicine.		

Advanced settings

The Advanced sheet

The *Advanced* sheet enables further configuration of the Measurement function. The settings are divided into application specific parameters and global parameters.

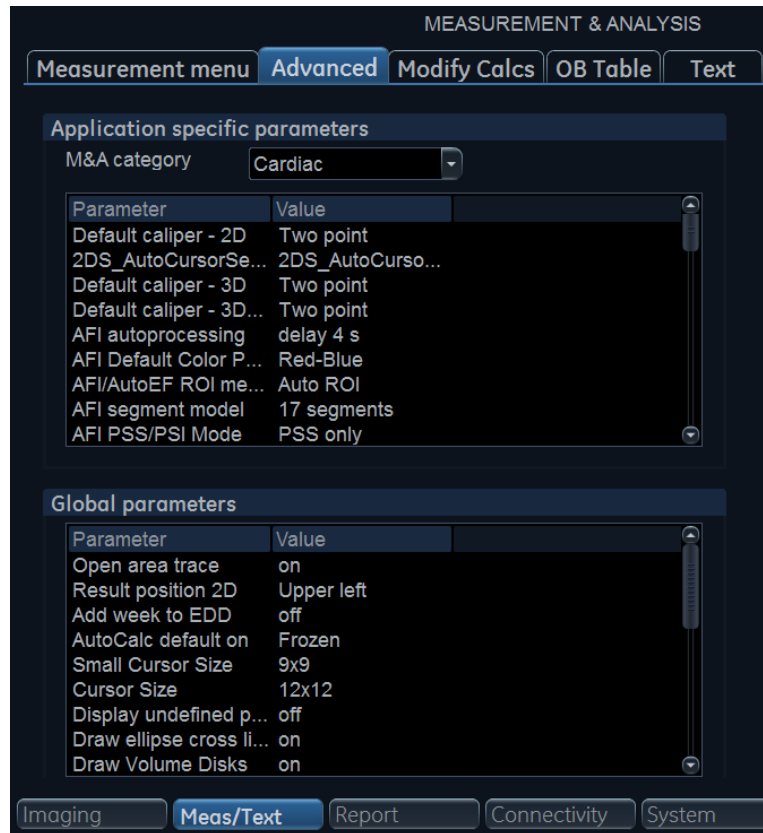

Figure 12-22. The Advanced sheet

1. If configuring application specific parameters, select an application from the *M&A category* pull-down menu.
2. Select the configuration value next to the parameter to configure.
A pull-down menu is displayed.
3. Select a new value from the pull-down menu.

The Modify calculations sheet

The *Modify calculation* sheet is used to configure the calculations to be performed for Doppler vascular measurements.

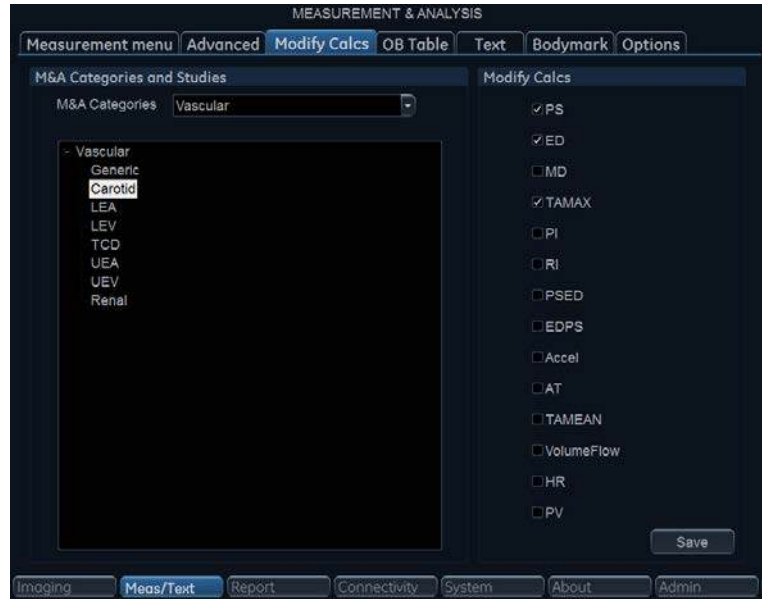

Figure 12-23. The Modify calculations sheet

The following example describes how to configure the Carotid Doppler calculations.

1. In the *Modify calculations* sheet, select **Vascular** next to *M&A Categories*.
The *Vascular measurement category* is displayed.
2. Select **Carotid**.
The available calculations are displayed.
3. Check the desired calculations to be performed.
4. Select **Save**.

The OB table sheet

The OB table sheet enables the creation and edition of user-defined OB tables.

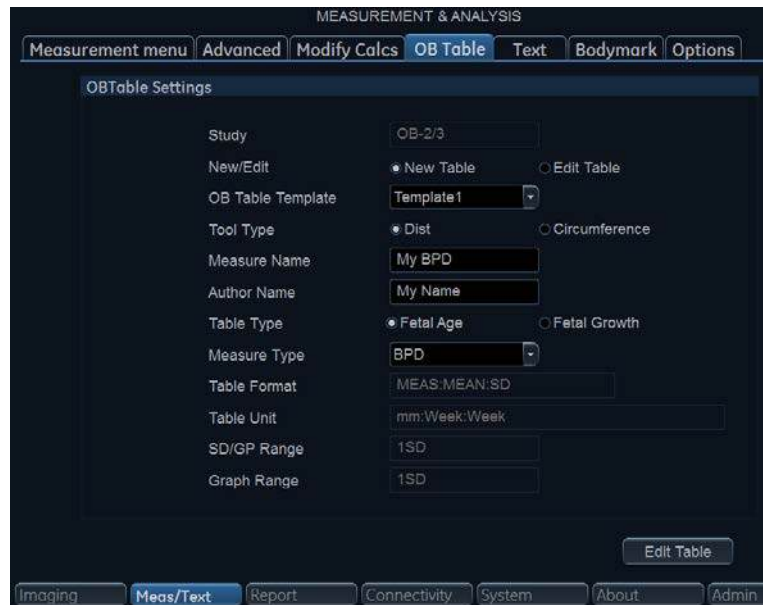

Figure 12-24. The OB table sheet

The following example describes how to create a fetal age OB-2/3 table based on Bi Parietal Diameter measurements.

1. In the *Measure/Text* category, select the **Measurement** menu.
2. In the *Measurement menu* sheet, select **2D** mode.
3. Select the **OB table** sheet.
4. In the *Measurement* menu, select the category **Obstetrics** and the **OB-2/3** measurement study.
5. In the *OB table* sheet, check **New table**.
6. Enter or select the following:
 - **OB Table Template:** when creating a new OB table, select Template (1 - 7) which you want to use as the basis of the user programmable OB Table (page 12-38). When editing an existing user OB table, select the desired OB table to edit.
 - **Tool type:** Select the type of measurement (e.g. Distance)

- **Measure Name:** type the name of measurement that will display in the *Measurement* menu (e.g. My BPD Measure).
 - **Author Name:** Type the author's name (e.g. My Name).
 - **Table Type:** If necessary, select the table type (e.g. Fetal Age).
 - **Measure type:** select the desired measurement (e.g. BPD).
7. Select **Edit table**.
The OB Table spreadsheet is displayed, showing the table template selected.
 8. Enter the Min, Max and Interval values in the *Parameters* field.
The system automatically fills in the *MEAS* column.
 9. Enter the input values for the *MEAN* and *SD* columns.
 10. Select **Exit to save**.

The OB table templates

Template 1 (based on Hadlock)				
Fetal age	format:	MEAS	MEAN	SD
	Unit:	mm	week	week
	Table range:	1 SD		
	Graph range:	1 SD		
Measurement result	Value:	[cm]		
	GA:	[#w#d]		
	Min:	[#w#d]		
	Max:	[#w#d]		
Fetal growth	Format:	AGE	MEAN	SD
	Unit:	week	mm	week
	Others are same as above			

Template 2 (based on Tokyo)				
Fetal age	Format:	MEAS	MEAN	SD
	Unit:	mm	day	day
	Table range:	1 SD		
	Graph range:	1 SD		

Template 2 (based on Tokyo)				
Measurement result	Value:	[cm]		
	GA:	[#w#d]		
	SD:	[day (+/-)]		
Fetal growth	Format:	AGE	MEAN	SD
	Unit:	day	mm	day
	Others are same as above			

Template 3 (based on Osaka)				
Fetal age	Format:	MEAS	MEAN	SD
	Unit:	mm	day	mm
	Table range:	1 SD		
	Graph range:	1 SD		
Measurement result	Value:	[cm]		
	GA:	[#w#d]		
	SD:	[(mv-pv)/sd]		
Fetal growth	Format:	AGE	MEAN	SD
	Unit:	day	mm	day
	Others are same as above			

Template 4 (based on several European tables)				
Fetal age	Format:	MEAS	MEAN	SD
	Unit:	mm	weekday	mm
	Table range:	5%–95%		
	Graph range:	5%–95%		
Measurement result	Value:	[cm]		
	GA:	[#w#d]		
	GP:	[%] Calculated by Fetal growth table. If Fetal growth table is not edited, GP is not calculated.		
Fetal growth	Format:	AGE	MEAN	SD
	Unit:	weekday	mm	day
	Others are same as above			

Template 5 (based on several European tables)				
Fetal age	Format:	MEAS	MEAN	SD
	Unit:	mm	weekday	mm
	Table range:	1 SD		
	Graph range:	5%–95%		
Measurement result	Value:	[cm]		
	GA:	[#w#d]		
	GP:	[%] Calculated by Fetal growth table. If Fetal growth table is not edited, GP is not calculated.		
Fetal growth	Format:	AGE	MEAN	SD
	Unit:	weekday	mm	day
	Others are same as above			

Template 6 (based on several European tables)					
Fetal age	Format:	MEAS	MIN	MEAN	SD
	Unit:	mm	weekday	weekday	weekday
	Table range:	10%–90%			
	Graph range:	10%–90%			
Measurement result	Value:	[cm]			
	GA:	[#w#d]			
	GP:	[%] Calculated by Fetal growth table. If Fetal growth table is not edited, GP is not calculated.			
Fetal growth	Format:	AGE	MIN	MEAN	SD
	Unit:	weekday	mm	mm	mm
	Others are same as above				

Template 7 (based on several European tables)				
Fetal age	Format:	MEAS	MEAN	SD
	Unit:	mm	weekday	mm
	Table range:	1 SD		
	Graph range:	10%–90%		

Template 7 (based on several European tables)				
Measurement result	Value:	[cm]		
	GA:	[#w#d]		
	GP:	[%] Calculated by Fetal growth table. If Fetal growth table is not edited, GP is not calculated.		
Fetal growth	Format:	AGE	MEAN	SD
	Unit:	weekday	mm	mm
	Others are same as above			

Normal values

Normal values can be defined by the user for all parameters. A Normal value can be either a range or a threshold. Normal values entered are grouped by measurement category (e.g. Cardiac, Pediatrics...etc).

Normal values are displayed in the report if the report template used is configured to display normal values (page 11-36).

To define a Normal value

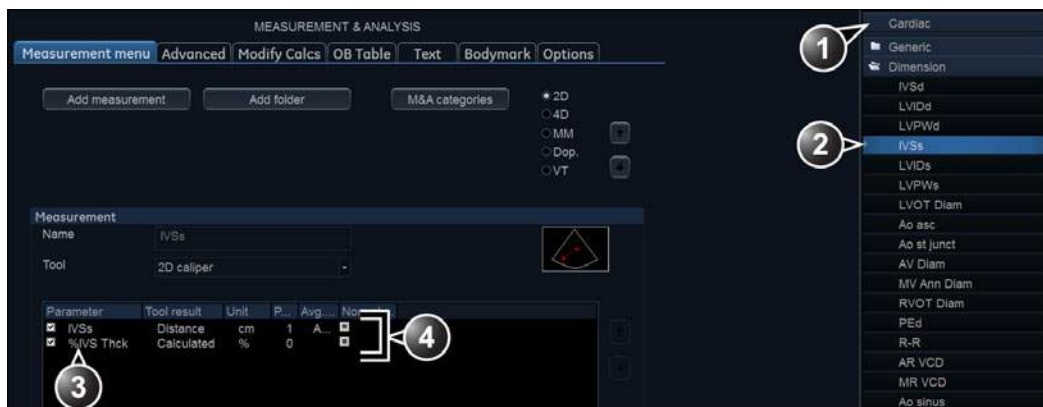

1. Measurement category
2. Selected measurement
3. Parameters
4. Press to define Normal value

Figure 12-25. Adding Normal value

1. Press **Utility/Config** on the Touch panel and select the Config category **Measure/Text**.
The *Measurement menu* sheet is displayed (Figure 12-25).
 2. In the *Measurement menu*, browse to the measurement of interest.
The parameters for the selected measurements are displayed in the *Measurement menu* sheet.
- NOTE:** To change *Measurement category*, press the **Heading** in the *Measurement menu* and select another *Measurement category*.
3. Select  in the *Normal value column*.
The *Normal value* window is displayed.

Figure 12-26. The Normal value window

4. In the *Normal value* window:
 - Select the Normal value type (Range, Above or Below).
 - Type in the Normal value.
 - Optionally enter a reference for the Normal value.
5. Select **OK**.

The Normal value is displayed in the *Measurement menu* sheet.

To display Normal values and references in the Report, the Report template must be configured to show Normal values ('Inserting a measurement container' on [page 11-36](#)). Measurements outside the Normal value are highlighted with an "!" in the report.

Transfer of user-defined measurements transfer in DICOM SR

Within a DICOM Server dataflow, it is possible to transfer user-defined measurements in DICOM SR. DICOM Mapping for the user-defined measurements can be configured in Utility -> Config -> Meas/Text -> DICOM Mapping.



Figure 12-28. Advanced Quantification tab with configuration options for AFI

AFI is described on page 8-23. AFI on RV is described on page 8-49. AFI on LA is described on page 8-63. Auto EF is described on page 8-74, page 8-23

Circumference and area (spline trace) measurement

To trace the circumference of a portion of the anatomy and calculate its area:

1. Press **Measure**.
2. Select **Generic > Spline Trace**, and a caliper displays.
3. To position the first caliper at the start point, move the Trackball.
4. To fix the trace start point, press **Set**. The second caliper appears at the same position as the first caliper is fixed.

NOTE: You can move the trace back towards the previous placed point to delete the previous caliper one by one.

NOTE: If **Clear** is pressed, all the calipers disappear, and the current measurement is cancelled.

5. To position the second caliper, move the Trackball and press **Set**. The third caliper appears at the same position.

NOTE: The spline trace requires at least three points to draw the trace. Continue setting the points of the trace until the desired points are set.

6. Double click **Set** after the last caliper is fixed to finalize the spline trace. All points disappear except the first and the last one and the spline trace turns blue.

*NOTE: Pressing **Set** twice finishes the trace measurement.*

NOTE: If the end point is close to the start point, there will only be a rounded shape mark after the spline trace is finalized. If the end point is far from the start point, there will be a straight line link the two points.

Edit the spline trace

You can edit the spline trace in two ways:

Method 1:

1. Hover the cursor near a finished spline trace until it turns green, then double-click and drag the trace to a desired target position.

*NOTE: Pressing **Clear** at this time removes all points and the trace graphic.*

*NOTE: To remove a point, press **Delete Point** once the point is selected.*

2. After performing a Single Edit on one point of the trace (the trace will stay in green), single-click to select any other point on the trace and drag to a desired target position.
3. Click outside the trace to end the trace.

Method 2:

- Select **Cursor Select**. The spline trace changes to green and all points appear on the trace as green.

The pick-caliper will be on the first or the last trace point depending on the user cursor select forward or backward. The message "Set the point" displays at the top of the screen.

NOTE: The pick-caliper is used to select and move the trace points.

- Move the pick-caliper to the desired position and press **Set**. The point is fixed.
- After performing a Single Edit on one point of the trace (the trace will stay in green), single-click to select any other point on the trace and drag to a desired target position.
- Click outside the trace to end the trace.

Connectivity configuration

System in a network environment

To be able to use the network functions when connected to a hospital network, the system must have a proper network address. Typically, the source for this information is the hospital network administrator.

System's Network settings

1. Press **Utility/Config** on the control panel and log on as administrator.
2. Select the **Connectivity** category and **Network** subgroup.
The **Network subgroup** is displayed.

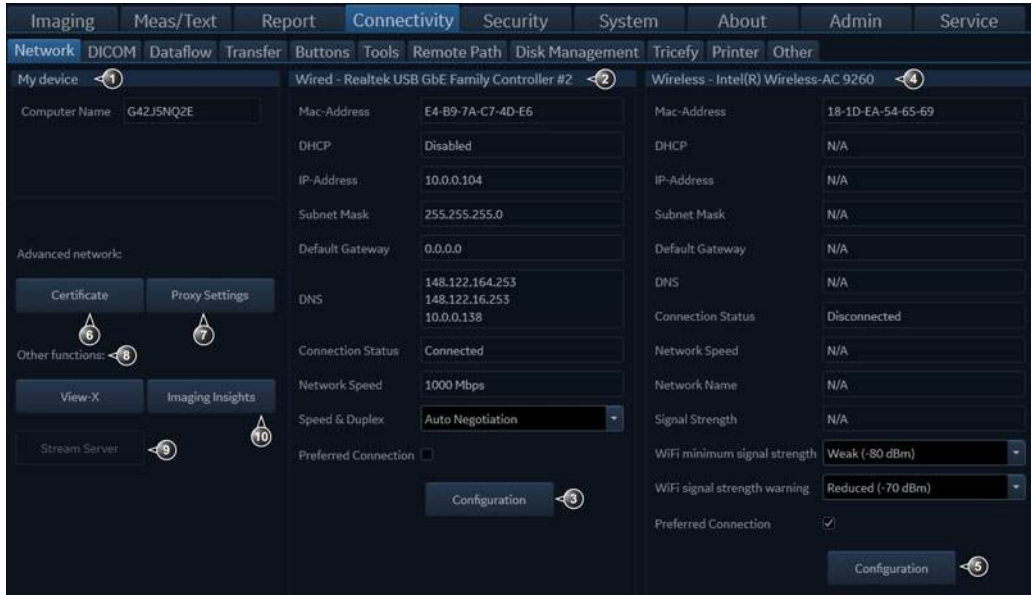

1. **My Device.**
Computer name: is shown but not editable.
2. **Wired** network adapter. Fields are automatically populated from the network adapter settings. In order to change them, press the **Configuration** button (3) in Windows. Speed and Duplex can be selected on this page.
3. **Configuration:** configure the Wired connection.
4. **Wireless** network adapter. Fields are automatically populated from the network adapter settings. To change them, press the **Configuration** button (5), (see page 12-76).
Note that both Wi-Fi minimal strength and strength warning can be selected on this page.
Note that the **Preferred Connection** method (wired/wireless) can be selected by checking a box.
5. **Configuration:** configure the Wireless connection.
6. **Certificate:** Click this button to be able to enter certificates.
7. **Proxy Settings:** Configure network proxy settings (see page 12-51).
8. **View-X Settings:** Configure streaming source for View-X (see page 14-11).
9. **Data Streaming Settings:** Configure streaming of live ultrasound image data.
10. **Imaging Insights:** Configure connection to the **Imaging Insights** server by providing device usage information.

Figure 12-29. Network subgroup

3. Select **Configuration** (in the **Wired** network section) to configure:
 - IP address for the system
 - Subnet mask for the system
 - IP address for the Default Gateway

This is done at the Windows level.
4. Press **Save settings** and reboot the system.

Imaging Insights

Imaging Insights automatically collects DICOM data from GE and other vendors' ultrasound equipment or equipment fleet and displays system utilization and operator usage insights in a plotted dashboard. Operational insights include exam volumes, first and last exam time, probes utilization, exam type; operator usage data includes length of exam, scan mode, probes, and exam type. It helps optimize system and probe fleet investment plans, identify staff assignment and training needs, and monitor variability of staff usage patterns.

1. Log on as ADM, press **Utility>Config** on the touch panel.
2. Select the Connectivity category and the Network subgroup. The *Network* sheet is displayed.

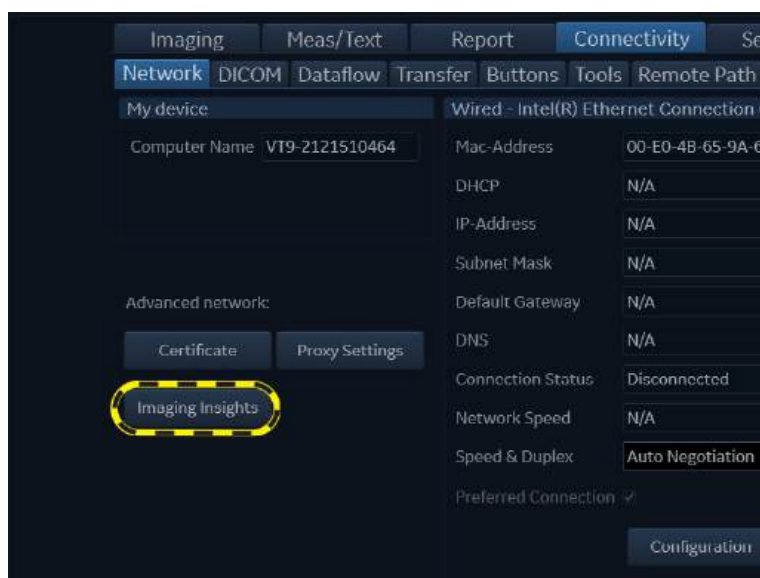

Figure 12-30. Imaging Insights button

3. Press *Imaging Insights* button and a window will pop up.
4. Configure the server information from the pop-up window and then click **Check**.

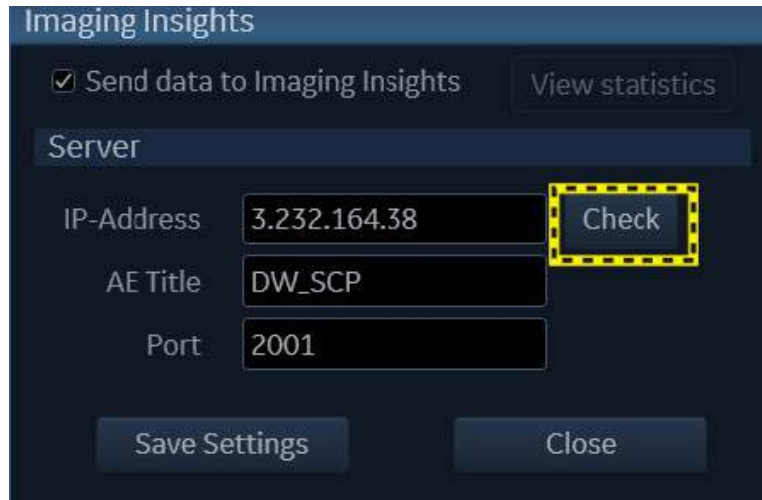

Figure 12-31. Server Configuration

5. If the network connection to the server is OK, it will be illustrated by the "Pass" sign, a green check mark . The "Fail" sign indicates that the connection has failed. Typical causes for the issue:
 - Network cable is not connected
 - Configuration error(s)
6. Choose **Send data to Imaging Insights**, then the data from this scanner will be sent to the Imaging Insights server.

NOTE: *If a doctor is doing the exam with patient information created, the data will be sent to server immediately when click **End Exam**: If the doctor is doing emergency scanning without creating patient information, the data will be sent to the server every two hours before system shutdown.*

NOTE: *User can press **View statistics** button to check whether the data is sent successfully or not.*

Network Proxy Settings

How to setup Network Proxy Settings

Press the **Proxy Settings** button on the *Connectivity > Network configuration* screen to show Network Proxy Settings dialog.

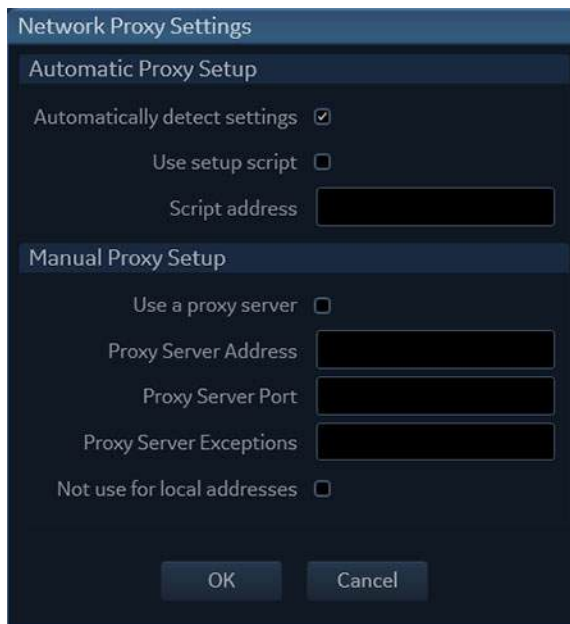

Figure 12-32. Network Proxy Settings window

Automatic Proxy Setup

Enable the *Automatically detect settings* option to use Web Proxy Auto-Discovery Protocol (WPAD) for detecting proxy settings. If the connected network requires a proxy and it provides that proxy via WPAD, the proxy will be automatically configured and used.

Enable the *Use setup script* option and insert the network address of the script into the Script address box to setup script for your proxy configuration. This script may also be referred to as a .PAC file.

Manual proxy setup

Enable the *Use a proxy server* option to manually configure the proxy server. The manual configuration of a proxy requires you to have a specific IP address and port for the server that you want to use. This information should be entered in the *Proxy Server Address* and *Proxy Server Port* fields.

For addresses you do not want the system to use the proxy server on, enter web or IP addresses separated with a semicolon (;) in the *Proxy Server Exceptions* field.

Enable the *Not use for local addresses* option to bypass the proxy server when you connect to resources on your local network or intranet.

Click **OK** to save and apply network proxy settings or click **Cancel** to ignore the recent changes.

Wireless setup

In order to configure the Wireless adapter (if used), click the Configuration box (5) in the Wireless section. This is done at Windows level, but both *Wi-Fi Minimum Signal Strength* and *Wi-Fi Signal Strength Warning* can be configured directly on the *Connectivity – Network* page.

See 'Wireless Network Setup' on *page 12-76* for details on how to set up wireless connection.

System in a network environment with a DICOM server

The system's Network settings must be configured as described in 'System's Network settings' on *page 12-48*.

In addition, to work against the DICOM server, the following information has to be entered in the system:

- The DICOM server IP address
- The DICOM server port number
- The DICOM server AE title (the server's name)

NOTE: *Changing the DICOM server AE title requires a reboot of the system to take effect.*

Typically, source for this information is the network administrator.

Create or modify a DICOM server IP address

Follow the steps below if the IP address settings for the DICOM server need to be modified or created:

1. Press **Utility/Config** on the Touch panel and log on as administrator.
2. Select the **Connectivity** category and **Dataflow** subgroup. The *Dataflow* sheet is displayed.
3. Click on the *Servers* button in the lower right corner.

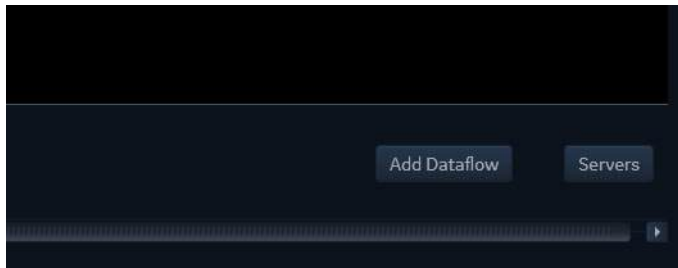

Figure 12-33. Dataflow-Servers location

4. Click *Add* to add a new server or *Modify* to change an existing one. To remove one, highlight the server and click *Remove*.

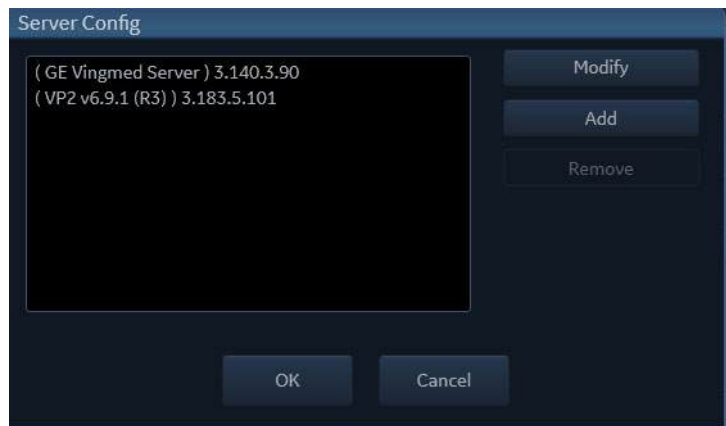

Figure 12-34. Server configuration window

5. Enter the name of the server, and typically deselect *Automatic* and enter the IP address manually.

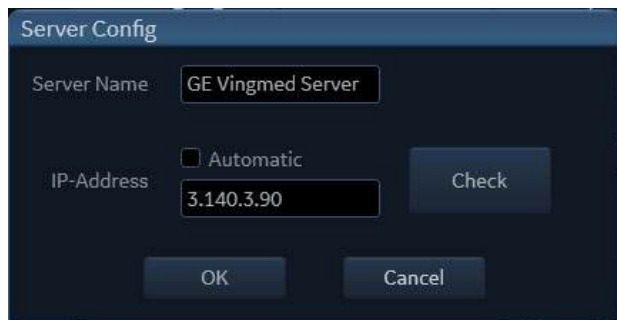

Figure 12-35. Entering the server name

6. Verify connection to the server by pressing the *Check* button.

7. Press *OK* to complete the setup of the server Name and IP address.

DICOM devices configuration

Depending on the DICOM dataflow selected, one or several DICOM devices may have to be configured.

1. Press **Utility/Config** on the Touch panel and log on as administrator.
2. Select the **Connectivity** category and **Dataflow** subgroup. The *Dataflow* sheet is displayed.
3. Select *Add Dataflow* (bottom right) to enter a new dataflow and choose from a factory template or create a Custom one from scratch.

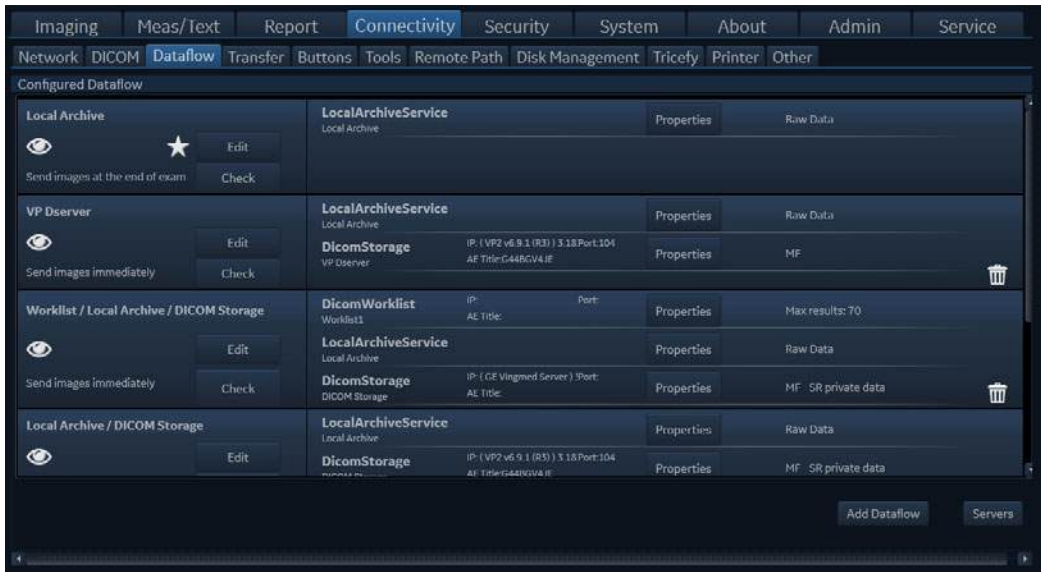

Figure 12-36. Dataflow selection window



Figure 12-37. New Dataflow selection

- In this example, the factory *Worklist / Local Archive / DICOM Storage* is used. The screen shows a list of what type of services are used and various preference settings for the dataflow.

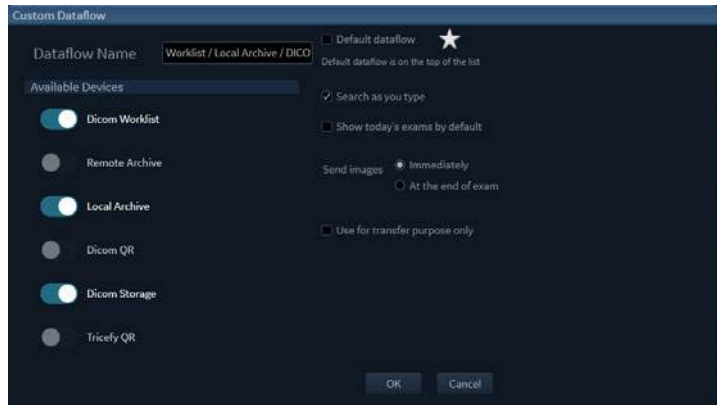

Figure 12-38. Custom Dataflow Settings

- Click **OK** when completed.
- Note that the different service need to be set up next. Each service must be configured by clicking on the respective **Properties** buttons

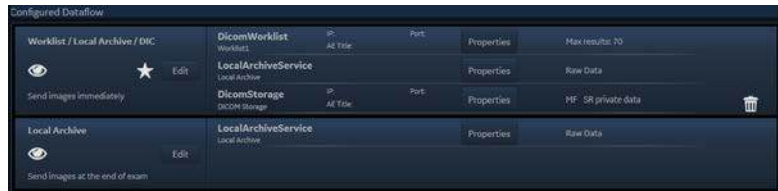

Figure 12-39. Configured dataflow window

7. DICOM Storage Properties:

In the Properties for DICOM Storage:

- Select the server previously defined from the pull-down menu in the **IP address** field.
- Enter the DICOM server **AE title**. This entry is case-sensitive.
- and must match exactly.
- Enter the DICOM server port number.

For some DICOM servers, the default **Timeout** setting may be too low.

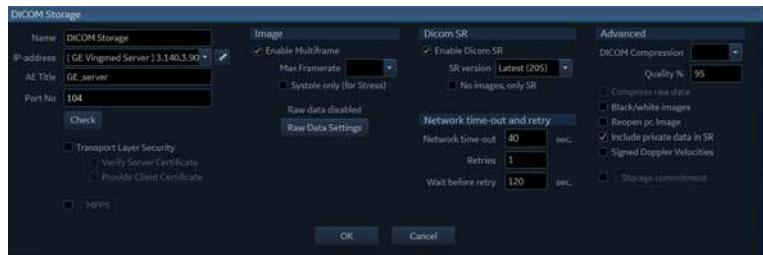

Figure 12-40. DICOM storage properties

8. When configuring the DICOM storage device, the following image settings are recommended to enter in the Properties.

- Check **Allow SR** if required (see 'DICOM SR' on page 12-68).
- Keep **Reopen per image** unchecked.
- Keep **Raw data** disabled.
- Set **Max Frame rate** to 30.
- Keep **Black/White images** unchecked.
- Set **Compression** to JPEG.
- Set **Quality** to 95.
- Check **Allow multiframe**.

Raw Data Settings gives you the ability to select which images to transfer in the raw data format by mode:

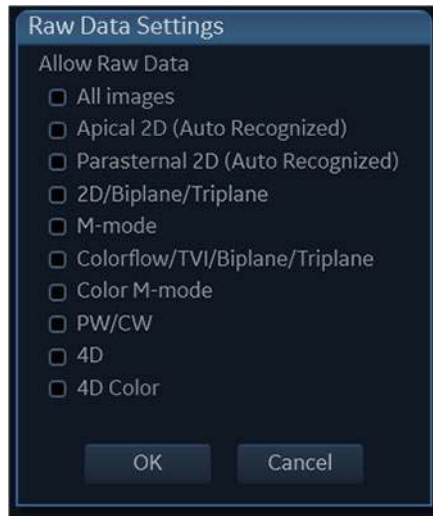

Figure 12-41. Raw Data settings

Systole only (for Stress). When this setting is active, all stress images will be sent to the DICOM server showing only systole. The setting is selectable when transferring only multiframe (not raw data).

NOTE: *Setting **Compression** to **None** may result in long transfer time and cineloop with more than 500 frames will be truncated. If **Compression** is set to **None**, set Max frame rate to either 25 or 30 frames per second to reduce the risk of truncating loops.*

DICOM / TLS

To use TLS protocol for secure communication with the DICOM server, the “Transport Layer Security” option must be checked off on the DICOM dataflow.

NOTE: *The DICOM / TLS must be supported by the DICOM server.*

1. Open the Properties view for the DICOM dataflow, as described in ‘DICOM devices configuration’ on page 12-55.
2. Check off for *Transport Layer Security*.

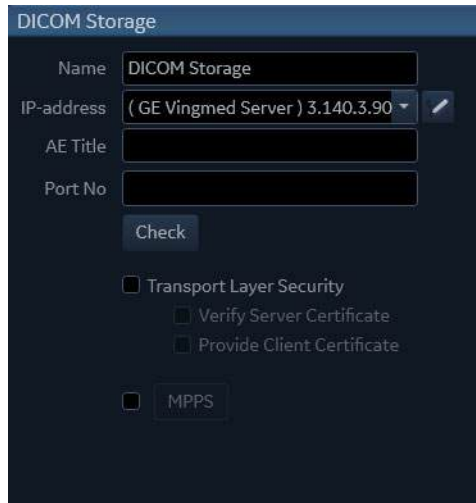

Figure 12-42. Check the 'Transport Layer Security'

3. (Optional) Select *Verify Server Certificate* to ensure the connected DICOM server is trusted by the Vivid S70N / S60N system.
4. (Optional) To add server or client certificate, open the Certificate utility accessible from *LDAP config* view, see 'Digital certificates' on page 12-59.
5. (Optional) To enable use of client certificate, check off for *Provide Client Certificate*. See 'Select Client Certificate' on page 12-65.

NOTE: *The client certificate must be selected before the Provide Client Certificate check box can be checked off.*

Digital certificates

The digital certificates can be managed from the **LDAP** configuration.

Public certificates can be added to trust connected devices. While client certificates with a private key can be added for authenticating the Vivid system towards a connected device.

Import/delete Certificate

1. Press **Utility/Config** on the Touch Panel as administrator.
2. Select the **Admin** category and the **LDAP** subgroup.
The LDAP sub group is displayed.

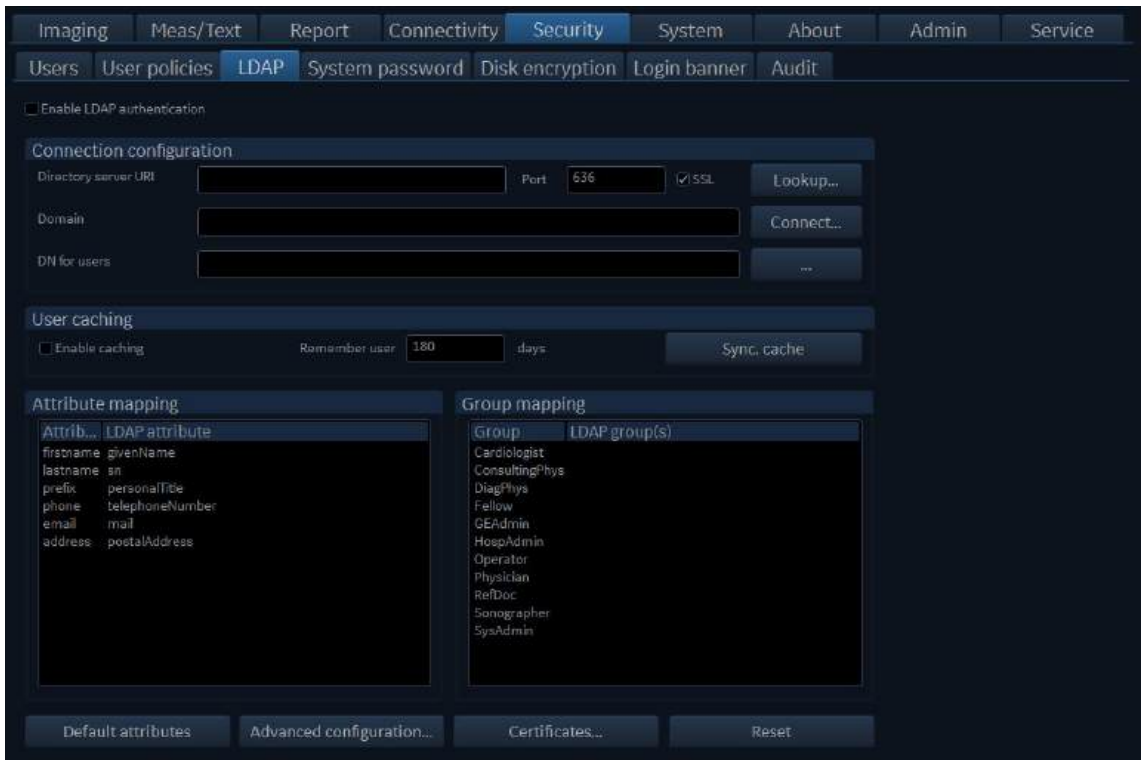

Figure 12-43. LDAP window

3. Click on the **Certificates..** button.
The *Certificate Manager* window is displayed.
4. In the *Certificate Manager* window, select the folder where the certificate is to be imported to.
5. Click **Action, All Tasks** and then **Import..** from the drop-down menu.

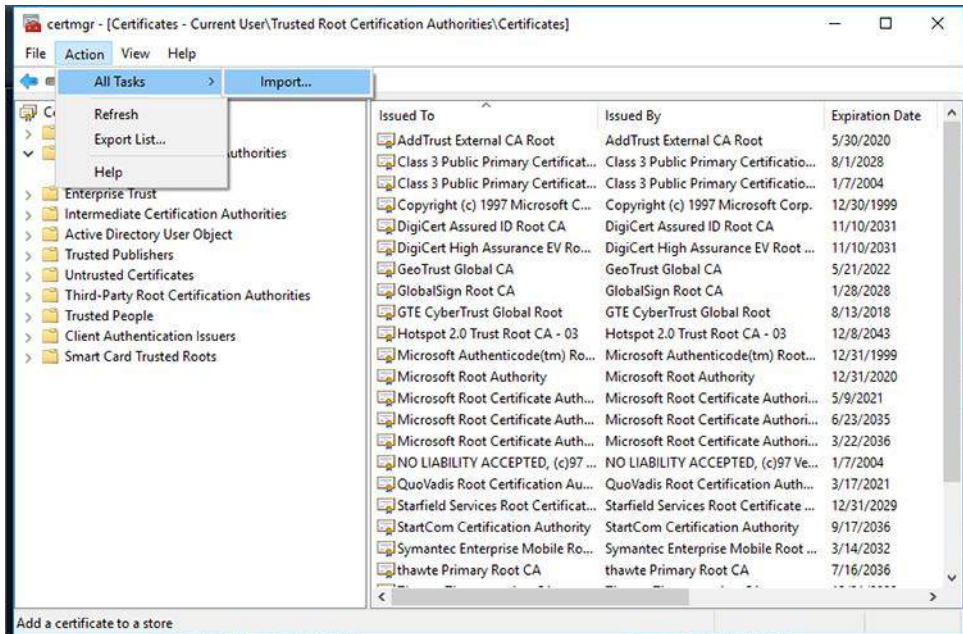

Figure 12-44. Import certificate

6. Press the **Next** button in the pop-up welcome window.

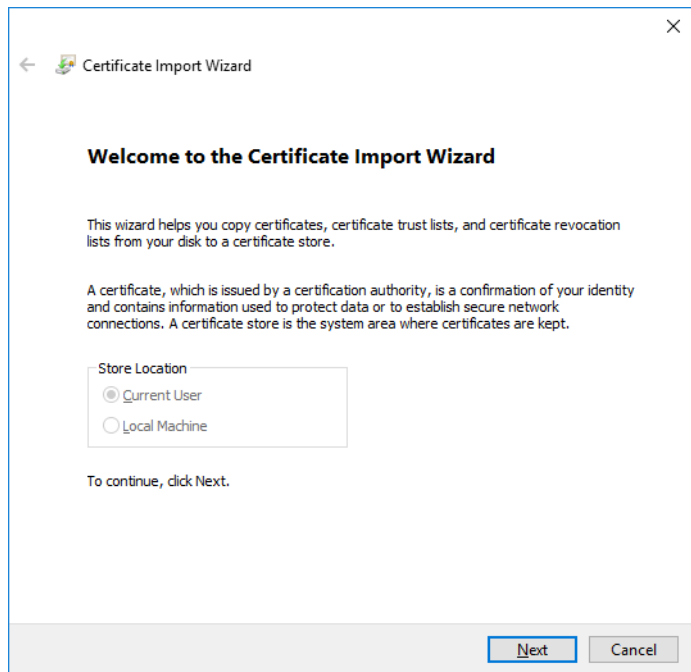

Figure 12-45. Welcome window

7. Click **Browse** to find the certificate file to import.

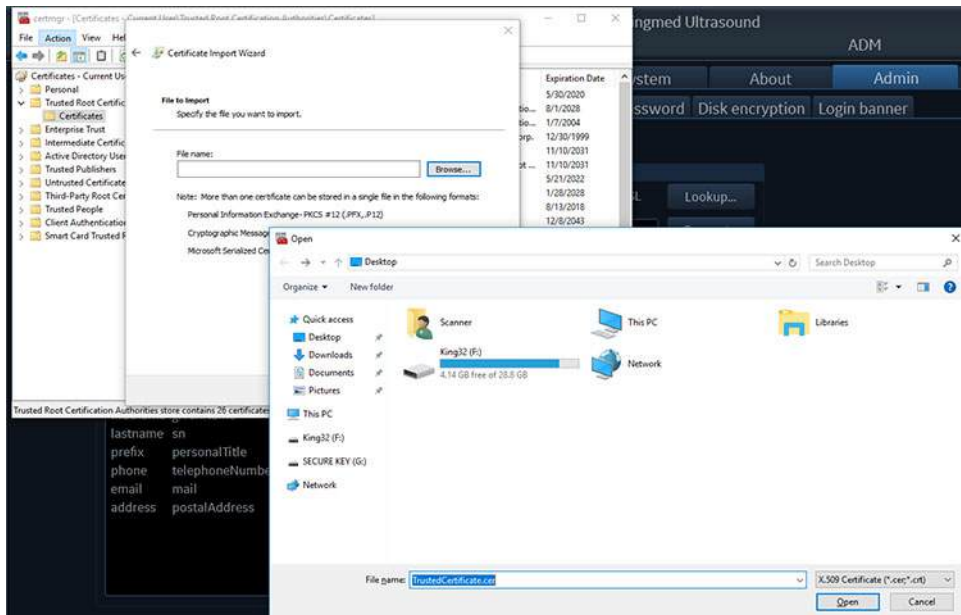

Figure 12-46. Find the certificate file to import

NOTE: *If importing a Client Certificate including a private key (e.g. in case of importing a certificate used for authenticating towards the DICOM server, the “Provide Client Certificate” option) choose the certificate type from the list on the right of the “File Name” box. Only the “*.pfx” certificate is supported for Client certificates.*

8. Browse to the certificate file to import, select the file and press **Next** to confirm.
9. (Optional) Enter the password and make sure that the second checkbox is selected.

Press the **Next** button to confirm the certificate import.

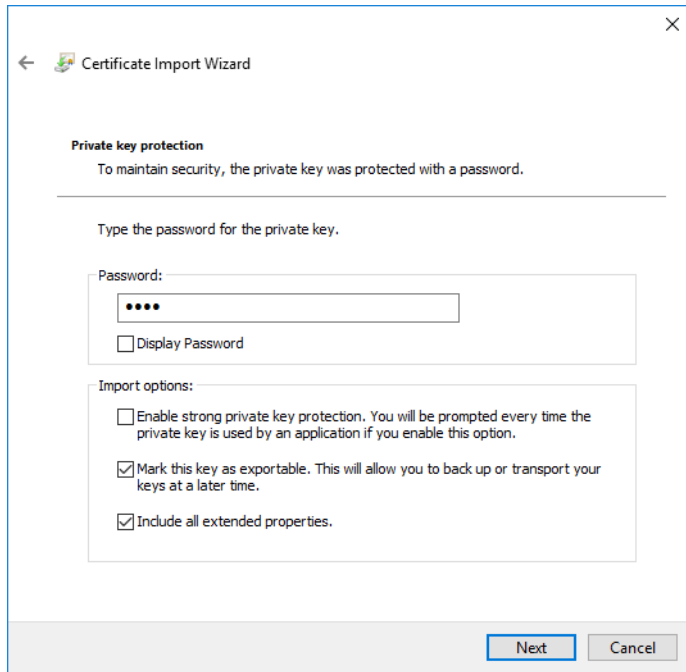

Figure 12-47. Enter Password

10. Confirm the certificate store by pressing **Next**.

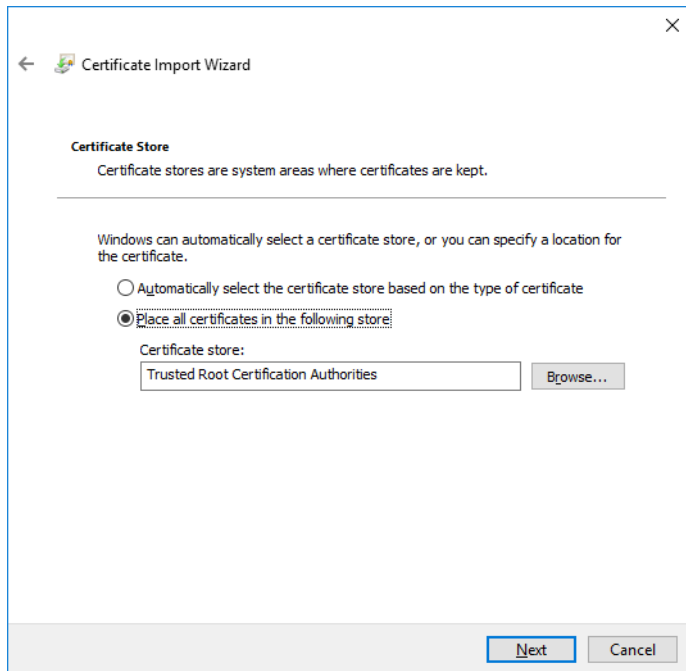

Figure 12-48. Certificate Store

11. Press the **Finish** button.

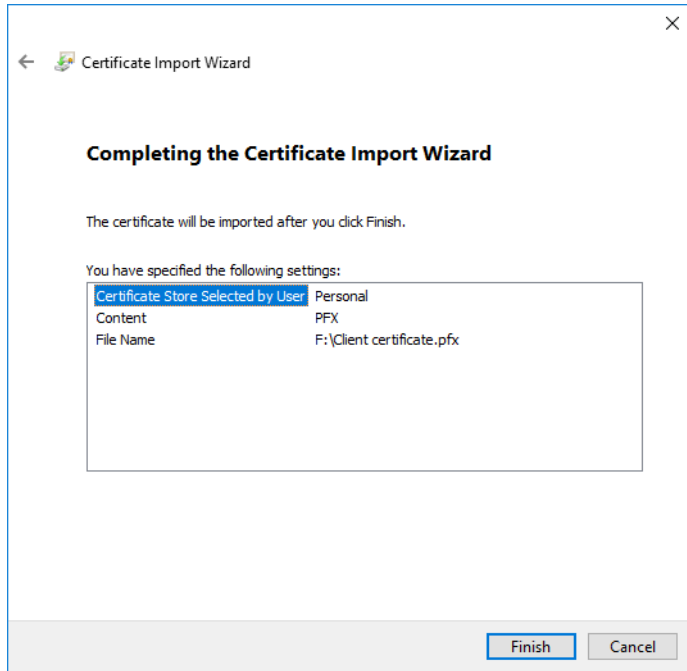

Figure 12-49. Completing the Certificate Import Wizard

12. A window is displayed to indicate the import was successful. Press **OK** to close the window.
13. Close the *Certificate Manager* window when finished.

Delete Certificate

1. Press **Utility/Config** on the Touch Panel as administrator.
2. Select the **Admin** category and the **LDAP** subgroup.
The LDAP sub group is displayed.

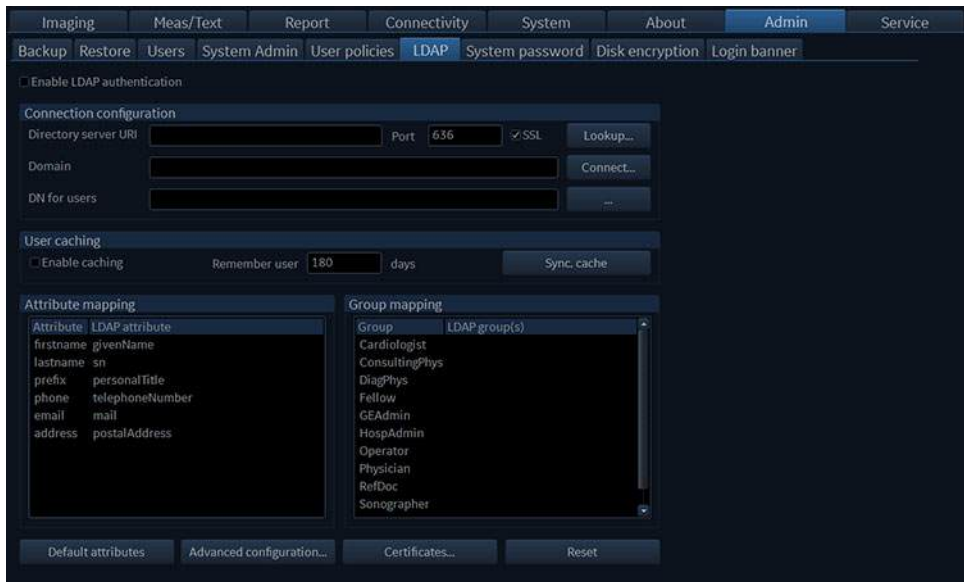

Figure 12-50. LDAP window

3. Click on the **Certificates..** button.
The *Certificate Manager* window is displayed
4. In the *Certificate Manager* window, select the certificate to delete.
5. Select **Delete** from the Action drop-down menu to delete the certificate.
6. Press **Yes** to finally delete the certificate or **No** to keep it.

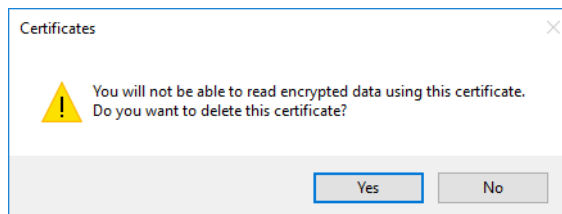

Figure 12-51. Delete Certificate confirmation window

Select Client Certificate

1. Press **Utility/Config** on the Touch Panel as administrator.
2. Select the **Connectivity** category and the **DICOM** subgroup.
The **DICOM** sub groups are displayed.

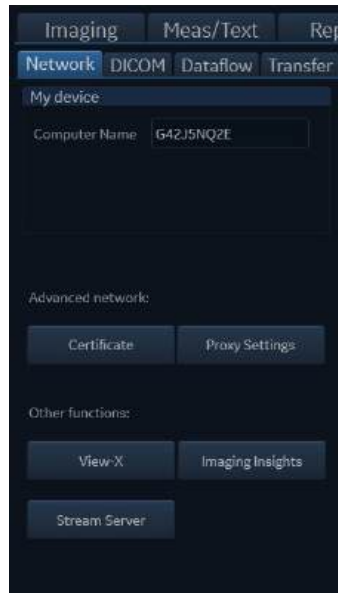

Figure 12-52. Connectivity - Network subgroup

3. Click on the **Client Certificates** button.
The *Select Client Certificate* window is displayed.

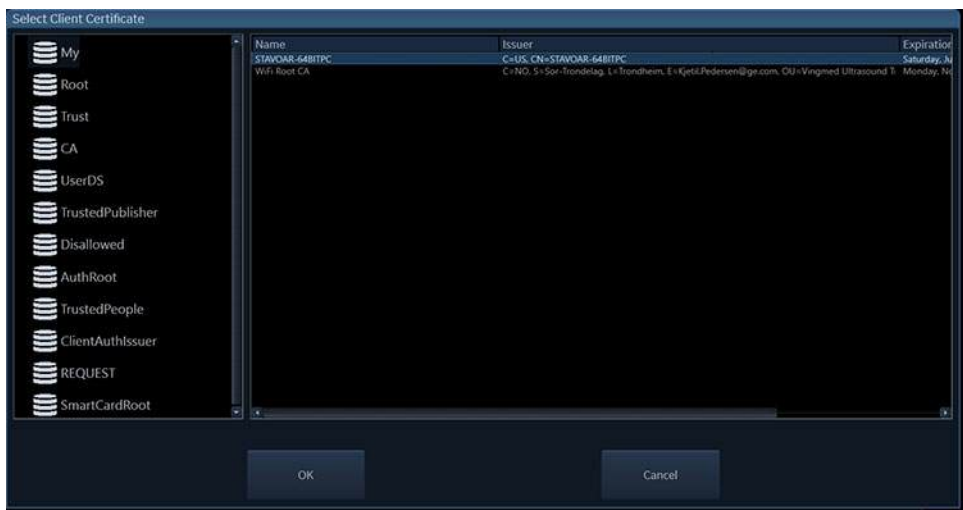

Figure 12-53. Select Client Certificate window

NOTE: *Only the certificate with a private key can be selected.*

4. Select a folder and a certificate.
5. Press **OK** and the certificated is selected as the client certificate to use.

Adjusting the Search Criteria

When selecting a DICOM Worklist dataflow or Query/Retrieve, search criteria can be set for the system to use when searching the database.

1. Press **Utility/Config** on the Touch panel and log on as administrator.
2. Select the **Connectivity** category and **Dataflow** subgroup. The *Dataflow* sheet is displayed (see Figure 12-36).
3. Select a DICOM Worklist dataflow or the Query/Retrieve dataflow.
4. Select the Worklist or Query/Retrieve device and press **Properties**.

The *Properties* window for the selected DICOM device is displayed.

Figure 12-54. DICOM Worklist properties window

NOTE: *By reducing **Max. Result** the performance might be improved, however all results might then not be shown.*

5. Press **Search criteria**.
The *Search criteria* window is displayed (Figure 12-55).
6. Select a Search criteria from the *Select tag* pull-down menu.
7. Enter a value if required or leave blank if not to be used. This entry is case sensitive and must match exactly.
8. Press **Update list**.
9. Press **OK** to close the *Search criteria* window.



Figure 12-55. The Search Criteria window

DICOM SR

DICOM Structured Reporting (SR) is a standardized format for medical results. Vivid S70N / S60N supports the specialized form for Echo Ultrasound (“TID 5200 Echocardiography Procedure Report”), Pediatric (“TID 5220 Pediatric Cardiac Ultrasound Report”) and Vascular Ultrasound (“TID 5100 Vascular Ultrasound Procedure Report”) for M&A results.

With the DICOM SR support, M&A for an exam can be sent at the end of the exam or when exported from local archive. The destination can be either a server on the network (Storage SCP) or a removable media (DICOM Media) depending on the DICOM dataflow selected.

NOTE: *In order for the patient’s blood pressure to be populated in the DICOM SR file, the user needs to enter the patient’s weight and height as well.*

"TID 5220 Pediatric Cardiac Ultrasound Procedure Report" is sent if the exam contains M&A from category Pediatric (Heart).

"TID 5200 Echocardiography Procedure Report" is sent if the exam contains M&A from category Cardiac and does not contain M&A from category Pediatric (Heart).

In addition, "TID 5200 Echocardiography Procedure Report" is sent per third-party application if the exam contains any measurements stored from third-party software.

"TID 5100 Vascular Ultrasound Procedure Report" is sent if the exam contains M&A from category Vascular/Abdominal.

"TID 5200 Echocardiography Procedure Report", "TID 5220 Pediatric Cardiac Ultrasound Report" and "TID 5100 Vascular Ultrasound Procedure Report" do not support all M&A results from Vivid S70N / S60N. They are limited to the following:

- No unassigned measurement.
Refer to the Vivid S70N / S60N Reference manual for a complete list of supported parameters.
- The following modes: 2D, M-mode, Color Flow, PW Doppler, CW Doppler, 3D and TDI.
- Not Modified Simpson method or Bullet methods.
Refer to the Vivid S70N / S60N Reference manual for a complete list of supported methods.
- Basic derivations (Average, Last, Min and Max), no references between the derived measurements and the ones they were made from.
- Wall Motion Scoring: individual segment scores only according to 16-segment model, no graded Hypokinesis (only Hypokinesis is used).

DICOM SR must be activated for each DICOM device.

1. Press **Utility/Config** on the control panel and log on as administrator.
2. Select the **Connectivity** category and **Dataflow** subgroup. The *Dataflow* sheet is displayed (see Figure 12-36).
3. Select the DICOM dataflow to configure in the *Dataflow* pull-down menu.
4. Select a DICOM storage device and press **Properties**. The *Properties* window for the selected DICOM storage device is displayed.

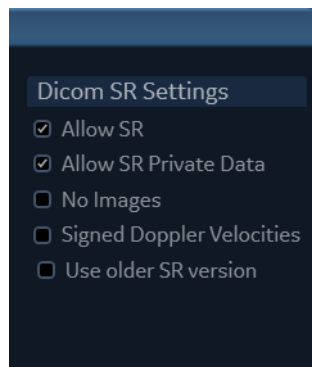

Figure 12-56. DICOM SR Settings

5. Check the option **Allow SR** to enable DICOM SR.

The following additional options are available:

- **Allow SR private data:** include current exam data in a private format within DICOM SR to retain measurements and complete exam information when recalling an exam from a DICOM environment. This is especially important if EchoPAC Plug-in is used in the DICOM environment or if any exam at any later time is expected to be recalled to Vivid S70N / S60N or EchoPAC Software Only using DICOM Query/Retrieve. If the DICOM server does not allow the private data format within DICOM SR files, this feature should be disabled.
- **No images:** no images are sent, only M&A.
- **Signed Doppler velocities:** send signed Doppler velocities.
- **Use older SR version:** when checked a *Use older SR version* pull-down menu is displayed. The current exam data will be sent in the same format as the selected SR version. Details about format and content of the SR version can be found in the corresponding user manual of the selected version.

These settings apply to both “TID 5200 Echocardiography Procedure Report” and “TID 5100 Vascular Ultrasound Procedure Report”

6. Select **OK**.

DICOM spooler

DICOM spooler displays the current DICOM output jobs. The jobs may be Storage, Print, Modality Performed Procedure Step (MPPS) or Storage Commitment. The DICOM spooler is used for checking the current job's status when a job is saved or when the total spooler status on the right of the *Archive* window displays an error.

From the DICOM spooler the user can also:

- **Delete** non-active jobs.
- **Resend** a job that has failed or is in hold.
- **Send** a job that has failed or is in hold, to a new destination.

The job's status displayed in the *DICOM spooler* window can be:

- **Pending:** the job is complete, waiting to be active.
- **Hold:** the job is complete, but suspended, waiting for an action from the user.
- **Append:** the job is incomplete, waiting for more images (Direct store function).
- **Active:** the job is complete and connected to the destination device.
- **Failed:** the job is complete but one or more images failed to transmit to the destination device.
- **Done:** the job is saved to the destination device. The jobs that are done are removed from the spooler after a few minutes.

To start the DICOM spooler:

1. Do one of the following:
 - Press **Utility** and **Spooler** on the control panel
 - Press **F4** on the alphanumeric keyboard
 - Press **Alt + S** on the alphanumeric keyboard
 - Press the **Spooler** icon () in the lower left corner of the status bar

The *DICOM spooler* window is displayed (see Figure 12-57).

The *DICOM spooler* window is automatically updated. Press **Refresh** to update the information displayed at any time.

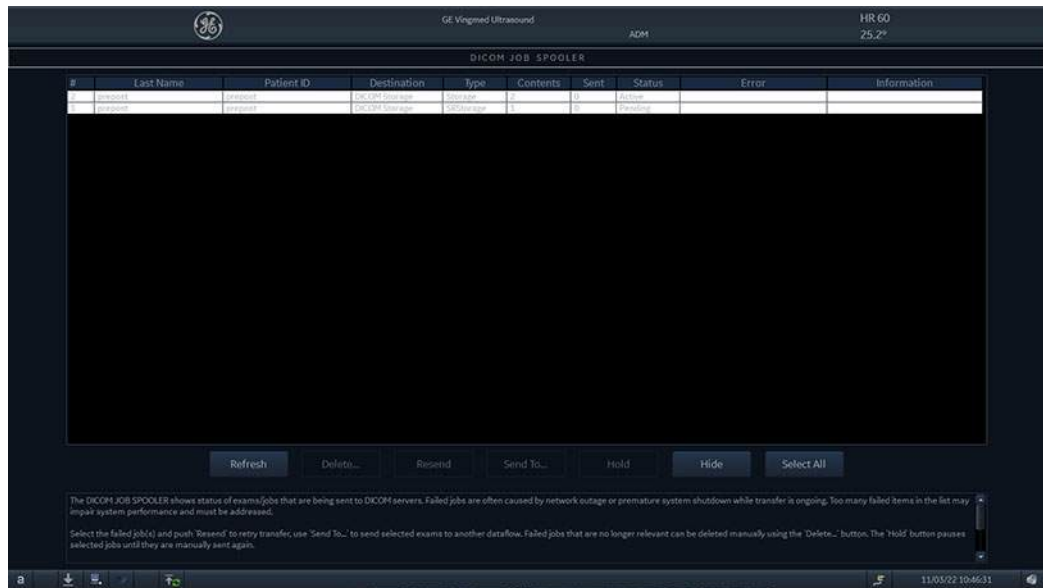

Figure 12-57. The DICOM job spooler window

The DICOM spooler window contains helpful troubleshooting information at the bottom of the screen.

To delete a job:

1. Select the job(s) to delete in the *DICOM job spooler* window.
2. Press **Delete**.

NOTE: Only non-active jobs can be deleted.

To resend a job:

1. Select the job(s) to re-send in the *DICOM job spooler* window.
2. Press **Resend**.

NOTE: Only jobs that failed or are in hold can be resent.

To send a job to a new destination:

This is typically used if the configuration of the server is changed.

1. Select the job(s) to send in the *DICOM job spooler* window.
2. Press **Send to...**
A dialogue window is displayed.
3. Select the new destination from the *Destination* pull-down menu.

NOTE: Only jobs that failed or are in hold can be sent to a new destination.

4. Press **Send**.

To hold a job:

NOTE: 1. Select the job(s) to hold in the *DICOM job spooler* window.
Only inactive jobs can be set on hold.

2. Press **Hold**.
3. To undo hold, press **Resend**.

Spooler status icon:

A Spooler icon is shown in the status bar (the right one below).



Figure 12-58. Spooler status bar

There are four different icons depending on the status of the data being transferred:





-  Transfer in progress. System connected to network.
-  Transfer paused or on hold. Transfer will resume automatically when network available.
-  Transfer completed successfully
-  Transfer failed. Please click spooler icon for more details.

Figure 12-59. Data transfer statuses

When hovering over the spooler icon the text shown above will be shown in the status bar.

Shutdown when data transferring from the DICOM Spooler:

Whenever there are images and/or measurements currently in the process of being transferred from the DICOM Spooler at the time the power button is pressed, this is indicated in the System Exit dialogue as shown below. A progress bar with a count-down timer gives an estimate for time remaining until transfer is completed.

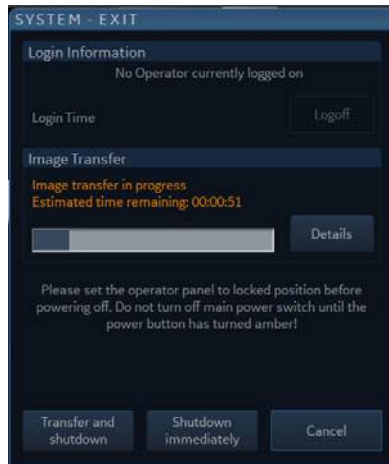

Figure 12-60. System Exit dialogue with data in DICOM Spooler

You can select the following options:

1. *Transfer and Shutdown*
The system will complete transfer of data before shutdown is performed.
2. *Shutdown immediately*
Transfer of data will be aborted, and the system will shut down immediately. Unsent data will remain in the spooler and will have to be resent from the DICOM Spooler at a later time when the system is connected to the network.
3. *Details*
Pressing the Details button launches the DICOM Spooler screen, where further details on the image transfer process can be seen.

NOTE: *Pressing Details button aborts the shutdown process.*

4. *Cancel*
Pressing Cancel will abort the Shutdown process, while data transfer will continue.

DICOM images

To configure DICOM images:

1. Press **Utility/Config** on the Touch panel and log on as administrator.
2. Select the **Connectivity** category and **DICOM** subgroup.

The *DICOM* sheet is displayed.

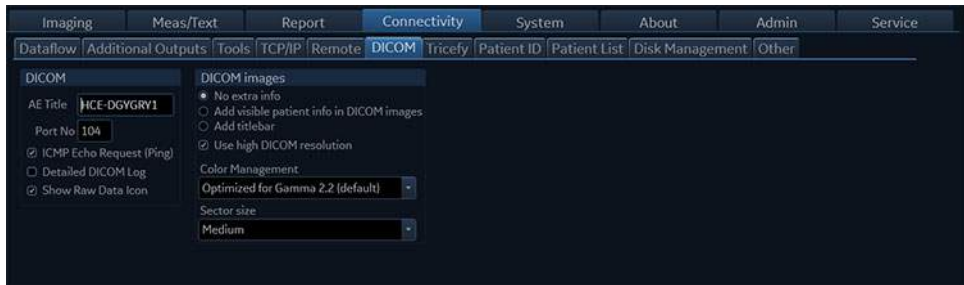

Figure 12-61. The DICOM sheet

From DICOM images the user can select between:

- **No extra info**
- **Add visible patient info in the DICOM images:** displays patient information (name, date of birth and ID) on DICOM images.
- **Add title bar:** adds the Title bar to the DICOM images. Must be enabled in order for images from the 4D Auto AVQ tool to contain traces, bullseye, 3D model and measurements as part of the stored DICOM Multiframe/Singleframe files when using a dataflow with RAW data disabled.

When **Use high DICOM resolution** is enabled, DICOM images are stored using a higher pixel density. Use this setting when exporting to systems accessed by high definition DICOM viewing stations.

NOTE: *Using high DICOM resolution will double the file size of the DICOM data when using standard compression settings. Such files will consume more disk space and also slow down storage, recall and transfer of files.*

Color management provides a selection of gamma settings for optimized representation of the Vivid images on DICOM workstations.

Sector size offers three different sizes of the 2D sector for viewing on DICOM work stations.

Wireless Network Setup

The following procedure is used to configure the Vivid S70N / S60N for a wireless network environment. This procedure is required for every new wireless network.

NOTE: Do not use any type of wireless network adapter other than a GE-approved Netgear Wireless Interface USB Adapter A6210.

NOTE: If you have questions regarding the configuration, please contact your local IT expert.

Configuring the Wireless Network adapter

1. From the default ultrasound system screen, press **Config (F2)** and log on as **Adm**.
2. Select **Connectivity** (lower part of window).
3. Select the Network tab.

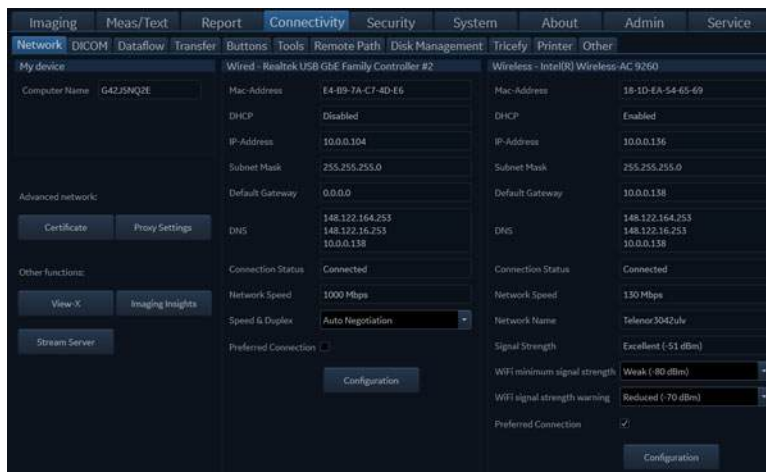

Figure 12-62. Connectivity - Network tab

NOTE:

4. Click the Configuration button in the lower right corner.
If a wireless network adapter is not connected or if the connected wireless network adapter is not the correct model, no wireless networks will be listed in the Wireless Settings page.

5. Either double-click or select the network you want to connect to, and press the **Connect** button.

If this is the first time you attempt to connect to the network, a dialog will pop up on screen asking you to configure the network setting.

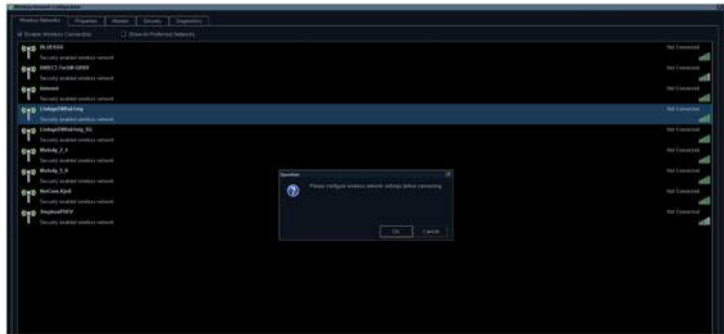

Figure 12-63. First Time Connection Dialog

6. Press **OK** in the dialog window. A new window for setting up your connection will open.

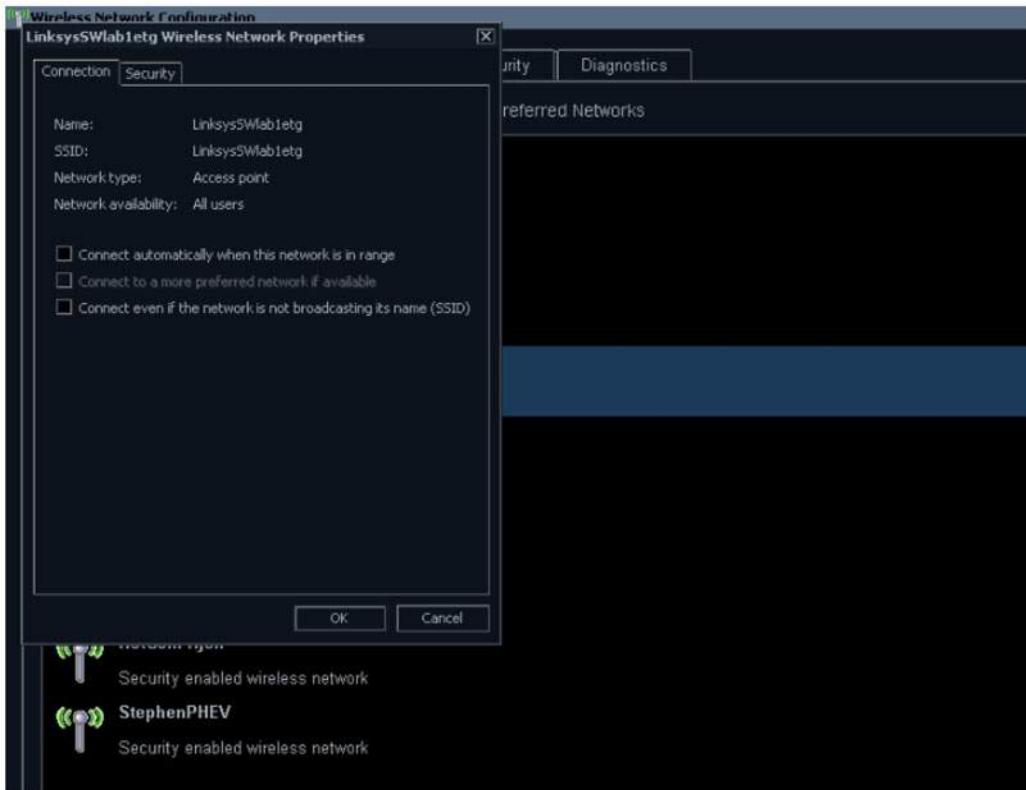

Figure 12-64. Network Settings Window - Connection

7. Select check-boxes according to preference.
 If **Connect automatically when this network is in range** setting is selected, then this network will auto-connect when

available, without needing to enter the **Wireless Settings** page.

8. Set up the security options in the Security tab of connection setup dialog.

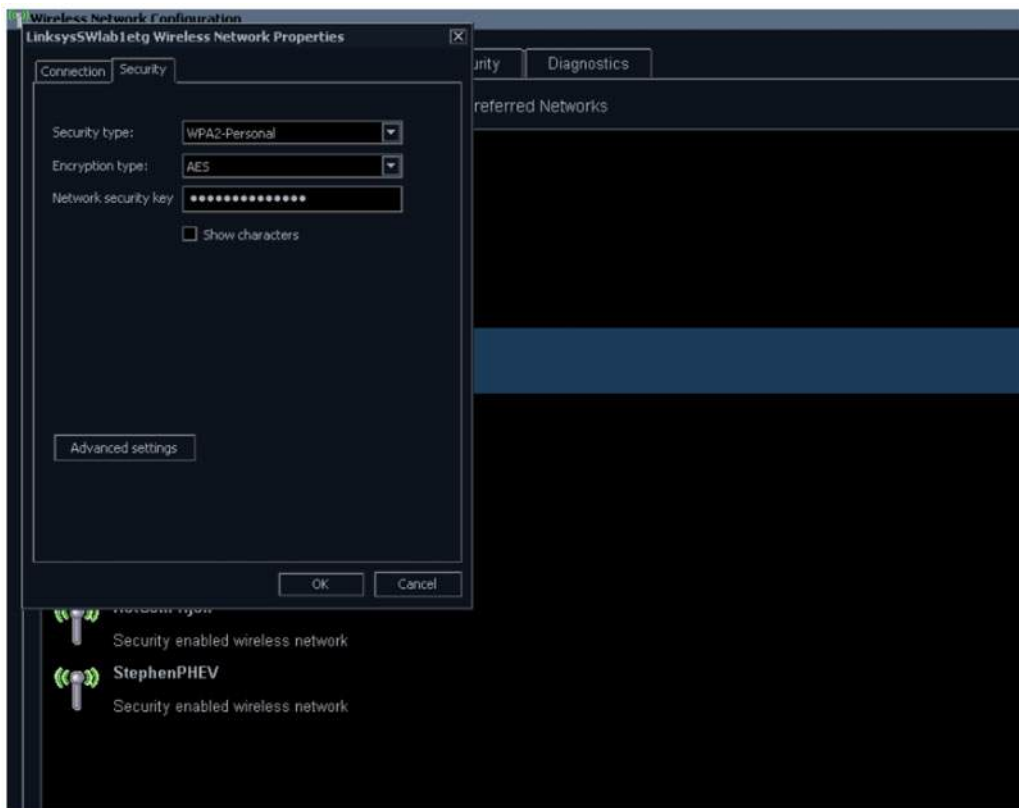

Figure 12-65. Network Settings Window - Security

9. If the wireless network is to be configured for WPA/SWPA2 Enterprise and a customer-specific certificate is to be installed on the system, this can be done by using the certificate dialog available from the LDAP config page in the Connectivity — Security section.
 - a. First, go to the LDAP config.

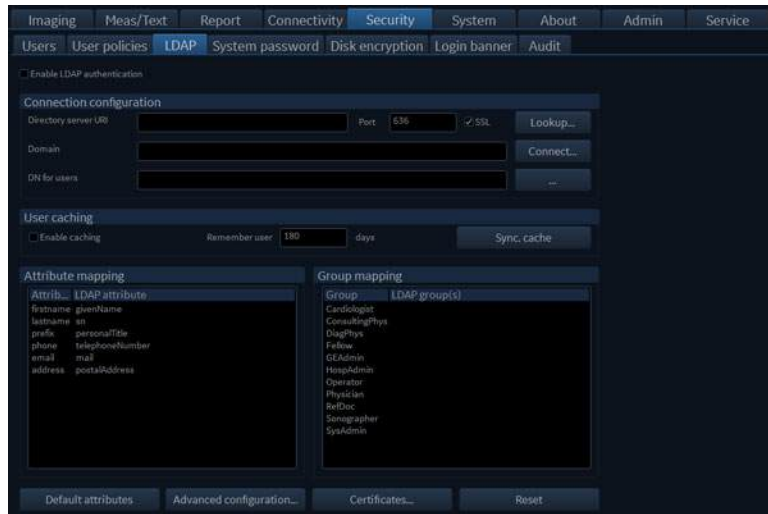

Figure 12-66. LDAP config screen

- b. Then click on the **Certificates...** button to open the Certificate dialog.

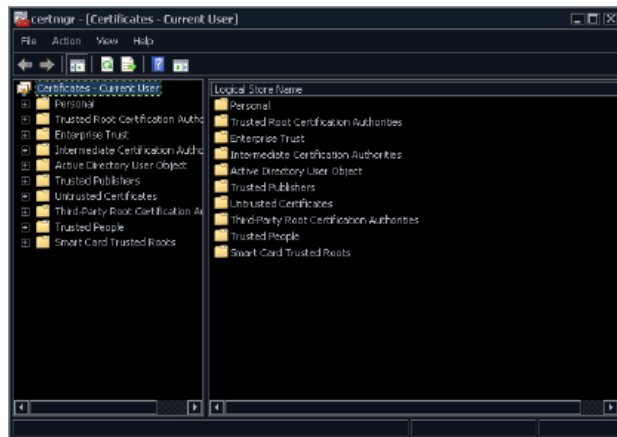

Figure 12-67. Certificate dialog

10. After you have finished setting up your connection press **OK**. The ultrasound system will then try to establish a connection to your network. A dialog will be shown on screen while this is in progress.

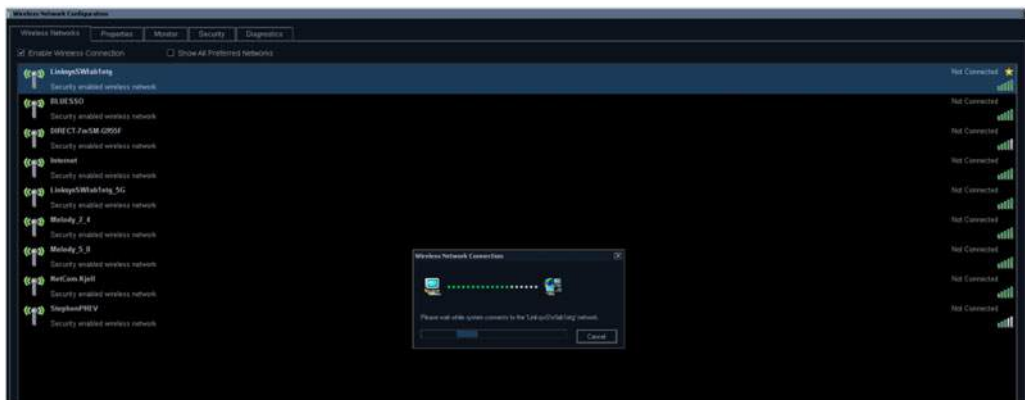

Figure 12-68. Connecting to Network Dialog

11. Once a connection has been established you will see the status **Connected** in the **Wireless Settings** page, next to the network you have connected to.

All network connections that are configured will also be displayed with a star icon.

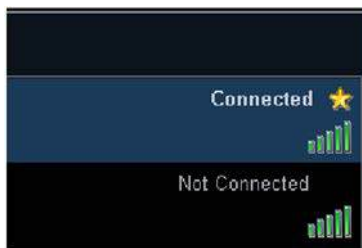

Figure 12-69. Connection Established

NOTE: Whenever connection to a new/different wireless network is required, it will be necessary to repeat all procedure steps above.

Data Streaming

NOTE: The **StreamServer** option key should be installed to enable streaming live ultrasound data.

The system has the capability to stream live ultrasound image data (both 2D and 3D) over the network connection to enabled devices. To configure this capability perform the following steps:

Enable data streaming

1. Press **More** on the Touch Panel, then **Utility**

2. Press **Config...** on the Touch Panel
3. Select the tab **Connectivity**, then **Network**
4. Press the **Stream Server** button
5. Check **Enable Streaming** on the **Data Streaming Settings** dialog
6. Enter stream server **Port No** (or use the default port)

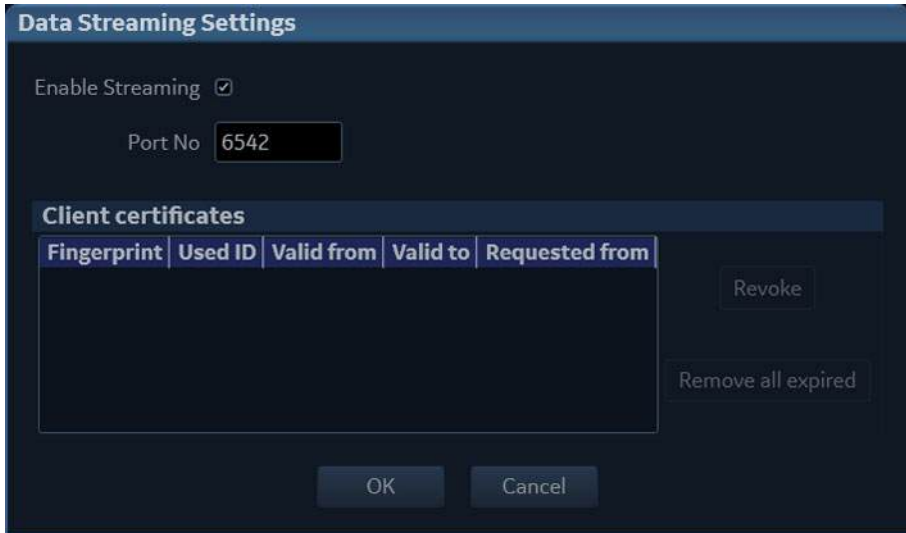

Figure 12-70. Data Streaming Settings

User setup for data streaming

Only a member of the group “ConsultingPhys” will have permission to receive streamed data.

See example of users who can receive streaming data below.

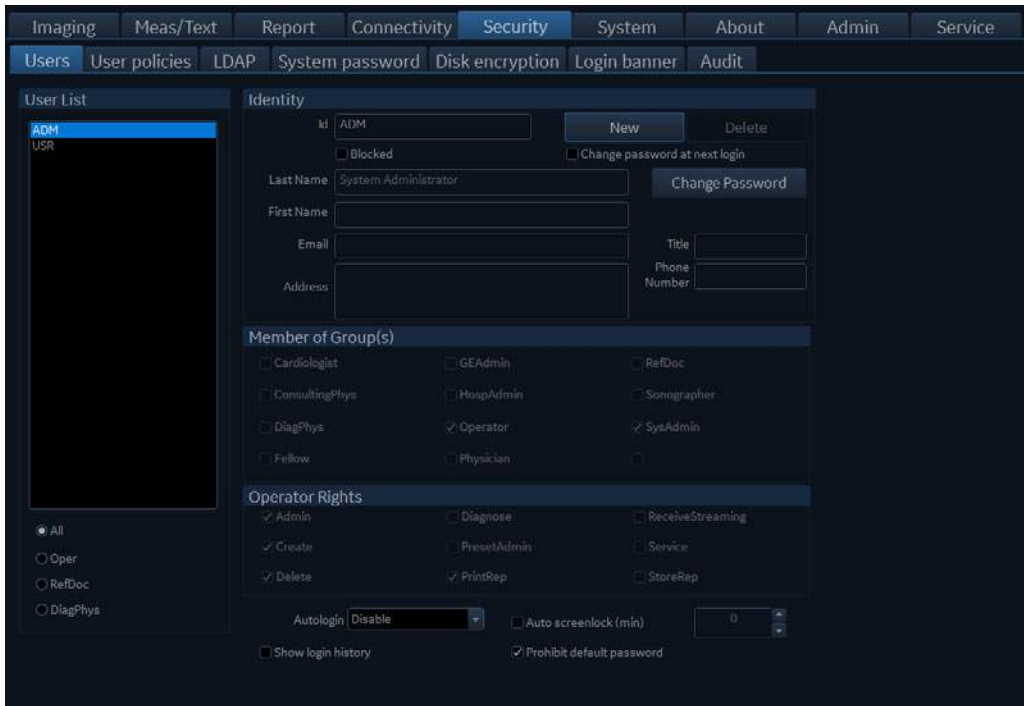

Figure 12-71. User setup for streaming data and images from the scanner

If LDAP authentication is enabled, at least one of the LDAP groups that the user belongs to must be mapped to the group “ConsultingPhys” in order to allow the user to receive streaming data.

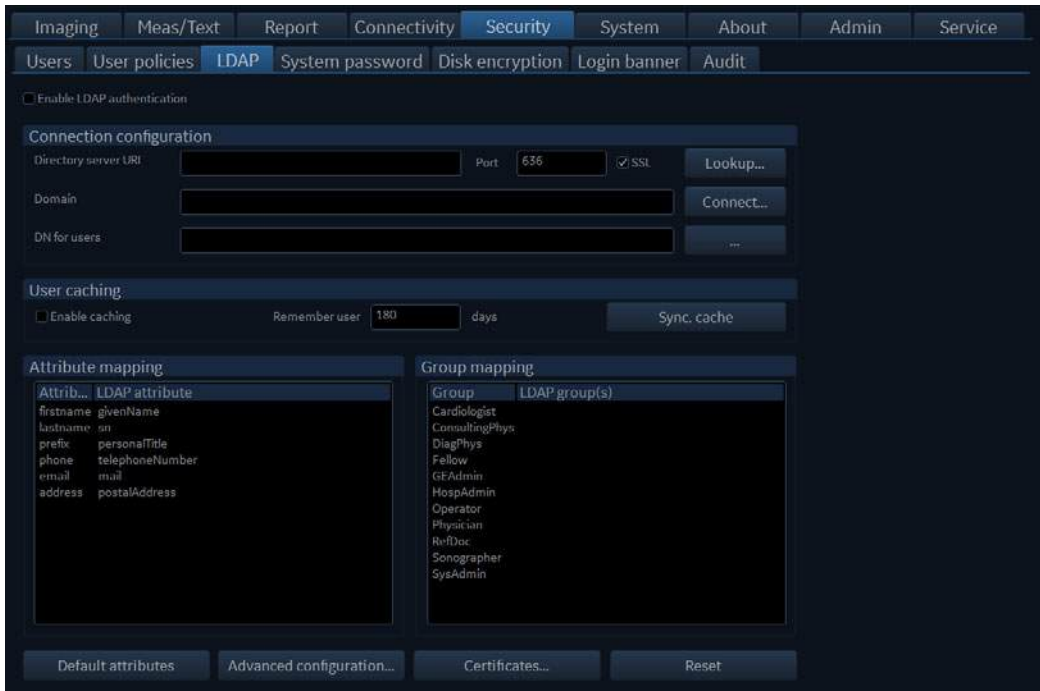

Figure 12-72. LDAP configuration

Authentication

Before an enabled device can receive streamed live ultrasound data, authentication is required to start. The user will be authenticated using both username/password (configured as described in 'Users and Security' on page 12-10) and a PIN code generated by the system upon first connected.

Subsequent connections will use a certificate generated after the first successful connection. The client will be asked to enter a PIN code if the client application has no valid client certificate. The system shows a dialog window with the PIN code (Figure 12-73).

After entering correct PIN code, client certificate will be issued and sent to client application automatically. The next attempts of connection do not require entering PIN code as long as the certificate is valid.

NOTE: *The certificate will automatically expire after one year.*

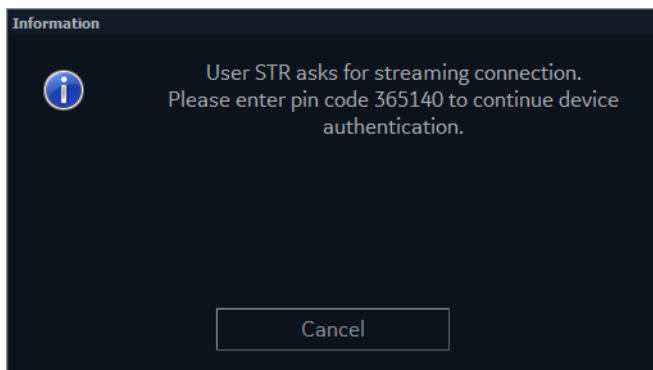

Figure 12-73. PIN code window

NOTE: Operator can refuse streaming data by pressing **Cancel** button.

Revoke Client certificate

All issued client certificates are listed in the *Data Streaming Settings* dialog. See 'Enable data streaming' on page 12-80.

To revoke a client certificate:

1. Select a client certificate
2. Press **Revoke**

NOTE: At the next attempt to connect, this client will be asked for authentication again (see page 12-83).

Press **Remove all expired** to clear the list of client certificates.

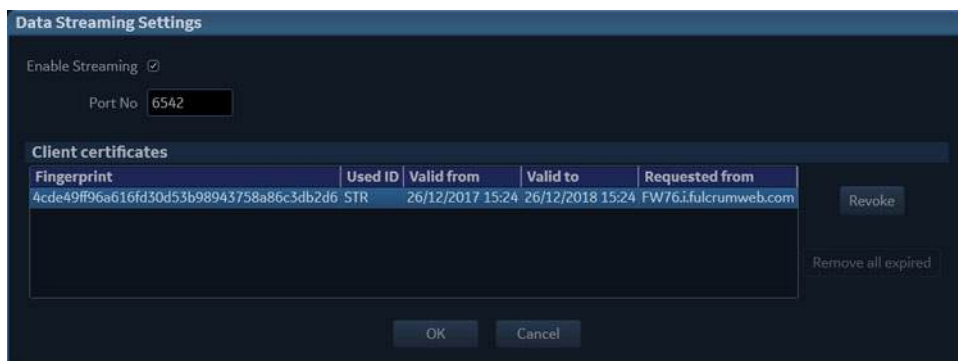

Figure 12-74. Client certificate example

Relocated features from v201 - v205

Below is the list of connectivity functions that have been relocated into version 206.

Table 12-1: List of relocated features

Configuration functions	Location in SW versions v201 - v205	Location in SW version v206
Server configuration	Connectivity - TCPIP (click Add or Modify, or Remove)	Connectivity - Dataflow ((click the Servers button) or the ' <i>pencil</i> ' icon after having selected Properties for a selected server). Then, click Add or Modify (or Remove).
Network Settings	Connectivity - TCPIP	Connectivity - Network
Proxy Settings		
Views-X		
Wireless Settings		
Client Certificate		
Data Streaming Settings		
Computer Name		
Ip address		
Client Certificate (for LTS)	Connectivity - TCPIP	Connectivity - DICOM
Certificates (general)	Admin - LDAP	Connectivity - Network
Show Raw Data icon	Connectivity - DICOM	Connectivity - Other
Select default dataflow	Connectivity - Dataflow	Connectivity - Dataflow - Edit
Hiding dataflows	Connectivity - Dataflow (' <i>Hidden</i> ' checkbox)	Connectivity - Dataflow (click on the ' <i>eye</i> ' icon to toggle)
Direct store	Connectivity - Dataflow (' <i>Direct Store</i> ' checkbox)	Connectivity - Dataflow - Edit (' <i>Send images immediately</i> ' checkbox).

Table 12-1: List of relocated features

Configuration functions	Location in SW versions v201 - v205	Location in SW version v206
Add dataflows	Connectivity - Dataflow (select a dataflow from pulldown and unhide clicking 'Hidden' checkbox. Select each 'service' one by one and click <i>Properties</i> to configure. To create a custom one, click <i>Add</i>).	Connectivity - Dataflow (click <i>Add Dataflow</i> and chose a predefined dataflow or Custom to create your own).
Add/remove services to a custom dataflow	Connectivity - Dataflow (click <i>Add</i> , then <i>Configure</i> and move the desired input and output services from the left side to the right side).	Connectivity - Dataflow (click <i>Add Dataflow</i> , select <i>Custom</i> , and select the services needed).
Configure source/destinations for media	Connectivity - Dataflow (select media from the list of dataflows, configure by selecting input/output, and then <i>Properties</i>).	Connectivity - Transfer (hide/show clicking the eye symbol, configure by clicking <i>Properties</i>).
Unlock Patients	Connectivity - Other	Connectivity - Tools
Exam screens/Report headings	Connectivity - Other	Report - Options
Patient ID	Connectivity - Patiend ID	Connectivity - Other
Patient List	Connectivity - Patient List	Connectivity - Other?
Database maintenance (View Audit Log)	Connectivity - Other	Security - Audit
View Activity Report	Connectivity - other	Admin - Activity Report
Printer setup	Connectivity - Additional Outputs	Printer (a new tab where the entire printer setup is done)
Network printer selection	Service	
Add printer	Service	
View/enter option strings	Admin - System Admin	Admin - Licenses
Creating users, setting Auto login, auto screen-lock	Admin - Users	Security - Users

Table 12-1: List of relocated features

Configuration functions	Location in SW versions v201 - v205	Location in SW version v206
Setting up User and password policies	Admin - User Policies	Security - User Policies
Enabling and configuring LDAP	Admin - LDAP	Security - LDAP
Changing system password (not options)	Admin - System Password	Security - System Password
Enabling and configuring Disk Encryption	Admin - Disk Encryption	Security - Disk Encryption
Enabling and setting up a custom log-in banner	Admin - Login banner	Security - Login banner

Configuration of the archiving functions

1. Press **Utility/Config** from the Touch panel and log on as administrator if required.
2. Select the **Connectivity** category and the **Other** subgroup.
The *Other* window with the Patient List displayed.

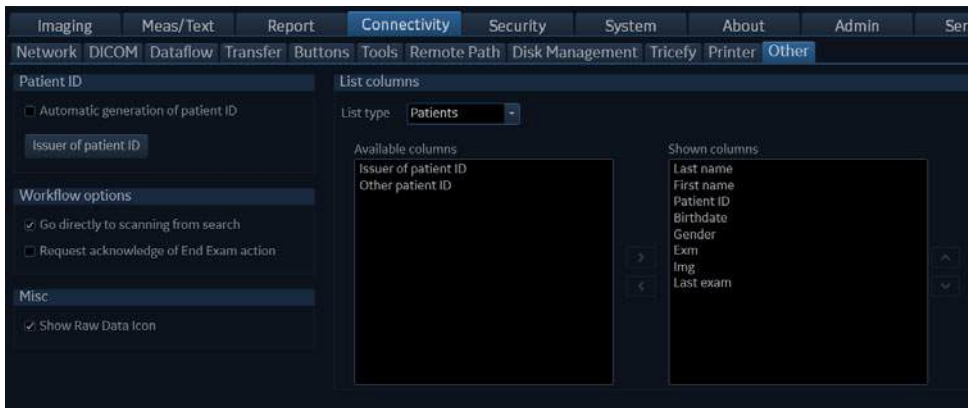





Figure 12-75. The Other window

Configuration of the Patient, Worklist and Examination list in the Archive screen

1. In the *List type* drop-down menu, select the list to edit.
2. To add a column to the list:
 - Select a column to display in the *Available columns* field and press  to add it to the list.
 - Press  /  to move the column.
3. To remove a column from the list:
 - Select the column to remove in the *Show columns* field and press .

NOTE: *The columns First name, Last name, Patient ID, Last exam and Exam date cannot be removed for the lists.*

Network configuration

To be able to use the network functions when connected to a hospital network, the system must have a proper network address. See Network 'System's Network settings' on *page 12-48* for more information.

Dataflow

Communication between the Vivid S70N / S60N and other information providers on the network takes the form of dataflows. Each dataflow defines the transfer of patient information and images from an input source to the system, and from the system to one or several output sources. Input/output devices cannot be added/removed to/from the pre-defined dataflows. However the settings for the devices can be adjusted.

See 'Dataflows available' on *page 10-3* for a complete list and description of dataflows available.

Dataflow adjustments

1. Press **Utility/Config** on the Touch panel and log on as administrator if required.
2. Select the **Connectivity** category and **Dataflow** subgroup. The *Dataflow* sheet is displayed.
3. Select **Add Dataflow** (choose a custom or factory template).

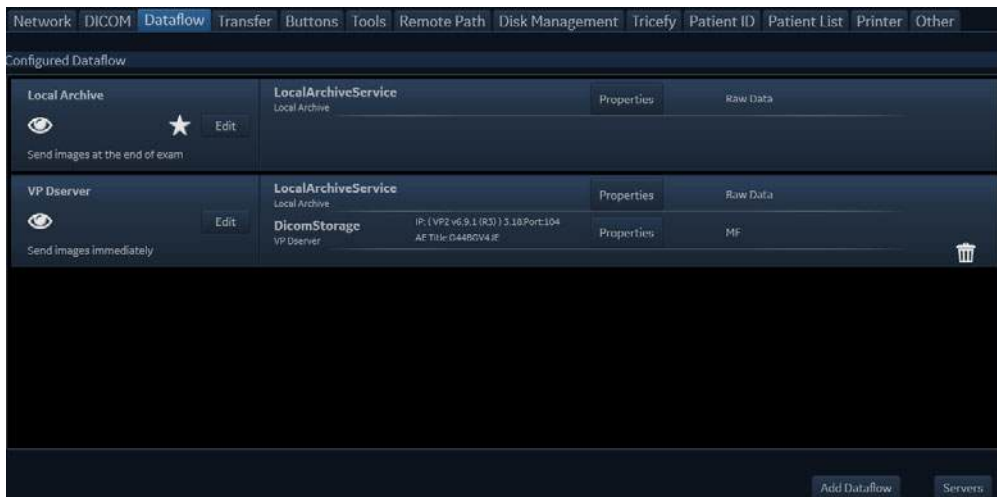

Figure 12-76. The Dataflow sheet

Then, click on the *Edit* button on the selected dataflow to open up the screen below:

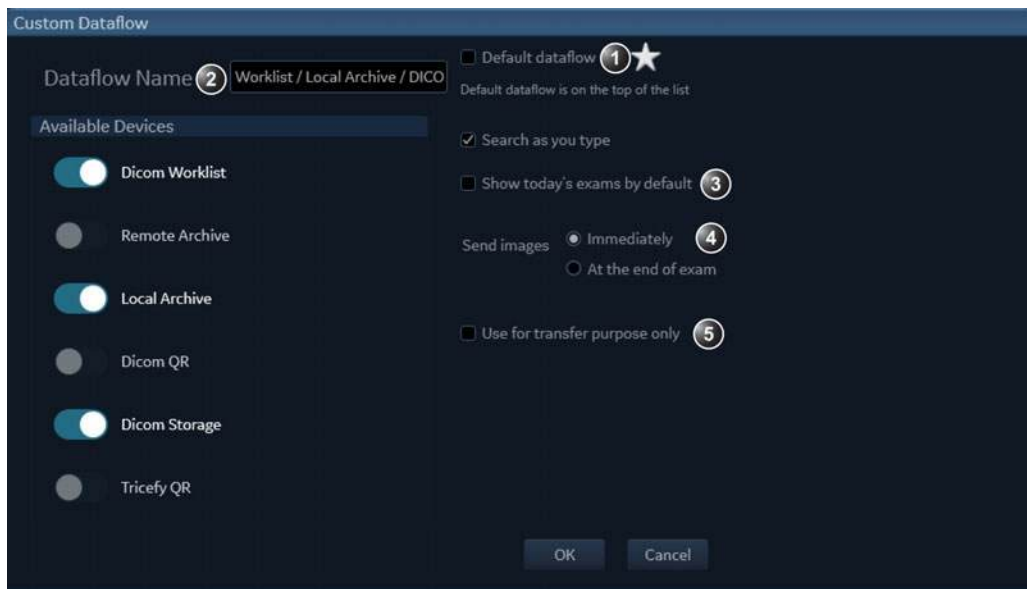

Figure 12-77. Custom Dataflow settings

1. Check Default dataflow to make it default. It will then show up at the top of the dataflow list — with the star icon next to it.

2. *Search as you type* will narrow the displayed patients in the archive the more letters/numbers are entered.
3. *Show today's exam by default* will limit the displayed patients when the box is checked.
4. Images can be sent immediately after Image Store (also called Direct Store) or at the end of the exam by configuring *Send images*.
5. If a dataflow is only to be used for transfer purposes and not as a dataflow used for acquiring exams, check the *Use for transfer purpose only* checkbox.

Adjusting the assigned devices

1. Select the dataflow to configure.
2. Select the input or output device to configure.
3. Press **Properties**.
The *Properties* window is displayed.
4. Adjust the device specific parameters as desired (see table below). Not all the settings listed below apply to all devices.

General settings	Definition
Name	Free text: give a descriptive name for the device.
IP address	Select from drop-down menu (if available)
Database Location	Automatically selected according to the IP address
File destination	Automatically selected according to the IP address
MPPS	Modality Perform Procedure Step: send information (typically to a HIS) that a scheduled exam has been started, performed or interrupted.

Image settings	Definition
Raw Data Settings	Raw Data Settings gives you the ability to select which images to transfer in raw data format by mode: <ul style="list-style-type: none"> • All images • Apical 2D (auto classified) • Parasternal 2D (auto classified) • 2D/Biplane/Triplane • M-mode • Colorflow/TVI/Biplane/Triplane • Color M-mode • PW/CW • 4D • 4D Color
Raw Compression	Enables compression of raw data images upon storage and export. Raw compression is active only if the setting <i>Allow raw data</i> is checked.

Image settings	Definition
Max Frame rate	Select 25, 30 or Full (original acquisition) from the pop-up menu. Applies to DICOM only.
Compression	Select compression type or no compression. Applies to DICOM only.
Quality	Set picture quality from 1 to 100%. A low picture quality level allows high data compression, while a high picture quality restrains the compression. Applies to DICOM only.
Allow Multiframe	<input checked="" type="checkbox"/> : Allow cine loop storage. Applies to DICOM only.
Systole only (for Stress)	When this setting is active, all stress images will be sent to the DICOM server showing only systole. The setting is selectable when transferring only multiframe (not raw data).

Connection settings	Definition
Retry	Set maximum number of connection retries, time interval between tentative and time-out.

DICOM settings	Definition
AE Title	The Application Entity Title is set during DICOM configuration. Refer to the network specifications. Please note that reboot of the system is required when changing the AE Title.
Port	The Port no. is allocated during DICOM configuration. Refer to your network specifications.
Verification	Verify the connection to another DICOM application.
Storage commitment	Send a request to a PACS, asking it to permanently archive image(s).
MPPS	Modality Perform Procedure Step: send information (typically to a HIS) that a scheduled exam has been started, performed or interrupted.
DICOM SR settings	<ul style="list-style-type: none"> • Allow SR: enable DICOM SR. • Allow SR private data: include current exam data in a private format within DICOM SR to retain measurements and complete exam information when recalling an exam from a DICOM environment. This is especially important if EchoPAC Plug-in is used in the DICOM environment or if any exam at any later time is expected to be recalled to Vivid S70N / S60N or EchoPAC Software Only using DICOM Query/Retrieve. If the DICOM server does not allow the private data format within DICOM SR files, this feature should be disabled. • Signed Doppler velocities: send signed Doppler velocities. • Use older SR version: when checked a <i>Use older SR version</i> pull-down menu is displayed. The current exam data will be sent in the same format as the selected SR version. Details about format and content of the SR version can be found in the corresponding user manual of the selected version. <p>See also 'DICOM SR' on page 12-68.</p>

Default remote path setting

The user can define a default remote path for a network shared folder (\\server-name\share-name). The default remote path can then be selected as a destination archive for the following operations:

- Export traces function in Q-Analysis
- Export of system error log file
- Export of report templates
- Save as function for images
- Save as function for reports

To define a default remote path:

1. Press **Utility/Config** on the Touch panel and log on as administrator if required.
2. Select the **Connectivity** category and **Remote** subgroup. The *Remote Path* sheet is displayed.

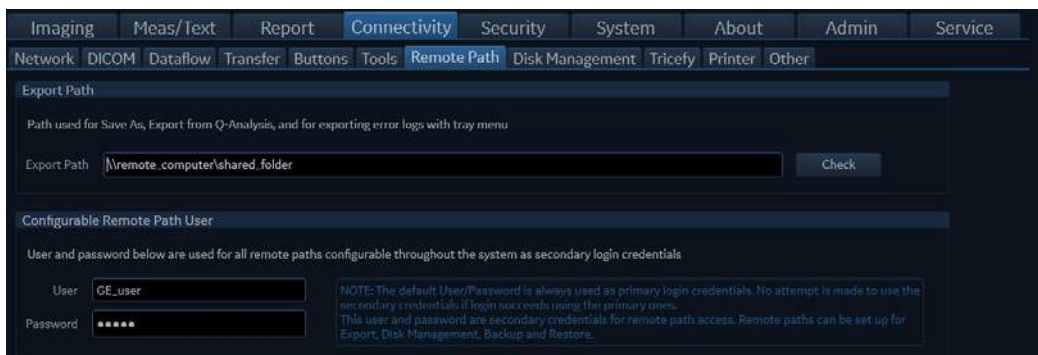

Figure 12-78. The Remote Path sheet

3. In the *Remote Path* section, enter a remote path of a shared folder on the network.
To check the connection, press **Check**.
4. In the *Configurable Remote path user* section enter the user name and password required to access the shared folder.

XML Export configuration

The destination for transfer of patient records to XML format must be configured prior to use. See 'Transferring patient records/examinations' on page 10-42 for a description of the transfer function.

To configure the Transfer function:

1. Press **Utility/Config** on the Touch panel and log on as administrator.
2. Select the **Connectivity** category and **Transfer** subgroup. The *Transfer* sheet is displayed (Figure 12-79).
3. Select the dataflow **Export as XML**.



Figure 12-79. The Transfer sheet (Export to XML)

Transfer to XML format - configuration

1. Select the **Export as XML** and press **Properties**. The properties window is displayed.



Figure 12-80. The XML Export Service properties window

2. Select a removable media or a network volume remote path as the *Destination* pull-down menu.
3. If **Remote path** is selected, enter the remote path and press **Check** to verify the connection.
4. Select **OK** and press **Config**.

Patient ID

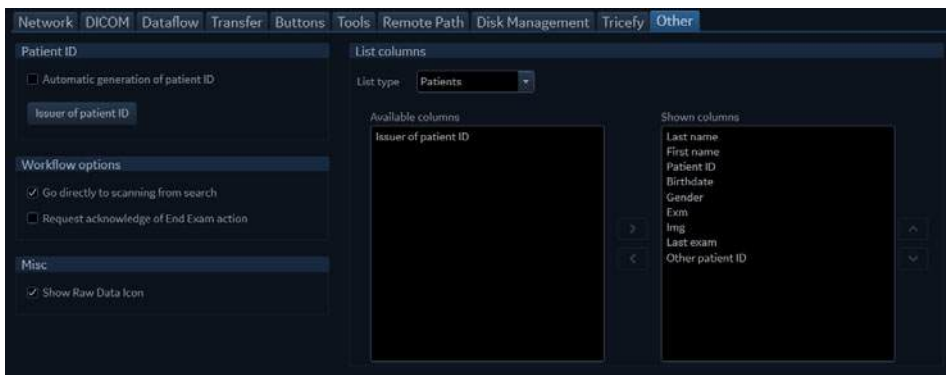

Figure 12-81. The Patient ID sheet

The following settings related to patient id can be adjusted:

Setting	Description
Automatic generation of patient ID	In the <i>Archive</i> screen (see Figure 10-5 on page 10-15), <input checked="" type="checkbox"/> : A Patient ID is automatically generated by the system. <input type="checkbox"/> : A Patient ID is required and must be entered by the user when creating a new patient record in the archive.

Setting	Description
Issuers of patient ID	<p>In the Archive screen (Figure 10-5 on page 10-15), the issuer of a patient id may be specified for a patient id. An issuer may be added, modified, or deleted. The issuer set as default will be used as issuer for all new patients that are created.</p> <p>In addition, in transfer between remote and local archive, two patients with same patient id, one with empty issuer and one with default issuer, are considered the same patient.</p>

Other

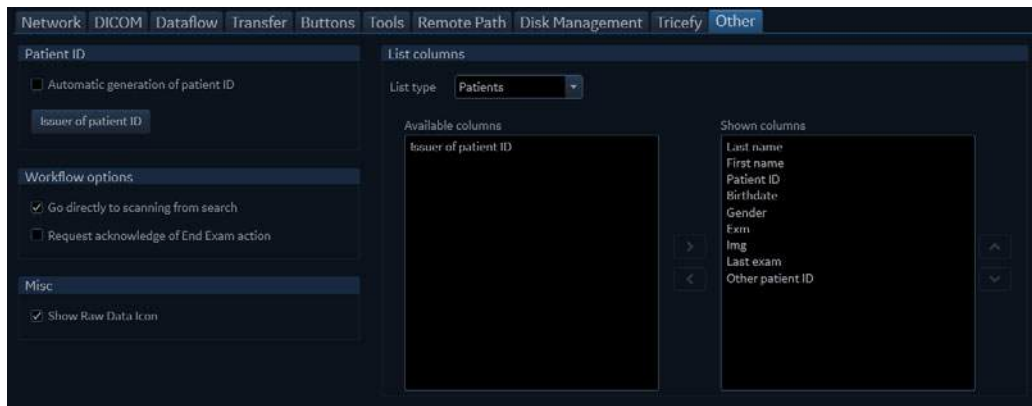

Figure 12-82. The Other sheet

Database maintenance

1. Press **View Audit Log**.
The *Audit log viewer* window is displayed.
2. Adjust the filters as required and press **Search**.
A log is generated showing the activity on the system.

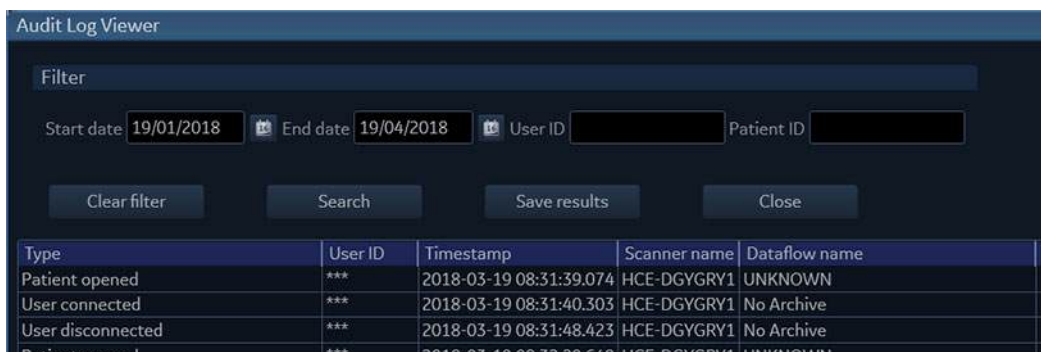

Figure 12-83. The Audit log viewer

3. Press **Save results** to save the log file.
The *Save as* window is displayed.
4. Select the destination media and enter a file name.
5. Press **Save** to save the log file.

Activity report

The Activity report function enables the creation of a report based on study type and user for a defined time frame.

1. Press **View activity report**.
The *Activity report* window is displayed.
2. Adjust the time frame, select the type of studies and users.
3. Select whether to print or save the report as a file.
4. Press **Send** to create the report.

The screenshot shows the 'Activity Report' window with the following details:

- Time frame:** Last: 1 months; Date range: from 19/04/2018 to 19/04/2018.
- Activities to be reported:**
 - TOTAL NUMBER OF STUDIES
 - ADULT ECHO STUDIES
 - Cardiac studies
 - Contrast studies
 - Stress echo studies
 - 2-level stress
 - 3-level stress
 - 4-level stress
 - 5-level stress
 - With contrast
 - FETAL ECHO STUDIES
 - 0 - 12 weeks
 - 12 weeks and older
 - Fetal heart
 - PEDIATRIC ECHO STUDIES
 - 0 - 2 years
 - 2 - 5 years
 - 5 - 10 years
 - 10 - 15 years
 - 15 - 20 years
 - 20 years and older
 - VASCULAR
 - Carotid studies
 - Lower extremity vein
 - Lower extremity arterial
 - Upper extremity vein
 - Upper extremity arterial
 - ABDOMINAL AND SHARED SERVICE
 - Abdominal
 - Small parts
 - Ob/Gyn
 - Contrast
- Show activities for:**
 - Sonographer (operator)
 - Referring physician
 - Diagnosing/reading physician
 - Lab
 - Ward/Department
- Report settings:**
 - Template: Standard (landscape)
 - Send to: Printer

Figure 12-84. The Activity report window

Unlock patients

If for any reason an examination is not properly finished, the patient record is locked and cannot be opened again unless it is unlocked.

To unlock patient records:

1. Press **Utility/Config** on the Touch panel.
2. Select the **Connectivity** category and the **Tools** subgroup.
3. In the *Tools* sheet, select the patient record(s) to unlock.
You can search for a specific patient record or a group of patient record using the searching filters.

4. Select **Unlock** to unlock the selected patient record(s) or select **Unlock all** to unlock all patient records listed.
A *Confirmation* window is displayed.
5. Select **OK**.

Patient management presets

The following settings related to patient management can be adjusted:

Setting	Description
Request acknowledge of End Exam action	<input checked="" type="checkbox"/> : The user is asked to confirm action when ending an examination.
Go directly to scanning from search	<input checked="" type="checkbox"/> : The system goes directly to the <i>Scanning</i> screen after creating a patient record. <input type="checkbox"/> : The system displays the <i>Patient info and exam</i> screen after creating a patient record for further information entry. The user must press Patient or one of the scanning keys on the Control panel to enter the <i>Scanning</i> screen.

Scan Assist Pro Creator

Overview

The Scan Assist Pro Creator is used to build customized Protocols that can be imported onto the Vivid S70N / S60N. These Protocols automate many of the steps normally performed manually by the user, thereby reducing the number of user actions and the amount of time to perform an exam.

The Scan Assist Pro Creator tool can be used both on the system and as an off-system tool. Where there are differences in behavior, this user manual uses the term “on-system” to indicate when the tool is running on the system and “off-system” to indicate when the tool is running off the system.

Protocol export from Vivid S70N / S60N and off-system installation of the Scan Assist Pro Creator

The installation of the Scan Assist Pro Creator on a PC can be done after exporting the installation file from the Vivid S70N / S60N.

The factory and user-defined Protocols can also be exported for editing with the Scan Assist Pro Creator.

1. Insert the USB media to save the files.

NOTE: *CD/DVD are not supported for this function.*

2. Press **Protocol** on the Control panel and **Config** on the Touch panel. Log on if required.

The *Scan Assist Pro* sheet is displayed.

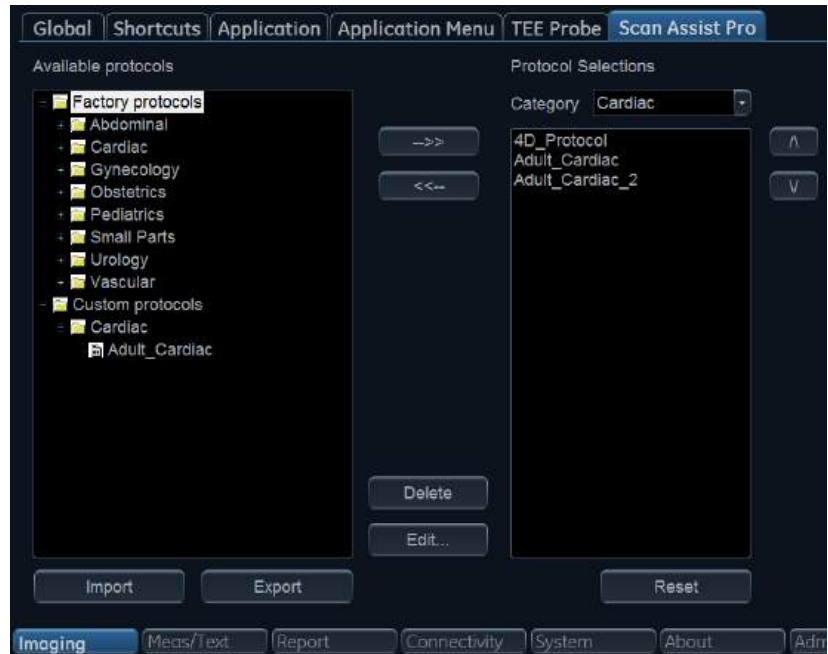

Figure 12-85. The Scan Assist Pro sheet

3. Select **Export** from the *Scan Assist Pro* sheet. The *Export Protocols* window is displayed.



Figure 12-86. Export Protocols

4. In the *Destination* field, select the media to store the files on.
5. In the *Protocol Directory* field, select an existing folder or enter the name of a new folder. The Protocols will be stored to that location.
6. Highlight the Protocol(s) to be exported. If a folder is highlighted, all Protocols in the folder are selected.

Make sure that the option **Export Scan Assist Pro Creator Installation** is checked.

The installation file for the Scan Assist Pro Creator will be stored to a separate folder named ScanAssistantCreatorSetup (Figure 12-87).

7. Select **Export**.

The Protocols and the Scan Assist Pro Creator installation file are exported.

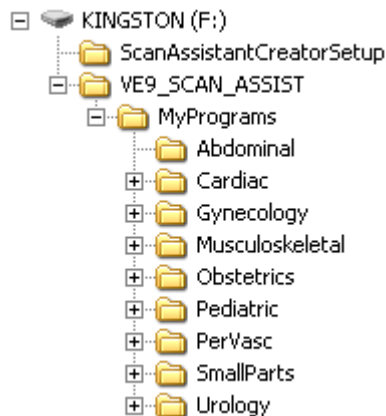

Figure 12-87. Export folder structure

Installation of the Scan Assist Pro Creator

1. Insert the USB media mentioned above into the computer.
2. Double-click on the **Setup.exe** file located in the ScanAssistantCreatorSetup folder and follow the instructions on screen to install the Scan Assist Pro Creator.

Starting Scan Assist Pro Creator

Off-system

1. Double-click on the **Scan Assist Pro Creator** icon on the computer desktop to start the Protocol.

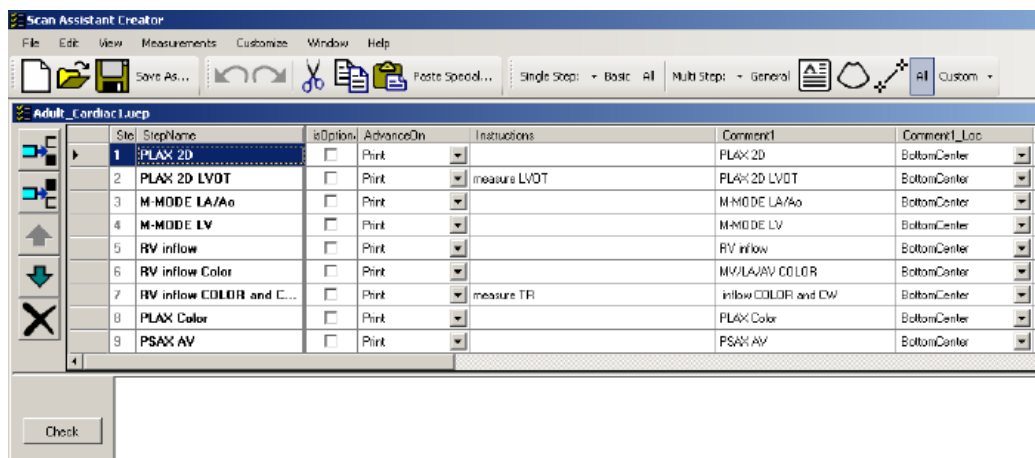

Figure 12-88. Scan Assist Pro Creator screen

On-system

1. Press **Protocol** on the Control panel and **Config** on the Touch panel. Log on if required.
The *Scan Assist Pro* sheet is displayed (Figure 12-85, page 12-101).
2. To edit an existing Protocol, select the Protocol in the *Available Protocols* field on the left-hand side of the *Scan Assist Pro* sheet.
3. Select **Edit** to start the Scan Assist Pro Creator.

File handling

Off-system directory structure

When using Scan Assist Pro Creator off-system, it is important to organize the Protocols in a way that will make it easy to import them onto the system. All Protocols must be stored in a VIVID_SCAN_ASSIST directory. Within this directory, one or more user-specified directories can be created. Within each of these user-specified directories are the category directories (Abdominal, Cardiac, etc.) that hold the actual Protocols.

To specify the directory structure:

1. In the Scan Assist Pro Creator, select **File/Directory**.
The *Directory configuration* window is displayed.

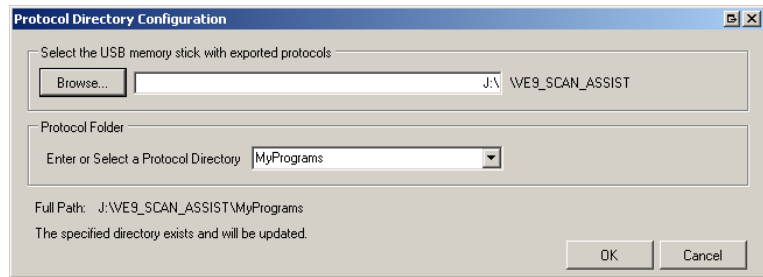

Figure 12-89. The Directory configuration window

2. Select the location of the VIVID_SCAN_ASSIST directory and select or create a user Protocol subdirectory.



File extensions

Factory defined Protocols have an .ep (exam protocol) extension while user-defined Protocols have an .uep (user exam protocol) extension. Both factory and user-defined Protocols can be read into the Scan Assist Pro Creator, but only user-defined Protocols are created. If a factory Protocol is read into the Scan Assist Pro Creator and then edited, it is saved as a user-defined Protocol.

Creating new Protocols

A Protocol is made up of a series of steps. Each step has various attributes that need to be defined. Protocols can be made from scratch or by modifying an existing Protocol.

To create a new Protocol:

1. Select either:
 - **File/New (Ctrl+n)** to start a new Protocol.
 - **File/Open (Ctrl+o)** to open an existing Protocol (.ep or .uep)
2. Select **View/Single step: All** to display all the attributes for the first step.
3. Adjust the attributes for the current step. See 'Step attributes' on page 12-108 for a description of the attributes.
4. Once done press  to add a new step below the first step (or select the next step if editing an existing Protocol) and adjust the attributes for this new step as required.
5. Other possible adjustments:
 - Select  (**Ctrl+Up Arrow**)/ (**Ctrl+Down Arrow**) to move a step.

Select  to delete selected step(s).

- When all steps are created, press **Check** to verify the Protocol.

Any invalid attribute settings reported should be corrected and the Protocol rechecked.

Measurements in Protocols

Because there are many measurements available on the Vivid S70N / S60N and because the measurement package is highly customizable, there is some special handling for measurements.

To set up a measurement step in a Protocol:

- Press **Measurements** and select a measurement category and optionally a measurement subcategory.

The measurements available for the attributes *Measure 1* to *Measure 3* and *Vessel* are limited to the measurements available in the category or subcategory selected.

- Select the desired *Measure trigger* parameter (see 'Measurement attributes' on page 12-111).

NOTE: *To configure a Vessel measurement, leave the Measure trigger attribute to **None**.*

- Select the desired measurements for *Measure 1*, *Measure 2* and *Measure 3*.

Saving Protocols

- Select **File/Save (Ctrl+s)**

NOTE: *Select **File/Save as** to save the Protocol with a different name.*

If the Protocol was not checked, a dialog is displayed giving the opportunity to check the Protocol for errors before saving.

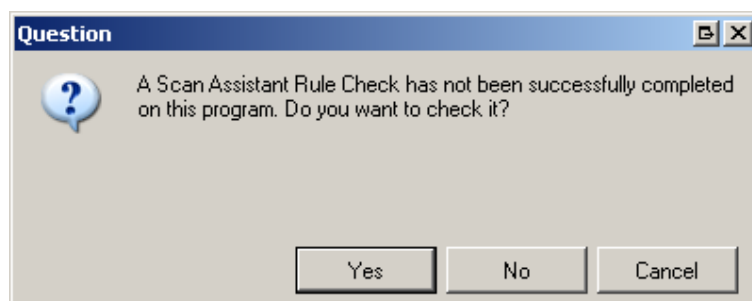

Figure 12-90. Protocol check dialog

2. Select:

- **Yes** to check the Protocol before saving it.
- **No** to bypass the Protocol check.
- **Cancel** to cancel the save request.

Views

A Protocol is made up of a series of steps. Each step is made up of various step attributes. The step and step attribute data can be viewed in many ways using the Scan Assist Pro Creator. The different ways to look at the data are called Views. The view of choice is selected from the *View Menu* or from toolbar.

Single step views

There are two Single step views: Basic and All. The Basic view shows the most common attributes of the selected step. The All view shows all of the attributes of the selected step.

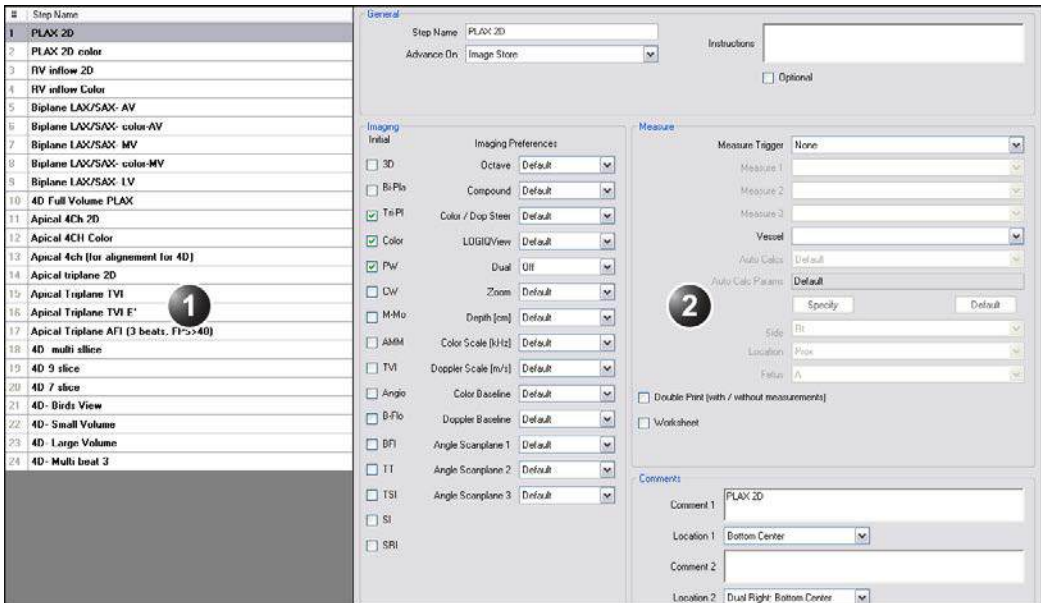

1. List of all steps in the Protocol
2. Attributes for the selected step

Figure 12-91. Single step view (All)

Multi step views

Multi step views show the step attributes for all the steps in a Protocol. There are six Multi step views: General, Comment, Scan, Measure, Custom and All.

#	Step Name	Optional	Advance On	Instructions	Comment 1	Location 1	Comment 2	Location 2	3D	Bt-Flt	Tn-Flt	Color	PW
1	PLAX 2D	<input type="checkbox"/>	Image Store		PLAX 2D	Bottom Center		Dual Right: Bottom ...	<input type="checkbox"/>	<input type="checkbox"/>	<input type="checkbox"/>	<input type="checkbox"/>	<input type="checkbox"/>
2	PLAX	<input type="checkbox"/>	Image Store	measure LVDT	PLAX 2D LVDT	Center		Dual Right: Bottom ...	<input type="checkbox"/>	<input type="checkbox"/>	<input type="checkbox"/>	<input type="checkbox"/>	<input type="checkbox"/>
3	M-MDL	<input type="checkbox"/>	Image Store		M-MODE LA/Ao	Center		Dual Right: Bottom ...	<input type="checkbox"/>	<input type="checkbox"/>	<input type="checkbox"/>	<input type="checkbox"/>	<input type="checkbox"/>
4	M-MODE LV	<input type="checkbox"/>	Image Store		M-MODE LV	Bottom Center		Dual Right: Bottom ...	<input type="checkbox"/>	<input type="checkbox"/>	<input type="checkbox"/>	<input type="checkbox"/>	<input type="checkbox"/>

1. List of all steps in the Protocol
2. Attributes for all steps in the Protocol

Figure 12-92. Multi step view (All)

The information displayed in each multi step view is configurable.

1. Select **Customize/Views**.
The Customize multi step views window is displayed.
Each tab represents a different Multi step view. Within a tab, the checked boxes are the step attributes that are displayed in that Multi step view.
2. For each Multi step view check the attributes to be displayed.
3. Select **Save**.

Step attributes

Scan Assist Pro allows the user to program the steps in an exam and to program certain attributes for each step. The attributes are what give the Scan Assist Pro Protocol behavior. The tables below provide a description of all attributes.

General attributes

Name	Input	Description
Step name	Any text	Name of the step that appears in the Scan Assist Pro window.
Advance on	Store	Advance to the next step after pressing Store on the Control panel.
	Store & Unfreeze	Advance to the next step after pressing Store and Unfreeze on the Control panel.
	Store & user selection	Advance to next step after pressing Store on the Control panel and Down arrow on the keyboard.
Instructions	Any text	Notes displayed in the Scan Assist Pro window when the step is active. Hint: the probe and application required for this Protocol should be entered in the <i>Instruction</i> field of the first step.
Optional	<input checked="" type="checkbox"/>	An optional step is given a check mark during Protocol execution even if no image is acquired.

Comment attributes

Name	Input	Description
Comment 1 Comment 2	Any text	User annotation associated with the step. When editing in a Multi step view, use Alt+Enter to create a new line.
Location 1 Location 2	Top Left Middle Left Bottom Left Top Center Bottom Center Top Right Mid Right Bottom Right	Location of the annotation on screen.

Imaging attributes

Name	Input	Description
Initial modes	<input checked="" type="checkbox"/>	Scanning mode associated with the step. Some scanning modes may be combined (e.g PW Doppler and Color Flow).
Octave	Off	Octave is off.
	On	Octave is on.
	Default	Octave not specified.
Compound	Off	Compound is off.
	On	Compound is on.
	Default	Compound is not specified.
Color/Doppler steer	Left	Color/Doppler steered to the left.
	Center	Color/Doppler not steered.
	Right	Color/Doppler steered to the right.
LogiqView	Off	LogiqView is off.
	On	LogiqView is on.
	Default	LogiqView not specified.

Name	Input	Description
Dual	Off	Single screen display
	Left Active	Dual screen display is on with the left image active.
	Right Active	Dual screen display is on with the right image active.
	Simultaneous	Displays 2D and Color mode side-by-side.
Zoom	Off	Zoom is off.
	On	Zoom is on.
	Default	Zoom is not specified.
Depth	Default	Depth is not specified.
	1 – 30 cm	Adjust Depth.
Color Scale	Default	Color Scale is not specified.
	0.25 – 14 kHz	Adjust Color Scale.
Doppler Scale	Default	Doppler Scale is not specified.
	0.05 – 13 m/s	Adjust Doppler Scale.
Color Baseline	Default	Color Baseline is not specified.
	0 – 20	Adjust Color Baseline.
Doppler Baseline	Default	Doppler Baseline is not specified.
	0 – 20	Adjust Doppler Baseline.
Angle Scan plane 1 – 3	Default	Scan plane is not specified.
	0 – 355 deg.	Adjust scan plane.

Measurement attributes

Name	Input	Description
Measure trigger	Measure key	Start Measure 1 attribute when Measure is pressed on the Control panel.
	Freeze key	Start Measure 1 attribute when Freeze is pressed on the Control panel.
	Store key	Start Measure 1 attribute when Store is pressed on the Control panel.
	None	Measurement not triggered by the Protocol. Vessel measurements are available when Measure trigger is set to None (see below).
Measure 1 Measure 2 Measure 3	Various measurements	Specify the measurement to perform. Select a measurement category from the <i>Measurement</i> menu.
Vessel	Various Doppler vessel measurements	Specify the vessel measurement to perform. Vessel measurement is available only if <i>Measure trigger</i> is set to None . The list of available measurements is dependent of the category selected in the <i>Measurement</i> menu.
Auto Calcs	Default	Auto Calcs state is not specified.
	Off	Auto Calcs state is set to off.
	Frozen	Auto Calcs state is set to Frozen.
	Live	Auto Calcs state is set to Live.
Auto Calc Params	Various Auto Calc parameters	Specify the Auto Calc parameters to be used. Press Specify and select the Auto Calc parameters from the <i>Auto Calc parameter</i> selection window. Press Default to set the Auto Calc parameter selection to default.
Side	Rt Lt None	Set the side measurement qualifier to either Right or Left. Note: the side measurement qualifier is not set by the Protocol.
Location	Prox Mid Dist None	Set the location measurement qualifier to either Proximal, Middle or Distal. Note: the location measurement qualifier is not set by the Protocol.

Customize Configuration

Name	Input	Description
Fetus	A, B, C or D	The fetus measurement qualifier is set to either Fetus A, B, C or D.
Double Save (with/without measurements)	<input checked="" type="checkbox"/>	The image is stored twice, once with measurements and once without.

Stress Echo

Each application can have a default stress protocol defined.

- Select a probe and an application ('Selecting a probe and an application' on *page 3-29*).
- Select the desired stress protocol application.

Application Presets List

The Application list for each connected probe can be configured to best suit the user's requirements.

The Application list is configured from the *Probe selection* screen on the Touch panel.

1. Press **Probe**.
The *Probe selection* screen is displayed on the control panel ('Selecting a probe and an application' on page 3-29).
2. Press the **Preset config** button for the probe with the application list to config.
3. Press an application preset to adjust. The *Preset config* menu is displayed (Figure 12-93).

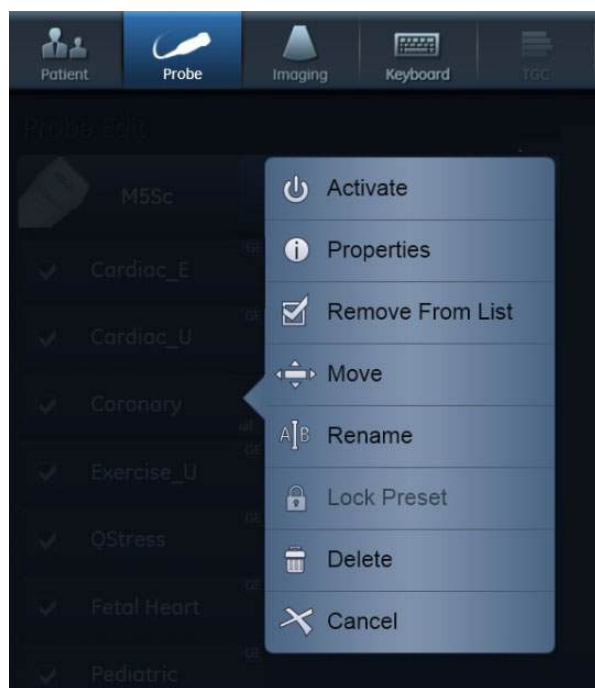

Figure 12-93. The Preset config menu

4. The following can be done:
 - Rename the selected preset

- NOTE:** Only non-active unprotected user-defined application presets can be renamed or deleted.
- Delete the selected preset ('Deleting an application preset' on page 12-118)
 - Move the selected preset up/down in the *Application* menu
 - Remove/Add the selected preset from/to the *Application* menu.
 - Lock/Unlock the selected preset by user with administrator rights.
 - Activate the selected preset.

Generating a new preset

- Press **Probe**.

The Probe selection screen is displayed.

- NOTE:** Any preset name which contains the GE tab in its top-right corner (see example in Figure 12-94) is a "factory preset" which cannot be modified.



Figure 12-94. Factory preset

To generate a new preset based on, for example, the factory-preset "Cardiac_E":

1. Activate the system using factory preset Cardiac_E.
2. Modify desired imaging setting in any imaging mode.
3. Activate the **Probe Selection** screen.
4. Press **Preset Config** at the bottom of the preset list of the selected probe.
5. Press **Save/Create** at the bottom.
6. Provide a name for the new preset.
7. Press **Done**.

The new preset appears at the top of the preset list and becomes the default preset.

Note that the new preset button contains the name Cardiac_E in its bottom right corner (Figure 12-95). This allows you to identify the source for the new preset.



Figure 12-95. User preset

Updating a user preset

1. Activate the **Probe Selection** screen and select a preset.
2. Modify the settings for image parameters.
3. Press the **Preset Config** button of the selected probe.
4. Press **Save/Create**.
A window appears with the name of the current preset.
5. Press **Save** to update the preset or edit the name and then press **Save** to generate a new preset.

To arrange the list of application presets

1. Touch the **Preset Config** button at the bottom of the column of the requested probe.
The **Preset Config** page appears (Figure 12-96).



Figure 12-96. Preset config page

2. Touch any preset.
A preset configuration menu appears (Figure 12-93).
3. Select **Remove from list** to clear the checkbox and remove this preset from the preset list.

NOTE: This removes the preset from the list but does not delete the preset from the Preset config. page.

4. Select **Move** and touch a new position to move the selected preset to a new position on the list.
5. Press **Done** to exit the Preset config page.

To modify additional settings for the selected application

In addition to the various imaging settings for the different scanning modes, other settings can be stored for each user preset. These can be found on the **Application preset config** page:

1. Activate the probe and application-preset to be modified.
2. Pres **Utility/Config** and log on if required.
3. Select Imaging/Application.

The **Application preset config** page appears.

The following settings can be configured on this page:

Parameter	Description
Image Store settings	<p>Single frame (live store):</p> <ul style="list-style-type: none"> • <input type="checkbox"/>: Store cineloop • <input checked="" type="checkbox"/>: Store single frame image only
Auto freeze	<ul style="list-style-type: none"> • <input checked="" type="checkbox"/> Freeze 2D image in Doppler: the last 2D or color flow image is displayed when entering Doppler mode. • Auto freeze after: sets the time after which the system enters in freeze when not in use.
Footswitch functionality	<p>Configure the footswitch pedals. For each pedal, select the operation to perform from the drop-down menu when in Live or in Freeze.</p> <p>Show indicator on screen: when selected, the assigned controls for the pedals are displayed on screen.</p>
Templates and Packages	<p>Defines the default stress protocol associated to the application.</p>
<input checked="" type="checkbox"/> Auto invert on steer	<p>In Color flow, the color bar is inverted when steering the color flow sector angle.</p>
<input checked="" type="checkbox"/> Keep cursor when pressing 2D <input checked="" type="checkbox"/> Keep cursor when changing mode	<p>The PW, CW or M-Mode cursor is kept on the 2D display when pressing 2D on the Control panel.</p>

Parameter	Description
<input type="checkbox"/> Keep cursor when pressing 2D <input checked="" type="checkbox"/> Keep cursor when changing mode	The PW, CW or M-Mode cursor is kept in the 2D display when turning off these modes (by pressing PW , CW or M-Mode on the Control panel). The PW, CW or M-Mode cursor is removed in the 2D display when pressing 2D on Control panel.
<input checked="" type="checkbox"/> Keep cursor when changing mode <input checked="" type="checkbox"/> Stay in cursor state when cursor is active	If cursor is active while in PW, CW or M-Mode, display the Cursor Touch panel when switching mode.

Deleting an application preset

Unprotected user-defined application presets can be deleted by any user with operator rights. Protected application presets can only be deleted by a user with Hospital admin rights ('Local System Users' on *page 12-10*). Factory application presets cannot be deleted.

1. Press **Probe**.
The *Probe selection* screen is displayed on the Touch panel.
2. Press the **Preset config** button belonging to the probe with the application preset to delete.
3. Select the application preset to delete.
The *Preset config* menu is displayed (see Figure 12-93 on *page 12-114*).
4. Press **Delete**.
A *Confirmation* window is displayed.
5. Press **OK** to confirm deletion.

6VT-D TEE Probe

1. Press **Utility/Config** on the Touch panel and log on if required.
2. Select **Imaging/Probe Buttons**.
The *Probe Button* sheet is displayed.

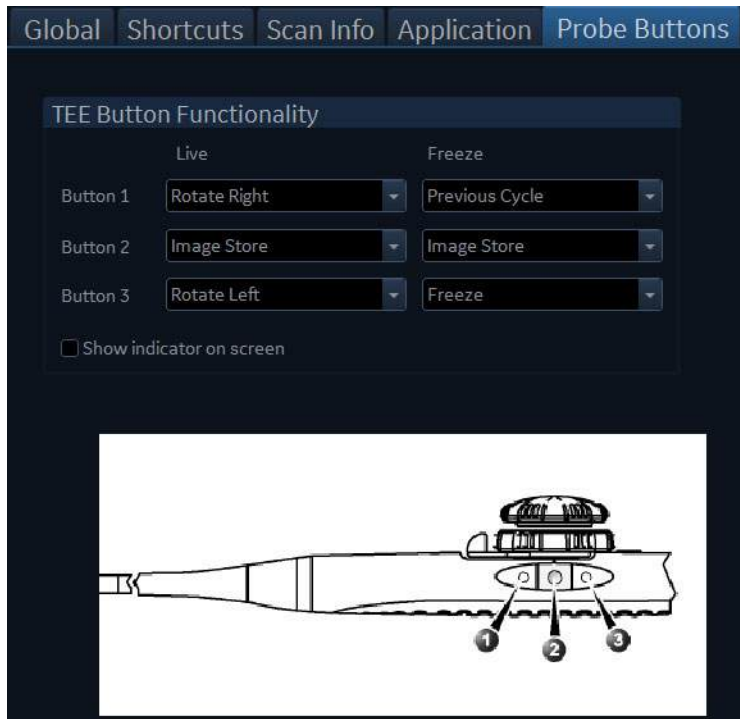
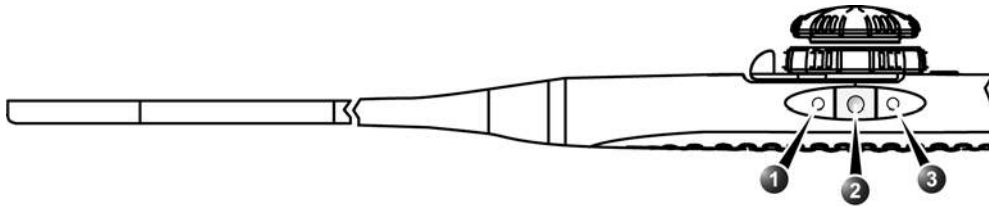

Figure 12-97. The Probe Buttons sheet

3. For each button on the TEE probe handle, select the operation to perform from the drop-down menu when in Live or in Freeze.
4. Check **Show indicator on screen** to display the button assignments on screen.



1. Button 1 (closest to the probe tip)
2. Button 2
3. Button 3

Figure 12-98. The TEE probe buttons

Image View

It is possible to display the content of the image area of the system monitor also on the Touch Panel. To enable this feature, the user should press the **More** button in the *Shortcut bar* (see Figure 3-26 on page 3-40), and then press **Image View**, see Figure 12-99 below.



Figure 12-99. Image View in the 'More' menu

The image area of the system monitor will then be visible also on the Touch Panel, as seen in Figure 12-100 below.

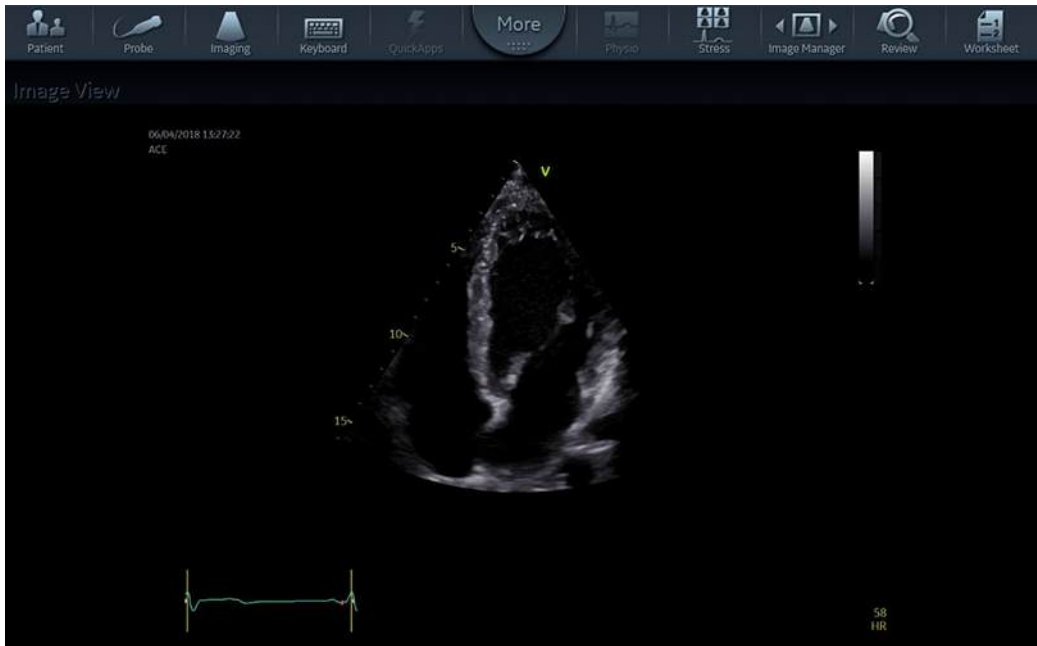

Figure 12-100. Touch Panel with Image View, showing the content of the image area of the main monitor



WARNING

Image quality on the Touch screen may be sub-optimal compared to the main system monitor.

Chapter 13

Probes

'Probe overview' on page 13-2

'Care and Maintenance' on page 13-19

'Probe safety' on page 13-63

'Biopsy' on page 13-67.

'Probe Check' on page 13-80

Probe overview

Supported probes / accessories

Probes described below are accessories for ultrasound systems
Vivid S70N / S60N.

Phased Array Sector probes

Probe	Technical data
M5Sc-D	Frequency: 1.5–4.6 MHz (H*) Foot print: 18 x 27 mm Field of View (FOV): 120 degrees Depth of Field (DOF): 36 cm # of elements: 240
3Sc-RS	Frequency: 1.3–4.5 MHz (H*) Foot print: 18 x 24 mm FOV: 120 degrees DOF: 36 cm # of elements: 64
6S-D	Frequency: 2.4–8.0 MHz (H*) Foot print: 17 x 24 mm FOV: 115 degrees DOF: 16 cm # of elements: 96
12S-D	Frequency: 3.0–12.0 MHz (H*) Foot print: 13 x 18 mm FOV: 105 degrees DOF: 12 cm # of elements: 96
4Vc-D (Vivid S70N only)	Frequency: 1.4–4.4 MHz (H*) Foot print: 18 x 29 mm FOV: 90 degrees DOF: 36 cm # of elements: 6000
H*: Harmonic Imaging Settings Available	

Linear Array probes

Probe	Technical data	
9L-D	Frequency:	2.4–10.0 MHz (H*)
	Foot print:	14 x 53 mm
	FOV:	45 mm
	DOF:	16 cm
	# of elements:	192
11L-D	Frequency:	4.0–12.0 MHz (H*)
	Foot print:	13 x 47 mm
	FOV:	39 mm
	DOF:	8 cm
	# of elements:	192
L8-18i-D	Frequency:	5.0–18.0 MHz (H*)
	Foot print:	11 x 35 mm
	FOV:	25 mm
	DOF:	10 cm
	# of elements:	168
ML6-15-D	Frequency:	4.5–15.0 MHz (H*)
	Foot print:	16 x 61 mm
	FOV:	50 mm
	DOF:	8 cm
	# of elements:	1008
H*: Harmonic Imaging Settings Available		

Curved Array (Convex) probes

Probe	Technical data	
C1-6-D	Frequency:	1.4–6.0 MHz (H*)
	Foot print:	16 x 70 mm
	FOV:	70 degrees
	DOF:	50 cm
	# of elements:	192
C1-5-D	Frequency:	1.4–6.0 MHz (H*)
	Foot print:	17 x 69 mm
	FOV:	70 degrees
	DOF:	50 cm
	# of elements:	192
C2-9-D	Frequency:	2.3–8.4 MHz (H*)
	Foot print:	14 x 51 mm
	FOV:	65 degrees
	DOF:	30 cm
	# of elements:	192

Probe	Technical data
C3-10-D	Frequency: 3.0–10.0 MHz (H*) Foot print: 12 x 22 mm FOV: 95 degrees DOF: 14 cm # of elements: 192
IC5-9-D	Frequency: 3.3–8.6 MHz (H*) Foot print: 17 x 21 mm FOV: 128 degrees DOF: 30 cm # of elements: 192
H*: Harmonic Imaging Settings Available	

Doppler probes

Probe	Technical data
2D (P2D)	Frequency: 2.0 MHz Foot print: 16 mm (diameter) # of elements: 2
6D (P6D)	Frequency: 6.3 MHz Foot print: 8 mm (diameter) # of elements: 2

Transesophageal Phased Array probes

Probe	Technical data
6VT-D	Frequency: 3.0–8.0 MHz (H*) Operating temperature: 8.5–42.5 °C Tip (LxWxH): 45 x 14 x 13 mm FOV: 90 degrees DOF: 20 cm # of elements: 2500
6Tc-RS	Frequency: 3.0–8.0 MHz (H*) Operating temperature: 8.5–42.7 °C Tip (LxWxH): 45 x 14 x 12 mm FOV: 90 degrees DOF: 20 cm # of elements: 64
9T-RS	Frequency: 3.0–10.0 MHz (H*) Operating temperature: 8.5–42.7 °C Tip (LxWxH): 35 x 11 x 8 mm FOV: 90 degrees DOF: 14 cm # of elements: 44
10T-D	Frequency: 3.3–10.0 MHz (H*) Operating temperature: 8.5–42.7 °C Tip (LxWxH): 16 x 8 x 6 mm FOV: 90 degrees DOF: 18 cm # of elements: 32
H*: Harmonic Imaging Settings Available	

Intracardiac Echocardiography (ICE) catheter

Probe	Technical data
ACUSON AcuNav™10F	Frequency: 4.5–11.5 MHz (H*) Aperture (array length): 7.0mm Dimension: 10 French (3.3 mm) / 90 cm catheter FOV: 90 degrees DOF: 16 cm
ACUSON AcuNav™ 8F	Frequency: 4.5–11.5 MHz (H*) Aperture (array length): 7.0mm Dimension: 8 French (2.8 mm) / 90 cm catheter FOV: 90 degrees DOF: 16 cm

Probe	Technical data
Biosense Webster, Inc. SoundStar™ 3D 10F	Frequency: 4.5–11.5 MHz (H*) Aperture (array length): 7.0mm Dimension: 10 French (3.3 mm) / 90 cm catheter FOV: 90 degrees DOF: 16 cm
Biosense Webster, Inc. SoundStar™ eco 10F	Frequency: 4.5–11.5 MHz (H*) Aperture (array length): 7.0mm Dimension: 10 French (3.3 mm) / 90 cm catheter FOV: 90 degrees DOF: 16 cm
Biosense Webster, Inc. SoundStar™ eco 8F	Frequency: 4.5–11.5 MHz (H*) Aperture (array length): 7.0mm Dimension: 8 French (2.8 mm) / 90 cm catheter FOV: 90 degrees DOF: 16 cm
H*: Harmonic Imaging Settings Available	

Modes of Operation for probes

Mode	Probe																									
	3Sc-RS	M5Sc-D	6S-D	12S-D	4Vc-D	9L-D	11L-D	L8-18i-D	ML6-15-D	C1-6-D	C1-5-D	C2-9-D	C3-10-D	6VT-D	6Tc-RS	9T-RS	10T-D	iC5-9-D	2D (P2D)	6D (P6D)	AcuNav™ 10F	AcuNav™ 8F	SoundStar™ 3D 10F	SoundStar™ eco 10F	SoundStar™ eco 8F	
B-Mode (2D-Mode)	+	+	+	+	+	+	+	+	+	+	+	+	+	+	+	+	+	+			+	+	+	+	+	+
B-Mode (4D-Mode ¹)					+									+												
M-Mode	+	+	+	+	+	+	+	+	+	+	+	+	+	+	+	+	+	+	+			+	+	+	+	+
Color Doppler	+	+	+	+	+	+	+	+	+	+	+	+	+	+	+	+	+	+	+			+	+	+	+	+
Doppler / Spectral Doppler or Pulsed Wave (PW) (PW Doppler)	+	+	+	+	+	+	+	+	+	+	+	+	+	+	+	+	+	+	+			+	+	+	+	+
Doppler / CW (Continuous Wave) (CW Doppler)	+	+	+	+	+									+	+	+	+	+	+			+	+	+	+	+
Power Doppler (Angio Flow ²)	+	+	+	+		+	+	+	+	+	+	+	+						+							
Combined Modes 1*						+	+	+	+	+	+	+	+						+							
Combined Modes 2*	+	+	+	+	+									+	+	+	+	+				+	+	+	+	+

¹ Vivid S70N with 4D option only
² Only available with non-cardiac presets
 Combined Modes 1*: B/M, B/Color M, B/PWD, B/Color/PWD, B/Power/PWD
 Combined Modes 2*: B/M, B/Color M, B/PWD or CWD, B/Color/PWD or CWD, B/Power/PWD

Additional Functionality

Mode/ Functionality	Probe																									
	3Sc-RS	M5Sc-D	6S-D	12S-D	4Vc-D	9L-D	11L-D	L8-18i-D	ML6-15-D	C1-6-D	C1-5-D	C2-9-D	C3-10-D	6VT-D	6Tc-RS	9T-RS	10T-D	IC5-9-D	2D (P2D)	6D (P6D)	AcuNav™ 10F	AcuNav™ 8F	SoundStar™ 3D 10F	SoundStar™ eco 10F	SoundStar™ eco 8F	
Color M-Mode	+	+	+	+	+	+	+	+	+	+	+	+	+	+	+	+	+	+			+	+	+	+	+	+
Tissue Velocity Imaging (TVI) ¹	+	+	+	+	+		+	+	+	+	+	+	+	+	+	+	+	+			+	+	+	+	+	+
Tissue Tracking ¹	+	+	+	+	+		+	+	+	+	+	+	+	+	+	+	+	+			+	+	+	+	+	+
Strain Rate Imaging ¹	+	+	+	+	+		+	+	+	+	+	+	+	+	+	+	+	+			+	+	+	+	+	+
Strain Imaging ¹	+	+	+	+	+		+	+	+	+	+	+	+	+	+	+	+	+			+	+	+	+	+	+
Tissue Synchronization Imaging ¹	+	+	+	+	+		+	+	+	+	+	+	+	+	+	+	+	+			+	+	+	+	+	+
TVI M-Mode ¹	+	+	+	+	+		+	+	+	+	+	+	+	+	+	+	+	+			+	+	+	+	+	+
TVI PW Doppler ¹	+	+	+	+	+		+	+	+	+	+	+	+	+	+	+	+	+			+	+	+	+	+	+
Virtual Apex	+	+	+	+	+										+	+					+	+	+	+	+	+
Virtual Convex						+	+	+	+																	
B-Flow Imaging (BFI) ²	+	+	+	+		+	+	+	+	+	+	+	+					+								
BFI Angio ²	+	+	+	+		+	+	+	+	+	+	+	+					+								
B-FLOW ²	+	+	+	+		+	+	+	+	+	+	+	+					+								
Contrast	+	+			+	+				+	+				+	+										
Harmonic imaging (Octave)	+	+	+	+	+	+	+	+	+	+	+	+	+	+	+	+	+	+			+	+	+	+	+	+
Coded Pulse	+	+	+			+	+	+	+	+	+	+	+		+			+								
Bi/Triplane					+										+											
4D Color Flow ³					+										+											

Mode/ Functionality	Probe																									
	3Sc-RS	M5Sc-D	6S-D	12S-D	4Vc-D	9L-D	11L-D	L8-18i-D	ML6-15-D	C1-6-D	C1-5-D	C2-9-D	C3-10-D	6VT-D	6Tc-RS	9T-RS	10T-D	iC5-9-D	2D (P2D)	6D (P6D)	AcuNav™ 10F	AcuNav™ 8F	SoundStar™ 3D 10F	SoundStar™ eco 10F	SoundStar™ eco 8F	
ECG and Respiration Traces	+	+	+	+	+	+	+	+	+	+	+	+	+	+	+	+	+	+	+	+	+	+	+	+	+	+

¹ Only available with Cardiac, Coronary, and Fetal Heart presets
² Only available with non-cardiac presets
³ Vivid S70N with 4D option only

Probe presets

Preset	Probe																										
	M5Sc-D	3Sc-RS	6S-D	12S-D	4Vc-D	9L-D	11L-D	L8-18i-D	ML6-15-D	C1-6-D	C1-5-D	C2-9-D	C3-10-D	6VT-D	6Tc-RS	9T-RS	10T-D	IC5-9-D	2D (P2D)	6D (P6D)	AcuNav™ 10F	AcuNav™ 8F	SoundStar™ 3D 10F	SoundStar™ eco 10F	SoundStar™ eco 8F		
Abdominal	+	+	+	+	+	+				+	+	+	+														
Aorto Iliac	+	+								+	+																
Breast							+		+																		
Cardiac*			+	+				+							+					+		+	+	+	+	+	
Cardiac_A	+	+																									
Cardiac_E	+	+			+									+													
Cardiac_U	+	+			+																						
Cardiac_I														+													
Carotid				+		+	+	+	+				+														
Carotid_J						+																					
Carto																								+	+	+	
Contrast						+			+	+																	
Contrast Low MI	+				+																						
Coronary	+	+	+	+	+									+	+												
Cranial	+	+			+																						
Exercise	+	+			+																						
Fetal Heart	+	+	+	+	+					+	+	+						+									
LEA						+	+		+	+	+		+								+						
LEV						+	+		+	+	+		+														
LEV_J						+																					
LV Contrast	+	+			+									+	+												
LVO Stress	+	+			+																						
Lung	+	+	+	+	+	+	+			+	+																

Preset	Probe																										
	M5Sc-D	3Sc-RS	6S-D	12S-D	4Vc-D	9L-D	11L-D	L8-18i-D	ML6-15-D	C1-6-D	C1-5-D	C2-9-D	C3-10-D	6VT-D	6Tc-RS	9T-RS	10T-D	1C5-9-D	2D (P2D)	6D (P6D)	AcuNav™ 10F	AcuNav™ 8F	SoundStar™ 3D 10F	SoundStar™ eco 10F	SoundStar™ eco 8F		
Msc Skel						+	+	+	+				+														
Neo Head			+	+									+														
Neonatal			+	+													+										
Ob	+	+																									
Ob 1										+	+	+						+									
Ob 2/3										+	+	+															
Pediatric	+	+	+	+	+												+	+									
Pelvic										+	+	+							+								
Preterm				+																							
Renal	+	+			+					+	+	+															
Scrotal							+		+																		
Small parts						+	+	+	+																		
Thyroid						+	+		+																		
UEA						+	+		+					+													
UEV						+	+		+					+													
Vascular						+	+		+					+													



CAUTION

Ultrasound Probes provided to clinics for human medicine should be used for humans only.

Maximum probe temperature

Probe	Max Temp (°C) (Simulated use)	Max Temp (°C) (Still air)
4Vc-D	40.9	40.5
M5Sc-D	42.0	42.2
3Sc-RS	41.3	37.1
6S-D	40.9	41.3
12S-D	41.4	38.5
9L-D	41.0	36.5
11L-D	41.8	38.0
L8-18i-D	41.7	34.5
ML6-15-D	41.6	39.7
C1-5-D	41.1	40.5
C1-6-D	41.9	37.6
C2-9-D	38.6	37.3
C3-10-D	41.3	38.1
IC5-9-D	41.9	35.4
2D (P2D)	35.7	35.5
6D (P6D)	34.8	28.1
6VT-D	41.6	36.2
6Tc-RS	41.7	37.9
9T-RS	41.6	36.3
10T-D	41.9	42.5
AcuNav™ 10F	41.0	34.9
AcuNav™ 8F	41.8	33.6
SoundStar™ 3D 10F	41.0	34.9
SoundStar™ eco 10F	41.0	34.9
SoundStar™ eco 8F	41.8	31.9

NOTE: Lens temperature measured under following conditions per IEC/ EN 60601-2-37 Ed2:

1. Thermocouple is placed at the maximum temperature spot of the lens. Ambient temperature at 23 °C ±3 °C.
2. a: Thermal phantom at >33°C for external probes and >37°C for non-external probes. Maximum probe temperature is measured to be <43°C
b: Thermal phantom at 20-33°C for external probes and at 20-37°C for non-external probes.
Maximum probe temperature rise is measured and added to 33°C for external probes and 37°C for non-external probes. Maximum probe temperature (Simulated use) <43°C.
c: With probe transmitting in air, temperature rise is measured and added to 23°C. Maximum probe temperature (Still air) <50°C
3. Probe placed in contact with a thermal phantom made of tissue-mimicking material as referenced in IEC/ EN60601-2-37
4. Auto-freeze capability is disabled.
5. Temperature is measured when stable (2a and 2b) or for 30 minutes (2c).
6. 6T-series, 9T-series, 6VT-D, 10T-D, 4Vc-D and M5Sc-D probes are equipped with internal temperature sensor and mechanism to monitor and limit temperature.
7. a: Measurement uncertainty for probes with temperature sensor: 0.3°C.
b: Measurement uncertainty and probe variation for other probes: 2°C.

Probe orientation

Some probes are provided with a green light (LED) orientation marking near their head (see Figure 13-1). Probes which do not have a LED have an indentation (notch) for orientation on the probe housing. This LED, or notch, corresponds with the **V** mark on the scanning screen. The **V** mark indicates the orientation of the probe to the scan.

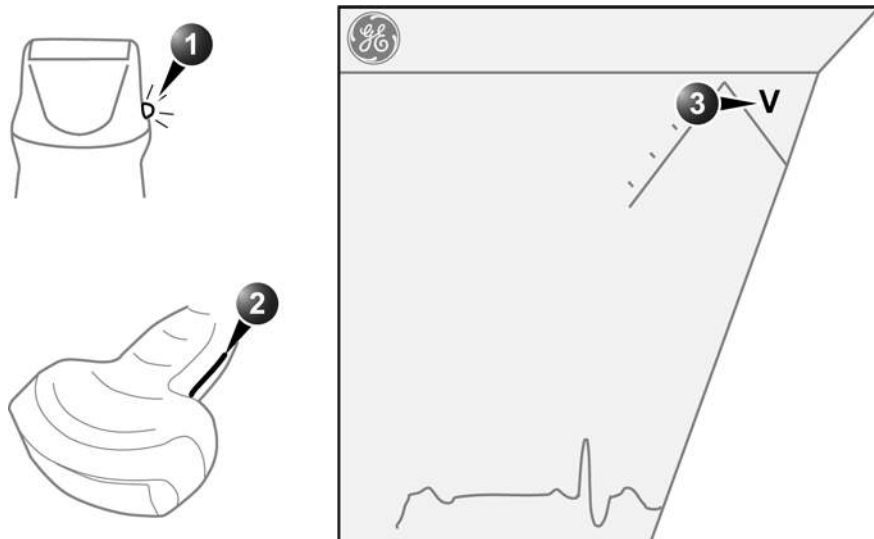

1. LED
2. Notch
3. V-mark on screen: indicates the orientation of the probe to the scan.

Figure 13-1. Orientation marking on probe and on screen

Probe labeling

The following information appears on all probe labels, regardless of the connector type, except for “IPX7,” “CE Mark,” “MD symbol,” and “XDclear™” which only appears on applicable probes.



- | | |
|---|---|
| <ol style="list-style-type: none"> 1. GE Logo 2. Probe Model (Name) 3. UDI Symbol and Data Matrix 4. UDI Human Readable Information 5. Type BF/CF Applied Part 6. Caution: Consult the Manual. 7. WEEE Waste Symbol 8. RoHS Hazardous Substance Symbol, China | <ol style="list-style-type: none"> 9. CE Mark and Notified Body Number 10. REF: Catalog/model number 11. Serial Number 12. Manufacturer's Site Country of Origin 13. Legal Manufacturer Name and Address 14. Date of Manufacture (YYYY-MM) 15. Product Marketing indicator information 16. IP Classification 17. Symbol indicates the item is a medical device |
|---|---|

Figure 13-2. Probe labeling

NOTE: *Non-GE probes may also bear the UDI mark and equivalent information.*

Intracardiac Ultrasound Catheters



CAUTION

Vivid S70N / S60N is designed for compatibility with commercially available 2D ICE catheters (AcuNav™ 10F, AcuNav 8F, SoundStar™ 3D 10F, Soundstar eco 10F, Soundstar eco 8F).

Verify clearance of these devices prior to using them with the Vivid S70N / S60N system.

The ICE ultrasound catheters are sterile, disposable, and licensed for single use only.



DANGER

Remove the ICE catheter from the patient, or disconnect the ICE cord connector from the scanner when defibrillators are used.



WARNING

During scanning, the displayed temperature is expected to be between the patient body temperature and 42.5°C. In case the displayed temperature is lower than the patient body temperature, please abort the scan and replace the ICE catheter.



CAUTION

In some cases, noise artifacts may appear in the ICE ultrasound image when using ablation catheters. In order to help reduce the noise level, please ensure that:

- The facility grounding is connected via a ground potential equalization (equipotentiality) cable to the terminal located in the rear of the system (marked with symbol).
- External ferrite filter is placed around the ICE cord probe cable. (Contact service representative if the ferrite is missing.)



CAUTION

ICE catheters and ICE cord cables require special handling. Refer to the user documentation enclosed with these probes.



Prior to insertion of the 2D ICE probe, test that the catheter is imaging by placing the tip in sterile fluid, and check that movement appears on the ultrasound system monitor.

Intended Use of ICE Catheters

All intra cardiac catheters are intended for intracardiac and intraluminal visualization of cardiac and great vessel anatomy and physiology as well as visualization of other devices in the heart.



Do not use ICE probes for transesophageal imaging.



For USA only:

Federal law restricts this device to sale by or on the order of a physician.

Contraindications

Use of the catheter is contraindicated under conditions where the cardiac catheterization process would cause unacceptable risk to the patient. Contraindicated conditions include, but are not limited to, cases where vascular access is inadequate. Known contraindicated conditions include:

- Sepsis
- Major coagulation abnormalities
- Presence of any intracardiac thrombus
- Presence of a class IV angina or heart failure
- Deep vein thrombosis
- Significant peripheral vascular disease or abnormalities



The catheter is not for use in coronary vessels or fetal tissue. Using the catheter in coronary vessels or fetal tissue can cause patient injury.

NOTE: Before using the AcuNav™ ultrasound catheter please read the ACUSON AcuNav™ Ultrasound Catheter User Manual where you will find:

- Technical description of the catheter and connector.
- Safety and care information for the catheter and connector.
- Procedures for preparing, conducting, and ending an examination.

AirScan Mode

The Vivid S70N / S60N automatically detects whether the ICE ultrasound catheter scans in air and enters a lower power mode to avoid probe surface overheating.

Once the catheter is inserted into the patient vessel/lumen, the ICE ultrasound catheter returns to regular scanning mode.



In some rare occasions, the system may falsely detect that the ICE catheter is in air and stop the scanning even while the catheter is inserted in the patient. In this case a message will appear and the scanner will enter AirScan mode. In such a case press the **Freeze** button twice to resume normal scanning and try changing user controls or reposition the catheter to get image with more echoes.



Start scanning in air and see that the system enters AirScan mode in less than 5 sec to ensure catheter surface overheating is avoided. In case AirScan mode is not activated within 5 sec, please immediately press **Freeze** to stop scanning and wait for 30 sec before the catheter is introduced into the patient's blood circulation.

2D ICE catheters

The 2D ICE catheters are optimized for intracardiac scanning. The catheters are a single-plane, 90-degree, wide-view imaging format catheter device with 64 channels that can transmit and receive data simultaneously.

With catheter, the physician can maneuver the imaging plane located inside the catheter tip to see the region of interest. The physician can steer the catheter to optimize tissue visualization.

The user can steer the tip of the catheter bidirectionally in two planes: left/right and posterior/anterior. The active face of the catheter faces anteriorly, and the scanning plane is longitudinal.

The reusable ICEcord-RS cable connects the catheter to the Vivid S70N / S60N system.

NOTE: *The reusable ICE cord-RS cable is designed exclusively for use with the ICE ultrasound catheters on Vivid S70N / S60N.*

The SoundStar™ 3D 10F, SoundStar eco 10F, and SoundStar eco 8F ultrasound catheters are intended to operate when the Vivid S70N / S60N is interfaced to the CartoSound. The SoundStar 3D 10F catheter may also be used on the Vivid S70N / S60N without the CartoSound interface.

The Acuson AcuNav 10F and AcuNav 8F are intended to be used on the Vivid S70N / S60N without an additional interface.



Use special 'Carto' preset when connected to CartoSound™ System and be careful when adjusting parameters to avoid framerate lower than 30 frames per second.

CartoSound



In some cases, noise artifacts may appear in the ultrasound image when using (ICE) ablation catheters and Carto mapping system is active.

In order to help reduce the noise level, please ensure that:

- The facility grounding is connected via a ground potential equalization (equipotentiality) cable to the terminal located in the rear of the system (marked with symbol).
- External ferrite filter is placed around the ICE cord probe cable. (Contact service representative if the ferrite is missing.)

Identifying the correct 2D ICE Ultrasound Catheter model

Inspect the catheter selected for use to make sure it is the catheter model compatible with Vivid S70N / S60N systems.



Only GE marked catheters are supported by the scanner. Check catheters labeling prior to connecting to the ICE cord.

Care and Maintenance

Planned maintenance



CAUTION

Improper handling can lead to early probe failure and electric shock hazards.

DO follow the specific cleaning and disinfection procedures provided in this chapter and the cleaner/disinfectant manufacturers instructions.

Failure to do so will void probe warranty.



CAUTION

Transesophageal, endocavity and intraoperative probes require special handling. Refer to the user documentation enclosed with these probes.

NOTE: Keep a log of all probe maintenance, along with a picture of any probe malfunction.

Follow the maintenance schedule below to ensure optimum operation and safety:

Before first use:

- Inspect the probe.
- Clean the probe.
- Disinfect the probe.

After each use:

- Inspect the probe.
- Clean the probe.
- Disinfect the probe.

Before each use:

- Inspect the probe.

Inspecting the probe



If any damage is found, DO NOT use the probe until it has been inspected and released for further use by a GE service representative.

After each use:

1. Inspect the lens, the probe housing and the cable (Figure 13-3) for cracks, cuts, tears, and other signs of physical damage.
2. Look for damage that might allow liquid into the probe.

Before each use:

1. Inspect the lens, the probe housing and the cable (Figure 13-3) for cracks, cuts, tears, and other signs of physical damage.
2. Look for damage that might allow liquid into the probe.
3. Test the functionality of the probe. Check also modular combinations and common operability of system and accessories.

1. Housing
2. Strain relief
3. Seal
4. Lens

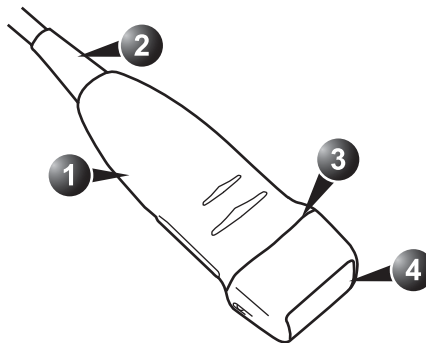

Figure 13-3. Probe parts

Safety tests

Recommended maintenance schedule: According to respective national regulations, and according to the manufacturer recommendations for the ultrasound system.

Electric test

Check the electric safety of system combinations according to IEC 62353 or respective national regulations.

Probe Leakage Current

Probe leakage current test should be performed:

- Annually
- After corrective maintenance or as required by your facilities quality program.

NOTE: *Attempting do-it-yourself repairs invalidate warranty, and are an infringement to regulations and are inadmissible according to IEC 60601-1. Only authorized personnel may perform service and repairs. For expected lifetime of equipment and probes see Service Manual.*

Environmental conditions

Probes can be used in clinical environment.

Ensure that the probe face temperature does not exceed the normal operation temperature range.

Probes should be operated, stored, or transported within their probe specific parameters.

For operational probe environmental parameters, see 'Probe overview' on *page 13-2*. Probe specific storage and transport conditions are defined on the individual environmental label on the probe box.

Cleaning and disinfecting probes



Probes must be cleaned and disinfected before they are replaced or disposed.



Transesophageal, endocavity and intraoperative probes require special handling. Refer to the user documentation enclosed with these probes.

The reprocessing instructions provided in this document have been validated with the chemicals specified in Table 13-3 on page 13-25. Therefore, only those agents listed in Table 13-3 should be used for reprocessing, and any reprocessing performed using chemicals not listed in Table 13-3 must be validated by the user.

Adequate cleaning and disinfection between patient cases are necessary to prevent disease transmission. All probes must be thoroughly cleaned prior to disinfection. The level of disinfection required is based on patient contact.

- Probes that contact mucosal or non-intact skin require cleaning followed by High-Level Disinfection (HLD) by either soaking or use of a trophon EPR. Verify probe compatibility on the GE probe website shown below.
- Probes that contact intact skin require cleaning followed by Intermediate-Level Disinfection (ILD) (wipe or spray).

NOTE: According to FDA Guidance and CDC Guideline, ILD have HBV, HIV and tuberculocidal claims. HLD refer to the FDA-cleared high-level disinfectants.

With the exception of the chemicals listed in Table 13-3, the chemicals listed in Table 13-4, Table 13-5, Table 13-6, Table 13-7, Table 13-8, and on the GE Website have been tested for compatibility only.

NOTE: The tables in the User Manual indicate the status when the User Manual was released. Please visit the website for the latest information.

Probe Care Cards

The Probe Care Card contains a list of chemicals that have been tested for compatibility with GE Ultrasound probes. The reprocessing instructions provided in this document have been validated with the chemicals specified in Table 13-3 on page 13-25.

Table 13-1: Web Site Links

Documentation Web Site
Customer Documentation Portal
https://www.gehealthcare.com/documentation
Support Documentation Library Web Site

Table 13-1: Web Site Links

Documentation Web Site
http://www.gehealthcare.com/DocumentationLibrary
Ultrasound Probe Web Site
http://www.gehealthcare.com/transducers
GEHC chemicals compatibility
https://cleaning.gehealthcare.com/

Table 13-2: Description of Pictogram on Probe Care Cards













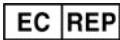

Pictogram	Description	Standard
	“ATTENTION” - Consult accompanying documents” is intended to alert the user to refer to the operator manual or other instructions when complete information cannot be provided on the label.	ISO 7000-0434A
	“CAUTION” - Dangerous voltage (the lightning flash with arrowhead) is used to indicate electric shock hazards.	IEC 60417-6042
	Biohazard - Patient/user infection due to contaminated equipment. Usage <ul style="list-style-type: none"> • Cleaning and care instructions • Sheath and glove guidelines 	ISO 7000-0659
	Ultrasound probes are highly sensitive medical instruments that can easily be damaged by improper handling. Use care when handling and protect from damage when not in use.	N/A- by GE Healthcare
	Do not immerse the probe into any liquid beyond the level specified for that probe. Refer to the user manual of the ultrasound system.	N/A- by GE Healthcare

Table 13-2: Description of Pictogram on Probe Care Cards

Pictogram	Description	Standard
	<p>Since there is a possibility of having negative effects on the probe, observe the specified immersing time by the germicide manufacturer strictly. Do not immerse the probe in liquid chemical germicides more than the time prescribed in the care card.</p>	<p>N/A- by GE Healthcare</p>
	<p>“Consult accompany document” - Refer to the ultrasound system user manual for important probe care and cleaning instruction.</p>	<p>ISO 7010-M002</p>
	<p>Authorized European Representative in the European Community.</p>	<p>ISO 15223-1</p>
	<p>Symbol indicates a useful information.</p>	<p>N/A- by GE Healthcare</p>
	<p>Compatible ultrasound coupling gels.</p>	<p>N/A- by GE Healthcare</p>
	<p>Compatible cleaners or disinfectants available in spray format.</p>	<p>N/A- by GE Healthcare</p>
	<p>Compatible cleaners or disinfectants available in wipes format.</p>	<p>N/A- by GE Healthcare</p>
	<p>Compatible cleaners or disinfectants available in powder.</p>	<p>N/A- by GE Healthcare</p>
	<p>Compatible cleaners or disinfectants available in liquid format</p>	<p>N/A- by GE Healthcare</p>
	<p>Compatible automated reprocessors.</p>	<p>N/A- by GE Healthcare</p>

Chemicals Used for Efficacy Validation

The table below lists the products and intended use (clean, Intermediate-Level Disinfection, High-Level Disinfection) that were validated.

Table 13-3: Chemicals used for Efficacy Validation on non-TEE probes

Product Type	Trade Name	Manufacturer	Minimum Contact Time	Active Ingredient	Validated for probe
Cleaning (Wipe)	Oxivir® Tb	Diversey	N/A	Hydrogen Peroxide	3Sc-RS, M5Sc-D, ML6-15-D, 4Vc-D, 9L-D, 11L-D, C1-5-D, C1-6-D, C2-9-D, C3-10-D, iC5-9-D, L8-18i-D
Enzymatic Detergent (Soak)	Enzol® (Cidezyme®)	Advanced Sterilization Products® (J&J)	1-Minute Soak	Proteolytic Enzymes	3Sc-RS, M5Sc-D, ML6-15-D, 6S-D, 12S-D, 4Vc-D, 9L-D, 11L-D, C1-5-D, C1-6-D, C2-9-D, C3-10-D, iC5-9-D, L8-18i-D
	MetriZyme™	Metrex™			
	Prolystica® 2X Concentrate Presoak & Cleaner	Steris			
Intermediate-level Disinfectant (wipe)	Oxivir® Tb	Diversey	10-Minute Exposure	Hydrogen Peroxide	3Sc-RS, M5Sc-D, ML6-15-D, 4Vc-D, 9L-D, 11L-D, C1-5-D, C1-6-D, C2-9-D, C3-10-D, iC5-9-D, L8-18i-D
High-level Disinfectant (Soak)	Cidex® OPA	Advanced Sterilization Products (J&J)	10-Minute Soak	Ortho-phthalaldehyde	3Sc-RS, M5Sc-D, ML6-15-D, 6S-D, 12S-D, 4Vc-D, 9L-D, 11L-D, C1-5-D, C1-6-D, C2-9-D, C3-10-D, iC5-9-D, L8-18i-D
	McKesson OPA/28	McKesson			

Probe Pre-Treatment at the Point of Use (Required for All Probes)

The pre-treatment step is for removal of gel and gross contamination.

1. After each use, remove protective sheath from the probe and gently remove all coupling gel by wiping from the cable strain relief to the acoustic lens end (i.e. from the cleanest to the dirtiest area) with a soft, low-/non-linting cloth.



DO NOT use abrasive paper products when cleaning or wiping a GE Ultrasound probe. The use of abrasive wipes can damage the soft lens (acoustic window). To extend the life of the probe lens, pat dry only.

2. Wipe the cable with one of the wipes listed in Probe Care Card from the strain relief to the connector. Wipe the cable with a low-/non-linting cloth dampened with potable water to remove chemical residue. Dispose of the cloth, wipe and gloves in the clinical trash.

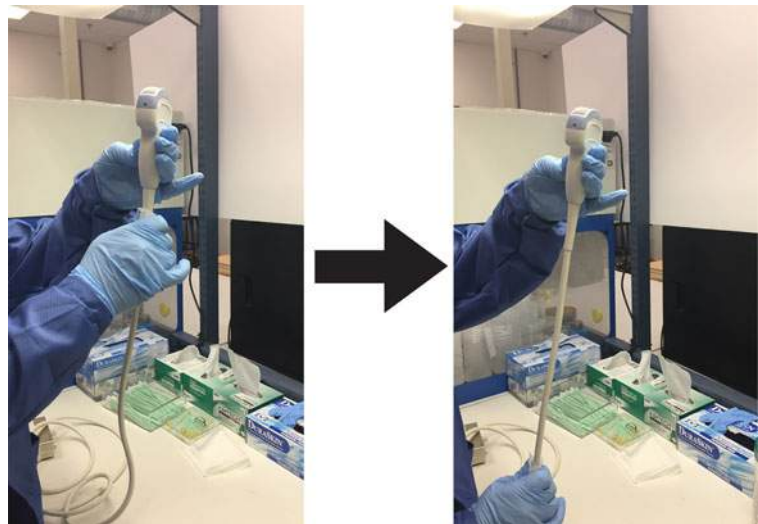

Figure 13-4. Cleaning the Probe Cable

NOTE: Use of wipes listed in the Probe Care Card may result in discoloration of the cable.



Use caution when cleaning the connector. This cable connector should only be cleaned with a slightly dampened cloth or wipe. Exposure to excessive moisture will result in damage to the probe and possibly the ultrasound console. **DO NOT** wet the connector/console interface surface or labels.

3. After each use, inspect the lens, cable, and housing of the probe. Look for any damage that would allow liquid to enter the probe.



If the probe is damaged, do not place it into any liquid (e.g. for disinfection) and do not use it until it has been inspected and repaired/replaced by a GE Service Representative.

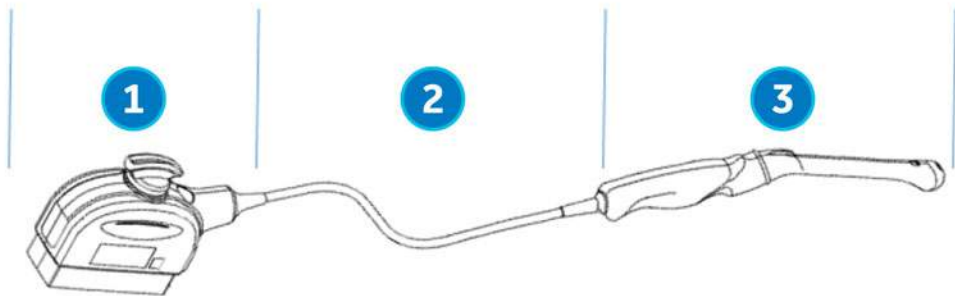

1. Cleaning only portion
2. Cleaning only or cleaning and disinfection portion
3. Cleaning followed by appropriate level of disinfection

Figure 13-5. Inspect the Lens, Cable, and Probe House After Each Use

Cleaning with Wipes

Manual cleaning is required to ensure the probes are cleaned to the extent necessary for further processing. Choose the most appropriate method, either the wipe or enzymatic soak.

1. Hold the probe by the handle near the strain relief cable. **DO NOT** suspend or hold the probe by the cable as this may damage the probe.
2. Dispense a cleaning wipe from the wipe canister.
3. Gently wipe the probe with a cleaning wipe from the cable strain relief to the acoustic lens (i.e. from the cleanest to the dirtiest area). Gently wipe the probe's acoustic lens.

NOTE:

Pay special attention to acoustic lens, edges, and groves.

4. Turn the probe and continue wiping until the entire surface of the probe has been cleaned. As the wipe becomes visibly soiled, discard the wipe into clinical trash and dispense fresh wipes as needed.
5. As needed for additional focused cleaning to crevices, wrap a clean wipe around a soft nylon bristle brush or other suitable instrument to access crevasses, such as biopsy notches, on the surface of the probe.
6. Visually inspect the probe for any remaining soil and, if necessary, repeat steps 3 through 5 until the probe is visibly clean.

Probe Manual Cleaning Instructions – Enzymatic Detergent

1. Ensure the probe has been disconnected from the console. Put on a clean pair of gloves and fill a sink or basin with warm utility water (30 - 40°C) to a level allowing immersion of the probe up to the immersion line shown in Figure 13-6 on page 13-29.
2. Prepare the cleaning solution in accordance with the detergent manufacturer's instructions.
3. Immerse the probe in the prepared cleaning solution up to the immersion line and ensure no air bubbles are trapped on the surface. Do not submerge probe beyond the immersion line shown in Figure 13-6 on page 13-29.

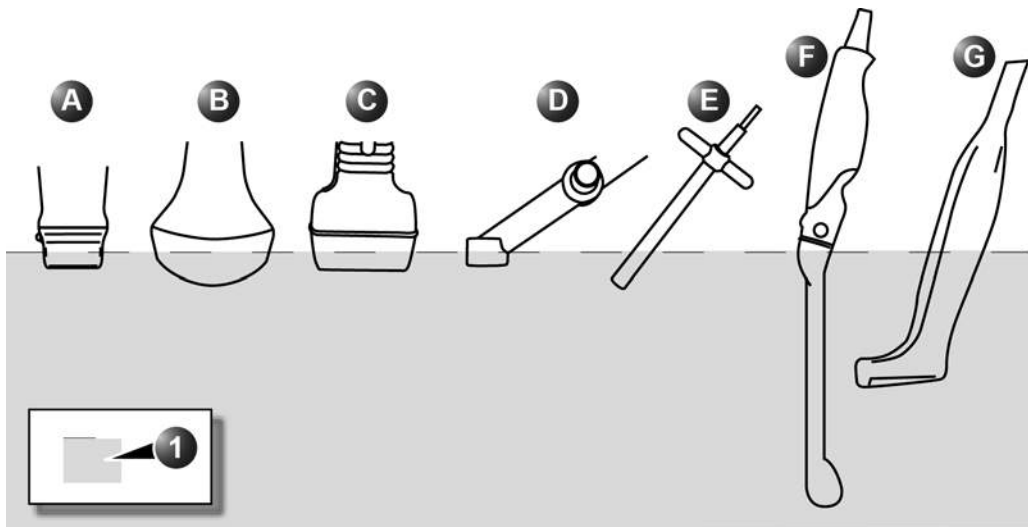

- a. 4Vc-D, M5Sc-D, 3Sc-RS, 6S-D, 12S-D
- b. C1-5-D, C1-6-D, C2-9-D, C3-10-D
- c. 9L-D, 11L-D, ML6-15-D
- d. 2D (P2D)
- e. 6D (P6D)
- f. iC5-9-D
- g. L8-18i-D

1. Fluid level

Figure 13-6. Probe immersion levels

4. Brushing with a clean, soft, nylon bristle brush from the base of the cable strain relief to the distal tip is critical to ensure cleaning and disinfection efficacy.

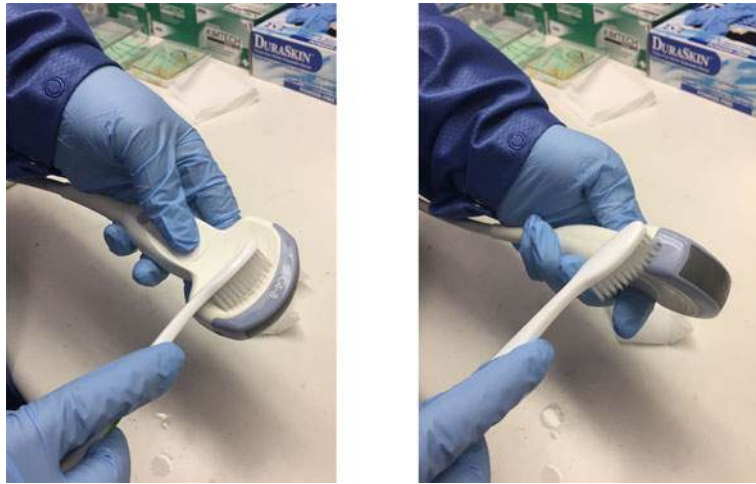

Figure 13-7. Cleaning the probe using a brush



CAUTION

Do not use the brush on the probe lens.



Figure 13-8. Probe Lens Examples

5. Continue brushing the probe for not less than the minimum contact time listed on the detergent manufacturer's label.
6. Visually inspect the probe for soil. Repeat Steps 3 through 5 until all visible soil has been removed from the surface of the probe.
7. Rinse the probe under running warm utility water (30 - 40°C) for not less than 2 minutes. Scrub the surface of the probe with a clean, soft, nylon bristle brush from the base of the cable strain relief to the acoustic lens.



CAUTION

DO NOT use the brush on the probe lens.

8. Visually inspect the device in a well-lit area to ensure all surfaces are free from residual cleaning solution. Repeat Step 7 if visible cleaning solution is observed.
9. Thoroughly dry the probe using a clean low-/non-linting soft and dry cloth or wipe. Pat dry acoustic lens.



DO NOT use a twisting motion or abrasive paper products when wiping the probe as this may damage the soft lens. Pat dry only.

Cable and Connector Manual Cleaning



WARNING

Use caution when cleaning the connector. This cable connector should only be cleaned with a slightly dampened cloth or wipe. Exposure to excessive moisture will result in damage to the probe and possibly the ultrasound console. **DO NOT** wet the connector/console interface surface or labels. **DO NOT** clean the probe in an automated washer-disinfector.

1. The cable and connector surfaces can be cleaned with the cleaners or wipes listed in the Probe Care Card.

NOTE:

Use of wipes listed in the Probe Care Card may result in discoloration of the cable.

2. Wipe the cable with a low lint cloth dampened with utility water to remove chemical residue.

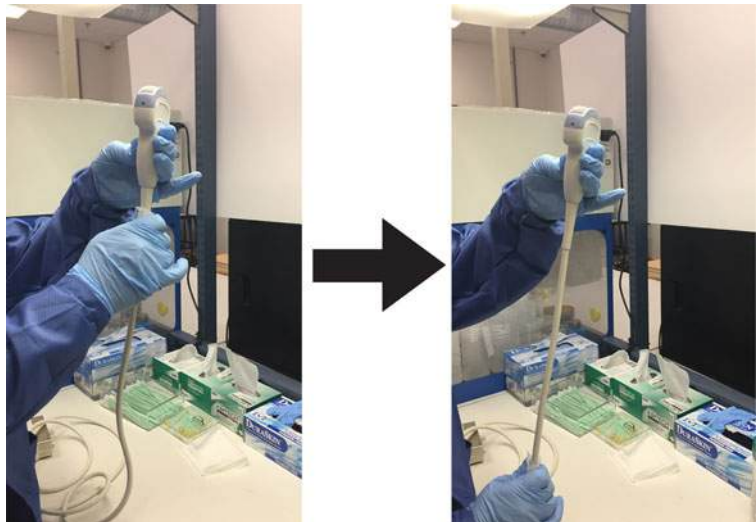

Figure 13-9. Cleaning the Probe Cable

Probe Intermediate-Level Disinfection - Spray

For Intermediate-Level Disinfection of surface-contacting probes, choose either the spray or wipe method.

NOTE: *Probes that contact only intact skin may be disinfected in this manner. All probes that contact non-intact skin or mucous membranes (e.g., endocavitary, Transesophageal) require High-Level Disinfection.*



After each use, inspect the lens, cable, and housing of the probe. Look for any damage that would allow liquid to enter the probe. If the probe is damaged, do not place it into any liquid (e.g. for disinfection) and do not use it until it has been inspected and repaired/replaced by a GE Service Representative.

1. Put on a new pair of gloves and spray enough disinfectant solution to saturate a new disposable low lint wipe or cloth.
2. Holding the probe near the strain relief, apply the dampened cloth to the patient contacting lens. Wipe the probe from the acoustic lens to the strain relief, slightly rotating the probe after each wiping pass.

Probe Intermediate-Level Disinfection - Spray (continued)

3. After the probe has been completely wiped, dampen a second wipe with disinfectant and starting at the probe lens begin wiping the probe in a rotating motion moving down towards the strain relief. Spray disinfectant directly on the recessed areas and ridges to saturate.

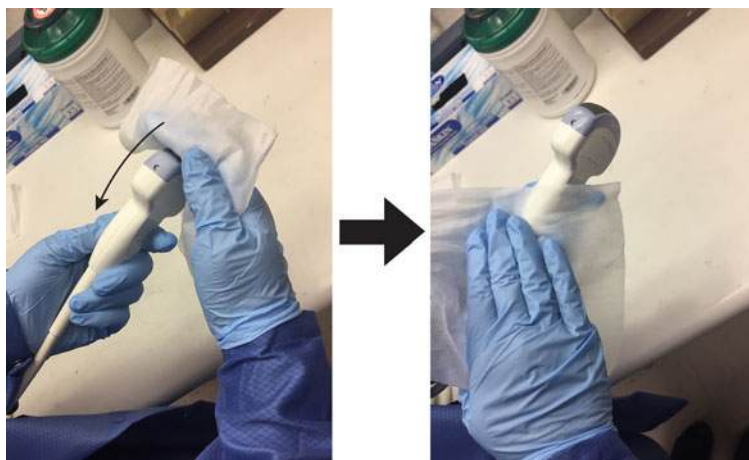

Figure 13-10. Disinfecting the Probe Moving from Lens to Strain Relief

4. Once the probe has been completely wiped, dampen a third wipe with disinfectant and continue wiping the probe as needed to ensure the surface remains wet for the required exposure time. Use as many wipes as needed and re-spray disinfectant on recessed areas and ridges, to ensure all surfaces remain wet for the minimum required contact time listed in Table 13-3 on page 13-25.
5. Thoroughly dry all surfaces of the probe using a soft, low-/non-linting wipe or cloth, changing wipes/cloths when necessary to ensure the probe is completely dry. Pat dry acoustic lens. Visually inspect the probe to ensure all surfaces are dry. Repeat drying steps if any moisture is visible.
6. If the probe is not immediately reused, store the probe in a manner that will protect and keep the probe from being recontaminated. This may be accomplished by placing the probe in a storage cabinet with filtered air flow and/or by using a disposable storage cover placed over the probe.

Probe Intermediate-Level Disinfection - Disinfectant Wipe



After each use, inspect the lens, cable, and housing of the probe. Look for any damage that would allow liquid to enter the probe. If the probe is damaged, do not place it into any liquid (e.g. for disinfection) and do not use it until it has been inspected and repaired/replaced by a GE Service Representative.

1. Put on a new pair of gloves. Holding the probe near the strain relief, apply the wipe to the patient contacting lens. Wipe the probe from the acoustic lens to the strain relief, slightly rotating the probe after each wiping pass.
2. After the probe has been completely wiped, use a second wipe and starting at the probe lens begin wiping the probe in a rotating motion moving down towards the strain relief. Wring the wipe above recessed areas, seams, and ridges to drip disinfectant directly onto these less accessible surfaces.

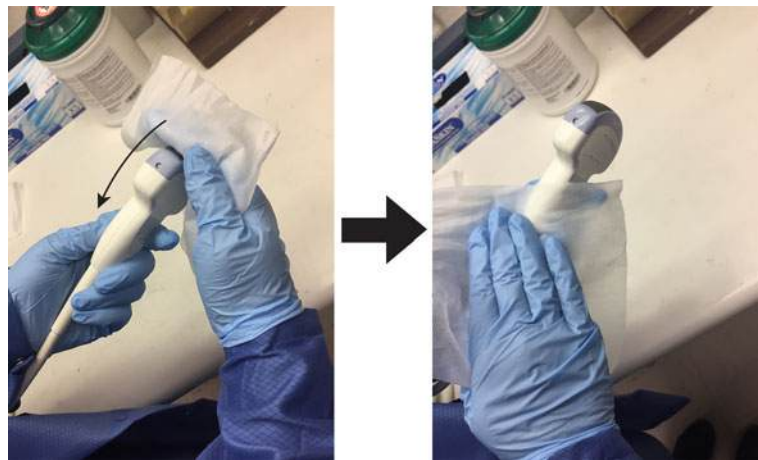

Figure 13-11. Disinfecting the Probe Moving from Lens to Strain Relief

NOTE: *Probes that contact only intact skin may be disinfected in this manner. All probes that contact mucous membranes (e.g., endocavitary, Transesophageal) require High-Level Disinfection.*

3. Once the probe has been completely wiped, use a third wipe and continue wiping the probe as needed to ensure the surface remains wet for the required exposure time. Use as many wipes as needed and drip additional disinfectant on

recessed areas and ridges, to ensure all surfaces remain wet for the minimum required contact time listed in Table 13-3 on page 13-25.

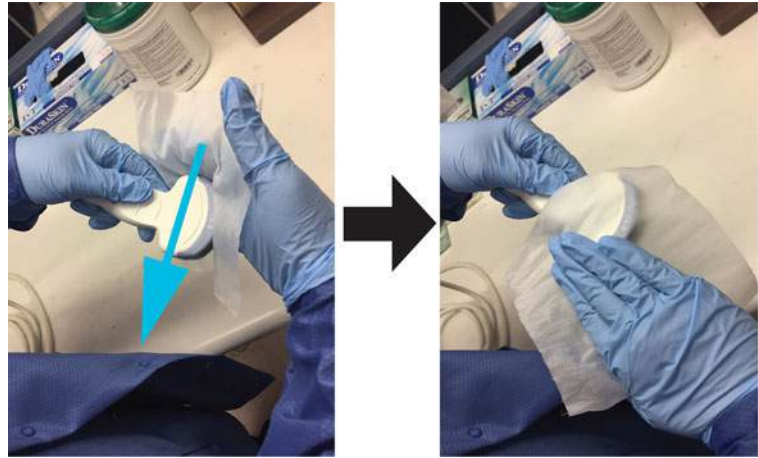

Figure 13-12. Disinfecting the Probe

4. Thoroughly dry all surfaces of the probe using a soft, low-/ non-linting wipe or cloth, changing wipes/cloths when necessary to ensure the probe is completely dry. Pat dry acoustic lens. Visually inspect the probe to ensure all surfaces are dry. Repeat drying steps if any moisture is visible.
5. If the probe is not immediately reused, store the probe in a manner that will protect and keep the probe from being recontaminated. This may be accomplished by placing the probe in a storage cabinet with filtered air flow and/or by using a disposable storage cover placed over the probe.

Probe High Level Disinfection – Soak

High-Level Disinfection is required for devices that contact intact mucous membranes or non-intact skin. High Level Disinfection can be performed using either a disinfectant soaking method or an automated system such as trophon® EPR.



DANGER

After each use, inspect the lens, cable, and housing of the probe. Look for any damage that would allow liquid to enter the probe. If the probe is damaged, do not place it into any liquid (e.g. for disinfection) and do not use it until it has been inspected and repaired/replaced by a GE Service Representative.

1. Ensure the probe has been disconnected from the console. Put on a clean pair of gloves and fill a sink or basin with High-Level Disinfectant diluted in accordance with the disinfectant manufacturers instructions to a level allowing immersion of the probe up to immersion line shown in Figure 13-6 on page 13-29.

NOTE: *Cleaning and disinfection instructions for Transesophageal probes are documented in the Transesophageal Probe Care Card and User Manual.*

NOTE: *All semi-critical probes* that contact mucous membranes require High-Level Disinfection.*

*Semi-critical probes are probes that contact mucous membranes or non-intact skin.

NOTE: *Handles of semi-critical probes that are not submerged during High-Level Disinfection require low or Intermediate-Level Disinfection to avoid cross contamination.*



CAUTION

Ensure no liquid comes into contact with the probe connector pins or labels.

2. Immerse probe in the disinfectant up to the immersion line and ensure no air bubbles are trapped. Ensure the probe remains in the disinfectant for at least the minimum contact time listed in Table 13-3 on page 13-25.

NOTE: *Over-exposing ultrasound probes to high-level disinfectants may damage the ultrasound probe. NEVER exceed the disinfectant manufacture's maximum exposure time.*



Ensure that the probe is suspended. The probe face should not be resting against the tank/basin surface and should be in full contact with the liquid. Carefully place the probe in the basin, taking care not to damage the transducer lens.



Figure 13-13. Probe suspended in disinfectant basin

3. Thoroughly rinse the probe by immersing it in a large volume of critical water for a minimum of 1 (one) minute. Remove the probe and discard the rinse water.
Repeat rinsing two additional times, for a total of 3 (three) rinses. Do not reuse the water. Always use fresh volumes of water for each rinse.



Failure to properly rinse probes with water following disinfection may cause skin irritation.

NOTE: *Critical Water is water that is treated (usually by a multistep treatment process that could include a carbon bed, softening, DI, and RO or distillation) to ensure that the microorganisms and the inorganic and organic material are removed from the water to an appropriate level (Refer to AAMI TIR34/ST108). Use of this type of water will reduce the recontamination of probes during processing.*

4. Thoroughly dry all surfaces of the probe using a soft, low-/ non-linting wipe or cloth, changing wipes' cloths when necessary to ensure the probe is completely dry. Visually inspect the probe to ensure all surfaces are clean and dry. Repeat drying steps if any moisture is visible.
5. If the probe is not immediately reused, store the probe in a manner that will protect and keep the probe from being recontaminated. This may be accomplished by placing the probe in a storage cabinet with filtered air flow and/or by using a disposable storage cover placed over the probe.

The instructions provided above have been validated to properly prepare GE Ultrasound probes for re-use. It remains the

responsibility of the processor to ensure that the processing is performed as specified in this document. This may require verification and routine monitoring of the process.

Probe High-Level Disinfection - trophon® EPR and trophon2

When performing High-Level Disinfection of GE ultrasound probes with the trophon® EPR and trophon2, it is not necessary to disconnect the probe from the ultrasound system. The probe must be inactive (not selected) during the disinfection cycle.

1. Upon completion of probe cleaning, ensure the probe has been thoroughly dried with a clean, low lint soft and dry cloth or wipe. Carefully dry the probe by wiping from the distal tip to the strain relief.



DO NOT use abrasive paper products when cleaning or wiping a GE Ultrasound Probe. The use of abrasive wipes can damage the soft lens (acoustic window). To extend the life of the probe lens, pat dry only.

2. Visually inspect the probe to ensure the probe is visibly clean.
3. Follow the trophon instructions for probe placement and operation of the trophon system. Incorrect positioning of the probe may lead to High-Level Disinfection not being achieved.



Damage to the probe may occur if the probe is placed in contact with the trophon chamber wall. Curved probes must be correctly positioned in the chamber using the Curved Probe Positioner (CPP) supplied with the trophon system.

4. Once the trophon High-Level Disinfection cycle is complete, don a new set of gloves and promptly remove the probe from the trophon machine. DO NOT allow the probe to remain in the machine for extended periods of time.
5. Hold the probe at the proximal end near the strain relief cable. DO NOT suspend or hold the probe by the cable, as this may damage the probe.
6. Wipe the probe from the distal end to the proximal end with a clean, low-/non-linting soft and dry cloth or wipe to remove any residual hydrogen peroxide from the probe surface.



DO NOT use a twisting motion or abrasive paper products when wiping the probe. Pat dry only.

7. If the probe is not immediately reused, store the probe in a manner that will protect and keep the probe from being

recontaminated. This may be accomplished by placing the probe in a storage cabinet with filtered air flow and/or by using a disposable storage cover placed over the probe.

Compatible Chemicals

The table below lists the chemicals that were tested for compatibility with the probes.



WARNING

The chemicals listed below are compatible with Vivid S70N / S60N probes and will not cause degradation, but have not been proven to effectively clean or disinfect the probes. If you are interested in using an alternate chemical from the compatibility tables, please contact your GE representative. Alternate chemicals require validation by GE prior to use to ensure efficacy.

Table 13-4: Cleaners Compatible with Non-TEE probes

Trade Name	Manufacturer	3Sc-RS	11L-D	12S-D	4Vc-D	6S-D	9L-D	C1-6-D	C1-5-D	C2-9-D	C3-10-D	IC5-9-D	L8-18i-D	M5Sc-D	ML6-15-D	P2D	P6D
AniosClean Excel D	Laboratoires Anios	X	X	X	X	X	X	X	X	X	X	X	X	X	X		
Aniosyme X3	Laboratoires Anios	X	X	X	X	X	X	X	X	X	X	X	X	X	X		
Aniosyme DD1	Laboratoires Anios	X	X	X	X	X	X	X	X	X	X	X	X	X	X		
Bodedex Forte	BODE Chemie GmbH (HARTMANN)	X	X	X	X	X	X	X	X	X	X	X	X	X	X		
Cidezyme/Enzol	Advanced Sterilization Products	X	X	X	X	X	X	X	X	X	X	X	X	X	X		
Cygnus Simple2 Multi-Tiered Enzymatic Detergent (bottle or sponge kits)	Cygnus Medical	X	X	X	X	X	X	X	X	X	X	X	X	X	X		
Eco-Zyme Multi-Tiered Enzymatic Detergent	Pro-Line Solutions Inc.	X	X	X	X	X	X	X	X	X	X	X	X	X	X		
EmPower	Metrex	X	X	X	X	X	X	X	X	X	X	X	X	X	X		
Endozyme	The Ruhof Corporation	X	X	X	X	X	X	X	X	X	X	X	X	X	X		

Table 13-4: Cleaners Compatible with Non-TEE probes

Trade Name	Manufacturer	3Sc-RS	11L-D	12S-D	4Vc-D	6S-D	9L-D	C1-6-D	C1-5-D	C2-9-D	C3-10-D	IC5-9-D	L8-18i-D	M5Sc-D	ML6-15-D	P2D	P6D
Endozime Sponge	The Ruhof Corporation	X	X	X	X	X	X	X	X	X	X	X	X	X	X		
Endozime AW Triple Plus with APA	The Ruhof Corporation	X	X	X	X	X	X	X	X	X	X	X	X	X	X		
Endozime AW Premium with APA	The Ruhof Corporation	X	X	X	X	X	X	X	X	X	X	X	X	X	X		
Endozime SLR	The Ruhof Corporation	X	X	X	X	X	X	X	X	X	X	X	X	X	X		
Endozime SLR Sponge	The Ruhof Corporation	X	X	X	X	X	X	X	X	X	X	X	X	X	X		
Enzyclean II Dual Enzyme Detergent	Micro-Scientific (Weiman)	X	X	X	X	X	X	X	X	X	X	X	X	X	X		
gigasept AF	Schulke & Mayr GmbH	X	X	X	X	X	X	X	X	X	X	X	X	X	X		
gigazyme	Schulke & Mayr GmbH	X	X	X	X	X	X	X	X	X	X	X	X	X	X		
gigazyme X-tra	Schulke & Mayr GmbH	X	X	X	X	X	X	X	X	X	X	X	X	X	X		
HALYARD Multi-Enzyme Detergent	Halyard Health Inc	X	X	X	X	X	X	X	X	X	X	X	X	X	X		
Intercept Detergent	Medivators Inc.	X	X	X	X	X	X	X	X	X	X	X	X	X	X		
Matrix	Whiteley Medical	X	X	X	X	X	X	X	X	X	X	X	X	X	X		
MetriSponge	Metrex															X	X
Metrizyme	Metrex	X	X		X		X	X	X	X	X	X	X	X	X		
Prolystica 2X Concentrate Enzymatic Presoak and Cleaner	STERIS Corporation	X	X	X	X	X	X	X	X	X	X	X	X	X	X		
Pure Enzymatic Detergent	EndoChoice	X	X	X	X	X	X	X	X	X	X	X	X	X	X		

Table 13-4: Cleaners Compatible with Non-TEE probes

Trade Name	Manufacturer	3Sc-RS	11L-D	12S-D	4Vc-D	6S-D	9L-D	C1-6-D	C1-5-D	C2-9-D	C3-10-D	IC5-9-D	L8-18i-D	M5Sc-D	ML6-15-D	P2D	P6D
Revital-ox Enzymatic Detergents	STERIS Corporation	X	X	X	X	X	X	X	X	X	X	X	X	X	X		
Sekusept MultiEnzyme	Ecolab	X	X	X	X	X	X	X	X	X	X	X	X	X	X		
Septanios MD	Laboratoires Anios	X	X	X	X	X	X	X	X	X	X	X	X	X	X		
Soft Soap	All manufacturer	X	X	X	X	X	X	X	X	X	X	X	X	X	X		
Valsure Enzymatic Cleaner	STERIS Corporation	X	X	X	X	X	X	X	X	X	X	X	X	X	X		

The table below lists the chemicals that were tested for compatibility with the probes.



WARNING

The chemicals listed below are compatible with Vivid S70N / S60N probes and will not cause degradation, but have not been proven to effectively clean or disinfect the probes. If you are interested in using an alternate chemical from the compatibility tables, please contact your GE representative. Alternate chemicals require validation by GE prior to use to ensure efficacy.

Table 13-5: Chemicals Compatible with Non-TEE probes

Product type	Chemical Name	Manufacturer	3Sc-RS	11L-D	12S-D	4Vc-D	6S-D	9L-D	C1-6-D	C1-5-D	C2-9-D	C3-10-D	IC5-9-D	L8-18i-D	M5Sc-D	ML6-15-D	P2D	P6D
Liquid/ Spray	3M MBS Disinfectant Cleaner Concentrate	3M	X	X	X	X	X	X	X	X	X	X	X	X	X	X		
	Accel INTERvention RTU	Diversey (Sealed Air)	X	X		X		X	X	X	X	X	X	X	X	X		
	Accel TB RTU	Diversey (Sealed Air)	X	X		X		X	X	X	X	X	X	X	X	X		
	Acrylan	Antiseptica Chem. Phar. Produkte	X	X	X	X	X	X	X	X	X	X	X	X	X	X		
	Alcohol 70% Ethanol on a wipe	All manufacturer	X	X	X	X	X	X	X	X	X	X	X	X	X	X		
	Alcohol 70% Isopropanol on a wipe	All manufacturer	X	X	X	X	X	X	X	X	X	X	X	X	X	X		
	Bacillof 30 Foam	BODE Chemie GmbH (HARTMANN)	X	X	X	X	X	X	X	X	X	X	X	X	X	X		
	Bacillof AF	BODE Chemie GmbH (HARTMANN)	X	X	X	X	X	X	X	X	X	X	X	X	X	X		

Table 13-5: Chemicals Compatible with Non-TEE probes

Product type	Chemical Name	Manufacturer	3Sc-RS	11L-D	12S-D	4Vc-D	6S-D	9L-D	C1-6-D	C1-5-D	C2-9-D	C3-10-D	IC5-9-D	L8-18i-D	M5Sc-D	ML6-15-D	P2D	P6D	
Liquid/ Spray	Bacillo plus	BODE Chemie GmbH (HARTMANN)	X	X	X	X	X	X	X	X	X	X	X	X	X	X			
	Biguacid-S	Antiseptica Chem. Phar. Produkte	X	X	X	X	X	X	X	X	X	X	X	X	X	X			
	Birex Quat	Biotrol	X	X	X	X	X	X	X	X	X	X	X	X	X	X			
	CaviCide	Metrex	X	X	X	X	X	X	X	X	X	X	X	X	X	X			
	CaviCide 1	Metrex	X	X	X	X	X	X	X	X	X	X	X	X	X	X			
	CaviCide AF	Metrex	X	X	X	X	X	X	X	X	X	X	X	X	X	X			
	Cidalkan	Alkapharm	X	X	X	X	X	X	X	X	X	X	X	X	X	X			
	Clinell Universal Spray	GAMA Healthcare Ltd	X	X	X	X	X	X	X	X	X	X	X	X	X	X			
	Clorox broad spectrum quaternary disinfectant cleaner	CloroxPro	X	X	X	X	X	X	X	X	X	X	X	X	X	X	X		
	Clorox Healthcare Hydrogen Peroxide Cleaner Disinfectant Liquids and Spray	CloroxPro	X	X		X		X	X	X	X	X	X	X	X	X	X		
	Coverage Spray TB Plus	STERIS Corporation	X	X	X	X	X	X	X	X	X	X	X	X	X	X	X		
	Hibitane (5% Chlorhexidine gluconate)	All manufacturer		X					X	X	X	X		X	X		X		
	Klercide 70/30 IPA on a wipe	Ecolab	X	X	X	X	X	X	X	X	X	X	X	X	X	X	X		
McKesson Germicidal Cleaner	McKesson	X	X	X	X	X	X	X	X	X	X	X	X	X	X	X			

Table 13-5: Chemicals Compatible with Non-TEE probes

Product type	Chemical Name	Manufacturer	3Sc-RS	11L-D	12S-D	4Vc-D	6S-D	9L-D	C1-6-D	C1-5-D	C2-9-D	C3-10-D	IC5-9-D	L8-18i-D	M5Sc-D	ML6-15-D	P2D	P6D	
Liquid/ Spray	NUGEN MB5A Series	Lonza Inc.	X	X	X	X	X	X	X	X	X	X	X	X	X	X			
	Opti-Cide3 Liquid	Micro-Scientific	X	X	X	X	X	X	X	X	X	X	X	X	X	X			
	Optim 33TB RTU	SciCan	X	X		X		X	X	X	X	X	X	X	X	X			
	Oxivir Tb RTU	Diversey (Sealed Air)	X	X		X		X	X	X	X	X	X	X	X	X			
	OxyCide Daily Disinfectant Cleaner	Ecolab		X				X	X	X	X		X	X		X			
	PCS 1000 Oxidizing Disinfectant/ Disinfectant Cleaner	Process Cleaning Solutions Ltd	X	X	X	X	X	X	X	X	X	X	X	X	X	X	X		
	Protex disinfectant spray	Parker Laboratoires Inc.	X	X	X	X	X	X	X	X	X	X	X	X	X	X	X	X	X
	SaniTex Plus 2	Crosstex International Inc	X	X	X	X	X	X	X	X	X	X	X	X	X	X	X		
	Sklar Disinfectant	Sklar Instruments	X	X	X	X	X	X	X	X	X	X	X	X	X	X	X		
	Surfa'Safe	Laboratoires Anios	X	X	X	X	X	X	X	X	X	X	X	X	X	X	X		
	Surfa'Safe Premium	Laboratoires Anios	X	X	X	X	X	X	X	X	X	X	X	X	X	X	X		
	Transeptic Spray	Parker Laboratoires Inc.		X				X		X			X				X		
	Tristel Duo for Ultrasound	Tristel Solutions Limited	X	X	X	X	X	X	X	X	X	X	X	X	X	X	X		
	Virex II 256	Diversey	X	X	X	X	X	X	X	X	X	X	X	X	X	X	X		
	Virox 5 RTU	Diversey	X	X		X		X	X	X	X	X	X	X	X	X	X		

Table 13-5: Chemicals Compatible with Non-TEE probes

Product type	Chemical Name	Manufacturer	3Sc-RS	11L-D	12S-D	4Vc-D	6S-D	9L-D	C1-6-D	C1-5-D	C2-9-D	C3-10-D	IC5-9-D	L8-18i-D	M5Sc-D	ML6-15-D	P2D	P6D	
Wipes	Accel INTERVention Wipes	Diversey (Sealed air)	X	X		X		X	X	X	X	X	X	X	X	X			
	Accel TB Wipes	Diversey (Sealed air)	X	X		X		X	X	X	X	X	X	X	X	X			
	Anios Quick Wipes	Laboratoires Anios	X	X	X	X	X	X	X	X	X	X	X	X	X	X			
	Asepti-Wipes II	Ecolab	X	X	X	X	X	X	X	X	X	X	X	X	X	X			
	Bacillof 30 Tissues	BODE Chemie GmbH (HARTMANN)	X	X	X	X	X	X	X	X	X	X	X	X	X	X			
	Bacillof AF Tissues	BODE Chemie GmbH (HARTMANN)	X	X	X	X	X	X	X	X	X	X	X	X	X	X	X	X	
	Bactinyl Lingettes desinfectantes inodores	Laboratoire Garcin-Bactinyl	X	X	X	X	X	X	X	X	X	X	X	X	X	X	X		
	Birex Quat Wipes	Biotrol	X	X	X	X	X	X	X	X	X	X	X	X	X	X	X		
	CaviWipes	Metrex	X	X	X	X	X	X	X	X	X	X	X	X	X	X	X		
	CaviWipes 1	Metrex	X	X	X	X	X	X	X	X	X	X	X	X	X	X	X		
	CaviWipes AF	Metrex	X	X	X	X	X	X	X	X	X	X	X	X	X	X	X		
	Cidalkan Wipes	Alkapharm	X	X	X	X	X	X	X	X	X	X	X	X	X	X	X		
	Cleanisept Wipes	Dr. Schumacher GmbH	X	X	X	X	X	X	X	X	X	X	X	X	X	X	X		
	Cleanisept Wipes forte	Dr. Schumacher GmbH	X	X	X	X	X	X	X	X	X	X	X	X	X	X	X		
	Clinell Clorox Wipes	GAMA Healthcare Ltd	X	X	X	X	X	X	X	X	X	X	X	X	X	X	X		

Table 13-5: Chemicals Compatible with Non-TEE probes

Product type	Chemical Name	Manufacturer	3Sc-RS	11L-D	12S-D	4Vc-D	6S-D	9L-D	C1-6-D	C1-5-D	C2-9-D	C3-10-D	IC5-9-D	L8-18i-D	M5Sc-D	ML6-15-D	P2D	P6D	
Wipes	Clinell Universal Sanitising wipes or Clinell Universal wipes	GAMA Healthcare Ltd	X	X	X	X	X	X	X	X	X	X	X	X	X	X			
	Clorox Healthcare Bleach Germicidal wipes	CloroxPro	X	X	X	X	X	X	X	X	X	X	X	X	X	X	X		
	Clorox Healthcare Hydrogen Peroxide Cleaner Disinfectant Wipes	CloroxPro	X	X		X		X	X	X	X	X	X	X	X	X			
	Clorox Healthcare Multi-Surface Quat Alcohol Cleaner Disinfectant Wipes	CloroxPro	X	X	X	X	X	X	X	X	X	X	X	X	X	X			
	Clorox Healthcare VersaSure Cleaner Disinfectant Wipes	CloroxPro	X	X	X	X	X	X	X	X	X	X	X	X	X	X			
	Coverage TB Plus Disinfectant Wipes	STERIS Corporation	X	X	X	X	X	X	X	X	X	X	X	X	X	X	X		
	Dispatch hospital cleaner disinfectant towels with bleach	CloroxPro	X	X	X	X	X	X	X	X	X	X	X	X	X	X	X	X	X

Table 13-5: Chemicals Compatible with Non-TEE probes

Product type	Chemical Name	Manufacturer	3Sc-RS	11L-D	12S-D	4Vc-D	6S-D	9L-D	C1-6-D	C1-5-D	C2-9-D	C3-10-D	IC5-9-D	L8-18i-D	M5Sc-D	ML6-15-D	P2D	P6D	
Wipes	General purpose disinfectant wipes	Total Solutions	X	X	X	X	X	X	X	X	X	X	X	X	X	X			
	Intercept Wipes	Medivators	X	X	X	X	X	X	X	X	X	X	X	X	X	X			
	Klerwipe 70/30 IPA	Ecolab	X	X	X	X	X	X	X	X	X	X	X	X	X	X			
	Matrix Wipes	Whiteley Medical	X	X	X	X	X	X	X	X	X	X	X	X	X	X	X	X	
	McKesson Disposable Germicidal Surface Wipes	McKesson	X	X	X	X	X	X	X	X	X	X	X	X	X	X			
	Mikrobac tissues	BODE Chemie GmbH (HARTMANN)	X	X	X	X	X	X	X	X	X	X	X	X	X	X	X		
	Mikrozid sensitive or Mikroizid alcohol free wipes	Schulke & Mayr GmbH	X	X	X	X	X	X	X	X	X	X	X	X	X	X	X		
	Mikrozid universal liquid and Mikroizid universal wipes	Schulke & Mayr GmbH	X	X	X	X	X	X	X	X	X	X	X	X	X	X	X		
	Opti-Cide3 Surface Wipes	Micro-Scientific	X	X	X	X	X	X	X	X	X	X	X	X	X	X	X		
	Optim 33TB Wipes	SciCan	X	X		X		X	X	X	X	X	X	X	X	X	X		
Oxivir Tb Wipes	Diversey (Sealed Air)	X	X		X		X	X	X	X	X	X	X	X	X	X	X	X	

Table 13-5: Chemicals Compatible with Non-TEE probes

Product type	Chemical Name	Manufacturer	3Sc-RS	11L-D	12S-D	4Vc-D	6S-D	9L-D	C1-6-D	C1-5-D	C2-9-D	C3-10-D	IC5-9-D	L8-18i-D	M5Sc-D	ML6-15-D	P2D	P6D	
Wipes	PCS 1000 Oxidizing Disinfectant/ Disinfectant Cleaner Wipes	Process Cleaning Solutions Ltd	X	X	X	X	X	X	X	X	X	X	X	X	X	X			
	Protex disinfectant wipes	Parker Laboratories Inc.	X	X	X	X	X	X	X	X	X	X	X	X	X	X			
	Protex ULTRA Disinfectant Wipes	Parker Laboratories Inc.	X	X	X	X	X	X	X	X	X	X	X	X	X	X	X	X	
	Reynard Neutral Detergent Wipes	Reynard Health Supplies	X	X	X	X	X	X	X	X	X	X	X	X	X	X			
	Reynard Premier Detergent & Disinfectant Wipes	Reynard Health Supplies	X	X	X	X	X	X	X	X	X	X	X	X	X	X			
	Sani-Cloth Active	Ecolab	X	X	X	X	X	X	X	X	X	X	X	X	X	X	X	X	
	Sani-Cloth Active	PDI	X	X	X	X	X	X	X	X	X	X	X	X	X	X	X	X	
	Sani-Cloth AF Germicidal Disposable Wipe	PDI	X	X	X	X	X	X	X	X	X	X	X	X	X	X	X		
	Sani-Cloth AF3 Germicidal Disposable Wipe	PDI	X	X	X	X	X	X	X	X	X	X	X	X	X	X	X		

Table 13-5: Chemicals Compatible with Non-TEE probes

Product type	Chemical Name	Manufacturer	3Sc-RS	11L-D	12S-D	4Vc-D	6S-D	9L-D	C1-6-D	C1-5-D	C2-9-D	C3-10-D	IC5-9-D	L8-18i-D	M5Sc-D	ML6-15-D	P2D	P6D	
Wipes	Sani-Cloth Bleach Germicidal Disposable Wipe	PDI	X	X	X	X	X	X	X	X	X	X	X	X	X	X			
	Sani-Cloth HB Germicidal Disposable Wipe	PDI	X	X	X	X	X	X	X	X	X	X	X	X	X	X	X		
	Sani-Cloth Plus Germicidal Disposable Cloth	PDI	X	X	X	X	X	X	X	X	X	X	X	X	X	X			
	Sani-Cloth Prime Germicidal Disposable Wipe	PDI	X	X	X	X	X	X	X	X	X	X	X	X	X	X	X		
	Sanizide Pro Surface Disinfectant Wipes	Safetec of America, Inc.	X	X	X	X	X	X	X	X	X	X	X	X	X	X	X		
	Saraya Surface Sanitizing wipes	Saraya	X	X	X	X	X	X	X	X	X	X	X	X	X	X	X		
	Septiwipes	Dr. Schumacher GmbH	X	X	X	X	X	X	X	X	X	X	X	X	X	X	X		
	Shodokku Super wipes	Hakujuji	X	X	X	X	X	X	X	X	X	X	X	X	X	X	X		
	SideKick Disinfecting Wipes	Stryker	X	X	X	X	X	X	X	X	X	X	X	X	X	X	X		

Table 13-5: Chemicals Compatible with Non-TEE probes

Product type	Chemical Name	Manufacturer	3Sc-RS	11L-D	12S-D	4Vc-D	6S-D	9L-D	C1-6-D	C1-5-D	C2-9-D	C3-10-D	IC5-9-D	L8-18i-D	M5Sc-D	ML6-15-D	P2D	P6D
Wipes	Sklar Disinfectant Surface Wipes	Sklar Instruments	X	X	X	X	X	X	X	X	X	X	X	X	X	X		
	Sofuraito disinfecting wipes	Asahi Kasei Chemicals Corporation	X	X	X	X	X	X	X	X	X	X	X	X	X	X		
	SONO Ultrasound Wipes	Advanced Ultrasound Solutions Inc.	X	X	X	X	X	X	X	X	X	X	X	X	X	X	X	X
	Sukitto-Cloth wipes	Osaki Medical Corporation	X	X	X	X	X	X	X	X	X	X	X	X	X	X	X	
	Sukitto-Cloth wipes refill	Osaki Medical Corporation	X	X	X	X	X	X	X	X	X	X	X	X	X	X	X	
	Super Sani-Cloth Germicidal Disposable Wipe	PDI	X	X	X	X	X	X	X	X	X	X	X	X	X	X	X	
	Tristel Pre-Clean Wipes	Tristel Solutions Limited	X	X	X	X	X	X	X	X	X	X	X	X	X	X	X	
	Tristel Rinse Wipes	Tristel Solutions Limited	X	X	X	X	X	X	X	X	X	X	X	X	X	X	X	
	Tristel Sporicidal Wipe - Activated Wipe	Tristel Solutions Limited	X	X	X	X	X	X	X	X	X	X	X	X	X	X	X	
	Tristel Trio Wipes System	Tristel Solutions Limited	X	X	X	X	X	X	X	X	X	X	X	X	X	X	X	
	trophon Companion Cleaning Wipes	Nanosonics Limited	X	X	X	X	X	X	X	X	X	X	X	X	X	X	X	
	trophon Companion Drying Wipes	Nanosonics Limited	X	X	X	X	X	X	X	X	X	X	X	X	X	X	X	

Table 13-5: Chemicals Compatible with Non-TEE probes

Product type	Chemical Name	Manufacturer	3Sc-RS	11L-D	12S-D	4Vc-D	6S-D	9L-D	C1-6-D	C1-5-D	C2-9-D	C3-10-D	IC5-9-D	L8-18i-D	M5Sc-D	ML6-15-D	P2D	P6D	
Wipes	Tuffie 5	Vernacare Ltd	X	X	X	X	X	X	X	X	X	X	X	X	X	X			
	Umonium38 Neutralis Tissues	Laboratoire Huckert's International	X	X	X	X	X	X	X	X	X	X	X	X	X	X			
	V Wipes	Whiteley Medical	X	X	X	X	X	X	X	X	X	X	X	X	X	X			
	Virox 5 RTU Wipes	Diversey	X	X		X		X	X	X	X	X	X	X	X	X	X		
	Wet Wipe Chlorine Disinfection	Wet Wipe A/S	X	X	X	X	X	X	X	X	X	X	X	X	X	X	X		
	Wet Wipe PHMB Disinfection	Wet Wipe A/S	X	X	X	X	X	X	X	X	X	X	X	X	X	X	X		
	Wet Wipe Triamin Disinfection	Wet Wipe A/S	X	X	X	X	X	X	X	X	X	X	X	X	X	X	X		
	Wet Wipe Universal	Wet Wipe A/S	X	X	X	X	X	X	X	X	X	X	X	X	X	X	X		
	Wip'Anios Excel	Laboratoires Anios	X	X	X	X	X	X	X	X	X	X	X	X	X	X	X		
	Wip'Anios Premium	Laboratoires Anios	X	X	X	X	X	X	X	X	X	X	X	X	X	X	X		
	Wipes Plus Hospital/ Surgical Wipes	Wipes Plus	X	X	X	X	X	X	X	X	X	X	X	X	X	X	X		
	Z3 Plus Surface Wipes	Benco	X	X	X	X	X	X	X	X	X	X	X	X	X	X	X		

The table below lists the chemicals that were tested for compatibility with the probes.



WARNING

The chemicals listed below are compatible with Vivid S70N / S60N probes and will not cause degradation, but have not been proven to effectively clean or disinfect the probes. If you are interested in using an alternate chemical from the compatibility tables, please contact your GE representative. Alternate chemicals require validation by GE prior to use to ensure efficacy.

Table 13-6: Chemicals Compatible with Non-TEE probes

Product type	Chemical Name	Manufacturer	3Sc-RS	11L-D	12S-D	4Vc-D	6S-D	9L-D	C1-6-D	C1-5-D	C2-9-D	C3-10-D	IC5-9-D	L8-18i-D	M5Sc-D	ML6-15-D	P2D	P6D	
Liquid	Aidal Plus (Only HLD, not sterilization)	Whiteley Medical	X	X	X	X	X	X	X	X	X	X	X	X	X	X			
	Anioxy-Twin	Laboratoires Anios		X				X	X	X	X		X	X		X			
	Anioxyde 1000	Laboratoires Anios		X				X	X	X	X		X	X		X	X		
	Bacillocid rasant	BODE Chemie GmbH (HARTMANN)	X	X	X	X	X	X	X	X	X	X	X	X	X	X	X		
	Cidex	Advanced Sterilization Products	X	X	X	X	X	X	X	X	X	X	X	X	X	X	X		
	Cidex OPA	Advanced Sterilization Products	X	X	X	X	X	X	X	X	X	X	X	X	X	X	X		X
	Cidex Plus	Advanced Sterilization Products	X	X	X	X	X	X	X	X	X	X	X	X	X	X	X		X
	gigasept FF neu	Schulke & Mayr GmbH	X	X		X		X	X	X	X	X	X	X	X	X	X		X
	gigasept PAA Concentrate	Schulke & Mayr GmbH		X					X	X	X	X		X	X		X		
	McKesson OPA 28	McKesson	X	X	X	X	X	X	X	X	X	X	X	X	X	X	X		

Table 13-6: Chemicals Compatible with Non-TEE probes

Product type	Chemical Name	Manufacturer	3Sc-RS	11L-D	12S-D	4Vc-D	6S-D	9L-D	C1-6-D	C1-5-D	C2-9-D	C3-10-D	IC5-9-D	L8-18i-D	M5Sc-D	ML6-15-D	P2D	P6D	
Liquid	Metricide	Metrex	X	X	X	X	X	X	X	X	X	X	X	X	X	X			
	Metricide 28	Metrex	X	X	X	X	X	X	X	X	X	X	X	X	X	X			
	Metricide Plus 30	Metrex	X	X	X	X	X	X	X	X	X	X	X	X	X	X			
	Metricide OPA Plus	Metrex	X	X		X		X	X	X	X	X	X	X	X	X			
	Nu-Cidex	Advanced Sterilization Products																X	
	Opal	Whiteley Medical	X	X	X	X	X	X	X	X	X	X	X	X	X	X	X		
	Opaster'Anios	Laboratoires Anios	X	X	X	X	X	X	X	X	X	X	X	X	X	X	X		
	Opidex OPA	Firson Co. Ltd.	X	X	X	X	X	X	X	X	X	X	X	X	X	X	X		
	Rapicide High-Level Disinfectant and Sterilant (use as HLD only)	Medivators Inc	X	X	X	X	X	X	X	X	X	X	X	X	X	X	X		
	Rapicide OPA 28	Medivators Inc	X	X	X	X	X	X	X	X	X	X	X	X	X	X	X		
	Revital-Ox Resert High Level Disinfectant	STERIS Corporation		X					X	X	X	X		X	X		X		
	Sporox II	DSHealthcare Inc.																	X
	Steranios 2% (use as HLD only)	Laboratoires Anios	X	X	X	X	X	X	X	X	X	X	X	X	X	X	X	X	
Wavicide-01	Medical Chemical Corporation	X	X	X	X	X	X	X	X	X	X	X	X	X	X	X			

Table 13-6: Chemicals Compatible with Non-TEE probes

Product type	Chemical Name	Manufacturer	3Sc-RS	11L-D	12S-D	4Vc-D	6S-D	9L-D	C1-6-D	C1-5-D	C2-9-D	C3-10-D	IC5-9-D	L8-18i-D	M5Sc-D	ML6-15-D	P2D	P6D
Powder	Gigasept pearls	Schulke & Mayr GmbH		X				X	X	X	X		X	X		X		
	HMC NF (HMC 9)	mdd Company GmbH		X				X	X	X	X		X	X		X		
	Rely+On PeraSafe	The Chemours Company		X				X	X	X	X		X	X		X		
	Sekusept Aktiv	Ecolab		X				X	X	X	X		X	X		X		
	Sekusept Easy	Ecolab		X				X	X	X	X		X	X		X		

The table below lists the chemicals that were tested for compatibility with the probes.



WARNING

The chemicals listed below are compatible with Vivid S70N / S60N probes and will not cause degradation, but have not been proven to effectively clean or disinfect the probes. If you are interested in using an alternate chemical from the compatibility tables, please contact your GE representative. Alternate chemicals require validation by GE prior to use to ensure efficacy.

Table 13-7: Chemicals Compatible with Non-TEE probes

Product type	Chemical Name	Manufacturer	3Sc-RS	11L-D	12S-D	4Vc-D	6S-D	9L-D	C1-6-D	C1-5-D	C2-9-D	C3-10-D	IC5-9-D	L8-18i-D	M5Sc-D	ML6-15-D	P2D	P6D
Gels	Aquasonic 100	Parker Laboratories Inc.	X	X	X	X	X	X	X	X	X	X	X	X	X	X	X	X
	Clear image	Sonotech Inc.	X	X	X	X	X	X	X	X	X	X	X	X	X	X		
	EcoGel 200 Ultrasound Gel	Eco-Med Pharmaceutical Inc.	X	X	X	X	X	X	X	X	X	X	X	X	X	X		
	EcoVue Ultrasound Gel	HR Pharmaceuticals Inc.	X	X		X		X	X	X	X	X	X	X	X	X		
	Haiyin	Wuxi Huasheng Medical Appliance		X	X		X	X	X	X	X		X	X		X		
	Kendall Life Trace Ultrasound Gel	Covidien/ Medtronic	X	X	X	X	X	X	X	X	X	X	X	X	X	X		
	Konix Ultrasound Gel	Turkuaz	X	X	X	X	X	X	X	X	X	X	X	X	X	X		
	MediChoice Standard Ultrasound Gel	MediChoice	X	X	X	X	X	X	X	X	X	X	X	X	X	X		

Table 13-7: Chemicals Compatible with Non-TEE probes

Product type	Chemical Name	Manufacturer	3Sc-RS	11L-D	12S-D	4Vc-D	6S-D	9L-D	C1-6-D	C1-5-D	C2-9-D	C3-10-D	IC5-9-D	L8-18i-D	M5Sc-D	ML6-15-D	P2D	P6D
Gels	Medline Ultrasound Gel / Ultrasound Transmission Gel	Medline Industries, Inc.	X	X	X	X	X	X	X	X	X	X	X	X	X	X		
	Scan	Parker Laboratories Inc.	X	X	X	X	X	X	X	X	X	X	X	X	X	X		
	Sonogel	Sonogel Vertriebs GmbH	X	X	X	X	X	X	X	X	X	X	X	X	X	X		
	Wavelength Multi-Purpose Ultrasound Gel	National Therapy Products Inc.	X	X	X	X	X	X	X	X	X	X	X	X	X	X		

The table below lists the systems that were tested for compatibility with the probes.



WARNING

The systems listed below are compatible with Vivid S70N / S60N probes and will not cause degradation, but have not been proven to effectively clean or disinfect the probes. If you are interested in using an alternate system from the compatibility tables, please contact your GE representative. Alternate systems require validation by GE prior to use.

Table 13-8: Automated Disinfection System Compatible with Non-TEE probes

Name	Manufacturer	3Sc-RS	11L-D	12S-D	4Vc-D	6S-D	9L-D	C1-6-D	C1-5-D	C2-9-D	C3-10-D	IC5-9-D	L8-18i-D	M5Sc-D	ML6-15-D	P2D	P6D
Antigermix AS1 - see warning below	Germitec	X	X	X		X	X	X	X	X	X	X	X	X	X	X	
Hypernova Chronos - see warning below	Germitec	X	X	X		X	X	X	X	X	X	X	X	X	X	X	
trophon EPR	Nanosonics Limited	X	X	X	X	X	X	X	X	X	X	X	X	X	X		
trophon2	Nanosonics Limited	X	X	X	X	X	X	X	X	X	X	X	X	X	X		



WARNING

Notices applicable to all probes listed as compatible with disinfection machines using UV technology (Antigermix AS1 and Hypernova Chronos from Germitec):

- UV rays might cause discoloration of exposed areas. Such discoloration does not impact performance, safety and lifetime of the probe. Probes will not be replaced for discoloration.
- The efficacy of disinfection by these machines has not been validated by GE.

Covering the Transducer using a Sterile, Protective Sheath



CAUTION

Protective barriers may be required to minimize disease transmission. Probe sheaths are available for use with all clinical situations where infection is a concern. Use of legally marketed, sterile probe sheaths is mandatory for intra-cavitary, intra-operative, and biopsy procedures.

NOTE: *Endoscopic, rectal, and transvaginal probes should be used with a single-use sterile sheath. (Marketing Clearance of Diagnostic Ultrasound Systems and Transducers, FDA June 27, 2019). Although a non-sterile transducer cover for all semi-critical procedures (e.g., endocavitary) is the minimal recommendation, a sterile cover is preferred. (Guidelines for Infection Prevention and Control in Sonography: Reprocessing the Ultrasound Transducer, SDMS, 2019).*

1. Place an appropriate amount of gel inside the protective sheath and/or on the transducer face.

NOTE: *Failure to use imaging gel may result in poor image quality.*

2. Insert transducer into sheath, making sure to use proper sterile technique. Pull cover tightly over transducer face to remove wrinkles and air bubbles, taking care to avoid puncturing the sheath.



Figure 13-14. Applying the Sheath

1. Secure the Sheath with a rubber band.
2. The probe sheath should extend past the end of the probe to the probe's cable.

NOTE: *No gel was applied to the probe in this photo.*

3. Secure the sheath in place.

NOTE: *Failure to use a sheath that fully covers the transducer to the cable strain relief may lead to cross-contamination of the transducer.*

4. Inspect the sheath to ensure there are no holes or tears. If the sheath becomes compromised, stop the procedure and replace immediately.

Coupling gels

In order to ensure optimal transmission of energy between the patient and probe, a conductive gel or couplant must be applied liberally to the patient where scanning will be performed.



CAUTION

Do not apply gel to the eyes. If there is gel contact to the eye, flush eye thoroughly with water.



CAUTION

Only use GE-recommended gels. Use of unapproved gels may result in damage to the probe and void the warranty.

Refer to the Probe Care Card enclosed in the probe case or to the Internet link below for the latest list of compatible coupling gels, cleaners and disinfectants.

<http://www.gehealthcare.com/Products/Ultrasound/Ultrasound-Transducers>

Precautions: coupling gels should not contain the following ingredients as they are known to cause probe damage:

- Methanol, ethanol, isopropanol, or any other alcohol-based product
- Mineral oil
- Iodine
- Lotions
- Lanoline
- Aloe Vera
- Olive Oil
- Methyl or Ethyl Parabens (para hydroxybenzoic acid)
- Dimethylsilicone
- Polyether glycol based
- Petroleum

Disposal



This symbol indicates that the waste of electrical and electronic equipment must not be disposed as unsorted municipal waste and must be collected separately. Please contact the manufacturer or other authorized disposal company to decommission your equipment according to local regulations.

For accessing the WEEE passport of the GE Healthcare products please:

- Go to GE Healthcare Support Documentation Library:
<https://customer-doc.cloud.gehealthcare.com>
- Select Modality: Ultrasound (UL)
- Enter Document Name or keyword: WEEE
- Click: Search
- Select the desired WEEE passport

NOTE: Probes must be cleaned and disinfected before they are replaced or disposed.

Probe safety

Electrical hazards

Probes are driven by electricity, which can injure the patient or user when exposed to contact with conductive solution.



Do not immerse the probe into any liquid beyond the level shown in Figure 13-6. Never immerse the probe connector or adaptors into any liquid.

Do not subject the probe to mechanical shock or impact, which may result in cracks or chips in the housing and degrade performance.

Inspect the probe before and after each use, as described on page 13-20, for damage or degradation to the housing, strain relief, lens and seal.

DO NOT apply excessive force to the probe cable, to prevent insulation failure.

Electrical leakage checks should be performed regularly by a GE service representative or qualified hospital personnel, according to the procedures described in IEC/EN 60601-1 Clause 8.7.

Mechanical hazards

Take precaution to avoid mechanical hazards.



Observe immersion levels as displayed in Figure 13-6 *on page 13-29*.

Inspect probes for sharp edges or rough surfaces that could injure sensitive tissue.

DO NOT bend or pull the cable forcefully, to avoid mechanical shock or impact to the probe.

Biological hazards



CAUTION

Transesophageal probes require a special handling. Refer to the user documentation enclosed with these probes.



CAUTION

Protective barriers may be required to minimize disease transmission. Probe sheaths are available for use with all clinical situations where infection is a concern. Use of legally marketed, sterile probe sheaths is strongly recommended for intra-cavity and intra-operative procedures.



CAUTION

According to local regulations, the use of sterile sheath is mandatory when performing intra-cavity procedures in China.

To reorder sheaths, please contact your local distributor or the appropriate support resource.

Adequate cleaning and disinfection are essential to prevent disease transmission. It is the responsibility of the user to verify and maintain the effectiveness of the infection control procedures in use.



CAUTION

Risk of Infection. ALWAYS clean and disinfect the probe between patients to the level appropriate for the type of examination and use FDA-cleared probe sheaths where appropriate.

Endocavity Probe Handling Precautions

If the probe is contaminated with residuals of disinfectant before use, please follow the cautions below.



Disinfectant Exposure to Patient: contact with a disinfectant to the patient's skin or mucous membrane may cause an inflammation. If this happens, refer to the disinfectant's instruction manual.

Disinfectant Exposure from Probe Handle to Patient: DO NOT allow the disinfectant to contact the patient. Only immerse the probe to its specified level. Ensure that no solution has entered the probe's handle before scanning the patient. If disinfectant comes into contact with the patient, refer to the disinfectant's instruction manual.

Disinfectant Exposure from Probe Connector to Patient: DO NOT allow the disinfectant to contact the patient. Only immerse the probe to its specified level. Ensure that no solution has entered the probe's connector before scanning the patient. If disinfectant comes into contact with the patient, refer to the disinfectant's instruction manual.

Restricted Areas

This equipment must not be used in the presence of inflammable gases.



For transportation:

This equipment is not to be used during transportation (e.g. ambulance cars, aircraft), but it is transportable between rooms (bedside-scanning).



This equipment can only be used up to a sea level of 2360m, if no other information is available.

Leakage of Silicon Grease

NOTE: Sporadically, silicone grease can leak in small amounts from the probes' cable bushing. This leakage is not a failure or harmful to the human body. Silicone grease does not contain any hazardous substances and is only used to seal the cable bushing. In case of a leakage wipe the grease with a cloth.

Biopsy

User qualification for biopsy

Biopsies must only be performed by physicians with adequate experience. Under all circumstances the necessary safety precautions and sterility measures have to be respected.

Biopsy capability for probes

The system supports biopsy capability for the probes listed in the table below.

Use only the biopsy needle guidance systems from Civco Medical Solutions listed in the table below.

Probe	Civco needle guidance systems	Cat #
C1-6-D	Ultra-Pro II™ Needle Guidance System	H4913BB
C2-9-D	Ultra-Pro II™ Needle Guidance System	H4913BA
9L-D	Ultra-Pro II™ Needle Guidance System	H4906BK
11L-D	Ultra-Pro II™ Needle Guidance System	H40432LC
M5Sc-D	Ultra-Pro II™ Needle Guidance System	H45561FC
3Sc-RS	Ultra-Pro II™ Needle Guidance System	H46222LC
C1-5-D	Ultra-Pro II™ Needle Guidance System	H40432LE
IC5-9-D	Disposable Endocavity Needle Guide	E8385MJ
4Vc-D	Ultra-Pro II™ Needle Guidance System	H40482LP
ML6-15-D	Ultra-Pro II™ Needle Guidance System	H40432LJ

The biopsy option is intended for use by a duly licensed physician who has received the appropriate training in biopsy techniques as dictated by current relevant practices, as well as in proper operation of the ultrasound system.

Precaution concerning the use of biopsy procedures



Do not freeze the image during a biopsy procedure. The image must be live to avoid a positioning error.



The use of biopsy devices and accessories that have not been evaluated for use with the equipment may not be compatible and could result in injury.



The invasive nature of biopsy procedures requires proper preparation and technique to control infection and disease transmission. Equipment must be cleaned as appropriate for the procedure prior to use.

- Follow the probe cleaning and disinfection procedures and precautions to properly prepare the probe.
- Follow the manufacturer's instructions for the cleaning of biopsy devices and accessories.
- After use, follow proper procedures for decontamination, cleaning, and waste disposal.

Improper cleaning methods and the use of certain cleaning and disinfecting agents can cause damage to the plastic components that will degrade imaging performance or increase the risk of electric shock.

General biopsy safety



All biopsy equipment depicted and described in these Instructions for use has been validated for use with the system and software. If biopsy equipment which is not listed in these Instructions for use is used, the user has the possibility to configure and store the predicted biopsy line. In this case the user has to be aware that the biopsy equipment/probe/system/software combination may not be validated and therefore responsibility for correct configuration and usage lies with the user.



CAUTION

- Use of legally marketed, sterile probe sheaths is recommended for biopsy procedures
- Before using a biopsy guide, read and follow the biopsy guide independent manuals given by the manufacturer.
- Every time before using a biopsy guide ensure its correct position and optimal fit on the probe.
- Always use a straight needle for each biopsy procedure.
- Before performing a biopsy, ensure that the selected and displayed biopsy line corresponds to the biopsy needle guide mounted to the ultrasound probe (left/right).
- The biopsy needle and the biopsy needle guide (and the bore inside) must be sterile.



CAUTION

For detailed information on a biopsy guide, please contact the manufacturer of the biopsy guide.



CAUTION

Biopsy equipment is not sterile when delivered unless it is clearly labeled! If biopsy equipment is not sterile it is mandatory to clean and sterilize it before usage. For additional details please contact the legal manufacturer of the biopsy equipment.



CAUTION

Ensure the correct position and optimal fit every time before using a biopsy guide!



CAUTION

- Disposable biopsy guides: Single-use components must be disposed as infectious waste!
- Reusable biopsy guides must be sterilized before they are disposed!



CAUTION

Before starting a biopsy procedure with a 3D/4D probe always perform a volume scan first. This is important to ensure proper mechanical alignment and centering of the transducer element before the biopsy is performed.



CAUTION

- The default biopsy lines provided with the system software, must be verified at least once by the user. The procedure must be repeated if probes and/or biopsy guides are exchanged.
- Before performing a biopsy, prepare a water bath of approx. 47°C and make sure that the displayed biopsy line coincides with the needle track. Observe probe specific information on the temperature of the water bath.
- The needle used for water bath alignment must not be used for a biopsy performed on a patient.
- Depending on the needle stiffness/thickness and the elasticity and composition of the different tissue-types in the path of the biopsy needle, the actual needle track can deviate from the predicted biopsy line. The biopsy needle might bend and not follow a straight line.

Freehand biopsy



CAUTION

When performing a freehand biopsy, i.e. without a biopsy guide, it is the user's responsibility to use appropriate equipment. Ensure that the needle (especially the needle tip) is always visible in the ultrasound image during the whole biopsy procedure.



CAUTION

Always only use basic modes when performing a freehand biopsy.

NOTE: *A water bath alignment verification is also necessary before performing freehand biopsy procedures.*

Preparing the Biopsy guide attachment - Convex, Sector and Linear probes

Convex, Sector and Linear probes have an optional biopsy kit specific for each probe. The biopsy kit consists of:

- A reusable non-sterile bracket
- Disposable sterile Ultra-Pro II™ Needle guide kits (Civco Medical Instruments Co, Inc.) consisting of:
 - Sets with needle inserts covering gauge size 14 through 23 (2.1 mm to 0.6 mm)
 - Sterile sheath
 - Rubber bands
 - Gel
- A reusable needle guide
- Instructions

In addition sterile Ultra-Pro II™ Needle guide kits can be ordered as replacement kit.



Read the following instructions and the user's guide for the Ultra-Pro II™ Needle Guide kit before using the biopsy equipment.

Biopsy guide mounting

All biopsy needle guides can easily be mounted to the transducer. Biopsy guides have a special stop or handle to guarantee a good fix into the notch of transducers.

Bracket attachment procedure

1. Identify the appropriate biopsy guide bracket as shown in Table 13-9.

Table 13-9: Biopsy guide brackets



Probe	Biopsy bracket
C1-6-D	 <p>The diagram shows a curved biopsy bracket labeled 'C1-6D'. It has a hook-like structure at the top right end with a small circular logo containing the number '36'. The bracket is designed to fit around a probe.</p>
C2-9-D	 <p>The diagram shows a curved biopsy bracket labeled 'C2-9'. It features a hook-like structure at the top right end. The bracket is designed to fit around a probe.</p>
9L-D	 <p>The diagram shows a curved biopsy bracket labeled '9L'. It has a hook-like structure at the top right end with a small circular logo containing the number '36'. The bracket is designed to fit around a probe.</p>
11L-D	 <p>The diagram shows a curved biopsy bracket labeled '11L/12L-RS'. It has a hook-like structure at the top right end with a small circular logo containing the number '36'. The bracket is designed to fit around a probe.</p>
M5Sc-D	 <p>The diagram shows a curved biopsy bracket labeled 'M5S-D'. It has a hook-like structure at the top right end with a small circular logo containing the number '36'. The bracket is designed to fit around a probe.</p>

Table 13-9: Biopsy guide brackets

Probe	Biopsy bracket
3Sc-RS	
C1-5-D	
4Vc-D	
ML6-15-D	

2. Orient the bracket so that the needle clip attachment is on the same side as the probe orientation mark, see Figure 13-15.
3. Attach the biopsy bracket to the probe by sliding the bracket over the end of the probe until it clicks or locks into place.
Make sure the bracket is firmly attached to the probe.

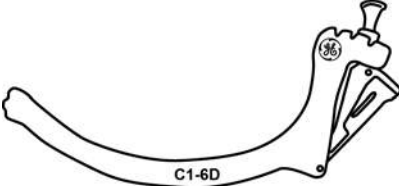
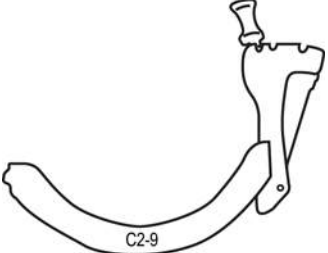
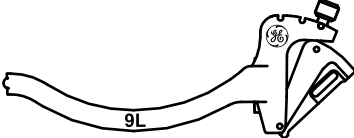
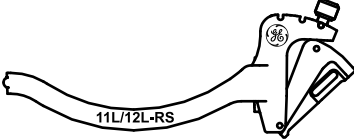

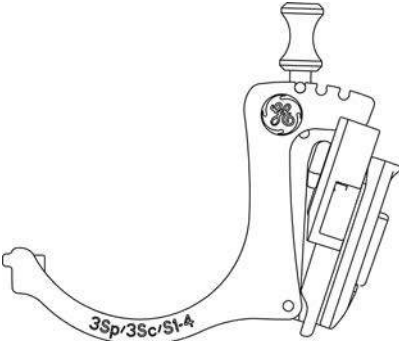
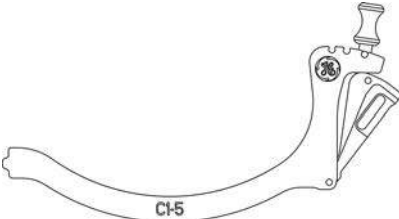
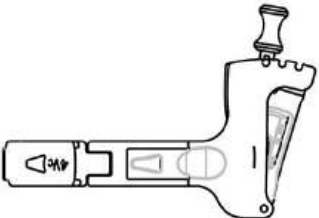
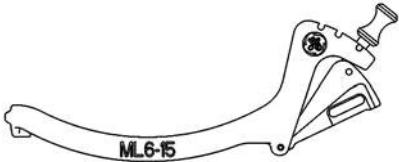
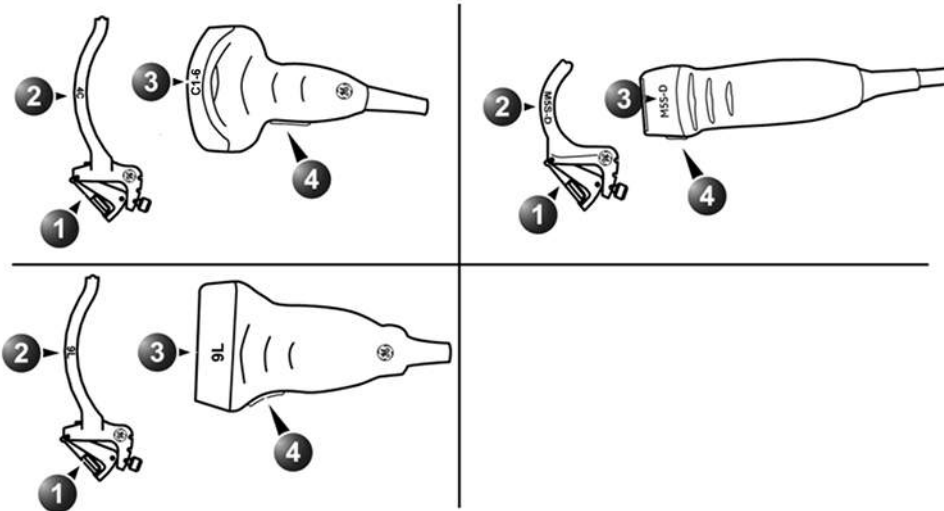
1. Needle clip attachment on the bracket
2. Bracket label
3. Probe label
4. Probe orientation mark

Figure 13-15. Probe/bracket alignment (representative examples)

Placing the probe and bracket into the sterile sheath

Refer to the Ultra-Pro II™ Needle Guide user manual.

Attaching the needle guide to the bracket

Refer to the Ultra-Pro II™ Needle Guide user manual.

Preparing the Biopsy guide attachment - endocavity probe

The endocavity probe IC5-9-D has an optional specific biopsy kit
The biopsy kit consists of:

- Disposable sterile needle guide



NOTE: *This is a single-use bracket. The probe label is placed on the packaging.*

- Sterile sheath
- Rubber bands
- Gel
- Reference Guide for the Disposable Endocavity Needle Guide

In addition disposable sterile endocavity needle guide can be ordered as replacement kit.



WARNING

Read the instructions in the Reference Guide for the Disposable Endocavity Needle Guide from Civco Medical Solutions before using the biopsy equipment.

Needle guide attachment

Refer to the “Disposable Endocavity Needle Guide” Reference Guide.

Biopsy guide mounting

All biopsy needle guides can easily be mounted to the transducer. Biopsy guides have a special stop or handle to guarantee a good fix into the notch of transducers.

Installation of the attachment

Before installing the attachment, the filling must be removed from the probe head where the biopsy guide attachment will be installed. This is only for first time installation. See Figure 13-16.

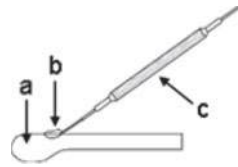

- a. Probe head
- b. Area where the biopsy guide attachment is installed
- c. Filling remover tool

Figure 13-16. Remove the filling

1. Fill the probe sheath with acoustic coupling gel as shown in Figure 13-17.

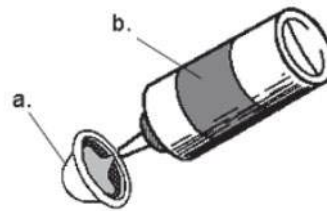

- a. Probe sheath
- b. Ultrasound gel

Figure 13-17. Ultrasound gel placement

2. Place the gel-filled probe sheath on the transducer face and bring it up the probe body so that the adjustment knob of the probe is completely covered with the probe sheath as shown in Figure 13-18.

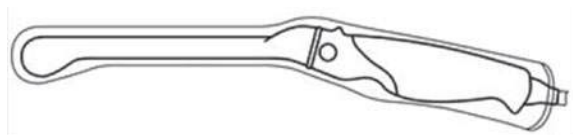
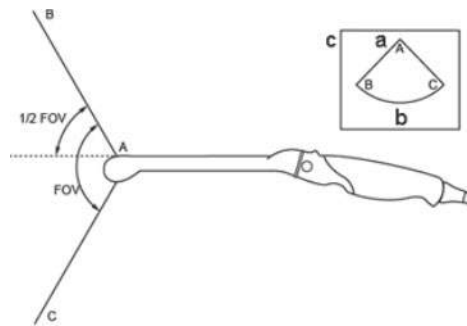

Figure 13-18. Probe sheath application

3. Apply gel to outer surface of the probe sheath at the transducer location for scanning.
4. Figure 13-19 shows the relationship between the displayed image direction during an axial scan compared to the probe and probe position.



- a. Patient's foot side
- b. Patient's head side
- c. Display on the monitor

Figure 13-19. Scan plane orientation

Placing the probe and needle guide into the sterile sheath

Refer to the “Disposable Endocavity Needle Guide” Reference Guide.

Displaying the Guide zone

1. Select the desired probe with biopsy support.
2. Press **Biopsy** on the Touch panel (Page 2).
3. If the needle multi-angle is supported, select the correct angle from the *Biopsy* menu.

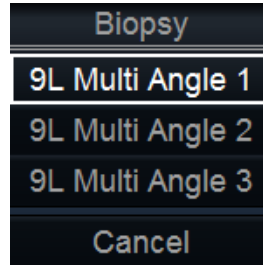
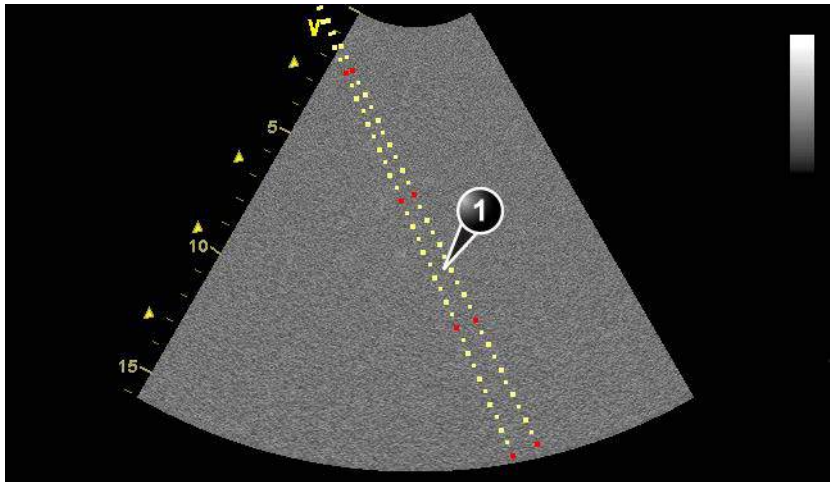

Figure 13-20. The Biopsy menu

The biopsy guide zone is displayed on the screen.



1. Biopsy guide zone
 - 5 cm between the red marks
 - 1 cm between the large yellow marks
 - 0.5 cm between two consecutive marks

The first red mark is at 5 cm from the top of the needle guide.

Figure 13-21. Biopsy guide zone

Biopsy needle path verification

Perform the Needle path verification once a year or whenever there is a suspicion of malfunction.

To verify that the path of the needle is accurately indicated within the guide zone on the system monitor, perform the following:

1. Properly install the bracket and biopsy guide (see page 13-72 and page 13-75).
2. Scan in a container filled with a glycerol solution (6% in water).
3. Display the biopsy guide zone on the monitor (see page 13-78).
4. Ensure that the needle echo falls within the guide zone markers.

Starting the biopsy procedure

1. Press **Biopsy** on the Touch panel (Page 2). When using multi-angle guides, select the correct angle from the *Biopsy* menu.
2. Place sterile coupling gel on the scanning surface of the probe/sheath.
3. Scan to locate the target. Center the target in the electronic guidezone path.

NOTE: *Enabling color flow would allow for visualization of the vascular structure around the area to be biopsied.*

4. Place the needle in the guide between the needle barrel and needle clip. Direct it into the area of interest for specimen retrieval.

Cleaning, disinfection and disposal

1. Refer to the Ultra-Pro II™ Needle Guide user manual for cleaning and disinfection of the bracket.
2. Perform cleaning and disinfection of the probe as described in page 13-21.
3. Dispose the sheath, bands and needle guide after use, according to medical regulations for biohazardous waste.



When the biopsy needle guide kit is opened, all parts must be discarded after the procedure whether they have been used or not.

Probe Check

Introduction

Probe Check is a probe assessment tool that evaluates each probe's element integrity, by transmitting on one channel at the time and recording the lens reflection, while scanning in air. During the test the probe lens should be clean because any gel residue might affect the test result. This test is intended to be used during the life of the probe to evaluate possible probe deterioration over time.

Activation of the Probe Check can be done manually from the probe/application menu, or run automatically when the probe/application is selected. The interval of the automatic test can be configured in the system configuration.

The Probe Check evaluates the ratio of weak elements to total element count and the overall reflection level from the probe lens. If the Probe Check fails, the user is still allowed to continue using the probe, but should then evaluate if the image quality is adequate for clinical use.

NOTE: Probe Check checks element integrity. There are other defects that can deteriorate probe performance that the Probe Check cannot detect, so the user should evaluate whether the probe performance is adequate regardless of the outcome of the test.

NOTE: GE is NOT responsible for the confirmation regarding the normal function of the ultrasound probe before use.

Supported probes

The probes that currently have this test available have a button labelled **Test Probe** in the probe/application menu. To activate the test manually one should open the probe menu and select **Preset Config/Test Probe** at the bottom of the application list. The **Test Probe** button is then available in the application menu.

Probe Test Activation

Auto Trigger

When the probe is connected to the scanner, the probe test will run automatically when you select probe/application. The interval between testing can be configured, and the test will run at probe/application selection when the previous test of the chosen probe type is older than the configured interval.

When the probe test is activated during probe/application selection, then “Probe Check: Checking probe, please wait...” is displayed in the info bar at the bottom of the screen (see Figure 13-22 below), then “Loading Probe/Application, please wait...” and finally “Probe Check: Probe test passed” if the test passed.

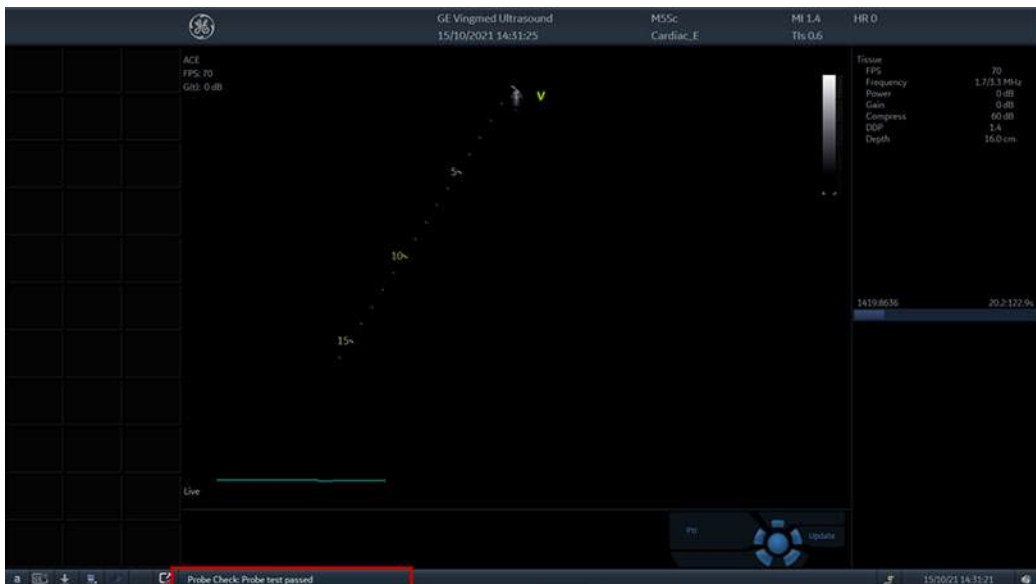
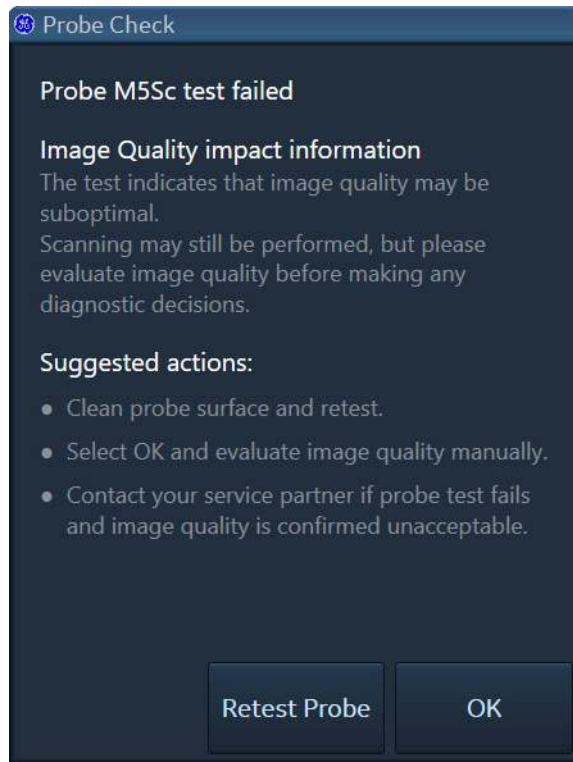

Figure 13-22. Main display with the info bar location indicated by the red rectangle

However, if the test fails the following user dialog appears:



Probe Check Message:

Probe test failed

Image Quality impact information

The test indicates that image quality may be suboptimal. Scanning may still be performed, but please evaluate image quality before making any diagnostic decisions.

Suggested actions:

- Clean probe surface and retest.
- Select OK and evaluate image quality manually.
- Contact your service partner if probe test fails and image quality is confirmed unacceptable.

Figure 13-23. Failed test user dialog

The dialog informs the user that the probe element integrity check failed, and image quality may be suboptimal.

If the lens is not clean, it should be cleaned, and the test should be repeated by selecting the **Retest Probe** button. Even if the test fails one can resume scanning by selecting the **OK** button. The image quality and the probe sensitivity should in that case

be evaluated and judged whether it is acceptable for clinical use and diagnostic decisions.

If image quality is confirmed not acceptable, please contact your Service partner.



DO NOT allow the probe head to hang free. Any possible impacts to the probe head could result in irreparable damages to the probe.

Auto Trigger interval configuration

The Probe Check frequency can be configured by entering **More > Utility > Config > Imaging > Probe Check** where one can select from five intervals:

NOTE:

- **Every exam:** probe check will be activated for each exam. *Every exam is selected as default.*
- **Once 1 day:** probe check will be activated upon probe/application selection if it is more than one day since last time the check was performed.
- **Once 7 days:** probe check will be activated upon probe/application selection if it is more than seven days since last time the check was performed.
- **Once 30 days:** probe check will be activated upon probe/application selection if it is more than thirty days since last time the check was performed.
- **Never:** probe checking will never execute during probe/application selection. If this choice is configured the user should run the test manually at regular intervals.

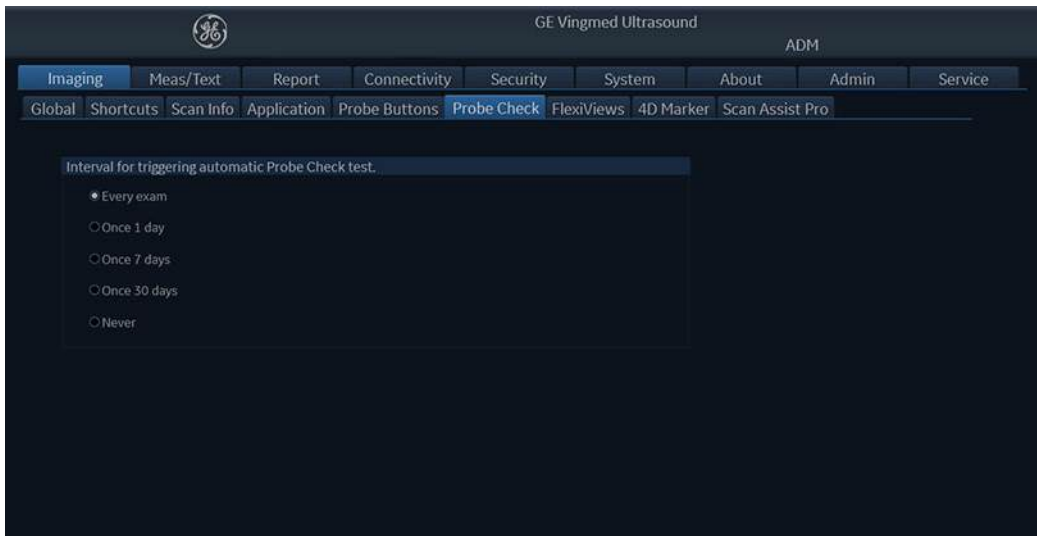

Figure 13-24. Configuration screen for Probe Test interval

If the auto test frequency is set low in the configuration, it is recommended to run Probe Check manually on a regular basis and especially if the probe performance shows sign of image or sensitivity deterioration. For curved and linear probes, compromised probe elements will typically show up as a localized dark area at shallow depths. For phased arrays, all elements are used for all imaging directions, but fewer elements are used at shallow depths, so loss of elements is most likely to give reduced image intensity at shallow depths. The following three images illustrate this.



Figure 13-25. Example of image degradation for a curved probe



Figure 13-26. Example of image degradation for a linear probe

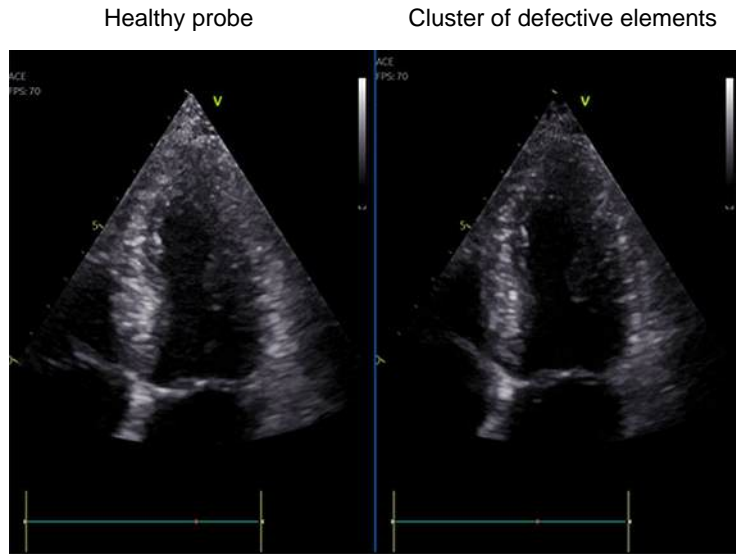

Figure 13-27. Example of image degradation for a phased array probe

Manual Trigger

Users can run the Probe Test manually at any time by entering the probe menu, selecting the probe to be tested, and then selecting the **Preset Config/Test Probe** button at the bottom of the application list. This menu displaying all applications will have a **Test Probe** button at the lower right corner if the Probe Test is available for the probe in question.

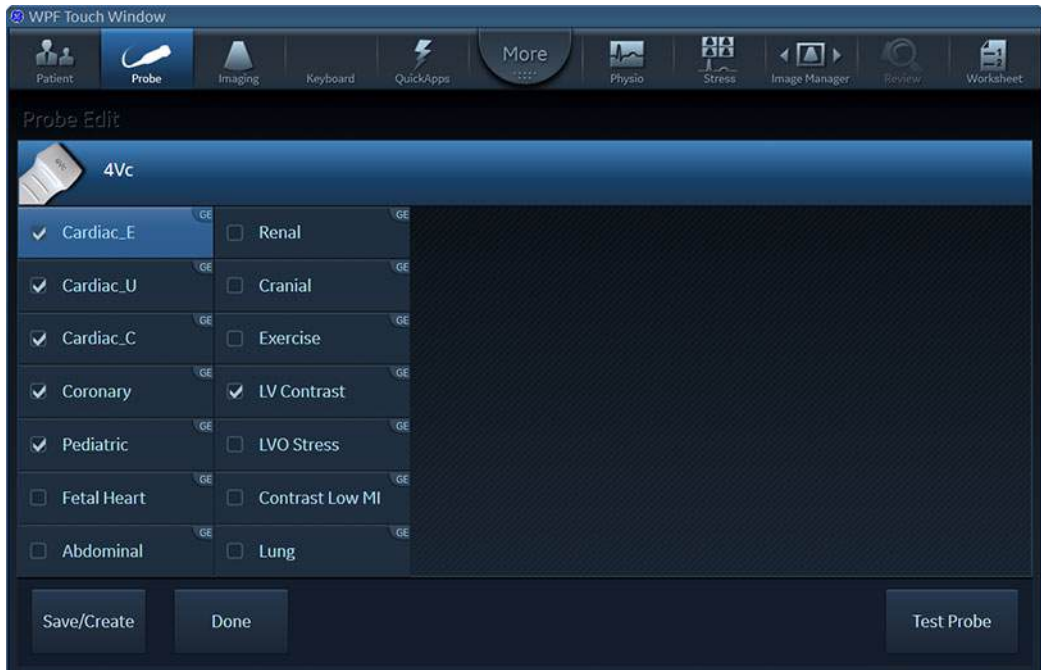
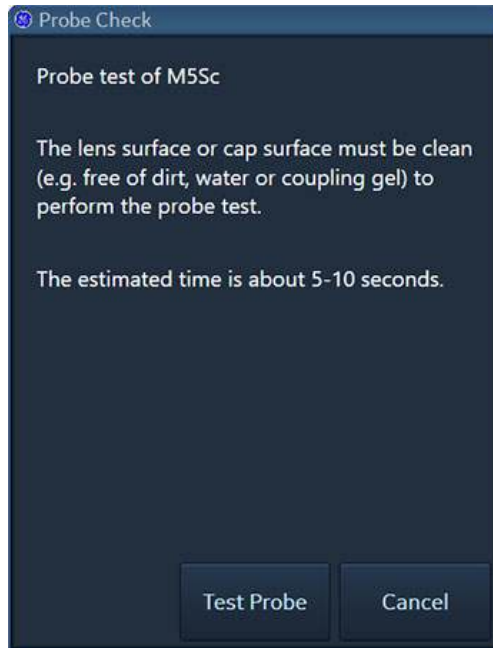

Figure 13-28. Manual Probe Test

After selecting the **Test Probe** button the following user dialog will appear:



Probe Check Message:

Probe test
The lens surface or cap surface must be clean (e.g. free of dirt, water or coupling gel) to perform the probe test.
The estimated time is about 5-10 seconds.

Figure 13-29. Probe Test manual activation user dialog

After selecting **Test Probe** the probe test activates and the user feedback is the same as described for the automatically activated "Probe Test".

Chapter 14

Peripherals

'Printing' on page 14-4

'Printing configuration' on page 14-5

'Flexible Video Out' on page 14-7

'View-X' on page 14-11

'CartoSound' on page 14-19

Introduction

This chapter provides information on peripherals that can operate with the ultrasound system.

- Internal black & white thermal video printer
- External USB connected printer
- Network printer, a range of network printers are supported. .
- View-X streaming box (see page 14-11)

Contact GE Healthcare representative for more information



If externally powered equipment supplied by GEHC is electrically connected to the scanner ME Equipment, an ME System is formed. Only items that have been specified as part of the ME System or have been specified as compatible with the ME System should be connected.

All GEHC supplied equipment which is externally powered and connects to the scanner shall be placed outside the patient environment (as defined by IEC/EN60601-1 Clause 16.2.c).



Use only GE Healthcare approved internal equipment when replacing an *internal* peripheral.

External peripheral equipment must be in compliance with related IEC/EN standards for safety. The electrical medical systems conformance to IEC/EN60601-1 Clause 16 must be verified.

All non-medical devices must be kept outside of the patient environment, unless it is equipped with additional protective earth and extra isolating device, such as a transformer. Commercial devices such as laser cameras, printers, VCRs and external monitors, usually exceed allowable leakage current limits and, when plugged into separate AC outlets, are in violation of patient safety standards. Suitable electrical isolation of such external AC outlets, or providing the device with extra protective earth, will be required in order to meet IEC/EN60601-1 Clause 16 standards for electrical leakage.

Only GE Healthcare approved devices and approved configurations are allowed.



Any devices or cables, other than those sold with the ultrasound unit, connected to the Peripheral /accessory connector panel or to an USB port on the unit may result in an increase of the electromagnetic emission from the unit, or a decrease of the electromagnetic immunity of the unit.



When using peripheral device, observe all warnings and cautions given in peripheral operator manuals.

Please refer to the manufacturer's instructions for use for cleaning and disinfection information for peripherals and accessories that are likely to come in contact with the patient (for example ECG cables).

The ultrasound system can support a thermal video printer. The printer device is controlled from the **P1** key on the Control panel.

The **P1** key can also be configured to perform alternative storage (i.e. storage to DICOM media or secondary capture). See page 14-5 for configuration of the **P1** key.

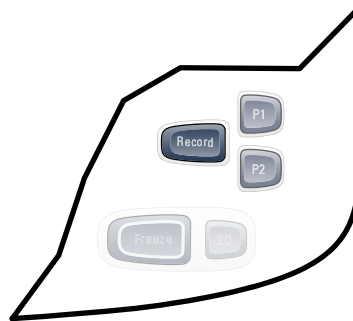

Figure 14-1. The printer controls on the Control panel

To print an image

1. Press **P1** on the Control panel.

The image displayed on the screen is printed on the printer, depending on the key assignment configuration (see page 14-5).

NOTE: *For details on the Thermal video printers operation, consult the manufacturer operator manual provided with the printer.*

Printing configuration

System configuration for printing requires to:

- configure the **P1** button on the Control panel.
- select and set up a printer.

P1 button configuration

The **P1** button on the Control panel can be configured to perform several actions (e.g. Video Print, Laser print, DICOM storage...etc.).

To configure the **P1** button:

1. Press **Utility/Config** on the Touch panel.
2. Select the **Connectivity** category and the **Buttons** subgroup.

The *Buttons* sheet is displayed (Figure 10-50 on page 10-71).

3. In *Button* field select **P1**.
4. Select an output device in the *Available output* field and press the **Right arrow** button to assign the device to the selected button.

The *Properties* window for the selected device is displayed, if configurable.

5. Click the *pull-down* to change the printer.
6. Click *Properties* to configure the printer.

To remove a device, select the device in the *Selected devices* field and press the **Left arrow** button.

Printer setup

Printers are configured in the *Connectivity — Printer* tab.

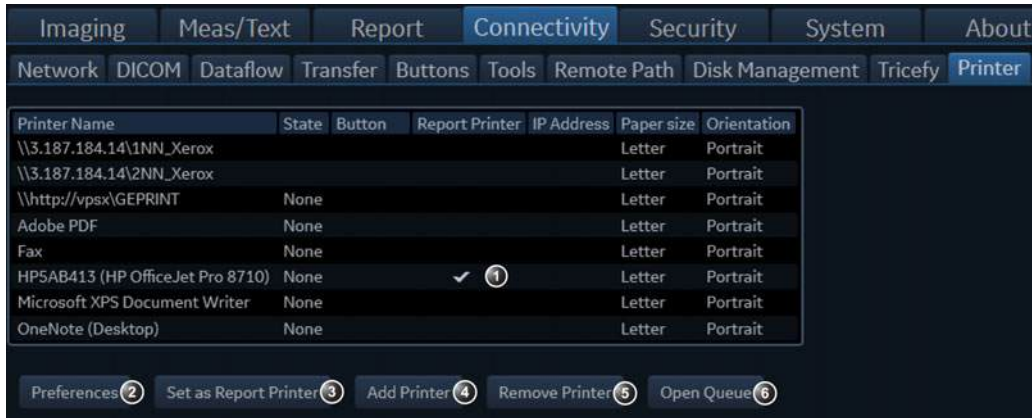

Figure 14-2. The Printer config sheet

1. To select a printer, highlight it in the table.
 2. Click *Preferences* to adjust Paper size and Orientation.
 3. Click *Set as Report printer* to use it for printing reports.
 4. Click *Add Printer* and use the windows printer wizard to add one.
- NOTE:** *Adding printer drivers is not possible.*
5. Click *Remove Printer* to remove printers from the list available for the scanner.
 6. Click *Open Queue* to view jobs in the printer spooler.

Flexible Video Out

**WARNING**

Image quality on the external monitor may be sub-optimal compared to the system monitor.

Connect external monitor

**CAUTION**

Read the external monitor's user manual thoroughly before attempting to use the monitor.

1. Connect the external monitor to the system using a DVI-D cable.
2. Connect the external monitor to mains as described in the monitor's user manual.



Figure 14-3. External monitor connection

NOTE: *It might take some seconds before the external monitor is detected and the flexible video out connection stabilizes.*

Select region to show on the external monitor

1. Press **More** on the touch panel, then **LCD**.
2. Select either **Full Screen** or **Image** under **Video Out**.

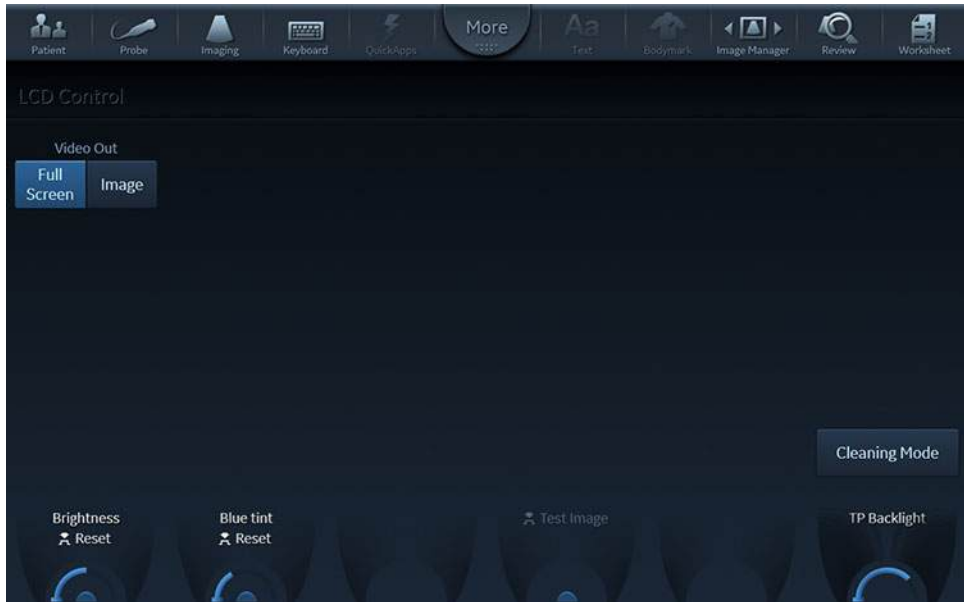

Figure 14-4. Touch panel LCD Control screen

NOTE: *It might take some seconds before the new setup is properly configured and the image on the external monitor stabilizes.*

Full Screen video out region

When **Full Screen** is selected, the full system main monitor contents are mirrored onto the external monitor.



Figure 14-5. Full Screen video out example

Image video out region

The **Image** option will mirror only the image area of the system monitor, as shown in Figure 14-6.



Figure 14-6. Image video out screen example

NOTE: The image aspect ratio of the system monitor is preserved on the external monitor, as long as the resolution on the external monitor itself is properly set up without any kind of aspect ratio distortion.

NOTE: External monitors with a resolution of 1280x800 are not supported, as that causes a conflict with the touch panel screen.

View-X

View-X is an option that enables streaming from an external video signal in a dedicated window on the system. The video signal is received by means of multimedia streaming over the IP network and without audio. For instructions to connect and set up View-X, consult the documentation for the device itself and the Service Manual.

Video streaming setup is described in 'TCP/IP Configuration for View-X' on page 14-12.

View-X is available from the *Imaging* screen and toggles the streaming window On/Off. When toggled On a dedicated window showing the streamed video appears in the lower right corner by default (Figure 14-7).

NOTE: *Network connection quality may impact streaming quality. Under ideal networking conditions a delay of approx. 1 sec will still persist.*

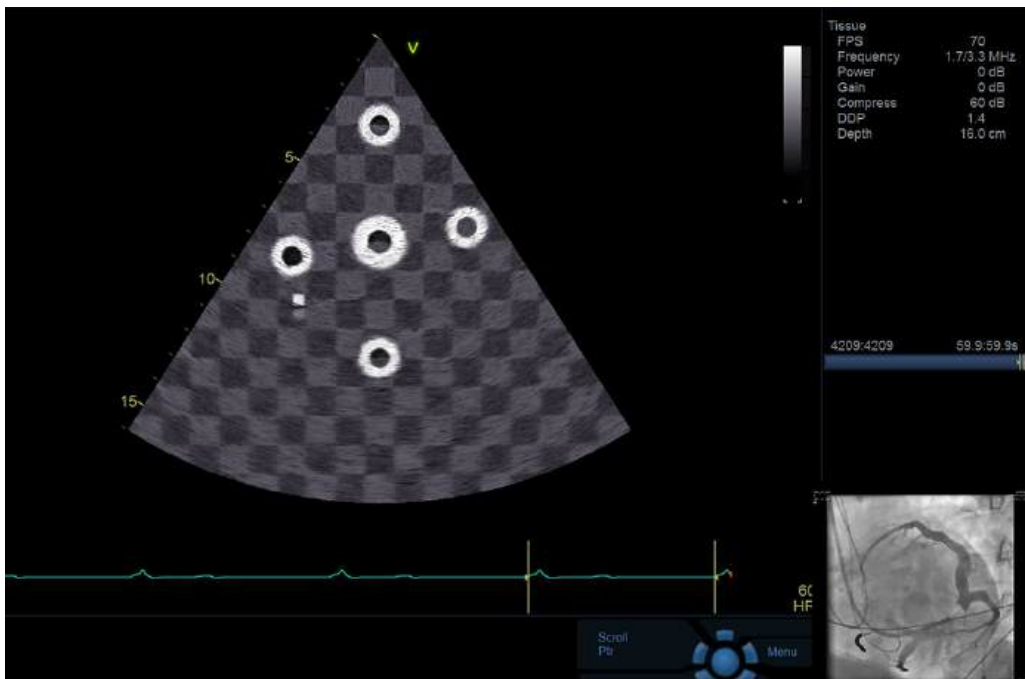

Figure 14-7. Scanning window with View-X on.

The size and position of the window can be adjusted by using the rotary control below the View-X button (Figure 14-8).



Figure 14-8. Rotary control for View-X size and position

TCP/IP Configuration for View-X

Streaming source and client configuration is set through the **View-X** settings:

1. Press **Utility/Config** on the Touch panel and log on as administrator if required.
2. Select the **Connectivity** category and the **Network** subgroup.
3. Select **View-X** (Figure 14-9).

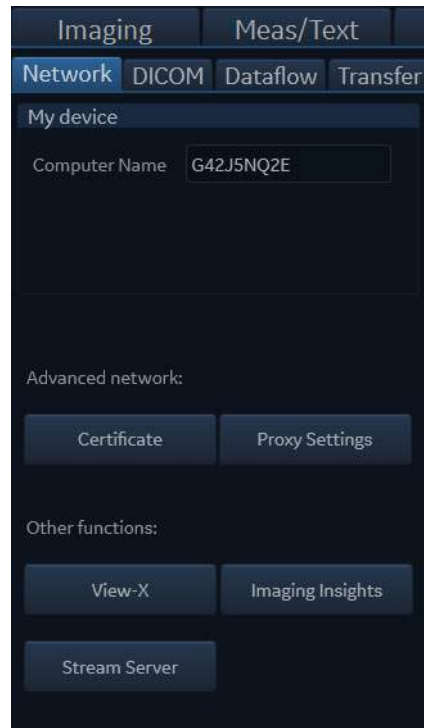

Figure 14-9. View-X under Network configuration

4. Configure the *View-X* server and client as necessary (Figure 14-10).



Figure 14-10. View-X Video streaming setup

View-X Direct

Activating View-X Direct

The View-X Direct button is available on the Utility page when Direct Connection is enabled in Config (default=enabled). See 'Enable Direct Connection' on *page 14-15* for information related to Direct Connection, if needed.



Figure 14-11. View-X Direct button on the Utility page

Typical Use Scenario

Prepare for examination:

- If needed, load worklist using the worklist dataflow while connected to the hospital network. It will still be available offline. Pull up the patient from Local Archive.
- If not using a network, start the exam with Patient name/ID in Local Archive. Connect to the Epiphan DVI Broadcaster:
 1. Connect the Epiphan DVI Broadcaster to the ultrasound system with the crossover network cable.
 2. Open the Utility tab and click View-X Direct to toggle on. This activates the IP addresses that allow the Epiphan DVI Broadcaster and the ultrasound system to communicate.
 3. Complete the study.
 4. Click View-X Direct to toggle off the setting.
 5. To transfer the study, connect back to the hospital network and transfer the study/exam/patient from Local Archive as needed.

NOTE: *The Epiphan DVI Broadcaster static IP address is 192.168.255.250 and the ultrasound system's underlying static IP address when View-X Direct is enabled is 192.168.255.249. These addresses cannot be changed while View-X Direct is active. When View-X Direct is not active, the system reverts to default TCP/IP settings.*

Enable Direct Connection

Follow these sections to select the Direct Connection to the Epiphan DVI Broadcaster for video streaming.

1. Ensure that the network cable from the Epiphan DVI Broadcaster is connected to the ultrasound system, and that the Epiphan DVI Broadcaster is switched on.
2. On the ultrasound system, enter: **Utility > Config > Connectivity > Network** and activate **View-X**. The *View-X* dialog opens.



Figure 14-12. The View-X dialog

3. Click the **Direct Connection** check box to activate direct connection to the Epiphan DVI Broadcaster.

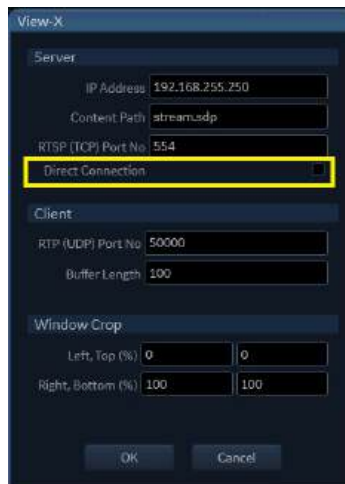

Figure 14-13. Activate Direct Connection

Selecting *Direct Connection* enables the **View-X Direct** button on the Utility page which will set the ultrasound

system to a static IP so it can connect to the factory default static IP on the Epiphan DVI Broadcaster.

4. Select **OK** to exit.
5. Log out of the ultrasound system.

Adjust Cropping of the Video Stream

Overview

By adjusting the Window Crop values, the user can crop incoming video stream. This way only a useful/interesting part of the video can be shown. The aspect ratio is preserved.



Figure 14-14. Window Crop

The crop box is described with four values: left, top, right, bottom positions given in percentage regarding to the original input video. These values define (left, top) and (right, bottom) corners of the crop box.

By default, the values are set to (left=0, top=0) and (right=100, bottom=100); meaning that the full input video is show. If the values are set to (left=0, top=0) and (right=50, bottom=50), only the upper left quadrant of the input video will be visible. The visualized subpart will be stretched (and this visually enlarged) to fit dedicated video windows on the scanner. Aspect ratio is still preserved.

Adjust the Window Crop

Follow these steps to adjust the Window Crop:

1. Go to **Utility > Config > Connectivity > Network** and activate the *View-X* dialog.
2. Adjust the values in the four Window Crop fields to crop the video stream window so the area of interest is displayed.
3. Select **OK** to set the new values.



Full Video Image



Cropped Video Image

CartoSound

CartoSound/SoundStar

The Vivid S70N / S60N can interface with the Carto 3 system, which includes the CartoSound 3-D electroanatomical navigation system and the SoundStar ultrasound Catheter, manufactured by Biosense Webster®.

The interface allows the Vivid S70N / S60N system to send images to the CartoSound system over a VGA video cable or, if supported by Carto system, over peer-to-peer LAN connection.

The Vivid S70N / S60N is able to send ultrasound scaling parameters to the CartoSound system via a peer-to-peer LAN connection.

Detailed instructions on interfacing and using the Vivid S70N / S60N with the CartoSound and SoundStar Catheter are found in dedicated user manuals and their updates issued by Biosense Webster, Inc. named:

- CARTOSOUND® Module User Guide (part no. UG-5400-1274)

NOTE: When turning on the Vivid S70N / S60N while interfaced with the CartoSound, the boot-up process may take up to about 3 minutes.

Using CartoSound

When the CartoSound interface is connected, navigate to **Utility** and select **CartoSound** from the touch panel.

Receiving images over peer-to-peer LAN connection is allowed only to members of the ConsultingPhys group. A user member of ConsultingPhys group must be available on the Vivid S70N / S60N, and Carto system must be configured to use this user when connecting to the Vivid S70N / S60N. See Figure 12-71 on page 12-82 and Figure 12-72 on page 12-83 for details.

Chapter 15

Maintenance

'System Care and Maintenance' on page 15-2

'System self-test' on page 15-14

'eDelivery - Software update' on page 15-18

System Care and Maintenance

Overview

Refer to Section 10 of the Vivid S70N / S60N Service Manual for any additional maintenance guidance.

Contact the local Service Representative for parts or periodic maintenance inspections.

Some Customer Quality Assurance Programs may require additional tasks and/or inspections to be performed at periods of frequency different from those listed in this manual.

Expected Service Life Description

The expected service life for the Vivid S70N / S60N system is identified in this table:

Equipment / Accessory	Expected Service Life
Vivid S70N / S60N system	The expected service life for the Vivid S70N / S60N is at least seven (7) years from the manufacturing date under the provision of regular maintenance by authorized service personnel.



If the product is older than the expected service life, it is recommended to perform functional checks of the functionality needed before every interventional use of the product.

Maintenance schedule

Follow this Maintenance Schedule to maintain optimum system function and patient care:

Table 15-1: Vivid S70N / S60N Maintenance schedule

After each patient	Bi-weekly	Monthly
<p>Clean and disinfect the following parts after each patient:</p> <ul style="list-style-type: none"> Probe (see Chapter 'Probes' on page 13-1) ECG leads and cable Biopsy Brackets, as applicable Monitor screen, monitor frame and touch panel Operator panel with buttons, rotaries and trackball Probe and gel holders Front handle Cable hooks Probe cable storage bin Alphanumeric keyboard (optional, if used) 	<p>Clean the following on a bi-weekly basis:</p> <ul style="list-style-type: none"> Rear storage bin Front cover incl. probe connector panels Side covers with optional B/W printer and DVD drive Filters: Bi-weekly or whenever requested by the system temperature surveillance mechanism Top cover of bottom part System rear side, incl. monitor arm, rear handle and other areas that do not come in direct or indirect contact with the patient Casters and caster covers/foot rest 	<p>Inspect the following on a monthly basis:</p> <ul style="list-style-type: none"> Rear connectors or cables for any mechanical defects Entire length of electrical and power cables for cuts or abrasions Equipment for loose or missing hardware Casters for proper movement and locking operation



The user must ensure that safety inspections are performed at least every 12 months according to the requirements of the patient safety standard IEC/EN 60601-1. Refer to the Service manual, Chapter 10.

Only trained persons are allowed to perform the safety inspections mentioned above.

Technical descriptions are available on request.

To ensure that the system constantly operates at maximum efficiency we recommend that the following procedures be observed as part of the customer's internal routine maintenance program.



If any defects are observed or malfunctions occur, DO NOT operate the equipment, and inform a qualified service person.



Do not use the system if any cover is missing or disassembled. To avoid electrical shock hazard, do not remove panels or covers from the system. This servicing must be performed by qualified service personnel. Failure to do so could cause serious injury.

Cleaning and disinfecting the system

The below listed cleaners/disinfectants in Table 15-2 on page 15-5 can be used for cleaning and disinfection of the identified parts in the table. Cleaning and disinfection of probes, ECG leads, ECG cables and biopsy brackets are described elsewhere:

- Probes: Refer to 'Cleaning and disinfecting probes' on page 13-21.
- ECG leads and cables: Refer to Instructions for use (IFU 2107129-001 and IFU 2107121-001) for ECG leads and ECG cables respectively. IFUs are included with the packaging of the ECG leads/cables.
- Reusable non-sterile biopsy brackets: Refer to Instructions for use (IFU) for the respective biopsy kits and brackets from Civco, the manufacturer: <https://www.civco.com/catalog/ultrasound-needle-guides/ultra-pro-2-ultrasound-needle-guides-multi-angle/>. IFUs are also included with the packaging.

Always consult the cleaner or disinfectant manufacturer's instructions for proper use of their product. Wear appropriate PPE as indicated by the manufacturer. Appropriate cleaners/ disinfectants for the console that have been validated for compatibility are shown below:

Table 15-2: Appropriate Cleaners/Disinfectants

	Manufacturer	Main monitor and touch panel screens (glass)	Monitor frame and rear panel	Operator Panel and keyboard	System console, probe and gel holders, front handle, cable hooks
Cleaning agents					
Mild, Non-Abrasive Soap and Water	Generic	x	x	x	x
Ammonia (2:1 Ratio of max 10% Home Ammonia)	Generic		x	x	x
Low level disinfection agents					
Hydrogen Peroxide / Hydrogen Peroxide Wipes	Clorox		x	x	x
T-Spray II™ Disinfectant Cleaner	Pharmaceutical Innovations			x	
Sani-Cloth HB® Germicida	PDI			x	
CIDEX OPA	ASP			x	
Diluted Cidex® (Activated Dialdehyde Solution)	ASP			x	
Metrex Metricide™ 14	Bowers			x	
Waviside-01	Medical Chemical Corporation			x	
Isopropyl Alcohol (70%) (Generic)	Generic	x	x	x	x

NOTE: When new cleaners and disinfectants are determined to be compatible with ultrasound systems materials, they are added to this website: <https://cleaning.gehealthcare.com>.

NOTE: Effective cleaning and disinfection of parts with narrow gaps and holes (e.g. keyboard, trackball) may be difficult.

NOTE: To identify the various parts in the table, see figures below.



DANGER

System surfaces and transducers are resistant to ultrasound gel, alcohol, and disinfectants, but if used, wipe them off to prevent permanent damage.

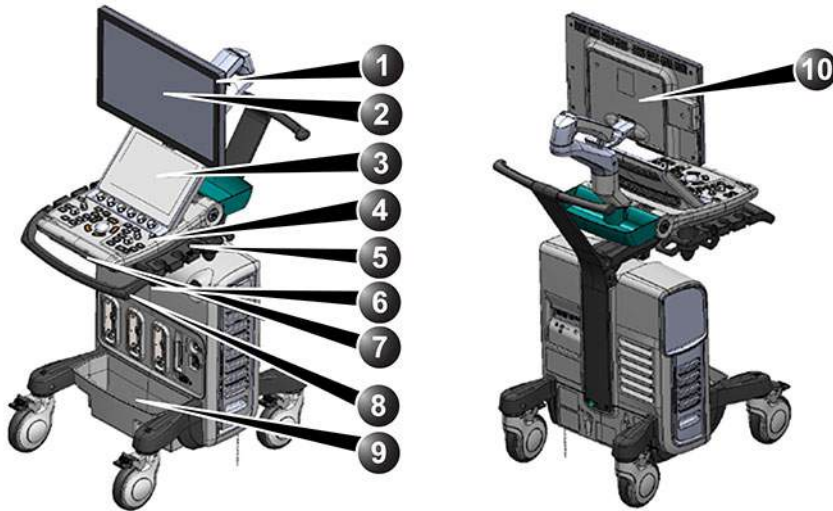

- | | |
|---------------------------------------|--|
| 1. Monitor frame | 6. Cable hooks (both sides if used) |
| 2. Monitor screen | 7. Alphanumeric keyboard (option) below operator panel |
| 3. Touch panel screen | 8. Front handle |
| 4. Operator panel | 9. Probe cable storage bin |
| 5. Probe holders (both sides if used) | 10. Monitor frame and rear panel |

Figure 15-1. Parts requiring cleaning and low-level disinfection after each patient according to the Maintenance schedule.

(See Table 15-1 on page 15-3 for details.)

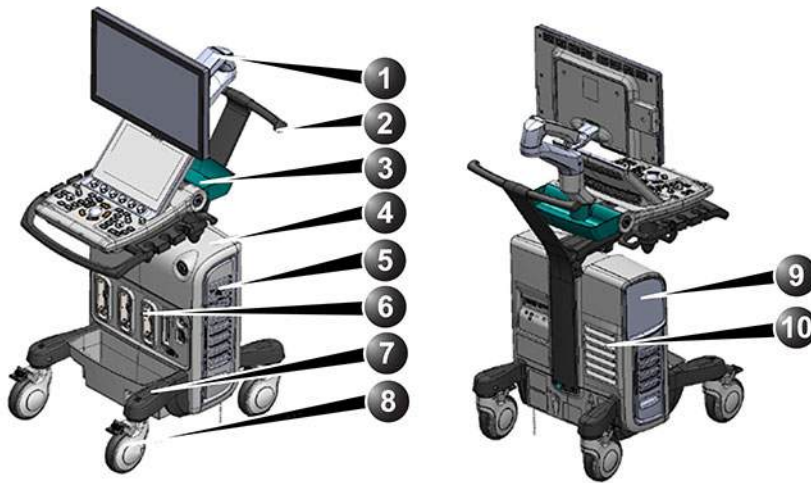

1. Monitor arm
2. Rear handle
3. Rear storage bin
4. Top cover, bottom console part
5. Side covers

6. Front cover, incl. probe connector panels
7. Bottom caster covers/foot rest
8. Casters, both sides, front and rear
9. B/W printer and DVD player (both optional)
10. Rear cover, incl. rear panel and air inlet grille

Figure 15-2. Parts requiring cleaning only and/or inspection according to the Maintenance schedule.

(See Table 15-1 on page 15-3 for details.)

Cautions

When performing cleaning and disinfection procedures, to prevent the risk of system damage, always observe the following precautions:



Prior to cleaning and disinfection, turn OFF power to the system and disconnect the mains cable.



- Do not spray any liquid directly onto the Vivid S70N / S60N covers, displays, or keyboard.
- Do not allow any liquid to drip or seep into the system.
- DO NOT scratch or press on the panel with any sharp objects, such as pencils or pens, as this may result in damage to the panel.
- Make sure not to spill or spray any liquid on the controls, into the system cabinet, or in the probe connection receptacle.



Never use thinner, benzene, ethanol or methanol alcohol, abrasive cleaners, or other strong solvents, as these may cause damage to the cabinet or display panels. Only use isopropyl alcohol, when instructed to do so.



Follow the disinfectant manufacturer recommendations.



System surfaces and transducers are resistant to ultrasound gel, alcohol, and disinfectants, but if used, wipe them off to prevent permanent damage.

Cleaning and disinfection procedures

NOTE: The following procedures describe cleaning of the complete ultrasound system, and low-level disinfection of certain parts of the ultrasound system.

Prior to cleaning and disinfection of any part of the system turn off the power. If possible, disconnect the power cord.

Always clean visible soil from surfaces first before disinfection.

Follow the cleaning/disinfection frequency suggested in the 'Maintenance Schedule' in Table 15-1 on page 15-3.

Cleaning only instructions

All parts listed on Figure 15-2 on page 15-7 shall be cleaned using these instructions. **These parts require cleaning only, not disinfection.**

To clean the part:

1. Moisten a soft, non-abrasive folded non-linting cloth with a mild, general purpose, non-abrasive soap and water solution or approved cleaning/disinfection agent. Approved wipes can also be used.

NOTE: The non-linting cloth/wipe should be damp, not dripping wet and running. Moisture should not drip into the crevices anywhere on the console.

NOTE: Refer to Table 15-2 on page 15-5 for a list of acceptable cleaning agents to be used with the various parts.

2. Use a gentle wiping action to clean any surface on the console.

NOTE: A scrubbing action with the wipe may be necessary to help remove stubborn soil from the surfaces. However, be careful with this action over crevices and gaps in the surface to prevent liquid from being scraped off the wipe and entering the product.

3. Clean until visually clean.
4. Wipe off excess cleaning agents.

NOTE: Do not spray any liquid directly into the unit.

NOTE: DO NOT scratch or press on the panel with any sharp objects, such as pencils or pens, as this may result in damage to the panel.

Combined cleaning and disinfection instructions

Parts listed on Figure 15-1 on page 15-6 **must be both cleaned and disinfected** as described below, in order to prevent crosscontamination. Refer to Table 15-2 on page 15-5 for which cleaning and disinfection agents to use with which part.

Table 15-3: Cleaning steps

Step	Cleaning instructions				
C1	<p>Moisten a soft, non-abrasive folded non-linting cloth with a mild, general purpose, non-abrasive soap and water solution or approved cleaning/disinfecting agent. Approved wipes can also be used.</p> <p><i>NOTE:</i> The non-linting cloth/wipe should be damp, not dripping wet and running. Moisture should not drip into the crevices anywhere on the console.</p> <p>Refer to Table 15-2 on page 15-5 for a list of acceptable cleaning agents to be used with the various parts.</p>				
C2	<p>Use a gentle wiping action to clean any surface on the console part or accessory as described in detail below.</p> <p><i>NOTE:</i> A scrubbing action with the wipe may be necessary to help remove stubborn soil from the surfaces. However, be careful with this action over crevices and gaps in the surface to prevent liquid from being scraped off the wipe and entering the product.</p>				
C3	Main display frame and rear panel	Main display screen and Touch panel glass	Operator control panel and keyboard	Probe (and gel) holders	Front handle, cable hooks, probe cable storage bin
	Gently wipe down the top, front, back, and both sides of the display frame. Do not spray any liquid directly onto the screen.	Gently wipe the surface of the main display and Touch panel.	Gently wipe the surface of the Control panel and the keycaps. Use a cotton swab to clean around keys or controls. Use a toothpick to remove solids from between keys and controls.	Gently wipe the probe holder surface to remove all traces of gel. If probe or gel-cup inserts are used, remove these and clean them separately.	Gently wipe the surface of the handle, the buttons on the sides, as well as the cable hooks underneath the operator panel.
C4	Clean until visually clean.				
C5	Wipe off excess cleaning agent and allow to dry.				

Table 15-4: Disinfection steps

Step	Disinfection instructions				
D1 	Moisten a non-linting cloth with a liquid disinfectant or remove a pre-moistened disinfectant wipe from the container. CAUTION: If a cleaner/disinfectant wipe was used to clean off visible soil per the above cleaning section, a second, fresh cleaner/disinfectant wipe should be used for the disinfectant step.				
D2	Wet the surfaces by applying disinfection agent with the non-linting cloth or wipe. See special instructions for each part below in step D5. Avoid high pressure or squeezing the wipe to avoid having the liquid enter the gaps and crevices of the part. Scrubbing is not necessary in the disinfection step; evenly applying the liquid is the goal.				
D3	Let the surface remain wet for the appropriate contact time as per the disinfectant manufacturer instructions.				
D4	Apply an additional application of the disinfectant, as necessary, to extend the time, if the surface does not remain wet for the full contact time.				
D5	Main display frame and rear panel	Main display screen and Touch panel glass	Operator control panel and keyboard (except trackball)	Probe (and gel) holders	Front handle, cable hooks, probe cable storage bin
	Gently apply disinfectant to the top, front, back, and both sides of the display frame. Do not spray any liquid directly onto the screen.	Gently apply disinfectant to the surface of the Main display and Touch panel.	Gently apply disinfectant to the surface of the Control panel and the keycaps. Use a cotton swab with disinfectant around keys or controls.	Gently apply disinfectant to the probe holders. If probe or gel-cup inserts are used, remove these and apply disinfectant to them separately.	Gently apply disinfectant to the surface of the handle, the buttons on the sides, as well as the cable hooks underneath the operator panel.
D6	Remove excess liquid with a dry non-linting cloth after the contact time has expired.				
D7	Perform a rinse step with a non-linting damp (using critical (or treated) water) cloth, if necessary, to avoid disinfectant buildup, or to remove disinfectant residue which may cause skin irritation.				

To clean and disinfect the trackball:

1. To disassemble the trackball, rotate the top locking ring counter-clockwise around the trackball and lift off the top locking ring and the trackball from the Control panel (1-3 in the figure below).

2. Apply an approved cleaning agent (see Table 15-2 on page 15-5) to a soft, non-abrasive, non-linting cloth. The cloth should be damp, not dripping wet. Wipe the trackball, the ring and the trackball housing with this cloth (4-6). If needed for access, use a cotton swab applied with the same agent. Wipe excess agent and allow to dry.
3. Use an approved disinfection wipe or apply a disinfection agent to a new non-linting cloth. Use this wipe/cloth and repeat step 2 above.
4. Let the surface remain wet for the appropriate contact time as per the disinfectant manufacturer instructions. If the surface does not remain wet for the full contact time, apply an additional application of the disinfectant, as necessary, to extend the time.
5. Wipe off any disinfectant residue with a dry non-linting cloth and/or cotton swab.
6. To avoid disinfectant buildup, or to remove disinfectant residue which may cause skin irritation, perform a rinse step with a non-linting damp cloth (using critical (or treated) water).
7. Insert the trackball into the housing, then insert the locking ring and rotate it clockwise to lock it in position (7-9).

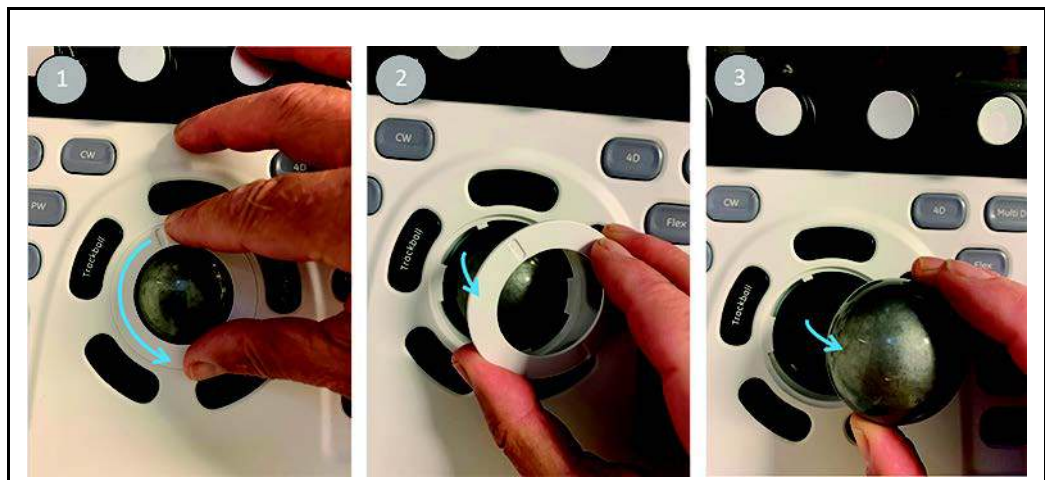

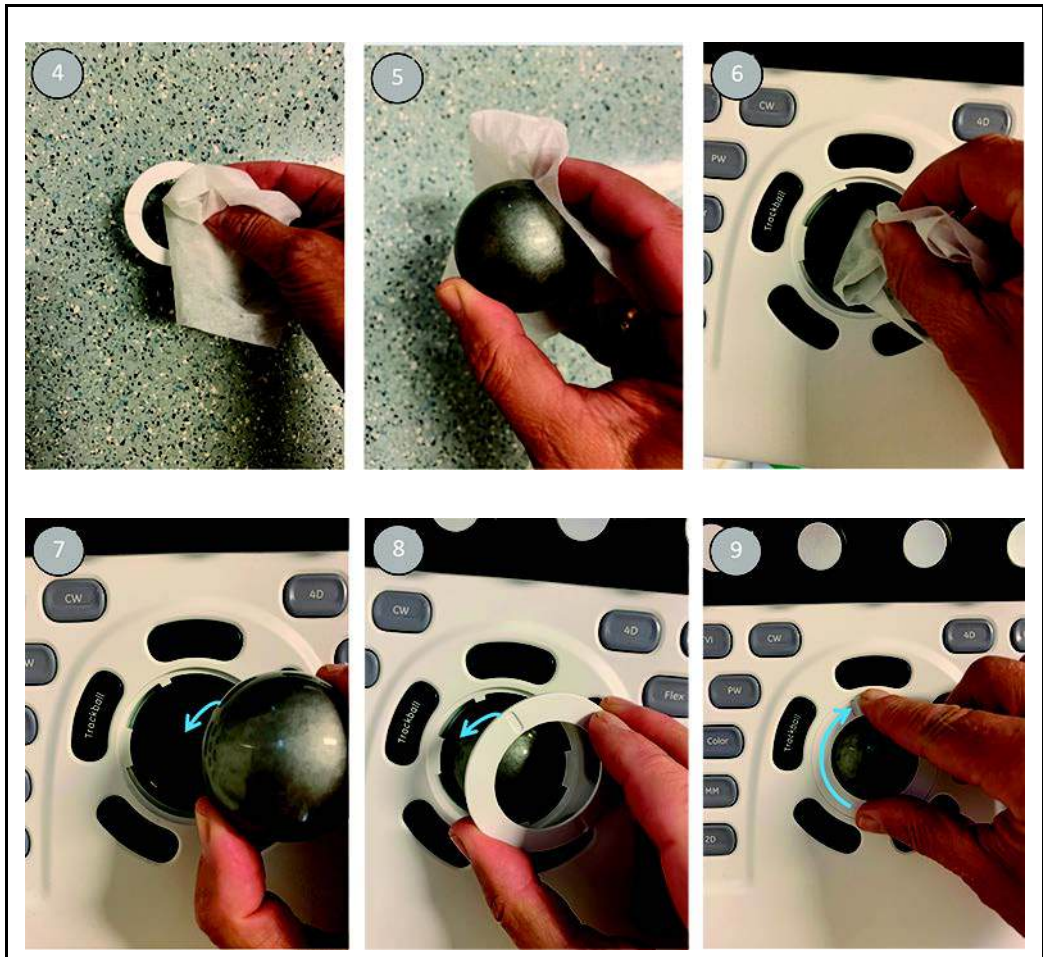

Prevention of static electricity interference

Interference from static electricity can damage electronic components in the system. The following measures help to reduce the likelihood of electrostatic discharge:

- Wipe the alphanumeric keyboard and monitor with lint-free tissue or a soft cloth dampened with anti-static spray on a monthly basis.
- Spray carpets with anti-static spray because constant walking on carpets in or near the scanning room may be a source of static electricity.

System self-test

System malfunction

The ultrasound system is designed for reliable operation and consistent, high-quality performance. Automatic self-testing facilities are provided to monitor system operation and to detect malfunction as soon as possible, thereby eliminating unnecessary downtime. The detection of any serious malfunction may result in immediate interruption of the system operation.

Unexpected system lockup and/or shutdown in time-critical situations



Any electronic device can fail without warning signs. Therefore the user is advised to have a backup imaging plan when performing time-critical image-guided examinations and interventions.

NOTE: Consider having a backup scanner and/or probe available.

Suggested user actions to prevent unexpected system lockup and/or shutdown in time-critical situations

- Ensure all air filters are cleaned prior to use.
- Ensure Dicom Spooler is emptied and does not contain unsent files prior to disconnecting network cable.

Related information:

- 'Air Filter Cleaning' section of the Service Manual
- 'DICOM spooler' on *page 12-71*

Suggested user actions if unexpected lockup or shutdown has happened in a time-critical situation

NOTE: Note that these user actions are suggested to provide imaging capability to safely complete or abort an ongoing examination.

1. Reselect the probe or preset, or try another probe.
2. Ensure the scanner has proper ventilation, do not place the rear side of the scanner close to a wall.

3. Remove the network cable, wireless adapter and all other non-crucial connections.
4. Ensure the power cable is properly seated.
5. Disconnect any UPS.
6. Reboot the scanner, with no probes connected.
 - a. Push and hold the power button on the front panel for 5 seconds to force shutdown.
 - b. Boot again.

If not successful, turn off the circuit breaker in the back. Leave off for 10 seconds before turning back on, followed by a push on the front panel power button to turn back on.
7. Clean dust from cooling air vent.

If none of the suggested actions are successful, use alternative imaging (e.g. backup scanner/probe), if available.

In the event of error or system malfunction the user may save locally or export a log file to a removable media as described below and contact authorized service personnel.

In addition, system malfunctions can be bookmarked, enabling creation of a log file specific to that event.

Bookmarking a system malfunction

1. If a system malfunction is observed, press **Alt - B**.

A bookmark will be created when creating a log file.

Generating a log file

1. Press **Alt - D** on the alphanumeric keyboard.

The *Problem description dialogue* window is displayed (see Figure 15-3).
2. Type in a description of the problem. Notes should be made regarding the selected probe, the imaging mode and the application that was being used at the time of malfunction. If applicable, try to describe the button or key pushing sequence that immediately preceded the problem.

Check the mention *System lockup* if applicable.
3. Select the destination where to save or export the log file.

If **Store locally** is selected, the log file is saved to the local hard disk.

If a removable media is selected, the current and previously saved log files are exported to the selected media.

NOTE: *To export to a shared folder on a network, a remote path must be defined (see 'Default remote path setting' on page 12-93).*

4. Press **Save and Export**.

A Zip file (named "logfile_<date>_<time>.zip") is created.

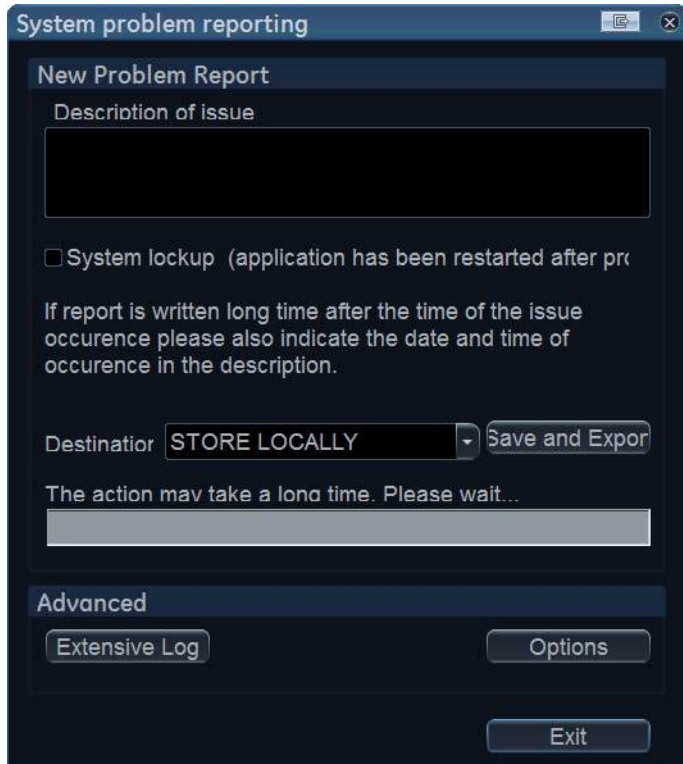

Figure 15-3. The Problem description dialogue window

Advanced log options

Extensive Log

Extensive Log enables the creation of a log file containing additional information for the selected functionality.

Options

Options enables creation of a log file based on a selected bookmark or for a user configurable time frame. Different type of information can be selected to be part of the log file.

eDelivery - Software update

Introduction

As part of the product lifecycle management, GE regularly analyzes and integrates software updates from our third party vendors into our products. These are typically released as part of regular updates or software releases.

The user can update to the latest software in two ways:

- Through the GE service platform on the ultrasound system. This requires RSvP connectivity. See 'Software update via Remote Service Platform (RSvP)' on *page 15-18*.
- Download the latest software from an end-user portal to a local storage location and install it on the ultrasound system. See 'Software update via End-User Portal' on *page 15-27*.

Software update via Remote Service Platform (RSvP)

Software update for the system may become available for download and installation through the GE Service platform.

Users must have administrator rights to perform the software download and installation. A user who is not logged in as ADM (administrator) will see the notification of an available update, but not be allowed to initiate the download.



Please backup presets and database before installation of the software (see 'Data Backup and restore' on *page 10-57*).

Remote software download should not change user presets or affect customer database; however, it is always best practice to ensure patient data and preset are backed up before proceeding with any software installation.



CAUTION

If the drives are encrypted, software update will have a catastrophic effect if the customer does not have the recovery key. All patient data will be lost.

If the drives are not encrypted, software can be reloaded without a recovery key.

NOTE: Please allow approximately one hour for complete software download (the download time may vary due to network connection speed). In addition, please allow approximately one hour for complete installation.

NOTE: Software update through the GE service platform may not be available in all markets.

Software download and installation



1. Log on as **ADM**.
2. Ensure the Agent Configuration is correctly configured.

NOTE: Refer to Service Manual or contact your Service Representative for Agent Configuration information.



CAUTION

Before loading software, make sure the patient archive has been encrypted and the password or the key to unlock the data is available. Failure to obtain those items, will cause permanent data loss!

3. Press the **Download** button ( or ) at the bottom of the display screen (Figure 15-4), or go to **Config -> About** page to press **Check updates** button (Figure 15-5).

NOTE: The system automatically queries if new SW is available. There is an icon on the bottom left corner of the title bar to illustrate the download connection status.

The icon  indicates the last query was negative. You may press it to initiate another query.



The icon  indicates that new software is available for download.



Figure 15-4. Press Download Button



Figure 15-5. Press 'Check Updates' Button

4. If there is no update package available, a message will be shown to remind the user. You can press the **Close** button and try it again until the arrow  turns green .

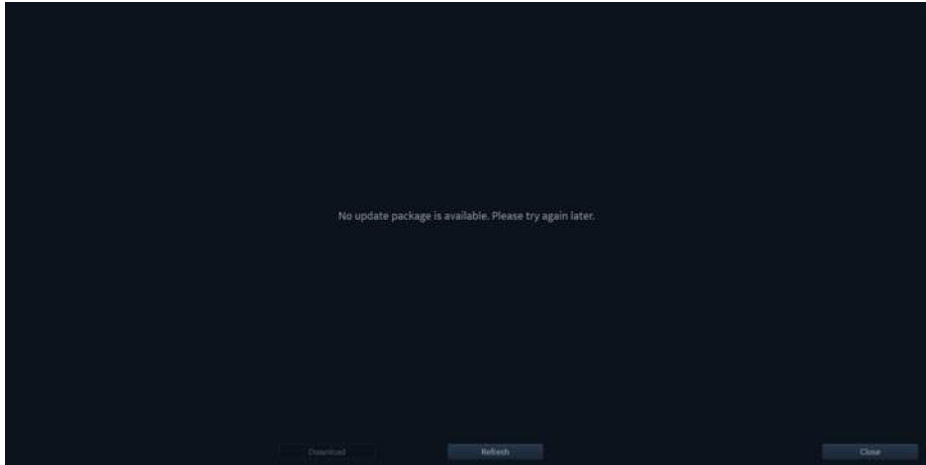

Figure 15-6. No update package is available

5. Available software updates are displayed in the list. If you want to refresh the query for available updates, press **Refresh**.

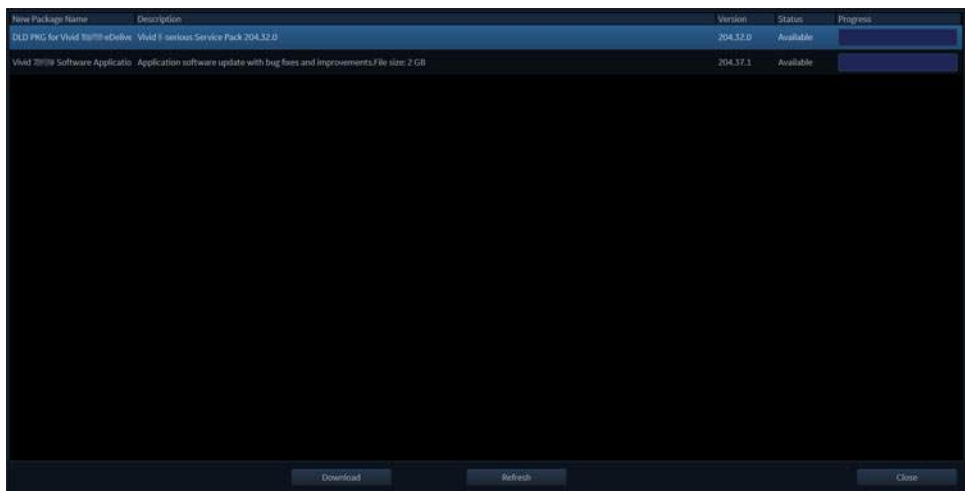

Figure 15-7. Software Available in the List

6. A window will pop up and ask for confirmation of refresh. Press **Yes**.

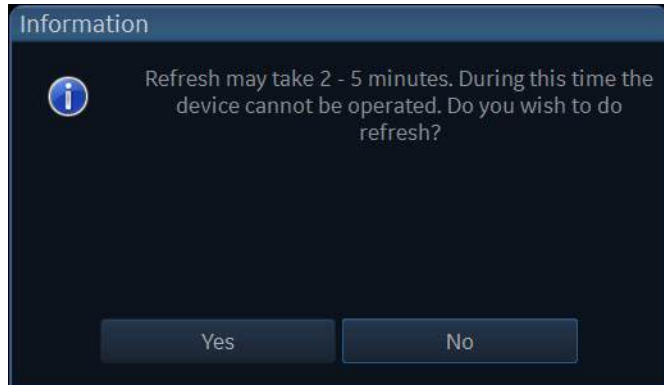

Figure 15-8. Refresh Confirmation

7. A dialogue informs that the refreshed list of available updates is being queried.

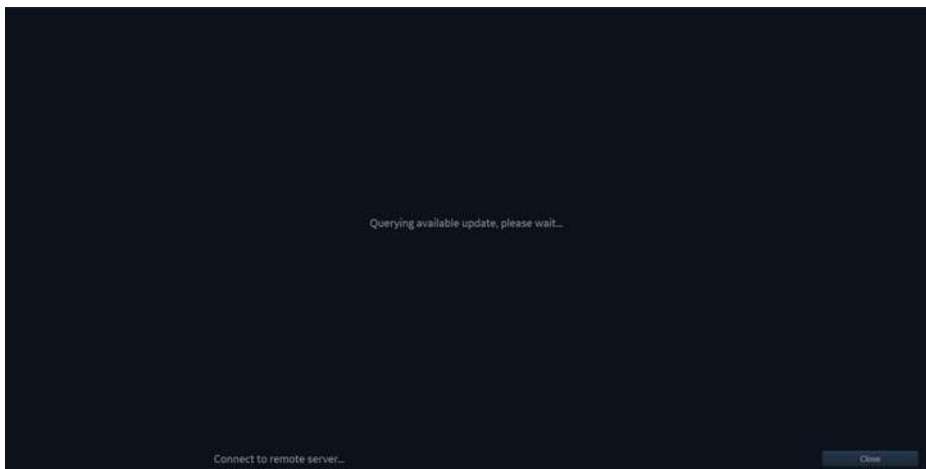

Figure 15-9. Querying Available Update

8. Select the desired software and press **Download** to download the software, or press **Close** to exit the window.

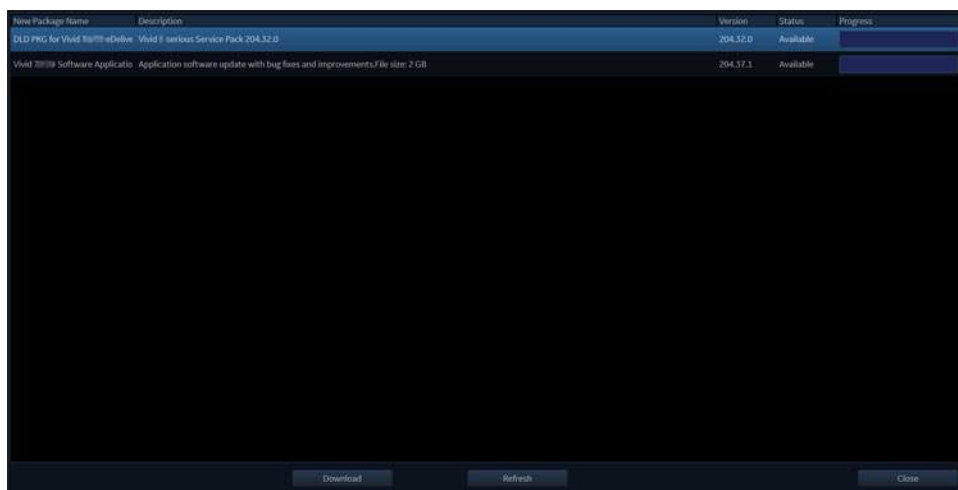

Figure 15-10. Press Download button

NOTE: *If the system doesn't have enough space for download and installation, please contact GE service representative.*

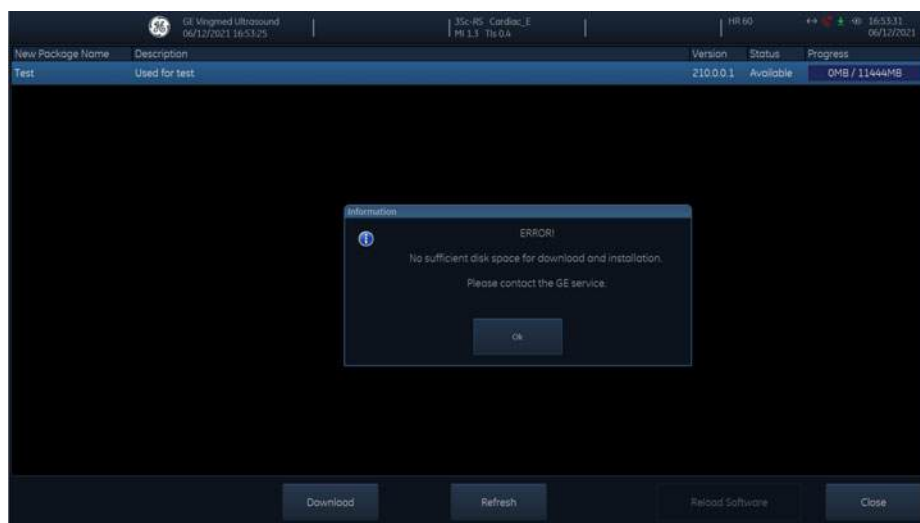

Figure 15-11. No Space Error

9. During the software download process, the status will be displayed as “Downloading”. You can press **Pause** to suspend the download or press **Cancel** to exit the download.

NOTE: *When the software is downloading, the **Close** button is disabled. If you want to go back to the scanning page, please press **Pause** to stop the download process first and then press the **Close** button.*

- Once the download process is suspended, press the **Resume** button to recover the download process from the point where it is stopped.
- If there is an error during the downloading process, press the **Retry** button to recover the download process from the beginning.

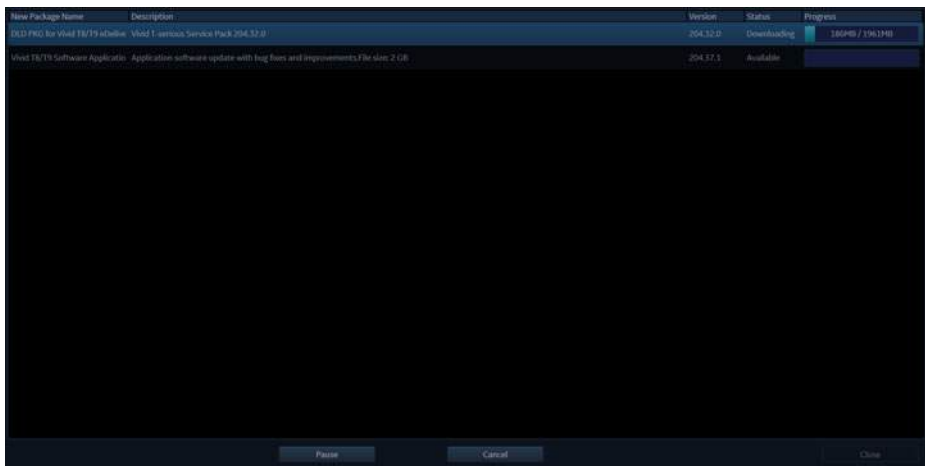

Figure 15-12. Software is Downloading

- When the download process finishes, the software is ready to be installed in the ultrasound system. Press **Install** to start the installation. Please wait for some time (around three minutes) to let the device reboot automatically if you are installing the software package.

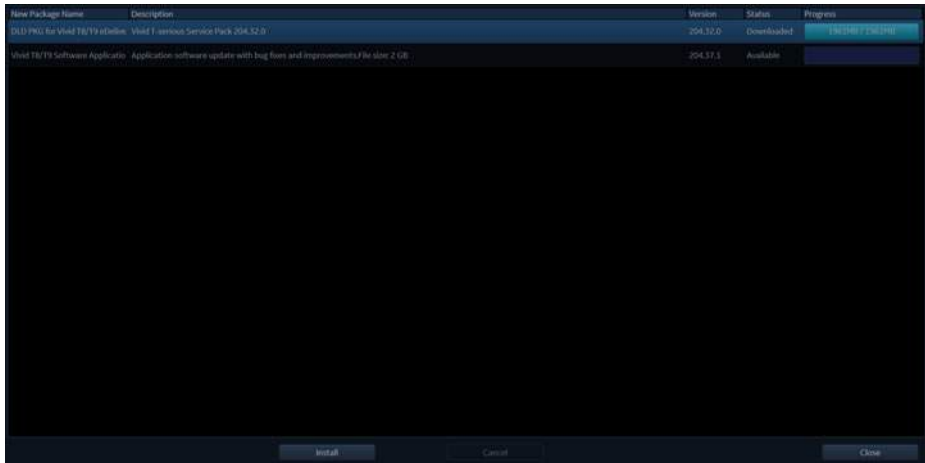

Figure 15-13. Press the Install button

- The system will reboot several times to complete the installation.

NOTE: Do not power off the system during the software installation.

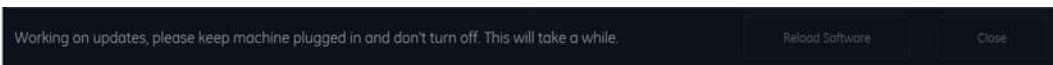

Figure 15-14. Warning during installation

NOTE: *A typical full installation may take up to 60 minutes.*

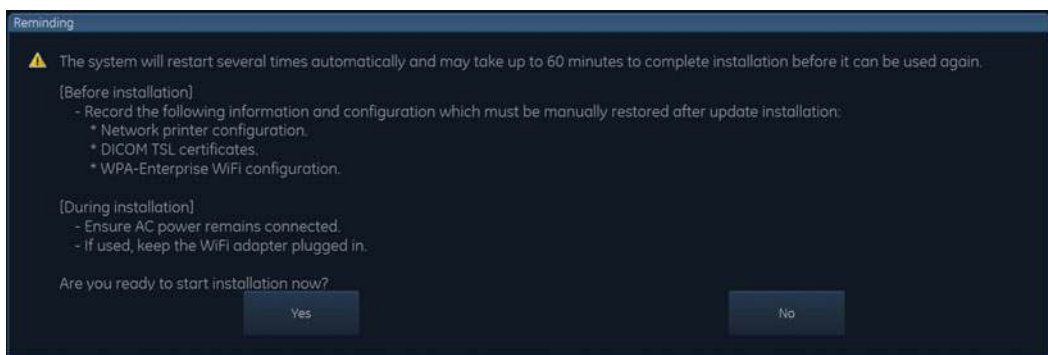

Figure 15-15. Reminder before installation

12. When the software installation is complete and the system is rebooted, a *Reminder after Installation* window is displayed.



Figure 15-16. Reminder after Installation

Software update via End-User Portal

Customers entitled to eDelivery updates get a customer account to download software within the End-User Portal.

User accounts are created based on e-mail addresses provided by the customer at the point of sale. These e-mail addresses are the log-in credential for the End-User Portal along with a temporary password provided to the user through e-mail. When logging in to the End-User Portal the first time, the user is prompted to change the password and enter a secret question and answer for password retrieval.

Follow the below instructions to download software from the portal:

1. Log on to the portal website which is provided to end user via a welcome email:
<https://gehealthcare.flexnetoperations.com/flexnet/operationsportal>
2. Log in using the user name (e-mail) and password.



The image shows a login interface for GE Healthcare. At the top left is the GE logo, and to its right is the text 'GE Healthcare'. Below this is the heading 'Login'. There are three input fields: 'Username', 'Password', and a dropdown menu currently showing 'English (United States)'. Below the input fields are two links: 'Forgot password?' and 'Register'. To the right of these links is a blue 'Log in' button.

Figure 15-17. Login Window

3. The Software and License Delivery dashboard is displayed. Downloads can be found by browsing the products under "Your Downloads".

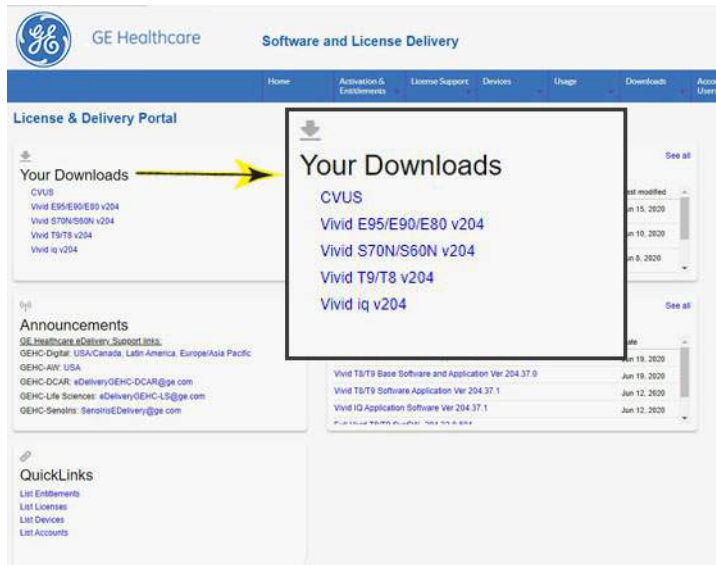

Figure 15-18. Software and License Delivery Page

4. Select the desired software to enter the Downloads page.

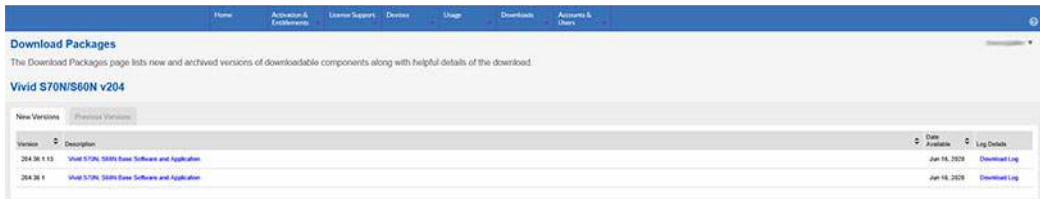

Figure 15-19. Downloads Page

5. Check the box in front the file you want to download and click the *Download Selected Files* button. Save it in a local storage location (i.e. USB flash drive).

NOTE: *If you are unable to download using the 'Download Selected Files' button, you can directly click the '.7z' file.*

NOTE: *Ensure that the USB is formatted as NTFS format so that the eDelivery package can be successfully copied into it.*



Figure 15-20. Downloads Page

6. Load the software on the ultrasound system from the selected storage location. Refer to the Basic Service Manual for detailed installation procedures.

Loading the Software

To load a software onto the Vivid S70N / S60N,

1. Power down the Vivid S70N / S60N and insert the USB Flash Drive into a rear USB port.

NOTE: *Ensure that the system is USB Device Enabled (check Config->Service page).*

NOTE: *Ensure that the USB is formatted as NTFS format so that the eDelivery package can be successfully copied into it.*

2. Power on the Vivid S70N / S60N. The software program files will be loaded onto the Vivid S70N / S60N automatically, following several screen prompts:

- a. Select **Install SW...** on the Start Application screen.

NOTE: *If by accident you try to load a software that is not compatible with the software on the Vivid S70N / S60N, error messages will indicate "The package present in media is not compatible. Please contact GE Service" and "Software installation is not started".*

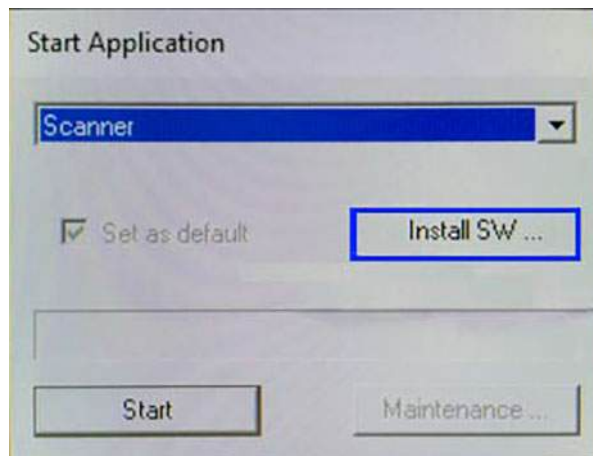

Figure 15-21. Select Install SW...

- b. Follow the prompts on screen to install the software update. Depending on the content of the update, for the full software which contains the operating system, patches and application software, the operating system will be installed first, then patches, and finally followed by the application software.

NOTE: Installation time depends on the type of update. A complete update with full software and application will take approximately 1 hour. An update of the application software only will take approximately 15 minutes. No action is needed until the installation is complete.

NOTE: The ultrasound device may restart multiple times during update.

- c. When the installation is complete, the same dialogue to Install SW appears. Instead of selecting Install SW, remove the USB stick from the ultrasound device and select **Start**.

Reload Software

Software Reload displays versions of the base image, application software currently installed on the Vivid S70N / S60N. Software Reload provides specific software versions for users to reload.

- If the drives are encrypted, **Software Reload** will have a catastrophic effect if the customer does not have the recovery key. All patient data will be lost.
- If the drives are not encrypted, software can be reloaded without a recovery key.

Before starting the Software Reload or Rollback, record the following information and configuration which must be manually restored after the selected software has been loaded.

- DICOM TLS certificates
- WPA-Enterprise configuration

To reload the software onto the Vivid S70N / S60N:

NOTE: *Ensure that AC power remains connected during the software loading.*

NOTE: *If used, keep the WiFi adapter plugged in.*

1. Log on as **ADM**.
2. Select **About > System Version**.

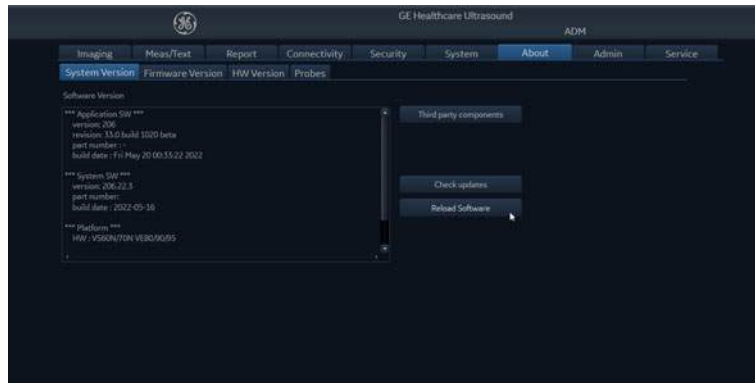

Figure 15-22. System Version screen

3. Select **Reload Software**.

After selecting **Reload Software**, the following pop-up is displayed:

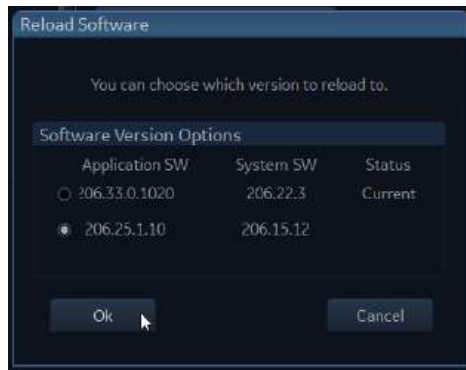

Figure 15-23. Software Version Options

In the pop-up, you may select to reinstall the current installed software (Reload) or select the previous installed software (Rollback).

4. Select the software version you want to install, then click **OK**.

A new pop-up with reminder is displayed:



Figure 15-24. Reminders before software loading

5. If you already have recorded the DICOM TLS certificates and the WPA-Enterprise configuration, and you are sure the system can stay connected to mains power during the software loading (50 to 60 minutes), click **OK**.

If not, click **Cancel**.

After clicking **OK**, the system starts the software loading. The system will automatically power down. Wait ten seconds, then press the ON switch on the Operator Panel to restart the system. It will start to prepare the C: drive and load the selected software.

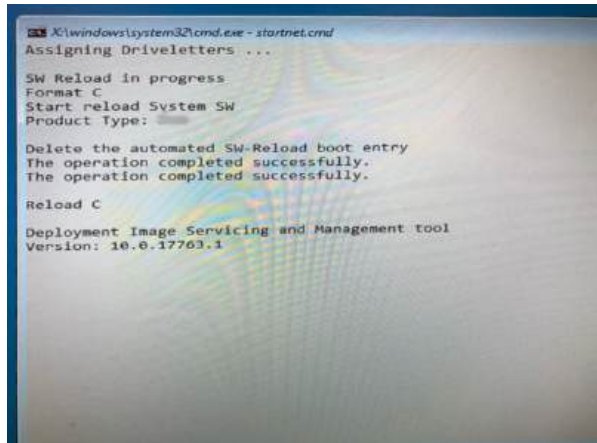

Figure 15-25. Starting the software loading

The system will restart several times during the installation process without any user actions, and the complete software loading will complete in 50 - 60 minutes.

When the software loading has completed, the ultrasound system remains ON.

6. Manually restore the DICOM TLS certificates and the WPA-Enterprise configuration that you recorded earlier.
7. Power down the ultrasound system.

NOTE: *The system keeps at most 2 versions of software for reload. When a newer version is installed, the earliest version will be removed permanently.*

Numerics

- 2D-Mode, 5-3
- 4D
 - Full volume acquisition, 6-6
 - Stereo vision, 6-33
- 4D Auto AVQ, 8-125
- 4D Auto LVQ, 8-92
- 4D Auto MVQ, 8-116
- 4D Auto RVQ, 8-110
- 4D Color Flow mode, 6-16
- 4D/Multi-plane LV, 8-92
- 4D-Mode, 6-2
 - Controls, 6-35

A

- Accessories
 - Ordering, 1-10
 - Requesting a catalog, 1-10
- Advanced cardiac measurements and analysis, 8-16
- Advanced vascular measurements and analysis, 8-136
- AI Auto Measure – 2D, 8-87
- AI Auto Measure – Spectrum Recognition, 8-11
- Annotations, 4-13
- Apps, 8-132
- Archive, 10-1
 - Configuration, 12-88
 - Edit archived information, 10-14
 - Retrieve archived information, 10-14
 - Review archived images, 10-29
 - Transfer patient records/examinations, 10-41
- Automated Functional Imaging, 8-23
 - Left Atrium, 8-63
 - Left Ventricle, 8-23
 - Right Ventricle, 8-49
- AVI, 10-9

B

- B Flow, 5-55
- Backup, 10-57
- Biopsy, 13-67
- Blood Flow Imaging, 5-56

C

- Cardiac Auto Doppler, 8-83
- Care and Maintenance, 15-2
- Cineloop, 4-9
- Cineloop store, 10-7
- Classifications, *i-4*
- Cleaning
 - instructions (for cleaning and disinfection), 15-10
 - instructions (for cleaning only), 15-9
 - Probes, 13-21
 - System, 15-4
- Color Mode, 5-12
- Comments, 10-20
- Compound, 5-55
- configuration
 - wireless network, 12-76
- Connecting peripherals, 3-19
- Connecting the system, 3-4
- Connectivity, 10-36
 - Configuration, 12-48
 - Dataflow, 12-89
- Contacts
 - Clinical questions, 1-10
 - Internet, 1-10
 - Manufacturer, 1-17
 - Service questions, 1-10
- Continuous capture, 7-9
- Contrast imaging, 5-39
 - LV Contrast Imaging, 5-41
 - Vascular Contrast Imaging, 5-45
- Control panel, 3-36
 - Image controls, 5-57
- Customize configuration, 12-1
 - 6VT-D TEE probe, 12-119
 - Application presets, 12-114
 - Archive, 12-88
 - Connectivity configuration, 12-48
 - Customize system settings, 12-3
 - Global imaging, 12-21
 - Measurement package, 12-23
 - Scan Assist Pro Creator, 12-100
 - Stress echo, 12-113
 - Touch panel, 12-8
 - Users and security, 12-10
- CW Doppler, 5-19

D

Data streaming, 10-73
 Configuration, 12-80
Dataflow, 10-3
Delete
 Examination, 10-25
 Image, 10-26
 Patient record, 10-25
Diagnosis code, 10-23
Diagnosis information, 10-20
DICOM spooler, 12-71
DICOM SR, 12-68
Direct report, 11-26
Disk space management, 10-49

E

ECG
 Connecting, 3-14
eDelivery, 15-18
Examination
 Emergency scanning, 4-2
 Starting, 4-5
Export
 Patient records, 10-42
External monitor
 Connection, 14-7

F

Flexible video out, 14-7
FlexiViews, 6-53
Footswitch, 3-21

G

Global imaging settings, 12-21

H

HD Color, 6-20
HDF, 10-9

I

Image store, 10-7
Indications for use
 Probes, 1-6
 System, 1-5
Information
 Requesting, 1-10
Intima-Media Thickness, 8-136
Intracardiac Ultrasound Catheters, 13-15

J

JPEG, 10-9

L

Labels, 2-27
Lock main display, 3-46
LogiqView, 5-54

M

Main display adjustment, 3-45
Maintenance schedule, 15-3
Measurement accuracy, 8-152
Measurement result table, 8-148
Measurements, 8-1
 Assign and measure, 8-6
 Configuration, 12-23
 Event timing, 8-16
 Measure and assign, 8-8
 Protocol images, 8-10
 User-defined formulas, 12-27
M-Mode, 5-7
Moving the system, 3-49
MPEG, 10-9
Multi-plane mode, 6-42
Multi-Slice, 6-8

O

OB measurements, 8-142
On/Off, 3-23

P

Patient record
 Transferring, 10-41
Pediatric Z-score measurements, 8-91
Physiological traces, 3-14
Printing, 14-4
 Printer configuration, 14-6
Probes, 13-1
 Activating, 3-29
 Biopsy, 13-67
 Care and Maintenance, 13-19
 Cleaning, 13-21
 Connecting, 3-27
 Coupling gels, 13-61
 Disconnecting, 3-27, 3-31
 Immersion levels, 13-29
 Intracardiac Ultrasound Catheters, 13-15
 Labeling, 13-14
 Orientation markers, 13-13
 Presets, 13-10
 Safety, 13-63
 Select probe, 1-6
 Supported probes, 13-2
 Types, 13-2
PW Doppler, 5-19

Q

- Quantitative Analysis, 9-1
 - Anatomical M-Mode, 9-20
 - Deletion of a trace, 9-12
 - Frame disabling, 9-13
 - Manual tracking, 9-11
 - Optimizing, 9-15
 - Sample area, 9-9
 - Strain cursor, 9-10
 - To generate a trace, 9-9
 - Trace smoothing, 9-18
- Quantitative TVI Stress analysis, 7-20

R

- Referral reasons, 10-20
- Reinstalling at a new location, 3-53
- Removable, 3-11
- Removable media, 3-11
 - Ejecting, 3-13
 - Formatting, 3-12
- Report, 11-1
 - Configuration, 11-45
 - Creating a report, 11-3
 - Deleting, 11-8
 - Direct report, 11-26
 - Export/Import templates, 11-46
 - Report designer, 11-28
 - Report function, 11-4
 - Save, 11-7
 - Structured Findings, 11-10
 - Templates management, 11-44
- Report designer, 11-28
 - Designing a template, 11-31
- Respiration
 - Connecting, 3-14
- Restore data, 10-57

S

- Safety, 2-1
 - Biological hazard, 2-17
 - Electrical hazard, 2-16
 - Equipment safety, 2-14
 - Explosion hazard, 2-15
 - Mechanical hazard, 2-12
 - Moving hazard, 2-16
 - Pacemaker hazard, 2-17
 - Personnel safety, 2-14
 - Probes, 13-63
- Scan Assist Pro, 5-67
 - Scan Assist Pro Creator, 12-100
- Scanning
 - Screen layout, 3-33
- Security, 12-10
- Service
 - Requesting, 1-10

- Site requirements, 3-2
- Software Loading, 15-29
- Software Reload, 15-31
- Spline trace measurement, 12-45
- Start examination, 4-5
- Strain, 5-32
- Strain Elastography, 5-47
- Strain rate, 5-29
- Streaming video, see View-X, 14-11
- Stress Echo, 7-1
 - Acquisition, 7-4
 - Analysis, 7-16
 - Configuration, 12-113
 - Configuring levels, 7-29
 - Editing template, 7-26
 - Quantitative TVI Stress analysis, 7-20
 - Scoring, 7-18
 - Selecting a template, 7-3
 - Tissue Tracking, 7-25
- Structured Findings, 11-10
- System
 - Cleaning, 15-4
 - Controls affecting acoustic output, 2-8
 - Customize system settings, 12-3
 - Preparing the system for use, 3-1
 - Self-test, 15-14
 - Software update, 15-18
 - Switching On/Off, 3-23

T

- TCP/IP, 12-89
- Tissue Tracking, 5-26
- Touch panel, 3-39, 12-8
 - Image controls, 5-57
- Trackball, 3-38
- Transportation mode, 3-51
- Transporting the system, 3-51, 3-52, 3-53
- Tricify Uplink, 10-65
- TSI
 - Tissue Synchronization Imaging, 5-35
 - TSI measurements, 8-17
- TVI
 - Quantitative TVI Stress analysis, 7-20
 - Tissue Velocity Imaging, 5-23

U

- Unlock main display, 3-45
- Unlock patient record, 12-97
- Users, 12-10

V

- Vascular Auto Doppler, 8-139
- View-X, 14-11
- Virtual Convex, 5-55

W

Wheels, 3-49

wireless network configuration, 12-76

Worksheet, 8-149

XYZ

Zoom, 4-12

