

COXO[®]

Professional Dental Manufacturer
Since 2003

Good Price

Better Quality

Suitable Delivery

Perfect Service

Foshan COXO Medical Instrument Co., Ltd.

Add: No. 17, Guangming Ave., New Light Source Industrial Base,
Nanhai National High-tech Zone, Foshan 528226, Guangdong, P.R. China

Tel: +86 757 66692050 Fax: +86 757 81800058

Web: www.coxotec.com

Email: coxotec@gmail.com



COXO[®]

2026-1

2026-1

COXO[®]

Professional Dental Manufacturer
Since 2003

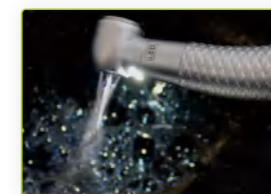

Catalogue 2026-1

COXO PROFILE

Foshan COXO Medical Instrument Co., Ltd. was established in 2003. It is a national high-tech enterprise focusing on the research, development, production and sales of dental medical devices. The main products are: Operating Microscope, Endo Motors, Dental Implantation Systems, Ultrasonic Surgery System, Root Apex Locators, Endodontic Obturation Systems, Dental Electrical Motors, LED Curing Lights, Dental High and Low Speed Handpiece, Teeth Whitening Accelerator, Dental Operating Light, etc.

COXO has an experienced core R&D team, lots of advanced testing, inspection and production equipment, and many national patents. COXO has passed ISO9001 and ISO13485 certifications, and its series of products have passed multiple quality certifications in China and abroad. COXO products rank among the top in the domestic market and have been exported to more than 130 countries and regions around the world, and are widely praised by users in China and abroad.

COXO invested heavily to build the "World Dental Device Museum", which collects thousands of dental equipment and instruments from dozens of countries and regions around the world in various periods, bringing together the crystallization of the history of the dental industry in China and the world into a museum, allowing The craftsmanship spirit of dental practitioners of past generations can be passed down and carried forward.

COXO adheres to the business philosophy of "pragmatic innovation, stable operation", continues to delve into the dental medical device industry, continuously expands product and service investment, and provides customers with better products and more considerate services.

CNC Center

Workshop

Laboratory



World Dental Device Museum



Content

Ultrasonic Surgery System , Ultrasonic Tip	01-08
Dental Implantation Systems	09-20
Implant UV Activator	21-22
Dental Abutment Placer	23-24
Dental Implant Torque Wrench	25-27
Endo Motors	29-42
Endo Irrigator	43-48
Endodontic Obturation Systems	49-52
Root Apex Locator	53-57
Pulp tester, Caries detector devices	58
Niti file system	59-64
File Removal System	65-68
Gutta cuts, Interproximal enamel kit	69-70
Oral digital viewing instrument	71-72
Operating Microscope	73-78
Surgical Loupes, Medical Headlight	79-82
Dental Surgical Motor Dental Electrical Motors	83-94
Dental Peristaltic Pump	95-96
LED Curing Lights	97-111
Teeth whitening accelerator	112
Amalgamators, Ultrasonic cleaners	113-114
Dental Scaler and Air Polisher	115-120
Prophylaxis Powder	121-122
Air Abrasion System with spray	123-124
Dental Polisher	125-126
Dental Anesthesia Booster	127-130
Accessory of electric equipment	131-134
Intraoral Scanner	135-136
4 way spray handpiece	138-140
Led handpiece with generator	141-146
Optical handpiece	147-148
1way spray handpiece	149-152
3way spray handpiece	153-154
Color handpiece	155-156
Nature Handpiece , Optical Handpiece	157-162
Led handpiece with generator	163-164
3way spray handpiece	165-166
Speed increased contra angle	167-172
Reduction contra angle	173-174
Low speed handpiece set	175-178
Contra angle handpiece, air motors, stright handpiece	179-182
Economical complete kit	183
Handpiece accessories	185-188
Dental operating light	191-196



NEW

C-EXPLORER SG Dental Ultrasonic Surgical Device

Intelligent, Efficient, Convenient

3 in 1

01 Dental Ultrasonic Surgical Device



Model: C-EXPLORER

Dental Ultrasonic Surgical Device

Order code: C-EXPLORER SG

Technical:

Input voltage: AC 100-240V~50/60Hz
Power: 180VA
Device for intermittent operation: 60s ON, 10s OFF

Osteotome Handpiece:

- ① Water flow rate: 20-100ml/min
- ② Tip primary amplitude: 8-63µm
- ③ Tip transverse amplitude: 1.5-12µm
- ④ Working tip vibration frequency: 30±15% kHz

Motor Handpiece:

- ① Speed range (no-load): 300 - 44,000r/min
- ② Speed range (1:4.2): 1,200 - 190,000r/min
- ③ Speed range (1:5): 1,500 - 220,000r/min
- ④ Speed range (20:1): 15 - 2,200r/min
- ⑤ Torque range (motor only): Max 4.8N·cm
- ⑥ Torque range (20:1): 5N·cm~80N·cm
- ⑦ Flow rate: 5-level adjustable water flow
- ⑧ Input voltage: d.c. 30V

Multi-mode operation

switch freely



Piezo

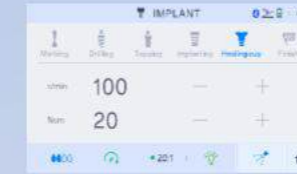

Implant

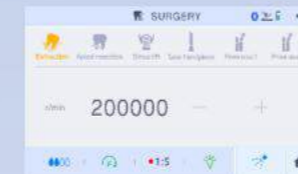

Surgery



Maintenance



Max Torque
80N·CM

Implant Function

Powerful torque with smooth, stable output



Surgery Function

Low heat generation, high efficiency



15% Power Boost

Piezo Function

One-touch boost, 15% more power



Auto-Cleaning

Prevents clogging, built for long-term durability



Wireless Foot Pedal

Quick response, flexible control

Option:
Surgical trolley



Ultrasonic Tip:



PS1



PS2



PS4



PS5



PL3



PC1

02 Dental Ultrasonic Surgical Device

NEW

C-EXPLORER PRO Ultrasonic Surgery Systems

Powerful
Stable
Multipurpose

03
Ultrasonic Surgery
Systems



Model: C-EXPLORER

Ultrasonic Surgery Systems

Order code: C-EXPLORER PRO

Technical:

Power-supply voltage:	100-240V 50/60Hz 150VA
Device for intermittent operation:	60s ON, 10 s OFF
Fuses:	3.15AT 250V
Flow:	20-100ml/min
Radial amplitude:	8-63um
Transeverse amplitude:	1.5-12um
Working tips frequency:	23.8kHz-32.2kHz
Handle:	130.3*Φ33.5mm
Tips (basic kit):	PS1/PS2/PS4/PS5/PL3/PC1



Silent water pump
comfortable operating
experience



10% increase in ultra power



**Multi-functional wireless
foot pedal**
control of multiple functions



Metal connector
More stable, longer life



Large LCD color screen



Tips kit
PS1/PS2/PS4/PS5/PL3/PC1

Multi-mode operation

switch freely



Bone mode



Perio mode



Endo mode



Rinsing mode

04
Ultrasonic Surgery
Systems

C-EXPLORER Ultrasonic Surgery Systems

Powerful
Stable
Multipurpose

05
Ultrasonic Surgery
Systems

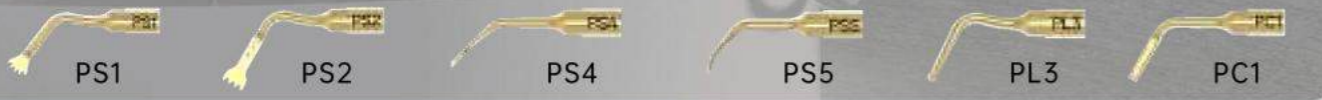

Model: C-EXPLORER

Ultrasonic Surgery Systems

Order code: C-EXPLORER

Technical:

Power-supply voltage:	100-240V 50/60Hz 150VA
Device for intermittent operation:	60s ON, 10s OFF
Fuses:	3.15AT 250V
Flow:	45-100ml/min
Radial amplitude:	8-63um
Tranverse amplitude:	1.5-12um
Working tips frequency:	23.8kHz-32.2kHz
Handle:	130.3*Φ33.5mm
Volume(cm):	28*23*14cm
Weight(kg):	3.4kg
Tips (basic kit):	PS1/PS2/PS4/PS5/PL3/PC1



Silent water pump
comfortable operating experience

Multi-function foot pedal
control of multiple functions

Tips kit
PS1/PS2/PS4/PS5/PL3/PC1

06
Ultrasonic Surgery
Systems

LED lighting



Separation design

Multi-mode operation
switch freely



Bone mode



Perio mode



Endo mode



Cleaning mode

Ultrasonic Tip

Extraction PC Series

PC1   

Used to cut off the ankylosis and root fraction techniques.

PC2   

Left-curved used to cut off the ankylosis, root fraction techniques in the posterior regions.

PC3   

Right-curved used to cut off the ankylosis, root fraction techniques in the posterior regions.

PC8   

It is used for minimally invasive cutting of ligaments and tooth extractions, with a very sharp and pointed tip extremity.

Planting preparation PI Series

PI1   

Used for implant site preparation.

PI2   

Used for implant site preparation.

PI3   

Sandblasted tip, used for final preparation of the implant site near the inferior alveolar nerve.

PI4   

Used for implant site preparation.

PI5   

Used for implant site preparation.

PI6   

Implant preparation tip used in the posterior tooth area, with sharp tip extremity and water out from the center.

PI7   

Implant preparation tip used in the anterior tooth area, with sharp tip extremity and water out from the center.

PI8   

Implant preparation tip used in the anterior tooth area, with sharp tip extremity and water out from the center.

PI9   

Implant preparation tip used in the posterior tooth area, with sharp tip extremity and water out from the center.

Periodontal Surgery PP Series

PP1   

For root canal orientation and removal of the calcifications located at the 1/3 part of root canal, it can also be used for micro-osteoplasty.

PP2   

Inflammatory tissue removal and fractured root apex extraction.

PP3   

Recommended for angled periodontal gentle curetting scaling.

PP4   

For root debridement and root planning.

PP5   

Recommended for root surface micro-smoothing.

PP6   

For micro-osteoplasty: interproximal osteoplasty and root planning.

PP7   

Recommended for periodontal gentle curetting scaling.

Root Canal Treatment PE Series

PE1   

For apical root debridement: diamond-coated instrument for efficient root planning

PE2   

Used for gentle canal cleaning.

PE3   

For apical root debridement: diamond-coated instrument for efficient root planning



PE4   

Used for gentle canal cleaning.



Maxillary Sinus Lift PL Series

PL1   

Separation of the sinus membrane in internal zones, non-cutting elevator of the sinus membrane.

PL2   

Schneiderian membrane separation from bony walls: separation of the sinus membrane.

PL3   

For micrometric osteotomy or osteoplasty: non-traumatic, to finalize the osteotomy or osteoplasty on thin bone and/or near delicate anatomic structures.

PL4   

For micrometric osteotomy: to finalize the osteotomy in proximity of soft tissue (e.g., sinus membrane, vessel/alveolar nerve).

PL5   



Separation of the sinus membrane in internal zones, non-cutting elevator of the sinus membrane.

PL6   



The head is equipped with four water outlets for better separation of the maxillary sinus periosteum. The diamond-coated portion allows for trimming of the edges of the bone window.

PL7   

The head is equipped with four water outlets for better separation of the maxillary sinus periosteum. The diamond-coated portion allows for trimming of the edges of the bone window.

PL8   

For micrometric osteotomy or osteoplasty: non-traumatic, to finalize the osteotomy or osteoplasty on thin bone and/or near delicate anatomic structures.

PL9   

For micrometric osteotomy or osteoplasty: non-traumatic, to finalize the osteotomy or osteoplasty on thin bone and/or near delicate anatomic structures.

Osteotomy PS Series

PS1   

High effectiveness osteotomy of large bone sections during maxillofacial surgery, it can also be used for exodontia/exodontics.

PS1L   

Left angle 90° horizontal osteotomy technique in maxilla and mandible.

PS1R   

Right angle 90° horizontal osteotomy technique in maxilla and mandible.

PS2   

High effectiveness osteotomy technique in maxilla and mandible (ridge expansion, corticotomy technique, bone block grafting).

PS3   

Osteotomy: osteotome of great precision in anatomically thin structures.

PS4   

Universal osteoplasty: periodontal osteotomy, bone chips harvesting, inflammatory tissue removal (cyst, etc.).

PS5   

High efficiency bone osteoplasty: bone remodelling and harvesting of bone chips.

PS6   

Osteotomy: osteotome of great precision in anatomically thin structures (ridge expansion, corticotomy technique).

PS13   

For osteotomy and the removal of apex in posterior teeth area.

PS18   

For osteotomy and the removal of apex.

PS21   

Used for bone cutting. Fan-shaped serration, more convenient for cutting in different angle.

NEW

C-SAILOR Air Dental Implantation System

Implant mode & Surgery mode

Small size ,Powerful performance ,
Powerful functions

51% ↑ Motor performance
34% ↓ Motor size
44% ↓ Host weight
37% ↓ Host volume



2 in 1

09 Dental Implantation Systems

Model:C-Sailor Air

Dental Implantation Systems



Technical:

Maximum power:	250VA
Power supply:	100-240V 50Hz/60Hz
Motor speed:	300r/min~40000r/min
Maxima torque(20:1):	80N.cm
Water supply volume:	4 level adjustable
Volume(cm):	23x23x10
Weight(kg):	1.95

Order code: C-SAILOR Air

Fifth generation "Raptor" motor

- Strong power
- Stable operation
- Low noise
- With LED light
- Smaller
- Lighter

C-Sailor Air Motor



Last generation motor



10 Dental Implantation Systems

Implant mode & Surgery mode 2 in 1

Implant mode



Surgery mode



• 4 shifts water supply up to 110ml/min



Imported bearings, stable output



Metal connector More stable, durable



Wireless pedal



7 inch LCD color full touch large screen

C-SAILOR PRO+ Dental Implantation System

Implant mode & Surgery mode
Graphical interface, Multiple program options

2 in 1



Order code: C-SAILOR PRO+

Technical:

Maximum power:	120VA
Power supply:	AC 110V 60Hz/230V 50Hz
Motor speed:	300r/min~40000r/min
Maxima torque(20:1):	80N.cm
Water supply volume:	5 level adjustable
Light source illumination:	30000lux
Input Voltage:	d.c.30V
Volume(cm):	28×25×12
Weight(kg):	3.4

Implant mode & Surgery mode 2 in 1

Powerful and user-friendly

Adaptable to various gears contra angle:
1: 1/1:2/1:3/1:4.2/1:5
4: 1/10:1/16:1/20:1/27:1/32:1/64:1



Implant mode



Surgery mode



Software updates
Torque store



Metal connector
More stable, longer life



Silent, waterproof
peristaltic pump



Contra angle



Large LCD color
screen



Wireless pedal

C-SAILOR PRO Dental Implantation System

Intuitive
Powerful
Safe & Reliable

Order code: C-SAILOR PRO

Technical:

Maximum power:	130VA
Power supply:	AC110V 60Hz / 230V 50Hz
Motor speed:	300-40000rpm
Adjustable torque:	5Ncm-80Ncm (20:1)
Water supply volume:	4 level adjustable, up to 150ml/min
Light source illumination:	30000lux
Motor:	surgical brushless motor
Volume(cm):	42x38x26cm
Weight(kg)/PCS	5.5kg
Packing material	Aluminum box
QTY per master carton	2 pc/ctn



13
Dental Implantation
Systems



14
Dental Implantation
Systems



Fiber optic contra angle
High brightness LED light
source up to 30000lux



-Full touch 7 inch screen-
Large size screen ensures that
the treatment parameters are
visible at any time



Built-in water supply system
4 shifts water supply
up to 150ml/min

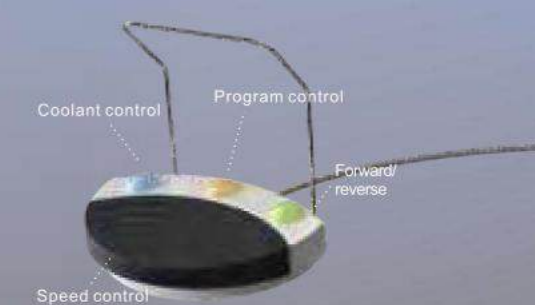

Full function pedal controller
Aseptic operation can be achieved
giving the maximum freedom of the handle

Patent design, delicate contracted

This product has been applied layout-design patent,
Counterfeit must be investigated.



The large size screen ensures that the treatment parameters
are visible at any time



NEW

C-SAILOR S1 Dental Implantation System

Implant mode & Surgery mode

Multiple program options

Graphical interface

Implant mode

Surgery mode



15 Dental Implantation Systems



2 IN 1

Model: C-Sailor S1

Dental Implantation Systems

Order code: C-SAILOR S1

Technical:

Input power:	120VA
Power supply:	AC 110V 60Hz/230V 50Hz
Motor speed:	300r/min~40000r/min
Maxima torque(20:1):	70N.cm
Water supply volume:	4 level adjustable
Light source illumination:	≥7000 lux
Weight(kg):	2.9



The 4th generation of "Hummingbird" brushless motor

- Brushless Motor
- Stable Operation
- Lower Noise
- Lower Temperature Rise
- Smaller
- Lighter
- More Durable
- With LED Light

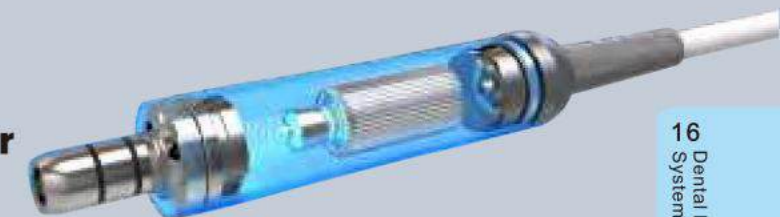

16 Dental Implantation Systems

Adaptable Contra-angle and Straight handpiece

Implant mode: 16:1/20:1/27:1/32:1/64:1

Surgery mode: 1:1/1:2/1:3/1:3.3/1:4.2/1:5/4:1/10:1/16:1/20:1/27:1



Smaller and Lighter

Host weight Just 2.9kg

Host size: 248mm X 232mm X 100mm



Large LCD color full touch screen

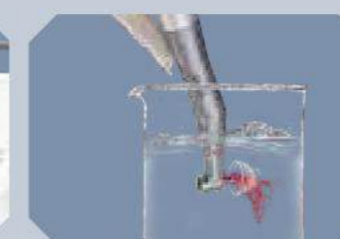

Automatic cleaning of contra-angle



Metal connector More stable, durable



Silent, waterproof peristaltic pump

C-SAILOR Dental Implantation System

Efficient
Big screen
Stable & Safe



The first Chinese brand implant machine which get license from Chinese government for producing and selling

Order code: C-SAILOR

Technical:

Maximum output power	120VA
Power	AC110V 60Hz / 230V 50Hz
Adjustable torque, range	5.0-55N.cm(20:1)
BLDC Speed	300rpm-50000rpm
Infusion flow(maximum)	150ml/min
Motor	Surgical brushless motor
Volume(cm)	40X33X26.5
Weight(kg)/PCS	8.2
Packing material	Aluminum box
QTY per master carton	2 pc/ctn



choose
Built-in 10 setting program

High performance control system
10 kinds of the reduction contra angle to



Big Screen

Clear and easy to understand

- Coolant control
- Program control
- Forward/Reverse



Multi functional foot pedal

Could achieve all the operation function
Easy and flexible



Built-in water supply system

5 shifts water supply
up to 150ml/min



NEW

C-SAILOR INT Dental Implantation System

Implant mode & Surgery mode
Graphical interface, Multiple program options

2 IN 1

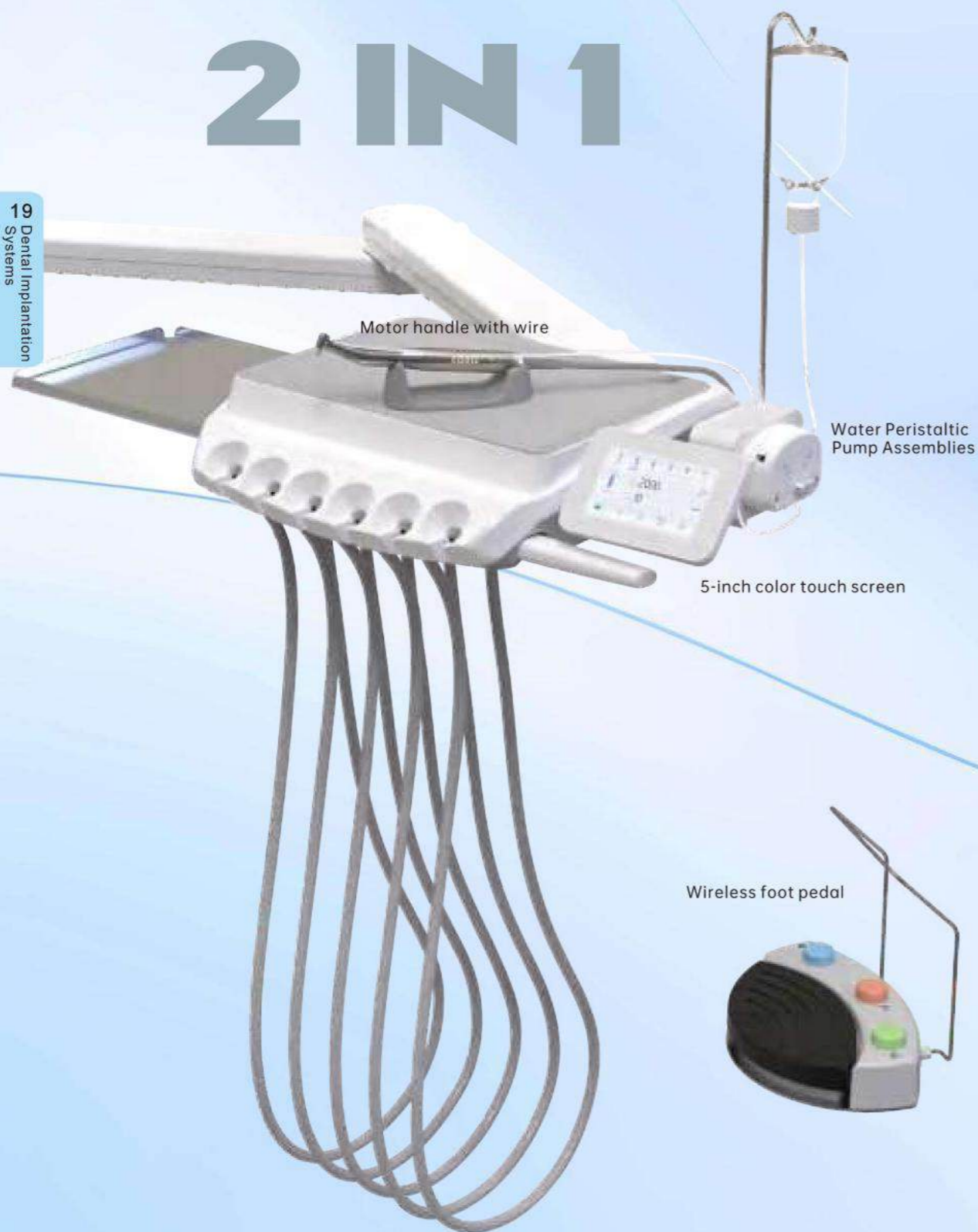

19 Dental Implantation Systems

20 Dental Implantation Systems

Model: C-Sailor

Dental Implantation Systems

Order code: C-SAILOR INT

Technical:

Power conversion box:
Input voltage: AC 24V 50/60Hz
Volume: 85*55*35mm

Drive box:
Operation mode: non-continuous operation
Input voltage: DC 28-32V
Input current: 3A
Volume: 179*113*45mm

Lighting device (LED):
Maximum illumination: ≥7000Lux (bending machine)

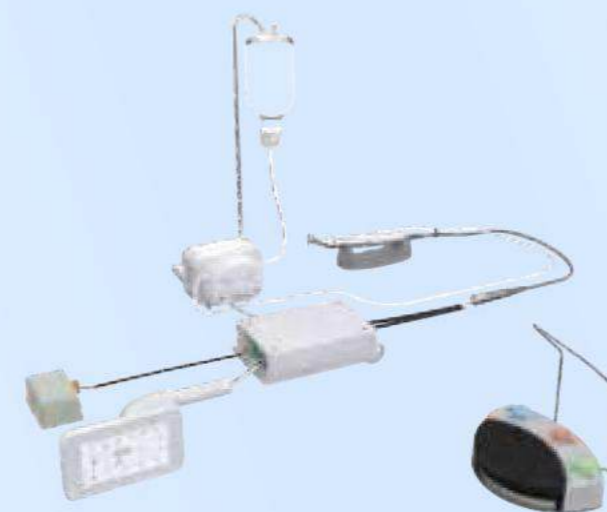

The 4th generation of "Hummingbird" brushless motor

Smaller motor size, lighter weight
Speed range: 300r/min ~ 40000r/min
Maximum torque: 5.5N·cm



Implant mode & Surgery mode

Adaptable Contra-angle and Straight Handpiece:
20:1/ 16:1/ 27:1/ 32:1/ 64:1/ 1:1/ 1:2/ 1:3/ 1:3.3/ 1:4.2/ 1:5/ 4:1/ 10:1/



Implant mode



Surgery mode



Automatic cleaning of contra-angle



Screen switch, the motor does not work after the screen is turned off



Silent, waterproof peristaltic pump

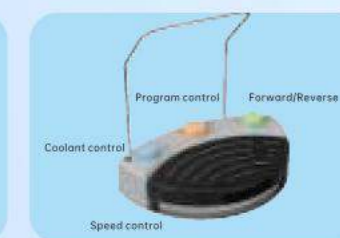

Multifunctional wireless foot pedal

UA-1 Implants UV Activator

10s Activation

Ultra strong implant compatibility

21 Implants UV Activator



Model:UA-1

Implants UV Activator

Order code: UA-1

Technical:

Adapter:	AC100-240V50/60Hz
Input power:	220W
Ozone production:	<0.02ppm
Activation time:	10s
UV wavelength:	172nm
Weight:	5.5kg
Control unit size:	18.7×31.6×33.1cm



Activation takes only 10s



22 Implants UV Activator

Induction switch
Contactless operation to avoid infection



High compatibility of implants



Voice-recognition & LED prompt



In standby mode

Activating

Activation Complete

CI-1 Dental Abutment Placer



Straight adapter & curved adapter



impact head
Medical engineering plastic impact head, capable of high-temperature sterilization

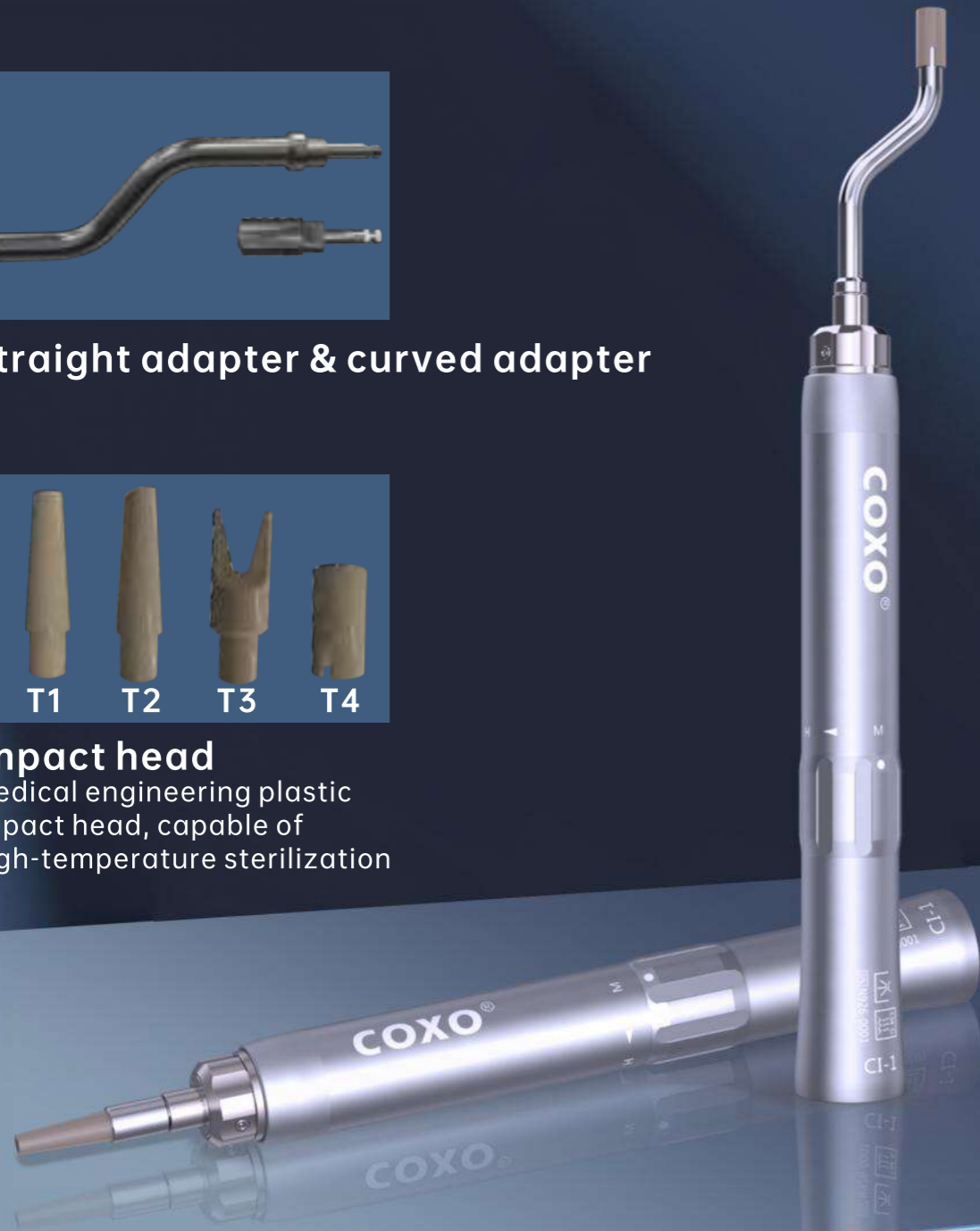

Model:CI-1

Dental Abutment Placer

Technical

- Length: 145mm
- Shell length * diameter: 128mm*20mm
- Weight: 120g
- Recommended air pressure for pneumatic motors: 0.02~0.1Mpa
- Paired with motor output torque: 0.75N.cm
- Matching motor speed: 12000rpm



Order code:CI-1

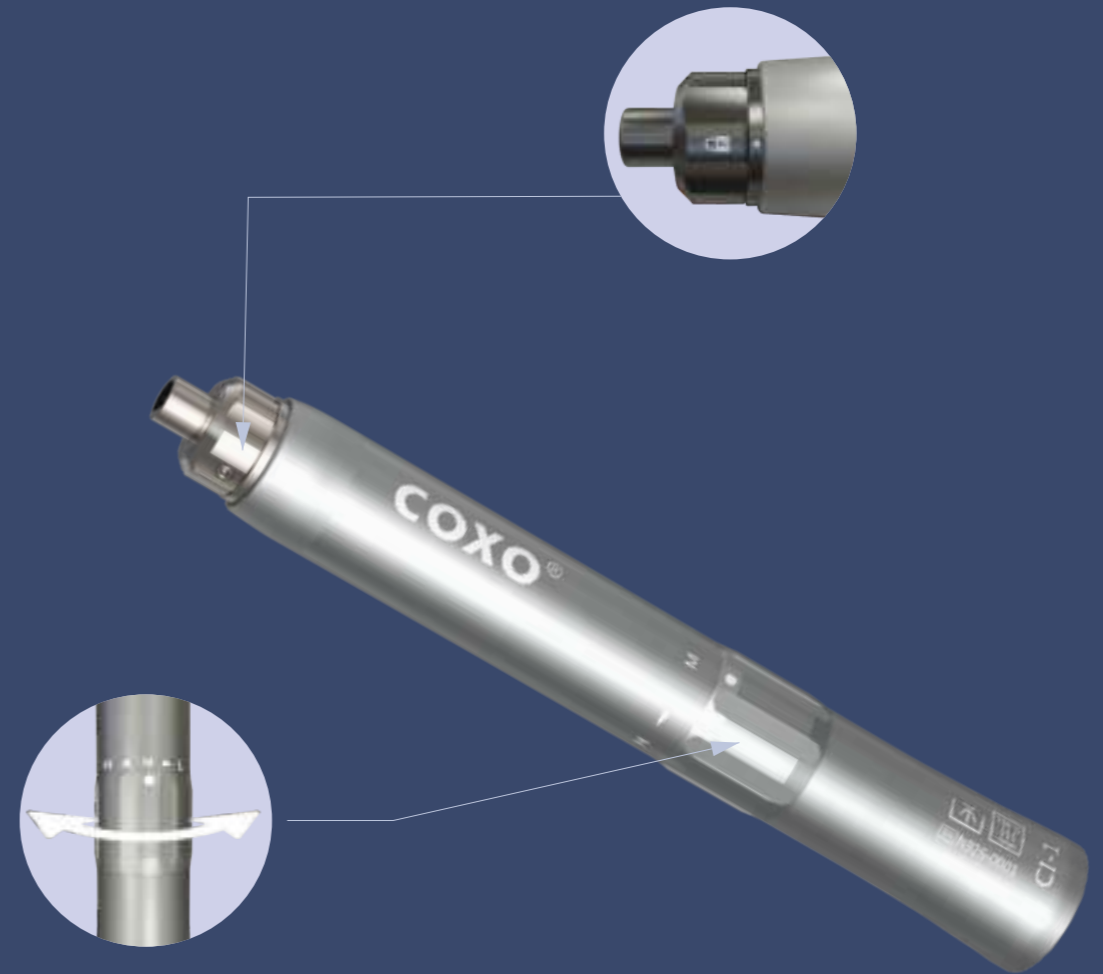

NEW

C-TW3 Dental Implant Torque Wrench

Precision, Compact, Lightweight

Max
50 N·cm

25
Dental Implant
Torque Wrench



Model: C-TW3

Dental Implant Torque Wrench

Technical:

Adapter Input Voltage	AC 100-240V, 50/60 Hz
Output	5V ~ 2A
Input Power	20 VA
Torque range	10-55N·cm
Speed range	5-50r/min
Main Unit Dimensions	24 × 21 × 131 mm
Main Unit Weight	Approx. 100 g
Package Dimensions	180x 130 x 50mm
Standard Screwdriver	16 Specifications



Order code: C-TW3

Dual Operating Modes

Standard Control and Intelligent Protection in Parallel

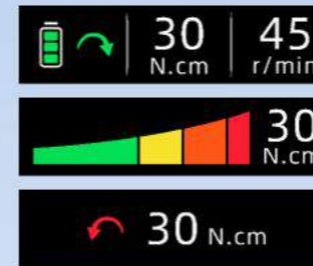

Standard Mode

Constant Speed Control

Key Features:
Immediate stop upon reaching target torque
Torque accuracy: ±3 N·cm

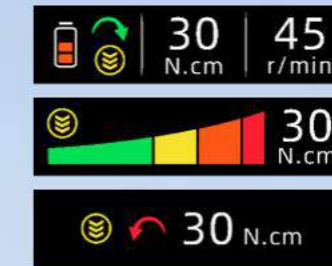

Intelligent Deceleration Mode

Automatic Speed Reduction

Key Features:
Early deceleration for smoother, safer control

Intelligent Trigger Logic:
1. When speed >20 r/min, deceleration protection is automatically activated
2. Level 1 Protection: When torque reaches 60% of the set value, speed automatically reduces by 10 r/min.
3. Level 2 Protection: When torque reaches 90% of the set value, speed further reduces by 10 r/min, precisely approaching the target value.

26
Dental Implant
Torque Wrench



Multi-button Layout, One-touch Function Access



Compact Body Design
Maximum handheld diameter is only 17mm, with a weight of approximately 100g



360° Rotatable Handpiece Head
Easily handles various intraoral positions and complex spaces

Model: C-TW1

Dental Implant Torque Wrench

Feature:

1. 10/15/20/25/30/35N torque gears
2. 16 kinds of screwdrivers
3. Used and upgraded the COXO implanting contra angle

Technical:

Torque: 10-35N.cm

Screwdriver type: $\phi 2.35$

Volume(cm) 13.8x13.8x15



Order code: C-TW1 Kit

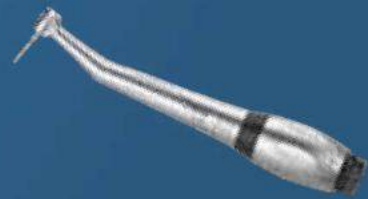

Order code: C-TW1

The conventional design of COXO implanting contra angle has been used with better quality and longer service life



Order code: C-SK1

16 kinds of screwdrivers of different specifications fully compatible with more than 30 mainstream implant systems

Model: C-TW2

Dental Implant Torque Wrench

Feature:

1. Equipped with 14 different screwdrivers,
2. More optimized structural design, more in line with ergonomics and the actual needs of clinicians.
3. CNC precision machining to ensure accurate torque.
4. Aluminum alloy box, can be sterilized at high temperature and high pressure
5. Paired with silicone pins of different colors

Technical:

Torque: 15-70N.cm

Screwdriver type: $\phi 7.5$

Volume(cm) 15.7x12.5x5



Order code: C-TW2 Kit



Order code: C-TW2

More optimized structural design, more in line with ergonomics and the actual needs of clinicians



Order code: C-SK2

14 kinds of screwdrivers of different specifications, fully compatible with more than 30 mainstream implant systems

Endo Series



C-SMART-I PILOT Brushless Endo motor
 Large screen, but also wireless
 Simple, but also rich functional
 Split Endo motor & Apex locator

NEW

More functions



Brushless motor
100-3000rpm



Powerful Bluetooth
 Stronger connection
 10m effective distance



Order code: C-SMART-I PILOT

Technical:

Adaptor working voltage: Input: AC100~240V, 50/60Hz
 Rotation speed range: 100~3000rpm
 Torque: 0.6~5.0N.cm
 Volume: 24×24×8.5cm
 Weight: 1.5kg
 Packing material: carton
 QTY per master carton: 10 pc/carton

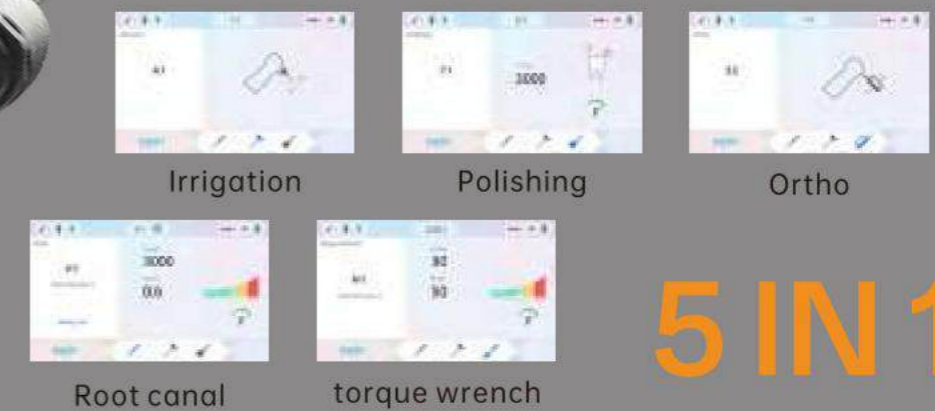

5 IN 1

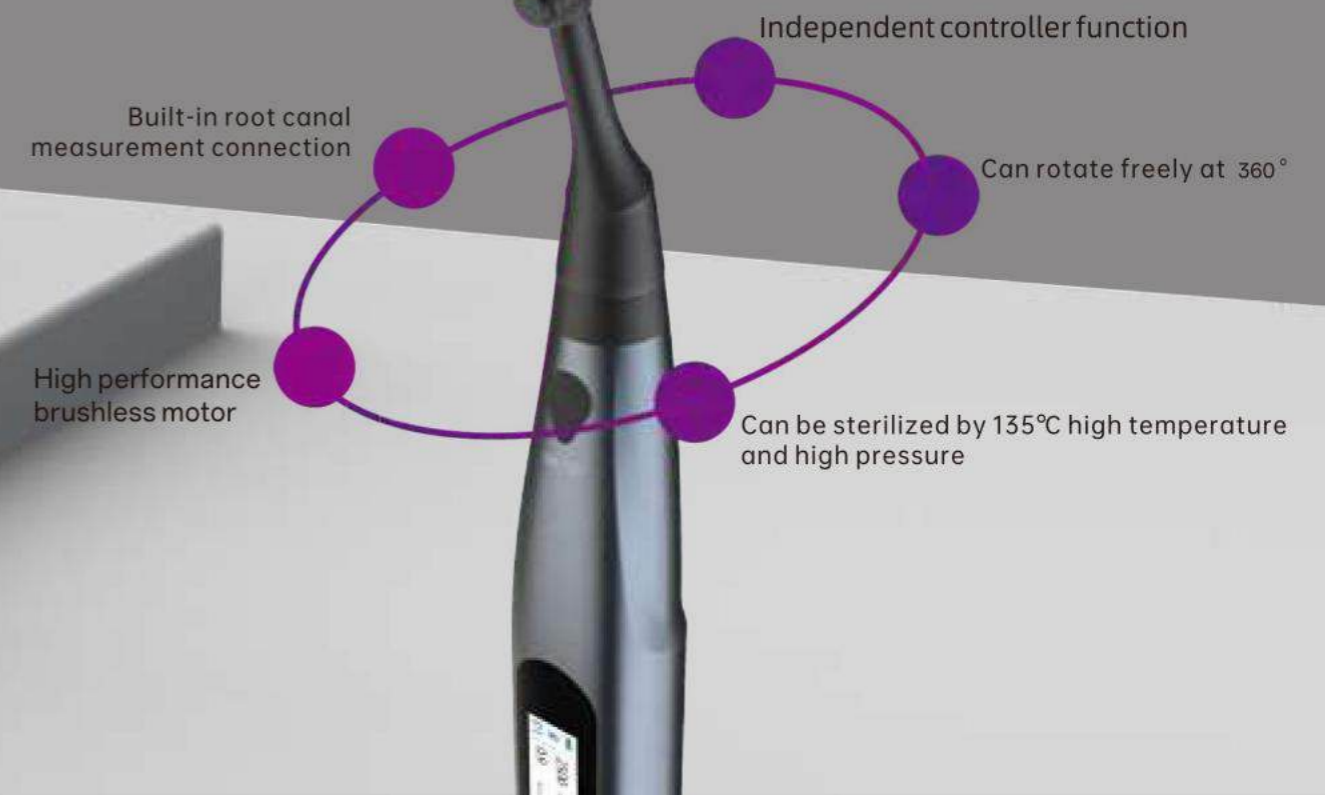

C-SMART-I PRO Endo motor

Touch control, System inside
With LED light
With Apex locator function

Order code: C-SMART-I PRO

Technical:

Adaptor working voltage	AC100-240V,50/60HZ;
Adjustable torque,range	0.6-5.2N.cm(6-52mN.m)
5 setting for adjustable rotational speed ranging:	150rpm-650rpm
Volume(cm)	23.5X20X14.5
Weight(kg)/PCS	2.8
Packing material	carton
QTY per master carton	6 pc/ctn

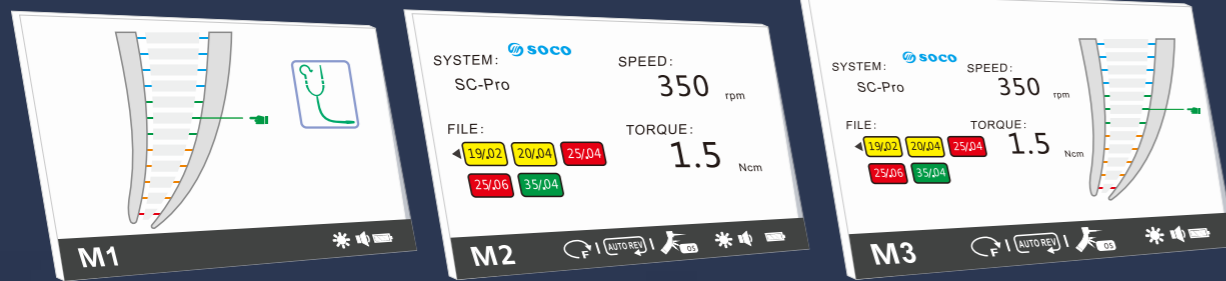

Built-in mainstream system



Endo motor & Apex locator Dual mode

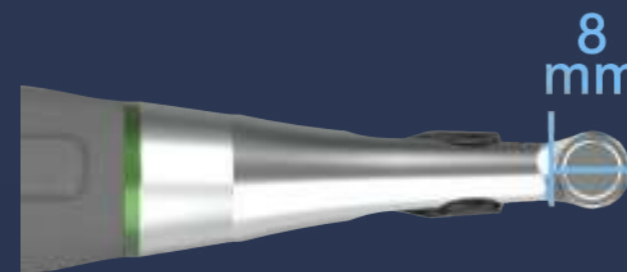

16:1 mini head contra angle

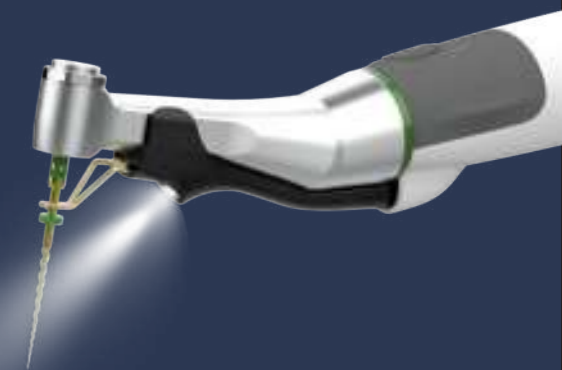

Big color LCD screen

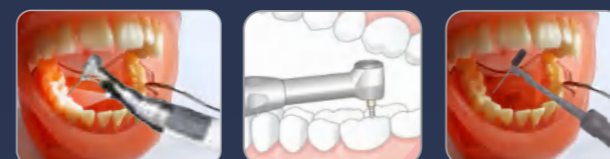

31 Endo Motors

32 Endo Motors

NEW

C-SMART NOVA X Brushless Endo motor

Wireless Endo Motor & Apex Locator

Efficient
Durable

33 Endo Motors

Endo Motor

Ledge Removal

Endo Activate

Tooth Polish



Brushless motor

2500 rpm
Max speed

5 N-cm
Max Torque

Model: C-SMART

Endo Motors



Order code: C-SMART NOVA X

Technical:

Adaptor working voltage	AC100-240V 50/60HZ;
Adjustable torque, range	0.6-5.0 N.cm
Rotation speed range:	100-2500rpm
Volume(mm)	78X74X225

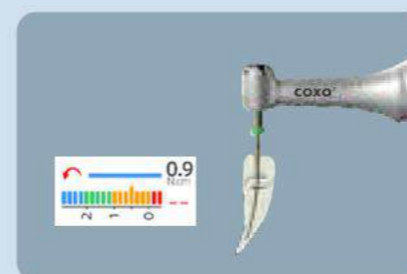

Multifunctional

Apex locator and Endo motor in one. Forward angle after reaching the set torque.

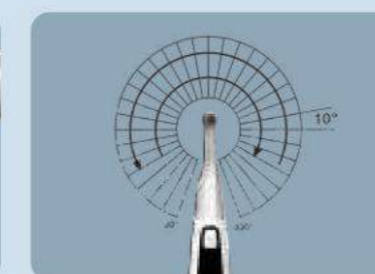

Adjustable angle

Reciprocating rotation angle adjustable every 10°.

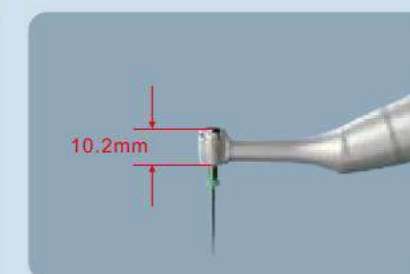

Mini head

The head height is only 10.2mm. The head can rotate 360°.

34 Endo Motors

4 modes



Endo Motor

Thorough Cleaning, Comprehensive Protection.



Ledge Removal

Smooth Transition, Seamless Restoration.



Tooth Polish

Polishing and cleaning of tooth surface.



Endo Activate

Deeply sterilizes the inner wall of the canal.



Optional

Contra-angle

Speed ratio 6:1, mini head tilt angle 108°, handle bending angle 18°.

C-SMART MINI2 Endo motor

Smaller-Safer



Model: C-SMART-MINI2

Endo Motors

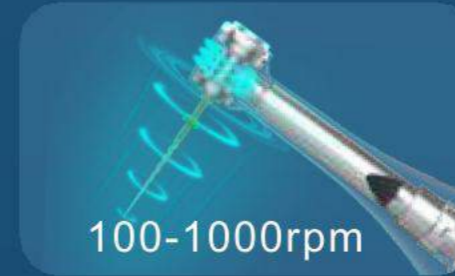

100-1000rpm

The maximum speed can reach to 1000 rpm



Super-mini contra angle
Easily reach every treatment area
Contra angle speed ratio 6:1



33dBA

Main Unit Weight
67.4g

Lighter and Quieter

Reducing hand fatigue, give you the best feel Improved motor, lower noise, allows you to better focus on treatment

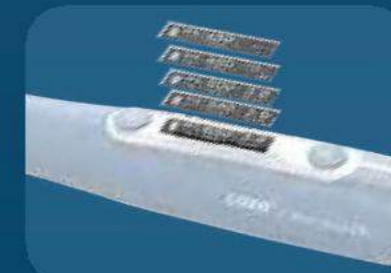

5 Programs

P1~P3: Memory program
P4: Reciprocation program
P5: OGP program



OGP Mode

Special ledge bypassing function
safer and more convenient

Measuring while cutting

Compatible with most root canal meters



*Compatible with most root canal meters.

35 Endo Motors

36 Endo Motors



Order code: C-SMART-MINI2

Technical:

Adaptor working voltage	AC100-240V 50/60HZ;
Adjustable torque, range	0.6-3.9N.cm
Rotation speed range:	100-1000rpm
Volume(mm)	130.2×23.4×20.5
Weight/PCS	67.4g
Packing material	carton



NEW

C-SMART MINI Brushless Endo motor AP+

Wireless Endo Motor & Apex Locator
Powerful Functions
Precise Measurements
Efficient And Safe



100 rpm Min speed  2500 rpm Max speed

37 Endo Motors

Model:C-Smart-Mini AP+

Endo Motors



Order code: C-SMART-MINI AP+

Technical:

Adaptor working voltage	AC100-240V 50/60HZ;
Adjustable torque range	0.6-5.0 N.cm
Rotation speed range:	100-2500rpm
Volume(cm)	19X13X6
Weight(kg)/PCS	0.7
Packing material	carton
QTY per master carton	12 pc/ctn

4 working mode

Endo Motor

Ledge Removal

Tooth Polish

Endo Activate



Apex locator & endodontic treatment

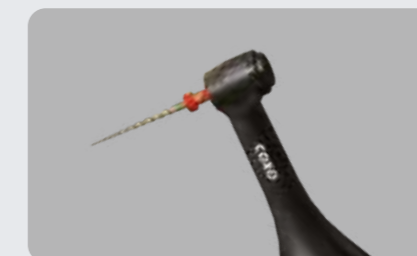

Super Mini Head Contra Angle with insulation coating



Smart wake up function

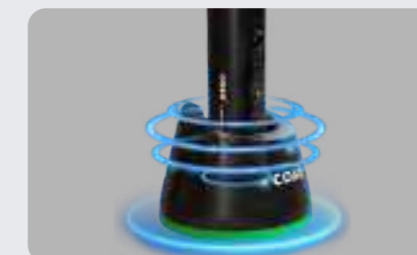

convenient wireless charge

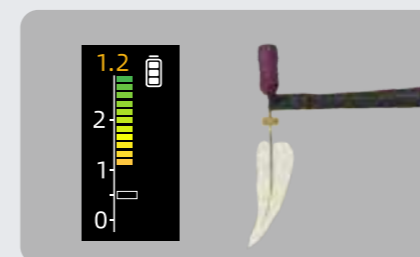

Apex locator

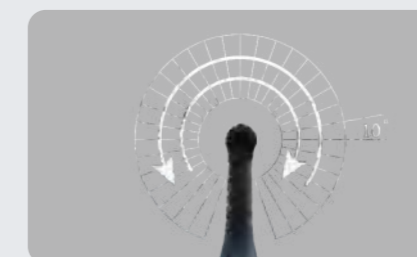

Adjustable reciprocating angle (10° for each unit)

Option



Endo Activate

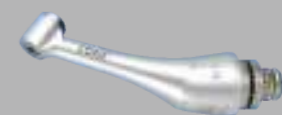

C5-7M

38 Endo Motors

C-SMART MINI AP Endo motor
 Wireless endo motor & apex locator
 Powerful functions
 Precise measurements
 Efficient and safe

Model: C-Smart-Mini AP

Endo Motors

Order code: C-SMART-MINI AP

Technical:

Adaptor working voltage	AC100-240V 50/60HZ;
Adjustable torque, range	0.6-3.9N.cm(6-39mN.m)
5 setting for adjustable rotational speed ranging:	150-600rpm
Volume(cm)	19X13X6
Weight(kg)/PCS	0.7
Packing material	carton
QTY per master carton	12 pc/ctn



39 Endo Motors

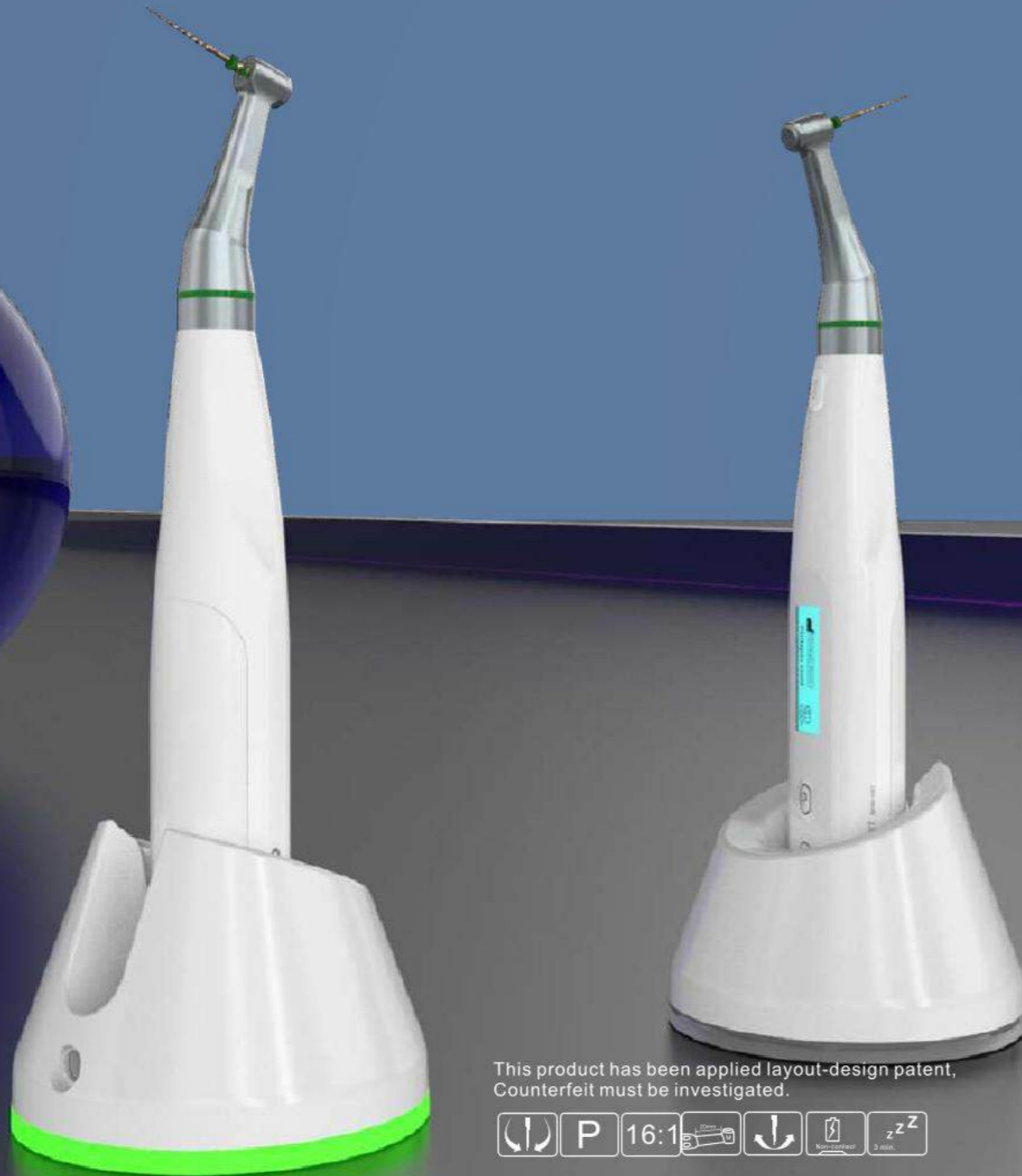

This product has been applied layout-design patent, Counterfeit must be investigated.



With 6 mainstream brands,
 31 mult file system
 Almost 200 Endo files parameters



3 working mode
 Auto-switch work mode
 Colorful and sound prompt

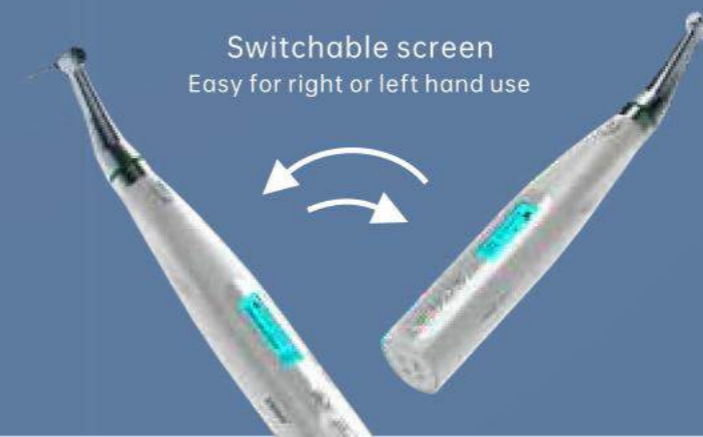

Switchable screen
 Easy for right or left hand use



16:1 Mini Head Design
 360° Rotation, Meet the needs of
 various treatment angles

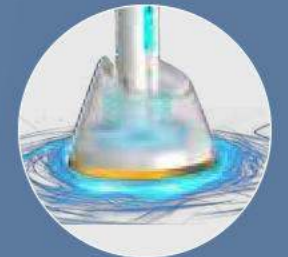

Non-contact recharge
 Faster and safer

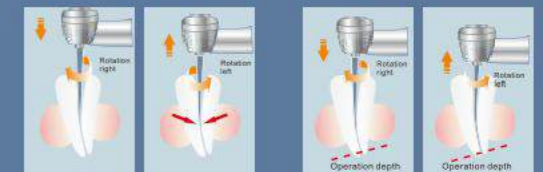

● auto reverse by torque ● auto reverse by apical position

40 Endo Motors

Order code: C-SMART-MINI

Technical:

Adaptor working voltage	100-240Vac, 50/60HZ;
Adjustable torque range	0.6-3.9N.cm(6-39mN.m)
5 setting for adjustable rotational speed ranging:	125rpm-625rpm
Volume(cm)	19X13X6
Weight(kg)/PCS	0.7
Packing material	carton
QTY per master carton	12 pc/ctn



Reciprocation



Non-contact recharge design



This product has been applied layout-design patent, Counterfeit must be investigated.

Order code: C-SMART-MINI (LED)

Technical:

Adaptor working voltage	AC100-240V,50/60HZ;
Adjustable torque range	0.6-3.9N.cm(6-39mN.m)
5 setting for adjustable rotational speed ranging:	125rpm-625rpm
Volume(cm)	19X13X6
Weight(kg)/PCS	0.7
Packing material	carton
QTY per master carton	12 pc/ctn



LED light

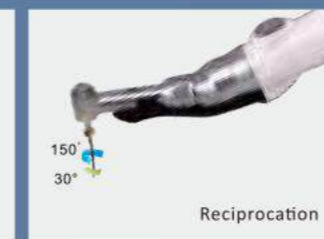

Reciprocation



LED screen



Non-contact recharge design



This product has been applied layout-design patent, Counterfeit must be investigated.

ULTRA SMART Endo Ultrasonic Activator

Safer
Cleaner
Professional

Model: Ultra Smart

Endo Ultrasonic Activator

Order code: ULTRA-SMART

Feature:

1. High frequency ultrasound up to 38kHz.
2. Variable frequency control, self adjusting frequency in treatment.
3. Activation sequences of 20 sec.
4. With LED lighting system.
-

Technical:

Volume: 17x17x6 cm

Weight: 0.65 kg

Packing material: carton

QTY per master carton: 8 pcs/carton



43
Endo Irrigator



CU1*3



44
Endo Irrigator



ULTRA SMART AI Ultrasonic Activator
Safer
Cleaner
Powerful and multi-use.

45 Endo Irrigator



Model: Ultra Smart

Endo Ultrasonic Activator

Order code: **ULTRA-SMART AI**

Feature:

1. High frequency ultrasound up to 38kHz.
2. Variable frequency control, self adjusting frequency in treatment.
3. Activation sequences of 20 sec.
4. With LED lighting system.

Technical:

Volume: 17x17x6 cm
 Weight: 0.65 kg
 Packing material: carton
 QTY per master carton: 8 pcs/carton



3 Working mode

High power mode
 Removing broken endo file



Middle power mode
 Normal irrigation



Low power mode
 Smallest tip to clean small canal

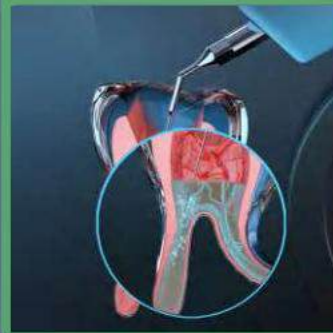

46 Endo Irrigator

Built-in LED light
 Easily observe the treatment area



Force-limiting Wrench

C-RCC Root Canal Irrigation And Suction System

Continuous flushing
With heating function
Negative pressure flushing



Developed with
Dr. Mandar Pimprikar



47
Endo Irrigator

Multi-function mode of irrigation and suction
allows irrigation and suction to be carried out at the same time

Model: C-RCC

Root Canal Irrigation and Suction System

Order code: C-RCC

Feature:

1. Three working modes: irrigate, suction and suction while irrigate
2. With heating function: can heat the irrigants to improve the disinfection effect by 400%
3. Joint developed. This product is co-developed from the rich clinical experience of experts.

Technical:

- Power: AC100-220V 50/60Hz
- Irrigate flow: 2-5ml/min
- Suction flow: Tip A: >10ml/min; Tip B: >3ml/min
- Volume: 35x26x11cm
- Weight: 1.65 kg
- Packing material: carton



Irrigation mode only
Working time:30s

3



Suction mode only
Working time:120s

Working modes



Circular irrigation mode
Working time:30s/60s/90s/120s

48
Endo Irrigator

Standard
2 types of tip



Tip B
Longer needle: 27G, for suction
Shorter needle: 21G, for irrigation



Tip A
Longer needle: 27G, for irrigation
Shorter needle: 27G, for suction

With heating function

Improve the disinfection effect by 400% making it safer and more efficient.

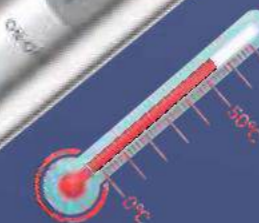

C-FILL X Endodontic Obturation system

Precise temperature control
Perfect filling



Order name: C-FILL X Set

49 Endodontic Obturation Systems

Model: C-Fill

Endodontic Obturation Systems

Order code: C-FILL X

Technical:

Battery: DC3.6V 2200mAH
Working temperature: 140 ° C, 160 ° C, 180 ° C, 200 ° C
Adapter: input AC 100~240V, output DC5V 4A
Use time: ≥30min
Needle specifications: 23G, 25G



Built in dental gum removal function

Simultaneously press and hold the "M" and "⏻" keys to clear the cavity dental gum

360 ° circular button

Replaceable



Grasp to wake up, no need to repeatedly turn on/off the machine

Heating protection

Discontinuous operation, work for 1 minute, stop for 3 minutes

Order code: C-FILL Mini P type

Technical:

Battery: DC3.7V 2000mAH
Heating time: 4S(With heat protection function, the single heating time is up to 4 S)
Working temperature: 150 ° C, 180 ° C, 200 ° C, 230 ° C
Adapter: input AC 100~240V, output DC5V 1.5A
Use time 1.5H
Plunger specifications: F 45/02, FM 50/04, M 55/06, ML 55/08



Different angle
Easy to reach any treatment places



Faster heating
P type can archive 200°C in 0.5s

Intelligent reminder
Sound and flashing prompt
With protection function, single heating time up to 4s

Precise temperature control
Good performance give you the most smooth cutting of gutta-percha



C-FILL mini P type

50 Endodontic Obturation Systems

C-FILL MINI Endodontic Obturation system

Precise temperature control
Perfect filling



Order code: C-FILL Mini



The tip of plunger with minimum diameter 0.45mm, 0.2 taper, can press the effective filling position that is 3 mm from the Apex.



The gun head can be rotated by ±100° for easy use.



Double-sided button operation, convenient and fast



360° dynamic charging display, more humane.

Model: C-Fill

Order code: C-FILL Mini G type

Battery: DC3.7V 2200mAh

Heating time: 15s To 200 °C.

Working temperature: 150 °C, 180 °C, 200 °C, 230 °C

Adapter: input AC 100~240V, output DC5V 1.5A

Use time 1.5H

Needle specifications: 23G, 25G



Accurate temperature control

Automatically cool down to 150°C on the base
Save electricity and prevent glue overflow

Endodontic Obturation Systems



Faster heating
G type can archive 200°C in 15s



New wrench design
Help you to push more accurately



Order code: C-FILL Mini P type

Battery: DC3.7V 2000mAh

Heating time: 4S(With heat protection function, the single heating time is up to 4 S)

Working temperature: 150 °C, 180 °C, 200 °C, 230 °C

Adapter: input AC 100~240V, output DC5V 1.5A

Use time 1.5H

Plunger specifications: F 45/02, FM 50/04, M 55/06, ML 55/08



Different angle
Easy to reach any treatment places



Faster heating
P type can archive 200°C in 0.5s

Intelligent reminder
Sound and flashing prompt
With protection function, single heating time up to 4s

Precise temperature control
Good performance give you the most smooth cutting of gutta-percha



C-FILL mini P type

Heat plunger		
Size	Color code	Taper/Size
#XF	Green	0.02#35
#F	White	0.02#45
#FM	Yellow	0.04#50
#M	Red	0.06#55
#ML	Red	0.08#55



Needle		
Gauge	Diameter	Length
23ga	0.65mm	23mm
23ga	0.65mm	23mm
25ga	0.55mm	23mm
25ga	0.55mm	23mm



NEW

C-ROOT I Root apex locator

Touch precision
All touch TFT LCD

53 Root apex locator

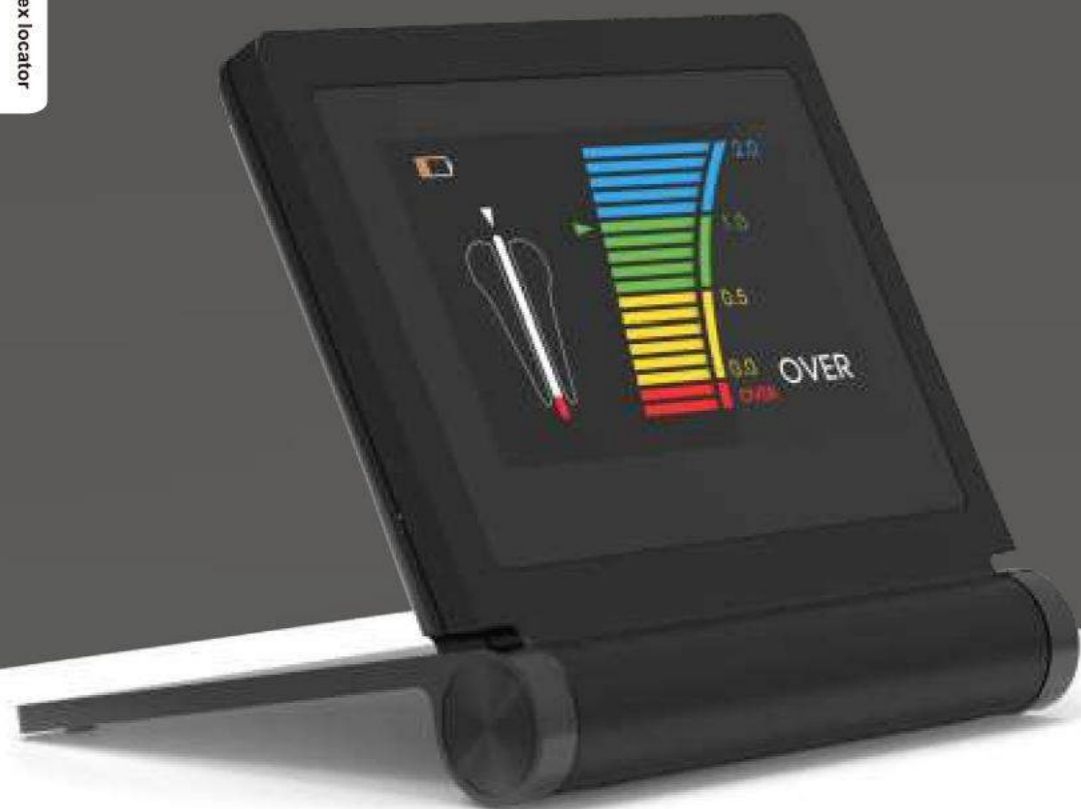

Root testing is more stable
Algorithms are more accurate

Model: C-Root I

Root Apex Locators

Order code: C-ROOT I

Technical:

Adaptor working voltage:	AC100-240V,50/60HZ; DC3.7V 1800mAh
Battery:	changeable LI-ion battery
Display:	color TFT-LCD touch screen
Display specifications:	size:73.44x48.96mm(3.5inch) resolution:480x320
Charge time:	4hours
Volume(cm):	10.3X11X2.1
Weight(kg)/PCS	0.27
Packing material	carton



Colorful touch screen
Easy to adjust various parameters



54 Root apex locator

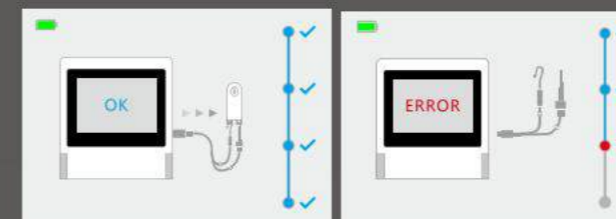

Automatic check function
Ensure you the accuracy of each measurement



Simple and light
The thickness is only 2cm, but it
brings unimaginable accuracy

NEW

C-ROOT I(V) Root apex locator

Convenient, Accurate
Energy-saving and Durable



5 Root apex locator

Model: C-Root I(V)

Root Apex Locators

Order code: C-ROOT I(V)

Technical:

Adaptor working voltage:	100-240V 50/60Hz
Battery:	DC3.7V 1200mAh
Volume(cm):	11.4 x 5.7 x 6.2cm
Weight(kg):	0.14



Accurate measurement:
Technology upgrades and massive data support soar the accuracy!



Energy-saving and durable:
large-capacity battery, ultra-long battery life.



Simple operation:
simple interface, streamlined buttons, progressive sound prompts, easy to use!



Small and portable:
Small size, light weight, easy to carry and widely used.

5 Root apex locator



Feature:

- 1-Root canal apex finder and pulp vital measurement;
- 2-Color LCD screen display and can adjust the angle you need;
- 3-Multi-frequency design, exact accurate;
- 4-Accurate current-stabilized generate technology
- 5-Self-test function in apex locator;
- 6-The narrow zone of the apex can be adjust if the doctor need;
- 7-Sound prompt for the apex in the narrow zone of the pulp vital;
- 8-Rechargeable Li-ion battery and charger

Technical

- 1.Adaptor voltage : AC100-240V, 50/60HZ
- 2.Battery:7.4V/2000mAh changeable Li-ion battery
- 3.Charge time:3 hours
- 4.Display:color LCD Screen,buzzer

Volume/Weight

- 1.Volume(cm):24X19X9
- 2.Weight(KG)/PCS:2.0KG
- 3.Packing material: carton
- 4.QTY per master carton : 6 pc/ctn

Order code: C-ROOTI(VI)
Root apex locator with pulp tester

57 Root apex locator

Two working modes

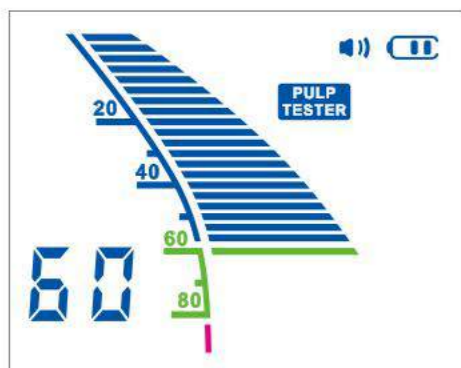

Pulp tester mode



Apex locator mode

Accessories



Order code: C-PULSE

Feature:

- 1-Preset speed mode(high-mid-low speed)
- 2-Agentle, pulsed stimulus begins to increase at a rate specifically designed for patient comfort.
- 3-If the patient indicates perception, simply release the button, the stimulus stops immediately, but the numbers remain frozen on the screen for about 3 minutes.
- 4-Specifically designed for patient comfort.
- 5-Convenient to operate.
- 6-Maximum stimulus--80, between 0-40, the patient feels ache and anesthesia, alive teeth nerve.
- 7-Between 40-80, with above-mentioned reaction, part of teeth nerve dead; 80, no above-mentioned reaction, dead teeth nerve.
- 8-The device turns itself off in three minutes after operation (No wasted batteries).

This product has been applied layout-design patent, Counterfeit must be investigated; NO.ZL200730333925.9

80 Pulp testers, 50 Detection on device

Caries Detection Devices



Simple, Effective, Innovative caries detection
Competitive with the products of KaVo and W&H



Order code: C-HUNTER

Feature:

- 1-Effective function for decayed tooth- detection , quickly, easily, painless
- 2-Wireless operation, Lightness using
- 3-Support minimally invasive surgery, safely, lighten patient's fear
- 4-Mini slender mainframe designing, provide the best treatment operation

Technical:

Adaptor working voltage:	AC100-240V,50/60HZ;
Lightwave Data:	LED intensities:40-280mw LED wavelength:380-420nm
Volume(cm):	16X14X6.5
Weight(kg)/PCS	0.5
Packing material	carton
QTY per master carton	6 pc/ctn

Function:

Bacteria in dentine infected by caries leave behind metabolic products (porphyrins). when an exposed cavity is illuminated with violet light, these porphyrins show a red fluorescence, thereby indicating the significant areas for caries excavation.

C-hunter aids detection and monitoring of carious tooth substance, in particular in dentin, during the excavation of previously opened cavities.

According to the particular fluorescence properties of the degradation product which is produced by the cariogenic bacteria, substances with teeth for removing infected, to remove the infected material on the teeth.

Accessories



SC-PRO2018 CONTROLLED MEMORY FILES

- High elasticity
- More Safety
- More Efficiency
- More Durable

5 NITI file System



Use nickel titanium file
to prevent detritus from introducing apical foramen
Optimized to clear the file to the transition of the forming file
Protection of curved root canal anatomy

leading operation concepts, advanced technical support
to the leap of the SC-pro NITI file.



New Swiss hard treatment
make good performance

Anti-cycle Fatigue Comparison

Model: SC-PRO

Dental Root Canal Instruments

SC-PRO2018 CONTROLLED MEMORY FILES



New series of SC-PRO 2018:
only need to dredge up to Hand use file K10.

Feature:

1. Upgrade open file 17/12 , more reasonable.
 2. With dual-variable taper of path file, nickel titanium file can be used after 10# hand file
 3. Upgrade shaping file 18/05, more perfect for the processing.
 4. Upgrade material , more flexible.
- Among classic 6 pcs system file , only it can used nickel titanium file after 10# hand file
 - SC Pro-2018 more suitable for the big taper of obturation filling system.

Technical:

Photo						
Cross section	Orifice Opener	12 Variable taper Path file	16 Variable taper Path file	18 / .05	25 / .06	35 / .04
Model	#17	#12	#16	#18	#25	#35
Taper	12	02	02	05	06	04
Speed	300	350	350	350	350	350
Torque	3	1.5	1.5	2	2	1.5
Length	21mm/25mm/31mm					

6 NITI file System

High elasticity Super cutting force Chimb triangle

SC-PRO2018 on the basis of the SC-PRO added 06 taper file,
Can face a variety of thickness of the root canal.



VS

SC-PRO Files Other factory which has not been done polish

Super Easy Operation

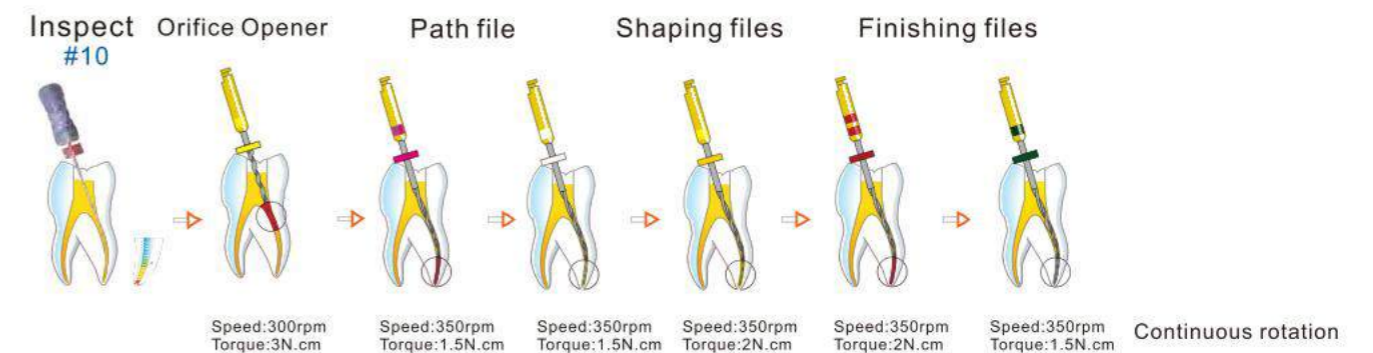

S-one PRO
Single Niti Reciprocation File

safer
easier
faster
more effective



High elasticity Super cutting force Evolving cross-section

Model: S-one pro

Dental Root Canal Instruments

S-one PRO
Single Niti Reciprocation File



Feature:

1. Super cutting force, anti-fatigue, anti-broken.
2. Maximized cutting efficiency
3. 3pens

Technical:

Photo			
Cross section	20/07	25/07	35/06
Model	# 20	# 25	# 35
Taper	07	07	06
Length	21mm/25mm/31mm		

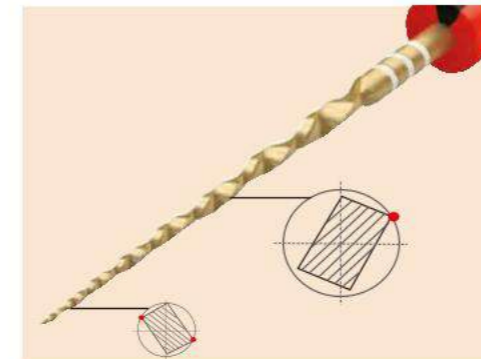

This image depicts how an alternating offset and transi-tioning parallelogram-shaped cross-section limits the engagement between the file and dentin.

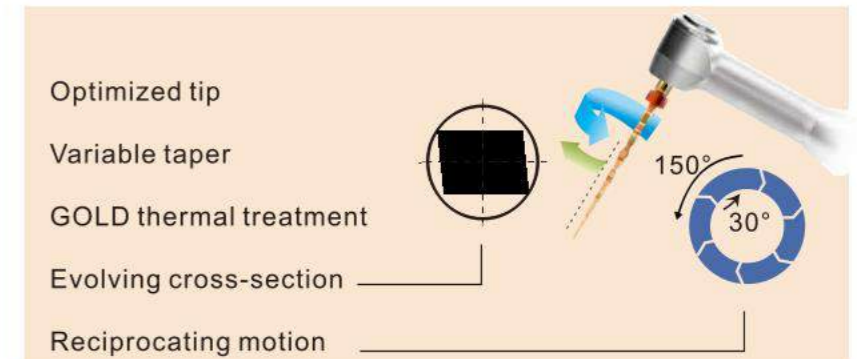

Super Easy Operation



Cutting Efficiency Comparison

simple complex

SC-PRO Lite 2018
CONTROLLED MEMORY FILES



Safe
Simple
Practical



Chimb triangle

Feature:

- 1-SC-PRO simplified version is suitable for conventional root canal preparation.
- 2-Anti-cyclic fatigue increased to 400%.
- 3-Safe, simple, practical.
- 4-4 pens

Technical:

Photo				
Cross section	Orifice Opener	18 / .05	25 / .06	35 / .04
Model	#17	#18	#25	#35
Taper	12	05	06	04
Speed	300	350	350	350
Torque	3	2	2	1.5
Length	21mm/25mm/31mm			

S-one 2018
Single Niti Reciprocation File

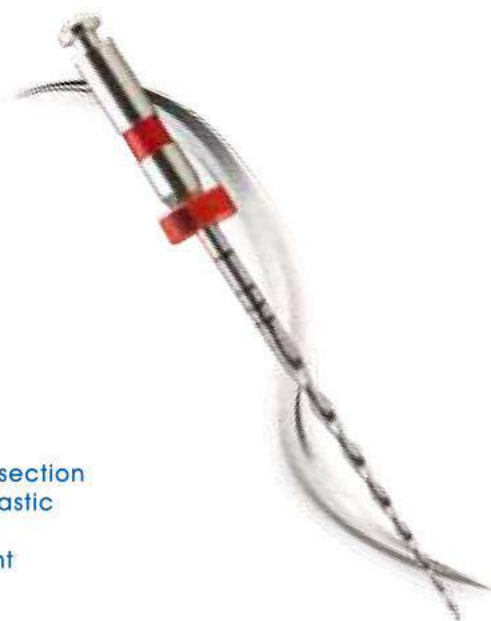

Sharp section
High elastic
Quick efficient

simple complex

Feature:

- 1-Single file to complete the preparation
- 2-Unusually sharp section
- 3-The capacity of chip and chip evacuation enhanced
- 4-More flexible than the traditional single file, indications broader
 - A-Good variable pitch design for quick and automatic removal of debris to the crown side.
 - B-Variable pitch design and S-section, enhanced transverse cutting force, and weakened "screwed in" dentin effect.
 - C-Instrument "screwed in" dentin effect.
- 5-Use 06 taper tooth glue tip filling.

Technical:

Photo			
	L1 20/07	L1 25/06	L1 35/06
Model	#20	#25	#35
Taper	07	06	06



-Three different size finish file, After predicting the root canal main sharp file,
-According to the fine root canal, middle root canal and rough root canal, Use a single file to complete the preparation

SC-PRO
CONTROLLED MEMORY FILES



Feature:

- 1-Super cutting force, anti-fatigue, anti-broken.
- 2-The new import CM NiTi material, good flexibility,
- 3-More responsive to the root canal morphology.
- 4-The super-hard alloy coating, increase product durability, and make a perfect looking.

Technical:

Photo						
Model	Φ17	Φ19	Φ20	Φ25	Φ25	Φ35
Taper	08	02	04	06	06	04
Torque	3.0N.cm	1.5N.cm				
Length	21mm/25mm					

Cutting Efficiency Comparison
切削效果对比图

Traditional Niti File Cutting not enough

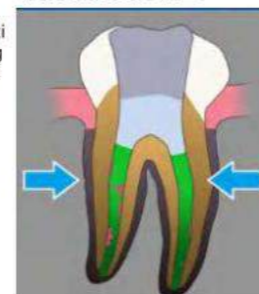

SC-PRO Files Cutting smoothly and equally

SC-PRO

VS

SC-PRO Niti Files

Smoothly and responsively Rotating in the canal

VS

Traditional Niti File

While Rotating, the file will go back to the center, it will easily harm to the canal and make ledge.



VS

SC-PRO Files

Other factory which has not been done polish

Anti-cycle Fatigue Comparison
New Swiss hard treatment make good per

C-FR2 File Removal System

More convenient, safer and less damage

Model: C-FR2

File Removal System

Feature:

1. Adopting a lasso style for easier removal of broken files.
2. Strong and secure tip.
3. Ergonomics design.
4. Equipped with standard disinfection box, standard 20 lasso components.

Order code: C-FR2



Standard 20pcs specially designed lasso component
Easy to install and easy to use

Strong and secure tip

Durable and tensile-resistant wire guarantees precise grip safe removal of a broken instrument
Order code: CX265-144



NiTi Path Drill
Different sizes, to meet your different needs
Order code: CX265-89

Model	#110	#90	#80	#70	#60
Taper	01	02	02	03	04

Model	1.1	0.9	0.8

NiTi Cutting Drill
Easy to create a stepped platform
Order code: CX265-90

Model	0.8x0.5	0.6x0.9	0.7x1.1

Micro-Trephine
Remove the dentin around the end of the broken file
Order code: CX265-91

C-FR1 File Removal System

A Product Every Dentist Should Own



67 File Removal System

Model: C-FR1

File Removal System

Feature:

1. Adopt clip-on file to minimize damage to teeth.
2. Equipped with three different sizes of work tips and it can meet multiple clinical needs.
3. Pre-bent work tip for easier operation.

Technical:

Volume: 15.5x9.3x5.5cm



Order code: C-FR1

Clip-on file design
To minimize damage to dentin



Special locking design
Help you catch every broken files

Equipped with three different sizes of work tips
Can meet multiple clinical needs.
Order code: CX265-88

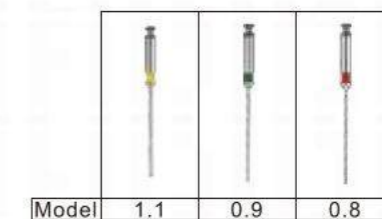

NiTi Flat Drill
Easy to create a stepped platform
Order code: CX265-90

NiTi Path Drill
Different sizes, to meet your different needs
Order code: CX265-89



Model	#110	#90	#80	#70	#60
Taper	01	02	02	03	04

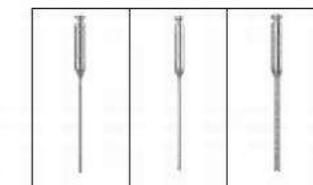

Micro-Trepine
Remove the dentin around the end of the broken file
Order code: CX265-91

67 File Removal System

Feature:

- 1-press rapid heating,release the button a few seconds for cooling,easy to use.
- 2-Using wireless charging technology,stylish,,fashionable.
- 3-2400mAh large capacity nickel cadmium rechargeable battery,avoid frequently charging trouble.
- 4-Fever needle can be sterilized,it can be repeatedly used.

This product has been applied layout-design patent, Counterfeit must be investigated;NO.ZL201430484927.3

Technical:

Ni-MHchargeable Battery:	1.2V 2700mAh	
Heating time:	≥ 2s	
Working temperature:	160°C	
Charger input voltage:	AC230V 50HZ,AC110V 60HZ	
Heat plunger	S,M,L,XL	
Volume(cm)	17.5X10.5X7.5	15X12X3.8
Weight(kg)/PCS	0.5	0.3
Packing material	carton	carton
QTY per master carton	10 pc/ctn	10 pc/ctn



Order code: C-BLADE



Feature:

- Rectilinear motion handpiece and carborundum blade:
- 1-Apply to invisible treatment; rapid repair of dental enamel
- 2-Carborundum blade is stable and durable
- 3-The blade frame and the blade adopts the locking type design, its more solid, has a good compatibility with all kinds of handpiece
- 4-When the knife frame put in to handpiece, can be completely fixed, no shake
- 5-There are holes in the blade, which can effectively discharge the water and powder produced in the glaze.



Order code: C3-11KIT



Different thicknss for the diamond

Technical:

Two side diamond (with hole)	15 μm	15HD	2 PCS
	25 μm	25HD	2 PCS
	40 μm	40HD	2 PCS
	60 μm	60HD	2 PCS
	90 μm	90HD	2 PCS



up an down movement



10pcs

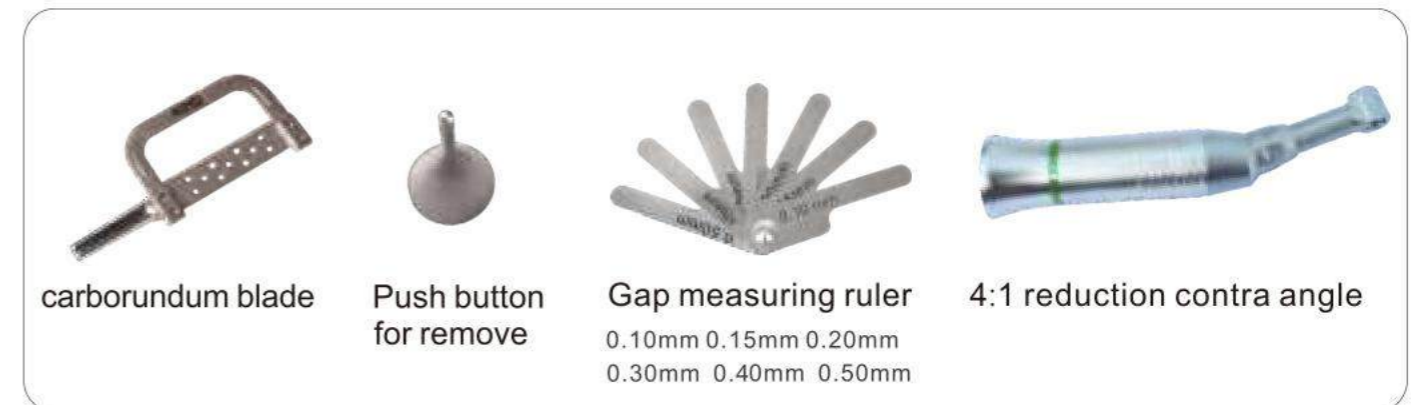

COMING SOON

Oral digital viewing instrument safer, smaller, easy to use!



71
Oral digital viewing
instrument

Oral digital viewing instrument

Technical

Image sensor:	High definition 1/9 image sensor chip
Image perspective:	Diagonal 100°
Image format:	MJPEG
Output interface:	USB-A interface, UVC CAMERA standard protocol
Working current:	<0.15A
Dynamic range:	60DB
Color temperature of fill light:	6000K-6500K white light
Image frame rate:	MJPEG/30FPS
Working voltage:	DC5V
Photo taking method:	button/wireless foot pedal capture



Miniature camera,
The outer diameter is only 3.9mm



Easy dual control, flexible operation (both the control box buttons and the wireless foot pedal can be used for control).



Scanning the QR code allows you to easily save the image to your phone, facilitating communication between doctors and patients.



1-megapixel high-resolution display effect

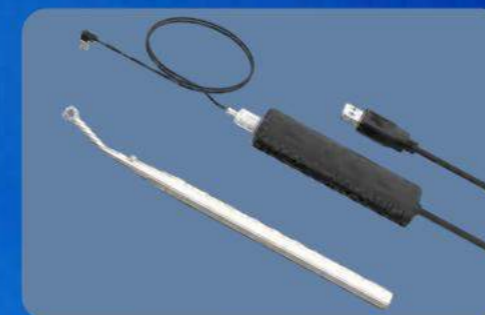

The camera module and control box feature a detachable design, making cleaning and maintenance more convenient.



Simple installation and easy use!

72
Oral digital viewing
instrument

NEW

C-CLEAR-2 Stepless Zoom Operating Microscope

See more details and treat more accurately

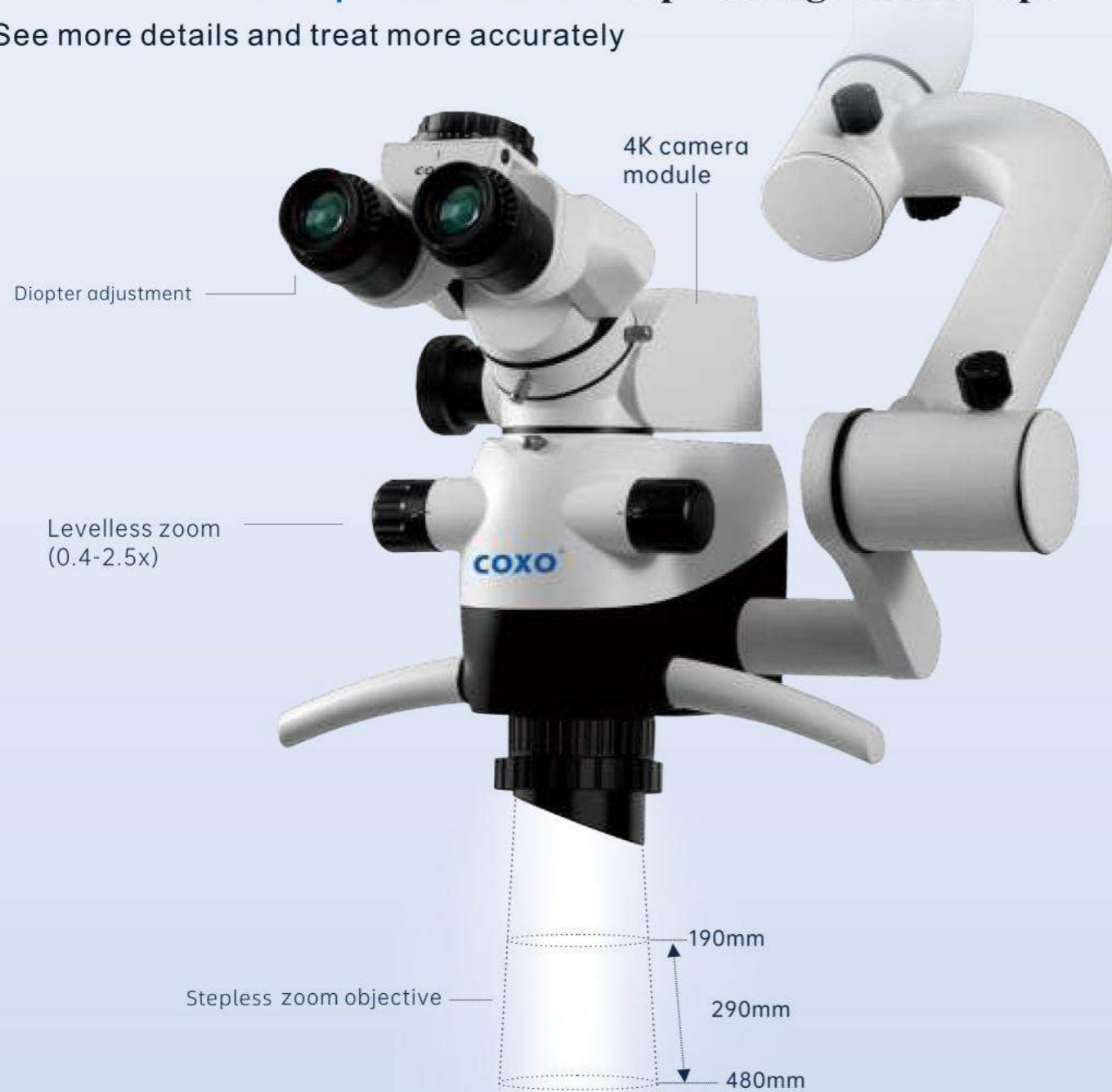

73 Operating Microscope

74 Operating Microscope

Technical parameters:

1. Optical system: Apochromatic optical system
 2. Zoom System: Levelless zoom(0.4-2.5x)
 3. Eyepiece Lens: 12.5x wide-angle eyepiece, diopter+7~-7D high eye point, suitable for operators with glasses
 4. Binocular tube: 0-180° angle adjustable, f=170mm
 5. Objective Lens: Working distance:190-480mm
 6. Illumination system: LED bulb, adjustable brightness, the illumination is not less than 120000Lux, Color rendering index (Ra/CRI)> 90%
- Multiple filter modes:3 size White light, Orange filter, Green filer

Optional accessories:

External camera system:SLR digital camera

Model:C-CLEAR-2

Operating Microscope



Multiple filter modes



Auto power on/off



Super Balance Arm System

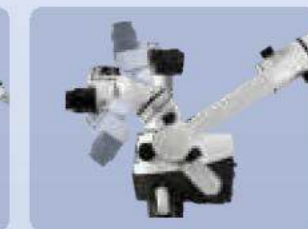

0-180° Variable angle
binocular tube



±30°
Host tilt adjustment

Optional mounting options:

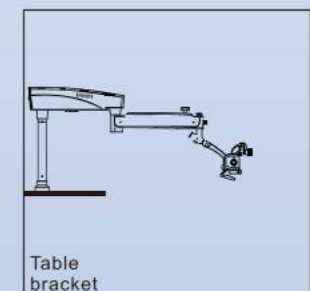
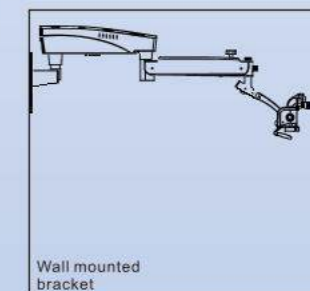
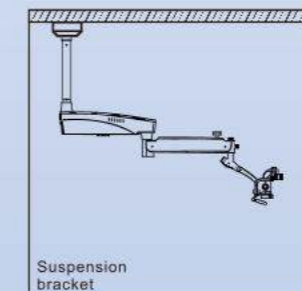
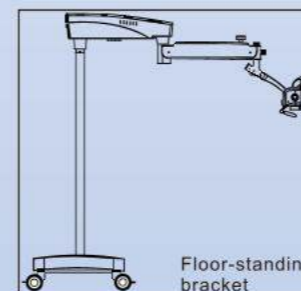

C-CLEAR-2 Operating Microscope

See more details and treat more accurately

12.5x Wide-angle Eyepiece

Diopter adjustment

Magnification adjustment knob
(5 levels of magnification: 0.4, 0.6, 0.8, 1.6, 2.5)

Lens protector

Larger zoom objective

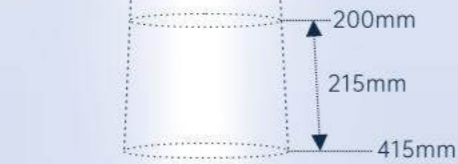

Auto power on/off



Super Balance Arm System



0-180° Variable angle binocular tube



±30° Host tilt adjustment

Model: C-CLEAR-2

Operating Microscope

Multiple filter modes



Orange Filter



Green Filter



3 Size White Light



Order code:
**C-CLEAR-2
Basic Edition**



Order code:
**C-CLEAR-2
Standard Edition
(No camera included)**

Optional mounting options:



Order code:
**C-CLEAR-2
Table bracket
(No camera included)**

Table bracket

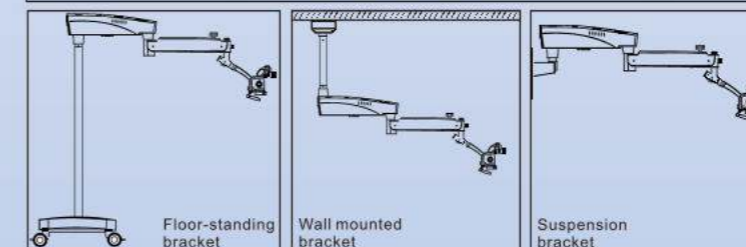

Floor-standing bracket

Wall mounted bracket

Suspension bracket

Technical parameters:

1. Optical system: Apochromatic optical system
 2. Zoom System: 5 levels of magnification, 0.4/0.6/0.8/1.6/2.5
 3. Eyepiece Lens: 12.5x wide-angle eyepiece, diopter +7~-7D high eye point, suitable for operators with glasses
 4. Binocular tube: 0-180° angle adjustable, f=170mm
 5. Objective Lens: Working distance: 200-415mm
 6. Illumination system: LED bulb, adjustable brightness, the illumination is not less than 65000Lux, Color rendering index (Ra/CRI) > 90%
- Multiple filter modes: 3 size White light, Orange filter, Green filter

Optional accessories:

External camera system: SLR digital camera

C-CLEAR 1 Operating Microscope

See more clearly, do more finely

NEW

High eye point, wide-angle eyepiece, suitable for operators with glasses

5-Gears magnification

Double handle angle adjustable

Big range Zoom Objective

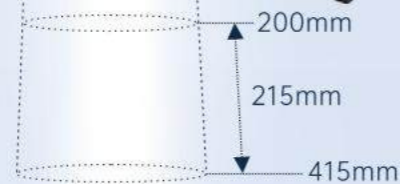

High pointwide angle eyepiece



Large zoom objective wide focus adjustment range, easier to observe



1 5-Gears magnification
2 Light source brightness adjustment for continuous brightness adjustment with simple operation



Eyepiece angle can be adjusted 180°



Comfort handle convenient positioning and comfortable feel

Model: C-CLEAR-1

Operating Microscope



Order code:
C-CLEAR-1 (Basic Edition)



Order code:
C-CLEAR-1 (Standard Edition)
(No camera included)

Feature:

1. Apochromatic optical system design
2. high-quality imported optical lens, multilayer nano-optical coating
3. 5-speed magnification
4. lighting using color rendering index of more than 95% of imported LED bulb.
5. Microscope support using optimized mechanical structure design
6. Germany imported gas spring,
7. high-quality imported Medical mute casters

Optional mounting options:

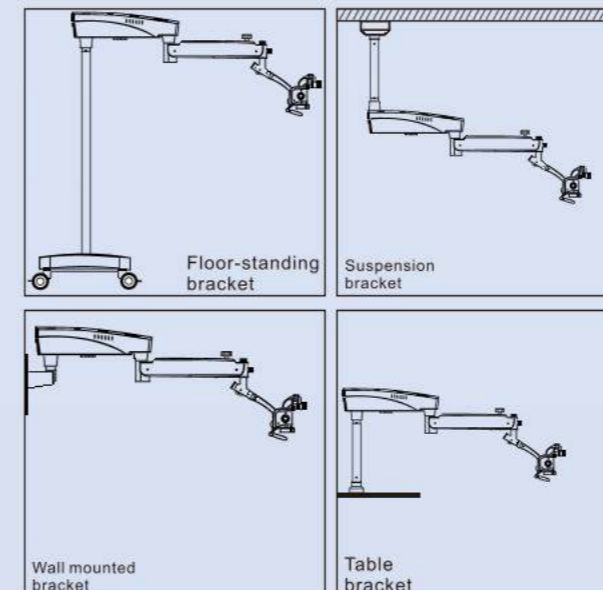

Technical parameters:

- Binocular tube:
 1. Eyepiece: 12.5x, ±6D diopter adjustment, eye cup height adjustment;
 2. Interpupillary distance adjustment range: 55-75mm;
 3. f=170mm, 0-180° rotation angle adjustment;
- Zoom range:
 1. Five-speed magnification adjustment, adjustment coefficient: 0.4, 0.6, 1, 1.6, 2.5;
 2. Five light spot adjustments: large, medium and small white light spots and green and orange light;
 3. Illumination is adjustable, the minimum illumination is not less than 65000Lux;
- Large objective lens: Working distance: 200-415mm
- Base, column: 3-inch medical silent casters;
- Swivel arm: Two-stage locking device;
- Balance arm:
 1. Load adjustment device;
 2. ±300mm adjustment range;
 3. Locking device;
 4. German imported gas spring;
- Main frame bracket: Two-stage locking device

Optional accessories:

- Beam splitter
 1. 45° optical extender
 2. +30° pendulum system
 3. 2:8 beam splitting system
- Sony digital camera lens barrel
 1. Knob-type camera focus adjustment system;
 2. Optional Canon digital camera lens barrel;
- Objective lens protective cover
- 30° tilt protective cover, easy to disassemble.
- Canon, Sony digital cameras
- Dell, LG monitors
- HDMI data cable
- Camera direct power supply
- Monitor stand
- Wireless foot switch

NEW

C-KT Surgical Loupes

Clear Vision, Ease of Posture

79 Surgical Loupes



Model: C-KT

Surgical Loupes

The angled medical loupes use high-quality prisms to deflect the optical path downward by 45°, allowing doctors to maintain a comfortable operating posture and significantly reducing cervical fatigue caused by long surgical procedures.



Features an apochromatic optical system, which helps reduce chromatic aberration, delivers clear images, and provides optimal visual support for surgeons.

The optical path is deflected downward by **45°**, reducing neck strain.

80 Surgical Loupes



Order code: C-KT30



Order code: C-KT50

Technical:

Order code	Magnification	Working Distance (mm)	Field of View (mm)	Depth of Field (mm)	Interpupillary Distance Range (mm)	Net Weight (g)
C-KT30	3.0x	450-550	85-105	95-135	50-80	64.1
C-KT50	5.0x	450-550	60-75	70-115	50-80	66.1

Model: C-GL

Surgical Loupes

NEW

C-GL Surgical Loupes

Pure Optics, True Sight



81 Surgical Loupes

Ergonomic Frame

Lightweight design-constructed with high-strength lightweight alloys/composites for comfortable, secure wear even during extended use.



Adjustable nose pads



Interpupillary distance (IPD) adjustment

Flip-up design allows instant lifting of the magnifier when not in use, facilitating easy communication with patients

Pupil height adjustment



Order code:
C-GL25



Order code:
C-GL35

Technical:

Order code	C-GL25	C-GL35
Magnification	2.5x	3.5x
Working Distance (mm)	450-550	300-580
Field of View (mm)	110-150	110-130
Depth of Field (mm)	115-180	200
Interpupillary Distance Range (mm)	50-80	50-80
Net Weight (g)	60.1	73.1

Model: C-AL

Medical Headlight

NEW

C-AL Medical Headlight

Pair with our medical wireless headlight for a complete visual solution.

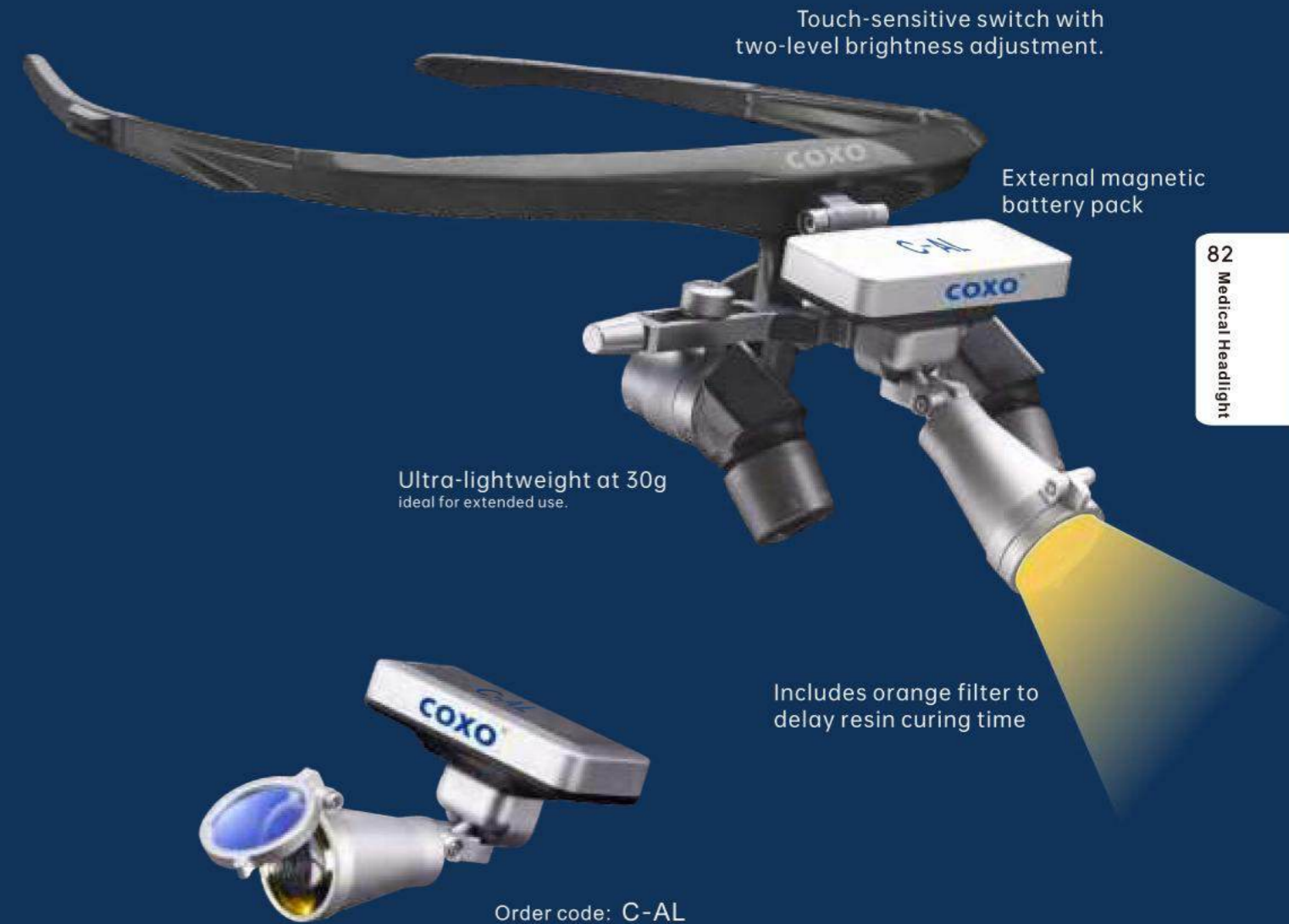

Touch-sensitive switch with two-level brightness adjustment.

External magnetic battery pack

Ultra-lightweight at 30g
ideal for extended use.

Includes orange filter to delay resin curing time

Order code: C-AL

82 Medical Headlight

Technical:

Light Source	LED enhanced white light, color temperature 5750K, Bulb lifespan ≥ 100,000 hours, Illuminance at working distance ≥ 35,000 Lux, Color Rendering Index (CRI) > 90%
Illuminate	Touch-sensitive two-level brightness control, Yellow filter included, 90° vertical adjustment range, Weight: 10.8 g
Lithium-ion Battery	External magnetic battery pack: 2-hour runtime, 1-hour full charge, >700 charge cycles Lithium-ion battery x3, total weight: 19.2 g
Charger	Dual-bay charging dock, charges two batteries simultaneously
Accessories	100-240V 50/60Hz charger, charging cable

NEW

C-PUMA PRO3 Dental Electrical Motors

One machine multi-use, super easy to use!



84 Dental Surgical Motors

84 Dental Surgical Motors

Model: C-PUMA Pro3

Dental Electrical Motors

Technical:

Input power:	AC100-240V,50/60Hz
Motor rotation speed:	300-40000r/min
Torque output:	≥5N·cm
Motor outer diameter:	Φ 21.3*134mm
Water supply volume:	5 level adjustable



Silent water pump



Large LCD color screen



Quick connect water tank,
Large capacity (1000ml)



Multi-functional
wireless foot pedal



Software updates



Imported bearing

Standard:



Order code:
C6-22(20:1)

Order code:
C7-5S(1:5)

Option:



Order code:
C7-5(1:5)

Order code:
C7-3(1:4.2)

Order code:
C7-3S(1:4.2)

Order code:
C-1B(1:1)

Order code:
S-2B(1:1)

Order code:
S-2S(1:1)

NEW

C-PUMA Pro Dental Electrical Motor

One machine multi-use ,Super easy to use!



4 IN 1

plug in and use

No need to connect the water and gas of the dental chair, just plug in and use.

Model:C-Puma

Dental Electrical Motors



Technical:

Input power:	AC100-240V,50/60Hz
Motor rotation speed:	2000-40000 r/min
Torque output:	≥2N·cm
Motor outer diameter:	Φ20.6mm×67.7mm
Water supply volume:	5 level adjustable

Order code: C-PUMA Pro

4 modes



Extraction

Osteotome

High-speed

Low-speed

Dual water supply

- One click switch.
- Direct supply of sterilized cooling physiological saline.
- Water heating function.

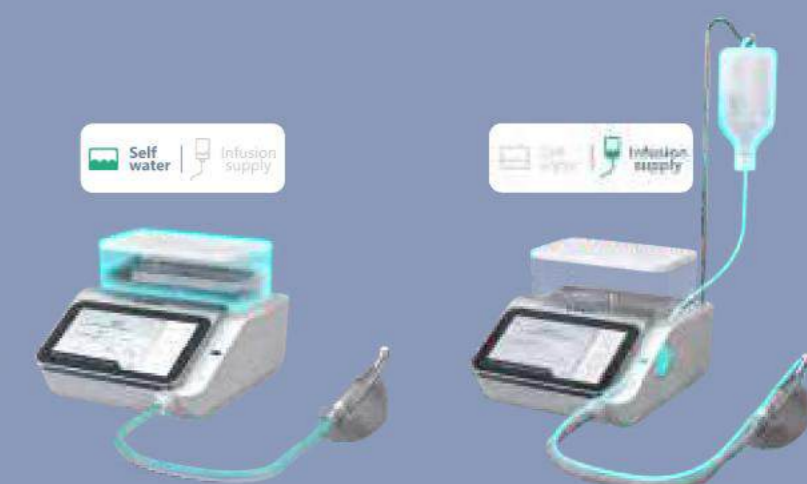

Standard:



Order code: C7-5(1:5)

Order code: C7-3S(1:4.2)

Option:

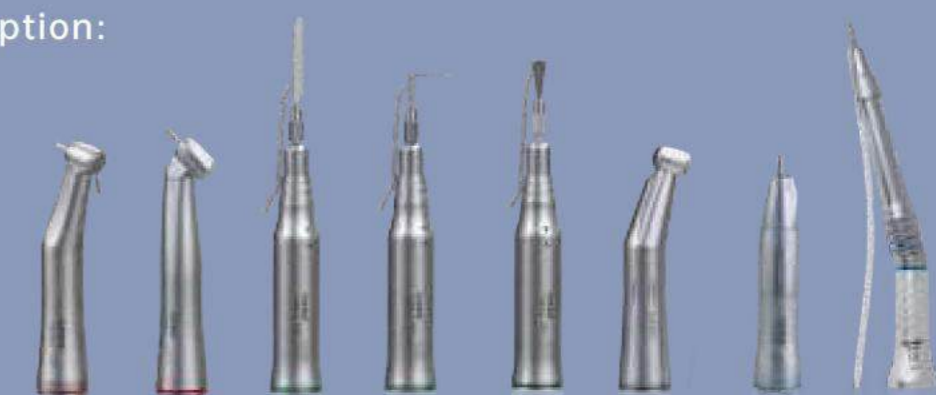

Order code: C7-5S(1:5)

Order code: C7-3(1:4.2)

Order code: S-GR1

Order code: S-GO1

Order code: S-GS1

Order code: C-1B(1:1)

Order code: S-2B(1:1)

Order code: S-2S(1:1)

NEW

C-PUMA EX Dental electrical motor

Excellent performance
Strong power

2 in 1



Brushless LED

87 Dental Electrical Motors

88 Dental Electrical Motors

Model: C-Puma

Dental Electrical Motors

Order code: C-PUMA EX

Technical:

- 1-Input power: AC100-240V, 50/60Hz
- 2-Host size: 120*150*90mm
- 3-Maximum speed: 40,000 rpm
- 4-Motor size: ϕ 20.6X67.7mm

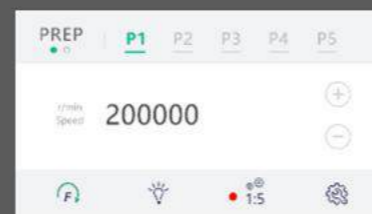

Electric motor

10 speed ratios, full coverage of high and low speed applications.
Adaptable Contra-angle: 1:1/1:3/1:3.3/1:4.2/1:5/4:1/10:1/16:1/20:1/27:1

Endo mode

continuous rotation and reciprocating rotation, wide speed 250-3000rpm, high torque 0.6-6Ncm, suitable for a variety of root canal files.
Adaptable Contra-angle: 16:1/10:1/6:1/4:1



Imported bearing

more precise motor control.



Clearer display

5 inch high-definition large screen, personalized style.

Option:



Order code: C7-3 (1:4.2)

Order code: C7-5 (1:5)

Order code: C-1C (1:1)

Order code: S-2C (1:1)

Order code: C5-1M (6:1)

C-PUMA Master Dental electrical motor

Electric motor & Endo motor

One machine multi-use ,Super easy to use!

2 in 1



Brushless LED

Order code: C-PUMA Master

Electric Motor Mode Features

- 1-Adapt with contra angle and straight head in accordance with ISO3964
- 2-The speed and steering are adjustable, the speed can reach up to 40,000 rpm.
- 3-Built-in 7 program memories, each program can adjust parameters independently.
- 4-The maximum torque can reach 3.0 N·cm
- 5-Internal water spray;
- 6-The handle is air-cooled to maintain a comfortable temperature;
- 7-LED lighting, light intensity and delay time can be adjusted.

Electric motor

With different contra angle, it can be used for teeth preparation, teeth restoration, and teeth polishing, etc.



Endo Motor Mode Features

- 1-Use 6:1 contra angle with one-piece Mini head;
- 2-Built-in mainstream file system, no need to set up, just select and use;
- 3-Auto-reverse and manual real-time reverse function;
- 4-Speed: 250-1200RPM;
- 5-Torque: 0.6-5.1 N.cm.

Endo Motor

with 6:1 Mini head contra angle, it can be used for root canal preparation



Feature:

- 1-The host has a novel shape and streamlined design;
- 2-Full-view color 5-inch LCD display, full touch control;
- 3-Pneumatic / manual start mode free to switch;
- 4-The motor is small and light, and can be autoclave;
- 5-Starting air pressure of the motor can be customized;
- 6-with electric motor and Endo motor function can be switch freely.

Technical:

- 1-Input power: AC100-240V, 50/60Hz
- 2-5.0 inch LCD screen Resolution: 800*480
- 3-Maximum speed: 40,000 rpm
- 4-Motor outer diameter: 20.6mm

Option:



Order code: C7-3 (1:4.2)

Order code: C7-5 (1:5)

Order code: C-1C (1:1)

Order code: S-2C (1:1)

Order code: C5-1M (6:1)

C-PUMA Dental electrical motor

Minimally invasive repair, polishing.....

Order code: C-PUMA

Feature:

- 1-Simple operating system
Connect the dental unit to the C-Puma with a 4 holes tubing, use the foot pedal to control the electric motor.
- 2-The New-Gen of technology micromotor C-Puma
According to the different treatments and different handpieces, the speed can be adjusted from 100—200,000rpm/min.
- 3-Compact and handy, high torque
Ergonomic designed length and weight greatly reduce the fatigue from long time operation, the motor can be sterilized.



Brushless LED

This product has been applied layout-design patent, Counterfeit must be investigated;NO.ZL201430485143.7

Technical:

Power:	120w
Speed range:	2000rpm-4000rpm (1:1) 100rpm-2500rpm(16:1) 10000rpm-200000rpm(1:5)
LED maximum:	>10000lux
Torque output:	3.5N.CM
Volume(cm)	29X23X11
Weight(kg)/PCS	2.3
Packing material	carton
QTY per master carton	8 pc/ctn

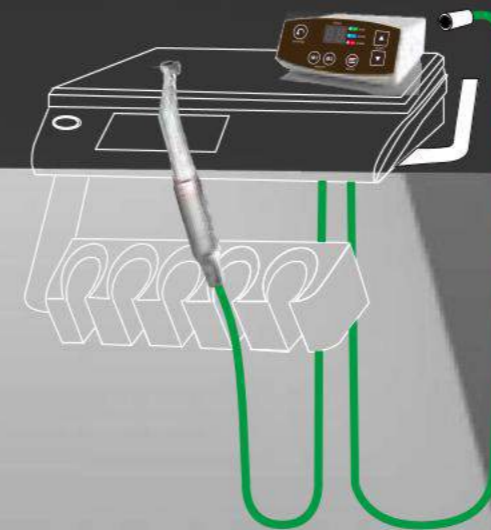

Optional speed ratio: 16:1/1:1/1:5

RPM	16:1	1:1	1:5
100	100		
1,000	2,500		
2,000		2,000	
2,500		40,000	
10,000			10,000
40,000			200,000
200,000			

Option:



Order code: C7-3 (1:4.2) Order code: C7-5 (1:5) Order code: C-1C (1:1) Order code: S-2C (1:1)

NEW

C-PUMA INT X Series Dental Electric Motors

High-Efficiency Treatment, Smart Control
Precision Power

93 Dental Electric Motors



Optional:



Functions:

Preparation Mode
10 adjustable speed ratios for different materials and preparation depths.

Endo Mode
Freely switch between continuous and reciprocating motion for efficient, safe shaping.

Preparation Mode (with Infusion supply)
Works with the X3 water pump to provide cooling and irrigation for extractions and tooth sectioning.

Model: C-PUMA INT

Dental Electric Motors

Features:

Brushless motor up to 40,000 rpm ≥2 N·cm torque

Fast & Precise Cutting
-Smooth, stable performance.
-Real-time mist cooling prevents heat.
-Bright LED for clear visibility.

Modular & Flexible
No chair modification required. Easily expand with peristaltic pump or multi-motor modules.

Easy Control
-5-inch touch screen with adjustable bracket.
-One-touch operation for quick use.

Quiet Water Supply
-4 adjustable flow levels, up to 110 ml/min.
-Low-noise operation.
-Simple and convenient.

Order Code	Application	Main Components	Number of Motors
C-PUMA INT X1	-Tooth Preparation	Controller, Power Box, Motor(cored), Direction Switch, Speed Knob	1
C-PUMA INT X2	-Tooth Preparation -Endodontic Treatment	Controller, Power Box, Motor(cored), Screen, Bracket	1
C-PUMA INT X3	-Tooth Preparation -Endodontic Treatment -Tooth Extraction	Controller, Power Box, Motor(cored), Screen, Bracket, peristaltic pump, Infusion pole	1
C-PUMA INT X4	-Tooth Preparation -Endodontic Treatment	Controller, Power Box, Motor(cored), Screen, Bracket, Multiple Motors, Motor adapter	2-3

94 Dental Electric Motors

Technical:

Motor Speed Range	2000-40000r/min (1:1)	Power Supply	Input: AC 24V, Output: DC 32V
Motor Torque for Endodontic Preparation	0.6-6N.cm (6:1)	Power	100VA
Maximum Motor Torque	≥2N·cm (1:1)	Size	Screen: 154 × 95 × 28 mm Control Box: 145 × 85 × 40 mm Power Box: 85 × 55 × 35 mm Motor Expansion Box: 110 × 70 × 40 mm
Motor Cable Length	1.6m		

NEW

Dental Peristaltic Pump

Simple and Fast Installation,
User-Friendly Operation

95
Dental Peristaltic Pump

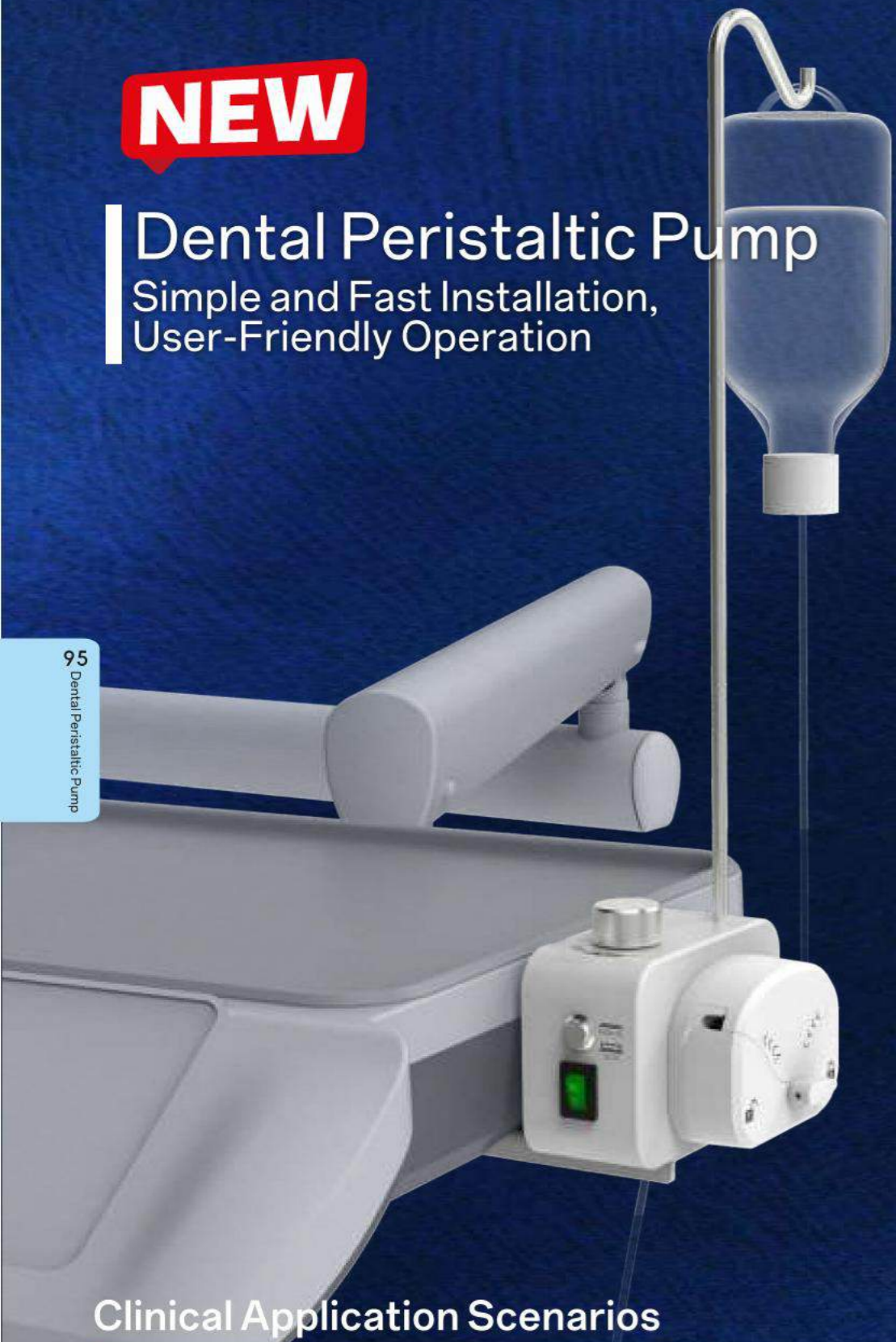

Clinical Application Scenarios



High-Speed Handpieces



Air Motors



Electric Motors

Dental Peristaltic Pump



Technical

Water Supply Flow Rate:	10~80 mL/min
Water supply modes:	Manual Mode, Foot Control Mode
Input voltage:	AC24V 50/60Hz
Sterilizable parts:	Adapter
Operating Air Pressure :	>0.4MPa
Overall Weight (incl. irrigation hanger):	1090g

A Simple Dental Peristaltic Pump for Existing Dental Chairs



Simple and Fast Installation



Easy Operation

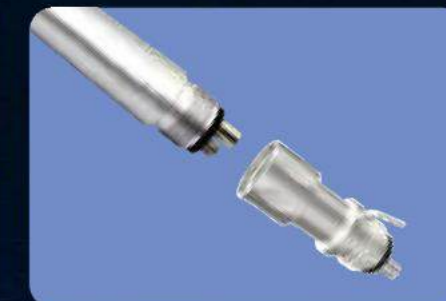

Safe and Compliant

96
Dental Peristaltic Pump

Four Simple Installation Steps



① -Secure the device to the dental chair tray

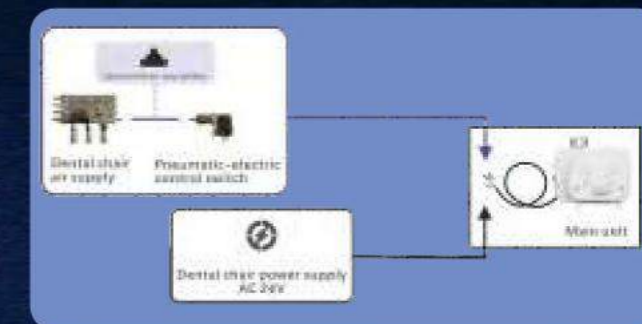

② -Connect the air line (direct or via three-way connector)
-Connect to the dental chair's AC 24V power supply



③ -Install the irrigation hanger and connect the sterile solution bottle

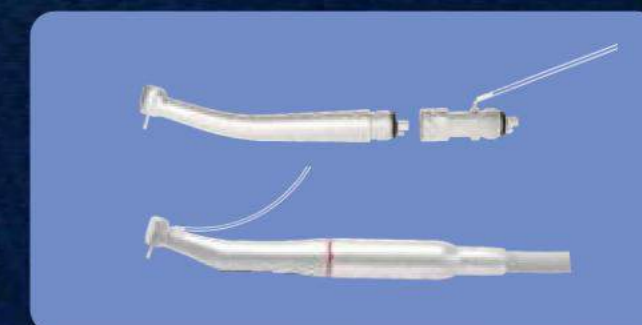

④ -Directly connect the external water supply handpiece
-Connect the internal water supply handpiece via an adapter

NEW

DB686 Q1 LED Curing Lights

Curing light and Caries detector
Efficient , lightweight



2 in 1

97 LED Curing Lights

98 LED Curing Lights

Model:DB686 Q1

LED Curing Lights

Order code: DB686 Q1

Technical:

Adapter:	AC100-240V~50/60Hz, Output: DC5V 1.5 A
Wavelength range:	385~515nm
Optical effective area:	78.5mm ²
LED power:	10W
Lithium battery:	3.7V1400mAh



Curing Mode

Low 20s

Low temperature mode
Unique low temperature technology, comfortable curing, relieve patient discomfort.

STD 20s

Standard Mode
Can be precisely controlled according to different treatment needs.

Fast 01s

Fast mode
Ultra-high light intensity (2300-2500 mW/cm²), high-efficiency curing, 1 second curing, improving treatment efficiency.

Caries Detector Mode

Caries 60s

Outputs a single purple light, with a special shade, caries appear obvious orange-red.



Unique lens design
Collimated beam and uniform curing.



Optical effective area: 78.5 mm².

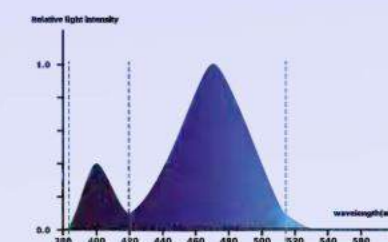

Wide spectrum
385nm-515nm wide spectrum curing, can cure most resins on the market.



OLED display
clear interface, simple operation.



Convenient charging
magnetic contact charging method, 360° charging at any time.



Handle design
light and sturdy, no need to feel tired when holding for a long time.

NEW

DB686 Q2 LED Curing Lights

Efficient, lightweight

99 LED Curing Lights



Model:DB686 Q2

LED Curing Lights

Order code: DB686 Q2

Technical:

Adapter:	24V~50/60Hz
Wavelength range:	385~515nm
Optical effective area:	78.5mm ²
LED power:	5W
Tail line length:	1.8~2m

Wide spectrum

385nm-515nm wide spectrum curing, can cure most resins on the market.

Curing Mode

 Low 20s

Low temperature mode

Unique low temperature technology, more comfortable treatment experience for patients.

 STD 20s

Standard Mode

effectively reduce shrinkage and micro-leakage.

 Fast 01s

Fast mode

Ultra-high light intensity (1800~2000mW/cm²), high penetration, 1 second curing time, higher curing efficiency.



Unique lens design

Collimated beam and uniform curing.



Optical effective area: 78.5 mm²



OLED display clear interface, simple operation.



Handle design

light and sturdy, and you won't feel tired when holding it for a long time.

100 LED Curing Lights

DB686 HALO LED Curing Lights

Comprehensive upgrade of optical systems



3 in 1

Model:DB686 HALO

LED Curing Lights

Order code: DB686 HALO

Technical:

Adapter:	AC100-240V, DC5V 2A, 50/60Hz
Wavelength range:	385~515nm
Optical effective area:	65mm ²
LED power:	10W
Lithium battery:	3.7V 800mAh



Mini head, the head height is only 8.82mm, easy to operate



more concentrated illumination , stronger penetration, achieving deep solidification

Curing Mode



Low temperature mode



Normal mode



Turbo mode
Ultra high light intensity, one second curing, efficient curing, Light intensity 3000mW/cm²

Orthodontic Mode



Caries Detector Mode



Five modes



101 LED Curing Lights

102 LED Curing Lights

DB686 Honor LED Curing Lights

Auto-focusing, more intelligent
Smart handheld power on



103 LED Curing Lights

Curing Mode

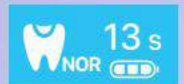

Normal Curing
Light power: 1200mw/cm²



Low-temp
Unique low-temperature technology
Equal curing effect, temperature lower than normal mode



Focus Curing
Automatic spot focusing during operation

Orthodontic Mode

Light power: > 3000mw/cm²



Dental Caries Mode



Model: DB686 Honor

LED Curing Lights

Order code: DB686 Honor

Technical:

Adapter:	AC100-240V, DC5V1.5A, 50/60Hz
Wavelength range:	385~515nm
Optical effective area:	50mm ²
LED power:	10W
Lithium battery:	3.7V 2200mAh
Dimension:	L211xW150xH104mm
Weight:	1.3kg



104 LED Curing Lights

Curing light focus

Automatic spot focusing during operation

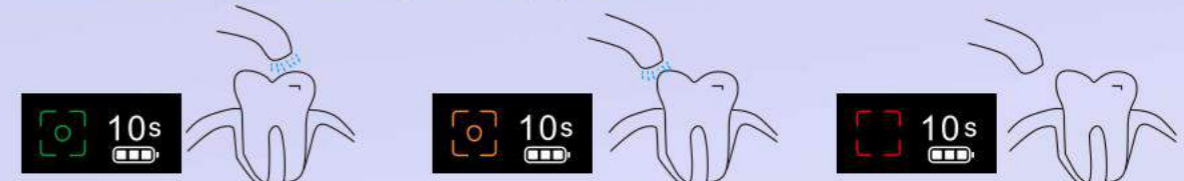

Built-in large-capacity battery
Non-contact recharge



Charging base with the
built-in light meter



Ultrahigh-intensity
Light intensity up to 3000mw/cm²



Smart handheld power on
Automatic recognition
Double reminder

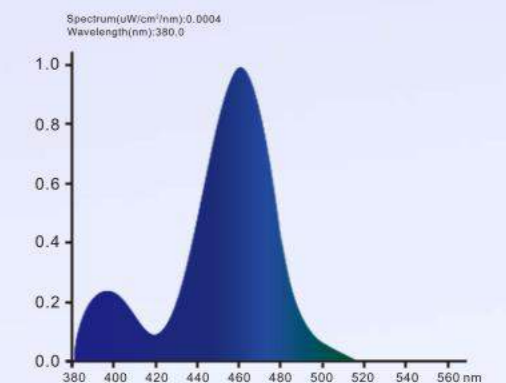

Wavelength: 385-515nm
Suitable for most of the resins in the market

DB686 NanoLED curing light

Small, just right;
Use, just handy.

Small body, powerful function
Light curing & caries detection

2 in 1

105
LED Curing Lights

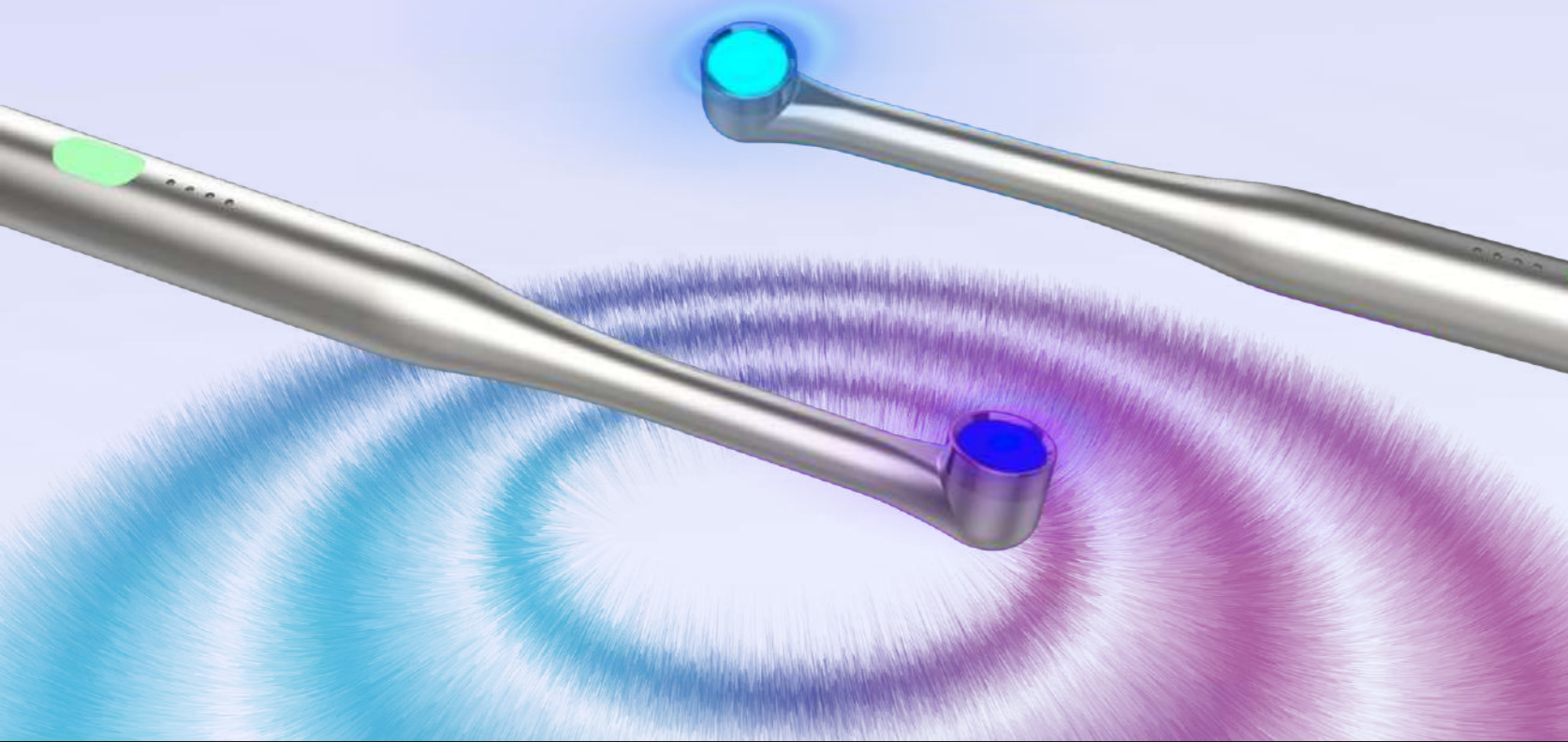

Model: DB686 NANO

LED Curing Lights

Order code: DB686 Nano

Technical:

Adapter: AC100-240V, DC5V/1.5A, 50/60Hz

Light curing mode:

Wavelength: 380-520nm

Curing time: 1s/3s/5s/10s

Curable depth: 8mm

Caries detection mode:

Wavelength: 380-420nm



LED light
measure system



Working time

-Curing light mode:

Strong light Curing 1s, 3s

Normal Curing 5s, 10s

-Caries detection mode:60s

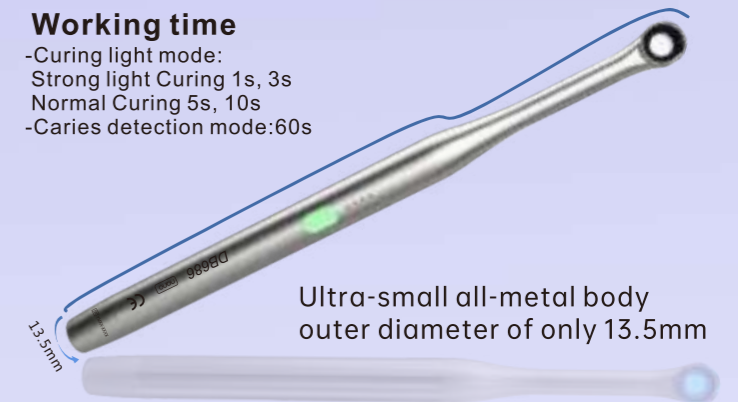

Ultra-small all-metal body
outer diameter of only 13.5mm

106
LED Curing Lights

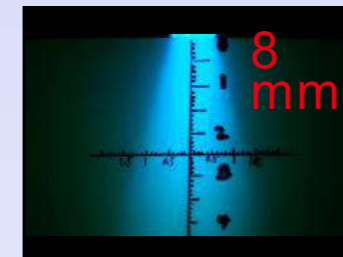

8 mm deep curing depth
Curing effect into every corner



10mm diameter
large area light emission

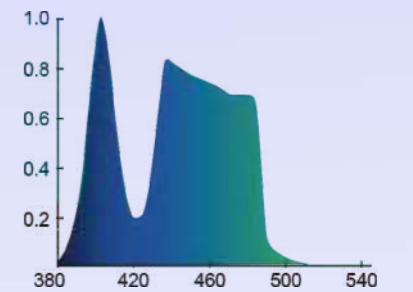

Wavelength:380-520nm
Suitable for most of the resins
in the market

Caries detector mode:
Simple, Effective
Innovative caries detection

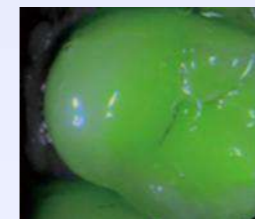

Green:Healthy



Red:Bacterial dentin

Nano can maintain strength even if
it is not focused on the center.
Curing at any angle can also ensure the effect

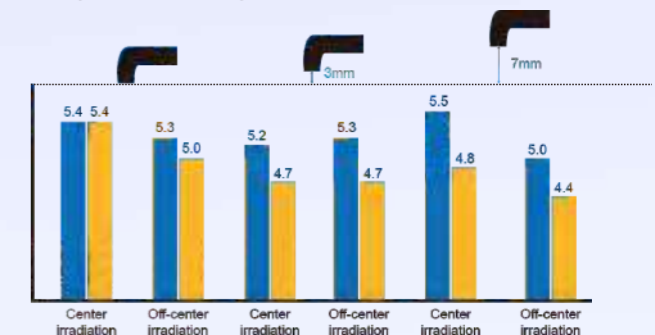

DB686 Swift LED curing light
 Curing & Orthodontic LED light
 Smaller, Stronger

2 in 1



Super power
 Up to 3000mw/cm²

Model: DB686 Swift

LED Curing Lights

Order code: Db686 **Swift**

Technical:

Adapters:	AC100-240V, 50/60Hz
Wide spectrum:	385-515nm
Curing time:	5s/10s/15s/20s(Soft up mode)
	5s(High power mode)
	1-8times(Orthodontic mode)
Volume(cm)	19x12x5
Weight(kg)/PCS:	0.54
Packing material:	Carton

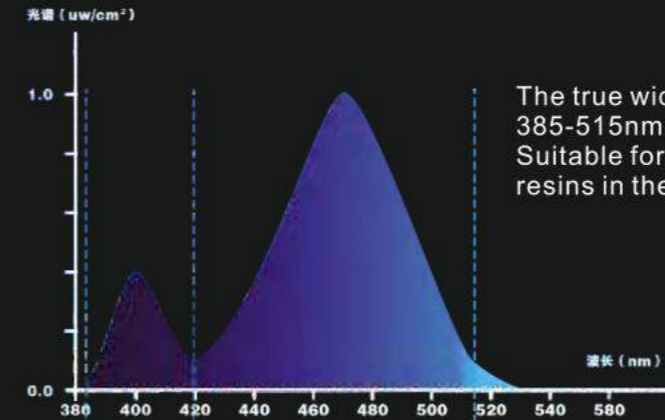

- 10mm large area light emissi
- 8mm deep curing depth

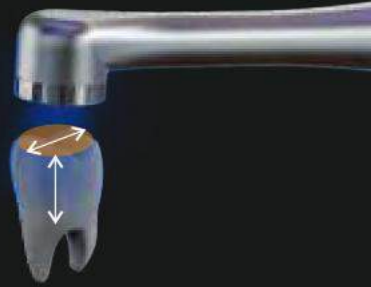

Soft up mode
 Light power: 1000mw/cm²
 Working time: 5s/10s/15s/20s



High power mode
 Light power: >2000mw/cm²
 Working time: 5s



Orthodontic mode
 Light power: >3000mw/cm²
 Working time: 1-8times



Super focus light



107 LED Curing Lights

108 LED Curing Lights



- Purple
- Green
- Blue
- Black



Feature:

- 1-High power LED, purely dental blue light.
- 2-High articulation optical fiber.
- 3-Digital display, Clear and intuitive operation.
- 4-Three working modes: strong, gradually strong, flashing.
- 5-Optional working time: 5sec, 10sec, 15sec, 20sec.
- 6-Automatic inactive, automatic power off.
- 7-Low battery detection.
- 8-Removable large capacity Li-ion battery.
- 9-Soft pushbutton, nice feel.

Technical:

Charger working voltage:	AC100-240V,50/60Hz
wavelength::	420-480nm
Solidification time and depth:	5s3mm
Volume(cm)	23X13X5.5
Weight(kg)/PCS	0.6
Packing material	carton
QTY per master carton	10 pc/ctn

Application:

Solidify all brands of resin materials.

Order code: DB686 DELI



Feature:

- 1-High power LED, purely dental blue light
- 2-Digital display, adjustable work time
- 3-High capacity rechargeable Li-ion battery ,low battery detection
- 4-Low-power,long standby time
- 5-Over-temperature protection,light source detection

This product has been applied layout-design patent, Counterfeit must be investigated;NO.ZL200830107969.4

Technical:

Charger working voltage:	AC100-240V,50/60Hz
wavelength::	420-480nm
Solidification time and depth:	5s3mm
Volume(cm)	24X19X9
Weight(kg)/PCS	0.6
Packing material	carton
QTY per master carton	10 pc/ctn

Application:

Solidify all brands of resin materials.

Order code: DB686 LATTE

This product has been applied layout-design patent. Counterfeit must be investigated.



Feature:

- 1-High power LED,professional dental spectrum.
- 2-Bionic design,LCD display.
- 3-Optional working mode: strong, low, gradually strong, flashing.
- 4-Solidifying time:5-40s,can be adjustable.
- 5-Temperature inspect, over-temperature protection.
- 6-High capacity Li-ion battery , and can charge with charge base or adaptor.
- 7-Wireless and corded are compatible in one
- 8-Built-in high sensitive LED light measure system.
- 9-Handle can put on the tool tray with the holder.

Technical:

Charger working voltage:	AC100-240V,50/60Hz
wavelength::	420-480nm
Solidification time and depth:	5s3mm
Volume(cm)	24X22.5X9.5
Weight(kg)/PCS	1.5
Packing material	carton
QTY per master carton	6 pc/ctn

Application:

Solidify all brands of resin materials.

This product has been applied layout-design patent, Counterfeit must be investigated;NO.ZL2010930080816.X

Order code: DB686 PENGUIN



Feature:

- 1-Dental special high power LED
- 2-High articulation optical fiber
- 3-Three working modes:strong,gradually strong,flashing
- 4-Optional working time:10sec,15sec,20sec
- 5-Automatic inactive,automatic power off
- 6-Low battery alert
- 7-Super capacity battery
- 8-Membrane pushbutton,soft feel

This product has been applied layout-design patent, Counterfeit must be investigated;NO.ZL201073052828.2

Application:

Solidify all brands of resin materials.

Technical:

Charger working voltage:	AC100-240V,50/60Hz
wavelength::	420-480nm
Solidification time and depth:	5s3mm
Volume(cm)	23X13X5.5
Weight(kg)/PCS	0.6
Packing material	carton
QTY per master carton	10 pc/ctn

corded



wireless



Free Connecting the main unit to use as cord style with adaptor. Free Coupling For Corded Use

Order code: DB686-1b

Model: DB686 Super-Lux

LED Curing Lights



Feature:

- 1-Dental special high power LED
- 2-Optional light intensity:strong,medium,low
- 3-Optional working mode:fixed,gradually strong,flashing
- 4-Time : 5 seconds to 30 minutes.
- 5-high-capacity lithium-ion battery, battery check function

This product has been applied layout-design patent, Counterfeit must be investigated;NO.ZL201220344676.9

Technical:

Charger working voltage:	AC100-240V,50/60Hz
wavelength::	420-480nm
Solidification time and depth:	5s3mm
Volume(cm)	24X19X9
Weight(kg)/PCS	1.0
Packing material	carton
QTY per master carton	6 pc/ctn

Application:

Solidify all brands of resin materials.

Order code: DB686 SUPER-LUX

Model: DB686 Super-Dual



Feature:

- 1-high power LED, dentistry dedicated spectrum
- 2-streamlined design, LCD display and
- 3-both the light-curing treatment and teeth whitening
- 4-3 light intensity profiles are available: light, medium, low
- 5-3 operating modes: bright, fade, blink
- 6-time: 5 seconds to 30 seconds to select
- 7-high-capacity lithium-ion battery, battery check function
- 8-built-in high sensitive LED metering system

Technical:

Charger working voltage:	AC100-240V,50/60Hz
wavelength::	420-480nm
Solidification time and depth:	5s3mm
Volume(cm)	24X19X9
Weight(kg)/PCS	1.0
Packing material	carton
QTY per master carton	6 pc/ctn

Application:

Solidify all brands of resin materials.

Order code: DB686 SUPER DUAL



Model: C-Bright

Teeth Whitening Accelerator

Technical:

Input power:	AC100-240V,50/60Hz
Light resource:	6pcs high power LED
Wavelength:	420nm-490nm
Light intensity:	6 intensities,maximum>6000mW/cm ²
Adjustable timer:	10s,30s,1m,2m,5m,8m,10m,15m,20m,30m

	C-bright	C-bright-b
Volume(cm)	base:63x63x23, arm:100x26x27	base:22x18x3 arm:52x52x22
Weight(kg)/PCS	20.0kg	0.13kg 6.0kg
Packing material		carton

Feature:

- 1-new-style structure and unique form, compact and elegance
- 2-Double handles, drug type arm,multi-angle adjustment to make the operate more flexibly
- 3-Unique semi-circular head design, both arches whitened at the same time
- 4-6pcs high power LED, fan-cooled
- 5-10s and 30s as a curing ligh, 1-30minutes as a whitening accelerator
- 6-6 light intensities,suitable for more brands tooth whitening gel
- 7-LCD module screen shows all the information, all the operation is so easy
- 8-Chairside type is available



Order code: C-BRIGHT

This product has been applied layout-design patent. Counterfeit must be investigated. ZL201030178145.3 ZL201220344678.9

Technical:

Voltage:	220 V / 50 Hz(110 V / 60 Hz are available)
Absorbed power:	200W Fuse 2A
Mixing frequency:	>3400tr/mn(rpm)
Noise:	<65dB
Programmable mixing time:	1-99sec.
Volume(cm)	33x27x20
Weight(kg)/PCS	4.5kg
Packing material	carton



Order code: DB-338



Feature:

- 1-This kind of amalgamator, controlled by a microprocessor, ensures a precise, controlled, consistent mix.
- 2-With the width of the oscillating range, the mixing frequency, and your selected time(1-99S).
- 3-It's revolve according to "8" model.
- 4-For mercury-based fillings. trust the performance of DB338 amalgamator. Together, it provides the clinical perfection you need with the ease-of-use you want.
- 5-For safe operation, the DB338 deactivates when you open the front cover to access the capsule.
- 6-Its ergonomic design is easy to use, stable, extremely quiet and easy to clean and maintain

Technical:

Tank capacity	6000ML (1.6 gallon US)	Max.5000ml/1.3gallon (US) Min.3350ml / 0.9gallon(US)
Tank Size	33.1X23.8 X10.5CM/ 13.0"X9.4"X4.1"	
Longest Item Fits Inside Tank	34.0CM/13.4"	
Power	290 W (AC100~120V 60Hz) 310W (AC220~240V 50HZ) 270W (AC100V 50/60Hz)	
Digital timer	1 to 30-minute full range timer	
Drainage	Drainage valve	
Ultrasonic Frequency	35,000Hz	
Tank Weight	Stainless steel SU 304	
Net Weight	9.3kg/20.7lb	
Gross Weight	10.9kg/24.2lb	
Inner Box Size	50.5x36.0x25.0cm/17.2"x11.8"x 9.8 "	
Master Carton Size	52.0 x37.5 x 66.0cm/20.0"x14.8"x26.0"	



Order code: DB-4860

Technical:

Ultrasonic Frequency	42,000 Hz
Tank Material	Stainless Steel SUS304
Tank Capacity	2500 ml Digital timer with 5 cycles
Timer	(180/280/380/480/90 seconds)
Power Supply	AC 100 ~ 120V, 50 / 60Hz AC 220 ~ 240V, 50 / 60 Hz
Power	160 W(AC110V-120V);170W(AC220V-240V)
Unit Size	35X26X23 cm (L x W x H)
Unit N.W.	3KG



Order code: DB-4820

NEW

PT EX Dental Scaler and Air Polisher

Powerful
More intelligent

PT EX A

Ultrasonic System:Scaling/Perio/Endo
Blasting System:Prophy/Perio
Scaler Tips:G1/G2/G4/P1/P3/P4



115 Dental Scaler and Air Polisher



PT EX B

Ultrasonic System:Scaling/Perio/Endo
Blasting System:Prophy
Scaler Tips:G1/G2/G4/P1/P3/P4



PT EX C

Blasting System:Prophy/Perio

Model:PT EX

Dental Scaler and Air Polisher



Order code: PT EX A

Technical:

Adapter:	AC100-240V50/60Hz
Input power:	80VA
Operating mode:	Continuous operation
Scaler Tips vibration offset:	<200um
Scaler Tips vibration frequency:	24-36 kHz
Half offset force:	≥0.5N
Input pressure:	0.55-0.7Mpa
Weight:	2.8kg
Control unit size:	28×25×27cm



Order code: PT EX B

Technical:

Adapter:	AC100-240V50/60Hz
Input power:	80VA
Operating mode:	Continuous operation
Ultrasonic Tips vibration offset:	20μm-150μm
Ultrasonic Tips vibration frequency:	24-36 kHz
Half offset force:	≥0.5N
Input pressure:	0.55-0.7Mpa
Weight:	2.8kg
Control unit size:	28×25×27cm

116 Dental Scaler and Air Polisher



Order code: PT EX C

Technical:

Adapter:	AC100-240V50/60Hz
Input power:	80VA
Operating mode:	Continuous operation
Input pressure:	0.55-0.7Mpa
Control unit size:	28×25×27cm
Weight:	2.6kg



Dental scaler & Air Polishing
2-in-1 — From therapy to aesthetics in one device



Smart Handpiece Recognition
Auto switch between ultrasonic and air polishing



New patent powder handpiece
Less sand powder flying and more convenient maintenance



Wireless Circular Foot Pedal
Multi-functional, omni-directional, with Boost mode



Flexible Water Supply
Bottle system compatible with medicated solutions



One-touch Maintenance
Pipeline cleaning & pressure release at a click

PT Master Dental Scaler and Air Polisher

Powerful
More intelligent

2 in 1



Model: PT Master

Dental Scaler and Air Polisher

Order code: PT Master

Technical:

Adapter:	AC100-240V50/60Hz
Input power:	80VA
Operating mode:	Continuous operation
Ultrasonic Tips vibration offset:	<200um
Ultrasonic Tips vibration frequency:	24-36 kHz
Half offset force:	≥0.5N
Ultrasonic Tips output power:	0.8-13w
Input pressure:	0.55-0.7Mpa
Weight:	3kg
Control unit size:	30×26×13cm

Scaler Tips:

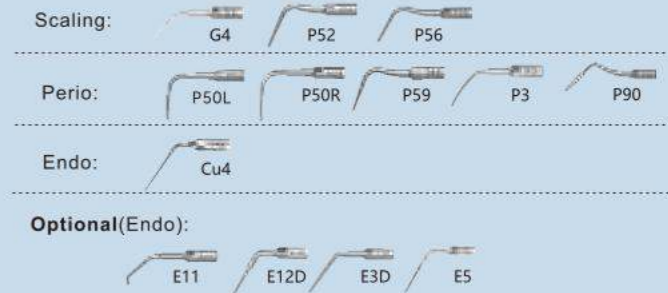

Handpiece intelligent recognition system
Pick up the handle and automatically switch to working mode



Small caliber nozzle
More accurate scaling



Large bottle design
Design of funnel-shaped powder chamber, Smoother use, 1000ml water storage bottle



3 hole sandblasting
More concentrated sandblasting, Reduce sand powder flying



Segmented design
Simple disassembly, Convenient cleaning

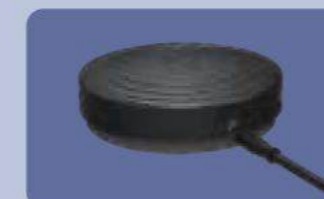

Dual-purpose pedal
Dual-purpose (cored and wireless) foot pedal, natural switching introduction



LED ultrasonic handpiece
Safe and durable

117 Dental Scaler and Air Polisher

118 Dental Scaler and Air Polisher



CP-1 Dental Air Polisher

Comfortable and clean

Better sandblasting effect

Supragingival & subgingival mode Two-in-one

2 in 1



119
Dental Air Polisher

Model:CP-1

Dental Air Polisher

Order code: CP-1(M4) ☹️
CP-1(B2) ☹️

Technical:

Input air pressure:	250-450kPa
Input water pressure:	70-220kPa
Water flow:	> 30ml/min
Nozzle caliber for power measures	0.7mm
Nozzle caliber for water measures	1.4mm
Weight:	145g



Supragingival &
subgingival mode
Two-in-one



120
Dental Air Polisher

Order code: CP-1(Q6)



360° rotation
Removable for easy cleaning
and maintenance



Sectional design
simple loading and unloading
easy to clean and maintain

360° viewable
Transparent powder container enables
easier observation of remaining powder



DP-1/ DP-2/ DP-3 Prophylaxis Powder

3 major series & 4 specifications
Meet various needs
Improve treatment efficiency

Model:DP-1/ DP-2/ DP-3

Prophylaxis Powder



65um Sodium Bicarbonate

Order code: DP-1
Particle size: 65um
Net:300g
Supragingival application
Product Flavor:Lemon /Strawberry
Sodium bicarbonate has an anti-inflammatory and anti-caries effect, with a Mohs hardness of 2.5. It is a quick and easy scaling method. The hardness remains between the enamel and dentin. It can easily clean plaque and stubborn pigments on the gums without damaging the teeth.



14um Erythritol

Order code: DP-3(14um)
Particle size: 14um
Net:120g
Supragingival & Subgingival application
The average diameter of Erythritol powder particles is 14 microns. The very fine powder can clean teeth in a minimally invasive manner without damaging tooth enamel, root surface cementum and soft tissue. Erythritol antibacterial and anti-caries which can effectively prevent and treat gingivitis and periodontitis.



25um Glycine

Order code: DP-2(25um)
Particle size: 25um
Net:120g
Supragingival & Subgingival application
Glycine itself is slightly sweet and has a pleasant taste. The Mohs hardness is only 2.0, which is smaller than dentin. It has a gentle effect. The average particle diameter is only 25 microns. It is a fine particle. It can be used for subgingival scaling, periodontal and peri-implant cleaning in minimally invasive scaling and maintain



65um Glycine

Order code: DP-2(65um)
Particle size: 65um
Net:200g
Supragingival application
Glycine itself is slightly sweet and has a pleasant taste. Its Mohs hardness is only 2.0, which is smaller than dentin and has a gentle effect. It can be used on natural gum plaque and stubborn pigments without damaging teeth

121 Prophylaxis Powder

122 Prophylaxis Powder



CA-1 Air Abrasion System with spray

Dry and wet dual-use
 Better sandblasting effect
 Better moisture-proof effect



Model: CA-1

Air Abrasion System with spray

Order code: CA-1(M4) ☹️
 CA-1(B2) ☹️

Feature:

1. Built in unique design negative pressure balance gas path structure, effectively prevent external moisture into the sand bottle, prevent sand powder from moisture
2. Unique multi-point water spray design, External intersection, Effectively prevent back suction plugging hole and prevent sand powder from damp
3. The nozzle is made of tungsten steel with long service life
4. The nozzle seat can rotate 360° and is detachable for easy cleaning and maintenance



360° rotation
 Removable for easy cleaning and maintenance



Humanized Button Design
 It is more comfortable to press with your index finger



Standard 4-hole design
 Easy connect, easy to use

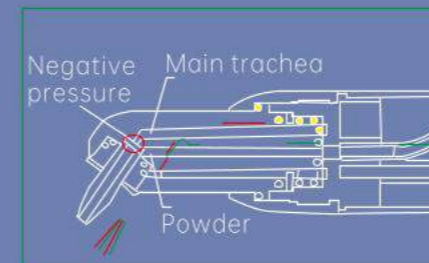

Negative pressure balance design
 Effectively prevent sand powder from getting damp

Unique multi-point water and air mixing outside, better effect and better moisture resistance



NEW

TP-1 Dental Polisher

125 Dental Polisher



Model: TP-1

Dental Polisher

Order code: TP-1

Technical:

Adaptor working voltage	AC 100-240V 50/60HZ;
Adjustable torque, range	0.9N.cm
rotational speed ranging:	500-5000rpm
Volume(mm)	130.2×23.4×20.5
Weight(kg)/PCS	2.8
Packing material	carton
QTY per master carton	6pc/ctn



126 Dental Polisher



Both bending machine and Polishing Handpiece can rotate 360



The application head can be directly plugged and unplugged



Easy switching between forward and reverse

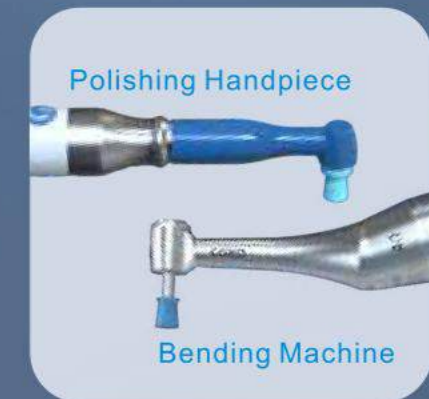

Dual head

NEW

GENI Pro Dental Anesthesia Booster

More accurate
More flexible
Safer

127 Dental Anesthesia Booster



3 Modes

Injection rate (1.8 ml per injection)

H 0.0ml / 1.8ml

• About 80s •

L 0.6ml / 1.8ml

• About 150s •

PDL 0.0ml / 1.8ml

• ≥265s •

Model: GENI Pro

Dental Anesthesia Booster

Order code: GENI Pro

Technical:

Adaptor working voltage:	Input: 100-240V 50/60Hz
	Output: DC5V, 2A
Handpiece lithium battery:	3.7V 220mAh
Charging stand lithium battery:	3.7V 1800mAh
Operation mode:	Continuous operation
Volume:	3.7X2.56X8.2cm
Weight:	69g



128 Dental Anesthesia Booster

Intelligent design



Two holding gestures
Pen style and injection style, flexible operation



Integrated design
Push-type charging box, storage and charging in one



Pressure feedback technology
real-time monitoring and feedback



Music prompts
Alleviate patient's fear

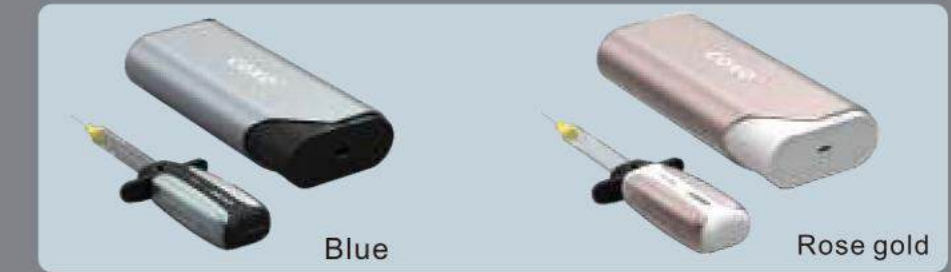

Two color options

GENI Dental Anesthesia Booster

Wireless handheld
Stable injection
Intelligent



Model: GENI

Dental Anesthesia Booster

Order code: GENI

Technical:

Adaptor working voltage:	Input: 100-240V 50/60Hz Output: DC5V, 2A
Handpiece lithium battery:	3.7V 220mAh
Charging stand lithium battery:	3.7V 800mAh
Operation mode:	Short time
Volume:	2.3×2.3×16.5cm
Weight:	80g
Packing material:	Carton



129 Dental Anesthesia Booster

130 Dental Anesthesia Booster



4 Boost Modes

High-precision stable injection

Injection rate (1.8ml per injection)

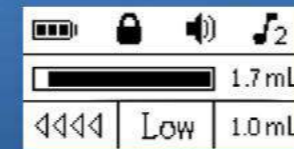

•About 265s•



•About 120s•

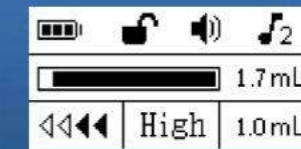

•About 80s•



PDL



•Soft touch control
Induction injection, more convenient for dentist to use



•Manual aspiration
Clear display interface at a glance



•Music prompts
Soothe patients get safe treatment

ACCESSORY OF Electric Equipment

Pulp tester

For C-PULSE

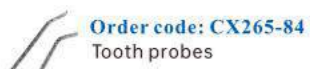

Order code: CX265-84
Tooth probes

Root Apex Locators

For C-ROOT I



Order code: CX265-19
Test wire



Order code: CX265-17
Lip hook



Order code: CX265-52
File holder



Order code: CX265-29
Adapter(DC5V, 1A)

For C-ROOT I(VI)

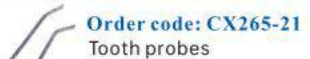

Order code: CX265-21
Tooth probes



Order code: CX265-22
Test handle



Order code: CX265-16
Text wire



Order code: CX265-17
Lip hook



Order code: CX265-20
Battery



Order code: CX265-28
Adapter(DC10V, 1.5A)



Order code: CX265-18
File holder

Endodontic Obturation System

For C-FILL MINI

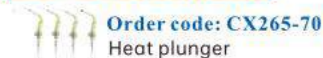

Order code: CX265-70
Heat plunger



Order code: CX265-2
Gun needle



Order code: CX265-71
Thermal protector cap



Order code: CX265-27
Adapter(DC5V, 1.5A)

Order code: CX265-4
Multi-tool

For C-FILL

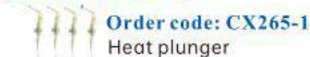

Order code: CX265-1
Heat plunger



Order code: CX265-2
Gun needle



Order code: CX265-3
Thermal protector cap



Order code: CX265-27
Adapter(DC5V, 1.5A)

Order code: CX265-4
Multi-tool

Root Canal Irrigation & Suction System

For C-RCC



Order code: CX265-86
Tip A (C-RCC)



Order code: CX265-87
Tip B (C-RCC)

Endo Ultrasonic Activator

For ULTRA-SMART



Order code: CX265-79
Working tip (CU1)



Order code: CX265-81
Wrench



Order code: CX265-80
Rubber sleeve



Order code: CX265-27
Adapter(DC5V, 1.5A)

For ULTRA-SMART AI

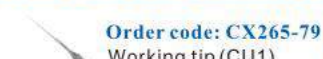

Order code: CX265-79
Working tip (CU1)

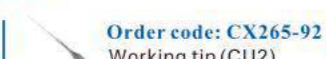

Order code: CX265-92
Working tip (CU2)

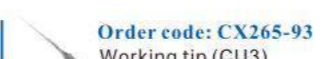

Order code: CX265-93
Working tip (CU3)



Order code: CX265-80
Wrench



Order code: CX265-81
Rubber sleeve



Order code: CX265-27
Adapter(DC5V, 1.5A)

Endo motors

For C-SMART-PILOT



Order code: CX265-67
Test wire



Order code: CX265-68
Lip hook line



Order code: CX265-52
File holder



Order code: CX265-28
Adapter(DC10V, 1.5A)



Order code: CXTY-I-43
4360587
Cover remover

Order code: CX265-17
Lip hook



Order code: C5-4M
Contra angle



Order code: CX265-77
Oil filling nozzle

For C-SMART-IPRO

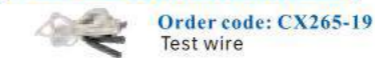

Order code: CX265-19
Test wire

Order code: CX265-9
Lip hook line



Order code: CX265-52
File holder



Order code: CX265-54
Adapter(DC10V, 1.5A)



Order code: CX265-53
LED part

Order code: CX265-17
Lip hook



Order code: C4-2M
16:1 Contra angle



Order code: CX265-62
Motor handle

For C-SMART-MINI AP



Order code: CX265-67
Test wire

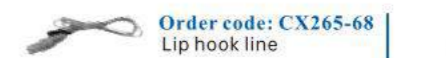

Order code: CX265-68
Lip hook line



Order code: CX265-52
File holder



Order code: CX265-28
Adapter(DC10V, 1.5A)



Order code: CX265-13
Cover remover

Order code: CX265-17
Lip hook



Order code: C4-2M
Contra angle



Order code: CX265-77
Oil filling nozzle

For C-SMART-MINI/C-SMART-MINI(LED)



Order code: CX265-55
LED part



Order code: CX265-28
Adapter(DC10V, 1.5A)



Order code: CX265-77
Oil filling nozzle



Order code: CX265-13
Cover remover



Order code: C1-16M
1:1 Contra angle
For C-SMART-MINI



Order code: C1-17M
1:1 Contra angle
For C-SMART-MINI(LED)

For C-SMART-I

Order code: CX265-8
Contra angle holder

Order code: CX265-9
Lip hook line



Order code: CX265-52
File holder



Order code: CX265-28
Adapter(DC10V, 1.5A)



Order code: CX265-10
Battery

Order code: CX265-17
Lip hook

Order code: CX265-60
Test wire

Order code: CX265-77
Oil filling nozzle

Order code: CX265-13
Cover remover



Order code: C1-17M
1:1 Contra angle

File Removal System

For C-FR1



Order code: CX265-88
For C-FR1 work tip



Order code: CX265-89
For C-FR1 NITI Path Drill



Order code: CX265-90
For C-FR1 Flat Drill



Order code: CX265-91
For C-FR1 Trepine

Ultrasonic Surgery System

For C-EXPLORER

 Order code: CX265-38 Water supply pipe	 Order code: CX265-94 Handpiece with wire	 Order code: CX265-95 Basic handpiece tips kit
Order code: CX265-96 Torque wrench	 Order code: CX265-97 Handpiece holder	 Order code: CX265-98 Pedal
 Order code: CX265-99 Sterilization case	 Order code: CX265-100 Tip holder	
 Order code: CX265-101 US1 Tip	 Order code: CX265-102 US2 Tip	 Order code: CX265-103 US4 Tip
 Order code: CX265-104 US5 Tip	 Order code: CX265-105 UL3 Tip	 Order code: CX265-106 UC1 Tip

Dental Implantation system

For C-SAILOR PRO













 Order code: CX265-38 Water supply pipe	 Order code: CX265-64 Motor with wire	 Order code: CX265-63 Foot control
 Order code: C6-22 Optic fiber 20:1 contra angle		

For C-SAILOR

 Order code: CX265-38 Water supply pipe	 Order code: CX265-40 Motor with wire	Order code: CX265-41 Foot control
 Order code: C6-23 20:1 contra angle		

Dental Scaler and Air Polisher

For PT-MASTER

 Order code: CX265-107 G4 Tip	 Order code: CX265-108 P52 Tip	 Order code: CX265-109 P56 Tip
 Order code: CX265-110 P50L Tip	 Order code: CX265-111 P50R Tip	 Order code: CX265-112 P59 Tip
 Order code: CX265-113 P3 Tip	 Order code: CX265-114 P90 Tip	 Order code: CX265-115 Cu4 Tip
Optional:		
 Order code: CX265-116 E11 Tip	 Order code: CX265-117 E12D Tip	 Order code: CX265-118 E3D Tip
 Order code: CX265-119 E5 Tip		

Dental Electrical Motors

For C-PUMA Series

Order code: CX265-75 |  **Order code: CX265-43**
Micro motor | Adapter(DC30V, 4A)

LED Curing Lights

Optical fiber

 order name: CX233-3 for 686/DB-686-1	 order name: CX233-6 for 686 LATTE/CAPPU	 order name: CX233-7 for 686 SUPER LUX/ SUPER DUAL
 order name: CX233-8 for 685 PENGUIN/ 686 DELI	 order name: CX233-10 for hunter(90°)	 order name: CX233-11 for hunter(120°)
 order name: CX265-78 for 686 NANO	 order name: CX265-85 for 686 SWIFT	

Battery

 Order code: CX265-45 Battery for DB686 DELI
 Order code: CX265-46 Battery for DB686 LATTE
 Order code: CX265-48 Battery for DB686 PENGUIN
 Order code: CX265-49 Battery for DB686 SUPER DUAL
 Order code: CX265-50 Battery for DB686-1b
 Order code: CX265-72 Battery for DB686 NANO

Other Accessories

 Order code: CX265-73 Head cover	Order code: CX265-51 Eye protection unit
Order code: CX265-74 Diagnostic goggles	

Other Accessory

 Order code: CX265-58 Gutta percha trimmer	 Order code: CX265-56 Disinfection box	 Order code: CX265-25 Cleaning table-board
 Order code: CX265-57 File rack with measuring ruler	 Order code: CX265-23 File rack with measuring ruler	 Order code: CX265-24 Measuring ruler
 Order code: CX265-33 Root canal plastic module		

DL-300P Intraoral Scanner

Lighter! Faster! More accurate!



FDA CE

135 Intraoral Scanner

Model:DL-300P

Intraoral Scanner



Order code: DL-300P

Technical:

Half-mouth scanning time	30s
Scanning accuracy	10μm
Camera size	220*36*34mm
Weight	180g
Scan head size	Standard:20mmx17mm Mini:17mmx14.5mm
Depth of field	0~18mm
Light source	LED
Window size	17mmx15mm
Number of frames	FPS



Fast imaging speed

Deliberate practitioners can scan half a mouth in 30 seconds



Lightweight

Easy to hold, no fatigue, providing users with a comfortable scanning experience



High precision

Advanced logic algorithm effectively controls the digital impression data error to 10μm

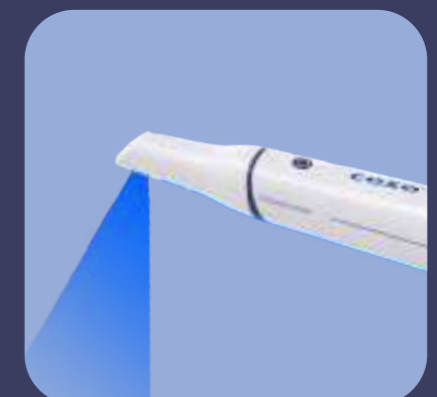

Extraordinary field of view

Maximum field of view 17X15mm, 36% more than the second generation scanning speed and fluency are further improved.

136 Intraoral Scanner

X TITAN SUPER TORQUE

*special design of cartridge and air duct
more stable, more quiet, more powerful*

The super torque is bigger than most other brand

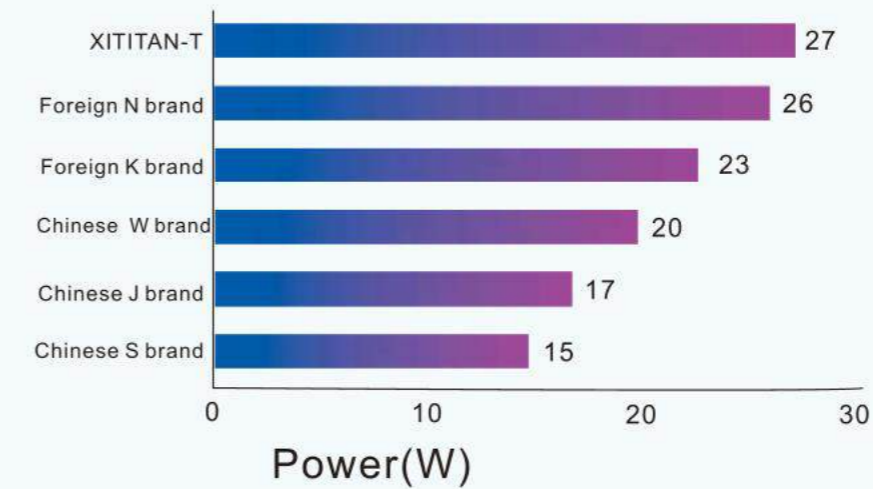

Mute, compare favorably with international high level products

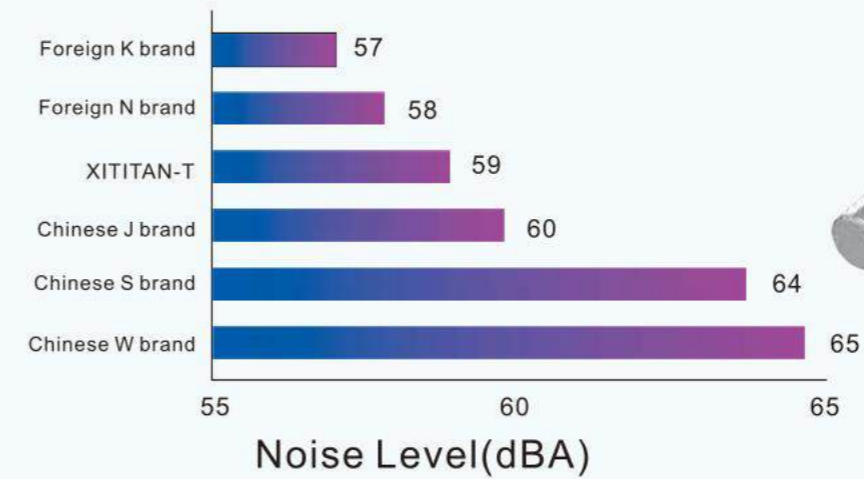

Compared with previous models
improvement in the efficiency 76.9%

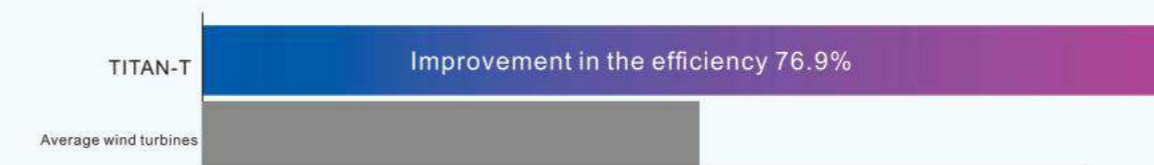

Handpiece Series
Professional Dental Handpiece Manufacturer

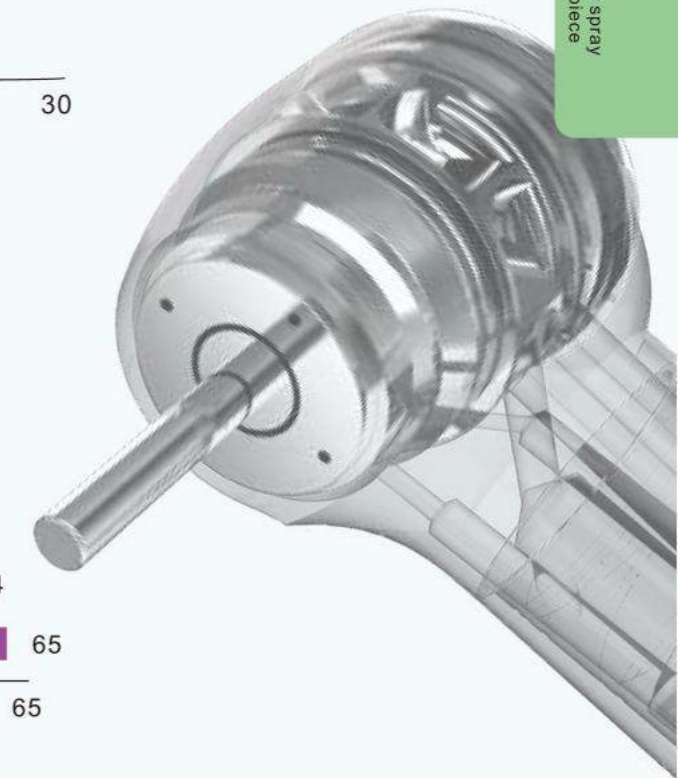

XTITAN SUPER TORQUE

- The cartridge according to Germany dynamic balancer to keep balance, lower noise
- Optimized torsion design, ensure provide stronger torque in long time

139
4 way spray
handpiece



Order code: 210-B3-SP



Order code: 210-B3-TP



Standard head Order code: H33-SP4
H33-SP2

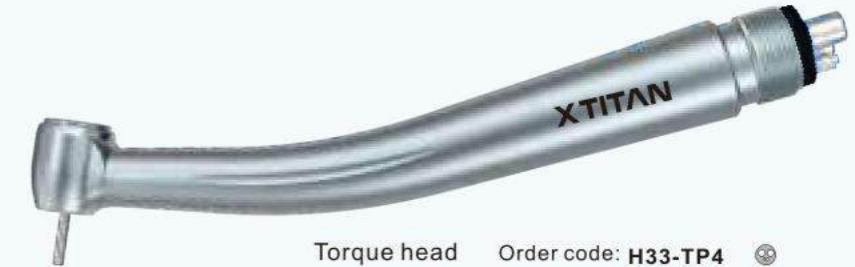

Torque head Order code: H33-TP4
H33-TP2

140
4 way spray
handpiece



Technical:

The type of cooling	4 way spray
Chuck type:	push button
Noise	≤60dB
Air pressure at the back end of HP:	0.25-0.28 MPA(4hole) 0.20-0.22 MPA(2hole)
Bur applicable:	Ø1.59-Ø1.6mmx21-23mm
Rotation speed:	≥370,000rpm
The size of head	Ø12.5X14.8 (toque head) Ø11.5X14 (standard head)



4 way spray, Good cooling system

LED HANDPIECE
SHADOWLESS

Model: CX207-F

NEW

New upgrade, new LED bulb, new integrated head

SHADOWLESS LED HANDPIECE



141 LED handpiece with generator

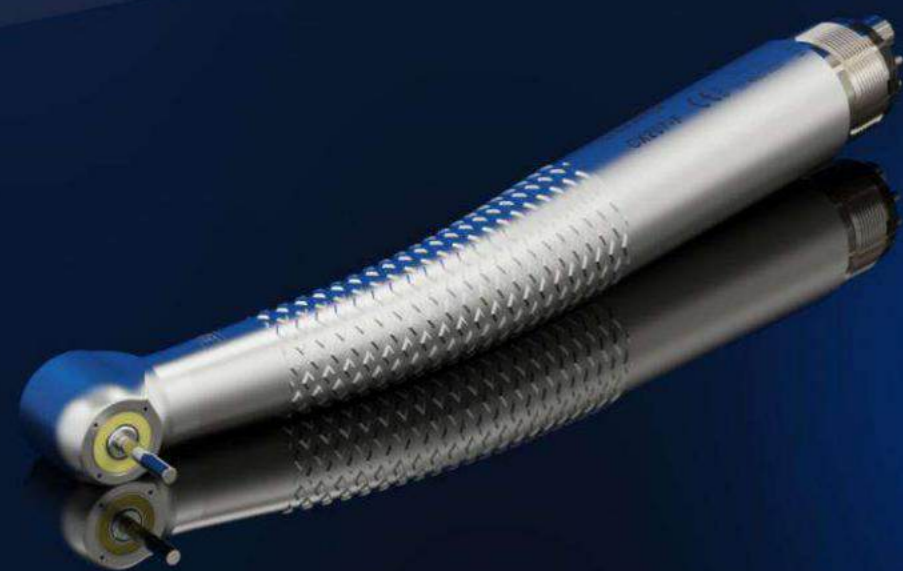

Technical:

The type of cooling	4 way spray
Chuck type:	push button
Air pressure at the back end of HP:	0.28MPA
Bur applicable:	Ø1.59-Ø1.6mmx21-23mm
Rotation speed:	300,000-400,000rpm



Model: CX207-F

High-speed air turbine handpieces

Imported bearing
Long life, low noise and stable

Balanced impeller
Cartidge passed the Germany
dynamic balance machine test

Unique electric generator,
just a little air can generate
sufficient power;
LED E-generator



Ring LED light
glows for
shadowless lighting



Reject welding,
complete head made
by CNC, more stable!



Graceful body, simple, portable
easy clean, easy control

142 LED handpiece with generator



Order code: 210-F-TP(R)



Torque head Order code: H75-TP4
H75-TP2

**LED HANDPIECE
WITH GENERATOR**

Model: CX207-F

New upgrade, new LED bulb, new integrated head

Self-luminous

Graceful body, simple, portable
easy clean, easy control

Balanced impeller
Cartridge passed the Germany
dynamic balance machine test

Imported bearing
Long life, low noise and stable

Reject welding,
complete head made
by CNC, more stable!

3 way spray, 3 air
Head and cartridge with
anti-retraction structure

Professional LED light source,
superior brightness, Longevity
10000 hours.

Unique electric generator,
just a little air can generate
sufficient power;

143 LED handpiece
with generator

144 LED handpiece
with generator

This product has been applied layout-design
patent, counterfeit must be investigated.
NO.ZL201220717131.8 ZL201210563855.6

Technical:

High speed handpiece:	3 way spray 3 air
Chuck type:	push button
Bulb:	LED light
Noise	≤70dB
Air pressure at the back end of HP:	0.25-0.28 MPA(4hole) 0.20-0.22 MPA(2hole)
Bur applicable:	Ø1.59-Ø1.6mmx21-23mm
Rotation speed:	≥300,000rpm

Model: CX207-F

High-speed air turbine handpieces

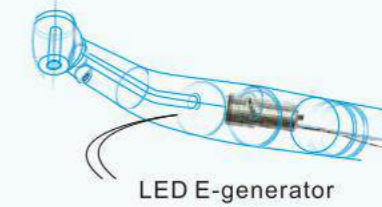
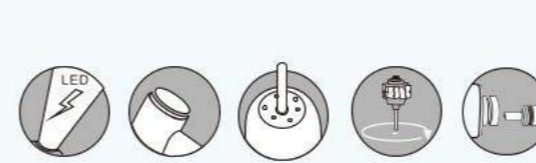

Order code: 210-F+-SP



Standard head

Order code: H15-SP4
H15-SP2



Order code: 210-F+-TP



Torque head

Order code: H15-TP4
H15-TP2



Order code: 210-B1-MP



(Self-Luminous) Mini head

Order code: H05-MP4
H05-MP2



Order code: 210-F+-SP



Standard head Quick coupling

Handpiece order code: H15-SPQ
Complete order code: H15-SPQ4
H15-SPQ2



Order code: 210-F+-TP



Torque head Quick coupling

Handpiece order code: H15-TPQ
Complete order code: H15-TPQ4
H15-TPQ2

LED HANDPIECE WITH GENERATOR

Model: CX207-F

Caries detection function

Self-luminous



Balanced impeller
Cartridge passed the Germany dynamic balance machine test

Reject welding, complete head made by CNC, more stable!

Imported bearing
Long life, low noise and stable

3 way spray, 3 air
Head and cartridge with anti-retraction structure

LED for caries detection
Treat while checking
Faster and better

Unique electric generator, just a little air can generate sufficient power;



This product has been applied layout-design patent. counterfeit must be investigated.
NO.ZL201220717131.8 ZL201210563855.6

Technical:

High speed handpiece:	3 way spray 3 air
Chuck type:	push button
Bulb:	LED light
Noise	≤70dB
Air pressure at the back end of HP:	0.25-0.28 MPA(4hole) 0.20-0.22MPA(2hole)
Bur applicable:	Ø1.59-Ø1.6mmx21-23mm
Rotation speed:	≥ 300,000rpm

145 LED handpiece with generator

146 LED handpiece with generator

Model: CX207-F

High-speed air turbine handpieces

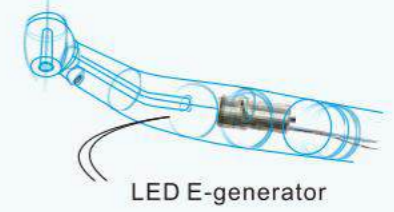

Order code: 210-F+-SP



Standard head

Order code: H65-SP4
H65-SP2



Order code: 210-F+-TP



Torque head

Order code: H65-TP4
H65-TP2



Order code: 210-F+-SP



Standard head Quick coupling

Handpiece order code: H65-SPQ
Complete order code: H65-SPQ4
H65-SPQ2



Order code: 210-F+-TP



Torque head Quick coupling

Handpiece order code: H65-TPQ
Complete order code: H65-TPQ4
H65-TPQ2

OPTICAL HANDPIECE

Model: CX207-G

Optical fiber illumination

New upgrade, new integrated head

Fiber optic



Reject welding, complete head made by CNC, more stable!

Imported bearing
Long life, low noise and stable

Balanced impeller
Cartridge passed the Germany dynamic balance machine test

3 way spray, 3 air clean head system
Head and cartridge with anti-dust structure

Optical fiber illumination

Graceful body, simple, portable, easy clean, easy control

Technical:

High speed handpiece:	3 way spray 3 air
Chuck type:	push button
Bulb:	LED light
Noise:	≤70dB
Air pressure:	0.25-0.28 MPA(6hole)
Bur applicable:	Ø1.59-Ø1.6mmx21-23mm
Rotation speed:	≥300,000rpm
Bulb power:	1w
Work voltage:	2.9v-3.2v
Work current:	160mA

147 Optical handpiece

Model: CX207-G

High-speed air turbine handpieces



(Fit into **NSK**
Machlite/Phatelus)

Standard head Handpiece Order code: **H16-NSPQ**
Complete order code: **H16-NSPQ6**

Torque head Handpiece Order code: **H16-NTPQ**
Complete order code: **H16-NTPQ6**



(Fit into **W&H**
Roto Quick)

Standard head Handpiece Order code: **H16-WSPQ**
Complete order code: **H16-WSPQ6**

Torque head Handpiece Order code: **H16-WTPQ**
Complete order code: **H16-WTPQ6**



(Fit into **Sirona** R/F)

Standard head Handpiece Order code: **H16-SSPQ**
Complete order code: **H16-SSPQ6**

Torque head Handpiece Order code: **H16-STPQ**
Complete order code: **H16-STPQ6**



(Fit into **KaVo**
MULTifelix LUX)

Standard head Handpiece Order code: **H16-KSPQ**
Complete order code: **H16-KSPQ6**

Torque head Handpiece Order code: **H16-KTPQ**
Complete order code: **H16-KTPQ6**



Order code: **210-F+-TP**
For torque head



Order code: **210-F+-SP**
For standard head



Order code: **229-GN**
(Fit into **NSK**
Machlite/Phatelus)



Order code: **229-GW**
(Fit into **W&H**
Roto Quick)



Order code: **229-GS**
(Fit into **Sirona** R/F)



Order code: **229-GK**
(Fit into **KaVo**
MULTifelix LUX)

148 Optical handpiece

1 WAY SPRAY
HANDPIECE

Model: CX207-B/CX207-F

New upgrade, Mini Head
Wider vision

Mini



149
1 way spray
handpiece

Technical:

High speed handpiece:	1 way spray
Noise:	≤68dB
Rotation speed:	390-485Krpm
Water-flow rates:	> 50ml/min
Atomization gas flow rate:	≥1.5L/min
Radial runout:	< 0.03mm
Clamping force:	> 22N



Model: CX207-B/CX207-F

High-speed air turbine handpieces

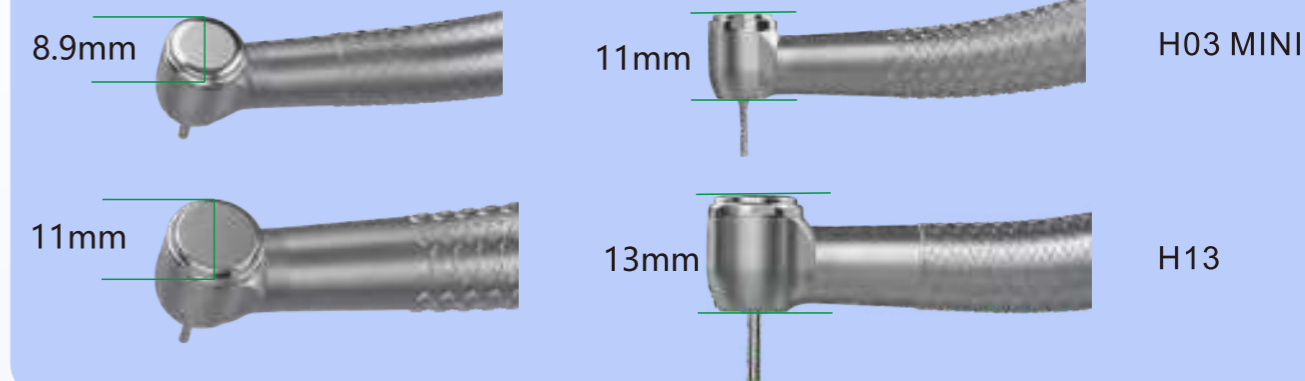

Dustproof structure
Cartridge passed the German
dynamic balance machine test



Imported bearing
long life, stable

150
1 way spray
handpiece

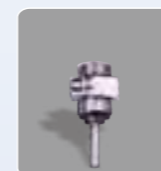

Order code: 210-B+-MP



Mini head

Order code: H03-MP4
H03-MP2



(Self-Luminous) Mini head

Order code: H05-MP4
H05-MP2

1 WAY SPRAY
HANDPIECE

Model: CX207-B

New upgrade, new integrated head



Technical:

High speed handpiece:	1 way spray, 4 air spray
Chuck type:	push button
Noise	≤68dB
Air pressure at the back end of HP:	0.25-0.28 MPA(4hole) 0.20-0.22 MPA(2hole)
Bur applicable:	Ø1.59-Ø1.6mmx21-23mm
Rotation speed:	≥ 300,000rpm

151
1 way spray
handpiece

152
1 way spray
handpiece

Model: CX207-B

High-speed air turbine handpieces

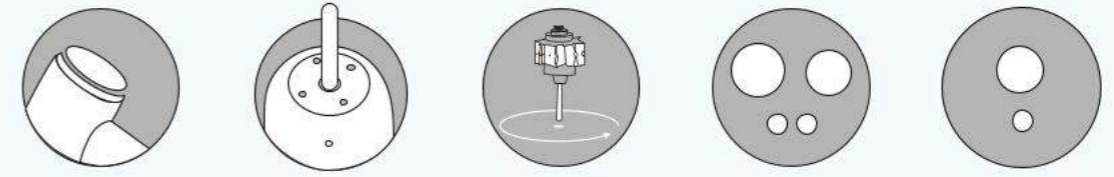

anti-dust structure



Order code: 210-B+-SP



Standard head Order code: H13-SP4
H13-SP2



Order code: 210-B+-TP



Torque head Order code: H13-TP4
H13-TP2

**3 WAY SPRAY
HANDPIECE**

Model: CX207-W

New upgrade, new integrated head

Cartridge passed the Germany dynamic balance machine test

3 way spray, 3 air spray
Head and cartridge with anti-dust structure

Good cooling system,
soft push button

Wear-resisting, efficient operation

Graceful body, simple,
easy clean, easy control

153
3 way spray
handpiece

Technical:

High speed handpiece:	3 way spray, 3 air spray
Chuck type:	push button
Noise	≤68dB
Air pressure at the back end of HP:	0.25-0.28MPA(4hole) 0.20-0.22MPA(2hole)
Bur applicable:	Ø1.59-Ø1.6mmx21-23mm
Rotation speed:	≥300,000rpm

Model: CX207-W

High-speed air turbine handpieces

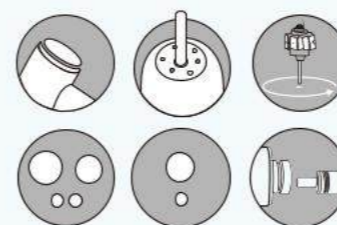

Order code: 210-W+-SP



Standard head Order code: H17-SP4
H17-SP2



Order code: 210-W+-TP



Torque head Order code: H17-TP4
H17-TP2



Order code: 210-W+-SP



Standard head Quick coupling Order code: H17-SPQ4
H17-SPQ2



Order code: 210-W+-TP



Torque head Quick coupling Order code: H17-TPQ4
H17-TPQ2

154
3 way spray
handpiece

**COLOR
HANDPIECE**

Model: CX207-C

New upgrade, new integrated head

Ceramic bearing
Cartridge passed the Germany
dynamic balance machine test

Wear-resisting, efficient operation

Good cooling system,
soft push button

Aluminum alloys body, light,
colorful, easy clean, easy control

Technical:

High speed handpiece:	1 way spray, 4 air spray
Chuck type:	push button
Noise	≤68dB
Air pressure at the back end of HP:	0.25-0.28 MPA(4hole) 0.20-0.22MPA(2hole)
Bur applicable:	Ø1.59-Ø1.6mmx21-23mm
Rotation speed:	≥300,000rpm
color:	red yellow purple blue black

155
Color handpiece

Model: CX207-C

High-speed air turbine handpieces

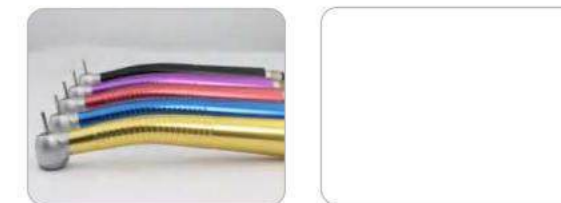

Standard head Order code: **H14-1SP4**
H14-1SP2



Torque head Order code: **H14-1TP4**
H14-1TP2



Standard head Order code: **H14-2SP4**
H14-2SP2



Torque head Order code: **H14-2TP4**
H14-2TP2



Standard head Order code: **H14-3SP4**
H14-3SP2



Torque head Order code: **H14-3TP4**
H14-3TP2



Standard head Order code: **H14-4SP4**
H14-4SP2



Torque head Order code: **H14-4TP4**
H14-4TP2



Standard head Order code: **H14-5SP4**
H14-5SP2



Torque head Order code: **H14-5TP4**
H14-5TP2



Order code: **210-C+-SP**
For standard head



Order code: **210-C+-TP**
For torque head

156
Color handpiece

Model: CX207-A

High-speed air turbine handpieces

New upgrade, new integrated head



Single way spray
more three air spray
Head and cartridge with
anti-dust structure



Cartridge passed the Germany
dynamic balance machine test

The special clean head designed
to avoid the entry of oral fluids and
other impurity into handpiece head.

Graceful body, simple,
easy clean, easy control



Order code: 210-A+-SP(21)



Standard head

Order code: H02-SP4
H02-SP2



Order code: 210-A+-TP(21)



Torque head

Order code: H02-TP4
H02-TP2

157
Nature handpiece

Model: CX207

High-speed air turbine handpieces

Technical:

High speed handpiece: 4 way spray

Chuck type: push button/latch

Air pressure at the back end of HP: 0.25-0.27MPA(4 hole)
0.20-0.22MPA(2 hole)

Bur applicable: 1.6x25mm

Rotation speed: Above 30000rpm



4 way spray

New water supply structure,
the cooling effect is better



Windproof front

Add a dust cover to prevent
air leakage from the front end
and effectively prevent emphysema



Order code: 210-D2-SP



45° Standard head

Order code: H01-D2SP4
H01-D2SP2

158
Nature handpiece

OPTICAL HANDPIECE

Optical fiber illumination

Model: CX207-G

High-speed air turbine handpieces

Reject welding, complete head made by CNC, more stable!

Imported bearing
Long life, low noise and stable

Balanced impeller
Cartridge passed the Germany dynamic balance machine test

Optical fiber illumination



Order code: 210-FD-SP



Order code: 229-GK1
fit into KaVo® MULTfelx® LUX

LED light
fit into KaVo® MULTfelx® LUX



360° water adjustor

Standard head 45° Handpiece Order code: H06-KD1SPQ
Complete order code: H06-KD1SPQ6



LED HANDPIECE WITH GENERATOR

Model: CX207-F

High-speed air turbine handpieces



Order code: 210-FD-SP



Standard head 45°

Order code: H05-DSP4
H05-DSP2

Model: CX207

High-speed air turbine handpieces

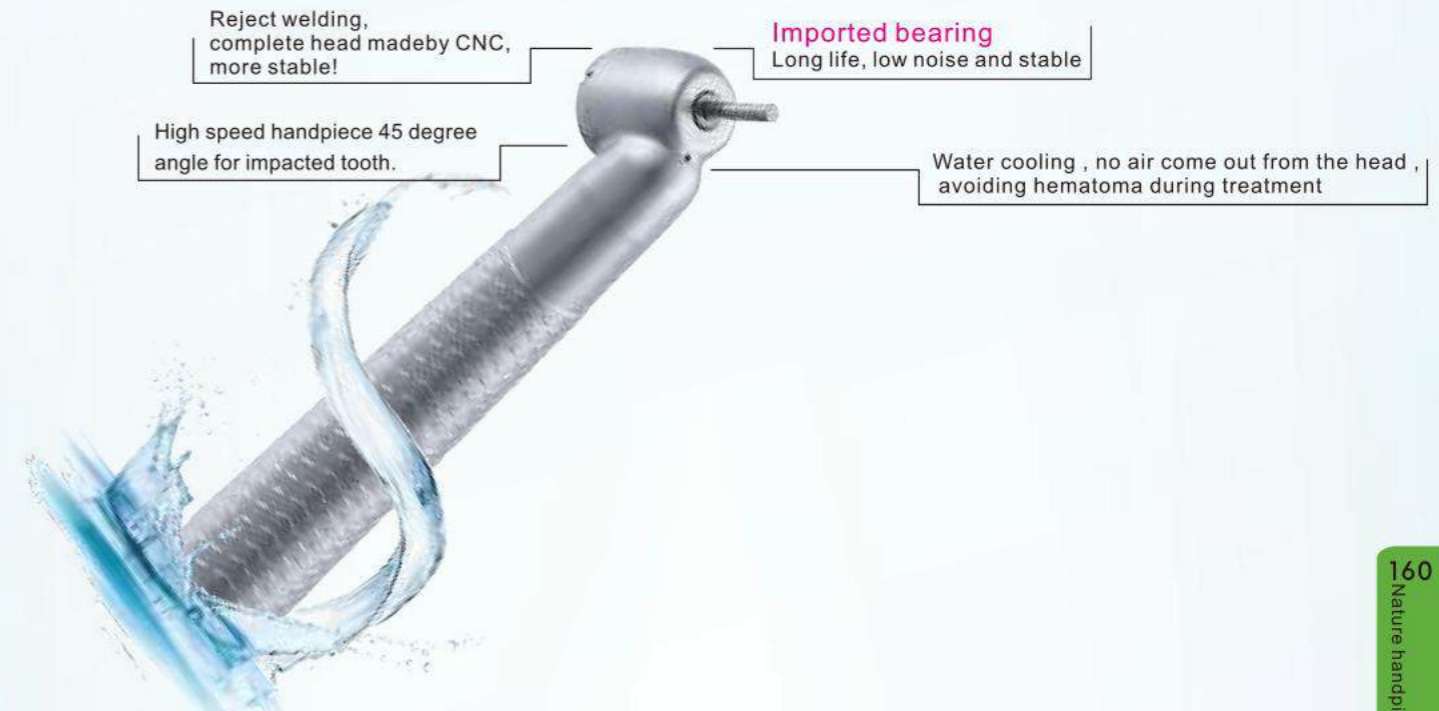

Reject welding, complete head made by CNC, more stable!

Imported bearing
Long life, low noise and stable

High speed handpiece 45 degree angle for impacted tooth.

Water cooling, no air come out from the head, avoiding hematoma during treatment

- High speed handpiece 45 degree angle for impacted tooth.
- Water cooling, no air come out from the head, avoiding hematoma during treatment
- Small trauma, short time, accurate force
- High torque, stable speed
- Minimally invasive extraction of impacted teeth is faster and safer



Technical:

High speed handpiece:	1 way spray
Chuck type:	push button/latch
Noise	≤68dB
Air pressure at the back end of HP:	0.25-0.28 MPA(4hole) 0.20-0.22MPA(2hole)
Bur applicable:	Ø1.59-Ø1.6mmx21-23mm
Rotation speed:	≥ 300,000rpm



Order code: 210-D-SP



Standard head 45° Order code: H01-D1SP4
H01-D1SP2

**NATURE
HANDPIECE**

Model: CX207



Push button or wrench choose

Model: CX207

High-speed air turbine handpieces



Order code: 210-S



Order code: 210-SP



Order code: 210-TP



Standard head Order code: H01-S4
H01-S2



Standard head Order code: H01-SP4
H01-SP2



Torque head Order code: H01-TP4
H01-TP2

Technical:

High speed handpiece:	1 way spray
Chuck type:	push button/latch
Noise	≤68dB
Air pressure at the back end of HP:	0.25-0.28 MPA(4hole) 0.20-0.22 MPA(2hole)
Bur applicable:	Ø1.59-Ø1.6mmx21-23mm
Rotation speed:	≥ 300,000rpm



**LED HANDPIECE
WITH GENERATOR**

Model: CX207-F

NEW

New upgrade, new LED bulb, new integrated head



163 LED handpiece with generator

164 LED handpiece with generator

Model: CX207-F

High-speed air turbine handpieces

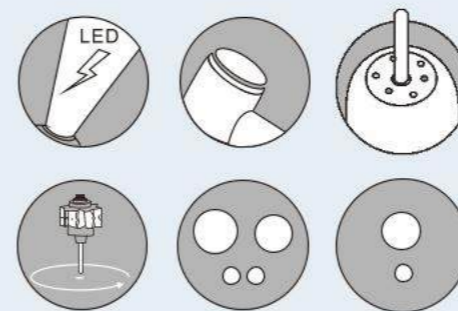

Technical:

The type of cooling	3 way spray
Chuck type:	push button
Air pressure at the back end of HP:	0.26-0.28MPA
Bur applicable:	Ø1.59-Ø1.6mmx21-23mm
Rotation speed:	≥300,000rpm

Unique electric generator, just a little air can generate sufficient power;

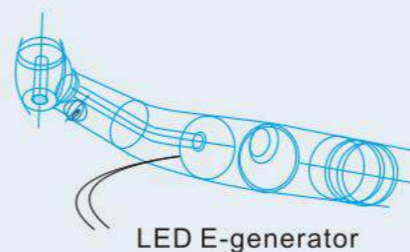

Reject welding, complete head made by CNC, more stable!



Dustproof structure
Cartidge passed the German dynamic balance machine test



Order code: 210-F-ESP



Order code: 210-F-ETP



Standard head Order code: H85-ESP4
H85-ESP2



Torque head Order code: H85-ETP4
H85-ETP2

3 WAY SPRAY
HANDPIECE

Model: CX207-W

NEW

New upgrade, new integrated head



165
3 way spray
handpiece

Technical:

High speed handpiece:	3 way spray, 3 air spray
Chuck type:	push button
Noise	≤68dB
Air pressure at the back end of HP:	0.22-0.24MPA(4 hole) 0.20-0.22MPA(2 hole)
Bur applicable:	Ø1.59-Ø1.6mmx21-23mm
Rotation speed:	≥300,000rpm

Model: CX207-W

High-speed air turbine handpieces



Reject welding,
complete head made
by CNC, more stable!



4 way spray
new water supply structure,
the cooling effect is better



Dustproof structure
Cartidge passed the German
dynamic balance machine test



166
3 way spray
handpiece



Order code: 210-W-ESP



Standard head

Order code: H37-ESP4
H37-ESP2



Order code: 210-W-ETP



Torque head

Order code: H37-ETP4
H37-ETP2

SPEED INCREASED
CONTRA ANGLE

Model: CX235C7

1:5 Speed increased Contra Angle

New upgrade, Better structure
Better performance



167
Speed increased
contra angle

1:5 speed increase

Technical:

Chuck type:	push button
Spray:	Inner channel
Bur applicable:	Ø1.6mm
Rotation speed:	about 200,000rpm

Model: CX235C7

Geared Angle Handpieces



Order code: C7-5
Optic fiber



Externa & Internal water
Order code: C7-5S
Optic fiber



Order code: C7-6



V shape water spray structure
More stable and better cooling



More concentrated light
Increase the illumination
by 100%



Add sanitary hole
Reduce the risk of dirt
entering



Improved shaft structure
Service life increased by
more than 90%



Better waterproof structure
To better prevent water from
entering the head

168
Speed increased
contra angle

SPEED INCREASED
CONTRA ANGLE

Model: CX235C7

1:5 Speed increased Contra Angle

New upgrade, smaller size
better handfeeling

Mini

169
Speed increased
contra angle



1.5 speed increase

Technical:

Chuck type: push button
Spray: Inner channel
Bur applicable: Ø1.6 mm
Rotation speed: about 200,000rpm

Model: CX235C7

Geared Angle Handpieces

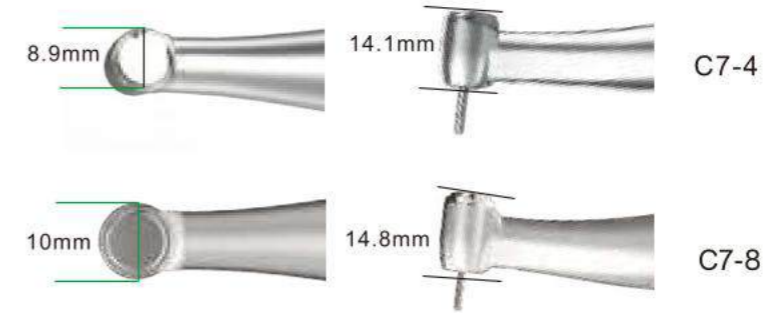

Reducing size and better angle

Improved handpiece and head angle, making it easier to reach the back teeth



Smaller head with 92° angle

Larger elevation angle, making it easier to reach the back teeth



170
Speed increased
contra angle

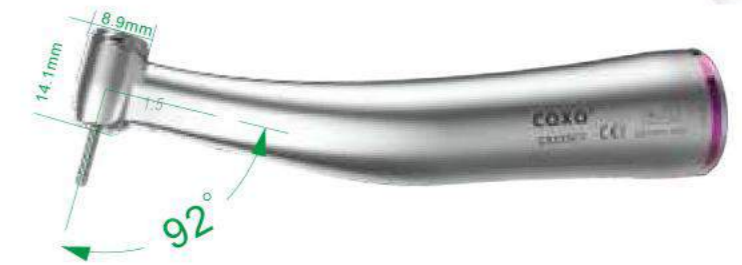

mini head



Order code: C7-4

mini head



External water Order code: C7-4S

standard head



Order code: C7-8

NEW

SPEED INCREASED
CONTRA ANGLE

Model: CX235C7

Geared Angle Handpieces

1:3.3 speed increase

Technical:

Chuck type:	push button
Spray:	Inner channel
Bur applicable:	Ø1.6mm
Rotation speed:	about 132,000rpm



The nose has a 45° elevation angle, and the fuselage has an angle of 17°

NEW



Equipped with a built-in self generating structure to drive LED lighting



Easy to disassemble

The nose is designed with anti water ingress

Cover anti scalding design

Detachable structural design for easy maintenance

Order code: C7-7
LED Light



SPEED INCREASED
CONTRA ANGLE

Model: CX235C7

Contra angle handpiece

1:4.2 speed increase

Technical:

Chuck type:	push button
Spray:	Inner channel
Bur applicable:	Ø1.6mm
Rotation speed:	about 168,000rpm

4 hole water spraying
Spraying water to prevent subcutaneous emphysema during surgery
Effectively and quickly cool the needle.



Perfect accessibility of 45 degree angle fiber-optic handpiece provides the best adaptability and maximum performance for teeth
Easy access to the molar area
Minimize interference with front and adjacent teeth
45 degree inclined head for supine accessibility and maximum visibility

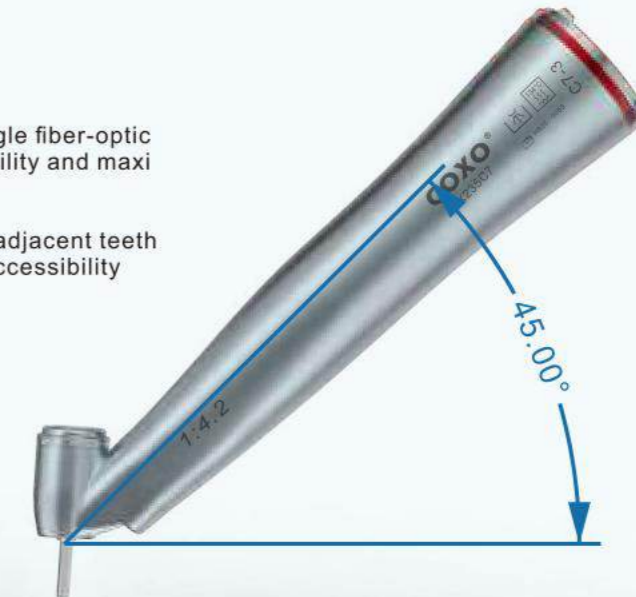

Order code: C7-3
Optic fiber



External water
Order code: C7-3S
Optic fiber

171 Speed increased
contra angle

172 Speed increased
contra angle

REDUCTION
CONTRA ANGLE

Model: CX235C6

Contra angle handpiece

Model: CX235C6

Geared Angle Handpieces

20:1 Contra Angle for Implant

Easily disassembled, more reassuring treatment



Easy to disassemble with tool

Detachable



173
Contra angle
handpiece

174
Contra angle
handpiece



Optic fiber Order code: C6-22



Order code: C6-23

20:1 reduction

Technical:

Chuck type:	push button
Spray:	Inner channel and external
Bur applicable:	Ø2.35 _{±0.014} mm(ISO1797-1)
Max speed:	2,000RPM For implant
Internal cooling system:	Kirschner / Meyer

EXTERNAL
LOW SPEED HANDPIECE
SET

Geared Angle Handpieces



External water spray,
Short motor,
Reducing size and weight
More comfortable to use

External Order code: **235-M SET-4** ☺



M-3F

Reducing size and weight
More comfortable to use



Technical:

Chuck type:	push button
Noise	≤70dB
Air pressure:	0.30MPA
Bur applicable:	Ø2.35 _{-0.014} mm(ISO1797-1)
Rotation speed:	about20,000rpm

175
Dental low speed
handpiece set

EXTERNAL
LOW SPEED HANDPIECE
SET

Geared Angle Handpieces



External Order code: **235-F SET-4** ☺
235-F SET-2 ☺



External Order code: **235-A SET-4** ☺
235-A SET-2 ☺

176
Dental low speed
handpiece set

INNER CHANNEL
LOW SPEED HANDPIECE
SET

Geared Angle Handpieces



Optic fiber inner channel Order code: 235-C SET-6



Optical fiber



6 hole



360 degrees of freedom rotary interfa

Technical:

Low speed handpiece:	1 way spray
Chuck type:	push button
Noise	≤70dB
Air pressure:	0.30MPA
Bur applicable:	Ø2.35 _{-0.018} mm(ISO1797-1)
Rotation speed:	about20,000rpm

INNER CHANNEL
LOW SPEED HANDPIECE
SET

Geared Angle Handpieces



inner channel Order code: 235-B SET-4
235-B SET-2



Generator in contra angle



inner channel LED Order code: 235-E SET-4
235-E SET-2

Technical:

Low speed handpiece:	1 way spray
Chuck type:	push button
Noise	≤70dB
Air pressure:	0.30MPA
Bur applicable:	Ø2.35 _{-0.018} mm(ISO1797-1)
Rotation speed:	about20,000rpm

REDUCTION
CONTRA ANGLE

Geared Angle Handpieces

4:1 Reduction

Low speed handpiece: 4:1 direct drive
 Chuck type: push button or wrench
 Spray: external
 Bur applicable: $\varnothing 2.35_{\pm 0.016}$ mm
 Rotation speed: MAX 5,000rpm



4:1 Order code: **CB-3**



Order code: **CH-11**



Up and down movement



Order code: **C3-11**

6:1 Reduction

Low speed handpiece: 6:1 Reduction
 Chuck type: push button
 Max speed: 6600rpm
 Max torque: 5.2N.cm



Order code: **C5-1M**

10:1 Reduction

Low speed handpiece: 10:1 Reduction
 Chuck type: push button
 Spray: external
 Bur applicable: engine use file/hand use file
 Rotation speed: MAX 4,000rpm
 Rotation style: 90° reciprocating rotate head

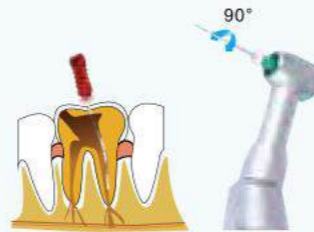

Fit to hand use files



10:1 Order code: **CB-5**



Order code: **CH-12**



hand use files



Order code: **C5-12**

REDUCTION
CONTRA ANGLE

Geared Angle Handpieces

64:1 Reduction

Low speed handpiece: 64:1 Reduction
 Chuck type: push button or wrench
 Spray: external
 Bur applicable: $\varnothing 2.35_{\pm 0.016}$ mm
 Rotation speed: MAX 625 rpm



64:1 Order code: **CB-8**



Order code: **CH-4**



Order code: **C8-4**

1:1 DIRECT DRIVE
CONTRA ANGLE

1:1 Direct drive

Low speed handpiece: 1:1 direct drive
 Chuck type: push button or wrench
 Spray: external
 Bur applicable: $\varnothing 2.35_{\pm 0.016}$ mm
 Rotation speed: MAX 40,000rpm



1:1 Order code: **CB-1**



Order code: **CH-2**



Order code: **C1-2**



Order code: **CH-4**



Order code: **C1-4**



1:1 Order code: **CB-7**



Order code: **CH-17**



Order code: **C1-F**

**1:1 DIRECT DRIVE
CONTRA ANGLE**

Geared Angle Handpieces

New upgrade, new integrated head

1:1 Direct drive

Low speed handpiece: 1:1 direct drive
 Chuck type: push button
 Spray: Inner channel
 Bur applicable: $\varnothing 2.35_{-0.015}^{+0.015}$ mm
 Rotation speed: MAX40,000rpm



Model: **CX235-1C**
 Order code: **C-1C**
LED LIGHT



Model: **CX235-1E**
 Order code: **C-1E**
GENERATOR



Model: **CX235-1B**
 Order code: **C-1B**



Model: **CX235C1**
 Order code: **C-1-1**
 Rotation speed:
 about 20,000rpm

181
 Contra angle
 Handpieces,
 Air motors

AIR MOTOR

Air Motors

Spray: Inner channel or External
 Hole type: 6 hole or 4 hole or 2 hole
 Rotation speed: 20,000rpm



INNER
 CHANNEL

Model: **CX235-3C**
 Order code: **M-3C**
Optic fiber



Model: **CX235-3B**
 Order code: **M-3B-4**
M-3B-2



EXTERNAL

Model: **CX235-3F**
 Order code: **M-3F-4**
M-3F-2



External

Model: **CX235-3F**
 Order code: **M-3M-4**

**INNER CHANNEL/EXTERNAL
STRAIGHT HANDPIECE**

Straight Handpieces

1:1 Direct drive

Low speed handpiece: 1:1 direct drive
 Spray: Inner channel or External
 Bur applicable: For surgical $\varnothing 2.35_{-0.015}^{+0.015}$ mm
 Rotation speed: MAX40,000rpm



Order code: **S-2S**
 surgical operation 20°
 straight head



Model: **CX235-2C**
 Order code: **S-2C**
Optic fiber



Model: **CX235-2B**
 Order code: **S-2B**



Model: **CX235-2B**
 Order code: **S-2BS**



Model: **CX235-2C**
 Order code: **S-2CS**
Optic fiber



Model: **CX235-2F**
 Order code: **S-2F**



Model: **CX235-2A**
 Order code: **S-2A**



Model: **CX235-2**
 Order code: **S-2**

Inner Channel

Inner Channel + External

External

182
 Straight handpiece

ECONOMICAL

Economical complete kit

COMPLETE KIT

1:1 Direct drive



Order code: **H01-1 KIT-SP4**
H01-1 KIT-SP2

STUDENT HANDPIECE KIT

- 1PCS Anti-retraction high speed standard push handpiece
- 1PCS contra angle
- 1PCS straight head
- 1PCS low speed air motor
- 1PCS push button cartridge <Free>



Order code: **H01-2 KIT-S4**
H01-2 KIT-S2

HANDPIECE KIT

- 2PCS high speed standard handpiece
- 1PCS contra angle
- 1PCS straight head
- 1PCS low speed air motor
- 1PCS standard cartridge <Free>



Order code: **H01-2 KIT-SP4**
H01-2 KIT-SP2

HANDPIECE KIT

- 2PCS standard push handpiece
- 1PCS contra angle
- 1PCS straight head
- 1PCS low speed air motor
- 1PCS push button cartridge <Free>



Order code: **H01-1 KIT-S4**
H01-1 KIT-S2

HANDPIECE KIT

- 1PCS high speed standard handpiece
- 1PCS contra angle
- 1PCS straight head
- 1PCS low speed air motor
- 1PCS standard cartridge <Free>



Handpiece Accessories
Manufacturing all kinds of spare parts for handpiece

HANDPIECE ACCESSORIES

Shaft of cartridge

		ORDER CODE
	For NSK For W&H For KaVo L:12.6mm (long)	245-4-1
	For NSK For W&H For KaVo L:11.8mm (short)	245-4-2
	For NSK L:13.5mm (long)	245-2
	For NSK L:12.5mm (short)	245-3

Generator

	ORDER CODE
	245-52

HANDPIECE ACCESSORIES

Quick coupling of high speed handpiece

		ORDER CODE
	fit into NSK machlite/ phatelus® (LED/optic fiber/6 hole)	229-GN
	fit into W&H Roto Quick® (optic fiber/6 hole)	229-GW
	fit into Sirona R/F (LED/optic fiber/6 hole)	229-GS
	fit into KaVo® MULTiflex® LUX (LED/optic fiber/6 hole)	229-GK
	fit into KaVo® MULTiflex® LUX (LED/optic fiber/6 hole)	229-GK1
	for KaVo® (4 hole)	229-GK2
	for NSK (4 hole)	229
	for NSK (2 hole)	229-1
	(For H17-SPQ4,H17-TPQ4) (4 hole)	229-b
	(For H17-SPQ2,H17-TPQ2) (2 hole)	229-1b
	245-55 4 or 6 hole gasket	
	245-10 2 hole gasket	

HANDPIECE ACCESSORIES

Bulb(LED light)

		ORDER CODE
	For NSK (for 229-GN)	261-1
	(for 229-GW)	261-2
	For Sirona (for 229-GS)	261-6
	For KaVo (for 229-GK)	261-3

HANDPIECE ACCESSORIES

Cartridge of contra angle

		ORDER CODE
	(for C7-5, C7-5S, C7-6) push button	235-53(20)
	(for C7-4, C7-4S) push button	235-60
	(For C-1E, C-1C, C-1B, C1-4) push button	235-13-3
	for NSK	235-9
	(for C1-2, C-1F)	235-12
	(for C6-19, C6-22, C6-23)	235-30 (19A)

HANDPIECE ACCESSORIES

Head cup of handpiece

		ORDER CODE
	Standard back cap (wrench chuck)	245-5 For H01-S
	Standard back cap (push chuck)	245-7 For H01-SP
	Torque back cap (push chuck)	245-8 For H01-TP
	Standard back cap (push chuck)	245-37 For H13/14/15/16/17/23/25-SP For H15-8SP
	Torque back cap (push chuck)	245-38 For H13/14/15/16/17/23/25-TP For H15-8TP
	Cover for contra angle cartridge	245-17 For CH-1
	Standard back cap (push chuck)	245-57 For H02-SP
	Torque back cap (push chuck)	245-58 For H02-TP

HANDPIECE ACCESSORIES

Bearing of handpiece

		ORDER CODE
	For NSK For W&H For KaVo For Sirona Imported bearing (ø6.35Xø3.175X2.38)	245-18
	For NSK For W&H For KaVo For Sirona Steel bearing (ø6.35Xø3.175X2.38)	245-11
	For NSK For W&H For KaVo For Sirona Steel bearing with cover (ø6.35Xø3.175X2.38)	245-12
	For NSK For W&H For KaVo For Sirona Ceramic bearing (ø6.35Xø3.175X2.38)	245-13
	For W&H For KaVo Ceramic bearing with cover (ø6.35Xø3.175X2.38)	245-19
	For W&H For KaVo Steel bearing (ø6.35Xø3.175X2.78)	245-23
	For KaVo Steel bearing with step (ø6.35Xø3.175Xø5.97X2.38X1.0)	245-20
	For KaVo Steel bearing with step (ø6.35Xø3.175Xø5.97X2.78X1.0)	245-22
	For Bien air (ø3.175Xø7.938Xø3.571) Steel bearing	245-30
	(ø8Xø4X3) Steel bearing for straight head	245-14
	(ø10Xø5X4) Steel bearing for straight head	245-15
	(ø7Xø4x2) Steel bearing for push button contra angle	245-24
	(ø8Xø5x2.5) for CX235-2C Steel bearing for straight head	245-27
	(ø7.938Xø2.38x3.572) Steel bearing for contra angle or motor	245-28
	(ø6Xø3x2) Steel bearing for contra angle	245-29
	(ø6.5Xø4x1.3) Steel bearing for mini contra angle	245-56

HANDPIECE ACCESSORIES





























Head set of contra angle

	ORDER CODE
 for NSK (for CA burs ϕ 2.35) Max.40,000RPM	CH-2
 for NSK (for CA burs ϕ 2.35) Max.40,000RPM	CH-4
 for KaVo (for CA burs ϕ 2.35) Max.40,000RPM	CH-18
 for NSK Lock of contra angle	245-49

	ORDER CODE
 for NSK (for CA burs ϕ 2.35) Max.30,000RPM (MINI head)	CH-13
 for NSK (for file burs) Max.4000RPM	CH-12
 (for CA burs ϕ 2.35) for Endodontic treatment	CH-17M
 (for CA burs ϕ 2.35) for Endodontic treatment	C1-17M

HANDPIECE ACCESSORIES

Cartridge

			
Order code:210-B3-SP For H33-SP	Order code:210-F+-TP For H16-NTPQ/H16-WTPQ H16-STPQ/H16-KTPQ	Order code:210-W+-SP For H17-SP/H17-SPQ	Order code:210-TP For H01-TP
			
Order code:210-B3-TP For H33-TP	Order code:210-F+-SP For H16-NSPQ/H16-WSPQ H16-SSPQ/H16-KSQP	Order code:210-W+-TP For H17-TP/H17-TPQ	Order code:210-S For H01-S
			
Order code:210-F+-SP H15-SP	Order code:210-B+-S For H13-S	Order code:210-C+-SP For H14-SP	Order code:210-SP For H01-SP
			
Order code:210-F+-TP H15-TP	Order code:210-B+-T For H13-T	Order code:210-C+-TP For H14-TP	Order code:210-FD-SP For H05-DSP
			
Order code:210-F-MP H05-MPQ	Order code:210-B+-SP For H13-SP	Order code:210-A+-SP(21) For H02-SP	Order code:210-FD-SP For H06-KD1SPQ
			
Order code:210-F+-SP H05-SPQ	Order code:210-B+-TP For H13-TP	Order code:210-A+-TP(21) For H02-TP	Order code:210-D-SP For H01-D1SP
			
Order code:210-F+-TP For H05-TPQ	Order code:210-1-SP For H11-SP	Order code:210-A-SP For PAX-SU03	Order code:210-A-TP For PAX-TU03

HANDPIECE ACCESSORIES

Shaft of contra angle

	ORDER CODE
 (for C6-19)	235-25
 (for C5-12/C5-12M)	235-28
 (for NSK) (for C1-2)	235-8
 (for C1-4) push button	235-19
 (for C-1C/C-1E) (for C-1B)	235-23
 (for C-1F)	235-24
 (for C6-22/C6-23)	235-56
 (for C7-4/C7-4S)	235-59
 (for C7-5)	235-54

	ORDER CODE
 for NSK	235-8-1

Accessories of Handpiece

	ORDER CODE
 Cartridge repair kit	254-2
 Low speed handpiece repair kit	254-3
 Spanner	211
 For NSK Tubing for low speed handpiece	245-16
 For S-2S Tubing	245-45
 For C4-9/C6-9 Tubing	245-46
 For C6-19 Tubing	245-48

CUSTOM PRODUCT

HANDPIECE

MOQ:500PCS

▼ 3 way spray 3 air spray handpiece

- A1-SP Stan push head
- A1-TP Max push head
- A1-45SP Stan push head 45°

▼ Clean head system handpiece

- A2-S Stan head
- A2-T Max head
- A2-SP Stan push head
- A2-TP Max push head

▼ Three way spray handpiece

- A3-SP Stan push head
- A3-TP Max push head

▼ LED handpiece with generator

- A4-SP Stan push head
- A4-TP Max push head
- A4-45SP Stan push head 45°

▼ Fiber optical handpiece

- A5-SP Stan push head
- A5-TP Max push head

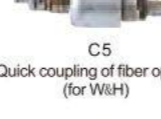
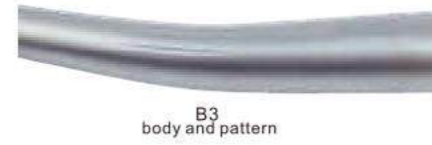
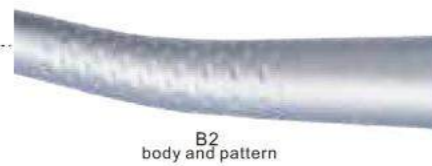

COXO could Provide OEM,ODM service,and COXO have some handpiece style and pattern provide customers choice, Choose as shown in figure:

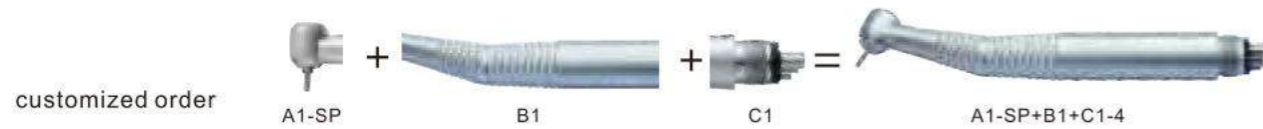

Dental Operating Lights

Professional dental products manufacturer

NEW

CX249-19 Dental Operating Light

Clarity · Accuracy · Multifunctional



Wireless



Photo



Video



Audio



Wireless Multifunctional

Model: CX249-19

Dental Operating Light

Technical:

Power supply:	AC12-24V
LED light:	6 PCS
Light intensity:	8000LUX-40000LUX
Dimension of pattern:	80×160mm
Colour temperature:	3500K-5500K
CRI:	>90Ra
Optimal Imaging:	Distance 70-90 mm
Resolution:	Full HD (1920 × 1080)
Focal length:	700-1000 mm
White balance:	Manual / Auto

Easy installation
AC12-24V



Bluetooth receiver

order name: CX249-19



1080P HD Imaging

Clear images and videos with built-in image stabilization.



Digital Case Recording

Audio and video are recorded at the same time for complete case records.



Natural Color Imaging

Manual and auto white balance provide natural and accurate colors.



Six-Point Light

Uniform central illumination with no shadows, helping to see deep root canals clearly.



Five-Hole Heat Dissipation

Efficient cooling for long-term use without overheating, ensuring safe operation.



Wireless Output

No cables, making communication easier for doctors and patients.

Optional:



All-in-one PC

Display	Input: AC 24V , Output: DC 32V
Processor	100VA
Memory	8GB RAM
Storage	128-256GB hard drive
Operation	Touch control
System	Windows 7-10

Optional mounting options:



Ceiling-mounted bracket



Machine-mounted bracket



Mobile bracket

191 Dental operating light

192 Dental operating light



order name: **CX249-24**

Feature:

- 1-There are 4 color can adjust temperature, from 4000 to 6000K
- 2-There are 12 high-power LED lights with adjustable illumination and the maximum illumination can reach 100000lux
- 3-Use LED lamp bead with 90 ORL to restore color authenticity
- 4-Conclude touch key and dual control switch with touch
- 5-Both sides have the same key panel, which is convenient for both hands to operate
- 6-Removable handle, alcohol sterilization or high temperature sterilization
- 7-The mirror panel can be easily observed by doctors or patients
- 8-The perfect for no shadow effect

Technical:

Power supply:	24V
Power consumption:	25W
LED light:	12PCS
Light intensity(lux):	>100000LUX
Dimension of pattern:	80X160mm(in the 700mm)
Colour temperature:	4000K~6000K
CRI:	>90Ra
Shadow(solution)	<Φ8mm
Eye intensity(lux):	<600lux
Interatcion range:	20-80mm
Joint dimension:	ø22
Weight(kg)/PCS	2kg



The mirror panel can be easily observed by doctors or patients



There are 12 high-power LED lights with adjustable illumination and the maximum illumination can reach 100000lux



Removable handle, alcohol sterilization or high temperature sterilization



Both sides have the same key panel, which is convenient for both hands to operate



The beam spot is rectangular and the size is moderate. (80x160mm at 700mm) And no dazzle light around



order name: **CX249-23**

Feature:

- 1-Free movement of 3axes,positioning the light to where you want.
- 2-Removable handles,easy to clean and easy to mount and dismount.
- 3-Optimized color of light,color temperature range from 5500-6500K,similar just like the natural light from your window.the power of light from 450-550 is limited to minimize the effect on the sensitive material use for the restoration,
- 4-Factory calibrated at 700mm(the average length of the human arm).a precise 80X160 rectangular light pattern with uniform intensity is produced.out side the light pattern there are 50% lower illustration level compare to specified requirement in ISO standard-illumination occurs only where you want it to in the oral cavity.not in the patient's eyes.

Technical:

Power supply:	AC12-24V
Power consumption:	6-10W
LED light:	6 PCS
Light intensity(lux):	>40000LUX
Dimension of pattern:	80X160mm(in the 700mm)
Colour temperature:	5000-5300k
CRI:	85%
Shadow(solution)	<ø12mm
Eye intensity(lux):	<200lux
Interatcion range:	20-80mm
Joint dimension:	ø22
Weight(kg)/PCS	1.6kg



6 high power LEDs Space for camera system reserved



Removable handles,easy to clean.



Adjustable illumination (stepless), color temperature in the range of 5000K and 5300K.As a natural light, reduce damage to the eyes during long time operation.



Free movement of 3 axes,positioning the light to where you want.



Double control system (sensor and switch)



The color and color temperature for the whole light spot are the same,greatly reduce the color separation through the lens,as well as the effecto the light sensitive material.



Feature:

- 1-Super-intense Illumination
- 2-Complete shadowless
- 3-Multi-angle adjustable
- 4-Life cycle of the LED can reach 17 years
- 5-Natural color Temperature

Technical:

Power supply:	AC12-24V
Power consumption:	6W
LED light:	1 PCS
Light intensity(lux):	>35000LUX
Dimension of pattern:	80X160mm(in the 700mm)
Colour temperature:	5000-6000k
CRI:	85%
Shadow(solution)	<ø12mm
Eye intensity(lux):	<200lux
Interacion range:	20-80mm
Joint dimension:	ø22
Weight(kg)/PCS	1.75kg

order name: **CX249-22**
Reflectance



Feature:

- 1-The light is soft and comfortable, reducing eye fatigue. adpot CRI makes the shining face more realistic.
- 2-No color separation: the color and the color temperature for the whole light spot are the same, greatly reduce the color separation through the lens, as well as the effect to the light sensitive material.
- 3-Light efficiency is higher: The illuminance can reach over 45000 lux when the power is 6W. The reflect mode can reach over 50000lx.
- 4-The LED dental lamp supports stepless adjustment.

Technical:

Input Voltage:	12-24 V~, 50/60 Hz
Input Power:	15 VA
Maximum Illuminance:	> 23,000 lux (measured at a distance of 700 mm from the light source)
Light Spot Size:	< 180 × 90 mm (measured at a distance of 700 mm from the light source)
Color Temperature:	4000-6400 K
Sensing Distance:	0-90 mm
Connector Diameter:	Ø22 mm
LED Service Life:	5000 h
Net Weight:	1.0 kg

order name: **CX249-21**
Reflectance



Bionic Design, Patented Design



Almost 300 reflective palta, the projecting plane of them are more than Ø180. sensor range is 20mm-80mm



Gripping comfort and easy operation, removable cleaning

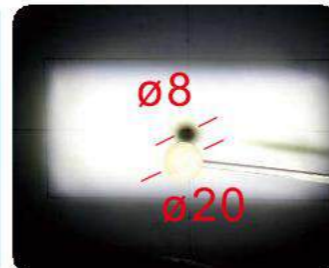

Shadowless effect is good. actual measure is Ø8.



The beam spot is rectangular and the size is moderate. (80x160mm at 700mm) And no dazzle light around

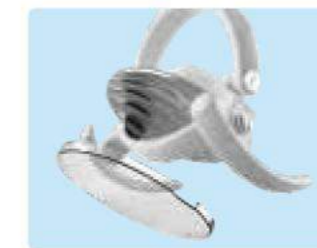

A light shield is provided to effectively reduce the impact of dust and liquids or the reflector surface.

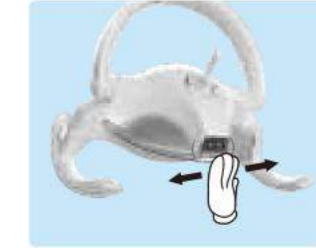

The light can be switched on or off by moving within the sensor range.



The holder shaft is removable for easy maintenance. Knob handle next to the handle for disassembly purposes, Easy to handle clean.

CULTURE

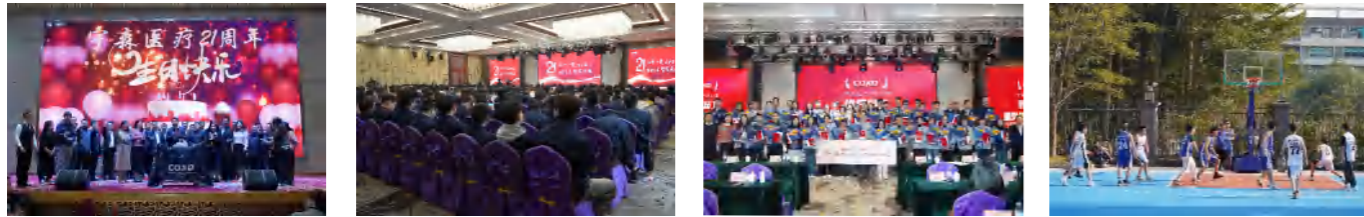

VISITOR



COXO International Academic Summit



AIOI



Global Dealer Meeting

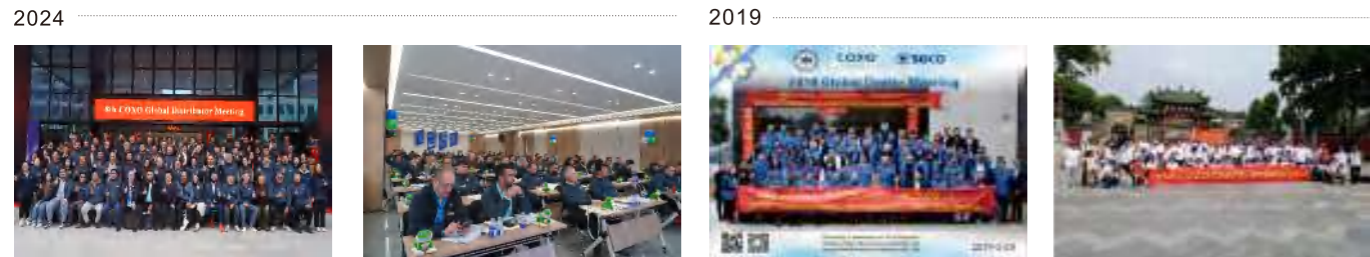
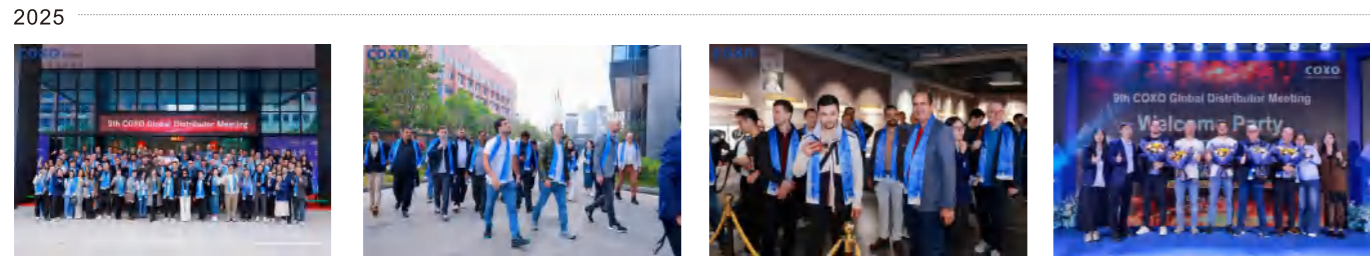

THE FACTORY OPEN DAY



China & Mexico-COXO Joint Investigation Activity



The national tour of dental implant training



RCT (The national tour of root canal training)

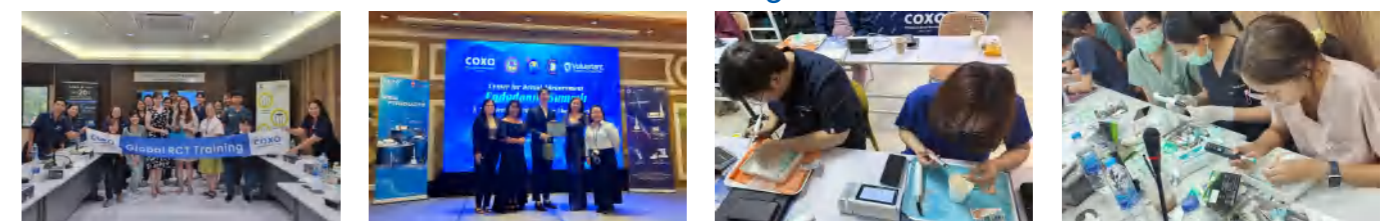

The national tour of minimally invasive repair training



2023 IDS

2024 Dubai

2024 Dental South China

2025 Dubai

2025 Guanzhou

2025 IDS

2025 Beijing

We know you want more than this even after you browsed all of the products in this book.

As the first professional manufacturer to supply the full series of components for dental chair unit, we are trying to make your China trip more comfortable and more simple, along this spirit, we make your one-stop purchasing dream be reality by our professional service and high-quality products with cheaper price. Today, our products have been sold to all over the world and our services have been extended to the whole world as well, and we have built up long term cooperation with a lot of manufacturers and distributors.

What we can do for you is:

one-stop purchasing service

Supply many kinds of products and components for you.

Introduce, recommend excellent dental chair manufacturers to you.

Offer you the services of inspection, loading, and logistic, etc.

And.....all you need in China.

Thanks for your attention, let's hold hands and remain our cooperation forever!

Welcome to visit our factory or contact us any time.



**Thanks for your
attention and support!**