

Photon Mono M7 Max

 [User Manual](#)

Dear customer,

Thank you for choosing Anycubic products.

Maybe you are familiar with 3D printing technology or have purchased Anycubic printers before. However, we still highly recommend you read this manual carefully, as the installation techniques and precautions can help you avoid any unnecessary damage or frustration.

Please visit <https://support.anycubic.com> to contact us if you have any questions. You can also learn more information from the website, such as software, videos, models.



Anycubic support center

Copyrighted by "Shenzhen Anycubic Technology Co., Ltd ", all rights reserved.

Team Anycubic

Safety Instructions

Always follow the safety instructions during assembly and usage, to avoid unnecessary damage to the 3D printer or individual injury.



Please contact our Customer Service if you have any issues after receiving the products.



In case of emergency, please immediately cut off the power of the 3D printer and contact our technical support.



UV light is harmful to the eyes; please avoid direct contact. When operating, wear protective equipment such as anti-UV goggles and gloves.



Anycubic 3D printer includes components that can cause injury.



Be cautious when using the scraper, and make sure to orient the sharp parts of machine and tool away from people.



Keep the Anycubic 3D printer and its accessories out of the reach of children.



Vapors or fumes may be irritating at operating temperatures.

Always use the Anycubic 3D printer in an open and well ventilated area.



Do not expose Anycubic 3D printer to any water or rain environment.



Use Anycubic 3D printer in an environment with a temperature of 8°C-40°C and a humidity of 20%-50%. For optimal performance, do not exceed this range. Also, avoid direct sunlight exposure.



Do not disassemble Anycubic 3D printer, please contact technical support if you have any questions.



FCC-ID:2AXYK-M7MAX
CMIIT ID:24J44VY8M616



214-240471

Contents

1. Product Overview	5
2. In the Box	6
3. Technical Specification	7
4. Recommended Print Parameters	8
5. Menu Directory	9
6. Preparations	14
7. Start Printing	18
8. Resin Recycling	25
9. Resin Exposure Range Finder	26
10. Machine Maintenance	28
11. FAQ	30

Product Overview

The pictures are for reference only. Please comply with the actual products.

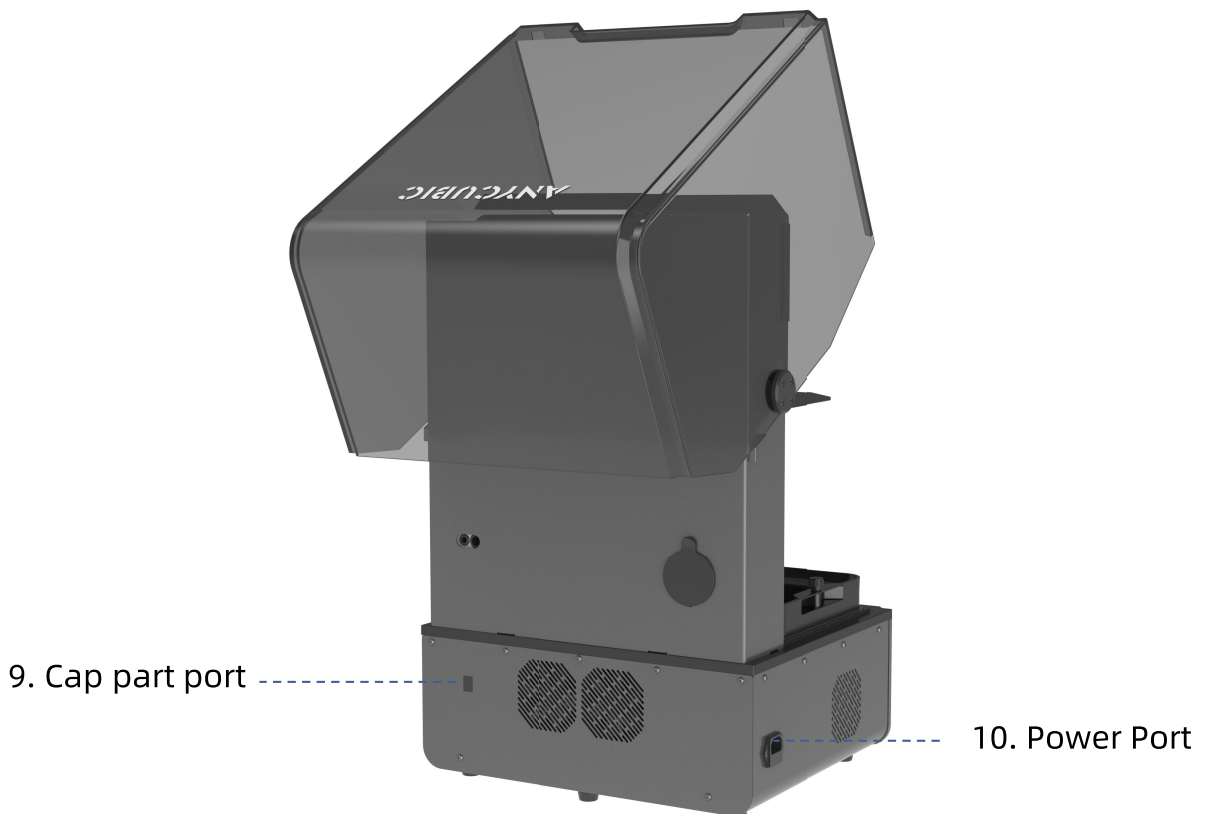
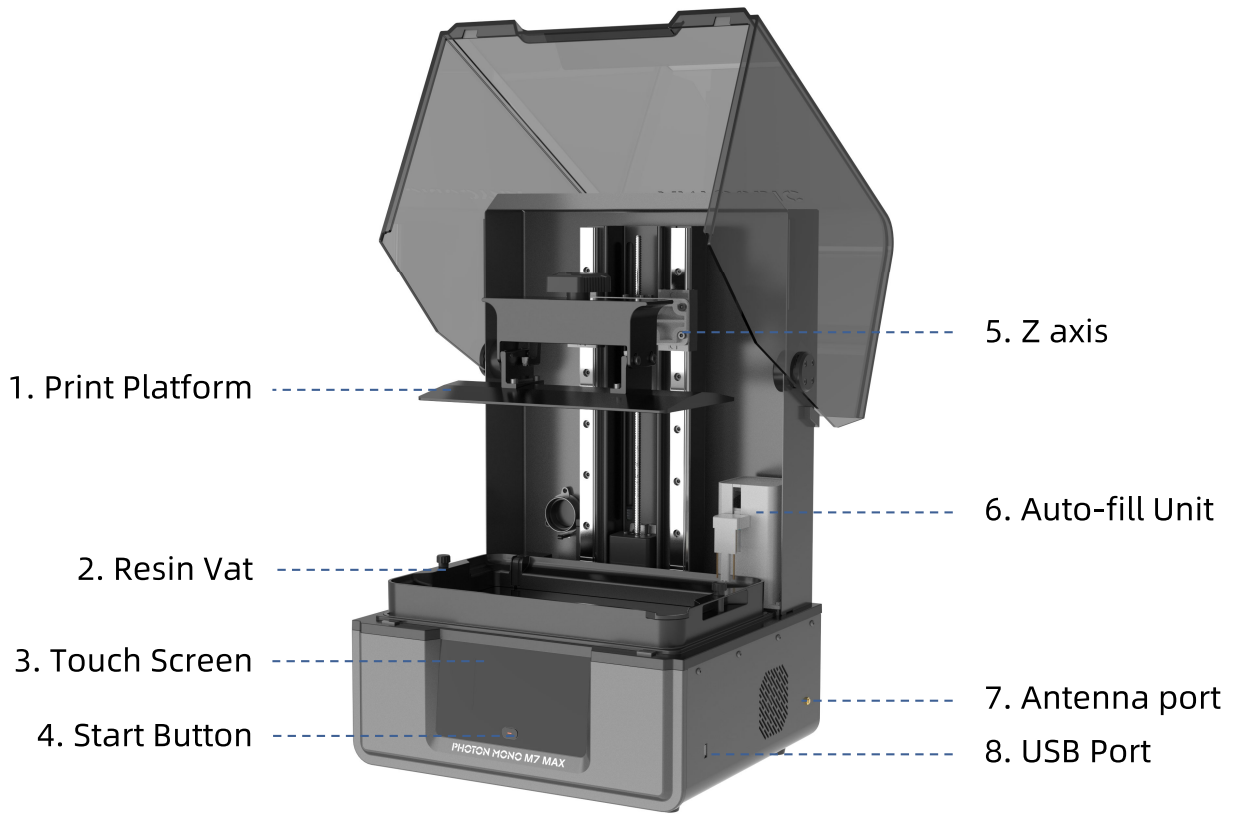

In the Box

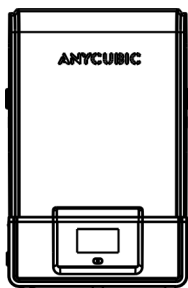

Photon Mono
M7 Max

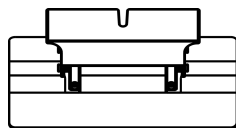

Print platform * 1

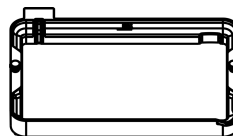

Resin vat * 1



Cap part of
auto-fill unit

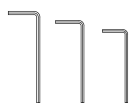

Hex key set



Protective
equipment

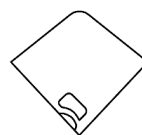

Filter



Scraper * 2



Leveling paper



Manual * 1



USB drive * 1



Power adapter



Power cord

Operating System

System	Photon Mono M7 Max
Touch Screen	4.3-inch Resistive Screen
Software	Anycubic Photon Workshop (also compatible with other software)
Connectivity	USB Drive, WLAN

Specifications

LCD screen	13.6 inch 7K
Light source	COB light
XY Resolution	6480* 3600
Z axis Accuracy	0.01 mm
Suggested Layer Thickness	0.01 ~ 0.15 mm

Physical Dimensions

Dimension	425 mm(L) *362 mm(W) *652 mm(H)
Build volume	297.5 mm(L) *164 mm(W) *300 mm(H)
Weight	24 kg

WLAN

Frequency Range	2.4 G (2.400~2.4835 GHz)
Work Mode	AP, STA, AP+STA mode

Recommended Print Parameters

Parameters Group	① Default Resin_Normal	② Default Resin_Fast	③ High Speed Resin
Layer Thickness	0.05 mm	0.1 mm	0.1 mm
Normal Exposure Time	2 s	3 s	1.6 s
Off Time	0.5 s		
Bottom Exposure Time	30 s	30 s	20 s
Bottom Layers	5	3	3
Z Lift Distance	8 mm	5 mm	5 mm
Z Lift Speed	6 mm/s	15 mm/s	15 mm/s
Z Retract Speed	6 mm/s	15 mm/s	15 mm/s
Anti-alias	1		
Notice	<p>1.If the print object needs high accuracy, please use group ① and modify the anti-alias level as 16 and the image blur as 3.</p> <p>2. The group ②③ apply to the model whose hollowed thickness is no more than 2mm.</p> <p>3. The group ②③ can significantly increase the print speed by cases test. To ensure the print success and print speed, do not modify the parameters casually.</p> <p>4. The group ②③ must work with the ACF release film this printer provided to avoid print failure. The film can be used to print 45000 layers.</p> <p>5. The group ③ only apply to Anycubic high speed resin.</p> <p>6. Refer to 18-19 pages for the instructions of parameter groups.</p>		

--The data above root in Anycubic lab, only for reference.

Menu Directory

Note: The current interface is for reference only. Please refer to the latest firmware for accurate information.

Home menu

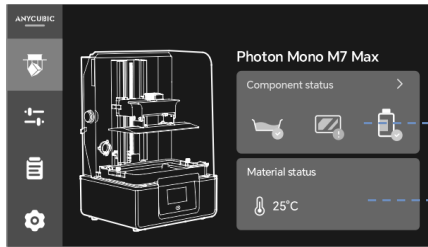

- 1. Heating resin vat connection
- 2. Statistic of print layers
- 3. Resin bottle connection

Resin temperature

Print

Print:

Switch to local/ USB drive/cloud file list

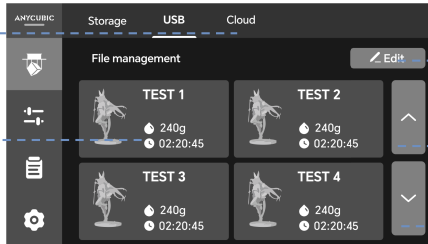

Edit files

Click to enter into file details

Page up

Page down

File Details:

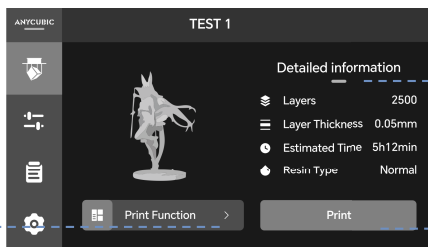

Print file information

Print function setting

Start the printing

Tools

Z-axis:

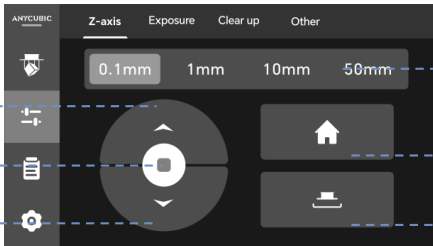

The screenshot shows the 'Z-axis' menu with a central directional pad and two buttons on the right. The menu is divided into four sections: 'Z-axis', 'Exposure', 'Clear up', and 'Other'. The 'Z-axis' section contains four buttons labeled '0.1mm', '1mm', '10mm', and '50mm'. The 'Other' section contains two buttons: a home icon and a printer icon.

Move the Z axis upwards

Stop moving the Z axis

Move the Z axis downwards

Move Z by 0.1mm /1mm/10mm/50mm

Return to zero

Enter in leveling interface

Exposure:

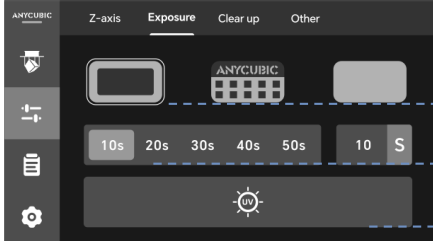

The screenshot shows the 'Exposure' menu with a central image selection area and a row of exposure time buttons. The menu is divided into four sections: 'Z-axis', 'Exposure', 'Clear up', and 'Other'. The 'Exposure' section contains a large image selection area with a grid of icons, a row of buttons labeled '10s', '20s', '30s', '40s', '50s', '10', and 'S', and a large button with a sun icon.

Choose an image to expose

Set the exposure time

Start exposure

Clear up:

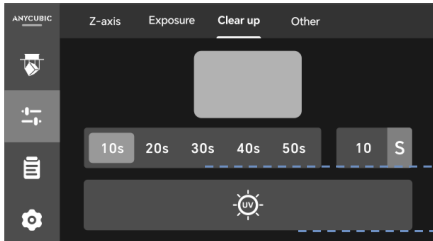

The screenshot shows the 'Clear up' menu with a central image selection area and a row of exposure time buttons. The menu is divided into four sections: 'Z-axis', 'Exposure', 'Clear up', and 'Other'. The 'Clear up' section contains a large image selection area, a row of buttons labeled '10s', '20s', '30s', '40s', '50s', '10', and 'S', and a large button with a sun icon.

Set the exposure time

Start exposure

Other:

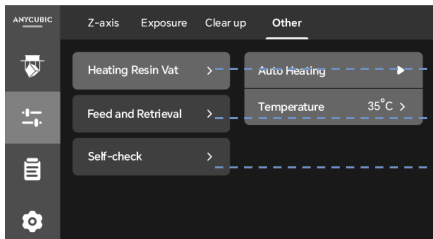

The screenshot shows the 'Other' menu with three menu items. The menu is divided into four sections: 'Z-axis', 'Exposure', 'Clear up', and 'Other'. The 'Other' section contains three menu items: 'Heating Resin Vat', 'Feed and Retrieval', and 'Self-check'. The 'Heating Resin Vat' item has a sub-menu with 'Auto Heating'. The 'Feed and Retrieval' item has a sub-menu with 'Temperature 35°C'.

Heating resin vat

Feed and Retrieval

Self-check

Tools

Other-Heating Resin Vat:

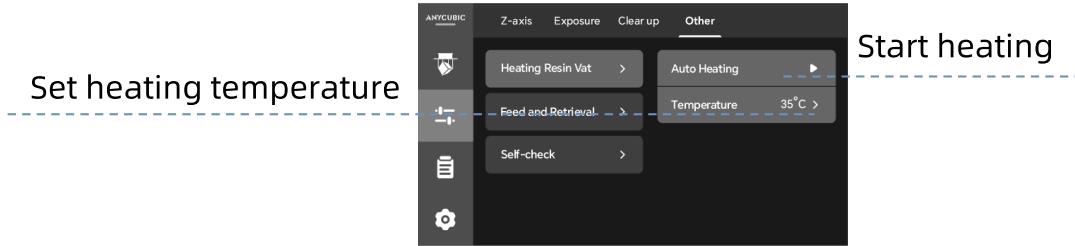

Other- Feed and Retrieval:

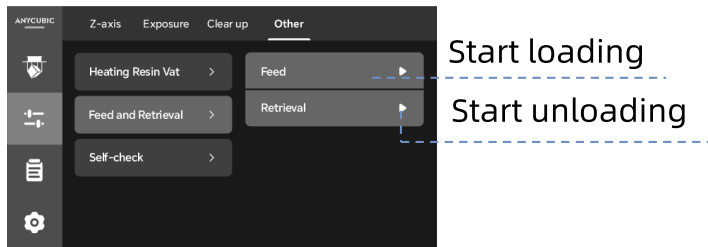

Other- Self-check:

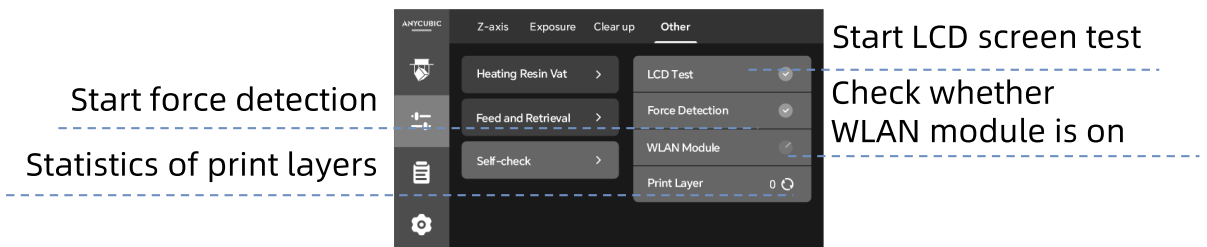

Menu Directory

Information

Print logs:

Click to check more details

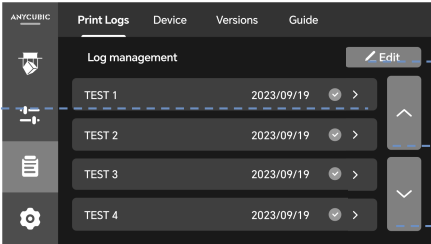

Edit print logs

Page up

Page down

Detailed description: This screenshot shows the 'Print Logs' menu. At the top, there are tabs for 'Print Logs', 'Device', 'Versions', and 'Guide'. Below the tabs is a 'Log management' section with an 'Edit' button. A list of logs is displayed, each with a name (TEST 1-4), a date (2023/09/19), and a right-pointing arrow. On the right side of the list, there are three vertical navigation arrows: a top arrow, a middle arrow, and a bottom arrow.

Device:

Used space/total space

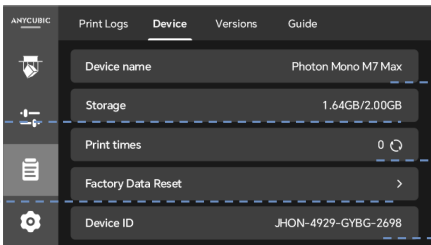

Machine type

Statistics of print times

Factory reset

Printer ID

Detailed description: This screenshot shows the 'Device' menu. It features a list of device information: 'Device name' (Photon Mono M7 Max), 'Storage' (1.64GB/2.00GB), 'Print times' (0), 'Factory Data Reset' (with a right-pointing arrow), and 'Device ID' (JHON-4929-GYBG-2698). On the left side, there are four vertical navigation arrows: a top arrow, a middle arrow, a bottom arrow, and a gear icon at the bottom.

Versions:

Application version

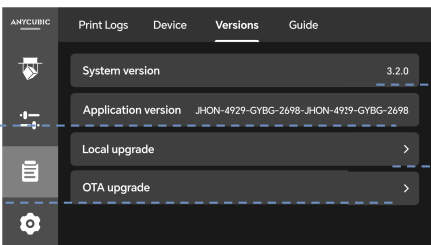

System version

USB upgrade

OTA upgrade

Detailed description: This screenshot shows the 'Versions' menu. It displays 'System version' (3.2.0) and 'Application version' (JHON-4929-GYBG-2698-JHON-4929-GYBG-2698). Below these are two upgrade options: 'Local upgrade' and 'OTA upgrade', both with right-pointing arrows. On the left side, there are four vertical navigation arrows: a top arrow, a middle arrow, a bottom arrow, and a gear icon at the bottom.

Guide:

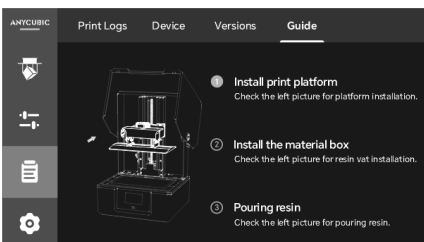

Detailed description: This screenshot shows the 'Guide' menu. It features a central image of the printer with three numbered steps: 1. 'Install print platform' (Check the left picture for platform installation.), 2. 'Install the material box' (Check the left picture for resin vat installation.), and 3. 'Pouring resin' (Check the left picture for pouring resin.). On the left side, there are four vertical navigation arrows: a top arrow, a middle arrow, a bottom arrow, and a gear icon at the bottom.

Menu Directory

Settings

App:

App connection

App connection

WLAN connection status

WLAN connection

Printer's hotspot (which is hidden when the network is connected)

Scan code to install Anycubic App
Log in to the App and scan the QR code to add the printer

The screenshot shows the 'App' settings menu. At the top, there are tabs for 'App', 'WLAN', 'Language', and 'System'. Below the tabs, there are three main sections: 'WLAN' (status: Not connected), 'Anycubic App' (status: Not connected), and 'Printer hotspot' (status: On). At the bottom, there is a QR code and text: 'Scan code to install Anycubic App. Log in to the App and scan the QR code to add the printer.'

WLAN:

Set server

IP address

WLAN connection

Check printer's CN

Mac

The screenshot shows the 'WLAN' settings menu. It lists several configuration options: 'WLAN' (status: Anycubic), 'Server Location' (status: Global), 'CN' (status: 4E-74-Da-0C-D3-F1), 'IP' (status: 10.2.32.104), and 'Mac' (status: 4E-74-Da-0C-D3-F1).

Language:

Set the language

The screenshot shows the 'Language' settings menu. It lists several language options: 'English', 'Deutsch', 'Español', 'Italiano', '简体中文', 'Русский язык', 'Français', and '日本語'. The '简体中文' option is currently selected.

System:

Turn on/off the sound and screen calibration

Format internal storage/ USB file

Repair the storage

Information

The screenshot shows the 'System' settings menu. It lists several system options: 'Basic settings', 'Storage repair', 'Format', 'About', 'Sound', and 'Screen calibration'. The 'Sound' option is currently turned on.

Preparations

Please place the 3D printer on a stable, level workbench and operate it in an open, well ventilated area away from sunlight. Refrain from using the printer in areas with ultraviolet light sources (such as fluorescent lamps or UV disinfection lamps) to prevent poor printing results. For the first use, please follow the instruction to finish the preparations.

1. Unbox, and take out the machine and its accessories, and inspect them.
2. The screen protector is installed on the LCD screen. Please peel off the protective film upon it.

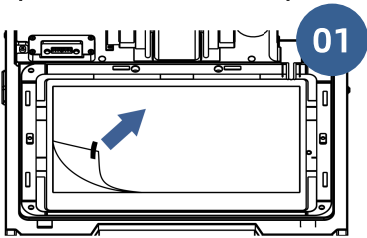

3. Install antenna.

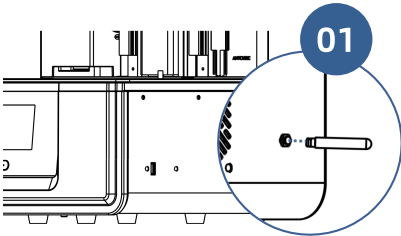

4. Connect to the power cord and press the start button to turn on the printer. To Power off, hold down the start button for 2 seconds.

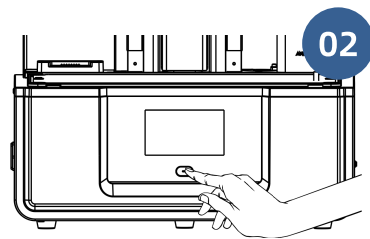
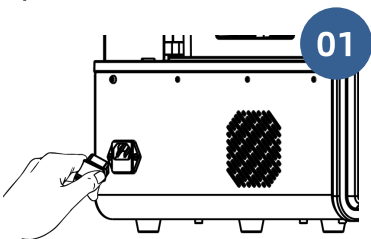

5. Set the system language and choose server location. Users in mainland Chinese please select "China", users in other countries and regions please select "Global". Then, complete the setup steps.

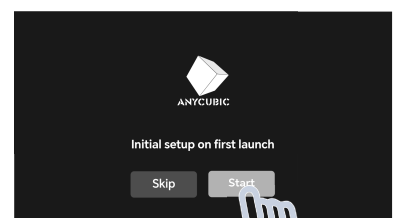
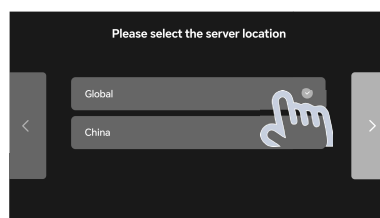

Preparations

6. Install the print platform.

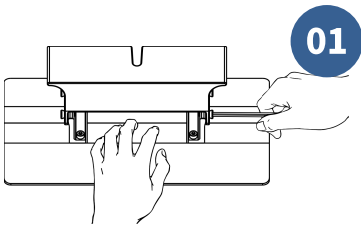

Loosen the four screws on the print platform

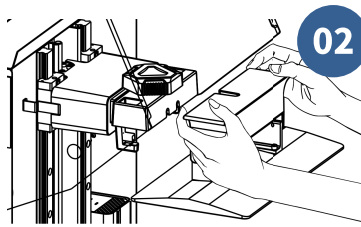

Push the platform onto the platform carrier

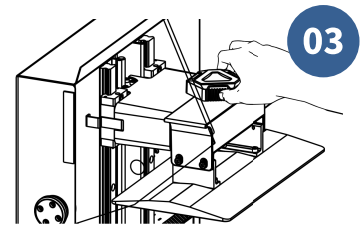

Tighten the knob

7. Leveling.

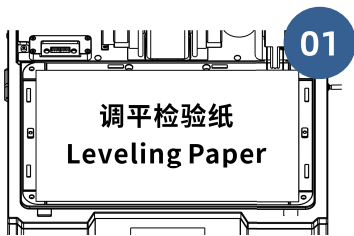

Place the leveling paper on the LCD screen

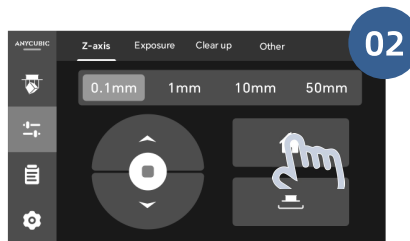

Click Leveling button

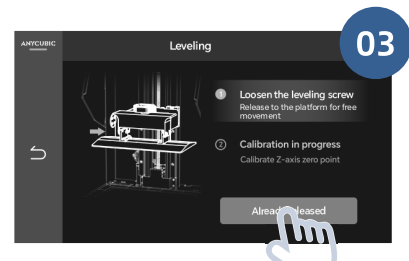

Start Leveling

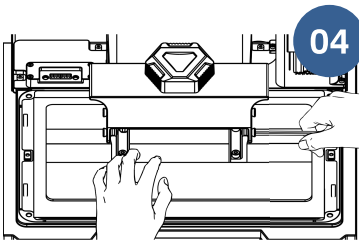

Press the platform gently, tighten the four screws

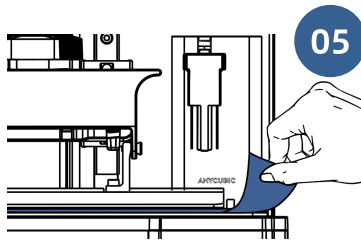

When pulling the leveling paper, there is a significant resistance or it cannot be pulled out

8. Set the zero position.

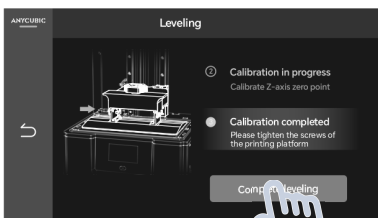

Preparations

9. Choose an exposure image to test after the platform stops moving. Please close the lid before starting exposure.

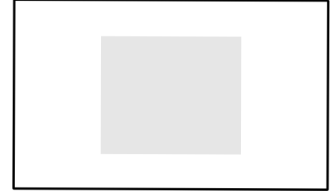
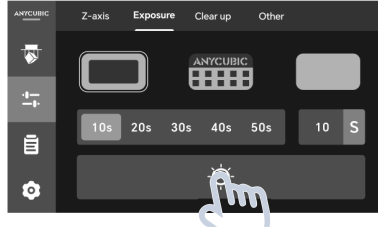
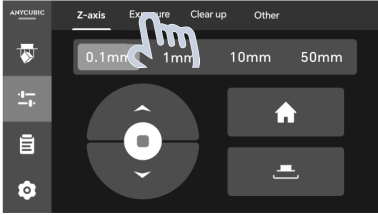

The white part is the exposure area

10. Install the resin vat.

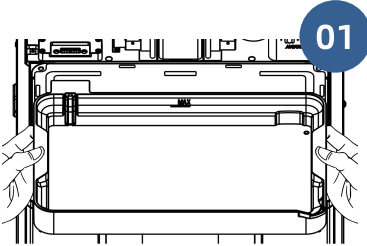

Put the resin vat upon the LCD screen

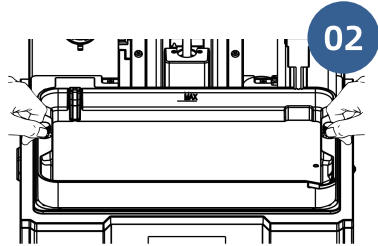

Slightly adjust the position of vat until the two knobs can be tightened

11. Install the auto-fill unit (optional). Please remove the seal from the resin bottle first, as any residual seal on the bottle mouth may cause poor air tightness and affect the automatic feeding.

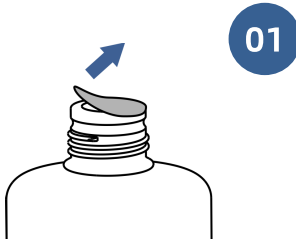

Remove the seal from Anycubic 1kg resin bottle

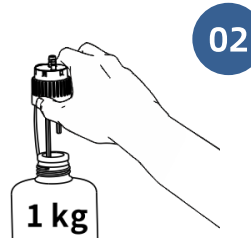

Insert the cap part to the resin bottle and tighten it

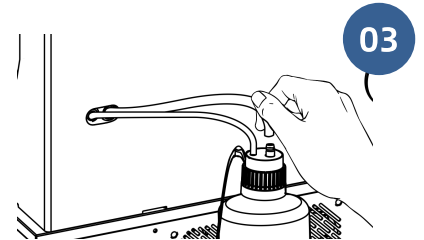

Connect the two pipes to the cap part

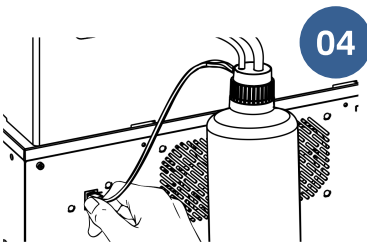

Insert the wire into the port on the back

Preparations

Attention:

1. It is suggested to use the resin with a viscosity below 2000pcs, and place the resin bottle behind or on the right side of the printer.
2. Never vigorously shake or turn over the resin bottle when the cap part is installed. If the inside of the cap is stained by resin, please immediately clean it to avoid malfunction or damage to auto-fill unit.
3. The operating temperature for auto-fill unit is 10-40°C and the humidity range is 20-80%. For optimal performance, do not exceed these limits. If using Anycubic Bio Resin or Anycubic Rigid 100 Resin, the recommended ambient temperature is over 25°C. Otherwise, the functions of auto-fill unit may fail.

It is suggested to wear gloves and a mask for subsequent operations, as the contact with resin or smell of the resin may cause your discomfort.

12. Check the release film. If the film is broken, replace it immediately to avoid further damage to the 3D printer.

13. Slowly pour the resin into the vat and make sure the resin is within the vat's maximum scale.

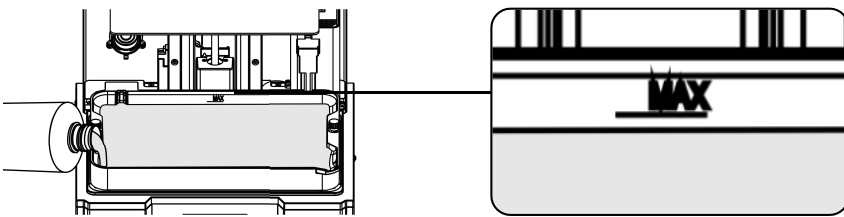

14. Close the lid.

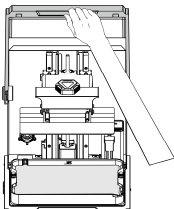

Start printing on 3D printer

1. Use Anycubic Photon Workshop software to process the 3D model file. The installer and instructions is saved in the USB drive.
2. When you set the parameters in Anycubic Photon Workshop, there are three groups of parameter which can be apply to the print with different needs. The included USB drive also provides normal, fast and high speed mode slice files that can be used for print test. You can choose a file to print according to your personal requirements.

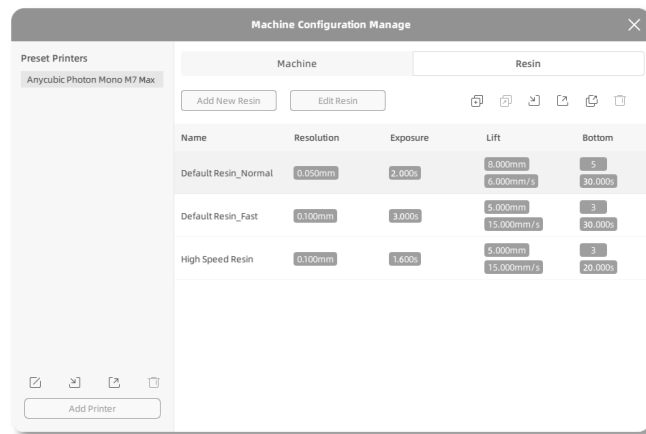

Choose the parameter group according to the personal requirement

① Default Resin_Normal: print at normal speed

- Apply to all Anycubic resin.
- If the print object needs high accuracy, please modify the anti-alias level as 16 and the image blur as 3.

② Default Resin_Fast: print relatively fast through optimizing the Z-axis motion control

- Apply to all Anycubic resin.
- The layer thickness is 0.1 mm.
- Apply to the model whose hollowed thickness is no more than 2mm.
- The ACF release film is necessary to avoid print failure. It can be used to print 45000 layers.

③ High Speed Resin: print at high speed through optimizing the Z-axis motion control

- Only apply to the Anycubic high speed resin.
- The layer thickness is 0.1 mm.
- Apply to the model whose hollowed thickness is no more than 2mm.
- The ACF release film is necessary to avoid print failure. It can be used to print 45000 layers.

3. Save the sliced file to USB drive.

4. Insert the USB drive to the printer.

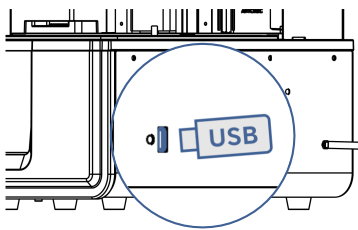

USB drive:

1. It is recommended that use the USB drive we provide. If you are using your own USB drive, please ensure that it is formatted to **FAT/FAT 32** and has a memory size of less than **64G**.
2. To ensure proper file reading, please put print files in the root directory of USB drive.

5. Then, choose a file to print.

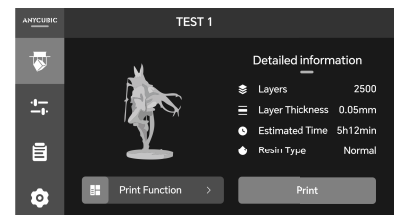
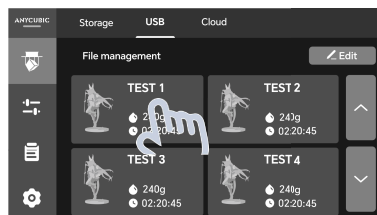
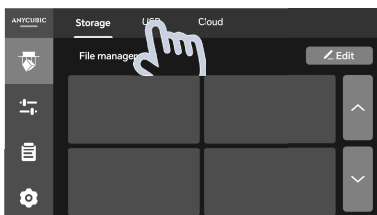

Start Printing

6. Set the print functions(optional). When the setting is finished, start the printing.

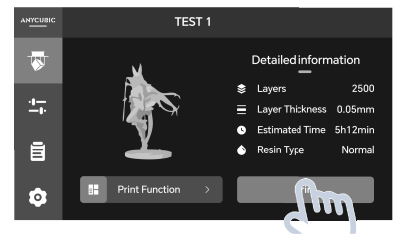
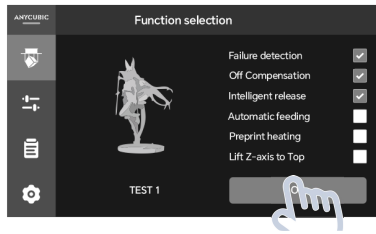
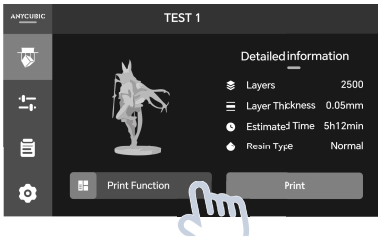

-Failure detection: During printing, the printer automatically monitors the conditions which may cause print failure to avoid wasting resin or damaging to the printer. When the printer detects an abnormal condition, it will pause the print job automatically and pop up the error report. Please check the sliced file and the model according to the report. The failure detection is enabled by default.

Bottom non-stick detection

It checks whether the model sticks to the print platform.

When the printer detects that the model does not stick the platform, please check the bottom exposure time of the sliced file.

-Off compensation:

(1) When the exposure area is large during printing, due to the surface tension and the resin characteristic, there may be problems such as delay of Z-axis or delay of resin reflowing, resulting print failure. It is suggested to enable exposure off compensation to improve success rate.

(2) It also has an intelligent speed control function. When a layer area is large, the printing speed can be adjusted to address issues such as model cracking or printing failures caused by excessive pressure and release force, improving the success rate and printing quality.

(3) Off compensation, which is enabled by default, adds print time. If the print objects or their areas of layers are small, you can disable the function.

-Intelligent release: The function can improve the printing success rate by optimizing algorithm. Enabling intelligent release while printing with the default resin_normal parameter group can also increase printing speed. The function is disabled by default.

- Automatic feeding: The resin will be automatically fed in when printing starts. Please install the auto-fill unit before using.

TIPS: When using resin with a viscosity over 500cps at room temperature (25°C), the resin bottle may experience slight deflation or inflation due to pressure changes. This is normal and does not affect loading and unloading.

-Preprint heating: When the ambient temperature is below 20 °C, it may cause the detachment of printed bottom or partial loss of printed objects. You can enhance the printing effect by enabling preprint heating.

Enable preprint heating. The printing starts when the resin temperature reaches 25 °C.

Attention: When the resin vat heats up for a long time, its surface temperature becomes high. Avoid touching the resin vat without protection after heating.

-Lift Z-axis to top: When the printing is completed, the printing platform will lift to the top.

7. Before printing, the printer checks the hardware condition, resin volume and residue before each print job. When there is an error, the printer will pop up the error QR code. Please scan the code and follow the guide.

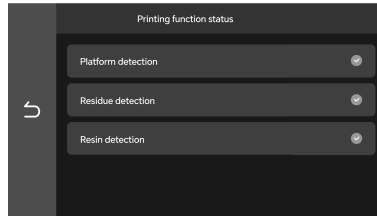

-Platform Detection: Before printing, check whether the print platform is installed.

-Residue Detection: Before printing, check if there are the solid residues (height ≥ 3 mm, cross section ≥ 9 mm²) in the resin vat. If residues are detected, please clean the vat and check again.

-Resin Detection: Before printing, check whether the resin in the vat is sufficient to finish the print job. Usually, the required volume is a little more than the volume estimated by the slice software.

Start Printing

Start printing on Anycubic App

Please connect the printer to Anycubic App first for remote control.

1. Connect to the network.

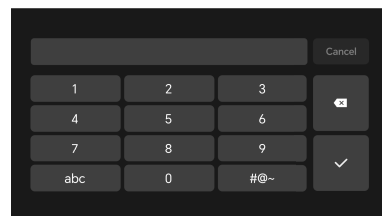
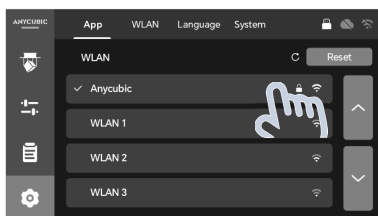
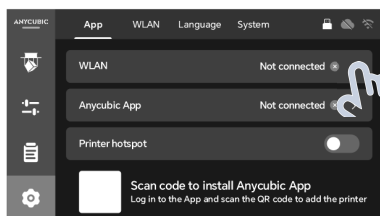

2. Please search "Anycubic" in App Store or Goolge Play, or scan the QR code on the printer, to download Anycubic App. Then, sign up and sign in.

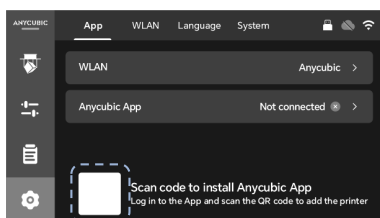

3. Add a printer on Anycubic App.

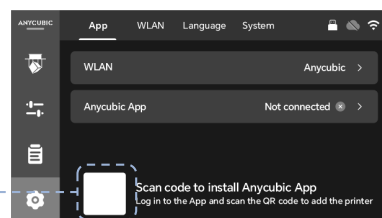
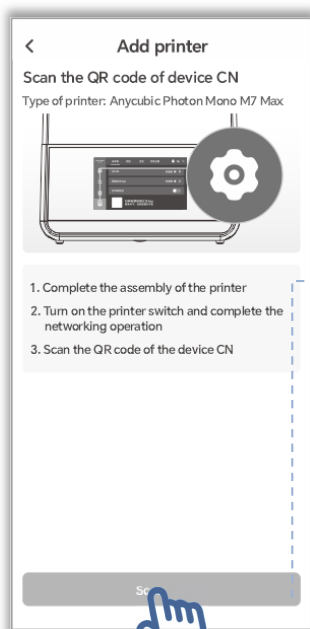

Scan the QR code to add printer

4. Start print on the Anycubic App.

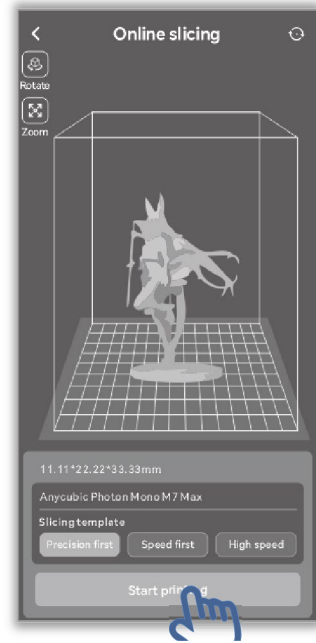
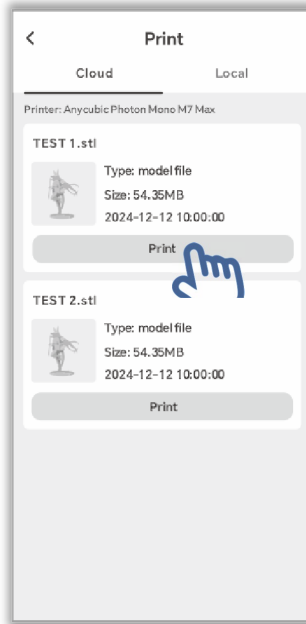
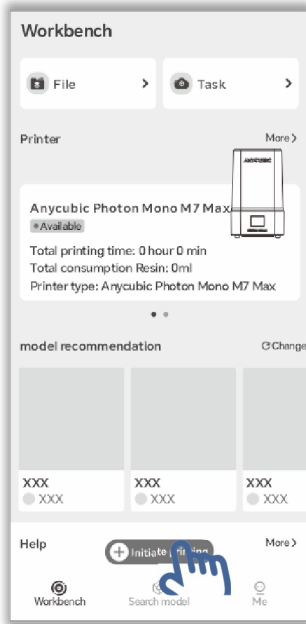

Start printing on Anycubic Photon Workshop

Run the installer in the USB drive to install Anycubic Photon Workshop slicing software. Then, log in and bind your printer for starting printing on the software. For details, refer to the instructions of Anycubic Photon Workshop in the USB drive.

Resin Recycling

1. After printing, remove the platform when resin stop dropping from the platform. Remove the model by metal scraper and then wash it with 95% alcohol or other detergent. Then, dry and post-cure the model.
2. After printing, click “Unload” to recycle the resin. Use a plastic scraper to guide resin to the output of the auto-fill unit, facilitating the unloading process. However, if the printing fails, do not enable the unloading function to prevent the auto-fill unit from blocking or being damaged.



2. Enable the vat cleaning function when the resin is partially cured to avoid the damage to the LCD screen and the printer.

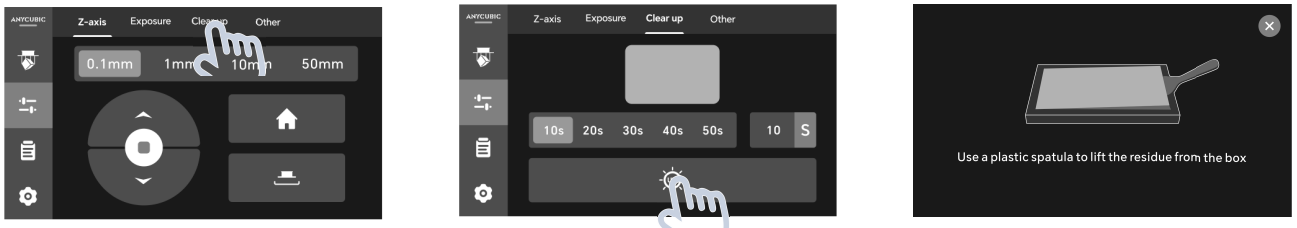

Remove resin sheet by plastic scraper

3. If there is any remaining resin, please pour it out through a vat spout and recycle it with a filter and a funnel. The model file of funnel is saved in the included USB drive, please print the model according to your personal requirements.

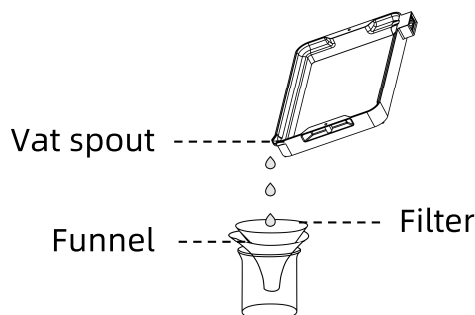

4. If you do not use the 3D printer for a long time, please clean the resin vat timely and store the resin in an airtight container away from light.

Resin Exposure Range Finder

“R_E_R_F” is an abbreviation for “Resin Exposure Range Finder” . This function is used to find out the optimal exposure parameters for different resins.

1. Import the R_E_R_F file which is saved on USB drive into the slicing software. There are eight models in the file. The exposure time for model 1 is equal to "normal exposure time (s)" of the file, and the exposure time for other models will be increased by an increment of **0.25 s**.

For example:

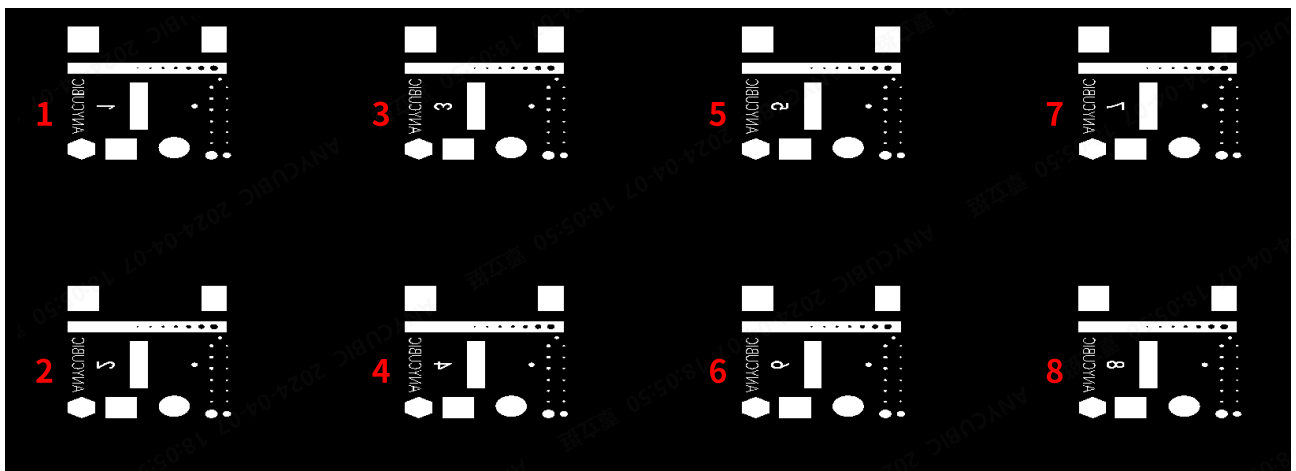

The numbers on the models indicate the order

2. According to the personal requirement, adjust the exposure time of the models by modifying "normal exposure time (s)" of the file. When exposure time for Model No. 1 is changed, the exposure time for other models will be increased by an increment of **0.25 s**.

For example, when normal exposure time is set to 1.5 s, the exposure time for Model No.1-8 is: 1.5 / 1.75 / 2 / 2.25 / 2.5 / 2.75 / 3 / 3.25 s.

3. After printing, remove and clean the models. Compare the print effect of models and choose the model's exposure time that meets your needs as the print parameter. Take a comparison of model A&B as an example.

Resin Exposure Range Finder

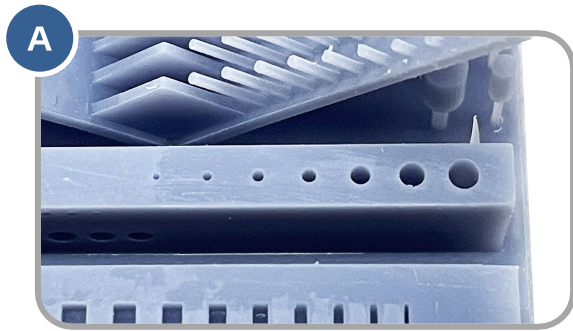

More holes

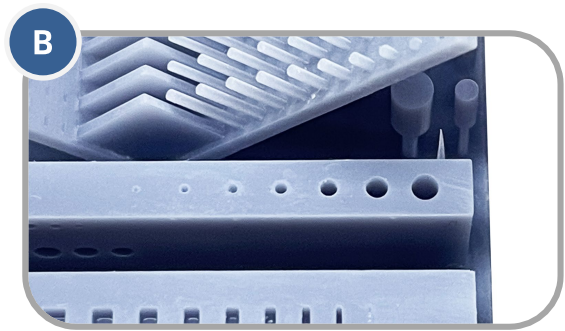

Less holes

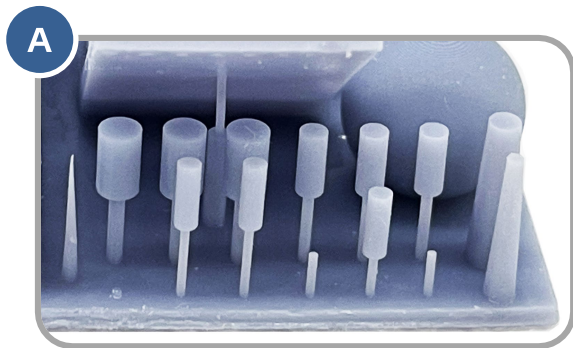

Less cylinder

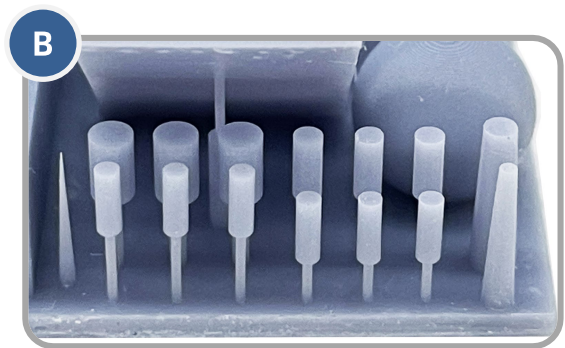

More cylinder

- Model A has more holes and fewer cylinder. If you print by the parameter of model A, more details of model can be printed with high risk of failure.
- Model B has fewer holes and more cylinder. If you print by the parameter of model B, model may be printed successfully yet with some details lost.

In addition, you can compare the bridges, needles or other parts to choose a proper model and find the parameter. If none of them can be chose, adjusting the "normal exposure time (s) " is suggested.

Notice: DO NOT change the file name of "R_E_R_F" , because Anycubic 3D printer can only recognize THIS file name to run this function. Also, do not name other file as "R_E_R_F" .

Maintenance

Resin Vat Maintenance

- **Remove the cured resin from release film:** Set Cleaning and then remove the cured resin sheet to protect the film. Do not use sharp objects to scrape off the residues from the film.

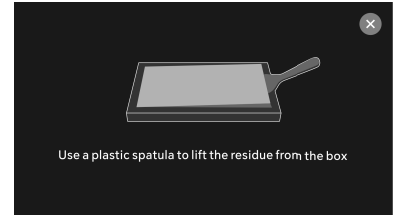
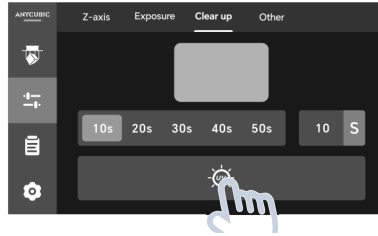

Remove resin sheet by plastic scraper

- **Release film replacement:** The statistics of print layers are shown in Home menu. Please check them and replace release film timely to avoid print failure or even the damage to printer.

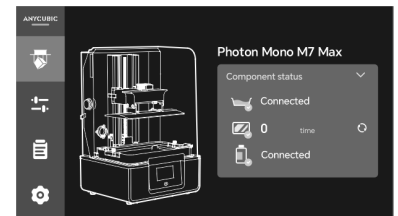
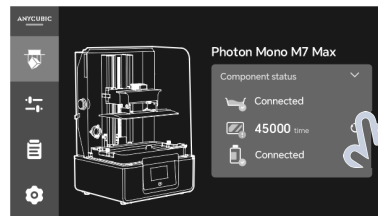
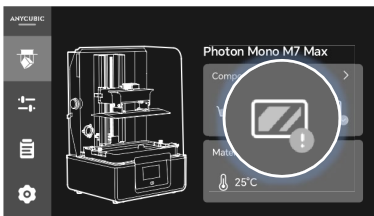

Click reset button after replacement

- If you do not use the resin for over 48H, store it in an airtight container away from light.
- If resin is stained on the resin vat, wipe it off timely.

Z-axis Maintenance

If Z axis makes a noisy sound, please apply lubricant to Z lead screw.

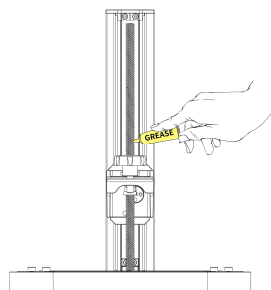

Firmware Upgrade

- **USB upgrade:** Visit the official website to download the firmware and save it onto a USB drive that doesn't save any other version of firmware. Then, insert the USB drive to printer to upgrade.
- **OTA upgrade:** If the network is connected, directly upgrade by OTA.

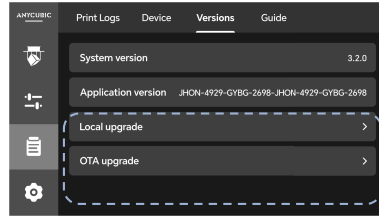
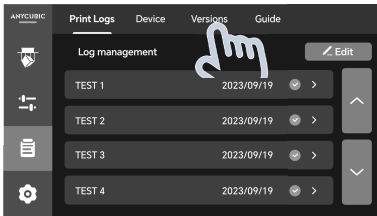

Cleaning

- **Clean the print platform:** Clean platform with alcohol and paper towel.
- **Protect LCD screen:** If there is resin being cured on the screen protector, please replace the protector immediately.
- **Clean the body of printer:** Clean the body of the printer with alcohol.

Complete the initial trouble shooting steps by referring to the following proposed solutions, or contact our technical support for additional assistance.

Print

1. Model do not stick to platform

- Bottom exposure time is insufficient. Please increase the exposure time.
- Contact area between the model and platform is small. Please add a raft.

2. Layer separation or splitting

- The machine is not stable during printing.
- The release film is not tight enough or needs a replacement.
- The printing platform or resin vat is not tightened.
- The lift speed is too fast.
- The model is hollowed without punching.

3. Layer shift

- Add supports.
- Reduce the lift speed.

4. Floccules left in resin vat or attached to models

- The exposure time is too long. Reduce the normal exposure time and bottom exposure time.

Cloud connection

1. WLAN connection is failed

- WLAN name or password is wrong. Please reset the network and reconnect.
- The WLAN network is unavailable. Join an available network. Then, reset the network and reconnect.

2. Fail to add printer in App

- Check "Server Location" . Users in mainland Chinese please select "China", users in other countries and regions please select "Global".

Complete the initial trouble shooting steps by referring to the following proposed solutions, or contact our technical support for additional assistance.

Auto feeding & Retrieval

1. The printer prompts that resin in the vat is not enough before printing.

- The auto-fill unit has a poor connection to the printer. Please reinstall the auto-fill unit and then click “OK” .
- The auto-fill unit has been malfunctioned because resin entered in the air pipe.

2. The resin in the bottle is sufficient, but the printer prompts no resin in the bottle.

- The cap part has a poor connection to the printer. Please reinsert the cap part wire.

3. The resin liquid level reaches the needles of the auto-fill unit. However, when you click “Retrieval” , the printer immediately prompts that retrieval completes.

- The thumb screws securing the resin vat are not tightened. Please stop unloading and tighten the thumb screws.

Thank you for purchasing Anycubic products! Under normal usage and service, the products have a warranty period of up to one year. Please visit Anycubic support center(support.anycubic.com/en) to report any issues with Anycubic products. Our professional after-sale service team would respond within 24 hours and solve the issues.