

Meril

Orthopedics

LATITUD<sup>™</sup> | HIP SYSTEM  
Freedom of Choice  
Proximally Coated Stem

YES TO  
NEXT

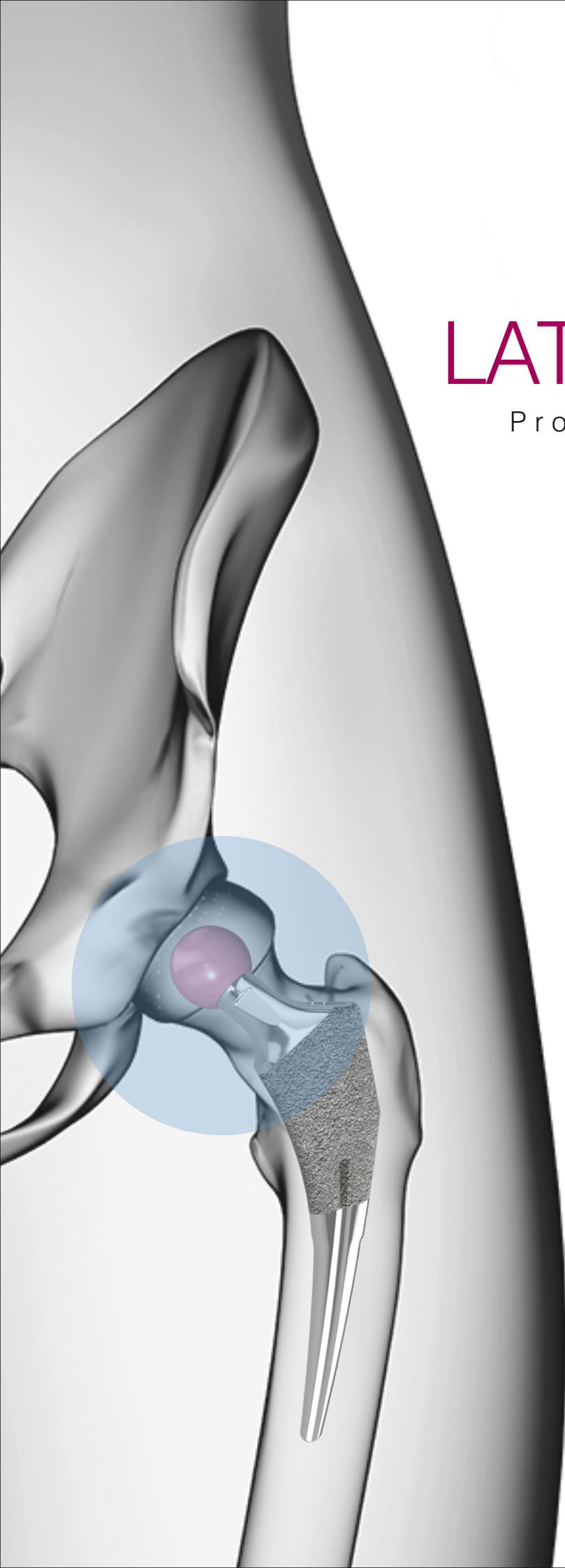

## Features



Latitud™ is a next-generation, high performance hip system. It is designed to deliver an efficient, predictable and flawless clinical experience.

### Product Highlights

- Optimized proximal/distal geometry
- Enhanced proximal offloading
- Incremental sizing
- Flexibility of Ti alloy with porous coating for natural load transfer and tissue strength<sup>3</sup>
- Wide range of motion
- Ideal choice for minimally invasive surgery
- Bone and soft tissue preservation



1. Standard proximally coated stem
2. Distally reduced proximally coated stem

*Note:*

Both the stems are 12/14 Universal taper and available in three different type of neck angles.

- 132° Standard
- 132° Lateral(High Offset)
- 128° Standard

## Stem (Standard & High Offset)

Polished Anterior-Posterior Neck Flats  
Increase ROM by geometrically reducing the potential for impingement of the neck with the cup

Rotational Stability Insertion Hole  
Provides rotational stability upon implantation

TPS Coating (Ti Growth-C)  
Allows for initial scratch-fit stability and bone fixation

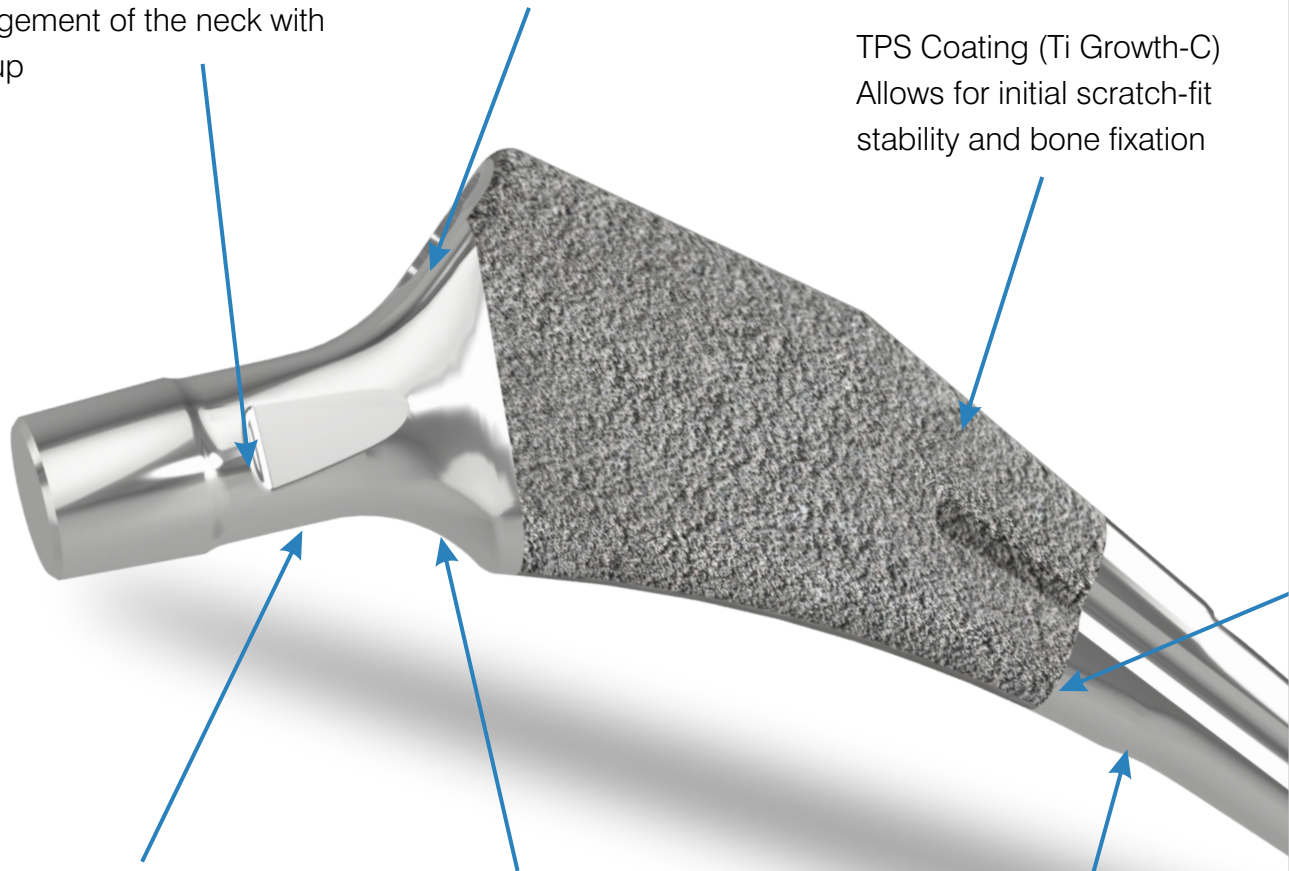

Optimal Neck Angle  
Available in standard (132°) and high offset (128°) for intraoperative adjustment

Offset Option  
Standard and high offset options reproduce various patient anatomies without lengthening the leg

Reduced Distal Transition  
Enhances implant fit in femoral canals with a proximal/distal mismatch



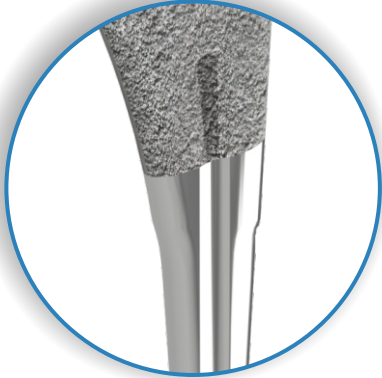

Distal Reduction

Flat Tapered Wedge  
Geometry

Enhances proximal offloading and  
bone preservation and provides for  
rotational stability

Titanium Alloy Ti-6AL-4V  
Flexibility of titanium allows for  
stress transfer to preserve  
cortical density

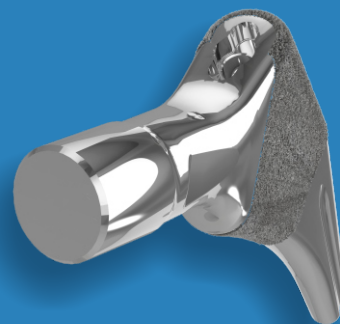
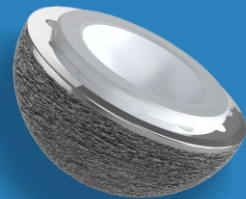
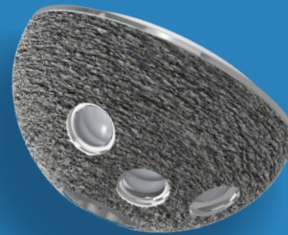
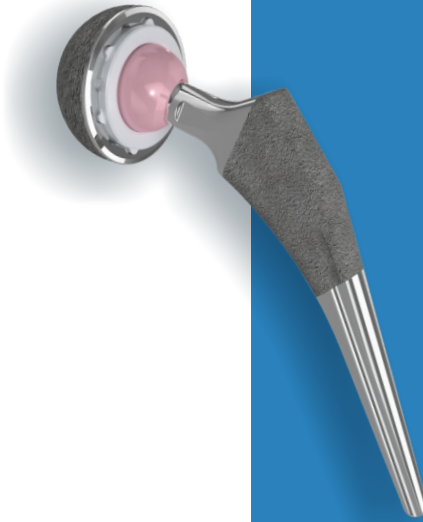
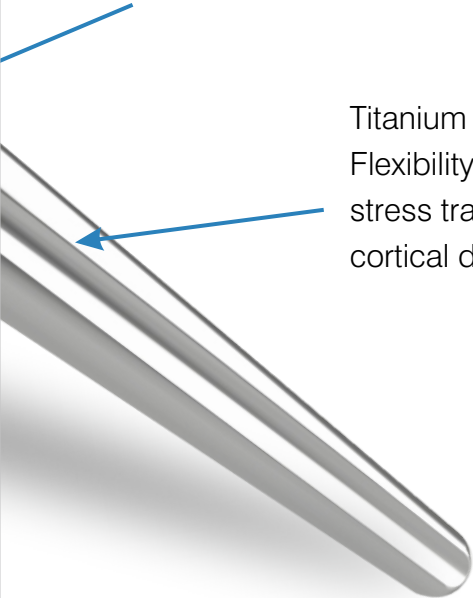

# Size Matrix

Meril Proximally Coated Stem - Size Matrix			
	132° Standard	132° Lateral	128° Standard
Standard	4.0	4.0	4.0
	5.0	5.0	5.0
	6.0	6.0	6.0
	7.0	7.0	7.0
	8.0	8.0	8.0
Distally Reduced	9.0	9.0	9.0
	10.0	10.0	10.0
	11.0	11.0	11.0
	12.0	12.0	12.0
	13.0	13.0	13.0
	14.0	14.0	14.0
	15.0	15.0	15.0
	16.0	16.0	16.0
	17.0	17.0	17.0
	18.0	18.0	18.0
	20.0	20.0	20.0
	22.0	22.0	22.0
24.0	24.0	24.0	

# Offset and Angle

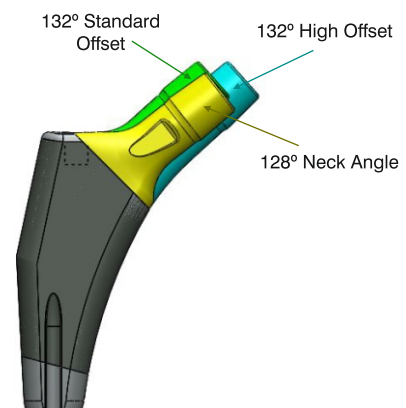
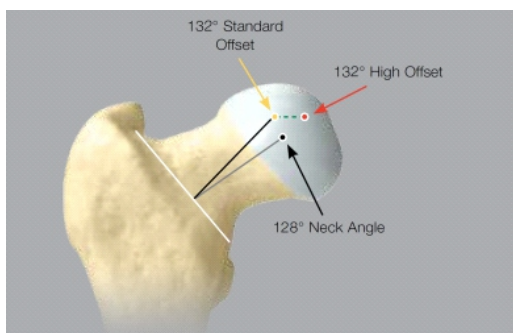

The 132° stem option has the same stem geometry, but provides a neck angle of 128° and standard neck length. These unique design features help to address femurs with more varus neck by allowing an additional offset; properly restoring hip bio-mechanics and soft tissue tensioning.

# Horizontal Offset

Meril Proximally Coated Stem - Horizontal Offset						
Size	132° Standard		132° Lateral		128° Standard	
	Standard	Distally Reduced	Standard	Distally Reduced	Standard	Distally Reduced
4.0	36.0		43.8		37.6	
5.0	36.3		44.1		37.9	
6.0	36.6		44.4		38.2	
7.0	37.1		44.9		38.7	
8.0	37.6		45.4		39.2	
9.0		38.1		45.9		39.7
10.0		38.6		46.4		40.2
11.0		39.1		46.9		40.7
12.0		39.6		47.4		41.2
13.0		40.1		47.9		41.7
14.0		40.6		48.4		42.2
15.0		41.1		48.9		42.7
16.0		41.6		49.4		43.2
17.0		42.1		49.9		43.7
18.0		44.8		52.6		44.2
20.0		45.8		53.6		45.2
22.0		46.8		54.6		46.2
24.0		47.8		55.6		47.2



# Vertical Offset

Meril Proximally Coated Stem - Vertical Offset						
Size	132° Standard		132° Lateral		128° Standard	
	Standard	Distally Reduced	Standard	Distally Reduced	Standard	Distally Reduced
4.0	31.0		31.0		28.0	
5.0	31.0		31.0		28.0	
6.0	31.0		31.0		28.0	
7.0	31.0		31.0		28.0	
8.0	31.0		31.0		28.0	
9.0		31.0		31.0		28.0
10.0		31.0		31.0		28.0
11.0		31.0		31.0		28.0
12.0		31.0		31.0		28.0
13.0		31.0		31.0		28.0
14.0		31.0		31.0		28.0
15.0		31.0		31.0		28.0
16.0		31.0		31.0		28.0
17.0		31.0		31.0		28.0
18.0		33.0		33.0		28.0
20.0		33.0		33.0		28.0
22.0		33.0		33.0		28.0
24.0		33.0		33.0		28.0

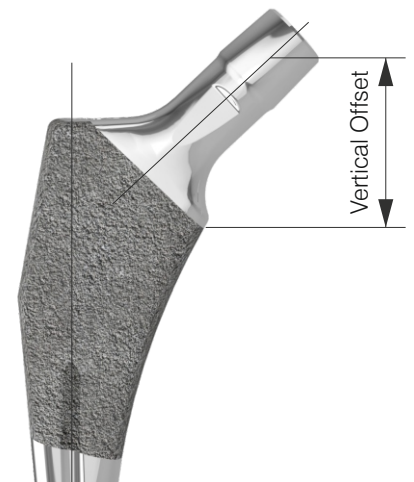

# Neck Length

Meril Proximally Coated Stem - Neck Length						
Size	132° Standard		132° Lateral		128° Standard	
	Standard	Distally Reduced	Standard	Distally Reduced	Standard	Distally Reduced
4.0	31.5		37.0		30.5	
5.0	31.5		37.0		30.5	
6.0	31.5		37.0		30.5	
7.0	31.5		37.0		30.5	
8.0	31.5		37.0		30.5	
9.0		31.5		37.0		30.5
10.0		31.5		37.0		30.5
11.0		31.5		37.0		30.5
12.0		31.5		37.0		30.5
13.0		31.5		37.0		30.5
14.0		31.5		37.0		30.5
15.0		31.5		37.0		30.5
16.0		31.5		37.0		30.5
17.0		31.5		37.0		30.5
18.0		34.5		40.0		30.5
20.0		34.5		40.0		30.5
22.0		34.5		40.0		30.5
24.0		34.5		40.0		30.5

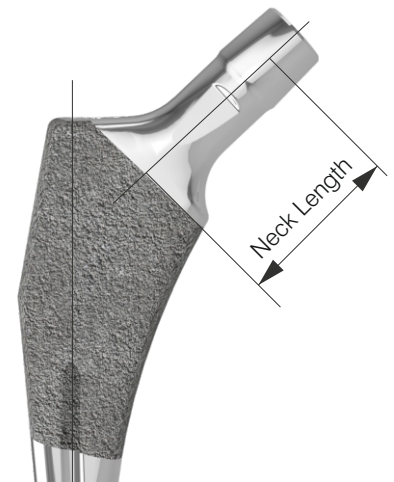

## Standard

## Distally Reduced

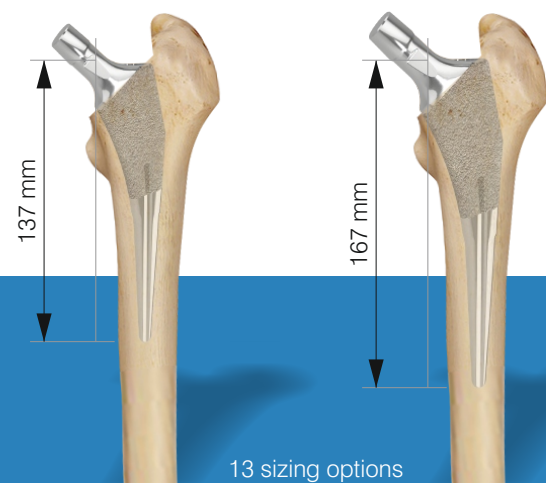
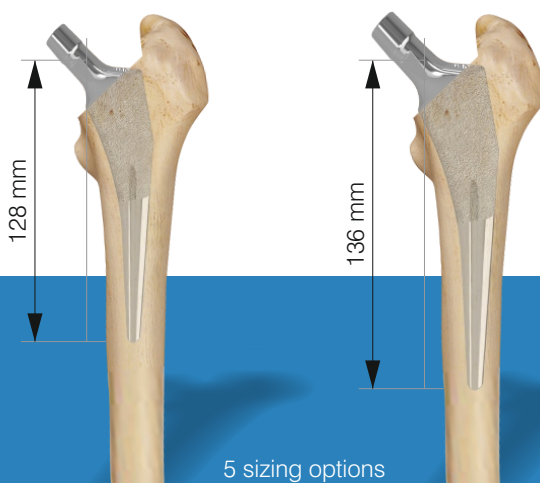

"Multiple studies suggest that, in the patient with high quality proximal bone, proximally coated stem may provide more physiological loading without sacrificing primary implant stability."



# Stem Length

Meril Proximally Coated Stem - Stem Length						
Size	132° Standard		132° Lateral		128° Standard	
	Standard	Distally Reduced	Standard	Distally Reduced	Standard	Distally Reduced
4.0	128		128		128	
5.0	130		130		130	
6.0	132		132		132	
7.0	134		134		134	
8.0	136		136		136	
9.0		137		137		137
10.0		140		140		140
11.0		142		142		142
12.0		144		144		144
13.0		146		146		146
14.0		148		148		148
15.0		150		150		150
16.0		152		152		152
17.0		154		154		154
18.0		156		156		156
20.0		160		160		160
22.0		164		164		164
24.0		167		167		167

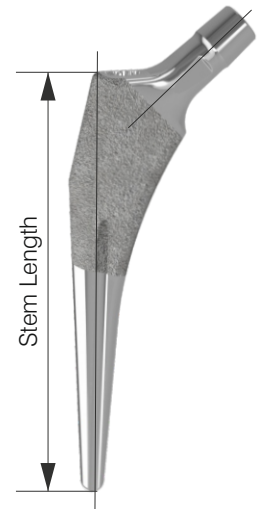

# Distal Reduction As Per Stem Sizes

Stem Sizes	Distal Reduction (mm)
9.0	1
10.0	2
11.0	2
12.0	2
13.0	2
14.0	3
15.0	3
16.0	3
17.0	4
18.0	4
20.0	4
22.0	4
24.0	4

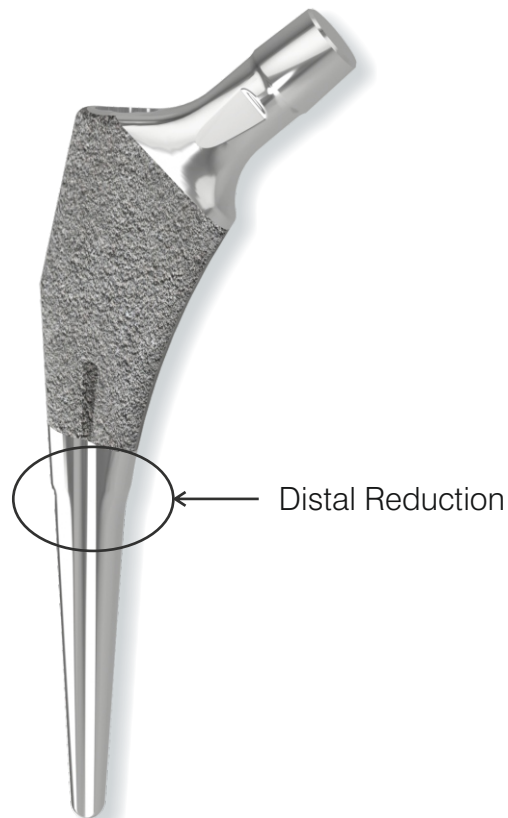

# Acetabular Cup System Options

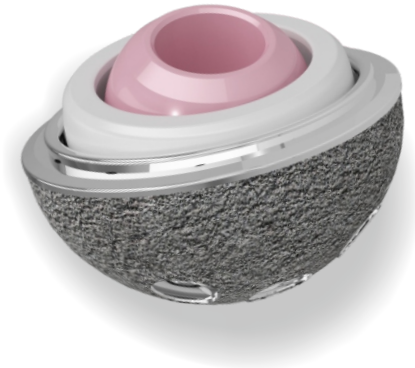

**Dual Mobility**

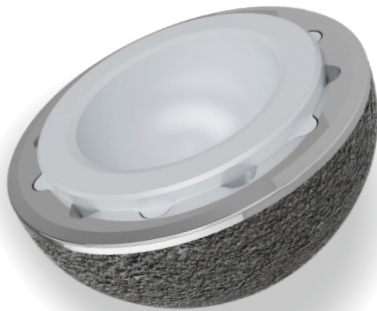

**Uncemented Cup**

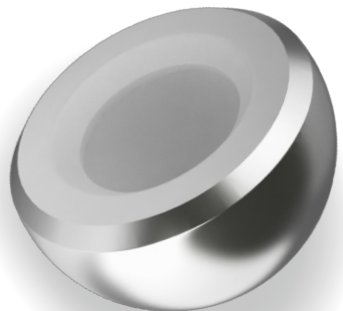

**Bi-polar Cup**

## Recommended Indication for Dual Mobility

1. Non-inflammatory degenerative joint disease, including osteoarthritis and avascular necrosis
2. Rheumatoid arthritis
3. Correction of functional deformity
4. Treatment of non-union, femoral neck fracture, and trochanteric fractures of the proximal femur with head involvement, unmanageable by other techniques
5. Revision of previously failed total hip arthroplasty
6. Dislocation risks

# Surgical Procedure

## Step 1: Patient Position and surgical approach

The goal of a surgical approach is to establish adequate visualization of the anatomy for stability and leg length evaluation. A number of surgical approaches can be explored for hip based on the extent of surgical experience and preference.



Fig. A



Fig. B

## Step 2: Accessing the Femoral Canal

To access femoral canal, use a straight box or offset chisel; determine the orientation and access lateral section of proximal femur (Fig. A). A single starter reamer on a T-handle can be used to initiate the opening in distal femoral canal, as per the requirement found on preoperative X-rays (Fig.B).

## Step 3: Femoral Canal Preparation

Choose the smallest proximally coated Uncemented Femoral Stem broach and attach it to the broach handle by pulling back on the trigger to engage the broach. Progressively increase the broach size to enlarge the canal until the broach engages with medial and lateral cortex and cannot be advanced further or until the templated implant size is reached. (Be careful with the insertion and removal of each broach to avoid rotation and thus to preserve the version of the femoral canal)

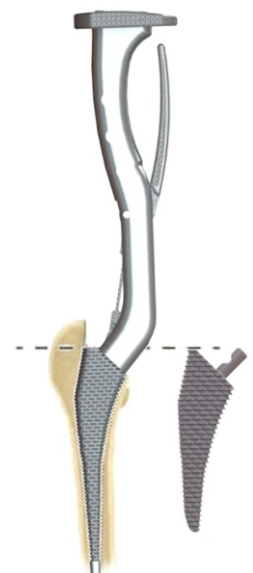

#### Step 4: Trial Reduction

Attach an appropriate magnetic neck trunnion onto the broach post. Once it's in place, take trial femoral head of desired diameter and neck length. Reduce the hip and evaluate the joint for soft tissue tension, anterior and posterior stability.



Change this as per implant



#### Step 5: Stem Insertion

Attach an implant to the blunt-tip femoral inserter and slide it distally into the canal. Gently tap the stem inserter to seat the prosthesis until there is an audible change in its pitch to verify that the implant is fully seated.

#### Step 6: Final Reduction

If desired, another trial reduction can be accomplished prior to selecting the final head size and impacting the modular head onto the femoral implant. Provisional heads in seven neck lengths allow an additional trial reduction using the actual implant in order to ensure proper leg length and stability.



#### Warning and Precautions:

Latitud™ Proximally Coated Uncemented Femoral Stem (Ti6Al4V ELI-Coated Stem) must not implant with cement. It is intended for Press-fit uncemented use only.

Preoperative templates are provided for determining optimal component size, femoral neck resection level and appropriate neck length (Figure 2). Radiographs should include a full A/P (anterior/posterior) view of the pelvis, including the Proximal one-half of both femurs and a lateral view of the Proximal half of the affected femur.



# Instruments

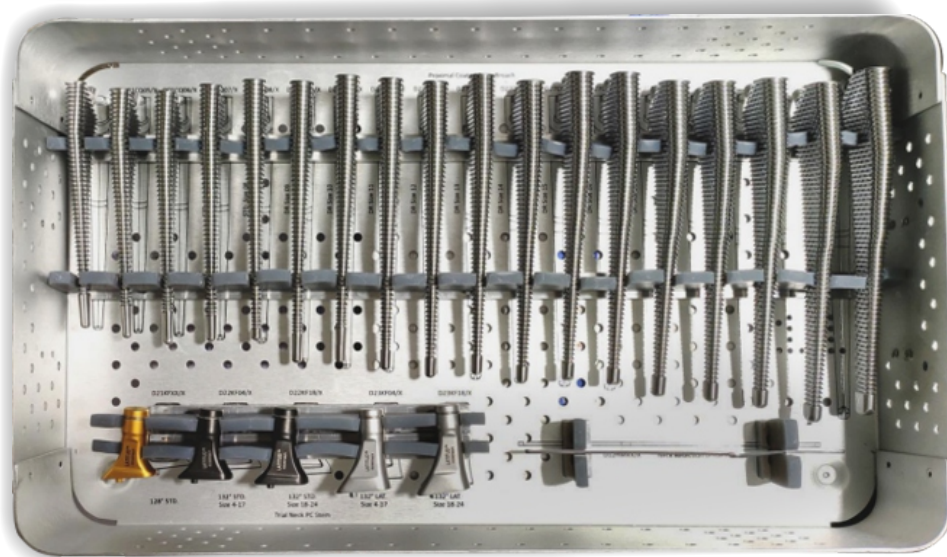

## References

1. Harpal S. Khanuja, Jeffrey J. Vakil, Maria S. Goddard, Michael A. Mont, Cementless Femoral Fixation in Total Hip Arthroplasty, 2011
2. Rui B. Ruben, Joao Folgado, Paulo R. Fernandes, Three-dimensional shape optimization of hip prostheses using a multi-criteria formulation, 2007; 34 : 261-275
3. Emerson RH, Sanders SB, Head WC, Higgins L, Effect of circumferential plasma-spray porous coating on the rate of femoral osteolysis after total hip arthroplasty, 1999; 81(9): 1291-8



**India Office**

Meril Health Care Pvt. Ltd.  
H1 - H3, Meril Park  
Survey No 135/2/B & 174/2  
Muktanand Marg,  
Chala, Vapi-396191,  
Gujarat, India  
T : +91 260 3052 100  
E : info@maxxmed.com

**India Sales Office**

Maxx Medical Pvt. Ltd.  
512-513, Midas  
Sahar Plaza Complex  
J.B. Nagar  
Andheri (East)  
Mumbai 400 059  
T : +91-22-40479797/ 32170808  
F : +91-22-40479717  
E : info@maxxmed.com

**United States**

Maxx Orthopedics, Inc.  
531 Plymouth Road  
Suite 526  
Plymouth Meeting, PA 19462  
T : +1-484-342-0092 x 2100  
F : +1-484-342-0096  
E : info@maxxortho.com