

Template	Instructions for Use for Transfer bag	Size	210×297mm
Drawing No.	TH-TZ-097	Material	Ordinary wood pulp paper
Version	02/2020	Color	Black
Designed by	Lu Yangge	Reviewed by	Wu Yun Wangxiaoping
Approved by	Lu Jianqiang	Effective date	February 20, 2020
Note			



INSTRUCTIONS FOR USE FOR TRANSFER BAG

0197 CE

APPLICABLE PRODUCTS

ES-300

DESCRIPTION

1. Transfer bag systems are used for the separation and storage of human blood components.
2. The product is sterile and nonpyrogenic after terminal EO sterilization.

INDICATIONS

See, "Guide to the preparation, use and quality assurance of Blood Components."

GENERAL PREPARATIONS BEFORE USAGE

1. Before opening transfer bag systems, control the overwrap in terms of including tear or puncture.
2. After opening the overwrap, control the transfer bag in terms of including tear or puncture.

INSTRUCTIONS FOR USE

- 1) Remove the blood bag from its outer package.
- 2) This device is connected to the Storage bag with below ways:
 - a) Manual Connection:
 - i) Open the transfer pin protector on the transfer tube.
 - ii) Connect it to the outlet port of the blood bag firmly.
 - b) Connection with Sterile Connector Device:
 - i) Connect the transfer tube to the Storage bag with a sterile connector.

Warning: See Sterile Connector User Instructions
- 3) Storage :
Please abide by the operating specifications of the local blood station, and store them properly according to different types of blood components.

TRANSFUSION

*This part is used for bedside filter

1. Inspect the container and blood component for any defects.
2. Before transfusing the blood, make sure that serological test results are acceptable, cross match test results match with the recipient. If appropriate, apply cross match again at bed side.
3. Use transfusion set compatible with ISO EN 1135-4.
4. After inserting the spike, squeeze the bag to the level that transfusion set filter is filled with blood.
5. Hook up the bag from its holder.

PRECAUTIONS

1. After products removal from the carton, store the blood bag with closed outer package and/or individual package in a cool and dry place.
2. Use the blood bag on the same day of opening individual package.
3. Use blood bag in accordance with the instructions for use.
4. Do not use if the bag shows visible signs of damage.
5. Protect the bags and tubings from sharp objects.
6. When frozen, plastic is more fragile.
7. Do not add medication to blood.
8. Check blood bags and blood components for defects before blood transfusion.
9. Use Transfusion set compatible with ISO EN 1135-4.
10. The blood bag is for single use. No secondary use. Discard the used blood bag into the medical waste bin.

SPECIAL PRECAUTION: This product contains di (2-ethylhexyl) phthalate (DEHP). Based on animal experimental data, there is a risk of adverse effects on reproduction and development in a specific patient group, and long-term exposure to DEHP should be avoided. These specific patients are male neonates, infants, children, adolescent boys, and women who are pregnant or breastfeeding. However, in cases where the benefits of DEHP-containing products are more important than any health risks, medical procedures should not be avoided. Please refer to the existing literature to make a favorable choice.

Instructions of Graphs and Symbols



Caution



Consult instructions for use



Single use only



Do not use if package is damaged



Lot number



Expiry date



CE mark and Identity No. of Notifying body. The product complies with the requirements of the Council Medical Products 93/42/EEC



Do not re-sterilize



Film plasticizer DEHP



ETO Sterilization



Pyrogen free



Manufacturing date



Manufacturer



Authorized Representative in the European Community

OBELIS S.A
Bd.Général Wahis, 53 1030 Brussels, Belgium



Jiaying Tianhe Pharmaceutical Co., Ltd.

Zhongfa Foreign Trade Industrial Zone, Fengqiao Town, Nanhu District, 314008, Jiaying, Zhejiang, China

Tel: 0086-573-8261-8903

<http://www.jxtianhe.com/> E-mail: jingru(a)jxtianhe.com

Template	Instructions for Use for Top & Bottom Blood Bag (without Inline Filter)	Size	210×297mm
Drawing No.	TH-TZ-226	Material	Ordinary wood pulp paper
Version	02/2020	Color	Black
Designed by	Lu Yangge	Reviewed by	Wu Yun Wangxiaqing
Approved by	Lu Jianqiang	Effective date	February 20, 2020
Note			



INSTRUCTIONS FOR USE FOR TOP&BOTTOM BLOOD BAG

CE 0197

APPLICABLE PRODUCTS

OTA-450SSTB

DESCRIPTION

1. For collection, processing and storage of human blood and blood components.
2. The product is sterile and nonpyrogenic after terminal steam sterilization.

PRE-COLLECTION BLOOD BAG PREPARATION

1. Open the transparent overwrap at the tear notches and take out the blood bag system.
2. Before venipuncture, inspect the blood bag system for visual defects, confirm that there is no turbidity or leakage of anticoagulant or additive solution, confirm that the needle cap has never been opened. **Note:** Avoid mistakenly lock the needle into the needle protective device before blood collection.
3. Place the blood bag on a scale of blood mixer (or blood collection machine) as far as possible below the donor's arm.
4. Close the clamp (Figure 1, #2) on sampling tubing.

*Or close the donation tubing, if there is no Pre-donation Sampling Device (PDS) in the system or no breakaway cannula on the donation tubing.

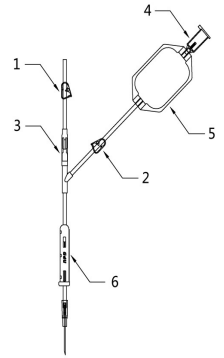

Figure 1

COLLECTION

1. Apply tourniquet or blood pressure cuff to donor's arm. Disinfect the venipuncture site according to institutional SOP.
2. Hold the needle cap and the hub with both hands and twist to break the tamper-proof between the needle hub and the cap. Remove the needle cap straight so that the needlepoint does not come in contact inside the needle cap.
3. Perform venipuncture. Note that the marked point is upward to ensure that the edge of the needle tip is upward.
4. Open the clamp (Figure 1, #2) or breakaway cannula on the sampling tubing and collect required volume of blood into the in-line sampling pouch (Figure 1, #5).
*If there is no sampling pouch in the system, directly insert the vacuum tube into the tube holder (Figure 1, #4) for blood sampling.
5. Close the clamp (Figure 1, #2) on the sampling tubing.
6. Open the breakaway cannula (Figure 1, #3) or the clamp on the donation tubing. **Note:** Make sure that the breakaway cannula is fully opened.
7. Immediately on starting the collection, mix blood with anticoagulant solution thoroughly and continue until completion of blood collection.
8. Collect the required quantity of blood within the limits indicated on the primary bag label.
9. Close the clamp (Figure 1, #1) on the donation tubing after completion of blood collection.
10. Remove the tourniquet or blood pressure cuff, then remove the needle and lock the needle in the Needle Protective Device (NPD) (Figure 1, #6) completely. Connect the NPD to the barrel of the vacuum tube holder (Figure 1, #4). Seal and cut off the donation tubing just above the Y-connector, discard the needle and any other devices according to local protocol.
11. Strip the blood from the donation tubing into the primary bag, mix thoroughly and allow the tube to fill again, repeat several times, then seal and cut the donation tubing as needed.
12. Blood collection is expected to be completed within 12 minutes. **Note:** If it exceeds 15 minutes, the collected blood may not be suitable for the preparation of platelets and cryoprecipitates.
13. Blood should be stored at 20 to 24 °C and should not be refrigerated. Platelets should be prepared within 24 hours after blood collection.

USING OF PRE-DONATION SAMPLING DEVICE

Complete the following operations during blood collection:

1. Pre-donation sampling device with sampling pouch (Figure 1, #5)
 - 1.1 Open the cap of the tube holder, insert vacuum tube to collect the required number of blood samples. **Note:** Before collecting the blood samples, keep the sampling pouch positioned vertically so that air is at the upper end to prevent air being mixed into the vacuum tube.
 - 1.2 During blood sampling, hold the tube holder and vacuum tube firmly to prevent the sampling needle from slipping out of the vacuum tube, to ensure that the required blood samples are collected.
2. Pre-donation sampling device without sampling pouch
 - 2.1 According to the number of blood samples to be collected, insert the vacuum tube into the tube holder in sequence to collect blood samples.

COMPONENT SEPARATION

Top&Bottom bag system: (intended for preparation of platelets, buffy coat removed red cells and plasma, by buffy coat method)

1. Load the whole system on the centrifuge bucket, ensure that the breakaway cannula is placed at the upper position. **Note:** Proper position can prevent the blood bag from bursting during centrifugation.
2. Centrifuge the whole system at 22°C according to local validated standard procedures.
3. After centrifugation, load the whole system on the blood component separator. Clamp the tubing to platelet storage bag.
4. Use the blood component separator in accordance with the operation manual.
5. First break the breakaway cannula (Figure 2) on the primary bag and then break the breakaway cannula on the SAG-Mannitol solution bag.

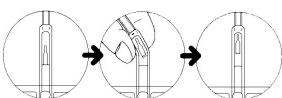

Figure 2

6. Blood component separator transfers plasma upward to plasma bag and red cells downward to SAG-M bag, remain buffy coat in the primary bag. If single unit platelet concentrate is to be prepared: remain appropriate plasma in the primary bag to get a buffy coat suspension.
7. After separation, seal transfer tubings of plasma bag and red cell suspension bag and detach the blood components.
8. Strip the red cell from the transfer tubing into the bag, mix thoroughly and allow the tube to fill again, repeat two times, to ensure that there is red cell in the tubing. **Note:** For identification purposes, the coding segment closest to the bag is usually remained with the bag.
9. Rest the prepared buffy coat suspension for more than 1 hour, prepare pooling platelet concentrates according to local validated standard procedures by using a pooling set.
10. If the system (which with platelet storage bag) is used for single unit platelet preparation
 - 10.1 Close the tubing near the breakaway cannula of the primary bag, mix thoroughly the contained buffy coat and appropriate plasma, rest the bag for more than 1 hour.
 - 10.2 Centrifuge the primary bag and platelet bag at 22°C according to local validated standard procedures.
 - 10.3 Transfer platelet into platelet storage bag by the blood component separator. **Note:** Platelets should be separated immediately after centrifugation.
11. If the system is used for cryoprecipitate preparation
 - 11.1 Place the fresh frozen plasma under condition of 2 to 6°C overnight for unfreezing.
 - 11.2 After unfreezing, perform heavy centrifugation at 2 to 6°C. Transfer the upper layer cryoprecipitate-depleted plasma to the empty transfer bag, remained is the cryoprecipitate.
 - 11.3 Cryoprecipitate can also be prepared by Quick Unfreezing – Siphonage Method.
 - 11.4 The prepared cryoprecipitate should be frozen immediately.

BLOOD COMPONENTS STORAGE

Store the blood components according to appropriate regulations.

PRECAUTIONS

1. Store the blood bag with closed outer package and/or individual package in a cool and dry place after products removal from shipping carton.
2. Do not use the blood bags if the outer package is opened more than 15 days.
3. Use the blood bag within the same day of opening individual package.
4. Use blood bag in accordance with the instructions for use.
5. Do not use unless solutions are clear.
6. Do not use if the bag shows visible signs of damage.
7. Protect the bags and tubings from sharp objects.
8. Do not use if the needle cap shows signs of opening.
9. Do not use if fluid path closures are loose or not intact.
10. Do not vent.
11. When frozen, plastic is more fragile.
12. Do not add medicine to blood.
13. Check blood bags and blood components for defects before blood transfusion.
14. Use transfusion set compatible with ISO EN 1135-4.
15. The blood bag is for single use. No secondary use. Discard the used blood bag into the medical waste bin.

SPECIAL PRECAUTION: This product contains di (2-ethylhexyl) phthalate (DEHP). Based on animal experimental data, there is a risk of adverse effects on reproduction and development in a specific patient group, and long-term exposure to DEHP should be avoided. These specific patients are male neonates, infants, children, adolescent boys, and women who are pregnant or breastfeeding. However, in cases where the benefits of DEHP-containing products are more important than any health risks, medical procedures should not be avoided. Please refer to the existing literature to make a favorable choice.



Jiaying Tianhe Pharmaceutical Co., Ltd.

Zhongfa Foreign Trade Industrial Zone, Fengqiao Town, Nanhu District, 314008, Jiaying,
Zhejiang, China

Tel: 0086-573-8261-8903

<http://www.jxtianhe.com/> E-mail: [jingru\(a\)jxtianhe.com](mailto:jingru(a)jxtianhe.com)

Template	Instructions for Use for WB Filter Blood Bag	Size	210×297mm
Drawing No.	TH-TZ-099	Material	Ordinary wood pulp paper
Version	02/2020	Color	Black
Designed by	Lu Yangge	Reviewed by	Wu Yun Wangxiaoqing
Approved by	Lu Jianqiang	Effective date	February 20, 2020
Note			



INSTRUCTIONS FOR USE FOR WB FILTER BLOOD BAG



APPLICABLE PRODUCTS

OTC-450SSFW

DESCRIPTION

• Intended for the collection of human blood, the filtration of whole blood and the preservation of blood components.

VENEPUNCTURE

- A**
- 1) Tear open the transparent overwrap.
 - 2) Place blood pack at a distance of ~50cm below donor arm, ideally on an automated blood mixer.
 - 3) Apply tourniquet.
 - 4) Thoroughly disinfect site of venepuncture.
- B**
- 5) To remove the needle cap: Hold the hub and twist the cap. Remove the cap in a straight line to avoid any damage to the needle tip.
 - 6) Carry out venepuncture.

PRE-DONATION SAMPLING

- C**
- 1) Allow the sampling pouch to fill.
 - 2) While filling the sampling pouch, do not let the sampling pouch hang freely. Fill the sampling pouch.
 - 3) Close the clamp (b) and break the breakaway cannula (c) on the donation line with a side to side motion.
- D**
- 4) Immediately on starting the collection, thoroughly mix the blood/anticoagulant and continually mix throughout the collection.
 - 5) Release the cap of the vacuum tube holder by pushing the handle of the cap with a thumb. Invert the sampling pouch to ensure any air is directed to the bottom of the sampling pouch.
 - 6) Collect the blood samples using the vacuum tube holder and the appropriate sampling tubes.

BLOOD COLLECTION

- 1) Ensure that the anticoagulant and the blood are mixed thoroughly immediately upon the start of collection, and also at least every 50mL during the donation, ideally using an automated blood mixer.
- 2) Collect the quantity of blood stated on the pack label.
- 3) Once the required quantity has been reached, close the clamp of the donation line (a) and seal the donation tubing, using a permanent closure device, between the blood pack and the Y-junction of any attached devices.
- 4) Release the tourniquet, and immediately mix the full blood pack.
- 5) If using an in-line filter, do not strip the donation tubing. Seal it close to the pack (~2cm), using a permanent closure device.
- 6) If required (quality control, crossmatch, pool of buffy coats...), strip the donation line, and mix the pack. Repeat several times. Seal and cut the donation tubing as needed.

USE OF NEEDLE PROTECTIVE DEVICE

- E**
- 1) After donation and sampling, move the needle protective device close to the hub of the needle.
 - 2) Remove the donation needle, then gently lower the needle into the barrel of the needle protective device until a click is heard.
 - 3) The needle and needle protective device must be held upright. Ensure that no pressure is put on the donation line at any time, to prevent possible spillage.
 - 4) The needle protective device may be pushed into the barrel of the vacuum tube holder.
 - 5) The needle, needle protective device and any other devices should be disposed of in a safe manner.

PACK HANDLING WHILST PROCESSING

- 1) After filtration, centrifuge all transfer packs together as required by the blood transfusion center, and then do the separation.
 - 2) Process the pack as required by the blood transfusion center. Ensure the bags and tubing are correctly packed for centrifugation.
- F**
- 3) To allow fluid transfer, break the cannula at the seal, by bending the breakaway cannula with a side to side motion.
 - 4) After transfer, seal the transfer tubing, using a permanent closure device, and cut to separate.

*Note:

- 1) If time interval between whole blood collection and separation is over 4 hours, the leukoreduced whole blood shall be placed at $4\pm 2^{\circ}\text{C}$.
- 2) Centrifugation at $4\pm 2^{\circ}\text{C}$.
- 3) After separation, red cell shall be stored at $4\pm 2^{\circ}\text{C}$ as soon as possible.

HANDLING OF FILTER

- 1) Hang the whole blood unit. Position the empty transfer bag below the filter and make sure the head height is 120 to 150cm.
- 2) Clamp the bypass and the tubing below filter.
- 3) Break the breakaway cannula on the collection pack.
- G** 4) Open the clamp below filter, keep the bypass closed, whole blood will start to flow into the filter. Leave the unit to gravity prime, filter and drain.
- 5) When flow stops, close clamp below filter, and open the bypass, transfer air through bypass into upper collection bag, close the bypass after air exhausted.
- 6) Seal the tubing close to the filter. If required (quality control, crossmatch...), strip the tube, and mix the pack. Repeat several times. Seal and cut the tubing as needed.
- 7) Discard the filter and the upper collection bag according local procedure in appropriate medical waste containers.
- 8) Obtain the leukoreduced whole blood in the transfer bag.

***Caution:**

- 1) Do not squeeze, tap or hit the filter or the packs during filtration
- 2) Do not centrifuge the filter together with blood pack.
- 3) Do not manhandle the filter(s).
- 4) If either face of the filter remains white, the blood components have not been leukoreduced and must be discarded.

***Suggestion:**

- 1) Time interval between collection and filtration shall be 2 to 20 hours when whole blood stored at $4\pm 2^{\circ}\text{C}$. Before filtration, whole blood shall be placed in room temperature (18 to 25°C) for 0.5 to 1 hour.
- 2) Time interval between collection and filtration shall be 2 to 12 hours when whole blood stored at 10 - 25°C .
- 3) Filtration shall be conducted at room temperature (18°C to 25°C).

HANDLING OF PORT PROTECTORS

- H** 1) Peel off the port protector.
- 2) Hold down the port protector pieces with one hand.
- I** 3) Using the free hand, take the spike and engage into the port.
- 4) Twist the spike to secure fully in port.

PRECAUTIONS

1. After products removal from the carton, store the blood bag with closed outer package and/or individual package in a cool and dry place.
2. Do not use the blood bags if the outer package is opened more than 15 days.
3. Use the blood bag on the same day of opening individual package.
4. Use blood bag in accordance with the instructions for use.
5. Do not use unless solutions are clear.
6. Do not use if the bag shows visible signs of damage.
7. Protect the bags and tubings from sharp objects.
8. Do not use if the needle cap shows signs of opening.
9. Do not use if fluid path closures are loose or not intact.
10. Do not vent.
11. When frozen, plastic is more fragile.
12. Do not add medication to blood.
13. Check blood bags and blood components for defects before blood transfusion.
14. Use Transfusion set compatible with ISO EN 1135-4.
15. The blood bag is for single use. No secondary use. Discard the used blood bag into the medical waste bin.

SPECIAL PRECAUTION: This product contains di (2-ethylhexyl) phthalate (DEHP). Based on animal experimental data, there is a risk of adverse effects on reproduction and development in a specific patient group, and long-term exposure to DEHP should be avoided. These specific patients are male neonates, infants, children, adolescent boys, and women who are pregnant or breastfeeding. However, in cases where the benefits of DEHP-containing products are more important than any health risks, medical procedures should not be avoided. Please refer to the existing literature to make a favorable choice.

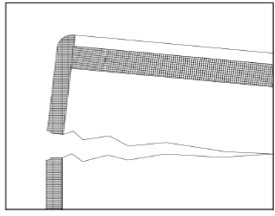

A

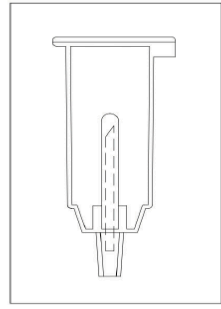

Vacuum tube holder

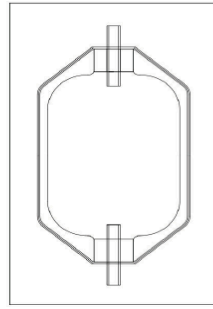

Sampling pouch

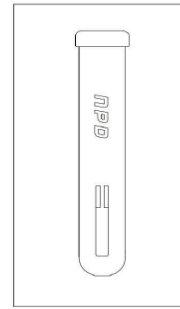

Needle protective device

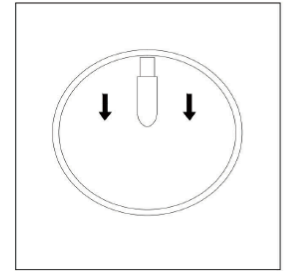

Whole blood filter

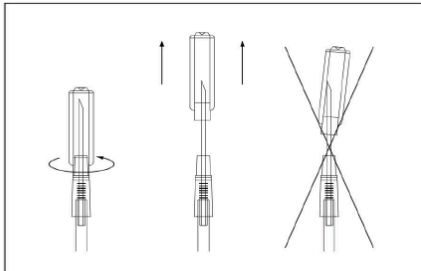

B

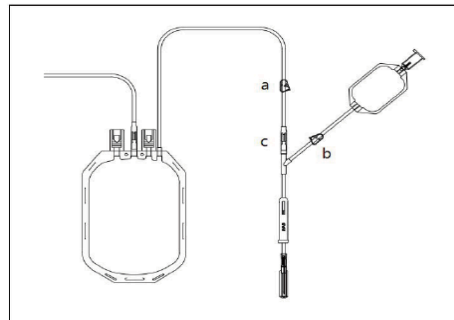

C

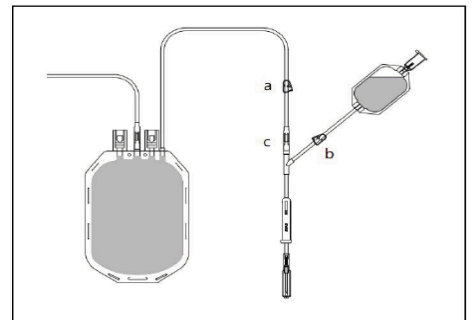

D

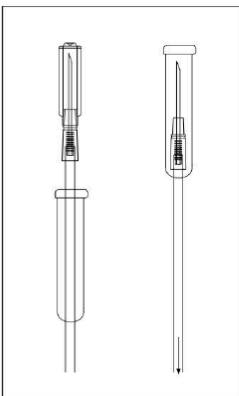

E

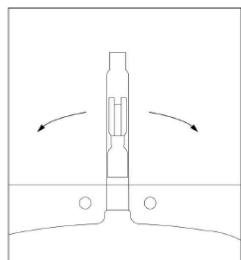

F

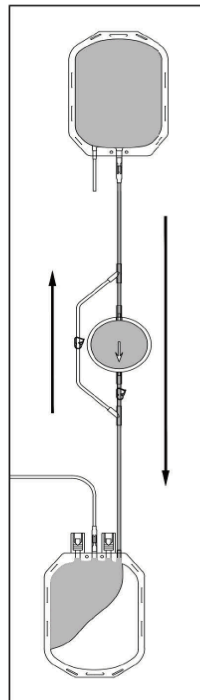

G

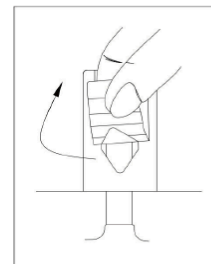

H

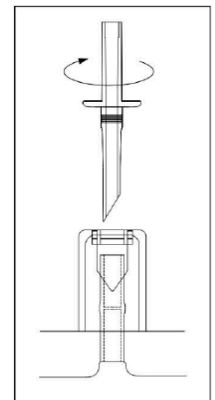

I



Jiaying Tianhe Pharmaceutical Co., Ltd.

Zhongfa Foreign Trade Industrial Zone, Fengqiao Town, Nanhu District, 314008, Jiaying, Zhejiang, China

Tel: 0086-573-8261-8903

<http://www.jxtianhe.com/> E-mail: jingru(a)jxtianhe.com