

BULDOCK

FLOATING DOCK



Quality Modular Pontoon Systems

PRODUCT PORTFOLIO 2022

www.buldock.com

2D Configurator

Dock Dimensions

Shoreline - T shape

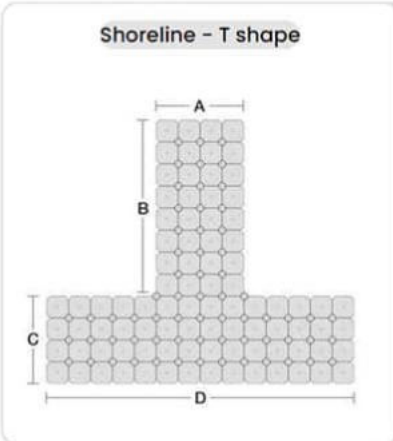

Dock Dimensions
**in meters*

A • m

B • m

C • m

D • m

Dock color

Gray

Beige

Blue

Orange

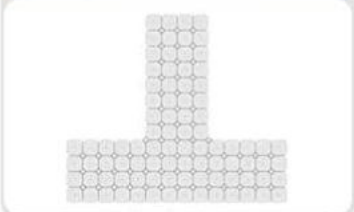

3D Configurator



Go to the Configurator



The System

Our floating system is designed to be simple: the blocks are held together strongly and firmly by specially designed mounting screws. All pieces are lightweight and provide easy handling.

The cubes are suitable for any shoreline. They are adaptable and can be assembled to create any shape and size - no limit for the configuration options!

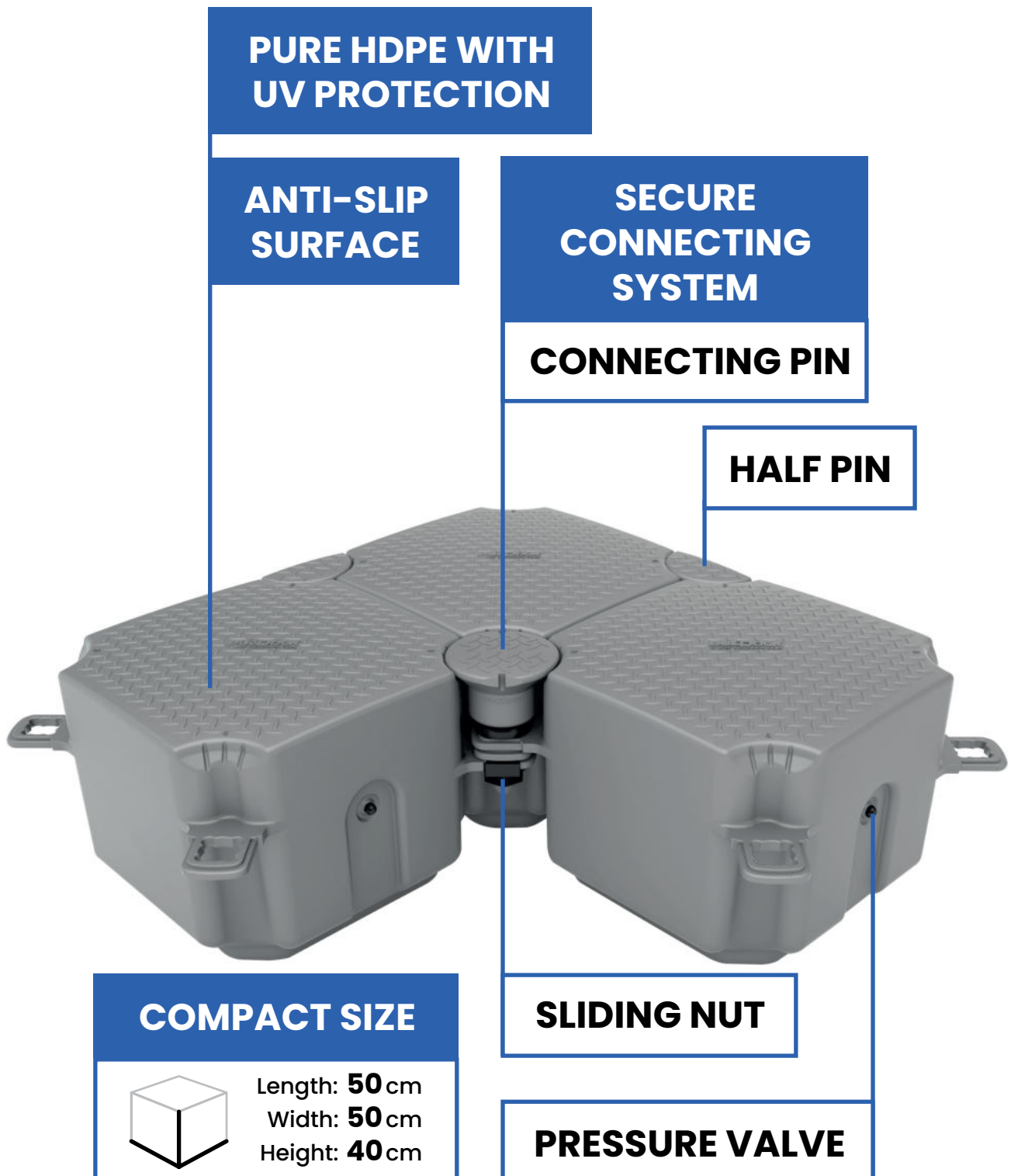

Cube H40



Material / Composition: High-density Polyethylene (HDPE)
Surface: Anti-Slip
Dimensions: 50 x 50 x 40 cm (Length / Width / Height)
Weight: 6.8 kg
Capacity: 92 kg per cube or 368 kg per m²

Grey
003622S16

Light Blue
003625S16

Beige
003628S16

Orange
003750S16

*Any color per customers wish

Cube H27



Material / Composition: High-density Polyethylene (HDPE)
Surface: Anti-Slip
Dimensions: 50 x 50 x 27 cm (Length / Width / Height)
Weight: 5.5 kg
Capacity: 62 kg per cube or 248 kg per m²

Grey
003729S16

Light Blue
003730S16

Beige
003731S16

Orange
003778S16

*Any color per customers wish

V-Cube H40 – Flat



Material / Composition: High-density Polyethylene (HDPE)
Surface: Anti-Slip
Dimensions: 50 x 50 x 40 cm (Length / Width / Height)
Weight: 8.0 kg
Capacity: 80 kg per cube or 320 kg per m²

Grey
003743S16

Light Blue
003744S16

Beige
003742S16

Orange
003779S16

*Any color per customers wish

V-Cube H27 – Flat



Material / Composition:	High-density Polyethylene (HDPE)
Surface:	Anti-Slip
Dimensions:	50 x 50 x 27 cm (Length / Width / Height)
Weight:	7.5 kg
Capacity:	50 kg per cube or 200 kg per m ²

Grey
003737S16

Light Blue
003738S16

Beige
003736S16

Orange
003780S16

*Any color per customers wish

V-Cube H40 – Roller



Material / Composition:	High-density Polyethylene (HDPE)
Surface:	Anti-Slip
Dimensions:	50 x 50 x 40 cm (Length / Width / Height)
Weight:	8.5 kg
Capacity:	80 kg per cube or 320 kg per m ²

Grey
003740S16

Light Blue
003741S16

Beige
003739S16

Orange
003781S16

*Any color per customers wish

V-Cube H27 – Roller



Material / Composition:	High-density Polyethylene (HDPE)
Surface:	Anti-Slip
Dimensions:	50 x 50 x 27 cm (Length / Width / Height)
Weight:	8.0 kg
Capacity:	50 kg per cube or 200 kg per m ²

Grey
003734S16

Light Blue
003735S16

Beige
003733S16

Orange
003782S16

*Any color per customers wish

V-Cube H25 – Roller



Material / Composition:	High-density Polyethylene (HDPE)
Surface:	Anti-Slip
Dimensions:	50 x 50 x 25 cm (Length / Width / Height)
Weight:	8.0 kg
Capacity:	50 kg per cube or 200 kg per m ²

Grey
003952S16

Light Blue
003956S16

Beige
003957S16

Orange
003958S16

*Any color per customers wish

V-Cube H35 – Roller



Material / Composition:	High-density Polyethylene (HDPE)
Surface:	Anti-Slip
Dimensions:	50 x 50 x 35 cm (Length / Width / Height)
Weight:	8.0 kg
Capacity:	50 kg per cube or 200 kg per m ²

Grey
003989S16

Light Blue
004005S16

Beige
004006S16

Orange
004507S16

*Any color per customers wish

U-Slide H40 – Roller

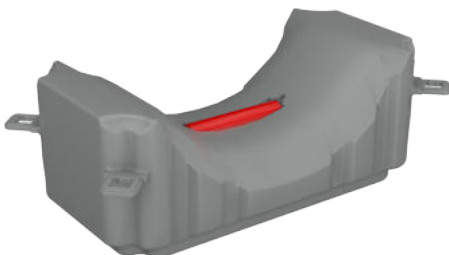

Material / Composition:	High-density Polyethylene (HDPE)
Surface:	Anti-Slip
Dimensions:	100 x 50 x 40 cm (Length / Width / Height)
Weight:	12.0 kg
Capacity:	150 kg per U-slider or 300 kg per m ²

Grey
2021BG001

U-Slide H40

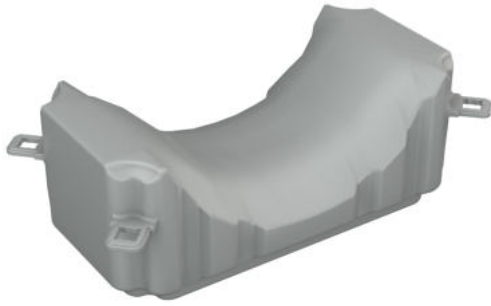

Material / Composition:

Surface:

Dimensions:

Weight:

Capacity:

High-density Polyethylene (HDPE)

Anti-Slip

100 x 50 x 40 cm (Length / Width / Height)

10.5 kg

150 kg per U-slider or 300 kg per m²

Grey
2021BG002

U-Slide H30 – Roller



Material / Composition:

Surface:

Dimensions:

Weight:

Capacity:

High-density Polyethylene (HDPE)

Anti-Slip

100 x 50 x 30 cm (Length / Width / Height)

12.0 kg

100 kg per U-slider or 200 kg per m²

Grey
2021BG003

Pile Guiding Cube H40



Material / Composition:

Surface:

Dimensions:

Weight:

Capacity:

High-density Polyethylene (HDPE)

Anti-Slip

50 x 50 x 40 cm (Length / Width / Height)

8.0 kg

90 kg per cube or 360 kg per m²

Grey
2018BG001

Light Blue
2018BG002

Beige
2018BG003

Orange
2018BG004

*Any color per customers wish

Connecting Pin TFP Model



Material / Composition:

High-density Polyethylene (HDPE)

Surface:

Anti-Slip

Dimensions:

25.5 x 18 cm (Height / Ø)

Weight:

0.480 kg

Grey
003850S16

Light Blue
003961S16

Beige
003962S16

Orange
003963S16

*Connecting Pin Standard
003623S16

*Any color per customers wish

Half Pin



Material / Composition:

High-density Polyethylene (HDPE)

Surface:

Anti-Slip

Dimensions:

27.5 x 8 cm (Height / Ø)

Weight:

0.330 kg

Grey
003624S16

Light Blue
003627S16

Beige
003630S16

Orange
003783S16

*Any color per customers wish

Sliding Nut



Material / Composition:

High-density Polyethylene (HDPE)

Surface:

Anti-Slip

Dimensions:

5 x 9.5 cm (Length / Ø)

Weight:

0.069 kg

Black
003728T16

Nut



Material / Composition:

Surface:

Dimensions:

Weight:

High-density Polyethylene (HDPE)

Anti-Slip

3.5 x 8.5 cm (Length / \varnothing)

0.060 kg

Black
003650T16

Spacer



Material / Composition:

Surface:

Dimensions:

Weight:

High-density Polyethylene (HDPE)

Anti-Slip

1.5 x 9 cm (Length / \varnothing)

0.038 kg

Black
003732T16

Lug Connector

NEW



Material / Composition:

Surface:

Dimensions:

Weight:

High-density Polyethylene (HDPE)

Anti-Slip

13.5 x 9 cm (Height / \varnothing)

0.225 kg

Black
2018BG005

Lug Connector with Ribs



Material / Composition:

High-density Polyethylene (HDPE)

Surface:

Anti-Slip

Dimensions:

13.5 x 9 cm (Height / Ø)

Weight:

0.225 kg

Black
2018BG005

Connecting Pin with Top Up Ring



Material / Composition:

High-density Polyethylene (HDPE) &
INOX Steel

Surface:

Anti-Slip

Dimensions:

30 x 18 cm (Height / Ø)

Weight:

2.500 kg

Black
003650T16

Connecting Pin with Stud



Material / Composition:

High-density Polyethylene (HDPE) &
INOX Steel

Surface:

Anti-Slip

Dimensions:

34 x 18 cm (Height / Ø)

Weight:

2.00 kg

Grey
2020BG014

Inox Cleat



Material / Composition: **INOX Steel**
Dimensions: **20 x 37.5 cm (Width / Height)**
Weight: **2.00 kg**

Silver
2020BG001

Connecting Pin With Inox Cleat – Strong



Material / Composition: **High-density Polyethylene (HDPE) & INOX Steel**
Surface: **Anti-Slip**
Dimensions: **30 x 18 cm (Height / Ø)**
Weight: **3.00 kg**

Black
003650T16

Connecting Pin with Solar Navigation Light



Material / Composition: **High-density Polyethylene (HDPE)**
Dimensions: **38.5 x 18 cm (Height / Ø)**
Weight: **0.715 kg**

Grey
2021BG019

Light Blue
2021BG020

Beige
2021BG021

Orange
2021BG022

Changing LED Illumination color : White, Green, Blue, Orange, Yellow, Red



HDPE Cleat



Material / Composition:

Surface:

Dimensions:

Weight:

High-density Polyethylene (HDPE)

Anti-Slip

13 x 25 cm (Width / Height)

0.400 kg

Grey
2018BG008

Single Fender



Material / Composition:

Surface:

Dimensions:

Weight:

High-density Polyethylene (HDPE)

Anti-Slip

50 x 25 x 35 cm (Length / Width / Height)

3.500 kg

Grey
2020BG003

Double Fender



Material / Composition:

Surface:

Dimensions:

Weight:

High-density Polyethylene (HDPE)

Anti-Slip

100 x 20 x 27 cm (Length / Width / Height)

4.600 kg

Grey
2020BG004

Inox Ladder



Material / Composition: **INOX Steel**
Dimensions: **83 x 183 cm (Width / Height)**
Weight: **18.00 kg**

Silver
2018BG011

Single Handrail Bar



Material / Composition: **Galvanized Steel / INOX Steel**
Dimensions: **4,5 x 110 cm (Width / Height)**
Weight: **3.500 kg**

Silver/Black
2019BG012

Silver
2019BG012.1

Handrail 50 cm



Material / Composition: **Galvanized Steel / INOX Steel**
Dimensions: **50 x 108 cm (Length / Height)**
Weight: **6.300 kg**

Silver/Black
2019BG009

Silver
2019BG009.1

Handrail 190 cm



Material / Composition: Galvanized Steel / INOX Steel
Dimensions: 190 x 108 cm (Length / Height)
Weight: 12.00 kg

Silver/Black
2019BG008

Silver
2019BG008.1

Pin With Umbrella Holder



Material / Composition: High-density Polyethylene (HDPE) & INOX Steel
Surface: Anti-Slip
Dimensions: 59 x 18 cm (Height / Ø)
Weight: 2.800 kg

Grey
2018BG007

Double Layer Connector



Material / Composition: High-density Polyethylene (HDPE)
Dimensions: 57 x 5 cm (Height / Ø)
Weight: 1.300 kg

Black / White
2019BG006

*Any color per customers wish

Storage Cube H40



Material / Composition:	High-density Polyethylene (HDPE)
Surface:	Anti-Slip
Dimensions:	50 x 50 x 40 cm (Length / Width / Height)
Weight:	7.5 kg
Capacity:	92 kg per cube or 368 kg per m ²
Hatch dimensions :	37.5 x 37.5 cm (Length / Width)

Grey
2021BG015

Light Blue
2021BG016

Beige
2021BG017

Orange
2021BG018

Side Roller Set



Material / Composition:	Inox Steel/ Polyurethane
Dimensions:	44 /55 x 18 cm
Weight:	4.150 kg

Red
2021BG004

Keel Roller RP-5 with Axis



Material / Composition:	Polyurethane , Steel AISI 316
Dimensions:	12 x 7 cm (Lenght / Ø)
Weight:	0.590 kg

Red
2018BG010

Keel Roller RP-212 with Axis



Material / Composition: Polyurethane , Steel AISI 316
Dimensions: 29.5 x 6 cm (Lenght / Ø)
Weight: 1.420 kg

Red
2021BG005

Winchpost with bow rollers/ no winch



Model No	Height in mm
401.4-6	400-600
401.6-8	600-800
401.8-1	800-1000

Material / Composition: Inox Steel
Length: 680 -800 mm
Width: 102 mm
Height: 600-800 mm
Weight: 15.00 kg

Small Handwinch with Strap



Model No	Boats up to
103231	1500 KGS/ 6m
1032313	3000 KGS/12m

Electric Winch



	Boats up to
401513- Ninja	2 000 kgs
401520- Warrior	3 500 kgs

Description:

Winch is equipped with a 70% stronger Amortek winch rope instead of a traditional steel cable.

- Small winch rope assembled specially.
- Stainless steel winch adapter plate for attaching the electric winch to the winch pole.
- Stainless steel Battery box holder for a secure attachment to the trailer chassis
- 80 Amp. – model №: 401513/ 100 Amp. – model №: 401520 High quality Semi-traction battery for long-term discharge.
- Fully automatic battery charger which, in addition to charging, also keeps the battery in top condition automatically.
- Main switch with red main switch key
- Remote control wired for both models and wired and wireless for model №: 401520.

Assembling Tool



Material / Composition:	INOX Steel
Dimensions:	55 x 100 cm (Width/ Height)
Weight:	2.700 kg

Silver
2018BG013

Nut Tool



Material / Composition:	Aluminium
Dimensions:	36 x 9 cm (Lenght / Width)
Weight:	0.200 kg

Silver
2019BG013

Hexagon Screw Tool



Material / Composition:

Aluminium

Dimensions:

40 x 65 cm (Width/ Height)

Weight:

2.00 kg

Silver

2020BG017

Anchoring Ring



Material / Composition:

High-density Polyethylene (HDPE) & INOX Steel

Surface:

Anti-Slip

Dimensions:

31 x 9 cm (Length / Ø)

Weight:

1.230 kg

Black

2018BG008

Anchoring Pin



Material / Composition:

High-density Polyethylene (HDPE) & INOX Steel

Surface:

Anti-Slip

Dimensions:

48 x 18 cm (Length / Ø)

Weight:

2.500 kg

Black

2018BG006

Helix ECO Anchor Ellipse I



Material / Composition: **Steel**

Surface: **Hot Galvanization**

Dimensions: **100 x 25 x 2,5 cm (Height / Ø Disk/ Ø Rod)**

Weight: **5.500 kg**

Helix ECO Anchor Ellipse II



Material / Composition: **Steel**

Surface: **Hot Galvanization**

Dimensions: **150 x 25 x 2,5 cm (Height / Ø Disk/ Ø Rod)**

Weight: **8.500 kg**

Helix ECO Anchor Ellipse IIS



Material / Composition: **Steel**

Surface: **Hot Galvanization**

Dimensions: **200 x 30 x 3 cm (Height / Ø Disk/ Ø Rod)**

Weight: **24.00 kg**

Helix ECO Anchor Ellipse IVF



Material / Composition: **Steel**
 Surface: **Hot Galvanization**
 Dimensions: **300 x 30/40 x 3 cm (Height / Ø Disk/ Ø Rod)**
 Weight: **28.00 kg**

Tensile Streight Certificate	Ellipse I	Ellipse II	Ellipse IIIS	Ellipse IVF
Minimum holding certified by VERITAS - soft soil	0.8 t	1.0 t	2.3 t	4.0 t
Equivalent concrete block - soft soil	1.1 t	1.7 t	3.3 t	5.7 t
Maximum holding certified by VERITAS - compact soil	1.3 t	2.0 t	4.2 t	5.3 t
Equivalent concrete block - compact soil	1.8 t	2.9 t	6.0 t	7.7 t

Concrete Anchor



Material / Composition: **Concrete & Steel**
 Dimensions: **On Request**
 Weight: **On Request**

Pontoon-to-Pontoon Adaptor



Material / Composition: **Galvanized Steel**

Silver
2019BG003

Mooring Arm Bracket



Material / Composition:

Dimensions:

Weight:

Galvanized Steel

112 x 72 cm (Length / Height)

17.500 kg

Silver

2019BG018

Wall Plate



Material / Composition:

Silver

2019BG019

Galvanized Steel

Galvanized Pile Bracket V2



Material / Composition:

Dimensions:

Weight:

Galvanized Steel

60 x 26 cm (Length / Height)

3.00 kg

Silver

2021BG006

Galvanized Pile Bracket V3



Material / Composition:

Galvanized Steel

Dimensions:

112 x 30 cm (Length / Width)

Weight:

10.00 kg

Silver

2019BG022

Pile Pontoon Adaptor



Material / Composition:

Galvanized Steel

Dimensions:

121.5 x 30 cm (Length / Width)

Weight:

13.700 kg

Silver

2019BG023

Wall Bracket Adaptor Set



Material / Composition:

Galvanized Steel

Dimensions:

On Request

Silver

2019BG024

Jet Sliders

The **Jet Slider** is made of efficient new-generation HDPE (high-density polyethylene).

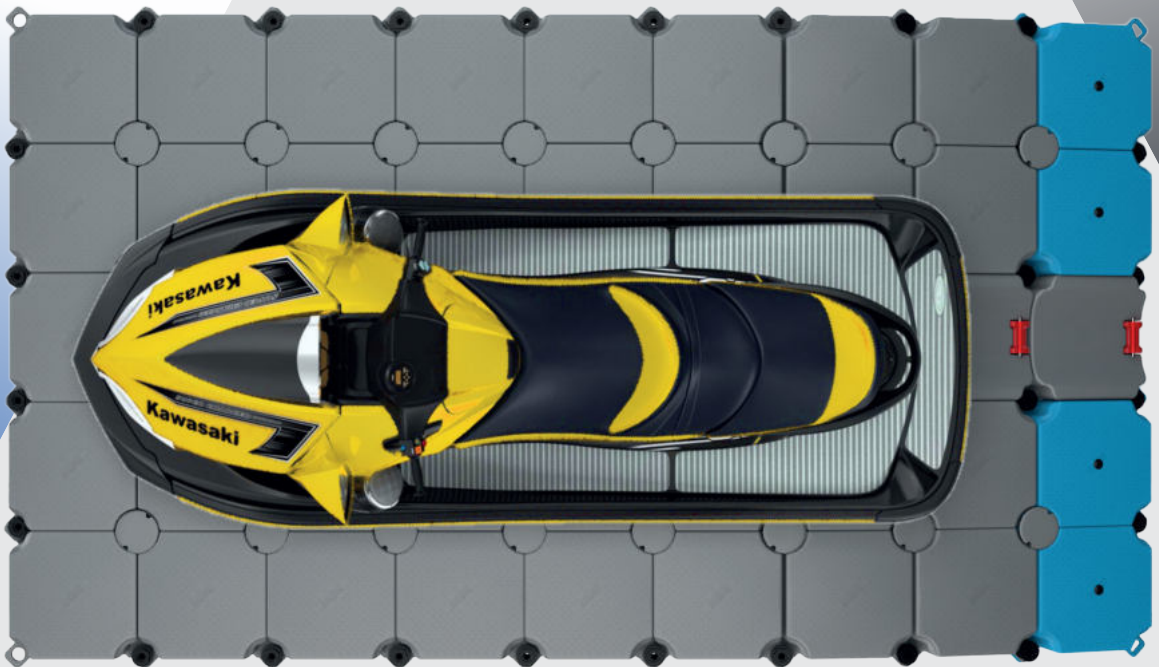

BulDock Jet Slider is a unique dry dock system.

The **Jet Slider** is lightweight, but thanks to its' technology, it is resistant to impact, chemical products, UV rays and severe weather conditions.

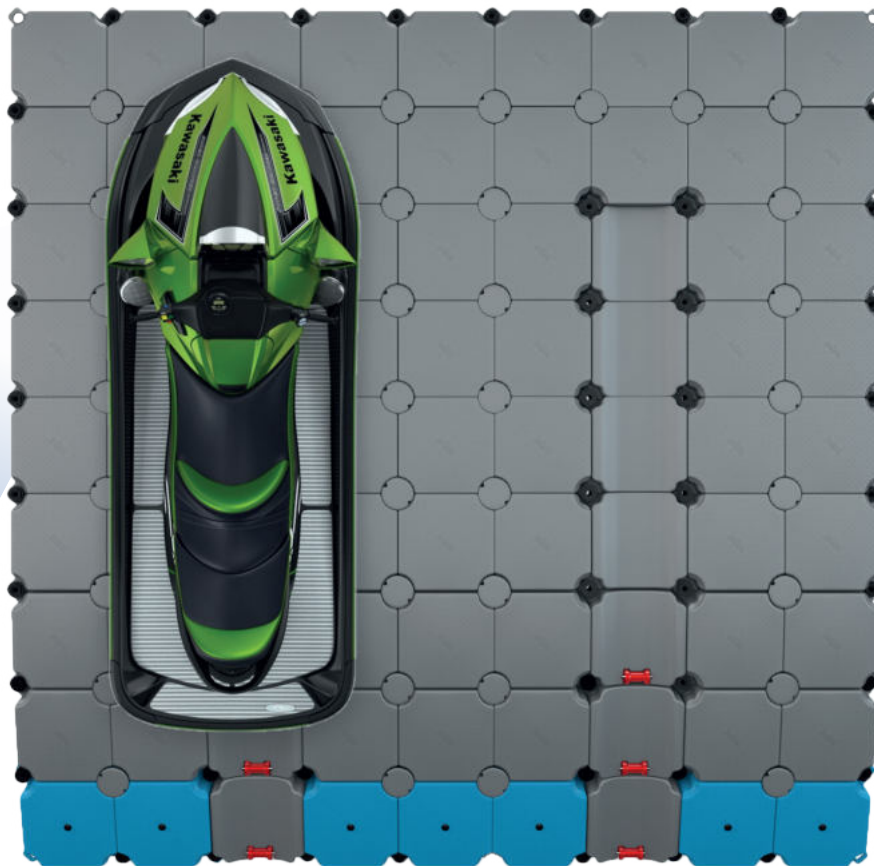

Its' exceptional design prevents any disproportionate strain on the hull by distributing the watercraft's weight evenly.

The **Jet Slider** does not feature any moving parts that might be damaged or would require maintenance.

Jet Slider 350

Material / Composition:

Rollers:

Surface:

Dimensions:

Weight:

High-density Polyethylene (HDPE)

Polyurethane, Inox Steel

Anti-Slip

350 x 150 x 27 cm (L / W / H)

135 kg

Grey
2018BG015

Beige
2018BG016

*Any color per customers wish

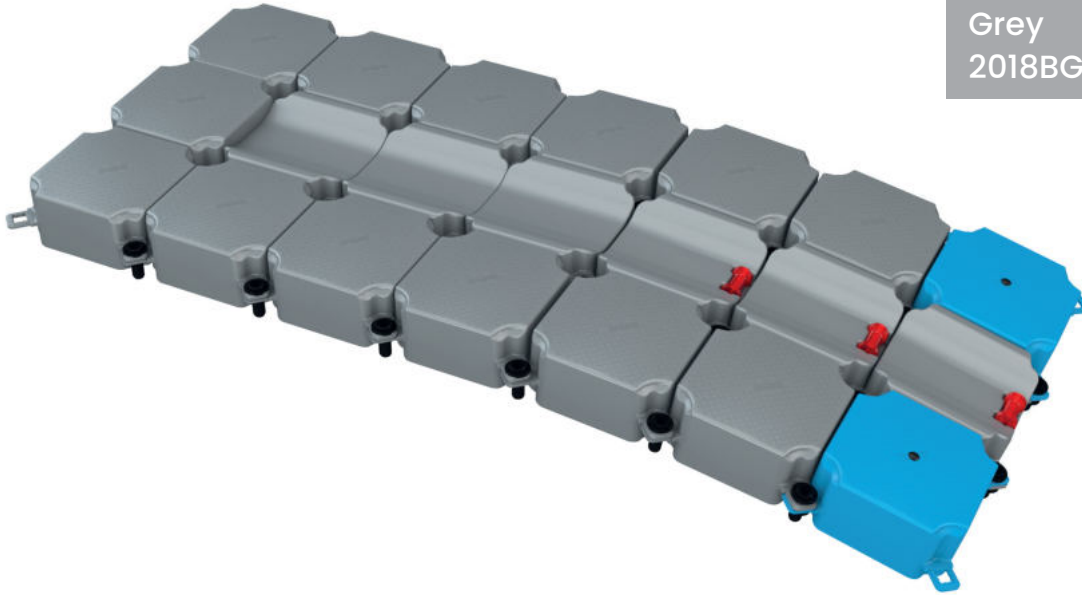

Jet Slider Big Size 400

Material / Composition:

Rollers:

Surface:

Dimensions:

Weight:

High-density Polyethylene (HDPE)

Polyurethane, Inox Steel

Anti-Slip

400 x 150 x 40 cm (L / W / H)

180 kg

Grey
2018BG017

Beige
2018BG018

*Any color per customers wish

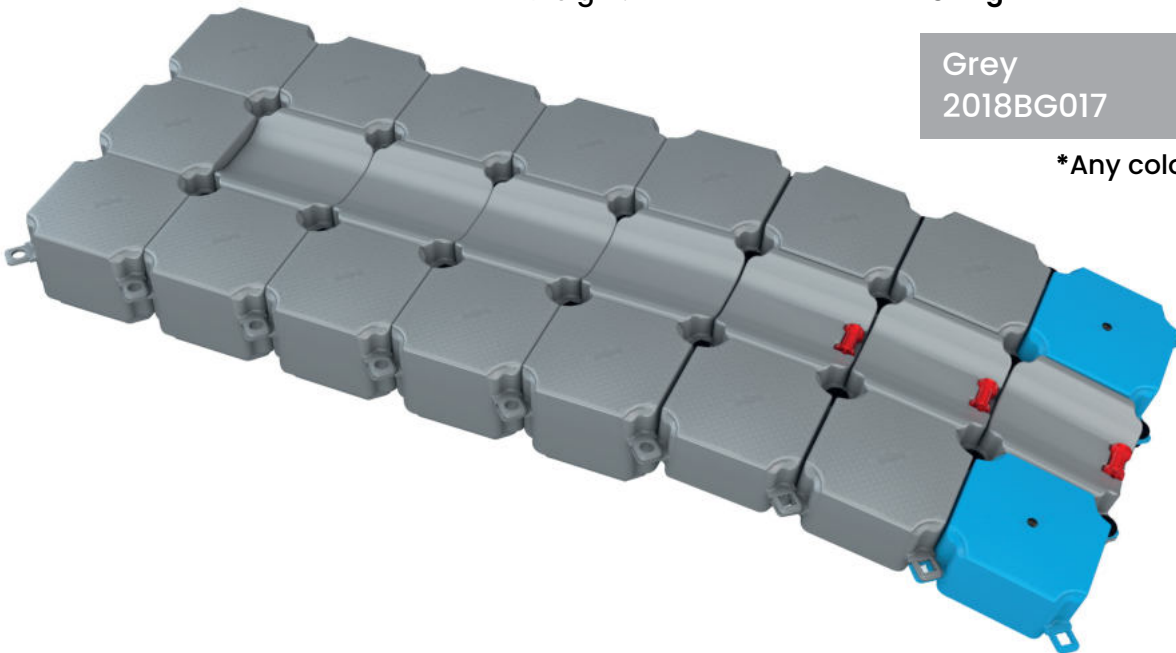

Jet Slider Twin 450

Material / Composition:
Rollers:
Surface:
Dimensions:
Weight:

High-density Polyethylene (HDPE)
Polyurethane, Inox Steel
Anti-Slip
450 x 450 x 40 cm (L / W / H)
540 kg

Grey
2018BG019

Beige
2018BG020

*Any color per customers wish

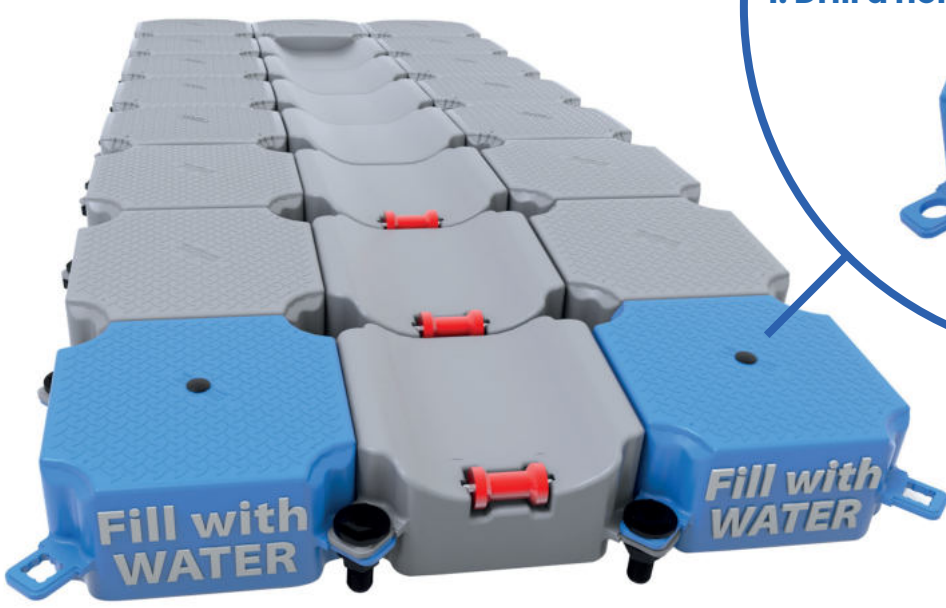
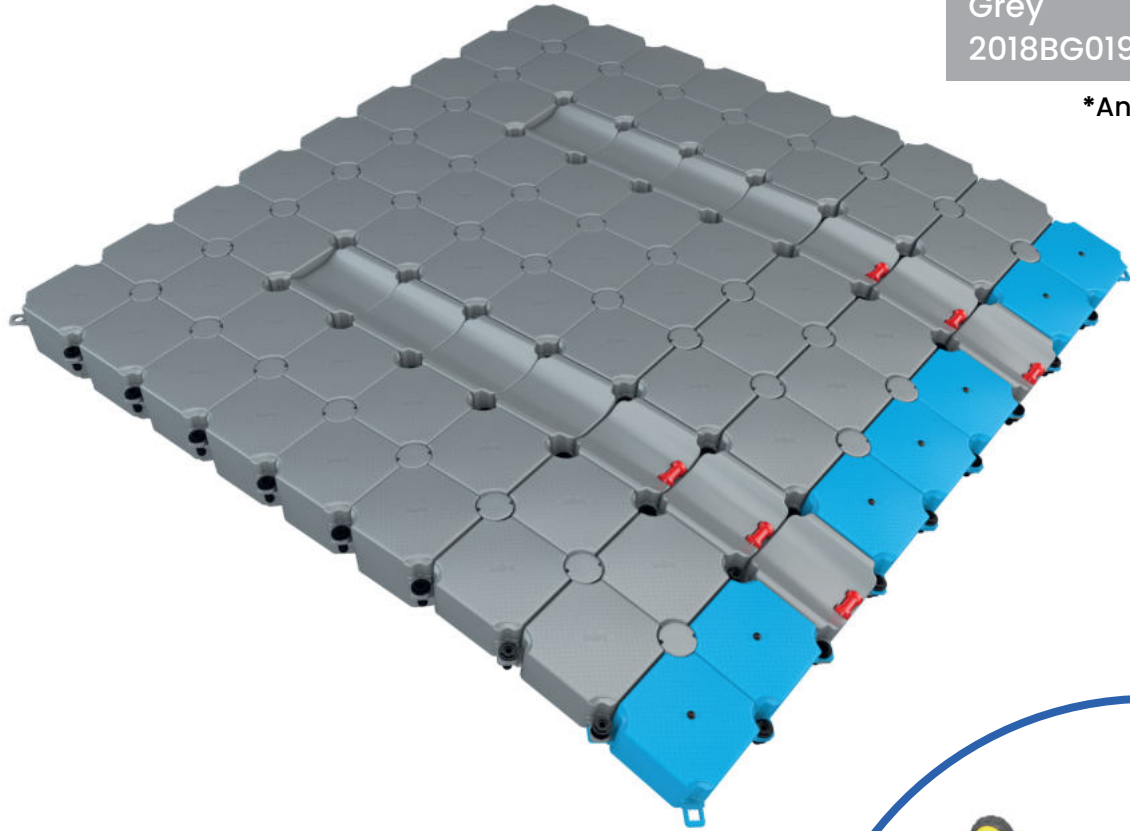

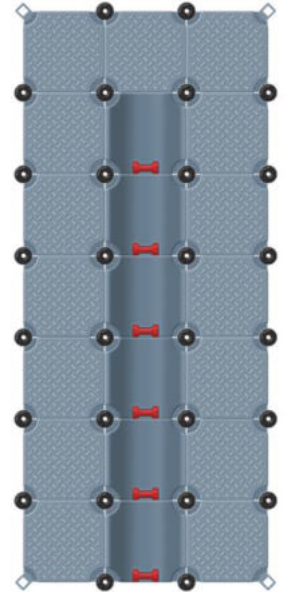
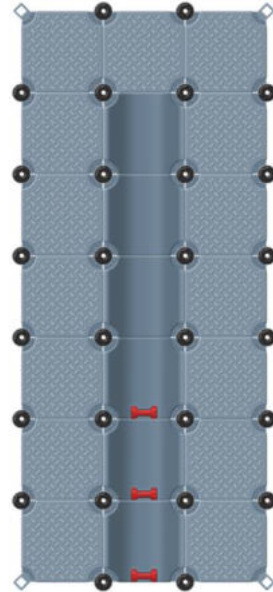
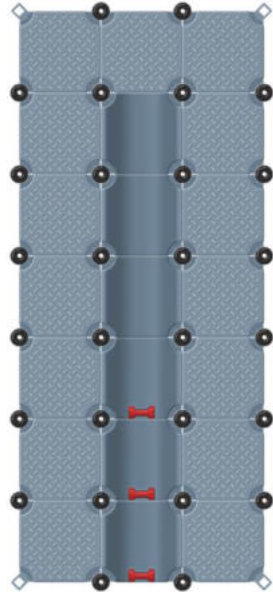
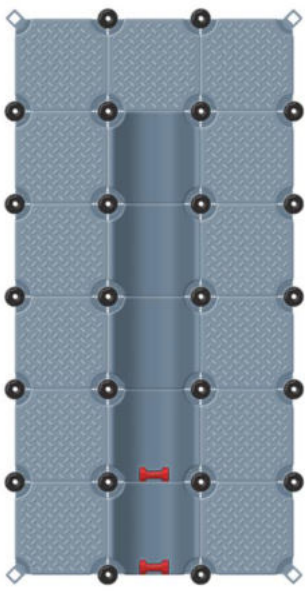

Jet Slider 300 H27

Jet Slider 350 H27

Jet Slider 350 H40

Jet Slider 350 H40 R

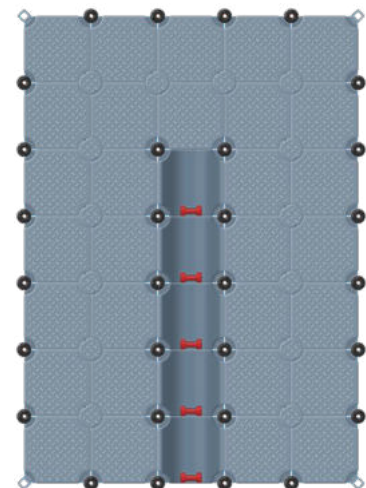
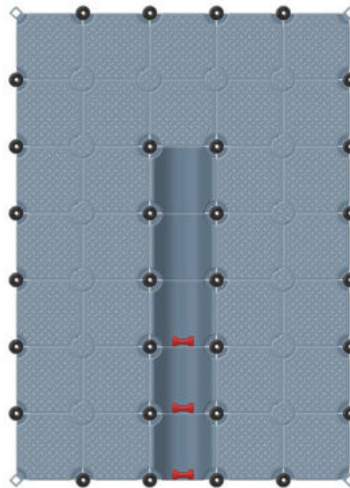
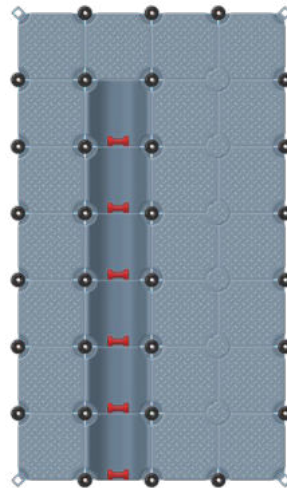
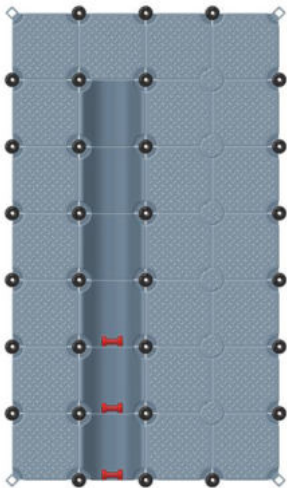

Jet Slider 350 H27 L

Jet Slider 350 H27 R L

Jet Slider 350 H27 XL

Jet Slider 350 H27 R XL

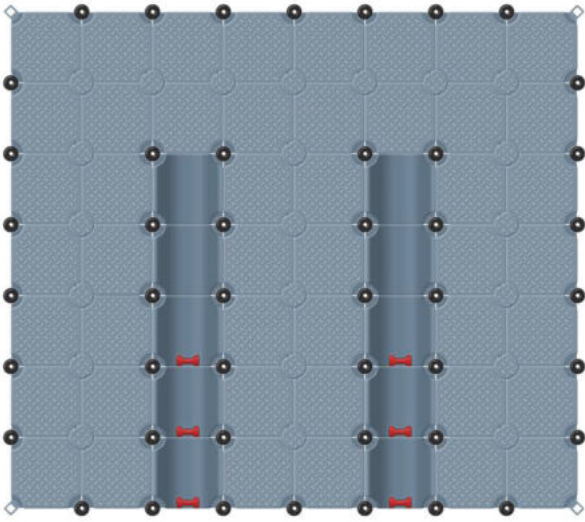

Jet Slider 350 Twin H27

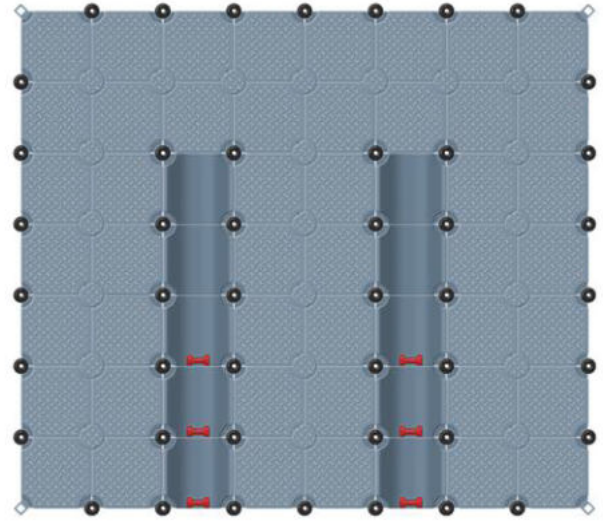

Jet Slider 350 Twin H40

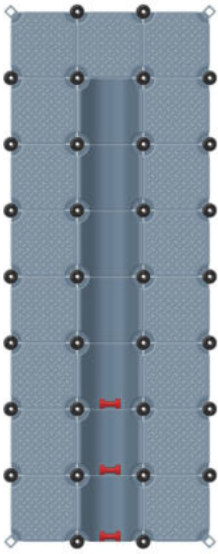

Jet Slider 400

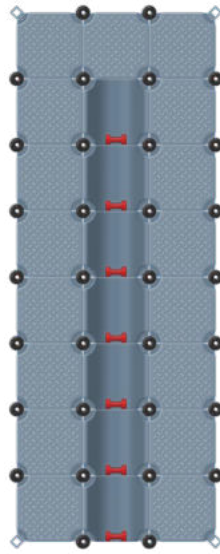

Jet Slider 400 R

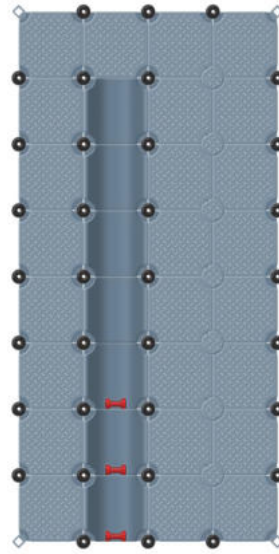

Jet Slider 400 L

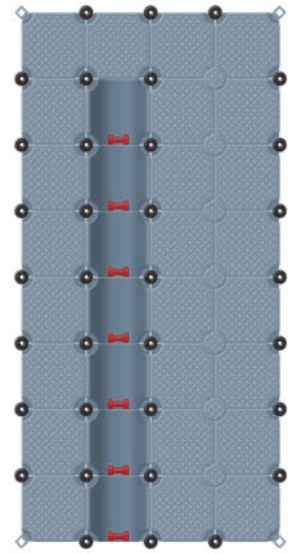

Jet Slider 400 R L

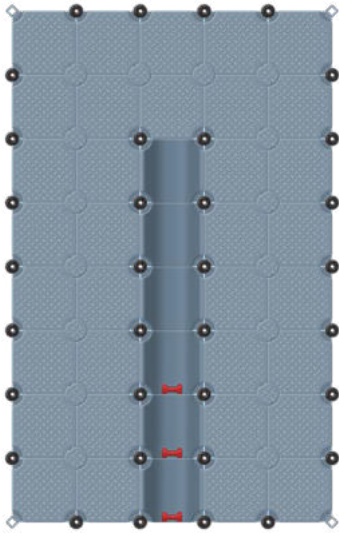

Jet Slider 400 XL

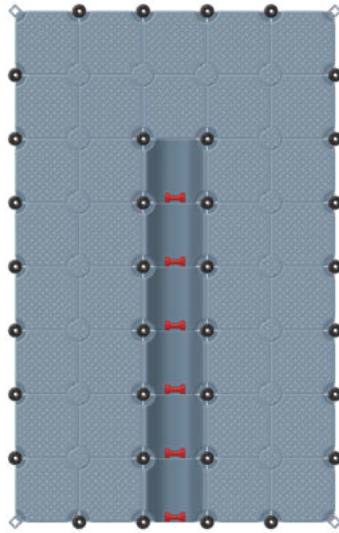

Jet Slider 400 R XL

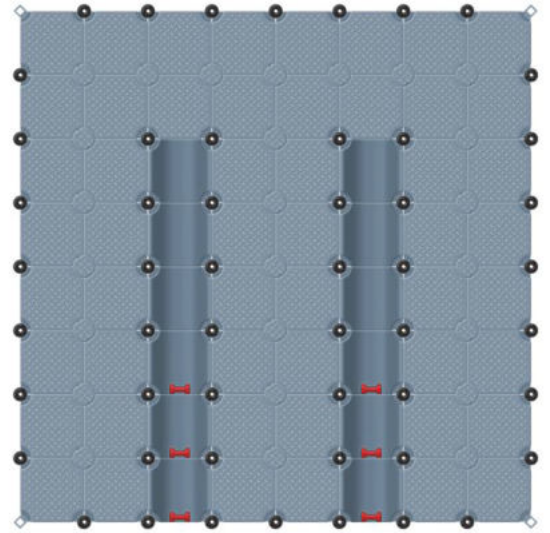

Jet Slider 400 Twin

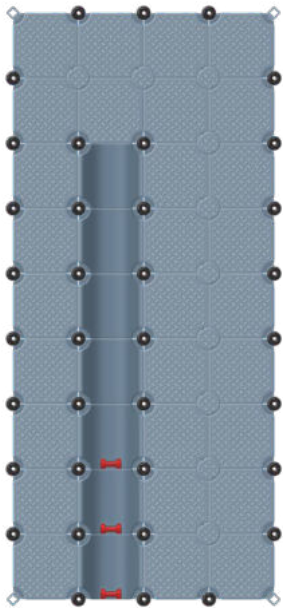

Jet Slider 450 L

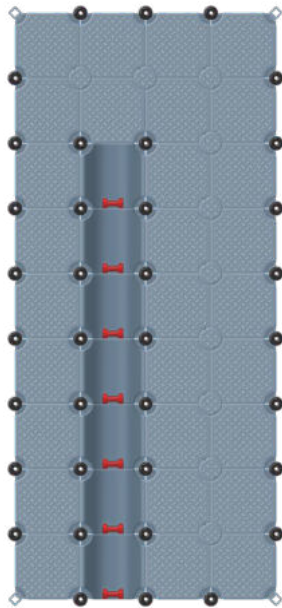

Jet Slider 450 R L

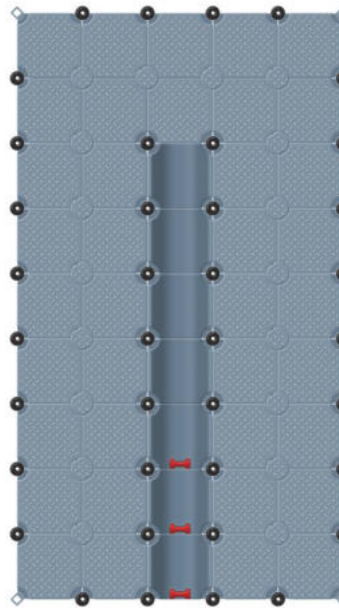

Jet Slider 450 XL

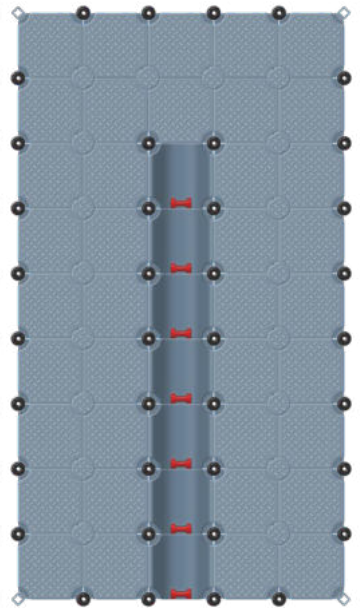

Jet Slider 450 R XL

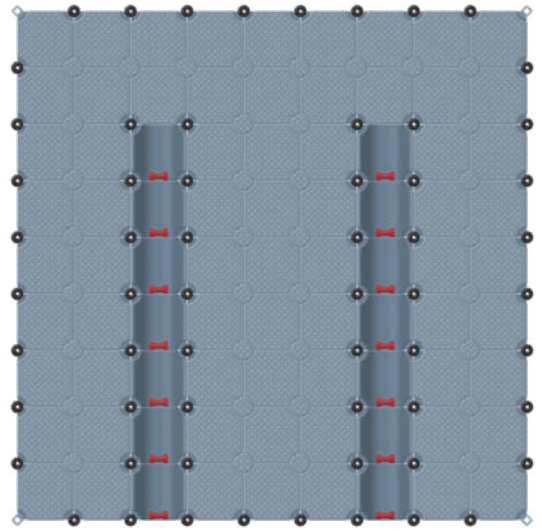
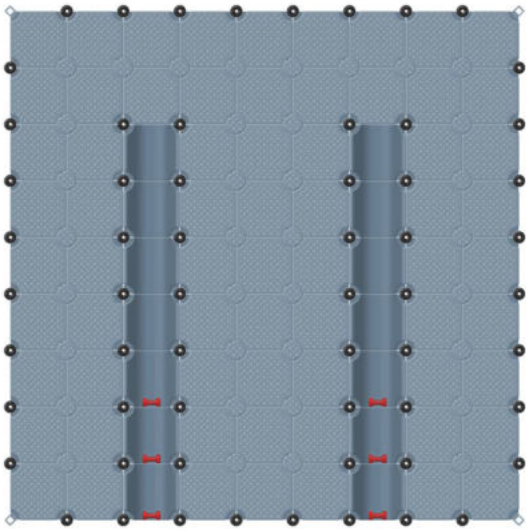

Jet Slider 450 Twin

Jet Slider 450 Twin

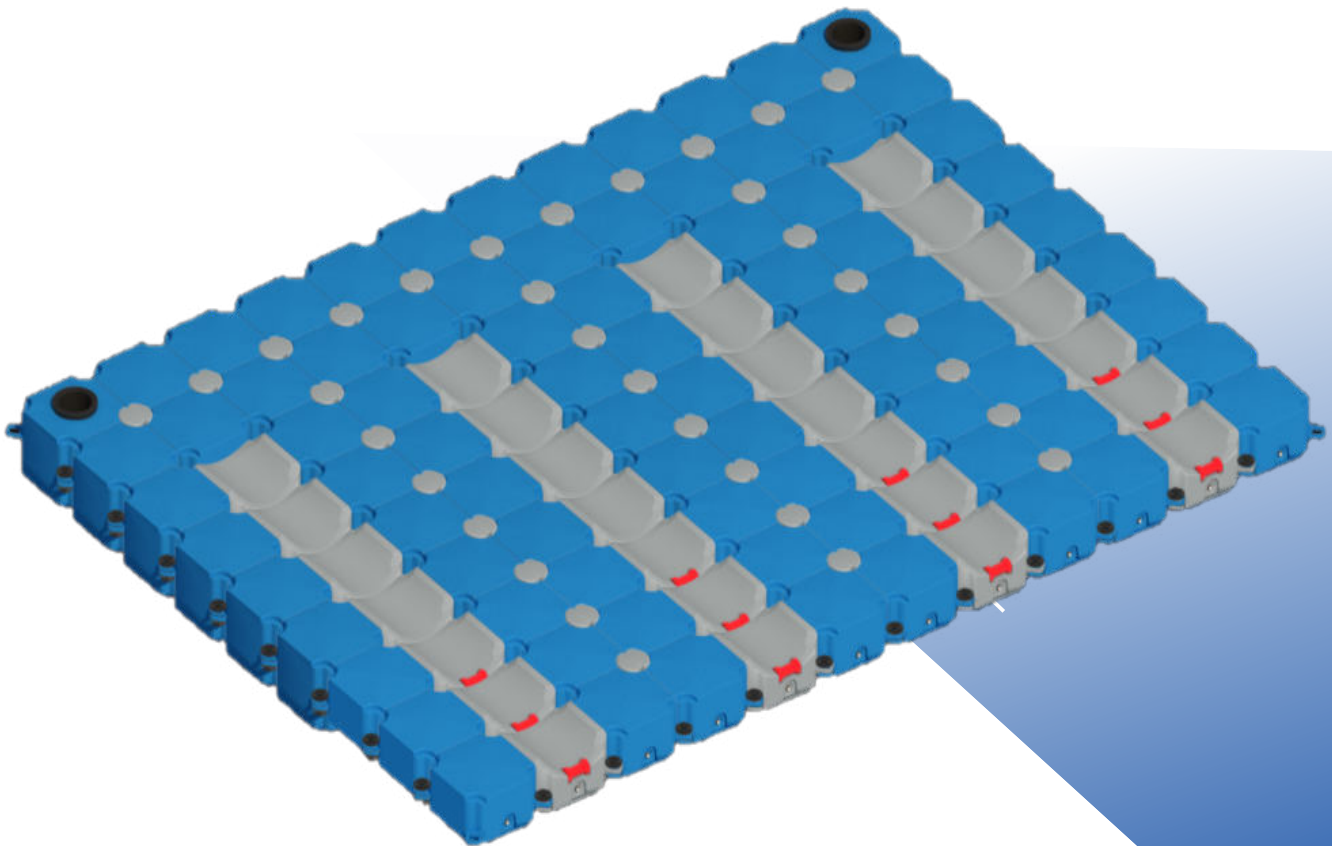

Boat Sliders

BulDock's Boat Slider is a unique dry-dock system. Its' exceptiona design prevents any disproportionate strain on the hull by distributing the watercraft's weight evenly. The Boat Slider does not feature any moving parts that might be damaged or would require maintenance. The **BulDock Boat Slider** is lightweight, resistant to UV rays, chemicals and collision.



V – Boat Sliders

Boat Slider V-Slide 550 & 650

Material / Composition: High-density Polyethylene (HDPE)
Rollers: Polyurethane, Inox Steel
Surface: Anti-Slip
Dimensions: 550 / 650 x 250 x 40 cm(L / W / H)
Weight: 390 / 465 kg

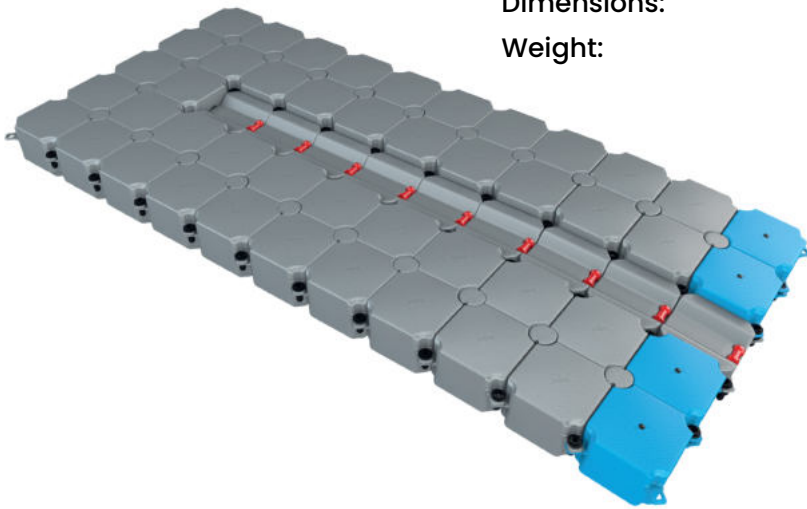

Grey
2018BG021 550

Beige
2018BG022 550

Grey
2018BG023 650

Beige
2018BG024 650

*Any color per customers wish

Boat Slider V-Slide 850 L & 1050 L

Material / Composition: High-density Polyethylene (HDPE)
Rollers: Polyurethane, Inox Steel
Surface: Anti-Slip
Dimensions: 850 / 1050 x 350 x 40 cm(L / W / H)
Weight: 850 / 1050 kg

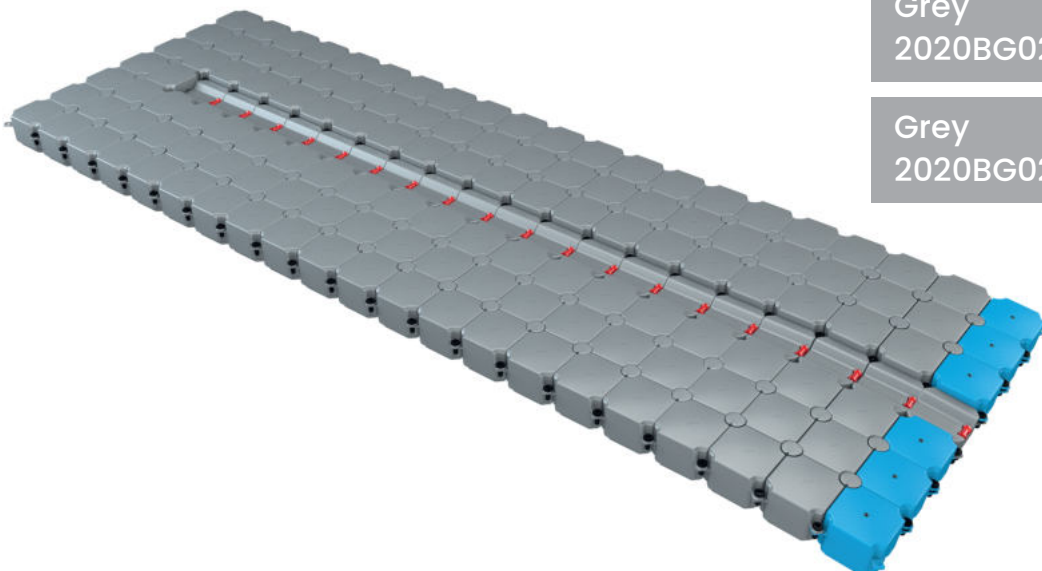

Grey
2020BG025 850

Beige
2020BG026 850

Grey
2020BG027 1050

Beige
2020BG028 1050

*Any color per customers wish

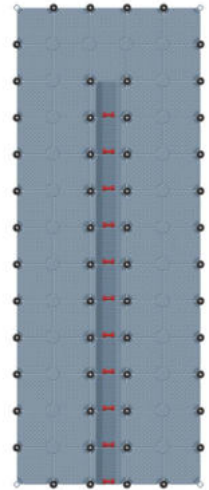
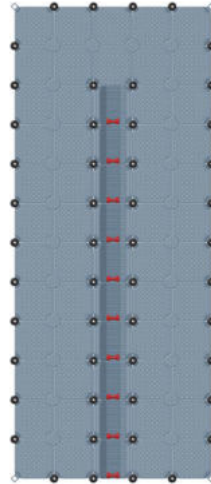
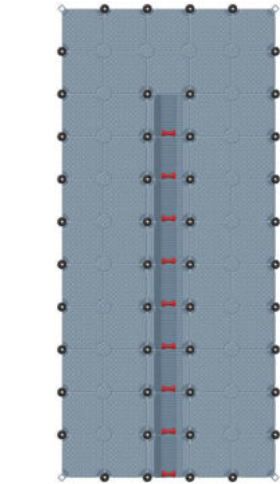
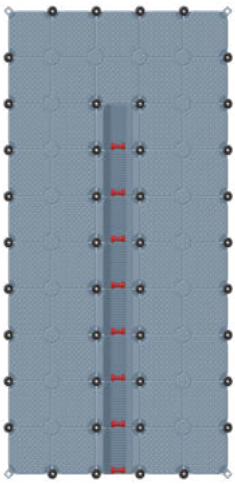

Boat Slider V-Slider 500

Boat Slider V-Slider 550

Boat Slider V-Slider 600

Boat Slider V-Slider 650

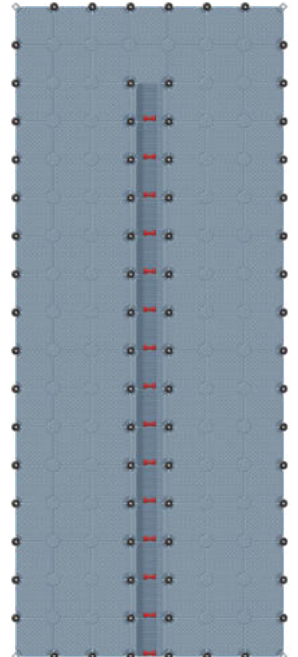
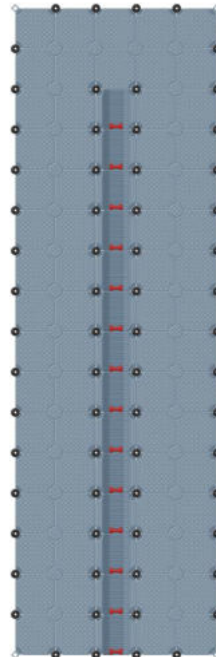
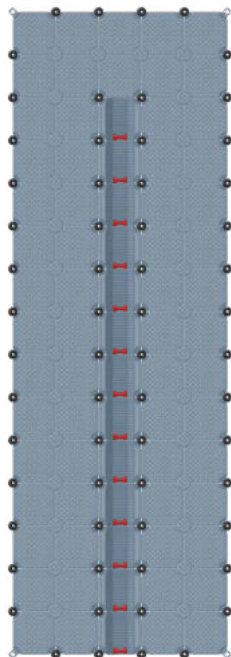
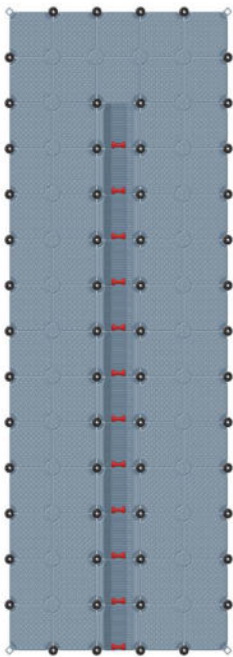

Boat Slider V-Slider 700

Boat Slider V-Slider 750

Boat Slider V-Slider 800

Boat Slider V-Slider 850 L

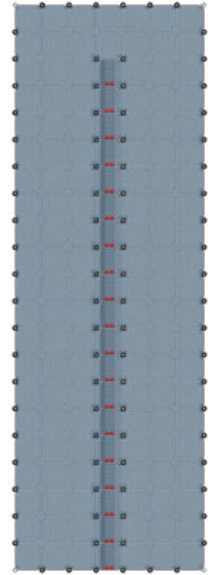
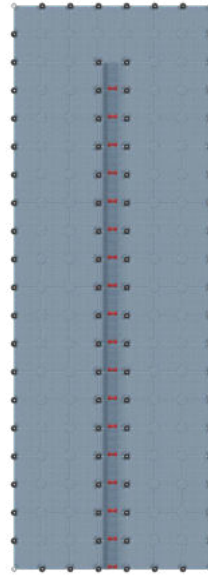
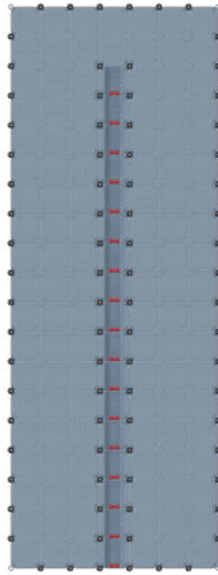
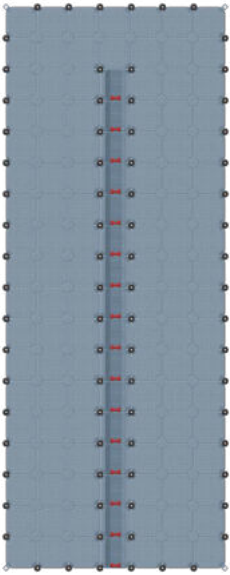

Boat Slider V-Slider 900 L

Boat Slider V-Slider 950 L

Boat Slider V-Slider 1000 L

Boat Slider V-Slider 1050 L

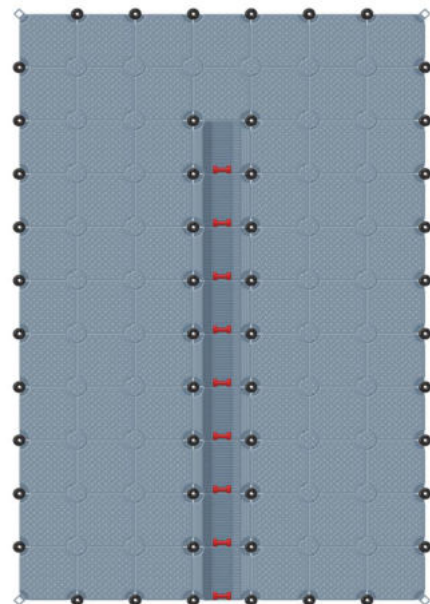
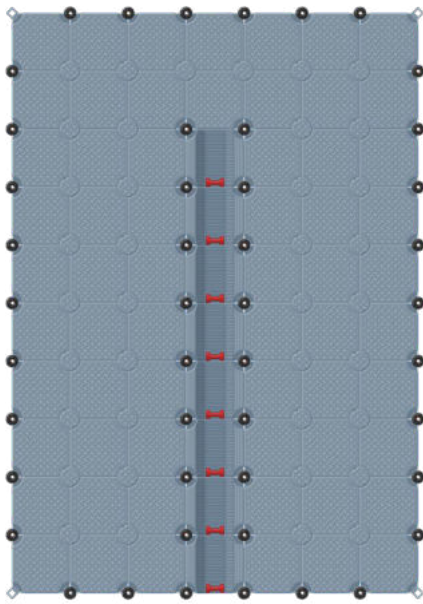

Boat Slider V-Slider 500 L

Boat Slider V-Slider 550 L

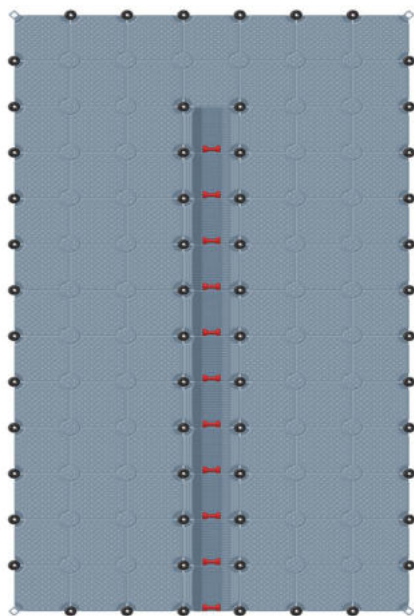
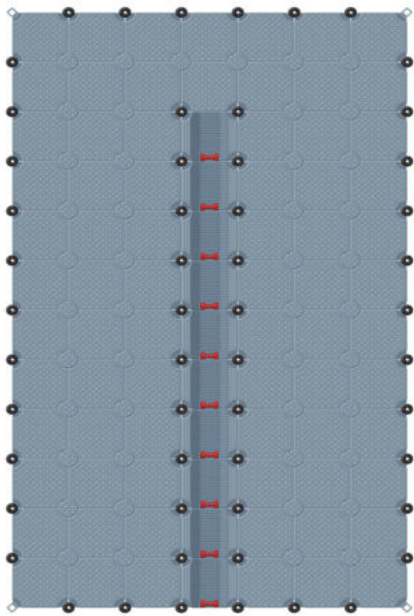

Boat Slider V-Slider 600 L

Boat Slider V-Slider 650 L

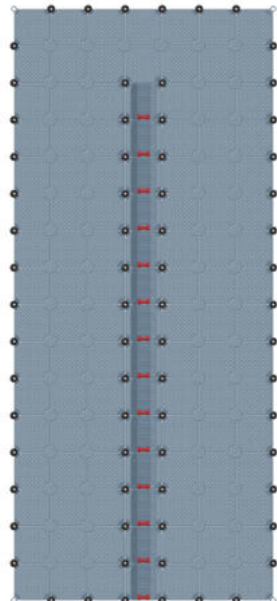
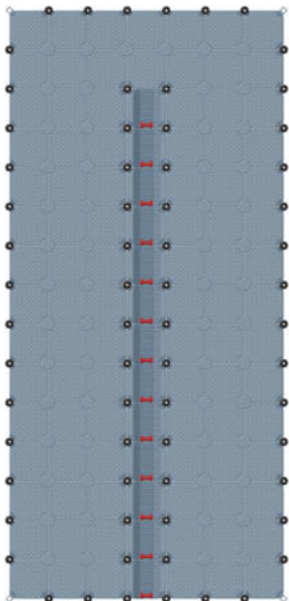
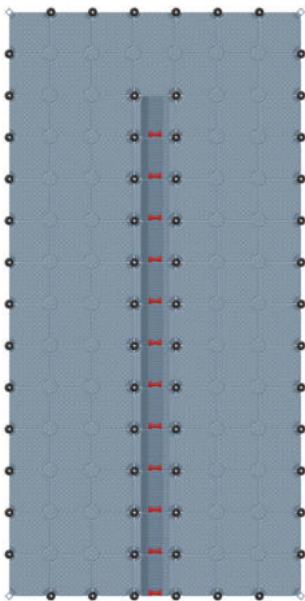

Boat Slider V-Slider 700 L

Boat Slider V-Slider 750 L

Boat Slider V-Slider 800 L

U – Boat Sliders

Boat Slider U-Slide 550 & 650

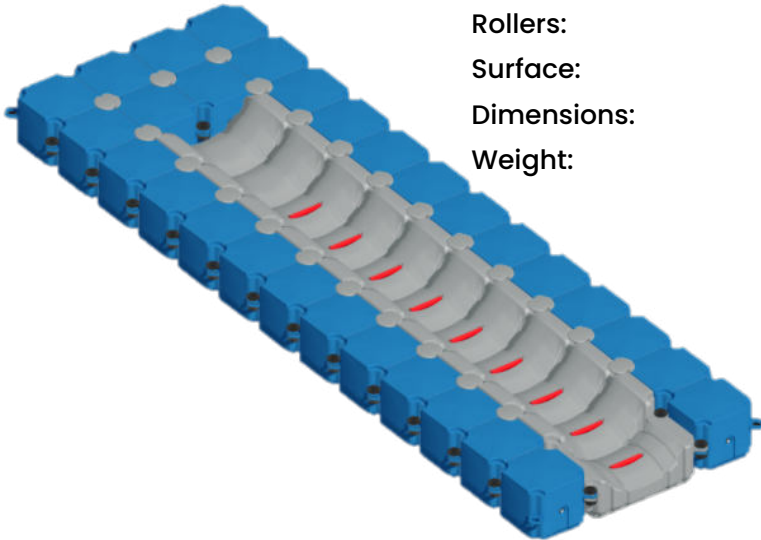

Material / Composition: High-density Polyethylene (HDPE)
Rollers: Polyurethane, Inox Steel
Surface: Anti-Slip
Dimensions: 550 / 650 x 200 x 40 cm (L / W / H)
Weight: 303 / 357 kg

Grey
2021BG007 550

Beige
2021BG008 550

Grey
2021BG009 650

Beige
2021BG010 650

*Any color per customers wish

Boat Slider U-Slide 850 L & 1050 L

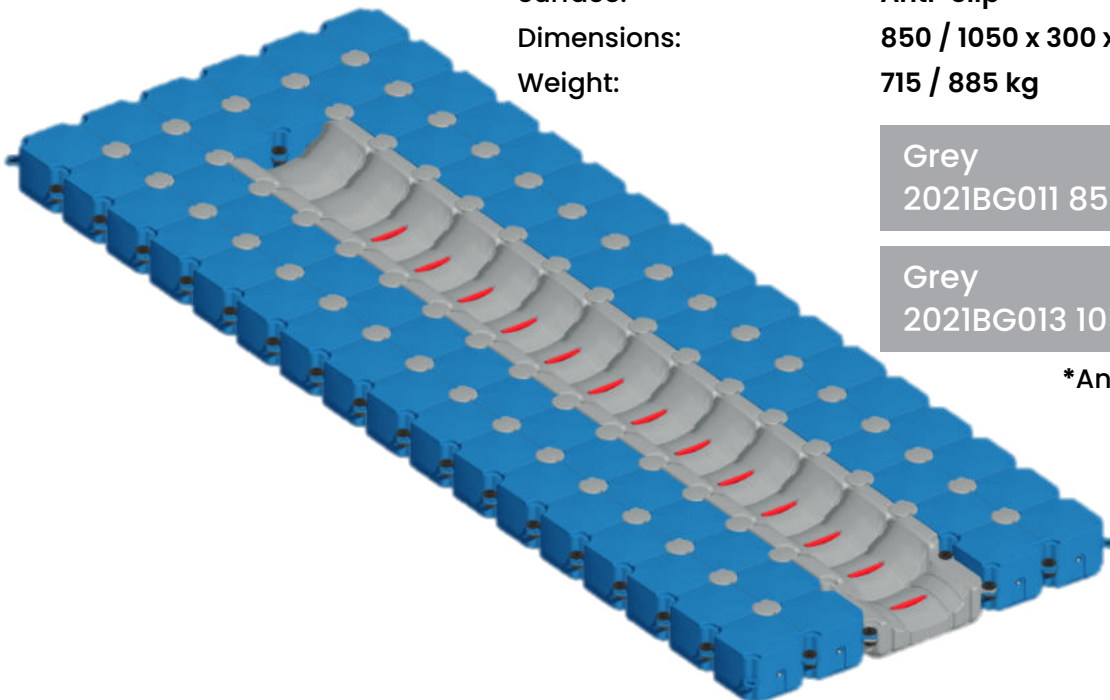

Material / Composition: High-density Polyethylene (HDPE)
Rollers: Polyurethane, Inox Steel
Surface: Anti-Slip
Dimensions: 850 / 1050 x 300 x 40 cm (L / W / H)
Weight: 715 / 885 kg

Grey
2021BG011 850

Beige
2021BG012 850

Grey
2021BG013 1050

Beige
2021BG014 1050

*Any color per customers wish

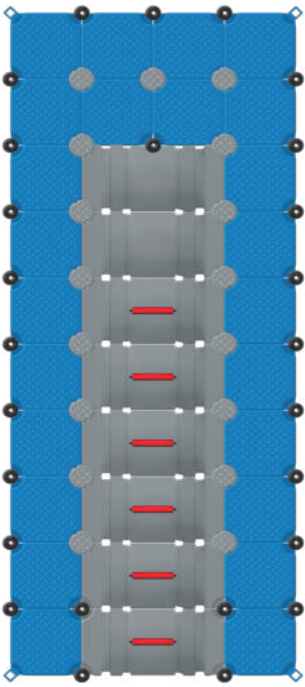

Boat Slider U-Slide 500

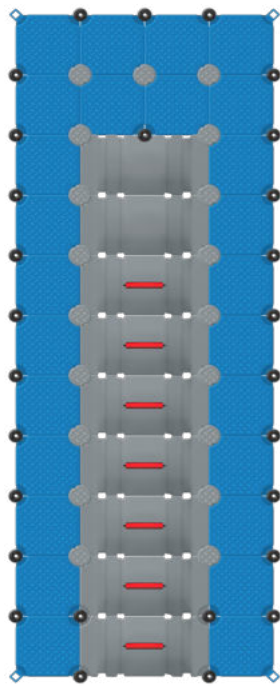

Boat Slider U-Slide 550

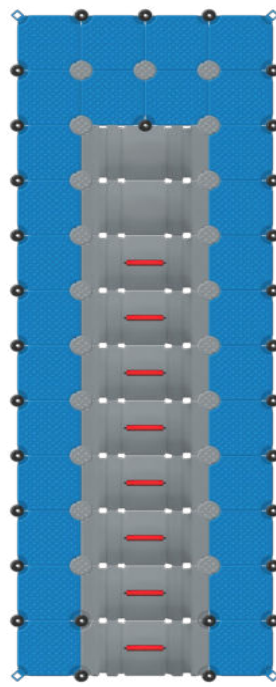

Boat Slider U-Slide 600

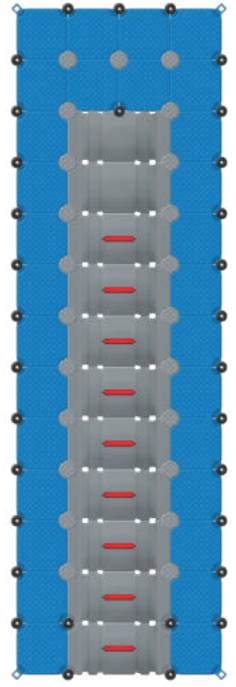

Boat Slider U-Slide 650

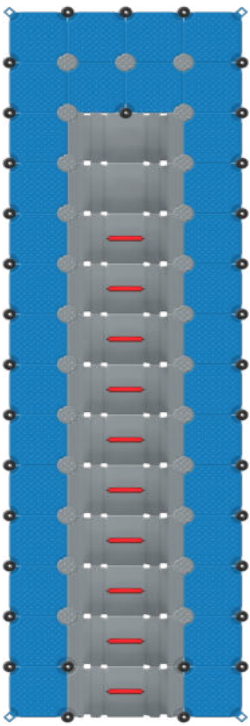

Boat Slider U-Slide 700

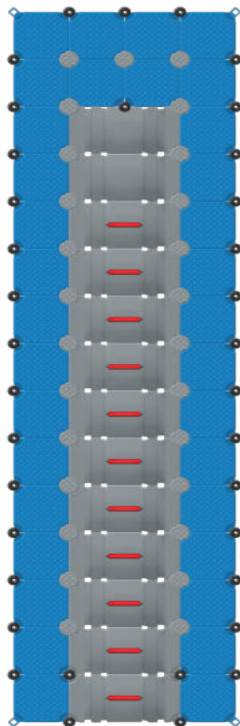

Boat Slider U-Slide 750

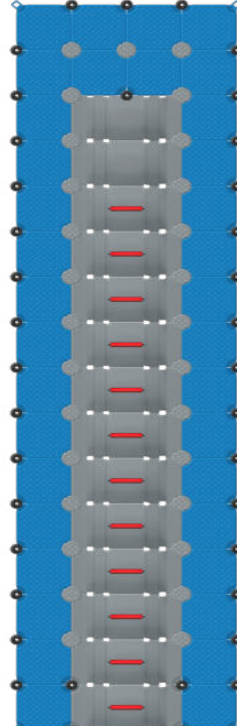

Boat Slider U-Slide 800

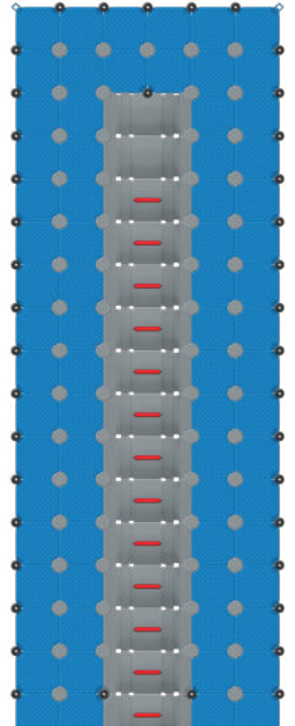

Boat Slider U-Slide 850 L

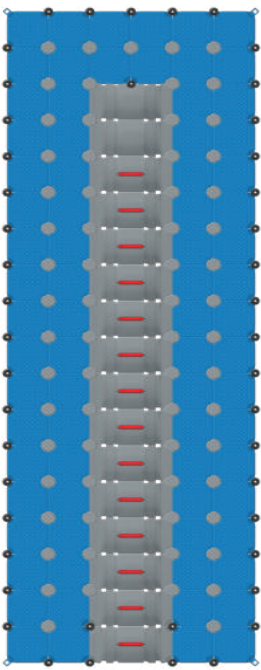

Boat Slider U-Slide 900 L

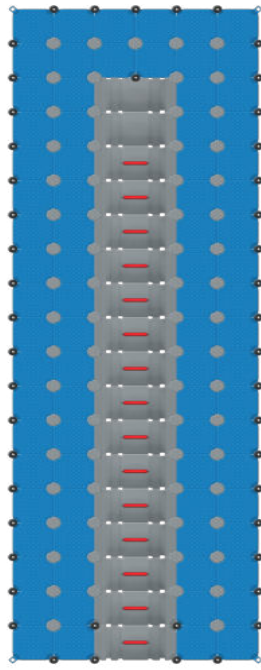

Boat Slider U-Slide 950 L

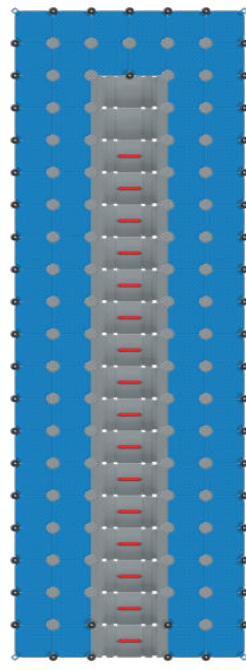

Boat Slider U-Slide 1000 L

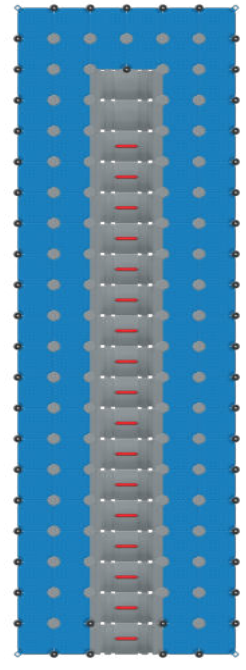

Boat Slider U-Slide 1050 L

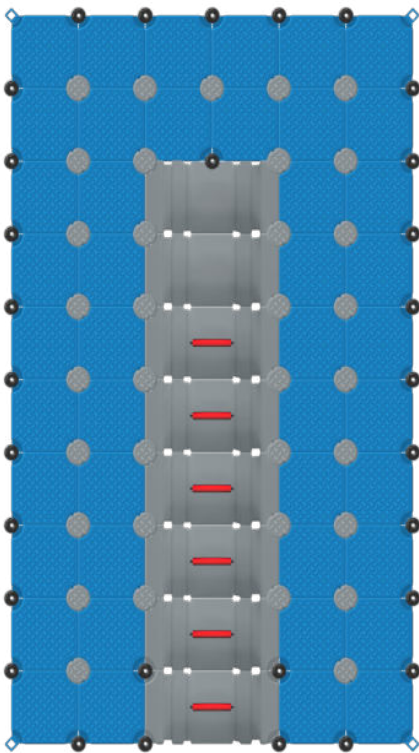

Boat Slider U-Slide 500 L

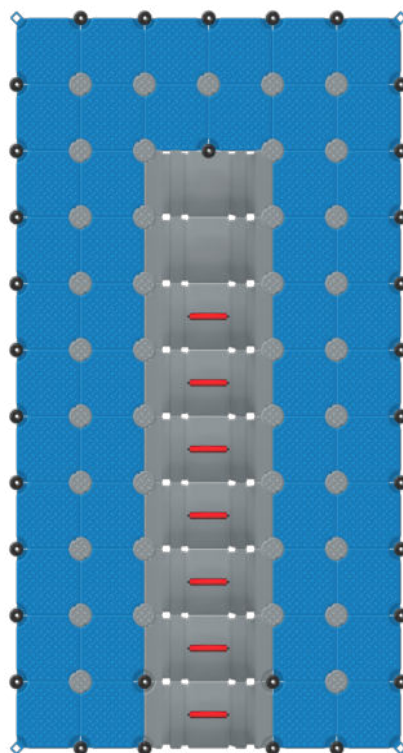

Boat Slider U-Slide 550 L

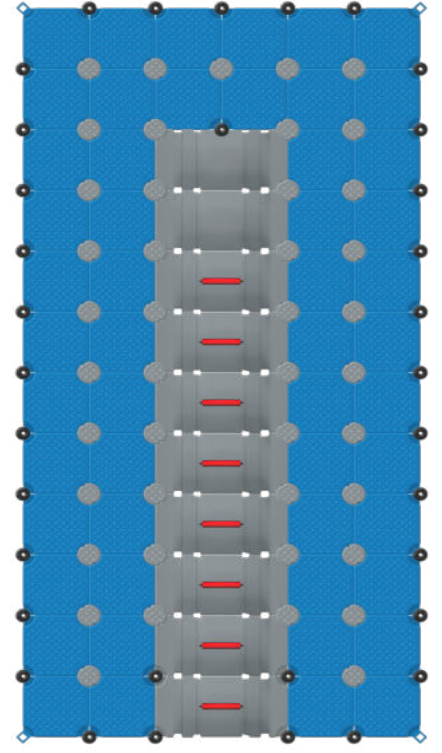

Boat Slider U-Slide 600 L

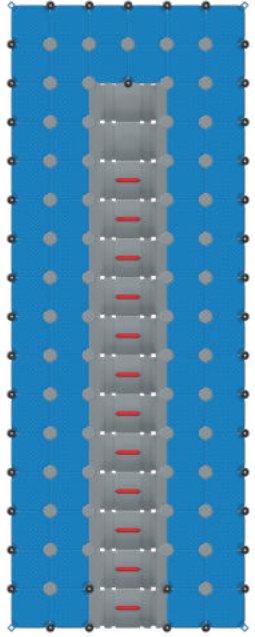
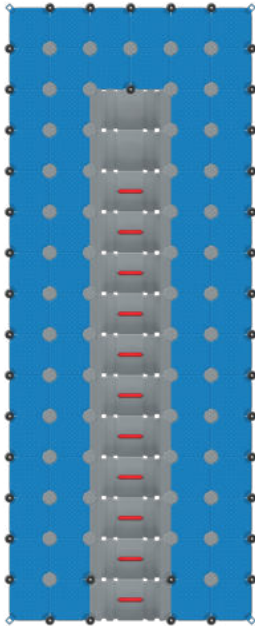
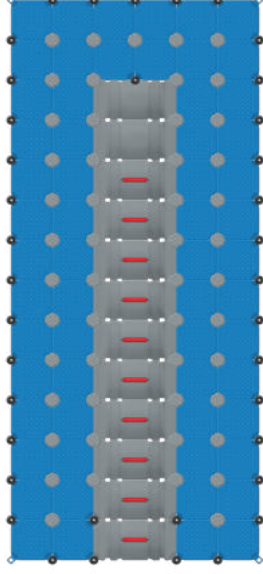
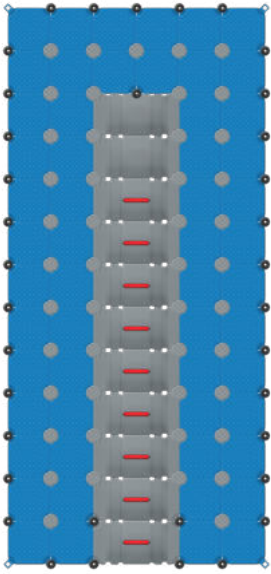

Boat Slider U-Slide 650 L

Boat Slider U-Slide 700 L

Boat Slider U-Slide 750 L

Boat Slider U-Slide 800 L

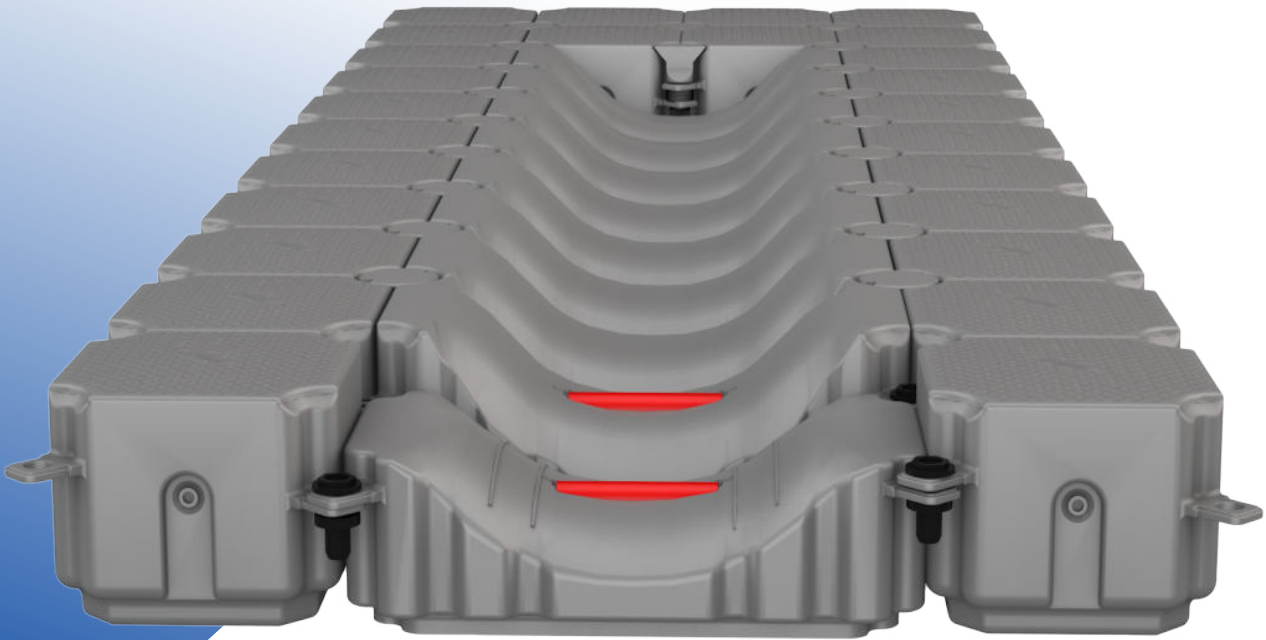

DISTRIBUTORS

Bulgaria

BulDock Ltd.

Address: Perla Park Complex, sector B, floor 2,
36, Okolovrasten pat Str. Sofia, Bulgaria

Phone: +359 878 333 878

E-mail: office@buldock.com

Website: www.buldock.com

Benelux Union

Creative Composite Solutions BVBA

Address: Steenovenstraat 11/a 3980 Tessenderlo,
BELGIUM

Contact: Mr. Philip Kennes

Phone: +32 476 624 634

E-mail: philip.epoxy@gmail.com

Website: www.buldock.com

Croatia

Area Maris d.o.o.

Address: Trg Kralja Tomislava 7, 52100,Pula, Croatia

E-mail: info@areamaris.hr

Website: www.areamaris.hr

Czechia

Kola s.r.o.

Address: Prešov, Slovakia

Phone: +421 948 091 191

E-mail: info@buldock.sk

Website: www.buldock.sk

Estonia

ABC TENT OÜ

Address: Sassi, Mäksa küla Kastre vald Tartumaa
62306, Estonia

Contact: Mr. Aleksandr Suvorov

Phone: +372 56240284

E-mail: info@abctent.ee

Website: www.abctent.ee

Germany

Harms & Steder Handelsgesellschaft mbH

Address: Hansestraße 19, 18182 Bentwisch, Germany

Phone: +49 15678 571357

E-mail: buldock@schwimmsteg.de

Website: www.harms-steder.de

Montenegro

Beny com DOO

Address: Dzordza Vasingtona 73, Podgorica,
Montenegro

Contact: Mr. Petar Popovic

Phone: +38267600829; +38267600899;

E-mail: poppetar17@gmail.com

Poland

Taurus Sea Power Sp. z o.o.

Address: Dziewięć Włók 33 a 03-021, Pruszcz Gdanski,
Poland

Phone: +48 58 30 20 225

E-mail: taurus@taurus.gda.pl

Website: www.taurus.gda.pl

Romania

SC.CLAYSGROUP SRL

Contact: Mr. Bogdan Puie

Phone: +40 742 697 048

E-mail: bogdan@kdmanager.eu

Website: www.intensewater.eu

Scandinavia

BulDock Scandinavia AB

Address: Energigatan 4 43437 Kungsbacka, Sweden

Phone: +46 73 2853625

E-mail: info@buldockscandinavia.se

Website: www.buldockscandinavia.se

Seychelles

PMC Auto

Contact: Mr. Cedric d'Offay; Mr. Perry Mancienne

Phone:+248 2710767; +248 2717273

E-mail: cedric.doffay@pmcauto.com

perry.mancienne@pmcauto.com

Serbia

Novomax d.o.o.

Address: Novi Sad 21000 Vatroslava Jagica 11 Srbija

Phone: +381 69 1908708

E-mail: info@novomax.rs

Website: www.novomax.rs

Slovakia

Kola s.r.o.

Address: Prešov, Slovakia

Phone: +421 948 091 191

E-mail: info@buldock.sk

Website: www.buldock.sk

Switzerland

Idea Green SA

Address: Via St. Maria 69a, 6596 Gordola

Contact: Mr. Enzo Trazzera

Phone: +41 225 72 70

E-mail: info@buldock.ch

Website: www.buldock.ch

DEALERS

Bulgaria

SALTUS Ltd.

Address: Burgas 8000, Aleksandar Batenberg Str., Hotel Marina Burgas, Bulgaria

Contact: Mr. George Rangelov

Phone: +359 879 998 777

E-mail: ecobeach.solutions@gmail.com

Web: www.ecobeach.solutions/index.php/en/

Austria

Harms & Steder Handelsgesellschaft mbH

Address: Hansestraße 19, 18182 Bentwisch, Germany

Phone: +49 15678 571357

E-mail: bulldock@schwimmsteg.de

Website: www.harms-steder.de

Belarus, Latvia, Lithuania, Ukraine, Russia

ABC TENT OÜ

Address: Sassi, Mäksa küla Kastre vald Tartumaa 62306, Estonia

Contact: Mr. Aleksandr Suvorov

Phone: +372 56240284

E-mail: info@abctent.ee

Website: www.abctent.ee

Bosnia and Herzegovina

Novomax d.o.o.

Address: Novi Sad 21000 Vatroslava Jagica II Srbija

Phone: +381 69 1908708

E-mail: info@]novomax.rs

Website: www.novomax.rs

Cyprus

MORE WATERSPORTS LTD.

Address: Marathonos , 13, 4040, Limassol, Cyprus

Phone: +357 99 43 42 95

E-mail: demetriou.e.b@cytanet.com.cy

Website: www.morewatersport.com

Egypt

SeaServ Marine Services and Agencies LLC (SSMA)

Address: Block 1602, Al Hadaba Al Wosta, Mokkatam City, Cairo, Egypt

Contact: Mr. Mohammed Nabil, CEO

Phone: +2 01116556664; +2 01205662443

E-mail: info@ seaserv.tech

Website: www.seaserv.tech

Greece

IDEAGENESIS

Address: Thessaloniki, Greece

Contact: Mr. Yannis Kaplanidis

Phone: +30 23130 37 100

Mobile: +30 698 37 97 125

E-mail: info@ideagenesis.gr

Website: www.esc.guide/bulldock

Guadeloupe

ELECTRO-NAUTIC S. A.

Address: ZI De Jarry Impasse, Emile Dessout, 97122, Baie Mahault, Guadeloupe

Phone: + 590590213670; +590690388957

E-mail: maxime.delacaze@electronautic.com

Hungary

Energy Top Class KFT

Contact: Mr. Peter Paksi

Phone: +36 304 174 464

E-mail: info@amperyacht.hu

Website: www.amperyacht.hu

Italy

Oliva Srl , Centro Sud Italia

Address: Via Lanzara 33 84014 Nocera Inferiore (SA), Italia

Contact: Mr. Alfonso Oliva

Phone: +39 388 241 45 96

E-mail: info@olivasrl.it

Malta

Triton Diving Services Ltd.

Address: Landier Street 2, Mosta MST 4000, Malta

Contact: Mr. Etienne Pecorella

Phone: +356 21372418

Mobile: +356 99457803

E-mail: bulldock_equip@protonmail.com

Spain

INTERMAR SAILING

Contact: Mr. Joan Gelpí

Phone: +34 670 29 69 46

E-mail: info@intermarsailing.com

Website: www.intermarsailing.com

United Kingdom

MURLAC

Address: Anders, Lichfield Road Industrial Estate, Tamworth, Staffordshire, B79 7TA, United Kingdom

Contact: Mr. Scott Dawson

Phone: +44 (0) 121 313 1008

E-mail: scott.dawson@murlac.com

Website: www.murlac.com

United States, Florida

KMB Yachting LLC

Address: 13301 Biscayne Blvd Suite 102 North Miami, FL 33181, USA

Phone: +1 305 570 5004

Website: www.kmbyachting.com

Request a quote
Let's build your dock!

Become a **BulDock** distributor
Sign up now!

Get in touch

office@buldock.com

+359 878 333 878

BULDOCK
FLOATING DOCKS

Learn more about **BulDock**
products on our website

www.buldock.com