



SAMAY
Surgical

An **ISO 13485:2003**
Certified Company



Mfg. : Orthopedic Implant & Instruments

Samay Surgical is one of the most reputed and rapidly growing orthopedic companies in India. We have been in business for more than a decade and have been continuously innovating and improving our products. Our main focus areas are Surgical instruments and implants and of late we have also been diversifying in the design and manufacture of Surgical equipments. While our dealer network spans almost all of India.

Samay Surgical is a leading manufacturer of quality surgical equipment for high surgical requirements. Our offering includes surgical, dental that are designed as per the international quality standards & medical parameters. We aspire to become a Global Healthcare' brand identity synonymous with nurturing healthcare, eternal values, strong ethics and global quality of highest standards in surgical equipment.

Samay Surgical is a leading manufacturer of quality surgical equipment for high surgical requirements. Our offering includes surgical, dental that are designed as per the international quality standards & medical parameters. We aspire to become a Global Healthcare' brand identity synonymous with nurturing healthcare, eternal values, strong ethics and global quality of highest standards in surgical equipment.

Samay Surgical is known synonymous with high quality, efficient service and close correspondence with its customers. Its success depends upon those who work for it and equally on those who work with it. The company is growing in an evolving industry and Mr. MAHESH GODHASARA has promised itself to stay up to date with changes. After all, a successful company will produce successful clients and successful clients will produce a successful company.

The catalog contains our standard line of products, it is based on modern market requirements and consists of commonly used sizes, materials and configurations, **Samay Surgical, as a full cycle manufacturer of orthopedic implants and instruments, ISO 13485 certified and in compliance with MDD 93/42/ECC is producing by request additional sizes and configurations, all additional sizes are CE marked and covered by our ISO and CE certification. Please feel free to request any additional information you may require.**



Bone Screw	01
Bone Plate	07
Locking Screw	18
Locking Plate	20
Nail & Screw System	30
Wire & Pins	37
Hip System	39
Spine System	41
External Fixator	46



Locking Plates

Small Locking Plate

(Stainless Steel & Titanium)

Code No. SS	Code No. TT	Holes
SS 310-004	TT 310-004	4
SS 310-005	TT 310-005	5
SS 310-006	TT 310-006	6
SS 310-007	TT 310-007	7
SS 310-008	TT 310-008	8
SS 310-009	TT 310-009	9
SS 310-010	TT 310-010	10
SS 310-011	TT 310-011	11
SS 310-012	TT 310-012	12

Screw Places :

- 3.5 mm Locking Screw
- 3.5 mm Cortical Screw



Narrow Locking Plate

(Stainless Steel & Titanium)

Code No. SS	Code No. TT	Holes
SS 311-004	TT 311-004	4
SS 311-005	TT 311-005	5
SS 311-006	TT 311-006	6
SS 311-007	TT 311-007	7
SS 311-008	TT 311-008	8
SS 311-009	TT 311-009	9
SS 311-010	TT 311-010	10
SS 311-011	TT 311-011	11
SS 311-012	TT 311-012	12
SS 311-013	TT 311-013	13
SS 311-014	TT 311-014	14
SS 311-015	TT 311-015	15
SS 311-016	TT 311-016	16
SS 311-018	TT 311-018	18
SS 311-020	TT 311-020	20

Screw Places :

- 5.0 mm Locking Screw
- 4.5 mm Cortical Screw



Broad Locking Plate

(Stainless Steel & Titanium)

Code No. SS	Code No. TT	Holes
SS 312-005	TT 312-005	5
SS 312-006	TT 312-006	6
SS 312-007	TT 312-007	7
SS 312-008	TT 312-008	8
SS 312-009	TT 312-009	9
SS 312-010	TT 312-010	10
SS 312-011	TT 312-011	11
SS 312-012	TT 312-012	12
SS 312-013	TT 312-013	13
SS 312-014	TT 312-014	14
SS 312-015	TT 312-015	15
SS 312-016	TT 312-016	16
SS 312-017	TT 312-017	17
SS 312-018	TT 312-018	18
SS 312-019	TT 312-019	19
SS 312-020	TT 312-020	20
SS 312-021	TT 312-021	21
SS 312-022	TT 312-022	22



Screw Places :
5.0 mm Locking Screw
4.5 mm Cortical Screw



Screw Places :
3.5 mm Locking Screw
3.5 mm Cancellous Locking Screw
3.5 mm Cortical Screw

Small T Locking Plate Right Angled

(Stainless Steel & Titanium)

Code No. SS	Code No. TT	Holes
SS 313-002	TT 313-002	2
SS 313-003	TT 313-003	3
SS 313-004	TT 313-004	4
SS 313-005	TT 313-005	5
SS 313-006	TT 313-006	6
SS 313-007	TT 313-007	7
SS 313-008	TT 313-008	8
SS 313-009	TT 313-009	9
SS 313-010	TT 313-010	10

Reconstruction Locking Plate Straight 3.5 mm

(Stainless Steel & Titanium)

Code No. SS	Code No. TT	Holes
SS 315-004	TT 315-004	4
SS 315-005	TT 315-005	5
SS 315-006	TT 315-006	6
SS 315-007	TT 315-007	7
SS 315-008	TT 315-008	8
SS 315-009	TT 315-009	9
SS 315-010	TT 315-010	10
SS 315-011	TT 315-011	11
SS 315-012	TT 315-012	12
SS 315-014	TT 315-014	14
SS 315-016	TT 315-016	16
SS 315-018	TT 315-018	18
SS 315-020	TT 315-020	20
SS 315-022	TT 315-022	22
SS 315-024	TT 315-024	24
SS 315-025	TT 315-025	25

Screw Places :

3.5 mm Locking Screw



Screw Places :

3.5 mm Locking Screw
3.5 mm Cortical Screw



Reconstruction Locking Plate Straight D.C Holes 3.5 mm

(Stainless Steel & Titanium)

Code No. SS	Code No. TT	Holes
SS 315-104	TT 315-104	4
SS 315-105	TT 315-105	5
SS 315-106	TT 315-106	6
SS 315-107	TT 315-107	7
SS 315-108	TT 315-108	8
SS 315-109	TT 315-109	9
SS 315-110	TT 315-110	10
SS 315-111	TT 315-111	11
SS 315-112	TT 315-112	12
SS 315-114	TT 315-114	14
SS 315-116	TT 315-116	16
SS 315-118	TT 315-118	18
SS 315-120	TT 315-120	20
SS 315-122	TT 315-122	22
SS 315-124	TT 315-124	24
SS 315-125	TT 315-125	25



Locking Plates

Lateral Tibia Buttress Locking Plate 5.0mm

(Stainless Steel & Titanium)

Code No. SS	Code No. TT	Holes	
SS 323-003	TT 323-003	3	Right
SS 323-004	TT 323-004	4	Right
SS 323-005	TT 323-005	5	Right
SS 323-006	TT 323-006	6	Right
SS 323-007	TT 323-007	7	Right
SS 323-008	TT 323-008	8	Right
SS 323-009	TT 323-009	9	Right
SS 323-010	TT 323-010	10	Right
SS 323-011	TT 323-011	11	Right
SS 323-012	TT 323-012	12	Right
SS 323-013	TT 323-013	13	Right
SS 323-014	TT 323-014	14	Right
SS 323-015	TT 323-015	15	Right

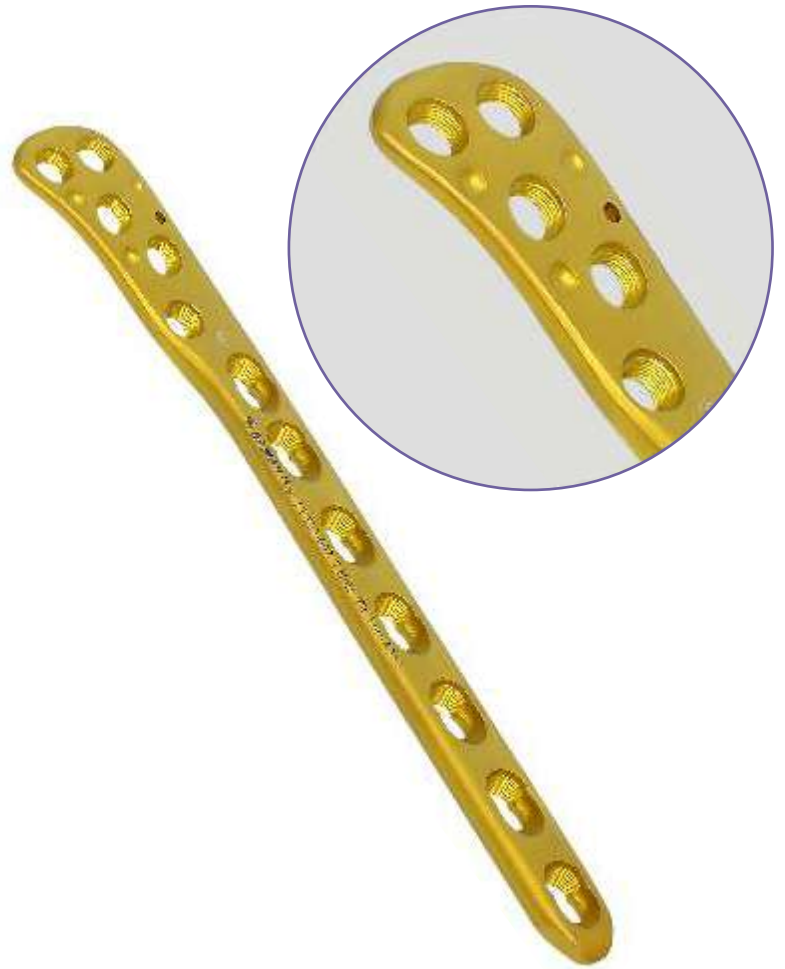

Screw Places :

- 5.0 mm Locking Screw
- 5.0 mm Cancellous Locking Screw
- 4.5 mm Cortical Screw



Code No. SS	Code No. TT	Holes	
SS 324-003	TT 324-003	3	Left
SS 324-004	TT 324-004	4	Left
SS 324-005	TT 324-005	5	Left
SS 324-006	TT 324-006	6	Left
SS 324-007	TT 324-007	7	Left
SS 324-008	TT 324-008	8	Left
SS 324-009	TT 324-009	9	Left
SS 324-010	TT 324-010	10	Left
SS 324-011	TT 324-011	11	Left
SS 324-012	TT 324-012	12	Left
SS 324-013	TT 324-013	13	Left
SS 324-014	TT 324-014	14	Left
SS 324-015	TT 324-015	15	Left

Lateral Tibia Buttress Locking Plates 6.5mm

(Stainless Steel & Titanium)

Code No. SS	Code No. TT	Holes	
SS 323-103	TT 323-103	3	Right
SS 323-104	TT 323-104	4	Right
SS 323-105	TT 323-105	5	Right
SS 323-106	TT 323-106	6	Right
SS 323-107	TT 323-107	7	Right
SS 323-108	TT 323-108	8	Right
SS 323-109	TT 323-109	9	Right
SS 323-110	TT 323-110	10	Right
SS 323-111	TT 323-111	11	Right
SS 323-112	TT 323-112	12	Right
SS 323-113	TT 323-113	13	Right
SS 323-114	TT 323-114	14	Right
SS 323-115	TT 323-115	15	Right

Screw Places :

- 5.0 mm Locking Screw
- 5.0 mm Cancellous Locking Screw
- 6.5 mm Cancellous Locking Screw
- 4.5 mm Cortical Screw

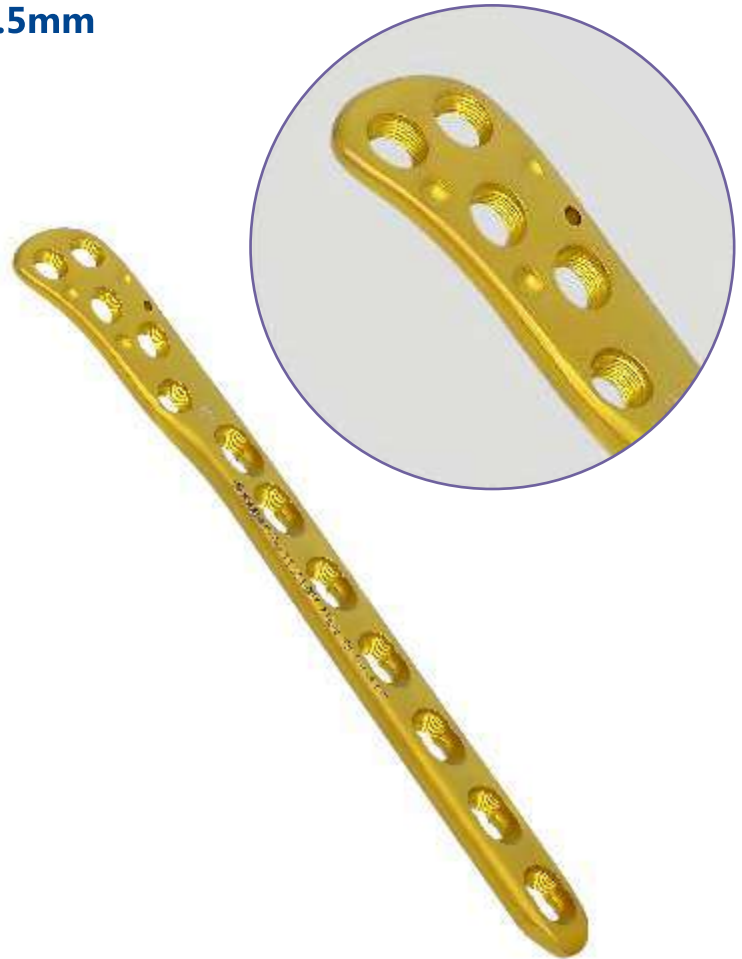

Code No. SS	Code No. TT	Holes	
SS 324-103	TT 324-103	3	Left
SS 324-104	TT 324-104	4	Left
SS 324-105	TT 324-105	5	Left
SS 324-106	TT 324-106	6	Left
SS 324-107	TT 324-107	7	Left
SS 324-108	TT 324-108	8	Left
SS 324-109	TT 324-109	9	Left
SS 324-110	TT 324-110	10	Left
SS 324-111	TT 324-111	11	Left
SS 324-112	TT 324-112	12	Left
SS 324-113	TT 324-113	13	Left
SS 324-114	TT 324-114	14	Left
SS 324-115	TT 324-115	15	Left



Locking Plates

Distal Femur Locking Plate 5.0 mm

(Stainless Steel & Titanium)

Code No. SS	Code No. TT	Holes	
SS 327-003	TT 327-003	3	Left
SS 327-004	TT 327-004	4	Left
SS 327-005	TT 327-005	5	Left
SS 327-006	TT 327-006	6	Left
SS 327-007	TT 327-007	7	Left
SS 327-008	TT 327-008	8	Left
SS 327-009	TT 327-009	9	Left
SS 327-010	TT 327-010	10	Left
SS 327-011	TT 327-011	11	Left
SS 327-012	TT 327-012	12	Left
SS 327-013	TT 327-013	13	Left
SS 327-014	TT 327-014	14	Left
SS 327-015	TT 327-015	15	Left
SS 327-016	TT 328-016	16	Left

Screw Places :

- 5.0 mm Locking Screw
- 5.0 mm Cancellous Locking Screw
- 4.5 mm Cortical Screw

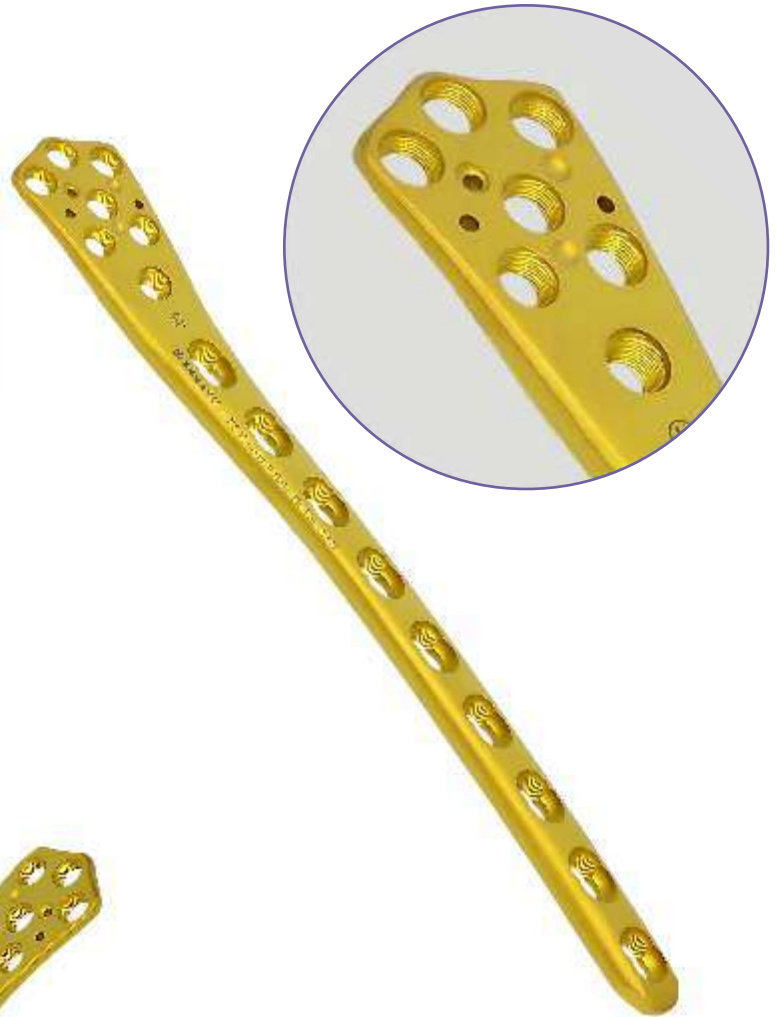

Code No. SS	Code No. TT	Holes	
SS 328-003	TT 328-003	3	Right
SS 328-004	TT 328-004	4	Right
SS 328-005	TT 328-005	5	Right
SS 328-006	TT 328-006	6	Right
SS 328-007	TT 328-007	7	Right
SS 328-008	TT 328-008	8	Right
SS 328-009	TT 328-009	9	Right
SS 328-010	TT 328-010	10	Right
SS 328-011	TT 328-011	11	Right
SS 328-012	TT 328-012	12	Right
SS 328-013	TT 328-013	13	Right
SS 328-014	TT 328-014	14	Right
SS 328-015	TT 328-015	15	Right
SS 328-016	TT 328-016	16	Right



Locking Plates

Proximal Humorous Locking Plate

(Stainless Steel & Titanium)

Code No. SS	Code No. TT	Holes
SS 330-002	TT 330-002	2
SS 330-003	TT 330-003	3
SS 330-004	TT 330-004	4
SS 330-005	TT 330-005	5
SS 330-006	TT 330-006	6
SS 330-007	TT 330-007	7
SS 330-008	TT 330-008	8
SS 330-009	TT 330-009	9
SS 330-010	TT 330-010	10
SS 330-011	TT 330-011	11
SS 330-012	TT 330-012	12



Screw Places :

- 3.5 mm Locking Screw
- 3.5 mm Cancellous Locking Screw
- 3.5 mm Cortical Screw



poz 2.36

1/3 Tubular Locking Plate

(Stainless Steel & Titanium)

Code No. SS	Code No. TT	Holes
SS 349-004	TT 349-004	4
SS 349-005	TT 349-005	5
SS 349-006	TT 349-006	6
SS 349-007	TT 349-007	7
SS 349-008	TT 349-008	8
SS 349-009	TT 349-009	9
SS 349-010	TT 349-010	10
SS 349-011	TT 349-011	11
SS 349-012	TT 349-012	12

Screw Places :

- 3.5 mm Locking Screw

Distal Medial Tibia Locking Plate Without tab

(Stainless Steel & Titanium)

Code No. SS	Code No. TT	Holes	
SS 331-004	TT 331-004	4	Right
SS 331-005	TT 331-005	5	Right
SS 331-006	TT 331-006	6	Right
SS 331-007	TT 331-007	7	Right
SS 331-008	TT 331-008	8	Right
SS 331-009	TT 331-009	9	Right
SS 331-010	TT 331-010	10	Right
SS 331-011	TT 331-011	11	Right
SS 331-012	TT 331-012	12	Right
SS 331-013	TT 331-013	13	Right
SS 331-014	TT 331-014	14	Right

Code No. SS	Code No. TT	Holes	
SS 331-104	TT 331-104	4	Left
SS 331-105	TT 331-105	5	Left
SS 331-106	TT 331-106	6	Left
SS 331-107	TT 331-107	7	Left
SS 331-108	TT 331-108	8	Left
SS 331-109	TT 331-109	9	Left
SS 331-110	TT 331-110	10	Left
SS 331-111	TT 331-111	11	Left
SS 331-112	TT 331-112	12	Left
SS 331-113	TT 331-113	13	Left
SS 331-114	TT 331-114	14	Left

Screw Places :

- 3.5 mm Locking Screw
- 3.5 mm Cancellous Locking Screw
- 3.5 mm Cortical Screw





Locking Plates

Anterolateral Distal Tibia Locking Plate

(Stainless Steel & Titanium)

Code No. SS	Code No. TT	Holes	
SS 332-004	TT 332-004	4	Right
SS 332-005	TT 332-005	5	Right
SS 332-006	TT 332-006	6	Right
SS 332-007	TT 332-007	7	Right
SS 332-008	TT 332-008	8	Right
SS 332-009	TT 332-009	9	Right
SS 332-010	TT 332-010	10	Right
SS 332-011	TT 332-011	11	Right
SS 332-012	TT 332-012	12	Right
SS 332-013	TT 332-013	13	Right
SS 332-014	TT 332-014	14	Right
SS 332-015	TT 332-015	15	Right
SS 332-016	TT 332-016	16	Right
SS 332-017	TT 332-017	17	Right
SS 332-018	TT 332-018	18	Right
SS 332-019	TT 332-019	19	Right
SS 332-020	TT 332-020	20	Right
SS 332-021	TT 332-021	21	Right



Screw Places :

- 3.5 mm Locking Screw
- 3.5 mm Cancellous Locking Screw
- 3.5 mm Cortical Screw



Code No. SS	Code No. TT	Holes	
SS 332-104	TT 332-104	4	Left
SS 332-105	TT 332-105	5	Left
SS 332-106	TT 332-106	6	Left
SS 332-107	TT 332-107	7	Left
SS 332-108	TT 332-108	8	Left
SS 332-109	TT 332-109	9	Left
SS 332-110	TT 332-110	10	Left
SS 332-111	TT 332-111	11	Left
SS 332-112	TT 332-112	12	Left
SS 332-113	TT 332-113	13	Left
SS 332-114	TT 332-114	14	Left
SS 332-115	TT 332-115	15	Left
SS 332-116	TT 332-116	16	Left
SS 332-117	TT 332-117	17	Left
SS 332-118	TT 332-118	18	Left
SS 332-119	TT 332-119	19	Left
SS 332-120	TT 332-120	20	Left
SS 332-121	TT 332-121	21	Left

Proximal Femoral Locking Plate

(Stainless Steel & Titanium)

Code No. SS	Code No. TT	Holes	
SS 333-002	TT 333-002	2	Right
SS 333-003	TT 333-003	3	Right
SS 333-004	TT 333-004	4	Right
SS 333-005	TT 333-005	5	Right
SS 333-006	TT 333-006	6	Right
SS 333-007	TT 333-007	7	Right
SS 333-008	TT 333-008	8	Right
SS 333-009	TT 333-009	9	Right
SS 333-010	TT 333-010	10	Right
SS 333-011	TT 333-011	11	Right
SS 333-012	TT 333-012	12	Right
SS 333-013	TT 333-013	13	Right
SS 333-014	TT 333-014	14	Right
SS 333-015	TT 333-015	15	Right
SS 333-016	TT 333-016	16	Right

Code No. SS	Code No. TT	Holes	
SS 333-102	TT 333-102	2	Left
SS 333-103	TT 333-103	3	Left
SS 333-104	TT 333-104	4	Left
SS 333-105	TT 333-105	5	Left
SS 333-106	TT 333-106	6	Left
SS 333-107	TT 333-107	7	Left
SS 333-108	TT 333-108	8	Left
SS 333-109	TT 333-109	9	Left
SS 333-110	TT 333-110	10	Left
SS 333-111	TT 333-111	11	Left
SS 333-112	TT 333-112	12	Left
SS 333-113	TT 333-113	13	Left
SS 333-114	TT 333-114	14	Left
SS 333-115	TT 333-115	15	Left
SS 333-116	TT 333-116	16	Left

Screw Places :

- 5.0 mm Locking Screw
- 7.3 mm C.C. Locking Screw
- 4.5 mm Cortical Screw



Locking Plates

V.A. Proximal Tibia Locking Plate 3.5 mm

(Stainless Steel & Titanium)

Code No. SS	Code No. TT	Holes	
SS 372-004	TT 372-004	4	Right
SS 372-005	TT 372-005	5	Right
SS 372-006	TT 372-006	6	Right
SS 372-007	TT 372-007	7	Right
SS 372-008	TT 372-008	8	Right
SS 372-009	TT 372-009	9	Right
SS 372-010	TT 372-010	10	Right
SS 372-011	TT 372-011	11	Right
SS 372-012	TT 372-012	12	Right

Code No. SS	Code No. TT	Holes	
SS 372-104	TT 372-104	4	Left
SS 372-105	TT 372-105	5	Left
SS 372-106	TT 372-106	6	Left
SS 372-107	TT 372-107	7	Left
SS 372-108	TT 372-108	8	Left
SS 372-109	TT 372-109	9	Left
SS 372-110	TT 372-110	10	Left
SS 372-111	TT 372-111	11	Left
SS 372-112	TT 372-112	12	Left

Screw Places :

3.5 mm Locking Screw

3.5 mm Cancellous Locking Screw

3.5 mm Cortical Screw



Proximal Medial Tibia Locking Plate 3.5 mm

(Stainless Steel & Titanium)

Code No. SS	Code No. TT	Holes	
SS 336-004	TT 336-004	4	Right
SS 336-005	TT 336-005	5	Right
SS 336-006	TT 336-006	6	Right
SS 336-007	TT 336-007	7	Right
SS 336-008	TT 336-008	8	Right
SS 336-009	TT 336-009	9	Right
SS 336-010	TT 336-010	10	Right
SS 336-011	TT 336-011	11	Right
SS 336-012	TT 336-012	12	Right
SS 336-013	TT 336-013	13	Right
SS 336-014	TT 336-014	14	Right
SS 336-015	TT 336-015	15	Right
SS 336-016	TT 336-016	16	Right
SS 336-017	TT 336-017	17	Right
SS 336-018	TT 336-018	18	Right
SS 336-019	TT 336-019	19	Right
SS 336-020	TT 336-020	20	Right

Code No. SS	Code No. TT	Holes	
SS 336-104	TT 336-104	4	Left
SS 336-105	TT 336-105	5	Left
SS 336-106	TT 336-106	6	Left
SS 336-107	TT 336-107	7	Left
SS 336-108	TT 336-108	8	Left
SS 336-109	TT 336-109	9	Left
SS 336-110	TT 336-110	10	Left
SS 336-111	TT 336-111	11	Left
SS 336-112	TT 336-112	12	Left
SS 336-113	TT 336-113	13	Left
SS 336-114	TT 336-114	14	Left
SS 336-115	TT 336-115	15	Left
SS 336-116	TT 336-116	16	Left
SS 336-117	TT 336-117	17	Left
SS 336-118	TT 336-118	18	Left
SS 336-119	TT 336-119	19	Left
SS 336-120	TT 336-120	20	Left

Screw Places :

- 3.5 mm Locking Screw
- 3.5 mm Cancellous Locking Screw
- 3.5 mm Cortical Screw





Locking Plates

Metaphyseal Plate 3.5/5.0 mm

(Stainless Steel & Titanium)

Code No. SS	Code No. TT	Holes
SS 338-003	TT 338-003	5+3
SS 338-004	TT 338-004	5+4
SS 338-005	TT 338-005	5+5
SS 338-006	TT 338-006	5+6
SS 338-007	TT 338-007	5+7
SS 338-008	TT 338-008	5+8
SS 338-009	TT 338-009	5+9
SS 338-010	TT 338-010	5+10
SS 338-011	TT 338-011	5+11
SS 338-012	TT 338-012	5+12
SS 338-013	TT 338-013	5+13
SS 338-014	TT 338-014	5+14
SS 338-015	TT 338-015	5+15



Screw Places :

- 3.5 mm Locking Screw
- 3.5 mm Cancellous Locking Screw
- 3.5 mm Cortical Screw
- 5.0 mm Locking Screw
- 4.5 mm Cortical Screw

Calcaneal Locking plate

(Stainless Steel & Titanium)

Code No. SS	Code No. TT	MM	
SS 340-060	TT 340-060	60mm	Right
SS 340-070	TT 340-070	70mm	Right

Code No. SS	Code No. TT	MM	
SS 340-160	TT 340-160	60mm	Left
SS 340-170	TT 340-170	70mm	Left



Screw Places :

- 3.5 mm Locking Screw
- 3.5 mm Cancellous Locking Screw



Locking Plates

Extra Articular Distal Humerus Locking Plate

(Stainless Steel & Titanium)

Code No. SS	Code No. TT	Holes	
SS 359-004	TT 359-004	4	Right
SS 359-005	TT 359-005	5	Right
SS 359-006	TT 359-006	6	Right
SS 359-007	TT 359-007	7	Right
SS 359-008	TT 359-008	8	Right
SS 359-009	TT 359-009	9	Right
SS 359-010	TT 359-010	10	Right
SS 359-011	TT 359-011	11	Right
SS 359-012	TT 359-012	12	Right
SS 359-013	TT 359-013	13	Right
SS 359-014	TT 359-014	14	Right

Code No. SS	Code No. TT	Holes	
SS 359-104	TT 359-104	4	Left
SS 359-105	TT 359-105	5	Left
SS 359-106	TT 359-106	6	Left
SS 359-107	TT 359-107	7	Left
SS 359-108	TT 359-108	8	Left
SS 359-109	TT 359-109	9	Left
SS 359-110	TT 359-110	10	Left
SS 359-111	TT 359-111	11	Left
SS 359-112	TT 359-112	12	Left
SS 359-113	TT 359-113	13	Left
SS 359-114	TT 359-114	14	Left

Screw Places :

3.5 mm Locking Screw

3.5 mm Cancellous Locking Screw

3.5 mm Cortical Screw



Metaphyseal Locking Plate for Distal, Medial Humerus

(Stainless Steel & Titanium)

Code No. SS	Code No. TT	Holes
SS 347-007	TT 347-007	7
SS 347-008	TT 347-008	8
SS 347-009	TT 347-009	9
SS 347-010	TT 347-010	10
SS 347-011	TT 347-011	11
SS 347-012	TT 347-012	12
SS 347-013	TT 347-013	13
SS 347-014	TT 347-014	14
SS 347-015	TT 347-015	15

Screw Places :

- 3.5 mm Locking Screw
- 3.5 mm Cancellous Locking Screw
- 3.5 mm Cortical Screw



Fibula Locking Plate

(Stainless Steel & Titanium)

Code No. SS	Code No. TT	Holes
SS 348-003	TT 348-003	3
SS 348-004	TT 348-004	4
SS 348-005	TT 348-005	5
SS 348-006	TT 348-006	6
SS 348-007	TT 348-007	7
SS 348-008	TT 348-008	8

Screw Places :

- 3.5 mm Locking Screw
- 3.5 mm Cancellous Locking Screw
- 3.5 mm Cortical Screw





Locking Plates

Olecranon Locking Plate

(Stainless Steel & Titanium)

Code No. SS	Code No. TT	Holes	
SS 376-002	TT 376-002	2	Right
SS 376-003	TT 376-003	3	Right
SS 376-004	TT 376-004	4	Right
SS 376-005	TT 376-005	5	Right
SS 376-006	TT 376-006	6	Right
SS 376-007	TT 376-007	7	Right
SS 376-008	TT 376-008	8	Right
SS 376-009	TT 376-009	9	Right
SS 376-010	TT 376-010	10	Right
SS 376-011	TT 376-011	11	Right
SS 376-012	TT 376-012	12	Right

Code No. SS	Code No. TT	Holes	
SS 376-102	TT 376-102	2	Left
SS 376-103	TT 376-103	3	Left
SS 376-104	TT 376-104	4	Left
SS 376-105	TT 376-105	5	Left
SS 376-106	TT 376-106	6	Left
SS 376-107	TT 376-107	7	Left
SS 376-108	TT 376-108	8	Left
SS 376-109	TT 376-109	9	Left
SS 376-110	TT 376-110	10	Left
SS 376-111	TT 376-111	11	Left
SS 376-112	TT 376-112	12	Left

Screw Places :

3.5 mm Locking Screw

3.5 mm Cancellous Locking Screw

3.5 mm Cortical Screw





Locking Plates

L - Distal Radius Oblique Locking Plate

(Stainless Steel & Titanium)

Code No. SS	Code No. TT	Holes	
SS 362-403	TT 362-403	3+3	Left
SS 362-404	TT 362-404	4+3	Left

Screw Places :

2.7 mm Locking Screw
2.7 mm Cortical Screw



Code No. SS	Code No. TT	Holes	
SS 362-503	TT 362-503	3+3	Right
SS 362-504	TT 362-504	4+3	Right



T - Distal Radius Straight Locking Plate

(Stainless Steel & Titanium)

Code No. SS	Code No. TT	Holes	
SS 363-003	TT 363-003	3+3	
SS 363-004	TT 363-004	4+3	

Screw Places :

2.7 mm Locking Screw
2.7 mm Cortical Screw



Volar Distal Radius Locking Plate

(Stainless Steel & Titanium)

Code No. SS	Code No. TT	Holes	
SS 364-003	TT 364-003	3+5	Left
SS 364-005	TT 364-005	5+5	Left

Screw Places :

2.7 mm Locking Screw
2.7 mm Cortical Screw



Code No. SS	Code No. TT	Holes	
SS 364-103	TT 364-103	3+5	Right
SS 364-105	TT 364-105	5+5	Right



Volar Buttress Locking Plate

(Stainless Steel & Titanium)

Code No. SS	Code No. TT	Holes	
SS 365-003	TT 365-003	3+5	Left

Code No. SS	Code No. TT	Holes	
SS 365-103	TT 365-103	5+5	Right

Screw Places :

2.7 mm Locking Screw
2.7 mm Cortical Screw



Volar Distal Radius Extra-Articular Locking Plate

(Stainless Steel & Titanium)

Code No. SS	Code No. TT	Holes	
SS 367-003	TT 367-003	3+5	Left
SS 367-005	TT 367-005	5+5	Left

Code No. SS	Code No. TT	Holes	
SS 367-103	TT 367-103	3+5	Right
SS 367-105	TT 367-105	5+5	Right

Screw Places :

2.7 mm Locking Screw
2.7 mm Cortical Screw

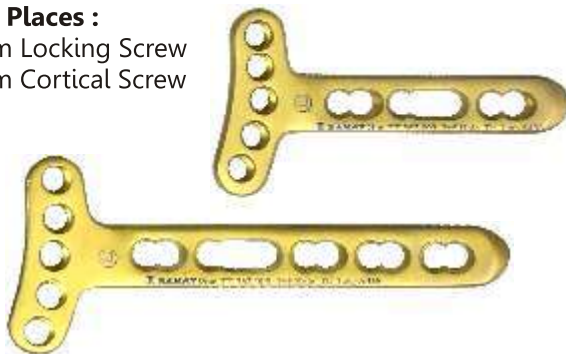

Volar Distal Radius Extra-Articular Locking Plate

(Stainless Steel & Titanium)

Code No. SS	Code No. TT	Holes	
SS 367-203	TT 367-203	3+4	Left
SS 367-205	TT 367-205	5+4	Left

Code No. SS	Code No. TT	Holes	
SS 367-303	TT 367-303	3+4	Right
SS 367-305	TT 367-305	5+4	Right

Screw Places :

2.7 mm Locking Screw
2.7 mm Cortical Screw





Locking Screws



2.7 mm Locking Screw

(Stainless Steel & Titanium)

Code No. SS	Code No. TT	Size mm
SS 303-012	TT 303-012	12
SS 303-014	TT 303-014	14
SS 303-016	TT 303-016	16
SS 303-018	TT 303-018	18
SS 303-020	TT 303-020	20
SS 303-022	TT 303-022	22
SS 303-024	TT 303-024	24
SS 303-026	TT 303-026	26
SS 303-028	TT 303-028	28
SS 303-030	TT 303-030	30
SS 303-032	TT 303-032	32
SS 303-034	TT 303-034	34
SS 303-036	TT 303-036	36
SS 303-038	TT 303-038	38
SS 303-040	TT 303-040	40
SS 303-042	TT 303-042	42
SS 303-044	TT 303-044	44
SS 303-046	TT 303-046	46
SS 303-048	TT 303-048	48
SS 303-050	TT 303-050	50
SS 303-052	TT 303-052	52
SS 303-054	TT 303-054	54
SS 303-056	TT 303-056	56
SS 303-058	TT 303-058	58
SS 303-060	TT 303-060	60



3.5 mm Locking Screw

(Stainless Steel & Titanium)

Code No. SS	Code No. TT	Size mm
SS 304-012	TT 304-012	12
SS 304-014	TT 304-014	14
SS 304-016	TT 304-016	16
SS 304-018	TT 304-018	18
SS 304-020	TT 304-020	20
SS 304-022	TT 304-022	22
SS 304-024	TT 304-024	24
SS 304-026	TT 304-026	26
SS 304-028	TT 304-028	28
SS 304-030	TT 304-030	30
SS 304-032	TT 304-032	32
SS 304-034	TT 304-034	34
SS 304-036	TT 304-036	36
SS 304-038	TT 304-038	38
SS 304-040	TT 304-040	40
SS 304-042	TT 304-042	42
SS 304-044	TT 304-044	44
SS 304-046	TT 304-046	46
SS 304-048	TT 304-048	48
SS 304-050	TT 304-050	50
SS 304-052	TT 304-052	52
SS 304-054	TT 304-054	54
SS 304-056	TT 304-056	56
SS 304-058	TT 304-058	58
SS 304-060	TT 304-060	60
SS 304-065	TT 304-065	65
SS 304-070	TT 304-070	70
SS 304-075	TT 304-075	75
SS 304-080	TT 304-080	80

Locking Screws



5.0 mm Locking Screw

(Stainless Steel & Titanium)

Code No. SS	Code No. TT	Size mm
SS 305-016	TT 305-016	16
SS 305-018	TT 305-018	18
SS 305-020	TT 305-020	20
SS 305-022	TT 305-022	22
SS 305-024	TT 305-024	24
SS 305-026	TT 305-026	26
SS 305-028	TT 305-028	28
SS 305-030	TT 305-030	30
SS 305-032	TT 305-032	32
SS 305-034	TT 305-034	34
SS 305-036	TT 305-036	36
SS 305-038	TT 305-038	38
SS 305-040	TT 305-040	40
SS 305-042	TT 305-042	42
SS 305-044	TT 305-044	44
SS 305-046	TT 305-046	46
SS 305-048	TT 305-048	48
SS 305-050	TT 305-050	50
SS 305-052	TT 305-052	52
SS 305-054	TT 305-054	54
SS 305-056	TT 305-056	56
SS 305-058	TT 305-058	58
SS 305-060	TT 305-060	60
SS 305-062	TT 305-062	62
SS 305-064	TT 305-064	64
SS 305-066	TT 305-066	66
SS 305-068	TT 305-068	68
SS 305-070	TT 305-070	70
SS 305-075	TT 305-075	75
SS 305-080	TT 305-080	80
SS 305-085	TT 305-085	85
SS 305-090	TT 305-090	90



3.5 mm Cancellous Locking Screw (Full Thread)

(Stainless Steel & Titanium)

Code No. SS	Code No. TT	Size mm
SS 304-112	TT 304-112	12
SS 304-114	TT 304-114	14
SS 304-116	TT 304-116	16
SS 304-118	TT 304-118	18
SS 304-120	TT 304-120	20
SS 304-122	TT 304-122	22
SS 304-124	TT 304-124	24
SS 304-126	TT 304-126	26
SS 304-128	TT 304-128	28
SS 304-130	TT 304-130	30
SS 304-132	TT 304-132	32
SS 304-134	TT 304-134	34
SS 304-136	TT 304-136	36
SS 304-138	TT 304-138	38
SS 304-140	TT 304-140	40
SS 304-142	TT 304-142	42
SS 304-144	TT 304-144	44
SS 304-146	TT 304-146	46
SS 304-148	TT 304-148	48
SS 304-150	TT 304-150	50
SS 304-152	TT 304-152	52
SS 304-154	TT 304-154	54
SS 304-156	TT 304-156	56
SS 304-158	TT 304-158	58
SS 304-160	TT 304-160	60
SS 304-165	TT 304-165	65
SS 304-170	TT 304-170	70
SS 304-175	TT 304-175	75
SS 304-180	TT 304-180	80



Locking Screws



5.0 mm Cancellous Locking Screw (Full Thread)

(Stainless Steel & Titanium)

Code No. SS	Code No. TT	Size mm
SS 305-125	TT 305-125	25
SS 305-130	TT 305-130	30
SS 305-135	TT 305-135	35
SS 305-140	TT 305-140	40
SS 305-145	TT 305-145	45
SS 305-150	TT 305-150	50
SS 305-155	TT 305-155	55
SS 305-160	TT 305-160	60
SS 305-165	TT 305-165	65
SS 305-170	TT 305-170	70
SS 305-175	TT 305-175	75
SS 305-180	TT 305-180	80
SS 305-185	TT 305-185	85
SS 305-190	TT 305-190	90
SS 305-195	TT 305-195	95
SS 305-100	TT 305-100	100



6.5 mm Cancellous Locking Screw Fully Threaded

(Stainless Steel & Titanium)

Code No. SS	Code No. TT	Size mm
SS 309-025	TT 309-025	25
SS 309-030	TT 309-030	30
SS 309-035	TT 309-035	35
SS 309-040	TT 309-040	40
SS 309-045	TT 309-045	45
SS 309-050	TT 309-050	50
SS 309-055	TT 309-055	55
SS 309-060	TT 309-060	60
SS 309-065	TT 309-065	65
SS 309-070	TT 309-070	70
SS 309-075	TT 309-075	75
SS 309-080	TT 309-080	80
SS 309-085	TT 309-085	85
SS 309-090	TT 309-090	90
SS 309-095	TT 309-095	95
SS 309-100	TT 309-100	100



Bone Screw

7.0 mm CANNULATED CANCELLOUS SCREW 16 mm THREADED (Stainless Steel & Titanium)

Profile

Thread Diameter	: 7.0mm
Drill Bit for Threaded Hole	: 4.5mm
Shaft Diameter	: 4.5mm
Core Diameter	: 4.5mm
Hexagonal Socket	: 3.5mm
Head Diameter	: 8.0mm
Cannulation	: 2.2mm
Guide Wire Dia	: 2.0mm
Pitch	: 2.75mm

Note: Define Code For
S.S. SS 121 & Titanium TT 121



Code No.	Length
SS 121-020	20 mm
SS 121-025	25 mm
SS 121-030	30 mm
SS 121-035	35 mm
SS 121-040	40 mm
SS 121-045	45 mm
SS 121-050	50 mm
SS 121-055	55 mm
SS 121-060	60 mm
SS 121-065	65 mm
SS 121-070	70 mm
SS 121-075	75 mm
SS 121-080	80 mm
SS 121-085	85 mm
SS 121-090	90 mm
SS 121-095	95 mm
SS 121-100	100 mm
SS 121-105	105 mm
SS 121-110	110 mm
SS 121-115	115 mm
SS 121-120	120 mm



7.0 mm CANNULATED CANCELLOUS SCREW 32 mm THREADED (Stainless Steel & Titanium)

Profile

Thread Diameter	: 7.0mm
Drill Bit for Threaded Hole	: 4.5mm
Shaft Diameter	: 4.5mm
Core Diameter	: 4.5mm
Hexagonal Socket	: 3.5mm
Head Diameter	: 8.0mm
Cannulation	: 2.2mm
Guide Wire Dia	: 2.0mm
Pitch	: 2.75mm

Note: Define Code For
S.S. SS 122 & Titanium TT 122



Code No.	Length
SS 122-035	35 mm
SS 122-040	40 mm
SS 122-045	45 mm
SS 122-050	50 mm
SS 122-055	55 mm
SS 122-060	60 mm
SS 122-065	65 mm
SS 122-070	70 mm
SS 122-075	75 mm
SS 122-080	80 mm
SS 122-085	85 mm
SS 122-090	90 mm
SS 122-095	95 mm
SS 122-100	100 mm
SS 122-105	105 mm
SS 122-110	110 mm
SS 122-115	115 mm
SS 122-120	120 mm

WASHER 7.0 mm

Product Code: Stainless Steel: SS 124-007
Product Code: Titanium : TT 124-007

For 2.7, 3.5 and 4.0 mm Screws

7.0 mm CANNULATED CANCELLOUS SCREW FULLY THREADED (Stainless Steel & Titanium)

Profile

Thread Diameter	: 7.0mm
Drill Bit for Threaded Hole	: 4.5mm
Shaft Diameter	: 4.5mm
Core Diameter	: 4.5mm
Hexagonal Socket	: 3.5mm
Head Diameter	: 8.0mm
Cannulation	: 2.2mm
Guide Wire Dia	: 2.0mm
Pitch	: 2.75mm

Note: Define Code For
S.S. SS 123 & Titanium TT 123



Code No.	Length
SS 123-020	20 mm
SS 123-025	25 mm
SS 123-030	30 mm
SS 123-035	35 mm
SS 123-040	40 mm
SS 123-045	45 mm
SS 123-050	50 mm
SS 123-055	55 mm
SS 123-060	60 mm
SS 123-065	65 mm
SS 123-070	70 mm
SS 123-075	75 mm
SS 123-080	80 mm
SS 123-085	85 mm

WASHER 13.0 mm



Product Code: Stainless Steel: SS 125-007
Product Code: Titanium : TT 125-007

For 4.5, 6.5 and 7.0 mm Screws

Locking Screws



5.0 mm Cancellous Locking Screw (Short Thread)

(Stainless Steel & Titanium)

Code No. SS	Code No. TT	Size mm
SS 309-140	TT 309-140	40
SS 309-145	TT 309-145	45
SS 309-150	TT 309-150	50
SS 309-155	TT 309-155	55
SS 309-160	TT 309-160	60
SS 309-165	TT 309-165	65
SS 309-170	TT 309-170	70
SS 309-175	TT 309-175	75
SS 309-180	TT 309-180	80
SS 309-185	TT 309-185	85
SS 309-190	TT 309-190	90
SS 309-195	TT 309-195	95
SS 309-100	TT 309-100	100

2.7 mm Cortical Screw Self Tapping

(Stainless Steel & Titanium)

Code No. SS	Code No. TT	Size mm
SS 106-008	TT 106-008	8
SS 106-010	TT 106-010	10
SS 106-012	TT 106-012	12
SS 106-014	TT 106-014	14
SS 106-016	TT 106-016	16
SS 106-018	TT 106-018	18
SS 106-020	TT 106-020	20
SS 106-022	TT 106-022	22
SS 106-024	TT 106-024	24
SS 106-026	TT 106-026	26
SS 106-028	TT 106-028	28
SS 106-030	TT 106-030	30

poz 2.5

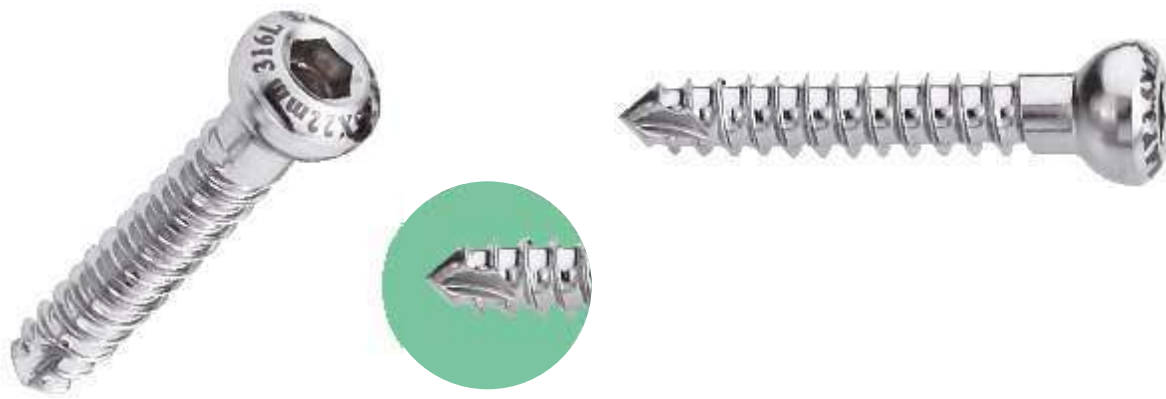

3.5mm Cortex Screw (Pitch 1.25) Self Tapping

Code No. S.S. 316L	Code No. Titanium	Code No. S.S. 316LVM	Length
SS 107-010	TT 107-010	LM 107-010	10mm
SS 107-012	TT 107-012	LM 107-012	12mm
SS 107-014	TT 107-014	LM 107-014	14mm
SS 107-016	TT 107-016	LM 107-016	16mm
SS 107-018	TT 107-018	LM 107-018	18mm
SS 107-020	TT 107-020	LM 107-020	20mm
SS 107-022	TT 107-022	LM 107-022	22mm
SS 107-024	TT 107-024	LM 107-024	24mm
SS 107-026	TT 107-026	LM 107-026	26mm
SS 107-028	TT 107-028	LM 107-028	28mm
SS 107-030	TT 107-030	LM 107-030	30mm
SS 107-032	TT 107-032	LM 107-032	32mm
SS 107-034	TT 107-034	LM 107-034	34mm
SS 107-036	TT 107-036	LM 107-036	36mm
SS 107-038	TT 107-038	LM 107-038	38mm
SS 107-040	TT 107-040	LM 107-040	40mm
SS 107-042	TT 107-042	LM 107-042	42mm
SS 107-044	TT 107-044	LM 107-044	44mm
SS 107-046	TT 107-046	LM 107-046	46mm
SS 107-048	TT 107-048	LM 107-048	48mm
SS 107-050	TT 107-050	LM 107-050	50mm
SS 107-052	TT 107-052	LM 107-052	52mm
SS 107-054	TT 107-054	LM 107-054	54mm
SS 107-056	TT 107-056	LM 107-056	56mm
SS 107-058	TT 107-058	LM 107-058	58mm
SS 107-060	TT 107-060	LM 107-060	60mm
SS 107-065	TT 107-065	LM 107-065	65mm
SS 107-070	TT 107-070	LM 107-070	70mm
SS 107-075	TT 107-075	LM 107-075	75mm
SS 107-080	TT 107-080	LM 107-080	80mm

Mfg. : Orthopedic Implants & Instruments

Bone Screw

An ISO 13485
Certified Company





4.5mm Cortex Screw (Pitch 1.75) Self Tapping

Code No. S.S. 316L	Code No. Titanium	Code No. S.S. 316LVM	Length
SS 109-012	TT 109-012	LM 109-012	12mm
SS 109-014	TT 109-014	LM 109-014	14mm
SS 109-016	TT 109-016	LM 109-016	16mm
SS 109-018	TT 109-018	LM 109-018	18mm
SS 109-020	TT 109-020	LM 109-020	20mm
SS 109-022	TT 109-022	LM 109-022	22mm
SS 109-024	TT 109-024	LM 109-024	24mm
SS 109-026	TT 109-026	LM 109-026	26mm
SS 109-028	TT 109-028	LM 109-028	28mm
SS 109-030	TT 109-030	LM 109-030	30mm
SS 109-032	TT 109-032	LM 109-032	32mm
SS 109-034	TT 109-034	LM 109-034	34mm
SS 109-036	TT 109-036	LM 109-036	36mm
SS 109-038	TT 109-038	LM 109-038	38mm
SS 109-040	TT 109-040	LM 109-040	40mm
SS 109-042	TT 109-042	LM 109-042	42mm
SS 109-044	TT 109-044	LM 109-044	44mm
SS 109-046	TT 109-046	LM 109-046	46mm
SS 109-048	TT 109-048	LM 109-048	48mm
SS 109-050	TT 109-050	LM 109-050	50mm
SS 109-052	TT 109-052	LM 109-052	52mm
SS 109-054	TT 109-054	LM 109-054	54mm
SS 109-056	TT 109-056	LM 109-056	56mm
SS 109-058	TT 109-058	LM 109-058	58mm
SS 109-060	TT 109-060	LM 109-060	60mm
SS 109-062	TT 109-062	LM 109-062	62mm
SS 109-064	TT 109-064	LM 109-064	64mm
SS 109-066	TT 109-066	LM 109-066	66mm
SS 109-068	TT 109-068	LM 109-068	68mm
SS 109-070	TT 109-070	LM 109-070	70mm
SS 109-075	TT 109-075	LM 109-075	75mm
SS 109-080	TT 109-080	LM 109-080	80mm

Mfg. : Orthopedic Implants & Instruments

Bone Screw

An ISO 13485
Certified Company



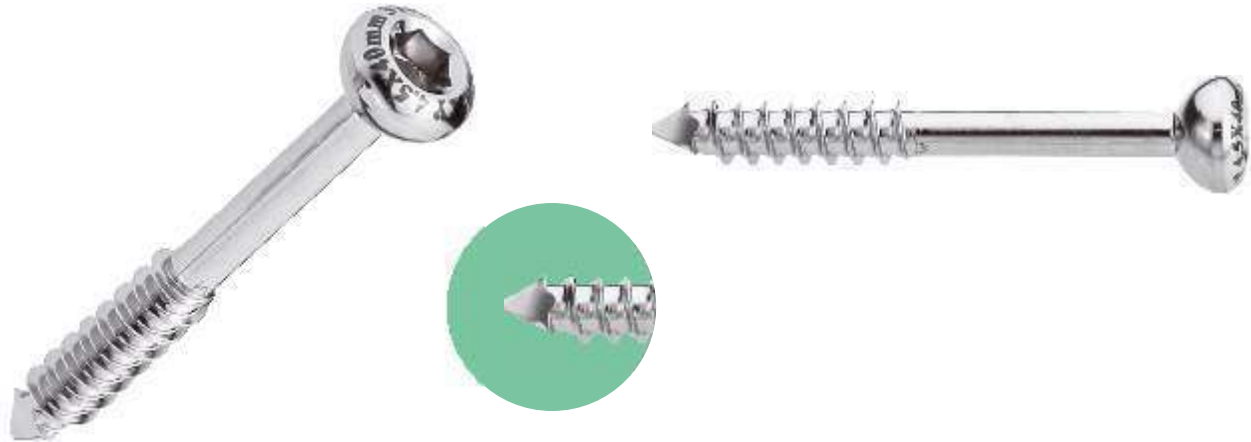

4.5mm Malleolar Screw

Code No. S.S. 316L	Code No. Titanium	Code No. S.S. 316LVM	Length
SS 110-025	TT 110-025	LM 110-025	25mm
SS 110-030	TT 110-030	LM 110-030	30mm
SS 110-035	TT 110-035	LM 110-035	35mm
SS 110-040	TT 110-040	LM 110-040	40mm
SS 110-045	TT 110-045	LM 110-045	45mm
SS 110-050	TT 110-050	LM 110-050	50mm
SS 110-055	TT 110-055	LM 110-055	55mm
SS 110-060	TT 110-060	LM 110-060	60mm
SS 110-065	TT 110-065	LM 110-065	65mm
SS 110-070	TT 110-070	LM 110-070	70mm
SS 110-075	TT 110-075	LM 110-075	75mm
SS 110-080	TT 110-080	LM 110-080	80mm
SS 110-085	TT 110-085	LM 110-085	85mm
SS 110-090	TT 110-090	LM 110-090	90mm
SS 110-095	TT 110-095	LM 110-095	95mm
SS 110-100	TT 110-100	LM 110-100	100mm

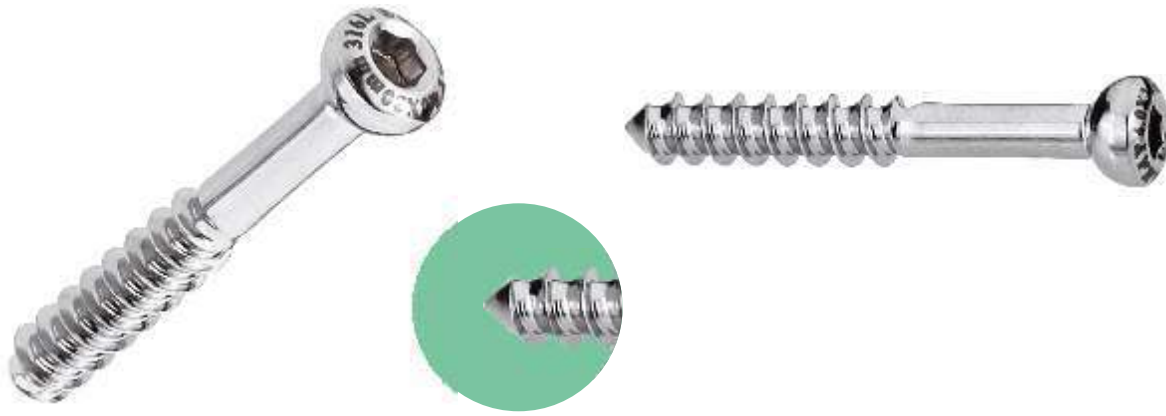

4.0mm Cancellous Screw Short Threaded

Code No. S.S. 316L	Code No. Titanium	Code No. S.S. 316LVM	Length
SS 111-010	TT 111-010	LM 111-010	10mm
SS 111-012	TT 111-012	LM 111-012	12mm
SS 111-014	TT 111-014	LM 111-014	14mm
SS 111-016	TT 111-016	LM 111-016	16mm
SS 111-018	TT 111-018	LM 111-018	18mm
SS 111-020	TT 111-020	LM 111-020	20mm
SS 111-022	TT 111-022	LM 111-022	22mm
SS 111-024	TT 111-024	LM 111-024	24mm
SS 111-026	TT 111-026	LM 111-026	26mm
SS 111-028	TT 111-028	LM 111-028	28mm
SS 111-030	TT 111-030	LM 111-030	30mm
SS 111-035	TT 111-035	LM 111-035	35mm
SS 111-040	TT 111-040	LM 111-040	40mm
SS 111-045	TT 111-045	LM 111-045	45mm
SS 111-050	TT 111-050	LM 111-050	50mm
SS 111-055	TT 111-055	LM 111-055	55mm
SS 111-060	TT 111-060	LM 111-060	60mm
SS 111-065	TT 111-065	LM 111-065	65mm
SS 111-070	TT 111-070	LM 111-070	70mm
SS 111-075	TT 111-075	LM 111-075	75mm
SS 111-080	TT 111-080	LM 111-076	80mm

Mfg. : Orthopedic Implants & Instruments

Bone Screw

An ISO 13485
Certified Company



Poz 1.1

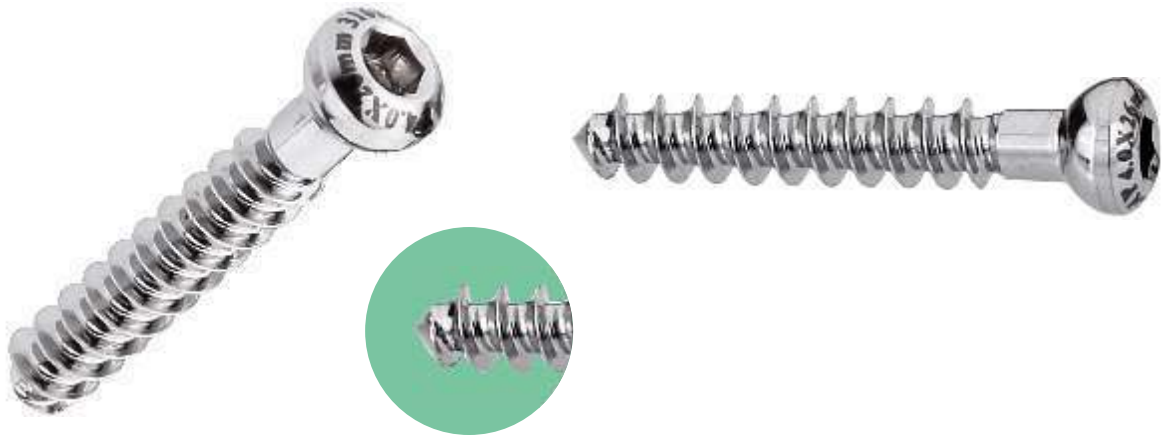

4.0mm Cancellous Screw Fully Threaded

Code No. S.S. 316L	Code No. Titanium	Code No. S.S. 316LVM	Length
SS 112-010	TT 112-010	LM 112-010	10mm
SS 112-012	TT 112-012	LM 112-012	12mm
SS 112-014	TT 112-014	LM 112-014	14mm
SS 112-016	TT 112-016	LM 112-016	16mm
SS 112-018	TT 112-018	LM 112-018	18mm
SS 112-020	TT 112-020	LM 112-020	20mm
SS 112-022	TT 112-022	LM 112-022	22mm
SS 112-024	TT 112-024	LM 112-024	24mm
SS 112-026	TT 112-026	LM 112-026	26mm
SS 112-028	TT 112-028	LM 112-028	28mm
SS 112-030	TT 112-030	LM 112-030	30mm
SS 112-035	TT 112-035	LM 112-035	35mm
SS 112-040	TT 112-040	LM 112-040	40mm
SS 112-045	TT 112-045	LM 112-045	45mm
SS 112-050	TT 112-050	LM 112-050	50mm
SS 112-055	TT 112-055	LM 112-055	55mm
SS 112-060	TT 112-060	LM 112-060	60mm
SS 112-065	TT 112-065	LM 112-065	65mm
SS 112-070	TT 112-070	LM 112-070	70mm



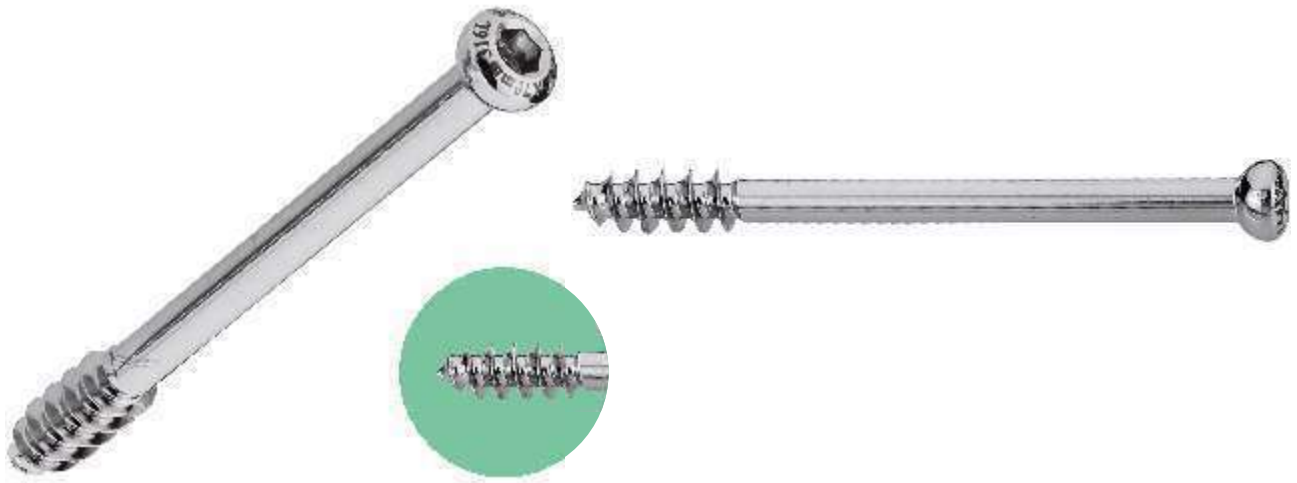

6.5mm Cancellous Screw 16mm Threaded

Code No. S.S. 316L	Code No. Titanium	Code No. S.S. 316LVM	Length
SS 113-025	TT 113-025	LM 113-025	25mm
SS 113-030	TT 113-030	LM 113-030	30mm
SS 113-035	TT 113-035	LM 113-035	35mm
SS 113-040	TT 113-040	LM 113-040	40mm
SS 113-045	TT 113-045	LM 113-045	45mm
SS 113-050	TT 113-050	LM 113-050	50mm
SS 113-055	TT 113-055	LM 113-055	55mm
SS 113-060	TT 113-060	LM 113-060	60mm
SS 113-065	TT 113-065	LM 113-065	65mm
SS 113-070	TT 113-070	LM 113-070	70mm
SS 113-075	TT 113-075	LM 113-075	75mm
SS 113-080	TT 113-080	LM 113-080	80mm
SS 113-085	TT 113-085	LM 113-085	85mm
SS 113-090	TT 113-090	LM 113-090	90mm
SS 113-095	TT 113-095	LM 113-095	95mm
SS 113-100	TT 113-100	LM 113-100	100mm
SS 113-105	TT 113-105	LM 113-105	105mm
SS 113-110	TT 113-110	LM 113-110	110mm
SS 113-115	TT 113-115	LM 113-115	115mm
SS 113-120	TT 113-120	LM 113-120	120mm

Mfg. : Orthopedic Implants & Instruments

Bone Screw

An ISO 13485
Certified Company





6.5mm Cancellous Screw 32mm Threaded

Code No. S.S. 316L	Code No. Titanium	Code No. S.S. 316LVM	Length
SS 114-040	TT 114-040	LM 114-040	40mm
SS 114-045	TT 114-045	LM 114-045	45mm
SS 114-050	TT 114-050	LM 114-050	50mm
SS 114-055	TT 114-055	LM 114-055	55mm
SS 114-060	TT 114-060	LM 114-060	60mm
SS 114-065	TT 114-065	LM 114-065	65mm
SS 114-070	TT 114-070	LM 114-070	70mm
SS 114-075	TT 114-075	LM 114-075	75mm
SS 114-080	TT 114-080	LM 114-080	80mm
SS 114-085	TT 114-085	LM 114-085	85mm
SS 114-090	TT 114-090	LM 114-090	90mm
SS 114-095	TT 114-095	LM 114-095	95mm
SS 114-100	TT 114-100	LM 114-100	100mm
SS 114-105	TT 114-105	LM 114-105	105mm
SS 114-110	TT 114-110	LM 114-110	110mm
SS 114-115	TT 114-115	LM 114-115	115mm
SS 114-120	TT 114-120	LM 114-120	120mm



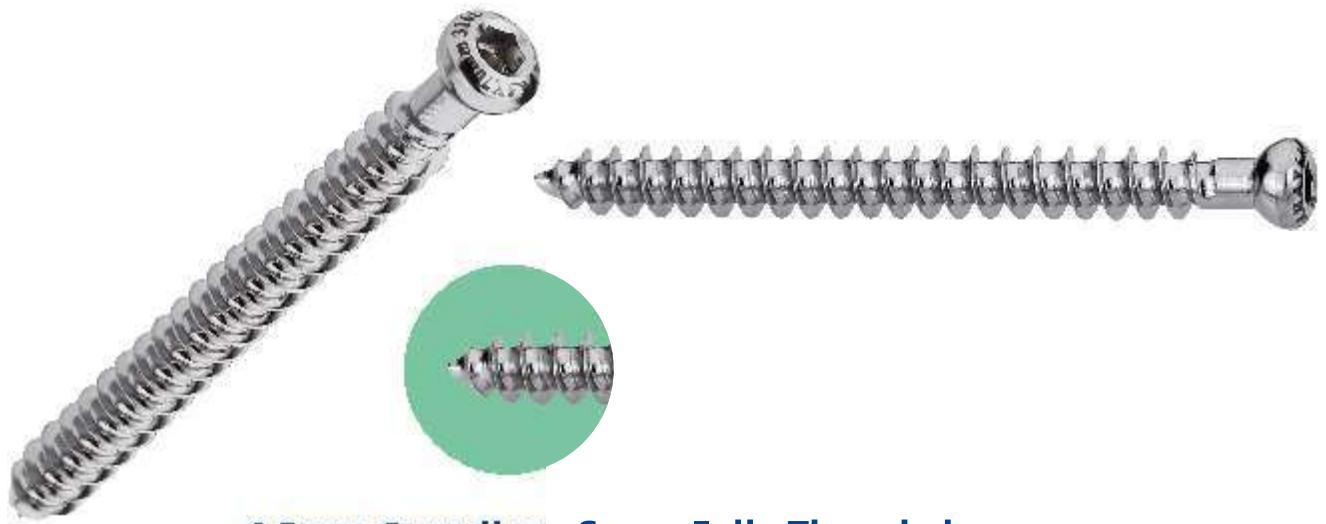

6.5mm Cancellous Screw Fully Threaded

Code No. S.S. 316L	Code No. Titanium	Code No. S.S. 316LVM	Length
SS 115-020	TT 115-020	LM 115-020	20mm
SS 115-025	TT 115-025	LM 115-025	25mm
SS 115-030	TT 115-030	LM 115-030	30mm
SS 115-035	TT 115-035	LM 115-035	35mm
SS 115-040	TT 115-040	LM 115-040	40mm
SS 115-045	TT 115-045	LM 115-045	45mm
SS 115-050	TT 115-050	LM 115-050	50mm
SS 115-055	TT 115-055	LM 115-055	55mm
SS 115-060	TT 115-060	LM 115-060	60mm
SS 115-065	TT 115-065	LM 115-065	65mm
SS 115-070	TT 115-070	LM 115-070	70mm
SS 115-075	TT 115-075	LM 115-075	75mm
SS 115-080	TT 115-080	LM 115-080	80mm
SS 115-085	TT 115-085	LM 115-085	85mm
SS 115-090	TT 115-090	LM 115-090	90mm
SS 115-095	TT 115-095	LM 115-095	95mm
SS 115-100	TT 115-100	LM 115-100	100mm
SS 115-105	TT 115-105	LM 115-105	105mm
SS 115-110	TT 115-110	LM 115-110	110mm

Mfg. : Orthopedic Implants & Instruments

Bone Screw

An ISO 13485
Certified Company



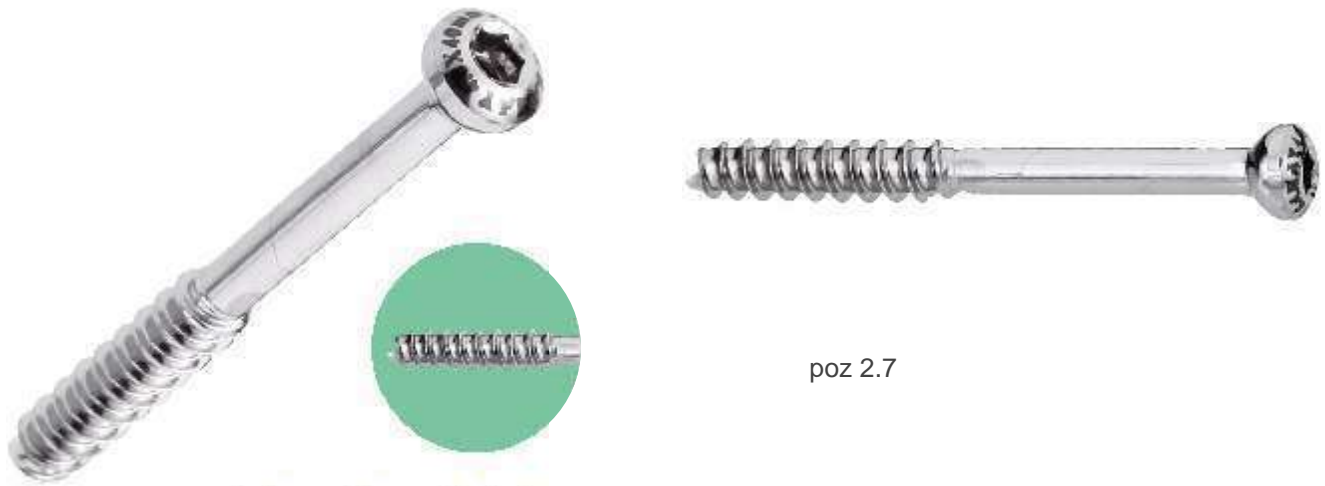

poz 2.7

4.0mm Cannulated Cancellous Screw Short Threaded

Code No. S.S. 316L	Code No. Titanium	Code No. S.S. 316LVM	Length
SS 116-012	TT 116-012	LM 116-012	12mm
SS 116-014	TT 116-014	LM 116-014	14mm
SS 116-016	TT 116-016	LM 116-016	16mm
SS 116-018	TT 116-018	LM 116-018	18mm
SS 116-020	TT 116-020	LM 116-020	20mm
SS 116-022	TT 116-022	LM 116-022	22mm
SS 116-024	TT 116-024	LM 116-024	24mm
SS 116-026	TT 116-026	LM 116-026	26mm
SS 116-028	TT 116-028	LM 116-028	28mm
SS 116-030	TT 116-030	LM 116-030	30mm
SS 116-035	TT 116-035	LM 116-035	35mm
SS 116-040	TT 116-040	LM 116-040	40mm
SS 116-045	TT 116-045	LM 116-045	45mm
SS 116-050	TT 116-050	LM 116-050	50mm
SS 116-055	TT 116-055	LM 116-055	55mm
SS 116-060	TT 116-060	LM 116-060	60mm
SS 116-065	TT 116-065	LM 116-065	65mm
SS 116-070	TT 116-070	LM 116-070	70mm
SS 116-075	TT 116-075	LM 116-075	75mm
SS 116-080	TT 116-080	LM 116-080	80mm





4.0mm Cannulated Cancellous Screw Fully Threaded

Code No. S.S. 316L	Code No. Titanium	Code No. S.S. 316LVM	Length
SS 117-012	TT 117-012	LM 117-012	12mm
SS 117-014	TT 117-014	LM 117-014	14mm
SS 117-016	TT 117-016	LM 117-016	16mm
SS 117-018	TT 117-018	LM 117-018	18mm
SS 117-020	TT 117-020	LM 117-020	20mm
SS 117-022	TT 117-022	LM 117-022	22mm
SS 117-024	TT 117-024	LM 117-024	24mm
SS 117-026	TT 117-026	LM 117-026	26mm
SS 117-028	TT 117-028	LM 117-028	28mm
SS 117-030	TT 117-030	LM 117-030	30mm
SS 117-035	TT 117-035	LM 117-035	35mm
SS 117-040	TT 117-040	LM 117-040	40mm
SS 117-045	TT 117-045	LM 117-045	45mm
SS 117-050	TT 117-050	LM 117-050	50mm
SS 117-055	TT 117-055	LM 117-055	55mm
SS 117-060	TT 117-060	LM 117-060	60mm
SS 117-065	TT 117-065	LM 117-065	65mm
SS 117-070	TT 117-070	LM 117-070	70mm

Mfg. : Orthopedic Implants & Instruments

Bone Screw

An ISO 13485
Certified Company





6.5mm Cannulated Cancellous Screw 16mm Threaded

Code No. S.S. 316L	Code No. Titanium	Code No. S.S. 316LVM	Length
SS 118-025	TT 118-025	LM 118-025	25mm
SS 118-030	TT 118-030	LM 118-030	30mm
SS 118-035	TT 118-035	LM 118-035	35mm
SS 118-040	TT 118-040	LM 118-040	40mm
SS 118-045	TT 118-045	LM 118-045	45mm
SS 118-050	TT 118-050	LM 118-050	50mm
SS 118-055	TT 118-055	LM 118-055	55mm
SS 118-060	TT 118-060	LM 118-060	60mm
SS 118-065	TT 118-065	LM 118-065	65mm
SS 118-070	TT 118-070	LM 118-070	70mm
SS 118-075	TT 118-075	LM 118-075	75mm
SS 118-080	TT 118-080	LM 118-080	80mm
SS 118-085	TT 118-085	LM 118-085	85mm
SS 118-090	TT 118-090	LM 118-090	90mm
SS 118-095	TT 118-095	LM 118-095	95mm
SS 118-100	TT 118-100	LM 118-100	100mm
SS 118-105	TT 118-105	LM 118-105	105mm
SS 118-110	TT 118-110	LM 118-110	110mm
SS 118-115	TT 118-115	LM 118-115	115mm
SS 118-120	TT 118-120	LM 118-120	120mm



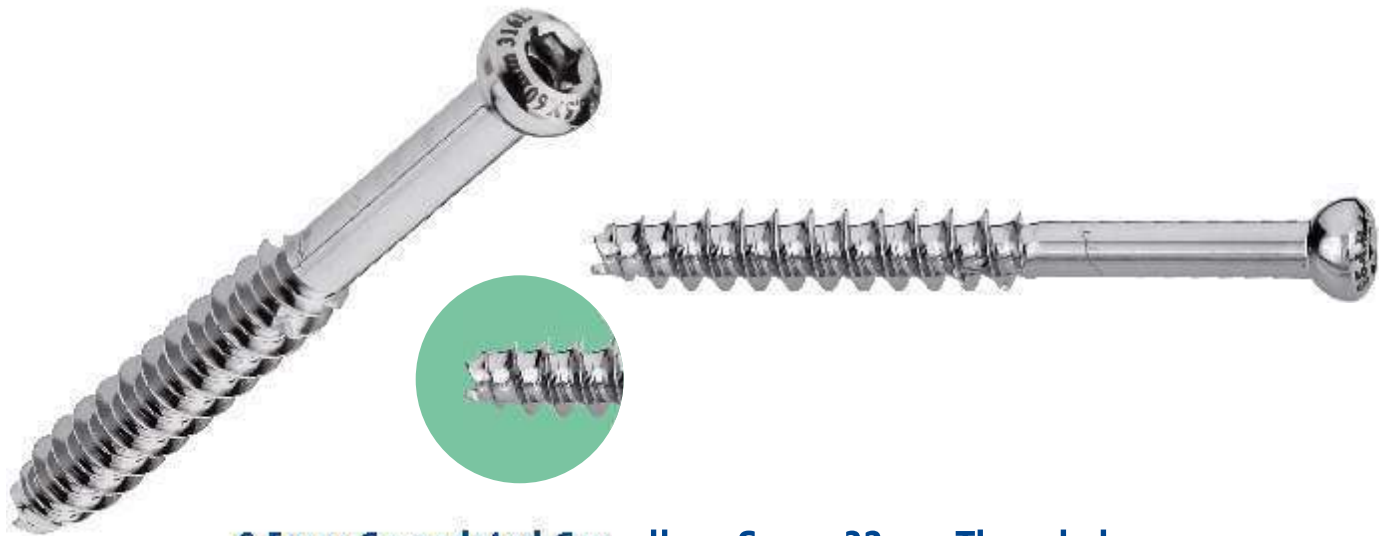

6.5mm Cannulated Cancellous Screw 32mm Threaded

Code No. S.S. 316L	Code No. Titanium	Code No. S.S. 316LVM	Length
SS 119-040	TT 119-040	LM 119-040	40mm
SS 119-045	TT 119-045	LM 119-045	45mm
SS 119-050	TT 119-050	LM 119-050	50mm
SS 119-055	TT 119-055	LM 119-055	55mm
SS 119-060	TT 119-060	LM 119-060	60mm
SS 119-065	TT 119-065	LM 119-065	65mm
SS 119-070	TT 119-070	LM 119-070	70mm
SS 119-075	TT 119-075	LM 119-075	75mm
SS 119-080	TT 119-080	LM 119-080	80mm
SS 119-085	TT 119-085	LM 119-085	85mm
SS 119-090	TT 119-090	LM 119-090	90mm
SS 119-095	TT 119-095	LM 119-095	95mm
SS 119-100	TT 119-100	LM 119-100	100mm
SS 119-105	TT 119-105	LM 119-105	105mm
SS 119-110	TT 119-110	LM 119-110	110mm
SS 119-115	TT 119-115	LM 119-115	115mm
SS 119-120	TT 119-120	LM 119-120	120mm

Mfg. : Orthopedic Implants & Instruments

Bone Screw

An ISO 13485
Certified Company





6.5mm Cannulated Cancellous Screw Fully Threaded

Code No. S.S. 316L	Code No. Titanium	Code No. S.S. 316LVM	Length
SS 120-020	TT 120-020	LM 120-020	20mm
SS 120-025	TT 120-025	LM 120-025	25mm
SS 120-030	TT 120-030	LM 120-030	30mm
SS 120-035	TT 120-035	LM 120-035	35mm
SS 120-040	TT 120-040	LM 120-040	40mm
SS 120-045	TT 120-045	LM 120-045	45mm
SS 120-050	TT 120-050	LM 120-050	50mm
SS 120-055	TT 120-055	LM 120-055	55mm
SS 120-060	TT 120-060	LM 120-060	60mm
SS 120-065	TT 120-065	LM 120-065	65mm
SS 120-070	TT 120-070	LM 120-070	70mm
SS 120-075	TT 120-075	LM 120-075	75mm
SS 120-080	TT 120-080	LM 120-080	80mm
SS 120-085	TT 120-085	LM 120-085	85mm
SS 120-090	TT 120-090	LM 120-090	90mm
SS 120-095	TT 120-095	LM 120-095	95mm
SS 120-100	TT 120-100	LM 120-100	100mm
SS 120-105	TT 120-105	LM 120-105	105mm
SS 120-110	TT 120-110	LM 120-110	110mm





Washer

Code No. S.S. 316L	Code No. Titanium	Code No. S.S. 316LVM	Length
SS 124-007	TT 124-007	LM 124-007	7.0mm
SS 125-013	TT 125-013	LM 125-013	13.0mm

Herbert Screw

Code No. S.S. 316L	Code No. Titanium	Code No. S.S. 316LVM	Length
SS 230-010	TT 230-010	LM 230-010	10mm
SS 230-012	TT 230-012	LM 230-012	12mm
SS 230-014	TT 230-014	LM 230-014	14mm
SS 230-016	TT 230-016	LM 230-016	16mm
SS 230-018	TT 230-018	LM 230-018	18mm
SS 230-020	TT 230-020	LM 230-020	20mm
SS 230-022	TT 230-022	LM 230-022	22mm
SS 230-024	TT 230-024	LM 230-024	24mm
SS 230-026	TT 230-026	LM 230-026	26mm
SS 230-028	TT 230-028	LM 230-028	28mm
SS 230-030	TT 230-030	LM 230-030	30mm
SS 230-035	TT 230-035	LM 230-035	35mm
SS 230-040	TT 230-040	LM 230-040	40mm
SS 230-045	TT 230-045	LM 230-045	45mm
SS 230-050	TT 230-050	LM 230-050	50mm
SS 230-055	TT 230-055	LM 230-055	55mm
SS 230-060	TT 230-060	LM 230-060	60mm
SS 230-065	TT 230-065	LM 230-065	65mm
SS 230-070	TT 230-070	LM 230-070	70mm
SS 230-075	TT 230-075	LM 230-075	75mm
SS 230-080	TT 230-080	LM 230-080	80mm



Mfg. : Orthopedic Implants & Instruments

Bone Screw

An ISO 13485
Certified Company





3.5mm Small Compression (DCP) Plates

Code No. S.S. 316L	Code No. Titanium	Code No. S.S. 316LVM	Hole
SS 126-003	TT 126-003	LM 126-003	3
SS 126-004	TT 126-004	LM 126-004	4
SS 126-005	TT 126-005	LM 126-005	5
SS 126-006	TT 126-006	LM 126-006	6
SS 126-007	TT 126-007	LM 126-007	7
SS 126-008	TT 126-008	LM 126-008	8
SS 126-009	TT 126-009	LM 126-009	9
SS 126-010	TT 126-010	LM 126-010	10
SS 126-011	TT 126-011	LM 126-011	11
SS 126-012	TT 126-012	LM 126-012	12



4.5mm Narrow Compression (DCP) Plates

Code No. S.S. 316L	Code No. Titanium	Code No. S.S. 316LVM	Hole
SS 127-004	TT 127-004	LM 127-004	4
SS 127-005	TT 127-005	LM 127-005	5
SS 127-006	TT 127-006	LM 127-006	6
SS 127-007	TT 127-007	LM 127-007	7
SS 127-008	TT 127-008	LM 127-008	8
SS 127-009	TT 127-009	LM 127-009	9
SS 127-010	TT 127-010	LM 127-010	10
SS 127-011	TT 127-011	LM 127-011	11
SS 127-012	TT 127-012	LM 127-012	12
SS 127-013	TT 127-013	LM 127-013	13
SS 127-014	TT 127-014	LM 127-014	14
SS 127-015	TT 127-015	LM 127-015	15
SS 127-016	TT 127-016	LM 127-016	16
SS 127-017	TT 127-017	LM 127-017	17
SS 127-018	TT 127-018	LM 127-018	18





4.5mm Broad Compression (DCP) Plates

Code No. S.S. 316L	Code No. Titanium	Code No. S.S. 316LVM	Hole
SS 128-005	TT 128-005	LM 128-005	5
SS 128-006	TT 128-006	LM 128-006	6
SS 128-007	TT 128-007	LM 128-007	7
SS 128-008	TT 128-008	LM 128-008	8
SS 128-009	TT 128-009	LM 128-009	9
SS 128-010	TT 128-010	LM 128-010	10
SS 128-011	TT 128-011	LM 128-011	11
SS 128-012	TT 128-012	LM 128-012	12
SS 128-013	TT 128-013	LM 128-013	13
SS 128-014	TT 128-014	LM 128-014	14
SS 128-015	TT 128-015	LM 128-015	15
SS 128-016	TT 128-016	LM 128-016	16
SS 128-017	TT 128-017	LM 128-017	17
SS 128-018	TT 128-018	LM 128-018	18
SS 128-019	TT 128-019	LM 128-019	19
SS 128-020	TT 128-020	LM 128-020	20



2.7mm Dynamic Compression Plates

Code No. S.S. 316L	Code No. Titanium	Code No. S.S. 316LVM	Hole
SS 132-002	TT 132-002	LM 132-002	2
SS 132-003	TT 132-003	LM 132-003	3
SS 132-004	TT 132-004	LM 132-004	4
SS 132-005	TT 132-005	LM 132-005	5
SS 132-006	TT 132-006	LM 132-006	6
SS 132-007	TT 132-007	LM 132-007	7
SS 132-008	TT 132-008	LM 132-008	8
SS 132-009	TT 132-009	LM 132-009	9
SS 132-010	TT 132-010	LM 132-010	10
SS 132-011	TT 132-011	LM 132-011	11
SS 132-012	TT 132-012	LM 132-012	12

Mfg. : Orthopedic Implants & Instruments

Bone Plate

An ISO 13485
Certified Company





3.5mm Small Compression (LC-DCP) Plates

Code No. S.S. 316L	Code No. Titanium	Code No. S.S. 316LVM	Hole
SS 129-003	TT 129-003	LM 129-003	3
SS 129-004	TT 129-004	LM 129-004	4
SS 129-005	TT 129-005	LM 129-005	5
SS 129-006	TT 129-006	LM 129-006	6
SS 129-007	TT 129-007	LM 129-007	7
SS 129-008	TT 129-008	LM 129-008	8
SS 129-009	TT 129-009	LM 129-009	9
SS 129-010	TT 129-010	LM 129-010	10
SS 129-011	TT 129-011	LM 129-011	11
SS 129-012	TT 129-012	LM 129-012	12



3.5mm One Third Tubular Plates

Code No. S.S. 316L	Code No. Titanium	Code No. S.S. 316LVM	Hole
SS 133-003	TT 133-003	LM 133-003	3
SS 133-004	TT 133-004	LM 133-004	4
SS 133-005	TT 133-005	LM 133-005	5
SS 133-006	TT 133-006	LM 133-006	6
SS 133-007	TT 133-007	LM 133-007	7
SS 133-008	TT 133-008	LM 133-008	8
SS 133-009	TT 133-009	LM 133-009	9
SS 133-010	TT 133-010	LM 133-010	10
SS 133-011	TT 133-011	LM 133-011	11
SS 133-012	TT 133-012	LM 133-012	12





4.5mm Narrow Compression (LC-DCP) Plates

Code No. S.S. 316L	Code No. Titanium	Code No. S.S. 316LVM	Hole
SS 130-004	TT 130-004	LM 130-004	4
SS 130-005	TT 130-005	LM 130-005	5
SS 130-006	TT 130-006	LM 130-006	6
SS 130-007	TT 130-007	LM 130-007	7
SS 130-008	TT 130-008	LM 130-008	8
SS 130-009	TT 130-009	LM 130-009	9
SS 130-010	TT 130-010	LM 130-010	10
SS 130-011	TT 130-011	LM 130-011	11
SS 130-012	TT 130-012	LM 130-012	12
SS 130-013	TT 130-013	LM 130-013	13
SS 130-014	TT 130-014	LM 130-014	14
SS 130-015	TT 130-015	LM 130-015	15
SS 130-016	TT 130-016	LM 130-016	16
SS 130-017	TT 130-017	LM 130-017	17
SS 130-018	TT 130-018	LM 130-018	18
SS 130-020	TT 130-020	LM 130-020	20



4.5mm Semi Tubular Plates

Code No. S.S. 316L	Code No. Titanium	Code No. S.S. 316LVM	Hole
SS 134-003	TT 134-003	LM 134-003	3
SS 134-004	TT 134-004	LM 134-004	4
SS 134-005	TT 134-005	LM 134-005	5
SS 134-006	TT 134-006	LM 134-006	6
SS 134-007	TT 134-007	LM 134-007	7
SS 134-008	TT 134-008	LM 134-008	8
SS 134-009	TT 134-009	LM 134-009	9
SS 134-010	TT 134-010	LM 134-010	10
SS 134-011	TT 134-011	LM 134-011	11
SS 134-012	TT 134-012	LM 134-012	12

Mfg. : Orthopedic Implants & Instruments

Bone Plate

An ISO 13485
Certified Company





4.5mm Broad Compression (LC-DCP) Plates

Code No. S.S. 316L	Code No. Titanium	Code No. S.S. 316LVM	Hole
SS 131-005	TT 131-005	LM 131-005	5
SS 131-006	TT 131-006	LM 131-006	6
SS 131-007	TT 131-007	LM 131-007	7
SS 131-008	TT 131-008	LM 131-008	8
SS 131-009	TT 131-009	LM 131-009	9
SS 131-010	TT 131-010	LM 131-010	10
SS 131-011	TT 131-011	LM 131-011	11
SS 131-012	TT 131-012	LM 131-012	12
SS 131-013	TT 131-013	LM 131-013	13
SS 131-014	TT 131-014	LM 131-014	14
SS 131-015	TT 131-015	LM 131-015	15
SS 131-016	TT 131-016	LM 131-016	16
SS 131-017	TT 131-017	LM 131-017	17
SS 131-018	TT 131-018	LM 131-018	18
SS 131-019	TT 131-019	LM 131-019	19
SS 131-020	TT 131-020	LM 131-020	20



3.5mm Small T Plates, Right Angled

Code No. S.S. 316L	Code No. Titanium	Code No. S.S. 316LVM	Hole
SS 135-003	TT 135-003	LM 135-003	3
SS 135-004	TT 135-004	LM 135-004	4
SS 135-005	TT 135-005	LM 135-005	5
SS 135-006	TT 135-006	LM 135-006	6
SS 135-007	TT 135-007	LM 135-007	7
SS 135-008	TT 135-008	LM 135-008	8





3.5mm Small T Plates, Oblique Angled

Code No. S.S. 316L	Code No. Titanium	Code No. S.S. 316LVM	Hole
SS 136-003	TT 136-003	LM 136-003	3
SS 136-004	TT 136-004	LM 136-004	4
SS 136-005	TT 136-005	LM 136-005	5
SS 136-006	TT 136-006	LM 136-006	6
SS 136-007	TT 136-007	LM 136-007	7
SS 136-008	TT 136-008	LM 136-008	8



3.5mm Reconstruction Plates, Curved

Code No. S.S. 316L	Code No. Titanium	Code No. S.S. 316LVM	Hole
SS 137-204	TT 137-204	LM 137-204	4
SS 137-205	TT 137-205	LM 137-205	5
SS 137-206	TT 137-206	LM 137-206	6
SS 137-207	TT 137-207	LM 137-207	7
SS 137-208	TT 137-208	LM 137-208	8
SS 137-209	TT 137-209	LM 137-209	9
SS 137-210	TT 137-210	LM 137-210	10
SS 137-211	TT 137-211	LM 137-211	11
SS 137-212	TT 137-212	LM 137-212	12
SS 137-214	TT 137-214	LM 137-214	14
SS 137-216	TT 137-216	LM 137-216	16
SS 137-218	TT 137-218	LM 137-218	18
SS 137-220	TT 137-220	LM 137-220	20
SS 137-222	TT 137-222	LM 137-222	22
SS 137-224	TT 137-224	LM 137-224	24
SS 137-225	TT 137-225	LM 137-225	25

Mfg. : Orthopedic Implants & Instruments

Bone Plate

An ISO 13485
Certified Company





3.5mm Reconstruction Plates, Straight Round Hole

Code No. S.S. 316L	Code No. Titanium	Code No. S.S. 316LVM	Hole
SS 137-004	TT 137-004	LM 137-004	4
SS 137-005	TT 137-005	LM 137-005	5
SS 137-006	TT 137-006	LM 137-006	6
SS 137-007	TT 137-007	LM 137-007	7
SS 137-008	TT 137-008	LM 137-008	8
SS 137-009	TT 137-009	LM 137-009	9
SS 137-010	TT 137-010	LM 137-010	10
SS 137-011	TT 137-011	LM 137-011	11
SS 137-012	TT 137-012	LM 137-012	12
SS 137-014	TT 137-014	LM 137-014	14
SS 137-016	TT 137-016	LM 137-016	16
SS 137-018	TT 137-018	LM 137-018	18
SS 137-020	TT 137-020	LM 137-020	20
SS 137-022	TT 137-022	LM 137-022	22
SS 137-024	TT 137-024	LM 137-024	24
SS 137-025	TT 137-025	LM 137-025	25



3.5mm Reconstruction Plates, Straight D.C Hole

Code No. S.S. 316L	Code No. Titanium	Code No. S.S. 316LVM	Hole
SS 137-104	TT 137-104	LM 137-104	4
SS 137-105	TT 137-105	LM 137-105	5
SS 137-106	TT 137-106	LM 137-106	6
SS 137-107	TT 137-107	LM 137-107	7
SS 137-108	TT 137-108	LM 137-108	8
SS 137-109	TT 137-109	LM 137-109	9
SS 137-110	TT 137-110	LM 137-110	10
SS 137-111	TT 137-111	LM 137-111	11
SS 137-112	TT 137-112	LM 137-112	12
SS 137-114	TT 137-114	LM 137-114	14
SS 137-116	TT 137-116	LM 137-116	16
SS 137-118	TT 137-118	LM 137-118	18
SS 137-120	TT 137-120	LM 137-120	20
SS 137-122	TT 137-122	LM 137-122	22
SS 137-124	TT 137-124	LM 137-124	24
SS 137-125	TT 137-125	LM 137-125	25





4.5mm Reconstruction Plates, Straight Round Hole

Code No. S.S. 316L	Code No. Titanium	Code No. S.S. 316LVM	Hole
SS 138-004	TT 138-004	LM 138-004	4
SS 138-005	TT 138-005	LM 138-005	5
SS 138-006	TT 138-006	LM 138-006	6
SS 138-007	TT 138-007	LM 138-007	7
SS 138-008	TT 138-008	LM 138-008	8
SS 138-009	TT 138-009	LM 138-009	9
SS 138-010	TT 138-010	LM 138-010	10
SS 138-011	TT 138-011	LM 138-011	11
SS 138-012	TT 138-012	LM 138-012	12
SS 138-014	TT 138-014	LM 138-014	14
SS 138-016	TT 138-016	LM 138-016	16
SS 138-018	TT 138-018	LM 138-018	18
SS 138-020	TT 138-020	LM 138-020	20
SS 138-022	TT 138-022	LM 138-022	22
SS 138-024	TT 138-024	LM 138-024	24
SS 138-025	TT 138-025	LM 138-025	25



4.5mm Reconstruction Plates, Straight D.C Hole

Code No. S.S. 316L	Code No. Titanium	Code No. S.S. 316LVM	Hole
SS 138-104	TT 138-104	LM 138-104	4
SS 138-105	TT 138-105	LM 138-105	5
SS 138-106	TT 138-106	LM 138-106	6
SS 138-107	TT 138-107	LM 138-107	7
SS 138-108	TT 138-108	LM 138-108	8
SS 138-109	TT 138-109	LM 138-109	9
SS 138-110	TT 138-110	LM 138-110	10
SS 138-111	TT 138-111	LM 138-111	11
SS 138-112	TT 138-112	LM 138-112	12
SS 138-114	TT 138-114	LM 138-114	14
SS 138-116	TT 138-116	LM 138-116	16
SS 138-118	TT 138-118	LM 138-118	18
SS 138-120	TT 138-120	LM 138-120	20
SS 138-122	TT 138-122	LM 138-122	22
SS 138-124	TT 138-124	LM 138-124	24
SS 138-125	TT 138-125	LM 138-125	25

Mfg. : Orthopedic Implants & Instruments

Bone Plate

An ISO 13485
Certified Company





4.5mm 'T' Plates

Code No. S.S. 316L	Code No. Titanium	Code No. S.S. 316LVM	Hole
SS 140-003	TT 140-003	LM 140-003	3
SS 140-004	TT 140-004	LM 140-004	4
SS 140-005	TT 140-005	LM 140-005	5
SS 140-006	TT 140-006	LM 140-006	6
SS 140-007	TT 140-007	LM 140-007	7
SS 140-008	TT 140-008	LM 140-008	8
SS 140-009	TT 140-009	LM 140-009	9
SS 140-010	TT 140-010	LM 140-010	10
SS 140-011	TT 140-011	LM 140-011	11
SS 140-012	TT 140-012	LM 140-012	12



4.5mm T-Buttress Plates

Code No. S.S. 316L	Code No. Titanium	Code No. S.S. 316LVM	Hole
SS 141-003	TT 141-003	LM 141-003	3
SS 141-004	TT 141-004	LM 141-004	4
SS 141-005	TT 141-005	LM 141-005	5
SS 141-006	TT 141-006	LM 141-006	6
SS 141-007	TT 141-007	LM 141-007	7
SS 141-008	TT 141-008	LM 141-008	8
SS 141-009	TT 141-009	LM 141-009	9
SS 141-010	TT 141-010	LM 141-010	10
SS 141-011	TT 141-011	LM 141-011	11
SS 141-012	TT 141-012	LM 141-012	12





DHS Barrel Plate DCP Hole (Barrel Length 38mm)

Also Available 125°,130°,140°,
 Code For S.S. 316L 125°/SS 152-103, 130°/SS 152-203, 140°/SS 152-403
 Titanium 125°/TT 152-103, 130°/TT 152-203, 140°/TT 152-403
 S.S. 316LVM 125°/LM 152-103, 130°/LM 152-203, 140°/LM 152-403

Code No. S.S. 316L	Code No. Titanium	Code No. S.S. 316LVM	Angled	Hole
SS 152-303	TT 152-303	LM 152-303	135°	3
SS 152-304	TT 152-304	LM 152-304	135°	4
SS 152-305	TT 152-305	LM 152-305	135°	5
SS 152-306	TT 152-306	LM 152-306	135°	6
SS 152-307	TT 152-307	LM 152-307	135°	7
SS 152-308	TT 152-308	LM 152-308	135°	8
SS 152-309	TT 152-309	LM 152-309	135°	9
SS 152-310	TT 152-310	LM 152-310	135°	10
SS 152-312	TT 152-312	LM 152-312	135°	12
SS 152-314	TT 152-314	LM 152-314	135°	14
SS 152-316	TT 152-316	LM 152-316	135°	16

Trochanteric Plate



Mfg. : Orthopedic Implants & Instruments

Bone Plate

An ISO 13485
 Certified Company





DHS Barrel Plate DCP Hole (Barrel Length 25mm)

Also Available 125°,130°,140°
 Code For S.S. 316L 125°/SS 166-103, 130°/SS 166-203, 140°/SS 166-403
 Titanium 125°/TT 166-103, 130°/TT 166-203, 140°/TT 166-403
 S.S. 316LVM 125°/LM 166-103, 130°/LM 166-203, 140°/LM 166-403

Code No. S.S. 316L	Code No. Titanium	Code No. S.S. 316LVM	Angled	Hole
SS 166-303	TT 166-303	LM 166-303	135°	3
SS 166-304	TT 166-304	LM 166-304	135°	4
SS 166-305	TT 166-305	LM 166-305	135°	5
SS 166-306	TT 166-306	LM 166-306	135°	6
SS 166-307	TT 166-307	LM 166-307	135°	7
SS 166-308	TT 166-308	LM 166-308	135°	8
SS 166-309	TT 166-309	LM 166-309	135°	9
SS 166-310	TT 166-310	LM 166-310	135°	10
SS 166-312	TT 166-312	LM 166-312	135°	12
SS 166-314	TT 166-314	LM 166-314	135°	14
SS 166-316	TT 166-316	LM 166-316	135°	16



DHS Pediatric Plate

Code No. S.S. 316L	Code No. Titanium	Code No. S.S. 316LVM	Angled	Hole
SS 163-303	TT 163-303	LM 163-303	135°	3
SS 163-304	TT 163-304	LM 163-304	135°	4
SS 163-305	TT 163-305	LM 163-305	135°	5
SS 163-306	TT 163-306	LM 163-306	135°	6

Mfg. : Orthopedic Implants & Instruments

Bone Plate

An ISO 13485
 Certified Company



95° DCS Barrel Plate Round Hole

Code No. S.S. 316L	Code No. Titanium	Code No. S.S. 316LVM	Angled	Hole
SS 153-002	TT 153-002	LM 153-002	95°	2+2
SS 153-003	TT 153-003	LM 153-003	95°	3+2
SS 153-004	TT 153-004	LM 153-004	95°	4+2
SS 153-005	TT 153-005	LM 153-005	95°	5+2
SS 153-006	TT 153-006	LM 153-006	95°	6+2
SS 153-007	TT 153-007	LM 153-007	95°	7+2
SS 153-008	TT 153-008	LM 153-008	95°	8+2
SS 153-009	TT 153-009	LM 153-009	95°	9+2
SS 153-010	TT 153-010	LM 153-010	95°	10+2
SS 153-012	TT 153-012	LM 153-012	95°	12+2
SS 153-014	TT 153-014	LM 153-014	95°	14+2
SS 153-016	TT 153-016	LM 153-016	95°	16+2



95° DCS Barrel Plate DCP Hole

Code No. S.S. 316L	Code No. Titanium	Code No. S.S. 316LVM	Angled	Hole
SS 154-002	TT 154-002	LM 154-002	95°	2+2
SS 154-003	TT 154-003	LM 154-003	95°	3+2
SS 154-004	TT 154-004	LM 154-004	95°	4+2
SS 154-005	TT 154-005	LM 154-005	95°	5+2
SS 154-006	TT 154-006	LM 154-006	95°	6+2
SS 154-007	TT 154-007	LM 154-007	95°	7+2
SS 154-008	TT 154-008	LM 154-008	95°	8+2
SS 154-009	TT 154-009	LM 154-009	95°	9+2
SS 154-010	TT 154-010	LM 154-010	95°	10+2
SS 154-012	TT 154-012	LM 154-012	95°	12+2
SS 154-014	TT 154-014	LM 154-014	95°	14+2
SS 154-016	TT 154-016	LM 154-016	95°	16+2

95° Condylar Angled Blade Plate DCP Hole

(Also available in 55mm, 60mm, 65mm, 70mm, 75mm, 80mm Blade Length)

Code No. S.S. 316L	Code No. Titanium	Code No. S.S. 316LVM	Blade Length	Hole
SS 159-004	TT 159-004	LM 159-004	50mm	4
SS 159-005	TT 159-005	LM 159-005	50mm	5
SS 159-006	TT 159-006	LM 159-006	50mm	6
SS 159-007	TT 159-007	LM 159-007	50mm	7
SS 159-008	TT 159-008	LM 159-008	50mm	8
SS 159-009	TT 159-009	LM 159-009	50mm	9
SS 159-010	TT 159-010	LM 159-010	50mm	10
SS 159-011	TT 159-011	LM 159-011	50mm	11
SS 159-012	TT 159-012	LM 159-012	50mm	12



130° Condylar Angled Blade plate DCP Hole

(Also available in 55mm, 60mm, 65mm, 70mm, 75mm, 80mm Blade Length)

Code No. S.S. 316L	Code No. Titanium	Code No. S.S. 316LVM	Blade Length	Hole
SS 160-004	TT 160-004	LM 160-004	50mm	4
SS 160-005	TT 160-005	LM 160-005	50mm	5
SS 160-006	TT 160-006	LM 160-006	50mm	6
SS 160-007	TT 160-007	LM 160-007	50mm	7
SS 160-008	TT 160-008	LM 160-008	50mm	8
SS 160-009	TT 160-009	LM 160-009	50mm	9
SS 160-010	TT 160-010	LM 160-010	50mm	10
SS 160-011	TT 160-011	LM 160-011	50mm	11
SS 160-012	TT 160-012	LM 160-012	50mm	12

Mfg. : Orthopedic Implants & Instruments

Bone Plate

An ISO 13485
Certified Company





DHS Lag Screw

Code No. S.S. 316L	Code No. Titanium	Code No. S.S. 316LVM	Length
SS 155-050	TT 155-050	LM 155-050	50mm
SS 155-055	TT 155-055	LM 155-055	55mm
SS 155-060	TT 155-060	LM 155-060	60mm
SS 155-065	TT 155-065	LM 155-065	65mm
SS 155-070	TT 155-070	LM 155-070	70mm
SS 155-075	TT 155-075	LM 155-075	75mm
SS 155-080	TT 155-080	LM 155-080	80mm
SS 155-085	TT 155-085	LM 155-085	85mm
SS 155-090	TT 155-090	LM 155-090	90mm
SS 155-095	TT 155-095	LM 155-095	95mm
SS 155-100	TT 155-100	LM 155-100	100mm
SS 155-105	TT 155-105	LM 155-105	105mm
SS 155-110	TT 155-110	LM 155-110	110mm
SS 155-115	TT 155-115	LM 155-115	115mm
SS 155-120	TT 155-120	LM 155-120	120mm



DHS Pediatric Screw

Code No. S.S. 316L	Code No. Titanium	Code No. S.S. 316LVM	Length
SS 164-035	TT 164-035	LM 164-035	35mm
SS 164-040	TT 164-040	LM 164-040	40mm
SS 164-045	TT 164-045	LM 164-045	45mm
SS 164-050	TT 164-050	LM 164-050	50mm
SS 164-055	TT 164-055	LM 164-055	55mm
SS 164-060	TT 164-060	LM 164-060	60mm
SS 164-065	TT 164-065	LM 164-065	65mm
SS 164-070	TT 164-070	LM 164-070	70mm
SS 164-075	TT 164-075	LM 164-075	75mm
SS 164-080	TT 164-080	LM 164-080	80mm



Proximal Femoral Nail (P.F.N), (Right)

Note : Define Code for S.S. 316L./SS 205, Titanium/TT 205, S.S. 316LVM/LM 205

Screw Places : 8.0mm/6.4mm/4.9mm

Code No. S.S. 316L	Code No. S.S. 316L	Code No. S.S. 316L	Length	Angled
Dia. (9.0mm)	Dia. (10.0mm)	Dia. (11.0mm)		
SS 205-034	SS 205-134	SS 205-234	34cm	135°
SS 205-036	SS 205-136	SS 205-236	36cm	135°
SS 205-038	SS 205-138	SS 205-238	38cm	135°
SS 205-040	SS 205-140	SS 205-240	40cm	135°
SS 205-042	SS 205-142	SS 205-242	42cm	135°
SS 205-044	SS 205-144	SS 205-244	44cm	135°

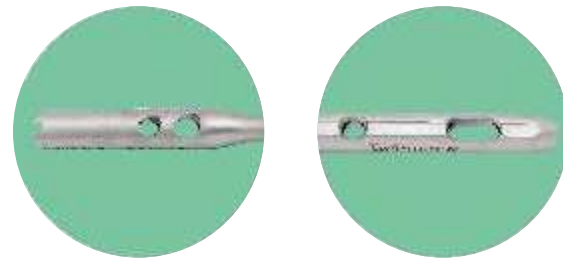

Proximal Femoral Nail (P.F.N), (Left)

Note : Define Code for S.S. 316L./SS 206, Titanium/TT 206, S.S. 316LVM/LM 206

Screw Places : 8.0mm/6.4mm/4.9mm

Code No. S.S. 316L	Code No. S.S. 316L	Code No. S.S. 316L	Length	Angled
Dia. (9.0mm)	Dia. (10.0mm)	Dia. (11.0mm)		
SS 206-034	SS 206-134	SS 206-234	34cm	135°
SS 206-036	SS 206-136	SS 206-236	36cm	135°
SS 206-038	SS 206-138	SS 206-238	38cm	135°
SS 206-040	SS 206-140	SS 206-240	40cm	135°
SS 206-042	SS 206-142	SS 206-242	42cm	135°
SS 206-044	SS 206-144	SS 206-244	44cm	135°

Mfg. : Orthopedic Implants & Instruments

Bone Nail

An ISO 13485
Certified Company



Proximal Femoral Nail (P.F.N), (Short) 25cm

Screw Places : 8.0mm/6.4mm/4.9mm

Code No. S.S. 316L	Code No. Titanium	Code No. S.S. 316LVM	Dia.	Angled
SS 207-009	TT 207-009	LM 207-009	9mm	130°
SS 207-010	TT 207-010	LM 207-010	10mm	130°
SS 207-011	TT 207-011	LM 207-011	11mm	130°
SS 207-012	TT 207-012	LM 207-012	12mm	130°
SS 207-013	TT 207-013	LM 207-013	13mm	130°
SS 207-014	TT 207-014	LM 207-014	14mm	130°
SS 207-109	TT 207-109	LM 207-109	9mm	135°
SS 207-110	TT 207-110	LM 207-110	10mm	135°
SS 207-111	TT 207-111	LM 207-111	11mm	135°
SS 207-112	TT 207-112	LM 207-112	12mm	135°
SS 207-113	TT 207-113	LM 207-113	13mm	135°
SS 207-114	TT 207-114	LM 207-114	14mm	135°



Trochanteric Femoral Nail (T.F.N), (Shot) 18cm

Screw Places : 8.0mm/6.4mm/4.9mm

Code No. S.S. 316L	Code No. Titanium	Code No. S.S. 316LVM	Dia.	Angled
SS 223-009	TT 223-009	LM 223-009	9mm	130°
SS 223-010	TT 223-010	LM 223-010	10mm	130°
SS 223-011	TT 223-011	LM 223-011	11mm	130°
SS 223-012	TT 223-012	LM 223-012	12mm	130°
SS 223-013	TT 223-013	LM 223-013	13mm	130°
SS 223-014	TT 223-014	LM 223-014	14mm	130°
SS 223-109	TT 223-109	LM 223-109	9mm	135°
SS 223-110	TT 223-110	LM 223-110	10mm	135°
SS 223-111	TT 223-111	LM 223-111	11mm	135°
SS 223-112	TT 223-112	LM 223-112	12mm	135°
SS 223-113	TT 223-113	LM 223-113	13mm	135°
SS 223-114	TT 223-114	LM 223-114	14mm	135°



4.9mm Inter-Locking Screw

Code No. S.S. 316L	Code No. Titanium	Code No. S.S. 316LVM	Length
SS 214-020	TT 214-020	LM 214-020	20mm
SS 214-022	TT 214-022	LM 214-022	22mm
SS 214-024	TT 214-024	LM 214-024	24mm
SS 214-026	TT 214-026	LM 214-026	26mm
SS 214-028	TT 214-028	LM 214-028	28mm
SS 214-030	TT 214-030	LM 214-030	30mm
SS 214-032	TT 214-032	LM 214-032	32mm
SS 214-034	TT 214-034	LM 214-034	34mm
SS 214-036	TT 214-036	LM 214-036	36mm
SS 214-038	TT 214-038	LM 214-038	38mm
SS 214-040	TT 214-040	LM 214-040	40mm
SS 214-042	TT 214-042	LM 214-042	42mm
SS 214-044	TT 214-044	LM 214-044	44mm
SS 214-046	TT 214-046	LM 214-046	46mm
SS 214-048	TT 214-048	LM 214-048	48mm
SS 214-050	TT 214-050	LM 214-050	50mm
SS 214-052	TT 214-052	LM 214-052	52mm
SS 214-054	TT 214-054	LM 214-054	54mm
SS 214-056	TT 214-056	LM 214-056	56mm
SS 214-058	TT 214-058	LM 214-058	58mm
SS 214-060	TT 214-060	LM 214-060	60mm
SS 214-062	TT 214-062	LM 214-062	62mm
SS 214-064	TT 214-064	LM 214-064	64mm
SS 214-066	TT 214-066	LM 214-066	66mm
SS 214-068	TT 214-068	LM 214-068	68mm
SS 214-070	TT 214-070	LM 214-070	70mm
SS 214-075	TT 214-075	LM 214-075	75mm
SS 214-080	TT 214-080	LM 214-080	80mm

Mfg. : Orthopedic Implants & Instruments

Bone Nail

An ISO 13485
Certified Company



6.4mm Proximal Femoral Screw (P.F.N)

Code No. S.S. 316L	Code No. Titanium	Code No. S.S. 316LVM	Length
SS 215-060	TT 215-060	LM 215-060	60mm
SS 215-065	TT 215-065	LM 215-065	65mm
SS 215-070	TT 215-070	LM 215-070	70mm
SS 215-075	TT 215-075	LM 215-075	75mm
SS 215-080	TT 215-080	LM 215-080	80mm
SS 215-085	TT 215-085	LM 215-085	85mm
SS 215-090	TT 215-090	LM 215-090	90mm
SS 215-095	TT 215-095	LM 215-095	95mm
SS 215-100	TT 215-100	LM 215-100	100mm
SS 215-105	TT 215-105	LM 215-105	105mm
SS 215-110	TT 215-110	LM 215-110	110mm
SS 215-115	TT 215-115	LM 215-115	115mm
SS 215-120	TT 215-120	LM 215-120	120mm



8.0mm Proximal Femoral Screw (P.F.N)



Code No. S.S. 316L	Code No. Titanium	Code No. S.S. 316LVM	Length
SS 216-060	TT 216-060	LM 216-060	60mm
SS 216-065	TT 216-065	LM 216-065	65mm
SS 216-070	TT 216-070	LM 216-070	70mm
SS 216-075	TT 216-075	LM 216-075	75mm
SS 216-080	TT 216-080	LM 216-080	80mm
SS 216-085	TT 216-085	LM 216-085	85mm
SS 216-090	TT 216-090	LM 216-090	90mm
SS 216-095	TT 216-095	LM 216-095	95mm
SS 216-100	TT 216-100	LM 216-100	100mm
SS 216-105	TT 216-105	LM 216-105	105mm
SS 216-110	TT 216-110	LM 216-110	110mm
SS 216-115	TT 216-115	LM 216-115	115mm
SS 216-120	TT 216-120	LM 216-120	120mm



Kirschner Wire

Note : Define Code for S.S. 316L/SS 226, Titanium/TT 226, S.S. 316LVM/LM 226

Code No. S.S. 316L	Code No. S.S. 316L	Code No. S.S. 316L	Code No. S.S. 316L	Code No. S.S. 316L	Code No. S.S. 316L	Code No. S.S. 316L	Length
Dia. (1.0mm)	Dia. (1.2mm)	Dia. (1.5mm)	Dia. (1.8mm)	Dia. (2.0mm)	Dia. (2.5mm)	Dia. (3.0mm)	
SS 226-110	SS 226-112	SS 226-115	SS 226-118	SS 226-120	SS 226-125	SS 226-130	150mm
SS 226-210	SS 226-212	SS 226-215	SS 226-218	SS 226-220	SS 226-225	SS 226-230	225mm
SS 226-310	SS 226-312	SS 226-315	SS 226-318	SS 226-320	SS 226-325	SS 226-330	300mm



Kirschner Wire Threaded

Note : Define Code for S.S. 316L/SS 227, Titanium/TT 227, S.S. 316LVM/LM 227

Code No. S.S. 316L	Code No. S.S. 316L	Code No. S.S. 316L	Code No. S.S. 316L	Code No. S.S. 316L	Code No. S.S. 316L	Code No. S.S. 316L	Length
Dia. (1.0mm)	Dia. (1.2mm)	Dia. (1.5mm)	Dia. (1.8mm)	Dia. (2.0mm)	Dia. (2.5mm)	Dia. (3.0mm)	
SS 227-110	SS 227-110	SS 227-115	SS 227-118	SS 227-120	SS 227-125	SS 227-130	150mm
SS 227-210	SS 227-210	SS 227-215	SS 227-218	SS 227-120	SS 227-225	SS 227-230	225mm
SS 227-310	SS 227-310	SS 227-315	SS 227-318	SS 227-120	SS 227-325	SS 227-330	300mm



Steinmann Pin

Note : Define Code for S.S. 316L/SS 228, S.S. 316LVM/LM 228

Code No. S.S. 316L	Code No. S.S. 316L	Code No. S.S. 316L	Code No. S.S. 316L	Code No. S.S. 316L	Length
Dia. (3.0mm)	Dia. (3.5mm)	Dia. (4.0mm)	Dia. (4.5mm)	Dia. (5.0mm)	
SS 228-005	SS 228-105	SS 228-205	SS 228-305	SS 228-405	125mm
SS 228-006	SS 228-106	SS 228-206	SS 228-306	SS 228-406	150mm
SS 228-007	SS 228-107	SS 228-207	SS 228-307	SS 228-407	170mm
SS 228-008	SS 228-108	SS 228-208	SS 228-308	SS 228-408	200mm
SS 228-009	SS 228-109	SS 228-209	SS 228-309	SS 228-409	225mm
SS 228-010	SS 228-110	SS 228-210	SS 228-310	SS 228-410	250mm
SS 228-011	SS 228-111	SS 228-211	SS 228-311	SS 228-411	275mm
SS 228-012	SS 228-112	SS 228-212	SS 228-312	SS 228-412	300mm

Mfg. : Orthopedic Implants & Instruments

Wires & Pin

An ISO 13485
Certified Company



HEADLESS CANNULATED
FULL THREAD SCREW
Ø 3,0 MM Ti



Code	Size
TT3008	8 mm
TT3010	10 mm
TT3012	12 mm
TT3014	14 mm
TT3016	16 mm
TT3018	18 mm
TT3020	20 mm
TT3022	22 mm
TT3024	24 mm
TT3026	26 mm
TT3028	28 mm
TT3030	30 mm

poz 2.7-15

HEADLESS CANNULATED
FULL THREAD SCREW
Ø 3,5 MM Ti



Code	Size
TT3512	12 mm
TT3514	14 mm
TT3516	16 mm
TT3518	18 mm
TT3520	20 mm
TT3522	22 mm
TT3524	24 mm
TT3526	26 mm
TT3528	28 mm
TT3530	30 mm
TT3532	32 mm
TT3534	34 mm
TT3536	36 mm
TT3538	38 mm
TT3540	40 mm
TT3542	42 mm
TT3544	44 mm
TT3546	46 mm
TT3548	48 mm
TT3550	50 mm

poz 2.16-24

HEADLESS CANNULATED
FULL THREAD SCREW
Ø 4,0 MM Ti



Code	Size
TT4020	20 mm
TT4022	22 mm
TT4024	24 mm
TT4026	26 mm
TT4028	28 mm
TT4030	30 mm
TT4032	32 mm
TT4034	34 mm
TT4036	36 mm
TT4038	38 mm
TT4040	40 mm
TT4045	45 mm
TT4050	50 mm
TT4055	55 mm
TT4060	60 mm
TT4065	65 mm
TT4070	70 mm

poz 2.25-35

HEADLESS CANNULATED
FULL THREAD SCREW
Ø 5,0 MM Ti



Code	Size
TT5020	20 mm
TT5025	25 mm
TT5030	30 mm
TT5035	35 mm
TT5040	40 mm
TT5045	45 mm
TT5050	50 mm
TT5055	55 mm
TT5060	60 mm
TT5065	65 mm
TT5070	70 mm
TT5075	75 mm
TT5080	80 mm
TT5085	85 mm
TT5090	90 mm
TT5095	95 mm
TT5100	100 mm

poz 2.64- 2.69

Philos Locking Plate Short

(Stainless Steel & Titanium)

Code No. SS	Code No. TT	Holes	
SS 330-103	TT 330-103	3	Short
SS 330-105	TT 330-105	5	Short

Screw Places :

3.5 mm Locking Screw
3.5 mm Cancellous Locking Screw
3.5 mm Cortical Screw



poz 2.40

Philos Locking Plate Long

(Stainless Steel & Titanium)

Code No. SS	Code No. TT	Holes
SS 330-203	TT 330-203	3
SS 330-204	TT 330-204	4
SS 330-205	TT 330-205	5
SS 330-206	TT 330-206	6
SS 330-207	TT 330-207	7
SS 330-208	TT 330-208	8
SS 330-209	TT 330-209	9
SS 330-210	TT 330-210	10
SS 330-211	TT 330-211	11
SS 330-212	TT 330-212	12
SS 330-213	TT 330-213	13

Screw Places :

3.5 mm Locking Screw
3.5 mm Cancellous Locking Screw
3.5 mm Cortical Screw

Superior Anterior Clavicle Locking Plate

(Stainless Steel & Titanium)

Code No. SS	Code No. TT	Holes	
SS 342-006	TT 342-006	6	Right
SS 342-007	TT 342-007	7	Right
SS 342-008	TT 342-008	8	Right

Code No. SS	Code No. TT	Holes	
SS 342-106	TT 342-106	6	Left
SS 342-107	TT 342-107	7	Left
SS 342-108	TT 342-108	8	Left

Screw Places :

- 3.5 mm Locking Screw
- 3.5 mm Cancellous Locking Screw
- 3.5 mm Cortical Screw

poz 2.38





SAMAY
Surgical

www.samaysurgical.com

Locking Plates

Superior Anterior Clavicle Locking Plate With Lateral extension

(Stainless Steel & Titanium)

Code No. SS	Code No. TT	Holes	
SS 343-004	TT 343-004	4	Right
SS 343-005	TT 343-005	5	Right
SS 343-006	TT 343-006	6	Right
SS 343-007	TT 343-007	7	Right
SS 343-008	TT 343-008	8	Right

Code No. SS	Code No. TT	Holes	
SS 343-104	TT 343-104	4	Left
SS 343-105	TT 343-105	5	Left
SS 343-106	TT 343-106	6	Left
SS 343-107	TT 343-107	7	Left
SS 343-108	TT 343-108	8	Left

Screw Places :

- 3.5 mm Locking Screw
- 3.5 mm Cancellous Locking Screw
- 3.5 mm Cortical Screw
- 2.7 mm Locking Screw

poz 2.39



Distal Humeral Locking Plate Dorsolateral - without Lateral Support

(Stainless Steel & Titanium)

Code No. SS	Code No. TT	Holes	
SS 344-003	TT 344-003	3	Right
SS 344-004	TT 344-004	4	Right
SS 344-005	TT 344-005	5	Right
SS 344-006	TT 344-006	6	Right
SS 344-007	TT 344-007	7	Right
SS 344-008	TT 344-008	8	Right
SS 344-009	TT 344-009	9	Right
SS 344-010	TT 344-010	10	Right
SS 344-011	TT 344-011	11	Right
SS 344-012	TT 344-012	12	Right
SS 344-013	TT 344-013	13	Right
SS 344-014	TT 344-014	14	Right

Code No. SS	Code No. TT	Holes	
SS 344-103	TT 344-103	3	Left
SS 344-104	TT 344-104	4	Left
SS 344-105	TT 344-105	5	Left
SS 344-106	TT 344-106	6	Left
SS 344-107	TT 344-107	7	Left
SS 344-108	TT 344-108	8	Left
SS 344-109	TT 344-109	9	Left
SS 344-110	TT 344-110	10	Left
SS 344-111	TT 344-111	11	Left
SS 344-112	TT 344-112	12	Left
SS 344-113	TT 344-113	13	Left
SS 344-114	TT 344-114	14	Left

Screw Places :

- 3.5 mm Locking Screw
- 3.5 mm Cancellous Locking Screw
- 3.5 mm Cortical Screw
- 2.7 mm Locking Screw



Distal Medial Humeral Locking Plate

(Stainless Steel & Titanium)

Code No. SS	Code No. TT	Holes	
SS 346-003	TT 346-003	3	Right
SS 346-004	TT 346-004	4	Right
SS 346-005	TT 346-005	5	Right
SS 346-006	TT 346-006	6	Right
SS 346-007	TT 346-007	7	Right
SS 346-008	TT 346-008	8	Right
SS 346-009	TT 346-009	9	Right
SS 346-010	TT 346-010	10	Right
SS 346-011	TT 346-011	11	Right
SS 346-012	TT 346-012	12	Right
SS 346-013	TT 346-013	13	Right
SS 346-014	TT 346-014	14	Right









Code No. SS	Code No. TT	Holes	
SS 346-103	TT 346-103	3	Left
SS 346-104	TT 346-104	4	Left
SS 346-105	TT 346-105	5	Left
SS 346-106	TT 346-106	6	Left
SS 346-107	TT 346-107	7	Left
SS 346-108	TT 346-108	8	Left
SS 346-109	TT 346-109	9	Left
SS 346-110	TT 346-110	10	Left
SS 346-111	TT 346-111	11	Left
SS 346-112	TT 346-112	12	Left
SS 346-113	TT 346-113	13	Left
SS 346-114	TT 345-114	14	Left







Screw Places :







- 3.5 mm Locking Screw
- 3.5 mm Cancellous Locking Screw
- 3.5 mm Cortical Screw
- 2.7 mm Locking Screw



poz 2.41



Category	Sr No.	Generic Name	Product Code S.S. 316L	Product Code Titanium	Size	Width	Thickness	Diameter	Intended Use	MATERIAL TO BE USED
poz 2.44	97	2.4MM Buttress Plate Lcp Right Angled Shaft (Head 5 Hole) 	SS 365-103	TT 365-103	3 Hole	10.mm	2.0mm		For pelvic, clavicle and calcaneus fractures.	SS316L / TITANIUM GR. 5
										SS316L / TITANIUM GR. 5
										SS316L / TITANIUM GR. 5
										SS316L / TITANIUM GR. 5
										SS316L / TITANIUM GR. 5
										SS316L / TITANIUM GR. 5
										SS316L / TITANIUM GR. 5
										SS316L / TITANIUM GR. 5
										SS316L / TITANIUM GR. 5
										SS316L / TITANIUM GR. 5
	98	2.4 mm Distal Radius Plate Extra Articular LCP Left 	SS 367-003	TT 367-003	3 Hole	10.mm	2.0mm	For fixation of complex intra and extra-articular fractures and osteotomies of the distal radius and other small bones	SS316L / TITANIUM GR. 5	
			SS 367-005	TT 367-005	5 Hole	10.mm	2.0mm		SS316L / TITANIUM GR. 5	
									SS316L / TITANIUM GR. 5	
									SS316L / TITANIUM GR. 5	
									SS316L / TITANIUM GR. 5	
									SS316L / TITANIUM GR. 5	
									SS316L / TITANIUM GR. 5	
									SS316L / TITANIUM GR. 5	
									SS316L / TITANIUM GR. 5	
									SS316L / TITANIUM GR. 5	
	99	2.4 mm Distal Radius Plate Extra Articular LCP Right 	SS 367-103	TT 367-103	3 Hole	10.mm	2.0mm	For fixation of complex intra and extra-articular fractures and osteotomies of the distal radius and other small bones	SS316L / TITANIUM GR. 5	
			SS 367-105	TT 367-105	5 Hole	10.mm	2.0mm		SS316L / TITANIUM GR. 5	
									SS316L / TITANIUM GR. 5	
									SS316L / TITANIUM GR. 5	
									SS316L / TITANIUM GR. 5	
									SS316L / TITANIUM GR. 5	
									SS316L / TITANIUM GR. 5	
									SS316L / TITANIUM GR. 5	
									SS316L / TITANIUM GR. 5	
									SS316L / TITANIUM GR. 5	
	100	2.4 mm Distal Radius Plate Extra Long LCP 	SS 368-008	TT 368-008	8 Hole	10.mm	2.0mm	The LCP Two-Column Distal Radius Plates are intended for fixation of complex intra and extra-articular fractures and osteotomies of the distal radius and other small bones in adults, skeletally mature adolescents, and the following adolescent distal radius fractures: intra-articular fractures exiting the epiphysis intra-articular fractures exiting the metaphysis physeal crush injuries any injuries which cause growth arrest to the distal radius	SS316L / TITANIUM GR. 5	
			SS 368-010	TT 368-010	10 Hole	10.mm	2.0mm		SS316L / TITANIUM GR. 5	
			SS 368-012	TT 368-012	12 Hole	10.mm	2.0mm		SS316L / TITANIUM GR. 5	
									SS316L / TITANIUM GR. 5	
									SS316L / TITANIUM GR. 5	
									SS316L / TITANIUM GR. 5	
									SS316L / TITANIUM GR. 5	
									SS316L / TITANIUM GR. 5	
									SS316L / TITANIUM GR. 5	
									SS316L / TITANIUM GR. 5	
	101	Two-Column Distal Radius LCP Plate – Left 	SS 366-002	TT 366-002	2 Hole	14.0mm	2.5mm	Indicated for – Extra-articular fractures of the distal humerus – Malunions of the distal humerus – Non-unions of the distal humerus	SS316L / TITANIUM GR. 5	
			SS 366-003	TT 366-003	3 Hole	14.0mm	2.5mm		SS316L / TITANIUM GR. 5	
									SS316L / TITANIUM GR. 5	
									SS316L / TITANIUM GR. 5	
									SS316L / TITANIUM GR. 5	
									SS316L / TITANIUM GR. 5	
									SS316L / TITANIUM GR. 5	
									SS316L / TITANIUM GR. 5	
									SS316L / TITANIUM GR. 5	
									SS316L / TITANIUM GR. 5	
	102	Two-Column Distal Radius LCP Plate – Right 	SS 366-102	TT 366-102	2 Hole	14.0mm	2.5mm	Indicated for – Extra-articular fractures of the distal humerus – Malunions of the distal humerus – Non-unions of the distal humerus	SS316L / TITANIUM GR. 5	
			SS 366-103	TT 366-103	3 Hole	14.0mm	2.5mm		SS316L / TITANIUM GR. 5	
			SS 366-104	TT 366-104	4 Hole	14.0mm	2.5mm		SS316L / TITANIUM GR. 5	
									SS316L / TITANIUM GR. 5	
									SS316L / TITANIUM GR. 5	
									SS316L / TITANIUM GR. 5	
									SS316L / TITANIUM GR. 5	
									SS316L / TITANIUM GR. 5	
									SS316L / TITANIUM GR. 5	
									SS316L / TITANIUM GR. 5	
	103	Extra Articular Distal Humerus LCP Plate Right 	SS 359-004	TT 359-004	4 Hole	13.0mm	4.0mm	Indicated for – Extra-articular fractures of the distal humerus – Malunions of the distal humerus – Non-unions of the distal humerus	SS316L / TITANIUM GR. 5	
			SS 359-005	TT 359-005	5 Hole	13.0mm	4.0mm		SS316L / TITANIUM GR. 5	
			SS 359-006	TT 359-006	6 Hole	13.0mm	4.0mm		SS316L / TITANIUM GR. 5	
			SS 359-007	TT 359-007	7 Hole	13.0mm	4.0mm		SS316L / TITANIUM GR. 5	
			SS 359-008	TT 359-008	8 Hole	13.0mm	4.0mm		SS316L / TITANIUM GR. 5	
			SS 359-009	TT 359-009	9 Hole	13.0mm	4.0mm		SS316L / TITANIUM GR. 5	
			SS 359-010	TT 359-010	10 Hole	13.0mm	4.0mm		SS316L / TITANIUM GR. 5	
			SS 359-011	TT 359-011	11 Hole	13.0mm	4.0mm		SS316L / TITANIUM GR. 5	
			SS 359-012	TT 359-012	12 Hole	13.0mm	4.0mm		SS316L / TITANIUM GR. 5	
			SS 359-013	TT 359-013	13 Hole	13.0mm	4.0mm		SS316L / TITANIUM GR. 5	
			SS 359-014	TT 359-014	13 Hole	13.0mm	4.0mm	SS316L / TITANIUM GR. 5		
	104	Extra Articular Distal Humerus LCP Plate Left 	SS 359-104	TT 359-104	4 Hole	13.0mm	4.0mm	Indicated for – Extra-articular fractures of the distal humerus – Malunions of the distal humerus – Non-unions of the distal humerus	SS316L / TITANIUM GR. 5	
			SS 359-105	TT 359-105	5 Hole	13.0mm	4.0mm		SS316L / TITANIUM GR. 5	
			SS 359-106	TT 359-106	6 Hole	13.0mm	4.0mm		SS316L / TITANIUM GR. 5	
			SS 359-107	TT 359-107	7 Hole	13.0mm	4.0mm		SS316L / TITANIUM GR. 5	
			SS 359-108	TT 359-108	8 Hole	13.0mm	4.0mm		SS316L / TITANIUM GR. 5	
			SS 359-109	TT 359-109	9 Hole	13.0mm	4.0mm		SS316L / TITANIUM GR. 5	
			SS 359-110	TT 359-110	10 Hole	13.0mm	4.0mm		SS316L / TITANIUM GR. 5	
			SS 359-111	TT 359-111	11 Hole	13.0mm	4.0mm		SS316L / TITANIUM GR. 5	
			SS 359-112	TT 359-112	12 Hole	13.0mm	4.0mm		SS316L / TITANIUM GR. 5	
			SS 359-113	TT 359-113	13 Hole	13.0mm	4.0mm		SS316L / TITANIUM GR. 5	
			SS 359-114	TT 359-114	14 Hole	13.0mm	4.0mm	SS316L / TITANIUM GR. 5		
	105	Posterior Medial Proximal Tibia LCP Plate 	SS 377-002	TT 377-002	2 Hole	15.0mm	3.5mm	The LCP Posterior Medial Proximal Tibial Plate is indicated for internal fixation of posteromedial proximal tibia fractures including buttressing of fractures of the proximal, distal and metaphyseal areas of the tibia.	SS316L / TITANIUM GR. 5	
			SS 377-003	TT 377-003	3 Hole	15.0mm	3.5mm		SS316L / TITANIUM GR. 5	
			SS 377-004	TT 377-004	4 Hole	15.0mm	3.5mm		SS316L / TITANIUM GR. 5	
			SS 377-005	TT 377-005	5 Hole	15.0mm	3.5mm		SS316L / TITANIUM GR. 5	
			SS 377-006	TT 377-006	6 Hole	15.0mm	3.5mm		SS316L / TITANIUM GR. 5	
			SS 377-007	TT 377-007	7 Hole	15.0mm	3.5mm		SS316L / TITANIUM GR. 5	
			SS 377-008	TT 377-008	8 Hole	15.0mm	3.5mm		SS316L / TITANIUM GR. 5	
			SS 377-009	TT 377-009	9 Hole	15.0mm	3.5mm		SS316L / TITANIUM GR. 5	
			SS 377-010	TT 377-010	10 Hole	15.0mm	3.5mm		SS316L / TITANIUM GR. 5	
									SS316L / TITANIUM GR. 5	

Category	Sr No.	Generic Name	Product Code S.S. 316L	Product Code Titanium	Size	Width	Thickness	Diameter	Intended Use	MATERIAL TO BE USED
44	Proximal Tibia LCP Plate 3.5mm Left		SS 334-012	TT 334-012	12 Hole	12.0mm	4.0mm		Proximal Tibia LCP Plate is intended for treatment of osteopenic bone, tibial osteotomies, nonunions, malunions and fractures of the proximal tibia including:	SS316L / TITANIUM GR. 5
			SS 334-013	TT 334-013	13 Hole	12.0mm	4.0mm			SS316L / TITANIUM GR. 5
			SS 334-014	TT 334-014	14 Hole	12.0mm	4.0mm			SS316L / TITANIUM GR. 5
			SS 334-015	TT 334-015	15 Hole	12.0mm	4.0mm			SS316L / TITANIUM GR. 5
			SS 334-016	TT 334-016	16 Hole	12.0mm	4.0mm			SS316L / TITANIUM GR. 5
			SS 334-104	TT 334-104	4 Hole	12.0mm	4.0mm			SS316L / TITANIUM GR. 5
			SS 334-105	TT 334-105	5 Hole	12.0mm	4.0mm			SS316L / TITANIUM GR. 5
			SS 334-106	TT 334-106	6 Hole	12.0mm	4.0mm			SS316L / TITANIUM GR. 5
			SS 334-107	TT 334-107	7 Hole	12.0mm	4.0mm			SS316L / TITANIUM GR. 5
			SS 334-108	TT 334-108	8 Hole	12.0mm	4.0mm			SS316L / TITANIUM GR. 5
			SS 334-109	TT 334-109	9 Hole	12.0mm	4.0mm			SS316L / TITANIUM GR. 5
			SS 334-110	TT 334-110	10 Hole	12.0mm	4.0mm			SS316L / TITANIUM GR. 5
			SS 334-111	TT 334-111	11 Hole	12.0mm	4.0mm			SS316L / TITANIUM GR. 5
			SS 334-112	TT 334-112	12 Hole	12.0mm	4.0mm			SS316L / TITANIUM GR. 5
			SS 334-113	TT 334-113	13 Hole	12.0mm	4.0mm			SS316L / TITANIUM GR. 5
			SS 334-114	TT 334-114	14 Hole	12.0mm	4.0mm			SS316L / TITANIUM GR. 5
			SS 334-115	TT 334-115	15 Hole	12.0mm	4.0mm			SS316L / TITANIUM GR. 5
SS 334-116	TT 334-116	16 Hole	12.0mm	4.0mm		SS316L / TITANIUM GR. 5				
45	Proximal Tibia LCP Plate 5.0mm Right		SS 335-004	TT 335-004	4 Hole	12.0mm	4.0mm		Simple comminuted fractures Lateral wedge fractures Depression medial wedge fractures Bicondylar combination of lateral wedge and depression fractures Periprosthetic fractures Proximal fractures with associated shaft fractures	SS316L / TITANIUM GR. 5
			SS 335-005	TT 335-005	5 Hole	12.0mm	4.0mm			SS316L / TITANIUM GR. 5
			SS 335-006	TT 335-006	6 Hole	12.0mm	4.0mm			SS316L / TITANIUM GR. 5
			SS 335-007	TT 335-007	7 Hole	12.0mm	4.0mm			SS316L / TITANIUM GR. 5
			SS 335-008	TT 335-008	8 Hole	12.0mm	4.0mm			SS316L / TITANIUM GR. 5
			SS 335-009	TT 335-009	9 Hole	12.0mm	4.0mm			SS316L / TITANIUM GR. 5
			SS 335-010	TT 335-010	10 Hole	12.0mm	4.0mm			SS316L / TITANIUM GR. 5
			SS 335-011	TT 335-011	11 Hole	12.0mm	4.0mm			SS316L / TITANIUM GR. 5
			SS 335-012	TT 335-012	12 Hole	12.0mm	4.0mm			SS316L / TITANIUM GR. 5
			SS 335-013	TT 335-013	13 Hole	12.0mm	4.0mm			SS316L / TITANIUM GR. 5
			SS 335-014	TT 335-014	14 Hole	12.0mm	4.0mm			SS316L / TITANIUM GR. 5
			SS 335-104	TT 335-104	4 Hole	12.0mm	4.0mm			SS316L / TITANIUM GR. 5
			SS 335-105	TT 335-105	5 Hole	12.0mm	4.0mm			SS316L / TITANIUM GR. 5
			SS 335-106	TT 335-106	6 Hole	12.0mm	4.0mm			SS316L / TITANIUM GR. 5
46	Proximal Tibia LCP Plate 5.0mm Left		SS 335-107	TT 335-107	7 Hole	12.0mm	4.0mm		The LCP Medial Proximal Tibial Plates are intended to buttress metaphyseal fractures of the medial tibial plateau, split-type fractures of the medial tibial plateau, medial split fractures with associated depressions and split or depression fractures of the medial tibial plateau. The plates may	SS316L / TITANIUM GR. 5
			SS 335-108	TT 335-108	8 Hole	12.0mm	4.0mm			SS316L / TITANIUM GR. 5
			SS 335-109	TT 335-109	9 Hole	12.0mm	4.0mm			SS316L / TITANIUM GR. 5
			SS 335-110	TT 335-110	10 Hole	12.0mm	4.0mm			SS316L / TITANIUM GR. 5
			SS 335-111	TT 335-111	11 Hole	12.0mm	4.0mm			SS316L / TITANIUM GR. 5
			SS 335-112	TT 335-112	12 Hole	12.0mm	4.0mm			SS316L / TITANIUM GR. 5
			SS 335-113	TT 335-113	13 Hole	12.0mm	4.0mm			SS316L / TITANIUM GR. 5
			SS 335-114	TT 335-114	14 Hole	12.0mm	4.0mm			SS316L / TITANIUM GR. 5
			SS 336-004	TT 336-004	4 Hole	12.0mm	4.0mm			SS316L / TITANIUM GR. 5
			SS 336-005	TT 336-005	5 Hole	12.0mm	4.0mm			SS316L / TITANIUM GR. 5
			SS 336-006	TT 336-006	6 Hole	12.0mm	4.0mm			SS316L / TITANIUM GR. 5
			SS 336-007	TT 336-007	7 Hole	12.0mm	4.0mm			SS316L / TITANIUM GR. 5
			SS 336-008	TT 336-008	8 Hole	12.0mm	4.0mm			SS316L / TITANIUM GR. 5
			SS 336-009	TT 336-009	9 Hole	12.0mm	4.0mm			SS316L / TITANIUM GR. 5
SS 336-010	TT 336-010	10 Hole	12.0mm	4.0mm		SS316L / TITANIUM GR. 5				
47	Proximal Medial Tibia LCP Plate 3.5mm Right		SS 336-011	TT 336-011	11 Hole	12.0mm	4.0mm		The LCP Medial Proximal Tibial Plates are intended to buttress metaphyseal fractures of the medial tibial plateau, split-type fractures of the medial tibial plateau, medial split fractures with associated depressions and split or depression fractures of the medial tibial plateau. The plates may	SS316L / TITANIUM GR. 5
			SS 336-012	TT 336-012	12 Hole	12.0mm	4.0mm			SS316L / TITANIUM GR. 5
			SS 336-013	TT 336-013	13 Hole	12.0mm	4.0mm			SS316L / TITANIUM GR. 5
			SS 336-014	TT 336-014	14 Hole	12.0mm	4.0mm			SS316L / TITANIUM GR. 5
			SS 336-015	TT 336-015	15 Hole	12.0mm	4.0mm			SS316L / TITANIUM GR. 5
			SS 336-016	TT 336-016	16 Hole	12.0mm	4.0mm			SS316L / TITANIUM GR. 5
			SS 336-017	TT 336-017	17 Hole	12.0mm	4.0mm			SS316L / TITANIUM GR. 5
			SS 336-018	TT 336-018	18 Hole	12.0mm	4.0mm			SS316L / TITANIUM GR. 5
			SS 336-019	TT 336-019	19 Hole	12.0mm	4.0mm			SS316L / TITANIUM GR. 5
			SS 336-020	TT 336-020	20 Hole	12.0mm	4.0mm			SS316L / TITANIUM GR. 5
			SS 336-104	TT 336-104	4 Hole	12.0mm	4.0mm			SS316L / TITANIUM GR. 5
			SS 336-105	TT 336-105	5 Hole	12.0mm	4.0mm			SS316L / TITANIUM GR. 5
			SS 336-106	TT 336-106	6 Hole	12.0mm	4.0mm			SS316L / TITANIUM GR. 5
			SS 336-107	TT 336-107	7 Hole	12.0mm	4.0mm			SS316L / TITANIUM GR. 5
			SS 336-108	TT 336-108	8 Hole	12.0mm	4.0mm			SS316L / TITANIUM GR. 5
			SS 336-109	TT 336-109	9 Hole	12.0mm	4.0mm			SS316L / TITANIUM GR. 5
			SS 336-110	TT 336-110	10 Hole	12.0mm	4.0mm			SS316L / TITANIUM GR. 5
48	Proximal Medial Tibia LCP Plate 3.5mm Left		SS 336-111	TT 336-111	11 Hole	12.0mm	4.0mm		The LCP Medial Proximal Tibial Plates are intended to buttress metaphyseal fractures of the medial tibial plateau, split-type fractures of the medial tibial plateau, medial split fractures with associated depressions and split or depression fractures of the medial tibial plateau. The plates may	SS316L / TITANIUM GR. 5
			SS 336-112	TT 336-112	12 Hole	12.0mm	4.0mm			SS316L / TITANIUM GR. 5
			SS 336-113	TT 336-113	13 Hole	12.0mm	4.0mm			SS316L / TITANIUM GR. 5
			SS 336-114	TT 336-114	14 Hole	12.0mm	4.0mm			SS316L / TITANIUM GR. 5
			SS 336-115	TT 336-115	15 Hole	12.0mm	4.0mm			SS316L / TITANIUM GR. 5
			SS 336-116	TT 336-116	16 Hole	12.0mm	4.0mm			SS316L / TITANIUM GR. 5
49	Proximal Medial Tibia LCP Plate 5.0mm Right		SS 336-117	TT 336-117	17 Hole	12.0mm	4.0mm		The LCP Medial Proximal Tibial Plates are intended to buttress metaphyseal fractures of the medial tibial plateau, split-type fractures of the medial tibial plateau, medial split fractures with associated depressions and split or depression fractures of the medial tibial plateau. The plates may	SS316L / TITANIUM GR. 5
			SS 336-118	TT 336-118	18 Hole	12.0mm	4.0mm			SS316L / TITANIUM GR. 5
			SS 336-119	TT 336-119	19 Hole	12.0mm	4.0mm			SS316L / TITANIUM GR. 5
			SS 336-120	TT 336-120	20 Hole	12.0mm	4.0mm			SS316L / TITANIUM GR. 5
49	Proximal Medial Tibia LCP Plate 5.0mm Right		SS 337-004	TT 337-004	4 Hole	12.0mm	4.0mm		The LCP Medial Proximal Tibial Plates are intended to buttress metaphyseal fractures of the medial tibial plateau, split-type fractures of the medial tibial plateau, medial split fractures with associated depressions and split or depression fractures of the medial tibial plateau. The plates may	SS316L / TITANIUM GR. 5
			SS 337-005	TT 337-005	5 Hole	12.0mm	4.0mm			SS316L / TITANIUM GR. 5
			SS 337-006	TT 337-006	6 Hole	12.0mm	4.0mm			SS316L / TITANIUM GR. 5

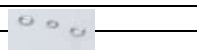
Category	Sr No.	Generic Name	Product Code S.S. 316L	Product Code Titanium	Size	Width	Thickness	Diameter	Intended Use	MATERIAL TO BE USED			
50	 Proximal Medial Tibia LCP Plate 5.0mm Left	SS 337-007	TT 337-007	7 Hole	12.0mm	4.0mm			<p>The LCP Medial Proximal Tibial Plates may also be used for fixation of nonunions and malunions of the medial proximal tibia and tibia shaft, as well as opening and closing wedge tibial osteotomies.</p>	SS316L / TITANIUM GR. 5			
		SS 337-008	TT 337-008	8 Hole	12.0mm	4.0mm				SS316L / TITANIUM GR. 5			
		SS 337-009	TT 337-009	9 Hole	12.0mm	4.0mm				SS316L / TITANIUM GR. 5			
		SS 337-010	TT 337-010	10 Hole	12.0mm	4.0mm				SS316L / TITANIUM GR. 5			
		SS 337-011	TT 337-011	11 Hole	12.0mm	4.0mm				SS316L / TITANIUM GR. 5			
		SS 337-012	TT 337-012	12 Hole	12.0mm	4.0mm				SS316L / TITANIUM GR. 5			
		SS 337-013	TT 337-013	13 Hole	12.0mm	4.0mm				SS316L / TITANIUM GR. 5			
		SS 337-014	TT 337-014	14 Hole	12.0mm	4.0mm				SS316L / TITANIUM GR. 5			
	SS 337-015	TT 337-015	15 Hole	12.0mm	4.0mm			SS316L / TITANIUM GR. 5					
	SS 337-016	TT 337-016	16 Hole	12.0mm	4.0mm			SS316L / TITANIUM GR. 5					
	SS 337-104	TT 337-104	4 Hole	12.0mm	4.0mm			SS316L / TITANIUM GR. 5					
	SS 337-105	TT 337-105	5 Hole	12.0mm	4.0mm			SS316L / TITANIUM GR. 5					
	SS 337-106	TT 337-106	6 Hole	12.0mm	4.0mm			SS316L / TITANIUM GR. 5					
	SS 337-107	TT 337-107	7 Hole	12.0mm	4.0mm			SS316L / TITANIUM GR. 5					
	SS 337-108	TT 337-108	8 Hole	12.0mm	4.0mm			SS316L / TITANIUM GR. 5					
	SS 337-109	TT 337-109	9 Hole	12.0mm	4.0mm			SS316L / TITANIUM GR. 5					
	SS 337-110	TT 337-110	10 Hole	12.0mm	4.0mm			SS316L / TITANIUM GR. 5					
	SS 337-111	TT 337-111	11 Hole	12.0mm	4.0mm			SS316L / TITANIUM GR. 5					
	SS 337-112	TT 337-112	12 Hole	12.0mm	4.0mm			SS316L / TITANIUM GR. 5					
	SS 337-113	TT 337-113	13 Hole	12.0mm	4.0mm			SS316L / TITANIUM GR. 5					
	SS 337-114	TT 337-114	14 Hole	12.0mm	4.0mm			SS316L / TITANIUM GR. 5					
	SS 337-115	TT 337-115	15 Hole	12.0mm	4.0mm			SS316L / TITANIUM GR. 5					
	SS 337-116	TT 337-116	16 Hole	12.0mm	4.0mm			SS316L / TITANIUM GR. 5					
	51	 Metaphyseal LCP Plates 3.5/5.0 mm	SS 338-003	TT 338-003	3 Hole	10.0mm	2.8mm				<p>LCP metaphyseal plates are intended for the fixation of various long bones, excluding the femur. They are also for use in fixation of osteopenic bone and fixation of nonunions or malunions.</p>	SS316L / TITANIUM GR. 5	
			SS 338-004	TT 338-004	4 Hole	10.0mm	2.8mm					SS316L / TITANIUM GR. 5	
			SS 338-005	TT 338-005	5 Hole	10.0mm	2.8mm					SS316L / TITANIUM GR. 5	
			SS 338-006	TT 338-006	6 Hole	10.0mm	2.8mm					SS316L / TITANIUM GR. 5	
			SS 338-007	TT 338-007	7 Hole	10.0mm	2.8mm					SS316L / TITANIUM GR. 5	
SS 338-008			TT 338-008	8 Hole	10.0mm	2.8mm			SS316L / TITANIUM GR. 5				
SS 338-009			TT 338-009	9 Hole	10.0mm	2.8mm			SS316L / TITANIUM GR. 5				
SS 338-010			TT 338-010	10 Hole	10.0mm	2.8mm			SS316L / TITANIUM GR. 5				
SS 338-011			TT 338-011	11 Hole	10.0mm	2.8mm			SS316L / TITANIUM GR. 5				
SS 338-012			TT 338-012	12 Hole	10.0mm	2.8mm			SS316L / TITANIUM GR. 5				
SS 338-013			TT 338-013	13 Hole	10.0mm	2.8mm			SS316L / TITANIUM GR. 5				
SS 338-014			TT 338-014	14 Hole	10.0mm	2.8mm			SS316L / TITANIUM GR. 5				
SS 338-015			TT 338-015	15 Hole	10.0mm	2.8mm			SS316L / TITANIUM GR. 5				
52			 Metaphyseal LCP Plates 3.5/5.0 mm for distal medial tibia Right	SS 339-003	TT 339-003	3 Hole	10.0mm	2.8mm				<p>LCP metaphyseal plates are intended for the fixation of various long bones, excluding the femur. They are also for use in fixation of osteopenic bone and fixation of nonunions or malunions.</p>	SS316L / TITANIUM GR. 5
				SS 339-004	TT 339-004	4 Hole	10.0mm	2.8mm					SS316L / TITANIUM GR. 5
	SS 339-005	TT 339-005		5 Hole	10.0mm	2.8mm			SS316L / TITANIUM GR. 5				
	SS 339-006	TT 339-006		6 Hole	10.0mm	2.8mm			SS316L / TITANIUM GR. 5				
	SS 339-007	TT 339-007		7 Hole	10.0mm	2.8mm			SS316L / TITANIUM GR. 5				
	SS 339-008	TT 339-008		8 Hole	10.0mm	2.8mm			SS316L / TITANIUM GR. 5				
	SS 339-009	TT 339-009		9 Hole	10.0mm	2.8mm			SS316L / TITANIUM GR. 5				
	SS 339-010	TT 339-010		10 Hole	10.0mm	2.8mm			SS316L / TITANIUM GR. 5				
	SS 339-011	TT 339-011		11 Hole	10.0mm	2.8mm			SS316L / TITANIUM GR. 5				
	SS 339-012	TT 339-012		12 Hole	10.0mm	2.8mm			SS316L / TITANIUM GR. 5				
	SS 339-013	TT 339-013		13 Hole	10.0mm	2.8mm			SS316L / TITANIUM GR. 5				
	SS 339-014	TT 339-014		14 Hole	10.0mm	2.8mm			SS316L / TITANIUM GR. 5				
	SS 339-015	TT 339-015		15 Hole	10.0mm	2.8mm			SS316L / TITANIUM GR. 5				
	53	 Metaphyseal LCP Plates 3.5/5.0 mm for distal medial tibia Left		SS 339-103	TT 339-103	3 Hole	10.0mm	2.8mm			<p>LCP metaphyseal plates are intended for the fixation of various long bones, excluding the femur. They are also for use in fixation of osteopenic bone and fixation of nonunions or malunions.</p>		SS316L / TITANIUM GR. 5
				SS 339-104	TT 339-104	4 Hole	10.0mm	2.8mm					SS316L / TITANIUM GR. 5
SS 339-105			TT 339-105	5 Hole	10.0mm	2.8mm			SS316L / TITANIUM GR. 5				
SS 339-106			TT 339-106	6 Hole	10.0mm	2.8mm			SS316L / TITANIUM GR. 5				
SS 339-107			TT 339-107	7 Hole	10.0mm	2.8mm			SS316L / TITANIUM GR. 5				
SS 339-108			TT 339-108	8 Hole	10.0mm	2.8mm			SS316L / TITANIUM GR. 5				
SS 339-109			TT 339-109	9 Hole	10.0mm	2.8mm			SS316L / TITANIUM GR. 5				
SS 339-110			TT 339-110	10 Hole	10.0mm	2.8mm			SS316L / TITANIUM GR. 5				
SS 339-111			TT 339-111	11 Hole	10.0mm	2.8mm			SS316L / TITANIUM GR. 5				
SS 339-112			TT 339-112	12 Hole	10.0mm	2.8mm			SS316L / TITANIUM GR. 5				
SS 339-113			TT 339-113	13 Hole	10.0mm	2.8mm			SS316L / TITANIUM GR. 5				
SS 339-114			TT 339-114	14 Hole	10.0mm	2.8mm			SS316L / TITANIUM GR. 5				
SS 339-115			TT 339-115	15 Hole	10.0mm	2.8mm			SS316L / TITANIUM GR. 5				
54			 Calcaneal LCP plate 3.5 mm Right	SS 340-060	TT 340-060	60 mm	60 mm	2.5		<p>The calcaneal LCP plates address complex fractures of the calcaneus. The calcaneal LCP plate is indicated for fractures and osteotomies of the calcaneus including, but not limited to, extra-articular, intra-articular, joint depression, tongue type, and severely comminuted fractures.</p>		SS316L / TITANIUM GR. 5	
				SS 340-070	TT 340-070	70 mm	70 mm	2.5				SS316L / TITANIUM GR. 5	
									SS316L / TITANIUM GR. 5				
55	 Calcaneal LCP plate 3.5 mm Left	SS 340-160	TT 340-160	60 mm	60 mm	2.5		<p>The calcaneal LCP plates address complex fractures of the calcaneus. The calcaneal LCP plate is indicated for fractures and osteotomies of the calcaneus including, but not limited to, extra-articular, intra-articular, joint depression, tongue type, and severely comminuted fractures.</p>	SS316L / TITANIUM GR. 5				
		SS 340-170	TT 340-170	70 mm	70 mm	2.5			SS316L / TITANIUM GR. 5				
										SS316L / TITANIUM GR. 5			
56	 Calcaneal LCP plate 3.5 mm Right	SS 340-064	TT 340-064	64 mm	64 mm	2.5		<p>The calcaneal LCP plates address complex fractures of the calcaneus. The calcaneal LCP plate is indicated for fractures and osteotomies of the calcaneus including, but not limited to, extra-articular, intra-articular, joint depression, tongue type, and severely comminuted fractures.</p>	SS316L / TITANIUM GR. 5				
		SS 340-069	TT 340-069	69 mm	69 mm	2.5			SS316L / TITANIUM GR. 5				
		SS 340-076	TT 340-076	76 mm	76 mm	2.5			SS316L / TITANIUM GR. 5				
		SS 340-081	TT 340-081	81 mm	81 mm	2.5			SS316L / TITANIUM GR. 5				

Category	Sr No.	Generic Name	Product Code S.S. 316L	Product Code Titanium	Size	Width	Thickne ss	Diameter	Intended Use	MATERIAL TO BE USED		
			SS 123-110	TT 123-110	110 mm			ø 6.5		SS316L / TITANIUM GR. 5		
			SS 123-115	TT 123-115	115 mm			ø 6.5		SS316L / TITANIUM GR. 5		
			SS 123-120	TT 123-120	120 mm			ø 6.5		SS316L / TITANIUM GR. 5		
			1.5 mm Cortex Screw	SS 863-004	TT 863-004	04 mm				ø 1.5	These screws are used in the metaphyseal / epiphyseal regions of small bones. Large Cancellous Screws are used only in the metaphyseal and epiphyseal areas, with fine trabecular bone and relatively thin cortex.	SS316L / TITANIUM GR. 5
				SS 863-005	TT 863-005	5 mm				ø 1.5	SS316L / TITANIUM GR. 5	
				SS 863-006	TT 863-006	6 mm				ø 1.5	SS316L / TITANIUM GR. 5	
				SS 863-007	TT 863-007	7 mm				ø 1.5	SS316L / TITANIUM GR. 5	
				SS 863-008	TT 863-008	8 mm				ø 1.5	SS316L / TITANIUM GR. 5	
				SS 863-009	TT 863-009	9 mm				ø 1.5	SS316L / TITANIUM GR. 5	
				SS 863-010	TT 863-010	10 mm				ø 1.5	SS316L / TITANIUM GR. 5	
	SS 863-011	TT 863-011	11 mm			ø 1.5	SS316L / TITANIUM GR. 5					
	SS 863-012	TT 863-012	12 mm			ø 1.5	SS316L / TITANIUM GR. 5					
	2.0 mm Cortex Screw	SS 864-004	TT 864-004	04 mm			ø 2.0		SS316L / TITANIUM GR. 5			
		SS 864-005	TT 864-005	5 mm			ø 2.0		SS316L / TITANIUM GR. 5			
		SS 864-006	TT 864-006	6 mm			ø 2.0		SS316L / TITANIUM GR. 5			
		SS 864-007	TT 864-007	7 mm			ø 2.0		SS316L / TITANIUM GR. 5			
		SS 864-008	TT 864-008	8 mm			ø 2.0		SS316L / TITANIUM GR. 5			
		SS 864-009	TT 864-009	9 mm			ø 2.0		SS316L / TITANIUM GR. 5			
		SS 864-010	TT 864-010	10 mm			ø 2.0		SS316L / TITANIUM GR. 5			
		SS 864-011	TT 864-011	11 mm			ø 2.0		SS316L / TITANIUM GR. 5			
		SS 864-012	TT 864-012	12 mm			ø 2.0		SS316L / TITANIUM GR. 5			
		SS 864-013	TT 864-013	13 mm			ø 2.0		SS316L / TITANIUM GR. 5			
	SS 864-014	TT 864-014	14 mm			ø 2.0	SS316L / TITANIUM GR. 5					
	2.5 mm Cortex Screw	SS 865-004	TT 865-004	04 mm			ø 2.5		SS316L / TITANIUM GR. 5			
		SS 865-005	TT 865-005	5 mm			ø 2.5		SS316L / TITANIUM GR. 5			
		SS 865-006	TT 865-006	6 mm			ø 2.5		SS316L / TITANIUM GR. 5			
		SS 865-007	TT 865-007	7 mm			ø 2.5		SS316L / TITANIUM GR. 5			
		SS 865-008	TT 865-008	8 mm			ø 2.5		SS316L / TITANIUM GR. 5			
		SS 865-009	TT 865-009	9 mm			ø 2.5		SS316L / TITANIUM GR. 5			
		SS 865-010	TT 865-010	10 mm			ø 2.5		SS316L / TITANIUM GR. 5			
		SS 865-011	TT 865-011	11 mm			ø 2.5		SS316L / TITANIUM GR. 5			
		SS 865-012	TT 865-012	12 mm			ø 2.5		SS316L / TITANIUM GR. 5			
		SS 865-013	TT 865-013	13 mm			ø 2.5		SS316L / TITANIUM GR. 5			
	SS 865-014	TT 865-014	14 mm			ø 2.5	SS316L / TITANIUM GR. 5					
	1.5 mm Cortex Screw Self Tapping	SS 863-004	TT 863-004	04 mm			ø 1.5		SS316L / TITANIUM GR. 5			
		SS 863-005	TT 863-005	5 mm			ø 1.5		SS316L / TITANIUM GR. 5			
		SS 863-006	TT 863-006	6 mm			ø 1.5		SS316L / TITANIUM GR. 5			
		SS 863-007	TT 863-007	7 mm			ø 1.5		SS316L / TITANIUM GR. 5			
		SS 863-008	TT 863-008	8 mm			ø 1.5		SS316L / TITANIUM GR. 5			
		SS 863-009	TT 863-009	9 mm			ø 1.5		SS316L / TITANIUM GR. 5			
		SS 863-010	TT 863-010	10 mm			ø 1.5		SS316L / TITANIUM GR. 5			
		SS 863-011	TT 863-011	11 mm			ø 1.5		SS316L / TITANIUM GR. 5			
		SS 863-012	TT 863-012	12 mm			ø 1.5		SS316L / TITANIUM GR. 5			
		2.0 mm Cortex Screw Self Tapping	SS 864-004	TT 864-004	04 mm				ø 2.0		SS316L / TITANIUM GR. 5	
	SS 864-005		TT 864-005	5 mm			ø 2.0	SS316L / TITANIUM GR. 5				
	SS 864-006		TT 864-006	6 mm			ø 2.0	SS316L / TITANIUM GR. 5				
	SS 864-007		TT 864-007	7 mm			ø 2.0	SS316L / TITANIUM GR. 5				
	SS 864-008		TT 864-008	8 mm			ø 2.0	SS316L / TITANIUM GR. 5				
	SS 864-010		TT 864-010	10 mm			ø 2.0	SS316L / TITANIUM GR. 5				
	SS 864-012		TT 864-012	12 mm			ø 2.0	SS316L / TITANIUM GR. 5				
	SS 864-014		TT 864-014	14 mm			ø 2.0	SS316L / TITANIUM GR. 5				
	SS 864-016		TT 864-016	16 mm			ø 2.0	SS316L / TITANIUM GR. 5				
	SS 864-018		TT 864-018	18 mm			ø 2.0	SS316L / TITANIUM GR. 5				
	SS 864-020	TT 864-020	20 mm			ø 2.0	SS316L / TITANIUM GR. 5					
	2.5 mm Cortex Screw Self Tapping	SS 865-004	TT 865-004	04 mm			ø 2.5		SS316L / TITANIUM GR. 5			
		SS 865-005	TT 865-005	5 mm			ø 2.5		SS316L / TITANIUM GR. 5			
		SS 865-006	TT 865-006	6 mm			ø 2.5		SS316L / TITANIUM GR. 5			
		SS 865-007	TT 865-007	7 mm			ø 2.5		SS316L / TITANIUM GR. 5			
		SS 865-008	TT 865-008	8 mm			ø 2.5		SS316L / TITANIUM GR. 5			
		SS 865-009	TT 865-009	9 mm			ø 2.5		SS316L / TITANIUM GR. 5			
		SS 865-010	TT 865-010	10 mm			ø 2.5		SS316L / TITANIUM GR. 5			
		SS 865-011	TT 865-011	11 mm			ø 2.5		SS316L / TITANIUM GR. 5			
		SS 865-012	TT 865-012	12 mm			ø 2.5		SS316L / TITANIUM GR. 5			
		SS 865-013	TT 865-013	13 mm			ø 2.5		SS316L / TITANIUM GR. 5			
	SS 865-014	TT 865-014	14 mm			ø 2.5	SS316L / TITANIUM GR. 5					
		7.0 mm WASHER		5					Washers is used to avoid penetration of the screw heads through the thin cortex	SS316L / TITANIUM GR. 5		
				SS 124-007	TT 124-007	4.0 mm				ø 7.0	SS316L / TITANIUM GR. 5	
		13.0 mm WASHER							Washers is used to avoid penetration of the screw heads through the thin cortex	SS316L / TITANIUM GR. 5		
				SS 124-013	TT 124-013	6.5 mm				ø 13.0	SS316L / TITANIUM GR. 5	
	Bone Plates	1	3.5 mm Small Compression (DCP) Plates		SS 126-004	TT 126-004	4 Hole	10mm	3.5mm	Dynamic Compression Plate is used for Diaphysis Non-comminuted (Spiral, Oblique or Transverse) and Diaphysis Wedge (Spiral.	SS316L / TITANIUM GR. 5	
					SS 126-005	TT 126-005	5 Hole	10mm	3.5mm		SS316L / TITANIUM GR. 5	
					SS 126-006	TT 126-006	6 Hole	10mm	3.5mm		SS316L / TITANIUM GR. 5	
					SS 126-007	TT 126-007	7 Hole	10mm	3.5mm		SS316L / TITANIUM GR. 5	
					SS 126-008	TT 126-008	8 Hole	10mm	3.5mm		SS316L / TITANIUM GR. 5	
					SS 126-009	TT 126-009	9 Hole	10mm	3.5mm		SS316L / TITANIUM GR. 5	

U - Staples

Code No. S.S. 316L	Code No. S.S. 316LVM	Dia	Length
SS 298-001	LM 298-001	1.5mm	10mm
SS 298-002	LM 298-002	1.5mm	15mm
SS 298-003	LM 298-003	1.5mm	20mm
SS 298-004	LM 298-004	1.5mm	25mm
SS 298-005	LM 298-005	1.5mm	30mm
SS 298-101	LM 298-101	2.0mm	10mm
SS 298-102	LM 298-102	2.0mm	15mm
SS 298-103	LM 298-103	2.0mm	20mm
SS 298-104	LM 298-104	2.0mm	25mm
SS 298-105	LM 298-105	2.0mm	30mm
SS 298-201	LM 298-201	2.5mm	10mm
SS 298-202	LM 298-202	2.5mm	15mm
SS 298-203	LM 298-203	2.5mm	20mm
SS 298-204	LM 298-204	2.5mm	25mm
SS 298-205	LM 298-205	2.5mm	30mm
SS 298-301	LM 298-301	3.0mm	10mm
SS 298-302	LM 298-302	3.0mm	15mm
SS 298-303	LM 298-303	3.0mm	20mm
SS 298-304	LM 298-304	3.0mm	25mm
SS 298-305	LM 298-305	3.0mm	30mm



S.S. Wire Reel

Code No. S.S. 316L	Dia
SS 229-016	16 SWG
SS 229-018	18 SWG
SS 229-020	20 SWG
SS 229-022	22 SWG
SS 229-024	24 SWG
SS 229-026	26 SWG
SS 229-028	28 SWG
SS 229-030	30 SWG
SS 229-032	32 SWG
SS 229-034	34 SWG



Coventry - Staples

Code No. S.S. 316L	Code No. S.S. 316LVM	Length
SS 298-401	LM 298-401	Small
SS 298-402	LM 298-402	Medium
SS 298-403	LM 298-403	Large
SS 298-404	LM 298-404	Extra Large

Mfg. : Orthopedic Implants & Instruments

Wires & Pin

An ISO 13485
Certified Company



Inter-Locking Tibia Nail

Note : Define Code for S.S.316L./SS 201, Titanium/TT 201, S.S. 316LVM/LM 201
Screw Places : 4.9mm/3.9mm

Code No. S.S. 316L	Code No. S.S. 316L	Code No. S.S. 316L	Code No. S.S. 316L	Length
Dia. (8.0mm)	Dia. (9.0mm)	Dia. (10.0mm)	Dia. (11.0mm)	
SS 201-028	SS 201-128	SS 201-228	SS 201-328	28cm
SS 201-030	SS 201-130	SS 201-230	SS 201-330	30cm
SS 201-032	SS 201-132	SS 201-232	SS 201-332	32cm
SS 201-034	SS 201-134	SS 201-234	SS 201-334	34cm
SS 201-036	SS 201-136	SS 201-236	SS 201-336	36cm
SS 201-038	SS 201-138	SS 201-238	SS 201-338	38cm

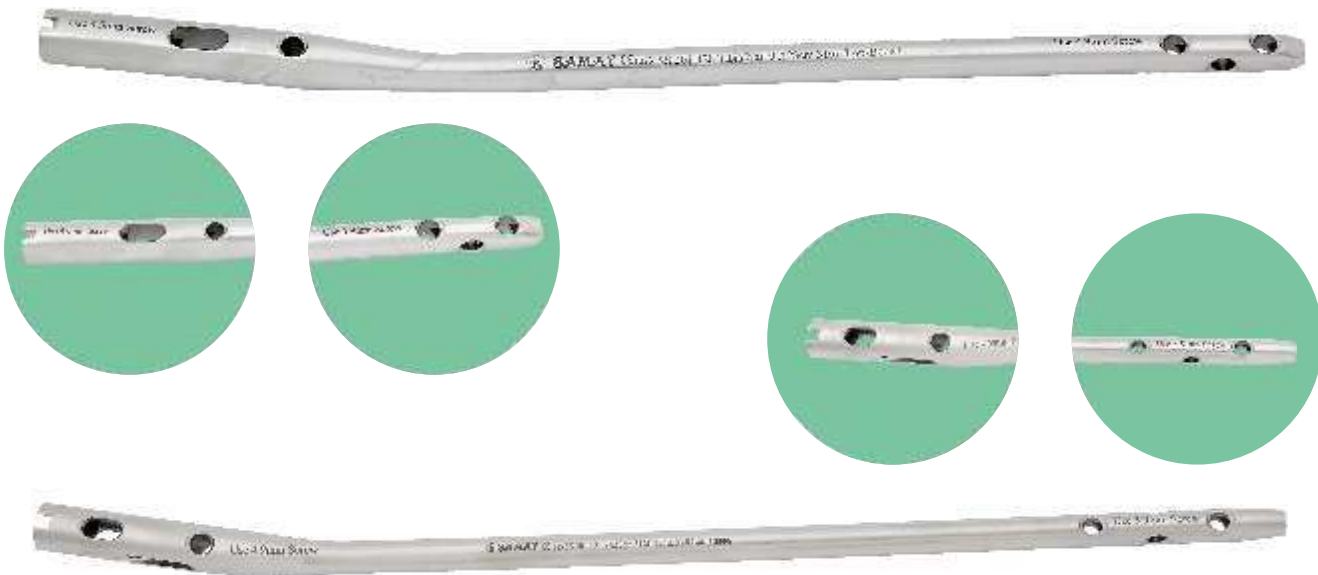

Inter-Locking Tibia Nail (New Design)

Note : Define Code for S.S.316L./SS 201, Titanium/TT 201, S.S. 316LVM/LM 201
Screw Places : 4.9mm/3.9mm

Code No. S.S. 316L	Code No. S.S. 316L	Code No. S.S. 316L	Code No. S.S. 316L	Length
Dia. (8.0mm)	Dia. (9.0mm)	Dia. (10.0mm)	Dia. (11.0mm)	
SS 201-028	SS 201-128	SS 201-228	SS 201-328	28cm
SS 201-030	SS 201-130	SS 201-230	SS 201-330	30cm
SS 201-032	SS 201-132	SS 201-232	SS 201-332	32cm
SS 201-034	SS 201-134	SS 201-234	SS 201-334	34cm
SS 201-036	SS 201-136	SS 201-236	SS 201-336	36cm
SS 201-038	SS 201-138	SS 201-238	SS 201-338	38cm

Mfg. : Orthopedic Implants & Instruments

Bone Nail

An ISO 13485
Certified Company



Sirus Femoral Nail Right

Note : Define Code for S.S. 316L/SS 221, Titanium/TT 221, S.S. 316LVM/LM 221
Screw Places : 6.4mm/4.9mm

Code No. S.S. 316L	Code No. S.S. 316L	Code No. S.S. 316L	Length
Dia. (9.0mm)	Dia. (10.0mm)	Dia. (11.0mm)	
SS 221-034	SS 221-134	SS 221-234	34cm
SS 221-036	SS 221-136	SS 221-236	36cm
SS 221-038	SS 221-138	SS 221-238	38cm
SS 221-040	SS 221-140	SS 221-240	40cm
SS 221-042	SS 221-142	SS 221-242	42cm
SS 221-044	SS 221-144	SS 221-244	44cm

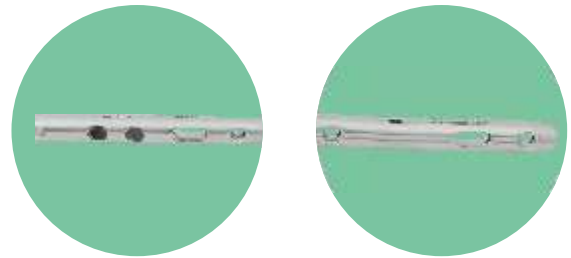

Sirus Femoral Nail Left

Note : Define Code for S.S. 316L/SS 221, Titanium/TT 221, S.S. 316LVM/LM 221
Screw Places : 6.4mm / 4.9mm

Code No. S.S. 316L	Code No. S.S. 316L	Code No. S.S. 316L	Length
Dia. (9.0mm)	Dia. (10.0mm)	Dia. (11.0mm)	
SS 221-434	SS 221-534	SS 221-634	34cm
SS 221-436	SS 221-536	SS 221-636	36cm
SS 221-438	SS 221-538	SS 221-638	38cm
SS 221-440	SS 221-540	SS 221-640	40cm
SS 221-442	SS 221-542	SS 221-642	42cm
SS 221-444	SS 221-544	SS 221-644	44cm