



Changshu Taining Medical Equipment Co., Ltd Brief Introduction

Changshu Taining Medical Equipment Co., Ltd is located in Changshu where is in the economic circle in Yangtze Delta of east of China. It takes only two hours by car to the city centre, and airports of Shanghai and only half of a hour to the nearest airport located in Wuxi City

Taining was established in 1994 and began the foreign trade business since 1995. We have had a great & rapidly growth during the last ten years while have been foreign trade concentrated manufacturer since then. We currently have 250 employees with a total area apx. 15,000 m2 in which the building area is apx. 10,000 m2. In 1999, we have been qualified by ISO9001: 2000/ISO13488: 1996 and then passed ISO9001:2008/ISO13485:2003 DNV audits in the following 2008. Till now we have 5,000 m2 in totally for GMP standard clean workshops, 100,000 grade clean workshops and 10,000 grades clean rooms for testing.

Our main products are single use medical equipments and devices. And we are specialized in producing different kinds of PVC Urine Bags, Suction Catheter, and urine drainage catheter etc. These products have been CE certified and have been exported to South-east Asia, America, Europe and Africa etc. Having a high trained and experienced Quality Assurance team and well controlled production lines, we were supplier of COLOPLAST and are now suppliers of B/BRAUN、GREAT BEAR、MANFRED SAUER which are all big companies for urinary system products and thus having quite a lot of new products developing ability with OEM.

Our managing policy is: developing our business with good faith and quality, satisfied service!

contents 目录

Urology Products 泌尿类产品			Anesthesia And Respiratory Products 麻醉人工气道	
● Nelaton catheter	01		● Endotracheal Tube	16
● Urine Bag	01		◆ Standard Endotracheal Tube	
◆ Urine Drainage Bag			◆ Reinforced Endotracheal Tube	
◆ Luxury Urine Bag			● Oral Pharyngeal Airway	18
● Urine Meter	04			
● Leg bag	05		Respiratory products 呼吸系统	
◆ Economy Leg bag			● Nasal oxygen cannula	19
◆ Leg bag (3 chambers)			● MASK	19
◆ Soft Leg bag			◆ Oxygen mask	
◆ Night Leg bag			◆ Multi-vent Mask	
● Pediatric urine bag	07		◆ Non-Rebreath Mask (with oxygen bag)	
● Leg Strap	07		● NEBULIZER & KIT	20
● Catheter Fixation Strip	08		◆ 20ml Nebulizer with Aerosol Mask	
● Catheter Securement Device	08		◆ 6ml Nebulizer with Aerosol Mask	
			● Nebulizer with Mouth Piece	21
Enteral Feeding 肠道喂养			● Tracheostomy Mask	21
● Feeding tube	08			
● Stomach tube	09		Other Product 其他产品	
● Common Enema Bag & Sitz Bath Bag	10		● Vaginal Speculum	22
● Irrigation Syringe	11		● Urine cup	22
● Enteral Feeding Bag Set	11		● Umbilical Cord Clamp	22
			● Amnio Hook	23
Surgical Suction Management 外科吸引类			● ID BAND	23
● Drainage Tube	12			
◆ Thoracic Duct Drainage			Component 配件	
◆ Abdominal Drainage Tube			●	
◆ Redon tube			●	
● Suction catheter	13		●	
● Rectal tube	14		●	
● Mucus Extractor	14		●	
● Connecting Tube with Yankauer Handle	15		●	
● Suction Connecting Tube	15		●	
● Yankauer Handle	15			

Urology Products 泌尿类产品

● **Nelaton catheter**

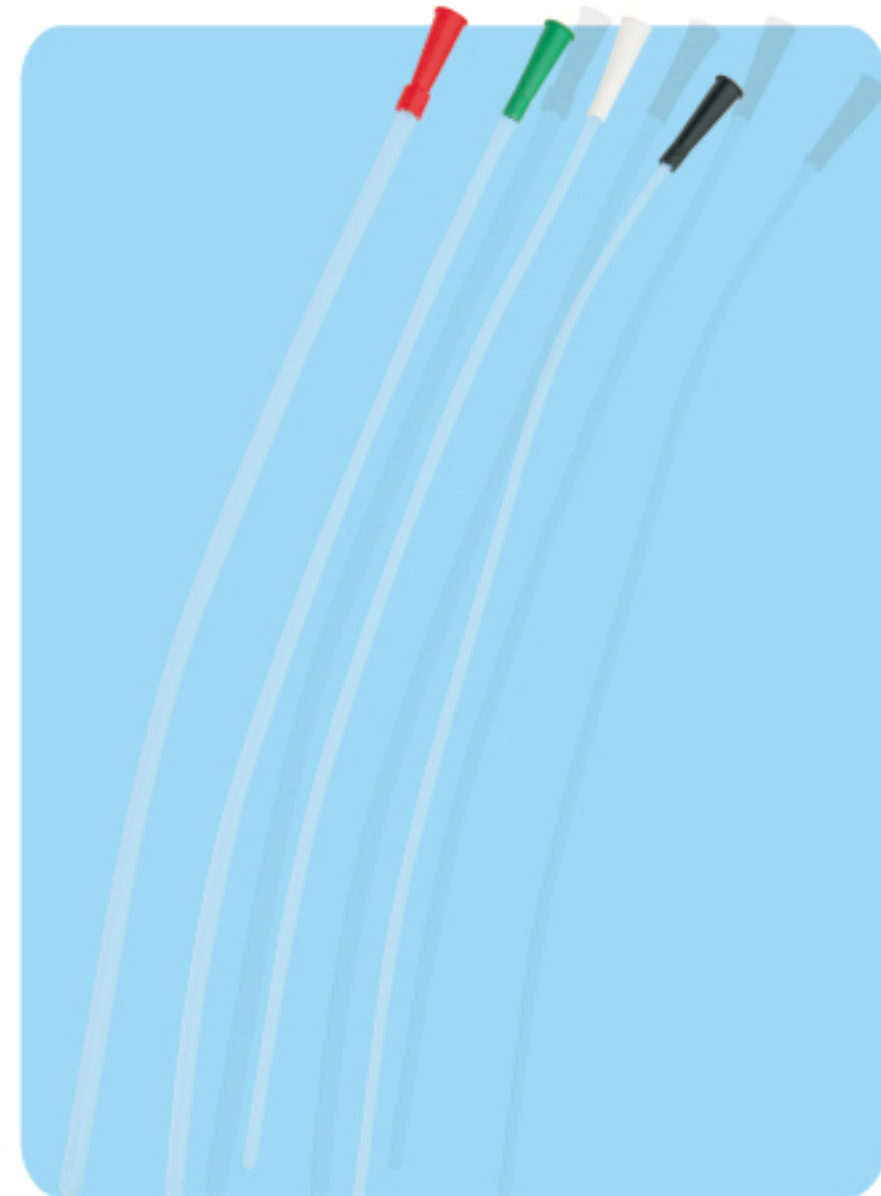

◆ ♂ **Standard Type**

Features:

- Designed for short term and temporary drainage of urine.
- Atraumatic, soft, rounded, closed tip with two lateral eyes for efficient drainage.
- Length:400mm.

Item No.	Item No. (DEHP FREE)	Size (Fr.)	Color code
250 06000	F250 06000	6	Light Green
250 08000	F250 08000	8	Light Blue
250 10000	F250 10000	10	Black
250 12000	F250 12000	12	White
250 14000	F250 14000	14	Green
250 16000	F250 16000	16	Orange
250 18000	F250 18000	18	Red
250 20000	F250 20000	20	Yellow
250 22000	F250 22000	22	Blue
250 24000	F250 24000	24	Violet

◆ ♀ **Female Type**

Features:

- Designed for short term and temporary drainage of urine.
- Atraumatic, soft, rounded, closed tip with two lateral eyes for efficient drainage.
- Length:20mm.

Item No.	Item No. (DEHP FREE)	Size(Fr.)	Color code
251 06000	F251 06000	6	Light Green
251 08000	F251 08000	8	Light Blue
251 10000	F251 10000	10	Black
251 12000	F251 12000	12	White
251 14000	F251 14000	14	Green
251 16000	F251 16000	16	Orange
251 18000	F251 18000	18	Red
251 20000	F251 20000	20	Yellow
251 22000	F251 22000	22	Blue
251 24000	F251 24000	24	Violet

● **Urine Bag**

◆ **Urine Drainage Bag**



Item No.	Size (ml.)	Style
440 00100	2000	Drainage bag with 90cm inlet tube,without outlet,non-sterile,CP.
440 00200	2000	Drainage bag with 90cm inlet tube,without outlet,non-sterile
440 00300	1500	Drainage bag with 90cm inlet tube,without outlet,non-sterile
440 00400	2600	Drainage bag with 90cm inlet tube,without outlet,non-sterile
440 01000	2000	Drainage bag with 90cm inlet tube,with non return valve , with pull-push outlet,sterilized in PE pouch.
440 01100	1500	Drainage bag with 90cm inlet tube,with non return valve , with pull-push outlet,sterilized in PE pouch.
440 03000	2000	Drainage bag with 90cm inlet tube,with non return valve , with screw outlet,sterilized in PE pouch.
440 03100	1500	Drainage bag with 90cm inlet tube,with non return valve , with screw outlet,sterilized in PE pouch.
440 05100	2000	Drainage bag with 90cm inlet tube,with non return valve , with T-tap outlet,sterilized in PE pouch.
440 05200	2000	Drainage bag with 90cm inlet tube,with non return valve , with T-tap outlet,sterilized in PE pouch.(CE Style)
440 05300	2000	Drainage bag with 90cm inlet tube,with non return valve , with T-tap outlet,sterilized in PE pouch.(FC Style)
440 05330	3000	Drainage bag with 90cm inlet tube,with non return valve , with T-tap outlet,sterilized in PE pouch.

Item No.	Size (ml.)	Style
440 04100	2000	Arc shape Drainage bag with 90cm inlet tube,with non return valve , with screw bottom outlet,sterilized in PE pouch.
440 04200	2000	Arc shape Drainage bag with 90cm inlet tube,with non return valve , with screw bottom outlet,sterilized in PE pouch.
440 04300	2000	Rectangle shape Drainage bag with 90cm inlet tube,with non return valve ,with screw top outlet,sterilized in PE pouch.
440 04400	2000	Rectangle shape Drainage bag with 90cm inlet tube,with non return valve ,with screw top outlet,sterilized in PE pouch.
440 05400	2000	Drainage bag with 90cm inlet tube,with non return valve ,with sample port and T-tap outlet,sterilized in PE pouch.
440 06100	2000	Drainage bag with 90cm inlet tube,with non return valve , with Clamp outlet,sterilized in ribbon bag.
440 06200	2000	Drainage bag with 90cm inlet tube,with non return valve , with Clamp outlet,sterilized in ribbon bag.
440 15000	2000	S1 type 2000ml drainage bag,with 100cm inlet tube,with non return valve, needleless sampling port,MT twist tap,sterilized in peel pouch.
440 16000	2000	S2 type 2000ml drainage bag,with 100cm inlet tube,with non return valve, needleless sampling port,MT twist tap,sterilized in peel pouch.
440 17000	2000	Rectangle shape,A4 type 2000ml drainage bag,with 100cm inlet tube, with non return valve,tube clamp,needleless sampling port, T-tap outlet,sterilized in peel pouch.



◆ Luxury Urine Bag

Item No.	Size (ml.)	Style
440 08000	2000	Pear shape, 2000ml drainage bag, with 110cm inlet tube, with non return valve, air vent, needleless sampling port, clamp bottom draining.
440 08100	2000	Pear shape, 2000ml drainage bag, with 110cm inlet tube, with non return valve, air vent, needleless sampling port, T-tap bottom draining.
440 09000	2000	322 shape, 2000ml drainage bag, with 120cm inlet tube, with non return valve, air vent, bed sheet clamp, needleless sampling port, T-tap bottom draining.
440 09100	2000	322 shape, 2000ml drainage bag, with 120cm inlet tube, with non return valve, air vent, bed sheet clamp, needleless sampling port, T-tap bottom draining. (BUS)
440 18000	2000	U2 type 2000ml drainage bag, with 100cm inlet tube, with non return valve, needleless sampling port, T-tap outlet, sterilized in peel pouch.
440 19000	2000	Apple shape ,drainage bag,with universal double hanger,120cm inlet tube, anti-reflux drip chamber,air vent,needleless sampling port, T-tap,sterilized in peel pouch.
440 19100	2000	Apple shape ,drainage bag,with universal double hanger,120cm inlet tube, anti-reflux drip chamber,air vent,needleless sampling port, T-tap,sterilized in peel pouch. (New)
450 01000	2000/2600	Apple shape ,drainage bag,with universal double hanger, 120cm inlet tube,anti-reflux drip chamber,air vent, needleless sampling port, T-tap, sterilized in peel pouch.
450 02000	2000	Drainage bag,with universal double hanger,110cm inlet tube,anti-reflux drip chamber,air vent,needleless sampling port,T-tap,sterilized in peel pouch. (28431 shape)
450 03000	2000	Diamond shape , 2000ml drainage bag, with universal double hanger,110cm inlet tube,anti-reflux drip chamber,air vent, needleless sampling port, T-tap, sterilized in peel pouch.
450 05000	2000	2000B shape, 2000ml drainage bag, with 120cm inlet tube, with non return valve, air vent, needleless sampling port, MT twist tap, sterilized in peel pouch.
450 06000	2000	Korea shape, 2000ml drainage bag, with universal double hanger 120cm inlet tube, air vent, needleless sampling port, T-tap, sterilized in peel pouch.
450 07000	4000	Apple shape ,5000ml drainage bag,with universal double hanger, 110cm inlet tube,anti-reflux drip chamber,air vent,bed sheet clamp, needleless sampling port, T-tap,sterilized in peel pouch.
450 08000	5000	Apple shape ,5000ml drainage bag, with universal double hanger, 110cm inlet tube,anti-reflux drip chamber,air vent,bed sheet clamp, needleless sampling port, T-tap,sterilized in peel pouch.



● Urine Meter

Designed for easy bag suspension with a reinforced double hanger and built-in anti-bank guide. 120cm star tubing facilitates port is accessible, fibrous urine and resists kinking. Convenient needleless sample port is accessible with either needleless or a blunt cannula, and offers added protection for patient and caregiver. Adjustable bed sheet clamp secures tubing. Includes additional rope hanger. 200ml to 500ml capacity meter with 2000ml or 2600ml drain bag. Sterile peel open pack.

Item No.	Size (ml.)	Style
480 10000	2000+200	Urine Meter, 200ml with 2000ml bag
480 12000	2000+400	Urine Meter, 200ml with 2000ml bag
480 13000	2000+500	Urine Meter, 500ml with 2000ml bag (with anti-reflux drip chamber)
480 20000	2600+400	Urine Meter M1, 2 chambers, 400ml with 2000ml or 2600ml bag
480 21000	2600+500	Urine Meter M3, 1 chamber, 500ml with 2000ml or 2600ml bag
480 22000	2600+400	Urine Meter M2, 3 chamber, 500ml with 2000ml or 2600ml bag



● Leg bag

◆ Economy Leg bag

Rectangle or arc style for customer option. Anti-reflux on this leg bag helps prevent urine reflux. High grade vinyl material(PVC) is recommended for single use. Available in 350ml to 1000ml. Leg bag is secured with two comfort straps in latex-free. They have outlet emptying. Tube length 5~90cm for customer option.



460 01075



440 11000

Item No.	Size (ml.)	Style
440 11000	500	Leg bag , wo/buttons straps, with screw bottom outlet
440 12000	750	Leg bag , wo/buttons straps, with screw bottom outlet
460 01035	350	Rectangle shape, with screw bottom outlet
460 01050	500	Rectangle shape, with screw bottom outlet
460 01060	600	Rectangle shape, with screw bottom outlet
460 01075	750	Rectangle shape, with screw bottom outlet
460 01100	1000	Rectangle shape, with screw bottom outlet
460 01150	1500	Rectangle shape, with screw bottom outlet
460 02050	500	Rectangle shape, with screw bottom outlet(Scrap Edge)
460 02075	750	Rectangle shape, with screw bottom outlet(Scrap Edge)
460 02150	500	Rectangle shape , without outlet
460 02175	750	Rectangle shape , without outle
460 02250	500	Corner inlet tube, with T-tap outlet
460 02275	750	Corner inlet tube, with T-tap outlet
460 03050	500	Diamond shape, with T-tap bottom outlet
460 03075	750	Diamond shape, with T-tap bottom outlet
460 04060	600	Arc style, with screw bottom outlet
460 04100	1000	Arc style, with screw bottom outlet



◆ Leg bag (3 chambers)

Diamond or arc style for customer option. Anti-reflux on this leg bag helps prevent urine reflux. High grade vinyl material(PVC) is recommended for single use. Available in 350ml to 750ml. Leg bag is secured with two comfort straps in latex-free. They have twist drainage outlet, cross valve or lever tap for easy emptying. Tube length 5~90cm for customer option.



460 07050

Item No.	Size (ml.)	Style
460 06050	500	Three chamber, diamond shape
460 06075	750	Three chamber, diamond shape
460 07035	350	Three chamber, arc style
460 07050	500	Three chamber, arc style
460 07075	750	Three chamber, arc style

◆ Soft Leg bag

Rectangle or arc style for customer option. Anti-reflux on this leg bag helps prevent urine reflux. High grade vinyl material(PVC) is recommended for single use. Available in 350ml to 1500ml. Leg bag is secured with two comfort straps in latex-free. With soft back foil for patients' comfort. They have twist drainage outlet, cross valve or lever tap for easy emptying. Tube length 5~90cm for customer option.

Item No.	Size (ml.)	Style
470 01135	350	Diamond shape-non woven cloth/fuzzy back foil
470 01150	500	Diamond shape-non woven cloth/fuzzy back foil
470 01175	750	Diamond shape-non woven cloth/fuzzy back foil
470 01180	800	Diamond shape-non woven cloth/fuzzy back foil
470 01235	350	Diamond shape(3 chamber)-non woven cloth/fuzzy back foil
470 01250	500	Diamond shape(3 chamber)-non woven cloth/fuzzy back foil
470 01275	750	Diamond shape(3 chamber)-non woven cloth/fuzzy back foil
470 01280	800	Diamond shape(3 chamber)-non woven cloth/fuzzy back foil
470 02035	350	Arc shape-non woven cloth/fuzzy back foil
470 02050	500	Arc shape-non woven cloth/fuzzy back foil
470 02075	750	Arc shape-non woven cloth/fuzzy back foil
470 03035	350	Arc shape(3 champer)-non woven cloth/fuzzy back foil
470 03050	500	Arc shape(3 champer)-non woven cloth/fuzzy back foil
470 03075	750	Arc shape(3 champer)-non woven cloth/fuzzy back foil
470 04035	350	Rectangle style, non woven cloth/fuzzy back foil
470 04050	500	Rectangle style, non woven cloth/fuzzy back foil
470 04075	750	Rectangle style, non woven cloth/fuzzy back foil
470 04100	1000	Rectangle style, non woven cloth/fuzzy back foil
470 04150	1500	Rectangle style, non woven cloth/fuzzy back foil
470 05050	500	Non woven cloth/fuzzy back foil



◆ Day Night Leg bag



470 05080 470 05100

Rectangle or arc style for customer option. Anti-reflux drip chamber on this leg bag helps prevent urine reflux. High grade vinyl material(PVC) with non-woven cloth for comfort skin touch. Air-vent on bag. Available in 800ml or 1000ml. Tube length 30~90cm for customer option.

Item No.	Size (ml.)	Style
470 05080	800	non woven cloth/fuzzy back foil
470 05100	1000	non woven cloth/fuzzy back foil

● Pediatric urine bag



Features:

- Safety Adhesive, Sterile, Latex Free.
- Infant Urine Collector 100ml/150/200ml, Plain type and female type.

Item No.	Size(ml.)	Style
440 13100	100	Plain type
441 13100	100	Female Type
440 13200	150	Plain type
441 13200	150	Female Type
440 13300	200	Plain type
441 13300	200	Female Type

● Leg Strap



Features:

- 100% latex free.
- Can be applied with all types of urine bags.

◆ Economy Leg Strap

Item No.	Size (cm)	Material
800 10100	1.8cm/wide, 48cm/length x 2	wo/buttons, Polyester, Nylon
800 31023	2.3cm/wide, 50cm/length x 2	wo/velcro, Polyester, Nylon

◆ Luxury Leg Strap

Item No.	Size (cm)	Material
800 34018	1.8cm/wide, 50cm/length x 2	wo/velcro, w/silicon wavy line, Polyester, Nylon
800 34123	2.3cm/wide, 50cm/length x 2	wo/velcro, w/silicon line, Polyester, Nylon
800 34125	2.5cm/wide, 50cm/length x 2	wo/velcro, w/silicon line, Polyester, Nylon
800 34025	2.5cm/wide, 50cm/length x 2	wo/velcro, w/silicon wavy line, Polyester, Nylon
800 23701	2.3cm/wide, 60cm/length x 1	wo/buttons, wo/velcro, Polyester, Nylon
	3.7cm/wide, 60cm/length x 1	wo/buttons, wo/velcro, Polyester, Nylon
800 23702	2.3cm/wide, 60cm/length x 1	wo/velcro, Polyester, Nylon
	3.7cm/wide, 60cm/length x 1	wo/velcro, Polyester, Nylon



Directions for use of buttons strap

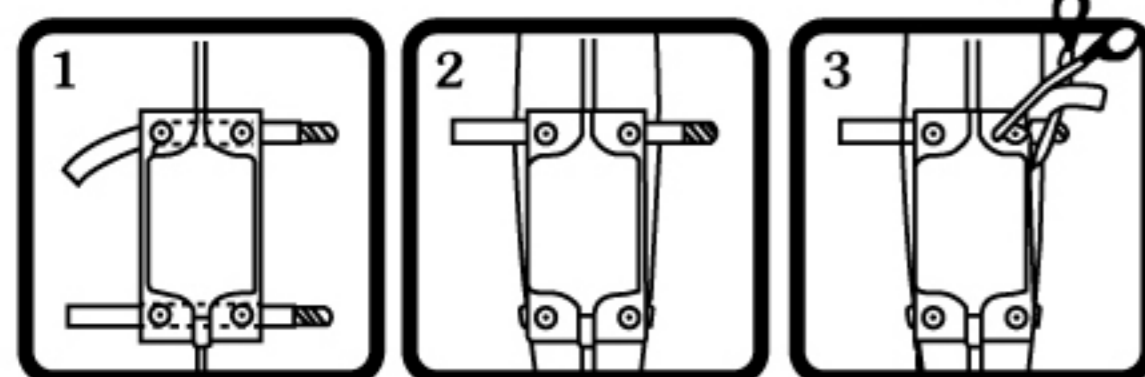

Directions for use of velcro strap

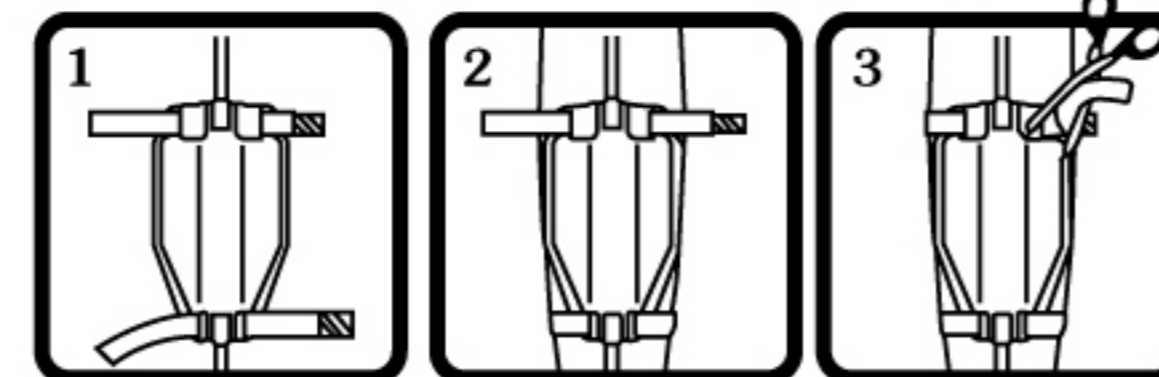

● Catheter Fixation Strap



Features:

- 100% latex free.
- Fixed catheter.

Item No.	Size (cm)	Material
800 34038	3.8cm/wide, 65cm/length	wo/silicone tie, wo/velcro, w/silicon wavy line, Polyester, Nylon
800 34135	3.5cm/wide, 50cm/length	wo/PVC tie, wo/velcro, w/silicon line, Polyester, Nylon

● Catheter Securement Device



Item No.	Size (cm)	Material
806 00311	Large	For 2&3 ways Foley catheters sized 12-30 Fr.
806 00312	Large	For lines and tubes sized 6-13mm in diameter.
806 00314	Medium	For lines and tubes sized 3-8mm in diameter.
806 00315	Small	For lines and tubes sized 1.5-4.5mm in diameter.

Enteral Feeding 肠道喂养

● Feeding tube

◆ Luer fitting and sealing plug connector

Features:

- Material: Made form Medical grade PVC.
- Two type: standard connector and Multifunction connector.
- Atraumatic, soft, rounded, opened tip with two lateral eyes.
- With X-ray line available.
- F4~F8 Length: 40cm; F10~F22 Length: 120cm.



Item No.	Item No. (DEHP FREE)	Size(Fr.)	Colorcode
220 04000	F220 04000	4	Red
220 05000	F220 05000	5	Light grey
220 06000	F220 06000	6	Light Green
220 07000	F220 07000	7	Blue
220 08000	F220 08000	8	Light Blue
220 10000	F220 10000	10	Black
220 12000	F220 12000	12	White
220 14000	F220 14000	14	Green
220 16000	F220 16000	16	Orange
220 18000	F220 18000	18	Red
220 20000	F220 20000	20	Yellow
220 22000	F220 22000	22	Blue

◆ Multifunction connector



Item No.	Item No. (DEHP FREE)	Size(Fr.)	Color code
221 04000	F221 04000	4	Red
221 05000	F221 05000	5	Light grey
221 06000	F221 06000	6	Light Green
221 07000	F221 07000	7	Blue
221 08000	F221 08000	8	Light Blue
221 10000	F221 10000	10	Black
221 12000	F221 12000	12	White
221 14000	F221 14000	14	Green
221 16000	F221 16000	16	Orange
221 18000	F221 18000	18	Red
221 20000	F221 20000	20	Yellow
221 22000	F221 22000	22	Blue

● Stomach tube

◆ Standard Type

Features:

- Material: Made from clear soft PVC.
- Material: Two kind of connector available with plain type connector and Cap-cone connector.
- Atraumatic, soft, rounded, opened tip with four lateral eyes.
- F4~F8 Length:900mm; F10~F24 Length:1250mm.
- X-ray line/ radio-opaque line is available for accurate placement.

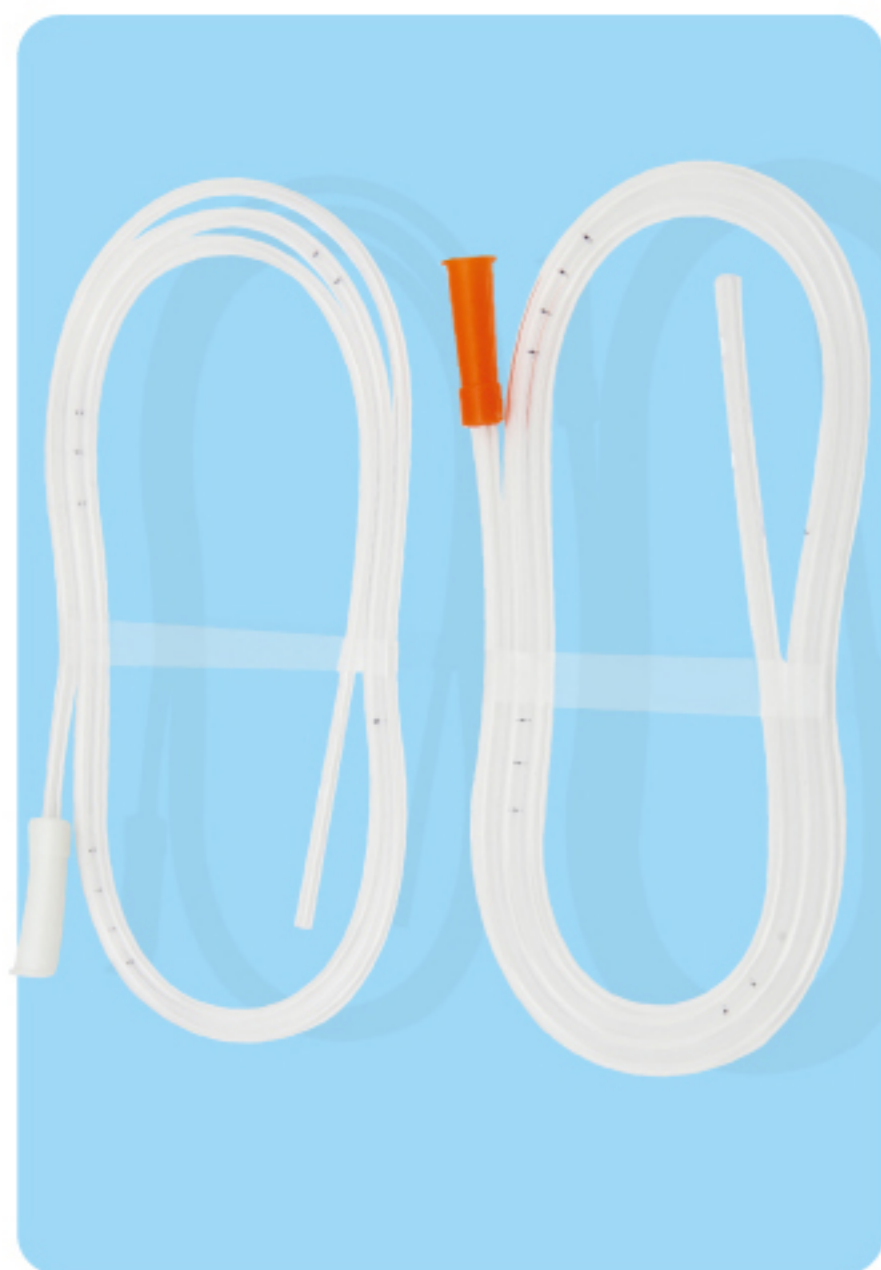

Item No.	Item No. (DEHP FREE)	Size(Fr.)	Color code
230 06000	F230 06000	6	Light Green
230 08000	F230 08000	8	Light Blue
230 10000	F230 10000	10	Black
230 12000	F230 12000	12	White
230 14000	F230 14000	14	Green
230 16000	F230 16000	16	Orange
230 18000	F230 18000	18	Red
230 20000	F230 20000	20	Yellow
230 22000	F230 22000	22	Blue
230 24000	F230 24000	24	Violet

◆ Ryle's Stomach Tube



Features:

- X-ray line/ radio-opaque line is available for accurate placement.
- Tube end is sealed with stainless steel balls, to assist the catheter indwelling in a certain place.

Item No.	Item No. (DEHP FREE)	Size(Fr.)	Color code
231 12000	F231 12000	12	White
231 14000	F231 14000	14	Green
231 16000	F231 16000	16	Orange
231 18000	F231 18000	18	Red
231 20000	F231 20000	20	Yellow
231 22000	F231 22000	22	Blue
231 24000	F231 24000	24	Violet

● Common Enema Bag

Features:

- Made from non-toxic polyethylene.
- Tube 120cm(Fr14),With tube clip.

Item No.	Size (ml)	Color
440 14001	1500	Transparent
440 14003	2000	Transparent



● Sitz Bath Bag



Features:

- Sitz Bath Is Contoured and Fits Easily Over Standard Commodes for Patient Comfort and Convenience Solution bag with 2000mL capacity can be hung from any convenient fixture and is graduated and imprinted with instructions for easy use.
- Shut-off clamp on the tubing controls flow.
- Sets are individually bagged.

Item No.	Size (ml)	Color
440 15001	2000	Transparent

● Irrigation Syringe



Features:

- Made from PE and PVC, non-toxic polyethylene.
- Ball type has two color to chose: transparent ball and blue ball.

Item No.	Size (ml)	Style
660 41060	60	Ball Type
660 41080	80	Ball Type
660 42060	60	Screw Type
660 42080	80	Screw Type

● Enteral Feeding Bag Set

Features:

- Two type: gravity and pump type.
- Rigid neck for easy filling and handing.
- With plug cap and strong, dependable hanging ring.
- Easy-to read graduations and easy-view translucent bag.
- Bottom exit port allows complete drainage.
- Pump set or gravity set, available individually.
- DEHP-Free available.

Item No.	Item No. (DEHP FREE)	Size (Fr.)	Style
500 01050	F500 01050	500	Gravity type
501 01050	F501 01050	500	Pump type
500 01100	F500 01100	1000	Gravity type
501 01100	F501 01100	1000	Pump type
500 01120	F500 01120	1200	Gravity type
501 01120	F501 01120	1200	Pump type



Surgical Suction Management 外科吸引类

● DRAINAGE TUBE

◆ Thoracic Drainage Tube

Features:

- Non-toxic, medical grade PVC material.
- X-ray opaque line.
- Type: round or fish-mouth tip.
- Length: 500mm.

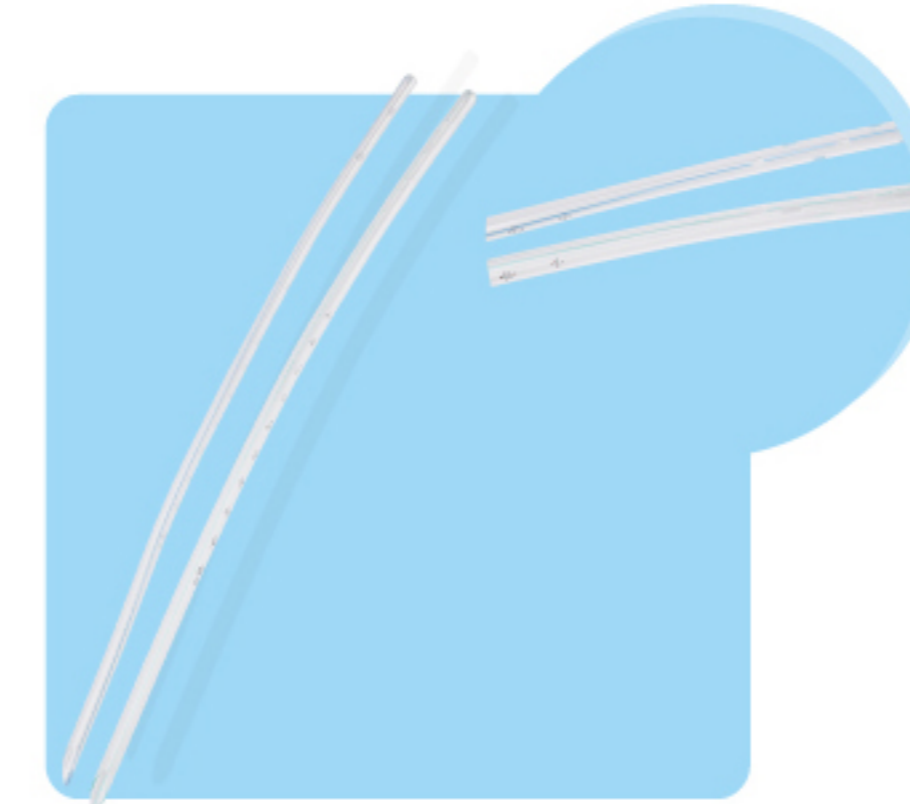

Item No.	Item No. (DEHP FREE)	Size (Fr)
560 20000	F560 20000	20
560 22000	F560 22000	22
560 24000	F560 24000	24
560 26000	F560 26000	26
560 28000	F560 28000	28
560 30000	F560 30000	30
560 32000	F560 32000	32
560 34000	F560 34000	34
560 36000	F560 36000	36

◆ Abdominal Drainage Tube

Features:

- Non-toxic, medical grade PVC material.
- X-ray opaque line.
- Length: 500mm.

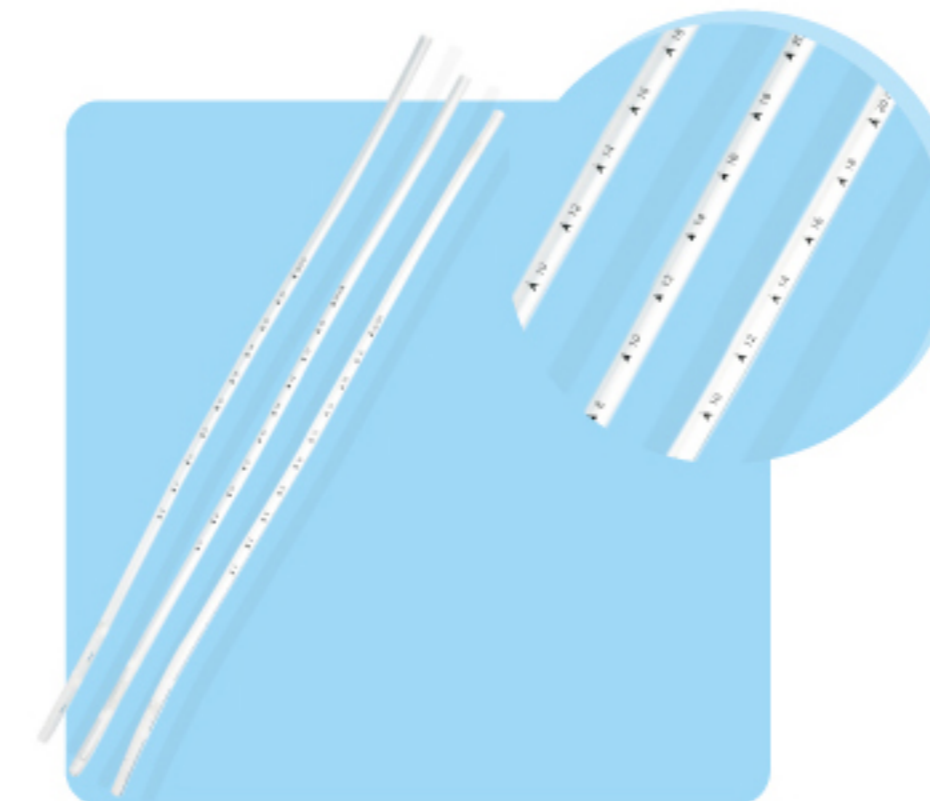

Item No.	Item No. (DEHP FREE)	Size (Fr)
570 20000	F570 20000	20
570 22000	F570 22000	22
570 24000	F570 24000	24
570 26000	F570 26000	26
570 28000	F570 28000	28
570 30000	F570 30000	30
570 32000	F570 32000	32
570 34000	F570 34000	34
570 36000	F570 36000	36

◆ Redon tube

Features:

- Non-toxic, medical grade PVC material.
- X-ray opaque line.
- Length: 500mm .

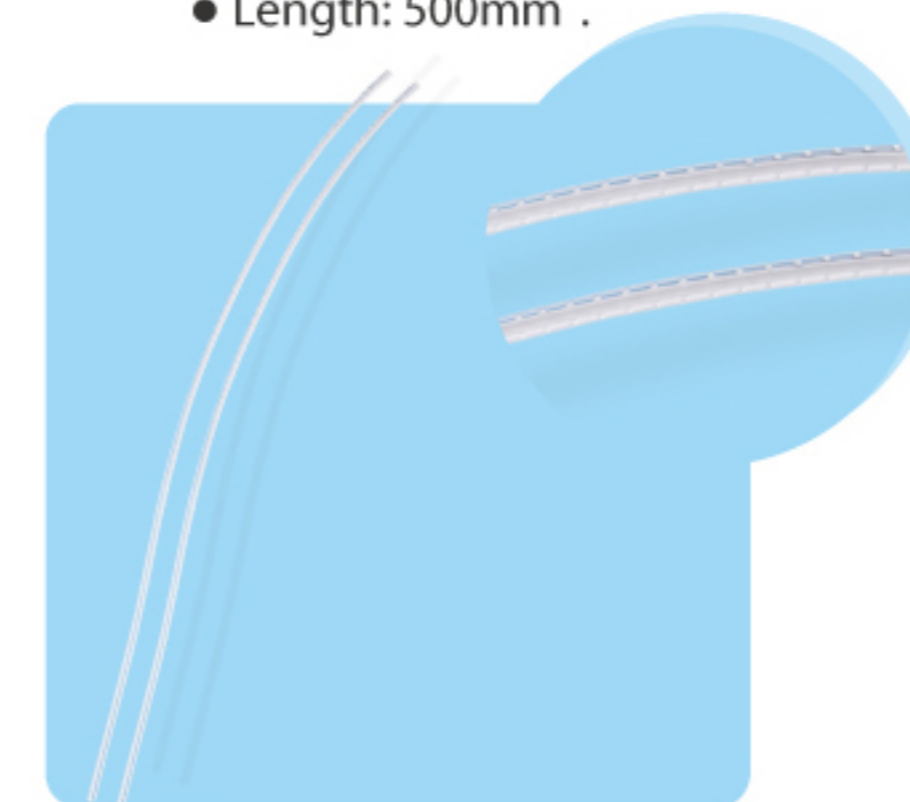

Item No.	Item No. (DEHP FREE)	Size (Fr)
280 06000	F280 06000	6
280 08000	F280 08000	8
280 10000	F280 10000	10
280 12000	F280 12000	12
280 14000	F280 14000	14
280 16000	F280 16000	16
280 18000	F280 18000	18

● Suction catheter

Features:

- Made from clear soft PVC.
- Four kind of connector available with T-type connector, Y-type connector, Cap-cone connector, Y-type transparent connector.
- Colour coded for size identification.
- Can With Scale line.
- Length: 500mm.

◆ Plain type connector

Item No.	Item No. (DEHP FREE)	Size(Fr.)	Color code
240 05000	F240 05000	5	Light Grey
240 06000	F240 05000	6	Light Green
240 08000	F240 08000	8	Light Blue
240 10000	F240 10000	10	Black
240 12000	F240 12000	12	White
240 14000	F240 14000	14	Green
240 16000	F240 16000	16	Orange
240 18000	F240 18000	18	Red
240 20000	F240 20000	20	Yellow
240 22000	F240 22000	22	Blue

◆ T-type connector

Item No.	Item No. (DEHP FREE)	Size(Fr.)	Color code
242 05000	F242 05000	5	Light Grey
242 06000	F242 05000	6	Light Green
242 08000	F242 08000	8	Light Blue
242 10000	F242 10000	10	Black
242 12000	F242 12000	12	White
242 14000	F242 14000	14	Green
242 16000	F242 16000	16	Orange
242 18000	F242 18000	18	Red
242 20000	F242 20000	20	Yellow
242 22000	F242 22000	22	Blue

◆ Y-type connector

Item No.	Item No. (DEHP FREE)	Size(Fr.)	Color code
244 05000	F244 05000	5	Light Grey
244 06000	F244 05000	6	Light Green
244 08000	F244 08000	8	Light Blue
244 10000	F244 10000	10	Black
244 12000	F244 12000	12	White
244 14000	F244 14000	14	Green
244 16000	F244 16000	16	Orange
244 18000	F244 18000	18	Red
244 20000	F244 20000	20	Yellow
244 22000	F244 22000	22	Blue

◆ Y-type transparent connector

Item No.	Item No. (DEHP FREE)	Size(Fr.)	Color code
241 05000	F241 05000	5	Light Grey
241 06000	F241 05000	6	Light Green
241 08000	F241 08000	8	Light Blue
241 10000	F241 10000	10	Black
241 12000	F241 12000	12	White
241 14000	F241 14000	14	Green
241 16000	F241 16000	16	Orange
241 18000	F241 18000	18	Red
241 20000	F241 20000	20	Yellow
241 22000	F241 22000	22	Blue

◆ Cap- cone connector

Item No.	Item No. (DEHP FREE)	Size(Fr.)	Color code
243 05000	F243 05000	5	Light Grey
243 06000	F243 05000	6	Light Green
243 08000	F243 08000	8	Light Blue
243 10000	F243 10000	10	Black
243 12000	F243 12000	12	White
243 14000	F243 14000	14	Green
243 16000	F243 16000	16	Orange
243 18000	F243 18000	18	Red
243 20000	F243 20000	20	Yellow
243 22000	F243 22000	22	Blue

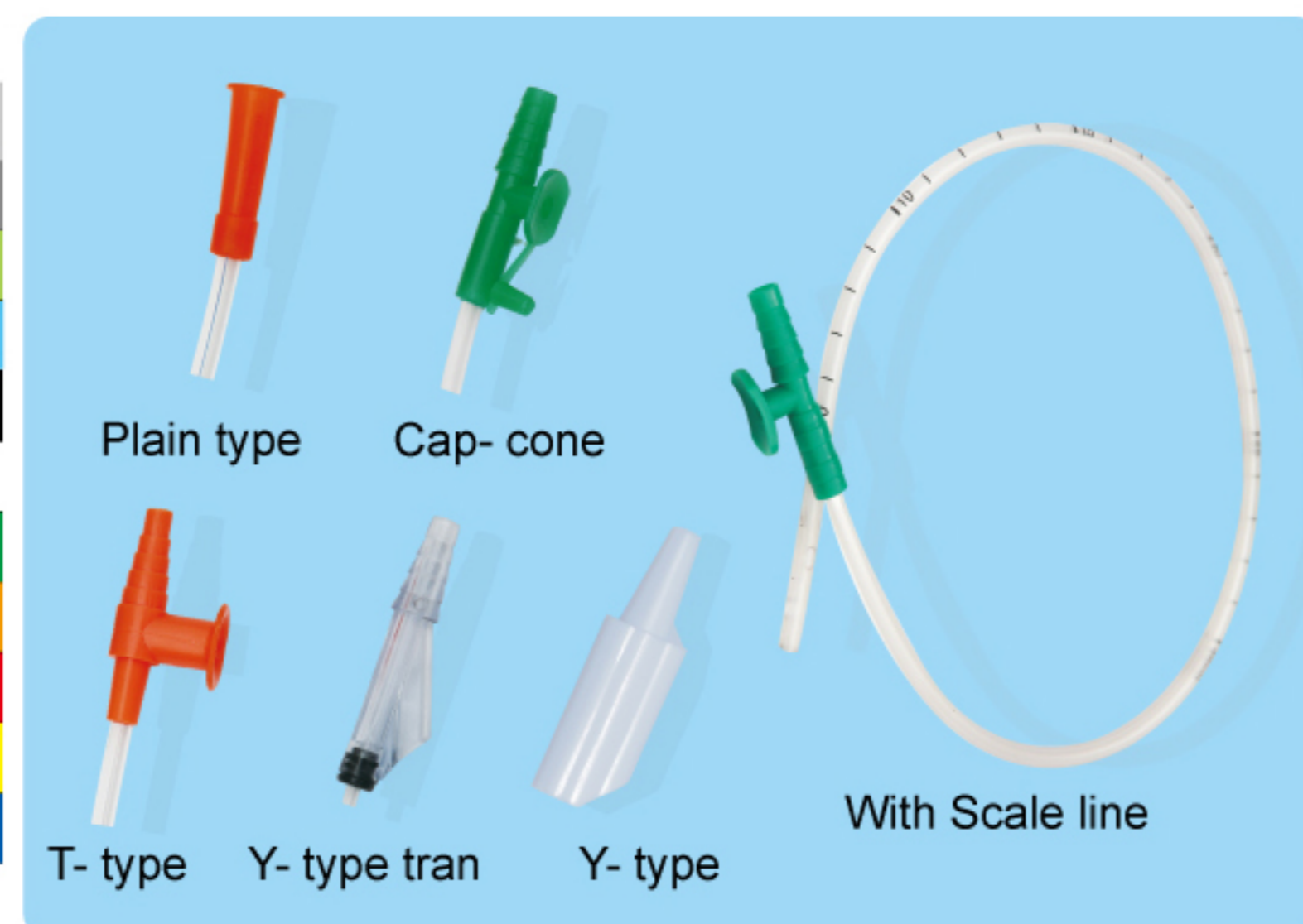

● RECTAL TUBE



Features:

- Soft, frosted and kink resistant PVC tubing.
- For introduction of enema solution into rectum to release.
- Atraumatic, soft, rounded, closed tip with two lateral eyes for efficient drainage.
- Colour coded plain connector for easy identification of size.
- Length:400mm.

Item No.	Item No. (DEHP FREE)	Size (Fr.)	Color code
260 2400	F260 2400	24	Violet
260 2600	F260 2600	26	Red
260 2800	F260 2800	28	Yellow
260 3000	F260 3000	30	Black
260 3200	F260 3200	32	Blue
260 3400	F260 3400	34	Green
260 3600	F260 3600	36	Light Blue

● Mucus Extractor



Features:

- Made from medical grade PVC.
- It is made up of storage bottle, suction catheter, tube and arc joint.
- Storage bottle classifies 25ml,40ml by volume.
- 660 01100 with filtering membrane.

Item No.	Item No. (DEHP FREE)	Size (Fr.)	Size (ml)
660 00906	F660 00906	6	25
660 00908	F660 00908	8	25
660 00910	F660 00910	10	25
660 00912	F660 00912	12	25
660 00914	F660 00914	14	25
660 00916	F660 00916	16	25
660 01000	F660 01000	6-16	40
660 01100	F660 01100	6-16	25

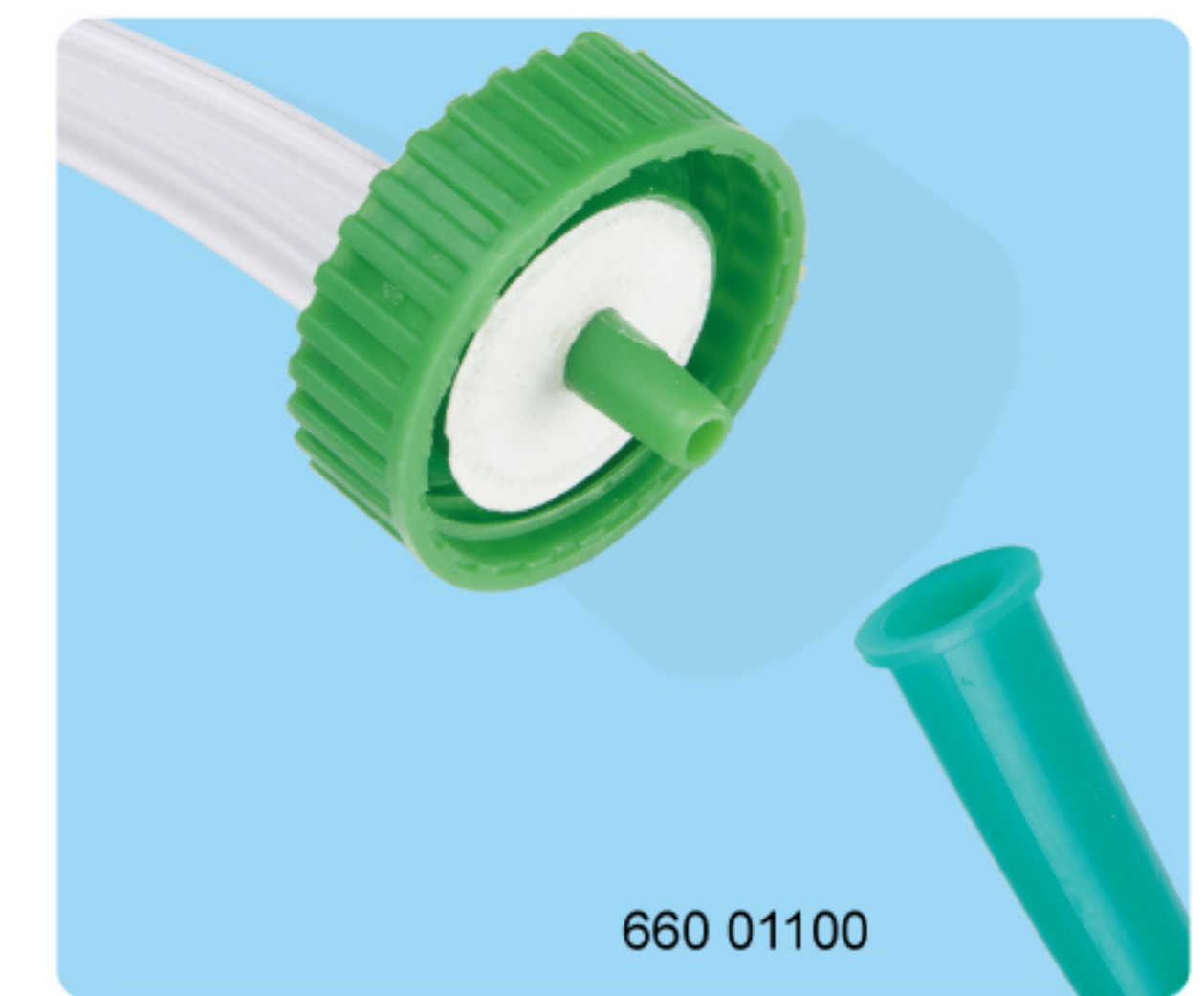

● Connecting Tube with Yankauer Handle



Features:

- Made from non-toxic PVC, clear or soft.
- Different type of connector and Yankauer Handle are available.

Item No.	Size	Length (cm)
660 07001	3/16"(F24)	180
660 07002	3/16"(F24)	360
660 07003	1/4"(F28)	180
660 07004	1/4"(F28)	360
660 07005	9/32"(F30)	180
660 07006	9/32"(F30)	360
660 07007	9/32"(F32)	180
660 07008	9/32"(F32)	360

● Suction Connecting Tube

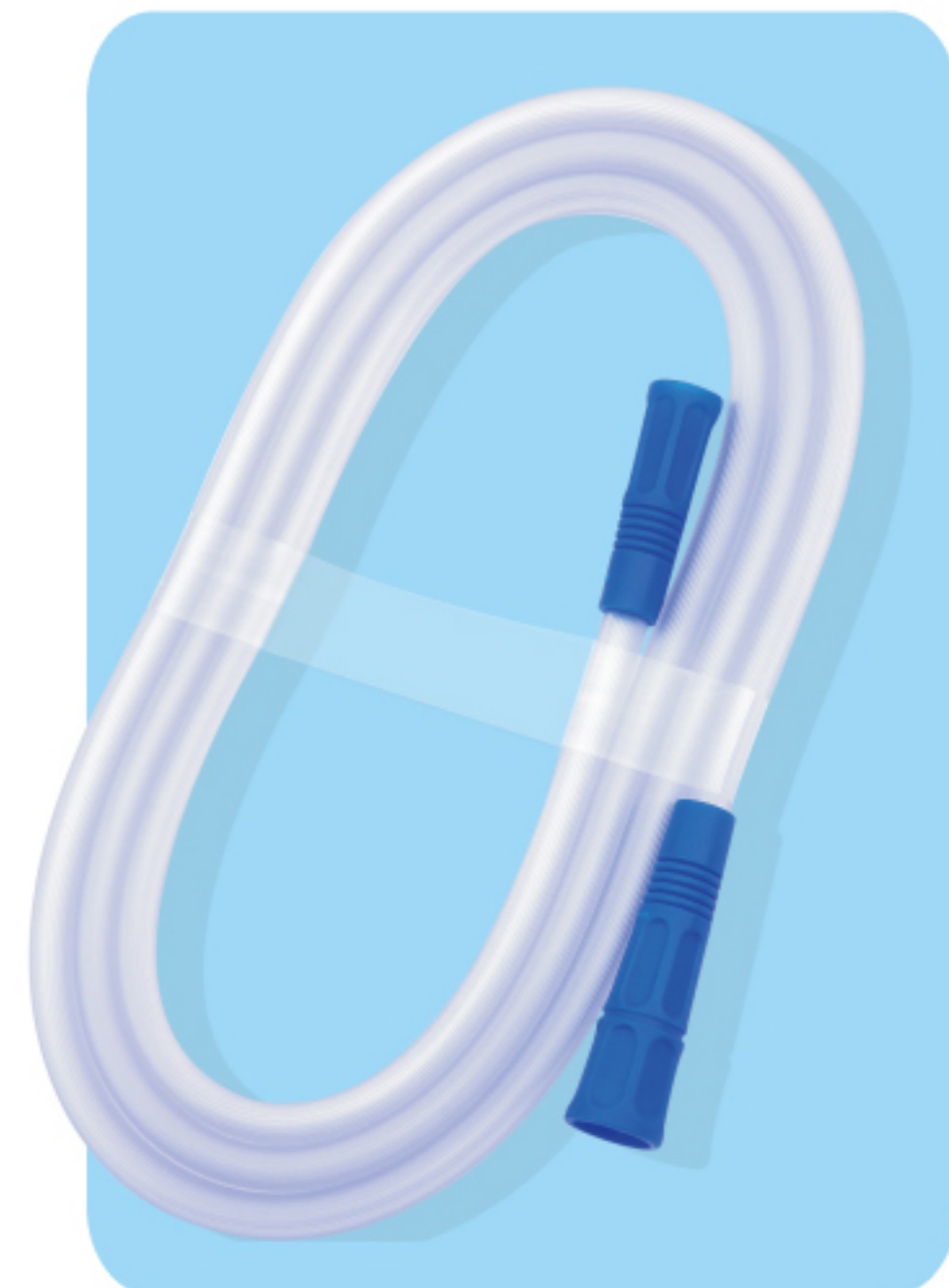

Features:

- Made from non-toxic PVC, medical grade.
- Length: 1.8m,2.5m,3.6m for choice.
- Different type of connector are available.

Item No.	Size	Length (cm)
661 24020	3/16"(F24)	180
661 24025	3/16"(F24)	250
661 24030	3/16"(F24)	360
661 28020	1/4"(F28)	180
661 28025	1/4"(F28)	250
661 28030	1/4"(F28)	360
661 30020	9/32"(F30)	180
661 30025	9/32"(F30)	250
661 30030	9/32"(F30)	360
661 32020	9/32"(F32)	180
661 32025	9/32"(F32)	250
661 32030	9/32"(F32)	360



A-Type



B-Type



C-Type



D-Type

● Yankauer Handle



Features:

- Made from non-toxic PVC.
- Different type are available including standard type,
- Medium type and Large type;
- Crown tip and standard tip are available bothly;

Item No.	Size	Style
660 08010	Large	Crown tip with vent
661 08010	Large	Crown tip without vent
660 08020	Medium	Bulb tip with vent
661 08020	Medium	Bulb tip without vent
660 08030	Small	Flat tip with vent
661 08030	Small	Flat tip without vent
662 08010	Medium lengthening	Standard tip with vent
662 08020	Large lengthening	Standard tip with vent

Anesthesia And Respiratory Products 麻醉人工气道

● Endotracheal Tube

◆ Standard Endotracheal Tube

Uncuffed

Features:

- Non-toxic,medical grade PVC material
- X-ray opaque line.
- Clear markings for easy observation.
- Murphy eye design.
- Standard 15mm ISO connector



Item No.	Item No. (DEHP FREE)	Size (Fr.)	Size ID(mm)
551 08020	F551 08020	8	2.0
551 10025	F551 10025	10	2.5
551 12030	F551 12030	12	3.0
551 14035	F551 14035	14	3.5
551 16040	F551 16040	16	4.0
551 18045	F551 18045	18	4.5
551 20050	F551 20050	20	5.0
551 22055	F551 22055	22	5.5
551 24060	F551 24060	24	6.0
551 26065	F551 26065	26	6.5
551 28070	F551 28070	28	7.0
551 30075	F551 30075	30	7.5
551 32080	F551 32080	32	8.0
551 34085	F551 34085	34	8.5
551 36090	F551 36090	36	9.0
551 38095	F551 38095	38	9.5
551 40100	F551 40100	40	10.0

* A available with Magill type(without Murphy eye).For details,please check website: www.tnmedical.cn.

Cuffed

Features:

- Non-toxic, medical grade PVC material .
- High volume low pressure cuff maintains good sealing.
- Murphy eye design.
- Smooth cuff edges reduce trauma.



Item No.	Item No. (DEHP FREE)	Size (Fr.)	Size ID(mm)
552 12030	F552 12030	12	3.0
552 14035	F552 14035	14	3.5
552 16040	F552 16040	16	4.0
552 18045	F552 18045	18	4.5
552 20050	F552 20050	20	5.0
552 22055	F552 22055	22	5.5
552 24060	F552 24060	24	6.0
552 26065	F552 26065	26	6.5
552 28070	F552 28070	28	7.0
552 30075	F552 30075	30	7.5
552 32080	F552 32080	32	8.0
552 34085	F552 34085	34	8.5
552 36090	F552 36090	36	9.0
552 38095	F552 38095	38	9.5
552 40100	F552 40100	40	10.0

* Available with Magill type(without Murphy eye).For details,please check website: www .tnmedical.cn.

● **Reinforced Endotracheal Tube**

Uncuffed

Features:

- Soft, flexible PVC tube with spiral reinforced wire reducing risk of kinking.
- Designed for neurosurgical procedures, head and neck procedures, etc.

Item No.	Item No. (DEHP FREE)	Size(Fr.)	Size ID(mm)
553 12030	F553 12030	12	3.0
553 14035	F553 14035	14	3.5
553 16040	F553 16040	16	4.0
553 18045	F553 18045	18	4.5
553 20050	F553 20050	20	5.0
553 22055	F553 22055	22	5.5
553 24060	F553 24060	24	6.0
553 26065	F553 26065	26	6.5
553 28070	F553 28070	28	7.0
553 30075	F553 30075	30	7.5
553 32080	F553 32080	32	8.0
553 34085	F553 34085	34	8.5
553 36090	F553 36090	36	9.0
553 38095	F553 38095	38	9.5

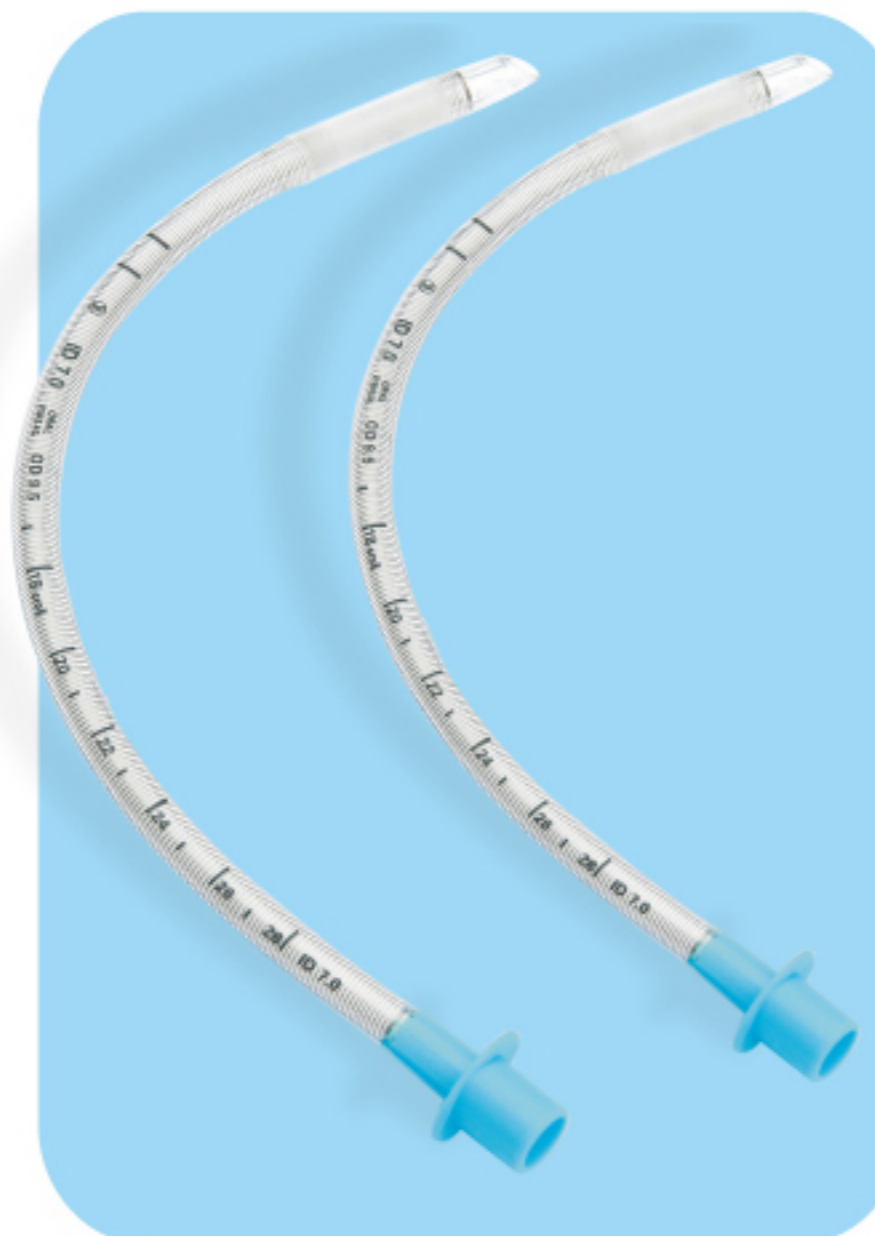

* Available with Magill type(without Murphy eye).For details,please check website: www .tnmedical.cn

Cuffed

Features:

- Soft, flexible PVC tube with spiral reinforced wire reducing risk of kinking.
- Designed for neurosurgical procedures, head and neck procedures, etc.
- High volume, low pressure cuff maintains good sealing.

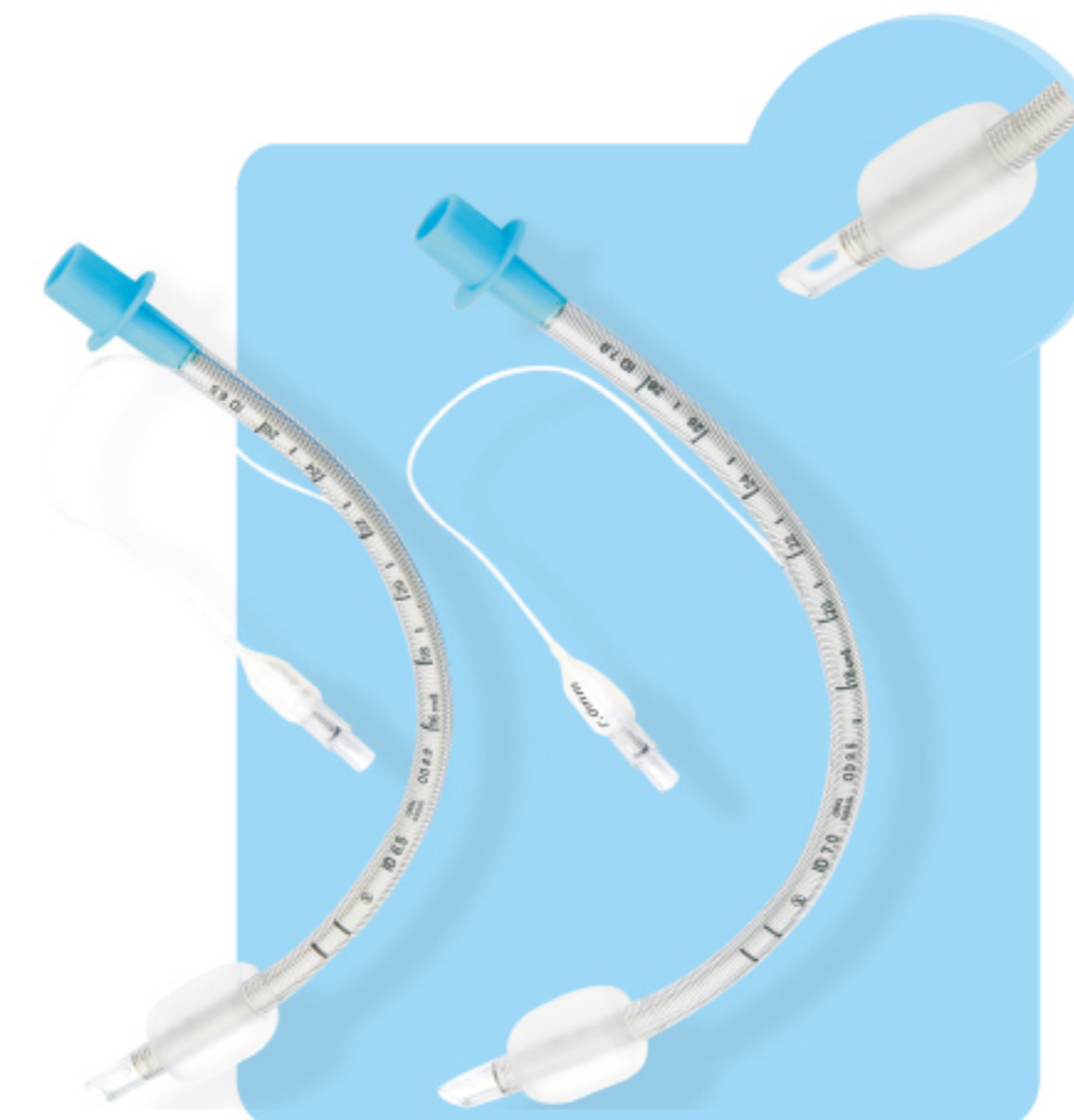

Item No.	Item No. (DEHP FREE)	Size(Fr.)	Size ID(mm)
554 12030	F554 12030	12	3.0
554 14035	F554 14035	14	3.5
554 16040	F554 16040	16	4.0
554 18045	F554 18045	18	4.5
554 20050	F554 20050	20	5.0
554 22055	F554 22055	22	5.5
554 24060	F554 24060	24	6.0
554 26065	F554 26065	26	6.5
554 28070	F554 28070	28	7.0
554 30075	F554 30075	30	7.5
554 32080	F554 32080	32	8.0
554 34085	F554 34085	34	8.5
554 36090	F554 36090	36	9.0
554 38095	F554 38095	38	9.5

* Available with Magill type(without Murphy eye).For details,please check website: www .tnmedical.cn.

● **Oral Pharyngeal Airway**

◆ **Guedel Type**

Features:

- Made from seririgid, non-toxic polyethylene.
- Color-coded bite block.

Item No.	Item No. (DEHP FREE)	Size(Fr.)	Color code
581 10400	F581 10400	40 /000#	Pink
581 10500	F581 10500	50 /00#	Blue
581 10600	F581 10600	60 /0#	Black
581 10700	F581 10700	70 /1#	White
581 10800	F581 10800	80 /2#	Green
581 10900	F581 10900	90 /3#	Yellow
581 11000	F581 11000	100 /4#	Red
581 11100	F581 11100	110 /5#	Light Blue
581 11200	F581 11200	120 /6#	Orange

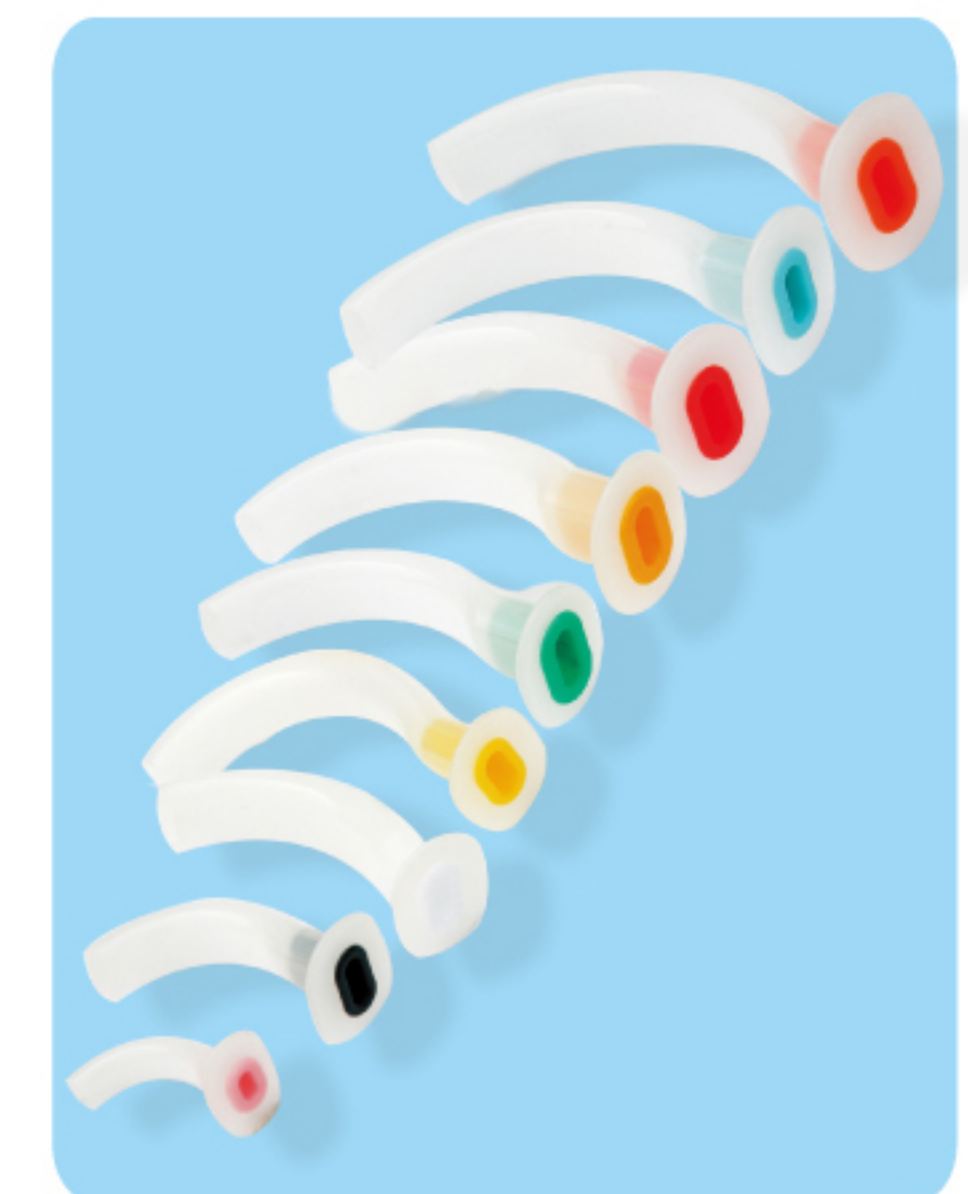

Respiratory products 呼吸系统

● Nasal oxygen cannula

Item No.	Size	Length
270 01000	Adult straight	2.1m
270 02000	Child straight	2.1m
270 03000	Infant straight	2.1m
270 04000	Neonate straight	2.1m
270 11000	Adult soft curved tip	2.1m
270 12000	Child soft curved tip	2.1m
270 13000	Infant soft curved tip	2.1m
270 14000	Neonate soft curved tip	2.1m

* Different length is available

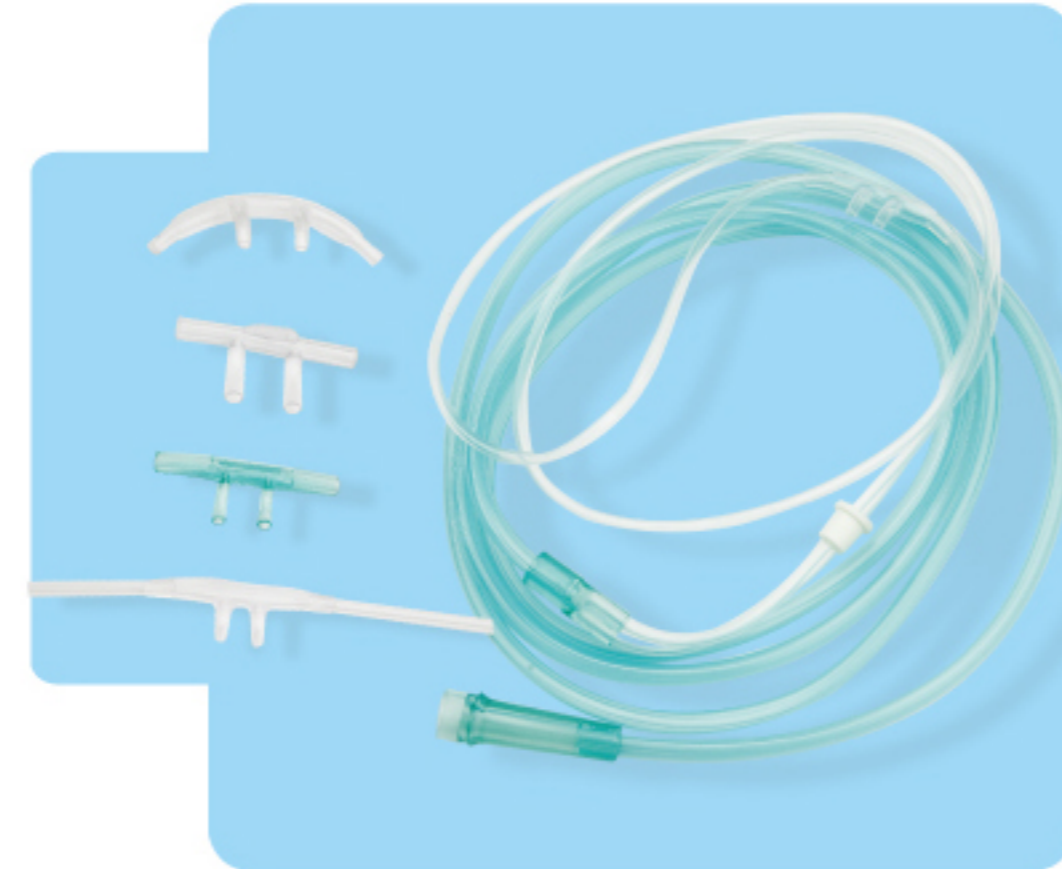

● MASK

◆ Oxygen Mask

Features:

- Material: Made of clear, non-toxic PVC.
- Adjustable nose clip assures comfortable fit
- Color: White, Green



Item No.	Size	Length
331 01000	Adult standard	2.0m tubing
331 02000	Child standard	2.0m tubing
331 03000	Infant standard	2.0m tubing
331 11000	Adult elongated	2.0m tubing
331 12000	Child elongated	2.0m tubing
331 13000	Infant elongated	2.0m tubing

◆ Multi-vent Mask

Features:

- Safe, simple delivery of oxygen with different concentrations.
- Includes color -code, low and medium concentration diluters. locking ring secures flow setting.
- Low concentration for 24%, 26%, 28% and 30%.
- Medium concentration for 35%, 40% and 50%.

Item No.	Size	Length
333 01000	Adult standard	2.0m tubing
333 11000	Child standard	2.0m tubing
333 02000	Infant standard	2.0m tubing
333 12000	Adult elongated	2.0m tubing
333 03000	Child elongated	2.0m tubing
333 13000	Infant elongated	2.0m tubing



◆ Non-Rebreath Mask (with oxygen bag)



Features:

- Made from medical PVC.
- Designed for high oxygen concentration.

Item No.	Size	Length
334 01000	Adult standard	1000ml bag/2.0m tubing
334 02000	Child standard	600ml bag/2.0m tubing
334 03000	Infant standard	600ml bag/2.0m tubing
334 11000	Adult elongated	1000ml bag/2.0m tubing
334 03000	Child elongated	600ml bag/2.0m tubing
334 13000	Infant elongated	600ml bag/2.0m tubing

◆ Adjustable Venturi Mask

Features:

- Different venturi connector for different oxygen concentration.

Adult Standard mask:

Item No.	Size	Color Code
339 01240	24%	Blue Venturi
339 01280	28%	Yellow Venturi
339 01310	31%	White Venturi
339 01350	35%	Green Venturi
339 01400	40%	Pink Venturi
339 01500	50%	Orange Venturi



● NEBULIZER & KIT

Features :

- Made from clear non-toxic ABS and PVC.
- Nebulizing at angles up to 45° to accommodate special treatment requirements.
- Atomization rate 0.3 ml/min, Drive flow 4 to 8 LPM.
- Atomization particles < 5μ

20ml Nebulizer with Aerosol Mask

Item No.	Size	Length
335 01000	Adult standard	2.0m tubing
335 02000	Child standard	2.0m tubing
335 03000	Infant standard	2.0m tubing
335 11000	Adult elongated	2.0m tubing
335 12000	Child elongated	2.0m tubing
335 13000	Infant elongated	2.0m tubing



6ml Nebulizer with Aerosol Mask

Item No.	Size (ml.)	Length
337 01000	Adult standard	2.0m tubing
337 02000	Child standard	2.0m tubing
337 03000	Infant standard	2.0m tubing
337 11000	Adult elongated	2.0m tubing
337 12000	Child elongated	2.0m tubing
337 13000	Infant elongated	2.0m tubing

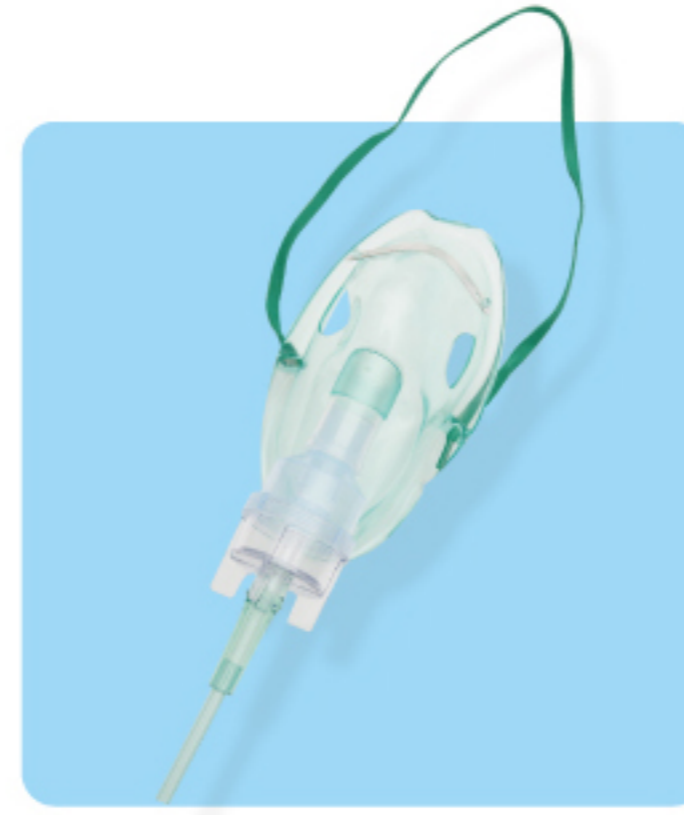

● Nebulizer with Mouth Piece



Features:

- Made from clear non-toxic ABS and PVC .
- Nebulizing at angles up to 45° to accommodate special treatment requirements.
- Atomization rate 0.3 ml/min, Drive flow 4 to 8 LPM.
- Atomization particles < 5μ

Item No.	Type
339 01006	6ml Jar with mouth piece, 2.0m tubing
339 01020	20ml Jar with mouth piece, 2.0m tubing



● Simple Nebulizer with Mouth Piece

Item No.	Type
339 02006	6ml Jar with mouth piece, 2.0m tubing
339 02020	20ml Jar with mouth piece, 2.0m tubing
339 03006	Curved beak/6ml Jar with mouth piece, 2.0m tubing
339 03020	Curved beak/20ml Jar with mouth piece, 2.0m tubing

● Tracheostomy Mask

Features:

- Designed for oxygen treatment or aerosol therapy on tracheostomy patient.
- The mask is soft and gentle, which deliver the great comfort to patient.
- Can rotate 360°, there is a hole at the top for expiration and suction.
- Atomization particles < 5μ

Item No.	Type
340 01000	Adult
340 02000	Children



800 6012

800 6014

800 6015



Other Product 其他产品

● Vaginal Speculum

Features:

- Made of PS, non-toxic, medical grade.
- Different type are available.

Item No.	Size	Style
660 11101	Large	Push-Pull Type
660 11102	Medium	Push-Pull Type
660 11103	Small	Push-Pull Type
660 11201	Large	Middle Screw
660 11202	Medium	Middle Screw
660 11203	Small	Middle Screw
660 11301	Large	Lateral Screw
660 11302	Medium	Lateral Screw
660 11303	Small	Lateral Screw
660 11401	Large	With Hook
660 11402	Medium	With Hook
660 11403	Small	With Hook



660 11201

* Please check website: www.tnmedical.cn.

● Urine cup



660 02000

660 02600

Features:

- Material: PP for Medical-use
- Color: Red, Green, Orange, We can do it as clients' request

Item No.	Volume(ml.)
660 02000	100
660 02600	60

● Umbilical Cord Clamp

Features:

- Material: PE, ABS material
- PE, ABS material
- White & blue color for choice

Item No.	Style
660 01000	one pin
660 01020	two pins



● **Amnio Hook**

Features:

- Material: White PP material.
- Amniotic membrane perforator.



Item No.	Size(cm)
660 0400	

● **ID BAND**

Features:

- Material: Made of non-toxic PVC
- OEM service offered



661 22000

Item No.	Size (cm)	Material
660 21000	Adult	Pvc material with name card
660 22000	Child	Pvc material with name card
660 23000	Maternal and child	Pvc material with name card
661 21000	Adult	Pvc material
661 22000	Child	Pvc material
661 23000	Maternal and child	Pvc material

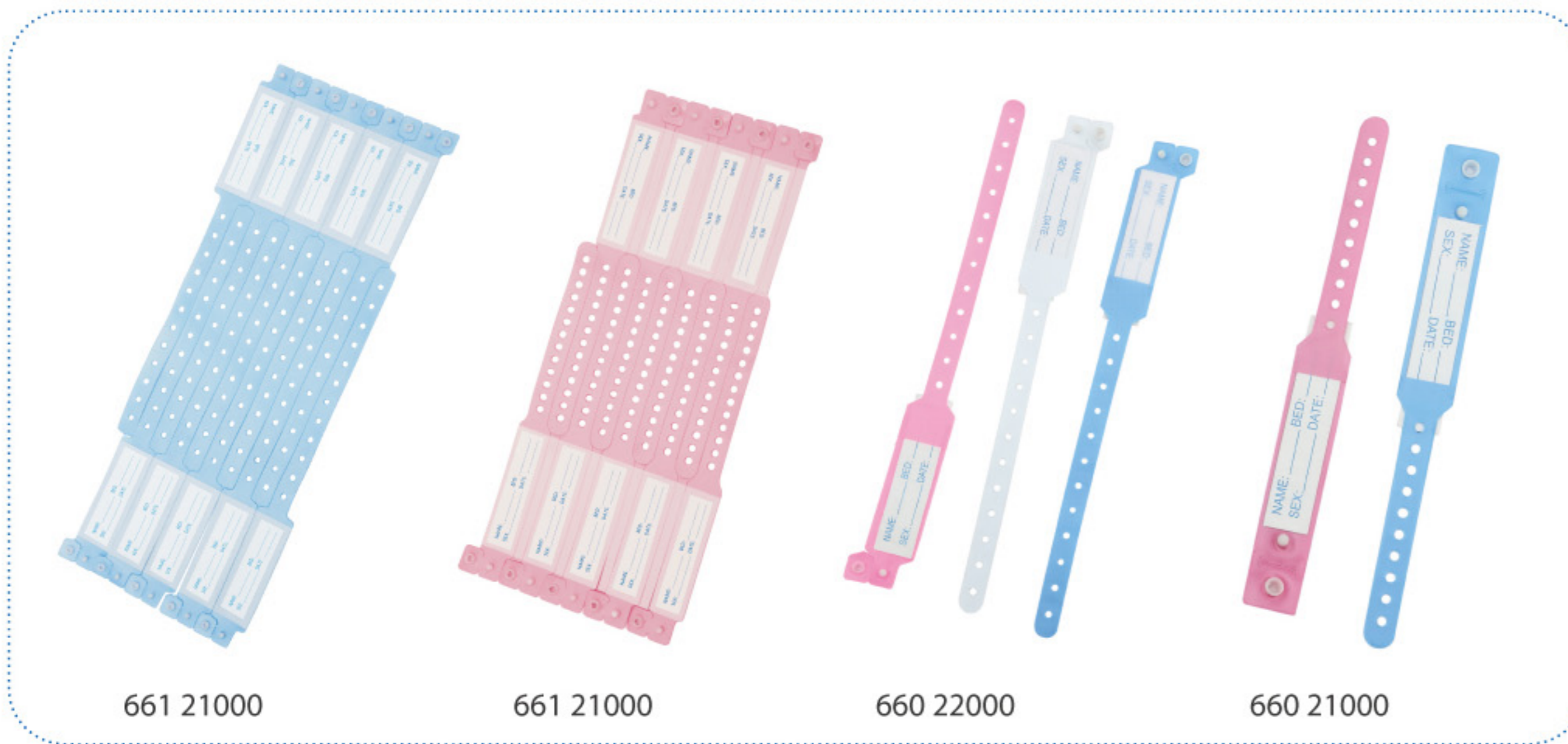

661 21000

661 21000

660 22000

660 21000

Component 配件



800 0510

800 0401

800 0402

800 0403



800 0404

800 0405

800 0406

800 0407

800 0408

800 0600

800 0601

800 0700

800 0701

800 0702

800 0703

800 0704

800 3001

800 3002

800 3003

800 5000

800 1900

800 1902

800 1904

800 2100

800 3800

800 0100

800 0120

800 0301

800 0302

800 3901

800 3902

800 3903

800 3904



TAINING
medical

2013

常熟市泰宁医疗器械有限责任公司
地址：江苏省常熟市辛庄镇光华工业园区
邮编：215562
电话：0512-52475876 0512-52472883
传真：0512-52471231
电子传真：400 6981 163转18176
E-mail：cs.taining@vip.163.com
Web：www.tnmedical.cn

CHANGSHU TAINING MEDICAL EQUIPMNT CO.,LTD
ADD: NAN SUOU,YANGYUAN TOWN,
CHANGSHU,JIANSU,215562,CHINA
TEL: +86-512-52475876 52472883
FAX: +86-512-52471231
E-FAX: 400 6981 163 * 18176
E-mail: cs.taining @ vip.163.com
Web: www.tnmedical.cn

TAINING
MEDICAL EQUIPMENT



常熟市泰宁医疗器械有限责任公司
Changshu Taining Medical Equipment Co., Ltd



专业让我们出众，服务让客户放心



厂房设备
Workshops & Equipments

