

# EcoFit® cup EPORE®







# TABLE OF CONTENTS

PREOPERATIVE PLANNING.....	4
DESIGN CHARACTERISTICS.....	5
SYSTEM OVERVIEW.....	6
SURGICAL TECHNIQUE.....	7
IMPLANTS.....	20
INSTRUMENTS.....	25
PRE- / POST-OPERATIVE INSTRUCTIONS.....	35
INDICATIONS / CONTRAINDICATIONS.....	36

**Nota Bene:** The author of this technique has outlined the procedure for the uncomplicated surgical scenario. Ultimately however it is the operating surgeon who is best placed to assess and address the individual needs of each patient.

**Copyright Information:** EcoFit®, EPORE®, implaFix®, implavit®, implatan®, implacross® and GIS® are registered trademarks of implantcast GmbH. The use and/or copying of the content of this brochure, be it wholly or in part, is only allowed with the prior written permission of implantcast GmbH. BIOLOX® is a trademark of CeramTec AG.

# PREOPERATIVE PLANNING

Pre-operative planning and precise surgical techniques are mandatory for optimal results. The instructions and the procedure given in the surgical technique to the system must be adhered to. Familiarity with the recommended surgical technique and its careful application is essential to achieve the best possible outcome.

Before surgery a surgical planning with regard to the dimensions of the prosthetic model and the positioning of the implant components in the bone has to be carried out by the surgeon.

For this purpose, x-ray templates are available:

**Digital templates:** Digital templates are included in the data base of the common planning systems. For missing templates, please contact the provider of the planning software and request for these templates.

**Radiographic templates:** Alternatively radiographic templates are available in various scale factors, which can be obtained from your local representative.

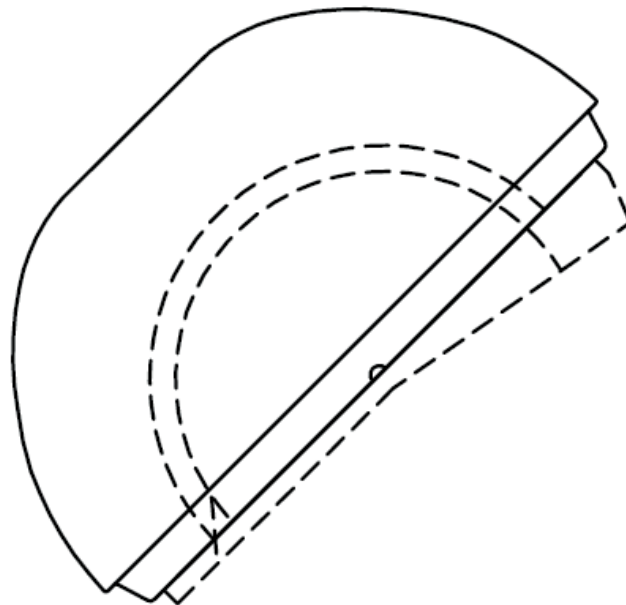

For more information, please refer to the instructions for use „cementless acetabular cup systems“ (09300038GB) and this surgical technique from page 35.

# DESIGN CHARACTERISTICS

## **Pole-area:**

- ⊗ gap between cup and acetabulum
- ⊗ protection of the bone

## **Fit-area:**

- ⊗ reduction of tension towards the pole area

## **PressFit-area:**

- ⊗ safety against tilting and migration

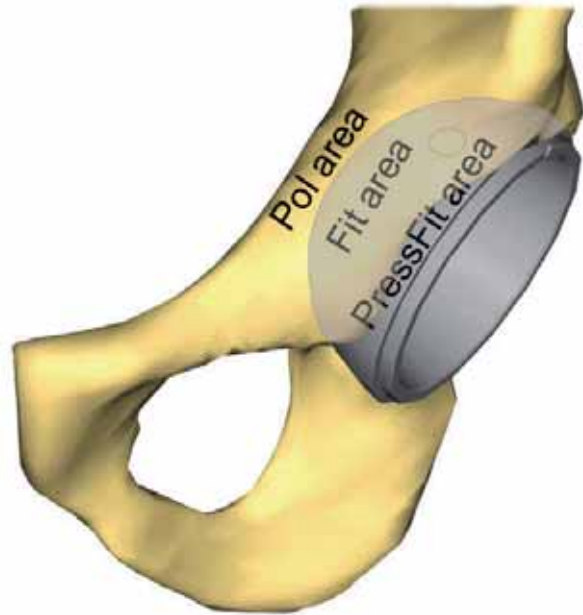

The 'Low Profile' design of the cementless EcoFit® acetabular system is defined to enhance the stability and to support long-lasting bony integration.

## **Pole-area**

The PressFit of hemispherical acetabular implants results from under-reaming of the implant bed. The resulting PressFit acts upon the total bony area of contact. In the area of the acetabular base and in the pole area respectively this action is undesirable, because the resulting forces hold the risk of migration and loosening of the implant. For this reason the EcoFit® EPORE® cup is flattened in order to guarantee the protection of the bone and to reduce the risk of loosening.

























## **PressFit-area**

The EcoFit® EPORE® cup locks stable through a peripheral enhanced PressFit. The PressFit grows progressively with the external diameter of the EcoFit® EPORE® acetabular implants. The primary stability decisively depends on the rate of tensions which appear during insertion of the implant. The degrees of these bone tensions are defined by the rate of the under-reaming. On equal under-reaming with all implant diameters you can see an increase of the resulting bone tensions rising with the growing diameter of the cups.

## **Fit area**

The cup has also got the EPORE® surface structure in the adjacent Fit area in order to enhance the osseointegration. The geometry corresponding to the reaming of the cup leads to reduced tensions in direction to the pole.

# SYSTEM OVERVIEW

42-44mm	46-48mm	50-54mm	56-58mm	60-72mm	
					EcoFit® cup EPORE®
not available	 28 / 39 32 / 39*	 28 / 44 32 / 44 36 / 44*	 28 / 48 32 / 48 36 / 48	 28 / 52 32 / 52 36 / 52	PE-insert 0° UHMWPE acc. to ISO 5834-2 or implacross®
 28 / 35*	 28 / 39 32 / 39*	 28 / 44 32 / 44 36 / 44*	 28 / 48 32 / 48 36 / 48	 28 / 52 32 / 52 36 / 52	PE-insert 10° UHMWPE acc. to ISO 5834-2 or implacross®
 28 / 35	 32 / 39	 32 / 44 36 / 44	 32 / 48 36 / 48 40 / 48	 32 / 52 36 / 52 40 / 52	BIOLOX® delta insert acc. to ISO 6474-2
not available	not available	 38 / 44  22 / 38	 42 / 48  28 / 42	 46 / 52  28 / 46	EcoFit® cup insert acc. to ISO 5832-12 + 2M implacross® E / EcoFit® 2M head

\* only available in implacross®

In order to minimize the micro motions and prevent PE abrasion in the contact area between metal cup and PE insert, a special locking mechanism has been developed. It allows the use of the identical acetabular cup implant for the use of BIOLOX® delta ceramic or PE inserts. The PE inserts are sterilized with ethylene oxide gas to prevent oxidative predegradation of the material. Alternatively PE inserts made of implacross® crosslinked polyethylene, are available. These PE-inserts have shown improved wear characteristics during preclinical tests.

The implants of the EcoFit® EPORE® system show a central hole in the acetabular base. The hole allows the control of the seating and the attachment of the impactor. It is covered by the use of a central screw cover which captures the cover while inserting. The EcoFit® EPORE® cup has three or seven (multihole) covered screw holes. To enhance the primary stability by using screws, the tapered covers may be removed (while the cup is already seated) and screws will be used. The cancellous screws can be angled up to 15°. The cup is also available without three additional holes (EcoFit® EPORE® NH).

# SURGICAL TECHNIQUE

## Preparation of the acetabulum

Please expose the hip joint completely. Resect the articular capsule and the labrum acetabulare. Dissect the bony rim of the acetabulum, if possible, completely.

Remove the osteophytes and the connective tissue of the fossa acetabuli. In order to rebuild normal anatomical proportions, the acetabulum should be medialised to the extent to which you are able to reconstruct the preoperatively chosen centre of rotation.

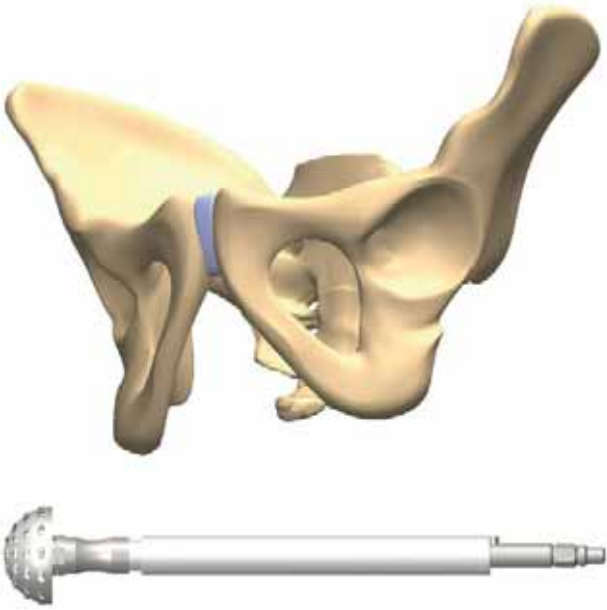

Figure 1

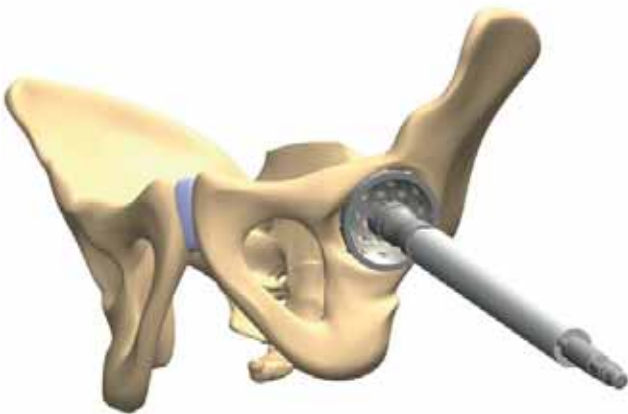

Figure 2

To prepare the acetabular bone, reamers of external diameters in increments of 2mm are available (Fig. 1).

Align the reamer anatomically, in abduction of about 45° and anteversion of 10 - 20°. By using the reamer the acetabulum is prepared until bleeding subchondral bone is reached (Fig. 2).

Please note that the posterior and anterior acetabular rim serve for sizing and therefore should be preserved accordingly.



# SURGICAL TECHNIQUE

## Sizing

Using the trial shells, the size of the prepared implant bed is checked (Fig. 3a).

The slots of the trial shells serve for the determination of the bone contact between the respective trial shell and the prepared acetabulum (Fig. 3b).

Please consider that the trial shells are of a hemispherical shape, while the EcoFit® cup shows a circumferential enhanced PressFit.

### **NOTE:**

For the EcoFit® trial cup Ø 42mm please use the impactor 42mm.

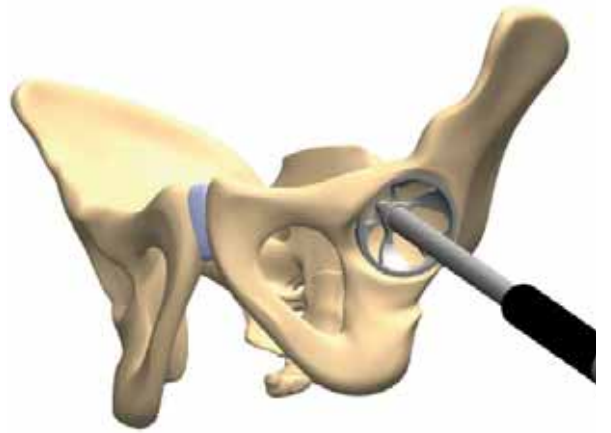

Figure 3b

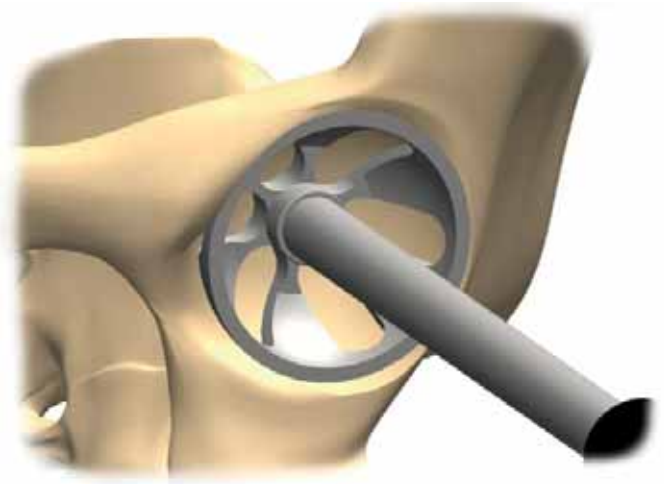

Figure 3c



# SURGICAL TECHNIQUE

## Insertion of the cup

The chosen EcoFit® cup is combined with the universal impactor and inserted in the prepared acetabulum (Fig. 4).

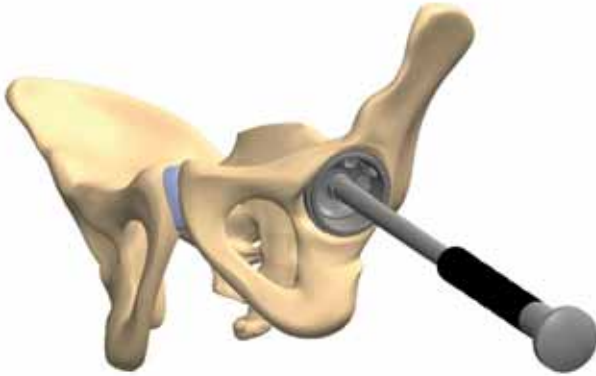

Figure 4

Exactly aligned the EcoFit® cup should rest at an angle of abduction of 45° and an anteversion of 10-20°. The chosen size of the EcoFit® cup should have the same diameter as the previously used reamer. The PressFit of the EcoFit® cup increases proportionally to the cup diameter. The stability of the implant fit (PressFit) and the implant-to-bone contact can be adjusted by moving the impactor at the end of the handle. In doing so the whole pelvic should move without changing the position of the cup in the acetabulum.

If so, you can act on the assumption of a firm primary fit and the impactor can be removed (Fig. 5). Peripheral osteophytes that possibly hinder the femoral implant from its full range of motion have to be removed.

If the stability is not desirable, please consider to use a larger reamer and cup size or consider to use additional cancellous bone screws to enhance the stability (see page 16).

### **NOTE:**

The EcoFit® EPORE® cup 42mm does not have a central bore hole. The cup is placed with the impactor 42mm which is assembled with the cup impactor.

In the case of pathologically altered bone tissue of the operated patient (e.g. Osteosclerosis), there is a risk that during impaction of the EcoFit® EPORE® cup into the bone the crunchplugs may come loose from the cup.

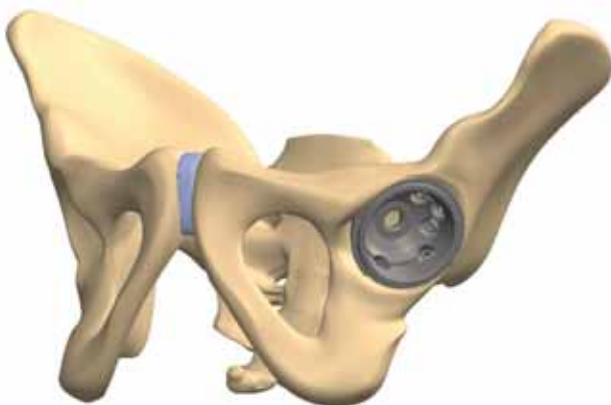

Figure 5

# SURGICAL TECHNIQUE

## Insertion of the central cover

The central hole of the EcoFit® cup has got a thread and is closed with a screw driver. Before inserting the central screw, the central hole has to be cleaned thoroughly by rinsing and sucking off. The captured screw driver holds the cover while inserting (Fig. 6 and Fig. 7)

Make sure that the central cover is seated completely (Fig. 8).

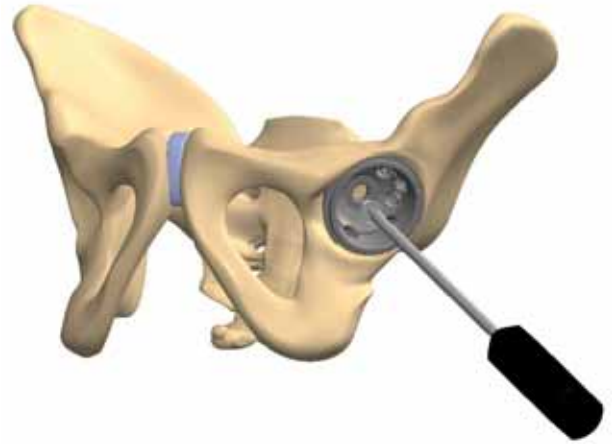

Figure 6

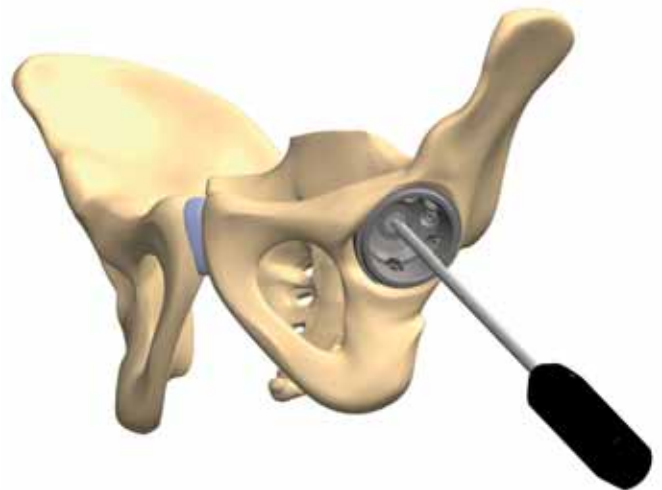

Figure 7



Figure 8

# SURGICAL TECHNIQUE

## Trial reduction

When the EcoFit® cup is fixed firmly in the desired position, a trial insert of the appropriated size may be inserted for the trial reduction.

By the use of the trial insert you avoid damages of the PE and the ceramic insert respectively.

Combine the universal impactor with the trial impactor and insert the trial insert (Fig. 9).

Table 1 shows the colour coding of the trial inserts. The same colour coding could be found on the outside labelling of the implant packages.

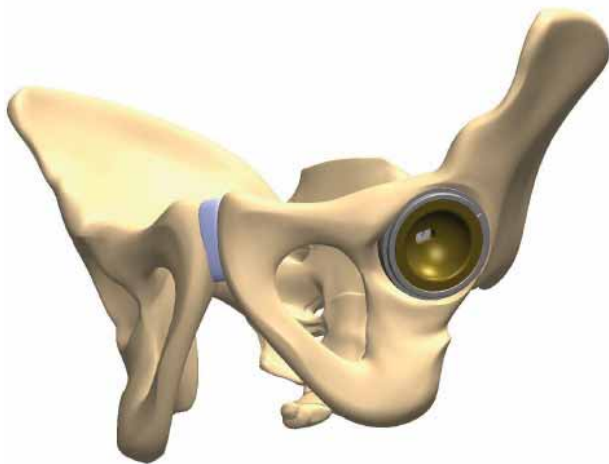

Figure 9



	trial insert 0°		trial for EcoFit® insert
cup Ø 42-44mm			not available
cup Ø 46-48mm			not available
cup Ø 50-54mm			
cup Ø 56-58mm			
cup Ø 60-72mm			

Table 1

# SURGICAL TECHNIQUE

## Removal of the trial insert

Mount the trial insert extractor to the universal impactor.

Insert the tip of the extractor into the bottom hole of the trial insert (Fig. 10) and turn the extractor. It will hook in and the trial insert can be pulled out (Fig. 11).

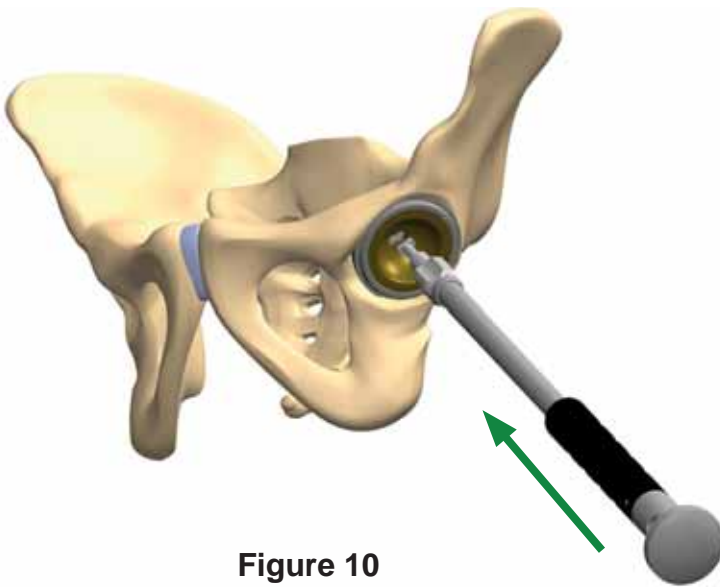

Figure 10

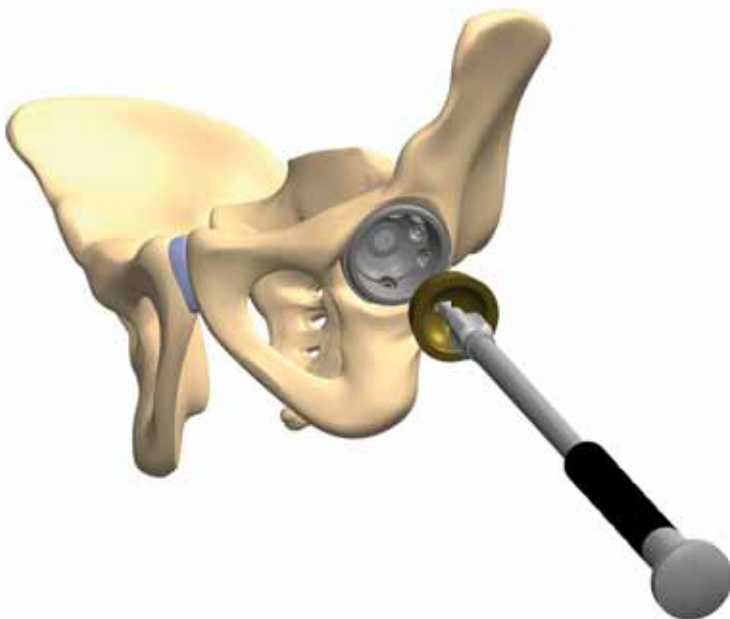
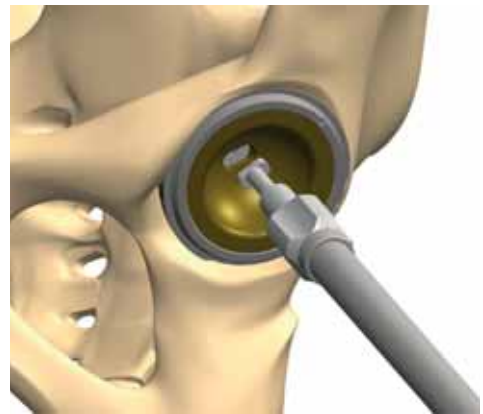

Figure 11

# SURGICAL TECHNIQUE

## Insertion of the PE-insert

Before final insertion of the PE articulation inserts into the EcoFit® cup, the rim and the inner surface have to be cleaned thoroughly. Tissue and bone particles have to be removed.

Combine the impactor for PE insert 10° with the PE insert of the correct size. The two spikes of the impactor will seat firmly into the holes of the PE insert. Before pressing in the PE insert 10° make sure the overhang is placed in the appropriate position. Please respect that the X-mark of the impactor should line up with the mark of the acetabular cup (Fig. 12).

The overhang optimizes the stability of the joint and reduces the tendency to subluxate. Usually the overhang is inserted in the cranio/posterior direction.

The PE insert 0° is inserted by using the non captured impactor as it is used for inserting the ceramic inserts (see next page).

Please make sure that the PE insert fits with stability thus assuring that the snap mechanism of the PE insert is caught completely by the cup (Fig. 13).

If a removal of the PE insert from the EcoFit® cup is necessary for correction, the polyethylene component has to be lifted up and discarded. In no case the PE insert may be inserted into the cup a second time. The use of a new PE insert is mandatory.

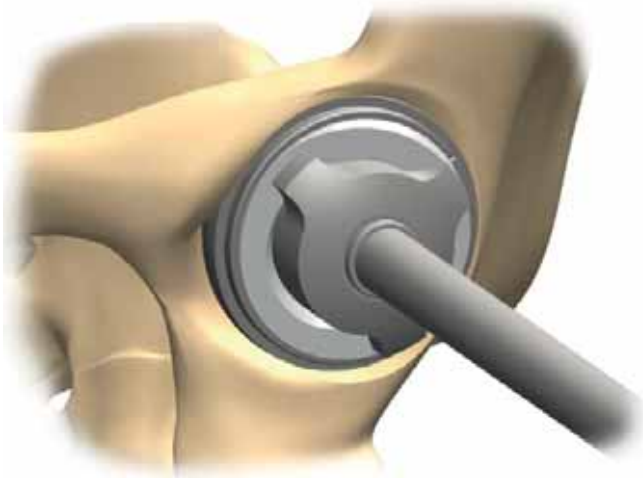

Figure 12



Figure 13



# SURGICAL TECHNIQUE

## Insertion of the ceramic insert

Before final insertion of one of the three insert types into the EcoFit® cup the rim and the inner surface of the cup have to be cleaned thoroughly. Tissue and bone particles have to be removed.

After a positioner for ceramic of the appropriated diameter had been mounted to the universal impactor, the insert is inserted into the cup (Fig. 14).

The insert is conically locked into the EcoFit® cup (Fig. 15a). If a ceramic insert has to be removed in case of revision, only a PE insert may be inserted in the residual cup implant afterwards.

Make sure that the insert is fully seated (Fig. 15b) before final reduction of the joint is performed (Fig. 15c).

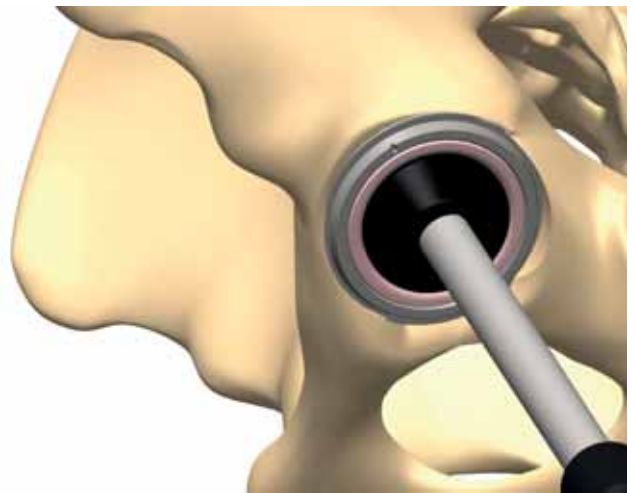

Figure 14



Figure 15a

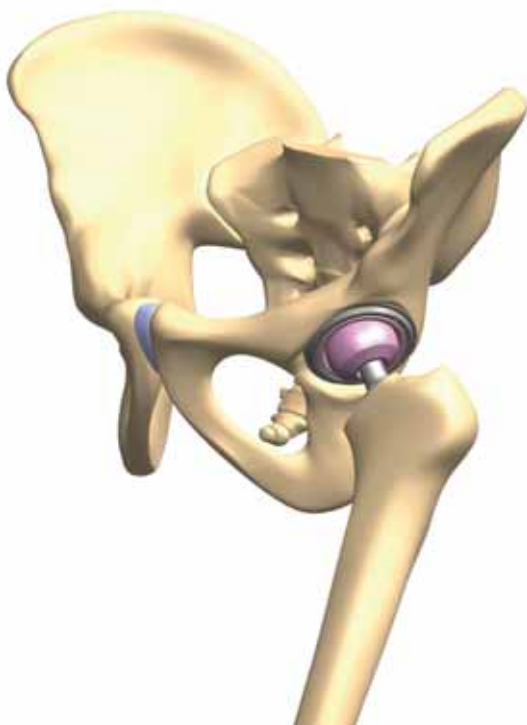

Figure 15c



Figure 15b

# SURGICAL TECHNIQUE

## Impacting of EcoFit® insert (tripolar version)

After a successful trial reduction with the sample inserts for EcoFit® cup insert and the 2M sample head, the selected implant can be used. Before inserting any of the inserts into the EcoFit® cup, the edge and the inner surface of the cup must be freed from tissue and bone particles and carefully cleaned.

The EcoFit® cup insert is then compressed with the impactor. Beforehand, the ladle insert is mounted with the insert for the EcoFit® insert (38mm, 42mm or 46mm) (Fig. 16a).

The EcoFit® insert seizes via taper connection in the EcoFit® cup.

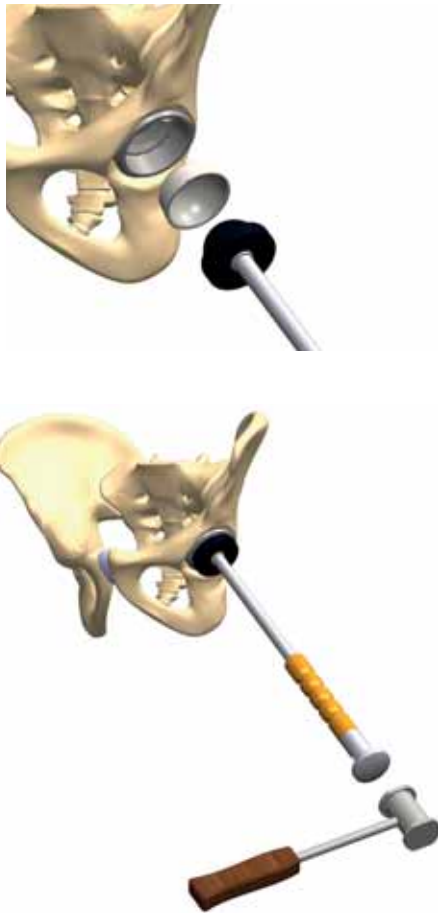

Figure 16a

## Combination of the components

Combine the 2M head of the appropriate size with the desired femoral head (ic femoral head CoCrMo, ic femoral head, BIOLOX® delta) (Fig. 16b). Use the assembling tool for this purpose (Fig. 16c). Head and 2M head are combined by turning the thread of the assembling tool.

With the head impactor and some light hammer blows the combined heads are fixed on the taper of the hip stem.



Figure 16c



Figure 16b



# SURGICAL TECHNIQUE

## Application of screws

The stability of the primary fixation of the cup can be enhanced by the use of additional cancellous bone screws.

The screw holes are covered with plugs that must be removed. Therefore put the screw driver 3,5mm into the relevant plug (Fig. 17a). By right- or leftturning and levering out the plugs can be removed (Fig. 17b). The plug is captured by the tip of the remover and it can be pulled out. The removed plugs (Fig. 18a and 18b) can be wiped off using the plug remover located in the container.

Alternatively, the cup can be placed on a sterile basis. By gently tapping the plug on the outside of the cup, it comes loose and can be removed out of the cup. For this you can use the cross bar tapered which can be found in the hip stem container.

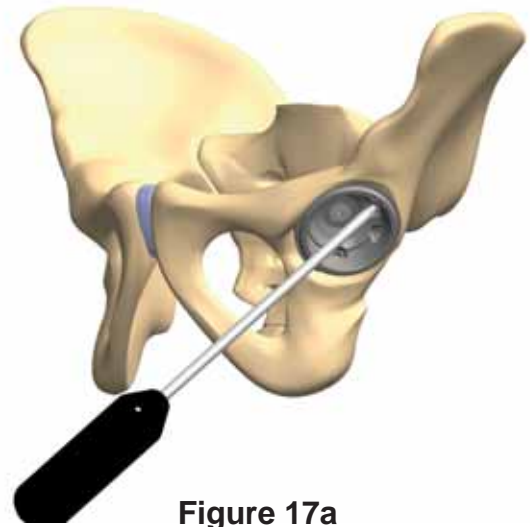

Figure 17a



Figure 17b

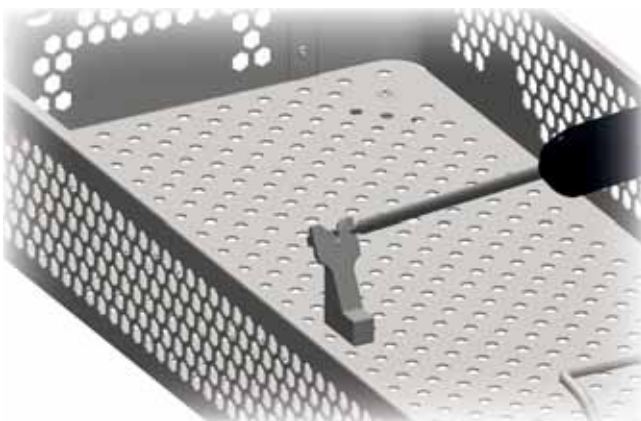

Figure 18a

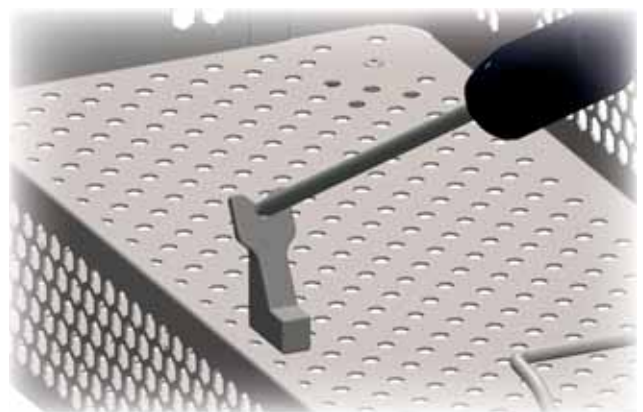
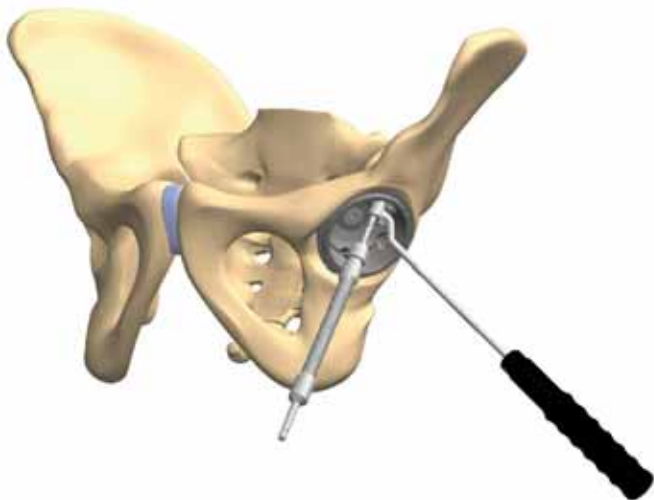

Figure 18b

# SURGICAL TECHNIQUE



Two drill bits are available for preparing the screw holes.



Mount a drill bit to the flexible drill shaft and drill through the drill guide (Fig. 19). Screws can be angled up to 15 degrees.

Flexible drill shafts are allowed to be loaded with a maximum torque of 0,2Nm at a maximum bending of 45°. Pay attention that the flexible part is bent with a preferably uniform bending radius during application. The application with adjustments of narrow nonuniform or s-curved bendings can reduce the lifetime. The form stability of the flexible drill shaft is given for a torque of up to 0,5Nm.

**Figure 19**

When you position the holes, please consider that the most suitable bone for screw fixation is situated in the cranio/posterior parts of the acetabulum, whereas a screw fixation in the os ischii or os pubis leads to an unsatisfactory fit of the screws. In case of inserting the cancellous bone screws in direction to the foramen ischiadicum, you may guard against an injury of the N. ischiadicus by an exact palpation of this part. When positioning the screws and drilling the holes, please act with utmost caution to avoid the penetration of the interior corticalis of the pelvis or the foramen ischiadicum. Please consider the run of the neurovascular structures.

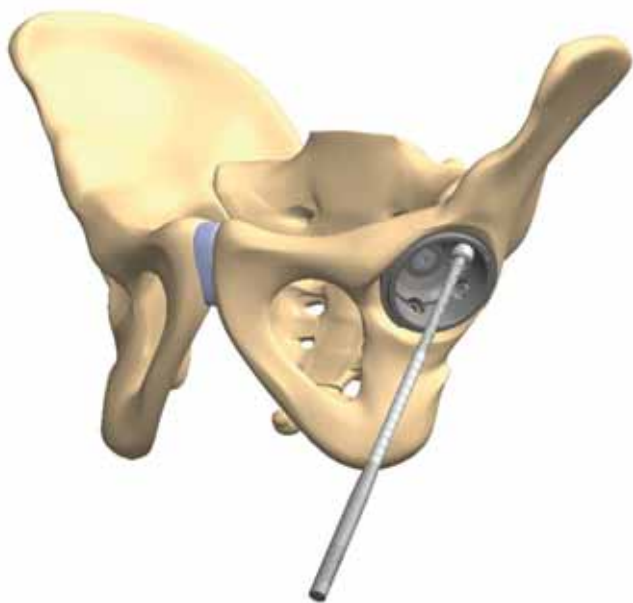
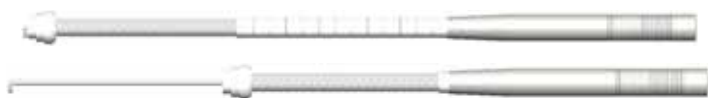

Please insert the depth gauge and determine the required length of the screw (Fig. 20). If you plan to use additional screws, proceed in the same way.

**Figure 20**

# SURGICAL TECHNIQUE

The cancellous screw is inserted into the prepared hole (Fig. 21 and 22). Either a straight or a cardan screwdriver can be used.

Make sure that the head of the cancellous bone screw is completely counter-sunk into the hole of the EcoFit® cup to assure the correct positioning of the cup insert (Fig. 23).

The stability of the implant fit is checked by exercising pressure to the rim of the cup. This stability test must not show any visible motion of the EcoFit® cup.

If the primary stability is still uncertain, an additional fixation of the screw or the use of a cemented acetabular component shall be considered.



Figure 21



Figure 22



Figure 23

# EcoFit® EPORE® cup

# PRODUCT- INFORMATION



IMPLANTS with reference number.....	20
INSTRUMENTS with reference number.....	25



# IMPLANTS

## EcoFit® cup EPORE®, cementless

TiAl<sub>6</sub>V<sub>4</sub> with EPORE®



REF standard	size	REF NH-version
0220-0742	42mm	0220-0942
0220-0744	44mm	0220-0944
0220-0746	46mm	0220-0946
0220-0748	48mm	0220-0948
0220-0750	50mm	0220-0950
0220-0752	52mm	0220-0952
0220-0754	54mm	0220-0954
0220-0756	56mm	0220-0956
0220-0758	58mm	0220-0958
0220-0760	60mm	0220-0960
0220-0762	62mm	0220-0962
0220-0764	64mm	0220-0964
0220-0766	66mm	0220-0966
0220-0768	68mm	0220-0968
0220-0770	70mm	0220-0970
0220-0772	72mm	0220-0972

## EcoFit® cup EPORE® multihole, cementless

TiAl<sub>6</sub>V<sub>4</sub> with EPORE®



REF multihole	size
0220-0642	42mm
0220-0644	44mm
0220-0646	46mm
0220-0648	48mm
0220-0650	50mm
0220-0652	52mm
0220-0654	54mm
0220-0656	56mm
0220-0658	58mm
0220-0660	60mm
0220-0662	62mm
0220-0664	64mm
0220-0666	66mm
0220-0668	68mm
0220-0670	70mm
0220-0672	72mm

# IMPLANTS

## EcoFit® cup EPORE® /TCP, cementless\*

TiAl<sub>6</sub>V<sub>4</sub> with EPORE®, with TCP-coating

REF standard	size	REF NH-version
0220-2042	42mm	0220-7042
0220-2044	44mm	0220-7044
0220-2046	46mm	0220-7046
0220-2048	48mm	0220-7048
0220-2050	50mm	0220-7050
0220-2052	52mm	0220-7052
0220-2054	54mm	0220-7054
0220-2056	56mm	0220-7056
0220-2058	58mm	0220-7058
0220-2060	60mm	0220-7060
0220-2062	62mm	0220-7062
0220-2064	64mm	0220-7064
0220-2066	66mm	0220-7066
0220-2068	68mm	0220-7068
0220-2070	70mm	0220-7070
0220-2072	72mm	0220-7072



## EcoFit® cup EPORE® / TCP multihole, cementless\*

TiAl<sub>6</sub>V<sub>4</sub> with EPORE®, with TCP-coating

REF multihole	size
0220-6042	42mm
0220-6044	44mm
0220-6046	46mm
0220-6048	48mm
0220-6050	50mm
0220-6052	52mm
0220-6054	54mm
0220-6056	56mm
0220-6058	58mm
0220-6060	60mm
0220-6062	62mm
0220-6064	64mm
0220-6066	66mm
0220-6068	68mm
0220-6070	70mm
0220-6072	72mm



\* only available on special request

# IMPLANTS

## spongiosa screw flat head Ø 6,5mm

implatan®, TiAl<sub>6</sub>V<sub>4</sub> acc. to ISO 5832-3



REF	length
0280-1015	15mm
0280-1020	20mm
0280-1025	25mm
0280-1030	30mm
0280-1035	35mm
0280-1040	40mm
0280-1045	45mm

The spongiosa screws are included in the shipment till length 50mm. We are providing lengths till 80mm on request.

## BIOLOX® delta-cup insert

BIOLOX® delta ceramic Al<sub>2</sub>O<sub>3</sub> and ZrO<sub>2</sub>  
acc. to ISO 6474-2



REF	size
0220-2835	insert 28/35 (42-44mm)
0220-3239	insert 32/39 (46-48mm)
0220-3244	insert 32/44 (50-54mm)
0220-3644	insert 36/44 (50-54mm)
0220-3248	insert 32/48 (56-58mm)
0220-3648	insert 36/48 (56-58mm)
0220-4048*	insert 40/48 (56-58mm)
0220-3252	insert 32/52 (60-72mm)
0220-3652	insert 36/52 (60-72mm)
0220-4052*	insert 40/52 (60-72mm)

## PE cup insert 0°

UHMWPE acc. to ISO 5834-2



REF	size
0280-2039	insert 28/39 (46-48mm)
0280-2044	insert 28/44 (50-54mm)
0280-3444	insert 32/44 (50-54mm)
0280-2048	insert 28/48 (56-58mm)
0280-3448	insert 32/48 (56-58mm)
0280-4448	insert 36/48 (56-58mm)
0280-2052	insert 28/52 (60-72mm)
0280-3452	insert 32/52 (60-72mm)
0280-4452	insert 36/52 (60-72mm)

\*only available on request



# IMPLANTS

## PE cup insert 10°

UHMWPE acc. to ISO 5834-2

REF	size
0280-2139	insert 28/39 (46-48mm)
0280-2144	insert 28/44 (50-54mm)
0280-3144	insert 32/44 (50-54mm)
0280-2148	insert 28/48 (56-58mm)
0280-3148	insert 32/48 (56-58mm)
0280-4548	insert 36/48 (56-58mm)
0280-2152	insert 28/52 (60-72mm)
0280-3152	insert 32/52 (60-72mm)
0280-4552	insert 36/52 (60-72mm)



## implacross® PE cup insert 0°

crosslinked UHMWPE

REF	size
0223-2839	insert 28/39 (46-48mm)
0223-3239	insert 32/39 (46-48mm)
0223-2844*	insert 28/44 (50-54mm)
0223-3244	insert 32/44 (50-54mm)
0223-3644	insert 36/44 (50-54mm)
0223-2848*	insert 28/48 (56-58mm)
0223-3248	insert 32/48 (56-58mm)
0223-3648	insert 36/48 (56-58mm)
0223-2852*	insert 28/52 (60-72mm)
0223-3252	insert 32/52 (60-72mm)
0223-3652	insert 36/52 (60-72mm)



## implacross® PE cup insert 10°

crosslinked UHMWPE

REF	size
0224-2835	insert 28/35 (42-44mm)
0224-2839	insert 28/39 (46-48mm)
0224-3239	insert 32/39 (46-48mm)
0224-2844*	insert 28/44 (50-54mm)
0224-3244	insert 32/44 (50-54mm)
0224-3644	insert 36/44 (50-54mm)
0224-2848*	insert 28/48 (56-58mm)
0224-3248	insert 32/48 (56-58mm)
0224-3648	insert 36/48 (56-58mm)
0224-2852*	insert 28/52 (60-72mm)
0224-3252	insert 32/52 (60-72mm)
0224-3652	insert 36/52 (60-72mm)



# IMPLANTS

## EcoFit® insert TiN

implavit® CoCrMo acc. to ISO 5832-12  
with TiN coating\*



REF	size (inner-Ø/outer-Ø)
0220-3844	38/44mm
0220-4248	42/48mm
0220-4652	46/52mm

## EcoFit® insert

implavit® CoCrMo acc. to ISO 5832-12



REF	size (inner-Ø/outer-Ø)
0223-3844	38/44mm
0223-4248	42/48mm
0223-4652	46/52mm

## 2M implacross® E head

implacross® E, crosslinked UHMWPE with Vitamin E



REF	size (inner-Ø/outer-Ø)
2905-2238	22/38mm
2905-2842	28/42mm
2905-2846	28/46mm

## EcoFit® 2M head

UHMWPE acc. to ISO 5834-2



REF	size (inner-Ø/outer-Ø)
2906-2238	22/38mm
2906-2842	28/42mm
2906-2846	28/46mm

\* EcoFit® insert with TiN coating is only available on request as a special product!

# INSTRUMENTS

**0220-0036**  
**EcoFit® cup EPORE® container**  
**(top)**

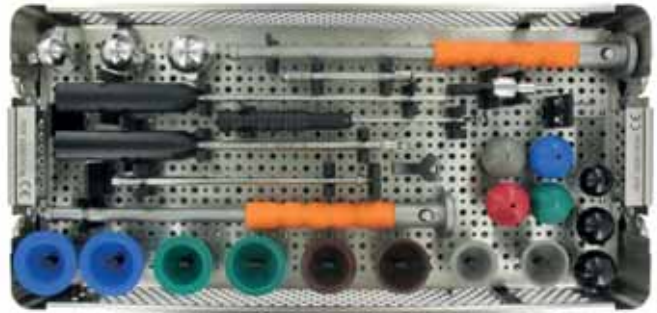

**0220-0036**  
**EcoFit® cup EPORE® container**  
**(bottom)**

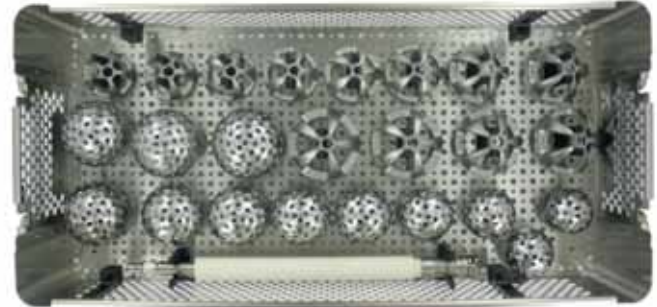

**0220-0336**  
**EcoFit® Cup EPORE® container**  
**(top)**

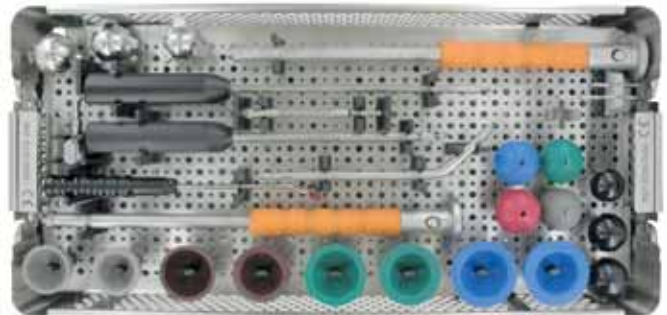

**0220-0336**  
**EcoFit® Cup EPORE® container**  
**(bottom)**



**0220-2020**  
**container for EcoFit® insert**

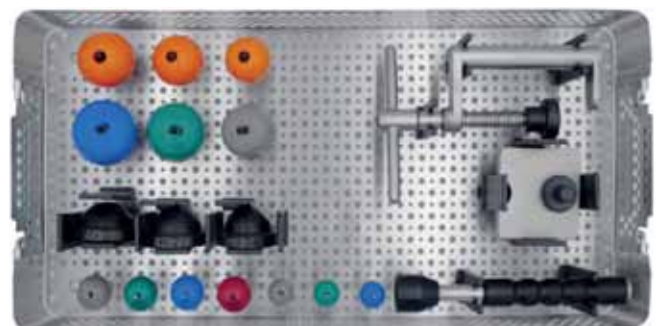

# INSTRUMENTS

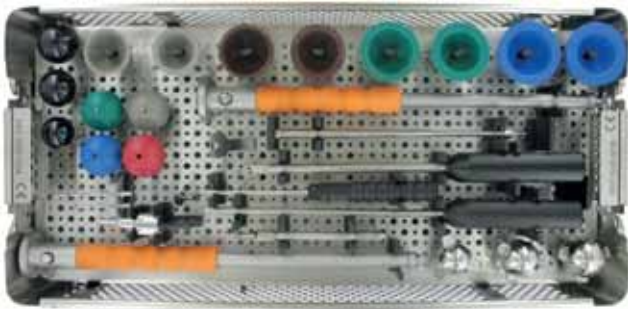

**0220-0236**  
**EcoFit® Cup GIS® container 36mm**  
**(top)**

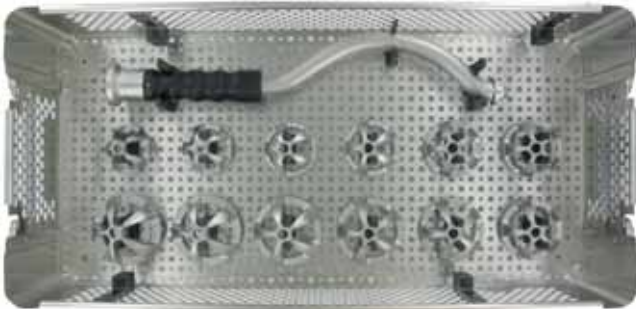

**0220-0236**  
**EcoFit® Cup GIS® container 36mm**  
**(bottom)**

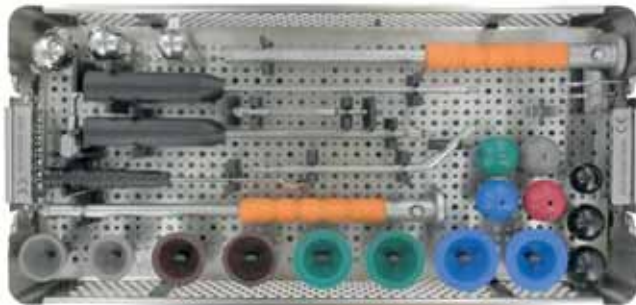

**0220-0436**  
**EcoFit® Cup EPORE® container GIS®**  
**(top)**

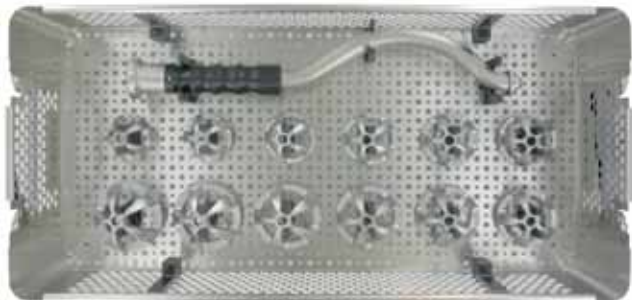

**0220-0436**  
**EcoFit® Cup EPORE® container GIS®**  
**(bottom)**

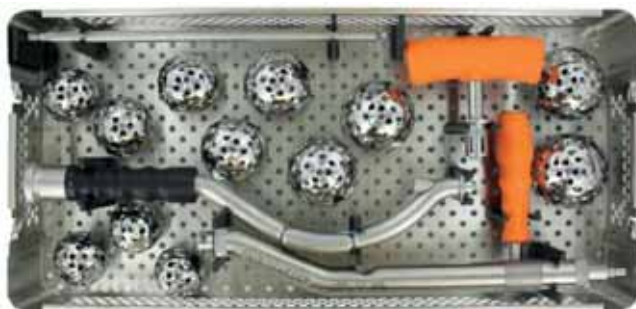

**7999-0800**  
**GIS® acetabulum reamer container**  
**with curved cup impactor**

**NOTE: The containers 0220-0236 and 0220-0436 have always to be used with container 7999-0800.**



# INSTRUMENTS

**0220-0037**  
**EcoFit® cup EPORE® NH container**  
**(top)**

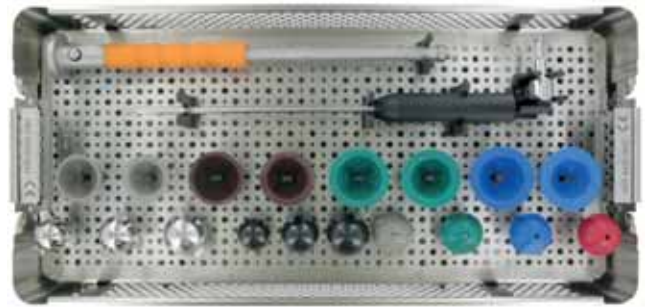

**0220-0037**  
**EcoFit® cup EPORE® NH container**  
**(bottom)**

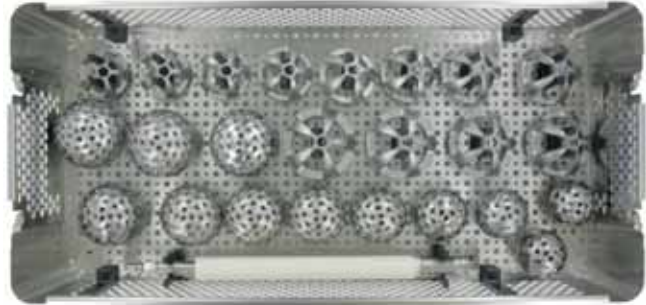

**0220-0136**  
**EcoFit® Cup EPORE® container**  
**42-44mm**



**0220-0138**  
**EcoFit® cup EPORE® container**  
**70-72mm**



**0220-0040**  
**Trial container for ceramic insert 40mm**  
only available on request



Instruments are delivered non-sterile. The relevant information on reprocessing must be observed.

# INSTRUMENTS

## CONTAINER 0220-0036 / -0336 / -0236 / -0436 / -0037



### acetabulum reamer low profile (not in container 02200236 and 02200436)

2950-3046 / 2960-3046	Ø 46mm
2950-3048 / 2960-3048	Ø 48mm
2950-3050 / 2960-3050	Ø 50mm
2950-3052 / 2960-3052	Ø 52mm
2950-3054 / 2960-3054	Ø 54mm
2950-3056 / 2960-3056	Ø 56mm
2950-3058 / 2960-3058	Ø 58mm
2950-3060 / 2960-3060	Ø 60mm
2950-3062 / 2960-3062	Ø 62mm
2950-3064 / 2960-3064	Ø 64mm
2950-3066 / 2960-3066	Ø 66mm
2950-3068 / 2960-3068	Ø 68mm



### handle for acetabulum reamer (not in container 02200236 and 02200436)

2950-2010



### EcoFit® trial cup

0220-3046	Ø 46mm
0220-3048	Ø 48mm
0220-3050	Ø 50mm
0220-3052	Ø 52mm
0220-3054	Ø 54mm
0220-3056	Ø 56mm
0220-3058	Ø 58mm
0220-3060	Ø 60mm
0220-3062	Ø 62mm
0220-3064	Ø 64mm
0220-3066	Ø 66mm
0220-3068	Ø 68mm



### handle curved (only in container 02200236 and 02200436)

7512-2202



### positioner PE Liner 10°

0282-0003	Ø 28mm
0282-0004	Ø 32mm
0282-0036	Ø 36mm

# INSTRUMENTS

**shell impactor (2x; in container 02200037 1x)**  
0282-0030



**impactor for cup insert**

0282-0002                    Ø 28mm  
0282-0007                    Ø 32mm  
0282-0009                    Ø 36mm



**trial head snap taper 12/14mm**

7962-3600 / 7965-3600    Ø 36mm short  
7962-3605 / 7965-3605    Ø 36mm medium  
7962-3610 / 7965-3610    Ø 36mm long  
7962-3615 / 7965-3615    Ø 36mm extra long



**trial insert 0°**

0225-2839                    Ø 28/39mm  
0225-3239                    Ø 32/39mm

0225-3244                    Ø 32/44mm  
0225-3248                    Ø 32/48mm  
0225-3252                    Ø 32/52mm

0225-3644                    Ø 36/44mm  
0225-3648                    Ø 36/48mm  
0225-3652                    Ø 36/52mm



**drill bit 3,2mm (not in container 02200037)**

0282-1005                    56mm (container 02200036 and 02200236)  
0282-1070                    70mm (container 02200036 and 02200236)

0282-3240                    40mm (container 02200336 and 02200436)  
0282-3260                    60mm (container 02200336 and 02200436)



**flexible drill shaft (not in container 02200037)**

0282-1000 (container 02200036 and 02200236)  
0282-2110 (container 02200336 and 02200436)



**depth gauge**

**(only in container 02200036 and 02200236)**  
0282-1007



**depth gauge two-piece**

**(only in container 02200336 and 02200436)**  
0282-1009





# INSTRUMENTS



**trial insert extractor**  
1260-0009



**screw driver long 3,5mm**  
0280-1006



**flexible screw driver 3,5mm**  
(not in container 02200037)  
0270-1002



**angled drill guide 3,2mm**  
(not in container 02200037)  
0282-1001



**plug remover (not in container 02200037)**  
0220-2011

# INSTRUMENTS

## CONTAINER 0220-2020

### trial head taper 12/14

- 7965-2200 Ø 22mm short
- 7965-2205 Ø 22mm medium
- 7965-2210 Ø 22mm long
- 7965-2800 Ø 28mm short
- 7965-2805 Ø 28mm medium
- 7965-2810 Ø 28mm long
- 7965-2815 Ø 28mm x-long



### femoral head impactor

2950-0039



### ic head assembling tool

2900-2000



### 2M trial head

- 2950-2238 22/38mm
- 2950-2842 28/42mm
- 2950-2846 28/46mm



### trial for EcoFit® insert

- 0225-3844 38/44mm
- 0225-4248 42/48mm
- 0225-4652 46/52mm



### impactor for EcoFit® insert

- 0282-0038 38mm
- 0282-0042 42mm
- 0282-0046 46mm



# INSTRUMENTS

## CONTAINER 7999-0800



**cup impactor curved constrained**  
2950-0606

**ic-T-handle Zimmer-Jakobs**  
4223-0023

**ic adapter with hexagon ball 8mm**  
7512-3608

**offset handle for acetabular reamer GIS®**  
7512-1700



### **acetabulum reamer solid profile**

- 7512-1746 Ø 46mm
- 7512-1748 Ø 48mm
- 7512-1750 Ø 50mm
- 7512-1752 Ø 52mm
- 7512-1754 Ø 54mm
- 7512-1756 Ø 56mm
- 7512-1758 Ø 58mm
- 7512-1760 Ø 60mm
- 7512-1762 Ø 62mm
- 7512-1764 Ø 64mm
- 7512-1766 Ø 66mm
- 7512-1768 Ø 68mm

# INSTRUMENTS

## CONTAINER 0220-0136

**impactor 42mm**  
0220-4042

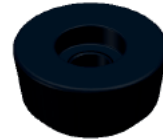

**trial insert 0°**  
0225-2835                      Ø 28/35mm



**acetabulum reamer low profile**  
2950-3042 / 2960-3042    Ø 42mm  
2950-3044 / 2960-3044    Ø 44mm



**EcoFit® trial cup**  
0220-3042                      Ø 42mm  
0220-3044                      Ø 44mm



## CONTAINER 0220-0138

**acetabulum reamer low profile**  
2960-3070    Ø 70mm  
2960-3072    Ø 72mm



**trial shell open**  
2950-2370                      Ø 70mm  
2950-2372                      Ø 72mm



**flexible screw driver 3,5mm**  
0270-1008



# INSTRUMENTS

## CONTAINER 0220-0040



### **trial head taper 12/14**

7965-4000	Ø 40mm S
7965-4005	Ø 40mm M
7965-4010	Ø 40mm L
7965-4015	Ø 40mm XL



### **trial insert 0°**

0225-4048	Ø 40/48mm
0225-4052	Ø 40/52mm



### **impactor for cup insert**

0282-0040	Ø 40mm
-----------	--------

**Only available on request!**

## ADDITIONAL SINGLE INSTRUMENT



### **alignment guide**

7512-2203 for curved handle  
(current version: with screw)



### **alignment guide**

7512-2204 for shell impactor straight  
(current version: with screw)

**Only available on request!**

# PRE- / POST-OPERATIVE INSTRUCTIONS

## Intended Use

The EcoFit® cups EPORE® are acetabular components intended to be used in combination with an acetabular cup insert to replace the natural acetabulum in total hip arthroplasty.

The EcoFit® cups EPORE® are intended for cementless, press-fit fixation.

PE insert 0°, PE insert 10°, implacross® PE insert 0° and implacross® PE insert 10° are acetabular cup inserts intended to articulate with a femoral head prosthesis.

The BIOLOX® delta cup insert is intended for insertion into a modular acetabular cup to provide the articulating surface with an ic-head BIOLOX® as part of a total hip arthroplasty.

EcoFit® inserts are acetabular cup inserts intended to articulate with the convex (outer) spherical surface of the 2M polyethylene head (EcoFit® 2M Head / 2M implacross® E Head) in Dual Mobility total hip arthroplasty.

## Pre-operative Instructions

The implantation must be carried out according to the established surgical technique which is available from the implantcast GmbH. A list of the associated surgical techniques is provided at the end of the instructions for use of the cementless acetabular cups "09300038\_Cementless Acetabular Cups".

The surgeon should ensure that:

- An adequate number of all necessary implant components will be available during surgery.
- All instruments necessary will be present for surgery and that they match the implants being used. Only instruments designed for use with the implant system by implantcast GmbH should be used.
- The correct sized instruments are used during surgery to prevent damage to the implants.

The implantcast GmbH instruments are supplied non-sterile and must be disinfected, cleaned, and sterilized before use. Please refer to the cleaning statement RA\_000\_ISO17664 for the correct procedures. If the equipment is not treated before use, there is a risk of infection.

## Post-operative Instructions

Post-operative patient care, patient instructions and warnings are of the utmost importance.

The use of an external support of the operated limb for a limited period is recommended.

Active and passive movements of the patient should be monitored.

The post-operative regime should be aimed at the prevention of overloading of the joint and stimulation of the healing process.

Regular monitoring of the position and condition of the prosthetic components and the surrounding bone is recommended.

# INDICATIONS / CONTRAINDICATIONS

## Indications

The decision for replacement of the joint should be based on careful evaluation. The indication for this type of surgery should only be made when all other conservative or surgical alternatives are less promising.

Danger of post-operative complications can be limited by careful evaluation of the individual anatomical and load conditions, the condition of the soft tissues and the condition of the bone bed for the implants.

The provision of prostheses is generally indicated only in patients whose skeleton is fully grown.

Before intervention, preoperative examinations should be performed. The examinations depend on the patient's history.

Under consideration of these conditions, the hip joint replacement applies to the following indications:

- Non-inflammatory degenerative joint disease including osteoarthritis and avascular necrosis,
- Post-traumatic osteoarthritis,
- Fractures,
- Rheumatoid arthritis.

The surgeon decides which version of prosthesis for the individual patient is used. This decision depends on several factors, such as the age and the patient's weight, bone quality, shape of the bone and deformation of the joint.

The EcoFit® Inserts are only to be used in conjunction with the EcoFit® 2M or 2M implacross® E heads in Dual Mobility Hip Arthroplasty. The EcoFit® insert is indicated for patients with an increased risk of dislocation.

## Contraindications

The longevity of an orthopaedic joint replacement device can be reduced by biological aspects, material characteristics and biomechanical factors. Patient selection and indication should be carefully monitored especially in patients who are overweight, patients with high physical activity levels and patients younger than 60 years of age. An absolute contraindication is a known allergy to any of the implant materials used. The label on the secondary packaging of each component specifies the material used. Indication for testing, it is strongly recommended to perform an allergy test. Further absolute contraindications are infections. The relative contraindications include:

1. Anatomic conditions, which preclude or are not expected to maintain an adequate bony support of the implant or do not allow the implantation of a sufficiently large prosthesis.
  - Insufficient quantity and quality of bone stock, e.g. as a result of osteoporosis or osteomaci
  - Vascular disease of the affected limb
2. Metabolic disorders that can affect a stable anchorage of the implant
3. Bone tumors in the implant fixation area
4. Neuromuscular diseases that can impair the affected limb
5. Lack of patient compliance
6. Mental or neurological conditions that affect the ability of patients to comply with medical instructions, especially during the healing phase
7. Obesity

## Risk factors

The following risk factors may affect the success of joint replacement:

- Nicotine and/or drug abuse
- Alcoholism
- Severe deformities, which lead to an impairment of the anchorage, the exact positioning or function of the implant
- Excessive loading of the operated joint by strong physical work and/or inappropriate sports
- Therapies that may affect bone quality











implantcast GmbH  
Lüneburger Schanze 26  
21614 Buxtehude  
Germany  
phone: +49 4161 744-0  
fax: +49 4161 744-200  
e-mail: [info@implantcast.de](mailto:info@implantcast.de)  
internet: [www.implantcast.de](http://www.implantcast.de)



Your local distributor:

