

MEDIVATORS™ ISA™

Endoscope Reprocessor



USER MANUAL

WASHER-DISINFECTOR

MEDIVATORS™

is a trademark of Medivators Inc.

INTERCEPT™

is a trademark of Medivators Inc.

RAPICIDE™

is a trademark of Medivators Inc.

ISA™

is a trademark of Cantel Medical (Italy) S.r.l.

ISASPOR™

is a trademark of Cantel Medical (Italy) S.r.l.

ISAZONE™

is a trademark of Cantel Medical (Italy) S.r.l.

ISACLEAN™

is a trademark of Cantel Medical (Italy) S.r.l.

FUJIFILM™

is a trademark of Fujifilm Corporation.

OLYMPUS®

is a registered trademark of Olympus Corporation.

PENTAX®

is a registered trademark of Hoya Corporation.

50098-864-EN REV K

© 2018 All rights reserved. This publication is protected by copyright laws.

Copying, distribution or use of this publication are prohibited without the express written consent of Cantel Medical (Italy).

Cantel Medical (Italy) reserves the right to amend the specifications described herein without any obligation for advance warning. For further information, contact your Cantel representative.

DEAR CUSTOMER,

Thank you for having chosen the MEDIVATORS™ ISA™ Endoscope Reprocessor, designed and manufactured by Cantel Medical (Italy) S.r.l.

This MEDIVATORS ISA Endoscope Reprocessor medical device has been manufactured to the highest standards in order to achieve the highest quality performance, ease of use and safety for reprocessing endoscopes.

Cantel, present in various locations throughout the world, is the major PARTNER in the prevention and control of Hospital Infections, Warranting clients excellent and innovative solutions in compliance with applicable standards and regulations.

Client satisfaction is OUR MISSION and the driving factor for the development of increasingly innovative and satisfactory solutions.

We ask that you read this manual carefully prior to performing any operations on medical equipment so as to Warranty performance and the safety of all personnel involved.

Besides compromising the cleansing/disinfection process, failure to comply (even partially) with the recommendations reported in this manual invalidates the Warranty and relieves the manufacturer from all responsibility.

For further information regarding this MEDIVATORS ISA Endoscope Reprocessor medical device, please contact your Cantel representative.

USE OF THE MANUAL

This manual describes the characteristics of the MEDIVATORS™ ISA™ Endoscope Reprocessor, including the hardware, software, operations, safety, maintenance and problem resolution procedures.

It is important to follow the instructions provided in this manual in order to maintain the

MEDIVATORS ISA Endoscope Reprocessor in the correct operational mode and to ensure that endoscopes are suitably disinfected.

This is not a technical support manual and does not provide detailed instructions for support apart from general maintenance. Please refer to the Service Manual for support instructions.

Contact the technical support representative on (+31) 45 5 471 444 for further information.

It is important that this manual be kept safe and in the same location as the equipment so that it may be consulted in the case of any hazard, and that its location be known to all personnel involved in reprocessing/maintenance/installation.

CONTENTS

USE OF THE MANUAL

Important notes	03
-----------------------	----

CHAPTER 1

Safety notices	06
----------------------	----

Regulatory compliance.....	11
----------------------------	----

Intended use of the MEDIVATORS™ ISA™ Endoscope Reprocessor	12
---	----

Description of the validated chemical solutions	13
--	----

Handling and storage of 70% isopropyl alcohol	15
--	----

Endoscopic channel connections	16
--------------------------------------	----

Technical specifications of the MEDIVATORS ISA Endoscope Reprocessor	17
---	----

CHAPTER 2

Main components of the MEDIVATORS ISA Endoscope Reprocessor	22
--	----

Endoscopic channel connections	26
--------------------------------------	----

Basin cover control pedal	28
---------------------------------	----

Printer.....	29
--------------	----

RFID recognition system.....	30
------------------------------	----

Filtration systems	31
--------------------------	----

CHAPTER 3

Instrumentation preparation guide	34
---	----

Manual endoscope cleaning steps.....	34
--------------------------------------	----

Leak testing	35
--------------------	----

Manual cleaning.....	36
----------------------	----

Disinfection	37
--------------------	----

Drying and Storage	38
--------------------------	----

CHAPTER 4

Cycle start-up procedure.....	40
-------------------------------	----

Loading the endoscopes into the basin.....	42
--	----

Removing the endoscopes from the basin	45
--	----

Endoscope treatment cycles	45
----------------------------------	----

Software procedures.....	48
--------------------------	----

End of cycle traceability reports.....	64
--	----

Other operator software functions	73
---	----

Tank replacement procedure	79
----------------------------------	----

CHAPTER 5

Maintenance	87
-------------------	----

CHAPTER 6

Warranty	89
----------------	----

CHAPTER 7

Resolving problems.....	93
-------------------------	----

CHAPTER 1

INTRODUCTION

This chapter describes the medical device for endoscope reprocessing MEDIVATORS™ ISA™ Endoscope Reprocessor, the safety notices, regulatory compliance, the validated chemical solutions and the technical specifications of the medical device.



SAFETY NOTICES

The purpose of the following notices is to reduce the risk to personnel and prevent the equipment from becoming unsafe due to improper use.

Therefore, both operators and maintenance personnel must follow the instructions in the user and maintenance manual for the MEDIVATORS™ ISA™ Endoscope Reprocessor cold chemical endoscope Washer-Disinfector.

SAFETY NOTICES



This symbol indicates that the operator must pay particular attention and consult the enclosed documentation.



Symbol of EER regulatory compliance.



This symbol indicates “open”, i.e. disconnected from the main power supply.



Symbol indicating the year of manufacture.



This symbol indicates “closed”, i.e. connected to the main power supply.



Symbol indicating the manufacturer.



Warning symbol for the risk of electric shock.



CE mark issued by the Notified Body in compliance with Directive 93/42/EEC and updates.

DEFINITIONS

Abbreviation	Description
PPE	Personal protective equipment
Manufacturer*	The physical or legal entity responsible for the design, manufacture, packaging and labelling of a device with regard to marketing in their own name, independently of the fact that these operations have been performed by an entity themselves or by a third party acting on their behalf.
MD – Medical Device**	Any instrument, equipment, system, software, substance or other product, used alone or in combination, including software intended by the manufacturer to be used specifically for diagnostic or therapeutic purposes and necessary for the correct operation of the device, intended by the manufacturer to be used in humans for diagnosis, prevention, control, therapy or attenuation of a disease; for diagnosis, control, therapy, attenuation or compensation of a wound or handicap; for study, replacement or modification of anatomy or a physiological process; for intervention in conception, where the product does not exert the main action, in or on the human body, for which it is intended, with pharmacological or immunological means, not by means of a metabolic process but whose function may be assisted by said means.
Accessory***	A product which, despite not being a device, is intended specifically by the manufacturer to be used with a device in order to permit its use as envisaged by the manufacturer themselves.
Intended use****	The use for which the device is intended in accordance with the instructions provided by the manufacturer in the labelling, the information leaflet or in the publicity materials.
Operator	A person instructed by personnel authorized by the manufacturer to use the equipment.
dB	Decibel (relative measurement of sound).
°fH/dH°	French/German Degrees (relative measurement of water hardness).
ppm	Parts per million Calcium Carbonate
RFID	(Radio Frequency Identification); a technology for the automatic identification of objects, animals or people based on the ability to store and access said information using remote electronic devices (known as TAGs or transponders) capable of responding by communicating the stored information when queried”.

*/**/****/*****: IMPLEMENTATION OF DIRECTIVE 93/42/EEC and subsequent amendments and additions.

SAFETY NOTICES



Take care when opening the electrical panel and junction boxes labelled with the danger of electric shock sign.



Operators using the MEDIVATORS™ ISA™ Endoscope Reprocessor must be qualified for this activity and must have completed a training course organized by the manufacturer or personnel authorized by the manufacturer.



Maintenance and repair of the MEDIVATORS ISA Endoscope Reprocessor must be performed by technical staff, qualified and authorized by the manufacturer.



The MEDIVATORS ISA Endoscope Reprocessor work area must be kept clean in order to avoid hazardous situations due to the floor conditions.



The electricity supply must be disconnected prior to starting repair or maintenance operations on the MEDIVATORS ISA Endoscope Reprocessor.



The MEDIVATORS ISA Endoscope Reprocessor safety devices must not be altered or tampered with any way.



The MEDIVATORS ISA Endoscope Reprocessor panelling must be cleaned with a soft cloth and non-aggressive solutions.



Sharp pointed tools must not be used to insert or remove the machine's gaskets.



In the case of a cycle terminated due to an alarm, the operator must pay the utmost attention, adopting the precautions envisaged, so that the endoscope is reprocessed correctly.

OPERATOR SAFETY



In order to avoid biological contamination and/or chemical burning, PPE must be always be worn when handling the endoscope or the chemical solutions.



The chemical solutions must be used in compliance with the regulations prescribing their use, safety and shelf life. During handling of the chemical solutions, use the protective measures and devices reported in the material safety data sheet. In the case of leakage or the accidental spillage of chemical solutions, follow the material safety data sheets for the chemical solutions.



Do not attempt to open the machine basin cover during the operation cycle.

WARNINGS AND PRECAUTIONS



Wear protective clothing, gloves and eyewear. The manufacturer of the chemical solutions may recommend additional protective measures.



All endoscope connections must be checked periodically in order to make sure they are not damaged, and if that is the case, they must be replaced in order to avoid unfit endoscope reprocessing.



Prior to inserting the endoscope in the MD, make sure it is not damaged, using the instruments and methods envisaged for manual leak testing. Check that all connections to the endoscope are properly inserted. Otherwise there is a risk of the endoscope not being reprocessed correctly and consequently cannot be used on the patient.

WARNINGS AND PRECAUTIONS



Prior to removing the endoscope from the MD, check that all channel connections are inserted correctly. If an adapter is loose or disconnected, the cycle must not be considered valid, and must therefore be repeated.



Wear clean gloves in order to avoid fouling the reprocessed endoscope. If a cycle execution error is generated, the endoscope must not be used on a patient.



Use only the chemical solutions (detergent and high level sterilizer/disinfectant) declared and validated by the manufacturer. Never use chemical solutions beyond the expiration date indicated by the manufacturer.



Should it become necessary to replace the tanks containing the chemical solutions, always wear PPE.



Should it become necessary to replace the filters, always wear PPE.



If the equipment is used in a manner not specified by the manufacturer, the safety devices envisaged might be compromised.



Do not place objects on the glass cover.

REGULATORY COMPLIANCE

MEDIVATORS™ ISA™ Endoscope Reprocessor is a class IIB medical device, complying with the Medical

Devices Directive 93/42/EEC and upgrades.

THE MEDICAL DEVICE IS COMPLIANT WITH THE FOLLOWING STANDARDS:

- **UNI EN ISO 15883-1**
“Endoscope Reprocessors - Part 1: General requirements, terms and definitions and tests”.
- **UNI EN ISO 15883-4**
“Endoscope Reprocessors - Part 4: Requirements and tests for endoscope reprocessors employing chemical disinfection for thermolabile endoscopes”.
- **UNI CEN ISO/TS 15883-5**
“Endoscope Reprocessors - Part 5: Test soils and methods for demonstrating cleaning efficacy”.
- **CEI EN 61010-1**
“Safety Requirements for Electrical Equipment for Measurement, Control, and Laboratory Use - Part 1: General Requirements”.
- **CEI EN 61010-2-040**
“Safety requirements for electrical equipment for measurement, control and laboratory use - Part 2-040: Particular requirements for sterilizers and Endoscope Reprocessors used to treat medical materials”.
- **CEI EN 61326-1**
“Electrical equipment for measurement, control and laboratory use - EMC requirements - Part 1: General requirements”.
- **CEI EN 62366**
“Medical devices - Application of usability engineering to medical devices”.

INTENDED USE OF THE MEDIVATORS™ ISA™ ENDOSCOPE REPROCESSOR

The MEDIVATORS ISA Endoscope Reprocessor is a medical device designed for the cold chemical washing and disinfection of rigid and flexible endoscopes and endoscopic accessories.

The MD must NOT be used for any purposes not envisaged by the manufacturer and/or NOT reported in the present manual.

THE MAIN CHARACTERISTICS OF THE MEDIVATORS ISA ENDOSCOPE REPROCESSOR INCLUDE:

- Configuration conforming with the current European regulations and international standards UNI EN ISO 15883-1/4 and UNI CEN ISO/TS 15883-5.
- PC All in one with touch screen dedicated to the user interface and recording of the cycle parameters.
- A spacious basin for the reprocessing of endoscopes and/or endoscopic accessories.
- The possibility to have a drying cycle with alcohol (optional).
- The use of safe and validated single shot detergent and sterilizing/disinfectant chemical solutions, compatible with the various brands of endoscope available on the market.
- A validated process (equipment and chemicals) for use at room temperature.
- Continuous monitoring of the channel pressure, the flow rates in the channels and the general parameters throughout the entire cycle.
- A rapid and unique interconnecting system for the endoscope channel connectors Warranting the proper control of flow rates in the endoscope channels.
- Operator and endoscope recognition system using RFID (Radio-Frequency Identification).
- The possibility to perform the self-disinfection cycle using programmable automatic start-up.
- Air filtration system capable of Warranting the complete sterility of the process, and dual filter system for the water feed (0.45 µm - 0.1 µm).
- Traceability of the processes in hardcopy format (using the integrated printer) and electronic format (using complete traceability management software).
- Opening of the lid by pedal (hands-free).
- Capable of adapting to all hospital situations, even in small spaces, thanks to compact size.
- Acoustic and visual alarm signals with a description of the type of fault to allow the operator to immediately identify the type of problem.
- Tanks for the detergent/decontaminant and high level sterilizing/disinfectant solutions A and B, that are safe with no harmful emissions.



The equipment must only be used by qualified personnel and only after having attended a training course organized by the manufacturer or by personnel authorized by the manufacturer.

DESCRIPTION OF THE VALIDATED CHEMICAL SOLUTIONS

The MEDIVATORS™ ISA™ Endoscope Reprocessor uses specific and validated chemical solutions in

order to obtain an effective cleaning and disinfection process.

In particular:

FOR THE CLEANSING PHASE:

ISACLEAN™ multienzyme detergent/decontaminant:

- For the cleaning cycle, MEDIVATOR ISA Endoscope Reprocessor uses ISACLEAN multienzyme detergent/decontaminant, a certified medical device (CE 0546) specific for the removal of microbial biofilms.
- ISACLEAN multienzyme detergent/decontaminant is available in 10 L or 5 L tanks.
- A 10 L tank of ISACLEAN multienzyme detergent/decontaminant allows the execution of approx. 625 cycles.
- A 5 L tank of ISACLEAN multienzyme detergent/decontaminant allows the execution of approx. 312 cycles.

INTERCEPT™ PLUS detergent/decontaminant:

- For the cleaning cycle, MEDIVATOR ISA Endoscope Reprocessor uses INTERCEPT PLUS Detergent, specific for the removal of microbial biofilms.
- INTERCEPT PLUS detergent/decontaminant is available in 5 L tanks.
- A 5 L tank of INTERCEPT PLUS detergent/decontaminant allows the execution of approx. 147 cycles.

FOR THE DISINFECTION PHASE:

ISASPOR™ SINGLE SHOT or RAPICIDE™ PA High Level Disinfectant/Sterilizing solution:

- For the disinfection cycle, the MEDIVATOR ISA Endoscope Reprocessor uses ISASPOR™ Single Shot High Level Disinfectant/Sterilant, a certified medical device (CE0546) or RAPICIDE PA Disinfectant/Sterilant.
- When using ISASPOR HLD/Sterilant the device consists of a tank containing solution A (5% peracetic acid) and a tank containing solution B (containing ISAZONE™*) ingredient.
- When using RAPICIDE PA Disinfectant/Sterilant the device consists of a tank containing solution A (5% peracetic acid) and a tank containing solution B (containing Buffer) ingredient.
- ISASPOR Single Shot HLD/Sterilant is available in 10 L tanks (10 L Solution A + 10 L Solution B) or in 5 L tanks (5 L Solution A + 5 L Solution B). RAPICIDE PA Disinfectant/Sterilant is available in 5 L tanks (5 L Solution A + 5 L Solution B).
- ISASPOR Single Shot HLD/Sterilant or RAPICIDE PA Disinfectant/Sterilant is available in 5 L tanks (5 L Solution A + 5 L Solution B).
- A 5 L tank of ISASPOR Single Shot HLD/Sterilant or RAPICIDE PA Disinfectant/Sterilant allows the execution of approx. 26 cycles.
- A 10 L tank of ISASPOR Single Shot HLD/Sterilant allows the execution of approx. 52 cycles.
- The detergent and high level disinfectant/sterilizing solution used for each cycle are single use (single shot).
- The medical device distribution system ensures that, for each cycle, the correct amount of concentrated product is withdrawn from the tanks and ensures that said products are injected into the basin containing the endoscope.

*molecule patented by Cantel Medical (Italy).

FOR THE DISINFECTION PHASE:

To aid with the proper connection of the aspiration nozzle to the relevant product tanks, the black cap for part A (5 liter tank) has a different colour and

shape from the white cap for part B HLDisinfectant/ Sterilant (5 liter tank).



In order to Warranty the efficacy of the process, only use the chemical solutions reported above, as recommended by the manufacturer.

The use of detergent and disinfectant products that are NOT validated and NOT authorized by the manufacturer does NOT Warranty process efficacy. Further, compatibility with the equipment and with the endoscopes is NOT Warrantyd

The tanks for the chemical solutions are housed in the lower, front compartment of the device so as to allow easy access (by opening the hatches) and at the same time prevents any potential dispersion outside of the equipment.

On completion of the disinfection cycle, the used and exhausted solutions are discharged directly into the waste water system without further treatment, in accordance with the applicable regulations.



It is necessary to use personal protective equipment (PPE) during handling and disposal of the chemical solutions (detergent and high level sterilizer/disinfectant), always referring to the material safety data sheet for the products.



The decontaminant and high level disinfectant/sterilizing solutions must be used in compliance with the instructions prescribing their use, safety and shelf life.



Should there be any leakage of a chemical solution, please refer to the manufacturer's instructions prior to proceeding with its removal.

HANDLING AND STORAGE OF 70% ISOPROPYL ALCOHOL

In the MEDIVATORS™ ISA™ Endoscope Reprocessor, it is possible to incorporate a final drying step after the cleaning cycles using 70% isopropyl alcohol (optional). The isopropyl alcohol solution is not

supplied by Cantel Medical (Italy) S.r.l. but must be purchased by the client. The device has an internal compartment at the top right of the equipment where the alcohol bottle may be connected.

The following instructions must be followed for the handling and storage of 70% isopropyl alcohol:

- **Handling**
Avoid spillage of the product and any prolonged and/or repeated contact with the skin. Extinguish any naked flames. Remove any sources of ignition and avoid the creation of sparks. Do not smoke. Take precautionary measures against static discharges. Connect all instruments to earth. Do not dispose of the product in the waste water system.
- **Handling temperature**
Ambient temperature.
- **Storage**
Keep out of direct sunlight and away from sources of heat or ignition. Do not smoke in storage areas. Keep the container tightly sealed and in a well-ventilated area.
- **Storage temperature**
Ambient temperature.
- **Transfer of the product**
Adopt precautionary measures against static discharges. Connect all instruments to earth.
- **Protection of the respiratory tracts**
No special measures.
- **Eye protection**
Single lens face mask.
- **Body protection**
Standard work clothes. Safety footwear or boots resistant to chemical products.

MEDIVATORS™ ISA™ ENDOSCOPE REPROCESSOR CHANNEL CONNECTIONS

Endoscopes must be connected to the MEDIVATORS ISA Endoscope Reprocessor using the connectors provided by Cantel Medical (Italy) S.r.l. and following the instructions provided.

Any modifications to the connectors provided may compromise proper function of the system and irrigation of the endoscope channels, and hence the reprocessing cycle.



The connectors must NEVER be modified.

It is prohibited to use connectors other than those recommended by the manufacturer. To identify the type of connector required for your endoscope, contact the Cantel Medical or Medivators authorized representative

TECHNICAL SPECIFICATIONS

The basic specifications required for installation and operation of the MEDIVATORS™ ISA™ system are reported below:

Abbreviation	Description
Power Supply	100V–240V; 50/60 Hz
Power Consumption	300 VA
Compressed Air Pressure/Quality	4-6 Bar / oil free
Compressed Air Flow Rate	≥ 20 l/min
Water Supply Pressure	Max 4 Bar
Water Flow Rate	≥ 10 l/min
Water Quality	Potable water – Hardness 8 – 50 °F
Water Temperature	25°C ± 5°C
Ambient Relative Humidity For Use	20 – 80%, condensate-free
Ambient Temperature For Use	5°C ÷ 40°C
Discharge Pipe Height	Max 510 mm
Environment	Emission-free closed circuit
Level of noise	< 65dBA
Environment Light Required	(215 ± 15) lx to (1 500 ± 15) lx
Heat Emission	60 KJ
Dimensions (LxHxP)	Dimensions: 70 cm x 140 cm x 65 cm
Weight	~ 75 kg (version STANDARD)

DESCRIPTION OF THE TECHNICAL SPECIFICATIONS

- Power supply**
 The required power supply is in the range between 100V and 240V with a frequency of 50/60Hz.
- Nominal power**
 The maximum power consumption is 300W.
- Compressed air**
 The MEDIVATORS™ ISA™ Endoscope Reprocessor requires oil-free compressed air with pressure between 4 and 6 bar and a minimum flow rate of 20 l/min. The device has a connector for a 3/8 mm tube, found in the accessories supplied with the equipment. In the case where hospital medical air is not available, an oil-free medical compressor is available (optional).
- Water supply**
 The water supply for the MD must be of “potable” quality with a hardness between 8°FH and 50°FH (4,5°dH - 28°dH, 80–500ppm) supplied at a temperature of between 20°C and 30°C by connecting the hot and cold water supplies to a thermostatic water mixer (not included in the standard kit). The equipment has a 3/4“ male connector and the relevant feed tube is included in the standard kit. There is an optional device for back flow prevention, conforming to the requirements of IEC 61770.
- Machine discharge**
 The equipment has a stainless steel discharge connector, and a flexible tube is provided in the standard kit. The maximum height of the discharge tube to be connected to the MD is 510 mm.
- Operating relative humidity**
 For correct use of the MEDIVATORS ISA Endoscope Reprocessor the relative humidity level must be less than 80% (condensation-free).
- Operating temperature**
 The operating ambient temperature for the MEDIVATORS ISA Endoscope Reprocessor must be no less than 5°C and no greater than 40°C. For correct operation, the system must be located away from sources of heat.
- Atmospheric emissions**
 The MEDIVATORS ISA Endoscope Reprocessor operates as a closed-circuit and there are no detectable environmental emissions. Any emissions due to changing the tanks or opening the basin are not toxic or harmful to human health.
- Ventilation of the environment**
 It is recommended that the equipment be installed in an environment with a ventilation system capable of providing 10 changes per hour. For the installation of several MEDIVATORS ISA Endoscope Reprocessor in the same room, it may be necessary to increase the number of exchanges per hour.
- Transportation and storage**
 The MEDIVATORS ISA Endoscope Reprocessor must be stored and housed in compliance with the following conditions: temperature 5-40°C, relative humidity 20-80% and pressure of 500-1060 hPa. Prior to moving the equipment, make sure that the electrical cable, the discharge tube and the water supply system are disconnected, or that their lengths are sufficient to allow movement of the equipment.



The technical specifications reported above ensure the correct operation of the MEDIVATORS ISA Endoscope Reprocessor. Failure to comply with the above alters the performance of the equipment and the efficacy of the cycle, and can result in damage not covered by the manufacturer's Warranty.

DIMENSIONS

Figure 1
Front Dimensions.

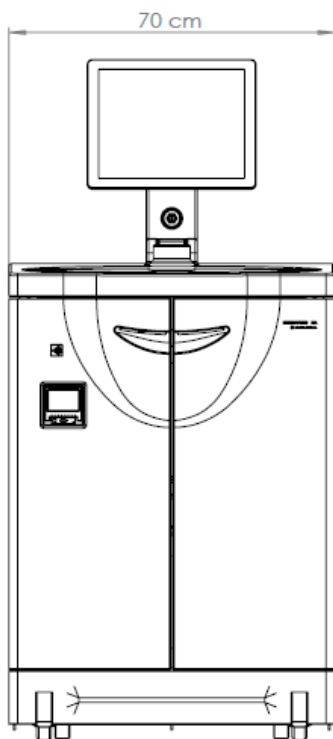
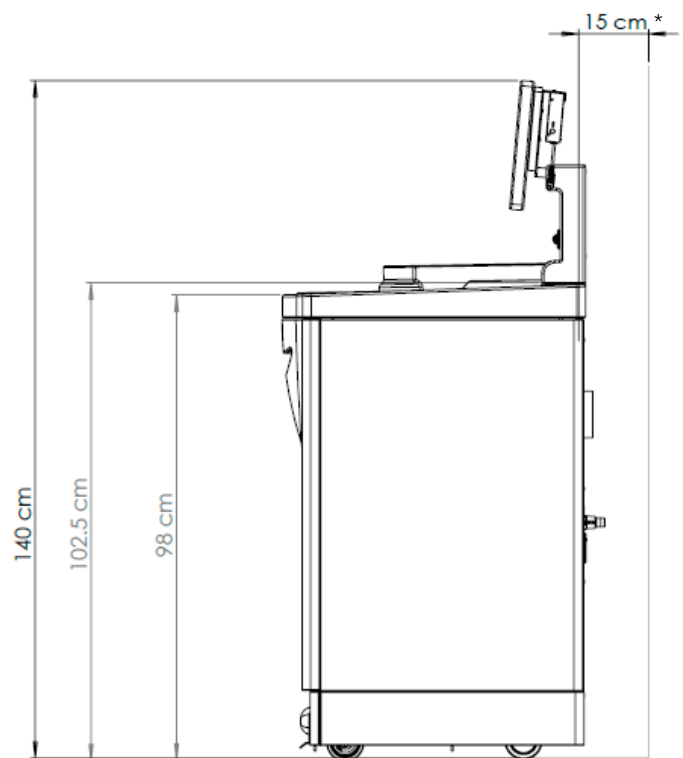

Figure 2
Side Dimensions and Spacing
(cover closed).



*recommended but not mandatory distances.

DIMENSIONS

Figure 3
Side Dimensions and Spacing (cover open).

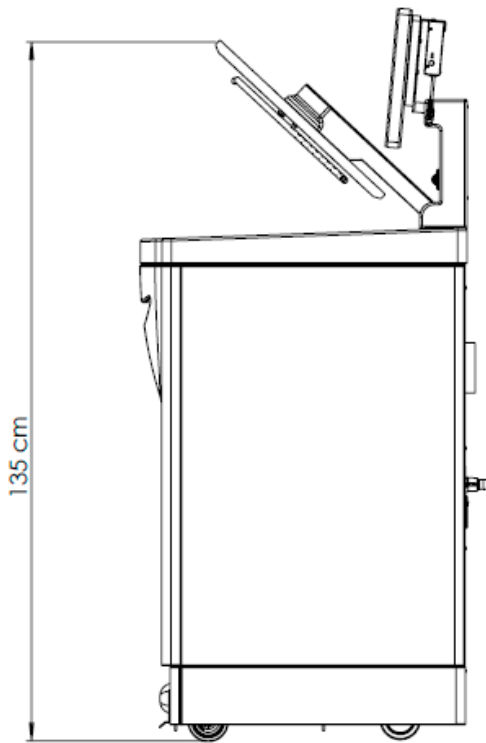
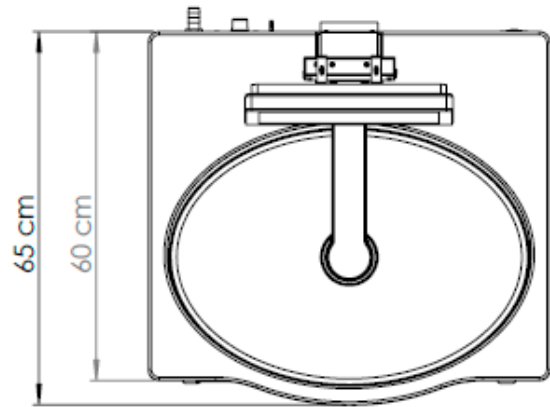

Figure 4
Basin dimensions.



CHAPTER 2

MAIN COMPONENTS

This chapter describes the main components of the MEDIVATORS™ ISA™ Endoscope Reprocessor.



EXTERNAL COMPONENTS

Figure 1
Front view of the MEDIVATORS™ ISA™
Endoscope Reprocessor

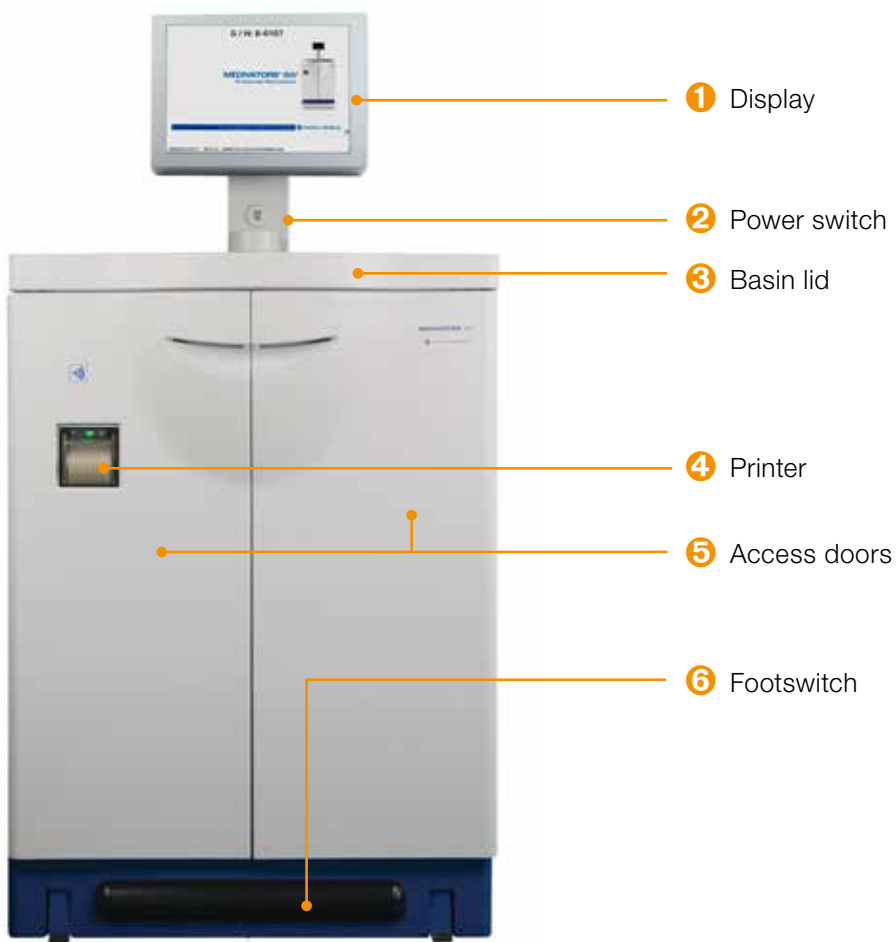

EXTERNAL COMPONENTS

Figure 2
Rear view of the MEDIVATORS™ ISA™
Endoscope Reprocessor.

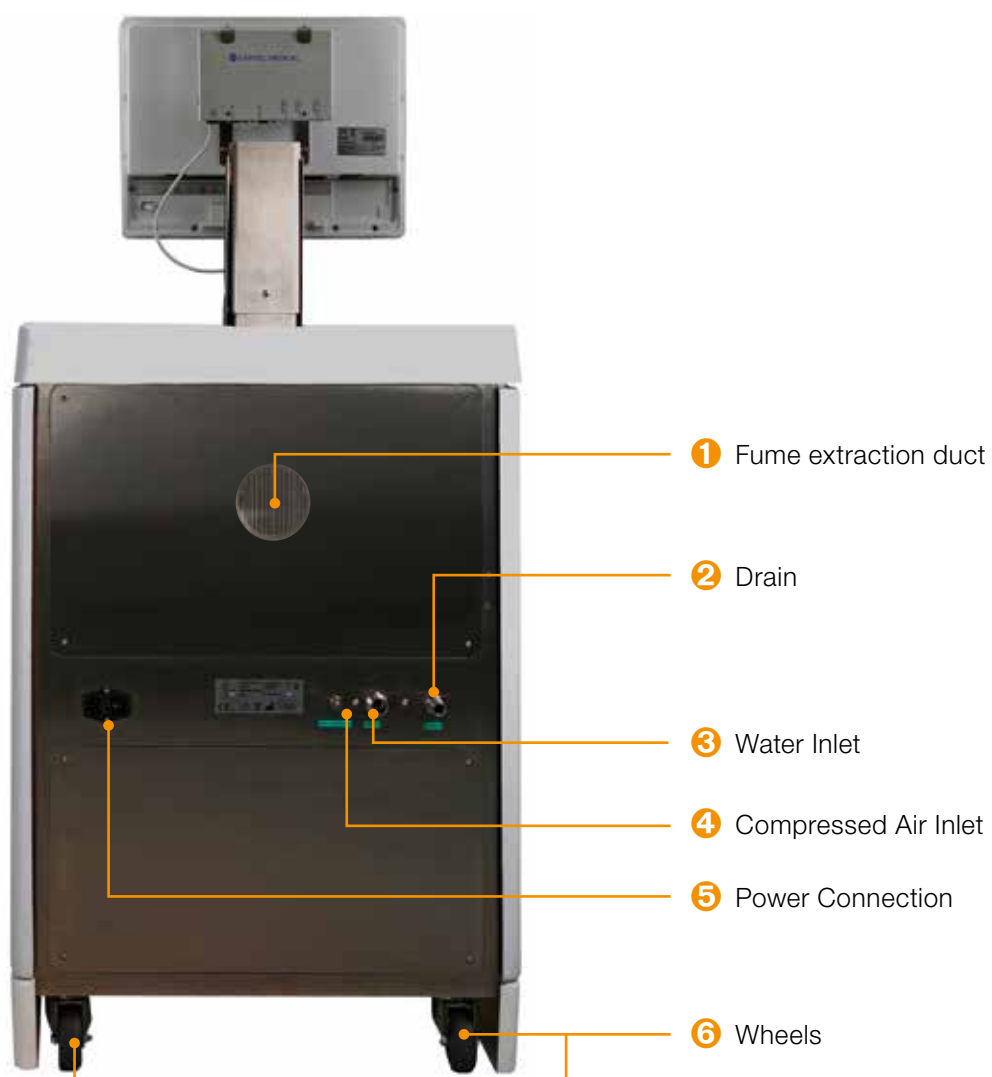

INTERNAL COMPONENTS

Figure 3

Viewed from above the basin of the MEDIVATORS™ ISA™ Endoscope Reprocessor.

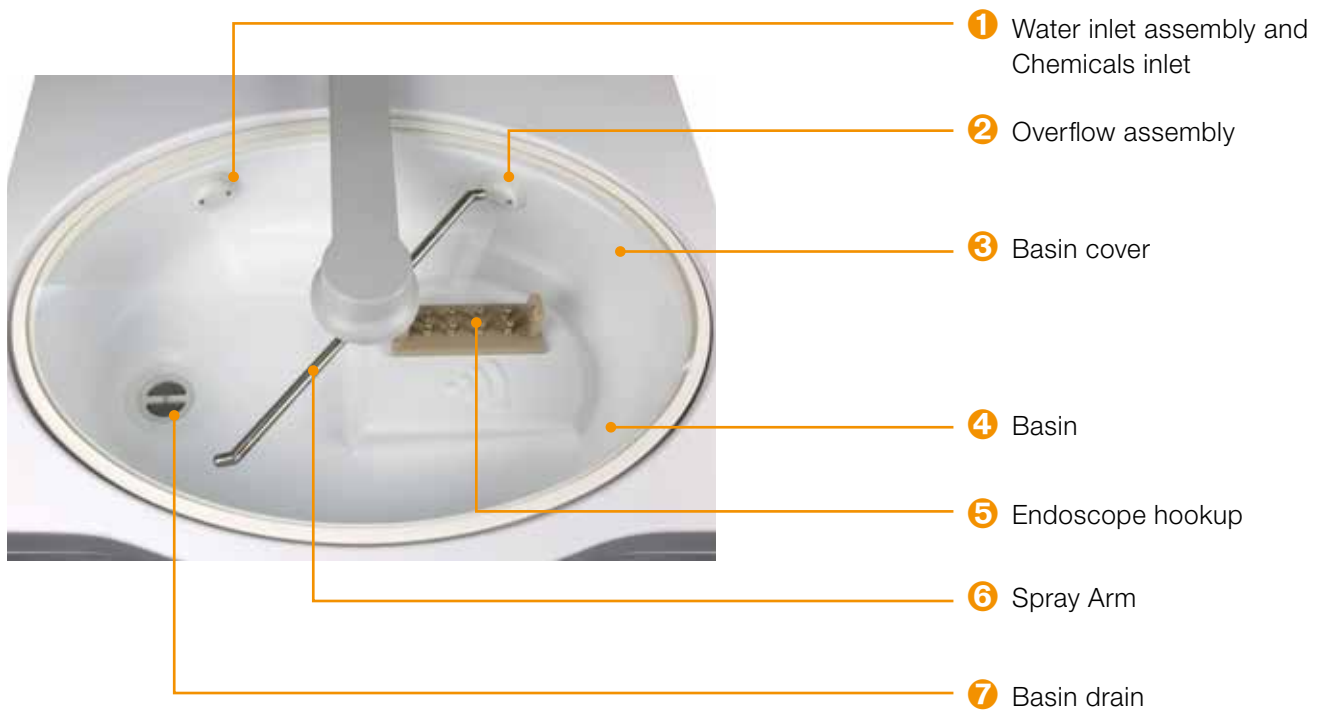

INTERNAL COMPONENTS

Figure 4
Chemical solutions and alcohol (optional)
of the MEDIVATORS™ ISA™ Endoscope
Reprocessor.



ENDOSCOPIC CHANNEL CONNECTION



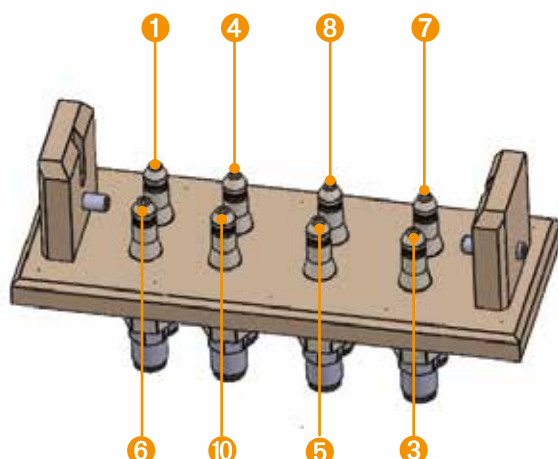



The MEDIVATORS™ ISA™ Endoscope Reprocessor is fitted with a connection system in order to allow the rapid and unambiguous connection of the endoscope channels with the relevant connectors.

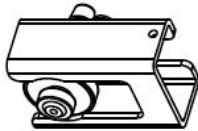

Position	Name in the software	Channel
1	Channel 1	Leak Test
3	Channel 5	Elevator Channel
4	Channel 2	Jet Channel
5	Channel 6	Water Channel
6	Channel 8	Extra Channel
7	Channel 4	Air 2 Channel
8	Channel 3	Biopsy Channel
10	Channel 7	Suction Channel

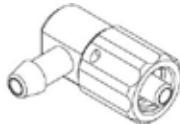
The mobile connection block supplied with the MEDIVATORS ISA Endoscope Reprocessor comes with a range of kits for connecting to endoscopes from the major manufacturers (OLYMPUS, FUJIFILM, PENTAX, KARL STORZ etc.), supplied according to the client's needs.

EXAMPLE OF CONNECTORS FOR ENDOSCOPE CHANNELS

Leak Test connection	
Biopsy channel connection	
Air channel connection	
Auxiliary or elevator channel connection	
Channel separator connection (buttons)	
Air-water connection	
Suction channel connection	



To identify the type of connector required to reprocess the v Medical or Medivators authorized representative.

BASIN COVER CONTROL PEDAL

The control footswitch allows the operator to open and close the lid without the use of hands, thus aiding easy insertion of the endoscope inside.

Once the pedal is pressed, the equipment emits an acoustic warning signal confirming the execution of the command.



PRINTER

The MEDIVATORS™ ISA™ Endoscope Reprocessor is equipped with an integrated printer fitted as standard, facing frontwards and located to the upper left of the device.

On completion of each reprocessing cycle, the device automatically prints a report containing the information relating to the cycle: cycle start date and time, endoscope ID code, medical operator (optional), patient (optional), type of cycle executed, all the various phases conducted, indicating the times and cycle outcome.

Reprocessing report



5 Printer

RFID RECOGNITION SYSTEM

An automatic recognition system is provided for the endoscope and the operator by means of TAGS, using an RFID data acquisition system.

The TAG recognition zones are positioned according to the layout proposed in the following figures:

RFID A =
Operator TAG
recognition

RFID B =
Endoscope TAG
recognition

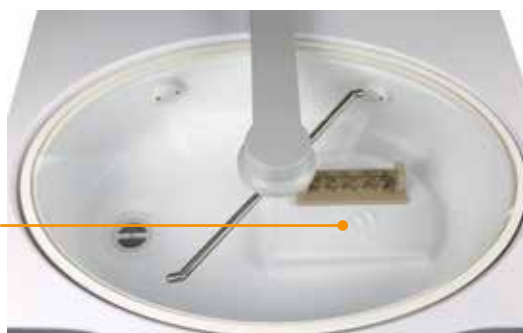

RFID SYSTEM OPERATOR- ENDOSCOPE RFID SYSTEM

Once the basin cover is opened using the control pedal, the automatic operator-endoscope RFID identification function allows the user to insert the endoscope into the basin and automatically recognize them by means of the related TAGS. Subsequently, having closed the lid using the control pedal, the user can proceed in two ways:

1. Proceed with user recognition and start the desired cycle using the manual on-screen commands;

2. Proceed with user recognition and automatic preset cycle start by holding your TAG on the reading strip for at least 3 seconds. At this point the cycle starts automatically without the need to press any of the buttons on the screen;

In the case where a password request has been set to remove the endoscope from the basin, on completion of the cycle, the user must ensure their tag is recognized and it will then be possible to open the cover.

FILTRATION SYSTEMS

The MEDIVATORS™ ISA™ Endoscope Reprocessor is equipped with a water and air filtration system capable of Warrantying the efficacy of the reprocessing cycles performed.



Water filter

- The device is equipped with a dual water filtration system:
- 0.45 micron water filter capsule;
- 0.1 micron water filter capsule;
- A pair of water filters are supplied with the equipment on installation.
- Replacement of both water filters is scheduled with a frequency of 6 months. However, the lifespan of the water filters might be less than expected due to poor water quality at the installation site.

- ① 0.1 MICRON
② 0.45 MICRON

Code	Description
93250-222	Water Filter Kit Colder (0.1 μm + 0.45 μm)



Replacement of the water filters must be performed by qualified technical staff authorized by the manufacturer. Otherwise the efficacy of the washing and sterilization processes is NOT Warrantyd.

Any damage resulting from failure to replace the water filters and/or the use of NON ORIGINAL filters and/or operations performed by NON authorized personnel will invalidate any type of Warranty. The use of filters other than those indicated by the manufacturer does NOT Warranty the efficacy of the washing and disinfection processes.

AIR FILTERS

The device is equipped with two air filters:

1. Leak test air filter;
2. Drying air filter.

A pair of air filters are supplied with the equipment on installation. Subsequently, they must be replaced with a frequency of 6 months.

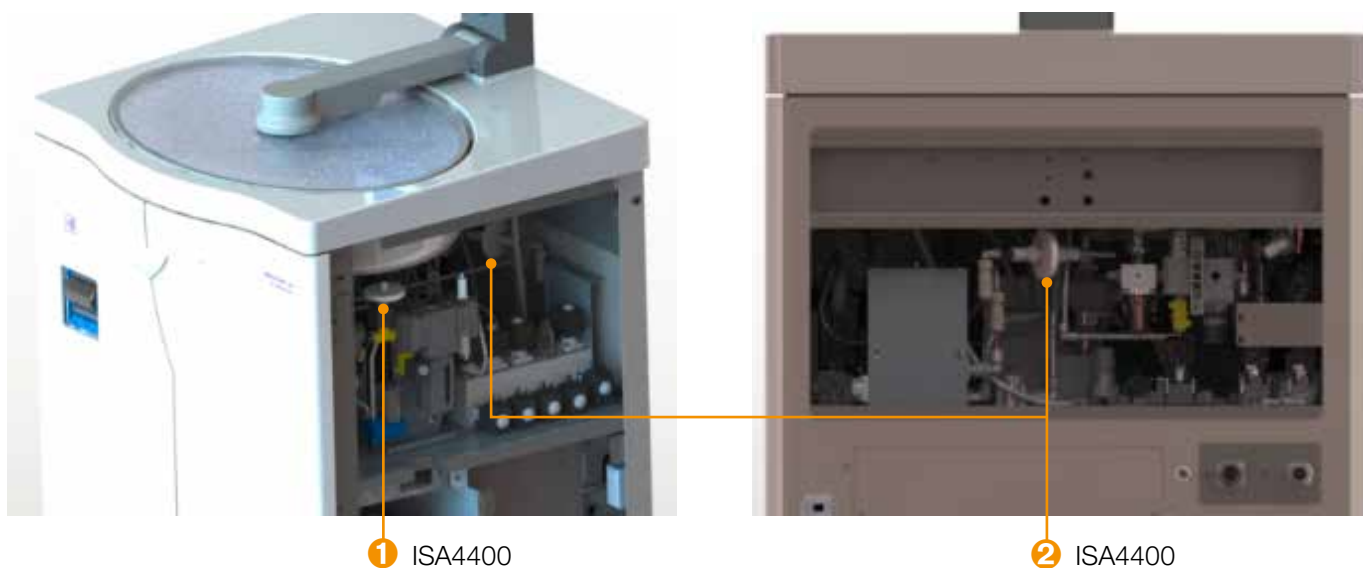

1 ISA4400

2 ISA4400

	Code	Description
1	ISA4400	0.2 micron Leak Test Air Filter
2	ISA4400	0.2 micron Compressed Air Filter



Replacement of the AIR filters must be performed by qualified technical staff authorized by the manufacturer. Otherwise the efficacy of the washing and disinfection processes is NOT Warrantied.

Any damage resulting from failure to replace the air filters and/or the use of NON ORIGINAL filters and/or operations performed by NON authorized personnel will invalidate any type of Warranty. The use of filters other than those indicated by the manufacturer does NOT Warranty the efficacy of the washing and disinfection processes.

CHAPTER 3

DISINFECTION OVERVIEW

This chapter describes the processing to be performed on endoscopes subsequent to their use, starting from the manual pre-treatments up to the automatic reprocessing to be performed in the MEDIVATORS™ ISA™ Endoscope Reprocessor.



INSTRUMENTATION PREPARATION GUIDE



Reference to the “Extract from the GUIDELINES States: Cleaning and Disinfection in Endoscopy“

In order to be effective, the decontamination and disinfection process for endoscopes must be performed according to a pre-established and consistent sequence.

This consists of the following steps, none of which must be omitted or performed in a rush or in an approximate manner:

Decontamination and Disinfection process for instruments:

- Pre-cleaning
- Leak test
- Manual Cleaning
- Manual or Automatic disinfection or sterilization
- Final rinse
- Drying
- Storage

MANUAL ENDOSCOPE CLEANING STEPS

Pre-cleaning

- a) On completion of the endoscopy examination, apply the cleaning valve.
- b) Aspirate water and detergent through the channels inside the instrument.
- c) Wipe the exterior of the instrument with a gauze moistened in the same solution.
- d) Turn off the column.
- e) Apply the video control cover cap to the light holder stem of the instrument (seal cap) for videoendoscopes.
- f) Place the instrument inside a suitable container and take it to the wash room.

LEAK TEST

Prior to starting cleaning, it is necessary to check that the instrument has not suffered any damage during use (holes due to biting, assorted prosthetics, examination manoeuvres). Depending on the type of instrument, use the manual tester or immerse the instrument itself in water taking care to keep it in as extended a position as possible (not coiled) and after having connected the tester, turn on the tap. In the case any problems should be observed, send the instrument to a specialist company for repair, without

attempting any manipulation that might be even more damaging for both the device itself and the Operator. **It should be remembered that certain endoscope washing machines have the ability to automatically check the instrument, but the manual method is the most certain and valid in that it avoids false negatives.**



Only move on to the subsequent step if the instrument is intact.

MANUAL CLEANING

- a) Wear the appropriate PPEs.
- b) Insert the leak test in the light source and connect it to the endoscopy device; it is recommended the leak test be inserted in order to keep the pressure constant and suitable inside the internal channels of the instrument for the entire time of manual washing.
- c) Still connected to the leak test, immerse the instrument in the detergent solution, prepared in accordance with the manufacturer's instructions.
Never immerse the instrument prior to having connected it to the leak test: in the case of rupture this may cause further damage due to infiltration. The instrument must be immersed completely in the detergent solution.
- d) Remove all the valves from the instrument.
- e) Pass the short pipecleaner at least three times through the biopsy and aspiration channels.
- f) Then use the long brush to clean all the channels inside the instrument at least three times.

Make sure that this emerges from the opposite end of the instrument every time.

The brush must be recleaned after each introduction, its bristles must be cleaned under running water in order to avoid retrograde recontamination.

There are currently brushes on the market with more bristles, or systems with solutions other than bristles, for example small disks, or even microspheres that are aspirated through the channel together with detergent, thus removing the dirt.

In the case of employing said alternative systems, it is recommended that the manufacturer's instructions be followed strictly.
- g) Brush the ends of the instrument using a soft brush, paying particular attention to the air/water nozzle and the directional elevator (e.g. duodeno-scopes).
- h) Clean the instrument externally using a soft sponge.
- i) Apply the specific connectors for washing the operative-auxiliary channels (e.g. angled)
- j) Insert the adapter by sliding it in and wash each channel separately by aspirating the detergent solution, ensuring that this passes through the channel from the inlet to the end section of the wash and aspiration channels, and the connection to the light source.
- k) For the auxiliary channels, wash after having applied the adapter, using small syringes (e.g. 5 ml).
- l) Rinse the instrument thoroughly, both internally and externally, using running water in order to remove any traces of detergent.
- m) On completion of this operation, pat the instrument dry using disposable swabs.
- n) Proceed with disinfection.

DISINFECTION

All operations must be carried out using appropriate PPEs.

- Following manual cleaning, lodge the instrument in the disinfection basin of the endoscope reprocessor
- Connect all channels using the specific connectors so that the disinfectant floods them completely; follow the manufacturer's instructions
- Make sure all channels are connected
- Insert the valves and the accessories in the specific container, where available
- Remove gloves and close the endoscope reprocessor
- Select the appropriate program and start the machine
- On completion of the cycle, check that all operations have been completed according to the manufacturer's parameters
- Open the cover and remove the endoscope. Dry the instrument thoroughly and place it in a dedicated cabinet along with its valves

DRYING AND STORAGE

The internal and external surfaces, valves and disinfection accessories must be dried completely so as to avoid the regrowth of microorganisms present in any residual water. Drying must be performed using filtered (0.2 micron filter) or medical grade air at a maximum pressure of 0.5 bar so as not to damage the internal channels of the instruments.

The majority of washers-disinfectors, even those with a drying step, do not Warranty the complete removal of water residues.

Therefore, prior to storing the instruments at the end of the working day, it is recommended they be dried manually and completely.

Drying can be more rapid between one examination and another: residual water is removed from the internal and external surfaces, and the valves and all parts of the light holder stem (electrical contacts) are dried.

The endoscopes, complete with their valves and disinfection accessories, must be stored vertically in a dry environment, in specific cabinets, possibly ventilated.

The valves and sealing cap must not be inserted in the instrument, but stored together with it.

During the drying and storage procedures and removal from the cabinets, gloves must be worn in order to avoid any recontamination from microorganisms present on the operators hands.

There are various type of cabinets available on the market fitted with filters and capable of maintaining such an environment (temperature, humidity) as to prevent the proliferation of pathogenic microorganisms during prolonged periods of storage.

There is no scientific evidence showing the need to process endoscopic devices at the start of each working day, providing these have been properly reprocessed, dried and stored. On the other hand, there is also no evidence available to support the need for reprocessing endoscopes even after storage for 48-72 hours.

Or rather, the few published works tend to confirm that, having performed the final reprocessing steps correctly, no regrowth of pathogens is observed several days later (Rejchrt 2004; Vergis 2007).



Failure to carry out the preliminary steps does NOT Warranty the efficacy of the process and correct reprocessing of the endoscope. Therefore, the manufacturer is exempt from all responsibility resulting from the failure to conduct the operations described.

Failure to carry out the preliminary steps may lead to the presence of residual organic matter capable of causing damage to the components of the instrument circuit: in this case, maintenance operations will NOT be considered to be covered by the Warranty.

CHAPTER 4

OPERATION

This chapter describes the operation of the MEDIVATORS™ ISA™ Endoscope Reprocessor vice, and how to disinfect an endoscope.



COLD CHEMICAL ENDOSCOPE REPROCESSOR CYCLE START PROCEDURE

Prior to starting a reprocessing cycle on a MEDIVATORS™ ISA™ Endoscope Reprocessor, ensure that:

- The connections to the mains electricity, water and compressed air supplies are active.
- The tanks containing the detergent and high level disinfectant/sterilant chemical solutions are present in the specific compartment.
- The bottle of 70% isopropyl alcohol (optional) for MEDIVATORS ISA Endoscope Reprocessor is present.
- The main electricity power shut-off switch for the equipment, located on the rear panel of the equipment, is activated.
- Open the stopcocks for the water and air.

Figure 1 | Activation switch

To activate the power, move the switch to position



Activation switch

Figure 2 | Display on/off switch

Turn on the Display using the button located under the PC monitor



LOADING THE ENDOSCOPES INTO THE BASIN

To correctly load the endoscope into the basin, proceed as reported below:

1. Wear the personal protective equipment for transport of the endoscope to be reprocessed.

1. Open the lid of the basin using the pedal (Figure 3).

This will be followed by a short acoustic signal confirming the command has been implemented.

Figure 3 | Pedal
Black strip present on the lower part of the equipment

Footswitch



Figure 4
Basin connector

3. Connect the mobile interconnection block to the fixed basin connector (Figure 4) and fix it by turning the red lever on it counterclockwise until it is locked.

Basin connector



Figure 5
RFID B-Endoscope TAG

Insert the endoscope inside the basin and perform recognition by passing the endoscope tag over the RFID B recognition zone, located close to the front of the island: a short confirmatory acoustic signal will follow.

RFID B-Endoscope TAG



N.B. Place the endoscope inside the basin, paying attention to locate it below the spray arm (rotating arm located on the cover). In addition, ensure that

the endoscope connecting tubes do not interfere with rotation of the spray arm.

Figure 6

1. Connect all endoscope channels to the relevant interconnection block connectors.



Figure 7

2. Proceed with operator recognition by bringing the operator TAG close to the RFID A reading zone, as reported below:

RFID A-OPERATOR TAG



3. Close the basin lid by using the pedal (black band present on the lower part of the equipment). This will be followed by a short acoustic signal confirming the command has been implemented.
4. Proceed with the cycle start procedure from the software, reported in this chapter.

REMOVING THE ENDOSCOPES FROM THE BASIN

To correctly remove the endoscope from the basin, proceed as reported below:

1. Wear personal PPE.
2. Proceed with operator recognition by bringing the operator tag close to the RFID A reader as reported below.
3. Disconnect the connecting tubes from the relevant endoscope channels.
4. Disconnect the mobile interconnection block from that fixed to the basin by turning the red lever on the mobile interconnection block clockwise until open.
5. Remove the endoscope from the basin.
6. Close the basin cover using the pedal (black band present on the lower part of the equipment). This will be followed by a short acoustic signal confirming the command has been implemented.

RFID A-OPERATOR TAG



ENDOSCOPE TREATMENT CYCLES

The MEDIVATORS™ ISA™ Endoscope Reprocessor has numerous cycles that are validated for the treatment of endoscopes, as reported in the following table (Table 1).

The self-disinfection cycle refers to sterilization of the circuit and the water filters.

Cycle	Duration	Description
Complete Disinfection	20 min	Washing and disinfection cycle
Complete Double Clean Disinfection	25 min	Double Washing and disinfection cycle
Disinfection	12 min	Disinfection cycle only, with no cleaning
Self-Disinfection	20 min	Internal circuit sterilization cycle

Table 1. The MEDIVATORS ISA Endoscope Reprocessor pre-set cycles

It is also possible to perform a final drying cycle using isopropyl alcohol (optional).

STEPS IN THE “COMPLETE DISINFECTION CYCLE”

1. Initial leak test (with monitoring throughout the entire cycle)
2. Water and detergent loading
3. Cleansing
4. Discharge
5. Water loading
6. Rinsing
7. Water discharge
8. Water and disinfectant solution loading
9. Disinfection
10. Solution discharge
11. Water loading
12. Rinsing
13. Water discharge
14. Endoscope channel drying

duration:
20 minutes



STEPS IN THE “COMPLETE DOUBLE CLEAN DISINFECTION CYCLE”

1. Initial leak test (with monitoring throughout the entire cycle)
2. Water and detergent loading
3. Cleaning
4. Drain
5. Water loading
6. Rinsing
7. Water Drain
8. Water and detergent loading
9. Cleaning
10. Drain
11. Water loading
12. Rinsing
13. Water Drain
14. Water and disinfectant solution loading
15. Disinfection
16. Solution Drain
17. Water loading
18. Rinsing
19. Water Drain
20. Endoscope channel drying

duration:
25 minutes



STEPS IN THE “DISINFECTION CYCLE”

1. Initial leak test (with monitoring throughout the entire cycle)
2. Water and disinfectant solution loading
3. Disinfection
4. Solution discharge
5. Water loading
6. Rinsing
7. Water discharge
8. Endoscope channel drying

duration:
12 minutes



STEPS IN THE “SELF-DISINFECTION” CYCLE

1. Initial leak test (equipment circuits only, and with monitoring throughout the entire cycle)
2. Water and sterilizer loading
3. Mixing
4. Sterilization
5. Solution Discharge
6. Water Loading
7. Rinsing
8. Water discharge
9. Drying

duration:
20 minutes



Cantel Medical recommends daily execution of the programmed self-disinfection cycle in order to sterilize all internal fluid circuits and water filters in order to Warranty a higher level of safety with regard to infections.

VOLUME OF WATER USED PER CYCLE

- Complete Disinfection cycle: 31 litres
- Complete Double Clean and Disinfection cycle: 40 litres
- Disinfection Cycle: 17 litres
- Self-disinfection Cycle 17 litres

MEDIVATORS™ ISA™ ENDOSCOPE REPROCESSOR SOFTWARE PROCEDURES

On start-up of the equipment management program, the following page appears:



Date and time
synchronized with the
computer

Software revision

Cycle counter

Touching any part of the screen accesses the following page, requiring authorization for access to the user interface functions, obtained by entering a personal ID code.

The line located under the LEVEL option represents a menu with the various software function access levels.

MEDIVATORS® ISA®
Endoscope Processor

LEVEL

OPERATOR
TECHNICIAN
ADMINISTRATOR

PASSWORD

1	2	3	4	5	6	7	8	9	0	
Q	W	E	R	T	Y	U	I	O	P	
A	S	D	F	G	H	J	K	L	CAPS	
Z	X	C	V	B	N	M	-	.	SHIFT	
ESC	< BACKSPACE	SPACE					ENTER			

MEDIVATORS® ISA®
Endoscope Processor

LEVEL

OPERATOR
TECHNICIAN
ADMINISTRATOR

PASSWORD

Level selection menu

Password

1	2	3	4	5	6	7	8	9	0	
Q	W	E	R	T	Y	U	I	O	P	
A	S	D	F	G	H	J	K	L	CAPS	
Z	X	C	V	B	N	M	-	.	SHIFT	
ESC	< BACKSPACE	SPACE					ENTER			

Your personal ID code should be entered in the strip under the PASSWORD option by clicking on the screen and using the keyboard to enter the

alphanumeric code, which appears in “encrypted” form as a series of asterisks.

MEDIVATORS[®] ISA[®]
Endoscope Reprocessor

LEVEL

OPERATOR
TECHNICIAN
ADMINISTRATOR

PASSWORD

1	2	3	4	5	6	7	8	9	0	
Q	W	E	R	T	Y	U	I	O	P	
A	S	D	F	G	H	J	K	L	CAPS	
Z	X	C	V	B	N	M	-	.	SHIFT	
ESC	< BACKSPACE	SPACE						ENTER		

On completion of entry, click the ENTER button. If an erroneous password is entered, the following error message will be displayed:

Incorrect entry

OK

After having entered the LEVEL and PASSWORD, press the ENTER button. This will access the following page (in the most complete configuration possible, i.e. with an ongoing alarm and with the

periodic maintenance warning expired):

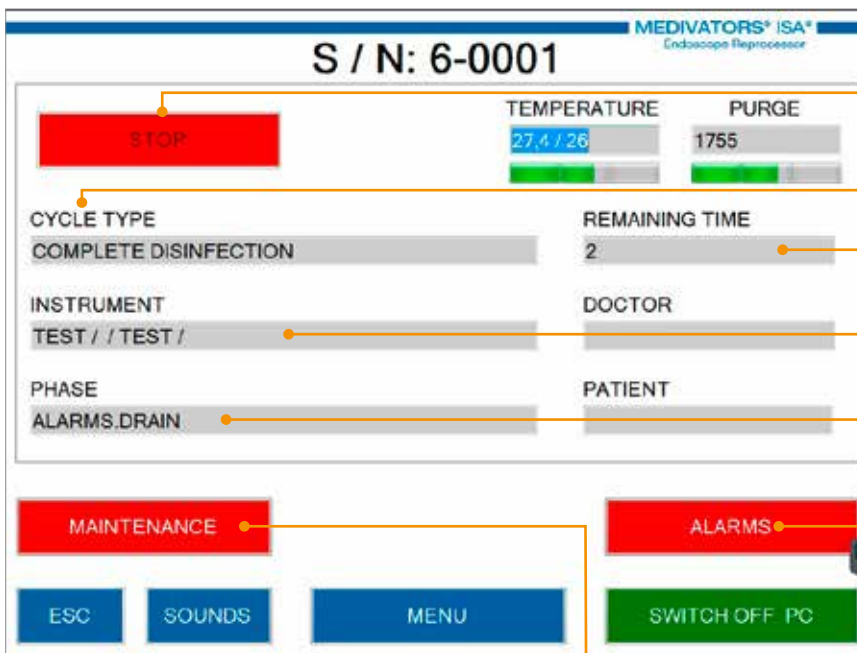

STOP cycle button

Type of cycle in progress

Remaining cycle time

Endoscope identification

Cycle phase

Alarm button

Previous page

Reset acoustic signal

Warning button for expired maintenance

Typing on MAINTENANCE button, you can view the expired maintenance and especially the days spent

by the installation of filters with an indication of the set-up (indicating the duration of the filters).

	DAYS PASSED	CONFIGURATION
1ST STAGE FILTER CHANGE	0	180
2ND STAGE FILTER CHANGE	0	180
COMPRESSED AIR FILTER CHANGE	0	180
LEAK TEST FILTER CHANGE	0	180
RECYCLING FILTER SUBSTITUTION	0	180
SELF-DISINFECTION	310	5

MEDIVATORS® ISA®
Endoscope Reprocessor

MENU ALARMS

Typing on the ALARMS button, you can display the page the historian of alarms triggered:

DATE	ALARMS	CODE
2016-07-07 13:49:49	STOP FILT (ON (Cycle 324 Instrument TEST))	1

MEDIVATORS® ISA®
Endoscope Reprocessor

INFORMATION SOUNDS MENU RESET ALARMS

Pressing the SOUNDS button disables all acoustic signals (the button colour turns red):

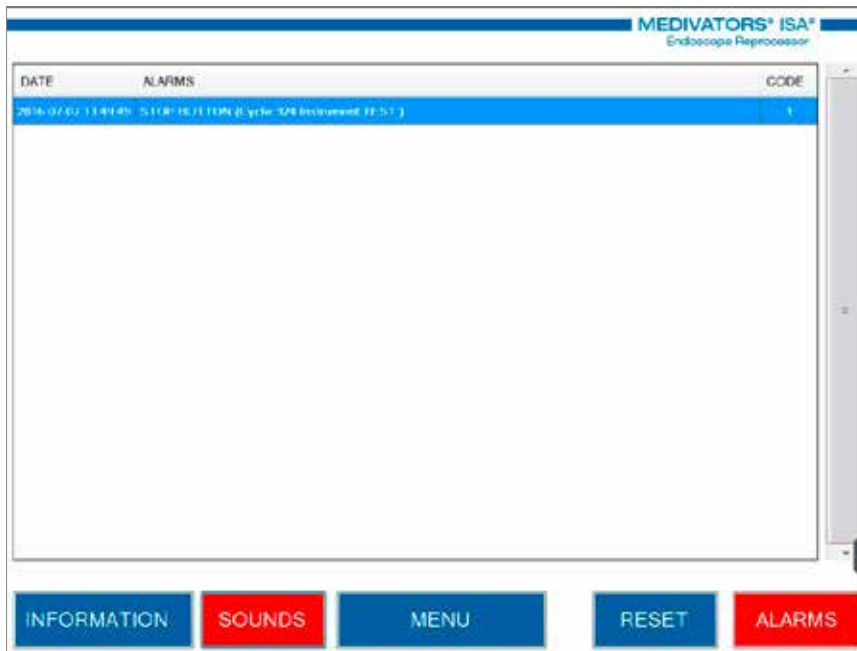

Pressing the INFORMATION button can allow viewing of the information relating to alarms in progress, and in particular, the potential causes and possible solutions.

Possible solutions are not displayed for all those types of alarms requiring the exclusive intervention of a specialized technician.



Pressing the RESET button resets the alarm in progress and the related acoustic signal.

This operation indicates to the equipment that the user is aware that the cycle is in an alarm state.

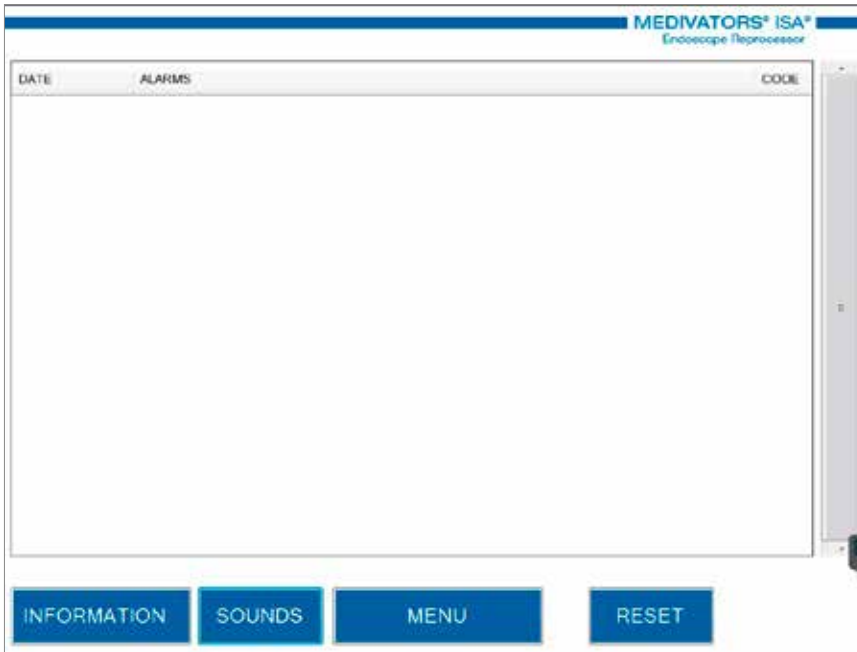

Pressing the MENU button returns to the main page:

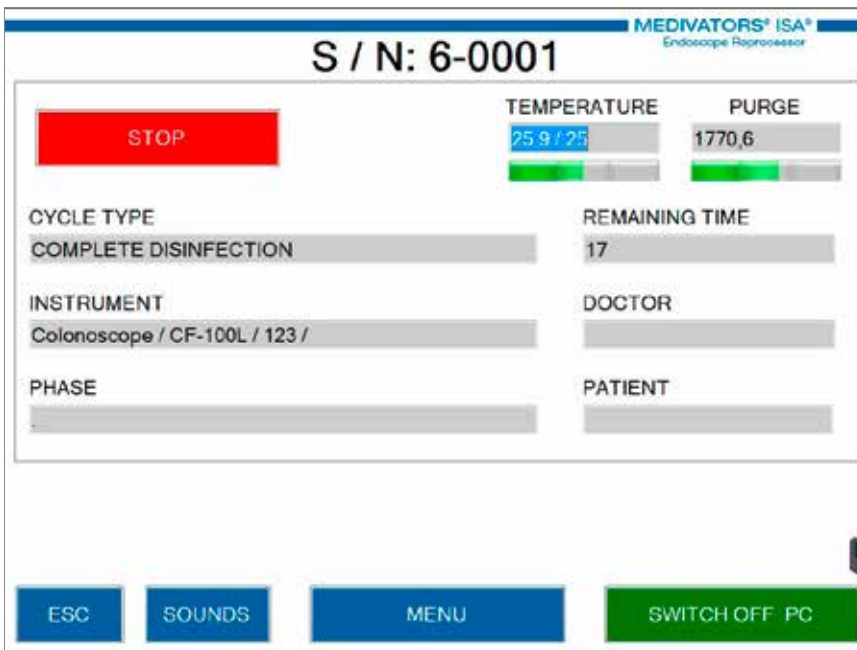

The STOP button can be used to interrupt the cycle at any time. After having pressed it, confirmation is required to stop the cycle in progress.

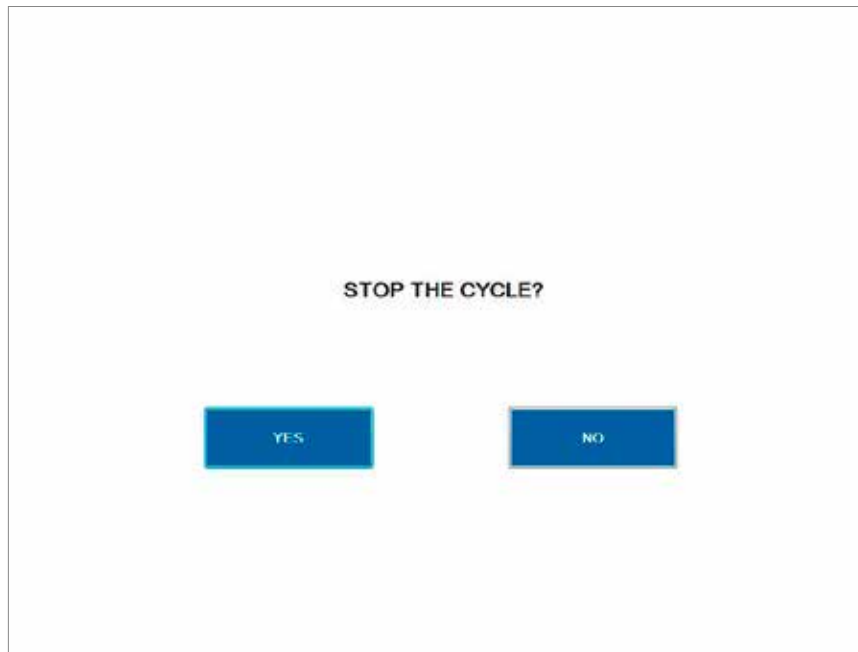

The main page normally appears as follows:

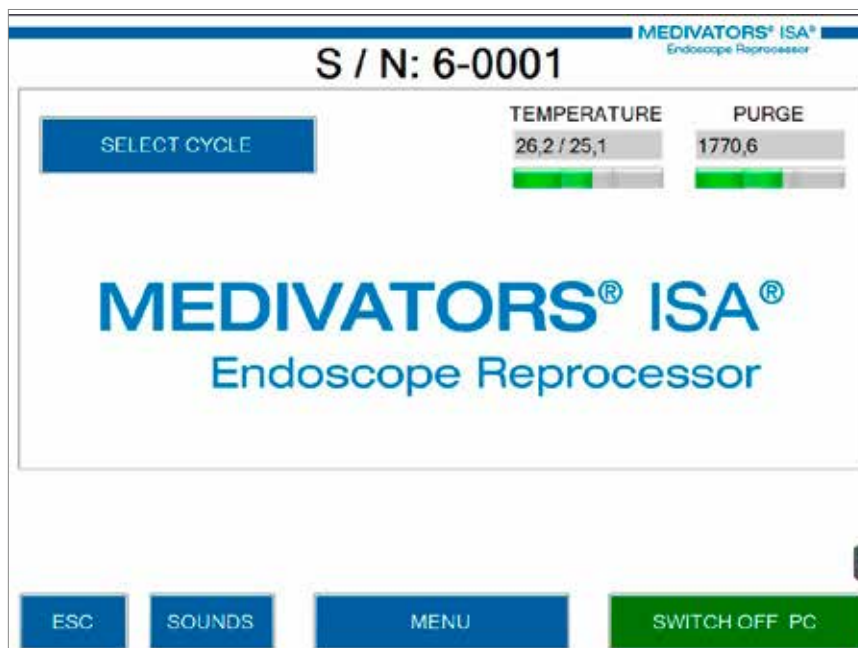

CYCLE START PROCEDURE

To start a cycle, press the MENU button.
This accesses the SELECT CYCLE page:

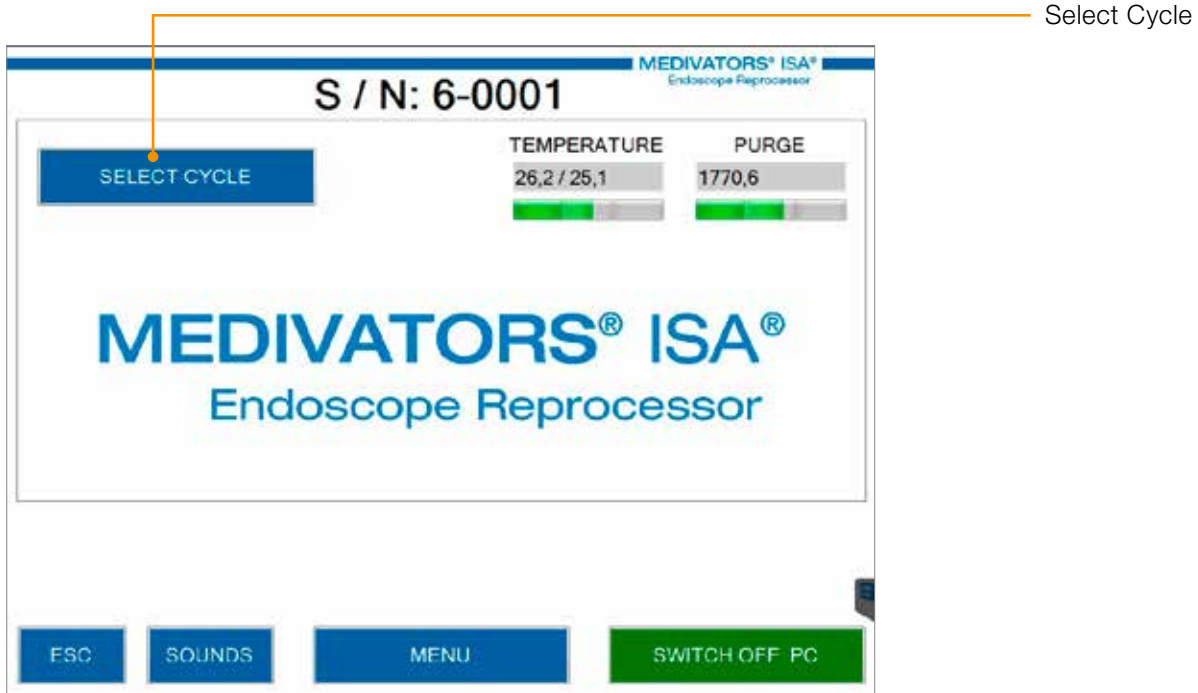

Pressing the SELECT CYCLE button opens the recognition request page:

MEDIVATORS[®] ISA[®]
Endoscope Reprocessor

LEVEL

OPERATOR
TECHNICIAN
ADMINISTRATOR

PASSWORD

1	2	3	4	5	6	7	8	9	0
Q	W	E	R	T	Y	U	I	O	P
A	S	D	F	G	H	J	K	L	CAPS
Z	X	C	V	B	N	M	-	.	SHIFT
ESC	< BACKSPACE	SPACE					ENTER		

Insert the personal ID code. This then opens the cycle select page:

INSTRUMENT				CYCLE TYPE	
CATEGORY	MODEL	SERIAL NUMBER	ID	CYCLE NAME	
Sigmoidoscope	ES-3840	1	1	COMPLETE DISINFECTION	
Gastroscope	GIF-Q185	A012345	1	FAST DISINFECTION	
Colonoscope	CF-100L	123			
Duodenoscope	JF-130	A123			
TEST		TEST			
	TESTER	A			
Duodenoscope	JF-130	1	1		
Gastroscope	GIF-100	e			

PHYSICIAN	
PATIENT	

SELF-DISINFECTION	MENU	START
-------------------	------	-------

To select the type of cycle to be performed, press once above the name of the cycle to be run so as to display the corresponding line. Press the instrument to be reprocessed once so as to display the corresponding line.

Once completed, press the START button to start the cycle.

On this page, there are two OPTIONAL panels indicating the physician and the patient, in the case of use, the text inserted here will be printed in the cycle report.

With regard to the PHYSICIAN, pressing the LIST button to the right of the white line makes it possible to select one of the options previously included in the list.

In the case where it is intended to insert a new physician, you can use two ways:

1. Enter Physician's name in the box at the right of the PHYSICIAN button:

INSTRUMENT			
CATEGORY	MODEL	SERIAL NUMBER	ID
Gastroendoscope	E-11 3040		
Gastroendoscope	GF-Q165	A012345	1
Colonoscope	CF-100L	123	
Duodenoscope	JF-130	A123	
TEST	TESTER	A	
Duodenoscope	JF-130	1	1
Gastroscope	GF-100	e	

CYCLE TYPE	
CYCLE NAME	
COMPLETE DISINFECTION	
FAST DISINFECTION	

PHYSICIAN

PATIENT

SELF-DISINFECTION MENU START

ROSSI

1	2	3	4	5	6	7	8	9	0
Q	W	E	H	T	Y	U	I	O	P
A	S	D	F	G	H	J	K	L	COM
Z	X	C	V	B	N	M	-	_	SHIFT
ESC	← BACKSPACE		SPACE				ENTER		

INSTRUMENT			
CATEGORY	MODEL	SERIAL NUMBER	ID
Gastroendoscope	E-11 3040		
Gastroendoscope	GF-Q165	A012345	1
Colonoscope	CF-100L	123	
Duodenoscope	JF-130	A123	
TEST	TESTER	A	
Duodenoscope	JF-130	1	1
Gastroscope	GF-100	e	

CYCLE TYPE	
CYCLE NAME	
COMPLETE DISINFECTION	
FAST DISINFECTION	

PHYSICIAN ROSSI

PATIENT

SELF-DISINFECTION MENU START

2. Select Physician from a list:



If the Physician is not present in the list, simply click on **MENU** → **PHYSICIAN**, press the **NEW** button and enter the information on the page.

Press button

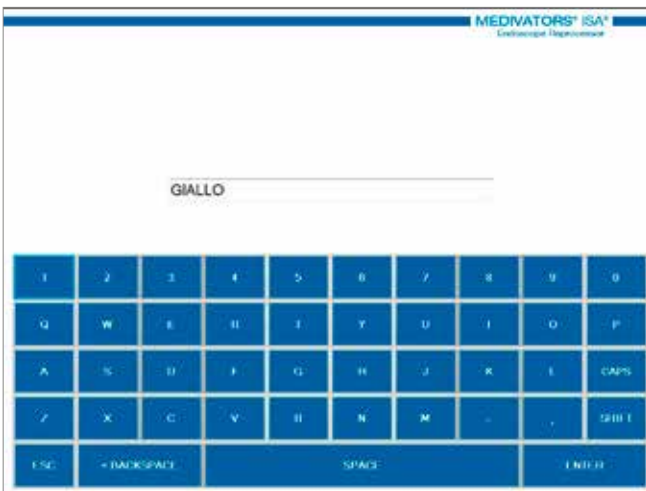

It is possible to enter patient ID information by clicking the white line to the right of the relevant PATIENT button, and once inserted, press the ENTER button:

The interface consists of several panels:

- INSTRUMENT**: A table with columns for CATEGORY, MODEL, SERIAL NUMBER, and ID.

CATEGORY	MODEL	SERIAL NUMBER	ID
Sigmoidoscope	ES-3840	1	1
Gastroscope	GIF-Q165	A012345	1
Colonoscope	CF-100L	123	
Duodenoscope	JF-130	A123	
TEST	TESTER	TEST	
Duodenoscope	JF-130	t	1
Gastroscope	GIF-100	e	
- CYCLE TYPE**: A panel with a 'CYCLE NAME' field containing 'COMPLETE DISINFECTION' and 'FAST DISINFECTION'.
- PHYSICIAN**: A field containing 'ROSSI'.
- PATIENT**: A field that is initially empty, then receives the input 'bianchi'.
- Buttons**: 'SELF-DISINFECTION', 'MENU', and 'START'.

The process shown is: clicking the white line on the 'PATIENT' button, entering 'bianchi' via the keypad, and pressing 'ENTER' to confirm the entry.

On completion of data insertion, the cycle selection page is displayed thus:

INSTRUMENT				CYCLE TYPE	
CATEGORY	MODEL	SERIAL NUMBER	ID	CYCLE NAME	
Sigmoidoscope	ES-384J	1	1	COMPLETE DISINFECTION	
Gastroscope	GIF-Q165	A012345	1	FAST DISINFECTION	
Colonoscope	CF-100L	123			
Duodenoscope	JF-130	A123			
TEST		TEST			
	TESTER	A			
Duodenoscope	JF-130	t	1		
Gastroscope	GIF-100	e			

PHYSICIAN	ROSSI
PATIENT	bianchi

SELF-DISINFECTION	MENU	START
-------------------	------	-------

Press the START button to start the cycle. The screen is updated as follows:

- The main page if accessing as the OPERATOR;
- A synoptic page if accessing as the TECHNICIAN or ADMINISTRATOR.

In addition, from the same page it is possible to run the auto-decontamination cycle by pressing the corresponding SELF-DISINFECTION button, and the cycle starts without the need for any further selection.

Pressing the MENU button or starting the cycle returns the system to the previous page.

CYCLE END PROCEDURE

On completion of a cycle, it is not possible to open the cover until the OK button is pressed. In the case of a regularly completed cycle, the green

“REGULAR CYCLE” screen appears, accompanied by an acoustic signal, indicating the correct conclusion:

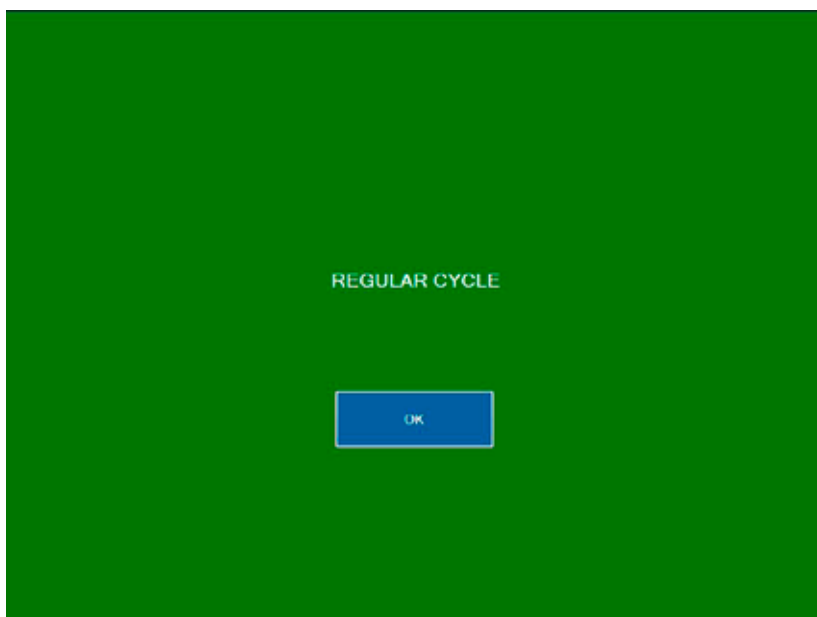

In the case of an irregularly completed cycle, a red “IRREGULAR CYCLE” screen appears, accompanied by an acoustic signal, indicating the incorrect conclusion (this sound is different from that for a regular cycle):

Again in this case, it is not possible to remove the endoscope until the OK button is pressed.

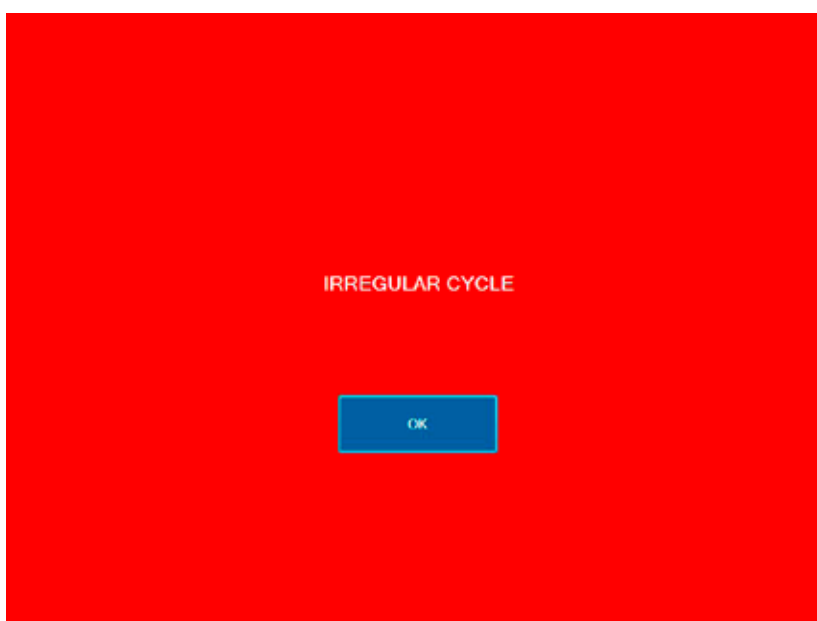

END OF CYCLE REPORT - ARCHIVING PROCEDURES

The MEDIVATORS™ ISA™ system records all the information relating to the cycles performed on its own hard disk, creating an electronic archive that can be consulted at any time. It is also equipped with a built-in printer which automatically prints the cycle report on completion of the cycle. The report is a document that is essential for cycle validation and must always be filed.

Parameters included in the print-out:

- MEDIVATORS ISA serial number
- Cycle start date and time
- Instrument data (category-s/n)
- Physician (optional)
- Patient (optional)
- Operator
- Type of cycle performed
- Cycle progressive number
- Cycle steps with relevant contact times
- Cycle outcome

A sample report relating to a correctly concluded cycle is reported below:

```

MEDIVATORS ISA
-----
SERIAL NUMBER: 6-0006
CYCLE START: 03/12/2015 11:06:32
INSTRUMENT: GIF-Q165
CATEGORY: GASTROSCOPE
SERIAL NUMBER: A012345
OPERATOR: VERDI
PHYSICIAN: ROSSI
PATIENT: 12345
CYCLE TYPE: COMPLETE DISINFECTION
CYCLE NUMBER: 27
11:06:33 LEAK TEST
11:06:33 WATER LOAD
11:06:53 DETERGENT LOAD
11:07:10 CLEANING (120s,14°C)
11:09:16 DRAIN
11:10:41 WATER LOAD
11:11:16 RINSE
11:12:27 DRAIN
11:13:52 WATER LOAD
11:14:12 STERILANT 1 LOAD
11:15:15 DISINFECTION (180s,14°C)
11:18:21 DRAIN
11:19:46 WATER LOAD
11:20:21 RINSE
11:21:31 DRAIN
11:22:56 PURGE
11:24:04 CYCLE END

11:24:06 REGULAR CYCLE

```

In addition, if the requirement of identification for removal of the endoscope is set, the report also states the ID of the operator that performed the task.

In case of need, it is in any case possible to print any report performed and archived in the device database.

To perform this operation, proceed as indicated below:

Figure A

From the main screen, press the MENU button:

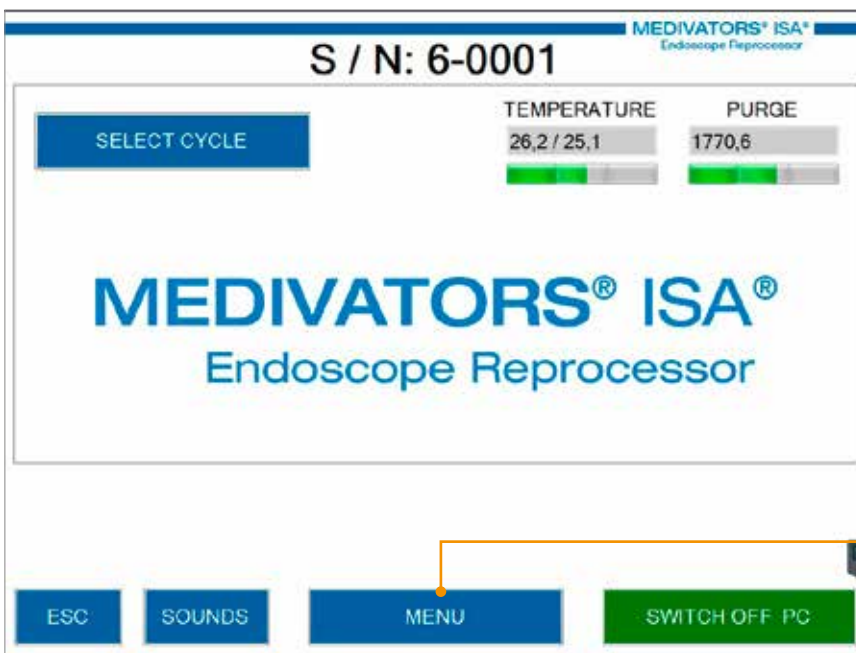
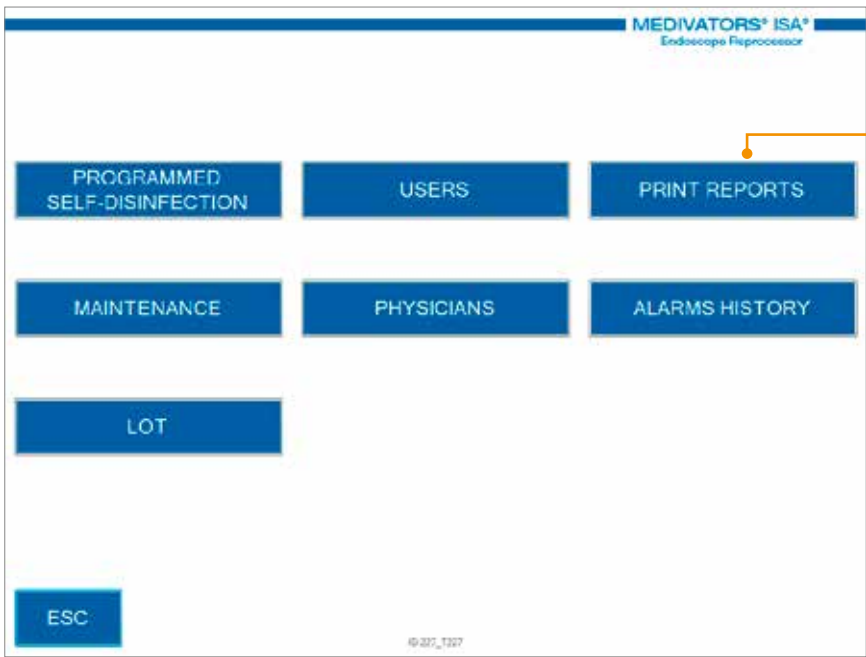

Figure B

Press the PRINT REPORTS button:



Press button

Figure C

The following screen is displayed:

CYCLE	DATE	CYCLE NAME	INSTRUMENT	CATEGORY	MODEL	USER
270	09/06/2016 11:55	clean intercept plus	A123	Duodenosc...	JF-130	1
269	09/06/2016 11:03	double clean	TEST	TEST		1
268	07/06/2016 16:33	double clean	A		TESTER	2
266	06/06/2016 10:53	CALIBRATION SOLUTIO...	A123	Duodenosc...	JF-130	2
265	06/06/2016 10:50	CALIBRATION SOLUTIO...	A123	Duodenosc...	JF-130	2
264	06/06/2016 10:47	calib. detergent	A123	Duodenosc...	JF-130	2
263	06/06/2016 10:45	calib. detergent	A123	Duodenosc...	JF-130	2
262	06/06/2016 10:43	calib. detergent	A123	Duodenosc...	JF-130	2
261	06/06/2016 10:40	CALIBRATION SOLUTIO...	A123	Duodenosc...	JF-130	2
260	06/06/2016 10:37	CALIBRATION SOLUTIO...	A123	Duodenosc...	JF-130	2
259	06/06/2016 10:34	CALIBRATION SOLUTIO...	A123	Duodenosc...	JF-130	2
258	06/06/2016 10:30	CALIBRATION SOLUTIO...	A123	Duodenosc...	JF-130	2
257	06/06/2016 10:24	CALIBRATION SOLUTIO...	A123	Duodenosc...	JF-130	2
256	06/06/2016 10:20	CALIBRATION SOLUTIO...	A123	Duodenosc...	JF-130	1009
255	06/06/2016 10:17	CALIBRATION SOLUTIO...	A123	Duodenosc...	JF-130	1009
254	06/06/2016 10:14	CALIBRATION SOLUTIO...	A123	Duodenosc...	JF-130	1009
253	06/06/2016 10:11	CALIBRATION SOLUTIO...	A123	Duodenosc...	JF-130	1009
252	06/06/2016 10:08	CALIBRATION SOLUTIO...	A123	Duodenosc...	JF-130	1009

The PRINT REPORTS screen displays all the reports for the cycles performed in chronological order, indicating the instrument used, the operator that performed the cycle, the cycle outcome and the batch numbers for the filters and products used, for each type of cycle performed.

Each cycle can be selected by pressing above the relevant line, which changes colour to blue.

Figure D

Pressing the VIEW button opens the report screen for the cycle selected:

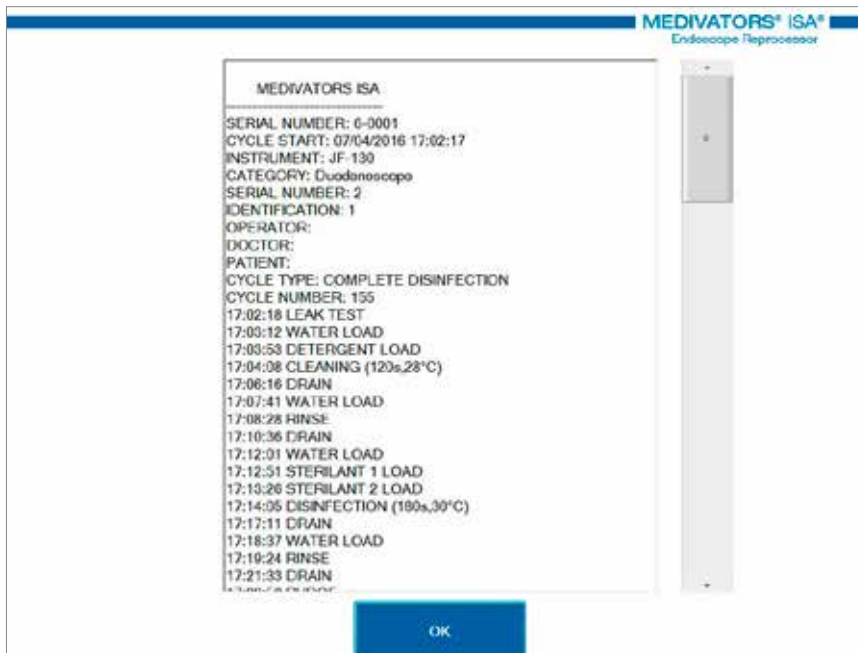

Press the OK button to return to the previous screen.

1. Press the PRINT button to start the process.

2. In the case of more than one printer being available, select the desired printer from the PRINTER SELECTION menu. It is also possible to select the FONT size:

Figure E

Press the PRINT button to conclude the process.

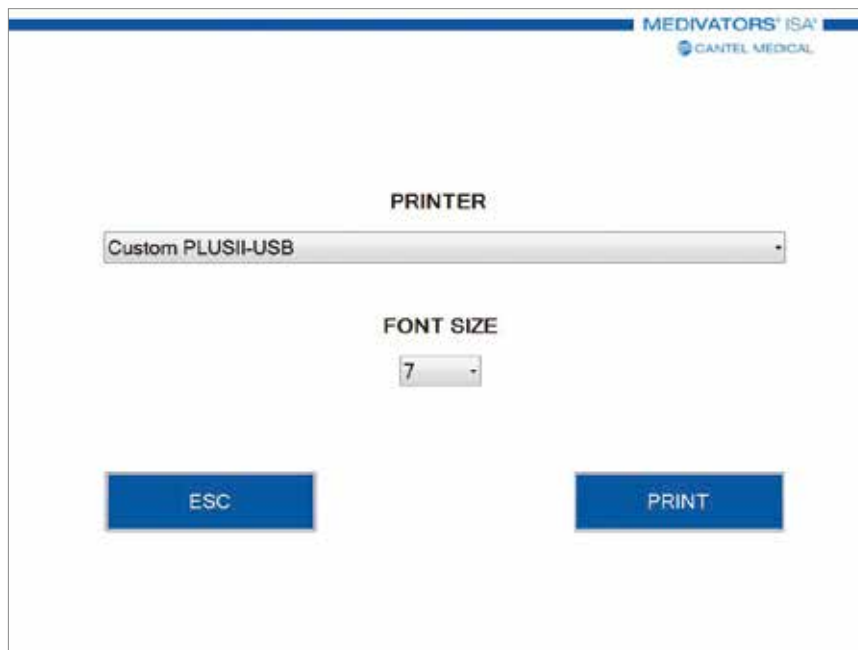

Press the EXPORT button to copy the complete report database to the desired media. Press the UPDATE button to display all available connected media:



It is possible to apply filters to the select report page using flags and the drop-down menu located in the lower left of the page:

MEDIVATORS® ISA® Endoscope Reprocessor						
CYCLE	DATE	CYCLE NAME	INSTRUMENT CATEGORY	MODEL	USER	
200	25/04/2016 10:16	double clean	123456			2
198	25/04/2016 09:20	double clean	2			2
197	26/04/2016 15:07	double clean	2			2
196	26/04/2016 14:03	double clean	2			2
195	26/04/2016 13:04	double clean	2			2
193	27/04/2016 14:33	double clean	2			2
189	22/04/2016 11:21	double clean	2			1
187	22/04/2016 10:21	double clean	2			1
183	21/04/2016 16:37	double clean	2			1
181	21/04/2016 16:20	double clean	2			1
159	11/04/2016 16:13	COMPLETE STERILIZAT...	2			1
158	08/04/2016 09:16	COMPLETE STERILIZAT...	2			1
156	07/04/2016 17:02	COMPLETE DISINFECTI...	2			1
152	07/04/2016 11:28	FAST DISINFECTION	2			1
147	07/04/2016 10:24	FAST DISINFECTION	2			1
145	07/04/2016 09:43	FAST DISINFECTION	2			1
118	29/03/2016 16:22	SETTING	1	Sigmoidesc...	ES-3840	2

REGULAR CYCLE

IRREGULAR CYCLE

REGULAR CYCLE

MENU

VIEW

PRINT

PRINTER SELECTION

EXPORT

LOT

Select the REGULAR CYCLES filter to display only cycles that have concluded regularly. Select the IRREGULAR CYCLES filter to display only cycles that have concluded irregularly. Selecting nothing to display all cycles, independently of outcome.

In the case where a checkmark is applied to LOT, the lots of filters and chemical products used in the corresponding cycle will be displayed:

MEDIVATORS [®] ISA [®] Endoscope Reprocessor						
CYCLE	DATE	STERILANT 1	STERILANT 2	DETERGENT	FILTER 1	FILTER 2
200	29/04/2016 10:16					
198	29/04/2016 09:20					
197	28/04/2016 16:07					
196	28/04/2016 14:03					
195	28/04/2016 13:04					
193	27/04/2016 14:33					
189	22/04/2016 11:21					
187	22/04/2016 10:21					
183	21/04/2016 16:37					
181	21/04/2016 16:20					
169	11/04/2016 16:13					
156	08/04/2016 09:16					
155	07/04/2016 17:02					
152	07/04/2016 11:28					
147	07/04/2016 10:24					
145	07/04/2016 09:43					
118	29/03/2016 16:22					

FILTER
 REGULAR CYCLE -

MENU

VIEW

PRINT

PRINTER SELECTION

EXPORT

LOT

OTHER OPERATOR SOFTWARE FUNCTIONS

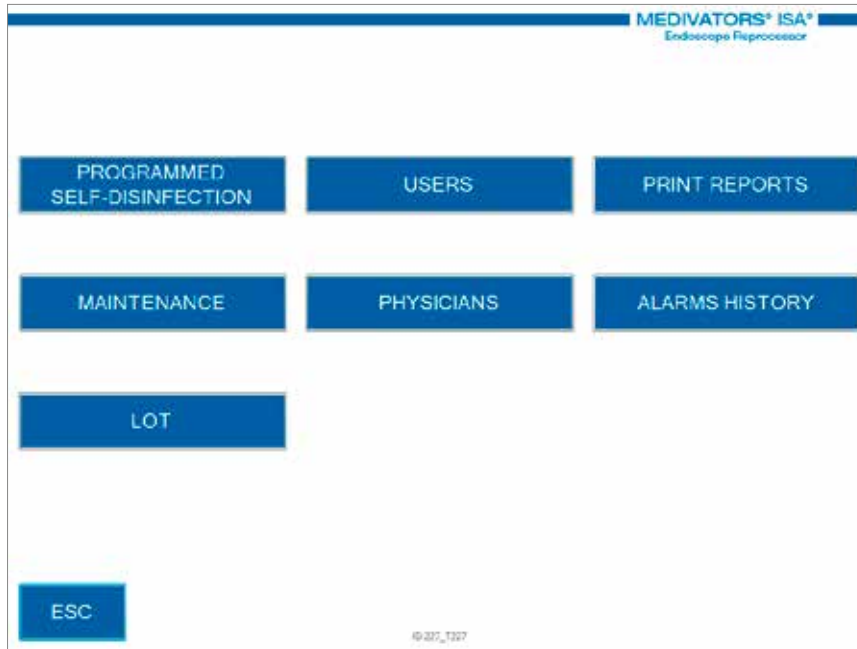

From the MENU screen, the user has access to other functions:

- a. MAINTENANCE: press this button to display the status of routine maintenance for the equipment. It is possible to verify the SETUP (days scheduled

between one maintenance operation and the next) and the number of days elapsed since the most recent maintenance operation:

	DAYS PASSED	CONFIGURATION
1ST STAGE FILTER CHANGE	0	180
2ND STAGE FILTER CHANGE	0	180
COMPRESSED AIR FILTER CHANGE	0	180
LEAK TEST FILTER CHANGE	0	180
RECYCLING FILTER SUBSTITUTION	0	180
SELF-DISINFECTION	3	5

Press the MENU button to return to the previous screen.

b. USERS: in this screen, the user can display the list of registered operators.

It is not possible to insert, modify or delete the users present in the list using the USERS user level.

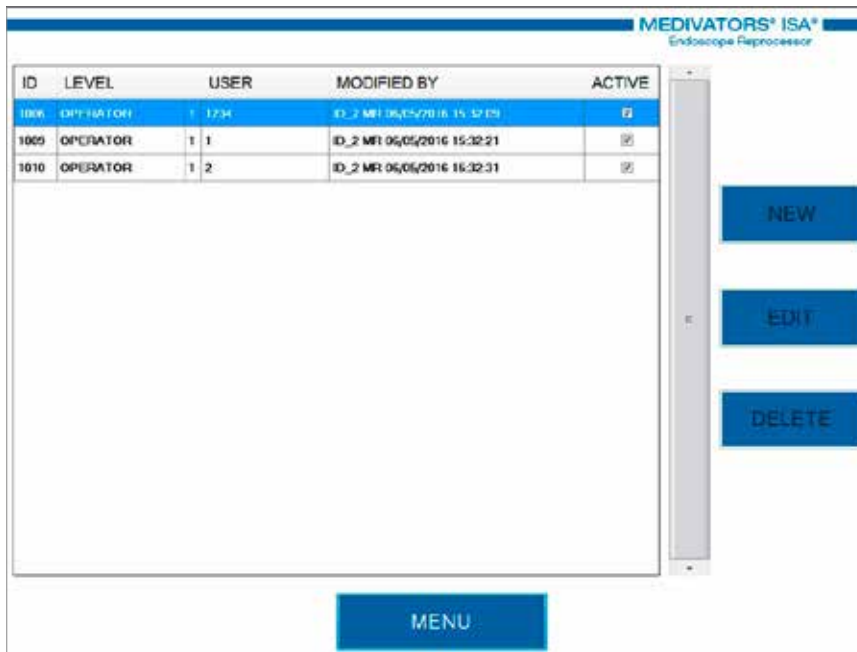

The screenshot displays the 'MEDIVATORS ISA Endoscope Reprocessor' interface. It features a table with the following columns: ID, LEVEL, USER, MODIFIED BY, and ACTIVE. The table contains three rows of data. To the right of the table is a vertical sidebar with three buttons: 'NEW', 'EDIT', and 'DELETE'. At the bottom center of the screen is a 'MENU' button.

ID	LEVEL	USER	MODIFIED BY	ACTIVE
1006	OPERATOR	1 1234	ID_2 MR 05/05/2016 15:32:03	<input type="checkbox"/>
1009	OPERATOR	1 1	ID_2 MR 05/05/2016 15:32:21	<input checked="" type="checkbox"/>
1010	OPERATOR	1 2	ID_2 MR 05/05/2016 16:32:31	<input checked="" type="checkbox"/>

The insertion, modification and deletion of users can only be made at TECHNICIAN and/or ADMINISTRATOR level.

TECHNICIAN level can only insert, modify and delete up to technician level, on the other hand the ADMINISTRATOR can act at all levels.

MEDIVATORS[®] ISA[™]
CANTEL MEDICAL

ID	LEVEL	USER	MODIFIED BY	ACTIVE
2	TECHNICIAN	2 Technical		<input checked="" type="checkbox"/>
3	ADMINISTRATOR	3 Administrator		<input checked="" type="checkbox"/>
4	OPERATOR	1 1221	ID_2 Technical 17/02/2016 13:01:35	<input checked="" type="checkbox"/>

NEW

EDIT

DELETE

FILTER
 ACTIVE

MENU

c. PHYSICIANS: in this screen, the user can display and add medical personnel, which can be included in the end of cycle report print-out, if selected.

(Instruction to add a new Physician was explained in the previous pages).



d. ALARM HISTORY: press this button to display the log of all alarm events:

The screenshot shows the 'ALARM HISTORY' screen. At the top, it says 'MEDIVATORS ISA Endoscope Reprocessor'. Below that is a table with columns 'DATE', 'ALARMS', and 'CODE'. The table contains 18 rows of alarm events. At the bottom, there are two buttons: 'INFORMATION' and 'MENU'.

DATE	ALARMS	CODE
2016-07-07 14:07:06	Alarm dist charge (Cycle: 326 Instrument: A, Valore: 0)	40
2016-07-07 14:00:03	STOP BUTTON (Cycle:327 Instrument:1)	1
2016-07-07 13:53:07	STOP BUTTON (Cycle:326 Instrument:1)	1
2016-07-07 13:52:12	STOP BUTTON (Cycle:325 Instrument:123)	1
2016-07-07 13:49:49	STOP BUTTON (Cycle:324 Instrument: TEST)	1
2016-07-04 09:21:55	Alarm loss of liquid (Valore:SL2)	60
2016-07-01 09:25:51	STOP BUTTON (Cycle:306 Instrument:e)	1
2016-06-24 13:44:52	Communication error alarm (Valore:06)	3
2016-06-24 13:26:59	Alarm opening basin (Cycle:292 Instrument:A)	59
2016-06-24 13:26:37	Alarm opening basin (Cycle:291 Instrument:A)	59
2016-06-24 13:26:11	Alarm opening basin (Cycle:290 Instrument:A)	59
2016-06-24 13:26:15	Alarm opening basin (Cycle:289 Instrument:A)	59
2016-06-22 16:34:51	Alarm channel 7 disconnected (Cycle:288 Instrument:1 Valore:364)	37
2016-06-22 16:21:19	Alarm channel 7 disconnected (Cycle:287 Instrument:1 Valore:1111,5)	48
2016-06-22 16:12:36	Alarm channel 7 disconnected (Cycle:286 Instrument:1 Valore:128,7)	48
2016-06-21 11:30:54	Alarm channel 7 obstructed (Cycle:281 Instrument:1 Valore:1456,4)	49
2016-06-21 11:27:01	Alarm channel 7 obstructed (Cycle:280 Instrument:1 Valore:1396,2)	49

Press the desired line and then the INFORMATION button to display the information relating to the alarm:

Press the MENU button to return to the previous screen.



e. PROGRAMMED SELF-DISINFECTION (TIMER SELF DISINFECTION): from this screen it is possible to schedule self-disinfection, which will start automatically according to the programmed schedule.

To program this event, access the following page:



From which it is possible to set the days and insert an automatic cycle start time.

Cantel Medical recommends daily execution of the programmed self-disinfection cycle in order to sterilize the fluid circuit and to Warranty a higher level of safety with regard to infections.



The Self-disinfection cycle must be performed without endoscopes. The basin must be empty, and must only be connected to the selfdisinfection connector.

f. LOT: from this screen the user can provide the lot serial number in case of substitution of a tank of detergent/sterilant or a filter.

After the user tap on the „LOT“ button the following screen is shown.

The user will insert the LOT serial number using the virtual on-screen keyboard. The key “ENTER” will be

used to confirm, the key “ESC” to cancel (i.e. to close this window without insert a LOT serial)

- g. SWITCH OFF THE PC: it is obligatory that this button be used to shut-down the PC. **Any other**

PC shut-down procedure could cause damage to the PC itself, which DOES NOT fall within the scope of the manufacturer's Warranty.



TANK REPLACEMENT PROCEDURE

During the cycle, if the equipment detects a lack or partial load for one of the products, it informs the user of the need to replace the relevant tank by means of visual and acoustic messages.

This warning is managed so as to allow the operator

to be able to replace the corresponding product tank without the need to interrupt and restart the cycle from the start.

When an absence of product load is detected, the screen displays one of the following messages:

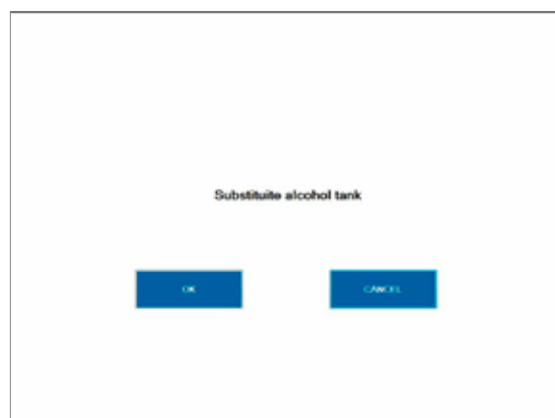
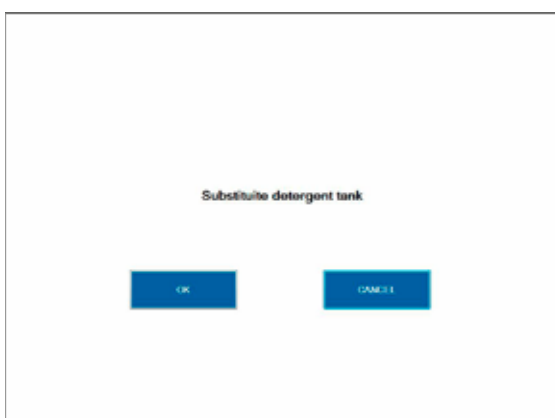

Having replaced the tank, press the OK button to restart the cycle.

This operation may be performed a maximum of 3 times, after which the cycle is interrupted and reset.

It is also possible to interrupt the cycle by pressing the CANCEL button on the warning screen.

The purpose is to establish a procedure to instruct personnel of the actions to be implemented for the correct replacement of MEDIVATORS™ ISA™ Endoscope Reprocessor tanks.

This procedure takes into account the chemical risks associated with the replacement actions, decontamination of the machine and disposal of the spent tanks.

APPLICABILITY

This procedure must be applied by staff members each time the MEDIVATORS ISA Endoscope Reprocessor chemical agents are correctly replaced.

RESPONSIBILITIES

Responsibility for the correct replacement of chemical agents and proper disposal of the empty tanks is entrusted to the operator performing said operation.



WARNING! When handling the solutions, adopt the protective measures present in the product material safety data sheets.

OPERATING CONDITIONS FOR SUBSTITUTION OF THE ISASPOR™ OR RAPICIDE™ PA PART A, STERILANT/ DISINFECTANT (SOLUTION A) TANK

1. Wear PPE, including: face mask, gloves and eye protection.
2. Remove the seals from the cap on the full tank.
3. Place the full tank in front of the tank to be replaced.
4. Unscrew the cap on the tank to be replaced without removing it.
5. Unscrew and remove the cap from the full tank.
6. Extract the nozzle, together with the cap, from the spent tank.
7. Insert the extracted nozzle into the full tank and tighten the cap.
8. Seal the empty tank using the cap from the full tank.
9. Remove the empty tank and insert the full tank into the compartment.
10. Dispose of the tank in accordance with the applicable legislation and the provisions reported in the material safety data sheet.

OPERATING CONDITIONS FOR SUBSTITUTION OF THE ISASPOR™ OR RAPICIDE™ PA PART B, STERILANT/ DISINFECTANT (SOLUTION B) TANK

1. Wear PPE, including: face mask, gloves and eye protection (goggles/mask).
2. Remove the seals from the cap on the full tank.
3. Place the full tank in front of the tank to be replaced.
4. Unscrew the cap on the tank to be replaced without removing it.
5. Unscrew and remove the cap from the full tank.
6. Extract the nozzle, together with the cap, from the spent tank.
7. Insert the extracted nozzle into the full tank and tighten the cap.
8. Seal the empty tank using the cap from the full tank.
9. Remove the empty tank and insert the full tank into the compartment.
10. Dispose of the tank in accordance with the applicable legislation and the provisions reported in the material safety data sheet.

OPERATING CONDITIONS FOR SUBSTITUTION OF THE ISACLEAN™ OR INTERCEPT™ PLUS TANK

1. Wear PPE, including: face mask, gloves and eye protection (goggles/mask).
2. Remove the seals from the cap on the full tank.
3. Place the full tank in front of the tank to be replaced.
4. Unscrew the cap on the tank to be replaced without removing it.
5. Unscrew and remove the cap from the full tank.
6. Extract the nozzle, together with the cap, from the spent tank.
7. Insert the extracted nozzle into the full tank and tighten the cap.
8. Seal the empty tank using the cap from the full tank.
9. Remove the empty tank and insert the full tank into the compartment.
10. Dispose of the tank in accordance with the applicable legislation and the provisions reported in the material safety data sheet.

OPTIONAL FUNCTIONS



WARNING! The optional functions can be activated only by request. The levels that are authorized to activate these functions are Technician and Administrator.

DOUBLE CLEAN OPTION.

If activated, this option will generate a confirmation

request, before to start a cycle, when it is with a simple washing phase:

INSTRUMENT				CYCLE TYPE	
CATEGORY	MODEL	SERIAL NUMBER	ID	CYCLE NAME	
Sigmoidoscope	FS-3843	1	1	COMPLETE DISINFECTION	
Gastroscope	GIF-Q165	A012345	1	FAST DISINFECTION	
Colonoscope	GF-100L	123			
Duodenoscope	JF-130	A123			
TEST		TEST			
	TESTER	A			
Duodenoscope	JF-130	t	1		
Gastroscope	GIF-100	e			

PHYSICIAN	ROSSI
PATIENT	bianchi

SELF-DISINFECTION	MENU	START
-------------------	------	-------

CYCLE WITH SINGLE CLEANING

OK CANCEL

SAMPLE OPTION.

If activated, this option allows to pick up the sample for analysis on the performance for cycle in MEDIVATORS™ ISA™ Endoscope Reprocessor:

1. Pick up water in before to start cleaning phase;

2. Pick up tester after washing phase;

3. Pick up last rinse water;

To run a cycle with this option, need to select flag in this page:

INSTRUMENT				CYCLE TYPE	
CATEGORY	MODEL	SERIAL NUMBER	ID	CYCLE NAME	
Sigmoidoscope	LS-3840	1	1	COMPLETE DISINFECTION	
Gastroscope	GIF-Q185	A012345	1	FAST DISINFECTION	
Colonoscope	CF-100L	123			
Duodenoscope	JF-130	A123			
TEST		TEST			
	TESTER	A			
Duodenoscope	JF-130	1	1		
Gastroscope	GIF-100	e			

PHYSICIAN		SAMPLE	X
PATIENT			
SELF-DISINFECTION	MENU	START	

In the case 1. , after load water in cleaning phase, the cycle will stop and will appear this request:

**SAMPLE
CLEANING WATER LOAD**

IT IS POSSIBLE TO OPEN THE COVER
OR
PRESS OK TO CONTINUE

OK

EXTERNAL FUNCTION OPTION.

If activated, this option activates a button in the MENU, that connect MEDIVATORS™ ISA™ software with an external application

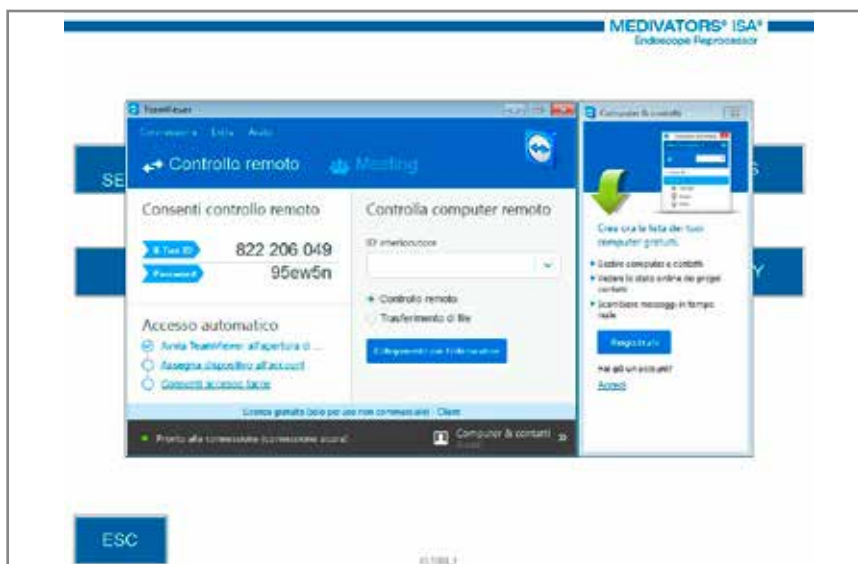
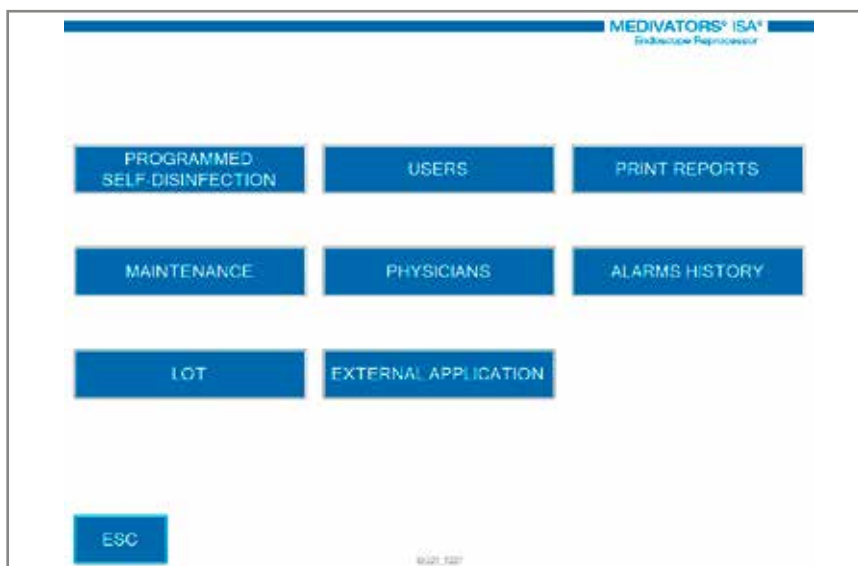

In this case, external application is a software for connection: remote control.

PRINT REQUEST OPTION.

If activated, this option will generate a request, at the end of cycle, about the printers to use and about the size for font:

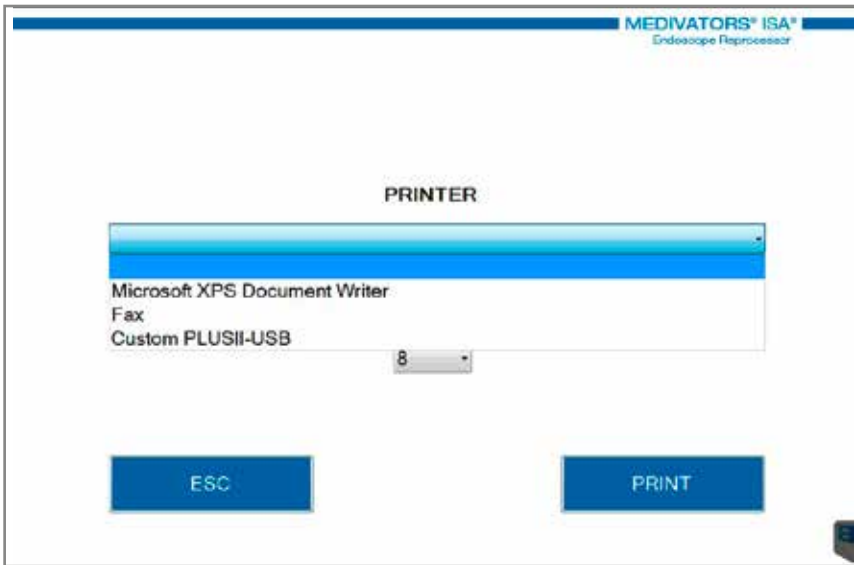

PASSWORD REQUEST OPTION.

If activated, this option will generate a request, at

the end of cycle, about the PASSWORD for the user that is pick upping the scope from the basin :



CHAPTER 5

MAINTENANCE

This chapter describes the periodic maintenance that must be performed by the operator.

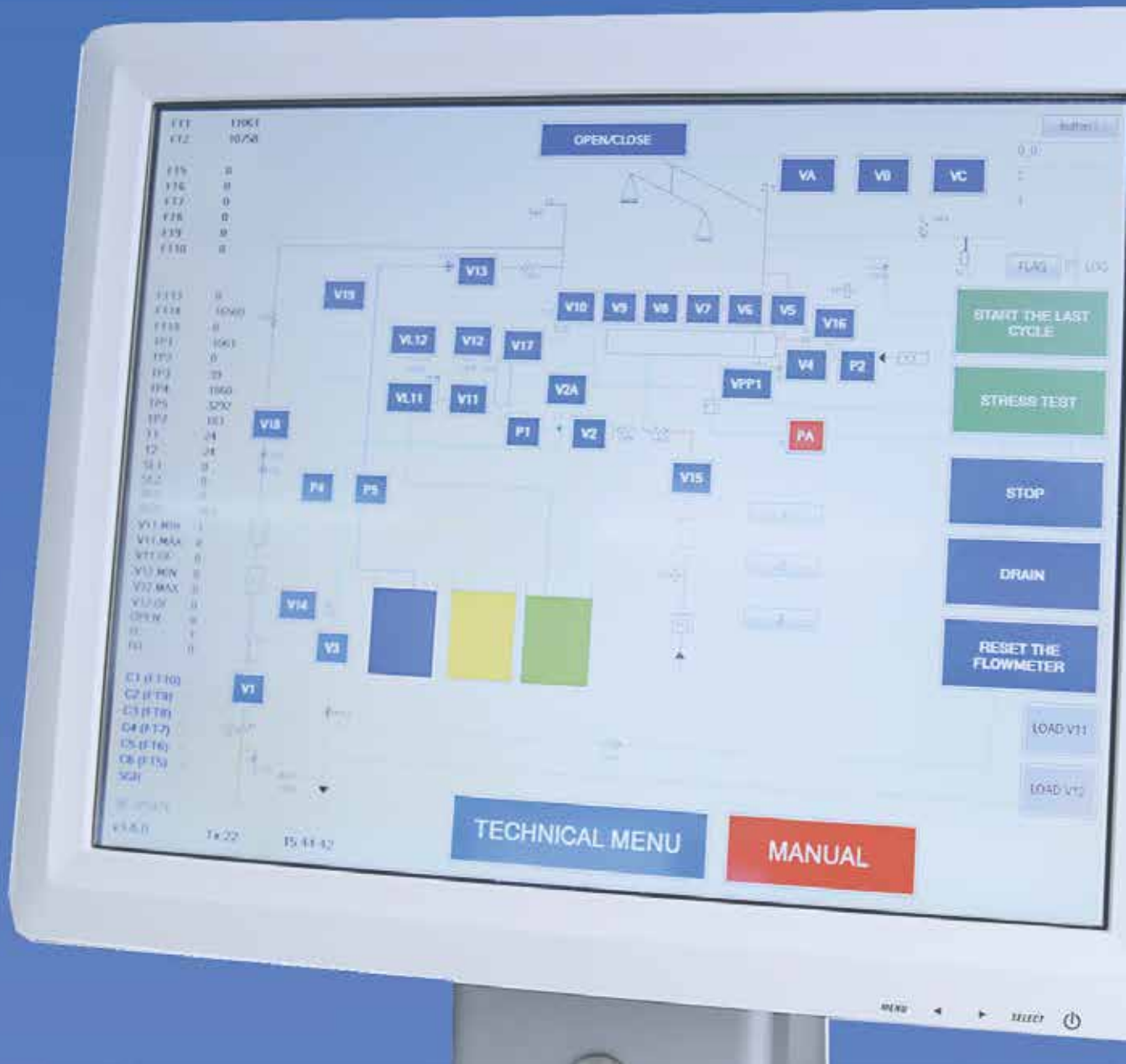

OPERATOR PERIODIC MAINTENANCE

With regard to periodic maintenance of the MEDIVATORS™ ISA™ Endoscope Reprocessor, the operator must verify that changing the water/air filters and the periodic checks are conducted

regularly every 6 months and that they are documented by work reports suitably signed by staff, specialized and authorized by the equipment manufacturer.

CLEANING THE MEDIVATORS ISA ENDOSCOPE REPROCESSOR

For cleaning of the MEDIVATORS ISA Endoscope Reprocessor, use specific products according to surface type:

- Non-aggressive products for steel surfaces in the machine structure.
- Non-aggressive products for plastic and glass surfaces.
- Non-aggressive products for the PC and for the screen.



WARNING! Make sure that no residues remain inside the basin.

WARNING! clean the pc after first having made sure that the electricity supply has been disconnected. Use specific products and do not leave any liquid residues that might damage the pc.

CHANGING TO STANDBY MODE DUE TO INACTIVITY

If MEDIVATORS ISA Endoscope Reprocessor is inactive for a long time, proceed as described below:

- Insert and connect the auto-decontamination connector to the basin.
- Close all the machine's feed inlets (water, compressed air, electricity).
- Remove the air and water filters from the machine.



WARNING! Filters must only be removed by technical staff that are specialized and/or authorized by the manufacturer.

WARNING! Do not leave endoscope connectors not connected to the related endoscope in the basin: any liquid present could infiltrate into the leak test connector and damage the endoscopes. In this case, the manufacturer is exonerated from all responsibility relating to damage to the endoscope.

CHAPTER 6

WARRANTY

This chapter describes the Warranty covering the MEDIVATORS™ ISA™ Endoscope Reprocessor and related parts.

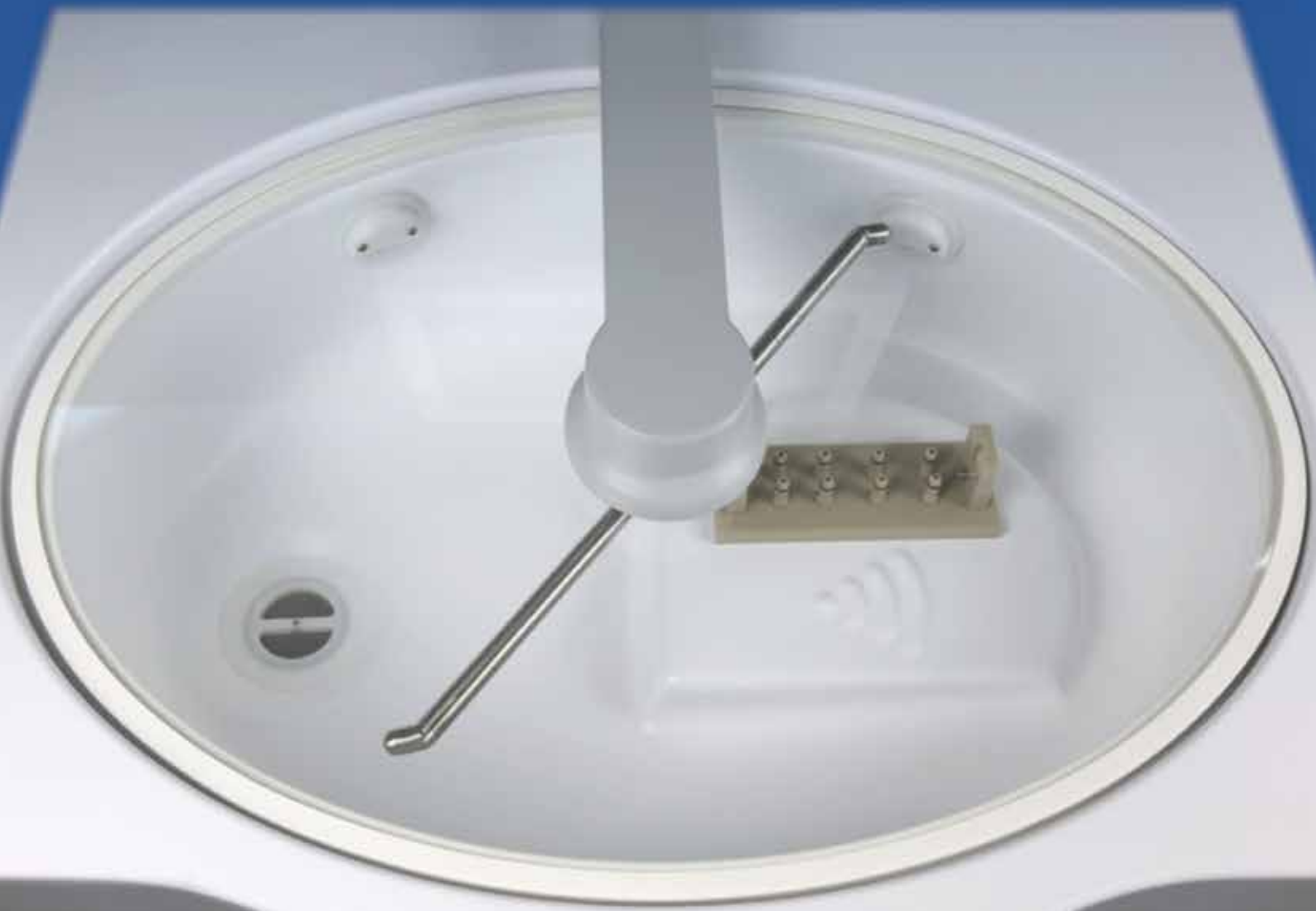

EXCLUSION OF RESPONSIBILITY

Cantel Medical (Italy) S.r.l. warrants the perfect operation of the MEDIVATORS™ ISA™ Endoscope Reprocessor and the attainment of washing and disinfection results for the endoscopes reprocessed only if:

- The equipment is used in compliance with the procedures described in this manual and in accordance with the instructions provided by the manufacturer.
- Technical servicing is performed by technical personnel authorized by Cantel.
- Consumable products (filters, products, spare parts etc.) that are validated and supplied by the Manufacturer are used.

LIMITED WARRANTY

Cantel Medical (Italy) S.r.l. warrants that the MEDIVATORS ISA Endoscope Reprocessor complies with the specifications declared by Cantel Medical and is warranted to be free from material and processing defects during normal use and maintenance for a period of fifteen (15) months from the date of dispatch from Cantel or one (1) year from the date of installation, depending on which of the two situations should occur first.

Independently of all provisions to the contrary contained in the present document, the warranty period for consumables and accessories supplied by Cantel, including by way of non-limiting example, endoscope connectors, filters, printers, printer spare parts, accessories, is ninety (90) days from the date of installation or 120 days from the date of dispatch, depending on which of the two situations should occur first.

The warranty only includes any faults or manufacturing defects.

The warranty does not cover, and the Company shall have no obligation of warranty regarding damages to the Product caused by or associated with: (i) external causes, including, without limitation, accidents, acts of vandalism, natural disasters, acts of God, loss of electricity supply or power surges, (ii) abuse, negligence or improper use of the product by the client or third parties, or the use of unauthorized third party filters or other consumables or accessories or chemical substances not validated by the Company, (iii) use not in compliance with the Product instructions, (iv) lack of preventive maintenance requested by the client, or (v) unauthorized support and repairs.

LIMITATION OF RESPONSIBILITIES

At the discretion of the Company, the SOLE RESPONSIBILITY of the Company, with regard to the warranty, shall be the repair or replacement of defective Product(s) or the reimbursement or the issuing of credit to the value of the purchase price. This shall be the sole solution for the client for a defect covered by the warranty.

To obtain compensation under warranty, the client should inform the Company of the defect (describing the problem in a reasonably detailed way) before the expiration of the warranty period and within thirty (30) days of discovery of the defect.

After having received the official „return merchandise authorization“ (RMA) from the Company, the client should return the defective product immediately to the company itself (or to the support centre indicated in the RMA), paying transport and insurance in advance. The Company shall not be responsible for any damages occurring during transport.

LIMITATION OF THE WARRANTY

The above Warranty represents the entirety of the Warranty obligations of the company towards the product purchaser. The company expressly declines all other warranties and conditions, expressed or implied, statutory or of any other nature, including, without limitation, warranties or conditions of commerciability and suitability for a particular purpose, in addition to warranties resulting from execution of an agreement and from commercial uses; the company does not declare nor Warranty that the products satisfy the needs of the client.

Within the legally permitted limits, and except in the case of gross negligence or malicious behaviour by the company, the company shall not be responsible to the client for indirect or consequential damages or for damages or other costs or passivity (whether foreseeable or not), even if advised of the possibility of said damages, resulting from the warranty or from the contract, from negligence or other illegal acts of another

nature, including, without limitation, foreseeable commercial losses, loss of profits, loss of contracts or commercial opportunities, and dependant damages.

This New Product Limited Warranty provides the Product client with specific legal rights; the client themselves can also benefit from other rights which vary from one jurisdiction to another.

Within legally permitted limits, the Company's responsibilities cannot exceed the original purchase price of the Product covered by the warranty.

No Company representative or agent has the power to bind the Company to any other declaration or warranty with regard to the Products, and the client accepts that the Products are subject to all the aforementioned terms.

CHAPTER 7

RESOLUTION OF PROBLEMS

This chapter deals with the resolution of problems affecting the MEDIVATORS™ ISA™ Endoscope Reprocessor, with regard to alarms indicated by the equipment and the potential actions of healthcare workers for the resolution of said problems.

Any other operations for the restoration of equipment function must be performed by staff that are qualified and authorized by the Manufacturer.



WARNING! When a cycle is interrupted and it is necessary to remove the instrument to be reprocessed, use all envisaged protection systems (gloves, face visor, face mask etc.). It is possible that liquid will be present inside the basin and the endoscope.

Therefore, rinse the instrument with copious amounts of running water and do not use it on patients.

RESOLUTION OF PROBLEMS

▶ Type of alarm	▶ Cause	▶ Solution
MINIMUM WATER PRESSURE	<ol style="list-style-type: none"> 1. No mains water pressure 2. Failure in TP1 	<ul style="list-style-type: none"> ▶ Check the mains water supply is on. ▶ Check the inlet water pressure. ▶ Send technical intervention request.

▶ Type of alarm	▶ Cause	▶ Solution
MINIMUM AIR PRESSURE	<ol style="list-style-type: none"> 1. No compressed air feed 2. Fault in R1 3. Fault in F4 4. Fault in TP4 	<ul style="list-style-type: none"> ▶ Check that the inlet air pressure is present and/or sufficient. ▶ Send technical intervention request.

▶ Type of alarm	▶ Cause	▶ Solution
MAXIMUM AIR PRESSURE	<ol style="list-style-type: none"> 1. Fault in R1 2. Fault in TP4 	<ul style="list-style-type: none"> ▶ Check that the inlet air pressure is not too high. ▶ Send technical intervention request.

▶ Type of alarm	▶ Cause	▶ Solution
DISINFECTANT 1 LOADING TIME OUT ALARM	<ol style="list-style-type: none"> 1. Component A tank empty 2. Aspiration nozzle not inserted in the tank or faulty 3. Fault in SL11 4. Fault in V11 5. Fault in V11a 6. Fault in V11b 7. Fault in V17 8. Fault in P1 	<ul style="list-style-type: none"> ▶ Replace the tank. ▶ Check that the cap is correctly inserted into the tank and that it is properly closed. ▶ Check that the nozzle tube is not kinked and is obstructing the passage of liquids. ▶ Send technical intervention request.

▶ Type of alarm	▶ Cause	▶ Solution
DISINFECTANT 2 LOADING TIME OUT	<ol style="list-style-type: none"> 1. Component B tank empty 2. Aspiration nozzle not inserted in the tank 3. Fault in SL12 4. Fault in V12 5. Fault in V12a 6. Fault in V12b 7. Fault in V17 8. Fault in P1 	<ul style="list-style-type: none"> ▶ Replace the tank. ▶ Check that the cap is correctly inserted into the tank and that it is properly closed. ▶ Check that the nozzle tube is not kinked and obstructing the correct liquid flow. ▶ Send technical intervention request.

▶ Type of alarm	▶ Cause	▶ Solution
DETERGENT LOADING TIME OUT	<ol style="list-style-type: none"> 1. Detergent tank empty 2. Aspiration nozzle not inserted in the tank 3. Fault in FT13 4. Fault in V13 5. Fault in P5 	<ul style="list-style-type: none"> ▶ Replace the tank. ▶ Check that the cap is correctly inserted into the tank and that it is properly closed. ▶ Check that the nozzle tube is not kinked and obstructing the correct liquid flow. ▶ Send technical intervention request.

▶ Type of alarm	▶ Cause	▶ Solution
ALCOHOL LOADING TIME OUT	<ol style="list-style-type: none"> 1. Alcohol bottle empty. 2. Aspiration nozzle not inserted in the tank. 3. Fault in FT19 4. Fault in V19 5. Fault in P4 	<ul style="list-style-type: none"> ▶ Change the bottle. ▶ Check that the cap is correctly inserted into the tank and that it is properly closed. ▶ Check that the nozzle tube is not kinked and obstructing the correct liquid flow. ▶ Send technical intervention request.

RESOLUTION OF PROBLEMS

▶ Type of alarm	▶ Cause	▶ Solution
DISINFECTANT 1 DISCHARGE TIME OUT	<ol style="list-style-type: none"> 1. Fault in SL11 2. Fault in V11 3. Fault in V11a 4. Fault in V11b 5. Fault in V17 6. Fault in P1 	▶ Send technical intervention request.

▶ Type of alarm	▶ Cause	▶ Solution
DISINFECTANT 2 DISCHARGE TIME OUT ALARM	<ol style="list-style-type: none"> 1. Fault in SL12 2. Fault in V12 3. Fault in V12a 4. Fault in V12b 5. Fault in V17 6. Fault in P1 	▶ Send technical intervention request.

▶ Type of alarm	▶ Cause	▶ Solution
DISINFECTANT 1 MAX LEVEL ALARM	<ol style="list-style-type: none"> 1. Fault in SL11 2. Fault in V11 3. Fault in V11a 4. Fault in V11b 5. Fault in V17 6. Fault in P1 	▶ Send technical intervention request.

▶ Type of alarm	▶ Cause	▶ Solution
DISINFECTANT 2 MAX DISCHARGE LEVEL ALARM	<ol style="list-style-type: none"> 1. Fault in SL12 2. Fault in V12 3. Fault in V12a 4. Fault in V12b 5. Fault in V17 6. Fault in P1 	▶ Send technical intervention request.

▶ Type of alarm	▶ Cause	▶ Solution
COVER CLOSURE ALARM	<ol style="list-style-type: none"> 1. Cover open 2. Fault in SW1 	<ul style="list-style-type: none"> ▶ Check that the cover of the basin is closed. ▶ Check that nothing is obstructing correct cover closure. ▶ Send technical intervention request.

▶ Type of alarm	▶ Cause	▶ Solution
SPRAY TURNING SENSOR	<ol style="list-style-type: none"> 1. Erroneous endoscope positioning. 2. Fault in SGR 	<ul style="list-style-type: none"> ▶ Check that the cover of the basin is closed. ▶ Check that nothing is obstructing the proper movement of the spray arm. ▶ Send technical intervention request.

▶ Type of alarm	▶ Cause	▶ Solution
LEAK TEST ALARM	<ol style="list-style-type: none"> 1. Endoscope selected incorrectly. 2. Interblock connector connected incorrectly. 3. Endoscope connected incorrectly. 4. Endoscope damaged. 5. Fault on P2 6. Fault on V4 7. Fault on V16 8. Fault on TP2 	<ul style="list-style-type: none"> ▶ Check correct endoscope selection. ▶ Check proper endoscope seal by manual testing. ▶ Check the interblock connector is connected properly. ▶ Check the endoscope is correctly connected to the interblock connector. ▶ Send technical intervention request.

RESOLUTION OF PROBLEMS

▶ Type of alarm	▶ Cause	▶ Solution
LEAK TEST OVERPRESSURE ALARM	<ol style="list-style-type: none"> 1. Endoscope selected incorrectly 2. Fault on V16 3. Fault on TP2 	<ul style="list-style-type: none"> ▶ Check correct endoscope selection. ▶ Check that the interblock connection leak test tube is positioned correctly. ▶ Check that the endoscope is correctly positioned inside the basin. ▶ Send technical intervention request.

▶ Type of alarm	▶ Cause	▶ Solution
CHANNEL 1 BLOCKED ALARM	<ol style="list-style-type: none"> 1. Endoscope selected incorrectly 2. Endoscope channel blocked 3. Channel connector fault 4. Fault in P1 5. Fault in R2 6. Fault in FT-5 7. Fault in V5 8. Connector fault 	<ul style="list-style-type: none"> ▶ Check correct endoscope selection. ▶ Check that the endoscope channel is not actually blocked. ▶ Check that the channel connector is connected correctly. ▶ Check that the interblock connector tube has no blockages. ▶ Send technical intervention request.

▶ Type of alarm	▶ Cause	▶ Solution
CHANNEL 2 BLOCKED ALARM	<ol style="list-style-type: none"> 1. Endoscope selected incorrectly 2. Endoscope channel blocked 3. Channel connector fault 4. Fault in P1 5. Fault in R2 6. Fault in FT-6 7. Fault in V6 8. Connector fault 	<ul style="list-style-type: none"> ▶ Check correct endoscope selection. ▶ Check that the endoscope channel is not actually blocked. ▶ Check that the channel connector is connected correctly. ▶ Check that the interblock connector tube has no blockages. ▶ Send technical intervention request.

▶ Type of alarm	▶ Cause	▶ Solution
CHANNEL 3 BLOCKED ALARM	<ol style="list-style-type: none"> 1. Endoscope selected incorrectly 2. Endoscope channel blocked 3. Channel connector fault 4. Fault in P1 5. Fault in R2 6. Fault in FT-7 7. Fault in V7 8. Connector fault 	<ul style="list-style-type: none"> ▶ Check correct endoscope selection. ▶ Check that the endoscope channel is not actually blocked. ▶ Check that the channel connector is connected correctly. ▶ Check that the interblock connector tube has no blockages. ▶ Send technical intervention request.

▶ Type of alarm	▶ Cause	▶ Solution
CHANNEL 4 BLOCKED ALARM	<ol style="list-style-type: none"> 1. Endoscope selected incorrectly 2. Endoscope channel blocked 3. Channel connector fault 4. Fault in P1 5. Fault in R2 6. Fault in FT-8 7. Fault in V8 8. Connector fault 	<ul style="list-style-type: none"> ▶ Check correct endoscope selection. ▶ Check that the endoscope channel is not actually blocked. ▶ Check that the channel connector is connected correctly. ▶ Check that the interblock connector tube has no blockages. ▶ Send technical intervention request.

▶ Type of alarm	▶ Cause	▶ Solution
CHANNEL 5 BLOCKED ALARM	<ol style="list-style-type: none"> 1. Endoscope selected incorrectly 2. Endoscope channel blocked 3. Channel connector fault 4. Fault in P1 5. Fault in R2 6. Fault in FT-9 7. Fault in V9 8. Connector fault 	<ul style="list-style-type: none"> ▶ Check correct endoscope selection. ▶ Check that the endoscope channel is not actually blocked. ▶ Check that the channel connector is connected correctly. ▶ Check that the interblock connector tube has no blockages. ▶ Send technical intervention request.

RESOLUTION OF PROBLEMS

▶ Type of alarm	▶ Cause	▶ Solution
CHANNEL 6 BLOCKED ALARM	<ol style="list-style-type: none"> 1. Endoscope selected incorrectly 2. Endoscope channel blocked 3. Channel connector fault 4. Fault in P1 5. Fault in R2 6. Fault in FT-10 7. Fault in V10 8. Connector fault 	<ul style="list-style-type: none"> ▶ Check correct endoscope selection. ▶ Check that the endoscope channel is not actually blocked. ▶ Check that the channel connector is connected correctly. ▶ Check that the interblock connector tube has no blockages. ▶ Send technical intervention request.

▶ Type of alarm	▶ Cause	▶ Solution
CHANNEL 7 BLOCKED ALARM	<ol style="list-style-type: none"> 1. Endoscope selected incorrectly 2. Endoscope channel blocked 3. Channel connector fault 4. Fault in P1 5. Fault in R2 6. Fault in TP7 7. Fault in VPP1 	<ul style="list-style-type: none"> ▶ Check correct endoscope selection. ▶ Check that the endoscope channel is not actually blocked. ▶ Check that the channel connector is connected correctly. ▶ Check that the interblock connector tube has no blockages. ▶ Send technical intervention request.

▶ Type of alarm	▶ Cause	▶ Solution
CHANNEL 1 DISCONNECTED ALARM	<ol style="list-style-type: none"> 1. Endoscope selected incorrectly 2. Endoscope channel disconnected 3. Endoscope connector fault 4. Fault in R2 5. Fault in FT-5 	<ul style="list-style-type: none"> ▶ Check correct endoscope selection. ▶ Check the connector-channel connection is correct. ▶ Check the endoscope connector and replace if necessary. ▶ Check the correct insertion of the channel separator slide on the endoscope handle. ▶ Send technical intervention request.

▶ Type of alarm	▶ Cause	▶ Solution
CHANNEL 2 DISCONNECTED ALARM	<ol style="list-style-type: none"> 1. Endoscope selected incorrectly 2. Endoscope channel disconnected 3. Endoscope connector fault 4. Fault in R2 5. Fault in FT-6 	<ul style="list-style-type: none"> ▶ Check correct endoscope selection. ▶ Check the connector-channel connection is correct. ▶ Check the endoscope connector and replace if necessary. ▶ Check the correct insertion of the channel separator slide on the endoscope handle. ▶ Send technical intervention request.

▶ Type of alarm	▶ Cause	▶ Solution
CHANNEL 3 DISCONNECTED ALARM	<ol style="list-style-type: none"> 1. Endoscope selected incorrectly 2. Endoscope channel disconnected 3. Endoscope connector fault 4. Fault in R2 5. Fault in FT-7 	<ul style="list-style-type: none"> ▶ Check correct endoscope selection. ▶ Check the connector-channel connection is correct. ▶ Check the endoscope connector and replace if necessary. ▶ Check the correct insertion of the channel separator slide on the endoscope handle. ▶ Send technical intervention request.

▶ Type of alarm	▶ Cause	▶ Solution
CHANNEL 4 DISCONNECTED ALARM	<ol style="list-style-type: none"> 1. Endoscope selected incorrectly 2. Endoscope channel disconnected 3. Endoscope connector fault 4. Fault in R2 5. Fault in FT-8 	<ul style="list-style-type: none"> ▶ Check correct endoscope selection. ▶ Check the connector-channel connection is correct. ▶ Check the endoscope connector and replace if necessary. ▶ Check the correct insertion of the channel separator slide on the endoscope handle. ▶ Send technical intervention request.

RESOLUTION OF PROBLEMS

▶ Type of alarm	▶ Cause	▶ Solution
CHANNEL 5 DISCONNECTED ALARM	<ol style="list-style-type: none"> 1. Endoscope selected incorrectly 2. Endoscope channel disconnected 3. Endoscope connector fault 4. Fault in R2; 5. Fault in FT-9; 	<ul style="list-style-type: none"> ▶ Check correct endoscope selection. ▶ Check the connector-channel connection is correct. ▶ Check the endoscope connector and replace if necessary. ▶ Check the correct insertion of the channel separator slide on the endoscope handle. ▶ Send technical intervention request.

▶ Type of alarm	▶ Cause	▶ Solution
CHANNEL 6 DISCONNECTED ALARM	<ol style="list-style-type: none"> 1. Endoscope selected incorrectly 2. Endoscope channel disconnected 3. Endoscope connector fault 4. Fault in R2; 5. Fault in FT-10; 	<ul style="list-style-type: none"> ▶ Check correct endoscope selection. ▶ Check the connector-channel connection is correct. ▶ Check the endoscope connector and replace if necessary. ▶ Check the correct insertion of the channel separator slide on the endoscope handle. ▶ Send technical intervention request.

▶ Type of alarm	▶ Cause	▶ Solution
CHANNEL 7 DISCONNECTED ALARM	<ol style="list-style-type: none"> 1. Endoscope selected incorrectly 2. Endoscope channel incorrectly connected 3. Endoscope channel connector fault 4. Fault in TP7 5. Fault in R2 	<ul style="list-style-type: none"> ▶ Check correct endoscope selection. ▶ Check the connector-channel connection is correct. ▶ Check the endoscope connector and replace if necessary. ▶ Check the correct insertion of the channel separator slide on the endoscope handle. ▶ Send technical intervention request.

▶ Type of alarm	▶ Cause	▶ Solution
MAXIMUM TEMPERATURE ALARM	<ol style="list-style-type: none"> 1. Excessively high temperature 2. Fault in T1 and/or T2 3. Faulty connection in T1 and/or T2 	<ul style="list-style-type: none"> ▶ Check that the temperature is within the envisaged limits. ▶ Reduce the equipment inlet temperature. ▶ Send technical intervention request.

▶ Type of alarm	▶ Cause	▶ Solution
MINIMUM TEMPERATURE ALARM	<ol style="list-style-type: none"> 1. Temperature not reached 2. Fault in T1 and/or T2 3. Faulty connection in T1 and/or T2 	<ul style="list-style-type: none"> ▶ Check that the temperature is within the envisaged limits. ▶ Reduce the equipment inlet temperature. ▶ Send technical intervention request.

▶ Type of alarm	▶ Cause	▶ Solution
WATER LOADING TIME OUT ALARM	<ol style="list-style-type: none"> 1. No mains water supply 2. F1 filter fault 3. F2 filter fault 4. Basin water inlet connector fault 5. Fault in V1 6. Fault in V18 7. Fault in FT-1 and FT-2 	<ul style="list-style-type: none"> ▶ Check for water in the mains water feed. ▶ Check the water stopcock is opened correctly. ▶ Send technical intervention request.

▶ Type of alarm	▶ Cause	▶ Solution
WATER FLOW METER REDUNDANCY ALARM	<ol style="list-style-type: none"> 1. Fault in FT-1 and/or FT-2; 	<ul style="list-style-type: none"> ▶ Send technical intervention request.

RESOLUTION OF PROBLEMS

▶ Type of alarm	▶ Cause	▶ Solution
BASIN LEVEL ALARM	<ol style="list-style-type: none"> 1. Excessive basin liquid level 2. Fault in SL1 3. Fault in P1 4. Fault in FT-1 and/or FT-2 5. Fault in V3 6. Fault in FT-3 	<ul style="list-style-type: none"> ▶ Close the water inlet stopcock. ▶ Send technical intervention request.

▶ Type of alarm	▶ Cause	▶ Solution
DISCHARGE ALARM	<ol style="list-style-type: none"> 1. Discharge pipe blocked 2. Fault in P1 3. Fault in V3 	<ul style="list-style-type: none"> ▶ Check that the basin discharge pipe is not blocked. ▶ Check the external waste water system is not blocked. ▶ Send technical intervention request

▶ Type of alarm	▶ Cause	▶ Solution
COMMUNICATION ERROR	<ol style="list-style-type: none"> 1. USB cable disconnected 2. USB cable faulty 3. Faulty circuit board 	<ul style="list-style-type: none"> ▶ Check and insert the USB cable into the PC if necessary. ▶ Turn the PC off then on again. ▶ Send technical intervention request.





CE
0051

 Cantel Medical (Italy) S.r.l.
Via Laurentina, 169
00071 Pomezia (RM) Italia
Tel.: +39 06 9145399
Fax: +39 06 9146099
www.cantelmedical.it
www.cantelmedical.eu

Medivators Inc.
14605 28th Avenue North
Minneapolis, MN
55447-4822 USA
Tel: +1.763.553.3300
Fax: +1.763.553.3387

Medivators BV
Sourethweg 11
6422 PC Heerlen
The Netherlands
Tel: +31.45.5.471.471
Fax: +31.45.5.429.595

Cantel (UK) Limited
Campfield Road
Shoeburyness, Essex
SS3 9BX,
United Kingdom
Tel: +44 (0) 1702.291878
Fax: +44 (0) 1702.290013

Cantel Medical Asia/Pacific Pte. Ltd.
1A International Business Park
#05-01 Singapore 609933
Tel: +65.6227.9698
Fax: +65.6225.6848

Cantel Medical Devices (China) Co. Ltd.
Unit 804-805, Innov Tower Block A,
Hongmei Road, Xuhui 200233 Shanghai
Tel: +86 21 60161380
Fax: +86 21 61210913