

## Diagnostic High Frequency X-ray Equipment

Operation manual  
Technical manual  
Installation manual



#### User Registration

On the inscription plate at the back of the instrument, you will find the unit's model number, serial and reference number. Please double check the numbers and fill in the form with them, and quote the reference number, when you are in contact with your distributors.

Manufacturing Enterprise License

Product Technical Requirements Number

Registration Number

Product Name:

Product Model:

Serial Number:

Date of Manufacture:

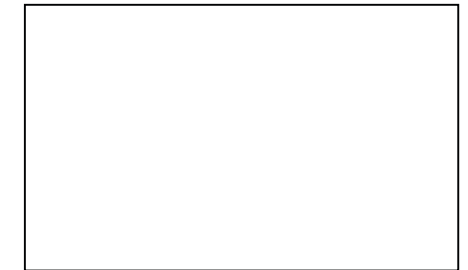

Software Released Version: RAY-02

\*Before operating, please read carefully all safety cautions and instructions for operation.

This operator's manual will help you understand all functions of Runyes X-ray instrument as much as possible.

\*According to different installations, the RAY series includes 2 types as follows. Wall mounted Type RAY98(W), Mobile Type RAY98(M). You can read the production information from the nameplate.

\*Please read carefully the instructions of this operator's manual while servicing and maintaining the units.

\*Please keep this manual for your future references.

\*If errors occur during operation of the instrument, please contact your local distributor or us, we will offer you the best qualified service and assistance.

\*Life expectancy: 8 Years

## Table Contents

1. Introduction
2. Technical Data
3. Check List – Before Use
4. Component
5. Operation
6. Error Code
7. Safety
8. Cleaning and Disinfection
9. Function Examination
10. Transportation and Store
11. Waste Treatment
12. User Claim
13. Installation Manual
14. Packing List
15. Fuse Check and Replacement
16. Electro Magnetic Compatibility

### 1. Introduction

#### 1.1 Purpose:

RAY dental X-ray machine is used for Dental oral cavity. According to different users' requirements, there are two types: wall mounted x-ray machine and mobile x-ray machine. Easy to use, less maintenance required, and long life use.

#### 1.2 Composed by

X-Ray machine is composed by X Ray tube head, timer, and arms.

#### 1.3 Assortment:

Electric shock protection type: BF Type equipment

Level of liquid prevention: Normal equipment

Operation Mode: Intermittent load run continuously

#### 1.4 Obligation of the Installer

Installer are required to:

- \*Make sure the voltage is accorded with the manufacturer requirement and range
- \*Make sure the switch can cut off the power supply when x-ray is working to ensure safety
- \*Follow the Installation manual to install and test the equipment
- \*Provide Operation manual to users

#### 1.5 Obligation of the users

Users must:

- \*Use the machine according to this operation manual
- \*Maintain the equipment according to the maintenance time table suggested by manufacturer. If the equipment maintained not properly by users themselves,

manufacturer and dealer are not responsible of the accident caused by incorrect operation.

\*When the accident occurred by incorrect operation, may result in death, injury, or body damage, please contact sanitation management department and manufactory or dealer immediately.

\*When users inform manufactory, the serial number and the type of related components are required. Users can get the information from technical tag.

### 1.6 Warning & Prevention

 It is important to use and operate the equipment, and the equipment should be shielded from the radiation safety requirements of each country and region. Users are responsible for ensuring compliance with local safety requirements.

 This X-ray machine may produce ionizing radiation, such as improper control. Therefore, it is recommended that only trained personnel operate the machine according to existing laws and regulations

 Be careful when operating the cantilever (ball tube) position to prevent clamping.









 Although the machine conforms to the electromagnetic adaptability specification, we would also recommend that the machine should not be used in places where there is external electromagnetic interference. (such as high power equipment or motor equipment, which can interfere with the electronic circuit of the system).

 Must cut off the power during the equipment maintenance.

 Must ensure the protected ground connection to the power.

 Do not repair the equipment without the permission of manufacturer.

### 1.7 Labels

No.	Icon	Description	No.	Icon	Description
1		BF Type Equipment	6		Fragile
2		Caution, please read manuals.	7		Wet proof
3		Fuse	8		Date of Manufactured
4		AC power	9		Manufacturing Number
5		Ground Connection			

### 2. Technical Data

#### 2.1 Parameter

Voltage: 220V-

Frequency: 50Hz

Maximum power:1100VA

Fuse: T8A 250V 5X20mm

Ray type: X-ray

Ray direction and distribution: The distribution of the beam is the 60mm diameter of the outlet.

Dosage Rate: 6mGy/S

X-ray tube model: CANON D-045

Focus: 0.4mm

Anodic angle: 19°

Tube voltage:65KV

Anodic Electric current:7mA

Load Circle: 1/30

Inherent Filtration:  $\geq 0.5$ mmAL

Extra Filtration: 1.5 mmAL

Total Filtration:  $\geq 2.1$  mmAL

Half-value Layer: 65KV if 1.6 mmAL

Loading time range: 0.01s-2.0s

Radiation leakage rate:  $1m \leq 0.25mGy/$

Connection: Coaxial Plug, 360°rotation.

Vertical angle: 320°

## 2.2 Beam

Circular output section

Distance from focus to skin: 22cm

Output radiation: Circle, diameter  $\phi$  6cm

## 2.3 Environmental Requirement

Working Temp.: 10°C-40°C

Store Temp.: 0°C-40°C

Transportation Temp.: 0°C-40°C

Relative Humidity:  $\leq 75\%$

Atmospheric Pressure: 700hPa $\sim$ 1060 hPa

## 2.4 Timer

Micro-process controller function

Set exposure time (0.01s-2.0s) automatically through object selection.

Manually set exposure time, range from 0.01s-2.0s.

Child(small), Adult(big), digital selection

Low dose set when operating digital sensor

Manual switch with 3m spring cable

Manual switch can be installed from distance.

## 3. Check List – Before Use

-Please ensure that you are familiar with the radiation protection measures and the manual instructions before use.

-Ensure that the film matches the requirements and is ready to use.

-Ensure the film and development/fixing solution.

-Ensure that the development of the development/fixing solution is valid and is in proper temperature and concentration.

-Ensure the film is valid and do not have expired film

-If other imaging devices are used, please ensure that the imaging equipment is in a normal state of availability

-The X-ray machine has been correctly connected to the power supply.

## 4. Component

### 4.1.1 Wall Mounted Type

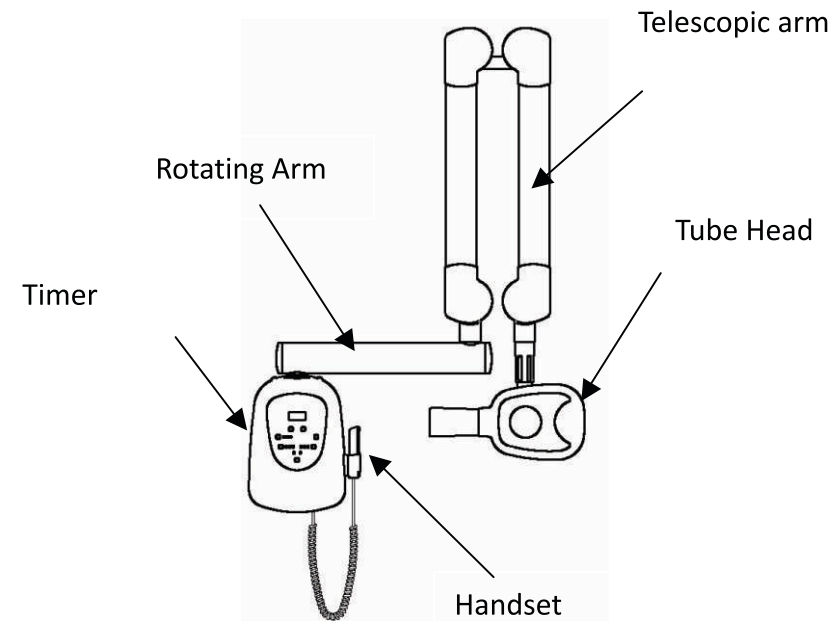

### 4.1.2 Mobile Type

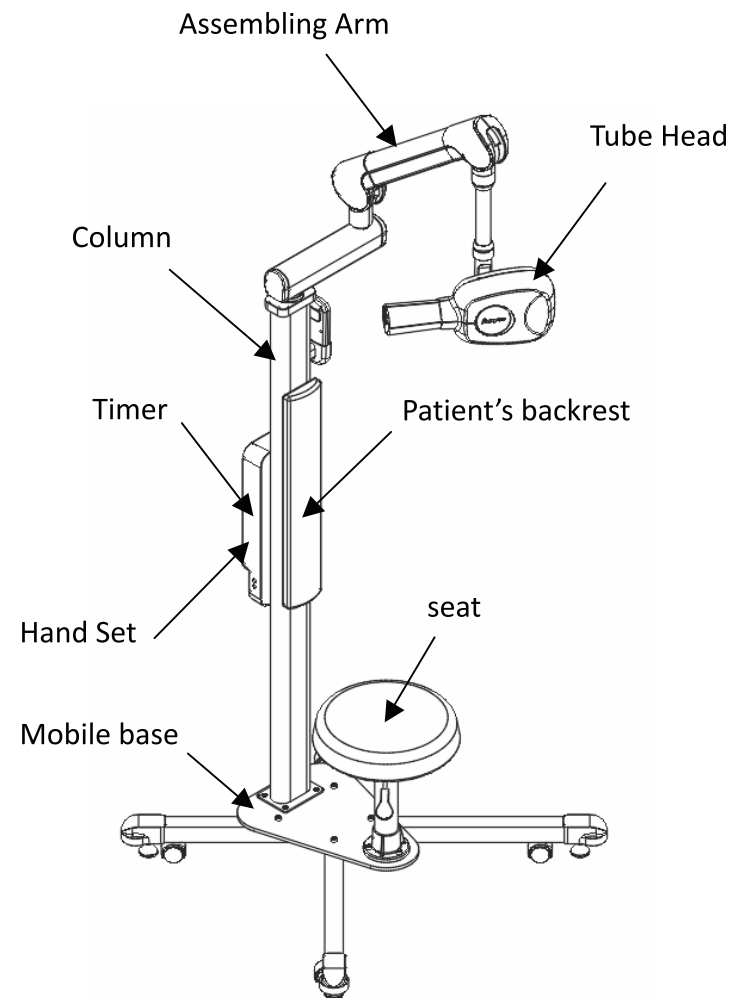

## 4.2 Timer and Hand set

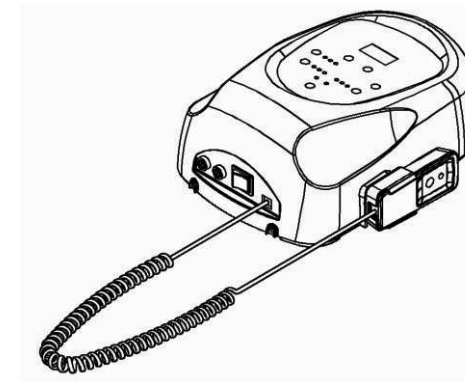

Wall-mounted programmable controller assembly



Handheld exposure

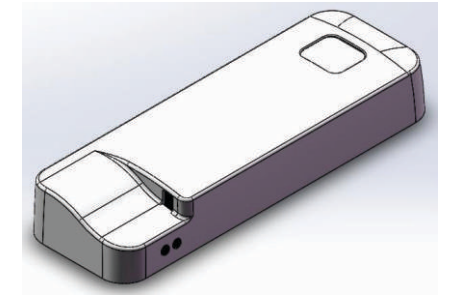

Mobile programmer component

Connect one end of the handset exposure device to the interface below the program controller and the other end to a handset exposure device. Note: handset expos cannot be connected to other devices!

## 5. Shooting

### 5.1 Turn on

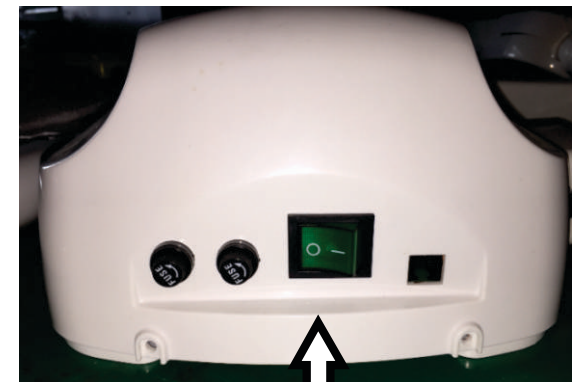

Power Switch

The power switch is located at the bottom of the program controller. When the power switch is on, the power switch indicator lights up, indicating that the power supply has been connected. All indicator lights on the program control panel are lit. The time window displays 888 to check whether the display surface is normal

## 5.2 control panel and exposure time set

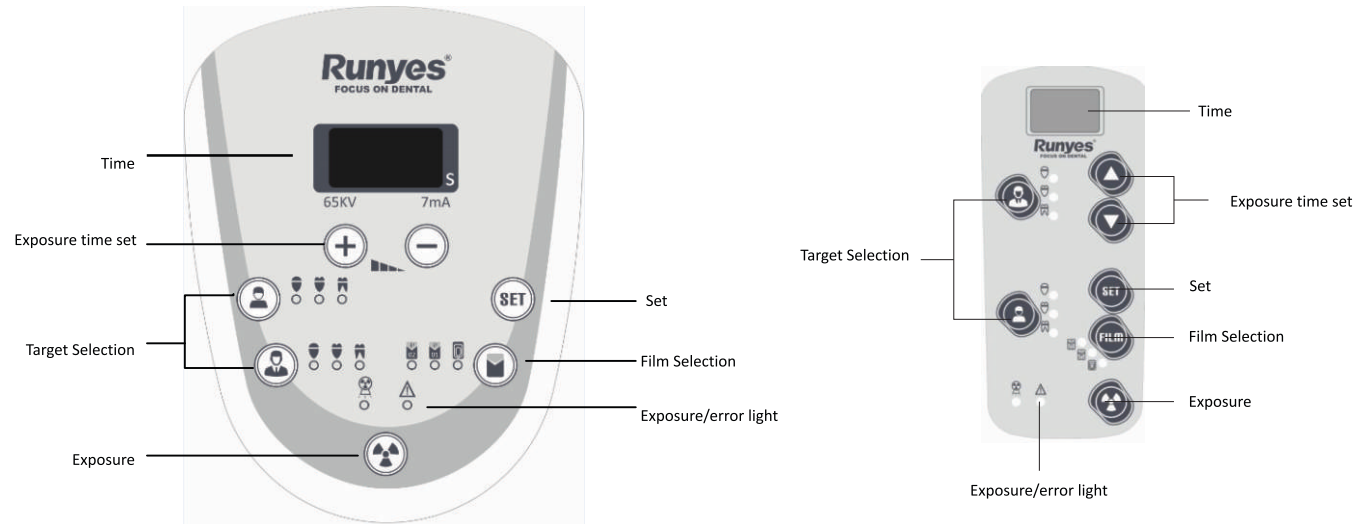

Time



Display exposure time, and the end of exposure shows the next exposure waiting time. The error code is displayed when there is an error

Film Selection



Choose low-speed film 02, high-speed film 01, digital imaging equipment. When choosing different modes, the default time will be different.

Target Selection



Select the teeth of children or adults to photograph, different dental exposure time.

Exposure time set



If the system default time is not suitable after selecting good film mode and dental position, you can adjust the key according to the parameters and properly add and reduce the exposure time. The exposure time adjustment range is 0.01~2 seconds.

Exposure



Set up the exposure time, and press the exposure button to start.

Set



When the system's own time is not appropriate, the user can adjust the appropriate time, and press the SET key, the system will save the current parameters. The next time you select the current film mode and the tooth location, the corresponding exposure time is the current setting time. By pressing the SET key for 5 seconds, the system will revert to the factory default parameter.

Exposure Indicator Light



When exposed, the head produces x-rays and the indicator lights orange light.

Error light



When the exposure is pressed, the indicator light will be red to indicate when there is a failure, and the time window will display the corresponding code

The system displays the default exposure time after the self-check, and the user can select the system default exposure time by pressing the "film mode" and "dental" key. If the default exposure time does not meet the requirements of the current user imaging medium, the appropriate exposure time can be adjusted by pressing the "exposure time adjustment" key.

The adjusted time will be restored to the system default time after rebooting. If you need to save the adjusted time, press the "Settings" button to save it after the time is adjusted to the right time. All the teeth on the panel can be reset.

If the user is not satisfied with the time set up and forgot the original exposure time, he can press the "set" button for 5 seconds and the system will return to the factory default time.

### 5.3 Position Locator

Sit in the right posture, place film or digital imaging equipment, and protect. Adjust the Angle and position between X-ray generator and patient.

#### Parallel line technology

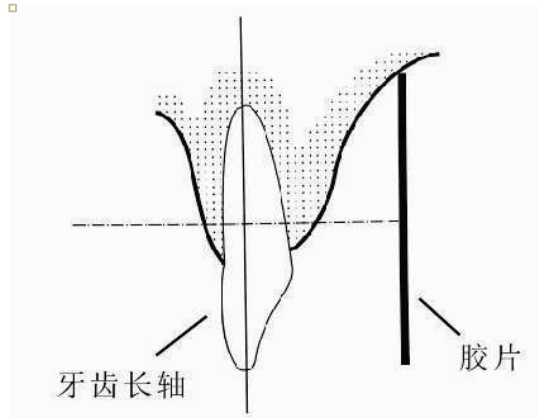

The film or digital sensor is placed in the oral cavity or film holder, and the film or sensor is parallel to the long axis of the tooth.

#### Diagonal technology

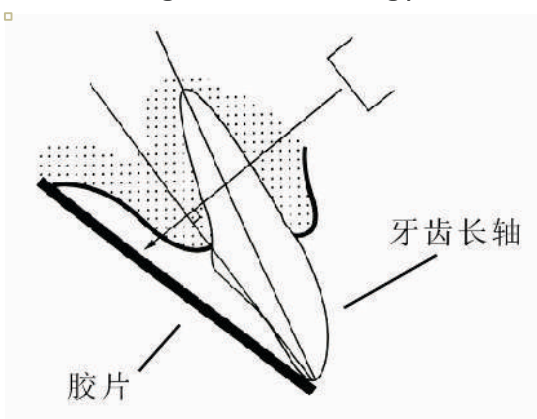

Allow the patient to put the film or digital sensor in the exposed position of the mouth. The guiding X-ray is perpendicular to an imaginary line, and this imaginary line bisects the Angle between the plane of the film or the digital sensor plane and the tooth length axis.

The average Angle of the X - line tilt of the teeth in the shots and jaws

Teeth Position	X ray direction	X ray tube tilt Angle
upper jaw incisors	Incline to foot side	+42°
upper jaw single tooth bit	Incline to foot side	+45°
upper jaw double teeth & 1 <sup>st</sup> Molar position	Incline to foot side	+30°
upper jaw 2 <sup>nd</sup> & 3 <sup>rd</sup> Molar position	Incline to foot side	+28°
lower jaw tooth bit	Incline to head side	-15°
lower jaw single tooth bit	Incline to head side	-18°~ -20°
lower jaw double teeth & 1 <sup>st</sup>	Incline to head side	-10°

Molar position		
lower jaw 2 <sup>nd</sup> & 3 <sup>rd</sup> Molar position	Incline to head side	-5°

### 5.4 Exposure

#### Two Exposure Method:



1. Press the exposure key on the handheld switch to expose. The orange indicator light will light up on the hand controller and the controller panel when exposed.



2. Press the exposure key on the controller panel to expose. The orange indicator light will light up on the hand controller and the controller panel when exposed.



**Press and hold the exposure key until the orange indicator on the hand controller or controller panel lights up and then unclench the exposure key, otherwise the exposure will be terminated and the error will be reported.**

### 6. Error Codes



When an error occurs, the code is displayed on the time



When an error occurs, press the SET key to clear the code for 3 seconds.



Code	Error Information	Solution
E01	Exposure of medium-range exposure key released too early	Release until exposure light off
E02	Failed filament preheating	Attempt exposure again, If the problem remains, please contact the distributor
E03	X-ray tube anode current overload	Attempt exposure again, If the problem remains, please contact the distributor
E04	X ray tube KV is too high	Attempt exposure again, If the problem remains, please contact the distributor

## 7. Safety

- Only trained, authorized technicians can open the chassis and contact circuit board.
- Power supply must comply with the requirements of the law, with grounding line
- Before cleaning or disinfecting the equipment, you must turn off the power supply and disconnect the power.
- water and other liquids shall not penetrate into the device and may cause short circuit or corrosion.
- When adjusting the position of the equipment, ensure that the patient or operator's finger or other part is not injured.
- The equipment cannot be used in flammable gas or steam environment.
- Only trained and qualified personnel are allowed to operate the equipment, and the existing regulations on the protection of relevant radiological protection must be honored.
- Ensure that the equipment is under watched.
- The unit contains components that must be disposed of in accordance with existing regulations.
- products have no contraindication requirements

## 8. Cleaning and disinfection

### Cleaning

Cut off the power supply before cleaning.

Use gentle soap to carefully remove fingerprints and other stains. Do not let liquids into the equipment.

use a soft cloth dipped in a small amount of detergent to clean the plastic shell.

### Disinfection

For components that are accidentally exposed to a patient, a cleansing agent (e.g. 2% of ammonia) must be cleaned and then disinfected. No solvent or corrosive disinfectant can be made.

## 9. Function Check

It is recommended that the user should check the installation and maintenance of calibration every six months:

- Turn on the power switch of the controller (below the controller) to check whether the status indicator of the switch green indicator is normal.
- Selecting a set of exposure time, adjusting the position of the head (ball tube) will not endanger anyone. Picked up a hand switch go from equipment as far as possible, and then press the exposure of the keys on the hand switch, check whether exposure in the process of orange indicator light will light up, the buzzer will send out "beep" prompt.

Check the position of the head (ball tube) and adjust it as necessary:

- Adjust the nose to rotate around the horizontal axis。
- Adjust the elastic of the cantilever spring。
- Adjust the arm position。

## 10. Transportation and Store

Store Temp.: 10°C-40°C

Transportation Temp.: 0°C-40°C

Relative Humidity: ≤75%

Atmospheric Pressure: 700hPa~1060 hPa



Note: dental X-ray machines are stored in non-corrosive gases, and in a well-ventilated and well-ventilated indoor environment, no dragging, throwing, falling, and vibration can be avoided during handling。

## 11. Waste Treatment

To reduce the burden on the environment, recyclable parts should be sent to the recycling center after removing harmful substances. Disposing of discarded products is the responsibility of the recyclers。

All components and components containing hazardous substances shall be disposed of according to law and environmental provisions. When dealing with obsolete products, necessary protection must be taken to avoid injury。

△Recyclable ▲Recyclable after treatment

Spare part	Material	Recyclable Material	Waste treatment center	Recovery of harmful substances after separation
cover	ABS	△		△
metal	aluminum	△		
circuit board		▲		
electric wire	copper	△		
packing	paper	△		
X-ray tube				△
Etc.			△	

## 12. User Claim

Voltage: 220V~ ±10%

Tube voltage bias: ±10%

Electric current bias: ±20%

Maximum deviation of exposure time and indication: ±10%

measure of technical factors:

Exposure Time

The starting point and end point of exposure time specifies the peak voltage of 70% of the peak radiation waveform measured by the X-ray calibration monitor

The regulation is to measure the high voltage average of the non-interventional KVp calibrated.

### Electric Current

The voltage divided by the measured feedback resistance of a calibrated multimeter or voltmeter is worth the mA value.

**X-ray tube anode heating. Cold - curve**

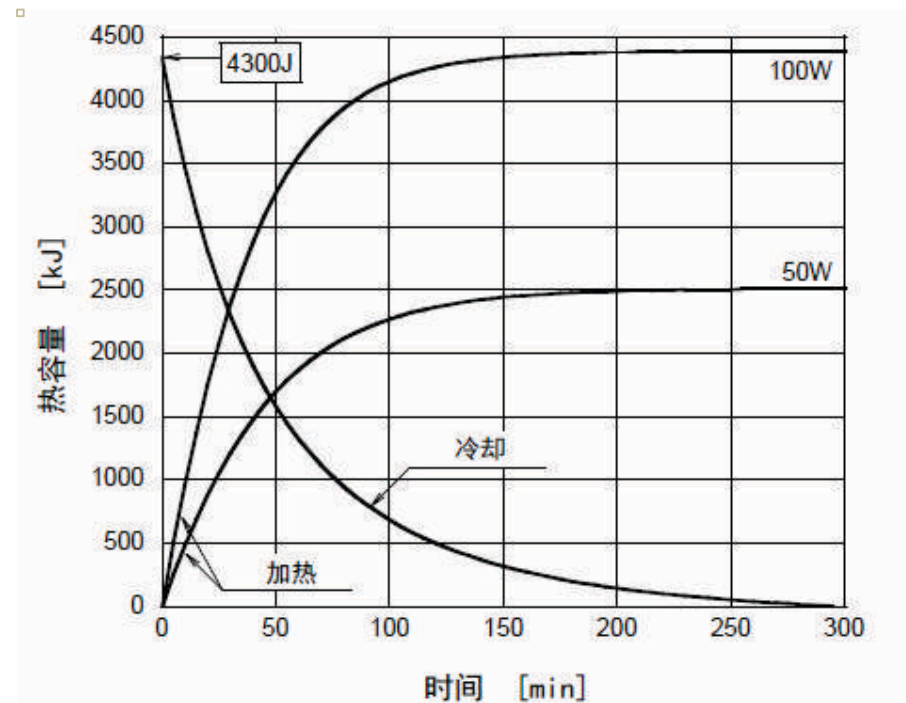

## 13. Installation Manual

### 1. Wall-mounted X-ray machine installation dimensions and equipment specifications

Reference: due to the limited space of individual clinics, the minimum operating room size is 1.3m, 1m wide and 2.2m high.

Note: operating within the size of the safe room and the minimum operating room size can cause the device to be damaged. Please use it carefully

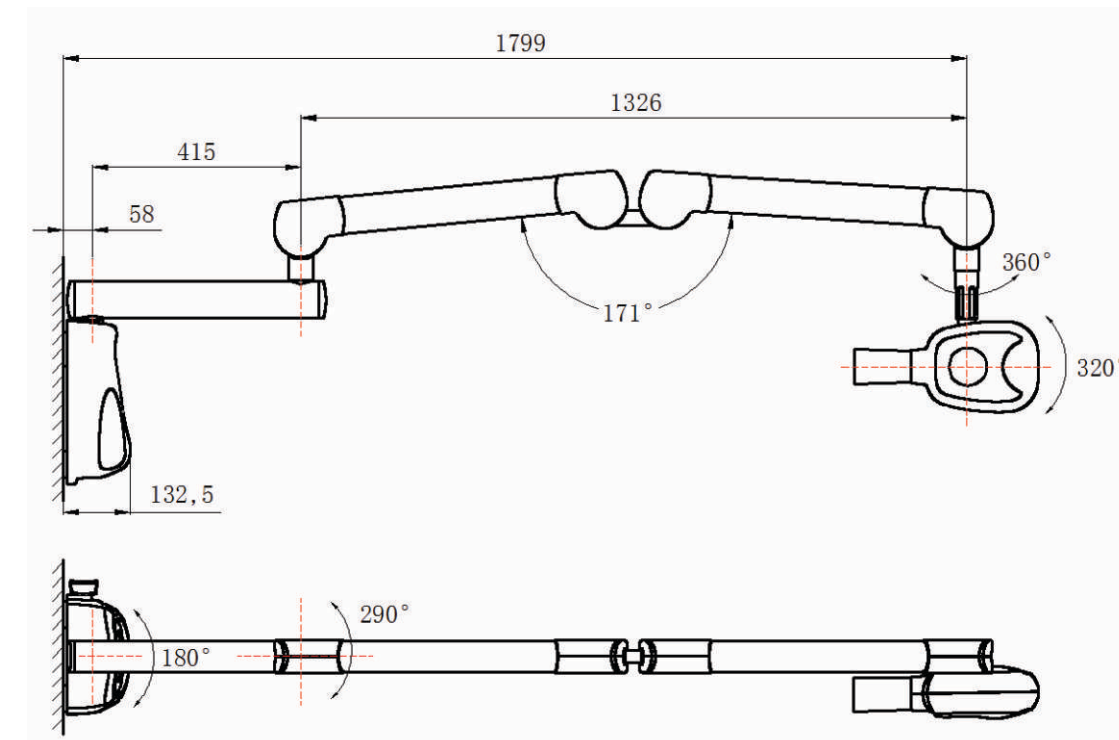
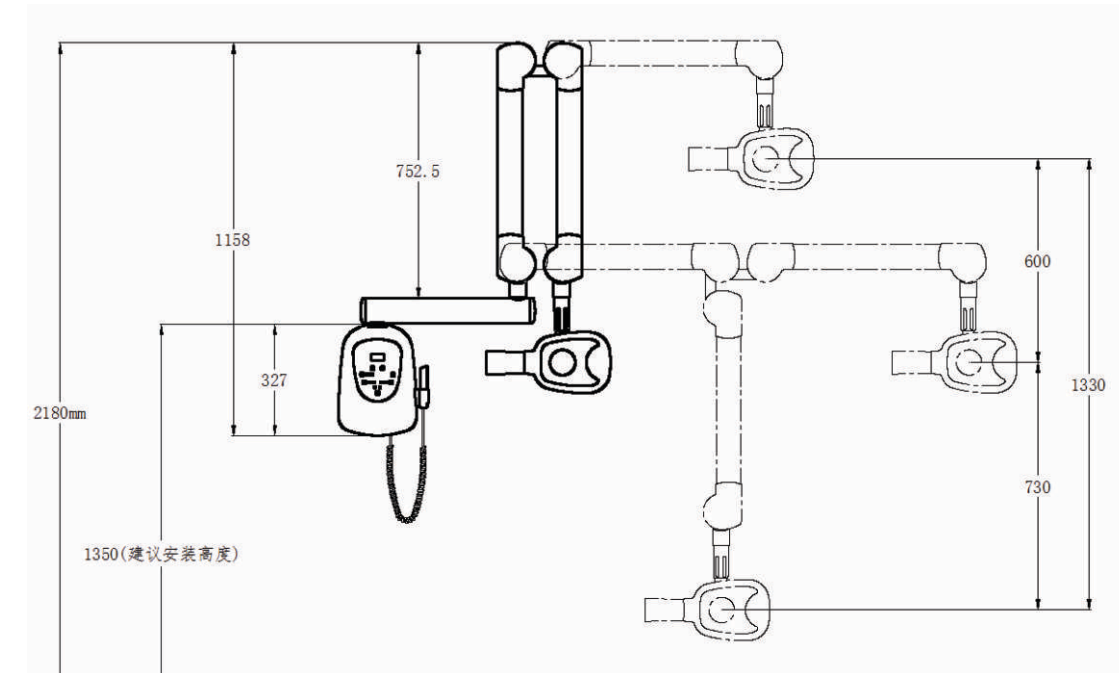

### 2. Mobile X-ray machine installation dimensions and equipment specifications

Reference: due to the limited space of individual clinics, the minimum operating room size is 1.3m, 1m wide and 2.2m high.

Note: operating within the size of the safe room and the minimum operating room size can cause the device to be damaged. Please use it carefully.

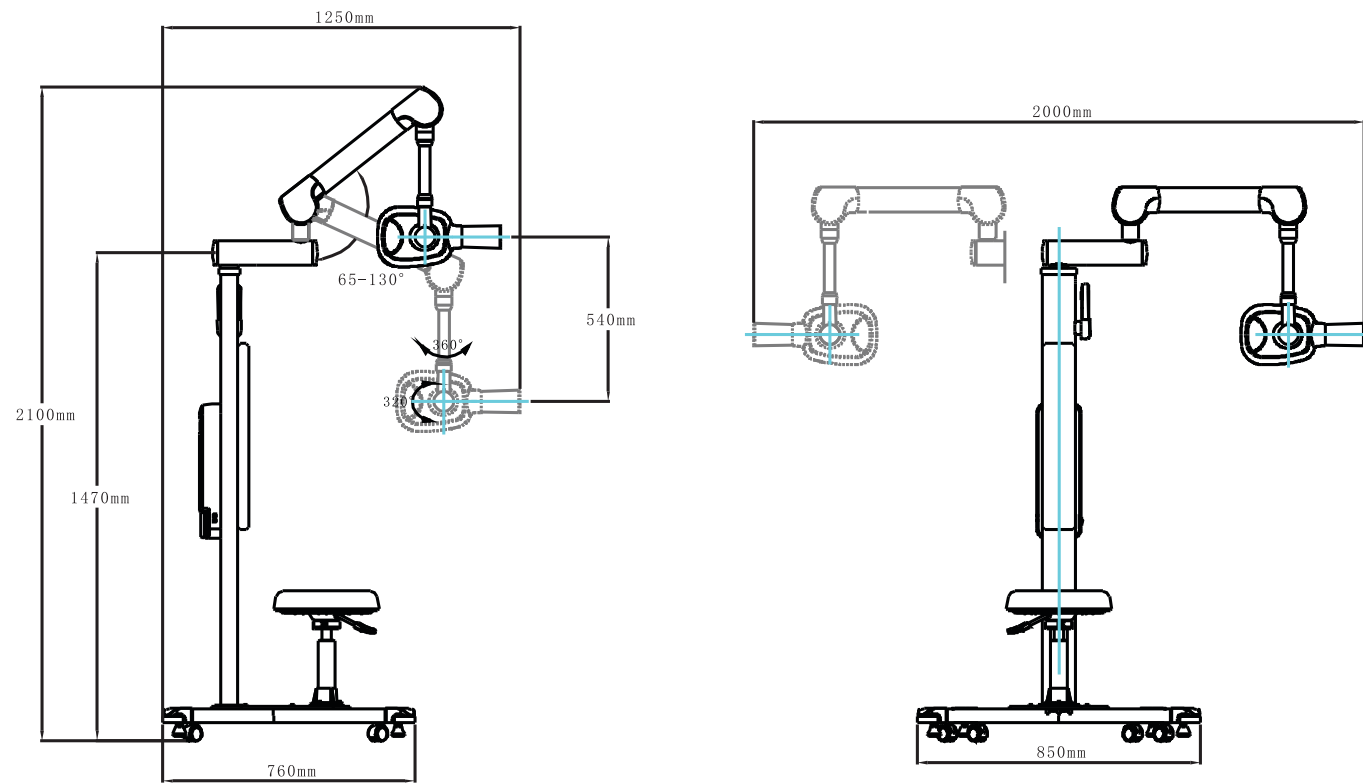

## 14. Packing List

### 1. Wall-mounted Type

No.	Part	QTY	Remark
1	Tube head	1	
2	Telescopic arm	1	
3	Rotating arm	1	
4	Timer	1	
5	Handset	1	

### 2. Mobile Type

1	Tube head	1	
2	Assembling arm	1	
3	Column	1	
4	Mobile Base	1	
5	Timer	1	
6	Hand set	1	
7	Seat	1	
8	Patient's backrest	1	

## 15. Fuse check and replacement

### 15.1 Fuse Check

If the power switch device is unresponsive, please check whether the fuse is broken after other reasons such as power supply. Replace the fuse if it is burnt.

### 15.2 Fuse replacement methods

Mobile type:

Mobile X-ray machine fuse holder and a power socket is an organic whole, behind the pillar of the X-ray machine at the bottom, as shown in figure 15- 1. The fuse blocks out with tools such as word screwdriver, as shown in figure 15-2 ran out the fuse, and push back again after replacement.

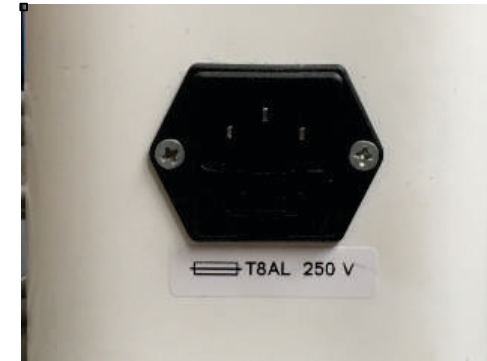

Figure 15-1



Figure 15-2

Wall-mounted Type:

The wall - mounted fuse holder is at the bottom of the controller, see figure 15-3.

Change the fuse cap counterclockwise, as shown in figure. 15-4. Then replace the insurance ratio with clockwise tightening.



Figure 15-3



Figure 15-4

## 16. Electro Magnetic Compatibility



Caution:

- Dental X-ray machine conforms to YY0505-2012 standard electromagnetic compatibility requirements.
- The user should install and use the EMC information provided by the random file.
- Portable and mobile RF communication equipment may affect the performance of dental X-ray machines and avoid strong electromagnetic interference, such as proximity to mobile phones and microwave ovens;
- Please see the attachment for the guide and manufacturer's statement.



Warning:

- The equipment or system should not be used in proximity or superimposed with other devices, and if it must be close or stacked, it should be observed that it works normally under the configuration used.
- In addition to the manufacturers of equipment or system as the internal components of the transducer and cable spare parts sale, using the specified attachment, transducer and cable may result in equipment or system increase or reduce the immunity.
- The use of external attachments, transducers, or cables in conjunction with equipment and systems may result in a decrease in the increase or disturbance of the device or system launch.

Provided cable and Accessories

Name	Cable length (m)	Shielding	Remark
Power Cable	2.5m	no	3×1mm <sup>2</sup>

### Guide and manufacturer's statement - electromagnetic emission

Dental X-ray machines are expected to be used in the electromagnetic environment specified below. The purchaser or user of the dental X-ray machine should ensure that it is used in this electromagnetic environment

Emission test	compliance	Electromagnetic environment - guide
GB4824 Rf launch	1 Group	Dental X-ray machines only use Rf energy for their internal functions. As a result, its Rf emission is low and the likelihood of interference with nearby electronics is minimal.
GB4824 Rf launch	B class	Dental X-ray machines are suitable for use in all facilities, including household and direct access to the residential public low voltage supply grid for household use.
Gb17625.1 Rf launch	A Class	

GB17625.2 Voltage fluctuation/scintillation launch	yes	
---	-----	--

### Guide and manufacturer's statement - electromagnetic immunity

Dental X-ray machines are expected to be used in the electromagnetic environment specified below. The purchaser or user of the dental X-ray machine should ensure that it is used in this electromagnetic environment:

Immunity test	IEC60601 The test level	Eligible electrical level	Electromagnetic environment - guide
(ESD) GB/T 17626.2	±6 kV contact discharge ±8 kV air discharge	±6 kV contact discharge ±8 kV air discharge	The ground should be wood, concrete or tile, and if the ground is covered with synthetic material, the relative humidity should be at least 30%.
electrical fast transient GB/T 17626.4	±2kV power cord ±1kV The input/output line	±2kV power cord	The power supply should have the quality of a typical commercial or hospital environment
surge GB/T 17626.5	±1 kV Differential mode voltage ±2 kV The common mode voltage	±1 kV Differential mode voltage ±2 kV The common mode voltage	The power supply should have the quality of a typical commercial or hospital environment.
Power input line voltage temporary drop, short - time interrupt and voltage change GB/T 17626.11	<5 % $U_T$ , for half week (在 $U_T$ 上, >95% 的 decrease) 40 % $U_T$ , for 5 weeks (在 $U_T$ 上, 60% 的 decrease) 70 % $U_T$ , for 25 weeks (在 $U_T$ 上, 30% 的 decrease) <5 % $U_T$ , for 5s (在 $U_T$ 上, >95% 的 decrease)	<5 % $U_T$ , for half week (在 $U_T$ 上, >95% 的 decrease) 40 % $U_T$ , for 5 weeks (在 $U_T$ 上, 60% 的 decrease) 70 % $U_T$ , for 25 weeks (在 $U_T$ 上, 30% 的 decrease) <5 % $U_T$ , for 5s (在 $U_T$ 上, >95% 的 decrease)	The power supply should have the quality of a typical commercial or hospital environment. If the user of the dental X-ray machine needs to run continuously during the power outage, the dental X-ray machine is recommended to use an uninterrupted power supply or battery power.
Power frequency magnetic field (50/60Hz) GB/T 17626.8	3A/m	3A/m	The labor frequency magnetic field should have the characteristic of the labor frequency magnetic field in typical

			commercial or hospital environment.
Note: U <sub>T</sub> The voltage of the ac network before the test voltage is applied			

Guide and manufacturer's statement - electromagnetic immunity			
Dental X-ray machines are expected to be used in the electromagnetic environment specified below. The purchaser or user of the dental X-ray machine should ensure that it is used in this electromagnetic environment:			
Immunity test	IEC60601 The test level	Eligible electrical level	Electromagnetic environment - guide
The radio frequency transmissionGB/T 17625.6	3 Vrms 150 kHz to 80 MHz	3 Vrms	Portable and mobile RF communication equipment should not be used in any part of dental X-ray machines, including cables, than recommended. The distance should be calculated by the formula corresponding to the frequency of the transmitter. <b>Recommended isolation distance</b> $d = 1.2\sqrt{P}$
	3 V/m 80 MHz to 2,5 GHz	3 V/m	$d = 1.2\sqrt{P}$ 80 MHz to 800 MHz $d = 2.3\sqrt{P}$ 800 MHz to 2,5 GHz  Among them, P is the maximum output rated power of the transmitter provided by the transmitter manufacturer, which is the unit of watt (W), and d is the recommended isolation distance, in meters (m)  The field intensity of the stationary RF transmitter is determined by the survey a of the electromagnetic field, and b should be lower than the level in each frequency range.  There may be interference near the device that marks the following symbols.
Radiofrequency radiationGB/T 17626.3			
Note 1: At 80MHz and 800MHz frequency, the formula of higher frequency band is adopted. Note 2: These guidelines may not be suitable for all situations, and electromagnetic communication is affected by the absorption and reflection of buildings, objects and bodies.			

- a Fixed transmitter field, such as wireless cellular/cordless phones and ground mobile radio base station, amateur radio, AM (amplitude modulation) and FM (frequency modulation) radio and television broadcasting, etc., the field intensity in theory can predict. In order to evaluate the electromagnetic environment of the stationary RF transmitter, the investigation of the electromagnetic field should be taken. A dental X-ray machine should be observed to verify the normal operation of the dental X-ray machine if the field intensity of the site is higher than that of the above application. If abnormal performance is observed, additional measures may be necessary, such as redirection or localization of the dental X-ray machine.
- b In the entire frequency range of 150KHz ~ 80MHz, the field intensity should be less than 3 V/m.

Recommended isolation distance between portable and mobile RF communication equipment and dental X-ray machines			
Dental X-ray machines are expected to be used in radiation RF disturbance controlled electromagnetic environment. On the basis of maximum output power communication equipment, dental X-ray machine buyers or users can through the following recommended by maintaining a portable and mobile RF communication equipment (transmitter) and minimum distance between dental X-ray machine to prevent electromagnetic interference.			
The maximum output power of the transmitter /W	The distance between the different frequencies of the transmitter /m		
	150 kHz ~ 80 MHz $d = 1.2\sqrt{P}$	80 MHz ~ 800 MHz $d = 1.2\sqrt{P}$	800 MHz ~ 2,5 GHz $d = 2.3\sqrt{P}$
0.01	0.12	0.12	0.23
0.1	0.38	0.38	0.73
1	1.2	1.2	2.3
10	3.8	3.8	7.3
100	12	12	23
For not listed above rated maximum output power transmitter, recommended isolation distance d, in meters (m), can use the corresponding column in the formula to determine the transmitter frequency, P here is provided by the transmitter manufacturers transmitter, maximum output power rating in watts (W) as the unit.  Note 1: At 80 MHz and 800 MHz frequencies, a more high-frequency formula is adopted. Note 2: These guidelines may not be suitable for all situations, and electromagnetic communication is affected by the absorption and reflection of buildings, objects and bodies.			



