

USER MANUAL



Laboratory centrifuge **MPW-55**

Read before use!

Serial number of the centrifuge:

For centrifuges with serial no (SN): from 10055086322



This manual was prepared with special care. MPW MED. INSTRUMENTS may change the manual at any time and without notice because of improvements, typographical errors, or improvements to facilities

All rights reserved. No part of this User Manual may be modified, distributed, published, or reproduced without the prior permission of MPW MED. INSTRUMENTS.









You can find the current version of the user manual on our website under:
www.mpw.pl DOWNLOAD section (one should choose demanded language version of website).

CONTENTS

1. Symbols used in the manual and on the device	5
2. Application	5
3. Technical data	6
3.1. Environmental conditions	6
4. Installation	7
4.1. The contents of the package	7
4.2. Other accessories	7
4.3. Location	7
4.4. Current protection	7
5. Safety notes.....	8
5.1. General remarks	8
5.2. Placing the rotor and accessories in the centrifuge	8
5.3. Filling tubes	9
5.4. Filling the rotor	9
5.5. Safety hints.....	10
5.6. Operating conditions.....	10
5.7. Equipment life	11
5.8. Work safety	11
5.9. Unbalance	12
5.10. Residual risk	12
6. Operating	13
6.1. Centrifuge overview	13
6.2. Centrifuge description.....	13
6.3. Name plate.....	14
6.4. Control device	14
6.5. Setting parameters.....	14
6.6. Safety features	14
6.6.1. Cover lock	14
6.6.2. Unbalance detecting	15
6.6.3. Rest state inspection	15
6.7. Increase a temperature.....	15
7. Centrifuging.....	15
7.1. Control panel.....	15
7.2. Sound signals.....	16
7.3. Display.....	17
7.4. Spin starts.....	17
7.5. Spin stops	17
7.6. Mathematical relations	18
1.1.1. RCF – relative centripetal force	18
7.6.1. Nomogram of relationship - rotational speed/centrifuging radius/RCF	18
7.6.2. Maximum load	18
8. Maintenance	18
8.1. Cleaning of the centrifuge	18
8.2. Maintenance of centrifuge elements.....	19
8.3. Sterilization	19
8.3.1. Autoclaving.....	20
8.4. Chemical resistance.....	21
9. Troubleshooting	22
9.1. Correction of errors.....	22
9.2. Emergency cover release	23
10. Guarantee	23
11. Transport and storage	23

11.1. Transport and storage conditions	23
12. Disposal	24
13. Manufacturer's info.....	24
Distributor's info	24
14. Annexes.....	24
A. Additional accessories	
B. Declaration of conformity (CE, ROHS 2)	
C. Declaration of decontamination (repair / return)	
D. Nomogram RPM / RCF	

1. Symbols used in the manual and on the device

Symbol	Explanation
	WARNING! Warning of potential injury or health risk
	DANGER! Risk of electric shock with potential for severe injury or death as a consequence
	DANGER! Biohazard with potential for risk to health or death as a consequence
	DANGER! Risk of explosion with potential for severe injury or death as a consequence
	Symbol identifying a medical device for in vitro diagnostic use
	CE mark
	Symbol informing about the method of disposal
	Please read the instruction manual before you start working with the device
	Manufacturer's data

The terms "**accessories**", "**optional accessories**" and "**equipment**" used in this manual mean the components of the centrifuge, such as: rotors, containers and reducing inserts.

2. Application

- The **MPW-55** centrifuge is a bench-top non-automatic laboratory centrifuge.
- The device is intended for In Vitro Diagnostics (IVD). This means that it is an in vitro diagnostic medical device - in accordance with the Regulation of the European Parliament and of the Council (EU) of 5 April 2017 on in vitro diagnostic medical devices and repealing Directive 98/79/EC and Commission Decision 2010 /227/EU.
- The centrifuge is used to separate aqueous solutions and suspensions of samples with a density not higher than 1.2g/cm³ taken from human, animal and plant organisms into components of different densities under the influence of centrifugal force, in order to provide information about their biological state and to other analytical work.

- The design of the centrifuge ensures ease of use, safe operation and a wide range of applications in medical, biochemical and other analysis laboratories.
- The centrifuge is not biotight, therefore, when centrifuging preparations that require biotightness, containers and rotors with a biotightness certificate should be used.

3. Technical data

manufacturer	"MPW MED. INSTRUMENTS" SPÓŁDZIELNIA PRACY 46 Boremlowska Street, 04-347 Warsaw – Poland				
type	MPW – 55				
cat. no (REF)	10055/12-56				
mains voltage (L1+N+PE)	230 V	100V	110V	120V	127V
	±10%	±5%			
frequency	50/60 Hz				
maximum power consumption	95W				
overcurrent protection	fuse WTA-T 3,15A 250V				
capacity (max.)	48 ml				
rotational speed range – RPM	100÷ 14500, step 100				
maximum acceleration – RCF [x g]	15279				
acceleration	3 linear characteristics				
deceleration	3 linear characteristics				
programs	9				
time range	15 s÷99 min 45 s, with 15 s interval and ∞				
electromagnetic compatibility	according to EN 61326-2-6:2006				
protection zone	300 mm				
dimensions:					
height (H)	140 mm				
width (W)	220 mm				
depth (D)	270 mm				
noise level	≤ 56 dBA				
weight of centrifuge 230V	approx. 4kg				
weight of centrifuge 120V	approx. 4kg				

3.1. Environmental conditions

- The device may only be used indoors.
- The permissible ambient temperature is 2°C to 40°C.
- Maximum allowed relative humidity 80% at temperature up to 31°C decreasing linearly to 50% relative humidity at 40°C.
- The mains voltage fluctuations must not exceed ± 10% of the nominal voltage.
- Maximum altitude 2,000 m above sea level.
- Overvoltage category II.
- Pollution degree 2.

4. Installation

Open the package. Remove the box containing the accessories. Take out centrifuge from the container. Keep the box and packing materials in case of service shipping.



4.1. The contents of the package

name	pcs	catalogue number
Centrifuge MPW-55	1	10055/12-56
Rotor fixing screw	1	17167
Rotor key	1	17099T
Spanner for emergency opening of the cover	1	17162
Power cord 230V / 120V	1	17866/17867
Fuses WTA-T 3,15 A 250 V (230V)	2	18676
Technical vaseline 20ml	1	17201
User manual	1	See page 1

4.2. Other accessories

Catalog no	Specification
16150	Hematocrit reader – round

4.3. Location

	<ul style="list-style-type: none"> ▪ The device should be lifted from below near its feet and placed directly on a suitable laboratory table. ▪ The centrifuge should be set so that access to the power switch is not difficult. ▪ Do not place the centrifuge near heaters and avoid direct sunlight. ▪ The table on which the centrifuge is placed should be stable and have a flat, leveled top. ▪ A protection zone of at least 30 cm on all sides should be provided around the centrifuge. The ambient temperature for normal operating conditions of the centrifuge is given in section Environmental conditions. ▪ When changing the place from cold to warm, water condensation inside the centrifuge will occur. It is important to allow sufficient time for drying before restarting the centrifuge (minimum 4 hours). ▪ The supply voltage must match the voltage specified on the rating plate. Laboratory centrifuges by "MPW MED. INSTRUMENTS" are devices with a basic safety class and have a three-wire connection cord with a plug resistant to dynamic loads. ▪ The power socket should have a protective pin. ▪ It is recommended to install an emergency switch located far from the centrifuge near the exit from the room or outside the room.
	<ul style="list-style-type: none"> ▪ <i>Before switching on, check if the centrifuge is properly connected to the power supply.</i> ▪ <i>Only the power cord recommended by the manufacturer may be used.</i>

4.4. Current protection

	<p>The centrifuge is equipped with thermal current protection. Fuse is situated in the plug-in socket unit at back wall of the centrifuge.</p>
---	--

5. Safety notes

5.1. General remarks

	<ul style="list-style-type: none">▪ The laboratory centrifuge may be operated only by qualified laboratory personnel, after reading the operating manual.▪ The operating instructions are part of the product.▪ The operating manual should always be kept in the vicinity of the centrifuge.▪ The centrifuge cannot be operated contrary to its purpose.▪ If the centrifuge is used in a manner inconsistent with the manufacturer's guidelines, the safety of its use may be impaired.▪ For centrifugation in the centrifuge, only containers and inserts provided in the list of equipment and centrifuge tubes, the diameter, length and strength of which are appropriate, should be used. The use of test tubes not included in the list should be agreed with MPW MED. INSTRUMENTS or its authorized representatives.▪ Pay attention to the quality and appropriate thickness of the glass test tubes walls. Glass tubes should be centrifuge tubes, and their use in the centrifuge should be made dependent on the following guidelines:<table border="1" data-bbox="550 813 1177 960"><thead><tr><th>glass tubes</th><th>max RCF in angular rotors</th></tr></thead><tbody><tr><td>5-10 ml</td><td>3000 x g</td></tr><tr><td>30-100 ml</td><td>spinning not allowed</td></tr></tbody></table>▪ Weighing the filled test tubes into the rotor is recommended. This will allow to minimize the differences in mass between them, and as a result to avoid the negative impact of vibrations on the engine suspension and to reduce noise levels during the operation of the centrifuge.	glass tubes	max RCF in angular rotors	5-10 ml	3000 x g	30-100 ml	spinning not allowed
glass tubes	max RCF in angular rotors						
5-10 ml	3000 x g						
30-100 ml	spinning not allowed						

5.2. Placing the rotor and accessories in the centrifuge

	<ul style="list-style-type: none">▪ Connect the centrifuge to the power supply (mains socket at the back of the centrifuge).▪ Turn on the centrifuge (switch on the side of the centrifuge).▪ Open the cover of the centrifuge by pressing the COVER key. Before installing the rotor, check that the rotating chamber is free from any contamination. If there is dust, glass splinters, liquid residues, etc., remove them.▪ The rotor can fall if not handled properly, therefore it should always be handled and placed in the centrifuge using both hands.▪ Place the rotor on the motor axis by sliding it onto the cone as far as it will go (keeping the coaxiality between the rotor and the motor axis).▪ Screw the screw fixing the rotor into the motor axis (clockwise), and then tighten it firmly with the rotor key.▪ Fill the rotor with containers / hangers / test tubes according to recommendations in section Filling the rotor.▪ In order to replace the rotor, first remove the tubes and containers from it, unscrew the screw fixing the rotor with the enclosed rotor key, counterclockwise, then using both hands, grab the rotor on opposite sides and remove it from the motor axis.▪ Install another rotor as described above instructions.
---	---

5.3. Filling tubes

- Fill test tubes outside the centrifuge.

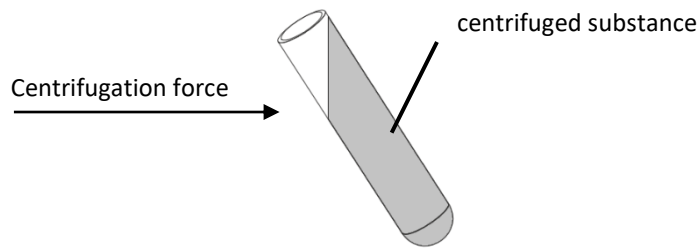

- If the manufacturer of the test tube has not specified the maximum level, fill the test tubes so that the centrifuged substance does not run out of the vessel during centrifugation. To do this, use the formula below:

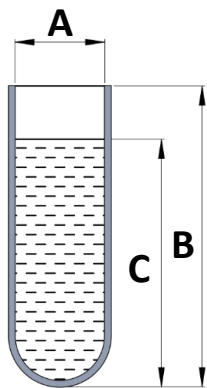

$$C < B - \frac{A}{2}$$

- A – internal tube diameter
- B – tube height
- C – max liquid level

5.4. Filling the rotor

CAUTION!



- Angle rotors must be used with a suitable cover which must be screwed securely onto the rotor. The rotor and the cover are marked with the same catalog number (REF) to eliminate the risk of incorrect selection when you have several types of rotors.

- Check that the impeller is seated correctly and firmly bolted to the motor shaft.
- Do not exceed the maximum rotor load (information is provided on the rotor).

An example of the marking on the angular rotor:

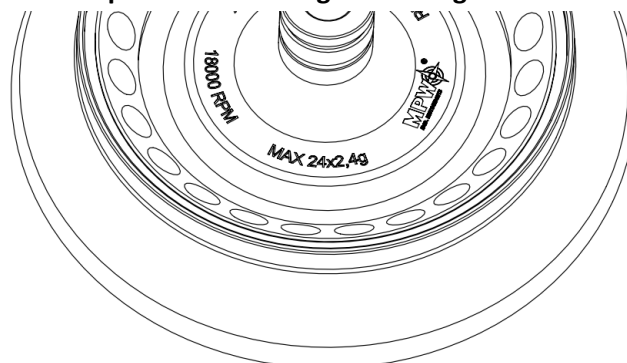





MAX. 24x2,4g - means the possibility of placing 24 test tubes in the rotor, each weighing 2.4 g.

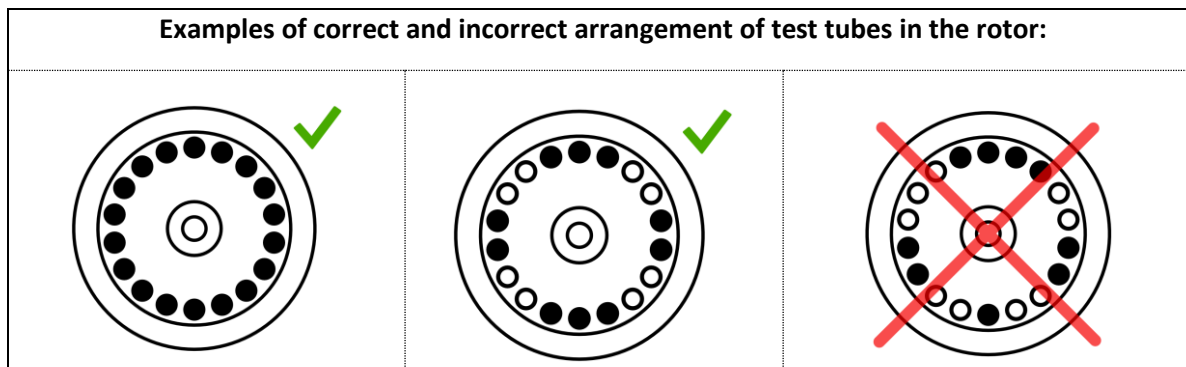

- To ensure symmetrical loading, insert test tubes of the same type and weight in pairs into opposite openings of the rotor. If reduction inserts are used, they should also be placed in the holes opposite to each other in pairs of the same type.





5.5. Safety hints

	<p>ROTOR MAINTENANCE</p> <ul style="list-style-type: none"> ▪ In order to increase the durability of gaskets, threaded places, rotor pins, undercuts for pins in containers, they must be cleaned, and then it is necessary to lubricate them with the technical petroleum jelly supplied with the device (catalog number 17201). ▪ Use only accessories that are in good technical condition.
	<p>HU EQUIPMENT MAINTENANCE</p> <ul style="list-style-type: none"> ▪ Make sure the sealing rings (rubber) are lightly coated with grease to maintain tightness. Use high vacuum silicone grease, eg type "C" by LUBRINA.
	<p>HAZARDOUS MATERIALS</p> <ul style="list-style-type: none"> ▪ Infectious materials should be centrifuged only in containers / rotors with covers. ▪ It is not allowed to centrifuge toxic or infectious materials if the rotor or test tube seal is damaged. ▪ Appropriate disinfection procedures should always be carried out, if hazardous substances have contaminated the centrifuge or its accessories.
	<p>EXPLOSIVE, FLAMMABLE MATERIALS</p> <ul style="list-style-type: none"> ▪ It is not allowed to centrifuge explosive and inflammable materials. ▪ Do not centrifuge substances that could create a potentially explosive atmosphere as a result of the high energy supply during centrifugation. ▪ The centrifuge must not be used in an explosive atmosphere. ▪ It is not allowed to centrifuge materials that may generate flammable or explosive mixtures when exposed to air.

5.6. Operating conditions

	<p>GENERAL REMARKS</p> <ul style="list-style-type: none"> ▪ Only original equipment of centrifuges and spare parts should be used. ▪ In case of a malfunction of the centrifuge, the MPW MED factory service should be used. INSTRUMENTS or its authorized representatives. ▪ It is not allowed to start the centrifuge if it is not installed correctly or the rotor and accessories are not properly mounted. ▪ The centrifuge must not be transported with the rotor installed on the motor shaft. ▪ Fill the rotor equipment to the same weight in order to prevent unbalance of the centrifuge (point Filling the rotor).
---	---

	<p>START-UP</p> <ul style="list-style-type: none"> Before switching on the device, carefully read all sections of this manual in order to ensure the correct operation of the device and to avoid damage to the device or its accessories.
---	--

	<p>CENTRIFUGAL SUBSTANCES</p> <ul style="list-style-type: none"> Rotors are designed for centrifuging liquids with an average density of 1.2 g / cm³ or less. This applies to centrifugation at maximum speed. If liquids with a higher density are to be used, be sure to enter the density value in the PARAM / DENSITY tab in order to reduce the available spin speed.
---	--

5.7. Equipment life

	<ul style="list-style-type: none"> Each spin cycle in which the rotor has accelerated and decelerated is considered a duty cycle, independent of speed and duration. Do not use the equipment after the allowable number of cycles or after the maximum service life has passed, whichever comes first (the service life is 15000 cycles or 5 years).
---	--

5.8. Work safety

The centrifuge should be inspected by an authorized service at least once a year (after the warranty period). Special circumstances, e.g., corrosive environment, may be the reason for more frequent checks. Tests should end with issuing a validation protocol, which specifies checking the technical condition of a laboratory centrifuge.

It is recommended to create a document that records all repairs and inspections. This document should be kept in the place where the centrifuge is used.

	<p>CONTROLS CONDUCTED BY THE OPERATOR</p> <ul style="list-style-type: none"> The operator must pay attention to the fact that the parts of the centrifuge, important from the safety point of view, are not damaged. This remark applies to: <ul style="list-style-type: none"> Centrifuge accessories, especially structural changes, corrosion, initial cracks, abrasion of metal parts. Bolted connections. Inspection of rotor and container seals, if any. Particular attention should be paid to rubber elements (seals). In the event of any damage or visible structural changes, they should be immediately replaced with new ones. Control of the performance of annual post-warranty inspections of the technical condition of the centrifuge. During centrifugation, it is not allowed to lift, shift the centrifuge or rest on it. During centrifugation one must not stay in the safety zone, i.e., 30 cm distance around the centrifuge, nor leave any objects, e.g., glass vessels, inside this zone. It is not allowed to put any objects on the centrifuge.
	<p>OPENING THE COVER DURING SPINNING</p> <ul style="list-style-type: none"> It is not allowed to use the emergency cover opening during centrifuging, because it may result in loss of health or life.

	<p>HANDLING OF ROTORS</p> <ul style="list-style-type: none"> ▪ It is not allowed to use accessories (rotors, lids, containers, hangers and round carriers) with signs of corrosion or other mechanical damage. ▪ It is not allowed to centrifuge substances of high corrosive aggressiveness, which may damage the materials and reduce the mechanical properties of rotors, buckets and round carriers. ▪ It is not allowed to centrifuge rotors with removed or loose covers.
---	---

5.9. Unbalance

The centrifuge is equipped with a rotor imbalance sensor. In the event of its activation, the centrifugation process is stopped by quick braking and an error message is displayed. Erasing the error message is possible by pressing any key (STOP, COVER, and ▲ ▼) after stopping the rotor.

Make sure that the rotor has been properly loaded - places in the rotor must be equipped with identically filled containers, inserts and test tubes in order to obtain the best possible weight balance (see chapter Filling the rotor).

Then close the lid and restart the spin cycle.

	<p>Unbalance causes noise, vibrations during operation and has a negative effect on the driveline (engine, shock absorbers). The more precisely the process of balancing the feed to the rotor is carried out, the smoother the centrifuge will run and the longer the useful life of the drive system will be. Moreover, an excellent level of separation of the swirl material is achieved, since the already separated components will not be picked up again by vibrations.</p>
---	---

5.10. Residual risk

The centrifuge is built according to the state-of-the-art and the recognized safety regulations.

Nevertheless, still remain some level of residual risk due to improper operation and malfunctions. It is possible to decrease residual risk by strictly applying user manual conditions and correcting malfunction which could threaten safety, immediately.

6. Operating

6.1. Centrifuge overview

The new generation of laboratory centrifuges "MPW MED. INSTRUMENTS" is equipped with modern microprocessor controllers, very durable and quiet brushless asynchronous motors and equipment that meets modern user requirements. The centrifuge has rigid self-supporting structure. Housing was made of ABS type plastic. Cover is fixed on steel axles of hinges and from the front is locked with electromagnetic lock blocking possible opening during centrifugation. Rotation chamber casing was made of thick steel sheet. The rotation chamber bowl is made of plastic. Rotors are from aluminum and reductive inserts from the polypropylene

6.2. Centrifuge description



**Fig.1. General view
MPW-55**

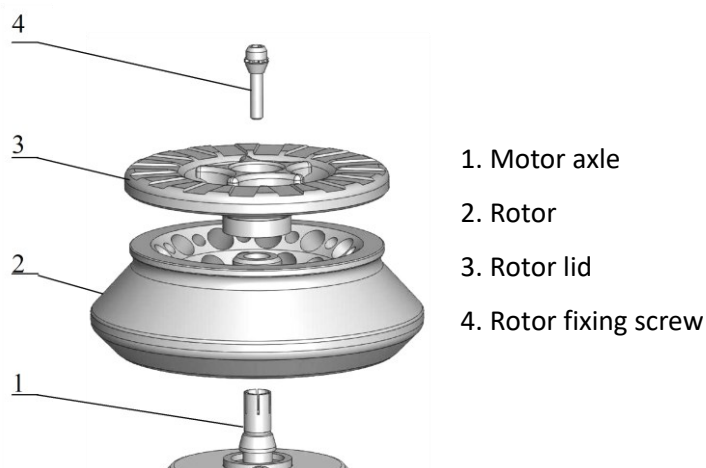
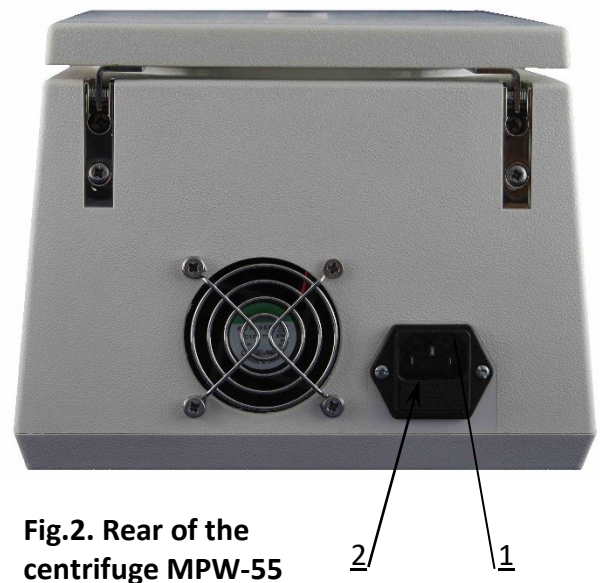

Fig.3. Assembly of angle rotor

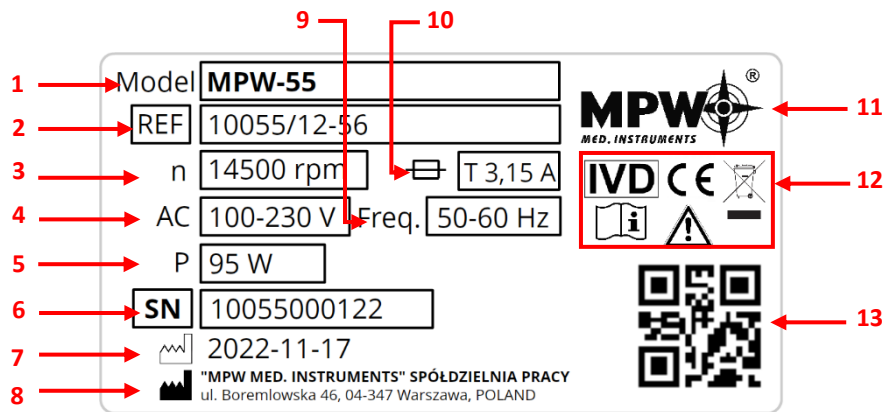

**Fig.2. Rear of the
centrifuge MPW-55**

- 1. Plug-in socket
- 2. Fuse socket

6.3. Name plate

The data concerning the device should be read from the rating plate located on the rear wall of the centrifuge (the picture below is an example).



- | | | | |
|---|---------------------|----|--|
| 1 | Centrifuge model | 8 | Manufacturer's information |
| 2 | Catalog number | 9 | Rated frequency |
| 3 | Maximum speed | 10 | Current protection |
| 4 | Rated voltage | 11 | Manufacturer's logo |
| 5 | Maximum rated power | 12 | Approval marks and symbols
(explained in chapter 1) |
| 6 | Serial number | 13 | QR code for serial number |
| 7 | Date of production | | |

6.4. Control device

The microprocessor control system used in the centrifuge provides a wide range of setting and implementing operating parameters, i.e.:

- selection of the spin speed from 100 to 14500 RPM, every 100 RPM or RCF x g,
- selection of the centrifugation time from 15 seconds to 99 minutes 45 seconds, every 15 seconds or continuous operation,
- selection of short-term operation "SHORT",
- possibility to program 9 work programs,
- selection of 3 characteristics of rising speed,
- selection of 3 braking characteristics

6.5. Setting parameters

Data setting and read-out system forms hermetically closed keyboard with distinctly accessible operation points. Easily readable displays signaling individual performed operations facilitate operator's programming and recording of parameters and condition of the centrifuge.

6.6. Safety features

6.6.1. Cover lock

The centrifuge can be started only with properly closed cover. The cover can only be opened after the rotor has stopped. In case of emergency opening of the cover during operation, the centrifuge will be immediately switched off and the rotor will be braked to a complete stop. When the cover is open (the **COVER** diode is on), the drive is completely disconnected from the power supply, which makes it impossible to start the centrifuge.

6.6.2. Unbalance detecting

When loads of opposite buckets or carriers in rotors are unbalanced, the drive will be switched-off during acceleration or operation of the centrifuge – and the **U** sign will be displayed.

6.6.3. Rest state inspection

Opening of the centrifuge's cover is possible only with the rotor in the state of rest. This state is being checked by the microprocessor which recognizes and signals with **S** sign on the display the rest state prior to opening the cover.

6.7. Increase a temperature

In uncooled centrifuges, the temperature in the rotor chamber, rotor and sample can increase to above 40°C, based on the run time, g-force (rcf)/speed and ambient temperature.

7. Centrifuging



Power switching ON/OFF is carried out with master switch situated on the side wall of the centrifuge. All settings on the centrifuge are done by means of the control panel.







7.1. Control panel

The control panel located on the front wall of the casing is used to control the operation of the centrifuge.



Fig. 4. Control panel

	<p>Start centrifuging</p>	<p>Blinking of the LED diode next to the START key indicates the rotation of the rotor.</p> <p>The centrifuge can be started if:</p> <ul style="list-style-type: none"> ▪ the cover is closed (a dot will appear on the display, ▪ the LED diode on the COVER key is off
	<p>Stop centrifuging</p>	<p>Interrupt the centrifugation at any time and break the rotor. After pressing the key, the display shows the arrow ↓ indicating the rotor braking and the number of the performed braking characteristics.</p> <p>- end of the rotor braking process - the S (Stop) sign lights up on the display, which also signals this state with a sound</p>
	<p>Cover opening</p>	<p>Opening the cover or its incorrect closing is signaled by the diode lighting, the key is active only when the rotor is not rotating. The cover can be opened only when the rotor stops, the S symbol will be displayed on the display and the centrifuge signals the possibility of opening the cover with five short beeps.</p> <p>ATTENTION! The centrifuge cannot be opened when the = sign, signaling the possibility of changing the parameter value, is active, even despite the stopped rotor.</p>

	Short-term centrifugation	<ul style="list-style-type: none"> ▪ Short-term operation of the centrifuge when the key is held down until it is released. ▪ In the short mode the rotor is accelerated to the speed set in the given program, ▪ Acceleration and deceleration of the rotor take place in accordance with the previously programmed characteristics, ▪ Pressing the STOP key after releasing the SHORT during deceleration of the rotor will result in faster deceleration of the rotor according to characteristic no. 1, ▪ The centrifugation time in the SHORT mode is measured in minutes and seconds from the moment the centrifuging cycle starts (from pressing the SHORT key) to the moment the rotor stops.
 	Increase / decrease values	<ul style="list-style-type: none"> ▪ The function key fields are used to change the program as well as to set their individual parameters such as: speed, RCF, time, acceleration and deceleration characteristics. ▪ After pressing the key corresponding to the called function, the equal sign "=" appears on the display instead of the colon ":" after the letter corresponding to the given function. It means that the value of a given parameter can be changed by buttons: down arrow or up arrow. ▪ The possibility of changing the parameter value is signaled by the "=" sign and is active for three seconds. This is the time when you should start setting the desired value. Three seconds after setting the desired value of a given parameter, this value will be saved in the program or after selecting a given program it will be set as active.
	Spin speed / RCF	<ul style="list-style-type: none"> ▪ change the spin speed ▪ pressing the key again will switch the programming mode from setting speed to setting RCF value
	Spin time	<ul style="list-style-type: none"> ▪ Programming the centrifugation time (from 15s to 99min 45s). ▪ Setting the - m - s symbol over 99min 45s will cause the continuous operation of the centrifuge.
	Acceleration / deceleration	<ul style="list-style-type: none"> ▪ Programming the acceleration characteristics ACC and deceleration DEC of the rotor. ▪ The rotor acceleration characteristic is symbolized by an up arrow ↑. Pressing the key again will switch the programming mode from setting the acceleration to programming the braking characteristics of the rotor. ▪ The rotor braking characteristic is indicated by a down arrow ↓. ▪ There are three characteristics of acceleration and deceleration to choose from. ▪ Characteristics numbered 1 are the fastest.
	Program	<ul style="list-style-type: none"> ▪ The key is used to select a program number which is to be executed or reprogrammed. ▪ Nine programs can be programmed.

7.2. Sound signals

The sound signal complements the information provided optically.

- One short beep - confirmation of the executed command (e.g., increasing the parameter etc.)
- Two short beeps - signals that the command cannot be carried out (e.g., increasing the spin speed above 14500).
- One long beep - signals the start of the following processes:
 - Braking after pressing the STOP key,
 - Starting work in short mode and braking after releasing the SHORT key,
- Five short beeps - the rotor stops, the cover can be opened,

- Five short beeps and one long beep - signaling readiness for operation after switching the power on.

7.3. Display

The centrifuge has readable display LCD, on which are showing information being referred to the actual condition of the system.

The information about the centrifuge type, program version and internet address are displaying at once after switching supply on for three seconds.

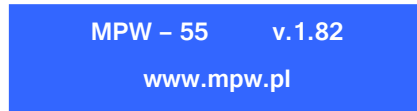

Following the information about program has been lately made, the time, speed and acceleration characteristic settings will be displayed.

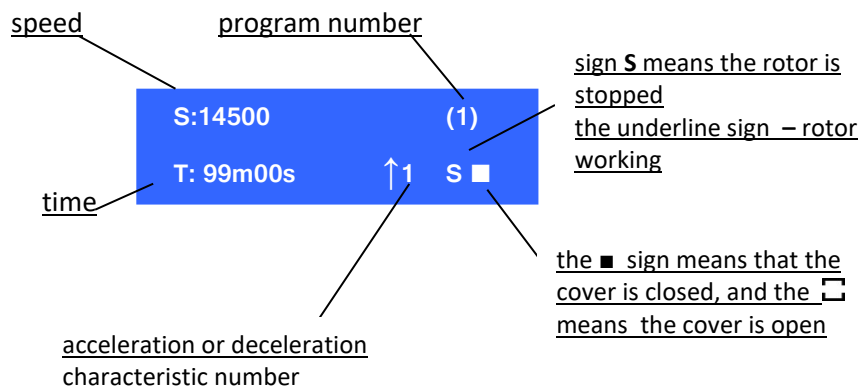

after pressing the key  twice, the display will show the acceleration value corresponding to the programmed speed

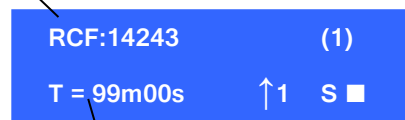

the = sign means that it can be changed value of a given

The program parameters cannot be changed during the centrifuge operation, but its further implementation can be interrupted by pressing the **STOP** key.

7.4. Spin starts

After familiarizing yourself with the operating elements, programming and preparation of the centrifuge for operation, set the program, then close the cover and press the **START** key . The centrifuge starts and runs the programmed program

7.5. Spin stops

The centrifugation is stopped automatically after the execution of the program. If you want to terminate the execution of a given program earlier, you can do it by pressing the **STOP** key .

After finishing work, remember to turn off the centrifuge power supply with the main switch located on the side of the centrifuge

7.6. Mathematical relations

1.1.1. RCF – relative centripetal force

RCF acceleration is the acceleration generated by the rotary motion of the rotor acting upon tested product and it can be calculated according to the formula:

$$\text{RCF} = 11,18 \times r \times (n/1000)^2$$

$$\text{RCF [x g]}, \quad r \text{ [cm]}, \quad n \text{ [rpm]}$$

Depending on the distance of particles of the tested product from the axis of rotation, one can establish with use of the above formula the minimum RCF, average RCF or maximum RCF. On the basis of pre-set RCF value and given radius of the bottom of the bucket one can calculate with it the rotational speed to be set in the program of centrifuging. Selection of the time of sedimentation and the RCF value shall be carried out experimentally for any given product.

Once every 100 rpm, an electronic circuit automatically calculates and displays RCF value. In order to program required RCF value one shall use nomogram or change the rotational speed, matching displayed value to required acceleration value.

7.6.1. Nomogram of relationship - rotational speed/centrifuging radius/RCF

The dependence nomogram – speed / radius / RCF is included in the appendix to this manual.

7.6.2. Maximum load

In order to avoid overloading of the rotor one shall observe maximum load which is recorded on every rotor. Maximum permissible load is reached when all test-tubes are filled with the fluid with 1.2 g/cm³ density.

If density of the centrifuged liquid is higher than 1.2 g/cm³, then test-tubes could be filled only partially or one shall limit operation speed of the centrifuge, which is being calculated from the formula:

$$n_{\text{perm}} = n_{\text{max}} * \sqrt{\frac{1,2}{\gamma}} ; \quad \gamma = \text{specific gravity} \left[\frac{G}{cm^3} \right]; \quad n_{\text{max}} \text{ [maximum rotational speed - rpm]}$$

8. Maintenance

8.1. Cleaning of the centrifuge



- **Pull the mains plug before cleaning.**
- **Before any cleaning or decontamination process other than that is recommended by the manufacturer, the user has to ask the manufacturer if the planned process does not damage the device**
- For cleaning, water with soap or other water-soluble **mild detergent** shall be used.
- One should avoid corrosive and aggressive substances.
- It is prohibited to use alkaline solutions, inflammable solvents or agents containing abrasive particles.
- Do not lubricate the centrifuge motor shaft.
- The unused centrifuge should have cover opened.

Once a week

Using wiping cloth, remove condensate or residues of the products from the rotor chamber.

Once a month

	<ul style="list-style-type: none"> ▪ Check the condition of the rotor fixing screw thread. If damaged, it must be replaced. ▪ Check the centrifuging chamber whether it is damaged. In case of damage, it cannot be longer put into operation. Notify authorized service workshop.
--	--

8.2. Maintenance of centrifuge elements

	<ul style="list-style-type: none"> ▪ In order to increase the durability of threaded places, they should be lubricated with technical petroleum jelly. ▪ Make sure that the sealing rings (rubber) are covered with a thin layer of technical petroleum jelly in order to maintain tightness (catalog number 17201 - element of basic equipment).
---	---

Cleaning of the equipment

	<ul style="list-style-type: none"> ▪ In order to ensure safe operation, one shall carry out in regular way periodical maintenance of the accessories. ▪ Rotors, buckets, and round carriers have to withstand high stresses originating from the centrifugal force. Chemical reactions as well as corrosion (combination of variable pressure and chemical reactions) can cause destruction of metals. Hard to observe surface cracks increase gradually and weaken material without visible symptoms. ▪ In case of observation of surface damage, crevice, or other change, as well as the corrosion, the given part (rotor, bucket, etc.) shall be immediately replaced. ▪ The rotor, including the fixing screw, buckets and round carriers must be regularly cleaned to prevent corrosion. ▪ Cleaning of the accessories shall be carried out outside of the centrifuge once every week or still better after each use. For cleaning them one should use neutral agent of pH value 6÷8. It is forbidden to use alkaline agent of pH > 8. Then, those parts shall be dried using soft fabric or in the chamber drier at ca. 50°C. ▪ Angle rotor should be placed on a fabric with holes facing down, for effective drying. ▪ Do not use bleach on plastic parts of the rotor. ▪ In this way, the useful service life of the device is substantially increased and susceptibility to corrosion is diminished. Accurate maintenance increases the service life as well and protects against premature rotor failures. ▪ Do not use bleach on plastic parts of the rotor. ▪ According to laboratory standards, minimize the immersion time in each solution. ▪ Especially prone to the corrosion are parts made of aluminium. ▪ Corrosion and damages resulting from insufficient maintenance could not be subject of claims lodged against the manufacturer. ▪ The unused rotor should have the lid removed.
---	--

HS accessories maintenance:

	<ul style="list-style-type: none"> ▪ Check the general condition of seals. ▪ Make sure that rubber O-rings are lightly coated with silicone grease. Use high vacuum grease, e.g., type „C” by LUBRINA. ▪ In order to maintain hermetic sealing, it is recommended to replace the sealing rings after each autoclaving. ▪ Store hermetically sealed rotors and buckets with the lids removed.
---	--

8.3. Sterilization

Plastics - legend to abbreviations

PS	polystyrene	ECTFE	ethylene/chlorotrifluoroethylene
SAN	styrene-acrylonitrile	ETFE	ethylene/tetrafluoroethylene
PMMA	polymethyl methacrylate	PTFE	polytetrafluoroethylene
PC	polycarbonate	FEP	tetrafluoroethylene/perfluoropropylene
PVC	polyvinyl chloride	PFA	tetrafluoroethylene/perfluoroalkylvinylether
POM	acetal polyoxymethylenel	FKM	fluorcarbon rubber
PE-LD	low density polyethylene	EPDM	ethylene propylene diene
PE-HD	high density polyethylene	NR	natural rubber
PP	polypropylene	SI	silicon rubber
PMP	polymethylpentene		

One can use all standard disinfectants. Centrifuges and devices are made of different materials, one should consider their variety.

	radiation β radiation γ 25 kGy	C ₂ H ₄ O (ethylene oxide)	formalin, ethanol
PS	●	○	●
SAN	○	●	●
PMMA	●	○	●
PC	●	●	●
PVC	○	●	●
POM	●	●	●
PE-LD	●	●	●
PE-HD	●	●	●
PP	●	●	●
PMP	●	●	●
ECTFE, ETFE	○	●	●
PTFE	○	●	●
FEP, PFA	○	●	●
FKM	○	●	●
EPDM	○	●	●
NR	○	●	●
SI	○	●	●
●	may be used		
○	cannot be used		

In the centrifuge, disinfectants and cleaning agents generally used in medical care should be used (e.g., Aerodesina-2000, Lysoformin 3000, Melseptol, Melsept SF, Sanepidex, Cutasept F).

8.3.1. Autoclaving

- Rotors, buckets, and round carriers can be sterilized in autoclave with temperature 121°C during 20 min (215 kPa), unless otherwise specified in the OPTIONAL ACCESSORY.
- During sterilization (autoclaved) by means of steam one should consider temperature resistance of individual materials.
- Deformation of the accessories (carriers or lids made of plastic) may occur during autoclaving.
- Do not autoclave disposable materials (e.g., tubes, cyto-container).
- The life of the accessory depends on the frequency of autoclaving and use.
- Autoclaving reduces lifespan of plastic components. They should be replaced if any signs of damage are visible, including a change in colour or shape or when leakage etc.
- Pressure in closed containers can cause plastic deformation or explosion.
- Prior to autoclaving the rotors and accessories, thoroughly wash and rinse with distilled water.
- Never exceed the permissible autoclaving temperature and time.
- If you want to keep the hermetic seals, replace the sealing rings after each autoclave.

Chemical resistance of plastics

	autoclaving 121 °C, 20 min		autoclaving 121 °C, 20 min
PS	○	PMP	●
SAN	○	ECTFE, ETFE	●
PMMA	○	PTFE	●
PC	●	FEP, PFA	●
PVC	○ ¹⁾	FKM	●
POM	●	EPDM	●
PE-LD	○	NR	○
PE-HD	○	SI	●
PP	●		

● may be used

○ cannot be used

1) Except PVC hoses which are resistant to the steam sterilization in the temperature 121°C.



8.4. Chemical resistance

Chemical resistance of plastics

	aldehydes	cyclic alcohols	esters	ether	ketones	strong or concentrated acids	weak or diluted acids	oxidizing substances	cyclic hydrocarbons	ahs	haloid hydrocarbons	alkalis
PS	○	●	○	○	○	○/●	○/●	○	○	○	○	●
SAN	○	●	○	○	○	○	○/●	○	○	○	○	●
PMMA	○/●	●	○	○	○	○	○/●	○	○/●	○	○	○
PC	○/●	●	○	○	○	○	○/●	○	○/●	○	○	○
PVC	○	●	○	○	○	●	●	○	●	○	○	●
POM	○/●	●	○	●	●	○	○	○	●	●	●	●
PE-LD		●	●	●	○/●	●	●	○	●	●	●	●
PE-HD	●	●	○/●	○/●	○/●	●	●	○	●	○/●	○/●	●
PP	●	●	○/●	○/●	○/●	●	●	○	●	○/●	○/●	●
PMP	○/●	●	○/●		○/●	●	●	○	○/●	○	○	●
ECTFE ETFE	●	●	●	●	○	●	●	●	●	●	●	●
PTFE FEP PFA	●	●	●	●	●	●	●	●	●	●	●	●
FKM	●	○	○	○	○	○	●	○/●	○/●	○/●	○/●	○/●
EPDM	●	●	○/●	○	○/●	●	●	○/●	○	○	○	●
NR	○/●	●	○/●	○	○	○	○/●	○	○	○	○	●
SI	○/●	●	○/●	○	○	○	○/●	○	○	○	○	○/●
●	very good	Permanent action of the substance does not cause damage through 30 days. The material is able to be resistant through years										
○/●	good to limited	Continuous action of the substance causes insignificant and partly reversible damage through the period of 7-30 days (e.g., puffing up, softening, reduced mechanical durability, discolouring).										
○	limited	The material should not have the continuous contact with the substance. The immediate occurrence of damage is possible (e.g., the loss of mechanical durability, deformation, discolouring, bursting, dissolving).										

Rubber inserts shall be exactly cleaned or possibly replaced. Centrifuges and accessories are made of different materials.

Do not use bleach on plastic parts of the rotor.

	<p>DANGER!</p> <p>MPW accessories are not biotight. For centrifuging infectious materials, it is necessary to use hermetically closed tubes meeting demands of biotightness, in order to prevent germs migration into the centrifuge and beyond it.</p>
	<p>User is responsible for proper disinfections of the centrifuge if some dangerous material was spilled inside or outside of the centrifuge. During the above mentioned works one must wear safety gloves.</p>

9. Troubleshooting

9.1. Correction of errors

Majority of faults could be removed by switching the centrifuge **OFF** and then **ON**. After switching the centrifuge **ON**, there shall be displayed parameters of the recently implemented program and sound signals comprising four successive tones shall be generated. In the case of short-duration power failure the rotor is decelerate.

Please find below the most frequent faults and their repair methods.

1. Lack of the display:	Remedies:
<i>Is mains socket live ?</i>	<i>Check mains socket fuse.</i>
<i>Is supply cable plugged into socket ?</i>	<i>Plug correctly supply cable.</i>
<i>Is input fuse good ?</i>	<i>Replace input fuse (rated data on rating plate).</i>
<i>Is master switch switched ON ?</i>	<i>Switch ON power supply.</i>
<i>Above was checked and still there is not display active.</i>	<i>Call service.</i>
2. Centrifuge does not start:	Remedies:
<i>START key pushing does not generate reaction or single tone only</i>	
<i>P message is displayed</i>	<i>Call service</i>
<i>LED diode of cover is shining</i>	<i>Close cover. The lock has to be locked with typical sound. He has to the sign of the dot appear on the display. If the diode is not switching off one shall call service.</i>
<i>LED diode of "Start" key is shining</i>	<i>Switch power supply OFF/ON. If fault still persists then call service.</i>
<i>The digit of display parameters is blinking</i>	<i>Push the "Stop" key which has been recorded program. If fault still persists then call service.</i>
3. Centrifuge starts but does not accelerate	Remedies:
<i>E symbol displayed after stopping. Drive overload</i>	<i>Wait for 15 minutes and switch again after opening and closing the cover.</i>
4. One cannot open the cover:	Remedies:
<i>With the attempt opening cover is audible buzzing of the lock.</i>	<i>One should lift up till the yellow LED "Cover" is switching on. Failed spring of cover lifting or bended the lock striker. One should bend the striker or call service.</i>
<i>LED diode "Cover" is not shining and the centrifuge not swirling.</i>	<i>Lock is failed. Call service.</i>

9.2. Emergency cover release

	<p>EMERGENCY COVER RELEASE</p> <p>Attention! <i>The cover may be opened in emergency only when the rotor is at rest. Before emergency opening the cover, switch off the mains power switch and disconnect the power cord. Wait 10 min and/or looking through the sight glass, make sure that the rotor is not rotating.</i></p> <p>To do this, insert the key for emergency opening of the cover (catalog number 17162) into the hole on the right side of the housing, and then push it until the lock is released and the cover is opened.</p> <p>The emergency opening of the cover can be used e.g., in the event of a power failure, failure of the control panel, etc.</p>
---	--

10. Guarantee

Manufacturer grants to the Buyer the guarantee on conditions specified in the Guarantee Certificate. Buyer forfeits the right to guarantee repair when using the device inconsistently with the User manual provisions, when damage results from the User's fault.

Repairs should be carried out in authorized service workshops, granted with the MPW Certificate.

The centrifuge shall be sent to repair after decontaminating disinfections. Information about authorized service workshops could be obtained from the Manufacturer

	<ul style="list-style-type: none"> ▪ Guarantee period amounts to 24 months (unless otherwise specified in the purchase documents). ▪ Guarantee conditions are described in guaranteed card. ▪ The service life of the centrifuge specified by the manufacturer amounts to 10 years. ▪ After 24 months from the start of the warranty period (date of purchase), a technical inspection of the centrifuge should be carried out (validation) by an authorized service of the manufacturer. Subsequent inspections should be carried out at annual intervals. ▪ Maximum period of storage of not used centrifuge amounts to 1 year. After this period, a service authorized by manufacturer should carry out technical inspection of the centrifuge. ▪ Manufacturer reserves the right to make technical changes in manufactured products.
---	--

11. Transport and storage

<ul style="list-style-type: none"> ▪ Store the device only in a closed and dry room. ▪ Remove rotor from centrifuge before transport. ▪ Use the original packaging and transport protection for transport.

11.1. Transport and storage conditions

	Storage (in the package)	Storage (without the package)	Transport
Temperature	-25 ÷ +55 °C	-5 ÷ +45 °C	-25 ÷ +60 °C (general) -20 ÷ +55 °C (air)
Relative humidity	10 ÷ 75 %	10 ÷ 75 %	10 ÷ 75 %
Pressure	70 ÷ 106 kPa	70 ÷ 106 kPa	30 ÷ 106 kPa

12. Disposal



- Dispose of the device in accordance with the applicable legal regulations in the country of use.
- In the countries of the European Community, the disposal of electrical equipment is regulated under the EU Directive 2012/19/EU on waste electrical and electronic equipment (WEEE). According to these regulations, centrifuges may not be collected together with municipal or household waste.
- Disposal regulations in individual EU countries may differ. In case of doubt, please contact the supplier of the device.

13. Manufacturer's info

"MPW MED. INSTRUMENTS" SPÓŁDZIELNIA PRACY

Boremlowska 46 Street

04-347 Warsaw

tel. (+48) 22 610 56 67 (sales department - POLAND)
(+48) 22 879 70 46 (sales department - outside POLAND)
(+48) 22 610 81 07 (service)

fax: (+48) 22 610 55 36

e-mail: mpw@mpw.pl

website: www.mpw.pl

000042924 - number of entries in the Waste Database

PL/CA01-01782 - identification number given by Office for Registration of Medicinal Products, Medical Devices and Biocidal Products.

Distributor's info

DISTRIBUTOR:

14. Annexes

A. Wyposażenie dodatkowe/Optional accessories**MPW-55****WIRNIK / ROTOR**PARAMETRY WIRNIKA / ROTOR PARAMETERS (RCF [x g], Rmax [mm], α [°])

POJEMNIK/BUCKET

WKŁADKA / ADAPTER

[liczba probówek na wirnik/tubes per rotor] PROBÓWKA / TUBE

11202**RPM 14500 RCF 15279 Rmax 65 α 42**

bez pojemnika/without bucket

bez wkładki/without adapter

[12] * 2-1,5 ml probówka (10,8x41,8 mm), Eppendorf®; [15011], 2 ml (10,8x41,8 mm); [15128], 1,5ml (10,8x40,5 mm)
2-1,5 ml tube (10,8x41,8 mm), Eppendorf®; [15011], 2 ml (10,8x41,8 mm); [15128], 1,5ml (10,8x40,5 mm)

14084

[12] 15127 0,5 ml probówka PCR (7,8 x 31 mm)
0,5 ml PCR tube (7,8 x 31 mm)

14133

[12] 15125 0,2 ml probówka PCR (6 x 21,6 mm)
0,2 ml PCR tube (6 x 21,6 mm)**11204****RPM 14500 RCF 15279 Rmax 65 α 51, 32**

bez pojemnika/without bucket

bez wkładki/without adapter

[24] * 2-1,5 ml probówka (10,8x41,8 mm), Eppendorf®; [15011], 2 ml (10,8x41,8 mm); [15128], 1,5ml (10,8x40,5 mm)
2-1,5 ml tube (10,8x41,8 mm), Eppendorf®; [15011], 2 ml (10,8x41,8 mm); [15128], 1,5ml (10,8x40,5 mm)

14084

[24] 15127 0,5 ml probówka PCR (7,8 x 31 mm)
0,5 ml PCR tube (7,8 x 31 mm)

14133

[24] 15125 0,2 ml probówka PCR (6 x 21,6 mm)
0,2 ml PCR tube (6 x 21,6 mm)**12205****RPM 14500 RCF 14574 Rmax 62 α 90**

bez pojemnika/without bucket

bez wkładki/without adapter

[24] 15101 19 μ l kapilara hematokrytowa (1,3 x 50 mm)
19 μ l micro-hematocrit capillary tube (1,3 x 50 mm)**Suma końcowa**

EU DECLARATION OF CONFORMITY

This EU declaration of conformity is issued under the sole responsibility of the manufacturer.

Manufacturer: **"MPW MED. INSTRUMENTS" SPÓŁDZIELNIA PRACY**
46 Boremłowska Street, 04-347 Warsaw, Poland

We apply the certified
Quality Management System
in accordance
with the standards: PN-EN ISO 9001:2015, PN-EN ISO 13485:2016

Product name: **Laboratory centrifuge MPW-55**

The aforementioned product is in conformity with the following EU regulations and directives:

- **2017/746 (IVDR)** REGULATION (EU) 2017/746 OF THE EUROPEAN PARLIAMENT AND OF THE COUNCIL of 5 April 2017 on in vitro diagnostic medical devices and repealing Directive 98/79/EC and Commission Decision 2010/227/EU
- **2011/65/UE (RoHS 2)** DIRECTIVE 2011/65/EU OF THE EUROPEAN PARLIAMENT AND OF THE COUNCIL of 8 June 2011 on the restriction of the use of certain hazardous substances in electrical and electronic equipment

Intended purpose: The product is a benchtop laboratory centrifuge specifically intended by the manufacturer for in vitro diagnostic (IVD) procedures. It is used for the separation of mixtures, suspensions, body fluids into components of different density under the influence of centrifugal force.

Risk class: **Class A (in accordance with Annex VIII, rule 5)**

The assessment of the conformity of the device has been carried out in accordance with Article 48(10) of Regulation (EU) 2017/746.

Wojciech Anisiewicz
Vice-President of the Management Board

Łukasz Satański
President of the Management Board

DECLARATION OF DECONTAMINATION

(repair)

In order to protect our employees please fill out the declaration of decontamination completely before sending centrifuge to the manufacturer (repair).

1. Device:

– type:

– serial No.:

2. Description of decontamination

(see user manual)

.....

.....

.....

.....

3. Decontamination carried out by:

name:

4. Date and signature:

.....

DECLARATION OF DECONTAMINATION

(return)

In order to protect our employees please fill out the declaration of decontamination completely before sending centrifuge to the manufacturer (return).

1. Device:

– type:

– serial No.:

2. Description of decontamination

(see user manual)

.....
.....
.....
.....

3. Decontamination carried out by:

name:

4. Date and signature:

.....

NOMOGRAM

Centrifuging radius [cm]

R.C.F. (x "g")
multiple of
gravitational
acceleration

[r.p.m.]

