



# SILICONE T, Y, DRAINAGE TUBE

Choices for alternative drainage



GENERAL  
SURGICAL  
SERIES

# SILICONE T, Y, DRAINAGE TUBE

## Fortune<sup>®</sup> Silicone T, Y, Drainage Tube Feature:

- 100% medical grade silicone for superior biocompatibility.
- Proper rigidity design to prevent from kink or clog over time.
- Larger diameter of connecting tube allows smooth withdrawn.
- X-ray opaque line.
- Sterilized double packaging.

**A** Silicone T Drainage Tube

**B** Silicone Y Drainage Tube

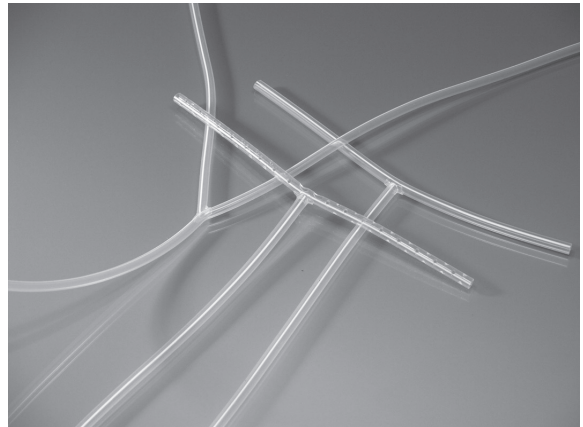

## SPECIFICATIONS

### T Drainage Tube:

REF. No.	Size	Description
1910-0008	8 FR	
1910-0010	10 FR	
1910-0012	12 FR	
1910-0014	14 FR	A: 180 mm
1910-0016	16 FR	B: 450 mm
1910-0018	18 FR	X-ray opaque line
1910-0020	20 FR	
1910-0022	22 FR	
1910-0024	24 FR	

### T Drainage Tube With Eyes:

REF. No.	Size	Description
1910-0210	10 FR	
1910-0212	12 FR	
1910-0214	14 FR	
1910-0216	16 FR	Perforation
1910-0218	18 FR	A: 180 mm
1910-0220	20 FR	B: 450 mm
1910-0222	22 FR	X-ray opaque line
1910-0224	24 FR	

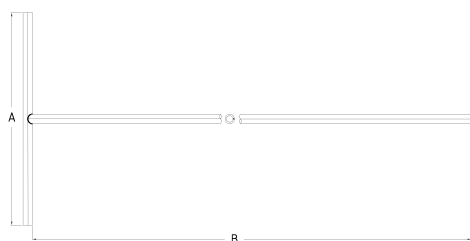

1910-00XX

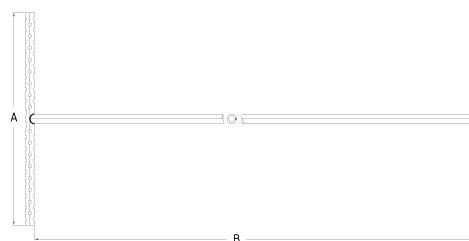

1910-02XX

# SILICONE T, Y, DRAINAGE TUBE

## T Drainage Set:

REF. No.	Size	Description
1910-8012	12 FR	
1910-8014	14 FR	
1910-8016	16 FR	T Drainage Tube
1910-8018	18 FR	Connector
		800 cc Collection Bag
1910-8020	20 FR	
1910-8022	22 FR	
1910-8024	24 FR	

## T Drainage Set With Eyes:

REF. No.	Size	Description
1910-8212	12 FR	
1910-8214	14 FR	
1910-8216	16 FR	T Drainage Tube With Eyes
1910-8218	18 FR	Connector
		800 cc Collection Bag
1910-8220	20 FR	
1910-8222	22 FR	
1910-8224	24 FR	

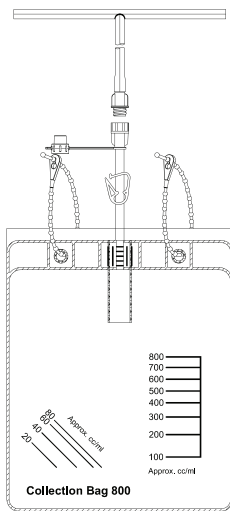

1910-80XX

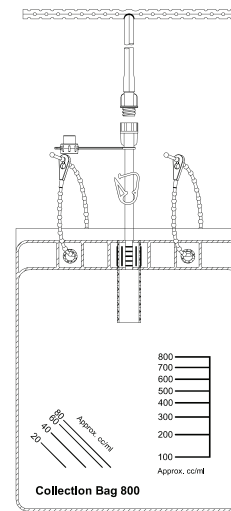

1910-82XX

# SILICONE T, Y, DRAINAGE TUBE

### Y Drainage Tube:

REF. No.	Size	Description
1920-0014	14 FR	
1920-0016	16 FR	
1920-0018	18 FR	A: 250 mm B: 450 mm
1920-0020	20 FR	X-ray opaque line
1920-0022	22 FR	
1920-0024	24 FR	

### Y Drainage Set:

REF. No.	Size	Description
1920-8014	14 FR	
1920-8016	16 FR	
1920-8018	18 FR	Y Drainage Tube Connector
1920-8020	20 FR	800 cc Collection Bag
1920-8022	22 FR	
1920-8024	24 FR	

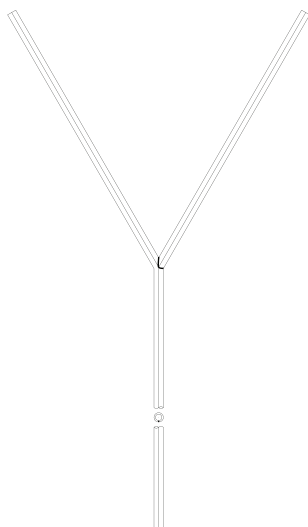

1920-00XX

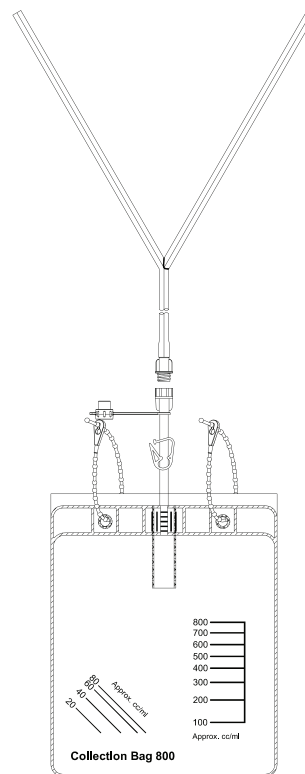

1920-80XX



**fortune  
medical**

6 F., No. 29, Sec. 2, Jhongjheng E. Rd.,  
Danshuei Dist, New Taipei City. 251 Taiwan  
Tel.:(886) 2-2624-2233 Fax.:(886) 2-2624-2266  
www.fortunemed.com Mail:info@fortunemed.com

