



SMART-2 Model Biological Microscope

STUDENT MICROSCOPES





Pretty

Durable

Good Effect

Smart Laboratory Microscope, new design with high quality optical system, supplying clear image, is good to be used in high school, university for student. Color can be made according to customer's requirement, new concept in microscope field.

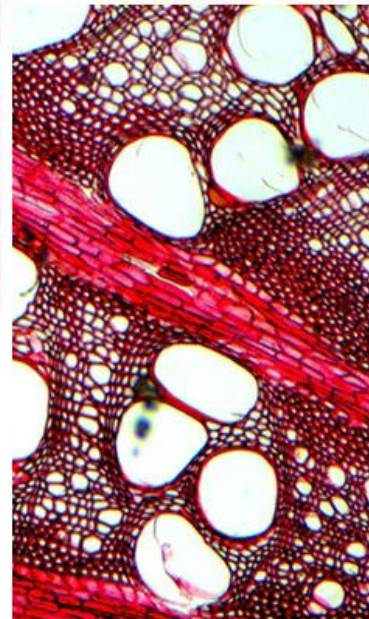
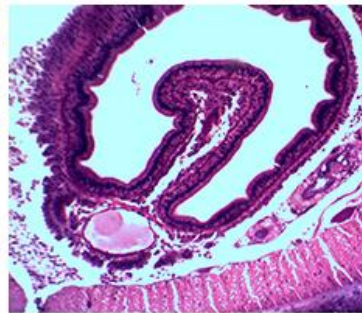
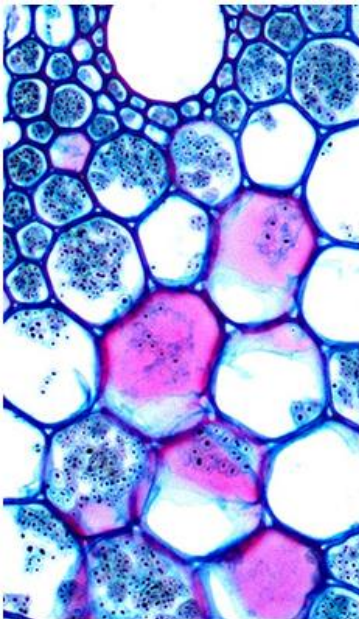

Observation Effect

Animal & Plant Slide

This microscope has a good sales for the school laboratory hospital

- ◆ Entry Level Laboratory Microscope With Full Range Upgrade Extention
- ◆ Can Use 40x LWD Infinity Plan Objective W.D.=3.0m To Avoid Contaminated By Cedar Oil
- ◆ Creative 100x Water Objective Instead Of 100x Oil Objective For Easy Use Without Oil
- ◆ High Rigidity Body Struction Design Supply High Steady And Easy Handle
- ◆ Different Color Available To Customrize Your Model!

PRODUCT DETAILS



01 Head

Seidentopf Trinocular Head, Light Split 20:80 with WF10x/20mm High Eyepoint Eyepiece, Inclined 30°, Rotatable 360°, Interpupillary Distance 48-75mm, The Left Eyepiece Tube Diopter Adjustable $\pm 5^\circ$.

02 Nosepiece & Objective

Backward Quadruple Nosepiece, **4 Sets**
Objective Available: Achromatic, Plan, Infinity E-Plan, Infinity Plan.
100X Water Objective(Optional) Instead Of 100X Oil Objective, More Be Convenient For Using



03 Working Stage

Double Layer Mechanical Stage, Size 145X140mm, Moving Range 76mmX52mm, Scale 0.1mm. Double Slide Holder For Easy Viewing And Comparing Two Slides.

04 Focus

Low Position Designed, Coaxial Coarse And Fine Focusing, Coarse Focusing Travel Range 26mm, Fine Focusing Scale $2\mu\text{m}/\text{Division}$, With Tension Adjustment.



Whatsapp: 0086-13260476608



05 Condenser

Abbe Condenser N.A.1.25, Iris Diaphragm, Rack & Pinion Up/Down, With Filter Holder

06 Light Source

High Brightness 3W LED Light Source, Brightness Adjustable. With Optional A56.2615 Field Diaphragm Can Upgrade To Kohler Illumination.



07 Attachment

Wire Winding Device For Easy Storage (Optional)

08 Power

Switch on back, wide range voltage 110V-240V, power cord detachable.



09 Holding Hole On Back

Back Hand Design For Easy Carry

Whatsapp: 0086-13260476608

 PRODUCT DISPLAY



Binocular

Trinocular



Whatsapp: 0086-13260476608

OPTIONAL ACCESSORIES

Eyepiece & Mirror



WF10x/18mm



WF10X/20mm (High Eyepoint)



Reflecting Mirror & Holder

Adapter



C-Mount 0.5x
Focus Adjustable



C-Mount 0.75x
Focus Adjustable



C-Mount 1.0x
Focus Adjustable



Digital Eyepiece
Camera Adapter

Objective



Achromatic Objective



Plan Objective



Infinity E-Plan Objective



Infinity Plan Objective

Smart-1

Smart-2

Smart-3

Smart-4

Whatsapp: 0086-13260476608

Field Diaphragm & Filter & Working Stage

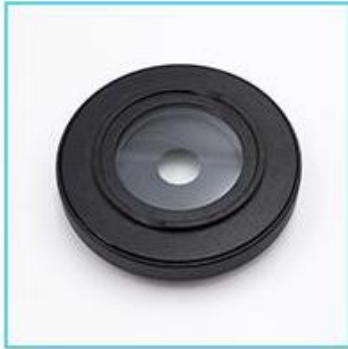

Field Diaphragm

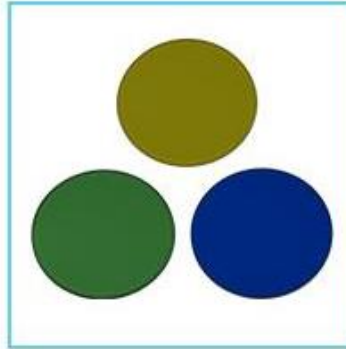

Filter: Blue, Green, Yellow



Rackless (Integrated) Stage

Polarizing & Dark Field Condenser & Phase Contrast System



Analyzer +
Polarizer Set



Dark Field
Condenser, Dry



Phase Contrast Objective
+ Slide + Condenser
+ Telescope + Green Filter

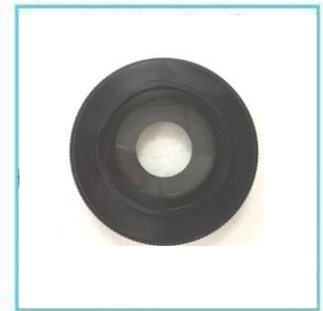

Field Diaphragm

PRODUCT
SIZE

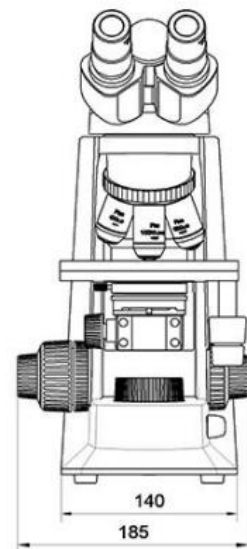
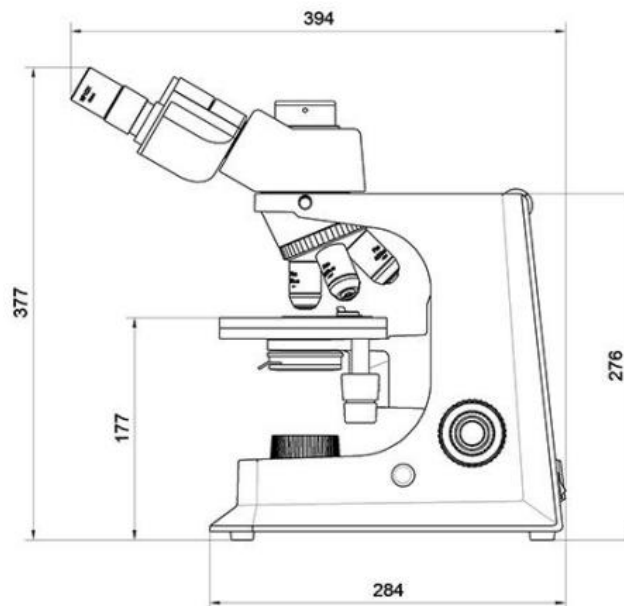

Whatsapp: 0086-13260476608

Product Specification

Items	Smart Series Microscope	Smart-2	Smart-2TR	Parts. No.
Head	Seidentopf Binocular Head Inclined 30°, Rotatable 360°, Interpupillary Distance 48-75mm	●	○	SB03(Infinity) ST04(Finity)
	Seidentopf Trinocular Head Inclined 30°, Rotatable 360°, Interpupillary Distance 48-75mm, Light Split Fixed P20:E80	○	●	SB03(Infinity) ST04(Finity)
Eyepiece	WF10x/18mm			EP10
	WF10X/20mm (High Eyepoint)	●●	●●	EP10a
Nosepiece	Quadruple, Backward	●	●	O-N734
	Quintuple, Backward	○	○	O-N735
Plan Objective	4x/0.1, W.D.=14.5mm	●	●	O-210
	10x/0.25, W.D.=5.65mm	●	●	O-220
	20x/0.40, W.D.=5.65mm	○	○	O-N/A
	40x/0.6(S), W.D.=0.85mm	●	●	O-230
	100x/1.25(S,O), W.D.=0.07mm	●	●	O-240
Working Stage	Mechanical Stage Size: 145 mm×140mm, Travel:X,Y; 76mm×52mm, Scale: 0.1mm, Double Slide Holder	●	●	O-S04
	Rackless (Integrated) Stage, Size 140×135mm, Travel Range 75×35mm, Double Slide Holder	○	○	O-S12
Focusing	Coaxial Coarse & Fine Focusing, Coarse Focusing Travel Range: 26mm, Fine Focusing Travel Range: 2μm/Division	●	●	
Condenser	Abbe Condenser N.A.1.25, Iris Diaphragm, Rack & Pinion Up/Down, With Filter Holder	●	●	C06b
Illumination	3W-LED Illumination Systems	●	●	DPW3(Set)
	12V/20W Halogen Lamp	○	○	
	6V/30W Halogen Lamp	○	○	
Field Diaphragm	Upgrade To Kohler Illumnation	●	○	DI02a
Filter	Dia.45mm, Blue	○	○	TY70-23
	Dia.45mm, Green	○	○	TY70-25
	Dia.45mm, Yellow	○	○	TY70-24
Dark Field	Dark Field Condenser, Dry, N.A.0.83-0.91, For 4x10x40x Objective	○	○	SK-DC
Polarizing	Analyzer + Polarizer Set	○	○	SK-P
Adapter	C-Mount 0.5x, Focus Adjustable		○	B3-0.5XC
	C-Mount 0.75x, Focus Adjustable		○	B3-0.75XC
	C-Mount 1.0x, Focus Adjustable		○	B3-1XC
	Digital Eyepiece Camera Adapter, Dia. 23.2mm/25mm		○	B3-EM
Mirror	Reflecting Mirror & Holder	○	○	B-MI
Attachment	Wire Winding Device	○	○	
Package	Carton Size 550x380x290mm, 1 Unit/Ctn			
Weight	Gross Weight: 8.0 kgs, Net Weight: 7.0 kgs			

Note: "●" In Table Is Standard outfits, "○" Is Optional Accessories

50 Years' Experience!



Professional Microscope Manufacturer

Chongqing Optec Instrument Ltd., Co.

Add: No. 13-3, No. 6, Fengqi Road, Caijiagang, Beibei District, Chongqing, China.
Telephone: 0086-10-88515310 Mobile Phone: 0086-18510862857
Website: www.optec-ahsnbj.com <https://bjoptec.en.made-in-china.com/>
Email: sales@optec-ahsnbj.com

WhatsApp/Wechat/Facebook/LinkedIn: 0086-18510862857



Beijing Brand Development Headquarters

