



Pos.	Cat.-no.	Quantity	Description
1	XK 100/12	23,00	SPECIAL NEEDLES, 2,00 X 120 MM VERRES
			
2	AO 450/04	38,00	ADSON SUCTION TUBE 4MM 21.0 CM
			
3	AO 430/06	35,00	FRAZIER SUCTION TUBE CHARR 6/WL 9 CM
			
4	AO 430/09	32,00	FRAZIER SUCTION TUBE CHARR 9 / WL 9 CM
			
5	AO 430/12	24,00	FRAZIER SUCTION TUBE CHARR12/ WL 9 CM
			

Pos.	Cat.-no.	Quantity	Description
6	AO 430/15	27,00	FRAZIER SUCTION TUBE CHARR15/ WL 9 CM



7	KU 306/15	15,00	NEEDLE CASE 150 x 95 x 13 MM
---	-----------	-------	------------------------------

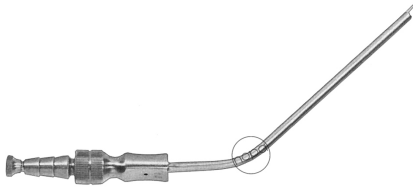
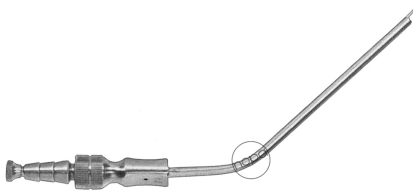
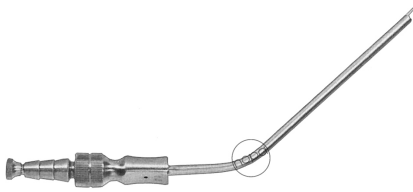
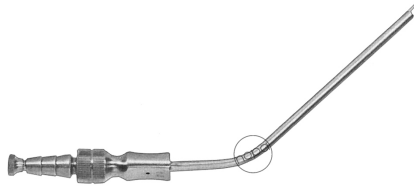
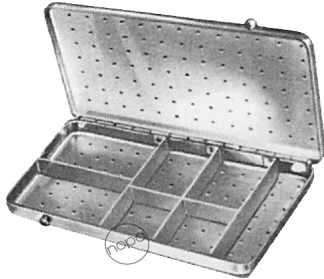

8	KM 566/16	54,00	ZAUFAL EAR HOOKLETS 16,5 CM
---	-----------	-------	-----------------------------

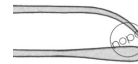



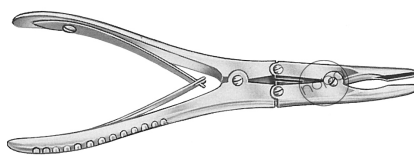

9	KA 825/01	16,00	BÖHLER BONE RONGEURS STRAIGHT, 15,0 CM
---	-----------	-------	--

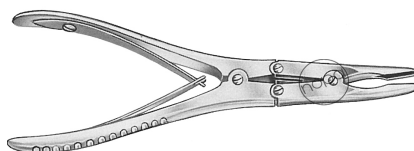

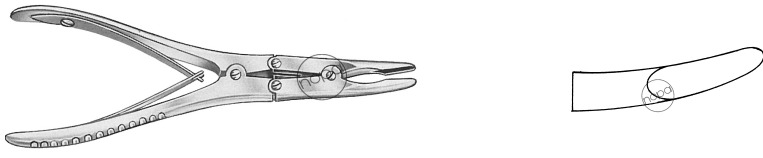
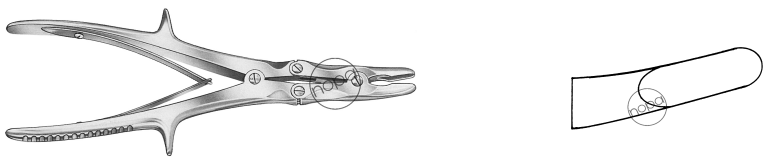

10	KA 825/02	16,00	BÖHLER BONE RONGEURS CURVED, 15,0 CM
----	-----------	-------	--------------------------------------

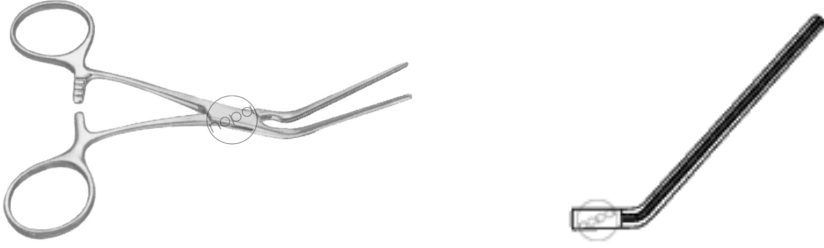
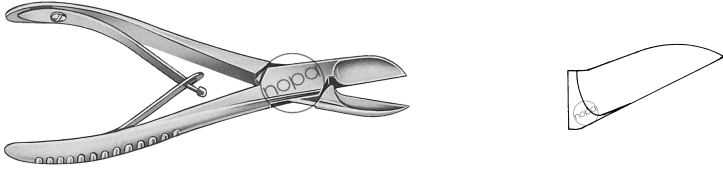
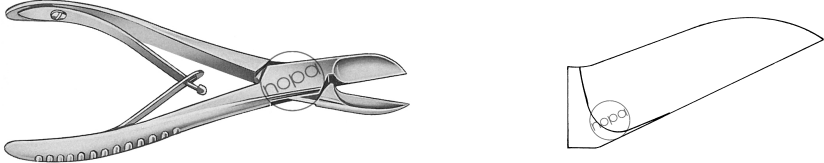
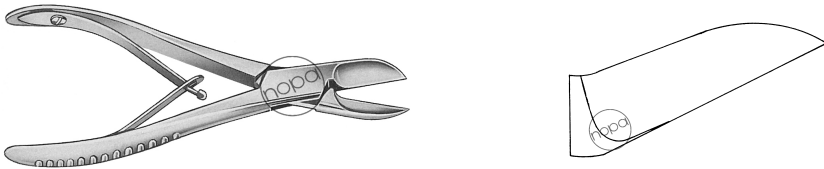
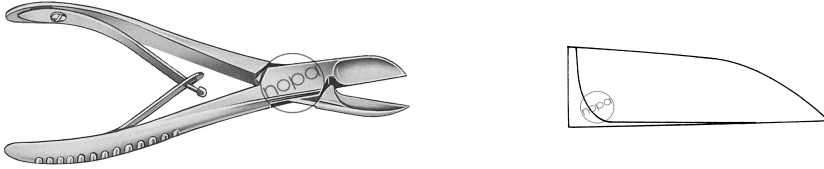

Pos.	Cat.-no.	Quantity	Description
11	KA 825/03	16,00	BÖHLER BONE RONGEURS CURVED, 15,0 CM
			
12	KA 841/23	19,00	STILLE-RUSKIN BONE RONGEURS 23,0 CM
			
13	KO 221/12	5,00	TAKAHASHI NAS.CUTT.FCPS. UP 4x10 MM
			
14	KK 585/16	2,00	COOLEY ATRAUMA FORCEPS 16,0 CM
			
15	KK 491/31	2,00	DE BAKEY ATRAUMA FORCEPS 31,0CM
			

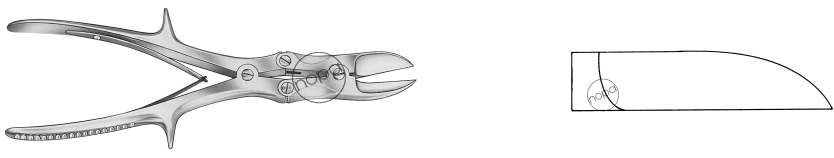
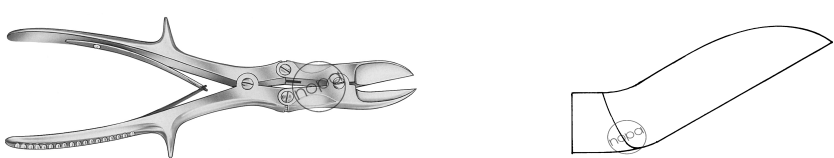
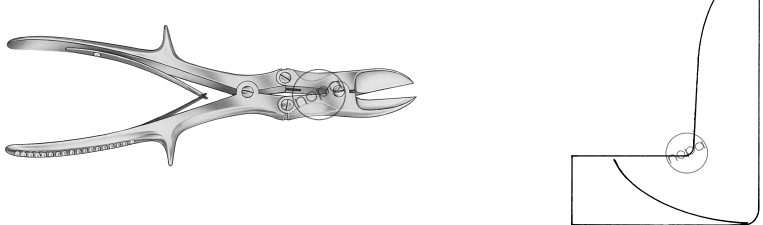
Pos.	Cat.-no.	Quantity	Description
16	KK 639/13	2,00	DE BAKEY ATRAUMA FORCEPS 13CM
			
17	KA 881/17	16,00	LISTON BONE CUTTING FORCEPS CVD.17,0 CM
			
18	KA 881/19	22,00	LISTON BONE CUTTING FORCEPS CVD.19,0 CM
			
19	KA 881/22	33,00	LISTON BONE CUTTING FORCEPS CVD.22,0 CM
			
20	KA 880/19	25,00	LISTON BONE CUTTING FORCEPS STR.19,0 CM
			

Pos.	Cat.-no.	Quantity	Description
21	KA 890/00	12,00	STILLE-LISTON BONE CUTT.FCPS STR 27,0CM
			
22	KA 890/30	12,00	STILLE-LISTON BONE CUTT.FCPS CVD 27,0CM
			
23	KA 890/90	12,00	STILLE-LISTON CUTTING FCPS.27,0 CM
			
24	KA 273/22	46,00	WIRE FORCEPS 22,0 CM TUC
			
25	AD 325/12	15,00	LANGENBECK AMPUTATING KNIFE BLADE 12.0CM
			

Pos.	Cat.-no.	Quantity	Description
26	KA 018/23	5,00	LANGENBECK SAW 23.0 CM



27	KU 302/25	320,00	KIDNEY TRAY 250 MM, 850 ML
----	-----------	--------	----------------------------

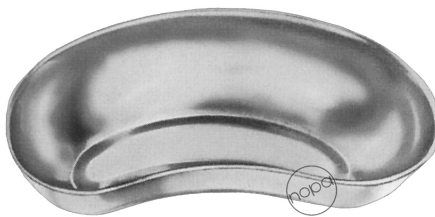

28	AK 556/20	24,00	ANDERSON-ADSON RETRACTOR SHARP 20.0 CM
----	-----------	-------	--





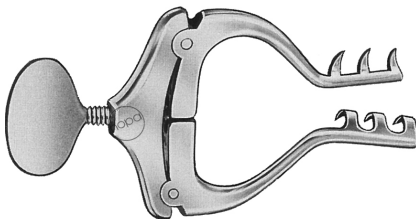





29	AK 510/10	11,00	JANSEN RETRACTOR SHARP 3X3 PRONGS 10.0CM
----	-----------	-------	--

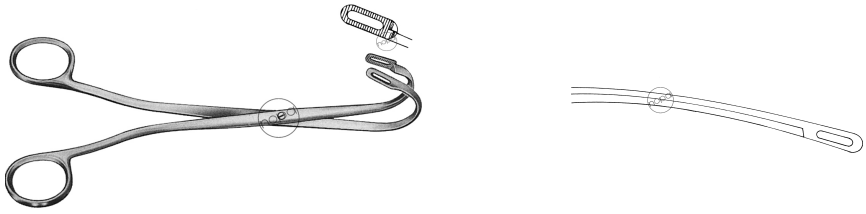



30	AK 511/10	11,00	JANSEN RETRACTOR BLUNT 3X3 PRONGS 10.0CM
----	-----------	-------	--

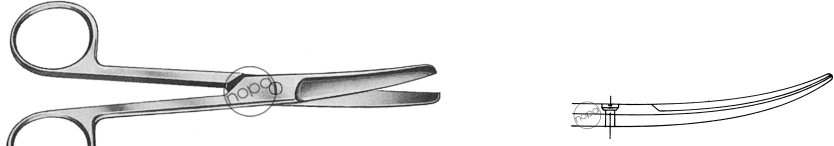
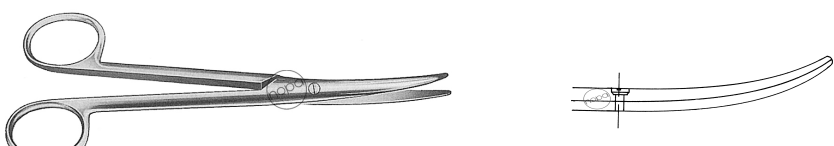





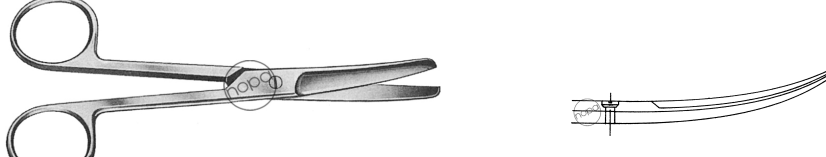
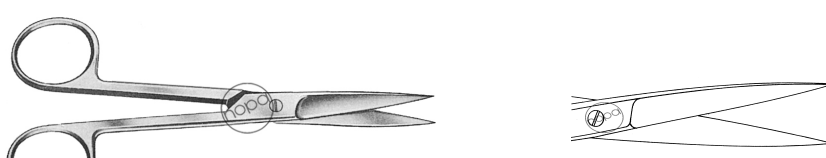

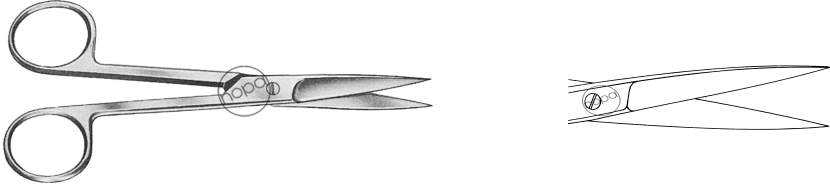
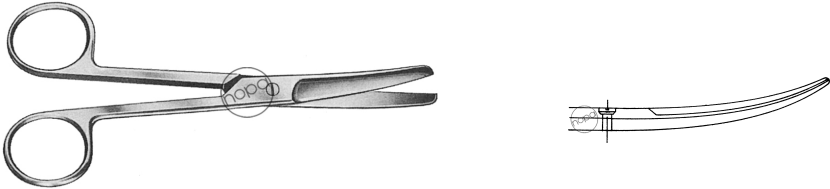
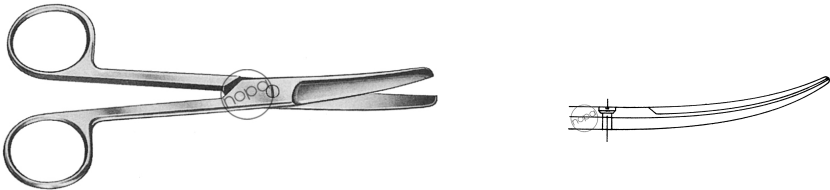
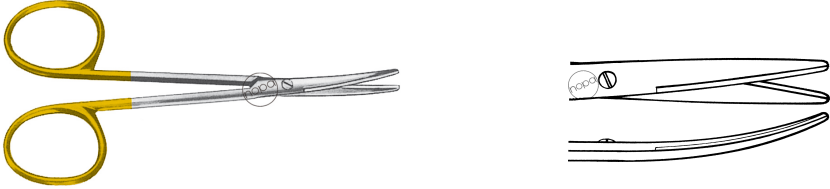
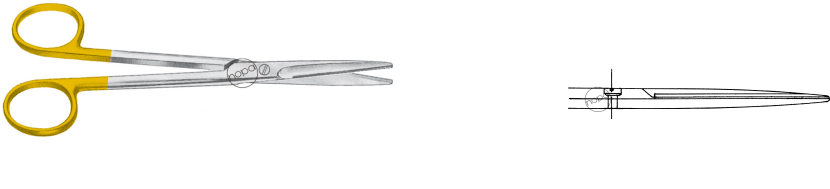



Pos.	Cat.-no.	Quantity	Description
31	XM 570/00	6,00	LIVER RETRACTOR, 10MM, 33,0CM / 13 1/4"
			
32	KS 638/04	15,00	PENFIELD DURA DISSECTORS FIG.4 20,5 CM
			
33	XK 556/03	30,00	L-HOOK ELECTRODE W/O SUCTION,5MM,32,0 CM
			
34	KC 051/01	7,00	RANDALL KIDNEY STONE FCPS FIG.1 23.0 CM
			
35	KA 769/26	20,00	FARABEU-F-LAMBOTTE BONE HOLD.FCP 11MM,26C
			





Pos.	Cat.-no.	Quantity	Description
36	AC 302/18	29,00	BOETTCHER TONSIL SCISSORS CVD 18.0 CM
			
37	AC 085/18	177,00	DOYEN ABDOMINAL SCISSORS CURVED 17,5 CM
			
38	AC 011/16	285,00	STANDARD OPER.SCS. CVD.BL/BL 16.5 CM
			
39	AC 073/17	224,00	MAYO-STILLE OPER.SCS CVD BL/BL 17.0 CM
			
40	AC 111/18	158,00	METZENBAUM-NELSON SCS CVD BL/BL 18.0 CM
			



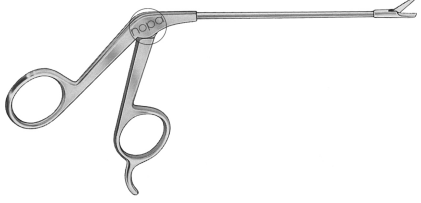
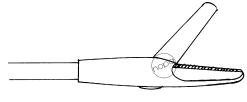

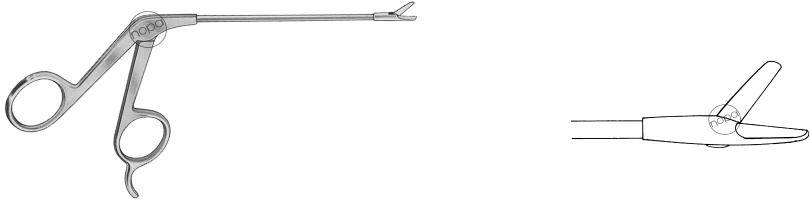
Pos.	Cat.-no.	Quantity	Description
41	AC 111/25	101,00	METZENBAUM-NELSON SCS CVD BL/BL 25.0 CM
			
42	AC 111/30	69,00	METZENBAUM-NELSON SCS CVD BL/BL 30.0 CM
			
43	AC 031/16	173,00	STANDARD OPER.SCS. CVD.SH/SH 16.5 CM
			
44	AC 011/15	327,00	STANDARD OPER.SCS. CVD.BL/BL 15.5 CM
			
45	AC 030/15	250,00	STANDARD OPER.SCS. STR.SH/SH 15.5 CM
			

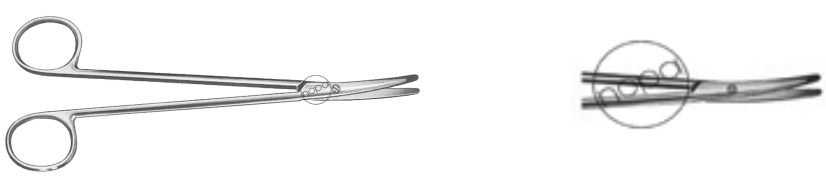
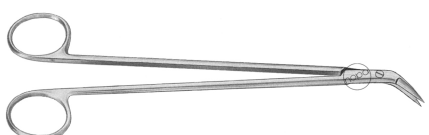

Pos.	Cat.-no.	Quantity	Description
46	AC 030/13	195,00	STANDARD OPER.SCS. STR.SH/SH 13.0 CM
			
47	AC 011/17	253,00	STANDARD OPER.SCS. CVD BL/BL 17.5 CM
			
48	AC 011/13	138,00	STANDARD OPER.SCS. CVD.BL/BL 13.0 CM
			
49	AC 931/14	36,00	METZENBAUM SCS TUC CVD BL/BL 14.5 CM
			
50	AC 910/14	91,00	MAYO DISS.SCS TUC STR BL/BL 14.5 CM
			

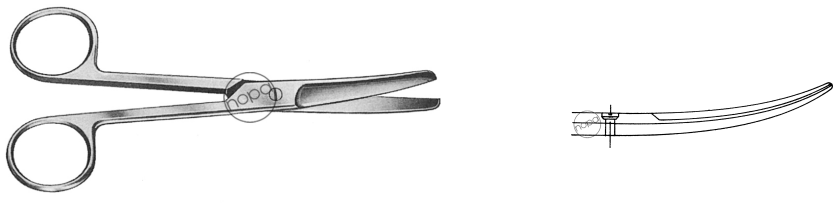
Pos.	Cat.-no.	Quantity	Description
51	AC 911/14	91,00	MAYO DISS.SCS TUC CVD BL/BL 14.5 CM
			
52	AC 911/17	82,00	MAYO DISS.SCS TUC CVD BL/BL 17.0 CM
			
53	AC 971/28	26,00	METZENBAUM-DELICATE SCS TUC CVD BL28.0CM
			
54	AC 210/18	31,00	KILNER PLASTIC SURGERY SCS CVD 18.0 CM
			
55	KL 438/80	3,00	MICRO-SCISS. STR., IRRIGATION CHANNEL,
			

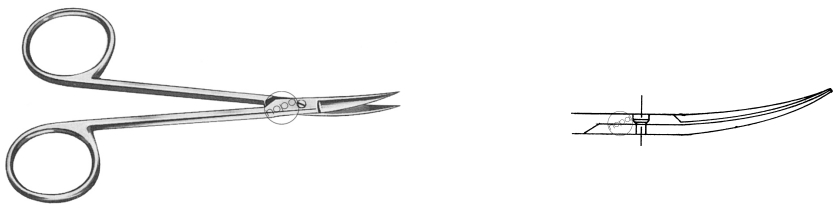
Pos.	Cat.-no.	Quantity	Description
56	KL 439/80	3,00	MICRO-SCISS., STR., IRRIGATION CHANNEL,
			
57	KL 438/81	9,00	MICRO-SCISS., CVD.UP,IRRIGATION CHANNEL,
			
58	KL 439/81	9,00	MICRO-SCISS.,CVD. UP,IRRIGATION CHANNEL,
			
59	XM 1153/45K	32,00	ENDO-SCISSORS, CURVED, 450MM
 			
60	KO 180/11	4,00	SINUSCOPY SCISSORS SERRATED 12CM
 			

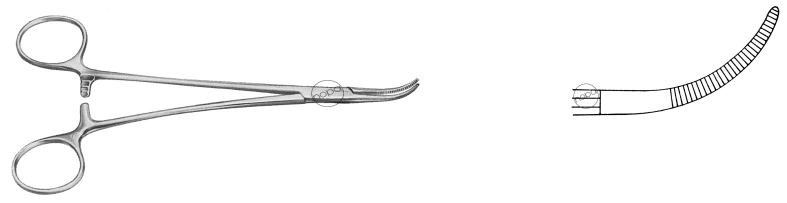
Pos.	Cat.-no.	Quantity	Description
61	KO 180/01	4,00	SINUSCOPY SCISSOR SMOOTH 12CM STRAIGHT
			
62	AC 315/16	17,00	COTTLE NASAL SCISSORS BLUNT 16.0 CM
			
63	AC 111/25	87,00	METZENBAUM-NELSON SCS CVD BL/BL 25.0 CM
			
64	AC 237/21	13,00	POTTS-DE MARTEL ART.SCS ANGLED 21.0 CM
			
65	AC 219/60	20,00	POTTS-SMITH ART.SCS 60 DEGREE 19.0 CM
			

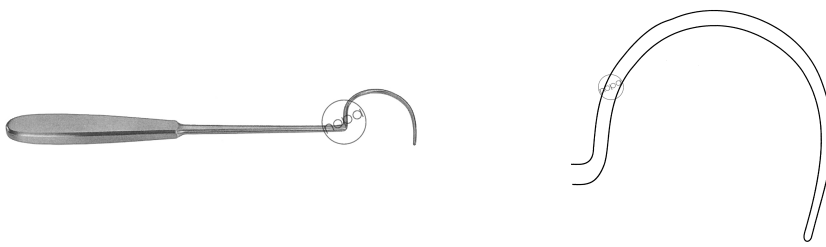
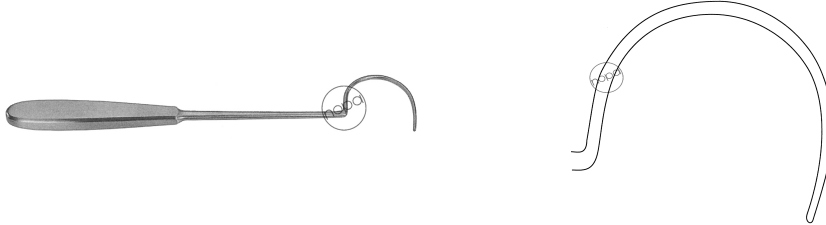
Pos.	Cat.-no.	Quantity	Description
66	AC 0111/14	102,00	STANDARD OPER.SCS. CVD.BL/BL 14.5 CM
			
67	AC 223/03	10,00	HEGEMANN-DIETRICH VASC.SCS 60DEG17.5C
			
68	AC 451/10	13,00	IRIS SCISSORS CVD SH/SH 10.5 CM
			
69	AC 451/11 SC	13,00	IRIS SCISSOR CVD. SH/SH 11,5 CM SC
			
70	AA 348/18	28,00	BABY-MIXTER ART.FCPS CVD 18.0 CM
			

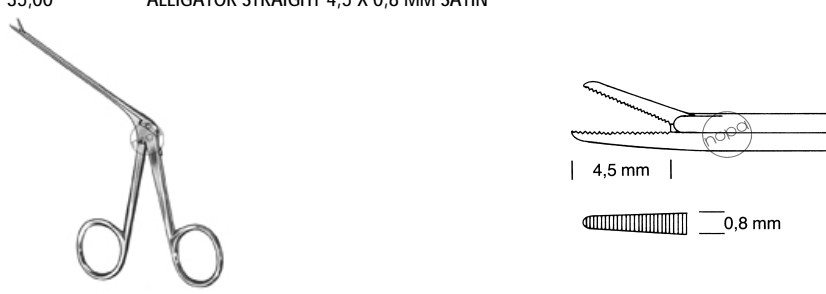
Pos.	Cat.-no.	Quantity	Description
71	KA 281/03	4,00	DEMEL BONE WIRE GUIDES
			
72	KA 281/02	4,00	DEMEL BONE WIRE GUIDES
			
73	XM 516/01	9,00	KNOT GUIDE
			
74	XM 516/04	9,00	KNOT PUSHER, 330MM
			
75	KM 300/08	35,00	ALLIGATOR STRAIGHT 4,5 X 0,8 MM SATIN
			

Pos.	Cat.-no.	Quantity	Description
76	AD 010/03	421,00	SCALPEL HANDLE NO.3



77	AD 010/04	392,00	SCALPEL HANDLE NO.4
----	-----------	--------	---------------------



78	KA 461/15	13,00	STILLE OSTEOTOMES 15X200 MM
----	-----------	-------	-----------------------------

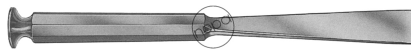



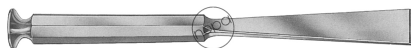



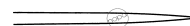

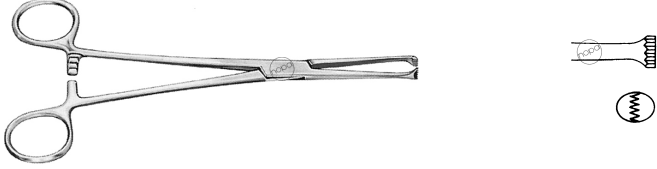

79	KA 460/15	12,00	STILLE CHISEL 15 MM 20.0 CM
----	-----------	-------	-----------------------------











80	KA 456/32	13,00	HIBBS OSTEOTOME 32MM 24,0CM
----	-----------	-------	-----------------------------

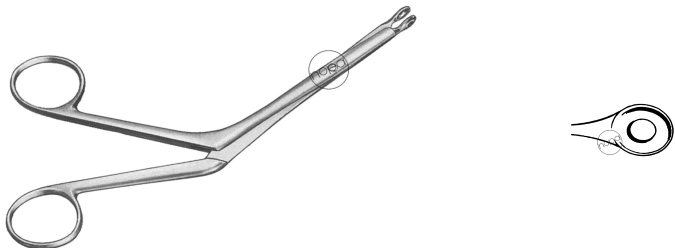





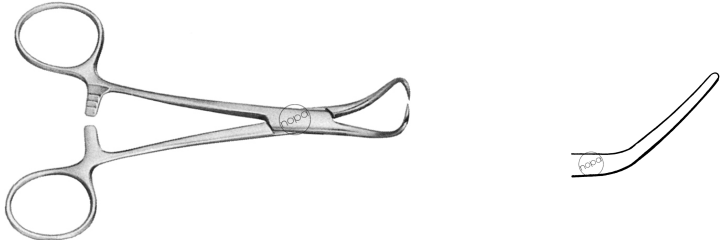

Pos.	Cat.-no.	Quantity	Description
81	KA 457/32	3,00	HIBBS OSTEOTOME 32MM 24,0CM
			
82	KA 455/32	3,00	HIBBS CHISELS 32MM 24,0CM
			
83	KD 055/19	78,00	ALLIS TISSUE FCPS 5X6T 19.0CM
			
84	KD 054/15	28,00	ALLIS TISSUE FCPS 4X5T 15.0CM
			
85	XR 880/25	89,00	DRESSING FORCEPS, MONOPOLAR 25,0 CM,
			



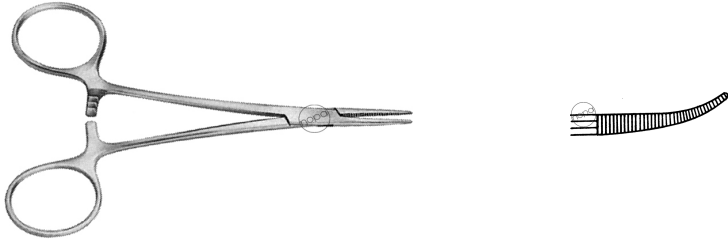
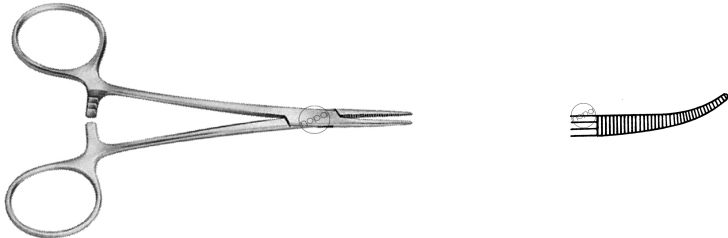

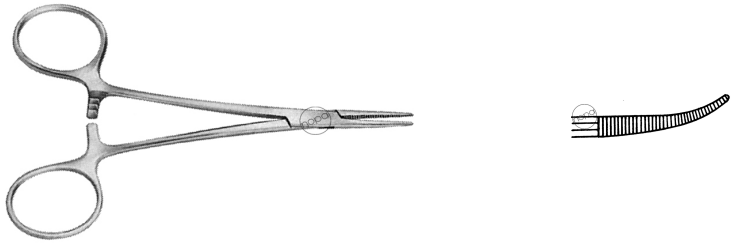
Pos.	Cat.-no.	Quantity	Description
86	XR 880/25	31,00	DRESSING FORCEPS, MONOPOLAR 25,0 CM,
			
87	AB 050/20	1283,00	STANDARD DRESSING FORCEPS STR 20.0 CM
			
88	AB 050/25	446,00	STANDARD DRESSING FORCEPS STR 25.0 CM
			
89	AB 862/20	100,00	DE BAKEY ATRAUMA FCPS STR 2.0MM 20.0 CM
			
90	KM 226/08	83,00	HARTMANN POLYPUS FORCEPS SHAFT 8.5 CM
			



Pos.	Cat.-no.	Quantity	Description
91	KM 220/08	46,00	HARTMANN-WULLSTEIN POLYPUS FCPS 8.5 CM
			
92	KM 222/08	46,00	HARTMANN-WULLSTEIN CUPPED FCPS.8.5 CM
			
93	KO 235/02	9,00	BRUENINGS SEPTUM FCPS FIG. 2
			
94	KO 236/02	9,00	LUC SEPTUM FCPS
			
95	AB 060/14	551,00	STANDARD TISSUE FCPS. 1X2 T STR 14,5 CM
			

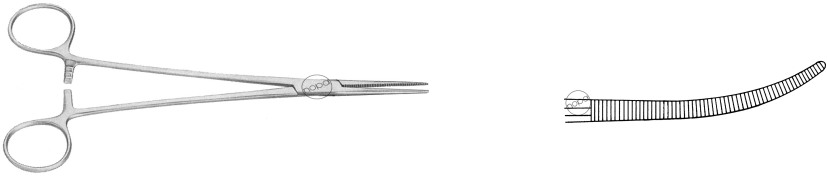

Pos.	Cat.-no.	Quantity	Description
96	AB 060/16	732,00	STANDARD TISSUE FCPS. 1X2 T STR 16.0 CM
			
97	AA 609/20	361,00	MIKULICZ PERIT.CLAMP-FCPS 1X2 T. 20.0 CM
			
98	AA 210/20	96,00	OCHSNER-KOCHER FCPS.STR 20.0 CM
			
99	AA 200/20	127,00	ROCHESTER-PEAN ARTERY FCPS STR 20.0 CM
			
100	AA 751/15	216,00	BACKHAUS TOWEL FORCEPS 15,0 CM
			



Pos.	Cat.-no.	Quantity	Description
101	AB 862/16	23,00	DE BAKEY ATRAUMA FCPS STR 2.0MM 16.0 CM
			
102	XM 1261/33KS	8,00	BABCOCK GRASPING FORCEPS, 330MM
			
103	XM 1262/33KS	8,00	BABCOCK GRASPING FORCEPS, 330MM
			
104	AA 151/14	185,00	HALSTED-MOSQUITO ART.FCPS CVD 14,0 CM
			
105	AA 151/12	450,00	HALSTED-MOSQUITO FCPS CVD 12,5 CM
			

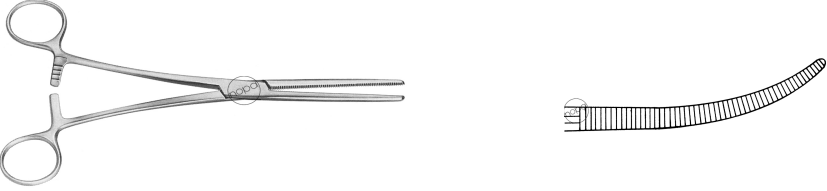
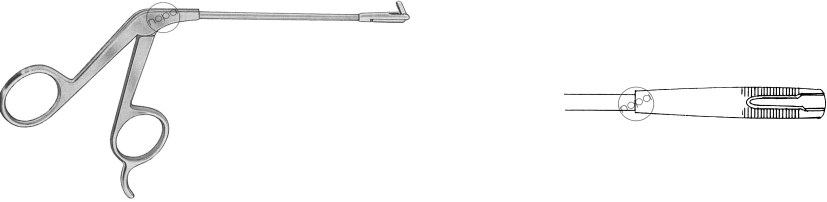
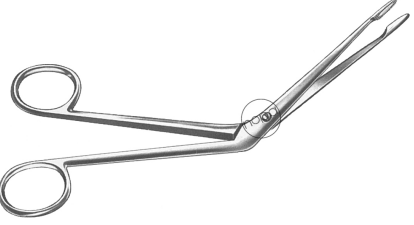



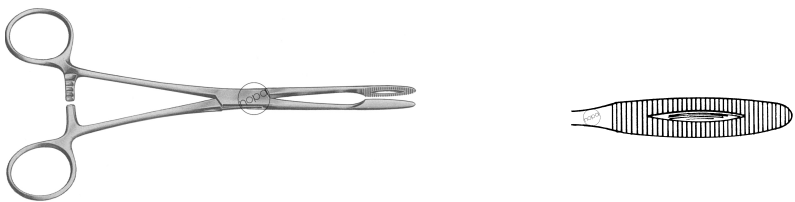
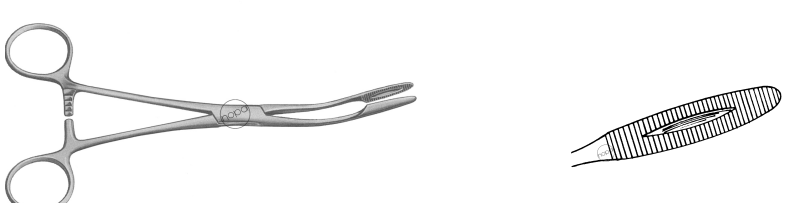
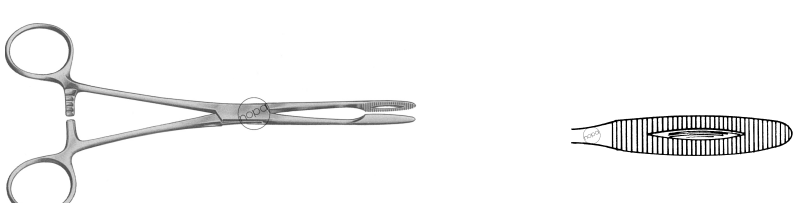

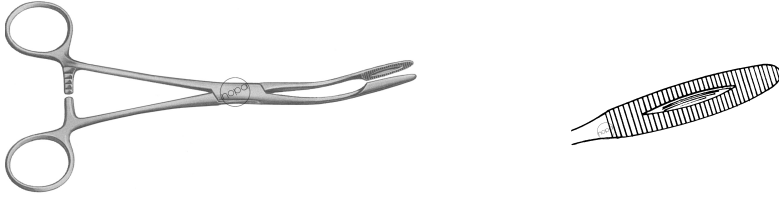
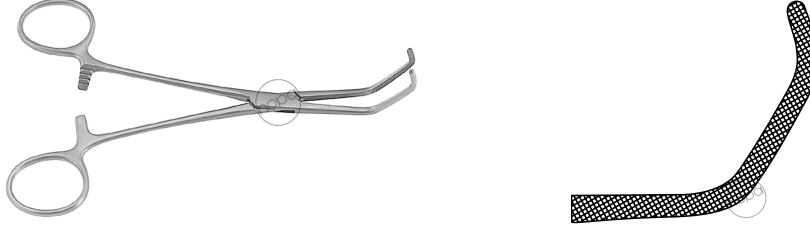
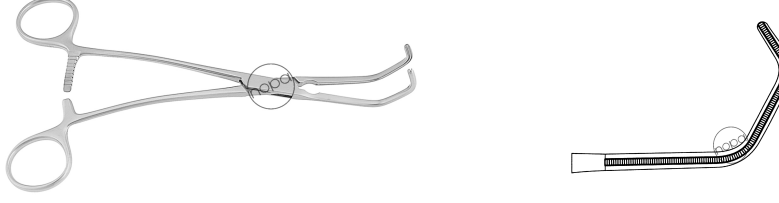

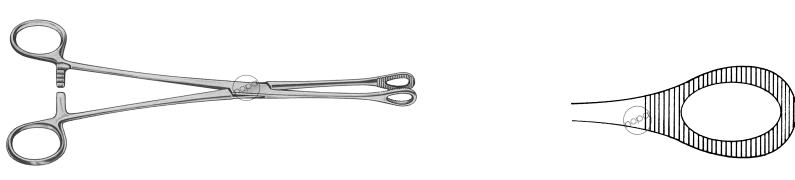
Pos.	Cat.-no.	Quantity	Description
106	AA 151/14	425,00	HALSTED-MOSQUITO ART.FCPS CVD 14,0 CM
			
107	AA 217/16	362,00	KOCHER-DELICATE ART.FCPS.CVD 1X2T 16 CM
			
108	AA 182/14	135,00	CRILE ARTERY FORCEPS STR 1X2 T. 14.0 CM
			
109	AA 330/24	97,00	CRAFOORD ARTERY FORCEPS CVD 24.0 CM
			
110	AA 185/16	143,00	CRILE-RANKIN FORCEPS CVD 16.0 CM
			



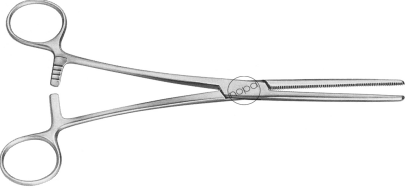

Pos.	Cat.-no.	Quantity	Description
111	AA 320/02	253,00	HEISS FORCEPS SLIGHTLY CVD 20.0CM
			
112	AA 211/16	114,00	OCHSNER-KOCHER ART.FCPS.CVD 16.0 CM
			
113	AA 211/20	215,00	OCHSNER-KOCHER FCPS.CVD 20.0 CM
			
114	AA 210/20	215,00	OCHSNER-KOCHER FCPS.STR 20.0 CM
			
115	AA 211/22	12,00	OCHSNER-KOCHER FCPS.CVD 22.0 CM
			

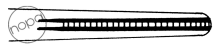
Pos.	Cat.-no.	Quantity	Description
116	AA 211/24	173,00	OCHSNER-KOCHER FCPS.CVD 24.0 CM
			
117	AA 215/14	135,00	PEAN-DELICATE FCPS.CVD 14.0 CM
			
118	AA 201/16	125,00	ROCHESTER-PEAN FCPS CVD 16.0 CM
			
119	KO 175/02	1,00	SINUSCOPY FORCEPS 2,0X6,0MM UPWARDS
			
120	KO 150/16	82,00	HARTMANN NASAL POLYPUS FORCEPS 16,0 CM
			



Pos.	Cat.-no.	Quantity	Description
121	AA 215/16	140,00	PEAN-DELICATE ART.FCPS.CVD 16.0 CM
			
122	AF 101/25	102,00	GROSS-MAIER DRESSING FCPS CURVED 25,0 CM
			
123	AF 100/25	205,00	GROSS-MAIER DRESSING FCPS STR 25,0 CM
			
124	AF 101/22	92,00	GROSS-MAIER DRESSING FCPS CURVED 22,0 CM
			
125	AF 100/20	82,00	GROSS-MAIER DRESSING FCPS STR 20,0 CM
			

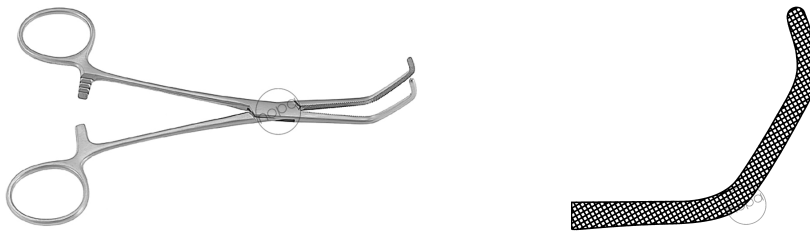



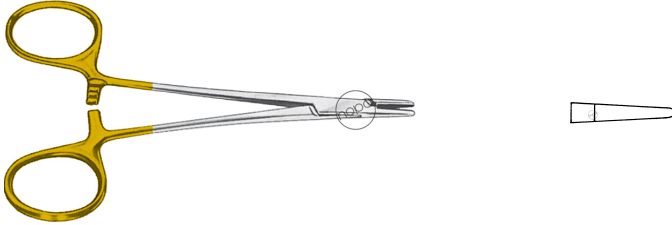
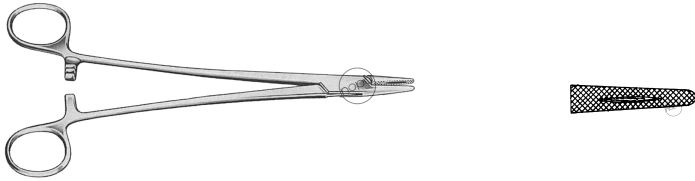
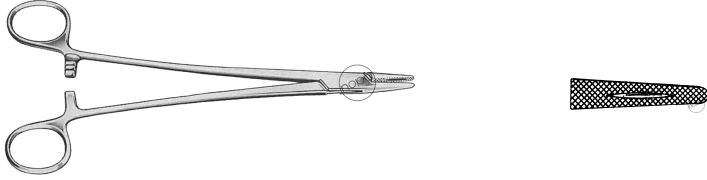
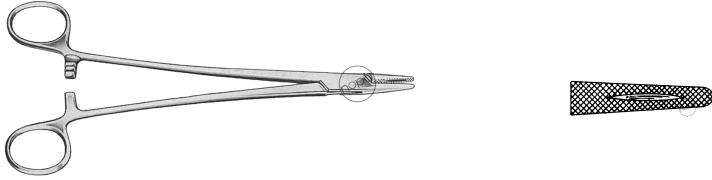
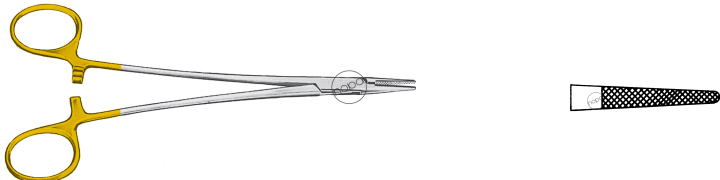

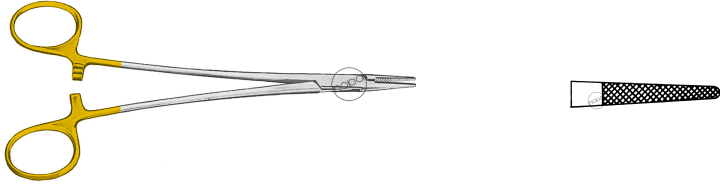
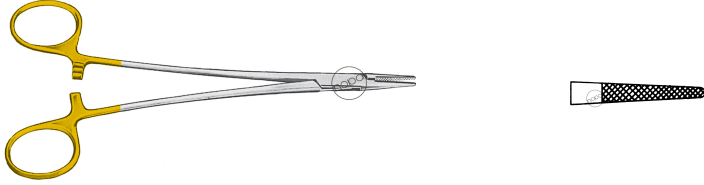
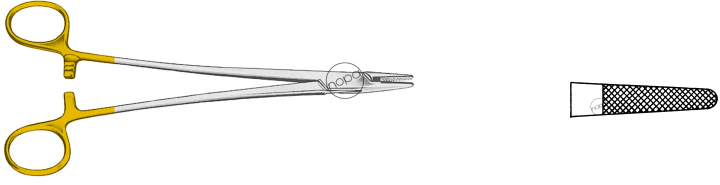



Pos.	Cat.-no.	Quantity	Description
126	AF 101/27	84,00	GROSS-MAIER DRESSING FCPS CURVED 27,0 CM
			
127	KK 708/15	5,00	BABY-SATINSKY VENA CAVA FCPS.
			
128	KK 493/20	7,00	SATINSKY FORCEPS 20,5 CM
			
129	AB 690/20	33,00	GRUENWALD NASAL TAMPON FORCEPS 20,0 CM
			
130	AF 200/25	86,00	FOERSTER-BALLENGER STR SERRATED 25CM
			

Pos.	Cat.-no.	Quantity	Description
131	XM 1219/33KS	69,00	MARYLAND DISSECT.& GRASP. FORCEPS, 330MM
 			
132	XM 1219/45KS	69,00	MARYLAND DISSECT.& GRASP. FORCEPS, 450MM
 			
133	AA 201/26	60,00	ROCHESTER-PEAN ARTERY FCPS CVD 26.0 CM
 			
134	AB 866/20	16,00	DE BAKEY ATRAUMA FCPS STR 3.5 MM 20.0 CM
 			
135	AB 866/24	12,00	DE BAKEY ATRAUMA FCPS STR 3.5 MM 24.0 CM
 			

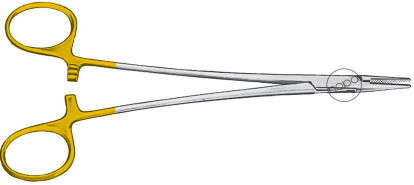
Pos.	Cat.-no.	Quantity	Description
136	AB 860/16	7,00	DE BAKEY ATRAUMA FCPS.STR. 1,5 MM 16.0CM
			
137	AB 860/20 T	12,00	DE BAKEY ATRAUMA FCPS STR 1.5 MM 20.0 CM
138	AB 860/20	20,00	DE BAKEY ATRAUMA FCPS STR 1.5 MM 20.0 CM
			
139	KK 708/15	6,00	BABY-SATINSKY VENA CAVA FCPS.
			
140	KO 200/02	4,00	WEIL-BLAKESLEY NAS.CUTT.FCPS W/O NECK F2
			
141	KO 200/03	14,00	WEIL-BLAKESLEY NAS.CUTT.FCPS W/O NECK F3
			

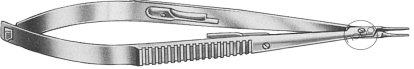
Pos.	Cat.-no.	Quantity	Description
142	AE 464/13	27,00	HALSEY NEEDLE HOLDER TUC SMOOTH 13.0CM
			
143	AE 100/16	64,00	MAYO-HEGAR NEEDLE HOLDER 16.0 CM
			
144	AE 100/18	83,00	MAYO-HEGAR NEEDLE HOLDER 18.0 CM
			
145	AE 100/20	66,00	MAYO-HEGAR NEEDLE HOLDER 20.0 CM
			
146	AE 420/31	13,00	DE BAKEY NEEDLE HOLDER TUC 31.0 CM
			

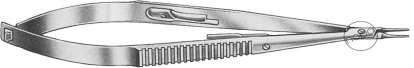
Pos.	Cat.-no.	Quantity	Description
147	AE 420/26	72,00	DE BAKEY NEEDLE HOLDER TUC 26.0 CM
			
148	AE 420/18	31,00	DE BAKEY NEEDLE HOLDER TUC 18.0 CM
			
149	AE 400/24	13,00	MAYO-HEGAR NEEDLE HOLDER TUC 24.0 CM
			
150	XM 1412/33	16,00	NEEDLE HOLDER TC, 330MM
			
151	XM 1422/33	16,00	NEEDLE HOLDER TC, 330MM
			

Pos.	Cat.-no.	Quantity	Description
152	XM 1410/33	5,00	NEEDLE HOLDER TC, 330MM
			 
153	XM 1420/33	5,00	NEEDLE HOLDER TC, 330MM
			 
154	AE 420/20	307,00	DE BAKEY NEEDLE HOLDER TUC 20.0 CM
			 
155	AE 663/14	5,00	CASTROVIEJO NH CVD RA SERRATED 14.0 CM
			 
156	AE 662/14	1,00	CASTROVIEJO NH STR RA SERRATED 14.0 CM
			 

Pos.	Cat.-no.	Quantity	Description
157	AE 578/18	10,00	MICRO-NH TUC STR RA SERRATED 18.0 CM

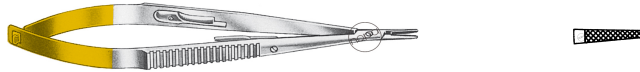

158	AE 580/02	6,00	JACOBSON MICRO-NH TUC RA SERRATED 21.0CM
-----	-----------	------	--



159	KA 715/30	5,00	PUTTI RASP 30,0CM
-----	-----------	------	-------------------



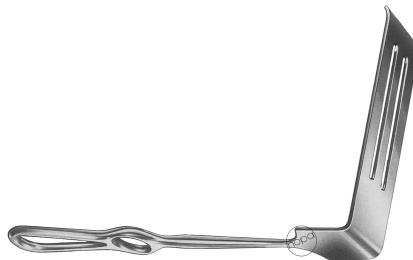

160	AK 330/25	2,00	SAUERBRUCH RETRACTOR 130X38 MM 25.0 CM
-----	-----------	------	--





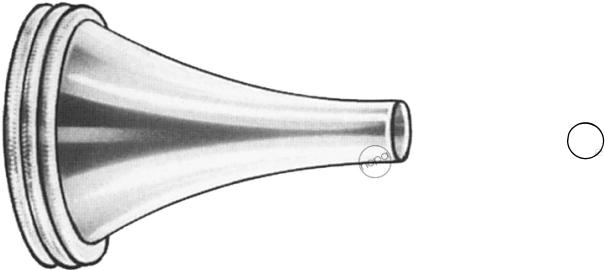
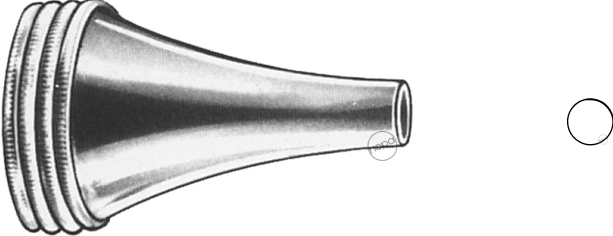
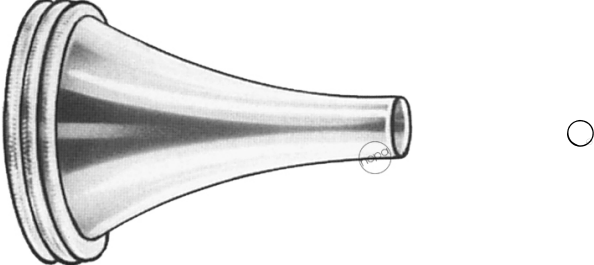
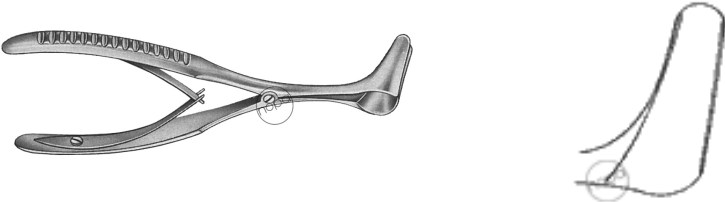
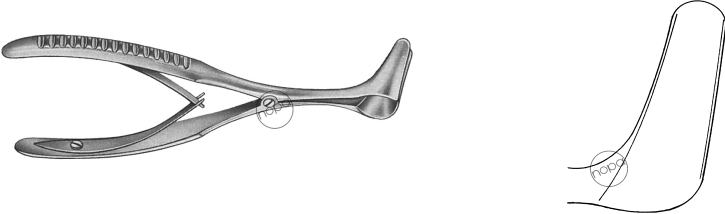

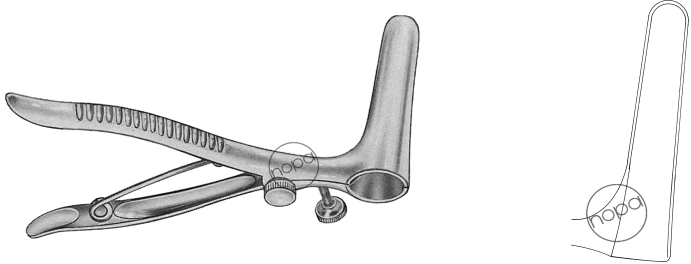
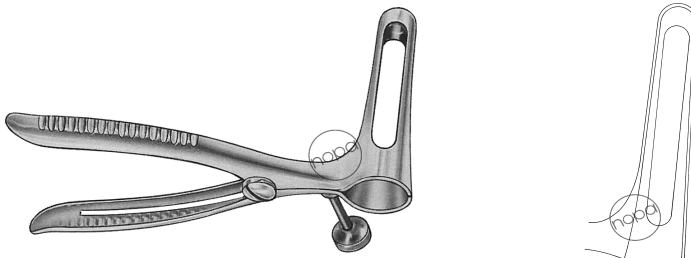
161	AO 870/15	123,00	JANET SYRINGE 150 ML
-----	-----------	--------	----------------------

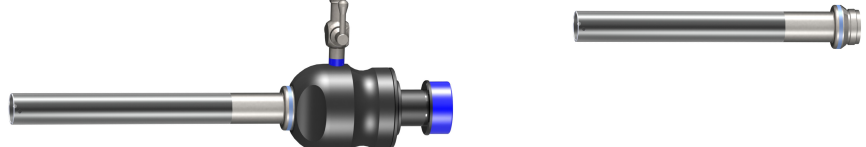

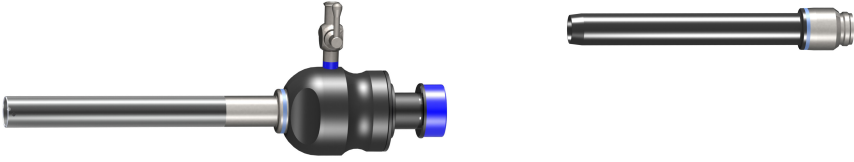
Pos.	Cat.-no.	Quantity	Description
162	KM 031/02	403,00	HARTMANN EAR SPECULA FIG.2 5 MM
			
163	KM 031/03	353,00	HARTMANN EAR SPECULA FIG.3 6,5 MM
			
164	KM 031/01	342,00	HARTMANN EAR SPECULA FIG.1 3,5 MM
			
165	KO 050/02	325,00	HARTMANN-HALLE NASAL SPEC. 15.0 CM FIG.2
			
166	KO 050/03	335,00	HARTMANN-HALLE NASAL SPEC. 15.0 CM FIG.3
			

Pos.	Cat.-no.	Quantity	Description
167	KD 622/15	59,00	SIMS RECTAL SPECULA FULL BLADES 15,0 CM
			
168	KD 624/15	18,00	SIMS RECTAL SPECULA FENESTRATED 15,0 CM
			
169	XK 607/03	31,00	TROCAR SLEEVE, 150MM, BARIATRIC
			
170	XK 621/11	43,00	TROCAR BARIATRIC
			
171	XK 605/03	20,00	TROCAR SLEEVE, 105MM
			

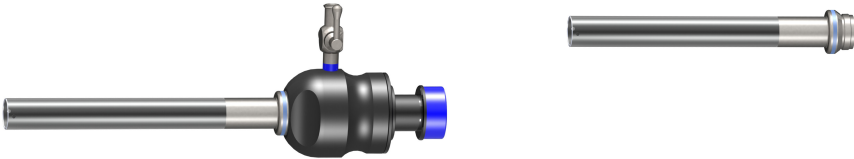
Pos.	Cat.-no.	Quantity	Description
172	XK 605/23	20,00	TROCAR SLEEVE, 97MM
			
173	XK 761/11	25,00	TROCAR, POINTED, 11,0MM
			
174	XK 607/02	30,00	TROCAR SLEEVE, 150MM, BARIATRIC
			
175	XK 621/06	36,00	TROCAR BARIATRIC
			
176	XK 605/02	15,00	TROCAR SLEEVE, 103MM
			

Pos.	Cat.-no.	Quantity	Description
177	XK 605/22	15,00	TROCAR SLEEVE, 95MM

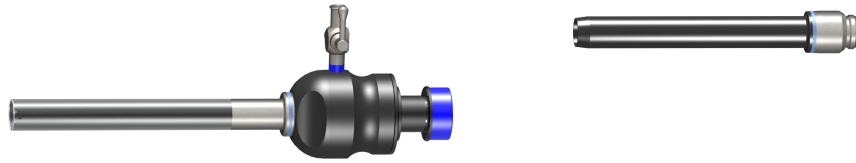

178	XK 761/06	20,00	TROCAR, POINTED, 5,5 MM
179	XK 662/10	30,00	SUCTION/IRRIGATION TUBE, 10MM



180	XK 662/01	30,00	HANDLE WITH 2 TRUMPET VALVES, 10MM
-----	-----------	-------	------------------------------------

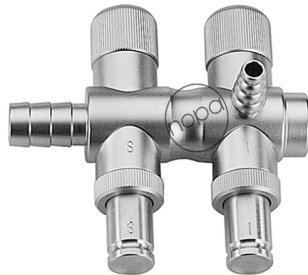

181	XK 660/11	36,00	ROUND HOLE SUCTION TUBE
-----	-----------	-------	-------------------------



182	XK 660/09	36,00	SUCTION IRRIGATION HANDLE
-----	-----------	-------	---------------------------



Pos.	Cat.-no.	Quantity	Description
183	XK 657/11	14,00	NEEDLE Ø1,5MM

184	XK 657/50	14,00	TWO-WAY STOPCOCK
-----	-----------	-------	------------------

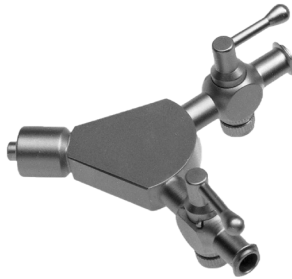

185	AL 180/00	21,00	NABATOFF VARICOSE VEIN PROBE SET COMPL.
-----	-----------	-------	---

