

DECLARATION OF CONFORMITY

Section No	TD-06/5.2-1-En
Rev Date	29.12.2021
Rev. No	01
Page No	1/1

Company Name : Su Biyomedikal Sistemler ve Sağlık Hizmetleri San. ve Tic. A.Ş.
 Address : Orhangazi mah. 1673. Sok No:20 Esenyurt İstanbul
 Tel : +90 212 320 37 53
 Fax : +90 212 320 53 51
 Web : www.submed.com.tr
 E-mail : info@submed.com.tr

L.279

Product Name	Reference No	GMDN Code	Class and Rule
ANGIOGRAPHY SURGERY PACK	ASP-001-4	33961	Class 2a Rule 6

Conformity Assessment Procedure : Annex V
 Related Standards : EN ISO 13485, EN ISO 9001, EN ISO 11135, EN ISO 14971, EN 13795-1

We herewith declare on our own responsibility that the above mentioned meet the provisions of the Council Directive 93/42/EEC with amended directive 2007/47/EC for Medical Device Directive.

Notified Body : KIWA Belgelendirme Hizmetleri A.Ş.
 NB Address : İTOSB 9. Cad. No :15 Tepeören, Tuzla - İstanbul TÜRKİYE
 NB Identification Number : 1984
 EC Certificate Number : 1984-MDD-14-266
 Expiry Date : 27 May 2024

Signature, Stamp

City Date : İstanbul, 29.12.2021
 Name : Yusuf Yiğit Akkuş
 Position : General Manager

SU BİYOMEDİKAL SİSTEMLER VE
 SAĞLIK HİZMETLERİ SANAYİ VE TİCARET A.Ş.
 Orhangazi Mah. 1673 Sk. No:20 Esenyurt / İSTANBUL
 Tel: 0212 320 37 53 Faks: 0212 320 53 51
 Yenikapı V.D.: 7810897506 Tic.Sic. No: 749756-0

Ürün Grubu / Product Group

Cerrahi Setler
Surgical Sets

Ürün Adı / Product Name

Anjiyografi Cerrahi Seti
Diagnostic Interventions Pack

Referans No / Reference No

ASP-001-4

1. Ürün İçerik ve Teknik Çizimi

Product Content and Technical Drawing

L. 242

Ürün Teknik Çizimi

Product Technical Drawing

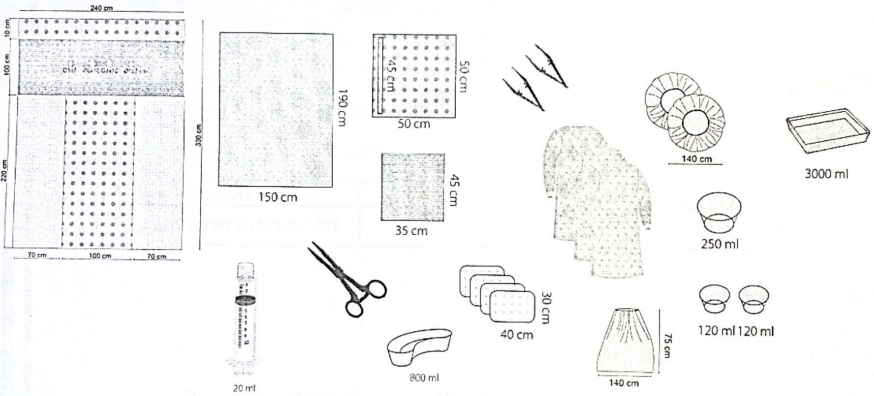

Ürün Malzeme Bilgileri

Product Material Information

1x Anjiyografi Örtüsü - Angiography Drape	240x330 cm
1x Emici Örtü - Absorbant Drape	35x45 cm 500ml/m ² liquid proof
1x Yan Bantlı Örtü - Adhesive Drape	50x50 cm
1x Alet Masa Örtüsü - Table Cover	150x190 cm
4x El Havlusu - Hand Towel	30x40 cm
3x Standart Cerrahi Önlük - Standard Surgical Gown	XL
1x Tepsi - Tray	3000 ml
1x LL, Şiringa - Syringe, LL	20 ml
2x Skopi Kılıfı - Scopy Cover	ø140 cm
1x C Skopi Kılıfı - C-Arm Scopy Cover	ø75 cm
2x Plastik Kap - Bowl	120 ml
1x Plastik Kap - Bowl	250 ml
1x Böbrek Kabı - Kidney Bowl	800 ml
1x Plastik Forseps - Plastic Forceps	15 cm
2x Plastik Cımbız - Plastic Tweezers	10 cm

DECLARATION OF CONFORMITY

Section No	TD-06/5.2-1-En
Rev Date	29.12.2021
Rev. No	01
Page No	1/1

Company Name : Su Biyomedikal Sistemler ve Sağlık Hizmetleri San. ve Tic. A.Ş.
Address : Orhangazi mah. 1673. Sok No:20 Esenyurt İstanbul
Tel : +90 212 320 37 53
Fax : +90 212 320 53 51
Web : www.submed .com.tr
E-mail : info@submed.com.tr

L.273

Product Name	Reference No	GMDN Code	Class and Rule
ANGIOGRAPHY SURGERY PACK	ASP-001-3	33961	Class 2a Rule 6

Conformity Assessment Procedure : Annex V
Related Standards : EN ISO 13485, EN ISO 9001, EN ISO 11135, EN ISO 14971, EN 13795-1

We herewith declare on our own responsibility that the above mentioned meet the provisions of the Council Directive 93/42/EEC with amended directive 2007/47/EC for Medical Device Directive.

Notified Body : KIWA Belgelendirme Hizmetleri A.Ş.
NB Address : İTOSB 9. Cad. No :15 Tepeören,Tuzla - İstanbul TÜRKİYE
NB Identification Number : 1984
EC Certificate Number : 1984-MDD-14-266
Expiry Date : 27 May 2024

Signature, Stamp

City Date : İstanbul, 29.12.2021
Name : Yusuf Yiğit Akkuş
Position : General Manager

SU BİYOMEDİKAL SİSTEMLER VE
SAĞLIK HİZMETLERİ SANAYİ VE TİCARET A.Ş.
Orhangazi Mah. 1673 Sk. No:20, Esenyurt / İSTANBUL
Tel: 0212 320 37 53 Faks: 0212 320 53 51
Yenikapı V.D.: 7810897506 Tic.Sic. No: 749756-0

DECLARATION OF CONFORMITY

Section No	TD-06/S.2-1-En
Rev Date	29.12.2021
Rev. No	01
Page No	1/1

Company Name : Su Biyomedikal Sistemler ve Sağlık Hizmetleri San. ve Tic. A.Ş.
 Address : Orhangazi mah. 1673. Sok No:20 Esenyurt İstanbul
 Tel : +90 212 320 37 53
 Fax : +90 212 320 53 51
 Web : www.submed.com.tr
 E-mail : info@submed.com.tr

Product Name	Reference No	GMDN Code	Class and Rule
CARDIOVASCULAR SURGERY PACK	CVKP-001	33961	Class 1s Rule 4
CARDIOVASCULAR SURGERY PACK	CVKP-002	33961	Class 1s Rule 4
CARDIOVASCULAR SURGERY PACK	CVKP-003	33961	Class 1s Rule 4

Conformity Assessment Procedure : Annex V
 Related Standards : EN ISO 13485, EN ISO 9001, EN ISO 11135, EN ISO 14971, EN 13795-1

We herewith declare on our own responsibility that the above mentioned meet the provisions of the Council Directive 93/42/EEC with amended directive 2007/47/EC for Medical Device Directive.

Notified Body : KIWA Belgelendirme Hizmetleri A.Ş.
 NB Address : İTOSB 9. Cad. No :15 Tepeören, Tuzla - İstanbul TÜRKİYE
 NB Identification Number : 1984
 EC Certificate Number : 1984-MDD-14-266
 Expiry Date : 27 May 2024

City Date : İstanbul, 29.12.2021
 Name : Yusuf Yiğit Akkuş

Signature, Stamp

SU BİYOMEDİKAL SİSTEMLER VE
 SAĞLIK HİZMETLERİ SANAYİ VE TİCARET A.Ş.
 Orhangazi Mah. 1673 Sok. No:20 Esenyurt / İSTANBUL
 Tel: 0212 320 37 53 Faks: 0212 320 53 51
 Yenikapı V.D.: 7810897506 Tic.Sic. No: 749756-0

Ürün Grubu / Product Group

Cerrahi Setler
Surgical Sets

Ürün Adı / Product Name

Kardiyovasküler Cerrahi Seti
Cardiovascular Surgery Pack

Referans No / Reference No

CVKP-002

Ürün İçerik ve Teknik Çizimi

Product Content and Technical Drawing

Ürün Teknik Çizimi

Product Technical Drawing

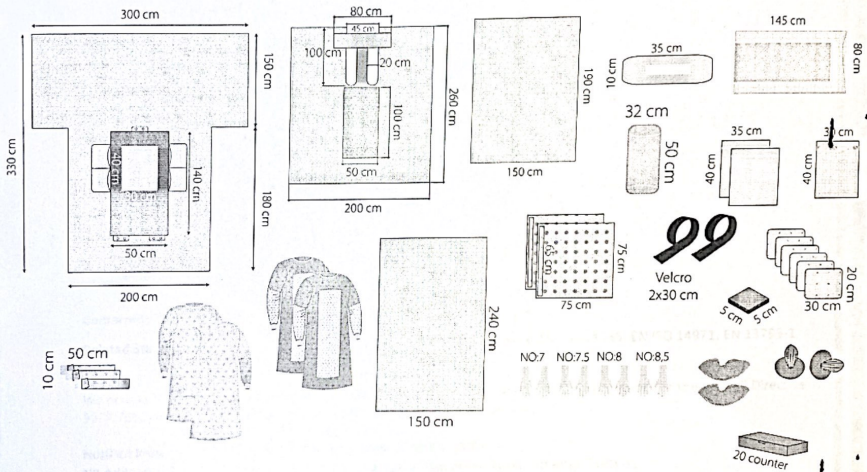

Ürün Malzeme Bilgileri

Product Material Information

1x Mayo Masa Örtüsü - Mayo Stand Cover	80x145 cm	2x Atık Torbası - Waste Bag	35x40 cm
6x El Havlusu - Hand Towel	20x30 cm	3x OP Tape	10x50 cm
1x Alet Masa Örtüsü - Table Cover	150x190 cm	2x Standart Cerrahi Önlük - Standrad Surgical Gown	XXL
1x PE Torba - Universal PE Bag	30x40 cm	2x Takviyeli Cerrahi Önlük - Reinforced Surgical Gown	XXL
1x Kol Kılıfı - Sleeve Cover	Length : 50 cm	2x Tutamaç Kılıfı - Lamp Handle Cover	
4x Pudrasız Eldiven - Powder-Free Gloves	NO :7-7,5-8-8,5	1x Needle Counter	20 needles
1x Yara Padi - Wound Pad	10x35 cm		
2x Velcro Kablo Tutucu - Velcro Cable Holder	2x30 cm		
1x Koter Zımpara - Instrument Cleaner	5x5 cm		
1x Cerrahi Kütol - Surgical Trunks	30x35 cm		
2x Yan Bantlı Örtü - Side Adhesive Drape	75x75 cm		
1x Perineal Örtü - Perineal Absorbant Drape	200x260 cm		
1x Göğüs Örtüsü - Chest Drape	200x300x330 cm		
1x Alet Masa Örtüsü - Table Cover	150x240 cm		



Cellulose

PE / Spunbond Reinforcement
(2x gsm)

Incise Film Use



Trix Spunbond / PE / Viscone
70 gsm



SMS 43 gsm

Transparent PE Film

PE / Viscone 110 gsm 3-layered
(Highly Absorbent Patch)

SMS 20 gsm

Spunbond

DECLARATION OF CONFORMITY

Section No	TD-06/5.2-1-En
Rev Date	29.12.2021
Rev. No	01
Page No	1/1

Company Name : Su Biyomedikal Sistemler ve Sağlık Hizmetleri San. ve Tic. A.Ş.
 Address : Orhangazi mah. 1673. Sok No:20 Esenyurt İstanbul
 Tel : +90 212 320 37 53
 Fax : +90 212 320 53 51
 Web : www.submed.com.tr
 E-mail : info@submed.com.tr

Product Name	Reference No	GMDN Code	Class and Rule
GENERAL SURGERY PACK	GSP-014-2	33961	Class 1s Rule 4

Conformity Assessment Procedure : Annex V
 Related Standards : EN ISO 13485, EN ISO 9001, EN ISO 11135, EN ISO 14971, EN 13795-1

We herewith declare on our own responsibility that the above mentioned meet the provisions of the Council Directive 93/42/EEC with amended directive 2007/47/EC for Medical Device Directive.

Notified Body : KIWA Belgelendirme Hizmetleri A.Ş.
 NB Address : İTOSB 9. Cad. No :15 Tepeören,Tuzla - İstanbul TÜRKİYE
 NB Identification Number : 1984
 EC Certificate Number : 1984-MDD-14-266
 Expiry Date : 27 May 2024

Signature, Stamp

City Date : İstanbul, 29.12.2021
 Name : Yusuf Yiğit Akkuş
 Position : General Manager

**SU BİYOMEDİKAL SİSTEMLER VE
 SAĞLIK HİZMETLERİ SANAYİ VE TİCARET A.Ş.**
 Orhangazi Mah. 1673 Sk. No:20.Esenyurt / İSTANBUL
 Tel: 0212 320 37 53 Faks: 0212 320 53 51
 Yenikapı V.D.: 7810897506 Tic.Sic. No: 749756-0

Ürün Grubu / Product Group

Cerrahi Setler
Surgical Sets

Ürün Adı / Product Name

Genel Cerrahi Seti
General Surgery Pack

Referans No. / Reference No.

GSP-014-2

Ürün İçerik ve Teknik Çizimi

Product Content and Technical Drawing

Ürün Teknik Çizimi

Product Technical Drawing

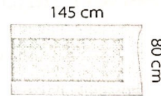
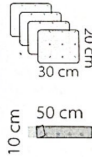
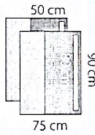
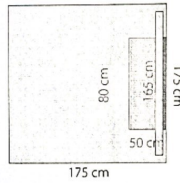
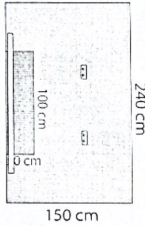

Ürün Malzeme Bilgileri

Product Material Information

1x Mayo Masa Örtüsü - Mayo Stand Cover	80x145 cm
2x Takviyeli Yan Bantlı Örtü - Reinforced Side Adhesive Drape	90x75 cm
4x El Havlusu - Hand Towel	20x30 cm
1x OP Tape	10x50 cm
1x Takviyeli Yan Bantlı Örtü - Reinforced Side Adhesive Drape	175x175 cm
1x Takviyeli Anestezi Örtüsü - Reinforced Anesthesia Drape	150x240 cm



Cellulose



Adhesive

Hydrophilic Spunbond
40 gsm

Transparent PE Film



SMS 43 gsm

PL / Wiscons 110 gsm 2-layered
(Highly Absorbent Patch)

Spunbond

DECLARATION OF CONFORMITY

Section No	TD-06/5.2-1-En
Rev Date	29.12.2021
Rev. No	01
Page No	1/1

Company Name : Su Biyomedikal Sistemler ve Sağlık Hizmetleri San. ve Tic. A.Ş.
Address : Orhangazi mah. 1673. Sok No:20 Esenyurt İstanbul
Tel : +90 212 320 37 53
Fax : +90 212 320 53 51
Web : www.submed.com.tr
E-mail : info@submed.com.tr

Product Name	Reference No	GMDN Code	Class and Rule
GENERAL SURGERY PACK	GSP-014-3	33961	Class 1s Rule 4

Conformity Assessment Procedure : Annex V
Related Standards : EN ISO 13485, EN ISO 9001, EN ISO 11135, EN ISO 14971, EN 13795-1

We herewith declare on our own responsibility that the above mentioned meet the provisions of the Council Directive 93/42/EEC with amended directive 2007/47/EC for Medical Device Directive.

Notified Body : KIWA Belgelendirme Hizmetleri A.Ş.
NB Address : İTOSB 9. Cad. No :15 Tepeören, Tuzla - İstanbul TÜRKİYE
NB Identification Number : 1984
EC Certificate Number : 1984-MDD-14-266
Expiry Date : 27 May 2024

Signature, Stamp

City Date : İstanbul, 29.12.2021
Name : Yusuf Yiğit Akkuş
Position : General Manager

SU BİYOMEDİKAL SİSTEMLER VE
SAĞLIK HİZMETLERİ SANAYİ VE TİCARET A.Ş.
Orhangazi Mah. 1673 Sk. No:20 Esenyurt / İSTANBUL
Tel: 0212 320 37 53 Faks: 0212 320 53 51
Yenikapı V.D.: 7810897506 Tic.Sic. No: 749756-0

Ürün Grubu / Product Group

Ürün Adı / Product Name

Referans No / Reference No

Cerrahi Setler
Surgical SetsGenel Cerrahi Seti
General Surgery Pack

GSP-014-3

Ürün İçerik ve Teknik Çizimi

Product Content and Technical Drawing

Ürün Teknik Çizimi

Product Technical Drawing

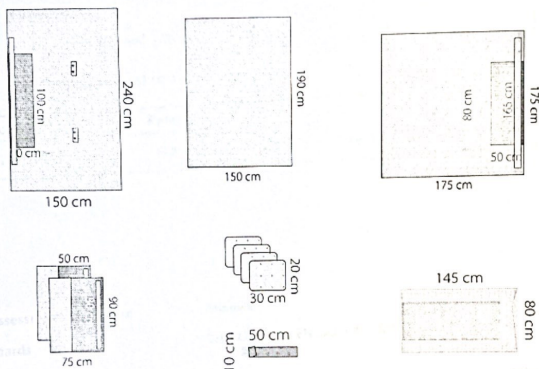

Ürün Malzeme Bilgileri

Product Material Information

1x Mayo Masa Örtüsü - Mayo Stand Cover	80x145 cm
2x Takviyeli Yan Bantlı Örtü - Reinforced Side Adhesive Drape	90x75 cm
4x El Havlusu - Hand Towel	20x30 cm
1x OP Tape	10x50 cm
1x Takviyeli Yan Bantlı Örtü - Reinforced Side Adhesive Drape	175x175 cm
1x Takviyeli Anestezi Örtüsü - Reinforced Anesthesia Drape	150x240 cm
1x Alet Masa Örtüsü - Table Cover	150x190 cm



DECLARATION OF CONFORMITY

Section No	TD-06/5.2-1-En
Rev Date	29.12.2021
Rev. No	01
Page No	1/1

Company Name : Su Biyomedikal Sistemler ve Sağlık Hizmetleri San. ve Tic. A.Ş.
Address : Orhangazi mah. 1673. Sok No:20 Esenyurt İstanbul
Tel : +90 212 320 37 53
Fax : +90 212 320 53 51
Web : www.submed .com.tr
E-mail : info@submed.com.tr

Product Name	Reference No	GMDN Code	Class and Rule
GENERAL SURGERY PACK	GSP-012-11	33961	Class 1s Rule 4

Conformity Assessment Procedure : Annex V

Related Standards : EN ISO 13485, EN ISO 9001, EN ISO 11135, EN ISO 14971, EN 13795-1

We herewith declare on our own responsibility that the above mentioned meet the provisions of the Council Directive 93/42/EEC with amended directive 2007/47/EC for Medical Device Directive.

Notified Body : KIWA Belgelendirme Hizmetleri A.Ş.
NB Address : İTOSB 9. Cad. No :15 Tepeören, Tuzla - İstanbul TÜRKİYE
NB Identification Number : 1984
EC Certificate Number : 1984-MDD-14-266
Expiry Date : 27 May 2024

City Date : İstanbul, 29.12.2021
Name : Yusuf Yiğit Akkuş
Position : General Manager

Signature, Stamp

SU BİYOMEDİKAL SİSTEMLER VE
SAĞLIK HİZMETLERİ SANAYİ VE TİCARET A.Ş.
Orhangazi Mah. 1673 Sok. No:20 Esenyurt / İSTANBUL
Tel: 0212 320 37 53 Faks: 0212 320 53 51
Yenikapı V.D.: 7810897506 Tic.Sic. No: 749756-0

Ürün Grubu / Product Group

Cerrahi Setler
Surgical Sets

Ürün Adı / Product Name

Genel Cerrahi Seti
General Surgery Pack

Referans No / Reference No

GSP-012-11

Ürün İçerik ve Teknik Çizimi
Product Content and Technical Drawing

Ürün Teknik Çizimi
Product Technical Drawing

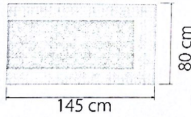
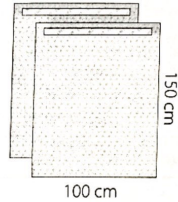
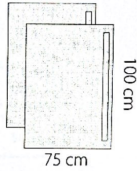
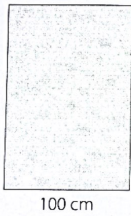

Ürün Malzeme Bilgileri
Product Material Information

- 1x Mayo Masa Örtüsü - Mayo Stand Cover
- 1x Alet Masa Örtüsü - Table Cover
- 2x Yan Bantlı Örtü - Side Adhesive Drape
- 2x Yan Bantlı Örtü - Side Adhesive Drape
- 2x El Havlusu - Hand Towel

- 80x145 cm
- 100x200 cm
- 100x150 cm
- 75x100 cm
- 20x30 cm

Transparent PE Film

Spunbond

Hydrophilic Spunbond
2 Layered
56 gsm

Adhesive

SMS 40 gsm

Cellulose

DECLARATION OF CONFORMITY

Section No	TD-06/S.2-1-En
Rev Date	29.12.2021
Rev. No	01
Page No	1/1

Company Name : Su Biyomedikal Sistemler ve Sağlık Hizmetleri San. ve Tic. A.Ş.
 Address : Orhangazi mah. 1673. Sok No:20 Esenyurt İstanbul
 Tel : +90 212 320 37 53
 Fax : +90 212 320 53 51
 Web : www.submed.com.tr
 E-mail : info@submed.com.tr

Product Name	Reference No	GMDN Code	Class and Rule
ADHESIVE FENESTRATED DRAPE 75X90 CM	SAFD-078	47783	Class Is Rule 4

Conformity Assessment Procedure : Annex V
 Related Standards : EN ISO 13485, EN ISO 9001, EN ISO 11135, EN ISO 14971, EN 13795-1

We herewith declare on our own responsibility that the above mentioned meet the provisions of the Council Directive 93/42/EEC with amended directive 2007/47/EC for Medical Device Directive.

Notified Body : KIWA Belgelendirme Hizmetleri A.Ş.
 NB Address : İTOSB 9. Cad. No :15 Tepeören, Tuzla - İstanbul TÜRKİYE
 NB Identification Number : 1984
 EC Certificate Number : 1984-MDD-14-266
 Expiry Date : 27 May 2024

Signature, Stamp

City Date : İstanbul, 29.12.2021
 Name : Yusuf Yiğit Akkuş
 Position : General Manager

SU BİYOMEDİKAL SİSTEMLER VE
 SAĞLIK HİZMETLERİ SANAYİ VE TİCARET A.Ş.
 Orhangazi Mah. 1673 Sok. No:20, Esenyurt / İSTANBUL
 Tel: 0212 320 37 53 Faks: 0212 320 53 51
 Yenikapı V.D.: 7810897506 Tic.Sic. No: 749756-0

Ürün Grubu / Product Group

Cerrahi Örtüler
Surgical Drapes

Ürün Adı / Product Name

Delikli Bantlı Örtü
Adhesive Fenestrated Drape

Referans No / Reference No

XXXXXXXXXX

1. Ürün İçerik ve Teknik Çizimi

Product Content and Technical Drawing

Ürün Teknik Çizimi

Product Technical Drawing

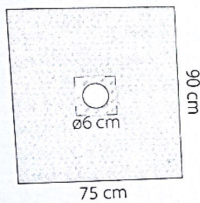

Digitally signed by Tutunaru Diana
Date: 2021.12.27 17:08:33 MSK
Reason: MoldSign Signature
Location: Moldova



Ürün Malzeme Bilgileri

Product Material Information

1x Delikli Bantlı Örtü - Adhesive Fenestrated Drape

75x90 cm



Hydrophilic Spunbond
2 Layered
54 gsm



Adhesive

DECLARATION OF CONFORMITY

Section No	TD-06/S.2-1-En
Rev Date	29.12.2021
Rev. No	01
Page No	1/1

Company Name : Su Biyomedikal Sistemler ve Sağlık Hizmetleri San. ve Tic. A.Ş.
 Address : Orhangazi mah. 1673. Sok.No:20 Esenyurt İstanbul
 Tel : +90 212 320 37 53
 Fax : +90 212 320 53 51
 Web : www.submed.com.tr
 E-mail : info@submed.com.tr

Product Name	Reference No	GMDN Code	Class and Rule
SURGICAL DRAPE PACK	SDP-002	33961	Class Is Rule 4

Conformity Assessment Procedure : Annex V
 Related Standards : EN ISO 13485, EN ISO 9001, EN ISO 11135, EN ISO 14971, EN 13795-1

We herewith declare on our own responsibility that the above mentioned meet the provisions of the Council Directive 93/42/EEC with amended directive 2007/47/EC for Medical Device Directive.

Notified Body : KIWA Belgelendirme Hizmetleri A.Ş.
 NB Address : İTOSB 9. Cad. No :15 Tepeören, Tuzla - İstanbul TÜRKİYE
 NB Identification Number : 1984
 EC Certificate Number : 1984-MDD-14-266
 Expiry Date : 27 May 2024

Signature, Stamp

City Date : İstanbul, 29.12.2021
 Name : Yusuf Yiğit Akkuş
 Position : General Manager

SU BİYOMEDİKAL SİSTEMLER VE
 SAĞLIK HİZMETLERİ SANAYİ VE TİCARET A.Ş.
 Orhangazi Mah. 1673 Sk. No:20 Esenyurt / İSTANBUL
 Tel: 0212 320 37 53 Faks: 0212 320 53 51
 Yenikapı V.D.: 7810897506 Tic.Sic. No: 749756-0

Ürün Grubu / Product Group

Cerrahi Örtüler
Surgical Drapes

Ürün Adı / Product Name

Yan Bantlı Takviyeli Örtü
Reinforced Adhesive Drape

Referans No / Reference No

SDP-002

1. Ürün İçerik ve Teknik Çizimi

Product Content and Technical Drawing

Ürün Teknik Çizimi

Product Technical Drawing

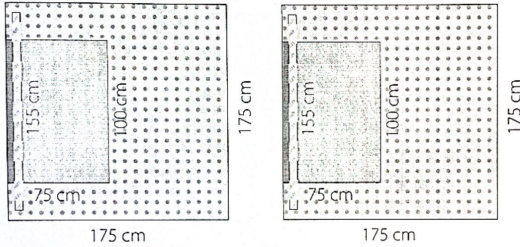

Ürün Malzeme Bilgileri

Product Material Information

2x Takviyeli Yan Bantlı Örtü - Reinforced Adhesive Drape

175x175 cm

Ürün Grubu / Product Group

Cerrahi Örtüler
Surgical Drapes

Ürün Adı / Product Name

Yan Bantlı Düz Örtüler
Adhesive Drape

Referans No. / Reference No.

SDP-001

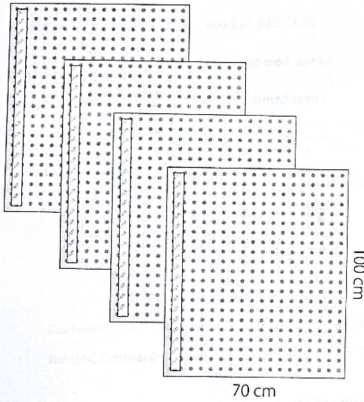
1. Ürün İçerik ve Teknik Çizimi
Product Content and Technical DrawingÜrün Teknik Çizimi
Product Technical DrawingÜrün Malzeme Bilgileri
Product Material Information

4x Yan Bantlı Düz Örtü - Absorbant Adhesive Drape

70x100 cm

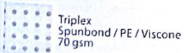
Triplex
Spunbond / PE / Viscone
70 gsm

Adhesive

DECLARATION OF CONFORMITY

Section No	TD-06/5.2-1-En
Rev Date	29.12.2021
Rev. No	01
Page No	1/1

Company Name : Su Biyomedikal Sistemler ve Sağlık Hizmetleri San. ve Tic. A.Ş.
 Address : Orhangazi mah. 1673. Sok No:20 Esenyurt İstanbul
 Tel : +90 212 320 37 53
 Fax : +90 212 320 53 51
 Web : www.submed.com.tr
 E-mail : info@submed.com.tr

Product Name	Reference No	GMDN Code	Class and Rule
PLAIN DRAPE 50X70 CM	SPD-085	47783	Class Is Rule 1

Conformity Assessment Procedure : Annex V
 Related Standards : EN ISO 13485, EN ISO 9001, EN ISO 11135, EN ISO 14971, EN 13795-1

We herewith declare on our own responsibility that the above mentioned meet the provisions of the Council Directive 93/42/EEC with amended directive 2007/47/EC for Medical Device Directive.

Notified Body : KIWA Belgelendirme Hizmetleri A.Ş.
 NB Address : İTOSB 9. Cad. No :15 Tepeören, Tuzla - İstanbul TÜRKİYE
 NB Identification Number : 1984
 EC Certificate Number : 1984-MDD-14-266
 Expiry Date : 27 May 2024

Signature, Stamp

City Date : İstanbul, 29.12.2021
 Name : Yusuf Yiğit Akkuş
 Position : General Manager

SU BİYOMEDİKAL SİSTEMLER VE
 SAĞLIK HİZMETLERİ SANAYİ VE TİCARET A.Ş.
 Orhangazi Mah. 1673 Sk. No:20 Esenyurt / İSTANBUL
 Tel: 0212 320 37 53 Faks: 0212 320 53 51
 Yenikapı V.D.: 7810897506 Tic.Sic. No: 749756-0

Ürün Grubu / Product Group

Ürün Adı / Product Name

Referans No / Reference No

Cerrahi Örtüler
Surgical Drapes

Emici Örtü
Absorbant Drape

SPD-085

1. Ürün İçerik ve Teknik Çizimi

Product Content and Technical Drawing

Ürün Teknik Çizimi

Product Technical Drawing

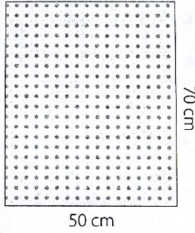

Ürün Malzeme Bilgileri

Product Material Information

1x Emici Örtü - Absorbant Drape

50x70 cm

Triplex
Spunbond / PE / Viscone
70 gsm ±5

DECLARATION OF CONFORMITY

Section No	TD-06/5.2-1-En
Rev Date	29.12.2021
Rev. No	01
Page No	1/1

Company Name : Su Biyomedikal Sistemler ve Sağlık Hizmetleri San. ve Tic. A.Ş.
 Address : Orhangazi mah. 1673. Sok No:20 Esenyurt İstanbul
 Tel : +90 212 320 37 53
 Fax : +90 212 320 53 51
 Web : www.submed.com.tr
 E-mail : info@submed.com.tr

Product Name	Reference No	GMDN Code	Class and Rule
INSTRUMENT TABLE COVER	STC-014	47783	Class Is Rule 1

Conformity Assessment Procedure : Annex V
 Related Standards : EN ISO 13485, EN ISO 9001, EN ISO 11135, EN ISO 14971, EN 13795-1

We herewith declare on our own responsibility that the above mentioned meet the provisions of the Council Directive 93/42/EEC with amended directive 2007/47/EC for Medical Device Directive.

Notified Body : KIWA Belgelendirme Hizmetleri A.Ş.
 NB Address : İTOSB 9. Cad. No :15 Tepeören, Tuzla - İstanbul TÜRKİYE
 NB Identification Number : 1984
 EC Certificate Number : 1984-MDD-14-266
 Expiry Date : 27 May 2024

Signature, Stamp

City Date : İstanbul, 29.12.2021
 Name : Yusuf Yiğit Akkuş
 Position : General Manager

SU BİYOMEDİKAL SİSTEMLER VE
 SAĞLIK HİZMETLERİ SANAYİ VE TİCARET A.Ş.
 Orhangazi Mah. 1673 Sk. No:20 Esenyurt / İSTANBUL
 Tel: 0212 320 37 53 Faks: 0212 320 53 51
 Yenikapı V.D.: 7810997506 Tic.Sic. No: 749756-0

submed SAFE EASY

ÜRÜN TEKNİK BİLGİLERİ
PRODUCT TECHNICAL INFORMATION

L 114

Ürün Grubu / Product Group

Ürün Adı / Product Name

Referans No / Reference No

Cerrahi Örtüler
Surgical DrapesAlet Masa Örtüsü
Table Cover

STC-014

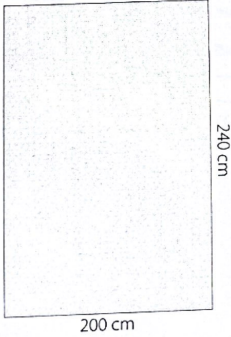
1. Ürün İçerik ve Teknik Çizimi
Product Content and Technical DrawingÜrün Teknik Çizimi
Product Technical DrawingÜrün Malzeme Bilgileri
Product Material Information

1x Alet Masa Örtüsü - Table Cover

200x240 cm

Hydrophilic Spunbond
2 Layered
56 gsm

DECLARATION OF CONFORMITY

Section No	TD-06/5.2-1-En
Rev Date	29.12.2021
Rev. No	01
Page No	1/1

Company Name : Su Biyomedikal Sistemler ve Sağlık Hizmetleri San. ve Tic. A.Ş.
 Address : Orhangazi mah. 1673. Sok No:20 Esenyurt İstanbul
 Tel : +90 212 320 37 53
 Fax : +90 212 320 53 51
 Web : www.submed .com.tr
 E-mail : info@submed.com.tr

Product Name	Reference No	GMDN Code	Class and Rule
NEPHRECTOMY PROCEDURE SET	UNSP-001	33961	Class 2a Rule 6

Conformity Assessment Procedure : Annex V

Related Standards : EN ISO 13485, EN ISO 9001, EN ISO 11135, EN ISO 14971, EN 13795-1

We herewith declare on our own responsibility that the above mentioned meet the provisions of the Council Directive 93/42/EEC with amended directive 2007/47/EC for Medical Device Directive.

Notified Body : KIWA Belgelendirme Hizmetleri A.Ş.
 NB Address : İTOSB 9. Cad. No :15 Tepeören,Tuzla - İstanbul TURKIYE
 NB Identification Number : 1984
 EC Certificate Number : 1984-MDD-14-266
 Expiry Date : 27 May 2024

Signature, Stamp

City Date : İstanbul, 29.12.2021
 Name : Yusuf Yiğit Akkuş
 Position : General Manager

SU BİYOMEDİKAL SİSTEMLER VE
SAĞLIK HİZMETLERİ SANAYİ VE TİCARET A.Ş.
 Orhangazi Mah. 1673 Sk. No:20 Esenyurt / İSTANBUL
 Tel: 0212 320 37 53 Faks: 0212 320 53 51
 Yenikapı V.D.: 7810897503 Tic.Sic. No: 749756-0

Ürün Grubu / Product Group

Ürün Adı / Product Name

Referans No / Reference No

Cerrahi Setler
Surgical Sets

Perkütan Nefrostomi Seti
Percutan Nephrostomy Pack

UNPS-001

Ürün İçerik ve Teknik Çizimi

Product Content and Technical Drawing

Ürün Teknik Çizimi

Product Technical Drawing

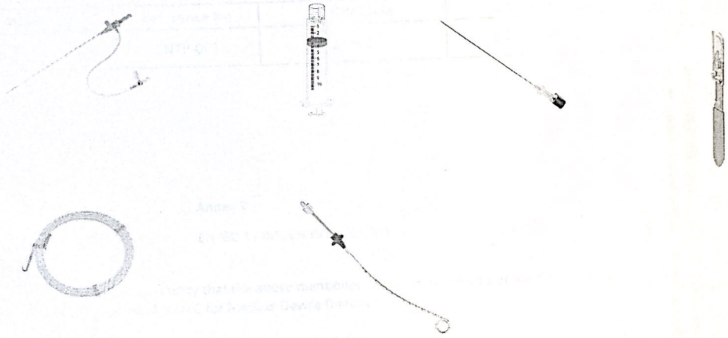

Ürün Malzeme Bilgileri

Product Material Information

- 1x Pigtail Tip Catheter - Pigtail Type Catheter
- 1x Dilator
- 1x Kılavuz Tel - Guidewire
- 1x Puncture İğne - Puncture Needle
- 1x LL, Şiringa - Syringe, LL
- 1x Bistüri - Scalpel

0.38x80 cm
185x20 cm
10 ml
NO: 11

ORL

DECLARATION OF CONFORMITY

Section No	TD-06/5.2-1-En
Rev Date	29.12.2021
Rev. No	01
Page No	1/1

Company Name : Su Biyomedikal Sistemler ve Sağlık Hizmetleri San. ve Tic. A.Ş.
 Address : Orhangazi mah. 1673. Sok No:20 Esenyurt İstanbul
 Tel : +90 212 320 37 53
 Fax : +90 212 320 53 51
 Web : www.submed.com.tr
 E-mail : info@submed.com.tr

Product Name	Reference No	GMDN Code	Class and Rule
ENT SURGERY PACK	ENTP-001	33961	Class 1s Rule 4

Conformity Assessment Procedure : Annex V
 Related Standards : EN ISO 13485, EN ISO 9001, EN ISO 11135, EN ISO 14971, EN 13795-1

We herewith declare on our own responsibility that the above mentioned meet the provisions of the Council Directive 93/42/EEC with amended directive 2007/47/EC for Medical Device Directive.

Notified Body : KIWA Belgelendirme Hizmetleri A.Ş.
 NB Address : İTOSB 9. Cad. No :15 Tepeören, Tuzla - İstanbul TÜRKİYE
 NB Identification Number : 1984
 EC Certificate Number : 1984-MDD-14-266
 Expiry Date : 27 May 2024

Signature, Stamp

City Date : İstanbul, 29.12.2021
 Name : Yusuf Yiğit Akkuş
 Position : General Manager

SU BİYOMEDİKAL SİSTEMLER VE
 SAĞLIK HİZMETLERİ SANAYİ VE TİCARET A.Ş.
 Orhangazi Mah. 1673 Sok. No:20 Esenyurt / İSTANBUL
 Tel: 0212 320 37 53 Paks: 0212 320 53 51
 Yenikapı V.D.: 781087505 Tic.Sic. No: 749756-0

Ürün Grubu / Product Group

Ürün Adı / Product Name

Referans No / Reference No

Cerrahi Setler
Surgical Sets

KBB Cerrahi Seti
ENT Surgery Pack

ENTP-001

Ürün İçerik ve Teknik Çizimi

Product Content and Technical Drawing

Ürün Teknik Çizimi

Product Technical Drawing

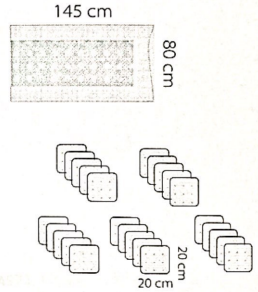
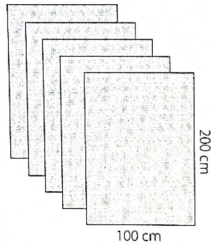
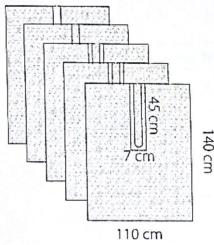

Ürün Malzeme Bilgileri

Product Material Information

- 5x U Yarıklı Örtü - U Split Drape
- 5x Alet Masa Örtüsü - Table Cover
- 20x El Havlusu - Hand Towel
- 1x Mayo Masa Örtüsü - Mayo Stand Cover

- 110x140 cm
- 100x200 cm
- 20x30 cm
- 80x145 cm

Cellulose

DECLARATION OF CONFORMITY

Section No	TD-06/5.2-1-En
Rev Date	29.12.2021
Rev. No	01
Page No	1/1

Company Name : Su Biyomedikal Sistemler ve Sağlık Hizmetleri San. ve Tic. A.Ş.
 Address : Orhangazi mah. 1673. Sok No:20 Esenyurt İstanbul
 Tel : +90 212 320 37 53
 Fax : +90 212 320 53 51
 Web : www.submed.com.tr
 E-mail : info@submed.com.tr

Product Name	Reference No	GMDN Code	Class and Rule
TUR PACK	UTSP-004	33961	Class 1s Rule 4

Conformity Assessment Procedure : Annex V
 Related Standards : EN ISO 13485, EN ISO 9001, EN ISO 11135, EN ISO 14971, EN 13795-1

We herewith declare on our own responsibility that the above mentioned meet the provisions of the Council Directive 93/42/EEC with amended directive 2007/47/EC for Medical Device Directive.

Notified Body : KIWA Belgelendirme Hizmetleri A.Ş.
 NB Address : İTOSB 9. Cad. No :15 Tepeören, Tuzla - İstanbul TÜRKİYE
 NB Identification Number : 1984
 EC Certificate Number : 1984-MDD-14-266
 Expiry Date : 27 May 2024

Signature, Stamp

City Date : İstanbul, 29.12.2021
 Name : Yusuf Yiğit Akkuş
 Position : General Manager

**SU BİYOMEDİKAL SİSTEMLER VE
 SAĞLIK HİZMETLERİ SANAYİ VE TİCARET A.Ş.**
 Orhangazi Mah. 1673 Sk. No:20 Esenyurt / İSTANBUL
 Tel: 0212 320 37 53 Faks: 0212 320 53 51
 Yenikapı V.D.: 7810897506 Tic.Sic. No: 749756-0

Ürün Grubu / Product Group

Ürün Adı / Product Name

Referans No / Reference No

Cerrahi Setler
Surgical Sets

TUR Cerrahi Seti
TUR Surgery Pack

UTSP-004

Ürün İçerik ve Teknik Çizimi

Product Content and Technical Drawing

Ürün Teknik Çizimi

Product Technical Drawing

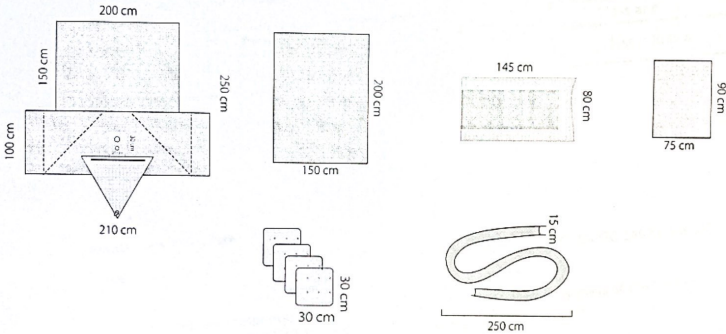

Ürün Malzeme Bilgileri

Product Material Information

1x TUR Örtüsü - TUR Drape	200x250 cm
1x Alet Masa Örtüsü - Table Cover	150x200 cm
1x Mayo Masa Örtüsü - Mayo Stand Cover	80x145 cm
1x Düz Örtü - Plain Drape	75x90 cm
4x El Havlusu - Hand Towel	30x30 cm
1x Kamera Kılıfı - Camera Cover	15x250 cm

PVC

Rubber

Spunbond

Hydrophilic Spunbond
2 Layered
56 gsm

Transparent PE Film

Cellulose

Transparent PE Film

DECLARATION OF CONFORMITY

Section No	TD-06/5.2-1-En
Rev Date	29.12.2021
Rev. No	01
Page No	1/1

Company Name : Su Biyomedikal Sistemler ve Sağlık Hizmetleri San. ve Tic. A.Ş.
 Address : Orhangazi mah. 1673. Sok No:20 Esenyurt İstanbul
 Tel : +90 212 320 37 53
 Fax : +90 212 320 53 51
 Web : www.submed.com.tr
 E-mail : info@submed.com.tr

Product Name	Reference No	GMDN Code	Class and Rule
SURGICAL DRAPE PACK	SDP-001	33961	Class Is Rule 4

Conformity Assessment Procedure : Annex V
 Related Standards : EN ISO 13485, EN ISO 9001, EN ISO 11135, EN ISO 14971, EN 13795-1

We herewith declare on our own responsibility that the above mentioned meet the provisions of the Council Directive 93/42/EEC with amended directive 2007/47/EC for Medical Device Directive.

Notified Body : KIWA Belgelendirme Hizmetleri A.Ş.
 NB Address : İTOSB 9. Cad. No :15 Tepeören, Tuzla - İstanbul TÜRKİYE
 NB Identification Number : 1984
 EC Certificate Number : 1984-MDD-14-266
 Expiry Date : 27 May 2024

Signature, Stamp

City Date : İstanbul, 29.12.2021
 Name : Yusuf Yiğit Akkuş
 Position : General Manager

SU BIYOMEDİKAL SİSTEMLER VE
 SAĞLIK HİZMETLERİ SANAYİ VE TİCARET A.Ş.
 Orhangazi Mah. 1673 Sk. No:20 Esenyurt / İSTANBUL
 Tel: 0212 320 37 53 Paks: 0212 320 53 51
 Yenikapı V.D.: 7810897506 Tic.Sic. No: 749758-0

Ürün Grubu / Product Group

Ürün Adı / Product Name

Referans No / Reference No

Cerrahi Örtüler
Surgical DrapesYan Bantlı Takviyeli Örtü
Reinforced Adhesive Drape

XXXXXXXXXX

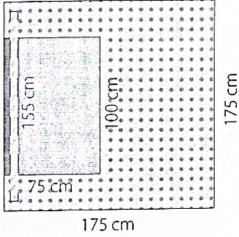
1. Ürün İçerik ve Teknik Çizimi
Product Content and Technical DrawingÜrün Teknik Çizimi
Product Technical Drawing

Digitally signed by Tutunaru Diana
Date: 2021.12.27 17:09:45 MSK
Reason: MoldSign Signature
Location: Moldova

Ürün Malzeme Bilgileri
Product Material Information

1x Takviyeli Yan Bantlı Örtü - Reinforced Adhesive Drape

175x175 cm



PE / Viscone 110 gsm 2-layered
(Highly Absorbent Patch)



Adhesive



Triplex
Spunbond / PE / Viscone
70 gsm

DECLARATION OF CONFORMITY

Section No	TD-06/5.2-1-En
Rev Date	29.12.2021
Rev. No	01
Page No	1/1

Company Name : Su Biyomedikal Sistemler ve Sağlık Hizmetleri San. ve Tic. A.Ş.
 Address : Orhangazi mah. 1673. Sok No:20 Esenyurt İstanbul
 Tel : +90 212 320 37 53
 Fax : +90 212 320 53 51
 Web : www.submed.com.tr
 E-mail : info@submed.com.tr

L. 112
113

Product Name	Reference No	GMDN Code	Class and Rule
CRANIOTOMY SURGERY PACK	NCSP-003	33961	Class 2a Rule 6

Conformity Assessment Procedure : Annex V
 Related Standards : EN ISO 13485, EN ISO 9001, EN ISO 11135, EN ISO 14971, EN 13795-1

We herewith declare on our own responsibility that the above mentioned meet the provisions of the Council Directive 93/42/EEC with amended directive 2007/47/EC for Medical Device Directive.

Notified Body : KIWA Belgelendirme Hizmetleri A.Ş.
 NB Address : İTOSB 9. Cad. No :15 Tepeören, Tuzla - İstanbul TÜRKİYE
 NB Identification Number : 1984
 EC Certificate Number : 1984-MDD-14-266
 Expiry Date : 27 May 2024

Signature, Stamp

City Date : İstanbul, 29.12.2021
 Name : Yusuf Yiğit Akkuş
 Position : General Manager

SU BİYOMEDİKAL SİSTEMLER VE
 SAĞLIK HİZMETLERİ SANAYİ VE TİCARET A.Ş.
 Orhangazi Mah. 1673 Sok. No: 20, Esenyurt / İSTANBUL
 Tel: 0212 320 37 53 Faks: 0212 320 53 51
 Yenikapı V.D.: 7810897505 Tic.Sic. No: 749756-0

Ürün Grubu / Product Group

Cerrahi Setler
Surgical Sets

Ürün Adı / Product Name

Beyin Cerrahi Seti
Brain Surgery Pack

Referans No / Reference No

NCSP-003

1. Ürün İçerik ve Teknik Çizimi
Product Content and Technical Drawing

Ürün Teknik Çizimi
Product Technical Drawing

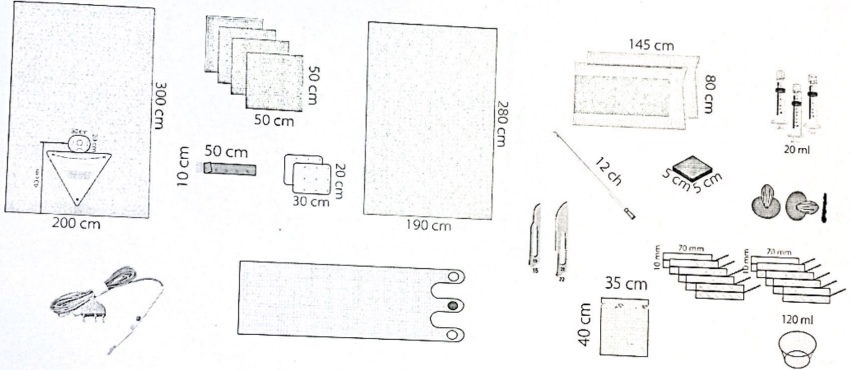

Ürün Malzeme Bilgileri
Product Material Information

- 1x Kraniyotomi Örtüsü - Craniotomy Drape
- 4x Emici Örtü - Absorbant Drape
- 2x El Havlusu - Hand Towel
- 1x OP Tape
- 1x Alet Masa Örtüsü (Bohça) - Table Cover
- 2x Mayo Masa Örtüsü - Mayo Stand Cover
- 1x Suction Kateter - Suction Catheter
- 1x Koter Zımpara - Instrument Cleaner
- 3x LL, Şırınga - Syring, LL
- 2x Tutamaç Koruyucu - Lamp Handle Cover
- 10x Beyin Cerrahi Tamponu - Neuro Surgical Pattie
- 1x Bistüri Ucu - Scalpel Blades
- 1x Bistüri Ucu - Scalpel Blades

- 200x300 cm
- 50x50 cm
- 20x30 cm
- 10x50 cm
- 190x280 cm
- 80x145 cm
- 12 ch
- 5x5 cm
- 20 cm
- 40 cm
- 35 cm
- 70 mm
- 20 mm
- 120 ml
- 1x Alet Torbası - Universal PE Bag
- 1x Plastik Kap - Gallipot
- 1x Mikroskop Kılıfı - Microscope Cover
- 1x Koter - Electrical Koter Pencil

- 35x40 cm
- 120 ml
- 300 cm



Cotton



Spunbond

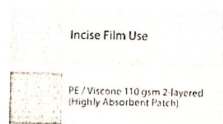

Transparent PE Film

Incise Film Use

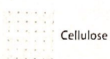

Cellulose

Ürün Grubu / Product Group

Cerrahi Setler
Surgical Sets

Ürün Adı / Product Name

Beyin Cerrahi Seti
Brain Surgery Pack

Referans No / Reference No

NCSP-002

1. Ürün İçerik ve Teknik Çizimi
Product Content and Technical Drawing

Ürün Teknik Çizimi
Product Technical Drawing

Digitally signed by Tutunaru Diana
Date: 2021.12.27 17:09:17 MSK
Reason: MoldSign Signature
Location: Moldova

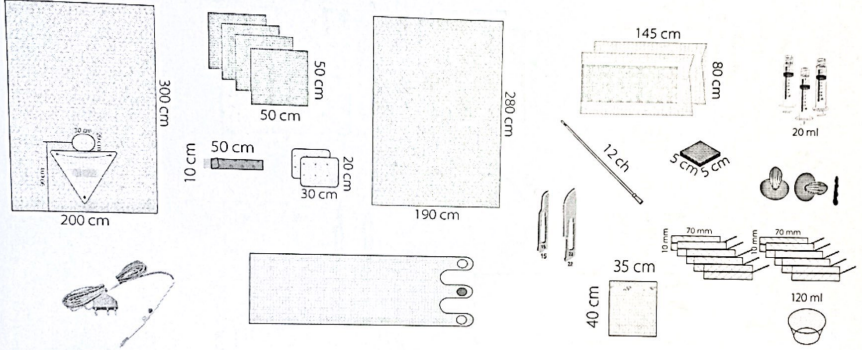

Ürün Malzeme Bilgileri
Product Material Information

- 1x Kraniotomi Örtüsü - Craniotomy Drape
- 4x Emici Örtü - Absorbant Drape
- 2x El Havlusu - Hand Towel
- 1x OP Tape
- 1x Alet Masa Örtüsü (Bohça) - Table Cover
- 2x Mayo Masa Örtüsü - Mayo Stand Cover
- 1x Suction Kateter - Suction Catheter
- 1x Koter Zımpara - Instrument Cleaner
- 3x LL, Şiringa - Syring, LL
- 2x Tutamaç Koryuyucu - Lamp Handle Cover
- 10x Beyin Cerrahi Tamponu - Neuro Surgical Pattie
- 1x Bistüri Ucu - Scalpel Blades
- 1x Bistüri Ucu - Scalpel Blades

- 200x300 cm
- 50x50 cm
- 20x30 cm
- 10x50 cm
- 190x280 cm
- 80x145 cm
- 12 ch
- 5x5 cm
- 20 ml
- 190x280 cm
- 80x145 cm
- 12 ch
- 5x5 cm
- 20 ml
- 10x70 mm
- NO 15
- NO 22
- 1x Alet Torbası - Universal PE Bag
- 1x Plastik Kap - Gallipot
- 1x Mikroskop Kılıfı - Microscope Cover
- 1x Koter - Electrical Koter Pencil

- 35x40 cm
- 120 ml
- 300 cm

