

## Silicone manual ventilation balloon

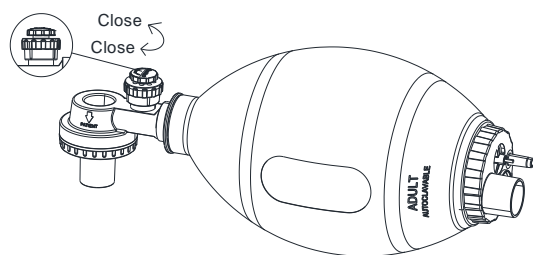

- Silicone manual ventilation balloon (Material: PC, silicone and stainless steel);
- Pressure Limiting Valve (in a default open position during operation. Cover the top with Thumb or twist

P/N: 1.87.005012, Version 2.0, 2023/06/14

### Intended Purpose / Indications

It is intended to provide lung ventilation to individuals whose breathing is inadequate.

The given body mass ranges of:

Infant: >5kg and ≤ 10Kg, Pediatric: >10kg and ≤ 40Kg, Adult: >40 Kg

### Contraindications

- Tension pneumothorax or mediastinal emphysema without decompression and drainage.
- Moderate or more serious hemoptysis.
- Serious Pulmonary cyst or pulmonary bullous.
- Hypovolemic shock without supplement the blood volume.
- Acute myocardial infarction.
- Suffocating respiratory failure caused by severe aspiration.
- Facial trauma or malformation.

### Warnings and Cautions

- This product must be used by persons who are trained in techniques of pulmonary resuscitation and device operation in accordance with local regulations. Make sure that the personnel are made familiar with the content of this instruction. Any misuse can endanger the patient's life.
- The Silicone manual ventilation balloon is intended for use in combination with anesthesia mask with 22mmID or 15mmOD connection port (Compower Medial Ref No: 1-G#, 2-G#, 4-G# or 5-G#); If necessary, it is used in combination with reservoir bag (Compower Medial Ref No: 1600ml or 2000ml) and oxygen tube (Compower

Medial Ref No: CP635001).

- Clear patient's airways before using Silicone manual ventilation balloon.
- Always check if the Silicone manual ventilation balloon functions properly.
- Never lock the pressure-limiting valve unless medical and professional assessment indicate the necessity. High ventilation pressures may cause lung rupture to certain patients.
- Check if the valve functions properly. Check if the patient is being ventilated by observing the rise and fall of the chest and color of the lips and face during resuscitation.
- Always make functional test of the Silicone manual ventilation balloon after unpacking and assembly.
- The device has not been tested with accessories or external device.
- Do not use the Silicone manual ventilation balloon in toxic or hazardous atmospheres; Insufficient, reduced, or limited airflow may result in brain damage to the patient being ventilated.
- Do not use in noisy or dark environments
- Air or air/oxygen mixture can be delivered to patient; DO NOT deliver other gases or drugs.
- When using supplemental oxygen, do not allow smoking or use unit near sparking equipment, open flame, oil or other flammable chemicals.
- Do not allow the Silicone manual ventilation balloon to contact the patient during scanning. It has not been evaluated for heating during MRI.
- The Silicone manual ventilation balloon can be reprocessed with cleaning, disinfection and sterilization up to 15 times.
- The shelf life of the Silicone manual ventilation balloon is 5 years. Do not use if it is beyond validity period.
- By adding accessories, it may increase inspiratory and/or expiratory resistance. Do not attach accessories if increased breathing resistance would be detrimental for the patient.
- Any deviation from these instructions may impact the performance and shelf life of the product.

### Clinical Benefits

Cardiopulmonary resuscitation for the patients without spontaneous breathing

Temporary ventilate for the patients with spontaneous breathing

### Performance and Specification

The Silicone manual ventilation balloon is in conformity with the product specific standard ISO 10651-4:2002.

Model	Infant	Pediatric	Adult
Body mass(B)	5<B≤10kg	10<B≤40kg	>40kg
Expiration resistance	≤5cmH2O@5L/min	≤5cmH2O@50L/min	≤5cmH2O@50L/min
Inspiration resistance	≤5cmH2O@5L/min	≤5cmH2O@50L/min	≤5cmH2O@50L/min
Patient valve malfunction	≤6.0cmH2O	≤6.0cmH2O	≤6.0cmH2O
Min. delivered volume	150ml	345ml	600ml
Pressure limitation	30-45cmH2O	35-50cmH2O	40-60cmH2O
Dead space	20ml	39ml	65ml
Forward and backward leakage	Not measurable		
Supplementary oxygen (LPM), Tidal Volume (Vt) and delivered oxygen concentration %	≥85%@15L/min Vt-150mlx25bpm	≥85%@15L/min Vt-345mlx20bpm	≥85%@15L/min Vt-600mlx12bpm
Patient connector	Outside 22 mm male (ISO 5356-1:2015) and Inside 15 mm female (ISO 5356-1:2015)		
Operation temperature	-18 °C to +50 °C		
Storage temperature	0°C to +35 °C		

The device can only be used for up to 1 hour limit in a single procedure.

### Preparation for Use

- Remove all packaging. Inspect the Silicone manual ventilation balloon and its accessories for deterioration. Do not use if appears aged or damaged.
- If the Silicone manual ventilation balloon is packed in a compressed state, expand the Silicone manual ventilation balloon from collapsed configuration to its operating position.
- Inspect the unit to be sure the system is complete.
- Before use on the patient make a brief functional test as described in *section Functional Test*.
- If connecting external devices to the Silicone manual ventilation balloon, make sure to test for functionality and consult the instructions for use accompanying the external device. The use of third-party products and oxygen delivery devices (e.g.

filters and demand valves) may have an effect on product performance. Please consult with the manufacturer of the third-party device to verify compatibility with the Silicone manual ventilation balloon and obtain information on the possible performance changes.

### Functional Test

- **Functional Testing Maintenance:** Visual inspection for cleanliness of the products. After cleaning and disinfection, a thorough inspection and maintenance ensures that the products are fit for use.
  - Check that the product has no dents, cracks, deformations, scratches, etc.;
  - Check all markings on the product for clear visibility. Discard and replace any components as necessary. The defects include: material deformation, cracks on the product, brittle or other change in the material etc.
- Squeeze the Silicone manual ventilation balloon with one hand and cover the patient connector with another hand: regardless of the Pressure limiting valve setting, air can be felt and heard to flow into another hand. It expands rapidly and air can be heard to flow through the inlet valve when release the Silicone manual ventilation balloon.

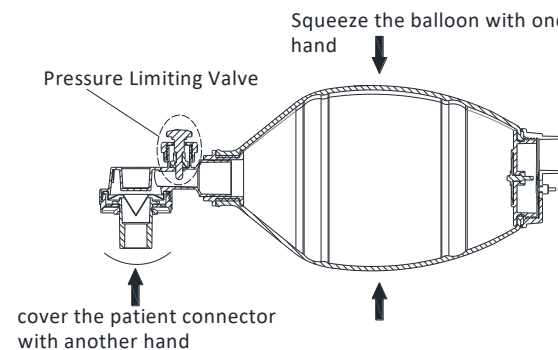

- Close the Pressure limiting valve and block the patient connector with the thumb. Briskly squeeze the Silicone manual ventilation balloon. The Silicone manual ventilation balloon shall offer resistance to the squeeze.
- Close the pressure limiting valve and the patient connector with a thumb while compressing the Silicone manual ventilation balloon Silicone manual ventilation balloon firmly to check tightness and proper valve fitting.

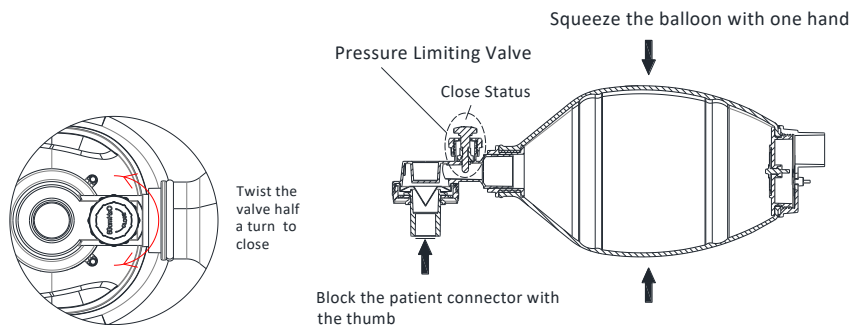

- Open the pressure limiting valve and close the patient connector with a thumb. The pressure limiting valve should now be activated and it should be possible to hear the expiratory flow from the valve.

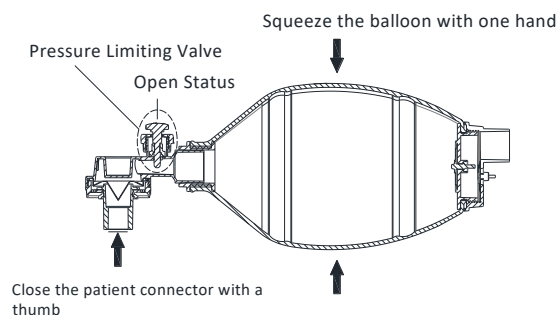

**Note:** Ensure the pressure limiting valve is in the open position when the functional test is completed.

### Instructions for Use

- Open the patient's mouth, clear airway of all foreign matter and fluids. The use of an Emergency Aspirator is recommended. Tilt head fully backwards and push the jaw upwards with neck stretched to open the airways. (As shown in Figure 1.)
- To augment ventilation, it may be beneficial to insert an artificial airway. Take precautions since it should not push the tongue back and thus obstruct the throat. (As shown in Figure 2.)
- Hold mask tightly to patient's face (the check valve of the mask points toward patient's chin), covering mouth and nose, tilt head fully backwards, and hold the mask hand lifting jaw forward. Squeeze the Silicone manual ventilation balloon appropriately and observe the chest if it expands. (As shown in Figure 3.)
- Release pressure from the Silicone manual ventilation balloon gradually and allow

the chest to deflate. Do this for 12-20 times per minute, or 30 times on infants. (As shown in Figure 4.)

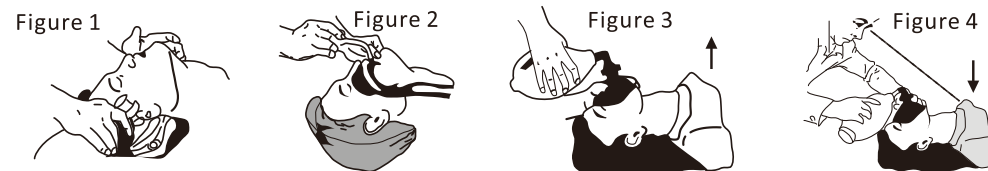

If continued resistance to insufflation is experienced, check for airways obstruction or check if the head is tilted. If adequate ventilation is not achieved with the Silicone manual ventilation balloon, immediately revert to air ventilation (mouth-to-mouth, or mouth-to-nose).

If high concentrations of oxygen are needed, attach oxygen tube to the inlet valve and an adjustable oxygen source, and attach a reservoir bag to the inlet valve. Adjust oxygen flow to ensure the reservoir bag remains fully or partially inflated during use.

If the Patient Valve becomes contaminated with vomit, blood or secretions **DURING VENTILATION** disconnect the device from the patient, remove the mask and clear the Patient Valve as follows:

- Rapidly compress and release the Silicone manual ventilation balloon to deliver several sharp breaths through the Patient valve to expel the contaminant. If the contaminant does not come off:
- Rinse the Patient valve in water and then rapidly compress and release the Silicone manual ventilation balloon to deliver several sharp breaths through the Patient valve to expel the contaminant. If the contaminant still does not come off:
- Discard the Silicone manual ventilation balloon.

### Preparation for Decontamination:

The devices must be reprocessed in a disassembled state, as far as possible. Disassembly Structure:

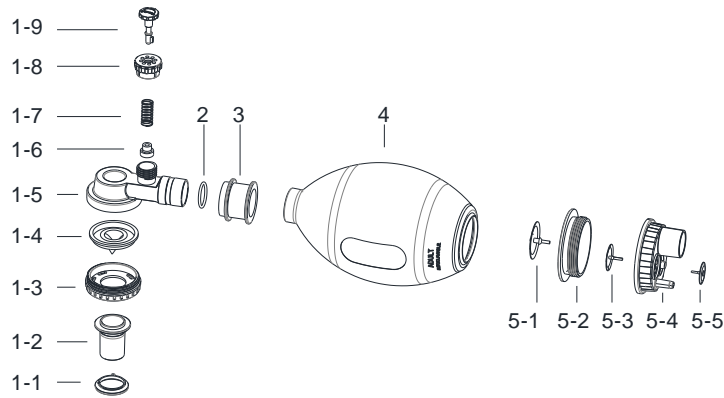

Unscrew “1-3” from “1-5”, remove “1-4” from “1-5”, remove “1-5” from “3”, Unscrew “5-4” from “5-2” and remove “5-2” from “4”.

**DO NOT** disassemble any other components.

**Advice:**

The device should no longer be reused in case of signs of material degradation, e.g. cracks on the product, brittle or other change in the material etc.

**Clean and Sterilize:**

**Preparation at the Point of Use:**

Disconnect the device. Remove gross soiling of the device with cold water (<40°C) immediately after use, if applicable. Don't use a fixating detergent or hot water (>40°C) as this can cause the fixation of residuals which may influence the result of the reprocessing process.

**Transportation:**

Safely store the device in a humid surrounding and transport it to the reprocessing area to avoid any damage and contamination to the environment.

**Pre-Cleaning:**

Do a manual pre-cleaning, until the product is visually clean. Submerge the product in a cleaning solution and flush the lumens with a water jet pistol with cold tap water for at least 10 seconds. Clean the surfaces with a soft bristol brush.

**Cleaning:**

Regarding cleaning/disinfection, rinsing and drying, it is to distinguish between manual and automated reprocessing methods. Preference is to be given to automated

reprocessing methods, especially due to the better standardizing potential and industrial safety.

**Automated Cleaning:**

Use a washer-disinfector meeting the requirements of the ISO 15883 series.

Put the instrument into the machine on a tray. Connect the instrument with the WD by using suitable adapter and start the program:

- 4 min pre-washing with cold water (<40°C); emptying
- 5 min washing with a mild alkaline cleaner at 55°C emptying
- 3 min neutralising with warm water (>40°C); emptying
- 5 min intermediate rinsing with warm water (>40°C) Emptying

The automated cleaning processes have been validated by using 0.5% neodisher MediClean forte (Dr. Weigert). Note Acc. to EN ISO 17664 no manual reprocessing methods are required for these devices. If a manual reprocessing method has to be used, please validate it prior to use.

**Disinfection:**

Automated thermal disinfection in washer/disinfector under consideration of national requirements in regards to AO value (see EN ISO 15883).

A disinfection cycle of 5 min disinfection at 90°C has been validated for the device to achieve an AO value of > 3000. Here we suggest a disinfection cycle of 5 min disinfection time at 93 °C.

**Drying:**

Automated Drying: Drying the instrument through drying cycle of washer/disinfector. If needed, additional manual drying can be performed through lint free towel. Insufflate cavities of products by using sterile compressed air.

**Packaging:**

Pack the instruments in an appropriate packaging material for sterilization. The packaging material and system refer to EN ISO11607.

**Sterilization:**

Sterilization of products by applying a fractionated pre-vacuum steam sterilization process (according to EN 285/EN ISO 17665) under consideration of the respective country requirements. Following sterilization parameters are commonly used: 134 °C, 5 min (standard program in EU)

**Drying time:**

For steam sterilization, we recommend a drying time of 20 to 40 minutes. Choose a

suitable drying time, depending on the autoclave and load. Refer to the autoclave's instructions for use. After sterilization:

- a. Remove the product from the autoclave.
- b. Let the product cool down at room temperature for at least 30 minutes. Do not use additional cooling.
- c. Check that the sterilization wraps or pouches are not damaged

**Storage:**

Storage of sterilized instruments in a dry, clean and dust free environment at modest temperatures, refer to label and instructions for use.

**Reprocessing validation study information:**

The above-mentioned reprocessing process (cleaning, disinfection, sterilization) has been successfully validated. Refer to test reports:

- Xiamen Compower Cleaning Disinfection Validation Report, Report No.:

MDS-RECD-220422-045

-Xiamen Compower Sterilization Validation Report, Report No.: MDS-RES-220422-046

-Xiamen Compower Sterilization Validation Report, Report No.: MDS-RES-220422-047

Additional Instructions: None:

It is the duty of the user to ensure that the reprocessing processes including resources, materials and personnel are capable to reach the required results. State of the art and often national law requiring these processes and included resources to be validated and maintained properly.

**Assemble:**

Assemble in the sequence shown in the assembly structure:

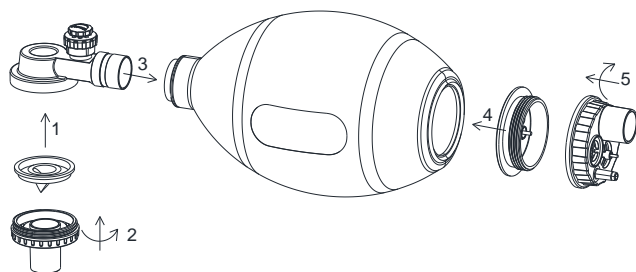

After the assembly is completed, the functional test is carried out according to the requirements of the **Functional Test** section.

**Disposal:**

Dispose of all materials in accordance with hospital protocols and procedures and all applicable local, state, and federal regulations.

Decontaminate and dispose of all potentially biohazardous material.

**Electronic IFU (e-IFU)**

The e-IFU is available in PDF format and can be downloaded from the website:

[http://www.cpmmedi.com/en/list\\_9793.html](http://www.cpmmedi.com/en/list_9793.html)

**The device can only be used for up to 1-hour limit.**

**Symbols and Explanations**

	Batch code		Date of manufacture		Use-by date
	Manufacturer		Consult instructions for use		Does not contain natural rubber latex
	Authorised representative in the European Community				Caution
	Non-sterile		Does not contain phthalate		Medical device

**CE 0197**



Xiamen Compower Medical Tech. Co., Ltd.  
 Unit 301, No.16, Xianghong Road, Xiang'An Torch Industrial Zone,  
 Xiamen, Fujian, 361101, P.R. China  
 Tel: +86-592-5799319 Fax: +86-592- 5796765  
 E-mail: [info@cpmedi.com](mailto:info@cpmedi.com)

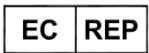

Shanghai International Holding Corp. GmbH (Europe)

Eiffestrasse 80, 20537 Hamburg, Germany

Tel: 0049-40-2513175 Fax: 0049-40-255726

**Any serious incident that has occurred in relation to the device should be reported to the manufacturer and the competent authority of the Member State in which the user and/or patient is established.**