

# Comprehensive **solutions** for healthcare **providers**

Product catalogue  
2024/2025

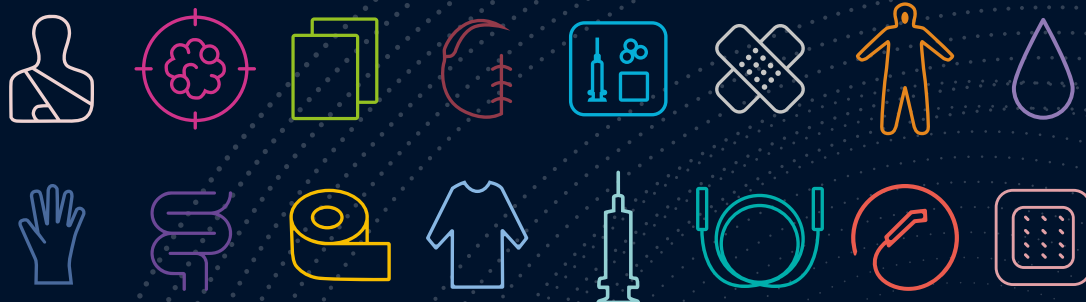

# 1989

**tradition since**

ZARYS is a family-owned company with Polish capital, operating on the market since 1989

Evolution from a small enterprise to a leader in the sourcing industry is a process that led to the creation of more comprehensive offers and solutions that facilitate the work of medics and save the lives of patients. ZARYS is currently hiring over 400 people, who are working to serve thousands of clients operating in the field of health care worldwide.

we provide

# medical disposable devices

to cover over



basic medical devices



gloves



dressings



medical clothing



surgical drapes and gowns

## comprehensive medical supplies for hospitals

The company's customers have many product groups at their disposal, starting from medical gloves, through dressing materials, to operating kits and treatment packages. Products from different categories have individual characteristics and specific purposes. In order to facilitate the identification of materials and improve the ordering process, 13 different categories were created in addition to the latest category „ZARYS kids“.

# 900%

## of the hospital's needs



surgical sets



personal protective equipment



patient hygiene



pharmaceutical line



sports & physiotherapy products

## being a manufacturer of disposable medical equipment, ZARYS meets the highest required standards

Part of ZARYS production plants are located in Silesia and combine sterile production - a cleanroom with an area of over 600 m<sup>2</sup> - a place for manufacturing dedicated operating sets, a sewing room and an automated production line.

pro



## Zarys logistic center

The ZARYS logistic center is the largest warehouse of disposable medical equipment in Central Europe. Located in Zabrze area as part of Katowice Special Economic Zone. Modern, high-bay warehouse, occupies an area of over 30 000 m<sup>2</sup>.

the lar  
ware



**production**  
**made in Poland**



**clean**  
**room**



**gest**  
**house**

**30 000** m<sup>2</sup>

**of medical**  
**disposable**  
**devices**  
**in Central**  
**Europe**

ZARYS



WWW.ZARYS.COM

# TABLE OF CONTENTS

ZARYS



## NITRILE GLOVES

- 13 **easyCARE** nitrile
- 13 **easyCARE** nitrile long **NEW**
- 14 **easyCARE** nitrile pink
- 14 **easyCARE** nitrile black
- 15 **easyCARE** nitrile berry **NEW**
- 16 **easyCARE** nitrile Hydra+

## INDUSTRIAL GLOVES

- 19 **Gripzzly** black **NEW**
- 19 **Gripzzly** blue **NEW**
- 19 **Gripzzly** orange **NEW**
- 19 **Gripzzly** X **NEW**

## LATEX GLOVES AND VINYL GLOVES

- 21 **HIGH RISK** **NEW**
- 22 **easyCARE** latex
- 22 **easyCARE** latex PF
- 23 **easyCARE** vinyl PF

## LATEX SURGICAL GLOVES

- 25 **SafeCARE** powdered **NEW**
- 25 **SafeCARE pf** powder-free **NEW**
- 28 **SafeCARE premium** powder-free **NEW**
- 29 **SafeCARE ortho** powder-free **NEW**
- 29 **SafeCARE micro** powder-free **NEW**

## SURGICAL GLOVES

- 31 **SafeCARE synthetic** powdered **NEW**



# BASIC MEDICAL DEVICES

pp. 32-87

## BASIC INJECTION EQUIPMENT

- 35 **dispoFINE** injection needle
- 35 **dispoGUARD** safety injection needle
- 36 **dispoSULIN** insulin pen needle
- 36 **dicoSPIKE, dicoSPIKE Chemo** withdrawal cannula
- 38 **duoNEX** single-use syringe, 2-part, Luer
- 38 **dicoNEX SN** single-use syringe, 3-part, Luer, with needle alongside the syringe
- 39 **dicoNEX** single-use syringe, 3-part, Luer
- 39 **dicoNEX** single-use syringe, 3-part, Luer-Lock
- 40 **dicoNEX** single-use syringe, 3-part, Luer-Lock + amber
- 40 **dicoNEX** single-use catheter syringe, 3-part
- 41 **dicoTUBER** tuberculin syringe
- 41 **dicoSULIN** insulin syringe

## INFUSION THERAPY

- 43 **SANViflon** I.V. cannula
- 43 **SANViflon S** I.V. cannula without port
- 44 **easyFLOW IS PREMIUM** infusion set **BESTSELLER**
- 44 **easyFLOW IS** infusion set
- 45 **easyFLOW IS** infusion set (dual chamber) **BESTSELLER**
- 45 **easyFLOW IS ECO** infusion set
- 46 **easyFLOW IS SAFE** infusion set
- 46 **easyFLOW IS AMBER** infusion set, amber
- 47 **easyFLOW IS REG** infusion set with precision flow rate regulator
- 47 **easyFLOW TS PREMIUM** transfusion set **BESTSELLER**
- 48 **easyFLOW TS** transfusion set
- 48 **easyFLOW LINE** extension tube for infusion pump
- 49 needle-free valve
- 49 needle free valve with extension line
- 50 3-way stopcock
- 50 3-way stopcock with extension tube
- 51 cannula stopper

## OXYGEN THERAPY

- 53 nasal oxygen cannula
- 53 oxygen tubing
- 53 oxygen mask
- 54 non-rebreather mask
- 54 multi-vent mask
- 54 nebulizer mask
- 55 nebulizer

## ANAESTHESIA PRODUCTS

- 57 endotracheal tube uncuffed
- 57 endotracheal tube cuffed
- 57 reinforced endotracheal tube cuffed
- 58 intubation stylet
- 58 tracheal tube introducer
- 58 endotracheal tube holder
- 59 oropharyngeal airway/guedel airway
- 59 laryngeal mask PVC
- 60 laryngeal mask silicone
- 60 tracheostomy tube cuffed
- 61 air cushion anaesthetic mask
- 61 anaesthetic mask with open seal
- 62 catheter mount with double swivel
- 62 elbow connector
- 62 dual-limb breathing circuit

## SUCTION CATHETERS, STOMACH TUBES

- 64 suction catheter with vacuum control
- 64 suction catheter
- 65 suction catheter with frozen surface
- 65 feeding tube graduated, with X-ray contrast
- 67 stomach tube/duodenal tube

## UROLOGICAL CATHETERS, URINE BAGS

- 68 Foley catheter 2-way, silicone-coated latex
- 69 Foley catheter 3-way, silicone-coated latex
- 69 Foley catheter 2-way with tiemann tip, silicone-coated latex
- 70 Foley catheter 2-way, 100% silicone
- 70 Foley catheter 3-way, 100% silicone
- 71 Nelaton catheter
- 71 Tiemann catheter
- 72 Pezzer catheter silicone-coated latex
- 72 urine bag with sample port 2W
- 73 urine bag
- 73 urine bag with sample port
- 74 urine bag with absirbet, non sterile
- 74 samples taking urine bag
- 74 urine bag hanger

## GENERAL SURGERY

- 76 Yankauer surgical suction cannula, standard CH21
- 76 Yankauer surgical suction cannula, bulb tip CH23
- 77 surgical suction tube
- 77 surgical suction set with Yankauer cannula, standard
- 78 surgical suction set with Yankauer cannula, bulb tip

## BASIC PRODUCTS FOR GYNECOLOGY

- 80 vaginal speculum, cusco type
- 80 cervical brush, standard
- 81 cervical brush, special
- 81 umbilical cord clamp

## OTHER PRODUCTS

- 83 ID wristband
- 83 entrance mat
- 83 enema bag
- 84 enema bag
- 84 enema set
- 84 vomit bag
- 85 tactical tourniquet CAT
- 85 automatic tourniquet
- 86 latex-free tourniquet
- 86 tongue depressor
- 87 electronic thermometer
- 87 **safeLANCE**, pressure-activated safety lancet

# DRESSINGS pp. 88-127



## TRADITIONAL DRESSING MATERIALS

### gauze and non-woven dressings

- 91 **GAZA lux** dressing gauze, zig-zag folded
- 91 **GAZA lux** cutting gauze
- 91 **GAZA lux S** cutting gauze
- 92 **KOMPRI lux** gauze swabs **BESTSELLER**
- 93 **KOMPRI lux S** gauze swabs
- 94 **SERVI lux** gauze lap sponges
- 94 **SERVI lux S** gauze lap sponges
- 95 **TUPFER lux** gauze balls
- 95 **TUPFER lux S** gauze balls
- 96 **NONVI lux** non-woven swabs
- 96 **NONVI lux S** non-woven swabs
- 96 **NONVI lux S** non-woven swabs, with Y-incision
- 97 **MULTIabsorb** ABD pads, multi-layer
- 97 **MULTIabsorb S** ABD pads, multi-layer
- 98 **elastoLUMENAL** eye pads
- 98 **elastoLUMENAL S** eye pads
- 98 **cellPAD** cellulose swabs **BESTSELLER**

## ADHESIVE TAPES AND PLASTERS WITH DRESSING

### adhesive tapes

- 100 **SENSiplast** adhesive fabric tape, white
- 100 **PLASTiplast** adhesive fabric tape, skin colour
- 101 **SOFTplast** adhesive non-woven tape
- 101 **SILKplast** adhesive silk tape
- 101 **SILLCoplast** adhesive perforated non-woven tape
- 102 **FILMplast** adhesive PE tape
- 102 **POREplast** adhesive perforated non-woven tape

### plasters with dressing

- 103 **NONVIplast** non-woven plaster with dressing
- 103 **FABRIplast** fabric plaster with dressing

## SPECIAL PURPOSE DRESSINGS

### self-adhesive non-woven dressings

- 105 **elastopor, elastopor E** adhesive non-woven dressing tape
- 106 **elastopor STERIL** non-woven dressing with absorbent pad **BESTSELLER**
- 106 **elastoKIDS STERIL** non-woven dressing with absorbent pad
- 107 **elastopor IV** non-woven IV cannula dressing **BESTSELLER**
- 107 **elastoKIDS IV** non-woven IV cannula dressing
- 108 **elastopor STERIL D** non-woven dressing with absorbent pad, incision and O-hole
- 108 **elastoKIDS STERIL D** non-woven dressing with absorbent pad
- 109 **elastopor EYE, elastoKIDS EYE** non-woven eye dressing with absorbent pad
- 109 **elastoKIDS** colorful kids plasters

## stabilizing tapes

- 110 | **elastoNASAL** non-woven nasal cannula fixation plaster
- 110 | **elastoNASAL KIDS** non-woven nasal cannula fixation plaster
- 111 | **elastoFIXAL** adhesive tape for catheter tubing fixation
- 111 | **elastoFIXAL KIDS** adhesive tape for catheter tubing fixation
- 111 | **elastoFIXAL Set** adhesive tape for endotracheal tube
- 112 | **elastoFIXAL Set KIDS** adhesive tape for endotracheal tube
- 112 | **elastoFIXAL TUBE** band for tracheostomy tube fixation
- 112 | **elastoDERM C** adhesive dressing pouch for dialysis catheters **NEW**

## STABILIZING DRESSINGS

### fixation of dressings

- 114 | **elastoBAND BASIC** knitted supporting bandage
- 114 | **elastoBAND KNITT** elastic supporting bandage, knitted **BESTSELLER**
- 115 | **elastoBAND FLEX** elastic supporting bandage, woven
- 115 | **elastoBAND FLEX S** elastic supporting bandage, woven **NEW**
- 115 | **elastoBAND FIX** elastic supporting bandage, woven **BESTSELLER**
- 116 | **elastoBAND CREPP** cohesive supporting bandage, non-woven **BESTSELLER**
- 116 | **yellowBAND** cohesive bandage
- 117 | **elastoNET** elastic tubular net bandage

### immobilizing dressings

- 118 | **orthoNATURAL** orthopedic padding, natural
- 118 | **orthoSYNTHETIC** orthopedic padding, synthetic
- 119 | **elastoSLING** triangular sling
- 120 | **orthoBAND FAST** P.O.P. bandages
- 120 | **orthoBAND NORMAL** P.O.P. bandages
- 120 | **orthoBAND LONG** P.O.P. bandages

## SPECIALIST DRESSINGS

- 123 | **paraffiNET** paraffin gauze dressing

### foil dressings

- 123 | **elastoDERM** foil dressing
- 123 | **elastoDERM PAD** foil dressing with absorbent pad
- 124 | **elastoDERM F** foil dressing with frame
- 124 | **elastoDERM F-IV** IV cannula dressing with frame
- 124 | **elastoDERM IV** IV cannula dressing

## ADDITIONAL PRODUCTS

- 126 | **thermPAD** cold/warm compress **BESTSELLER**
- 126 | **gynPAD** gynaecological-maternity pad **BESTSELLER**
- 126 | **Alcohol Prep Pad** gauze pad moistened with alcohol
- 127 | **ALKOPAD** gauze pad moistened with alcohol
- 127 | **ALKOPAD DUO** gauze pad moistened with alcohol
- 127 | **thermCARE** rescue blanket, foil, termic

## DELTA SET

pp. 128-138

### STANDARD DELTA SET SURGICAL KITS

- 133 | puncture kit 1
- 134 | suture removal kit 1
- 134 | urinary bladder catheterization kit 1
- 135 | urinary bladder catheterization kit 2
- 135 | dialysis on kit 1a
- 136 | dialysis off kit 1b
- 136 | dialysis on/off kit 2
- 137 | anesthesia kit 1
- 137 | suture application kit 1
- 138-139 | beWELL **NEW**



## OMEGAPACK

pp. 140-145

### PROCEDURE SETS

- 142 | components of the set
- 144 | advantages of using surgical sets
- 145 | components of our set



## PERSONAL PROTECTIVE EQUIPMENTS

pp. 146-147

### BETASAFE

- 147 | protective coverall **SAFE+**



## SURGICAL SETS, DRAPES, GOWNS

pp. 148-205

### SURGICAL DRAPES

#### 2-layer surgical drapes

- 159 | sterile surgical drapes with cellulose layer
- 159 | sterile surgical drapes (economic version)
- 159 | sterile surgical drapes
- 159 | sterile surgical drapes with adhesive edge (economic version)
- 160 | sterile surgical drapes with adhesive edge
- 160 | sterile surgical drapes with central fenestration (economic version)
- 160 | sterile surgical drapes with central fenestration
- 160 | sterile surgical drapes with adhesive central fenestration (economic version)
- 160 | sterile surgical drapes with adhesive central fenestration
- 161 | sterile surgical drapes with adhesive central adjustable fenestration (economic version)
- 161 | sterile surgical drapes with adhesive central adjustable fenestration
- 161 | sterile adhesive epidural drapes
- 161 | sterile instrument table covers

#### 3-layer surgical drapes

- 162 | sterile surgical drapes
- 162 | sterile surgical drapes with adhesive edge
- 162 | sterile surgical drapes with central fenestration
- 163 | sterile surgical drapes with adhesive central fenestration
- 163 | sterile surgical drapes with adhesive fenestration, reinforced

#### specialistic surgical drapes

- 164 | abdominal drape 1-IF
- 164 | abdo-perineal drape 1
- 164 | laparoscopy drape 3
- 165 | orthopaedic drape 1
- 165 | orthopaedic drape 2
- 165 | orthopaedic drape 3
- 165 | orthopaedic drape 4
- 166 | extremity drape 1
- 166 | extremity drape 2
- 166 | extremity drape 3
- 166 | extremity drape 4
- 167 | extremity drape 5
- 167 | gynaecology drape 1
- 167 | gynaecology drape 2
- 167 | delivery drape 1
- 168 | ophthalmic drape 1-IF
- 168 | ophthalmic drape 2-IF
- 168 | ophthalmic drape 3-IF
- 168 | ophthalmic drape 4-IF
- 168 | ophthalmic drape 5-IF

### SURGICAL COVERS, ACCESSORIES

#### surgical covers

- 170 | sterile mayo stand cover, reinforced - red **BESTSELLER**
- 170 | sterile set of limb cover
- 170 | sterile limb cover
- 170 | sterile limb cover - sleeve protector
- 170 | sterile camera cables cover - perforated, with 2 adhesive tapes **BESTSELLER**
- 171 | sterile camera cable cover - unperforated, with an adhesive tape

- 171 | sterile circular banded covers for medical devices
- 171 | sterile rectangular banded covers for medical devices
- 171 | sterile c-arm cover set
- 171 | sterile armboard cover set

### accessories

- 172 | sterile surgical tapes
- 172 | sterile adhesive pouches
- 172 | sterile adhesive fluid collection pouch
- 172 | sterile absorbent drape
- 173 | sterile absorbent drape
- 173 | sterile incise film **elastoFILM**

### SURGICAL SETS

#### universal sets

- 175 | basic set 1
- 175 | universal set 1
- 175 | universal set 2
- 175 | universal set 4 **BESTSELLER**
- 176 | universal set 5 **BESTSELLER**
- 176 | universal set 5-M **NEW**
- 177 | universal set 5-G
- 177 | universal set 5-GP
- 178 | universal set 6 **BESTSELLER**
- 178 | universal set 6-M
- 179 | universal set 7
- 179 | universal set 8 **BESTSELLER**
- 180 | pediatric universal set 9
- 180 | universal set 10



## general surgery

181	abdominal set 1-IF
181	abdo-perineal set 1
182	laparoscopy set 1-IF
182	laparoscopy set 2 <b>BESTSELLER</b>
183	laparoscopy set 3
183	varicose vein set 1
183	varicose vein set 2

## orthopaedics and traumatology

184	extremity set 1
184	extremity set 2
185	arthroscopy set 1
185	arthroscopy set 2
186	arthroscopy set 2-IP
186	arthroscopy set 3
187	arthroscopy set 4-IP
187	arthroscopy set 5
188	hip set 1
188	hip set 2
189	hip set 3
189	shoulder set 1
190	shoulder set 2
190	dynamic hip screw set 1-IF <b>NEW</b>
190	vertical isolation set 1-IP <b>NEW</b>

## gynaecology and urology

191	gynaecology set 1
191	gynaecology set 2 <b>BESTSELLER</b>
192	gynaecology set 3
192	cystoscopy set 1
192	uro/gynaecology set 2
193	uro/gynaecology set 3
193	tur set 1-IP
193	tur set 2-IP <b>BESTSELLER</b>
193	tur set 3-IP <b>NEW</b>
194	percutaneous lithotripsy set 1-IP <b>NEW</b>

## obstetrics

194	c-section set 1
195	c-section set 1-IF
195	c-section set 2-IF
196	c-section set 3-IF
196	delivery set 1
196	delivery set 2
197	delivery set 3
197	delivery set 4
197	delivery set 5

## ophthalmology

198	ophthalmic set 1-IF <b>NEW</b>
198	ophthalmic set 2-IF
198	ophthalmic set 3-IF

## neurosurgery and otolaryngology

199	otolaryngology set 1
199	otolaryngology set 2
199	craniotomy set 1-IF

## cardiosurgery and angiography

200	ablation set 1-IF
200	angiography set 2
200	angiography set 3

## SURGICAL GOWNS

202	sterile gown NORMAL - 22
202	surgical gown STANDARD - 35 <b>BESTSELLER</b>
202	surgical gown STANDARD - 35 (economic version)
202	surgical gown STANDARD - 40 <b>NEW</b>
203	surgical gown STANDARD - 45
203	surgical gown STANDARD PLUS - 35 <b>BESTSELLER</b>
203	surgical gown STANDARD PLUS - 35 (economic version)
204	surgical gown STANDARD PLUS - 40 <b>NEW</b>
204	surgical gown STANDARD PLUS - 45
204	surgical gown EXTRA SAFE - 35 <b>BESTSELLER</b>
204	surgical gown COMFORT - 68
205	surgical gown COMFORT PLUS - 68

## non-sterile surgical gowns

205	surgical gown STANDARD - 35
205	surgical gown PREMIUM - 35

# MEDICAL CLOTHING

pp. 206-233



## MEDICAL GOWNS

209	medical gown with elastic cuffs, non-woven
209	medical gown with knitted cuffs, non-woven

## SURGICAL CLOTHING

211	surgical suit, short-sleeved shirt+trousers, non-woven
212	surgical shirt, short-sleeved, non-woven
212	surgical shirt, long-sleeved, non-woven
213	surgical trousers, with ties, non-woven

## CAPS, PROTECTIVE MASKS AND CLOUING

215	medical bouffant cap, non-woven
215	<b>DONA</b> medical bouffant cap
215	<b>LILI</b> medical cap with rubber
216	<b>POLA</b> medical cap with rubber
216	<b>SOL</b> medical cap with ties
216	<b>ABI</b> medical cap with ties
216	<b>BEN</b> medical cap with ties

217	<b>NINO</b> medical cap
217	<b>KOKO long</b> medical cap with snood
217	<b>DORA long</b> medical cap with snood
218	<b>TOM</b> medical cap with ties
218	<b>ROS</b> medical cap with ties
218	<b>NURSE'S CAP CLIP TYPE NEW</b>
219	<b>OLAF</b> medical cap with ties
219	<b>MAYA</b> medical cap with rubber
220	medical mask with ties
220	medical mask with earloops
220	medical mask with earloops
221	PE gloves
221	PE oversleeves

## PATIENT CLOTHING

223	patient's gown, tied-up, non-woven
223	patient's gown, Y-neck, non-woven
223	patient's gown, V-neck, non-woven
224	patient's gown, for delivery, non-woven
224	patient's gown, for children, non-woven <b>NEW</b>
224	colonoscopy boxers, SMS non-woven
225	colonoscopy boxers, PP non-woven
225	gynecological skirt, non-woven
225	anti-thrombosis stocking <b>NEW</b>

## SHOE COVERS

227	shoe covers
227	shoe covers, calf-high

## BEDCLOTHES

229	disposable medical bed sheet
229	disposable medical pillow case
229	disposable medical quilt cover
229	disposable medical bedding set
230	disposable medical bed sheet, reinforced
230	thermal patient cover soft
230	thermal patient cover

## BEDCLOTHES

232	disposable absorbent underpad
232	disposable absorbent underpad for operating table
232	absorbent underpad for children
233	absorbent medical pad <b>NEW</b>
233	absorbent medical underpad for operating table <b>NEW</b>
233	hygienic pet underpad

# PATIENT HYGIENE

pp. 234-240

## WASHCLOTHS AND TOWELS

237	wet wipes for children <b>NEW</b>
237	waterless body wash wipes <b>NEW</b>
237	waterless body wash gloves <b>NEW</b>
238	waterless hair wash cap <b>NEW</b>
238	disposable towel, non-woven - SPUNLACE
238	disposable towel

239	wash glove - molton,
239	wash glove - Spunlace,
239	wash glove with film lining,

240	dental brush with suction,
240	oral swab,

# VITAHEALTH

pp. 242-243



## EXAMINATION GLOVES

The device is intended for patient diagnostics, providing a barrier to the transmission of microorganisms between the operator and the patient, minimizing the risk of cross-contamination.

**NITRILE GLOVES** are made of synthetic acrylonitrile butadiene rubber (NBR), they are an alternative to latex gloves. They do not contain latex proteins, and the content of chemical accelerators is minimized, so they are friendly to the skin.

They are characterized by:

- high **mechanical strength** (also for puncture),
- **chemical and biological resistance** (constitute a barrier for viruses and bacteria),
- **flexibility**, thanks to which they adjust to the hand, providing the work comfort to the user.

**VINYL GLOVES** made of PVC (polyvinyl chloride) are intended for low-risk procedures due to limited mechanical, chemical and biological resistance. The glove material does not cause Type I allergic reactions, ZARYS vinyl gloves are free of harmful phthalates.

**LATEX GLOVES** made of natural rubber are recognized as the best barrier against blood borne pathogens and part of hazardous chemical substances. They are also characterized by high flexibility, providing the work comfort to the user by fitting to the hand like a „second skin”. Latex gloves, due to the natural raw material, are biodegradable.

## STERILE, SURGICAL AND PROTECTIVE GLOVES

Made from natural rubber latex, intended to be worn on hands in surgical settings to provide barrier against potentially infectious fluids or other contaminants, and to protect the patient by ensuring sterility of the wound area. These gloves are intended for single use only, and are classified as Medical Devices Class IIa as well as a Personal Protective Equipment Category III. The indicated Gloves are designed to protect against substances and mixtures which are hazardous and against harmful biological agents.

# gloves

nitrile gloves | latex gloves  
| vinyl gloves | industrial gloves  
| latex surgical gloves  
| synthetic surgical gloves



ZARYS

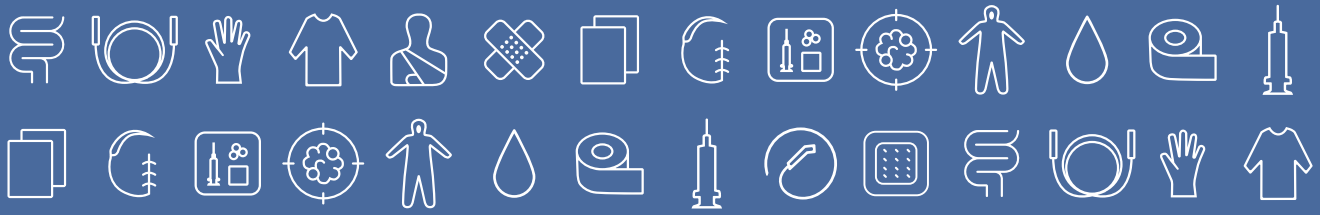

WWW.ZARYS.COM



# NITRILE GLOVES

# easyCARE nitrile

type	examination glove, <b>nitrile</b>
external surface	micro-textured with additional texturing at the fingertips
internal surface	chlorinated
cuff	beaded
AQL	1.0
classification	class I medical device personal protective equipment category III
length	245 mm
features	increased tactile sensitivity
packing unit/ bulk packing	100 pcs / 10 x 100 pcs 200 pcs / 10 x 200 pcs
REF	RNBXX10001 (XX:XS-XL) RNBXX20001 (XX:XS-XL)



sizes



# easyCARE nitrile long

NEW

type	examination glove, <b>nitrile</b> , with extended cuff
external surface	micro-textured with additional texturing at the fingertips
internal surface	chlorinated
cuff	beaded
AQL	1.0
classification	class I medical device personal protective equipment category III
length	300 mm
features	increased tactile sensitivity, extended cuff
packing unit/ bulk packing	100 pcs / 10 x 100 pcs
REF	RNBXX10001 (XX:S-XL)



sizes



# easyCARE nitrile pink

type	examination glove, <b>nitrile</b>
external surface	micro-textured with additional texturing at the fingertips
internal surface	chlorinated
cuff	beaded
AQL	1.0
classification	class I medical device personal protective equipment category III
length	240 mm
features	intense colour
packing unit/ bulk packing	100 pcs / 10 x 100pcs
REF	RNBRXX10001 (XX:XS-L)



# easyCARE nitrile black

type	examination glove, <b>nitrile</b>
external surface	micro-textured with additional texturing at the fingertips
internal surface	chlorinated
cuff	beaded
AQL	1.0
classification	class I medical device personal protective equipment category III
length	240 mm
features	increased endurance
packing unit/ bulk packing	100 pcs / 10 x 100pcs
REF	RNBCXX10001 (XX:XS-XL)



# easyCARE nitrile berry

NEW

type	examination glove, <b>nitrile</b>
external surface	micro-textured with additional texturing at the fingertips
internal surface	chlorinated
cuff	beaded
AQL	1.0
classification	class I medical device personal protective equipment category III
length	240 mm
features	intense colour
packing unit/ bulk packing	100 pcs / 10 x 100pcs
REF	RNBMXX10001 (XX:XS-L)



sizes



## pink black berry



# mediCARE nitrile Hydra+

## Dermatology solution for skin problems

gloves that protect and nourish the hands, while providing long-lasting hydration



### Almond oil

regenerates, moisturizes, slows the aging process of the skin, smoothen, firms and helps removing dead cells, brighten the skin, soothen irritations and accelerates healing skin lesions, strengthens the hydro-lipid layer of the skin



### Vitamin E

natural antioxidant, vitamin of youth – flights off free radicals and prevents wrinkles, moisturizes for a long time



### Glycerin

moisturizes, improves skin appearance, smoothen and soothes irritations



### Anti-wrinkle effects proven in clinical test\*

\*mediCARE Hydra+ glove presents a better anti-wrinkle effect compared to a traditional nitrile glove with visible reduction of wrinkles from the first day of use with progressive increase in improvement until the end of the tests.

## Nitrile gloves with moisturizing and nourishing coating

type	examination glove, <b>nitrile</b>
external surface	micro-textured with additional texturing at the fingertips
internal surface	chlorinated
cuff	beaded
AQL	1.0
classification	class I medical device personal protective equipment category III
length	240 mm
features	moisturizing and nourishing coating
packing unit/ bulk packing	100 pcs / 10 x 100 pcs
REF	RNBHXX10003 (XX:XS-XL)



sizes



protection against blood-borne pathogens



protection against chemotherapy drugs



acceptable quality level EN 455-1 EN ISO 374-2



ZARYS

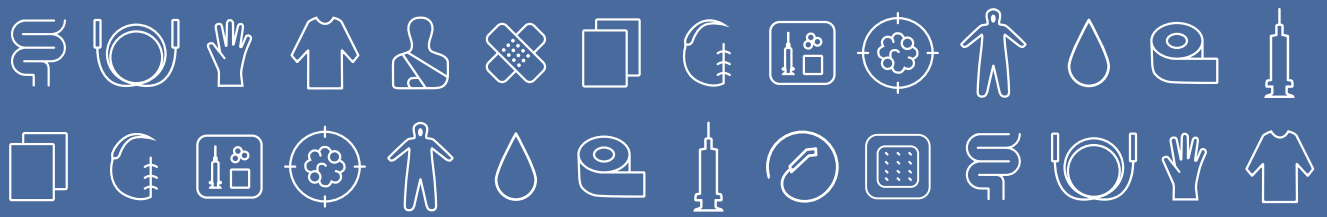

WWW.ZARYS.COM



# INDUSTRIAL GLOVES

Gripzzly gloves are made of high-quality nitrile and are characterized by extraordinary strength and thickness. This translates into their durability and increased resistance to all kinds of damage. Gripzzly gloves provide comfort, especially during prolonged and demanding tasks.

### diamond texture



allows you to use your smartphone without taking off your gloves

reduces hand perspiration, providing excellent air circulation inside the glove

offers excellent protection and comfort in use

makes the glove fit the shape of the hand

provides a precise and secure grip

### work safety

Gripzzly gloves are a guarantee of safety and comfort at work. They are not prone to tearing and abrasion, making them ideal for use in harsh and demanding conditions. They are characterized by resistance to a variety of oils, greases and other chemicals, ensuring safety at work.

Gripzzly are excellent protection for the hands of workers exposed to contact with sharp tools and other dangerous objects. They are recommended for those working in many industries, such as the chemical, pharmaceutical and automotive industries, exposed to chemicals.



# Gripzzy



type	industrial glove	REF	colour
external surface	diamond texture	RNBDCXX5005	black
internal surface	polymer coated	RNBDNXX5005	blue
cuff	beaded	RNBDPXX5005	orange
AQL	1.5	(XX-S-XXL)	
classification	PPE cat.III		
length	min. 245mm		
features	extra strong with diamond texture		
packing unit/ bulk packing	50pcs/ 10 x 50pcs		



# Gripzzy X



type	industrial glove
external surface	external surface: textured on the entire surface of the glove
internal surface	polymer coated
cuff	beaded
AQL	1.5
classification	PPE cat.III
length	min. 300mm
features	extra strong with long cuff
packing unit/ bulk packing	100pcs/ 10 x 100pcs
REF	RNBPCXX10003 (XX-S-XXL)



ZARYS

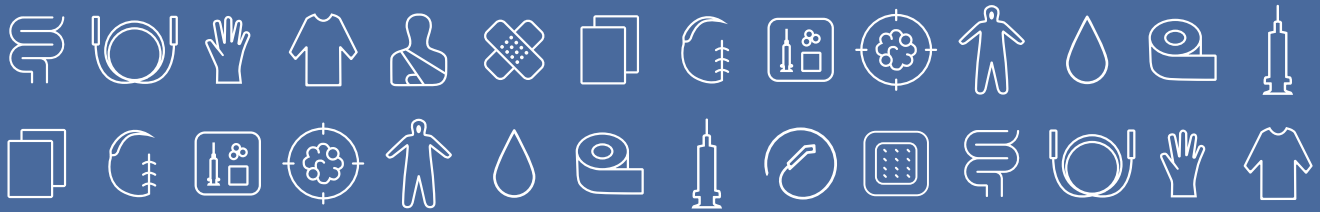

WWW.ZARYS.COM



# LATEX AND VINYL GLOVES

# HIGH RISK

INTENDED FOR: DIAGNOSTIC PROCEDURES WHERE THERE IS AN INCREASED RISK OF INFECTION

LENGTH OF GLOVE: **30 cm**

**ADDITIONAL TEXTURE ON FINGERTIPS**  
**POWDER - FREE GLOVE, INTERNALLY CHLORINATED**

**EXTRA**



**STRONG**

**NEW**

type	examination glove, <b>latex</b>
external surface	micro-textured with additional texturing at the fingertips
internal surface	powder-free, chlorinated
cuff	beaded
AQL	1.0
classification	class I medical device personal protective equipment category III
length	300 mm
features	increased endurance
packing unit/ bulk packing	50 pcs / 10 x 50 pcs
REF	RLBHRXX5008 (XX:S-XL)



sizes



protection against  
blood-borne pathogens



protection against  
chemotherapy drugs



extra protection



acceptable quality  
level EN 455-1  
EN ISO 374-2

# easyCARE latex

type	examination glove, <b>latex</b>
external surface	micro-textured with additional texturing at the fingertips
internal surface	powdered
cuff	beaded
AQL	1.0
classification	class I medical device personal protective equipment category III
length	245 mm
features	biodegradable
packing unit/ bulk packing	100 pcs / 10 x 100 pcs
REF	RLPXX10007 (XX:XS-XL)



sizes



protection against  
blood-borne pathogens



acceptable quality  
level EN 455-1  
EN ISO 374-2

# easyCARE latex PF

type	examination glove, <b>latex</b>
external surface	micro-textured with additional texturing at the fingertips
internal surface	powder-free, polymer coated
cuff	beaded
AQL	1.0
classification	class I medical device personal protective equipment category III
length	245 mm
features	easier donning due to inner polymer coating / biodegradable
packing unit/ bulk packing	100 pcs / 10 x 100 pcs
REF	RLBXX10007 (XX:XS-XL)



sizes



protection against  
blood-borne pathogens



acceptable quality  
level EN 455-1  
EN ISO 374-2

# easyCARE vinyl PF

type	examination glove, <b>vinyl</b>
external surface	smooth
internal surface	powder-free
cuff	beaded
AQL	1.5
classification	class I medical device personal protective equipment category III
length	240 mm
packing unit/ bulk packing	100 pcs / 10 x 100 pcs
REF	RWBXX10001 (XX:XS-XL)



sizes



protection against  
blood-borne pathogens



acceptable quality  
level EN 455-1  
EN 374-2

ZARYS

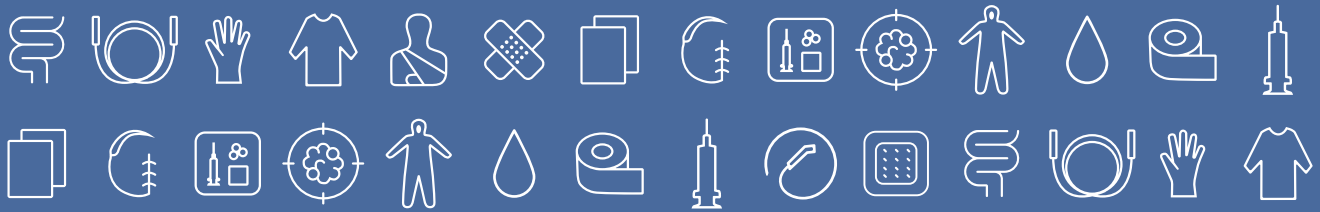

WWW.ZARYS.COM



# LATEX SURGICAL GLOVES



# SsafeCARE



**NEW**

type	natural rubber <b>latex</b> , sterile
external surface	smooth with micro -textured
internal surface	powdered
cuff	extended cuff, beaded
AQL	0.65
classification	class IIa medical device personal protective equipment category III
features	standard powdered latex surgical glove
packing unit/ bulk packing	1 pair / 1 x 50 pair
REF	RCHLP-XX-50-03 (XX:5.5-9.0)
sizes	5.5 - 9.0



**STERILE R**



protection against  
blood-borne pathogens



protection against  
chemotherapy drugs



acceptable quality  
level EN 455-1  
EN ISO 3742

# SsafeCARE pf



**NEW**

type	natural rubber <b>latex</b> , sterile
external surface	smooth with micro -textured
internal surface	powder-free
cuff	extended cuff, beaded
AQL	0.65
classification	class IIa medical device personal protective equipment category III
features	standard powder-free latex surgical glove
packing unit/ bulk packing	1 pair / 1 x 50 pair
REF	RCHLB-XX-50-03 (XX:5.5-9.0)
sizes	5.5 - 9.0



**STERILE R**



protection against  
blood-borne pathogens



protection against  
chemotherapy drugs



acceptable quality  
level EN 455-1  
EN ISO 3742

# Save space increase safety

reduction  
of occupied  
space

even up to  
**80%**



## ● Ease of customisation

The dispenser's ability to open both vertically and horizontally makes it easily adaptable to almost any space.

## ● Saving space

The compact dispenser reduces space requirements by up to 80% compared to standard packaging.

## ● Easy access

The packaging ensures easy access to the gloves and their optimal storage.

## ● Sustainable development

Smaller packaging means less cardboard is used, which contributes to waste reduction and a lower environmental impact.



# SsafeCARE



The safeCARE surgical glove packaging system is a breakthrough in space management and hygiene in medicine. The compact dispenser can accommodate up to 50 pairs of sterile gloves, reducing space requirements by up to 80 per cent compared with standard packaging of this type.

safeCARE surgical glove packaging not only ensures **easy access and optimum storage**, but also helps maintain a **high standard of hygiene and safety**, protecting against contamination and damage. They also offer consumption control, which allows for **efficient stock management**.



- **Saving time and increasing work efficiency**

An additional opening for returning unopened pairs of gloves saves time and increases staff efficiency without having to open the entire pack.

- **Safety and hygiene**

The packaging ensures a high standard of hygiene and safety, protecting against contamination and damage.

- **Consumption control**

Possibility of efficient stock management, thanks to the glove wear control function.

# NEW safeCARE premium

type of glove	surgical latex powder-free sterile gloves
external surface	smooth with microtexture
internal surface	polymer coated
cuff	extended straight with rolled edge
AQL	0.65
classification	class IIA medical device category III personal protective equipment
length	median above 285 mm
characteristic	anatomical shape, cream colour
unit packaging / bulk packaging	1pair / dispenser 50par / carton 200pairs (4x50)
catalog number	RCHLBP-XX-50-09 (XX - size: 5.5 - 9.0)



protection against  
blood-borne pathogens



protection against  
chemotherapy drugs



acceptable quality  
level EN 455-1  
EN ISO 374-2



## Precise protection, reliable durability

- with increased durability
- soft and flexible
- with enhanced tear resistance
- recommended for work with cytostatic drugs in aseptic conditions
- recommended for double gloving procedures



The use of an inner coating in gloves is an innovative solution that facilitates putting them on both dry and wet hands. Quantum Secure Technology reduces friction and improves user comfort. The QST coating ensures safety while harmoniously integrating with the glove's structure, guaranteeing optimal durability and flexibility, while also enhancing hygiene and protection standards.

**NEW** **SsafeCARE** ortho **secure** technology

type of glove	surgical latex powder-free sterile gloves
external surface	smooth with microtexture
internal surface	polymer coated
cuff	extended straight with rolled edge
AQL	0.65
classification	class IIa medical device category III personal protective equipment
length	median above 285 mm
characteristic	anatomical shape, brown
unit packaging / bulk packaging	1pair / dispenser 40par / carton 160pairs (4x40)
catalog number	RCHLBO-XX-40-09 (XX - size: 5.5 - 9.0)



**NEW** **SsafeCARE** micro **secure** technology

type of glove	surgical latex powder-free sterile gloves
external surface	smooth with microtexture
internal surface	polymer coated
cuff	extended straight with rolled edge
AQL	0.65
classification	class IIa medical device category III personal protective equipment
length	median above 285 mm
characteristic	anatomical shape, light brown
unit packaging / bulk packaging	1pair / dispenser 50par / carton 200pairs (4x50)
catalog number	RCHLBM-XX-50-09 (XX - size: 5.5 - 9.0)



ZARYS

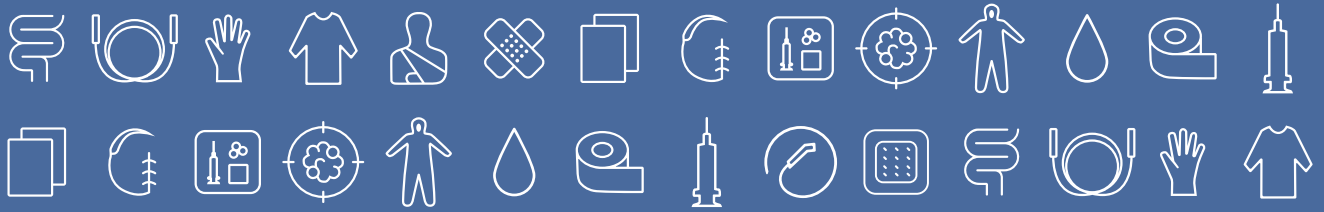

WWW.ZARYS.COM

# SYNTHETIC SURGICAL GLOVES

**NEW** **GsafeCARE**  
synthetic

type of glove	surgical neoprene (synthetic) powder-free sterile gloves
external surface	smooth with microtexture
internal surface	polymer coated
cuff	extended straight with rolled edge
AQL	0.65
classification	class IIa medical device category III personal protective equipment
length	median above 285 mm
characteristic	anatomical shape, natural colour
unit packaging / bulk packaging	1pair / dispenser 50par / carton 200pairs (4x50)
catalog number	RCHLBN-XX-50-09 (XX - size: 5.5 - 9.0)



protection against  
blood-borne pathogens



protection against  
chemotherapy drugs



acceptable quality  
level EN 455-1  
EN ISO 374-2



# GsafeCARE



by ZARYS







basic  
**medical devices**

basic injection equipment | infusion therapy  
| oxygen therapy | anaesthesia products |  
suction catheters, stomach tubes | urological  
catheters, urine bags | general surgery  
| basic products for gynecology | other products

ZARYS

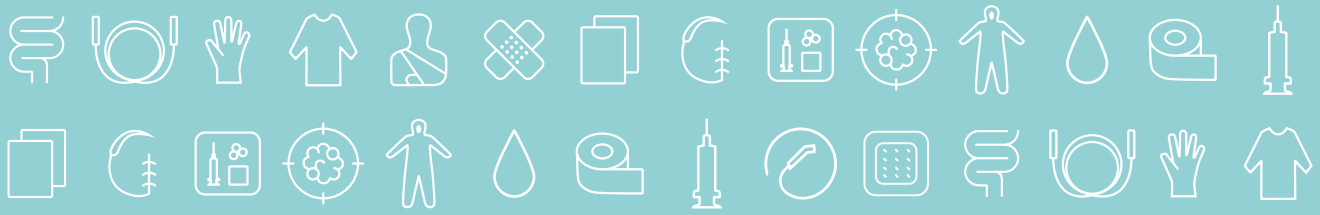

WWW.ZARYS.COM

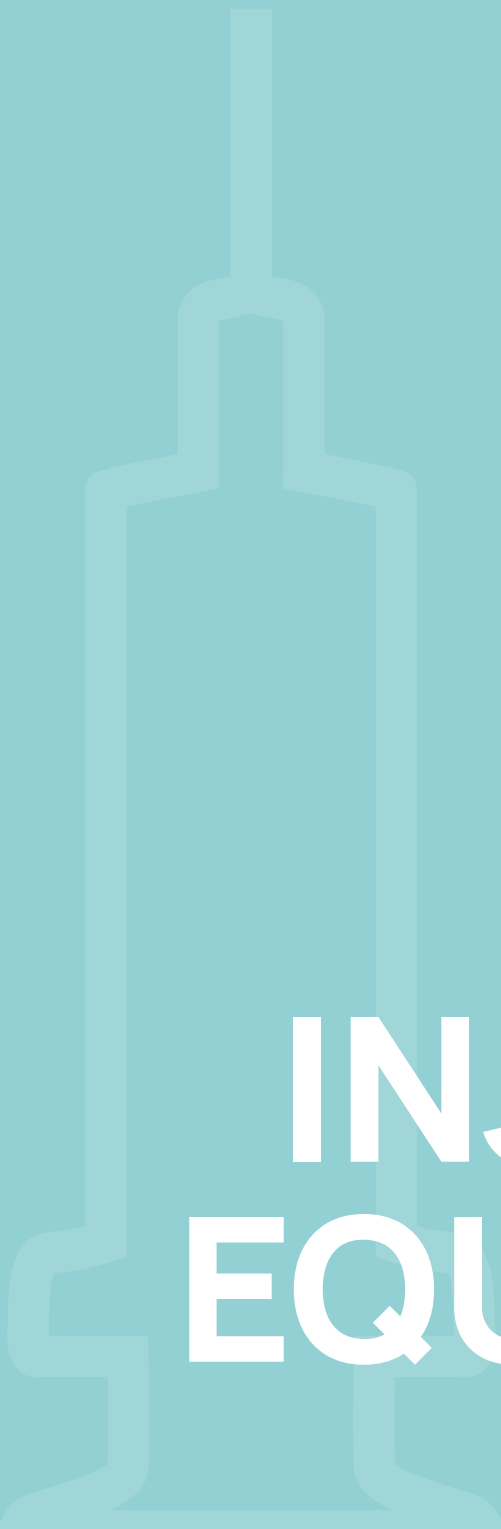

# BASIC INJECTION EQUIPMENT

# dispoFINE

## injection needle

### features

- needle tube is made of smooth and durable stainless steel
- sheath and hub made of polypropylene
- thin walls assure adequate stream pace
- tip sharpened in three surfaces (back cut)
- bevel type: LB/BL standard long bevel
- surface of needle tube covered with sliding agent (silicone)
- glued needle elements to prevent their separation (glue - epoxy resin)
- hubs coloured in accordance with ISO code allowing fast recognition of needle size
- single-use
- non-toxic, non-pyrogenic
- packaging: 1 pc./paper-foil

### indication

- device designed for intravenous, intramuscular and hypodermic injections



REF	size	colour	G	intermediate packaging
IN-03X13	0,3 mm x 13 mm	yellow	30	100 pcs
IN-04X19	0,4 mm x 19 mm	medium grey	27	100 pcs
IN-045X12	0,45 mm x 12 mm	brown	26	100 pcs
IN-045X16	0,45 mm x 16 mm	brown	26	100 pcs
*IN-045X22	0,45 mm x 22 mm	brown	26	100 pcs
IN-05X16	0,5 mm x 16 mm	orange	25	100 pcs
*IN-05X20	0,5 mm x 20 mm	orange	25	100 pcs
IN-05X25	0,5 mm x 25 mm	orange	25	100 pcs
IN-05X40	0,5 mm x 40 mm	orange	25	100 pcs
IN-06X25	0,6 mm x 25 mm	deep blue	23	100 pcs
IN-06X30	0,6 mm x 30 mm	deep blue	23	100 pcs
IN-06X40	0,6 mm x 40 mm	deep blue	23	100 pcs
IN-07X30	0,7 mm x 30 mm	black	22	100 pcs
IN-07X40	0,7 mm x 40 mm	black	22	100 pcs
*IN-07X50	0,7 mm x 50 mm	black	22	100 pcs

REF	size	colour	G	intermediate packaging
IN-08X25	0,8 mm x 25 mm	deep green	21	100 pcs
IN-08X40	0,8 mm x 40 mm	deep green	21	100 pcs
*IN-08X50	0,8 mm x 50 mm	deep green	21	100 pcs
IN-09X25	0,9 mm x 25 mm	yellow	20	100 pcs
IN-09X40	0,9 mm x 40 mm	yellow	20	100 pcs
IN-11X40	1,1 mm x 40 mm	cream	19	100 pcs
IN-12X40	1,2 mm x 40 mm	pink	18	100 pcs
IN-12X50	1,2 mm x 50 mm	pink	18	100 pcs
IN-16X40	1,6 mm x 40 mm	white	16	100 pcs
IN-18X40	1,8 mm x 40 mm	blue-grey	15	100 pcs
IN-21X40	2,1 mm x 40 mm	pale green	14	100 pcs

 bulk packaging:  
50 x 100 pcs

 \* available  
on request



# dispoGUARD

## safety injection needle

### features

- safety cover can be activated with one hand and it shields needle immediately after injection
- cover integrated with needle
- tip sharpened in three surfaces (back cut)
- colour coding system for size, marked on hub
- activation of safety mechanism signaled by audible click
- needle is securely closed inside activated safety cover
- single-use
- non-toxic, non-pyrogenic
- packaging: 1 pc./paper-foil (blister)

### indication

- device designed for intravenous, intramuscular and hypodermic injections

REF	size	colour	G	intermediate packaging
*INB-03X13	0,3 mm x 13 mm	yellow	30	50 pcs
*INB-045X12	0,45 mm x 12 mm	brown	26	50 pcs
INB-05X25	0,5 mm x 25 mm	orange	25	50 pcs
*INB-05X40	0,5 mm x 40 mm	orange	25	50 pcs
*INB-06X25	0,6 mm x 25 mm	deep blue	23	50 pcs
*INB-06X30	0,6 mm x 30 mm	deep blue	23	50 pcs
*INB-07X30	0,7 mm x 30 mm	black	22	50 pcs
INB-07X40	0,7 mm x 40 mm	black	22	50 pcs
INB-08X40	0,8 mm x 40 mm	deep green	21	50 pcs
INB-09X40	0,9 mm x 40 mm	yellow	20	50 pcs
INB-11X40	1,1 mm x 40 mm	cream	19	50 pcs
INB-12X40	1,2 mm x 40 mm	pink	18	50 pcs



 bulk packaging:  
50 x 50 pcs

 \* available  
on request



# dispoSULIN

## insulin pen needle

### features

- made of polypropylene, polyethylene and stainless steel
- triple-point needle blade allows easy and atraumatic skin penetration
- covering the needle with silicone lubricant reduces resistance during injection
- thin walls of needle ensure easy flow of medicine and the right flow rate
- coloured cap and paper cover of packaging make it easy to quickly recognize size of needle
- available in various sizes, allowing you to adapt to individual needs
- universal, compatible with all pen models
- single-use
- non-pyrogenic, non-toxic
- packaging: 100 pcs/box

### indication

- for subcutaneous injection
- dedicated for use with pre-filled pens (insulin pens)



REF	size	colour	G	intermediate packaging
INP-033X12	0,33 mm x 12 mm	pink	29	100 pcs
INP-030X08	0,30 mm x 8 mm	yellow	30	100 pcs
INP-025X06	0,25 mm x 6 mm	purple	31	100 pcs
INP-025X08	0,25 mm x 8 mm	blue	31	100 pcs

 bulk packaging:  
50 x 100 pcs



# dicoSPIKE, dicoSPIKE Chemo

## withdrawal cannula

### features

- easy to use, ergonomic shape
- body with knurled surface for a secure grip
- sharp receiving spike enabling tight and safe connection with containers of different capacity
- receiving spike groove guarantees complete emptying of the container
- hermetic self-Locking cap securing the connector against contamination
- available in version with air filter and in version with air and particle filter
- air filter protects against microbiological contamination and against harmful aerosols
- particle filter is an effective barrier to protect drugs and liquids from contamination
- female Luer-Lock connector compatible with products with either male or female Luer-Lock
- non-pyrogenic
- single-use
- packaging: 1 pc./ paper-foil

### indication

- device for needle-free dissolving and / or withdrawing drugs from multi-dose packages (bottles, vials, etc.) - in both directions
- dicoSPIKE Chemo model is designed for medicines releasing dangerous aerosols such as cytostatics



dicoSPIKE

REF	cap colour	air filter	particle filter	purpose	intermediate packaging
PPLZ	green	0,1 µm	-	standard medicines	100 pcs
PPLN	blue	0,1 µm	5 µm	standard medicines	100 pcs

 bulk packaging:  
10 x 100 pcs

dicoSPIKE Chemo

REF	cap colour	air filter	particle filter	purpose	intermediate packaging
PPLC	red	0,1 µm	5 µm	cytostatics	100 pcs



## construction of the syringe

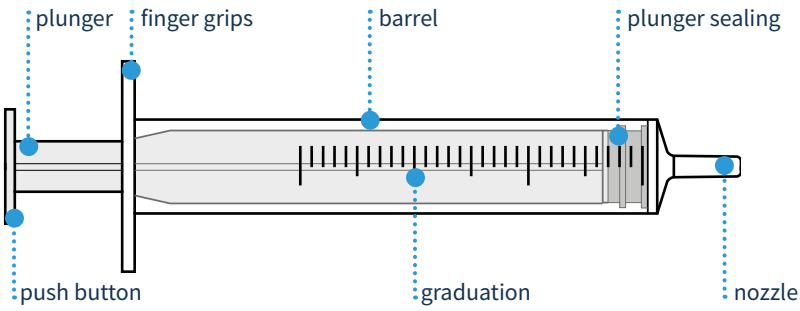

**GET TO KNOW  
OUR SYRINGES**

### nozzle types:

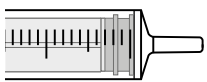

#### Luer slip, centric

tip of the syringe is pushed into the hub of the needle or other device (e.g. catheters) and twisted. It allows to remove the connection immediately if necessary

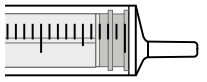

#### Luer slip, eccentric

eccentric location of the tip is used in procedures involving the administration of drugs and fluids where closer proximity to skin is necessary

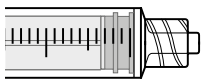

#### Luer-Lock

designed to secure connection between the syringe and the device (needle, tube, catheter, stopcock, etc.). The tip is equipped with thread to screw in the syringe to prevent disconnection

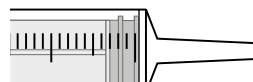

#### catheter tip 90°

type of connection used for rinsing (cleaning) catheters, stomach tubes and feeding purposes

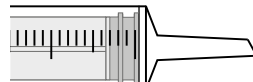

#### catheter tip 45°

nozzle cut at 45 degrees increases the lumen surface

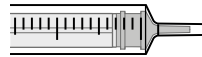

#### insulin and tuberculin syringes

special design of the plunger seal reduces the drug/liquid residues

## duoNEX

### syringe type:

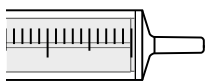

2-part - without plunger sealing

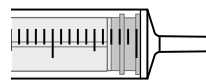

3-part - with plunger sealing

### graduation type:

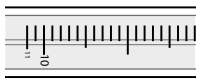

extended graduation

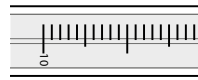

regular graduation

catheter syringes

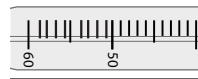

extended graduation

### package colour and shape code:

Luer slip nozzle:



Luer slip nozzle:



Luer-Lock nozzle:



amber type

catheter tip:



## duoNEX

### single-use syringe, 2-part, Luer

#### features

- white line
- transparent barrel allows full visual control of content
- white contrasting plunger
- Luer nozzle centrally located in 2 ml syringe, eccentric in 5, 10, 20 ml syringes
- smooth plunger sliding
- limitation flange securing against accidental removal of plunger
- clear, legible and permanent black graduation facilitating dosage, adequately:
  - every 0,1 ml for capacity of 2 ml
  - every 0,2 ml for capacity of 5 ml
  - every 0,5 ml for capacity of 10 ml
  - every 1 ml for capacity of 20 ml
- extended graduation that includes a 10% extension of the nominal capacity
- name of syringe and manufacturer's logo placed on barrel
- non-pyrogenic, non-toxic
- packaging: 1 pc./paper-foil



#### indication

- 2-piece syringe for subcutaneous, intramuscular and intravenous infusions intended for drawing up and administering of medicines/liquids to patient and collecting body fluid samples from patient

REF	type	capacity	position of nozzle	intermediate packaging	bulk packaging
002ML-2CZ-B	Luer	2 ml	centric	100 pcs	30 x 100 pcs
005ML-2CZ-B	Luer	5 ml	eccentric	100 pcs	24 x 100 pcs
010ML-2CZ-B	Luer	10 ml	eccentric	100 pcs	16 x 100 pcs
020ML-2CZ-B	Luer	20 ml	eccentric	50 pcs	16 x 50 pcs



## dicoNEX SN

### single-use syringe, 3-part, Luer, with needle alongside the syringe

#### features

- in set with needle alongside the syringe
- transparent barrel allows full visual control of content, green contrasting plunger
- Luer nozzle placed centrally for 2 ml, 5 ml, 10 ml capacity, eccentric for 20 ml, 50 ml
- sealing in the form of double ring on plunger stopper situated on the top of plunger
- smooth plunger sliding thanks to rubber sealing
- limitation flange securing against accidental removal of plunger
- name of syringe and manufacturer's logo placed on barrel
- clear, legible and permanent black graduation facilitating dosage, adequately:
  - every 0,1 ml for capacity of 2 ml
  - every 0,2 ml for capacity of 5 ml
  - every 0,2 ml for capacity of 10 ml
  - every 0,5 ml for capacity of 20 ml
  - every 1 ml for capacity of 50 ml (extended to 60 ml)
- needle tube is made of smooth and durable stainless steel
- needle tip sharpened in three surfaces
- bevel type: LB/BL standard long bevel
- hubs coloured in accordance with ISO code
- non-toxic, non-pyrogenic
- packaging: 1 pc./paper-foil (blister)



#### indication

- 3-piece syringe for subcutaneous, intramuscular and intravenous infusions

REF	type	capacity	position of nozzle	needle size	needle colour	intermediate packaging	bulk packaging
002ML-3CZ-SN	Luer	2 ml	centric	0,6mm x 30mm	deep blue	100 pcs	30 x 100 pcs
005ML-3CZ-SN	Luer	5 ml	centric	0,7mm x 30mm	black	100 pcs	24 x 100 pcs
010ML-3CZ-SN	Luer	10 ml	centric	0,8mm x 40mm	deep green	100 pcs	16 x 100 pcs
020ML-3CZ-SN	Luer	20 ml	eccentric	0,8mm x 40mm	deep green	50 pcs	16 x 50 pcs
050ML-3CZ-SN	Luer	50 ml/60ml	eccentric	0,8mm x 40mm	deep green	25 pcs	16 x 25 pcs



# dicoNEX

## single-use syringe, 3-part, Luer

### features

- transparent barrel allows full visual control of content
- green contrasting plunger
- Luer nozzle
- sealing in the form of double ring on plunger stopper situated on the top of plunger
- smooth plunger sliding thanks to rubber sealing
- limitation flange securing against accidental removal of plunger
- special design of the 1 ml syringe plunger stopper reduces dead space
- name of syringe and manufacturer's logo placed on barrel
- clear, legible and permanent black graduation facilitating dosage, adequately:
  - every 0,01ml for capacity of 1ml
  - every 0,1 ml for capacity of 2 ml
  - every 0,2 ml for capacity of 5 ml
  - every 0,2 ml for capacity of 10 ml
  - every 0,5 ml for capacity of 20 ml
  - every 1 ml for capacity of 50/60 ml
- non-pyrogenic, non-toxic
- packaging: 1 pc./paper-foil (blister)



### indication

- 3-piece syringe intended for drawing up and administering of medicines/liquids to patient and collecting body fluid samples from patient

REF	type	capacity	position of nozzle	intermediate packaging	bulk packaging
001ML-3CZ-BL	Luer	1 ml	centric	100 pcs	32 x 100 pcs
002ML-3CZ-BL	Luer	2 ml	centric	100 pcs	30 x 100 pcs
005ML-3CZ-BL	Luer	5 ml	centric	100 pcs	24 x 100 pcs
010ML-3CZ-BL	Luer	10 ml	centric	100 pcs	16 x 100 pcs
020ML-3CZ-BL	Luer	20 ml	eccentric	50 pcs	16 x 50 pcs
050ML-3CZ-BL	Luer	50/60 ml	eccentric	25 pcs	16 x 25 pcs



# dicoNEX

## single-use syringe, 3-part, Luer-Lock + ambe

### features

- transparent barrel allows full visual control of content
- green contrasting plunger
- Luer-Lock nozzle
- sealing in the form of double ring on plunger stopper situated on the top of plunger
- smooth plunger sliding thanks to rubber sealing
- limitation flange securing against accidental removal of plunger
- name of syringe and manufacturer's logo placed on barrel
- clear, legible and permanent black graduation facilitating dosage, adequately:
  - every 0,1 ml for capacity of 3 ml
  - every 0,2 ml for capacity of 5 ml and of 10 ml
  - every 0,5 ml for capacity of 20 ml
  - every 1 ml for capacity of 30 ml
- non-pyrogenic, non-toxic
- packaging: 1 pc./paper-foil (blister)



### indication

- 3-piece syringe intended for drawing up and administering of medicines/liquids to patient and collecting body fluid samples from patient

REF	type	capacity	position of nozzle	colour of plunger	intermediate packaging	bulk packaging
003ML-3CZ-LL-BL	Luer-Lock	3 ml	centric	green	100 pcs	30 x 100 pcs
005ML-3CZ-LL-BL	Luer-Lock	5 ml	centric	green	100 pcs	24 x 100 pcs
010ML-3CZ-LL-BL	Luer-Lock	10 ml	centric	green	100 pcs	16 x 100 pcs
020ML-3CZ-LL-BL	Luer-Lock	20 ml	centric	green	50 pcs	16 x 50 pcs
030ML-3CZ-LL-BL	Luer-Lock	30 ml	centric	green	50 pcs	16 x 50 pcs
050ML-3CZ-LL-BL	Luer-Lock	50 ml/60 ml	centric	green	25 pcs	16 x 25 pcs
050ML-3CZ-LL-B-BL	Luer-Lock	50 ml/60 ml	centric	white	25 pcs	16 x 25 pcs



# dicoNEX

## single-use syringe, 3-part, Luer-Lock + amber

### features

- transparent cylinder with a transparent or amber color
- green contrasting plunger (amber-coloured syringe - white contrasting plunger)
- Luer-Lock type termination
- sealing in the form of double ring on plunger stopper situated on the top of plunger
- smooth plunger sliding thanks to rubber sealing
- limitation flange securing against accidental removal of plunger
- name of syringe and manufacturer's logo placed on barrel
- clear, legible and permanent black graduation facilitating dosage
- scaling extension to 60 ml
- non-pyrogenic, non-toxic
- packaging: 1 pc./paper-foil

### indication

- 3-piece syringe intended for drawing up and administering of medicines/liquids to patient and collecting body fluid samples from patient
- amber-coloured syringe is intended for drawing up and administering of photosensitive medicines



REF	type	capacity	position of nozzle	colour of plunger	intermediate packaging
050ML-3CZ-LL-PI	Luer-Lock	50/60 ml	centric	green	25 pcs

### amber type

050ML-3CZ-LL-B-PI	Luer-Lock	50/60 ml	centric	white	25 pcs
-------------------	-----------	----------	---------	-------	--------



bulk packaging:  
16 x 25 pcs



# dicoNEX

## single-use catheter syringe, 3-part

### features

- 3-piece syringe with centrally located nozzle for catheter
- made of polypropylene
- transparent barrel allows full visual control of content
- green contrasting plunger (capacity 50/60 ml)
- white contrasting plunger (capacity 100 ml)
- two Luer connectors attached
- sealing in the form of double ring on plunger stopper situated on the top of plunger
- smooth plunger sliding thanks to rubber sealing
- limitation flange securing against accidental removal of plunger
- nozzle cut at 90° (capacity 50/60 ml)
- nozzle cut at 45° (capacity 100 ml)
- catheter nozzle secured with cap (capacity 50/60 ml)
- name of syringe and manufacturer's logo placed on barrel
- extended graduation (capacity 50/60 ml)
- clear, legible and permanent black graduation facilitating dosage
- non-pyrogenic, non-toxic
- packaging: 1 pc./paper-foil

### indication

- 3-piece syringe with catheter nozzle
- intended for drawing up and administering of medicines/liquids to patient and collecting body fluid samples from patient



REF	type	capacity	position of nozzle	intermediate packaging	bulk packaging
050ML-3CZ-CEW-BL	catheter tip	50/60 ml	centric	25 pcs	16 x 25 pcs
100ML-3CZ-CEW-BL	catheter tip	100 ml	centric	25 pcs	4 x 25 pcs





# dicoTUBER

## tuberculin syringe

### features

- with bypacked needle 0,45 x 13 mm
- made entirely of polypropylene
- white contrasting plunger
- transparent barrel allows full visual control of content
- Luer nozzle
- smooth plunger sliding thanks to rubber sealing
- limitation flange securing against accidental removal of plunger
- clear, legible and permanent black graduation every 0,01 ml that allows precise dosing of medicine/liquid
- special design of plunger stopper reduces the residual volume of medicine/liquid
- name of syringe and manufacturer's logo placed on barrel
- single-use
- non-pyrogenic, non-toxic
- packaging: 1 pc./paper-foil (blister)

### indication

- 3-piece syringe intended for precise drawing up and administering of medicines/liquids



REF	no. of units	capacity	intermediate packaging
TU-U20-1-BL	20	1 ml	100 pcs



bulk packaging:  
32 x 100 pcs



# dicoSULIN

## insulin syringe

### features

- with bypacked needle 0,4 x 13 mm
- transparent barrel made of polypropylene allows full visual control of content
- sealing in the form of double ring on plunger stopper situated on the top of plunger
- smooth plunger sliding thanks to rubber sealing
- limitation flange securing against accidental removal of plunger
- special design of plunger stopper reduces the residual volume of medicine/liquid
- clear, legible and permanent black graduation facilitating dosage
- name of syringe and manufacturer's logo placed on barrel
- single-use
- non-pyrogenic, non-toxic
- packaging: 1 pc./paper-foil (blister)

### indication

- 3-piece syringe for subcutaneous, intramuscular and intravenous infusions
- for insulin shots



REF	no. of units	capacity	colour of plunger	intermediate packaging
IN-U40-1-BL	40	1 ml	red	100 pcs
IN-U100-1-BL	100	1 ml	orange	100 pcs



bulk packaging:  
32 x 100 pcs



ZARYS



WWW.ZARYS.COM

# INFUSION THERAPY

# SANViflon

## I.V. cannula

### features

- needle (stylet) made of stainless steel with back-cut blade
- cannula catheter made of Teflon (FEP), equipped with 4 radiopaque lines
- cannula equipped with wings and hand-closed cap of the upper port colour coded according to size
- handle that allows you to insert with one hand
- valve that prevents blood leakage to outside after inserting the cannula into the vessel
- flashback chamber secured with a Luer-Lock cap
- available in various sizes from 14 G to 26 G
- single-use
- packaging: 1 pc. – hard blister (PVC + lacquered paper) with a colour print in accordance with the colour identification of the size

### indication

for cannulation of intravenous, peripheral vessels to:

- multiple injections of intravenous drugs
- intravenous infusion of solutions and parenteral nutrition suitable for peripheral veins
- maintain the patient's hydration and / or reduce dehydration if the patient is unable to take sufficient fluid orally
- blood transfusions and blood-like preparations
- ensuring vascular access in the event of the need for rapid drug delivery, especially during diagnostic and therapeutic procedures



REF	size [G]	size [mm]	colour	flow rate [ml/min]	intermediate packaging
KDF-06-19	26 x 3/4"	0,6 x 19	violet	17	100 pcs
KDF-07-19	24 x 3/4"	0,7 x 19	yellow	23	100 pcs
KDF-09-25	22 x 1"	0,9 x 25	blue	36	100 pcs
KDF-11-32	20 x 1 1/4"	1,1 x 32	pink	56	100 pcs
KDF-13-45	18 x 1 3/4"	1,3 x 45	green	90	100 pcs
KDF-15-45	17 x 1 3/4"	1,5 x 45	white	142	100 pcs
KDF-17-45	16 x 1 3/4"	1,7 x 45	grey	200	100 pcs
KDF-20-45	14 x 1 3/4"	2,0 x 45	orange	305	100 pcs



bulk packaging:  
10 x 100 pcs

STERILE EO



# SANViflon S

## I.V. cannula without port

### features

- needle (stylet) made of stainless steel with back-cut blade
- cannula catheter made of Teflon (FEP), equipped with 4 radiopaque lines
- cannula equipped with coloured fixing wings, without upper port
- handle that allows you to insert with one hand
- valve that prevents blood leakage to outside after inserting the cannula into the vessel
- flashback chamber secured with a Luer-Lock cap
- available in two sizes: 24 G and 26 G
- single-use
- packaging: 1 pc. – hard blister (PVC + lacquered paper) with a colour print in accordance with the colour identification of the size

### indication

for cannulation of intravenous, peripheral vessels to:

- multiple injections of intravenous drugs
- intravenous infusion of solutions
- maintain the patient's hydration and / or reduce dehydration if the patient is unable to take sufficient fluid orally
- ensuring vascular access in the event of the need for rapid drug delivery, especially during diagnostic and therapeutic procedures



REF	size [G]	size [mm]	colour	flow rate [ml/min]	intermediate packaging
KDFS-06-19	26 x 3/4"	0,6 x 19	violet	17	100 pcs
KDFS-07-19	24 x 3/4"	0,7 x 19	yellow	23	100 pcs



bulk packaging:  
10 x 100 pcs

STERILE EO



# easyFLOW IS PREMIUM

## infusion set



### features

- 2-way, sharp spike of the drip chamber with anti-slip surface that guarantees tight and reliable connection with fluid containers
- air-vent with anti-bacterial filter and blue flap
- flexible droplet chamber, size 6 cm, equipped with additional pressure wings to facilitate insertion into containers with liquids
- dropper: 20 drops = 1 ml ± 0,1 ml
- liquid filter protecting against larger particles with pore size 15 µm
- precise safe roll clamp with integrated spike holder and with a holder for securing the drain
- name of the manufacturer placed on the roll clamp
- soft, flexible drain
- universal Luer-Lock tip secured by an Air Pass plug with a hydrophobic filter, which allows the drain to be filled without accidental contamination and prevents fluid leakage
- single-use
- non-pyrogenic, non-toxic
- individual packaging: paper-foil with a colored code (blue) identifying the device type

### indication

- device for fluid transfer in infusion therapy

REF	version	length
IS-BF-P	without phthalates	150 cm



bulk packaging:  
250 pcs



# easyFLOW IS

## infusion set

### features

- 2-way sharp closure-piercing device of the drip chamber with anti-slip surface that guarantees tight and reliable connection with fluid containers/bags
- air inlet with anti-bacterial filter and coloured (blue) flap
- pliable drip chamber, size 6 cm, equipped with additional pressure wings to facilitate insertion into containers with liquids
- dropper: 20 drops = 1 ml +/- 0,1 ml
- fluid filter protecting against larger particles with pore size 15 µm
- soft, flexible tubing with Luer-Lock conical fitting
- precise safe flow regulator with integrated holder for the closure-piercing device and with hook for securing the tubing
- name of the manufacturer placed on the flow regulator
- both tips of the device additionally secured with protective caps
- single-use
- non-pyrogenic, non-toxic
- packaging: 1 pc./paper-foil with a coloured code (blue) identifying the device

### indication

- device for fluid transfer in infusion therapy

REF	version	length
IS *	with phthalates	150 cm
IS-BF **	without phthalates	150 cm
IS-BF-180 **	without phthalates	180 cm



bulk packaging:  
250 pcs



# easyFLOW IS

## infusion set (dual chamber)



### features

- made of high quality materials, using the latest technology, which guarantees very high quality and trouble-free, intended use
- 2-way, 2-plane sharp closure-piercing device of the drip chamber with anti-slip surface that guarantees tight and reliable connection with fluid containers
- air-inlet with anti-bacterial filter and coloured (green) flap
- dropler chamber divided into a flexible lower part and a hard upper part with an additional pressure ring for easy insertion into fluid containers
- name of the manufacturer placed on the dropler chamber
- device in its entirety including the spike and tip transparent, allowing visual inspection of the flow along its entire length
- dropper: 20 drops = 1 ml ± 0,1 ml
- fluid filter protecting against larger particles with pore size 15 µm
- soft, flexible tubing with Luer-Lock conical fitting
- precise safe roll clamp with integrated spike holder and with a holder for securing the drain
- both tips of the device additionally secured with protective caps
- single-use
- non-pyrogenic, non-toxic
- individual packaging: paper-foil with a coloured code (blue) identifying the device type



### indication

- device intended for connection to an intravenous line for the administration of fluids, photosensitive medicinal products solutions and other body fluids during infusion therapy

REF	version	length
IS-BF-D	without phthalates	180 cm



bulk packaging:  
100 pcs



# easyFLOW IS ECO

## infusion set

### features

- made of high quality materials
- 2-way sharp closure-piercing device of the drip chamber that guarantees tight and reliable connection with fluid containers
- air inlet with anti-bacterial filter and colored (blue) flap
- pliable drip chamber, size 4cm
- dropper: 20 drops = 1 ml +/- 0.1 ml
- fluid filter protecting against larger particles with pore size 15 µm
- soft, flexible tubing
- universal Luer-Lock conical fitting
- precise safe flow regulator
- both tips of the device additionally secured with protective caps
- packaging: 1pc./foil bag
- single-use
- non-pyrogenic, non-toxic



### indication

- device for fluid transfer in infusion therapy

REF	version	length
IS-E*	with phthalates	150 cm
IS-BF-E**	without phthalates	150 cm
IS-BF-E-180**	without phthalates	180 cm



bulk packaging:  
400 pcs



# easyFLOW IS SAFE

## infusion set

### features

- 2-way, sharp spike of the drip chamber with anti-slip surface that guarantees tight and reliable connection with fluid containers
- air-vent with anti-bacterial filter and blue flap
- flexible droplet chamber, size 6 cm, equipped with additional pressure wings to facilitate insertion into containers with liquids
- dropper: 20 drops = 1 ml ± 0.1 ml
- hydrophilic filter Liquid Lock with a mesh size of 8 µm, which automatically stops the flow when the chamber is emptied. Prevents air from entering the tubing to prevent air embolism
- soft, flexible drain with additional port for drug application
- precise safe roll clamp with integrated spike holder and with a holder for securing the drain
- universal Luer-Lock tip
- Air Pass plug with hydrophobic filter, which allows filling of the tubing without accidental contamination and protects against fluid leakage
- single-use
- non-pyrogenic, non-toxic
- individual packaging: paper-foil with a colored code (blue) identifying the device type

### indication

- device for fluid transfer in infusion therapy



REF	version	length
IS-BF-S	without phthalates	180 cm

 bulk packaging:  
100 pcs



# easyFLOW IS AMBER

## infusion set, amber

### features

- amber colouring of the tubing and drip chamber
- double-channel, sharp spike of the drip chamber with a matted surface with non-slip Surface guaranteeing tight and reliable connection with fluid containers/bags
- air inlet with anti-bacterial filter and coloured (blue) flap
- flexible drip chamber with length 6 cm, equipped with additional pressure wings to facilitating puncture into containers with liquids
- dropper: 20 drops = 1 ml +/- 0,1 ml
- fluid filter protecting against larger particles with pore size 15 µm
- soft and flexible drains with additional port for drug application
- precise safe roll clamp with integrated spike holder and with a holder for securing the drain with name of the manufacturer placed on the roll clamp
- single-use
- non-pyrogenic, non-toxic
- universal Luer-Lock tip
- packaging: 1 pc./paper-foil

### indication

- device for fluid transfer photosensitive medicinal and other body fluids in infusion therapy



REF	version	length
IS-BF-A	without phthalates	150 cm

 bulk packaging:  
100 pcs



# easyFLOW IS REG

## infusion set with precision flow rate regulator

### features

- 2-way, sharp closure-piercing device of the drip chamber with anti-slip surface that guarantees tight and reliable connection with fluid containers
- adjustable from 5 to 250 ml/h (dark blue digits on white background) for viscosities below 10% and adjustable from 5 to 200 ml/h (white digits on dark blue background) for viscosities 10%-40%
- ability to completely close (OFF) and open (ON) the flow rate
- air-inlet with anti-bacterial filter and coloured (blue) flap
- dropler chamber and drain made of phthalate-free PVC
- dropper: 20 drops = 1 ml ± 0,1 ml
- fluid filter protecting against larger particles with pore size 15 µm
- soft, flexible drain with additional port for drug application
- universal Luer-Lock tip secured by an Air Pass plug with a hydrophobic filter, which allows the drain to be filled without accidental contamination and prevents fluid leakage
- precise safe roll clamp with integrated spike holder and with a holder for securing the drain
- name of the manufacturer placed on the roll camp
- both tips of the device additionally secured with protective caps
- single-use
- non-pyrogenic, non-toxic
- individual packaging: paper-foil with a coloured code (blue) identifying the device type



### indication

- device intended for connection to an intravenous line for the administration of fluids, photosensitive medicinal products solutions and other body fluids during infusion therapy with adjustable flow control

REF	version	length
IS-RP-BF	without phthalates	180cm



bulk packaging:  
100 pcs

**STERILE EO**



# easyFLOW TS PREMIUM

## transfusion set



**BESTSELLER**

### features

- 2-way sharp spike of the drip chamber with matted surface that guarantees tight and reliable connection with fluid containers
- air-vent with anti-bacterial filter and a colored (red) flap
- flexible droplet chamber
- dropper: 20 drops = 1ml +/- 0.1ml
- special blood filter with large area, pore size 200µm
- soft, flexible drain
- universal luer-lock drain tip secured by an Air Pass stopper with a hydrophobic filter that allows the drain to be filled without accidental contamination and protects against fluid leakage
- precise safe roll clamp with integrated spike holder and with a holder for securing the drain
- name of the manufacturer placed on the roll clamp
- both tips of the device additionally secured with protective caps
- single-use
- non-pyrogenic, non-toxic
- individual packaging: blister-pack with a colored code (red) identifying the device type



### indication

- device intended for connection to an intravenous line for the administration of blood and blood products

REF	version	length
TS-BF-P	without phthalates	150 cm



bulk packaging:  
250 pcs

**STERILE EO**



# easyFLOW TS

## transfusion set

### features

- 2-way sharp closure-piercing device of the drip chamber with anti-slip surface that guarantees tight and reliable connection with containers/bags
- air inlet with anti-bacterial filter and a coloured (red) flap
- pliable drip chamber
- dropper: 20 drops = 1 ml +/- 0,1 ml
- special blood filter with large area, pore size 200 µm
- soft, flexible tubing
- universal Luer-Lock fitting at the end of tubing
- precise safe flow regulator with integrated holder for the closure-piercing device and with hook for securing the tubing
- name of the manufacturer placed on the flow regulator
- both tips of the device additionally secured with protective caps
- single-use
- non-pyrogenic, non-toxic
- packaging: 1 pc./paper-foil with a coloured code (red) identifying the device

### indication

- device used for the administration of blood and blood products



REF	version	length
TS*	with phthalates	150 cm
TS-BF**	without phthalates	150 cm



bulk packaging:  
250 pcs



# easyFLOW LINE

## extension tube for infusion pump

### features

- tubing made of PVC
- device available in a transparent and amber version for photosensitive medicines
- diameter of the tubing - outer: 2,4 mm; inner: 1,24 mm
- New version of the tubing outer : 2,8 mm; inner: 1,8 mm
- Luer-Lock fitting - male and female
- single-use
- non-pyrogenic, non-toxic
- packaging: 1 pc./paper-foil

### indication

- device used to extend infusion line



REF	colour of tube	length	intermediate packaging
P450-BF	transparent	45 cm	50 pcs
P1500-BF	transparent	150 cm	50 pcs
PB1500-BF	amber	150 cm	50 pcs
P2000-BF	transparent	200 cm	50 pcs
PB2000-BF	amber	200 cm	50 pcs



bulk packaging:  
24 x 50 pcs

### New version of the tubing outer

REF	colour of tube	length	intermediate packaging
P450-18-BF	transparent	45 cm	50 pcs
P1800-18-BF	transparent	180 cm	50 pcs





# needle-free valve

## features

- body made of transparent material - polycarbonate
- high-quality silicone membrane allows multiple port injections
- flat injection surface - smooth and evenly ended port membrane that facilitates disinfection
- metal-free, suitable for MRI examination
- male connector of the transparent port is secured with a cap allowing for aseptic removal of the item from the packaging\*
- may be used for 7 days or up to 350 activations
- priming capacity: 0,09 ml
- high flow rate: 350 ml/min
- withstands injection fluid pressure of 3 bars (44 PSI)
- withstands back pressure of 2 bars (29 PSI)
- single-use
- packaging: 1 pc./paper-foil



## indication

- intended for closing infusion ports
- device intended for multiple, needle-free injections (liquid drug administration, blood sample taking)
- protects infusion lines from contamination and infection during infusion therapy
- does not require using safety caps
- dedicated for standard Luer and Luer Lock connectors

REF	colour	intermediate packaging
PB-N	blue	100 pcs
PB-T	transparent	100 pcs

 bulk packaging:  
25 x 100 pcs



# needle free valve

## with extension line

### features

- housing made of transparent material - polycarbonate
- high-quality silicone membrane allows multiple port injections
- flat injection surface - smooth and evenly ended port membrane that facilitates disinfection
- extension line made of transparent polyurethane
- metal-free, suitable for MRI examination
- extension lines fitted with sliding clamps
- male connector protected with applicator
- total length 15 cm
- can be used for 7 days or 350 activations
- filling volume of needle-free port 0.09 ml
- dead space 0.001 ml
- resistance to injection fluid pressure 3 bar (44 PSI)
- resistance to back pressure 2 bar (29 PSI)
- single-use
- packaging: 1 pc. / paper-foil

### indication

- device used to close infusion ports for multiple, needle-free injections and to protect the infusion line from contamination
- does not require using safety caps
- dedicated for standard Luer and Luer Lock connectors

REF	diameters of extension lines	flow	number of needle-free ports
PB-T/1-27	1,0 x 2,7 mm	115 ml/min	1
PB-T/1-40	3,0 x 4,0 mm	185 ml/min	1
PB-T/2-27	1,0 x 2,7 mm	100 ml/min	2
PB-T/2-40	3,0 x 4,0 mm	165 ml/min	2
PB-T/3-27	1,0 x 2,7 mm	100 ml/min	3
PB-T/3-40	3,0 x 4,0 mm	160 ml/min	3
PB-T/4-27	1,0 x 2,7 mm	65 ml/min	4
PB-T/4-40	3,0 x 4,0 mm	135 ml/min	4

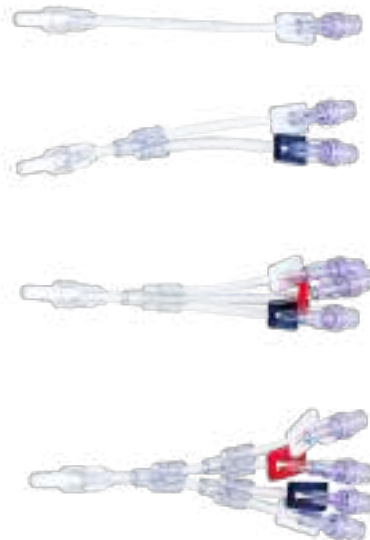

 bulk packaging:  
20 x 50 pcs



## 3-way stopcock

### features

- made of polycarbonate
- transparent housing
- clear optical identifier of open/close position (marked flow directions) operating in 360 degrees
- consistent, straight flow channels and an optimal internal diameter ensure correct pressure measurement
- rotating male Luer-Lock
- all inlets protected with caps
- resistant to lipids
- single-use
- non-pyrogenic, non-toxic
- packaging: 1 pc./paper-foil

### indication

- device designed for managing the flow of infusion fluids during administration
- enables switching the infusion flow path
- for blood pressure monitoring
- for direct medicine/fluid supply



REF	colour	intermediate packaging
KT-002	blue	50 pcs



bulk packaging:  
20 x 50 pcs



## 3-way stopcock with extension tube

### features

- three-way stopcock with an extension tube of various lengths (from 7 cm to 100 cm)
- transparent housing
- clear optical identifier of open/close position (marked flow directions)
- three-way stopcock made of polycarbonate, extension tube made of PVC
- all inlets protected with caps
- resistant to lipids
- single-use
- non-pyrogenic, non-toxic
- packaging: 1 pc./paper-foil

### indication

- device designed for managing the flow of infusion fluids during administration
- enables switching the infusion flow path
- for blood pressure monitoring
- for direct medicine/fluid supply



REF	length of tube	intermediate packaging
KTP-7	7 cm	50 pcs
KTP-10	10 cm	50 pcs
KTP-25	25 cm	50 pcs
KTP-50	50 cm	50 pcs
KTP-75	75 cm	50 pcs
KTP-100	100 cm	50 pcs



bulk packaging:  
20 x 50 pcs



# cannula stopper

## features

- precisely and safely closes standard ports
- Luer-Lock stopper has only one male tip
- combi stopper with male and female tip especially dedicated for securing Luer Lock fitting in infusion and transfusion sets
- single-use
- non-pyrogenic
- packaging: 1 pc./paper-foil

## indication

- as a stopper of intravenous cannulas, ports and catheters
- intended to be used in combination with other devices during infusion therapy, protecting against the outflow of blood through the cannula and protecting against contamination and infection



REF	type	intermediate packaging	bulk packaging
KDKLL	Luer-Lock	250 pcs	10 x 250 pcs
KDKC	combi	100 pcs	50 x 100 pcs



ZARYS



WWW.ZARYS.COM

# OXYGEN THERAPY

# nasal oxygen cannula

## features

- made of medical PVC
- very soft tips with smooth edges
- fastening under the chin with a soft, sliding adjustment ring
- various spacing of the nasal part of the cannula depending on the size
- universal connector compatible with any source of oxygen
- tubing with star cross-section that is resistant to bending
- available in 3 sizes: for adults, for children and for infants with 140 cm, 200 cm, 300 cm and 500 cm long tubing
- single-use
- packaging: 1 pc./foil

## indication

- designed to deliver oxygen through the nose



🕒 60 min to 30 days

REF	length of tubing	purpose	bulk packaging
CTNN-200	200 cm	for infants	10 x 25 pcs
CTNZ-200	200 cm	for children	10 x 25 pcs
CTND-140	140 cm	for adults	10 x 30 pcs
CTND-200	200 cm	for adults	10 x 25 pcs
CTND-300	300 cm	for adults	10 x 15 pcs
CTND-500	500 cm	for adults	10 x 10 pcs



# oxygen tubing

## features

- made of transparent, non-toxic PVC
- tubing with star cross-section that is resistant to bending, with reinforcing straps along the entire length
- standardized connectors at the end of the tubing allowing connection to oxygen devices
- single-use
- packaging: 1 pc./paper-foil

## indication

- for transporting oxygen from an oxygen source to another medical device for oxygen supply, e.g. oxygen mask



🕒 60 min to 30 days

REF	length of tubing	bulk packaging
DT2100	210 cm +/- 2%	100 x 1 pc.
DT4260	426 cm +/- 2%	50 x 1 pc.
DT7620	762 cm +/- 2%	25 x 1 pc.



# oxygen mask

## with tubing

## features

- made of transparent, non-toxic PVC
- adjustable nose metal plate and rubber fastening
- equipped with a 210 cm (+/- 5%) long tubing with universal connectors
- tubing with star cross-section that is resistant to bending
- revolving connector that allows adjusting to patient's position
- single-use
- packaging: 1 pc./paper-foil

## indication

- designed to deliver oxygen with precise regulation of concentration, for medium oxygen concentration



🕒 60 min to 30 days

REF	length of tubing	size
MTS-S	210 cm +/- 5%	S
MTS-M	210 cm +/- 5%	M
MTS-L	210 cm +/- 5%	L
MTS-XL	210 cm +/- 5%	XL

📦 bulk packaging:  
50 x 1 pc.



## non-rebreather mask with tubing

### features

- made of transparent, non-toxic PVC
- adjustable nose metal plate and rubber fastening
- equipped with a 210 cm (+/- 5%) long tubing with universal connectors
- tubing with star cross-section that is resistant to bending
- 1000 ml oxygen reservoir
- revolving connector that allows adjusting to patient's position
- silicone valves on the connector and ventilation openings
- single-use
- packaging: 1 pc./paper-foil

### indication

- designed to deliver oxygen with precise regulation of concentration, for high oxygen concentration



🕒 60 min to 30 days

REF	length of tubing	size
MTW-S	210 cm +/- 5%	S
MTW-M	210 cm +/- 5%	M
MTW-L	210 cm +/- 5%	L
MTW-XL	210 cm +/- 5%	XL

 bulk packaging:  
50 x 1 pc.

**STERILE EO**

 LATEX

 PHT

 DEHP

 5 YEARS SHELF LIFE

## multi-vent mask with tubing

### features

- made of transparent, non-toxic PVC
- adjustable nose metal plate and rubber fastening
- equipped with a 210 cm (+/- 5%) long tubing with universal connectors
- tubing with star cross-section that is resistant to bending
- equipped with 2 jets - white to set mid flow concentration (35%, 40% and 50%) and green to set low concentration (24%, 26%, 28% and 30%)
- single-use
- packaging: 1 pc./foil

### indication

- designed to deliver oxygen with precise regulation of concentration, regardless of way of patient's breathing



🕒 60 min to 30 days

REF	length of tubing	size
MTVR-L	210 cm +/- 5%	L
MTVR-XL	210 cm +/- 5%	XL

 bulk packaging:  
100 x 1 pc.

60 min to 30 days

**STERILE EO**

 LATEX

 PHT

 DEHP

 5 YEARS SHELF LIFE

## nebulizer mask with tubing

### features

- made of transparent, non-toxic PVC
- adjustable nose metal plate and rubber fastening
- equipped with a 210 cm (+/- 5%) long tubing with universal connectors
- tubing with star cross-section that is resistant to bending
- 8 ml nebulizer (graduated every 1 ml)
- average size of the molecule at a flow of 6l/min - 3,23 µm
- single-use
- packaging: 1 pc./paper-foil

### indication

- for producing aerosol containing a comminuted medicine, that can be delivered directly to the respiratory system as the patient breathes



🕒 up to 60 min

REF	length of tubing	size
MTN-S	210 cm +/- 5%	S
MTN-M	210 cm +/- 5%	M
MTN-L	210 cm +/- 5%	L
MTN-XL	210 cm +/- 5%	XL

 bulk packaging:  
50 x 1 pc.

**STERILE EO**

 LATEX

 PHT

 DEHP

 5 YEARS SHELF LIFE

# nebulizer

with T/F/M adaptor, mouthpiece,  
corrugated tube and tubing

## features

- made of non-toxic materials
- 210 cm long, bend-resistant tubing with star-shaped cross-section
- nebuliser with a 6ml capacity (graduated every 1ml), producing particles with an average size of MMAD = 3.91 µm at a flow rate of 6 l/min.
- nebuliser, tubing, T-adaptor, mouthpiece, one-way valve and corrugated tube included in a kit
- universal T-adaptor with a diameter of 22M/15F - 22F enables the kit to be connected to endotracheal, tracheostomy tube or breathing circuit and perform nebulisation on mechanically ventilated patients
- the universal (detachable) mouthpiece allows nebulisation to be given to patients who are breathing on their own
- silicone one-way valve (detachable) reduces medication waste during nebulisation
- single-use
- packaging: 1 pc./foil

## indication

- device is designed to produce an aerosol containing fragmented medication, which can be delivered deep into the respiratory system with the patient's inhalation
- enables nebulisation to be carried out in mechanically ventilated patients by connecting directly to the endotracheal tube, tracheostomy tube or inspiratory arm of the ventilator breathing system
- allows you to perform nebulisation in patient „on one's own breath“



🕒 up to 60 min



REF	length of tubing
NUTR	210 cm +/- 5%

  
bulk packaging:  
100 x 1 pc.



ZARYS

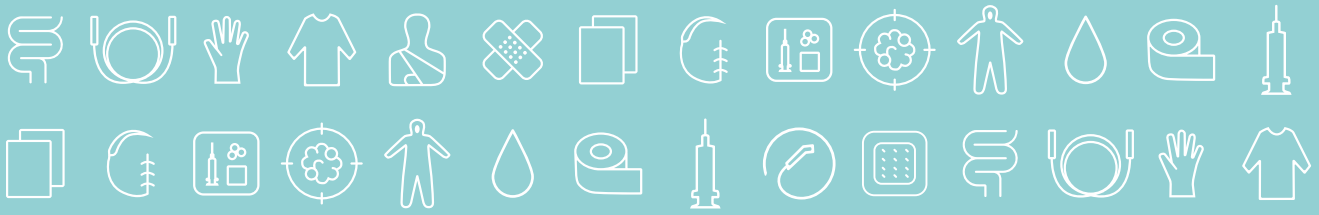

WWW.ZARYS.COM

# ANAESTHESIA PRODUCTS



# endotracheal tube

## uncuffed

### features

- made of flexible PVC
- radiopaque line over the entire tube length
- equipped with lateral Murphy eye
- graduated every 1 cm
- double depth marker to control the position of the tube
- tube size marked in 3 places (on the connector and in two places on the tube body)
- detachable connector with an outer diameter of 15 mm
- single-use
- packaging: 1 pc./paper-foil

### indication

- for both oral and nasal intubation
- inserted into the trachea to prevent airway obstruction and respiratory failure



REF	size	intermediate packaging
RIB-20	I.D. (mm) 2.0	20 pcs
RIB-25	I.D. (mm) 2.5	20 pcs
RIB-30	I.D. (mm) 3.0	20 pcs
RIB-35	I.D. (mm) 3.5	20 pcs
RIB-40	I.D. (mm) 4.0	20 pcs
RIB-45	I.D. (mm) 4.5	20 pcs
RIB-50	I.D. (mm) 5.0	20 pcs
RIB-55	I.D. (mm) 5.5	20 pcs
RIB-60	I.D. (mm) 6.0	20 pcs
RIB-65	I.D. (mm) 6.5	20 pcs
RIB-70	I.D. (mm) 7.0	20 pcs
RIB-75	I.D. (mm) 7.5	20 pcs
RIB-80	I.D. (mm) 8.0	20 pcs
RIB-85	I.D. (mm) 8.5	20 pcs
RIB-90	I.D. (mm) 9.0	20 pcs
RIB-95	I.D. (mm) 9.5	20 pcs
RIB-100	I.D. (mm) 10.0	20 pcs



bulk packaging:  
10 x 20 pcs

60 min to 30 days

# endotracheal tube

## cuffed

### features

- made of flexible PVC
- equipped with lateral Murphy eye and radiopaque line over the entire tube length
- graduated every 1 cm, double depth marker to control the position of the tube
- low-pressure, high-volume cuff
- tube size marked in 4 places (on the connector, on the pilot balloon and in two places on the tube body)
- detachable connector with an outer diameter of 15 mm
- pilot balloon with LOT and size indication
- single-use
- packaging: 1 pc./paper-foil

### indication

- for both oral and nasal intubation
- inserted into the trachea to prevent airway obstruction and respiratory failure



REF	size	intermediate packaging
RIM-30	I.D. (mm) 3.0	20 pcs
RIM-35	I.D. (mm) 3.5	20 pcs
RIM-40	I.D. (mm) 4.0	20 pcs
RIM-45	I.D. (mm) 4.5	20 pcs
RIM-50	I.D. (mm) 5.0	20 pcs
RIM-55	I.D. (mm) 5.5	20 pcs
RIM-60	I.D. (mm) 6.0	20 pcs
RIM-65	I.D. (mm) 6.5	20 pcs
RIM-70	I.D. (mm) 7.0	20 pcs
RIM-75	I.D. (mm) 7.5	20 pcs
RIM-80	I.D. (mm) 8.0	20 pcs
RIM-85	I.D. (mm) 8.5	20 pcs
RIM-90	I.D. (mm) 9.0	20 pcs
RIM-95	I.D. (mm) 9.5	20 pcs
RIM-100	I.D. (mm) 10.0	20 pcs



bulk packaging:  
10 x 20 pcs

60 min to 30 days

# reinforced endotracheal tube

## cuffed

### features

- made of flexible PVC
- reinforcing within the wall of the entire tube
- equipped with lateral Murphy eye and radiopaque line over the entire tube length
- graduated every 1 cm, double depth marker to control the position of the tube
- tube size marked in 4 places (on the connector, on the pilot balloon and in two places on the tube body)
- indissociable connector with an outer diameter of 15 mm
- single-use
- packaging: 1 pc./paper-foil

### indication

- for both oral and nasal intubation
- inserted into the trachea to prevent airway obstruction and respiratory failure
- for intubation of the patient in an unusual position, with a high risk of kinking the endotracheal tube



REF	size	intermediate packaging
RIMZP-30	I.D. (mm) 3.0	10 pcs
RIMZP-35	I.D. (mm) 3.5	10 pcs
RIMZP-40	I.D. (mm) 4.0	10 pcs
RIMZP-45	I.D. (mm) 4.5	10 pcs
RIMZP-50	I.D. (mm) 5.0	10 pcs
RIMZP-55	I.D. (mm) 5.5	10 pcs
RIMZP-60	I.D. (mm) 6.0	10 pcs
RIMZP-65	I.D. (mm) 6.5	10 pcs
RIMZP-70	I.D. (mm) 7.0	10 pcs
RIMZP-75	I.D. (mm) 7.5	10 pcs
RIMZP-80	I.D. (mm) 8.0	10 pcs
RIMZP-85	I.D. (mm) 8.5	10 pcs
RIMZP-90	I.D. (mm) 9.0	10 pcs
RIMZP-95	I.D. (mm) 9.5	10 pcs
RIMZP-100	I.D. (mm) 10.0	10 pcs



bulk packaging:  
10 x 10 pcs

60 min to 30 days

# intubation stylet

## features

- made of PVC-coated aluminium
- special material for both stiffness and pliability
- intended for use during difficult intubation
- size and diameter markings
- soft distal tip
- single-use
- packaging: 1 pc./paper-foil

## indication

- allows you to give the endotracheal tube the right curvature
- introduced to the endotracheal tube facilitates intubation in routine and difficult cases, when the laryngeal inlet is not visible

REF	size	diameter	length	tube size	intermediate packaging
PRI-06	6 Fr	2,0 mm	310 mm (±10)	from 2,0 to 4,0	20 pcs
PRI-10	10 Fr	3,3 mm	390 mm (±10)	from 4,5 to 6,5	20 pcs
PRI-14	14 Fr	4,7 mm	390 mm (±10)	from 7,0 to 10,0	20 pcs



⌚ up to 60 min

bulk packaging:  
20 x 20 pcs

STERILEEO

LATEX

PHI

5 YEARS  
SHELF LIFE

# tracheal tube introducer

## curved

## features

- made of medical grade low density polyethylene
- curved and rounded tip enables safe intubation without damaging the soft tissues
- optimum flexibility and rigidity facilitate correct insertion and safe removal of the introducer after intubation
- imprint of the size, diameter and manufacturer's name on the device
- bright yellow body for increased visibility of the introducer in the tracheal tube canal
- clear, easy to read graduation every 1 cm
- available in three sizes and lengths
- single-use
- PVC free
- packaging: 1 pc./paper-foil

## indication

- for use during difficult intubation procedures
- as an aid to facilitate the insertion of the endotracheal tube during standard intubation

REF	size	diameter O.D.	total length	tube size	graduation	intermediate packaging
PTIZ-06-535	6 Fr	2,0 mm	535 mm	from 2,0 to 4,0	10 – 45 mm	10 pcs
PTIZ-10-600	10 Fr	3,3 mm	600 mm	from 4,5 to 6,0	10 – 50 mm	10 pcs
PTIZ-10-800	10 Fr	3,3 mm	800 mm	from 4,5 to 6,0	10 – 60 mm	10 pcs
PTIZ-15-600	15 Fr	5,0 mm	600 mm	from 6,5 to 10,0	10 – 50 mm	10 pcs
PTIZ-15-800	15 Fr	5,0 mm	800 mm	from 6,5 to 10,0	10 – 60 mm	10 pcs



⌚ up to 60 min

bulk packaging:  
20 x 10 pcs

STERILEEO

LATEX

PHI

5 YEARS  
SHELF LIFE

# endotracheal tube holder

## features

- made of high-quality materials
- universal Velcro fasteners enabling fast and effective fixing of the holder around the head
- adjustable handle allows for easy and fast fixation of every size of endotracheal tube
- special design of the bite-piece prevents patient trauma or damaging the tube (by biting)
- additional opening allows for chyme, saliva and blood suction from the oral cavity
- single-use
- packaging: 1 pc./paper-foil

## indication

- to stabilize the position of the endotracheal tube after its insertion into the trachea

REF	version	colour
SRI-N	horizontal fixation	blue-red
SRI-A	vertical fixation	green

bulk packaging:  
100 x 1 pc.



⌚ 60 min to 30 days

STERILEEO

LATEX

PHI

5 YEARS  
SHELF LIFE

# oropharyngeal airway/guedel airway

## features

- made of high quality PE (polyethylene), free of PVC
- distinctive anatomical curve of airway tube allows for the opening of the upper respiratory tract and the free flow of anaesthetic gases, air
- colour coded sizes
- numeric marking of the size on the airway
- single-use
- packaging: 1 pc./foil

## indication

- used during artificial ventilation procedures to ensure the airway patency
- as a tool for paramedic to assist in the management of a casualty's airway which increases the effectiveness of the rescue operation
- facilitates the stabilization of the endotracheal tube and protects it against biting



REF	size	number	colour	intermediate packaging
RG-40	40 mm	000	pink	50 pcs
RG-50	50 mm	00	dark blue	50 pcs
RG-60	60 mm	0	black	50 pcs
RG-70	70 mm	1	white	50 pcs
RG-80	80 mm	2	green	50 pcs
RG-90	90 mm	3	yellow	50 pcs
RG-100	100 mm	4	red	50 pcs
RG-110	110 mm	5	orange	50 pcs
RG-120	120 mm	6	purple	50 pcs

 bulk packaging:  
10 x 50 pcs

 up to 60 min



# laryngeal mask

## PVC

## features

- made of medical PVC
- elastic mask body with description (size, cuff volume, suggested patient's weight)
- elliptic shape, flexible sealing cuff and universal, transparent connector: 15 mm
- colour-coded valve protection makes it easy to quickly recognize size
- single-use
- compatible with magnetic resonance (MR)
- no metal elements
- packaging: 1 pc./paper-foil

## indication

- device inserted through the mouth, up to the back of the throat, forms a seal at the top of the glottis in order to:
  - direct protecting the patient's airway patency
  - artificial ventilation also during cardiopulmonary resuscitation
  - maintaining airway patency in: short-term surgical procedures, without the need of muscles relaxation, when endotracheal intubation is not necessary and under anesthesia for diagnostic procedures



REF	size	colour of valve protection	weight of patient	max. inflation	intermediate packaging
MKPJ-10	1	pink	≤ 5 kg	4 ml	5 pcs
MKPJ-15	1.5	orange	5-10 kg	7 ml	5 pcs
MKPJ-20	2	dark green	10-20 kg	10 ml	5 pcs
MKPJ-25	2.5	brown	20-30 kg	14 ml	5 pcs
MKPJ-30	3	green	30-50 kg	20 ml	5 pcs
MKPJ-40	4	purple	50-70 kg	30 ml	5 pcs
MKPJ-50	5	dark blue	70-100 kg	40 ml	5 pcs

 bulk packaging:  
10 x 5 pcs

 60 min to 30 days



# laryngeal mask

silicone

## features

- made of biocompatible silicone, which ensures excellent flexibility of the device
- elastic mask body with description (size, cuff volume, suggested patient's weight)
- elliptic shape, flexible sealing cuff and universal, transparent connector: 15 mm
- single-use
- compatible with magnetic resonance (MR)
- no metal elements
- packaging: 1 pc./paper-foil

## indication

- device inserted through the mouth, up to the back of the throat, forms a seal at the top of the glottis in order to:
  - direct protecting the patient's airway patency
  - artificial ventilation also during cardiopulmonary resuscitation
  - maintaining airway patency in: short-term surgical procedures, without the need of muscles relaxation, when endotracheal intubation is not necessary and under anesthesia for diagnostic procedures



⌚ 60 min to 30 days

 bulk packaging:  
10 x 5 pcs

REF	size	weight of patient	max. inflation	intermediate packaging
MKSJ-10	1	≤ 5 kg	4 ml	5 pcs
MKSJ-15	1.5	5-10 kg	7 ml	5 pcs
MKSJ-20	2	10-20 kg	10 ml	5 pcs
MKSJ-25	2.5	20-30 kg	14 ml	5 pcs
MKSJ-30	3	30-50 kg	20 ml	5 pcs
MKSJ-40	4	50-70 kg	30 ml	5 pcs
MKSJ-50	5	70-100 kg	40 ml	5 pcs



# tracheostomy tube

cuffed

## features

- made of medical, flexible PVC
- swivel 15 mm connector
- flexible neckplates with slits for strap insertion to secure tube position
- soft, low-pressure, thin-walled cuff
- pilot balloon in contrasting colour clearly indicates the level of the cuff's inflation
- 2 fixation straps protected with foil
- clear size marking on the neckplates
- atraumatic, soft rounded tip, curved cannula
- radiopaque line
- equipped with obturator
- single-use
- packaging: 1 pc./rigid blister

## indication

- to control respiratory tracts in people after tracheostomy
- introduced to the airways by a surgical incision of the trachea's front wall to allow ventilation
- provides free breathing bypassing the nose, throat and larynx



⌚ 60 min to 30 days

 bulk packaging:  
10 x 10 pcs

REF	size	intermediate packaging
RTM-40	4.0	10 pcs
RTM-45	4.5	10 pcs
RTM-50	5.0	10 pcs
RTM-60	6.0	10 pcs
RTM-65	6.5	10 pcs
RTM-70	7.0	10 pcs
RTM-75	7.5	10 pcs
RTM-80	8.0	10 pcs
RTM-85	8.5	10 pcs
RTM-90	9.0	10 pcs
RTM-95	9.5	10 pcs
RTM-100	10.0	10 pcs



## air cushion anaesthetic mask

### features

- due to the high quality of materials used, ventilation is conducted in an atraumatic and safe way for the patient
- anatomically shaped inflatable cuff, ensures perfect tightness of the mask with minimal pressure
- device, when applied to the face, tightly covers the patient's mouth and nose without compressing the eyes
- clear shell provides continuous visual observation of the patient
- colour-coded retaining rings, easy for size recognition
- retaining ring can be removed when it is not needed
- full size range allows to properly choose the size of the mask depending on the age of the patient
- all sizes are equipped with inflatable check valve to adjust air amount for best cushion fitting auto patient's face
- single-use
- packaging: 1 pc./foil

### indication

- intended for the administration of a gas mixture coming through devices for artificial ventilation
- enables performing medical procedures including artificial ventilation, administration of anesthetic gas and carrying out emergency treatment of an unconscious patient



🕒 30 - 60 min

REF	size	age of patient/ size	colour	bulk packaging
MAP-0	0	neonate	white	200 x 1 pc.
MAP-1	1	infant	pink	200 x 1 pc.
MAP-2	2	pediatric	yellow	150 x 1 pc.
MAP-3	3	adult S	green	150 x 1 pc.
MAP-4	4	adult M	red	100 x 1 pc.
MAP-5	5	adult L	blue	100 x 1 pc.
MAP-6	6	adult XL	orange	80 x 1 pc.



## anaesthetic mask with open seal

### features

- due to the high quality of materials used, ventilation is conducted in an atraumatic and safe way for the patient
- anatomically shaped open seal made of TPE ensures perfect tightness of the mask with minimal pressure
- polypropylene, transparent mask dome allows continuous visual observation of the patient
- device, when applied to the face, tightly covers the patient's mouth and nose without compressing the eyes
- size embossed on the body and colour-coded seal
- full size range allows to properly choose the size of the mask depending on the age of the patient
- single-use
- packaging: 1 pc./medical foil

### indication

- device intended for the administration of a gas mixture coming through devices for artificial ventilation
- enables performing medical procedures including artificial ventilation, administration of anesthetic gas and carrying out emergency treatment of an unconscious patient
- device used in hospitals (operating theaters, intensive care units, emergency departments) as well as during pre-hospital care by rescue teams carrying out rescue operations in an unconscious patient



🕒 30 - 60 min

catalogue number	size	age of patient	seal colour	connector	bulk packaging
MAO-1	1	infant	blue	15 mm	200 x 1 pc.
MAO-2	2	pediatric	orange	15 mm	150 x 1 pc.
MAO-3	3	small adult	pink	22 mm	150 x 1 pc.
MAO-4	4	medium adult	white	22 mm	100 x 1 pc.
MAO-5	5	large adult	yellow	22 mm	100 x 1 pc.
MAO-6	6	very large adult	green	22 mm	80 x 1 pc.



# catheter mount with double swivel elbow connector

## features

- smooth bore type made of medical PVC
- expandable type made of high quality PE, EVA
- universal patient connection: 22M/15F
- ventilation device side connector: 15M or 22F
- expandable version characterized by shape memorizing and by the ability to control the position of the connector
- double swivel elbow connector
- port for suctioning and bronchoscope secured with a stopper
- available in versions: smooth bore and expandable
- single-use
- packaging: 1 pc./paper-foil

## indication

- used to connect the tracheostomy tube or endotracheal tube with the breathing circuit of the ventilation device
- provides greater mobility and rotation of the connection, increasing patient comfort and safety



🕒 60 min to 30 days

REF	type	connection	length (without connectors)	intermediate packaging
PM-15-G	smooth bore (not expandable)	22M/15F-15M	15 cm	10 pcs
PM-22-G	smooth bore (not expandable)	22M/15F-22F	15 cm	10 pcs
PMR-15-K	expandable	22M/15F-15M	8-15 cm	10 pcs
PMR-22-K	expandable	22M/15F-22F	8-15 cm	10 pcs



bulk packaging:  
10 x 10 pcs



# dual-limb breathing circuit

## features

- made of high quality EVA material, without PVC
- 15F/22M and 22F universal connector fits compatible products and devices for mechanical ventilation or anesthesia machine
- expandable arms with maximum length of 160 cm
- adjustable length of circuit enabling adjustment of length of respiratory system and optimization of dead space
- equipped with latex-free breathing bag: 2l and 3l (for adults) or 1l (for children)
- additional expandable tube, length: 100 cm
- elbow with Luer-Lock port
- single-use
- packaging: 1 pc./foil

## indication

- for patient's mechanical ventilation
- it enables transporting breathing mixture from equipment (ventilator, anesthesia machine) to respiratory protection device (e.g. tracheal tube, tracheostomy mask) and vice versa



## with bag

REF	purpose	capacity of bag	bulk packaging
OBWD-1601L	for children	1 liter	50x1 pc
OBWD-1603L	for adults	3 liters	40x1 pc
NEW OBWD-2002L	for adults	2 liters	40x1 pc

## without bag

REF	purpose	length of circuit (min/max)	tube diameter
OBP-160	for children	60 cm / 160 cm	15 mm
OBD-160	for adults	60 cm / 160 cm	22 mm

📦 bulk packaging:  
50 x 1 pc.



🕒 60 min to 30 days

ZARYS



WWW.ZARYS.COM

# SUCTION CATHETERS, STOMACH TUBES

# suction catheter with vacuum control

## features

- made of soft and flexible PVC, that is resistant to bending and kinking
- frozen surface prevents the catheter from sticking to the wall of the endotracheal tube
- full control over the suction
- atraumatic, soft rounded, open tip
- tip with two alternating side holes with smooth edges
- colour-coded connectors for size recognition, numerical size identification on the packaging
- single-use
- packaging: 1 pc./paper-foil

## indication

- device designed for suction of secretions from the upper respiratory tract



REF	size	length	colour	intermediate packaging
CO-A06-60	CH 6	600 mm	light green	50 pcs
CO-A08-60	CH 8	600 mm	blue	50 pcs
CO-A10-60	CH 10	600 mm	black	50 pcs
CO-A12-60	CH 12	600 mm	white	50 pcs
CO-A14-60	CH 14	600 mm	green	50 pcs
CO-A16-60	CH 16	600 mm	orange	50 pcs
CO-A18-60	CH 18	600 mm	red	50 pcs



bulk packaging:  
10 x 50 pcs

STERILE EO



DEHP

5 YEARS SHELF LIFE

# suction catheter

## features

- made of soft and flexible PVC, that is resistant to bending and kinking
- frozen surface prevents the catheter from sticking to the wall of the endotracheal tube
- atraumatic, soft rounded, open tip
- tip with two alternating side holes with smooth edges
- colour-coded connectors for size recognition, numerical size identification on the packaging
- single-use
- packaging: 1 pc./paper-foil

## indication

- device designed for suction of secretions from the upper respiratory tract
- recommended for source of suction with its own suction force regulation



REF	size	length	colour	intermediate packaging
CO-B06-40	CH 6	400 mm	light green	50 pcs
CO-B08-40	CH 8	400 mm	blue	50 pcs
CO-B10-40	CH 10	400 mm	black	50 pcs
CO-B12-50	CH 12	500 mm	white	50 pcs
CO-B12-60	CH 12	600 mm	white	50 pcs
CO-B14-50	CH 14	500 mm	green	50 pcs
CO-B14-60	CH 14	600 mm	green	50 pcs
CO-B16-50	CH 16	500 mm	orange	50 pcs
CO-B16-60	CH 16	600 mm	orange	50 pcs
CO-B18-50	CH 18	500 mm	red	50 pcs
CO-B18-60	CH 18	600 mm	red	50 pcs
CO-B20-50	CH 20	500 mm	yellow	50 pcs
CO-B20-60	CH 20	600 mm	yellow	50 pcs
CO-B22-50	CH 22	500 mm	purple	50 pcs
CO-B22-60	CH 22	600 mm	purple	50 pcs



bulk packaging:  
10 x 50 pcs

STERILE EO



DEHP

5 YEARS SHELF LIFE



## suction catheter with frozen surface

### features

- made of soft and flexible PVC, that is resistant to bending and kinking
- frozen surface enabling easy insertion
- atraumatic, soft rounded, open tip
- tip with two opposite lateral eyes with smooth edges
- colour-coded connectors for size recognition, numerical size identification on the packaging
- single-use
- packaging: 1 pc./paper-foil

### indication

- device designed for suction of secretions from the upper respiratory tract
- recommended for source of suction with its own suction force regulation



REF	size	length	colour	intermediate packaging
CO-BF-ZP-B06-40	CH 6	400 mm	light green	50 pcs
CO-BF-ZP-B06-60	CH 6	600 mm	light green	50 pcs
CO-BF-ZP-B08-40	CH 8	400 mm	blue	50 pcs
CO-BF-ZP-B08-60	CH 8	600 mm	blue	50 pcs
CO-BF-ZP-B10-40	CH 10	400 mm	black	50 pcs
CO-BF-ZP-B10-60	CH 10	600 mm	black	50 pcs
CO-BF-ZP-B12-60	CH 12	600 mm	white	50 pcs
CO-BF-ZP-B14-60	CH 14	600 mm	green	50 pcs
CO-BF-ZP-B16-60	CH 16	600 mm	orange	50 pcs
CO-BF-ZP-B18-60	CH 18	600 mm	red	50 pcs
CO-BF-ZP-B20-60	CH 20	600 mm	yellow	50 pcs
CO-BF-ZP-B22-60	CH 22	600 mm	purple	50 pcs
CO-BF-ZP-B24-60	CH 24	600 mm	dark blue	50 pcs

 bulk packaging:  
10 x 50 pcs



## feeding tube graduated, with X-ray contrast

### features

- made of soft PVC with a frosted surface, resistant to bending and kinking due to the appropriate degree of hardness
- atraumatic, soft rounded, closed tip facilitates precise insertion of catheter
- two alternate end side holes with gently stretched edges
- connector compatible with the conical tip of Luer syringe
- integrated stoper allows the tube to be closed tightly
- colour-coded connectors for size recognition, numerical size identification on packaging
- radiopaque line along the entire length of the catheter
- digital depth graduation every 1 cm (from 5 cm to 40 cm)
- length 50 cm
- name of the manufacturer placed on the catheter
- individually packed straight
- single-use
- packaging: 1 pc. / paper-foil

### indication

- device inserted through patient's nose or mouth to perform enteral nutrition



REF	size	length	colour	intermediate packaging
CKS-04-50	CH 4	500 mm	red	100 pcs
CKS-05-50	CH 5	500 mm	grey	100 pcs
CKS-06-50	CH 6	500 mm	pole green	100 pcs
CKS-08-50	CH 8	500 mm	blue	100 pcs
CKS-10-50	CH 10	500 mm	black	100 pcs

 bulk packaging:  
60 x 100 pcs



# stomach tube/duodenal tube

## features

- made of PVC
- made of material that is resistant to bending and kinking due to the appropriate degree of hardness
- atraumatic, soft rounded closed tip
- four side holes with smooth edges
- colour-coded connectors for size recognition, numerical size identification on packaging
- stomach tube is available in 3 lengths: 80 cm, 100 cm, 125 cm and duodenal tube is available in 150 cm length
- single-use
- packaging: 1 pc./paper-foil

## indication

- inserted through nose or mouth into stomach or duodenum
- drainage of stomach/intestinal content
- decompression of stomach (air or food evacuation)
- gastric lavage
- taking samples of stomach content
- control of bleeding from the upper section of digestive tract
- evaluation of secretory function
- administration of medicines, fluids and/or food content into stomach or duodenum



REF	size	length	colour	intermediate packaging	bulk packaging
* ZZ-80/CH05	CH 5	800 mm	grey	35 pcs	20 x 35 pcs
* ZZ-80/CH06	CH 6	800 mm	light green	35 pcs	20 x 35 pcs
ZZ-80/CH08	CH 8	800 mm	blue	35 pcs	20 x 35 pcs
ZZ-80/CH10	CH 10	800 mm	black	35 pcs	20 x 35 pcs
ZZ-80/CH12	CH 12	800 mm	white	35 pcs	20 x 35 pcs
ZZ-80/CH14	CH 14	800 mm	green	30 pcs	20 x 30 pcs
ZZ-80/CH16	CH 16	800 mm	orange	30 pcs	20 x 30 pcs
ZZ-80/CH18	CH 18	800 mm	red	25 pcs	20 x 25 pcs
ZZ-80/CH20	CH 20	800 mm	yellow	15 pcs	20 x 15 pcs
ZZ-80/CH22	CH 22	800 mm	purple	15 pcs	20 x 15 pcs
ZZ-80/CH24	CH 24	800 mm	dark blue	15 pcs	20 x 15 pcs
* ZZ-100/CH05	CH 5	1000 mm	grey	30 pcs	20 x 30 pcs
* ZZ-100/CH06	CH 6	1000 mm	light green	30 pcs	20 x 30 pcs
ZZ-100/CH08	CH 8	1000 mm	blue	30 pcs	20 x 30 pcs
ZZ-100/CH10	CH 10	1000 mm	black	30 pcs	20 x 30 pcs
ZZ-100/CH12	CH 12	1000 mm	white	30 pcs	20 x 30 pcs
ZZ-100/CH14	CH 14	1000 mm	green	25 pcs	20 x 25 pcs
ZZ-100/CH16	CH 16	1000 mm	orange	20 pcs	20 x 20 pcs
ZZ-100/CH18	CH 18	1000 mm	red	15 pcs	20 x 15 pcs
ZZ-100/CH20	CH 20	1000 mm	yellow	15 pcs	20 x 15 pcs
ZZ-100/CH22	CH 22	1000 mm	purple	10 pcs	20 x 10 pcs
ZZ-100/CH24	CH 24	1000 mm	dark blue	10 pcs	20 x 10 pcs
* ZZ-125/CH05	CH 5	1250 mm	grey	30 pcs	20 x 30 pcs
* ZZ-125/CH06	CH 6	1250 mm	light green	30 pcs	20 x 30 pcs
ZZ-125/CH08	CH 8	1250 mm	blue	30 pcs	20 x 30 pcs
ZZ-125/CH10	CH 10	1250 mm	black	30 pcs	20 x 30 pcs
ZZ-125/CH12	CH 12	1250 mm	white	30 pcs	20 x 30 pcs
ZZ-125/CH14	CH 14	1250 mm	green	25 pcs	20 x 25 pcs
ZZ-125/CH16	CH 16	1250 mm	orange	20 pcs	20 x 20 pcs
ZZ-125/CH18	CH 18	1250 mm	red	20 pcs	20 x 20 pcs
ZZ-125/CH20	CH 20	1250 mm	yellow	15 pcs	20 x 15 pcs
ZZ-125/CH22	CH 22	1250 mm	purple	10 pcs	20 x 10 pcs
ZZ-125/CH24	CH 24	1250 mm	dark blue	10 pcs	20 x 10 pcs
* ZD-150/CH5	CH 5	1500 mm	grey	30 pcs	20 x 30 pcs
* ZD-150/CH6	CH 6	1500 mm	light green	30 pcs	20 x 30 pcs
* ZD-150/CH8	CH 8	1500 mm	blue	30 pcs	20 x 30 pcs
* ZD-150/CH10	CH 10	1500 mm	black	30 pcs	20 x 30 pcs
* ZD-150/CH12	CH 12	1500 mm	white	30 pcs	20 x 30 pcs
* ZD-150/CH14	CH 14	1500 mm	green	20 pcs	20 x 20 pcs
* ZD-150/CH16	CH 16	1500 mm	orange	15 pcs	20 x 15 pcs
* ZD-150/CH18	CH 18	1500 mm	red	15 pcs	20 x 15 pcs
ZD-150/CH20	CH 20	1500 mm	yellow	10 pcs	20 x 10 pcs
ZD-150/CH22	CH 22	1500 mm	purple	10 pcs	20 x 10 pcs
ZD-150/CH24	CH 24	1500 mm	dark blue	10 pcs	20 x 10 pcs

\*   
available on request



ZARYS

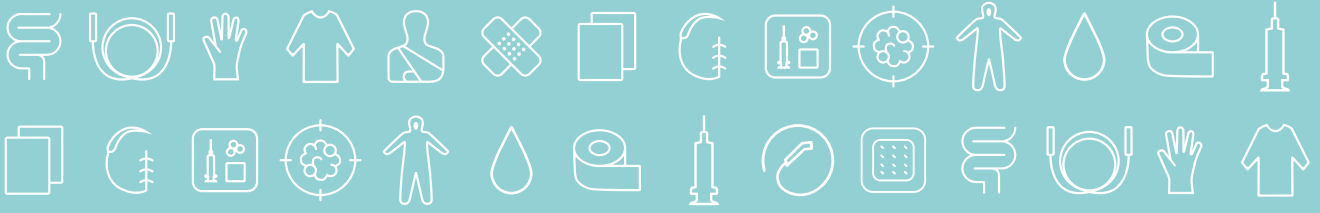

WWW.ZARYS.COM

# UROLOGICAL CATHETERS, URINE BAGS

# Foley catheter

## 2-way, silicone-coated latex

### features

- made of soft and flexible latex, that is resistant to bending and kinking
- atraumatic, soft rounded, special tip facilitating insertion of the catheter to the bladder
- tip with two lateral eyes with smooth edges
- universal urine drainage port of the catheter fits into standard connectors in urine bags
- silicone-coated surface that allows atraumatic insertion of the catheter
- easy to fill and to empty, tear-resistant balloon of various capacities
- plastic or rubber valve to ensure balloon tightness
- CH 6, CH 8, CH 10 size has a guide to facilitate catheterization
- single-use
- packaging: 1 pc./double packaging: internal- foil, external- paper-foil

### indication

- to drain urine from the bladder

### with plastic valve

REF	length	balloon	size	colour	intermediate packaging
CFNL-2D-06-03-P	270 mm	3 ml	CH 6	light green	10 pcs
CFNL-2D-08-05-P	270 mm	3-5 ml	CH 8	blue	10 pcs
CFNL-2D-10-05-P	270 mm	3-5 ml	CH 10	black	10 pcs
CFNL-2D-12-10-P	400 mm	5-10 ml	CH 12	white	10 pcs
CFNL-2D-14-10-P	400 mm	5-10 ml	CH 14	green	10 pcs
CFNL-2D-16-10-P	400 mm	5-10 ml	CH 16	orange	10 pcs
CFNL-2D-18-10-P	400 mm	5-10 ml	CH 18	red	10 pcs
CFNL-2D-20-10-P	400 mm	5-10 ml	CH 20	yellow	10 pcs
CFNL-2D-22-10-P	400 mm	5-10 ml	CH 22	purple	10 pcs
CFNL-2D-24-10-P	400 mm	5-10 ml	CH 24	dark blue	10 pcs
CFNL-2D-12-30-P	400 mm	30 ml	CH 12	white	10 pcs
* CFNL-2D-26-30-P	400 mm	30 ml	CH 26	pink	10 pcs
CFNL-2D-28-30-P	400 mm	30 ml	CH 28	brown	10 pcs
* CFNL-2D-30-30-P	400 mm	30 ml	CH 30	grey	10 pcs
CFNL-2D-14-50-P	400 mm	30-50 ml	CH 14	green	10 pcs
CFNL-2D-16-50-P	400 mm	30-50 ml	CH 16	orange	10 pcs
CFNL-2D-18-50-P	400 mm	30-50 ml	CH 18	red	10 pcs
CFNL-2D-20-50-P	400 mm	30-50 ml	CH 20	yellow	10 szt.
CFNL-2D-22-50-P	400 mm	30-50 ml	CH 22	purple	10 pcs
CFNL-2D-24-50-P	400 mm	30-50 ml	CH 24	dark blue	10 pcs
CFNL-2D-26-50-P	400 mm	30-50 ml	CH 26	pink	10 pcs
CFNL-2D-28-50-P	400 mm	30-50 ml	CH 28	brown	10 pcs
CFNL-2D-30-50-P	400 mm	30-50 ml	CH 30	grey	10 pcs



### with rubber valve

REF	length	balloon	size	colour	intermediate packaging
CFNL-2D-06-03-L	270 mm	3 ml	CH 6	light green	10 pcs
CFNL-2D-08-05-L	270 mm	3-5 ml	CH 8	blue	10 pcs
CFNL-2D-10-05-L	270 mm	3-5 ml	CH 10	black	10 pcs
CFNL-2D-12-10-L	400 mm	5-10 ml	CH 12	white	10 pcs
CFNL-2D-14-10-L	400 mm	5-10 ml	CH 14	green	10 pcs
CFNL-2D-16-10-L	400 mm	5-10 ml	CH 16	orange	10 pcs
CFNL-2D-18-10-L	400 mm	5-10 ml	CH 18	red	10 pcs
CFNL-2D-20-10-L	400 mm	5-10 ml	CH 20	yellow	10 pcs
CFNL-2D-22-10-L	400 mm	5-10 ml	CH 22	purple	10 pcs
CFNL-2D-24-10-L	400 mm	5-10 ml	CH 24	dark blue	10 pcs
CFNL-2D-26-10-L	400 mm	5-10 ml	CH 26	pink	10 pcs
CFNL-2D-16-30-L	400 mm	30 ml	CH 16	orange	10 pcs
CFNL-2D-18-30-L	400 mm	30 ml	CH 18	red	10 pcs
CFNL-2D-20-30-L	400 mm	30 ml	CH 20	yellow	10 pcs
CFNL-2D-22-30-L	400 mm	30 ml	CH 22	purple	10 pcs
CFNL-2D-24-30-L	400 mm	30 ml	CH 24	dark blue	10 pcs
CFNL-2D-26-30-L	400 mm	30 ml	CH 26	pink	10 pcs



bulk packaging:  
40 x 10 pcs

\* available  
on request



bulk packaging:  
50 x 10 pcs

# Foley catheter

## 3-way, silicone-coated latex

### features

- made of soft and flexible latex, that is resistant to bending and kinking
- universal urine drainage port of the catheter fits into standard connectors in urine bags
- additional inlet for flushing out the bladder
- atraumatic, soft rounded, special tip facilitating insertion of the catheter to the bladder
- tip with two lateral eyes with smooth edges
- silicone-coated surface that allows atraumatic insertion of the catheter
- easy to fill and to empty, tear-resistant balloon
- plastic valve to ensure balloon tightness
- single-use
- packaging: 1 pc./double packaging: internal- foil, external- paper-foil

### indication

- to drain urine from the bladder

REF	length	balloon	size	colour	intermediate packaging
CFNL-3D-16-30-P	400 mm	30 ml	CH 16	orange	10 pcs
CFNL-3D-18-30-P	400 mm	30 ml	CH 18	red	10 pcs
CFNL-3D-20-30-P	400 mm	30 ml	CH 20	yellow	10 pcs
CFNL-3D-22-30-P	400 mm	30 ml	CH 22	purple	10 pcs
CFNL-3D-24-30-P	400 mm	30 ml	CH 24	dark blue	10 pcs
*CFNL-3D-26-30-P	400 mm	30 ml	CH 26	pink	10 pcs



 bulk packaging:  
40 x 10 pcs

 available  
on request

# Foley catheter

## 2-way with tiemann tip, silicone-coated latex

### features

- made of soft and flexible latex, that is resistant to bending and kinking
- universal urine drainage port of the catheter fits into standard connectors in urine bags
- angled tip makes it easier to overcome obstacles in the urinary tract
- tip with two lateral eyes with smooth edges
- silicone-coated surface that allows atraumatic insertion of the catheter
- easy to fill and to empty, tear-resistant balloon
- plastic valve to ensure balloon tightness
- single-use
- packaging: 1 pc./double packaging: internal- foil, external- paper-foil

### indication

- to drain urine from the bladder in the case of a narrowed urethra

REF	length	balloon	size	colour	intermediate packaging
CFTL-2D-12-10-P	400 mm	5-10 ml	CH 12	white	10 pcs
CFTL-2D-14-10-P	400 mm	5-10 ml	CH 14	green	10 pcs
CFTL-2D-16-10-P	400 mm	5-10 ml	CH 16	orange	10 pcs
CFTL-2D-18-10-P	400 mm	5-10 ml	CH 18	red	10 pcs
CFTL-2D-20-10-P	400 mm	5-10 ml	CH 20	yellow	10 pcs
CFTL-2D-22-10-P	400 mm	5-10 ml	CH 22	purple	10 pcs
CFTL-2D-24-10-P	400 mm	5-10 ml	CH 24	dark blue	10 pcs
CFTL-2D-12-30-P	400 mm	30 ml	CH 12	white	10 pcs
CFTL-2D-14-30-P	400 mm	30 ml	CH 14	green	10 pcs
CFTL-2D-16-30-P	400 mm	30 ml	CH 16	orange	10 pcs
CFTL-2D-18-30-P	400 mm	30 ml	CH 18	red	10 pcs
CFTL-2D-20-30-P	400 mm	30 ml	CH 20	yellow	10 pcs



 bulk packaging:  
40 x 10 pcs

# Foley catheter

## 2-way, 100% silicone

### features

- made of soft and flexible silicone, that reduces the allergic reaction of the mucous membranes and increases the patient's comfort
- atraumatic, soft rounded, special tip facilitating insertion of the catheter to the bladder
- tip with two lateral eyes with smooth edges
- universal urine drainage port of the catheter fits into standard connectors in urine bags
- radiopaque line along the entire length of the catheter
- easy to fill and to empty, tear-resistant balloon of various capacities
- plastic valve to ensure balloon tightness
- CH 6, CH 8, CH 10 size has a nylon guide to facilitate catheterization
- available in version with 10 ml sterile water pre-filled syringe with 10% glycerin to seal the balloon
- separately packed Catheter Spigot inside the packaging
- single-use
- packaging: 1 pc./double packaging: internal- foil, external- paper-foil

### indication

- to drain urine from the bladder
- recommended for patients with blood clots or sediment in their urine

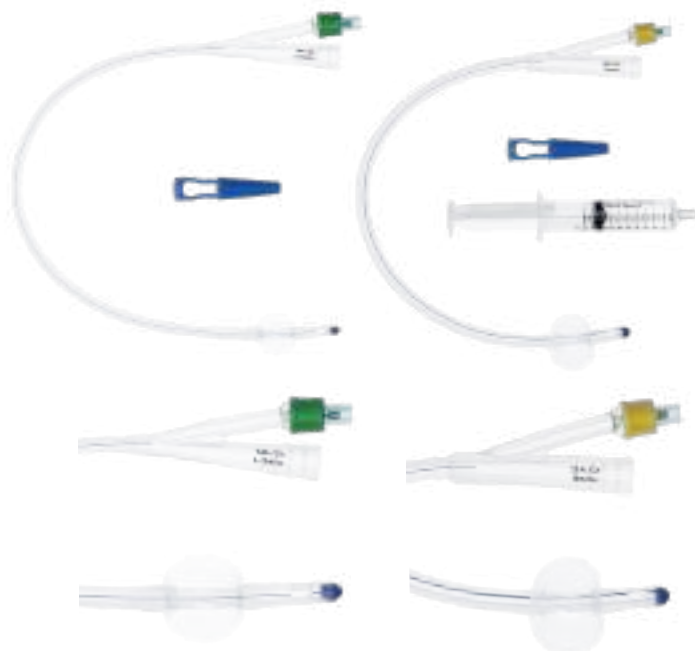

REF	intermediate packaging	REF for pre-filled syringe	intermediate packaging	length	balloon	size	colour
CFNS-2D-06-03-P*	10 pcs	CFNSG-2D-06-03-P	5 pcs	310 mm	3 ml	CH 6	pink
CFNS-2D-08-05-P*	10 pcs	CFNSG-2D-08-05-P	5 pcs	310 mm	3-5 ml	CH 8	black
CFNS-2D-10-05-P*	10 pcs	CFNSG-2D-10-05-P	5 pcs	310 mm	3-5 ml	CH 10	grey
CFNS-2D-12-10-P*	10 pcs	CFNSG-2D-12-10-P	5 pcs	400 mm	5-10 ml	CH 12	white
CFNS-2D-14-10-P*	10 pcs	CFNSG-2D-14-10-P	5 pcs	400 mm	5-10 ml	CH 14	green
CFNS-2D-16-10-P*	10 pcs	CFNSG-2D-16-10-P	5 pcs	400 mm	5-10 ml	CH 16	orange
CFNS-2D-18-10-P*	10 pcs	CFNSG-2D-18-10-P	5 pcs	400 mm	5-10 ml	CH 18	red
CFNS-2D-20-10-P*	10 pcs	CFNSG-2D-20-10-P	5 pcs	400 mm	5-10 ml	CH 20	yellow
CFNS-2D-22-10-P*	10 pcs	CFNSG-2D-22-10-P	5 pcs	400 mm	5-10 ml	CH 22	purple
CFNS-2D-24-10-P*	10 pcs	CFNSG-2D-24-10-P	5 pcs	400 mm	5-10 ml	CH 24	dark blue

  
bulk packaging:  
50 x 5 pcs

  
bulk packaging:  
\*40 x 10 pcs



# Foley catheter

## 3-way, 100% silicone

### features

- made of soft and flexible silicone, that reduces the allergic reaction of the mucous membranes and increases the patient's comfort
- universal urine drainage port of the catheter fits into standard connectors in urine bags
- additional inlet for flushing out the bladder
- atraumatic, soft rounded, special tip facilitating insertion of the catheter to the bladder
- tip with two lateral eyes with smooth edges
- radiopaque line along the entire length of the catheter
- easy to fill and to empty, tear-resistant balloon
- plastic valve to ensure balloon tightness
- separately packed Catheter Spigot inside the packaging
- single-use
- packaging: 1 pc./double packaging: internal- foil, external- paper-foil

### indication

- to drain urine from the bladder
- recommended for patients with blood clots or sediment in their urine



REF	length	balloon	size	colour	intermediate packaging
CFNS-3D-16-30-P	400 mm	30 ml	CH 16	orange	10 pcs
CFNS-3D-18-30-P	400 mm	30 ml	CH 18	red	10 pcs
CFNS-3D-20-30-P	400 mm	30 ml	CH 20	yellow	10 pcs
CFNS-3D-22-30-P	400 mm	30 ml	CH 22	purple	10 pcs
CFNS-3D-24-30-P	400 mm	30 ml	CH 24	dark blue	10 pcs

  
bulk packaging:  
40 x 10 pcs



# Nelaton catheter

## features

- made of soft and flexible PVC, that is resistant to bending and kinking
- frozen surface for easier insertion
- semi-transparent tube (catheters available in a transparent version for better visual inspection)
- atraumatic, soft rounded, closed tip facilitating insertion of the catheter to the bladder
- tip with two lateral eyes with smooth edges
- colour-coded connectors for size recognition, numerical size identification on the packaging
- single-use
- packaging: 1 pc./paper-foil

## indication

- for urinary bladder catheterization

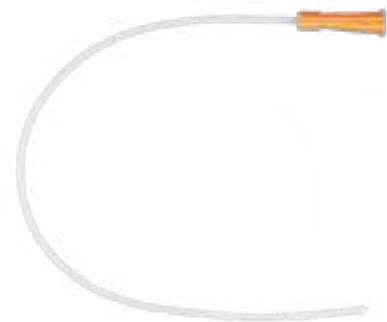

bulk packaging:  
10 x 50 pcs

REF for frozen tube	intermediate packaging	REF for <b>NEW!</b> transparent tube	intermediate packaging	length	size	colour
CN-06-40**	50 pcs	CNP-06-40*	50 pcs	400 mm	CH 6	light green
CN-08-40**	50 pcs	CNP-08-40*	50 pcs	400 mm	CH 8	blue
CN-10-40**	50 pcs	CNP-10-40*	50 pcs	400 mm	CH 10	black
CN-12-40**	50 pcs	CNP-12-40*	50 pcs	400 mm	CH 12	white
CN-14-40**	50 pcs	CNP-14-40*	50 pcs	400 mm	CH 14	green
CN-16-40**	50 pcs	CNP-16-40*	50 pcs	400 mm	CH 16	orange
CN-18-40**	50 pcs	CNP-18-40*	50 pcs	400 mm	CH 18	red
CN-20-40**	50 pcs	CNP-20-40*	50 pcs	400 mm	CH 20	yellow
CN-22-40**	50 pcs	CNP-22-40*	50 pcs	400 mm	CH 22	purple
CN-24-40**	50 pcs	CNP-24-40*	50 pcs	400 mm	CH 24	dark blue



# Tiemann catheter

## features

- made of soft and flexible PVC, that is resistant to bending and kinking
- atraumatic, soft rounded, special tip facilitating insertion of the catheter to the bladder
- tip with two lateral eyes with smooth edges
- cone-shaped angled tip, bent at an angle of 45°
- transparent tube allowing visual inspection of excreted urine
- colour-coded connectors for size recognition, numerical size identification on the packaging
- single-use
- packaging: 1 pc./paper-foil

## indication

- to drain urine from the bladder in the case of a narrowed urethra



REF	length	size	colour	intermediate packaging	bulk packaging
CT-08-40	400 mm	CH 8	blue	60 pcs	10 x 60 pcs
CT-10-40	400 mm	CH 10	black	60 pcs	10 x 60 pcs
CT-12-40	400 mm	CH 12	white	50 pcs	10 x 50 pcs
CT-14-40	400 mm	CH 14	green	50 pcs	10 x 50 pcs
CT-16-40	400 mm	CH 16	orange	50 pcs	10 x 50 pcs
CT-18-40	400 mm	CH 18	red	40 pcs	10 x 40 pcs
CT-20-40	400 mm	CH 20	yellow	40 pcs	10 x 40 pcs
CT-22-40	400 mm	CH 22	purple	40 pcs	10 x 40 pcs
CT-24-40	400 mm	CH 24	dark blue	40 pcs	10 x 40 pcs



# Pezzer catheter

## silicone-coated latex

### features

- made of soft and flexible silicone-coated latex, resistant to bending and kinking
- atraumatic, soft rounded, special tip facilitating insertion of the catheter to the bladder
- tip with three lateral eyes with smooth edges
- single-use
- packaging: 1 pc./double packaging: internal- foil, external- paper-foil

### indication

- to secure proper urinary drainage directly from the bladder or kidney in patients after surgical procedures
- introduced by the surgical wound, it is used for permanent urinary drainage, facilitating wound healing

REF	length	size	intermediate packaging
CP-12-40	400 mm	CH 12	10 pcs
CP-14-40	400 mm	CH 14	10 pcs
CP-16-40	400 mm	CH 16	10 pcs
CP-18-40	400 mm	CH 18	10 pcs
CP-20-40	400 mm	CH 20	10 pcs
CP-22-40	400 mm	CH 22	10 pcs
CP-24-40	400 mm	CH 24	10 pcs
CP-26-40	400 mm	CH 26	10 pcs
CP-28-40	400 mm	CH 28	10 pcs
CP-30-40	400 mm	CH 30	10 pcs
CP-32-40	400 mm	CH 32	10 pcs
CP-34-40	400 mm	CH 34	10 pcs
CP-36-40	400 mm	CH 36	10 pcs
CP-38-40	400 mm	CH 38	10 pcs
CP-40-40	400 mm	CH 40	10 pcs



 bulk packaging:  
40 x 10 pcs



# urine bag

## with sample port 2W

### features

- latex-free 2000 ml bag made of medical grade PVC
- white back wall making urine easy to notice
- effective non-return valve
- tight T-valve, that can be easily operated with one hand and which can be folded and tucked in a hard sheath
- Pasteur type droplet chamber providing a „dry“ air barrier
- two hydrophobic air filters (in a bag and chamber), which prevent sucking, balancing the pressure inside the system
- 120 cm long, large diameter tubing, ensuring a free and effective urinary outflow with a universal stepped connector
- self-tightening port for sample taking at the end of tubing
- tubing equipped with a sliding clamp and a fastening pin to stabilize the tubing
- at the place where the tubing connects to the chamber, an additional reinforcing element prevents bending and kinking the tubing
- precise, easy-to-read scale, adequate for diuresis measurement, with high measurement accuracy, every 25 ml from 25 ml to 100 ml and every 100 ml from 100 ml to 2000 ml
- tag to describe the patient's details and date
- integrated universal hanger system matching the round and square bed rails
- additional fixing with a string
- single-use
- packaging: 1 pc./paper-foil

### indication

- device is intended for 14-days urine collection in a closed system



REF	capacity	length of tubing
WM2T2000-120	2000 ml	120 cm

 bulk packaging:  
40 pcs





# urine bag

## with sample port

### features

- latex-free 2000 ml bag made of 0,40 mm thick PVC (double wall)
- effective non-return valve
- tight T-valve, that can be easily operated with one hand
- connecting tubing with universal stepped connector, standard tubing length 120 cm (other lengths available: 90 cm, 150 cm)
- tubing made of material that is resistant to bending and kinking and which ensures a free and effective urine outflow
- self-tightening port for sample taking
- precise, easy-to-read scale, adequate for diuresis measurement, with high measurement accuracy from 25 ml, every 50 ml from 50 ml to 200 ml and every 100 ml to 2000 ml
- strengthened holes for hanging, matching standard hangers
- white back wall making urine easy to notice
- single-use
- packaging: 1 pc./paper-foil

### indication

- for extracorporeal collection of urine and other body fluids
- maximum time of use - 7 days



REF	capacity	length of tubing	intermediate packaging
WMT2000-90	2000 ml	90 cm	10 pcs
WMT2000-120	2000 ml	120 cm	10 pcs
WMT2000-150	2000 ml	150 cm	10 pcs

  
bulk packaging:  
10 x 10 pcs



# urine bag

### features

- latex-free 2000 ml bag made of 0,22 mm thick PVC (double wall)
- double sealed PVC for maximum protection against tearing the bag
- effective non-return valve
- tight T-valve, that can be easily operated with one hand
- connecting tubing with universal stepped connector, standard tubing length 90 cm and 150 cm
- tubing made of material that is resistant to bending and kinking and which ensures a free and effective urine outflow
- precise, easy-to-read scale (every 100 ml), adequate for diuresis measurement
- strengthened holes for hanging, matching standard hangers
- white back wall making urine easy to notice
- single-use
- packaging: 1 pc./foil

### indication

- for 24-hour extracorporeal collection of urine and other body fluids
- maximum time of use - 24 hours



REF	capacity	length of tubing	intermediate packaging
WMD2000-90	2000 ml	90 cm	10 pcs
WMD2000-150	2000 ml	150 cm	10 pcs

  
bulk packaging:  
25 x 10 pcs



# urine bag with absorbent, non-sterile

## features

- made of medical-grade materials (PVC, ABS)
- pouch with a gelling medium (superabsorbent polymer) in the bag allows the liquid to change its physical state into a solid, providing for safe utilisation of the product after use
- specially shaped funnel-type connector to create a tight connection with the „T” type drain valve of the urine collection bag
- 2 cm long tube made of material that prevents kinking and twisting, ensuring free and efficient urine drainage, with a sliding clamp to close the tube after the bag is full
- strong cord, which is part of the absorbent collection bag, threaded through the drain valve of the „T” type of urine collection bag allows the connection of two bags to be secured
- easy-to-read, precise double scale from 100 ml, scaling in 100 ml increments
- non-toxic
- single-use



## indication

- for the disposable transfer of urine from a urine collection bag.

REF	capacity	intermediate packaging
WMA2000-2	2000 ml	10 pcs

 bulk packaging:  
25 x 10 pcs



# samples taking urine bag

## features

- latex-free bag with a capacity of 100 ml, size 19 cm x 7 cm
- made of delicate, durable PE foil
- easy-to-read scale, adequate for diuresis measurement, highly accurate - every 10 ml
- adhesive part of the bag coated with anti-allergic, high-quality glue
- additional sealing made of anti-allergic foam that protects against the wall sticking of the bag, thanks to which free flow of urine is possible
- single-use
- packaging: 1 pc./foil

## indication

- for urine sample collection in infants and small children



REF	capacity	purpose	version	intermediate packaging
WMCH-001	100 ml	for boys	with sponge	100 pcs
WMCH-002	100 ml	for boys	without sponge	100 pcs
WMDZ-001	100 ml	for girls	with sponge	100 pcs
WMDZ-002	100 ml	for girls	without sponge	100 pcs

 bulk packaging:  
25 x 100 pcs



# urine bag hanger

## features

- made of strong and durable plastic
- special clamp that prevents tube bending
- suitable for round and square bed rails
- two handles on each side for hanging urine bags of various sizes
- manufacturer's name placed on the device
- single-use

## indication

- for hanging standard urine collection bags



REF	intermediate packaging
WNM01	50 pcs

 bulk packaging:  
4 x 50 pcs



ZARYS



WWW.ZARYS.COM



# GENERAL SURGERY

# Yankauer surgical suction cannula

## standard CH21

### features

- completely transparent for full possibility of observing the sucked secretion
- light and perfectly balanced handle ensures high comfort of work and reduces hand fatigue
- perfectly smooth inner surface prevents blocking or retaining the sucked content, ensuring correct and optimal flow
- cannula with double bend of curvature
- four lateral eyes, which prevent the tip from sticking to the tissues and one central opening
- universal stepped connector ensures tight connection with a wide range of suction connecting tubes
- single-use
- packaging: 1 pc./double packaging: internal- foil, external- paper-foil

### indication

- evacuating secretions and body fluids from the operating field in general surgery

REF	features	intermediate packaging
KO-00204	without suction control	50 pcs
KO-00214	with suction control	50 pcs



bulk packaging:  
4 x 50 pcs

**STERILE EO**



# Yankauer surgical suction cannula

## bulb tip CH23

### features

- cannula with bulb tip with four lateral eyes, which prevent the tip from sticking to the tissues and one central opening
- completely transparent for full possibility of observing the sucked secretion
- light and perfectly balanced handle ensures high comfort of work and reduces hand fatigue
- perfectly smooth inner surface prevents blocking or retaining the sucked content ensuring correct and optimal flow
- cannula with double bend of curvature
- universal stepped connector ensures tight connection with a wide range of suction connecting tubes
- single-use
- packaging: 1 pc./double packaging: internal- foil, external- paper-foil

### indication

- evacuating secretions and body fluids from the operating field in general surge

REF	features	intermediate packaging
KO-00104	without suction control	50 pcs
KO-00114	with suction control	50 pcs



bulk packaging:  
4 x 50 pcs

**STERILE EO**



# surgical suction tube

## features

- made of soft and flexible PVC
- along the tube a special longitudinal reinforcement to prevent bending and sucking of the tube
- perfectly smooth inner surface of tube prevents the sucked content from settling on the walls, ensuring correct and optimal flow
- connector type funnel-funnel cut-to-fit with the possibility of cutting in the marked places of the connector and matching to any type of medical suction device (for the diameter of 8 mm to 18 mm)
- funnel connector equipped with a special bending system, enabling convenient manipulation of the tube
- tube connectors compatible with the standard suction cannulas, enabling their reliable, effective and tight connection
- single-use
- packaging: 1 pc./double packaging: internal- foil, external- paper-foil

## indication

- device designed for connecting the suction cannula to medical suction device
- Kapkon connector – designed to connect the catheter for aspiration of upper respiratory tract to medical suction device

REF	size	length of tube	connector
DO-24201	CH24	210 cm	funnel-funnel
DO-24301	CH24	300 cm	funnel-funnel
DO-30201	CH30	210 cm	funnel-funnel
DO-30301	CH30	300 cm	funnel-funnel
DO-24204	CH24	210 cm	funnel-funnel cut-to-fit
DO-24202	CH24	210 cm	funnel-Kapkon



### FUNNEL-FUNNEL CONNECTOR



### FUNNEL-FUNNEL CUT-TO-FIT CONNECTOR 3-STEP CONNECTOR TO CUT

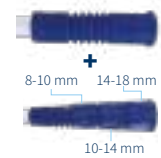

### FUNNEL-KAPKON CONNECTOR



bulk packaging:  
50 x 1 pc.

# surgical suction set with Yankauer cannula, standard

## CANNULA

- completely transparent for full possibility of observing the sucked secretion
- light and perfectly balanced handle ensures high comfort of work and reduces hand fatigue
- perfectly smooth inner surface prevents blocking or retaining the sucked content, ensuring correct and optimal flow
- cannula with double bend of curvature
- four lateral eyes, which prevent the tip from sticking to the tissues and one central opening
- universal stepped connector ensures tight connection with a wide range of suction connecting tubes

## TUBE

- made of soft and flexible PVC
- along the tube a special longitudinal reinforcement to prevent bending and sucking of the tube
- perfectly smooth inner surface of tube prevents the sucked content from settling on the walls, ensuring correct and optimal flow
- connector type funnel-funnel cut-to-fit with the possibility of cutting in the marked places of the connector and matching to any type of medical suction device (for the diameter of 8 mm to 18 mm)
- funnel connector equipped with a special bending system, enabling convenient manipulation of the tube
- tube connectors compatible with the standard suction cannulas, enabling their reliable, effective and tight connection

## features

- available with or without suction control
- single-use
- packaging: 1 set/double packaging: internal- foil, external- paper-foil

## indication

- evacuating secretions and body fluids from the operating field in general surgery

REF	size cannula/tube	length of tube	connector
ZO-212400104	CH21/CH24	210 cm	without suction control, funnel-funnel
ZO-212400114	CH21/CH24	210 cm	with suction control, funnel-funnel
ZO-402423104	CH21/CH24	400 cm	without suction control, funnel-funnel
ZO-402423114	CH21/CH24	400 cm	with suction control, funnel-funnel
ZO-2124001041	CH21/CH24	210 cm	without suction control, funnel-funnel cut-to-fit
ZO-2124001141	CH21/CH24	210 cm	with suction control, funnel-funnel cut-to-fit



bulk packaging:  
50 x 1 set



# surgical suction set

## with Yankauer cannula, bulb tip

### CANNULA

- cannula with bulb tip with four lateral eyes, which prevent the tip from sticking to the tissues and one central opening
- completely transparent for full possibility of observing the sucked secretion
- light and perfectly balanced handle ensures high comfort of work and reduces hand fatigue
- perfectly smooth inner surface prevents blocking or retaining the sucked content, ensuring correct and optimal flow
- cannula with double bend of curvature
- universal stepped connector ensures tight connection with a wide range of suction connecting tubes

### TUBE

- made of soft and flexible PVC
- along the tube a special longitudinal reinforcement to prevent bending and sucking of the tube
- perfectly smooth inner surface of tube prevents the sucked content from settling on the walls, ensuring correct and optimal flow
- connector type funnel-funnel cut-to-fit with the possibility of cutting in the marked places of the connector and matching to any type of medical suction device (for the diameter of 8 mm to 18 mm)
- funnel connector equipped with a special bending system, enabling convenient manipulation of the tube
- tube connectors compatible with the standard suction cannulas, enabling their reliable, effective and tight connection

### features

- available with or without suction control
- single-use
- packaging: 1 set/double packaging: internal- foil, external- paper-foil

### indication

- evacuating secretions and body fluids from the operating field in general surgery



REF	size cannula/tube	length of tube	connector
ZO-2124002041	CH23/CH24	210 cm	without suction control, funnel-funnel cut-to-fit
ZO-2124002141	CH23/CH24	210 cm	with suction control, funnel-funnel cut-to-fit
ZO-3024002041	CH23/CH24	300 cm	without suction control, funnel-funnel cut-to-fit
ZO-3024002141	CH23/CH24	300 cm	with suction control, funnel-funnel cut-to-fit

  
bulk packaging:  
50 x 1 set

**STERILE EO**



ZARYS



WWW.ZARYS.COM

# BASIC PRODUCTS FOR GYNECOLOGY

# vaginal speculum

## cusco type

### features

- both blades made of transparent polystyrene
- locking bolt made of polyethylene
- blades position blocked by a quarter turn of the Locking bolt (without screwing in the bolt)
- perfectly smooth and streamlined edges
- colour coded bolts depending on the size
- single-use
- packaging: 1 pc./foil

### indication

- device designed for gynecological examination of the cervix and vagina

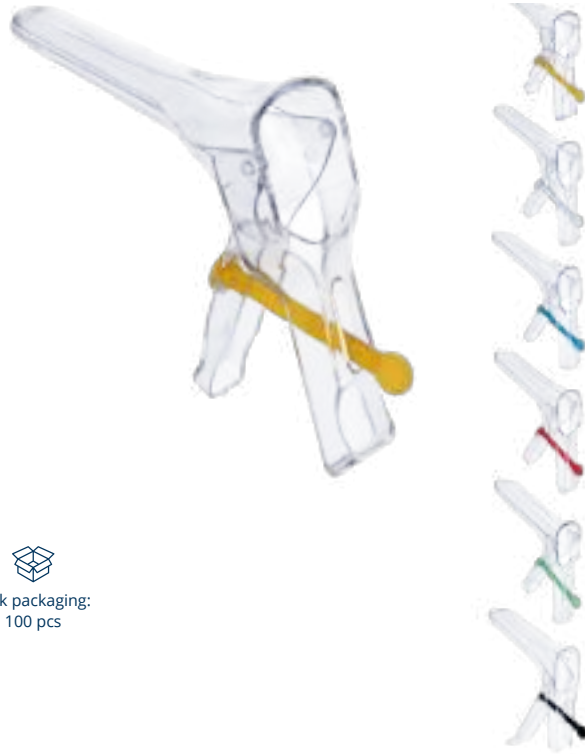

 bulk packaging:  
100 pcs

REF	width	colour	size
WG-XXS	16 mm	yellow	XXS
WG-XS	20 mm	white	XS
WG-S	24 mm	blue	S
WG-M	26 mm	red	M
WG-L	30 mm	green	L
WG-XL	32 mm	black	XL



# cervical brush

## standard

### features

- straight shape enables obtaining samples from the cervical canal
- soft bristle tips to prevent irritation
- optimal outreach thanks to the long handle
- single-use
- packaging: 1 pc./paper-foil

### indication

- device designed for obtaining cell samples from the cervix, cervical canal and transformation zone in smear tests



 bulk packaging:  
10 x 100 pcs

REF	type	intermediate packaging
SC-001	standard	100 pcs





# cervical brush

## special

### features

- broom type enables obtaining samples from the cervix, cervical canal and transformation zone
- soft bristle tips enables precise collection of material for examination
- made entirely of polyethylene
- optimal outreach thanks to the long handle
- single-use
- packaging: 1 pc./paper-foil

### indication

- device designed for obtaining cell samples from the cervix, cervical canal and transformation zone in smear tests

REF	type	intermediate packaging
SC-002	special	100 pcs



bulk packaging:  
10 x 100 pcs



# umbilical cord clamp

### features

- made of polypropylene
- safe clamping teeth with rounded edges do not cut the umbilical cord
- serrated clamping surface of the arms stabilize the clamp on the umbilical cord, after closing it is not possible to open the clamp again
- double Lock catch prevents accidental opening
- universal size
- single-use
- non-pyrogenic
- packaging: 1 pc./paper-foil (blister)

### indication

- device is designed for clamping the umbilical cord of a newborn in a labour ward in order to close the lumen of the umbilical blood vessels after cutting it off of the placenta

REF	size	colour	intermediate packaging
ZDPB	universal	white	50 pcs



bulk packaging:  
50 x 50 pcs



ZARYS

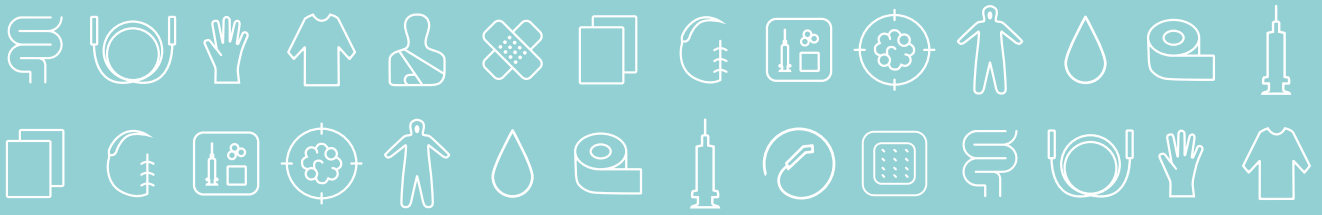

WWW.ZARYS.COM



# OTHER PRODUCTS

# ID wristband

## features

- durable wristband coating characterized by high humidity resistance and resistance to the activity of soaps, hand disinfectants and other liquids used in hospitals
- made of soft and delicate vinyl
- flexible, delicate, very light and easy to put on
- rounded edges prevent from injuring
- high tensile strength
- colour marking depending on the purpose
- single-use fastening resistant to accidental break
- hypoallergenic, latex-free, phthalate-free
- packaging: 100 pcs/box

## indication

- for identification of patients in hospital wards



REF	purpose	colour	version	intermediate packaging
OPD-B-01	for children and adults	white	insert card	100 pcs
OPN-R-01	for infants	pink	insert card	100 pcs
OPN-N-01	for infants	blue	insert card	100 pcs

 bulk packaging:  
50 x 100 pcs



# entrance mat

## features

- blue mat consisting of 30 layers - thin sticky sheets
- each of the sticky sheets made of polyethylene resin
- does not contain heavy metals
- excellent adhesive properties
- the first and last sheets secured with a non-adhesive foil
- low mat profile: app. 2 mm thick
- the bottom surface adheres very well to the floor over the entire surface, preventing adverse movement of the mat, allowing trouble-free passage of trolleys with equipment or beds, without the risk of curling up the mat or tearing
- no need to clean the mat - as soon as the surface of the mat is contaminated, it should be torn off to uncover a new, clean sheet
- there is numbering of sheets on a white non-adhesive material in the mat corner facilitate quick identification and easy removal of subsequent sheets
- light, easy to spread

## indication

- preventing spreading of contamination brought on shoe soles and wheelchairs to operating rooms



REF	dimensions	intermediate packaging
M001	45 cm x 115 cm	10 pcs

 bulk packaging:  
5 x 10 pcs



# enema bag

## features

- bag with a capacity of 1750 ml with two holes for hanging
- made of medical PVC
- scaled from 50 ml to 1750 ml
- linear scale every 100 ml, digital scale every 200 ml
- tube with a length of 150 cm with a sliding clamp, ended with an atraumatic opening and one lateral opening
- tube end is secured with a tube cap
- upper part of the bag is reinforced with an additional flange stabilizing the inlet during filling with liquid
- flange is equipped with a non-return valve
- single-use
- packaging: 1 pc./foil

## indication

- bag that allows introduction of fluid into the large bowel through the anus to remove fecal material and stimulate peristaltic bowel movement



REF
WLS

 bulk packaging:  
150 x 1 pc.



## enema bag

### features

- bag with a capacity of 1500 ml with a hole for hanging
- made of medical PVC
- digitally scaled every 250 ml
- tube with a length of 115 cm with a sliding clamp, ended with an atraumatic opening and one lateral opening
- greased end of the tube secured with a cap
- single-use

### indication

- bag that allows introduction of fluid into the large bowel through the anus to remove fecal material and stimulate peristaltic bowel movement



REF	 bulk packaging: 100 pcs	    
WLN		

## enema set

### features

- bag with a capacity of 1500 ml with a hole for hanging
- made of medical PVC
- digitally scaled every 250 ml
- tube with a length of 115 cm with a sliding clamp, ended with an atraumatic opening and one lateral opening
- greased end of the tube secured with a cap
- drape 42 cm x 45 cm
- liquid soap (9 ml)
- PE gloves - 1 pair
- single-use
- packaging: 1 set/foil

### indication

- set that allows introduction of fluid into the large bowel through the anus to remove fecal material and stimulate peristaltic bowel movement



REF	 bulk packaging: 50 x 1 set	    
ZLN		

## vomit bag

### features

- bag is made of durable, transparent blue foil, enabling the observation of secretions
- total bag capacity: 2000 ml
- exact measuring graduation (from 10 ml to 100 ml every 10 ml and from 100 to 2000 ml every 100 ml) placed on the bag allows accurate estimation of fluid volume
- direction of graduation reading for small volumes is marked with the tip
- wide bag inlet protected by a plastic collar
- circle-shaped collar ensures a firm grip, makes it easier to maneuver the bag, reducing the risk of content contamination
- collar equipped with a special incision to close the bag and hygienic disposal of the vomit - „twist and hook“
- device name, manufacturer's name and pictorial instructions for use printed directly on the bag
- single-use
- class I non-sterile medical device
- packaging: 20 pcs/foil bag

### indication

- recommended in uncomfortable situations, in cases of gastroesophageal reflux requiring immediate action
- used in hospitals, outpatient departments, ambulances, etc.



REF	colour	intermediate packaging	 bulk packaging: 30 x 20 pcs	   
WW-01	blue	20 pcs		
WW-03	white	20 pcs		

# tactical tourniquet CAT

## features

- made of soft and breathable material to prevent chafing and skin burns
- additional element to secure the tourniquet and control blood flow
- locking system to prevent accidental opening of the tourniquet
- one-handed mechanism
- durable loop system with internal, free-moving strap that provides circumferential compression to the limb
- the unique double fastening system allows to avoid the use of screws and clips
- high quality of workmanship
- place to write down the time of establishment
- weight: 82g
- folded dimensions: 16 cm x 6 cm x 4cm
- unfolded dimensions: 96 cm x 4 cm
- individually wrapped in foil packaging
- single-use



## indication

- tactical tourniquet used in case of limb injuries with massive arterial or venous bleeding that cannot be controlled by traditional techniques

REF	dimensions	intermediate packaging
ST-001	96 cm x 4 cm	1 pc.

 bulk packaging:  
100 x 1 pcs



# automatic tourniquet

## features

- components: blue stretchy strap and white ABS plastic buckle
- length 480 mm +/- 5 mm, width 25 mm +/- 1 mm
- wide, stretchable band put above the venipuncture site reduces the pressure intensity
- protects against the congestion of the arm, minimizes unpleasant sensations, improves the quality of the blood sample
- reusable
- packaging: 1 pc./double packaging: internal- foil, external- box

## indication

- used to induce venous stasis and to make a vein selected for puncture more prominent

REF	intermediate packaging
SA-001	21 pcs

 bulk packaging:  
20 x 21 pcs



## for children

## features

- components: polyester stretch strap and ABS plastic items
- length 450 mm +/- 5 mm, width 25 mm +/- 1 mm
- wide stretch strap to minimise pressure build-up during compression
- significantly protects against arm congestion, improves the quality of the blood sample for examination
- reduces unpleasant sensations during compression
- a simple one-handed mechanism for easy fastening and unfastening with gradual release of pressure
- reusable

## indication

- device used to induce venous stasis and to make a vein selected for puncture more prominent

REF	intermediate packaging	color
SA-002	21 pcs	yellow + imprint

 bulk packaging:  
20 x 21 pcs



# latex-free tourniquet

## features

- made of a wide stretch TPE strap (thermoplastic elastomer)
- latex-free material prevents allergic reactions and skin irritation
- high tensile strength
- single-use bands reduce the risk of infection
- total roller length 11,25 m
- single-use
- individual packaging contains: 25 tourniquets
- packaging: 1 roll/paper dispenser that allows convenient sharing of perforated tourniquets

## indication

- used to induce venous stasis and to make a vein selected for puncture more prominent

REF	size	colour
S001	25 mm x 450 mm	blue
S002	25 mm x 450 mm	pink

 bulk packaging:  
100 rolls



# tongue depressor

## wooden

## features

- made of birch wood
- rounded edges preventing injuries
- natural colour
- long outreach thanks to appropriate length
- durable
- single-use
- packaging: 1 pc./paper

## indication

- diagnostic examination of the oral cavity

REF	version	dimensions	 bulk packaging
SLS-001	sterile	150 mm x 17 mm	20 x 100 pcs



# tongue depressor

## wooden

## features

- made of birch wood
- rounded edges preventing injuries
- natural colour
- long outreach thanks to appropriate length
- durable
- single-use
- packaging: 100 pcs/box

## indication

- diagnostic examination of the oral cavity

REF	version	dimensions	 bulk packaging
SLN-001	non-sterile	150 mm x 17 mm	50 x 100 pcs



## electronic thermometer

### features

- digital thermometer
- fast, safe and reliable
- temperature readings
- waterproof
- measurement in 10 seconds
- range 32.0°C-42.9°C (90.0°F-109.9°F)
- accuracy ±0.1°C (±0.2°F)
- has a soft, flexible measuring tip
- sound signal
- automatic turning off
- memory of the last measurement
- low battery indicator
- battery life: approximately 200 hours
- package: 1 piece / plastic cover and paper box

### indication

- for measuring body temperature in the mouth, armpit and rectal area



REF	intermediate packaging
DMT-437	10 pcs

 bulk packaging:  
30 x 10 pcs



## safeLANCE

### pressure-activated safety lancet

### features

- easy to use, minimizes unpleasant feelings
- special construction allows lancet tip to be automatically inserted into finger pad and then to be retracted so that needle is not visible before or after puncturing
- correctly matched size of lancet allows you to get optimal amount of blood with minimal patient's pain
- design ensures safety for medical personnel and patient by eliminating accidental puncture and infection
- perfect guidance of lancet needle inside housing reduces vibration, thus decreases patient's pain and prevents damage to skin tissue
- available in two sizes:
  - 23 G, puncture depth 1,8 mm - green, dedicated for women and children
  - 21 G, puncture depth 2,4 mm - pink, dedicated for men
- single-use
- packaging: 100 pcs/box



### indication

- capillary blood sampling from fingertip or ear flap for testing, for example, glucose level

REF	size / puncture depth	colour	intermediate packaging
NA-18	23 G / 1,8 mm	green	100 pcs
NA-24	21 G / 2,4 mm	pink	100 pcs

 bulk packaging:  
20 x 100 pcs







# dressings

traditional dressings materials | adhesive tapes  
and plasters with dressing | special purpose  
dressings | stabilizing dressings | specialist  
dressings | additional products

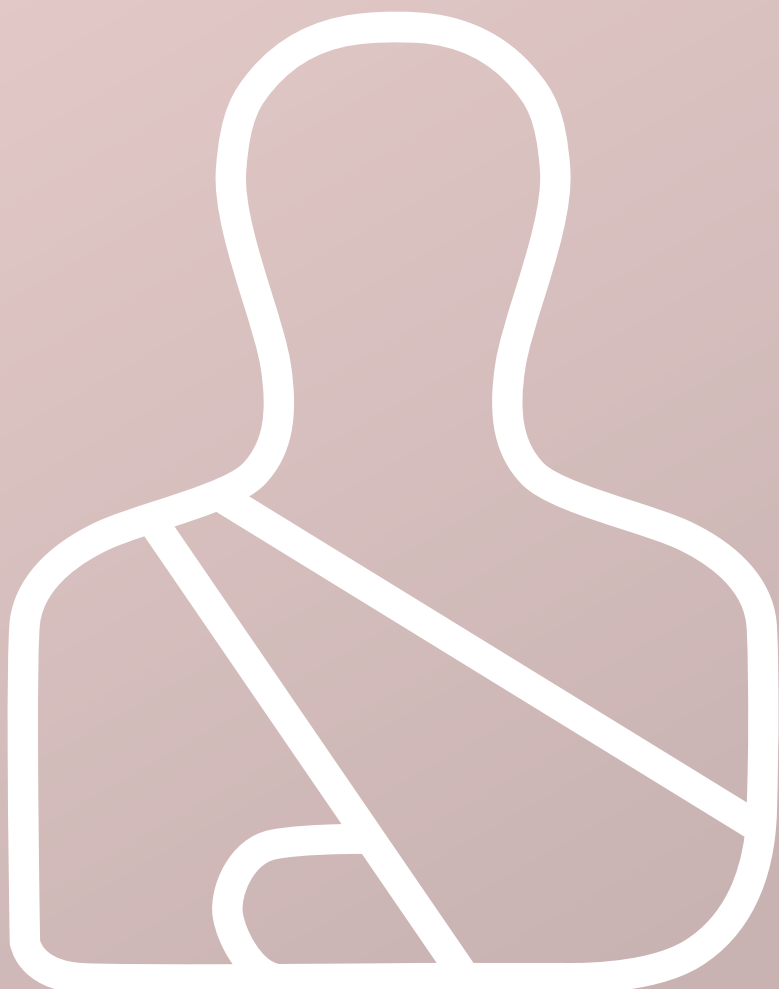

ZARYS

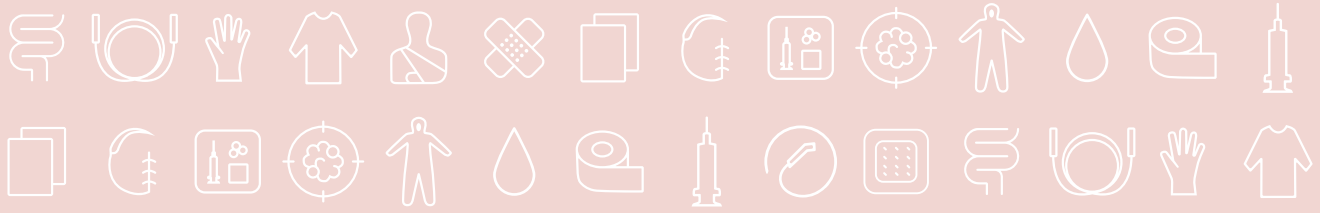

WWW.ZARYS.COM

# TRADITIONAL DRESSING MATERIALS

## DRESSING GAUZE

### features

- 100% hydrophilic cotton gauze
- bleached with the use of hydrogen peroxide
- soft and very absorbent
- increase in absorption capacity with increasing number of gauze threads
- homogeneous structure through a strong twist of fibers eliminates the risk of loose fibers on the surface

### indication

- general wound dressing in out-patient clinics, surgical sites, procedure department



## dressing gauze, zig-zag folded

### GAZA lux

Before use on open wounds, the device must be sterilized in accordance with a validated sterilization method. It can be sterilized with steam, ethylene oxide or radiation.

REF	dimensions	no. of threads	packaging unit foil bag	bulk packaging carton
GR1709100-XR	0,9 m x 100 m	17	1 pc.	5 x 1 pc.
GR1309100	0,9 m x 100 m	13	1 pc.	5 x 1 pc.
GR1709100	0,9 m x 100 m	17	1 pc.	5 x 1 pc.



can be cut and formed



## cutting gauze

### GAZA lux

Before use on open wounds, the device must be sterilized in accordance with a validated sterilization method. It can be sterilized with steam, ethylene oxide or radiation.

REF	size	no. of threads	packaging unit paper-foil	bulk packaging carton
*CG1325SQM	1/4 m <sup>2</sup>	13	1 pc.	100 x 1 pc.
*CG1305SQM	1/2 m <sup>2</sup>	13	1 pc.	50 x 1 pc.
CG1315SQM	1 m <sup>2</sup>	13	1 pc.	25 x 1 pc.
*CG1725SQM	1/4 m <sup>2</sup>	17	1 pc.	100 x 1 pc.
*CG1705SQM	1/2 m <sup>2</sup>	17	1 pc.	50 x 1 pc.
CG1715SQM	1 m <sup>2</sup>	17	1 pc.	25 x 1 pc.



edges ES-type folded



available on request



### GAZA lux S

REF	size	no. of threads	packaging unit paper-foil	bulk packaging carton
CG1748255-SS	25 cm x 25 cm	17	5 pcs	25 x 5 pcs
*CG1325SQM-S	1/4 m <sup>2</sup>	13	1 pc.	100 x 1 pc.
CG1305SQM-S	1/2 m <sup>2</sup>	13	1 pc.	50 x 1 pc.
CG1315SQM-S	1 m <sup>2</sup>	13	1 pc.	25 x 1 pc.
*CG1725SQM-S	1/4 m <sup>2</sup>	17	1 pc.	100 x 1 pc.
CG1705SQM-S	1/2 m <sup>2</sup>	17	1 pc.	50 x 1 pc.
CG1715SQM-S	1 m <sup>2</sup>	17	1 pc.	25 x 1 pc.



## GAUZE SWABS

### features

- 100% hydrophilic cotton gauze
- bleached with the use of hydrogen peroxide
- edges ES-type folded, which prevents fraying of loose threads
- available with a sewed in X-ray detectable thread, which enables fast and non-invasive identification of the swab left in the operating field

### indication

- general wound dressing in out-patient clinics, surgical sites, procedure departments

## gauze swabs

**KOMPRI lux**  **BESTSELLER**

### without X-ray detectable thread

REF	dimensions	no. of threads	no. of plies	packaging unit paper bag	bulk packaging carton
GS1305081	5 cm x 5 cm	13	8	100 pcs	250 x 100 pcs
GS1375081	7,5 cm x 7,5 cm	13	8	100 pcs	60 x 100 pcs
GS1310081	10 cm x 10 cm	13	8	100 pcs	40 x 100 pcs
GS1305121	5 cm x 5 cm	13	12	100 pcs	80 x 100 pcs
GS1305125	5 cm x 5 cm	13	12	500 pcs	4 x 500 pcs
GS1375121	7,5 cm x 7,5 cm	13	12	100 pcs	40 x 100 pcs
GS1375125	7,5 cm x 7,5 cm	13	12	500 pcs	4 x 500 pcs
GS1310121	10 cm x 10 cm	13	12	100 pcs	20 x 100 pcs
GS1310125	10 cm x 10 cm	13	12	500 pcs	4 x 500 pcs
GS1705081	5 cm x 5 cm	17	8	100 pcs	80 x 100 pcs
GS1775081	7,5 cm x 7,5 cm	17	8	100 pcs	90 x 100 pcs
GS1710081	10 cm x 10 cm	17	8	100 pcs	40 x 100 pcs
GS171020081	10 cm x 20 cm	17	8	100 pcs	40 x 100 pcs
GS1705121	5 cm x 5 cm	17	12	100 pcs	96 x 100 pcs
GS1705125	5 cm x 5 cm	17	12	500 pcs	4 x 500 pcs
GS1775121	7,5 cm x 7,5 cm	17	12	100 pcs	60 x 100 pcs
GS1775125	7,5 cm x 7,5 cm	17	12	500 pcs	4 x 500 pcs
GS1710121	10 cm x 10 cm	17	12	100 pcs	20 x 100 pcs
GS1710125	10 cm x 10 cm	17	12	500 pcs	4 x 500 pcs
GS171020121	10 cm x 20 cm	17	12	100 pcs	20 x 100 pcs
GS1705161	5 cm x 5 cm	17	16	100 pcs	96 x 100 pcs
GS1775161	7,5 cm x 7,5 cm	17	16	100 pcs	60 x 100 pcs
GS1710161	10 cm x 10 cm	17	16	100 pcs	40 x 100 pcs
GS171020161	10 cm x 20 cm	17	16	100 pcs	20 x 100 pcs

### with X-ray detectable thread

REF	dimensions	no. of threads	no. of plies	packaging unit paper bag	bulk packaging carton
*GS1705081X	5 cm x 5 cm	17	8	100 pcs	80 x 100 pcs
GS1775081X	7,5 cm x 7,5 cm	17	8	100 pcs	90 x 100 pcs
GS1710081X	10 cm x 10 cm	17	8	100 pcs	40 x 100 pcs
*GS1705121X	5 cm x 5 cm	17	12	100 pcs	96 x 100 pcs
GS1775121X	7,5 cm x 7,5 cm	17	12	100 pcs	60 x 100 pcs
GS1710121X	10 cm x 10 cm	17	12	100 pcs	20 x 100 pcs
GS171020121X	10 cm x 20 cm	17	12	100 pcs	20 x 100 pcs
GS1705161X	5 cm x 5 cm	17	16	100 pcs	96 x 100 pcs
GS1775161X	7,5 cm x 7,5 cm	17	16	100 pcs	60 x 100 pcs
GS1710161X	10 cm x 10 cm	17	16	100 pcs	40 x 100 pcs
GS171020161X	10 cm x 20 cm	17	16	100 pcs	20 x 100 pcs



Before use on open wounds, the device must be sterilized in accordance with a validated sterilization method. It can be sterilized with steam or ethylene oxide.



available on request



## KOMPRI lux S

without X-ray detectable thread



vitahealth

-S



-SS



REF	dimensions	no. of threads	no. of plies	packaging unit paper-foil / paper-paper*	intermediate packaging box	bulk packaging carton
GS1705081-S*	5 cm x 5 cm	17	8	1 pc.	50 x 1 pc.	30 x 50 pcs
GS1705082-S	5 cm x 5 cm	17	8	2 pcs	50 x 2 pcs	16 x 50 pcs
GS1705083-S	5 cm x 5 cm	17	8	3 pcs	50 x 3 pcs	16 x 50 pcs
GS1705085-S	5 cm x 5 cm	17	8	5 pcs	20 x 5 pcs	16 x 20 pcs
GS17050810-S	5 cm x 5 cm	17	8	10 pcs	40 x 10 pcs	10 x 40 pcs
GS17050820-SS	5 cm x 5 cm	17	8	20 pcs	20 x 20 pcs	10 x 20 pcs
GS1775081-S*	7,5 cm x 7,5 cm	17	8	1 pc.	50 x 1 pc.	30 x 50 pcs
GS1775082-S	7,5 cm x 7,5 cm	17	8	2 pcs	50 x 2 pcs	12 x 50 pcs
GS1775083-S	7,5 cm x 7,5 cm	17	8	3 pcs	50 x 3 pcs	12 x 50 pcs
GS1775085-S	7,5 cm x 7,5 cm	17	8	5 pcs	20 x 5 pcs	12 x 20 pcs
GS17750810-S	7,5 cm x 7,5 cm	17	8	10 pcs	40 x 10 pcs	10 x 40 pcs
GS17750820-SS	7,5 cm x 7,5 cm	17	8	20 pcs	20 x 20 pcs	10 x 20 pcs
GS1710081-S*	10 cm x 10 cm	17	8	1 pc.	50 x 1 pc.	30 x 50 pcs
GS1710082-SS	10 cm x 10 cm	17	8	2 pcs	50 x 2 pcs	8 x 50 pcs
GS1710083-S	10 cm x 10 cm	17	8	3 pcs	50 x 3 pcs	8 x 50 pcs
GS1710085-S	10 cm x 10 cm	17	8	5 pcs	50 x 5 pcs	8 x 50 pcs
GS17100810-S	10 cm x 10 cm	17	8	10 pcs	40 x 10 pcs	10 x 40 pcs
GS17100820-SS	10 cm x 10 cm	17	8	20 pcs	10 x 20 pcs	6 x 20 pcs
GS1705122-SS	5 cm x 5 cm	17	12	2 pcs	50 x 2 pcs	16 x 50 pcs
GS1705123-S	5 cm x 5 cm	17	12	3 pcs	50 x 3 pcs	16 x 50 pcs
GS1705123-S-IP*	5 cm x 5 cm	17	12	3x1 pcs	20 x 3 pcs	20 x 20 pcs
GS1705125-SS	5 cm x 5 cm	17	12	5 pcs	20 x 5 pcs	16 x 20 pcs
GS17051210-SS	5 cm x 5 cm	17	12	10 pcs	20 x 10 pcs	12 x 20 pcs
GS1775122-SS	7,5 cm x 7,5 cm	17	12	2 pcs	50 x 2 pcs	18 x 50 pcs
GS1775123-SS	7,5 cm x 7,5 cm	17	12	3 pcs	50 x 3 pcs	12 x 50 pcs
GS1775123-S-IP*	7,5 cm x 7,5 cm	17	12	3x1 pcs	20 x 3 pcs	20 x 20 pcs
GS1775125-SS	7,5 cm x 7,5 cm	17	12	5 pcs	20 x 5 pcs	12 x 20 pcs
GS17751210-SS	7,5 cm x 7,5 cm	17	12	10 pcs	40 x 10 pcs	10 x 40 pcs
GS17751220-SS	7,5 cm x 7,5 cm	17	12	20 pcs	20 x 20 pcs	10 x 20 pcs
GS1710123-SS	10 cm x 10 cm	17	12	3 pcs	50 x 3 pcs	8 x 50 pcs
GS1710123-S-IP*	10 cm x 10 cm	17	12	3x1 pcs	20 x 3 pcs	20 x 20 pcs
GS1710125-S	10 cm x 10 cm	17	12	5 pcs	20 x 5 pcs	8 x 20 pcs
GS17101210-SS	10 cm x 10 cm	17	12	10 pcs	20 x 10 pcs	6 x 20 pcs
GS17101220-SS	10 cm x 10 cm	17	12	20 pcs	20 x 20 pcs	4 x 20 pcs
GS171020123-SS	10 cm x 20 cm	17	12	3 pcs	50 x 3 pcs	8 x 50 pcs
GS1710201210-SS	10 cm x 20 cm	17	12	10 pcs	10 x 10 pcs	8 x 10 pcs
GS171020125-SS	10 cm x 20 cm	17	12	5 pcs	20 x 5 pcs	8 x 20 pcs
GS1705163-SS	5 cm x 5 cm	17	16	3 pcs	50 x 3 pcs	16 x 50 pcs
GS1705165-SS	5 cm x 5 cm	17	16	5 pcs	30 x 5 pcs	12 x 30 pcs
GS1775163-SS	7,5 cm x 7,5 cm	17	16	3 pcs	50 x 3 pcs	12 x 50 pcs
GS1775165-SS	7,5 cm x 7,5 cm	17	16	5 pcs	20 x 5 pcs	12 x 20 pcs
GS17751610-SS	7,5 cm x 7,5 cm	17	16	10 pcs	16 x 10 pcs	12 x 16 pcs
GS1710163-SS	10 cm x 10 cm	17	16	3 pcs	50 x 3 pcs	8 x 50 pcs
GS1710165-SS	10 cm x 10 cm	17	16	5 pcs	30 x 5 pcs	6 x 30 pcs
GS17101610-SS	10 cm x 10 cm	17	16	10 pcs	20 x 10 pcs	8 x 20 pcs
GS171020163-SS	10 cm x 20 cm	17	16	3 pcs	50 x 3 pcs	4 x 50 pcs
GS1710201610-SS	10 cm x 20 cm	17	16	10 pcs	10 x 10 pcs	8 x 10 pcs
GS179020062-SS	90 cm x 20 cm	17	6	2 pcs	40 x 2 pc.	4 x 40 pcs
GS179020065-SS	90 cm x 20 cm	17	6	5 pcs	16 x 5 pc.	4 x 16 pcs
GS179040062-SS	90 cm x 40 cm	17	6	2 pcs	20 x 2 pc.	4 x 20 pcs

with X-ray detectable thread



REF	dimensions	no. of threads	no. of plies	packaging unit paper-foil	bulk packaging box
GS17750810-SSXR	7,5 cm x 7,5 cm	17	8	10 pcs	40 x 10 pcs
GS17750820-SSXR	7,5 cm x 7,5 cm	17	8	20 pcs	20 x 20 pcs
✓ GS17100810-SSXR	10 cm x 10 cm	17	8	10 pcs	40 x 10 pcs
* GS1705125-SSXR	5 cm x 5 cm	17	12	5 pcs	20 x 5 pcs
* GS17051210-SSXR	5 cm x 5 cm	17	12	10 pcs	40 x 10 pcs
✓ GS1775125-SSXR	7,5cm x 7,5cm	17	12	5 pcs	20 x 5 pcs
✓ GS17751210-SSXR	7,5cm x 7,5cm	17	12	10 pcs	10 x 10 pcs
✓ GS17101210-SSXR	10cm x 10cm	17	12	10 pcs	20 x 10 pcs
✓ GS17101220-SSXR	10cm x 10cm	17	12	20 pcs	20 x 20 pcs
✓ GS17101240-SSXR	10cm x 10cm	17	12	40 pcs	10 x 40 pcs
✓ GS1710201210-SSXR	10cm x 20cm	17	12	10 pcs	10 x 10 pcs
✓ GS1710201220-SSXR	10cm x 20cm	17	12	20 pcs	6 x 20 pcs
* GS17051610-SSXR	5 cm x 5 cm	17	16	10 pcs	30 x 10 pcs
✓ GS1775165-SSXR	7,5 cm x 7,5 cm	17	16	5 pcs	20 x 5 pcs
✓ GS17751610-SSXR	7,5 cm x 7,5 cm	17	16	10 pcs	16 x 10 pcs
* GS1710165-SSXR	10 cm x 10 cm	17	16	5 pcs	20 x 5 pcs
✓ GS17101610-SSXR	10 cm x 10 cm	17	16	10 pcs	20 x 10 pcs

✓  
self-adhesive labels  
for medical  
documentation

\*🔔  
available  
on request

# GAUZE LAP SPONGES

## features

- 100% hydrophilic cotton gauze
- bleached with the use of hydrogen peroxide
- with a sewed in X-ray detectable thread or chip, which enables fast and non-invasive identification of the lap sponge left in the operating field
- with a belt to fix the lap sponge beyond the operating field

## indication

- as a surgical invasive dressing material for intraoperative absorption of large amounts of blood and body fluids from surgical wounds

## gauze lap sponges

### SERVI lux

#### with X-ray thread



REF	dimensions	no. of threads	no. of plies	packaging unit foil bag	bulk packaging carton
*LS1745458-X	45 cm x 45 cm	17	8	20 pcs	10 x 20 pcs
*LS1745704-X	45 cm x 70 cm	17	4	20 pcs	10 x 20 pcs
*LS1730304-X	30 cm x 30 cm	17	4	50 pcs	10 x 50 pcs
*LS1745454-X	45 cm x 45 cm	17	4	20 pcs	10 x 20 pcs
*LS1775904-X	75 cm x 90 cm	17	4	20 pcs	6 x 20 pcs
<b>NEW</b> *LS17505010-X	50 cm x 50 cm	17	10	20 pcs	9 x 20 pcs

#### with X-ray thread and belt

REF	dimensions	no. of threads	no. of plies	packaging unit foil bag	bulk packaging carton
LS1745454-XB	45 cm x 45 cm	17	4	20 pcs	10 x 20 pcs
LS1745704-XB	45 cm x 70 cm	17	4	20 pcs	10 x 20 pcs
LS1745456-XB	45 cm x 45 cm	17	6	20 pcs	10 x 20 pcs
LS1745706-XB	45 cm x 70 cm	17	6	20 pcs	10 x 20 pcs
LS1745458-XB	45 cm x 45 cm	17	8	20 pcs	10 x 20 pcs
LS2045454-XB	45 cm x 45 cm	20	4	20 pcs	10 x 20 pcs
*LS1775904-XB	75 cm x 90 cm	17	4	20 pcs	6 x 20 pcs
*LS1730454-XB	30 cm x 45 cm	17	4	50 pcs	10 x 50 pcs
*LS1730306-XB	30 cm x 30 cm	17	6	50 pcs	10 x 50 pcs
*LS1775752-XB	75 cm x 75 cm	17	2	20 pcs	10 x 20 pcs
*LS1730304-XB	30 cm x 30 cm	17	4	50 pcs	10 x 50 pcs
<b>NEW</b> *LS17505010-XB	50 cm x 50 cm	17	10	20 pcs	9 x 20 pcs

#### pre-washed with X-ray chip and belt

REF	dimensions	no. of threads	no. of plies	packaging unit foil bag	bulk packaging carton
LS2045454-XB-PW	45 cm x 45 cm	20	4	20 pcs	10 x 20 pcs

Before used on open wounds, the device must be sterilized in accordance with a validated sterilization method. It can be sterilized with steam or ethylene oxide.



available on request

### SERVI lux S

#### with X-ray thread and belt

✓ self-adhesive labels for medical documentation

REF	dimensions	no. of threads	no. of plies	packaging unit paper-foil	bulk packaging box
✓ LS17454542-SSXB	45 cm x 45 cm	17	4	2 pcs	20 x 2 pcs
✓ LS17454545-SSXB	45 cm x 45 cm	17	4	5 pcs	8 x 5 pcs
✓ LS17457042-SSXB	45 cm x 70 cm	17	4	2 pcs	20 x 2 pcs
✓ LS17454563-SSXB	45 cm x 45 cm	17	6	3 pcs	10 x 3 pcs
✓ LS17454582-SSXB	45 cm x 45 cm	17	8	2 pcs	10 x 2 pcs
✓ LS17454585-SSXB	45 cm x 45 cm	17	8	5 pcs	5 x 5 pcs
✓ LS17457043-SSXB	45 cm x 70 cm	17	4	3 pcs	10 x 3 pcs
✓ LS17759041-SSXB	75 cm x 90 cm	17	4	1 pc.	15 x 1 pcs
<b>NEW</b> LS17203045-SSXB	20 cm x 30 cm	17	4	5 pc.	20 x 5 pcs

#### pre-washed with X-ray chip and belt

REF	dimensions	no. of threads	no. of plies	packaging unit foil bag	bulk packaging carton
LS17454542-SSXB-PW	45 cm x 45 cm	17	4	2 pcs	20 x 2 pcs
LS17454543-SSXB-PW	45 cm x 45 cm	17	4	3 pcs	15 x 3 pcs
LS17454545-SSXB-PW	45 cm x 45 cm	17	4	5 pcs	10 x 5 pcs



The advantages of self-adhesive labels for medical documentation:

- fast data transport without the need to rewrite,
- safe identification of the device - elimination of the possibility of errors,
- improvement of the preparation of medical documentation.



# gauze balls



## TUPFER lux

### features

- 100% hydrophilic cotton
- bleached with the use of hydrogen peroxide
- available in a version with or without X-ray detectable thread, which enables fast and non-invasive identification of the gauze ball left in the operating field

### indication

- absorption of blood and body fluids from surgical wounds and hard to reach places

### without X-ray thread

REF	size of gauze	diameter approx.	shape	packaging unit foil bag	bulk packing
TK1515250	15 cm x 15 cm	2,5 cm	ball	250 pcs	24 x 250 pcs
TK2020250	20 cm x 20 cm	3 cm	ball	250 pcs	24 x 250 pcs
TK3030100	30 cm x 30 cm	4 cm	ball	100 pcs	10 x 100 pcs
*TFT1515100	15 cm x 15 cm	2,5 cm	bean	1000 pcs	60 x 1000 pcs
TF1515100	15 cm x 15 cm	2,5 cm	bean	100 pcs	60 x 100 pcs
<b>NEW</b> *TFT9595250	9,5 cm x 9,5 cm	1,5 cm	bean	250 pcs	24 x 250 pcs

### with X-ray thread

REF	size of gauze	diameter approx.	shape	packaging unit foil bag	bulk packing
TK1515250X	15 cm x 15 cm	2,5 cm	ball	250 pcs	24 x 250 pcs
TK2020250X	20 cm x 20 cm	3 cm	ball	250 pcs	24 x 250 pcs
TK2525250X	25 cm x 25 cm	3,5 cm	ball	250 pcs	8 x 250 pcs
TK3030100X	30 cm x 30 cm	4 cm	ball	100 pcs	10 x 100 pcs
TK3040100X	30 cm x 40 cm	4,5 cm	ball	100 pcs	10 x 100 pcs
TK5050100X	50 cm x 50 cm	5 cm	ball	100 pcs	10 x 100 pcs
*TFT1515100X	15 cm x 15 cm	2,5 cm	bean	1000 pcs	10 x 1000 pcs
*TF1515100X	15 cm x 15 cm	2,5 cm	bean	100 pcs	60 x 100 pcs
<b>NEW</b> *TFT1212100X	12 cm x 12 cm	2 cm	bean	100 pcs	10 x 1000 pcs
<b>NEW</b> *TFT9595250X	15 cm x 15 cm	1,5 cm	bean	250 pcs	24 x 250 pcs
<b>NEW</b> *TR1818100X	15 cm x 15 cm		triangular	100 pcs	60 x 100 pcs

Before use on open wounds, the device must be sterilized in accordance with a validated sterilization method. It can be sterilized with steam or ethylene oxide.



\* available on request



## TUPFER lux S

✓ self-adhesive labels for medical documentation

REF	size of gauze	diameter approx.	shape	packaging unit paper-foil	intermediate packing
✓ TF959505-SSXR	9,5 cm x 9,5 cm		bean	5 pcs	50 x 5 pcs
✓ TF959510-SSXR	9,5 cm x 9,5 cm		bean	10 pcs	25 x 10 pcs
✓ TF151505-SSXR	15 cm x 15 cm		bean	5 pcs	25 x 5 pcs
✓ TF151510-SSXR	15 cm x 15 cm		bean	10 pcs	20 x 10 pcs
✓ TR121205-SSXR	12 cm x 12 cm		triangular	5 pcs	15 x 5 pcs
✓ TR181810-SSXR	18 cm x 18 cm		triangular	10 pcs	15 x 10 pcs
✓ TK151510-SSXR	15 cm x 15 cm	2,5 cm	ball	10 pcs	20 x 10 pcs
✓ TK202010-SSXR	20 cm x 20 cm	3 cm	ball	10 pcs	20 x 10 pcs
✓ TK303010-SSXR	30 cm x 30 cm	4 cm	ball	10 pcs	10 x 10 pcs





## non-woven swabs

### NONVI lux

Before use on open wounds, the device must be sterilized in accordance with a validated sterilization method. It can be sterilized with steam, ethylene oxide or radiation.

REF	dimensions	grammage	packaging unit paper bag	bulk packaging carton
NL50-100	5 cm x 5 cm	30 g/m <sup>2</sup>	100 pcs	50 x 100 pcs
NL50-100-40	5 cm x 5 cm	40 g/m <sup>2</sup>	100 pcs	50 x 100 pcs
NL75-100	7,5 cm x 7,5 cm	30 g/m <sup>2</sup>	100 pcs	40 x 100 pcs
NL75-100-40	7,5 cm x 7,5 cm	40 g/m <sup>2</sup>	100 pcs	40 x 100 pcs
NL100-100	10 cm x 10 cm	30 g/m <sup>2</sup>	100 pcs	40 x 100 pcs
NL100-100-40	10 cm x 10 cm	40 g/m <sup>2</sup>	100 pcs	20 x 100 pcs
NL1020-100	10 cm x 20 cm	30 g/m <sup>2</sup>	100 pcs	20 x 100 pcs



### NONVI lux S

REF	dimensions	grammage	packaging unit paper-foil	intermediate packaging box	bulk packaging box
NL052-S	5 cm x 5 cm	30 g/m <sup>2</sup>	2 pcs	25 x 2 pcs	60 x 25 pcs
NL053-S	5 cm x 5 cm	30 g/m <sup>2</sup>	3 pcs	25 x 3 pcs	45 x 25 pcs
NL055-S	5 cm x 5 cm	30 g/m <sup>2</sup>	5 pcs	25 x 5 pcs	36 x 25 pcs
NL0510-S	5 cm x 5 cm	30 g/m <sup>2</sup>	10 pcs	10 x 10 pcs	32 x 10 pcs
NL052-S-40	5 cm x 5 cm	40 g/m <sup>2</sup>	2 pcs	25 x 2 pcs	60 x 25 pcs
NL053-S-40	5 cm x 5 cm	40 g/m <sup>2</sup>	3 pcs	25 x 3 pcs	45 x 25 pcs
NL055-S-40	5 cm x 5 cm	40 g/m <sup>2</sup>	5 pcs	25 x 5 pcs	24 x 25 pcs
NL0510-S-40	5 cm x 5 cm	40 g/m <sup>2</sup>	10 pcs	10 x 10 pcs	32 x 10 pcs
NL752-S	7,5 cm x 7,5 cm	30 g/m <sup>2</sup>	2 pcs	25 x 2 pcs	48 x 25 pcs
NL753-S	7,5 cm x 7,5 cm	30 g/m <sup>2</sup>	3 pcs	25 x 3 pcs	36 x 25 pcs
NL755-S	7,5 cm x 7,5 cm	30 g/m <sup>2</sup>	5 pcs	25 x 5 pcs	24 x 25 pcs
NL7510-S	7,5 cm x 7,5 cm	30 g/m <sup>2</sup>	10 pcs	10 x 10 pcs	12 x 10 pcs
NL752-S-40	7,5 cm x 7,5 cm	40 g/m <sup>2</sup>	2 pcs	25 x 2 pcs	48 x 25 pcs
NL753-S-40	7,5 cm x 7,5 cm	40 g/m <sup>2</sup>	3 pcs	25 x 3 pcs	24 x 25 pcs
NL755-S-40	7,5 cm x 7,5 cm	40 g/m <sup>2</sup>	5 pcs	25 x 5 pcs	18 x 25 pcs
NL7510-S-40	7,5 cm x 7,5 cm	40 g/m <sup>2</sup>	10 pcs	10 x 10 pcs	12 x 10 pcs
* NL7520-S-40	7,5 cm x 7,5 cm	40 g/m <sup>2</sup>	20 pcs	5 x 20 pcs	12 x 5 pcs
NL102-S	10 cm x 10 cm	30 g/m <sup>2</sup>	2 pcs	25 x 2 pcs	30 x 25 pcs
NL103-S	10 cm x 10 cm	30 g/m <sup>2</sup>	3 pcs	25 x 3 pcs	24 x 25 pcs
NL105-S	10 cm x 10 cm	30 g/m <sup>2</sup>	5 pcs	20 x 5 pcs	12 x 20 pcs
NL1010-S	10 cm x 10 cm	30 g/m <sup>2</sup>	10 pcs	10 x 10 pcs	12 x 10 pcs
NL102-S-40	10 cm x 10 cm	40 g/m <sup>2</sup>	2 pcs	25 x 2 pcs	30 x 25 pcs
NL103-S-40	10 cm x 10 cm	40 g/m <sup>2</sup>	3 pcs	25 x 3 pcs	18 x 25 pcs
NL105-S-40	10 cm x 10 cm	40 g/m <sup>2</sup>	5 pcs	20 x 5 pcs	12 x 25 pcs
NL1010-S-40	10 cm x 10 cm	40 g/m <sup>2</sup>	10 pcs	10 x 10 pcs	12 x 25 pcs
NL1020-S-40	10 cm x 10 cm	40 g/m <sup>2</sup>	20 pcs	5 x 20 pcs	12 x 25 pcs

## NON-WOVEN SWABS

### features

- hydrophilic medical non-woven, 30 or 40 g/m<sup>2</sup>
- 4-ply
- soft, non-fraying, durable

### indication

- general wound dressing in out-patient clinics, surgical sites, procedure department

\* available on request



## NONVI lux S with Y-incision

### features

- hydrophilic medical non-woven 40 g/m<sup>2</sup>
- 4-ply
- Y-incision for precise, aseptic protection of the outlet of various types of medical drains

### indication

- securing the outlet of drains, catheters, tracheostomy tubes etc.

REF sterilized by EO	REF sterilized by steam	dimensions	packaging unit paper-foil	bulk packaging box
NL105-S-40Y	* NL105-SS-40Y	10 cm x 10 cm	5 pcs	20 x 5 pcs
	NL104-SS-Y	10 cm x 10 cm	4 pcs	30 x 4 pcs

Y  
swab with  
„Y“ incision

\* available on request





# ABSORBENT WOUND DRESSINGS

## features

- layered structure: non-woven - cellulose - cellulose pulp
- increased absorption capacity due to the high absorbent cellulose layer
- bottom layer of the dressing covered with waterproof blue non-woven

## indication

- removing the exudate from strongly oozing wounds
- covering wounds after surgical procedures

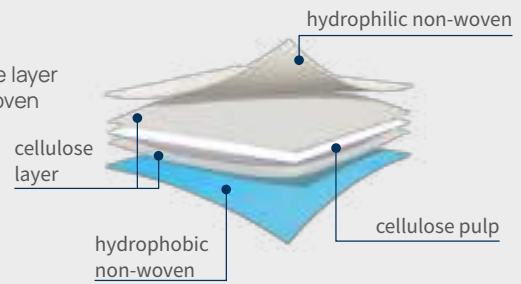

## ABD pads, multi-layer



### MULTIabsorb

Before use on open wounds, the device must be sterilized in accordance with a validated sterilization method. It can be sterilized with ethylene oxide or radiation.

REF	dimensions	packaging unit foil bag	bulk packaging carton
ABD1010	10 cm x 10 cm	50 pcs	40 x 50 pcs
ABD1020	10 cm x 20 cm	50 pcs	20 x 50 pcs
ABD2025	20 cm x 25 cm	50 pcs	12 x 50 pcs



### MULTIabsorb S



REF	dimensions	packaging unit paper-foil	intermediate packaging box	bulk packaging carton
ABD1010-S	10 cm x 10 cm	1 pc.	25 x 1 pc.	24 x 25 pcs
ABD1020-S	10 cm x 20 cm	1 pc.	25 x 1 pc.	18 x 25 pcs
ABD2025-S	20 cm x 25 cm	1 pc.	15 x 1 pc.	18 x 15 pcs
ABD2040-S	20 cm x 40 cm	1 pc.	8 x 1 pc.	12 x 8 pcs



## EYE DRESSINGS

### features

- layered structure: non-woven + cellulose pulp
- needs to be fixed with a secondary dressing e.g. with adhesive tape or tubular net bandage
- hypoallergenic

### indication

- covering an eye and its area after ophthalmic procedures and surgical procedures
- sight correction in strabismus therapy

## eye pads



### elastoLUMENAL

Before use on open wounds, the device must be sterilized in accordance with a validated sterilization method. It can be sterilized with ethylene oxide or radiation.

REF	dimensions	packaging unit paper-paper	intermediate packaging box	bulk packaging carton
803311	5,5 cm x 7,5 cm	1 pc.	50 x 1 pc.	24 x 50 pcs



### elastoLUMENALS

Conforms well to facial contours thanks to the oval shape.

REF	dimensions	packaging unit paper-paper	intermediate packaging box	bulk packaging carton
803310	5,5 cm x 7,5 cm	1 pc.	50 x 1 pc.	24 x 50 pcs



## cellulose swabs



### cellPAD

REF	dimensions	packaging unit foil bag	bulk packaging carton
KC4050	4 cm x 5 cm	2 rolls (2 x 500 pcs)	16 x 2 rolls



### features

- regular perforations to facilitate tearing off individual pieces as small swabs
- each roll contains 500 pieces of individual swabs

### indication

- device used for absorbing minor exudates, dressing minor cuts, abrasions on the skin and injection sites

ZARYS

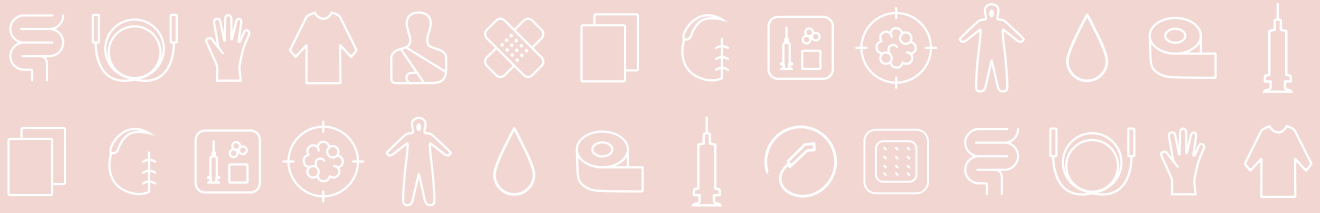

WWW.ZARYS.COM

# ADHESIVE TAPES AND PLASTERS WITH DRESSING

## ADHESIVE TAPES

### features

- flexible, conforms to the body's contours, guarantees freedom of movement
- characterized by adequate air and water vapour permeability
- good adhesion
- can be divided lengthwise and widthwise without the use of scissors
- hypoallergenic

### indication

- stabilization, protection and fixation of primary, non-adhesive dressings, applied directly to wounds and skin damages
- stabilization, protection and fixation of drains, catheters, medical tubes that do not require specialized fixing in the place of their insertion

## adhesive fabric tape, white

### SENSIplast



REF	dimensions	packaging unit box	bulk packaging carton
STA12505W	1,25 cm x 5 m	24 pcs	12 x 24 pcs
STA25005W	2,5 cm x 5 m	12 pcs	12 x 12 pcs
STA50005W	5 cm x 5 m	6 pcs	12 x 6 pcs
STA12509W	1,25 cm x 9,14 m	24 pcs	12 x 24 pcs
STA25009W	2,5 cm x 9,14 m	12 pcs	12 x 12 pcs
STA50009W	5 cm x 9,14 m	6 pcs	12 x 6 pcs
<b>NEW</b> STA25005W-L	2,5 cm x 5 m	12 pcs	12 x 12 pcs



## adhesive fabric tape, beige colour

### PLASTIplast



REF	dimensions	packaging unit box	bulk packaging carton
SZO12505S	1,25 cm x 5 m	24 pcs	12 x 24 pcs
SZO25005S	2,5 cm x 5 m	12 pcs	12 x 12 pcs
SZO50005S	5 cm x 5 m	6 pcs	12 x 6 pcs
<b>NEW</b> SZO25005S-L*	2,5 cm x 5 m	12 pcs	30 x 12 pcs



## adhesive non-woven tape



### SOFTplast

REF	dimensions	packaging unit box	bulk packaging carton
SNW12505W	1,25 cm x 5 m	24 pcs	12 x 24 pcs
SNW25005W	2,5 cm x 5 m	12 pcs	12 x 12 pcs
SNW50005W	5 cm x 5 m	6 pcs	12 x 6 pcs
SNW12509W	1,25 cm x 9,14 m	24 pcs	12 x 24 pcs
SNW25009W	2,5 cm x 9,14 m	12 pcs	12 x 12 pcs
SNW50009W	5 cm x 9,14 m	6 pcs	12 x 6 pcs



## adhesive silk tape



### SILKplast

REF	dimensions	packaging unit box	bulk packaging carton
SS12505W	1,25 cm x 5 m	24 pcs	12 x 24 pcs
SS25005W	2,5 cm x 5 m	12 pcs	12 x 12 pcs
SS50005W	5 cm x 5 m	6 pcs	12 x 6 pcs
SS12509W	1,25 cm x 9,14 m	24 pcs	12 x 24 pcs
SS25009W	2,5 cm x 9,14 m	12 pcs	12 x 12 pcs
SS50009W	5 cm x 9,14 m	6 pcs	12 x 6 pcs



## adhesive perforated non-woven tape

### SILLCoplast

REF	dimensions	packaging unit box	bulk packaging carton
<b>NEW</b> SWS25005B	2,5 cm x 5 m	12 pcs	30 x 12 pcs



# adhesive PE tape



## FILMplast

REF	dimensions	packaging unit box	bulk packaging carton
SPE12505W	1,25 cm x 5 m	24 pcs	12 x 24 pcs
SPE25005W	2,5 cm x 5 m	12 pcs	12 x 12 pcs
SPE50005W	5 cm x 5 m	6 pcs	12 x 6 pcs
SPE12509W	1,25 cm x 9,14 m	24 pcs	12 x 24 pcs
SPE25009W	2,5 cm x 9,14 m	12 pcs	12 x 12 pcs
SPE50009W	5 cm x 9,14 m	6 pcs	12 x 6 pcs



 made of polyethylene foil

 straight edge

 on a roll

 transparent

 perforation for easy dividing

 air permeable structure

Microporous structure permeable to air and water vapor, allowing proper gas exchange between the foil and the skin, which prevents maceration of the skin.

# adhesive perforated non-woven tape



## POREplast

REF	dimensions	colour	packaging unit box / cover*	bulk packaging carton
SPW25009W	2,5 cm x 9,14 m	white	12 pcs	12 x 12 pcs
VH-POPP *	2,5 cm x 5 m	pink	1 pc	12 x 24 pcs
VH-POPG *	2,5 cm x 5 m	green	1 pc	12 x 24 pcs
SPW12509W	1,25 cm x 9,14 m	white	24 pcs	12 x 24 pcs
SPW50009W	5 cm x 9,14 m	white	6 pcs	12 x 6 pcs



 made of perforated non-woven fabric

 straight edge

 on a roll/spooled with cover\*

 white/ pink/ green colour

 perforation for easy dividing



vitahealth



# PLASTERS WITH DRESSING

## PLASTERS WITH DRESSING

### features

- self-adhesive plasters with absorbent pads
- centrally situated absorbent pad absorbs a small and medium amount of exudate and protects from external factors
- absorbent pad coated with a polyethylene mesh that prevents sticking to the wound
- characterized by adequate air and water vapour permeability
- flexible, conforms to the body's contours, guarantees freedom of movement
- silicone backing paper facilitates precise, painless and efficient application
- hypoallergenic

### indication

- protection of small skin injuries, cuts, abrasions and lacerations

## non-woven plaster with dressing

### NONVIplast



REF	dimensions	packaging unit box	bulk packaging carton
NP6100	6 cm x 1 m	1 pc.	200 x 1 pc.
NP6500	6 cm x 5 m	1 pc.	100 x 1 pc.
NP8100	8 cm x 1 m	1 pc.	200 x 1 pc.
NP8500	8 cm x 5 m	1 pc.	100 x 1 pc.



## fabric plaster with dressing

### FABRIplast



REF	dimensions	packaging unit box	bulk packaging carton
FP6100	6 cm x 1 m	1 pc.	200 x 1 pc.
FP6500	6 cm x 5 m	1 pc.	100 x 1 pc.
FP8100	8 cm x 1 m	1 pc.	200 x 1 pc.
FP8500	8 cm x 5 m	1 pc.	100 x 1 pc.



ZARYS



WWW.ZARYS.COM

# SPECIAL PURPOSE DRESSINGS





## SELF-ADHESIVE NON-WOVEN DRESSINGS

### DRESSING TAPE

#### features

- made of hydrophobic non-woven
- covered with hypoallergenic acrylic glue
- micropores in the structure of the non-woven provide adequate vapor permeability, thanks to which a proper gas exchange between the dressing and the skin takes place
- flexible, conforms to the body's contours, guarantees freedom of movement
- backing layer made of silicone paper
- backing paper with metric scale facilitates the division of the tape and precise, painless and efficient application
- packed in a cardboard box - a dispenser that allows dosing without removing the tape from the packaging

#### indication

- stabilization, protection and fixation of primary, non-adhesive dressings, applied directly to wounds and skin damages
- stabilization, protection and fixation of drains, catheters, medical tubes



### adhesive non-woven dressing tape

#### elastopor

REF	dimensions	packaging unit box	bulk packaging carton
806009	2,5 cm x 10 m	1 pc.	200 x 1 pc.
806010	5 cm x 10 m	1 pc.	100 x 1 pc.
806011	10 cm x 10 m	1 pc.	50 x 1 pc.
806012	15 cm x 10 m	1 pc.	50 x 1 pc.
806013	20 cm x 10 m	1 pc.	25 x 1 pc.
806014	25 cm x 10 m	1 pc.	25 x 1 pc.
806015	30 cm x 10 m	1 pc.	25 x 1 pc.



made of hydrophobic non-woven



air permeable structure



possibility of cutting



white colour



straight intersection of backing paper



#### elastopor E

REF	dimensions	packaging unit box	bulk packaging carton
* 806009E	2,5 cm x 10 m	1 pc.	200 x 1 pc.
806010E	5 cm x 10 m	1 pc.	100 x 1 pc.
806011E	10 cm x 10 m	1 pc.	50 x 1 pc.
806012E	15 cm x 10 m	1 pc.	50 x 1 pc.
806013E	20 cm x 10 m	1 pc.	25 x 1 pc.
806014E	25 cm x 10 m	1 pc.	25 x 1 pc.
806015E	30 cm x 10 m	1 pc.	25 x 1 pc.



made of hydrophobic non-woven



air permeable structure



wavy intersection of backing paper



available on request



possibility of cutting



white colour



## SELF-ADHESIVE DRESSINGS WITH ABSORBENT PAD

### features

- self-adhesive dressings with centrally situated absorbent pad, made of hydrophobic non-woven, covered with acrylic glue
- absorbent pad coated with a polyethylene mesh that prevents sticking to the wound, absorbs a small and medium amount of exudate and protects against the influence of external factors
- rounded edges prevent accidental removal of the dressing
- silicone backing paper facilitates the precise, painless and efficient application
- micropores in the structure of the non-woven provide adequate vapor permeability, thanks to which a proper gas exchange between the dressing and the skin takes place
- hypoallergenic

## non-woven dressing with absorbent pad

### elastopor STERIL BESTSELLER



#### indication

- especially recommended for covering surgical wounds
- for treating wounds with a small and medium amount of exudate

REF		dimensions	packaging unit paper-paper	intermediate packaging box	bulk packaging carton
801001	801001E	5 cm x 7,2 cm	1 pc.	100 x 1 pc.	24 x 100 pcs
801012	801012E	6 cm x 10 cm	1 pc.	50 x 1 pc.	45 x 50 pcs
801002	801002E	8 cm x 10 cm	1 pc.	30 x 1 pc.	36 x 30 pcs
801013	801013E	10 cm x 10 cm	1 pc.	30 x 1 pc.	24 x 30 pcs
801021	801021E	10 cm x 12 cm	1 pc.	30 x 1 pc.	30 x 30 pcs
801014	801014E	10 cm x 15 cm	1 pc.	30 x 1 pc.	24 x 30 pcs
801003	801003E	6 cm x 15 cm	1 pc.	50 x 1 pc.	24 x 50 pcs
801004	801004E	8 cm x 15 cm	1 pc.	30 x 1 pc.	24 x 30 pcs
801005	801005E	8 cm x 20 cm	1 pc.	30 x 1 pc.	18 x 30 pcs
801015	801015E	10 cm x 20 cm	1 pc.	25 x 1 pc.	18 x 25 pcs
801016	801016E	10 cm x 25 cm	1 pc.	25 x 1 pc.	18 x 25 pcs
801017	801017E	10 cm x 30 cm	1 pc.	25 x 1 pc.	12 x 25 pcs
801018	801018E	10 cm x 35 cm	1 pc.	25 x 1 pc.	12 x 25 pcs

indexes without the ending E - cutting the securing paper along the long edge (exception 801001; 801012)  
indexes with the ending E - the intersection of the securing paper for all indexes along the short edge



## non-woven dressing with absorbent pad

### elastoKIDS STERIL

#### indication

- especially recommended for covering surgical wounds
- treating wounds with a small and medium amount of exudate



REF		dimensions	packaging unit paper-paper	intermediate packaging box	bulk packaging carton
801012A		6 cm x 10 cm	1 pc.	50 x 1 pc.	45 x 50 pcs
801004A		8 cm x 15 cm	1 pc.	30 x 1 pc.	24 x 30 pcs
801015A		10 cm x 20 cm	1 pc.	25 x 1 pc.	18 x 25 pcs



## SELF-ADHESIVE DRESSINGS FOR KIDS

### features

- self-adhesive dressing with absorbent pad, made of hydrophobic non-woven material with color overprint, covered by hypoallergenic glue
- absorbent pad coated with polyethylene mesh to prevent sticking to the wound, absorbing small and medium amounts of exudate and protecting against external influences
- rounded edges to prevent accidental removal of the dressing
- protective layer of silicone paper for precise, painless and effective application
- micropores in the non-woven material structure provide an adequate rate of moisture vapour permeability so correct gas exchange between the dressing and skin is guaranteed



white  
colour

STERILE EO



## non-woven IV cannula dressing

### elastopor IV



BESTSELLER

### features

- centrally situated absorbent pad protects the non-woven material from sticking to the injection site
- non-woven lining should be placed under cannula's wings, which prevents it from causing damage to the skin

### indication

- dressing application around the inserted cannula
- stabilization, protection and fixation of intravenous cannulas

REF			dimensions	packaging unit paper-paper	intermediate packaging box	bulk packaging carton
811013	811013C	811013E	6 cm x 8 cm	1 pc.	100 x 1 pc.	20 x 100 pcs
811012	811012C	811012E	5,1 cm x 7,6 cm	1 pc.	100 x 1 pc.	20 x 100 pcs
811023	n/a	811023E	6 cm x 8 cm	1 pc.	50 x 1 pc.	40 x 50 pcs
811022	n/a	811022E	5,1 cm x 7,6 cm	1 pc.	50 x 1 pc.	40 x 50 pcs

## non-woven IV cannula dressing

### elastoKIDS IV



### features

- centrally situated absorbent pad protects the non-woven material from sticking to the injection site
- non-woven lining should be placed under cannula's wings, which prevents it from causing damage to the skin

### indication

- application of the dressing around the cannula
- stabilization, protection and fixation of intravenous cannulas

STERILE EO



REF	dimensions	packaging unit paper-paper	intermediate packaging box
811001A	5,1 cm x 7,6 cm	1 pc.	100 x 1 pc.



bulk packaging:  
20 x 100 pcs



## non-woven dressing with absorbent pad, incision and O-hole

### elastopor STERIL D

#### indication

- dressing application around the inserted drain
- securing the outlet of drains and catheters
- for treating wounds with a small and medium amount of exudate

made of hydrophobic non-woven

air permeable structure

white colour

REF		dimensions	packaging unit paper-paper	intermediate packaging box	bulk packaging carton
801031	801031E	9 cm x 10 cm	1 pc.	30 x 1 pc.	24 x 30 pcs
801030	801030E	12 cm x 14 cm	1 pc.	25 x 1 pc.	16 x 25 pcs

indexes without the ending E - cutting the securing paper along the long edge (exception 801001; 801012)  
indexes with the ending E - the intersection of the securing paper for all indexes along the short edge



### elastoKIDS STERIL D



#### indication

- protection of the site of drain or catheter application

REF		dimensions	packaging unit paper-paper	intermediate packaging box
801031A		9 cm x 10 cm	1 pc.	30 x 1 pc.

bulk packaging:  
24 x 30 pcs



## HOW TO CHOOSE A DRESSING PROPERLY?

When choosing the proper type of dressing, pay special attention to:

- absorption rate and absorption capacity,
- vapor permeability,
- possibility of an atraumatic dressing change,
- safety of use.

# non-woven eye dressing with absorbent pad

## elastopor EYE



### indication

- covering an eye and its area after ophthalmic procedures and surgical procedures
- sight correction in strabismus therapy

Conforms well to facial contours thanks to the oval shape.



white, beige or colourful



REF	dimensions	shape	colour	packaging unit paper-paper	intermediate packaging box
803010	5,8 cm x 8,3 cm		absorbent pad - white	1 pc.	50 x 1 pc.
803011	6,5 cm x 9,4 cm		non-woven material - white	1 pc.	50 x 1 pc.
803212	5 cm x 7,5 cm		absorbent pad - white non-woven material - beige colour	1 pc.	50 x 1 pc.

## elastoKIDS EYE

803012A	5 cm x 7,5 cm		absorbent pad - white non-woven material - colourful print	1 pc.	50 x 1 pc.
---------	---------------	--	---	-------	------------

bulk packaging:  
24 x 50 pcs

# Colorful kids plasters

## elastoKIDS



vitahealth



### features

- made of polyethylene film with colourful print
- centrally situated absorbent pad that absorbs small and medium amounts of exudate and protects against external factors
- absorbent pad coated with polyethylene mesh to prevent sticking to the wound
- flexible, conforms to the body contours, guarantees freedom of movement and proper application
- hypoallergenic
- good air and water vapour permeability provides the right conditions for wound healing
- each plaster individually protected by paper-paper packaging

### indication

- for protection against contamination of small wounds, skin injuries, cuts, abrasions, lacerations with small to medium amount of exudate

REF	dimensions	packaging unit paper-paper	intermediate packaging box
VH-PDP7219	7,2 cm x 1,9 cm	1 pc.	100 x 1 pc.

bulk packaging:  
100 x 100 pcs



## STABILIZING TAPES



↑↑↑  
air permeable structure

beige colour



## non-woven nasal cannula fixation plaster

### elastoNASAL

#### features

- flexible fixation plaster made of non-woven
- covered with acrylic glue
- adequate vapor permeability, thanks to which a proper gas exchange between the dressing and the skin takes place
- thin and flexible plaster is comfortable for the patient, conforms to the body's contours
- "two-stage" application type facilitates precise and efficient application
- self-adhesive
- hypoallergenic

#### indication

- stabilization of catheters and stomach tubes fixed in the nasal area

REF	dimensions	purpose	packaging unit box
811014	7 cm x 7,1 cm	for adults	50 x 1 pc.
811015	5,9 cm x 6,2 cm	for children	50 x 1 pc.
811016	3,6 cm x 4 cm	for infants	50 x 1 pc.



bulk packaging:  
40 x 50 pcs



↑↑↑  
air permeable structure

colourful print



### elastoNASAL KIDS

#### features

- micropores in the non-woven fabric structure provide appropriate vapour-permeability rate, thanks to which proper gas exchange between the dressing and the skin takes place
- elastic - adheres well, conforms to the body contours
- does not absorb X-rays
- acrylic adhesive applied continuously over the entire surface of the plaster
- backing layer of siliconised paper
- two-step application system facilitating precise and effective application
- hypoallergenic

#### indication

- stabilization of catheters and stomach tubes fixed in the nasal area

REF	dimensions	purpose	packaging unit box
811015A	5,9 cm x 6,2 cm	for children	50 x 1 pc.



bulk packaging:  
40 x 50 pcs

# adhesive tape for catheter tubing fixation

## elastoFIXAL



### features

- two-part fixing tape consisting of a part attached to the skin and a part fastening the drain
- part attached to the patient's skin made of non-woven fabric
- drain fixing part is integrated with a part adhered to the patient's skin and has an additional adhesive tape - Velcro and adhesive field for better drain stabilization
- possibility of reposition and correction of the drain position thanks to Velcro
- covered with hypoallergenic glue

### indication

- stabilization of various types of drains and catheters

↑↑↑  
air permeable structure

blue-white colour



REF	dimensions	packaging unit paper-foil	intermediate packaging box
816101	9 cm x 4 cm	1 pc.	50 x 1 pc.



bulk packaging:  
20 x 50 pcs

## elastoFIXAL KIDS



### features

- two-part fixing tape consisting of a part attached to the skin and a part fastening the drain
- part attached to the patient's skin made of adhesive colorful non-woven
- drain fixing part is integrated with a part adhered to the patient's skin and has an additional adhesive tape - Velcro and adhesive field for better drain stabilization
- possibility of reposition and correction of the drain position thanks to Velcro
- micropores in the non-woven fabric structure provide appropriate vapour-permeability rate, thanks to which proper gas exchange between the dressing and the skin takes place
- elastic - adheres well, conforms to the body contours
- acrylic adhesive applied continuously over the entire surface of the tape

### indication

- device intended for stabilisation and protection of all types of drains, catheters and tubes

↑↑↑  
air permeable structure

colourful print



REF	dimensions	packaging unit paper-foil	intermediate packaging box
816101A	9 cm x 4 cm	1 pc.	50 x 1 pc.



bulk packaging:  
20 x 50 pcs

# adhesive tape for endotracheal tube

## elastoFIXAL Set



### features

- set consisting of 2 self-adhesive non-woven pads and a fastening strap
- self-adhesive non-woven pads attached to the patient's cheeks with an adhesive part with Velcro on the other side
- a strap for stabilization of the endotracheal or oropharyngeal tube made of non-woven fabric which should be attached to the velcro layer with which the pads are covered
- adhesive area in the middle of the strip for better stabilization of the medical tube
- the possibility of repositioning and correcting the position of the tube thanks to the Velcro
- pads and strap covered with hypoallergenic glue
- has excellent adhesive properties and high mechanical strength which prevents premature and accidental detachment from the skin

### indication

- long-term stabilization of the endotracheal or oropharyngeal tube

↑↑↑  
air permeable structure

white colour



REF	kit composition	packaging unit paper-foil	intermediate packaging box
816102	2 self-adhesive non-woven pads 1 fastening strap	1 set	30 x 1 set



bulk packaging:  
24 x 30 sets

## elastoFIXAL Set KIDS



### features

- micropores in the non-woven fabric structure provide appropriate vapour-permeability rate, thanks to which proper gas exchange between the dressing and the skin takes place
- elastic - adheres well, conforms to the body contours
- does not absorb X-rays
- acrylic adhesive applied continuously over the entire surface of the plaster
- backing layer of siliconised paper
- two-step application system facilitating precise and effective application
- hypoallergenic

### indication

- device intended for stabilisation of catheters and stomach tubes fixed in the nasal area

REF	kit composition	packaging unit paper-foil	intermediate packaging box
816102A	2 self-adhesive non-woven pads 1 fastening strap	1 set	30 x 1 set



bulk packaging:  
24 x 30 sets



made of  
a delicate  
material

beige  
colour



## band for tracheostomy tube fixation elastoFIXAL TUBE

### features

- stabilising band consisting of two parts made of gentle hydrophobic non-woven fabric in flesh-coloured
- on each part there are fastening strips with Velcro on one side enabling to attach it to the fastening wings of the tracheostomy tube
- shorter part of the stabilising band is additionally equipped with a second Velcro strap attached to an elastic white rubber band which makes it possible to adjust and determine the total length of the band stabilising the tracheostomy tube
- hypoallergenic
- single use

### indication

- device intended for stabilisation of tracheostomy tube

REF	dimensions	packaging unit paper-foil	intermediate packaging box	bulk packaging box
EFT2520	25cm x 2,0 cm	1 set	30 x 1 set	20 x 30 sets
EFT4325	43cm x 2,5cm	1 set	20 x 1 set	20 x 20 sets



## adhesive dressing pouch for dialysis catheters elastoDERM C

### features

- self-adhesive dressing with a pocket to protect dialysis catheters
- the upper fixing part is made of self-adhesive, breathable, waterproof polyurethane film which is a barrier against contact with water and contamination
- breathable, non-sticky pocket with an outer layer resistant to contact with water and microorganisms provides adequate protection for the tips of dialysis catheters
- lower part stabilizing the pocket made of hydrophobic non-woven fabric

### indication

- protective dressing is used to fix dialysis catheters quickly and safely
- dressing protect dialysis catheters against mechanical stress and contamination



REF	dimensions	packaging unit paper-foil	intermediate packaging box
811501	24 cm x 10 cm	1 pc.	25 x 1 pc.



bulk packaging:  
4 x 25 pcs



ZARYS

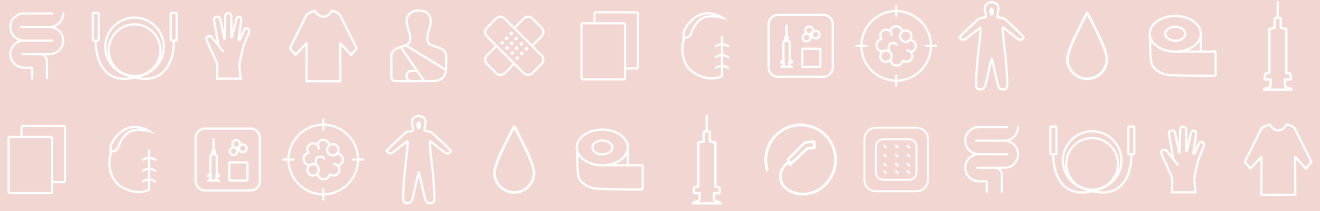

WWW.ZARYS.COM

# STABILIZING DRESSINGS



## FIXATION OF DRESSINGS

### SUPPORTING BANDAGES

#### features

- delicate, light, air and X-ray permeable
- conforms good to the body's contours
- hypoallergenic

#### indication

- fixation of all types of non-adhesive dressings

### knitted supporting bandage

#### elastoBAND BASIC



#### features

- contains viscose
- single-use

REF	dimensions	packaging unit paper	bulk packaging carton
OD05400	5 cm x 4 m	1 pc.	250 x 1 pc.
OD10400	10 cm x 4 m	1 pc.	150 x 1 pc.
OD15400	15 cm x 4 m	1 pc.	100 x 1 pc.



### elastic supporting bandage, knitted



#### elastoBAND KNITT



#### features

- one-layer, knitted elastic bandage
- breathable
- bandage does not have therapeutic properties, it is a product supporting the healing process
- packaged in foil-coated paper packaging from underneath

#### indication

- device intended for holding dressings and for supporting and compressing body parts to treat sprains and strains, and to strengthen skin layers after surgery

REF	dimensions	packaging unit paper	intermediate packaging box	bulk packaging carton
BED06400	6 cm x 4 m	1 pc.	20 x 1 pc.	54 x 20 pcs
BED08400	8 cm x 4 m	1 pc.	20 x 1 pc.	45 x 20 pcs
BED10400	10 cm x 4 m	1 pc.	20 x 1 pc.	36 x 20 pcs
BED12400	12 cm x 4 m	1 pc.	20 x 1 pc.	27 x 20 pcs
BED15400	15 cm x 4 m	1 pc.	20 x 1 pc.	27 x 20 pcs





## elastic supporting bandage, woven elastoBAND FLEX



### features

- supporting bandage, elastic, woven
- high cotton content makes the bandage safe for the skin and well-tolerated by people with allergic tendency
- equipped with a clip for fixing

### indication

- fixation of all types of non-adhesive dressings, especially where a non-elastic bandages can slide down
- in session therapy to facilitate correct blood circulation
- stabilization at bone-articular system damage, e.g. dislocation, joint twisting, weakness of muscles, tendons and ligaments
- as a sports bandage
- securing and strengthening integument after surgery

REF - cardboard box	REF - paper pouch	dimensions	packaging unit box/paper	bulk packaging carton
OE08400-E	OE08400P-E	8 cm x 4 m	1 pc.	124 x 1 pc.
OE10400-E	OE10400P-E	10 cm x 4 m	1 pc.	108 x 1 pc.
OE12400-E	OE12400P-E	12 cm x 4 m	1 pc.	96 x 1 pc.
OE15400-E	OE15400P-E	15 cm x 4 m	1 pc.	72 x 1 pc.
OE08500-E	OE08500P-E	8 cm x 5 m	1 pc.	124 x 1 pc.
OE10500-E	OE10500P-E	10 cm x 5 m	1 pc.	108 x 1 pc.
OE12500-E	OE12500P-E	12 cm x 5 m	1 pc.	96 x 1 pc.
OE15500-E	OE15500P-E	15 cm x 5 m	1 pc.	72 x 1 pc.



## elastic supporting bandage, woven elastoBAND FLEX S

REF - paper pouch	dimensions	packaging unit box/paper	bulk packaging carton
*OES08400P-E	8 cm x 4 m	32 pc.	6 x 32 pc.
*OES10400P-E	10 cm x 4 m	32 pc.	6 x 32 pc.
OES12400P-E	12 cm x 4 m	32 pc.	6 x 32 pc.
OES15400P-E	15 cm x 4 m	32 pc.	6 x 32 pc.
*OES08500P-E	8 cm x 5 m	32 pc.	6 x 32 pc.
OES10500P-E	10 cm x 5 m	32 pc.	6 x 32 pc.
*OES12500P-E	12 cm x 5 m	32 pc.	6 x 32 pc.
OES15500P-E	15 cm x 5 m	32 pc.	6 x 32 pc.



## elastic supporting bandage, woven elastoBAND FIX



### features

- one-layer, woven elastic bandage
- breathable
- bandage does not have therapeutic properties, it is a product supporting the healing process
- packaged in foil-coated paper packaging from underneath

### indication

- device intended for holding dressings and for supporting and compressing body parts to treat sprains and strains, and to strengthen skin layers after surgery

REF	dimensions	packaging unit paper	intermediate packaging box	bulk packaging carton
BET06400	6 cm x 4 m	1 pc.	20 x 1 pc.	54 x 20 pcs
BET08400	8 cm x 4 m	1 pc.	20 x 1 pc.	45 x 20 pcs
BET10400	10 cm x 4 m	1 pc.	20 x 1 pc.	36 x 20 pcs
BET12400	12 cm x 4 m	1 pc.	20 x 1 pc.	27 x 20 pcs
BET15400	15 cm x 4 m	1 pc.	20 x 1 pc.	27 x 20 pcs

# cohesive supporting bandage, non-woven elastoBAND CREPP



## features

- one-layer, non-woven bandage
- cohesive - adheres to itself (no need for fasteners), does not adhere to skin, hair, etc.
- breathable
- bandage does not have therapeutic properties, it is a product supporting the healing process
- can be divided into smaller sections, no need to use scissors, the bandage can be torn in the hands
- packaged in foil package or cardboard box

## indication

- device intended for holding dressings and for supporting and compressing body parts to treat sprains and strains, and to strengthen skin layers after surgery



REF	dimensions	packaging unit foil/box*	intermediate packaging box	bulk packaging carton
OK04400	4 cm x 4 m	1 pc.	10 x 1 pc.	28 x 10 pcs
OK06400	6 cm x 4 m	1 pc.	10 x 1 pc.	20 x 10 pcs
OK062000	6 cm x 20 m	1 pc.*	-	48 x 1 pc.
OK08400	8 cm x 4 m	1 pc.	10 x 1 pc.	16 x 10 pcs
OK082000	8 cm x 20 m	1 pc.*	-	36 x 1 pc.
OK10400	10 cm x 4 m	1 pc.	10 x 1 pc.	12 x 10 pcs
OK102000	10 cm x 20 m	1 pc.*	-	18 x 1 pc.
OK12400	12 cm x 4 m	1 pc.	10 x 1 pc.	8 x 10 pcs
OK122000	12 cm x 20 m	1 pc.*	-	12 x 1 pc.

# cohesive bandage yellowBAND



## features



















- 1-layer, breathable, made of non-woven
- cohesive - it coheres to itself, does not adhere to skin, hair or other materials

## indication

- fixation of all types of non-adhesive dressings, especially where the elastic band slides
- fixation of splinting rails
- in compression therapy
- reducing joints mobility after an injury



## AVAILABLE SIZES AND COLOURS:

											bulk packaging carton
<b>2,5cm x 4,5m</b>	—	—	—	YCB-2545-X	—	YCB-2545-B	—	—	—	—	16 x 36 pcs
<b>5cm x 4,5m</b>	YCB-545-S	YCB-545-Y	YCB-545-G	YCB-545-X	YCB-545-R	YCB-545-B	YCB-545-W	YCB-545-BC	YCB-545-IO	YCB-545-IG	24 x 12 pcs
<b>7,5cm x 4,5m</b>	YCB-7545-S	YCB-7545-Y	YCB-7545-G	YCB-7545-X	YCB-7545-R	YCB-7545-B	YCB-7545-W	YCB-7545-BC	YCB-7545-IO	YCB-7545-IG	16 x 12 pcs
<b>10cm x 4,5m</b>	YCB-1045-S	YCB-1045-Y	YCB-1045-G	YCB-1045-X	YCB-1045-R	YCB-1045-B	YCB-1045-W	YCB-1045-BC	YCB-1045-IO	YCB-1045-IG	12 x 12 pcs
<b>15cm x 4,5m</b>	—	—	—	YCB-1545-X	YCB-1545-R	YCB-1545-B	—	—	—	—	8 x 12 pcs
										bulk packaging carton	
<b>2,5cm x 4,5m</b>	YCB-2545-LB	YCB-2545-IP	YCB-2545-JG	YCB-2545-V	—	—	—	—	—	16 x 36 pcs	
<b>5cm x 4,5m</b>	YCB-545-LB	YCB-545-IP	YCB-545-JG	YCB-545-V	YCB-545-GC	YCB-545-GP	YCB-545-VP	YCB-545-XP	YCB-545-PH	24 x 12 pcs	
<b>7,5cm x 4,5m</b>	YCB-7545-LB	YCB-7545-IP	YCB-7545-JG	YCB-7545-V	YCB-7545-GC	YCB-7545-GP	YCB-7545-VP	YCB-7545-XP	YCB-7545-PH	16 x 12 pcs	
<b>10cm x 4,5m</b>	YCB-1045-LB	YCB-1045-IP	YCB-1045-JG	YCB-1045-V	—	YCB-1045-GP	YCB-1045-VP	YCB-1045-XP	YCB-1045-PH	12 x 12 pcs	
<b>15cm x 4,5m</b>	—	—	—	—	—	—	—	—	—	—	



## elastic tubular net bandage elastoNET

### features

- elastic net bandage in the form of a tube
- contains polyamide and elastomer
- high stretchability and strength of returning to pre-stretch state
- elastic and very soft
- easy and quick to use
- length before stretching:
  - 1 m, stretched: 2,5 m
  - 10 m, stretched: 25 m

### indication

- fixation of all dressings on the patient's body, replacing the traditional bandage
- the use of tubular net bandage reduces the time of wound dressing and makes it easier to fix the dressing to the patient's body



REF	length before stretching	size	indication	packaging unit box - dispenser	bulk packaging carton
SO-0101	1 m	1	finger	1 pc.	64 x 1 pc.
SO-0110	10 m	1	finger	1 pc.	6 x 1 pc.
SO-0201	1 m	2	hand, toe	1 pc.	64 x 1 pc.
SO-0210	10m	2	hand, toe	1 pc.	6 x 1 pc.
SO-0301	1 m	3	hand, foot	1 pc.	64 x 1 pc.
SO-0310	10 m	3	hand, foot	1 pc.	6 x 1 pc.
SO-0401	1 m	4	lower leg, knee, arm, foot, elbow	1 pc.	64 x 1 pc.
SO-0410	10 m	4	lower leg, knee, arm, foot, elbow	1 pc.	6 x 1 pc.
SO-0601	1 m	6	head, shoulder, lower leg, knee	1 pc.	64 x 1 pc.
SO-0610	10 m	6	head, shoulder, lower leg, knee	1 pc.	6 x 1 pc.
SO-0801	1 m	8	thigh, head, hips	1 pc.	64 x 1 pc.
SO-0810	10 m	8	thigh, head, hips	1 pc.	6 x 1 pc.
SO-1001	1 m	10	hips, trunk	1 pc.	32 x 1 pc.
SO-1010	10 m	10	hips, trunk	1 pc.	4 x 1 pc.
SO-1401	1 m	14	chest, trunk	1 pc.	32 x 1 pc.
SO-1410	10 m	14	chest, trunk	1 pc.	4 x 1 pc.



### How to make a HIPOCRATES CAP?

### FIRST AID FOR DRESSING WOUNDS USING BANDAGES

Hippocrates' achievements in treating head wounds were so widespread and advanced that they are still used today. The Hippocrates cap also called "mitrais" a headgear that allows you to hold the dressing and stop bleeding of the head wound. It is made of two bandage tapes. The main purpose of using the Hippocrates cap is to hold the dressing directly protecting the bleeding head wound, seal and warm the head, hold the compress applied to the skull area, compression, strengthening and immobilization after surgery and additional protection against the external environment. This solution is used in the absence of access to dressings such as elastic dressings and scarves.

### RULES FOR BANDAGING

1. Prepare a two-head bandage about 5-6 cm wide by sewing together two bands or by twisting the free end to the middle.
2. Put the two-headed bandage on the back of the head and drive bandage to the forehead a circular move.
3. Cross the bandages on the forehead and drive one through the top of the head towards the occiput by a longitudinal move.
4. Drive the other bandage above the ear to the occiput also (half-round).
5. Scroll the longitudinal course through the circular course bandage.
6. Drive back the longitudinal course bandage across the top of the head to the forehead.
7. Drive the circular course bandage around the other ear to the forehead
8. Continue longitudinal and circular moves, the circular course bandage wraps around the scalp
9. Little by little, move the longitudinal course bandage towards the temples
10. After covering the whole area with a two-head bandage, fix the ends of bandage





## IMMOBILIZING DRESSINGS

### ORTHOPEDIC PADDINGS

#### features

- very soft and fluffy
- adhere well and adjusts to the shape of the body
- coherent structure resistant to stratification makes it easier placement of the immobilizing dressing
- minimize the risk of skin abrasions and irritations under the P.O.P. bandage
- do not absorb moisture and thus do not allow for its contact with the skin
- hypoallergenic

#### indication

- as a protective layer put under plaster of Paris bandages
- in compression therapy as a padding under the bandages of various elasticity

### orthopedic padding, natural

#### orthoNATURAL



REF	dimensions	packaging unit paper cover	intermediate packaging foil bag	bulk packaging box
*ON-63	6 cm x 3 m	1 pc.	12 x 1 pc.	40 x 12 pcs
*ON-83	8 cm x 3 m	1 pc.	12 x 1 pc.	40 x 12 pcs
ON-103	10 cm x 3 m	1 pc.	12 x 1 pc.	20 x 12 pcs
ON-123	12 cm x 3 m	1 pc.	6 x 1 pc.	40 x 6 pcs
ON-153	15 cm x 3 m	1 pc.	6 x 1 pc.	30 x 6 pcs
*ON-203	20 cm x 3 m	1 pc.	6 x 1 pc.	20 x 6 pcs
*ON-253	25 cm x 3 m	1 pc.	6 x 1 pc.	10 x 6 pcs



made  
of viscose



white  
colour



available  
on request

### orthopedic padding, synthetic

#### orthoSYNTHETIC



REF	dimensions	packaging unit paper cover	intermediate packaging foil bag	bulk packaging box
OS-63	6 cm x 3 m	1 pc.	12 x 1 pc.	40 x 12 pcs
OS-83	8 cm x 3 m	1 pc.	12 x 1 pc.	40 x 12 pcs
OS-103	10 cm x 3 m	1 pc.	12 x 1 pc.	20 x 12 pcs
OS-123	12 cm x 3 m	1 pc.	6 x 1 pc..	40 x 6 pcs
OS-153	15 cm x 3 m	1 pc.	6 x 1 pc.	30 x 6 pcs
OS-203	20 cm x 3 m	1 pc.	6 x 1 pc.	20 x 6 pcs
OS-253	25 cm x 3 m	1 pc.	6 x 1 pc.	10 x 6 pcs



made of  
polyester



white  
colour



# triangular sling

## elastoSLING



  
white  
colour

### features

- triangle shaped sling made of non-woven or cotton
- thin, light and elastic - comfortable for the patient, adjusts to the shape of the body, provides freedom of movement
- possibility of connecting several slings to achieve bigger immobilization
- hypoallergenic

### indication

- short-term immobilization and support of the upper limb in case of various injuries e.g. dislocation or fracture of collar bone, humerus, forearm or hand bone

REF	dimensions	description	packaging unit zipper pouch	intermediate packaging foil bag
CHTW9696136	96 cm x 96 cm x 136 cm	non-woven	1 pc.	12 x 1 pc.
CHTB9696130	96 cm x 96 cm x 130 cm	cotton	1 pc.	12 x 1 pc.



bulk packaging:  
20 x 12 pcs

## HOW TO PROPERLY PUT ON A TRIANGULAR SLING?



1. Place the triangular sling on the patient's body so that one of the corners of the sling is at the level of the elbow of the immobilized hand.
2. Place the second corner of the sling on the opposite arm in relation to the immobilized hand.
3. Carefully place the sick / injured limb on the sling.
4. Wrap the sick/injured limb with dangling, third corner of the sling.
5. Make sure that the hand is in the right position, and then tie the corners of the sling around the neck.

## P.O.P. BANDAGES

### features

- made of cotton gauze coated with natural plaster of Paris on both sides
- on a plastic roll
- enable fast and durable immobilization
- before fixing need to be soaked in a container with water at 20°C temperature
- do not absorb X-rays

### indication

- large and small immobilizing dressings in orthopedic, ambulatory and surgical procedures

## P.O.P. bandage

### orthoBAND FAST



fast-setting

setting time approx. **3 minutes**  
fully dry after approx. **24 hours**

REF	dimensions	type of edge	packaging unit foil bag	bulk packaging carton
OB06300-F	6 cm x 3 m	straight	1 pc.	48 x 1 pc.
OB08300-F	8 cm x 3 m	straight	1 pc.	48 x 1 pc.
OB10300-F	10 cm x 3 m	serrated	1 pc.	48 x 1 pc.
OB12300-F	12 cm x 3 m	serrated	1 pc.	48 x 1 pc.
OB14300-F	14 cm x 3 m	serrated	1 pc.	36 x 1 pc.
OB15300-F	15 cm x 3 m	serrated	1 pc.	36 x 1 pc.
OB20300-F	20 cm x 3 m	serrated	1 pc.	24 x 1 pc.



### orthoBAND NORMAL



fast-setting

setting time approx. **5-6 minutes**  
fully dry after approx. **24 hours**

REF	dimensions	type of edge	packaging unit foil bag	bulk packaging carton
OB06300-N	6 cm x 3 m	straight	1 pc.	48 x 1 pc.
OB08300-N	8 cm x 3 m	straight	1 pc.	48 x 1 pc.
OB10300-N	10 cm x 3 m	serrated	1 pc.	48 x 1 pc.
OB12300-N	12 cm x 3 m	serrated	1 pc.	48 x 1 pc.
OB14300-N	14 cm x 3 m	serrated	1 pc.	36 x 1 pc.
OB15300-N	15 cm x 3 m	serrated	1 pc.	36 x 1 pc.
OB20300-N	20 cm x 3 m	serrated	1 pc.	24 x 1 pc.



### orthoBAND LONG



slow-setting

setting time approx. **8-12 minutes**  
fully dry after approx. **24 hours**

REF	dimensions	type of edge	packaging unit foil bag	bulk packaging carton
OB10400-L	10 cm x 4 m	serrated	1 pc.	48 x 1 pc.
OB12400-L	12 cm x 4 m	serrated	1 pc.	36 x 1 pc.
OB15400-L	15 cm x 4 m	serrated	1 pc.	24 x 1 pc.





# RULES FOR BANDAGING



1.

Select a bandage of proper type and size for the part of the body to be bandaged.



2.

✓ correctly



✗ incorrectly

With your right hand, grasp the beginning of the band, and with your left hand hold the rolled part so called "head".

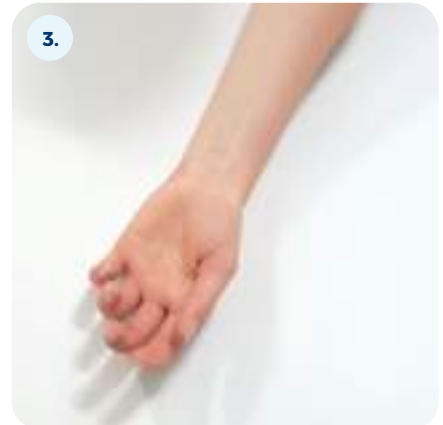

3.

Put the patient in a comfortable position supporting the bandaged lower or upper limb.



4.



For proper stabilization of dressing, start bandaging with a circular wrap, each subsequent layer covers exactly the previous one in a durable and aesthetic way. Little by little unroll the band during bandaging. Finish the bandaging with a circular wrap, end of the dressing secure with a clip or tie it.



5.



6.

The bandage should adhere correctly to the patient's body and be rolled up with adequate power - too much pressure can lead to impaired circulation, too loose it will slide and fall.

Remove the bandage by transferring it from one hand to other to minimize patient movement.

ZARYS

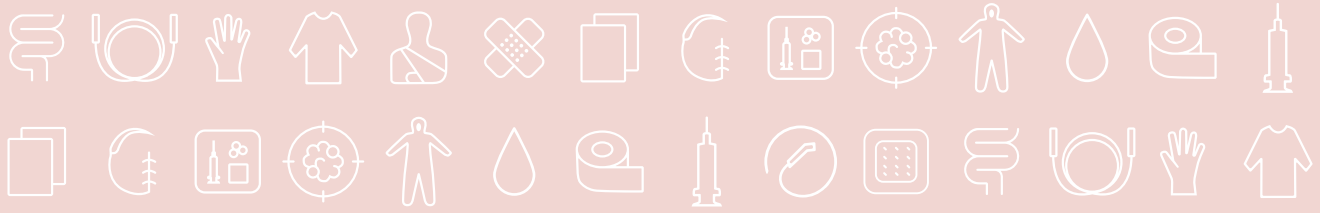

WWW.ZARYS.COM

# SPECIALIST DRESSINGS



## paraffin gauze dressing paraffiNET

### features

- wide-mesh dressing made of cotton gauze covered with paraffin
- structure of the carrier material allows exudate to be freely drained to the covering secondary dressing
- covering with a layer of paraffin reduces risk of adhesion to the wound and allows a painless change of dressing
- neutral properties of paraffin allow for using the dressing in combination with other preparations containing medicinal substances or antiseptics
- can be shaped and cut according to the needs aseptically
- needs to be covered with a dressing with absorbent properties, e.g. compress, high-absorption dressing, polyurethane foam
- non-adhesive, necessary fixing with a tape, bandage or net tubular dressing
- hypoallergenic

### indication

- keeping proper moisture in the wound
- preventing the wound edges from drying and maceration
- recommended for uninfected wounds
- treatment of chronic wounds: various ulcers, bedsores
- treatment of surgical and burn wounds, skin donor and grafting sites, skin damage, cuts
- protection against radiation skin damage



soaked with paraffin



possibility of cutting

**STERILE R**



REF	dimensions	packaging unit paper-aluminum foil	intermediate packaging box
PAR-01	5 cm x 5 cm	1 pc.	10 x 1 pc.
PAR-02	10 cm x 10 cm	1 pc.	10 x 1 pc.
PAR-06	10 cm x 40 cm	1 pc.	10 x 1 pc.
PAR-07	15 cm x 20 cm	1 pc.	10 x 1 pc.



bulk packaging:  
50 x 10 pcs



## FOIL DRESSINGS

### FOIL DRESSINGS

#### features

- made of polyurethane film
- covered with hypoallergenic acrylic glue
- transparent - they allow observation of the dressed place without the need to remove the dressing
- vapour permeability guarantees correct gas exchange between the dressing and the skin, and prevents it from excessive moisture accumulation and maceration
- barrier against microorganisms and bacteria, minimizing the risk of infection
- very thin and elastic - adjust to the shape of the body, guarantee freedom of movement
- waterproof
- self-adhesive
- hypoallergenic



## elastoDERM

### dressing without absorbent pad, with "three-stage" application type

REF	dimensions	shape	indication	packaging unit paper-paper	intermediate packaging box
811210	6 cm x 7 cm		- fixing and securing intravenous cannulas - secondary dressing - bedsore prevention, works as so-called "second skin" - for small epidermal abrasions and damages of the skin surface	1 pc.	100 x 1 pc.



bulk packaging:  
30 x 100 pcs

**STERILE EO**



## elastoDERM PAD

### dressing with central absorbent pad, with "three-stage" application type

REF	dimensions	shape	indication	packaging unit paper-paper	intermediate packaging box	bulk packaging box
802012	6 cm x 7 cm		- protection of post-operative wounds and stitches	1 pc.	100 x 1 pc.	12 x 100 pcs
802014	9 cm x 10 cm			1 pc.	50 x 1 pc.	24 x 50 pcs
802015	9 cm x 15 cm			1 pc.	50 x 1 pc.	24 x 50 pcs
802016	10 cm x 20 cm			1 pc.	50 x 1 pc.	18 x 50 pcs
802018	10 cm x 25 cm			1 pc.	50 x 1 pc.	15 x 50 pcs

**STERILE EO**





1. Remove the back paper protection.



2. Apply the dressing to the desired place.



3. Remove the paper protection on the outer side of the dressing starting from the cut.



4. Put the notes on the tape to describe the dressing and apply it on the dressing without covering the wound/ the place of needle insertion.

#### features

- "frame" or three-stage" application system makes dressing placement precise and accurate
- available in several sizes and options:
  - with a central absorbent pad
  - with notch enabling the dressing to fit the cannulas
  - without notch and absorbent pad

## elastoDERM F

dressing without absorbent pad, with "frame" application type

REF	dimensions	shape	indication	packaging unit paper-paper	intermediate packaging box	bulk packaging box
812003	4,4 cm x 4,4 cm		- fixing and securing intravenous cannulas - secondary dressing	1 pc.	100 x 1 pc.	36 x 100 pcs
812005	6 cm x 7 cm		- bed sore prevention, works as so-called „second skin“ - for small epidermal abrasions and damages of the skin surface	1 pc.	100 x 1 pc.	30 x 100 pcs
812008	10 cm x 12 cm		- fixing and securing central venous catheters - fixing epidural catheters - secondary dressing	1 pc.	100 x 1 pc.	20 x 100 pcs
812011	10 cm x 15 cm		- bed sore prevention, works as so-called „second skin“ - for small epidermal abrasions and damages of the skin surface	1 pc.	100 x 1 pc.	20 x 100 pcs
<b>NEW</b> 812018	10 cm x 25 cm			1 pc.	25 x 1 pc.	8 x 25 pcs
<b>NEW</b> 812023	20 cm x 30 cm			1 pc.	25 x 1 pc.	8 x 25 pcs



## elastoDERM F-IV

IV cannula dressing, with "frame" application type

REF	dimensions	shape	indication	packaging unit paper-paper	intermediate packaging box
812006	6 cm x 7 cm		- fixing and securing peripheral cannulas in adults - securing cannulas inserted into central veins	1 pc.	100 x 1 pc.
<b>NEW</b> 812001	5 cm x 6 cm			1 pc.	100 x 1 pc.
<b>NEW</b> 812009	9 cm x 7,2 cm			1 pc.	100 x 1 pc.
<b>NEW</b> 812014	8,5 cm x 11,5 cm			1 pc.	100 x 1 pc.



bulk packaging:  
30 x 100 pcs

## elastoDERM IV

IV cannula dressing, with "three-stage" application type

REF	dimensions	shape	indication	packaging unit paper-paper	intermediate packaging box
811301	5,8 cm x 8 cm		- fixing and securing peripheral cannulas in adults	1 pc.	100 x 1 pc.



bulk packaging:  
20 x 100 pcs

ZARYS



WWW.ZARYS.COM

# ADDITIONAL PRODUCTS

## cold/warm compress



thermPAD



### features

- cold/warm gel compress made of non-toxic durable film with gel insert
- presence of a fabric cover to prevent external damage
- ability to store and return accumulated heat or cold for a long time
- remains flexible after freezing, allowing the compress to be easily shaped to the body area
- reusable

### indication

- device used for the local cooling or heating of specific areas of the body to combat pain/neuralgia and reduce swelling and puffiness



REF	dimensions	packaging unit foil bag	bulk packaging carton
KCZ7513	7,5 cm x 13 cm	1 pc.	100 x 1 pc.
KCZ7552	7,5 cm x 52 cm	1 pc.	30 x 1 pc.
KCZ1229	12 cm x 29 cm	1 pc.	25 x 1 pc.
KCZ1314	13 cm x 14 cm	1 pc.	50 x 1 pc.
KCZ1626	16 cm x 26 cm	1 pc.	20 x 1 pc.
KCZ2138	21 cm x 38 cm	1 pc.	10 x 1 pc.
KCZ3040	30 cm x 40 cm	1 pc.	8 x 1 pc.

## gynaecological-maternity pad



gynPAD



### features

- an absorbent pad with an adhesive layer
- it has a layered construction
- pink foil sheet placed in the lower part of the pad as an insulating part to protect against wetness
- provides increased absorption capacity due to the highly absorbent cellulose pad
- structure of the dressing allows free passage of exudate to the absorbent pad inside
- can be used as a primary as well as a secondary dressing
- can be sterilised with ethylene oxide

### indication

- device used to absorb bodily fluids resulting from surgery, childbirth to protect the patient from contamination and infection



REF	dimensions	packaging unit foil bag	intermediate packaging box
PG34090	34 cm x 9 cm	1 pc.	10 x 1 pc.



bulk packaging:  
10 x 50 pcs

## gauze pad moistened with alcohol Alcohol Prep Pad



### features

- made of non-woven
- soaked with isopropyl alcohol (70%)
- two pouches connected in one-piece packaging can be separated thanks to perforation

### indication

- disinfection of small surfaces

REF	dimensions	no. of plies	packaging unit paper-aluminum foil	bulk packaging box
P1-IA-2	30 mm x 65 mm (unfolded) 30 mm x 32,5 mm (folded)	2	2 x 1 pc.	100 x 1 pc. 50 x 2 pcs



## Alcohol Prep Pad



### features

- made of non-woven
- each gauze pad is packed separately, in aluminum foil - paper
- soaked with isopropyl alcohol (70%)
- two pouches connected in one-piece packaging can be separated thanks to perforation (without L-06)

### indication

- disinfection low surface

REF	dimensions	packaging unit paper-aluminum foil	bulk packaging box
P2-IA-1	M 65 mm x 55 mm (unfolded) 32,5 mm x 27,5 mm (folded)	2 x 1 pc.	100 x 1 pc. (50 x 2 pcs.)
P2-IA-2	XL 110 mm x 90 mm (unfolded) 55 mm x 45 mm (folded)	2 x 1 pc.	100 x 1 pc. (50 x 2 pcs.)

## gauze pad moistened with alcohol

### ALKOPAD



### features

- made of non-woven
- each gauze pad is packed separately, in aluminum foil - paper
- soaked with isopropyl alcohol (70%)
- two pouches connected in one-piece packaging can be separated thanks to perforation (without L-06)

### indication

- disinfection low surface

REF	dimensions	packaging unit paper-aluminum foil	bulk packaging box
L-06	XXL 190 mm x 140 mm (unfolded)	2 x 1 pc.	50 x 1 pc. (25 x 2 pcs.)

### ALKOPAD DUO



### features

- made of non-woven
- each gauze pad is packed separately, in aluminum foil - paper
- gauze pad wet soaked with isopropyl alcohol (70%) and gauze pad dry
- two pouches connected in one-piece packaging can be separated thanks to perforation

### indication

- disinfection low surface

REF	dimensions	packaging unit paper-aluminum foil	bulk packaging box
L-05DUO	125 mm x 125 mm	2 x 1 pc.	50 x 2 pcs

## rescue blanket, foil, termic thermCARE



### features

- made of metallized PE foil
- protects against adverse weather conditions – cold, rain, heat, wind, depending on the side, which is applied towards the victim's body, prevents the life-threatening heat disorders and reduces the risk of shock
- resistant to damage

### indication

- protection against hypothermia and overheating of the victim's body
- in emergency cases such as car accidents, ski accidents, in mountain tourism, in sport

REF	dimensions	purpose	packaging unit zipper pouch	intermediate packaging foil bag
KR160210	160 cm x 210 cm	for adults	1 pc.	12 x 1 pc.

  
bulk packaging:  
20 x 12 pcs

# surgical kits

The company's offer also includes small surgical kits under the deltaset brand. They are used in treatment rooms, emergencies, hospital wards or dialysis units. They contain all disposable products necessary to perform the procedure in aseptic manner.

Deltaset packages are dedicated to a specific procedure, e.g. for changing a dressing, catheterization, dialysis or anaesthesia. The kit includes: disposable equipment, dressings, surgical drapes, surgical instruments, accessories, medical gloves and many more.



**PREVENTION**  
of nosocomial infections

**FACILITATING  
WORK**  
and  
**MINIMIZING  
POSSIBLE ERRORS**



ensuring the  
**HIGHEST  
QUALITY**  
and  
**SAFETY**  
FOR THE PATIENT



**TIME  
SAVING**  
and  
**COST  
REDUCTION**



**STANDARDIZATION  
of  
PROCEDURES**



ready to use

**ANYWHERE AND ANYTIME**



 **deltaset**

standard

**surgical kits**



## deltaset label

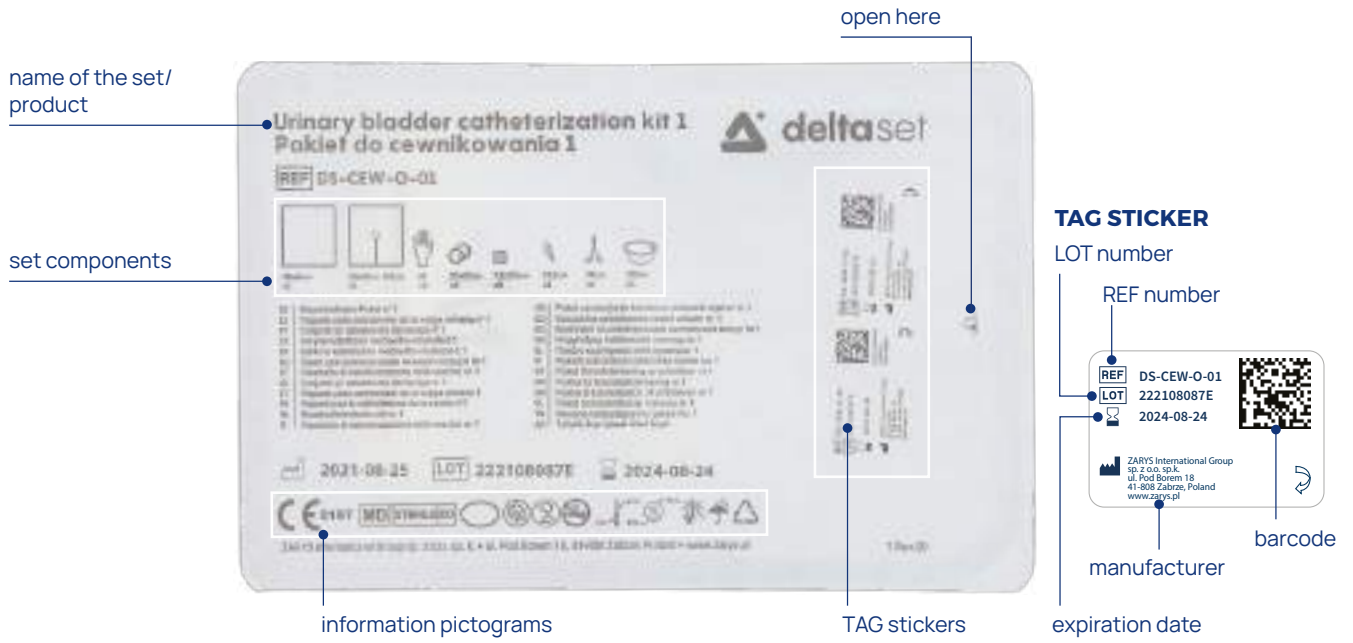

### 1-chamber blister



### 2-chamber blister



### 3-chamber blister



## Features of hard blister packaging along with the most important advantages, deltaset used in the operating room



ZARYS

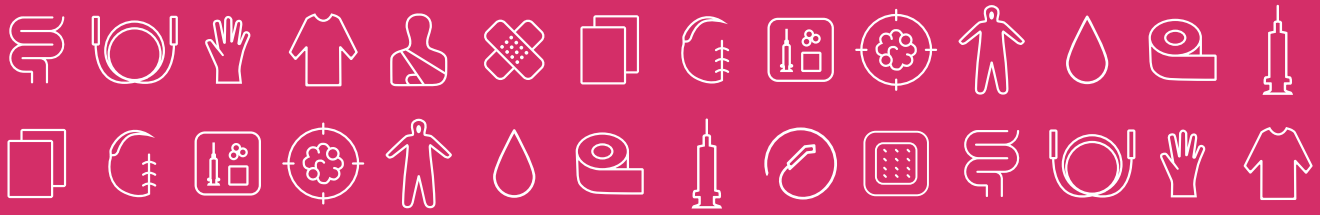

WWW.ZARYS.COM

# STANDARD DELTASET SURGICAL KITS



features

- single-use
- for short-term use
- shelf life: 3 years
- label with 2 adhesive tag labels for data archiving; the following information is available on each adhesive tag label: REF number, expiry date, batch number, manufacturer's data and barcode
- packaging: double-chamber hard blister

indication

- intended for use in treatment rooms, emergency services or hospital wards
- it contains auxiliary disposable medical devices necessary to perform the central puncture procedure

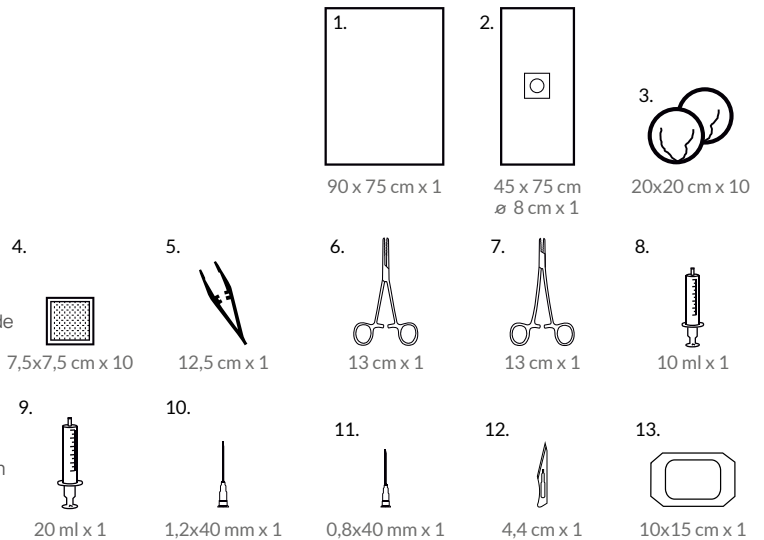

no.	quantity	component	specification	individual packaging
1.	1 pc.	2-layer surgical drape	90 cm x 75 cm cellulose layer + waterproof polyethylene film; blue colour	1 kit double-chamber hard blister
2.	1 pc.	2-layer surgical drape with central adhesive fenestration	45 cm x 75 cm fenestration dia. 8 cm, cellulose layer + waterproof polyethylene film; blue colour	
3.	10 pcs	gauze ball without X-ray thread	20 cm x 20 cm 17-thread cotton gauze; white colour	
4.	10 pcs	gauze swab	7,5 cm x 7,5 cm 17-thread cotton gauze, 8-ply; white colour	
5.	1 pc.	plastic tweezers	length 12,5 cm, polypropylene; blue colour	
6.	1 pc.	metal grasper (Pean)	length 13 cm, stainless steel	
7.	1 pc.	metal needle holder MAYO-HEGAR	length 13 cm, stainless steel	
8.	1 pc.	two-piece syringe in paper-foil packaging	capacity 10 ml, Luer	
9.	1 pc.	two-piece syringe in paper-foil packaging	capacity 20 ml, Luer	
10.	1 pc.	injection needle in paper-foil packaging	1,2 mm x 40 mm	
11.	1 pc.	injection needle in paper-foil packaging	0,8 mm x 40 mm	
12.	1 pc.	surgical blade	no. 11	
13.	1 pc.	foil dressing with frame and tape for description in paper-foil packaging	10 cm x 15 cm, polyethylene film	





### features

- single-use
- for short-term use
- shelf life: 3 years
- label with 2 adhesive tag labels for data archiving;  
the following information is available on each adhesive tag label:  
REF number, expiry date, batch number, manufacturer's data and barcode
- packaging: single-chamber hard blister

### indication

- intended for use in treatment rooms, emergency services, hospital wards or dialysis stations
- it contains auxiliary disposable medical devices necessary to perform the suture removal procedure

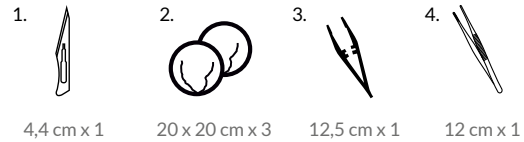

no.	quantity	component	specification	individual packaging
1.	1 pc.	surgical blade	no. 11	1 kit single-chamber hard blister
2.	3 pcs	non-woven ball without X-ray thread	20cm x 20cm, non-woven 30G, white colour	
3.	1 pc.	plastic tweezers	length 12,5cm, polypropylene, blue colour	
4.	1 pc.	anatomic metal tweezers	length 12cm, stainless steel	



### features

- single-use
- for short-term use
- shelf life: 3 years
- label with 2 adhesive tag labels for data archiving;  
the following information is available on each adhesive tag label:  
REF number, expiry date, batch number, manufacturer's data and barcode
- packaging: single-chamber hard blister

### indication

- intended for use in treatment rooms, emergency services or hospital wards
- it contains auxiliary disposable medical devices necessary to perform the urinary bladder catheterisation procedure

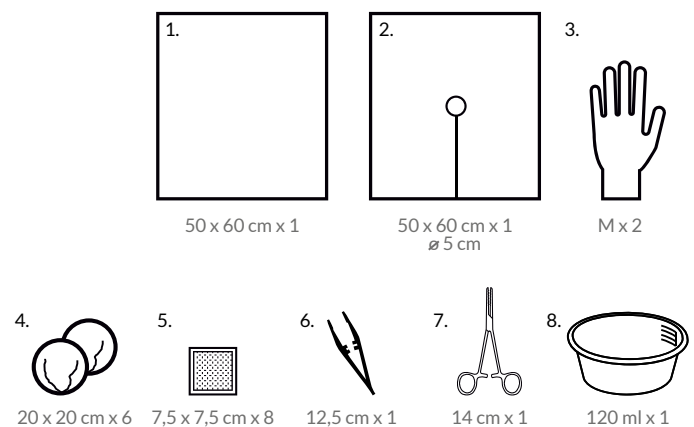

no.	quantity	component	specification	individual packaging
1.	1 pc.	2-layer surgical drape	50cm x 60cm non-woven polypropylene + waterproof, polyethylene film; blue colour	1 kit single-chamber hard blister
2.	1 pc.	2-layer surgical drape with central, fenestration and incision	50cm x 60cm fenestration: diameter 5cm, non-woven polypropylene + waterproof, polyethylene film; blue colour	
3.	2 pcs	examination gloves, nitrile, powderfree, in paper packaging	size. M, 100% nitrile; light blue colour	
4.	6 pcs	gauze ball without X-ray thread	20cm x 20cm, 17-thread cotton gauze; white colour	
5.	8 pcs	gauze swab	7,5cm x 7,5cm, 17-thread cotton gauze, 8-ply; white colour	
6.	1 pc.	plastic tweezers	length 12,5cm, polypropylene; green colour	
7.	1 pc.	plastic grasper (Pean)	length 14cm, polypropylene; blue colour	
8.	1 pc.	sponge bowl	capacity 120ml, polypropylene; transparent colour	



features

- single-use
- for short-term use
- shelf life: 3 years
- label with 2 adhesive tag labels for data archiving; the following information is available on each adhesive tag label: REF number, expiry date, batch number, manufacturer's data and barcode
- packaging: single-chamber hard blister

indication

- intended for use in treatment rooms, emergency services or hospital wards
- it contains auxiliary disposable medical devices necessary to perform the urinary bladder catheterisation procedure

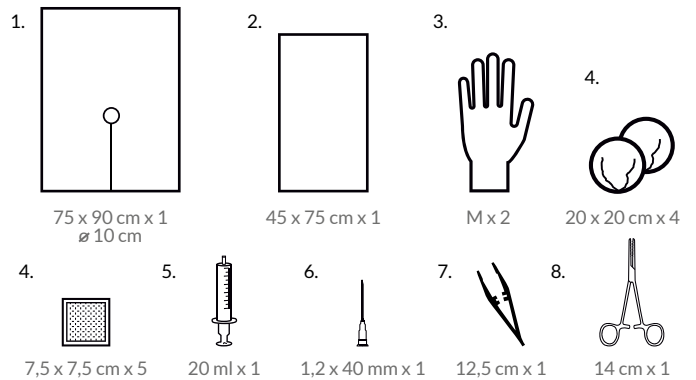

no.	quantity	component	specification	individual packaging
1.	1 pc.	2-layer surgical drape with central, fenestration and incision	75cm x 90cm, fenestration: diameter 10 cm non-woven polypropylene + waterproof polyethylene film; blue colour	1 kit single-chamber hard blister
2.	1 pc.	2-layer surgical drape	45cm x 75cm, non-woven polypropylene + waterproof, polyethylene film; blue colour	
3.	2 pcs	examination gloves, nitrile, powderfree, in paper packaging	size. M, 100% nitrile; light blue colour	
4.	4 pcs	gauze ball without X-ray thread	20cm x 20cm, 17-thread cotton gauze; white colour	
5.	5 pcs	gauze swab	7,5cm x 7,5cm, 17-thread cotton gauze, 8-ply; white colour	
6.	1 pc.	two-piece syringe in paper-foil packaging	capacity 20ml, Luer	
7.	1 pc.	injection needle in paper-foil packaging	1,2mm x 40mm	
8.	1 pc.	plastic tweezers	length 12,5cm, polypropylene; green colour	
9.	1 pc.	plastic grasper (Pean)	length 14cm, polypropylene; blue colour	



features

- single-use
- for short-term use
- shelf life: 3 years
- label with 2 adhesive tag labels for data archiving; the following information is available on each adhesive tag label: REF number, expiry date, batch number, manufacturer's data and barcode
- packaging: soft blister paper-foil

indication

- intended for use in treatment rooms, emergency services, hospital wards or dialysis stations
- it contains auxiliary disposable medical devices necessary to perform the dialysis procedure

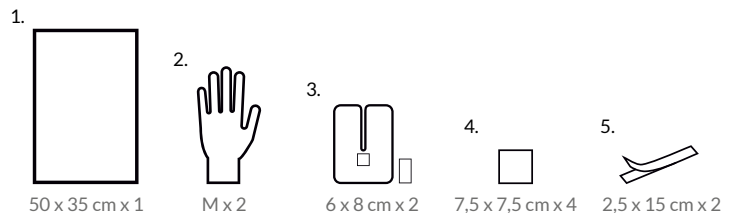

no.	quantity	component	specification	individual packaging
1.	1 pc.	2-layer surgical drape	50cm x 35cm cellulose layer + waterproof polyethylene film; blue colour	1 kit soft blister paper-foil
2.	2 pcs	examination gloves, nitrile, powderfree in paper packaging	size. M, 100% nitrile; light blue colour	
3.	2 pcs	IV cannula dressing, self-adhesive	6cm x 8cm, hydrophobic non-woven	
4.	4 pcs	non-woven swab	7,5cm x 7,5cm, non-woven 30G, 4 ply; white colour	
5.	2 pcs	dressing tape, self-adhesive	2,5cm x 15cm	



features

- single-use
- for short-term use
- shelf life: 3 years
- label with 2 adhesive tag labels for data archiving; the following information is available on each adhesive tag label: REF number, expiry date, batch number, manufacturer's data and barcode
- packaging: soft blister paper-foil

indication

- intended for use in treatment rooms, emergency services, hospital wards or dialysis stations
- it contains auxiliary disposable medical devices necessary to perform the dialysis procedure

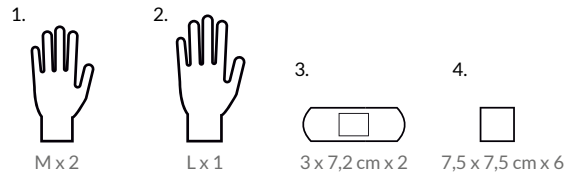

no.	quantity	component	specification	individual packaging
1.	2 pcs	examination gloves, nitrile, powderfree in paper packaging	size. M 100% nitrile; light blue colour	1 kit soft blister paper-foil
2.	1 pc.	examination gloves, nitrile	size. L 100% nitrile; white colour	
3.	2 pcs	post-injection dressing, self-adhesive	3cm x 7,2cm polyethylene film; transparent	
4.	6 pcs	non-woven swab	7,5cm x 7,5cm non-woven 30G, 4 ply; colour white	



features

- single-use
- for short-term use
- shelf life: 3 years
- label with 2 adhesive tag labels for data archiving; the following information is available on each adhesive tag label: REF number, expiry date, batch number, manufacturer's data and barcode
- packaging: two-piece soft blister with perforation, paper-foil

indication

- intended for use in treatment rooms, emergency services or hospital wards
- it contains auxiliary disposable medical devices necessary to perform the puncture procedure e.g. central venepuncture, subarachnoid puncture

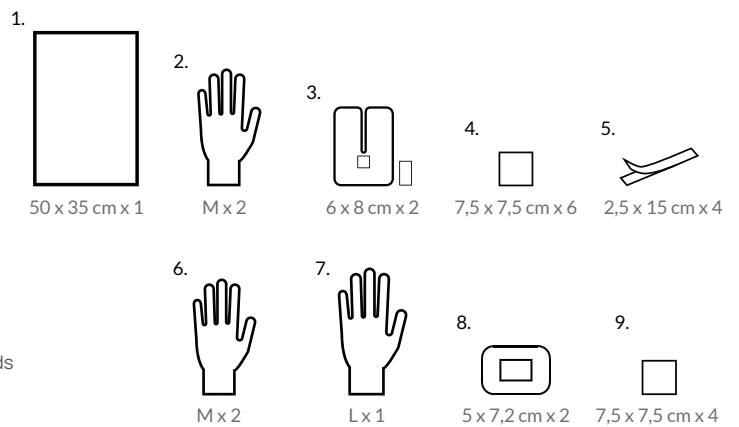

no.	quantity	component	specification	individual packaging
1.	1 pc.	2-layer surgical drape	50cm x 35cm; cellulose layer + waterproof polyethylene film; blue colour	1 kit two-piece soft blister with perforation, paper-foil
2.	2 pcs	examination gloves, nitrile, powderfree in paper packaging	size. M, 100% nitrile; light blue colour	
3.	2 pcs	IV cannula dressing, self-adhesive	6cm x 8cm, hydrophobic non-woven	
4.	6 pcs	non-woven swab	7,5cm x 7,5cm, non-woven 30G, 4 ply; white colour	
5.	4 pcs	dressing tape, self-adhesive	2,5cm x 15cm	
6.	2 pcs	examination gloves, nitrile, powderfree in paper packaging	size. M, 100% nitrile; light blue colour	
7.	1 pc.	examination gloves, nitrile	size. L, 100% nitrile; white colour	
8.	2 pcs	dressing with absorbent pad, selfadhesive	5cm x 7,2cm	
9.	4 pcs	non-woven swab	7,5cm x 7,5cm, non-woven 30G, 4 ply; colour white	





## features

- single-use
- for short-term use
- shelf life: 3 years
- label with 2 adhesive tag labels for data archiving;  
the following information is available on each adhesive tag label:  
REF number, expiry date, batch number, manufacturer's data and barcode
- packaging: three-chamber hard blister

## indication

- intended for use in treatment rooms, emergency services or hospital wards
- it contains auxiliary disposable medical devices necessary to perform procedures of conduction anesthesia

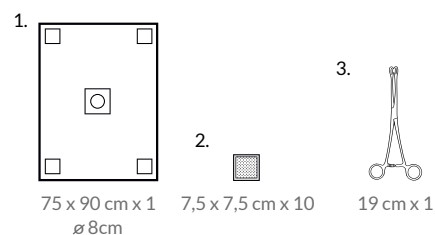

no.	quantity	component	specification	individual packaging
1.	1 pc.	2-layer surgical drape with central fenestration and adhesive corners	75cm x 90cm; fenestration: diameter 8 cm; non-woven polypropylene + waterproof polyethylene film; blue colour	1 kit three-chamber hard blister
2.	10 pcs	gauze swab	7,5cm x 7,5cm, 17-thread cotton gauze, 8 ply; white colour	
3.	1 pc.	plastic window forceps, Korcang type, wrapped in a 2-layer drape with a cellulose layer	length 19 cm, 45cm x 45cm, cellulose layer + waterproof polyethylene film, blue colour	



## features

- single-use
- for short-term use
- shelf life: 3 years
- label with 2 adhesive tag labels for data archiving;  
the following information is available on each adhesive tag label:  
REF number, expiry date, batch number, manufacturer's data and barcode
- packaging: double-chamber hard blister

## indication

- intended for use in treatment rooms, emergency services or hospital wards
- it contains auxiliary disposable medical devices necessary to perform the puncture procedure e.g. central venepuncture, subarachnoid puncture

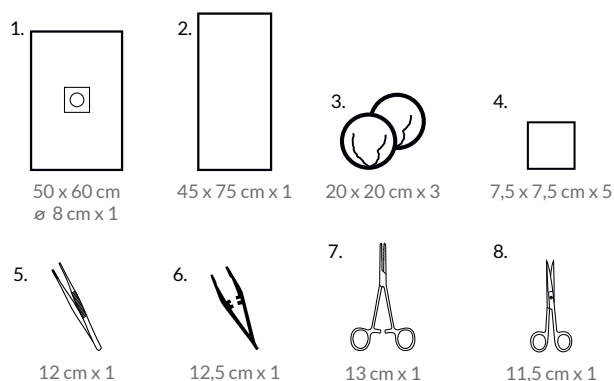

no.	quantity	component	specification	individual packaging
1.	1 pc.	2-layer surgical drape with central adhesive fenestration	50cm x 60cm, fenestration: diameter 8 cm; non-woven polypropylene + waterproof polyethylene film; blue colour	1 kit double-chamber hard blister
2.	1 pc.	2-layer surgical drape	45cm x 75cm, non-woven polypropylene + waterproof polyethylene film; blue colour	
3.	3 pcs	gauze ball without X-ray thread	20cm x 20cm 17-thread cotton gauze; white colour	
4.	5 pcs	non-woven swab	7,5cm x 7,5cm non-woven 30G, 4 ply; white colour	
5.	1 pc.	anatomic metal tweezers	length 12cm stainless steel	
6.	1 pc.	plastic tweezers	length 12,5cm polypropylene; green colour	
7.	1 pc.	metal needle holder MAYO-HEGAR	length 13 cm stainless steel	
8.	1 pc.	metal scissors sharp/sharp	length 11,5cm stainless steel	

# be well

NEW

## innovative home post-operative wound care kit

beWell is an innovative home post-operative wound care kit designed with maximum patient comfort and safety in mind. It consists of sterile disposable items and equipment that allow for three changes of dressings for sutured and uninfected post-operative wounds.

### What distinguishes the beWell kits?

elastoDERM F foil dressings with „frame“ type application system ensuring complete waterproofing, allowing patients to bathe freely without the risk of wetting the wound.

Elastopor STERILnon-woven dressings, tailored to the wound size. A special smooth layer of the absorbent pad prevents the dressing from sticking to the wound surface or stitches, ensuring a safe and painless dressing change.

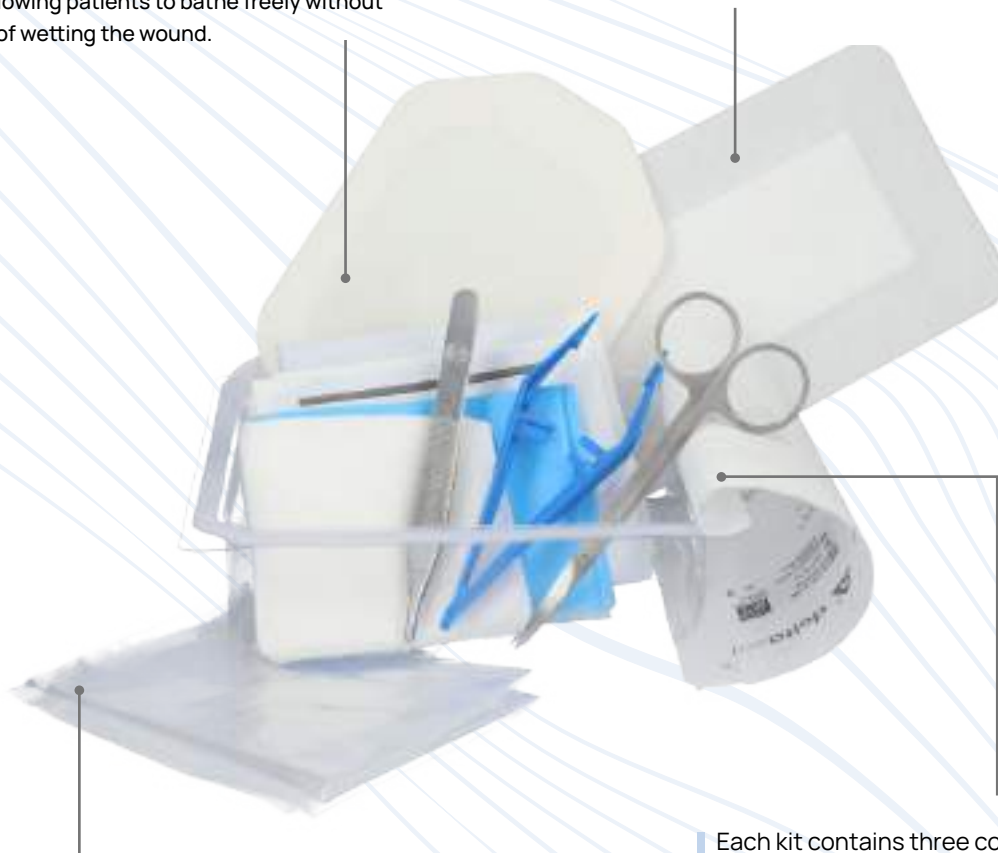

medical waste, which facilitate the safe disposal of used materials after dressing changes.

Each kit contains three complete sterile deltaset packages for changing dressings.

**< 5 cm**  
**small wounds**

BW-ZWM-ZOP01SN



**< 10 cm**  
**medium wounds**

BW-ZWM-ZOP02MN



**> 10 cm**  
**large wounds**

BW-ZWM-ZOP03LN



**The kit includes:**

- 3 sterile deltaset dressing change packages, including:
  - a surgical drape with a cellulose layer (38 x 45 cm)
  - plastic tweezers (125 cm)
  - non-latex, powder-free diagnostic gloves
  - gauze pads adjusted to the wound size
- 3 sterile elastopor STERIL dressings with absorbent inserts
- 3 sterile elastoDERM F foil dressings with „frame“
- 3 bags for medical waste,

The deltaset package marked (2) additionally contains:

- sharp-tipped metal surgical scissors
- metal anatomical tweezers



 omegapack

# surgical sets

Surgical sets are medical devices personalized according to customer needs, dedicated to a selected medical procedure.



# components of the Set

Operating theatre is a specific environment where time is the most valuable factor influencing the success of the operation. It is a place where every minute - or even a second - counts, because it can affect the patient's life. To meet the expectations of medicine, ZARYS introduces operating sets to its offer that meet the highest standards, helping to improve the preparation of the operating theatre before the procedure





# advantages of using surgical sets



## QUALITY

properly selected composition of the set according to individual needs for a specific medical procedure in line with the Customer's order



## EPIDEMIOLOGICAL SAFETY

reduced risk of patient infection by minimizing the time of contact of medical staff with devices during the preparation of the theatre and the patient



## STANDARDIZATION OF PROCEDURES

correct and schematic conduct during the procedure  
**one package - one treatment**



## EASY RECORD KEEPING

optimization of record keeping - one self-adhesive label with the identification of the used set, instead of each used product separately



## REDUCTION OF ERRORS

the complete set contains all disposable medical devices necessary for the surgical operation, which eliminates the possibility of errors during the selection of individual products



## WIDE RANGE OF PRODUCTS

a wide range of medical devices selected individually in accordance with the Customer's preferences



## SAVING THE STOCKS

reduced number of supplies, saving space in the warehouse



## TIME

unpacking the set and preparing the operating theatre takes about

**30%**

less time than selecting individual products and improving work at operating block



## REDUCING COST



## EFFECTIVENESS

increasing work productivity, so that you can perform more surgical procedures in one day, improvement of work of medical staff



## ENVIRONMENT

the amount of generated waste is reduced to a minimum

**- one packaging**



# complete your set own



**STEP 1:** specialized drape as a key component of each surgical set

**STEP 2: other components necessary for a given procedure, such as: dressing materials, disposable equipment, surgical gowns, disposable tools, containers and others**

Medical devices under the omegapack brand by ZARYS are operating sets containing complete equipment with all disposable products necessary to perform a given medical procedure to which the set is dedicated. The operating set contains carefully selected disposable components, such as:

- surgical drapes, pads
- accessories, e.g. fluid collection bags, tapes
- surgical gowns
- surgical gloves
- covers for equipment
- shoe covers, masks, caps
- gauze balls
- gauze and non-woven swabs
- bandages, dressings
- catheters, urine collection bags
- trays, bowls
- taps, three-way stopcocks
- manifolds, connectors
- infusion sets
- suction sets
- disposable surgical instruments
- injection needles and syringes
- disposable electrostimulation electrodes and accessories and many more.



personal protective  
**equipment**



# PROTECTIVE COVERALL SAFE+ AGAINST CHEMICAL AND INFECTIVE AGENTS TYPE 4b - 5b - 6b

Personal protective equipments (PPE) are products that protect against one or more risks to the user's health or safety. These products must comply with Regulation (EU) 2016/425 of the European Parliament and of the Council. PPE is classified into three categories according to the degree of risk.

**The coverall is a PPE category III in accordance with the Regulation (EU) 2016/425 of the European Parliament and of the Council**



The category III covers products of complex construction, intended to protect health or life against risks that may cause death or irreversible damage to health.

### Standards:



Coverall is personal protective equipment of category III in conformity with Regulation (EU) 2016/425 of the European Parliament and of the Council

EN ISO 13688:2013 Protective clothing. General requirements



EN 14605:2005  
+A1:2009

EN 14605:2005+A1:2009 Protective clothing against liquid chemicals. Performance requirements for clothing with liquid-tight (Type 3) or spray-tight (Type 4) connections, including items providing protection to parts of the body only (Types PB [3] and PB [4])



EN ISO 13982-1:2004  
+A1:2010

EN ISO 13982-1:2004+A1:2010 Protective clothing for use against solid particulates. Part 1: Performance requirements for chemical protective clothing providing protection to the full body against airborne solid particulates (type 5 clothing)



EN 13034:2005  
+A1:2009

EN 13034:2005+A1:2009 Protective clothing against liquid chemicals. Performance requirements for chemical protective clothing offering limited protective performance against liquid chemicals (Type 6 and Type PB [6] equipment)



EN 1073-2:2002

EN 1073-2:2002 Protective clothing against radioactive contamination. Part 2: Requirements and test methods for non-ventilated protective clothing against particulate radioactive contamination



EN 14126:2003  
+AC:2004

EN 14126:2003 + AC:2004 Protective clothing. Performance requirements and tests methods for protective clothing against infective agents

- class 6 Resistance to penetration of contaminated liquids under the influence of hydrostatic pressure
- class 6 Resistance to penetration by infective agents due to mechanical contact with substances
- class 3 Resistance to penetration of contaminated liquid aerosols
- class 3 Resistance to penetration of contaminated solid particles



EN 1149-5:2018

EN 1149-5:2018 Protective clothing. Electrostatic properties. Part 5: Material performance and design requirements

EN 14325:2004 Protective clothing against chemicals. Test methods and performance classification of chemical protective clothing materials, seams, joins and assemblages

### features:

- made of a laminate (non-woven polypropylene and polyethylene) with a weight of 63 g/m<sup>2</sup>
- polyester seams additionally covered with tape
- equipped with a hood with elastic trim
- equipped with an elastic waist band, wrists and ankles
- zipper covered with a self-adhesive flap
- available in version with boots



REF	size	version	packaging unit
BS-KCB02-S	S	without boots	1 pc.
BS-KCB02-M	M	without boots	1 pc.
BS-KCB02-L	L	without boots	1 pc.
BS-KCB02-XL	XL	without boots	1 pc.
BS-KCB02-XXL	XXL	without boots	1 pc.
BS-KCB02-XXXL	XXXL	without boots	1 pc.
*BS-KCB02-B-S	S	with boots	1 pc.
*BS-KCB02-B-M	M	with boots	1 pc.
*BS-KCB02-B-L	L	with boots	1 pc.
*BS-KCB02-B-XL	XL	with boots	1 pc.
*BS-KCB02-B-XXL	XXL	with boots	1 pc.
*BS-KCB02-B-XXXL	XXXL	with boots	1 pc.



\* available on request





*a* ALPHAtex

surgical  
**sets, drapes,  
gowns**

surgical drapes | surgical covers and accessories  
| surgical sets | surgical gowns





# surgical drapes and gowns













Surgical drapes are used to ensure microbiological cleanliness of the working area during surgery and to reduce the risk of bacterial flora migration from the patient's skin to the wound. They are also used to control the spread of bodily fluids.

Surgical gowns are an essential protective barrier. They prevent the transmission of infectious agents from the medical staff to the patient. They reduce the risk of spreading desquamated skin particles in the air in the operating room.

The ALPHAtex brand and its wide range of solutions are the result of over thirty years of ZARYS's presence in the medical market.

Sharing our experience and knowledge, we are confident that the use of ALPHAtex products ensures comfort, safety, and economic efficiency in daily work in operating theaters.

## materials legend

- |   |  |   |               |
|---|--|---|---------------|
|  | 2-ply surgical drape with non-woven (PP+PE)  |  | polypropylene |
|  | table cover                                  |  | neoprene      |
|  | SMS surgical drape                           |  | adhesive tape |
|  | 2-ply surgical drape with spunlace non-woven |  | PE foil       |
|  | Mayo stand cover red                         |  | PE foil blue  |
|  | Mayo stand cover blue                        |  | incise film   |
|  | reinforcement in the critical area           |   |               |

# comprehensive operating room protection

ALPHAtex surgical gowns



ALPHAtex medical equipment covers



disposable instruments



dressing materials



individual **omegapack** and **deltaset** kits





The operating room is the heart of every hospital, where hundreds or even thousands of surgical procedures are performed, during which the skin is opened and incised. This can lead to infections or contamination of the surgical site, which is why maintaining the highest level of safety in operating rooms is crucial.

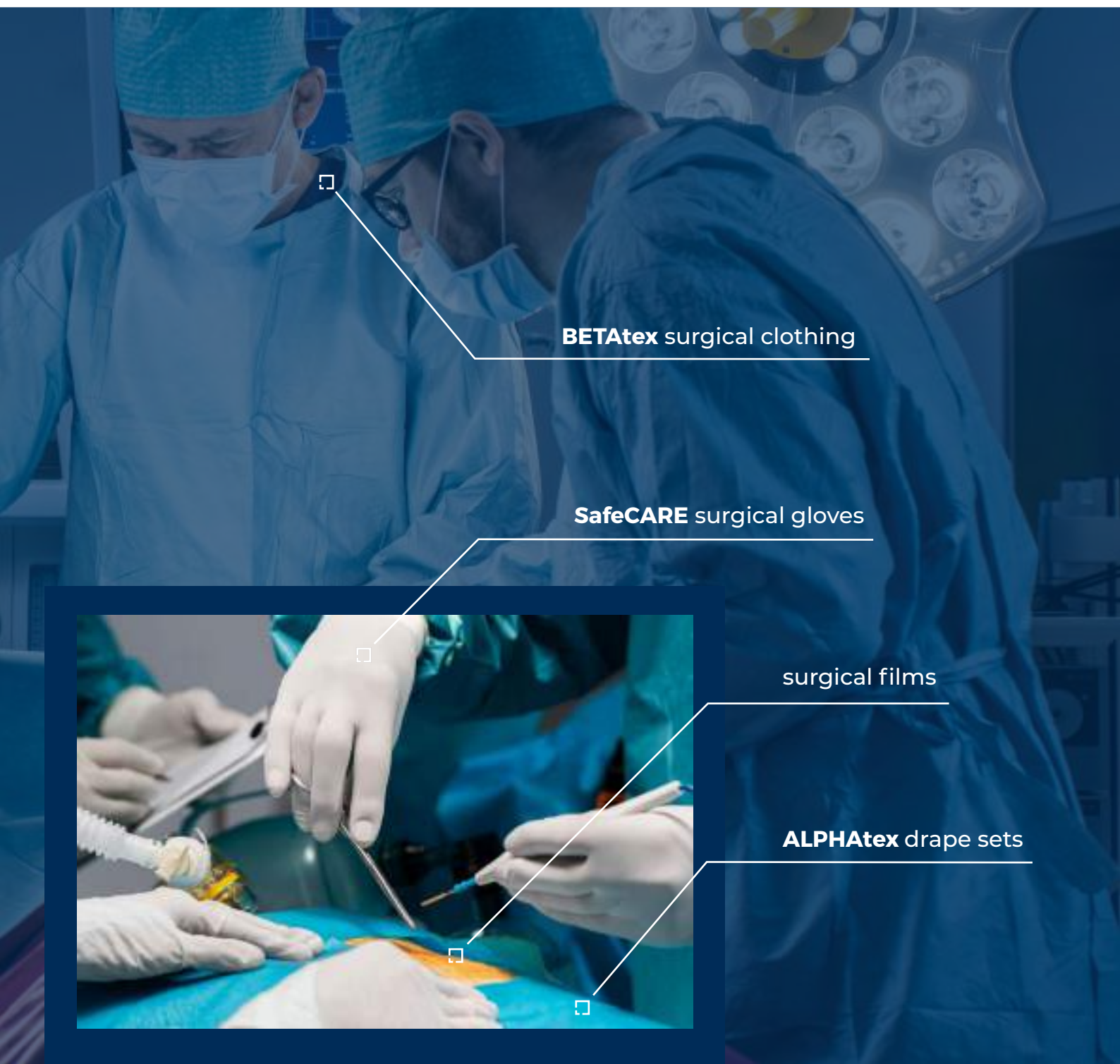

**BETAtex** surgical clothing

**SafeCARE** surgical gloves

surgical films

**ALPHAtex** drape sets



# communication packaging



We use two types of individual packaging: paper-foil type and durable Header Bag with a TYVEC insert that allows sterilization processes. All contain a label with the product name, its graphic representation, and informative pictograms. Additionally, they are equipped with self-adhesive TAG labels for data archiving and information on the opening direction.

# double packaging system



ALPHAtex product packaging is made according to the highest quality standards. The solutions used allow the user to easily open and safely remove the sterile product needed for the procedure.

Our medical product packaging is designed with safety, hygiene, and contamination protection in mind.



For ALPHAtex surgical drapes, ZARYS International Group uses a double packaging system involving the use of foil bags or smaller cardboard boxes and additional external protection in the form of a corrugated cardboard carton. This is to maintain the sterility of products delivered to the operating theater at every stage of transport.

# product lines: surgical field drape system

## STANDARD S

- Procedures with standard or slightly increased fluid levels
- 2-layer material
- Barrier against microorganism penetration
- Absorbent and waterproof material over the entire surface
- Tensile and puncture strength
- Paper-foil packaging
- 4 self-adhesive TAG labels

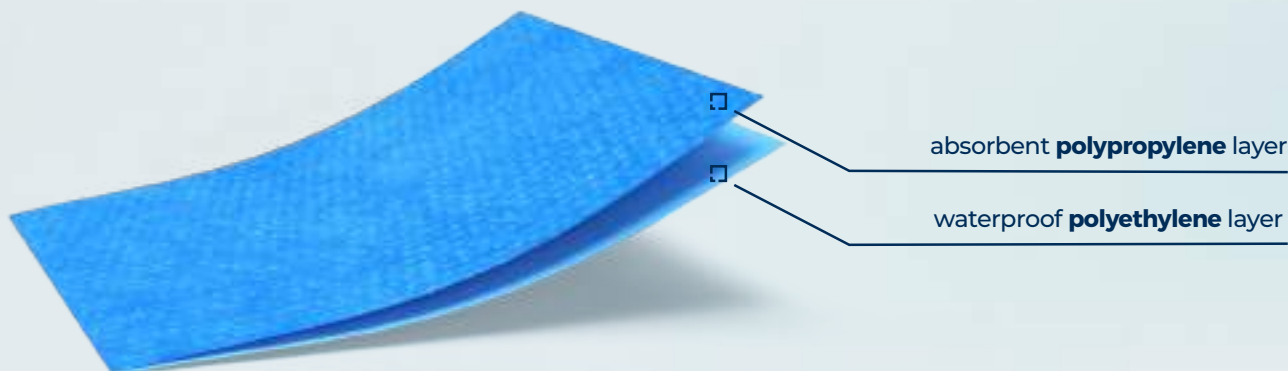

**STANDARD+ S+**

- Procedures with high fluid levels
- 2-layer material with reinforcement
- Barrier against microorganism penetration
- Absorbent and waterproof material over the entire surface
- Additional highly absorbent reinforcement in the critical zone
- Increased tensile and puncture strength
- Paper-foil packaging
- 4 self-adhesive TAG labels

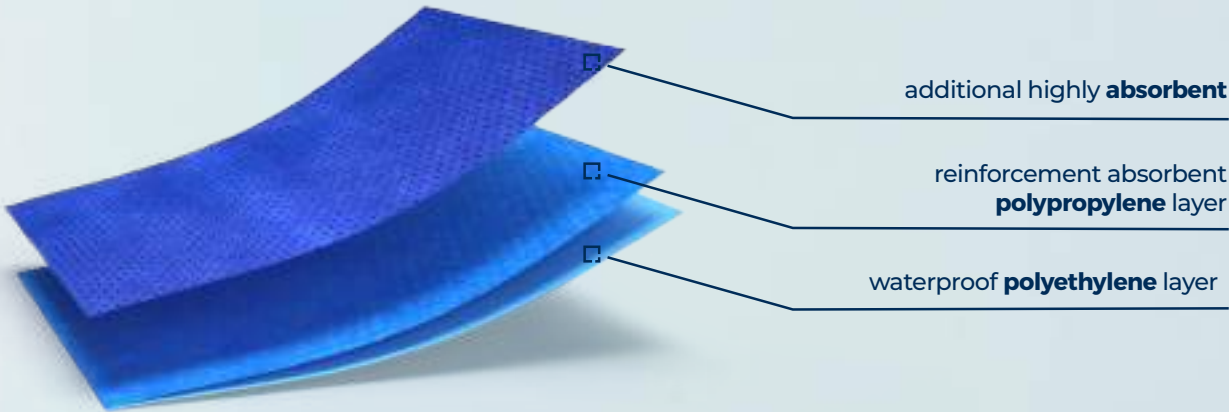

**COMFORT C**

- Procedures with very high fluid levels
- 3-layer material with reinforcement
- Barrier against microorganism penetration
- Absorbent and waterproof material over the entire surface
- Additional highly absorbent reinforcement in the critical zone
- Increased tensile and puncture strength
- Flexible material adapting to body shape
- Paper-foil packaging
- 4 self-adhesive TAG labels

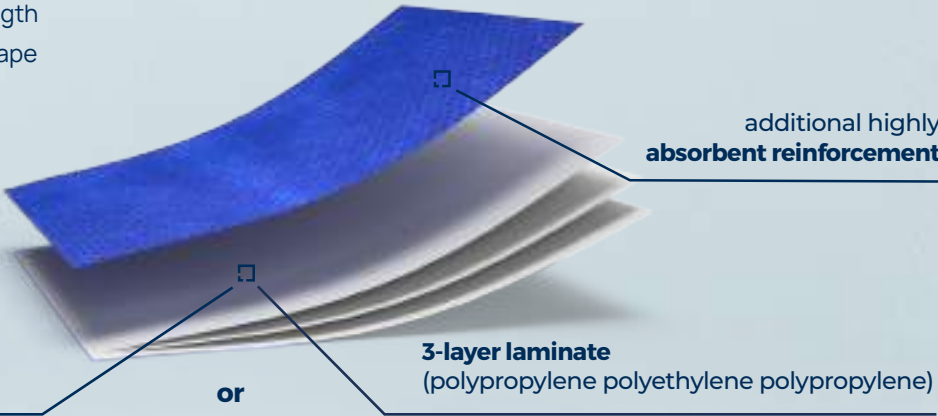

# ZARYS



WWW.ZARYS.COM

## BASIC TYPES OF MATERIALS USED IN SURGICAL DRAPES:

**PF DRAPE** - two layer material of the drape containing absorbency layer of cellulose on top and PE foil layer of the drape on back

**NF, NFA, NFF, NFFA, NFFAR DRAPE** - two layer material of the drape containing absorbency layer of non-woven material on top and PE foil layer on back of the drape

**NFN, NFNA, NFNF, NFNFA DRAPE** - three layer material on the drape containing absorbency non-woven layer on top, PE foil layer in the middle and non-woven absorbency layer on the back of the drape

# SURGICAL DRAPES



## SURGICAL DRAPES 2-LAYER DRAPES

### STERILE DRAPES WITH CELLULOSE LAYER - 2-LAYERED

REF	dimensions	packaging unit	bulk packaging
AT-PF-S 1	50cm x 50cm	1 pc.	4 x 125 pcs
AT-PF-S 3	50cm x 70cm	1 pc.	4 x 100 pcs
AT-PF-S 5	80cm x 80cm	1 pc.	4 x 50 pcs
AT-PF-S 6	75cm x 90cm	1 pc.	4 x 50 pcs
AT-PF-S 8	90cm x 150cm	1 pc.	2 x 50 pcs



54 g/m<sup>2</sup>



### STERILE SURGICAL DRAPES - 2-LAYERED

REF	dimensions	packaging unit	bulk packaging
AT-NF-S 1 E	45cm x 45cm	100 pcs	4 x 100 pcs
AT-NF-S 3 E	45cm x 60cm	100 pcs	4 x 100 pcs
AT-NF-S 4 E	45cm x 75cm	100 pcs	4 x 100 pcs
AT-NF-S 5 E	75cm x 75cm	50 pcs	4 x 50 pcs
AT-NF-S 9 E	75cm x 90cm	50 pcs	4 x 50 pcs
AT-NF-S 13 E	100cm x 150cm	50 pcs	4 x 50 pcs
AT-NF-S 15 E	150cm x 180cm	20 pcs	4 x 20 pcs
AT-NF-S 21 E	37cm x 45cm	100 pcs	4 x 100 pcs



economic version

40 g/m<sup>2</sup>



### STERILE SURGICAL DRAPES - 2-LAYERED

REF	dimensions	packaging unit	bulk packaging
AT-NF-S 1	45cm x 45cm	1 pc.	4 x 120 pcs
AT-NF-S 2	50cm x 50cm	1 pc.	4 x 100 pcs
AT-NF-S 3	50cm x 60cm	1 pc.	4 x 100 pcs
AT-NF-S 4	50cm x 75cm	1 pc.	4 x 80 pcs
AT-NF-S 5	75cm x 75cm	1 pc.	6 x 50 pcs
AT-NF-S 8	80cm x 90cm	1 pc.	6 x 50 pcs
AT-NF-S 9	75cm x 90cm	1 pc.	6 x 50 pcs
AT-NF-S 10	90cm x 120cm	1 pc.	4 x 40 pcs
AT-NF-S 12	75cm x 140cm	1 pc.	2 x 50 pcs
AT-NF-S 13	100cm x 150cm	1 pc.	4 x 25 pcs
AT-NF-S 14	120cm x 150cm	1 pc.	4 x 25 pcs
AT-NF-S 15	150cm x 180cm	1 pc.	2 x 20 pcs
AT-NF-S 16	150cm x 200cm	1 pc.	2 x 20 pcs
AT-NF-S 19	160cm x 220cm	1 pc.	2 x 20 pcs
AT-NF-S 20	150cm x 240cm	1 pc.	2 x 20 pcs
AT-NF-S 22	170cm x 300cm	1 pc.	2 x 20 pcs



60 g/m<sup>2</sup>



### STERILE SURGICAL DRAPES WITH ADHESIVE EDGE - 2-LAYERED

REF	dimensions	packaging unit	bulk packaging
AT-NFA-S 4 E	45cm x 75cm	100 pcs	8 x 50 pcs
AT-NFA-S 9 E	75cm x 90cm	50 pcs	4 x 50 pcs
AT-NFA-S 10 E	90cm x 120cm	50 pcs	4 x 50 pcs
AT-NFA-S 13 E	100cm x 150cm	50 pcs	4 x 25 pcs
AT-NFA-S 15 E	150cm x 180cm	20 pcs	4 x 20 pcs
AT-NFA-S 16 E	150cm x 200cm	20 pcs	4 x 20 pcs
AT-NFA-S 20 E	150cm x 240cm	20 pcs	4 x 20 pcs



adhesive tape on the longer side of drape

economic version

40 g/m<sup>2</sup>



## STERILE SURGICAL DRAPES WITH ADHESIVE EDGE - 2-LAYERED

REF	dimensions	packaging unit	 bulk packaging
AT-NFA-S 1	45cm x 45cm	1 pc.	8 x 60 pcs
AT-NFA-S 3	50cm x 60cm	1 pc.	4 x 50 pcs
AT-NFA-S 4	50cm x 75cm	1 pc.	6 x 70 pcs
AT-NFA-S 5	75cm x 75cm	1 pc.	6 x 45 pcs
AT-NFA-S 9	75cm x 90cm	1 pc.	4 x 50 pcs
AT-NFA-S 10	90cm x 120cm	1 pc.	4 x 50 pcs
AT-NFA-S 13	100cm x 150cm	1 pc.	4 x 25 pcs
AT-NFA-S 15	150cm x 180cm	1 pc.	2 x 20 pcs
AT-NFA-S 16	150cm x 200cm	1 pc.	2 x 20 pcs
AT-NFA-S 20	150cm x 240cm	1 pc.	2 x 20 pcs
AT-NFA-S 22	170cm x 300cm	1 pc.	2 x 20 pcs

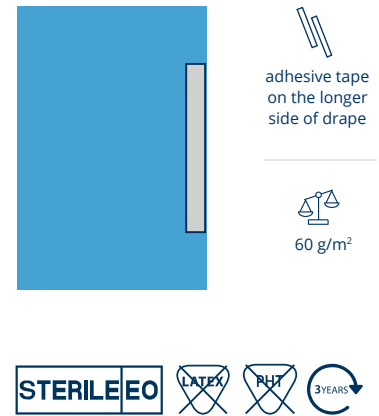

## STERILE SURGICAL DRAPES WITH CENTRAL FENESTRATION - 2-LAYERED

REF	dimensions	fenestration	packaging unit	 bulk packaging
AT-NFF-S 2 E	45cm x 75cm	6cm x 8cm	100 pcs	8 x 50 pcs
AT-NFF-S 3 E	45cm x 60cm	ø 6cm	100 pcs	4 x 100 pcs
AT-NFF-S 4 E	75cm x 90cm	ø 7cm	50 pcs	4 x 50 pcs
AT-NFF-S 5 E	75cm x 90cm	6cm x 8cm	50 pcs	4 x 50 pcs

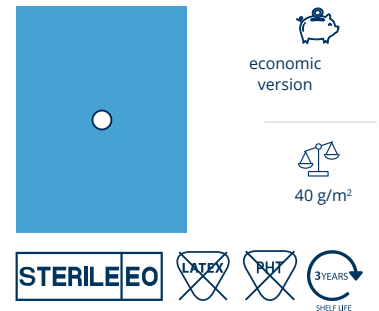

## STERILE SURGICAL DRAPES WITH CENTRAL FENESTRATION - 2-LAYERED

REF	dimensions	fenestration	packaging unit	 bulk packaging
AT-NFF-S 1	45cm x 45cm	ø 6cm	1 pc.	4 x 100 pcs
AT-NFF-S 2	50cm x 75cm	6cm x 8cm	1 pc.	4 x 60 pcs
AT-NFF-S 3	50cm x 75cm	ø 7cm	1 pc.	4 x 60 pcs
AT-NFF-S 4	75cm x 90cm	ø 7cm	1 pc.	4 x 60 pcs
AT-NFF-S 5	75cm x 90cm	6cm x 8cm	1 pc.	4 x 60 pcs
AT-NFF-S 21	50cm x 60cm	ø 7cm	1 pc.	6 x 100 pcs

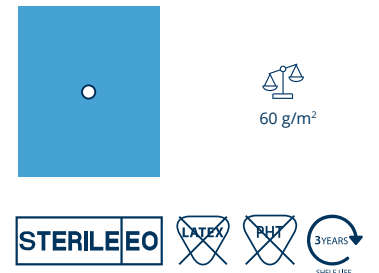

## STERILE SURGICAL DRAPES WITH ADHESIVE CENTRAL FENESTRATION - 2-LAYERED

REF	dimensions	fenestration	packaging unit	 bulk packaging
AT-NFFA-S 1 E	45cm x 45cm	ø 5cm	100 pcs	4 x 100 pcs
AT-NFFA-S 2 E	45cm x 75cm	6cm x 8cm	100 pcs	4 x 60 pcs
AT-NFFA-S 3 E	50cm x 60cm	ø 6cm	100 pcs	4 x 60 pcs
AT-NFFA-S 4 E	75cm x 90cm	ø 7cm	50 pcs	4 x 50 pcs
AT-NFFA-S 5 E	75cm x 90cm	6cm x 8cm	50 pcs	4 x 50 pcs
AT-NFFA-S 6 E	90cm x 120cm	ø 8cm	50 pcs	4 x 30 pcs

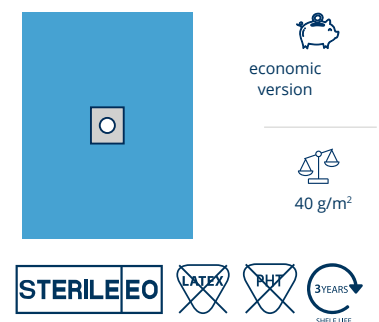

## STERILE SURGICAL DRAPES WITH ADHESIVE CENTRAL FENESTRATION - 2-LAYERED

REF	dimensions	fenestration	packaging unit	 bulk packaging
AT-NFFA-S 1	45cm x 45cm	ø 6cm	1 pc.	4 x 100 pcs
AT-NFFA-S 2	50cm x 75cm	6cm x 8cm	1 pc.	4 x 60 pcs
AT-NFFA-S 3	50cm x 75cm	ø 7cm	1 pc.	4 x 60 pcs
AT-NFFA-S 4	75cm x 90cm	ø 7cm	1 pc.	4 x 50 pcs
AT-NFFA-S 5	75cm x 90cm	6cm x 8cm	1 pc.	4 x 50 pcs
AT-NFFA-S 6	90cm x 120cm	ø 10cm	1 pc.	4 x 30 pcs
AT-NFFA-S 7	120cm x 150cm	ø 7cm	1 pc.	4 x 25 pcs
AT-NFFA-S 8	120cm x 150cm	ø 10cm	1 pc.	4 x 25 pcs
AT-NFFA-S 11	50cm x 60cm	6cm x 8cm	1 pc.	8 x 50 pcs

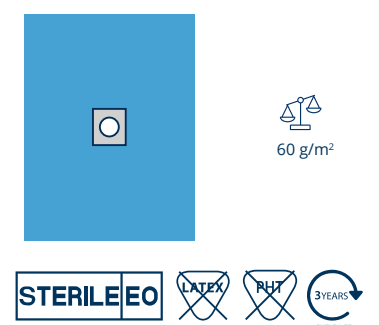



## STERILE SURGICAL DRAPES WITH ADHESIVE CENTRAL ADJUSTABLE FENESTRATION - 2-LAYERED

REF	dimensions	fenestration	packaging unit	 bulk packaging
AT-NFFAR-S 2 E	45cm x 75cm	6cm x 8cm	100 pcs	6 x 50 pcs
AT-NFFAR-S 4 E	75cm x 90cm	ø 7cm	50 pcs	4 x 45 pcs

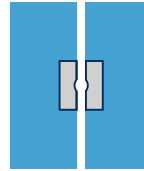

 economic version

 40 g/m<sup>2</sup>



## STERILE SURGICAL DRAPES WITH ADHESIVE CENTRAL ADJUSTABLE FENESTRATION - 2-LAYERED

REF	dimensions	fenestration	packaging unit	 bulk packaging
AT-NFFAR-S 2	45cm x 75cm	6cm x 8cm	1 pc.	6 x 50 pcs
AT-NFFAR-S 4	75cm x 90cm	ø 7cm	1 pc.	4 x 45 pcs



 60 g/m<sup>2</sup>



## STERILE ADHESIVE EPIDURAL DRAPES - 2-LAYERED

NEW

REF	dimensions	fenestration	packaging unit	 bulk packaging
AT-NFZRS-S 1	75cm x 80cm	6cm x 15cm	1 pc.	4 x 30 pcs
AT-NFZRS-S 2	60cm x 75cm	6cm x 9,5cm	1 pc.	8 x 30 pcs
AT-NFZRS-S 11	75cm x 90cm	10cm x 15cm	1 pc.	4 x 30 pcs

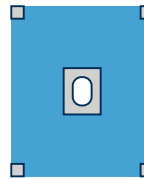

 60 g/m<sup>2</sup>



indication: epidural anesthesia

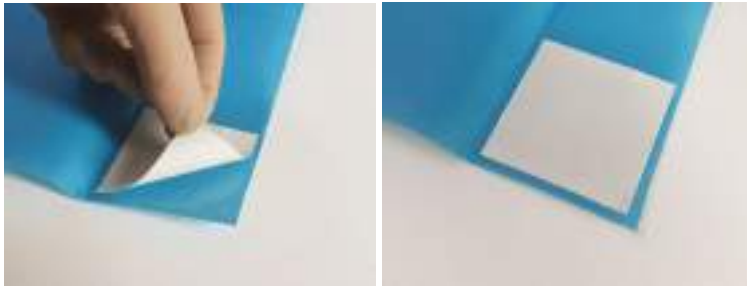

adhesive tape in the corners of drape

## STERILE INSTRUMENT TABLE COVERS

REF	dimensions	packaging unit	 bulk packaging
AT-SD-S 3	100cm x 150cm	1 pc.	2 x 50 pcs
AT-SD-S 4	150cm x 190cm	1 pc.	2 x 30 pcs
AT-SD-S 5	150cm x 260cm	1 pc.	50 pcs

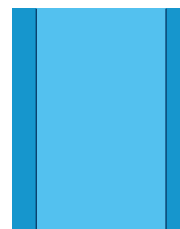

 77 g/m<sup>2</sup>





## SURGICAL DRAPES 3-LAYER DRAPES

### STERILE SURGICAL DRAPES - 3-LAYERED

REF	dimensions	packaging unit	 bulk packaging
AT-NFN-S 1	45cm x 45cm	1 pc.	300 pcs
AT-NFN-S 2	50cm x 50cm	1 pc.	300 pcs
AT-NFN-S 3	50cm x 60cm	1 pc.	150 pcs
AT-NFN-S 4	50cm x 70cm	1 pc.	160 pcs
AT-NFN-S 5	75cm x 75cm	1 pc.	100 pcs
AT-NFN-S 8	80cm x 90cm	1 pc.	80 pcs
AT-NFN-S 9	75cm x 90cm	1 pc.	80 pcs
AT-NFN-S 10	90cm x 120cm	1 pc.	75 pcs
AT-NFN-S 13	100cm x 150cm	1 pc.	50 pcs
AT-NFN-S 14	120cm x 150cm	1 pc.	50 pcs
AT-NFN-S 15	150cm x 180cm	1 pc.	50 pcs
AT-NFN-S 16	150cm x 210cm	1 pc.	25 pcs
AT-NFN-S 19	160cm x 220cm	1 pc.	25 pcs
AT-NFN-S 20	150cm x 240cm	1 pc.	25 pcs



75 g/m<sup>2</sup>

**STERILE R**



### STERILE SURGICAL DRAPES WITH ADHESIVE EDGE - 3-LAYERED

REF	dimensions	packaging unit	 bulk packaging
AT-NFNA-S 2	50cm x 50cm	1 pc.	256 pcs
AT-NFNA-S 4	50cm x 70cm	1 pc.	160 pcs
AT-NFNA-S 5	75cm x 75cm	1 pc.	100 pcs
AT-NFNA-S 8	80cm x 90cm	1 pc.	80 pcs
AT-NFNA-S 9	75cm x 90cm	1 pc.	90 pcs
AT-NFNA-S 13	100cm x 150cm	1 pc.	80 pcs
AT-NFNA-S 15	150cm x 180cm	1 pc.	25 pcs
AT-NFNA-S 16	150cm x 210cm	1 pc.	50 pcs
AT-NFNA-S 19	160cm x 220cm	1 pc.	25 pcs
AT-NFNA-S 20	150cm x 240cm	1 pc.	25 pcs



adhesive tape  
on the longer  
side of drape



75 g/m<sup>2</sup>

**STERILE R**



### STERILE SURGICAL DRAPES WITH CENTRAL FENESTRATION - 3-LAYERED

REF	dimensions	fenestration	packaging unit	 bulk packaging
AT-NFNF-S 1	45cm x 45cm	ø 6cm	1 pc.	300 pcs
AT-NFNF-S 2	50cm x 75cm	6cm x 8cm	1 pc.	160 pcs
AT-NFNF-S 3	50cm x 75cm	ø 7cm	1 pc.	200 pcs
AT-NFNF-S 4	75cm x 90cm	ø 7cm	1 pc.	80 pcs
AT-NFNF-S 5	75cm x 90cm	6cm x 8cm	1 pc.	80 pcs
AT-NFNF-S 6	90cm x 120cm	ø 10cm	1 pc.	100 pcs

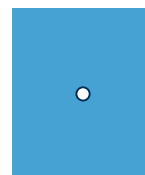

75 g/m<sup>2</sup>

**STERILE R**



## STERILE SURGICAL DRAPES WITH ADHESIVE CENTRAL FENESTRATION - 3-LAYERED

REF	dimensions	fenestration	packaging unit	 bulk packaging
AT-NFNFA-S 2	50cm x 75cm	6cm x 8cm	1 pc.	200 pcs
AT-NFNFA-S 3	50cm x 75cm	ø 7cm	1 pc.	100 pcs
AT-NFNFA-S 4	75cm x 90cm	ø 7cm	1 pc.	100 pcs
AT-NFNFA-S 5	75cm x 90cm	6cm x 8cm	1 pc.	100 pcs
AT-NFNFA-S 6	90cm x 120cm	ø 10cm	1 pc.	63 pcs



75 g/m<sup>2</sup>

**STERILE R**

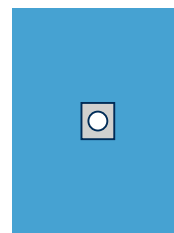

## STERILE SURGICAL DRAPES WITH ADHESIVE FENESTRATION, REINFORCED

REF	dimensions	fenestration	packaging unit	 bulk packaging
AT-NFZRF-S 1	120cm x 170cm	ø 12cm	1 pc.	50 pcs
AT-NFZRF-S 2	200cm x 280cm	ø 10cm	1 pc.	20 pcs
AT-NFZRF-S 3	200cm x 320cm	ø 15cm	1 pc.	20 pcs



50 g/m<sup>2</sup>



hydrophobic  
SMS material



highly absorbent  
material

**STERILE R**

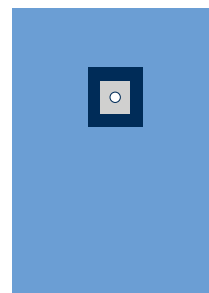



# SURGICAL DRAPES SPECIALISTIC DRAPES



## GENERAL SURGERY

AT-SD-ABD1-IF-C

### ABDOMINAL DRAPE 1-IF



REF	dimensions	quantity	component
AT-SD-ABD1-IF-C	200cm x 320cm	1 pc.	drape with adhesive fenestration 25cm x 30cm filled with an incise film, reinforced
AT-SD-S 4	150cm x 190cm	1 pc.	instrument table cover, reinforced

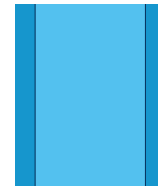

150x190cm

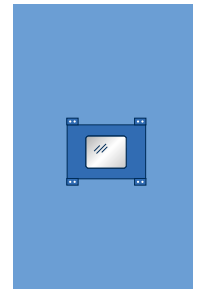

200x320cm



bulk packaging:  
20 pcs

**STERILE R**



AT-SD-ABPER1-S

### ABDO-PERINEAL DRAPE 1



REF	dimensions	quantity	component
AT-SD-ABPER1-S	180/280cm x 220cm	1 pc.	drape integrated with limb covers, adhesive trapezium-shaped fenestration 30cm x 20cm x 20cm and perineal fenestration 10cm x 15cm with covering flap
AT-SD-S 4	150cm x 190cm	1 pc.	instrument table cover, reinforced

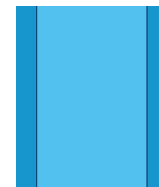

150x190cm

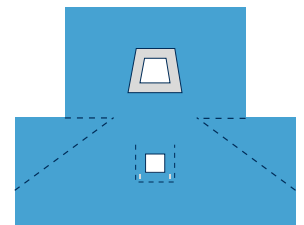

180/280x220cm



bulk packaging:  
16 pcs

**STERILE R**



AT-SD-LAP3-SP

### LAPAROSCOPY DRAPE 3



REF	dimensions	quantity	component
AT-SD-LAP3-SP	200/270cm x 300cm	1 pc.	drape integrated with limb covers, adhesive fenestration 25cm x 30cm, reinforced, with 8 cable holders Velcro type
AT-SD-S 4	150cm x 190cm	1 pc.	instrument table cover, reinforced

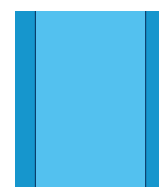

150x190cm

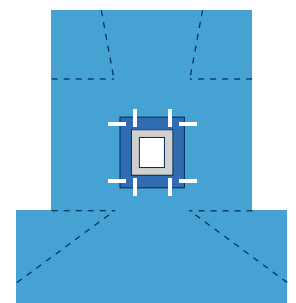

200/270x300cm



bulk packaging:  
12 pcs

**STERILE R**





## AT-SD-ORT1-SP

### ORTHOPAEDIC DRAPE 1



REF	dimensions	quantity	component
AT-SD-ORT1-SP	150cm x 250cm	1 pc.	drape with adhesive U-split 7cm x 70cm, reinforced
AT-SD-S 4	150cm x 190cm	1 pc.	instrument table cover, reinforced

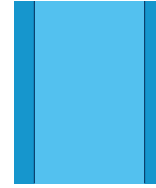

150x190cm

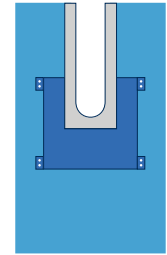

150x250cm



bulk packaging:  
20 pcs

**STERILE R**



## AT-SD-ORT2-SP

### ORTHOPAEDIC DRAPE 2



REF	dimensions	quantity	component
AT-SD-ORT2-SP	230cm x 260cm	1 pc.	drape with adhesive U-split 20cm x 100cm, reinforced
AT-SD-S 4	150cm x 190cm	1 pc.	instrument table cover, reinforced

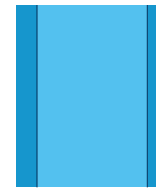

150x190cm

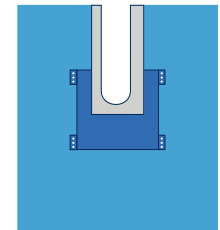

230x260cm



bulk packaging:  
16 pcs

**STERILE R**



## AT-SD-ORT3-C

### ORTHOPAEDIC DRAPE 3



REF	dimensions	quantity	component
AT-SD-ORT3-C	150cm x 200cm	1 pc.	drape with adhesive U-split 6cm x 65cm, reinforced
AT-SD-S 4	150cm x 190cm	1 pc.	instrument table cover, reinforced

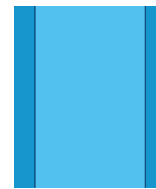

150x190cm

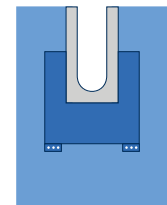

150x200cm



bulk packaging:  
20 pcs

**STERILE R**



## AT-SD-ORT4-C

### ORTHOPAEDIC DRAPE 4



REF	dimensions	quantity	component
AT-SD-ORT4-C	200cm x 260cm	1 pc.	drape with adhesive U-split 8.5cm x 85cm, reinforced
AT-SD-S 4	150cm x 190cm	1 pc.	instrument table cover, reinforced

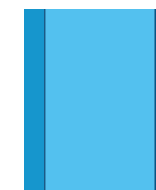

150x190cm

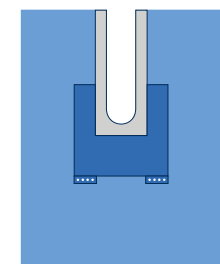

200x260cm



bulk packaging:  
15 pcs

**STERILE R**



AT-SD-EXT1-SP

**EXTREMITY DRAPE 1**



REF	dimensions	quantity	component
AT-SD-EXT1-SP	150cm x 180cm	1 pc.	drape with elastic fenestration ø 3,5cm, reinforced
AT-SD-S 4	150cm x 190cm	1 pc.	instrument table cover, reinforced

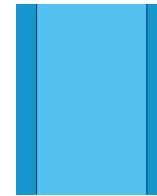

150x190cm

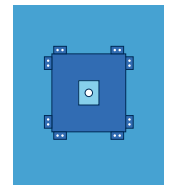

150x180cm

bulk packaging:  
24 pcs

**STERILE R**



AT-SD-EXT2-SP

**EXTREMITY DRAPE 2**



REF	dimensions	quantity	component
AT-SD-EXT2-SP	230cm x 300cm	1 pc.	drape with elastic fenestration ø 3,5cm, reinforced
AT-SD-S 4	150cm x 190cm	1 pc.	instrument table cover, reinforced

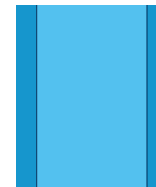

150x190cm

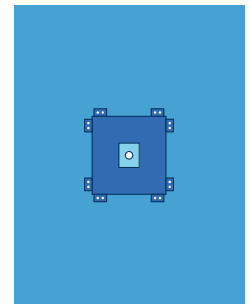

230x300cm

bulk packaging:  
18 pcs

**STERILE R**



AT-SD-EXT3-SP

**EXTREMITY DRAPE 3**



REF	dimensions	quantity	component
AT-SD-EXT3-SP	230cm x 300cm	1 pc.	drape with elastic fenestration ø 7cm, reinforced
AT-SD-S 4	150cm x 190cm	1 pc.	instrument table cover, reinforced

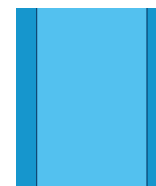

150x190cm

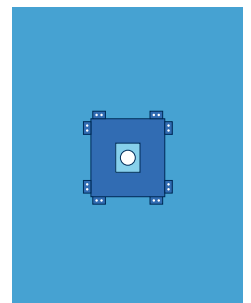

230x300cm

bulk packaging:  
18 pcs

**STERILE R**



AT-SD-EXT4-C

**EXTREMITY DRAPE 4**



REF	dimensions	quantity	component
AT-SD-EXT4-C	200cm x 320cm	1 pc.	drape with elastic fenestration 6cm x 8cm, reinforced
AT-SD-S 4	150cm x 190cm	1 pc.	instrument table cover, reinforced

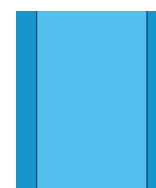

150x190cm

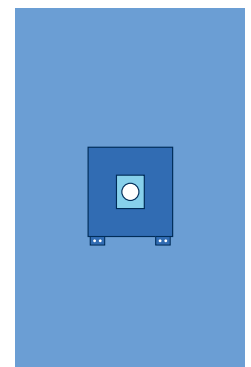

200x320cm

bulk packaging:  
15 pcs

**STERILE R**



AT-SD-EXT5-C

**EXTREMITY DRAPE 5**



REF	dimensions	quantity	component
AT-SD-EXT5-C	200cm x 300cm	1 pc.	drape with elastic fenestration ø 3,5cm, reinforced
AT-SD-S 4	150cm x 190cm	1 pc.	instrument table cover, reinforced

bulk packaging:  
20 pcs

**STERILE R**

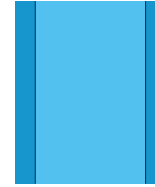

150x190cm

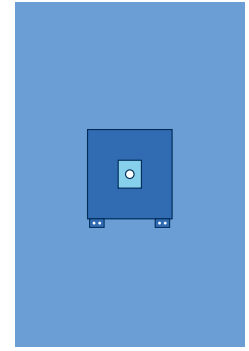

200x300cm



**GYNAECOLOGY AND UROLOGY**

AT-SD-GYN1-S

**GYNAECOLOGY DRAPE 1**



REF	dimensions	quantity	component
AT-SD-GYN1-S	160/240cm x 180cm	1 pc.	drape integrated with limb covers, adhesive perineal fenestration 10cm x 15cm
AT-SD-S 4	150cm x 190cm	1 pc.	instrument table cover, reinforced

bulk packaging:  
16 pcs

**STERILE R**

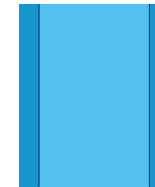

150x190cm

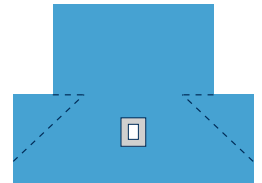

160/240x180cm

AT-SD-GYN2-S

**GYNAECOLOGY DRAPE 2**



REF	dimensions	quantity	component
AT-SD-GYN2-S	160/240cm x 180cm	1 pc.	drape integrated with limb covers, adhesive perineal fenestration 10cm x 15cm, integrated fluid collection pouch 35cm x 50cm with formable molder, filter and tubing port
AT-SD-S 4	150cm x 190cm	1 pc.	instrument table cover, reinforced

bulk packaging:  
8 pcs

**STERILE R**



150x190cm

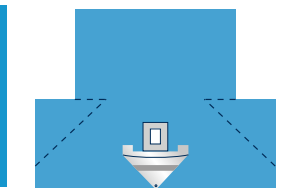

160/240x180cm

AT-SD-DEL1-SP

**DELIVERY DRAPE 1**



REF	dimensions	quantity	component
AT-SD-DEL1-SP	114cm x 150cm	1 pc.	delivery drape integrated with fluid collection pouch 78cm x 80cm with formable molder, filter and tubing port, reinforced

bulk packaging:  
45 pcs

without  
instrument table  
cover wrapping

**STERILE R**

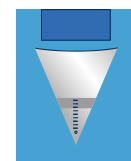

114x150cm



## OPHTHALMOLOGY

### AT-SD-OPHT1-IF-S OPTHALMIC DRAPE 1-IF



REF	dimensions	quantity	component
AT-SD-OPHT1-IF-S	100cm x 100cm	1 pc.	ophthalmic drape with fenestration 10cm x 10cm filled with an incise film
AT-SD-S 3	100cm x 150cm	1 pc.	instrument table cover, reinforced

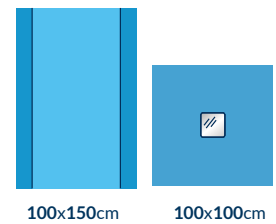

bulk packaging:  
50 sets

STERILE R



### AT-SD-OPHT2-IF-C OPTHALMIC DRAPE 2-IF



REF	dimensions	quantity	component
AT-SD-OPHT2-IF-C	100cm x 100cm	1 pc.	ophthalmic drape with fenestration 10cm x 10cm filled with an incise film, integrated with fluid collection pouch and with 2 formable molders, reinforced
AT-SD-S 3	100cm x 150cm	1 pc.	instrument table cover, reinforced

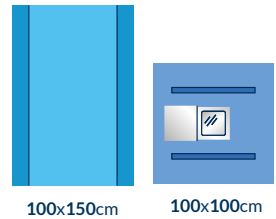

bulk packaging:  
60 sets

hydrophobic  
SMS material

STERILE R



### AT-SD-OPHT3-IF-C OPTHALMIC DRAPE 3-IF



REF	dimensions	quantity	component
AT-SD-OPHT3-IF-C	120cm x 170cm	1 pc.	ophthalmic drape with fenestration 10cm x 10cm filled with an incise film, integrated with 2 fluid collection pouches and with 1 formable molder, reinforced
AT-SD-S 3	100cm x 150cm	1 pc.	instrument table cover, reinforced

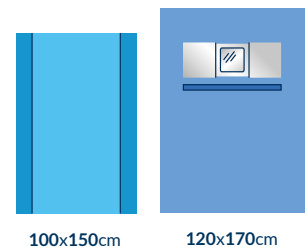

bulk packaging:  
40 sets

hydrophobic  
SMS material

STERILE R



formable molder to fit the patient's face

### AT-SD-OPHT4-IF-C OPTHALMIC DRAPE 4-IF



REF	dimensions	quantity	component
AT-SD-OPHT4-IF-C	140cm x 240cm	1 pc.	reinforced ophthalmic drape with a fenestration of 10cm x 10cm filled with an incise film, integrated with 2 fluid collection pouches and 1 formable molder
AT-SD-S 4	150cm x 190cm	1 pc.	instrument table cover, reinforced

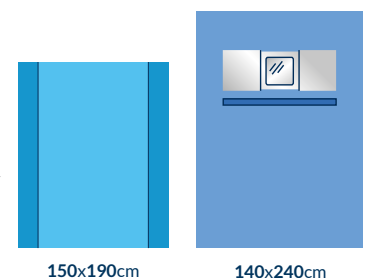

bulk packaging:  
25 sets

hydrophobic  
SMS material

STERILE R



### AT-SD-OPHT5-IF-C OPTHALMIC DRAPE 5-IF



REF	dimensions	quantity	component
AT-SD-OPHT5-IF-C	100cm x 100cm	1 pc.	ophthalmic drape with fenestration 10cm x 10cm filled with an incise film, integrated with fluid collection pouch and with 2 formable molders, reinforced



bulk packaging:  
80 sets

hydrophobic  
SMS material

STERILE R





ZARYS



WWW.ZARYS.COM

# SURGICAL COVERS, ACCESSORIES



# SURGICAL COVERS

## STERILE MAYO STAND COVER, REINFORCED - RED



NEW

REF	dimensions	packaging unit	bulk packaging
AT-SD-S 1 RED	80cm x 145cm	1 pc.	80 pcs
AT-SD-S 2 RED	80cm x 140cm	1 pc.	80 pcs

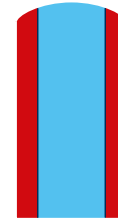

## STERILE SET OF LIMB COVERS

REF	dimensions	packaging unit	bulk packaging
AT-SD-S 9	70cm x 120cm	2 pcs	20 pcs

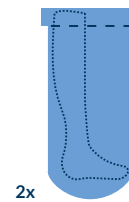

2x

70x120cm



## STERILE LIMB COVERS

REF	dimensions	packaging unit	bulk packaging
AT-SD-S 6	30cm x 60cm	1 pc. + OP tape 10cm x 50cm	3 x 50 pcs
AT-SD-S 7	30cm x 80cm	1 pc. + OP tape 10cm x 50cm	3 x 32 pcs
AT-SD-S 8	35cm x 120cm	1 pc. + OP tape 10cm x 50cm	3 x 28 pcs



## STERILE LIMB COVER - SLEEVE PROTECTOR

NEW

REF	dimensions	packaging unit	bulk packaging
AT-SD-S 12	50 cm length + 8 cm cuff	1 pc.	3 x 40 pcs



## STERILE CAMERA CABLE COVERS - PERFORATED, WITH 2 ADHESIVE TAPES



REF	dimensions	packaging unit	bulk packaging
AT-SP-S 3	14cm x 250cm	1 pc.	3 x 45 pcs
AT-SP-S 4	16cm x 200cm	1 pc.	3 x 50 pcs
AT-SP-S 5	16cm x 250cm	1 pc.	3 x 45 pcs
AT-SP-S 6	16cm x 300cm	1 pc.	3 x 40 pcs



sterile camera cover

## STERILE CAMERA CABLE COVER - UNPERFORATED, WITH AN ADHESIVE TAPE

REF	dimensions	packaging unit	 bulk packaging
AT-SP-S 7	7cm x 120cm	1 pc.	4 x 45 pcs
AT-SP-S 8	7cm x 170cm	1 pc.	4 x 45 pcs



## STERILE CIRCULAR BANDED COVERS FOR MEDICAL DEVICES

REF	dimensions in stretched state	maximum size of covered device	packaging unit	 bulk packaging
AT-SP-S 9	65cm x 85cm	35cm x 45cm	1 pc.	4 x 30 pcs
AT-SP-S 10	85cm x 85cm	50cm x 50cm	1 pc.	4 x 30 pcs
AT-SP-S 11	105cm x 105cm	60cm x 60cm	1 pc.	4 x 28 pcs
AT-SP-S 12	120cm x 120cm	70cm x 70cm	1 pc.	4 x 30 pcs
AT-SP-S 13	140cm x 140cm	80cm x 80cm	1 pc.	4 x 30 pcs

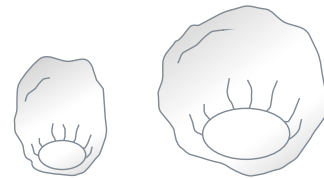

## STERILE RECTANGULAR BANDED COVERS FOR MEDICAL DEVICES

REF	dimensions	packaging unit	 bulk packaging
AT-SP-S 14	70cm x 80cm	1 pc.	4 x 30 pcs
AT-SP-S 15	90cm x 100cm	1 pc.	2 x 36 pcs
AT-SP-S 16	80cm x 150cm	1 pc.	4 x 30 pcs

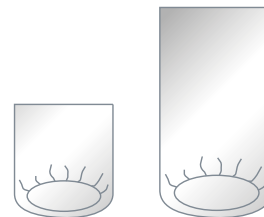

 strong PE film  
65 µm



## STERILE C-ARM COVER SET

REF	dimensions	packaging unit	 bulk packaging
AT-SP-S 17	100cm x 160cm 80cm x 150cm 3cm x 100cm	1 set	32 pcs

 strong PE film  
65 µm

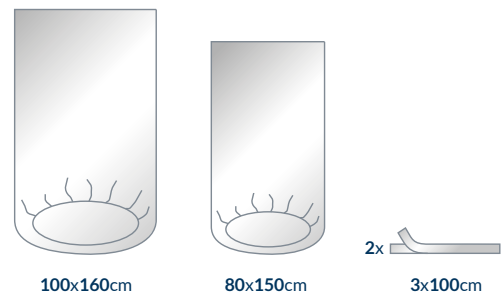

## STERILE ARMBOARD COVER SET

REF	dimensions	packaging unit	 bulk packaging
AT-AC	35cm x 75cm	2 pcs	3 x 15 pcs

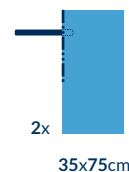

**STERILE SURGICAL TAPES**

REF	dimensions	description	packaging unit	 bulk packaging
AT-SP-S 1	10cm x 50cm	surgical tape, OP tape	1 pc.	4 x 200 pcs
AT-SP-S 2	2cm x 22cm	surgical tape, Velcro type	1 pc.	100 pcs

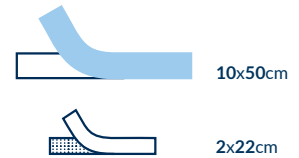

OP tape



Velcro surgical tape

**STERILE ADHESIVE POUCHES**

REF	dimensions	description	packaging unit	 bulk packaging
AT-SP-S 20	30cm x 40cm	adhesive pouch, one-chamber	1 pc.	4 x 45 pcs
AT-SP-S 21	50cm x 60cm	adhesive pouch, one-chamber	1 pc.	3 x 22 pcs
AT-SP-S 22	40cm x 30cm	adhesive pouch, two-chamber 15cm x 30cm left chamber 25cm x 30cm right chamber	1 pc.	4 x 55 pcs

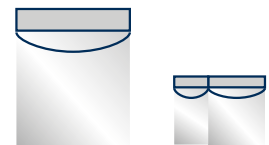
**STERILE ADHESIVE FLUID COLLECTION POUCH**

NEW

REF	dimensions	packaging unit	description	 bulk packaging
AT-SP-S 18	60cm x 100cm	1 pc.	arthroscopy cone-shaped pouch with self-sealing fenestration and suction port	36 pcs
AT-SP-S 19	50cm x 50cm	1 pc.	cone-shaped pouch with filter and tubing port	3 x 22 pcs

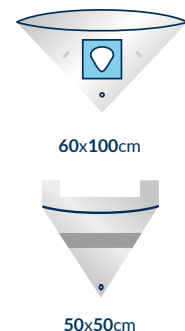
**STERILE ABSORBENT DRAPE**

REF	dimensions	packaging unit	 bulk packaging
AT-HT	40cm x 40cm	1 pc.	4 x 125 pcs



## STERILE ABSORBENT DRAPE

REF	dimensions	packaging unit	 bulk packaging
AT-BT	75cm x 80cm	1 pc.	80 pcs

  
made of highly  
absorbent Spunlace

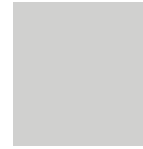

75x80cm

## STERILE INCISE FILM ELASTOFILM

REF	total dimensions	adhesive filed dimensions	packaging unit	 bulk packaging
808068	84cm x 56cm	84cm x <b>50cm</b>	1 pc.	6 pcs
808066	40cm x 42cm	40cm x <b>36cm</b>	1 pc.	20 pcs
808065	45cm x 55cm	45cm x <b>49cm</b>	1 pc.	20 pcs
808064	45cm x 28cm	45cm x <b>22cm</b>	1 pc.	20 pcs
808063	30cm x 28cm	30cm x <b>22cm</b>	1 pc.	20 pcs
808062	15cm x 28cm	15cm x <b>22cm</b>	1 pc.	40 pcs
808061	14cm x 25cm	14cm x <b>21cm</b>	1 pc.	40 pcs
805018	55cm x 55cm	55cm x <b>51cm</b>	1 pc.	20 pcs
805025	30cm x 40cm	30cm x <b>36cm</b>	1 pc.	20 pcs
805016	20cm x 30cm	20cm x <b>26cm</b>	1 pc.	30 pcs



  
do not cut  
the incise film



- thin incise film made of polyurethane
- flexible
- perfectly fits the patient's body
- double packed: externally paper-foil, internally paper

ZARYS

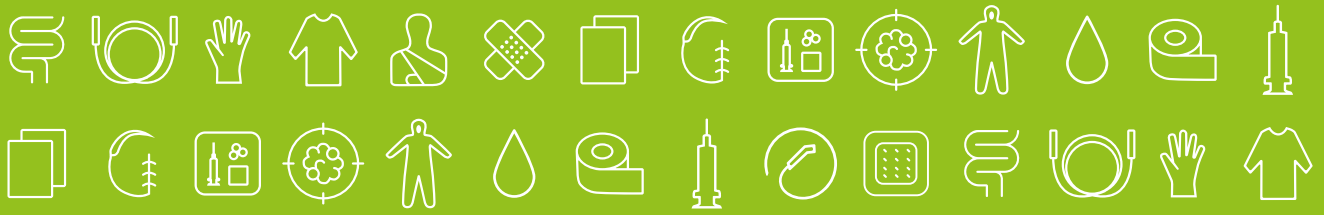

WWW.ZARYS.COM

# SURGICAL SETS



## AT-S-BASIC1-S BASIC SET 1

quantity	dimensions	component
1 pc.	75cm x 90cm	drape with central adhesive fenestration
1 pc.	10cm x 17cm	tray
10 pcs	10cm x 10cm	gauze swab
5 pcs	30cm x 30cm	gauze ball
1 pc.	100cm x 150cm	instrument table cover, reinforced

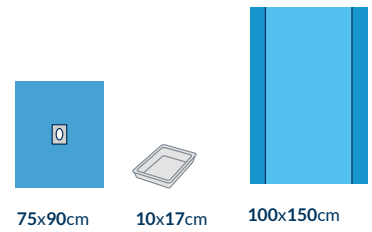

 bulk packaging:  
28 sets



## AT-S-UNI1-S UNIVERSAL SET 1

quantity	dimensions	component
4 pcs	75cm x 90cm	drape with adhesive edge
1 pc.	150cm x 190cm	instrument table cover, reinforced

 bulk packaging:  
50 sets

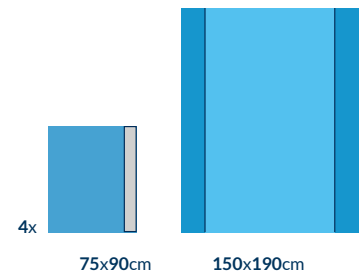

## AT-S-UNI2-S UNIVERSAL SET 2

quantity	dimensions	component
2 pcs	150cm x 180cm	drape with adhesive edge
2 pcs	75cm x 90cm	drape with adhesive edge
4 pcs	30cm x 30cm	absorbent towel
1 pc.	150cm x 190cm	instrument table cover, reinforced

 bulk packaging:  
20 sets

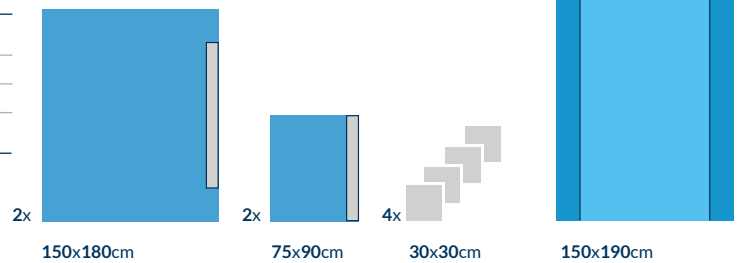

## AT-S-UNI4-C UNIVERSAL SET 4



quantity	dimensions	component
1 pc.	170cm x 240cm	drape with adhesive edge, reinforced
1 pc.	170cm x 180cm	drape with adhesive edge, reinforced
2 pcs	75cm x 90cm	highly absorbent drape with adhesive edge
4 pcs	30cm x 30cm	absorbent towel
1 pc.	10cm x 50cm	OP tape
1 pc.	80cm x 145cm	Mayo stand cover, reinforced - red
1 pc.	150cm x 190cm	instrument table cover, reinforced

 bulk packaging:  
10 sets

 hydrophobic  
SMS material

 highly absorbent  
material

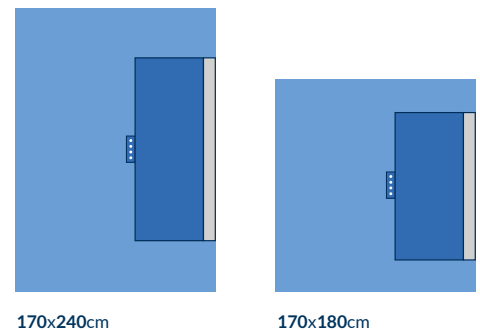

Mayo stand cover, reinforced - red

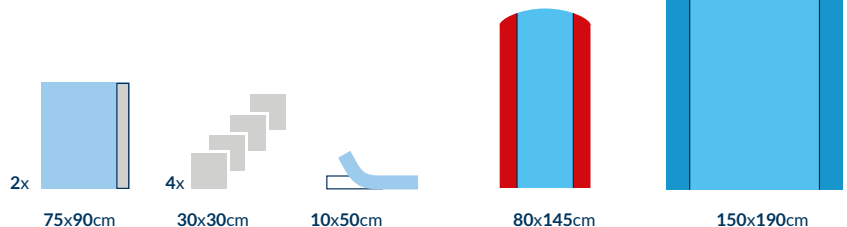

**AT-S-UNI5-S**

**UNIVERSAL SET 5**



quantity	dimensions	component
1 pc.	150cm x 240cm	drape with adhesive edge
1 pc.	180cm x 180cm	drape with adhesive edge
2 pcs	75cm x 90cm	drape with adhesive edge
4 pcs	30 cmx30 cm	absorbent towel
1 pc.	10cm x 50cm	OP tape
1 pc.	80cm x 145cm	Mayo stand cover, reinforced - red
1 pc.	150cm x 190cm	instrument table cover, reinforced

 bulk packaging:  
10 sets

 60 g/m<sup>2</sup>

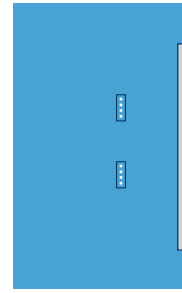

150x240cm

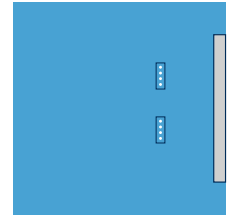

180x180cm

**STERILE R**

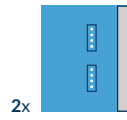

2x  
75x90cm



4x  
30x30cm



10x50cm



80x145cm

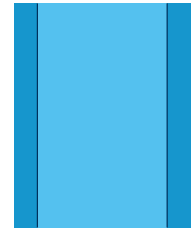

150x190cm

**AT-S-UNI5-M-S**

**UNIVERSAL SET 5-M**

quantity	dimensions	component
1 pc.	150cm x 240cm	drape with adhesive edge
1 pc.	180cm x 180cm	drape with adhesive edge
2 pcs	75cm x 90cm	drape with adhesive edge
4 pcs	30 cmx30 cm	absorbent towel
1 pc.	10cm x 50cm	OP tape
1 pc.	80cm x 145cm	Mayo stand cover, reinforced - red
1 pc.	150cm x 190cm	instrument table cover, reinforced

 bulk packaging:  
15 sets

 56 g/m<sup>2</sup>



150x240cm



180x180cm

**STERILE R**

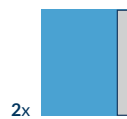

2x  
75x90cm

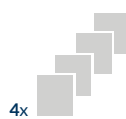

4x  
30x30cm



10x50cm



80x145cm

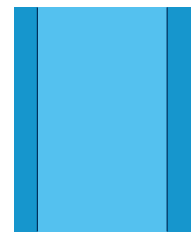

150x190cm



## AT-S-UNI5-G-S UNIVERSAL SET 5-G

quantity	dimensions	component
1 pc.	150cm x 240cm	drape with adhesive edge
1 pc.	180cm x 180cm	drape with adhesive edge
2 pcs	75cm x 90cm	drape with adhesive edge
4 pcs	30cm x 30cm	absorbent towel
1 pc.	10cm x 50cm	OP tape
1 pc.	80cm x 145cm	Mayo stand cover, reinforced - red
1 pc.	150cm x 190cm	instrument table cover, reinforced
1 pc.	L	surgical gown STANDARD
2 pcs	XL	surgical gown STANDARD

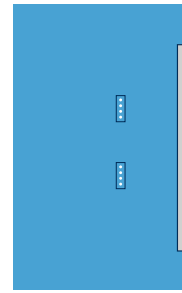

150x240cm

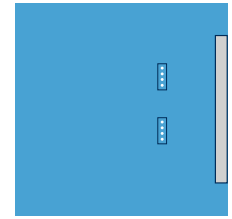

180x180cm

bulk packaging:  
6 sets

STERILE R

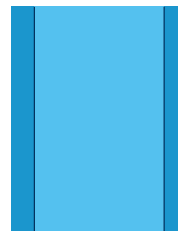
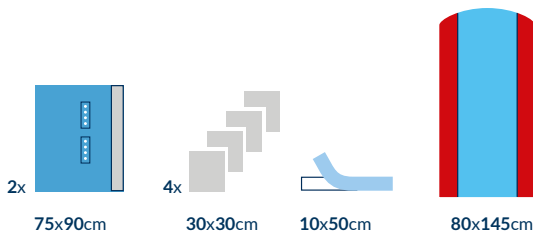

150x190cm

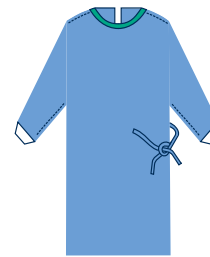

L



2x  
XL

## AT-S-UNI5-GP-S UNIVERSAL SET 5-GP

quantity	dimensions	component
1 pc.	150cm x 240cm	drape with adhesive edge
1 pc.	180cm x 180cm	drape with adhesive edge
2 pcs	75cm x 90cm	drape with adhesive edge
4 pcs	30cm x 30cm	absorbent towel
1 pc.	10cm x 50cm	OP tape
1 pc.	80cm x 145cm	Mayo stand cover, reinforced - red
1 pc.	150cm x 190cm	instrument table cover, reinforced
1 pc.	XL	surgical gown STANDARD
1 pc.	XXL	surgical gown, reinforced STANDARD PLUS
1 pc.	30cm x 40cm	adhesive pouch, one-chamber

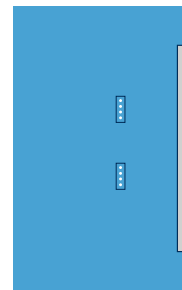

150x240cm

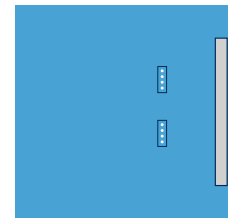

180x180cm

bulk packaging:  
7 sets

STERILE R

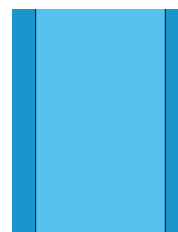
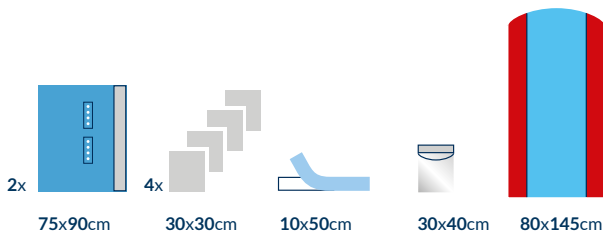

150x190cm

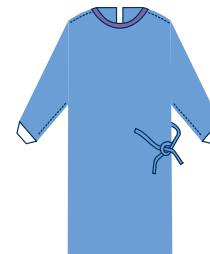

XL

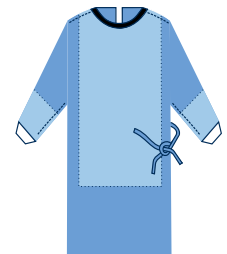

XXL

**AT-S-UNI6-SP**

**UNIVERSAL SET 6**



quantity	dimensions	component
1 pc.	150cm x 240cm	drape with adhesive edge, reinforced
1 pc.	180cm x 180cm	drape with adhesive edge, reinforced
2 pcs	75cm x 90cm	drape with adhesive edge, reinforced
4 pcs	30cm x 30cm	absorbent towel
1 pc.	10cm x 50cm	OP tape
1 pc.	80cm x 145cm	Mayo stand cover, reinforced - red
1 pc.	150cm x 190cm	instrument table cover, reinforced

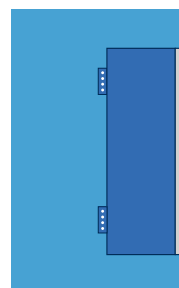

150x240cm

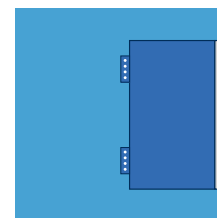

180x180cm

bulk packaging:  
9 sets

highly absorbent  
material

60 g/m<sup>2</sup>

**STERILE R**

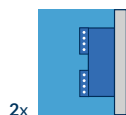

2x

75x90cm

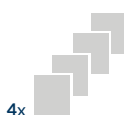

4x

30x30cm



10x50cm

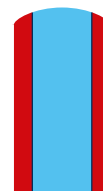

80x145cm

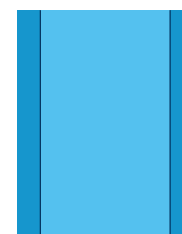

150x190cm

**AT-S-UNI6-M-SP**

**UNIVERSAL SET 6-M**

quantity	dimensions	component
1 pc.	150cm x 240cm	drape with adhesive edge, reinforced
1 pc.	180cm x 180cm	drape with adhesive edge, reinforced
2 pcs	75cm x 90cm	drape with adhesive edge, reinforced
4 pcs	30cm x 30cm	absorbent towel
1 pc.	10cm x 50cm	OP tape
1 pc.	80cm x 145cm	Mayo stand cover, reinforced - red
1 pc.	150cm x 190cm	instrument table cover, reinforced

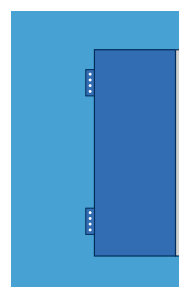

150x240cm

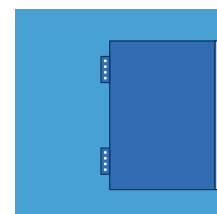

180x180cm

bulk packaging:  
12 sets

highly absorbent  
material

56 g/m<sup>2</sup>

**STERILE R**

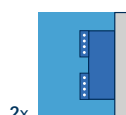

2x

75x90cm



4x

30x30cm



10x50cm

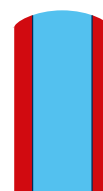

80x145cm

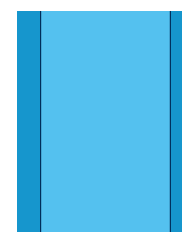

150x190cm

**AT-S-UNI7-C**

**UNIVERSAL SET 7**

quantity	dimensions	component
1 pc.	150cm x 240cm	drape with adhesive edge
1 pc.	180cm x 180cm	drape with adhesive edge
2 pcs	75cm x 90cm	drape with adhesive edge
4 pcs	30cm x 30cm	absorbent towel
1 pc.	10cm x 50cm	OP tape
1 pc.	80cm x 145cm	Mayo stand cover, reinforced - red
1 pc.	150cm x 190cm	instrument table cover, reinforced

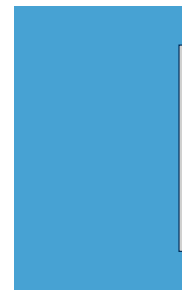

150x240cm



180x180cm

bulk packaging:  
8 sets

3-layer drapes  
PREMIUM

**STERILE R**

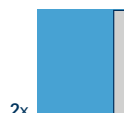

2x 75x90cm



4x 30x30cm



10x50cm



80x145cm

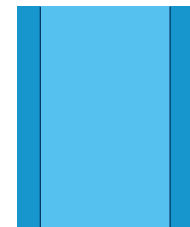

150x190cm

**AT-S-UNI8-C**

**UNIVERSAL SET 8**



**BESTSELLER**

quantity	dimensions	component
1 pc.	150cm x 240cm	drape with adhesive edge, reinforced
1 pc.	180cm x 180cm	drape with adhesive edge, reinforced
2 pcs	75cm x 90cm	drape with adhesive edge, reinforced
4 pcs	30cm x 30cm	absorbent towel
1 pc.	10cm x 50cm	OP tape
1 pc.	80cm x 145cm	Mayo stand cover, reinforced - red
1 pc.	150cm x 190cm	instrument table cover, reinforced

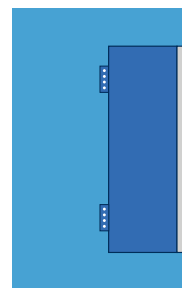

150x240cm

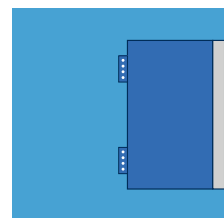

180x180cm

bulk packaging:  
7 sets

3-layer drapes  
PREMIUM

highly absorbent  
material

**STERILE R**

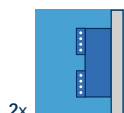

2x 75x90cm



4x 30x30cm



10x50cm



80x145cm

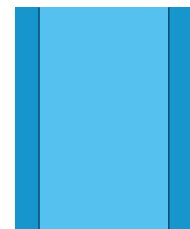

150x190cm

## AT-S-UNI9-SP PEDIATRIC UNIVERSAL SET 9

quantity	dimensions	component
1 pc.	150cm x 240cm	drape with adhesive edge
1 pc.	180cm x 180cm	drape with adhesive edge
2 pcs	75cm x 75cm	drape with adhesive edge, reinforced
4 pcs	30cm x 30cm	absorbent towel
1 pc.	10cm x 50cm	OP tape
1 pc.	80cm x 145cm	Mayo stand cover, reinforced - red
1 pc.	150cm x 190cm	instrument table cover, reinforced

 bulk packaging:  
8 sets

 pediatric set

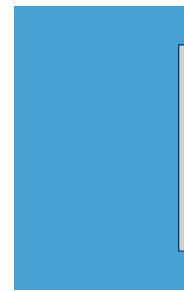

150x240cm



180x180cm

**STERILE R**   



thinner tape in drapes - 2,5cm

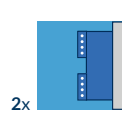

2x 75x75cm

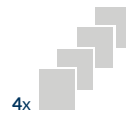

4x 30x30cm



10x50cm



80x145cm

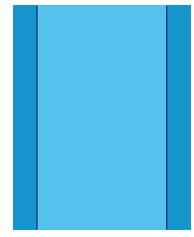

150x190cm

## AT-S-UNI10-S UNIVERSAL SET 10

quantity	dimensions	component
1 pc.	150cm x 230cm	drape with adhesive edge
1 pc.	150cm x 180cm	drape with adhesive edge
2 pcs	75cm x 90cm	drape with adhesive edge
4 pcs	30cm x 30cm	absorbent towel
1 pc.	10cm x 50cm	OP tape
1 pc.	80cm x 145cm	Mayo stand cover, reinforced - red
1 pc.	150cm x 190cm	instrument table cover, reinforced

 bulk packaging:  
10 sets

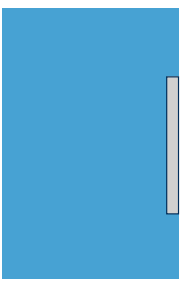

150x230cm

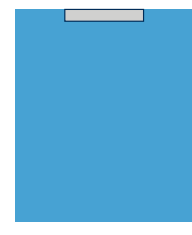

150x180cm

**STERILE R**   

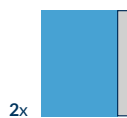

2x 75x90cm

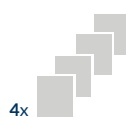

4x 30x30cm



10x50cm

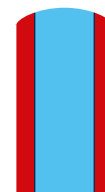

80x145cm

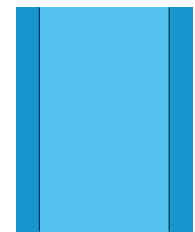

150x190cm



# GENERAL SURGERY

## AT-S-ABD1-IF-C ABDOMINAL SET 1-IF

quantity	dimensions	component
1 pc.	200cm x 320cm	drape with adhesive fenestration 25cm x 30cm filled with an incise film, reinforced
4 pcs	30cm x 30cm	absorbent towel
1 pc.	10cm x 50cm	OP tape
1 pc.	80cm x 145cm	Mayo stand cover, reinforced - red
1 pc.	150cm x 190cm	instrument table cover, reinforced

 bulk packaging:  
10 sets

 hydrophobic  
SMS material

 highly absorbent  
material

**STERILE R**

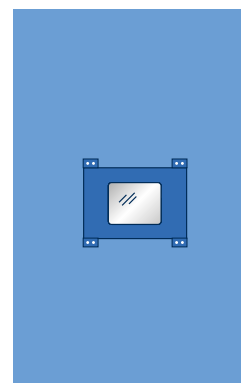

200x320cm



4x 30x30cm



10x50cm



80x145cm

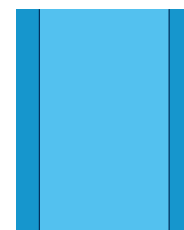

150x190cm

## AT-S-ABPER1-S ABDO-PERINEAL SET 1

quantity	dimensions	component
1 pc.	180/270cm x 220cm	drape integrated with limb covers, adhesive trapezium-shaped fenestration 30cm x 20cm x 20cm and perineal fenestration 10cm x 15cm with covering flap
4 pcs	30cm x 30cm	absorbent towel
1 pc.	10cm x 50cm	OP tape
1 pc.	2cm x 22cm	surgical tape, Velcro type
1 pc.	14cm x 250cm	camera cable cover
1 pc.	80cm x 145cm	Mayo stand cover, reinforced - red
1 pc.	150cm x 190cm	instrument table cover, reinforced

 bulk packaging:  
12 sets

**STERILE R**

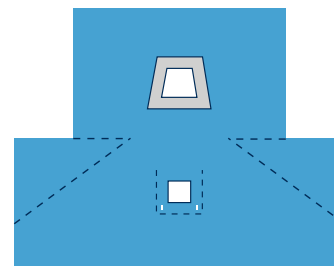

180/270x220cm

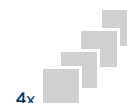

4x 30x30cm



10x50cm



2x22cm



14x250cm



80x145cm

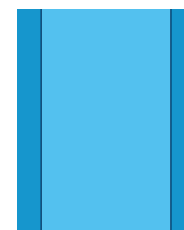

150x190cm



flap to secure the fenestration

## AT-S-LAP1-IF-C LAPAROSCOPY SET 1-IF

quantity	dimensions	component
1 pc.	200cm x 260cm	drape T-shaped with adhesive fenestration 30cm x 30cm filled with an incise film
4 pcs	30cm x 30cm	absorbent towel
1 pc.	10cm x 50cm	OP tape
1 pc.	14cm x 250cm	camera cable cover
2 pcs	70cm x 120cm	limb cover
1 pc.	80cm x 140cm	Mayo stand cover, reinforced - red
1 pc.	150cm x 190cm	instrument table cover, reinforced

 bulk packaging:  
12 sets

 hydrophobic  
SMS material

**STERILE R**   

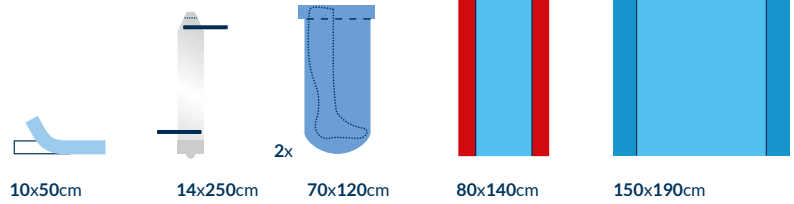
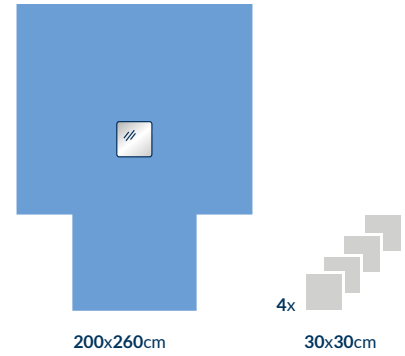

## AT-S-LAP2-SP LAPAROSCOPY SET 2

 **BESTSELLER**

quantity	dimensions	component
1 pc.	200/270cm x 300cm	drape integrated with limb covers, adhesive fenestration 25cm x 30cm, reinforced, with 8 cable holders Velcro type
4 pcs	30cm x 30cm	absorbent towel
1 pc.	10cm x 50cm	OP tape
1 pc.	2cm x 22cm	surgical tape, Velcro type
1 pc.	14cm x 250cm	camera cable cover
1 pc.	80cm x 145cm	Mayo stand cover, reinforced - red
1 pc.	150cm x 190cm	instrument table cover, reinforced

 bulk packaging:  
10 sets

 highly absorbent  
material

**STERILE R**   

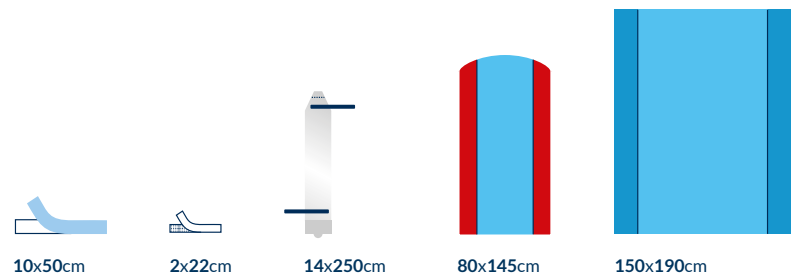
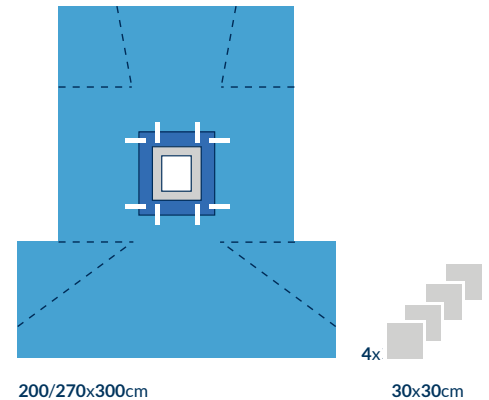

cable holders, Velcro type

## AT-S-LAP3-C

## LAPAROSCOPY SET 3

quantity	dimensions	component
1 pc.	200/270cm x 300cm	drape integrated with limb covers, adhesive fenestration 25cm x 30cm, reinforced, with 8 cable holders Velcro type
4 pcs	30cm x 30cm	absorbent towel
1 pc.	10cm x 50cm	OP tape
1 pc.	2cm x 22cm	surgical tape, Velcro type
1 pc.	14cm x 250cm	camera cable cover
1 pc.	30cm x 40cm	adhesive pouch, one-chamber
1 pc.	80cm x 145cm	Mayo stand cover, reinforced - red
1 pc.	150cm x 190cm	instrument table cover, reinforced

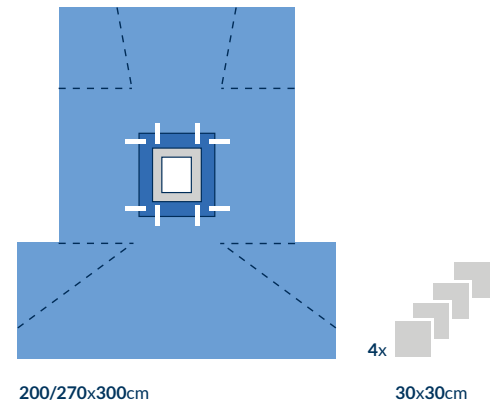

200/270x300cm



30x30cm

 bulk packaging:  
8 sets

 hydrophobic  
SMS material

**STERILE R**   

 highly absorbent  
material

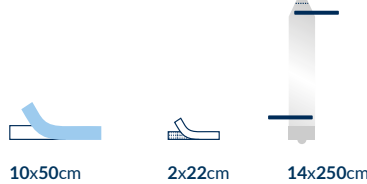

10x50cm

2x22cm

14x250cm



30x40cm

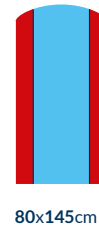

80x145cm

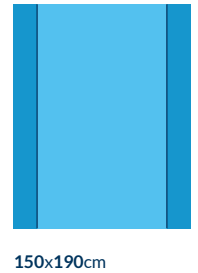

150x190cm

## AT-S-VAR1-S

## VARICOSE VEIN SET 1

quantity	dimensions	component
1 pc.	200cm x 260cm	drape with adhesive U-split 8,5cm x 85cm
1 pc.	160cm x 180cm	drape with adhesive edge
4 pcs	30cm x 30cm	absorbent towel
1 pc.	80cm x 140cm	Mayo stand cover, reinforced - red
1 pc.	150cm x 190cm	instrument table cover, reinforced

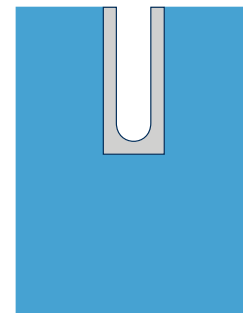

200x260cm

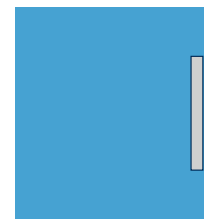

160x180cm

 bulk packaging:  
10 sets

 drape with  
U-split

**STERILE R**   

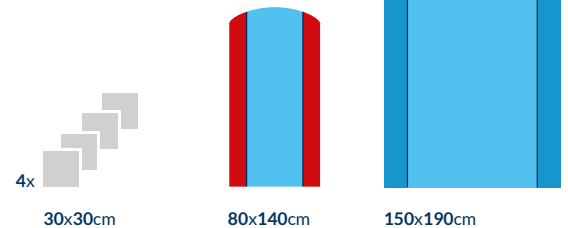

4x  
30x30cm

80x140cm

150x190cm

## AT-S-VAR2-C

## VARICOSE VEIN SET 2

quantity	dimensions	component
1 pc.	200cm x 260cm	drape with adhesive U-split 8,5cm x 95cm, integrated genital area cover, reinforced
1 pc.	170cm x 180cm	drape with adhesive edge, reinforced
4 pcs	30cm x 30cm	absorbent towel
1 pc.	80cm x 140cm	Mayo stand cover, reinforced - red
1 pc.	150cm x 190cm	instrument table cover, reinforced

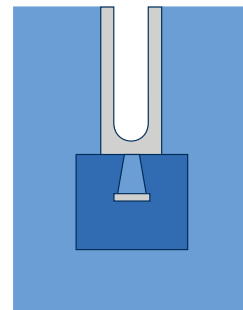

200x260cm

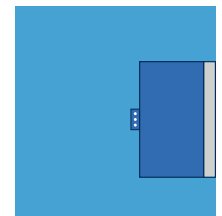

170x180cm

 bulk packaging:  
10 sets

 hydrophobic  
SMS material

 integrated genital area  
cover

 drape with  
U-split

 highly absorbent  
material

**STERILE R**   

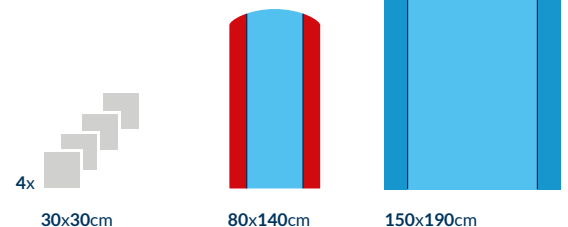

4x  
30x30cm

80x140cm

150x190cm



# ORTHOPAEDICS AND TRAUMATOLOGY

## AT-S-EXT1-C EXTREMITY SET 1

quantity	dimensions	component
1 pc.	200cm x 300cm	drape with elastic fenestration ø 3,5cm, reinforced
1 pc.	80cm x 145cm	Mayo stand cover, reinforced - red
1 pc.	150cm x 190cm	instrument table cover, reinforced

 bulk packaging: 12 sets  
 highly absorbent material  
 hydrophobic SMS material  
 limb surgery

**STERILE R**   

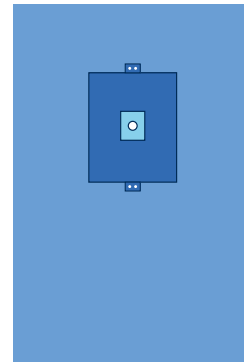

200x300cm



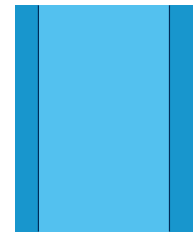

80x145cm



150x190cm

## AT-S-EXT2-C EXTREMITY SET 2

quantity	dimensions	component
1 pc.	200cm x 300cm	drape with elastic fenestration ø 3,5cm, reinforced
1 pc.	160cm x 180cm	drape with adhesive edge
4 pcs	30cm x 30cm	absorbent towel
1 pc.	10cm x 50cm	OP tape
1 pc.	80cm x 145cm	Mayo stand cover, reinforced - red
1 pc.	150cm x 190cm	instrument table cover, reinforced

 bulk packaging: 8 sets  
 highly absorbent material  
 hydrophobic SMS material  
 limb surgery

**STERILE R**   

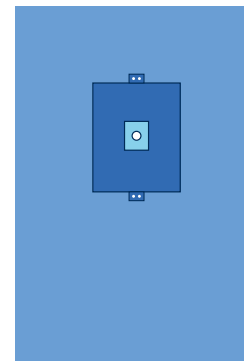

200x300cm



160x180cm

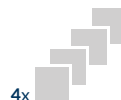

4x 30x30cm



10x50cm



80x145cm

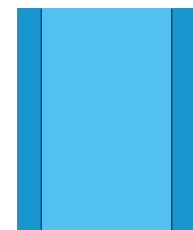

150x190cm



## AT-S-ART1-C ARTHROSCOPY SET 1

quantity	dimensions	component
1 pc.	200cm x 320cm	drape with elastic fenestration 6cm x 8cm, reinforced
4 pcs	30cm x 30cm	absorbent towel
1 pc.	10cm x 50cm	OP tape
1 pc.	30cm x 60cm	elastic limb cover
1 pc.	80cm x 145cm	Mayo stand cover, reinforced - red
1 pc.	150cm x 190cm	instrument table cover, reinforced

 bulk packaging:  
14 sets

 hydrophobic  
SMS material

 highly absorbent  
material

**STERILE R**   

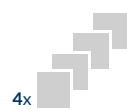

4x 30x30cm



10x50cm



30x60cm



80x145cm

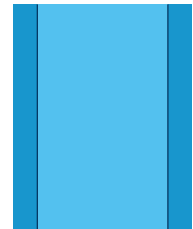

150x190cm

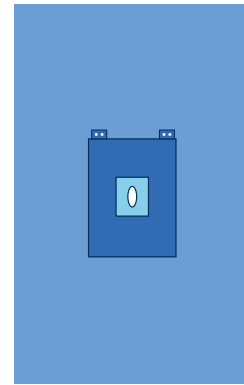

200x320cm

## AT-S-ART2-C ARTHROSCOPY SET 2

quantity	dimensions	component
1 pc.	200cm x 320cm	drape with elastic fenestration 6cm x 8cm, reinforced
2 pcs	30cm x 30cm	absorbent towel
2 pcs	10cm x 50cm	OP tape
1 pc.	14cm x 250cm	camera cable cover
1 pc.	30cm x 60cm	elastic limb cover
1 pc.	60cm x 100cm	fluid collection pouch with elastic fenestration, formable molder and tubing port
1 pc.	80cm x 145cm	Mayo stand cover, reinforced - red
1 pc.	150cm x 190cm	instrument table cover, reinforced

 bulk packaging:  
10 sets

 hydrophobic  
SMS material

 highly absorbent  
material

**STERILE R**   



arthroscopy pouch



2x 30x30cm



2x 10x50cm



14x250cm



30x60cm



60x100cm

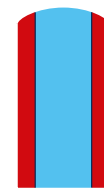

80x145cm

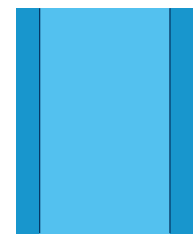

150x190cm

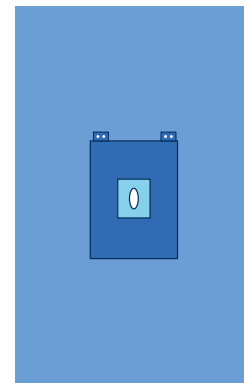

200x320cm

## AT-S-ART2-IP-C ARTHROSCOPY SET 2-IP

quantity	dimensions	component
1 pc.	200cm x 320cm	drape with elastic fenestration 6cm x 8cm, integrated fluid collection pouch, reinforced
2 pcs	30cm x 30cm	absorbent towel
3 pcs	10cm x 50cm	OP tape
1 pc.	14cm x 250cm	camera cable cover
1 pc.	30cm x 60cm	elastic limb cover
1 pc.	80cm x 145cm	Mayo stand cover, reinforced - red
1 pc.	150cm x 190cm	instrument table cover, reinforced

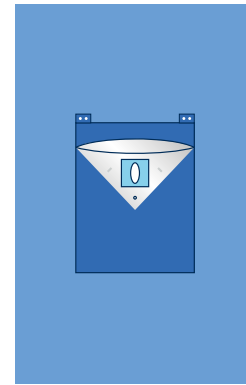

200x320cm

 bulk packaging:  
10 sets
  hydrophobic  
SMS material
  highly absorbent  
material

**STERILE R**

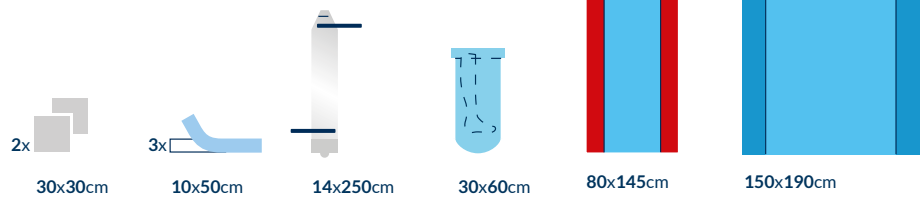

## AT-S-ART3-C ARTHROSCOPY SET 3

quantity	dimensions	component
1 pc.	200cm x 320cm	drape with elastic fenestration 6cm x 8cm, reinforced
2 pcs	30cm x 30cm	absorbent towel
3 pcs	10cm x 50cm	OP tape
1 pc.	14cm x 250cm	camera cable cover
1 pc.	30cm x 60cm	elastic limb cover
1 pc.	80cm x 145cm	Mayo stand cover, reinforced - red
1 pc.	150cm x 190cm	instrument table cover, reinforced

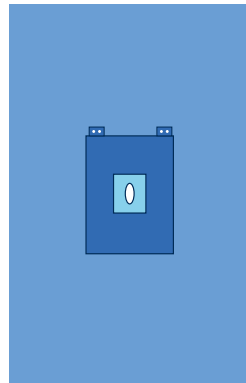

200x320cm

 bulk packaging:  
12 sets
  hydrophobic  
SMS material
  highly absorbent  
material

**STERILE R**



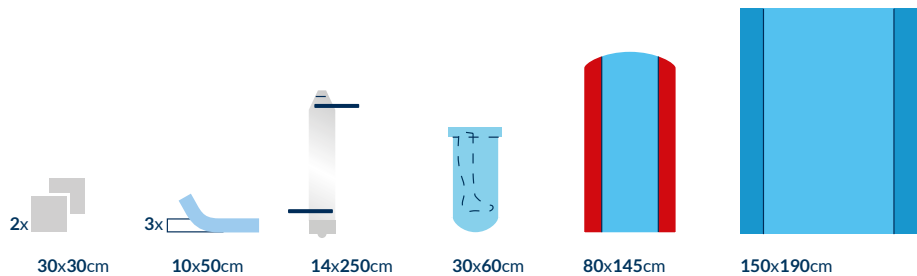



## AT-S-ART4-IP-S ARTHROSCOPY SET 4-IP

quantity	dimensions	component
1 pc.	230cm x 320cm	drape with elastic fenestration ø 7cm, integrated fluid collection pouch
4 pcs	30cm x 30cm	absorbent towel
3 pcs	10cm x 50cm	OP tape
1 pc.	22cm x 75cm	elastic limb cover
1 pc.	80cm x 145cm	Mayo stand cover, reinforced - red
2 pcs	150cm x 190cm	instrument table cover, reinforced

 bulk packaging:  
7 sets

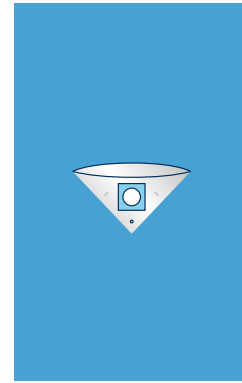
**2x**  
double instrument  
table cover



230x320cm

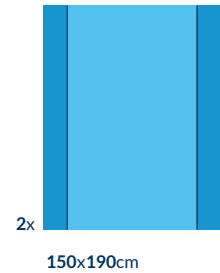
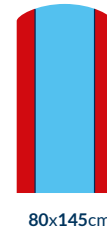
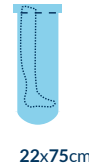
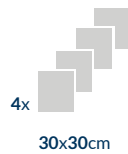

## AT-S-ART5-SP ARTHROSCOPY SET 5

quantity	dimensions	component
1 pc.	230cm x 300cm	drape with elastic fenestration ø 7cm, reinforced
4 pcs	30cm x 30cm	absorbent towel
3 pcs	10cm x 50cm	OP tape
1 pc.	22cm x 75cm	elastic limb cover
1 pc.	80cm x 145cm	Mayo stand cover, reinforced - red
2 pcs	150cm x 190cm	instrument table cover, reinforced

 bulk packaging:  
7 sets

 highly absorbent  
material

**2x**  
double instrument  
table cover

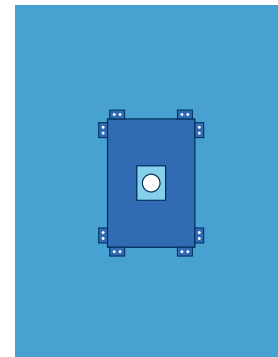

230x300cm

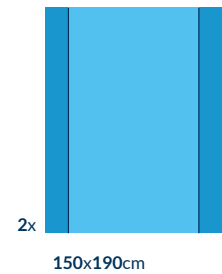
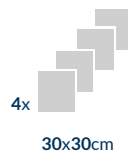

## AT-S-HIP1-C HIP SET 1

quantity	dimensions	component
1 pc.	200cm x 260cm	drape with adhesive U-split 8,5cm x 85cm, reinforced
1 pc.	170cm x 240cm	drape with adhesive edge, reinforced
4 pcs	30cm x 30cm	absorbent towel
2 pcs	10cm x 50cm	OP tape
1 pc.	35cm x 120cm	elastic limb cover
1 pc.	80cm x 145cm	Mayo stand cover, reinforced - red
1 pc.	150cm x 190cm	instrument table cover, reinforced

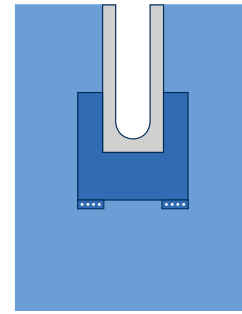

200x260cm

- bulk packaging: 8 sets
- hydrophobic SMS material
- highly absorbent material
- U  
drape with U-split

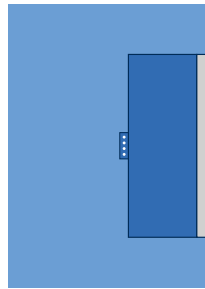

170x240cm



4x 30x30cm



2x 10x50cm



35x120cm



80x145cm

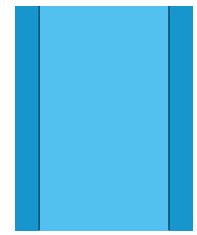

150x190cm



## AT-S-HIP2-C HIP SET 2

quantity	dimensions	component
1 pc.	200cm x 260cm	drape with adhesive U-split 8,5cm x 85cm, reinforced
1 pc.	170cm x 300cm	drape with adhesive edge, reinforced
1 pc.	160cm x 180cm	drape with adhesive edge
4 pcs	30cm x 30cm	absorbent towel
2 pcs	10cm x 50cm	OP tape
1 pc.	35cm x 120cm	elastic limb cover
1 pc.	80cm x 145cm	Mayo stand cover, reinforced - red
1 pc.	150cm x 190cm	instrument table cover, reinforced

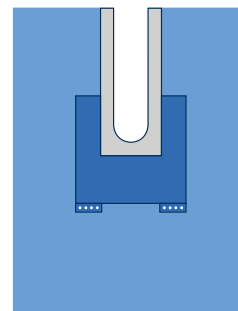

200x260cm

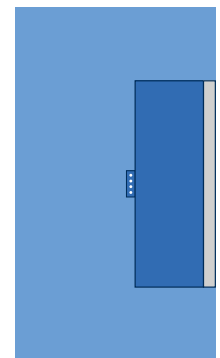

170x300cm

- bulk packaging: 8 sets
- hydrophobic SMS material
- highly absorbent material
- U  
drape with U-split

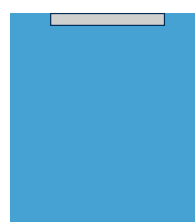

160x180cm

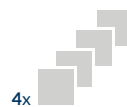

4x 30x30cm



2x 10x50cm



35x120cm

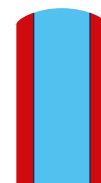

80x145cm

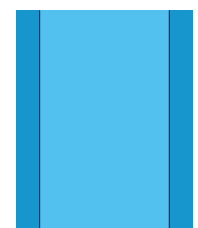

150x190cm



## AT-S-HIP3-SP HIP SET 3

quantity	dimensions	component
1 pc.	230cm x 260cm	drape with adhesive U-split 20cm x 100cm, reinforced
1 pc.	150cm x 240cm	drape with adhesive edge, reinforced
1 pc.	180cm x 180cm	drape with adhesive edge, reinforced
2 pcs	75cm x 90cm	drape with adhesive edge, reinforced
4 pcs	30cm x 30cm	absorbent towel
3 pcs	10cm x 50cm	OP tape
1 pc.	35cm x 120cm	elastic limb cover
1 pc.	10cm x 450cm	elastic bandage
1 pc.	80cm x 145cm	Mayo stand cover, reinforced - red
1 pc.	150cm x 190cm	instrument table cover, reinforced



bulk packaging:  
5 sets



highly absorbent  
material



drape with  
U-split

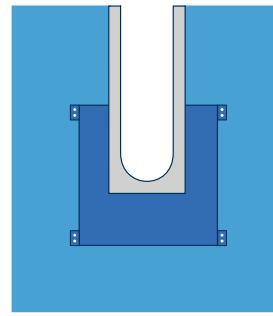

230x260cm

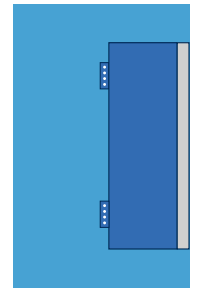

150x240cm



elastic bandage

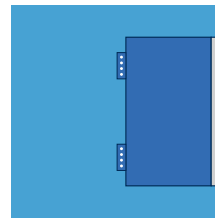

180x180cm



2x

75x90cm

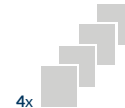

4x

30x30cm



3x

10x50cm

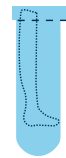

35x120cm



10x450cm

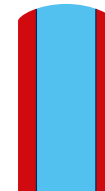

80x145cm

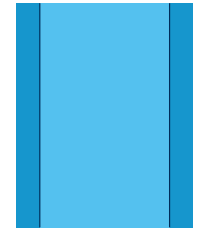

150x190cm

**STERILE R**



5YEARS  
SHELF LIFE

## AT-S-SHLR1-C SHOULDER SET 1

quantity	dimensions	component
1 pc.	200cm x 260cm	drape with adhesive U-split 8,5cm x 85cm, reinforced
1 pc.	170cm x 180cm	drape with adhesive edge, reinforced
1 pc.	150cm x 180cm	drape with adhesive edge
4 pcs	30cm x 30cm	absorbent towel
1 pc.	10cm x 50cm	OP tape
1 pc.	30cm x 60cm	elastic limb cover
1 pc.	80cm x 145cm	Mayo stand cover, reinforced - red
1 pc.	150cm x 190cm	instrument table cover, reinforced



bulk packaging:  
8 sets



hydrophobic  
SMS material



highly absorbent  
material



drape with  
U-split

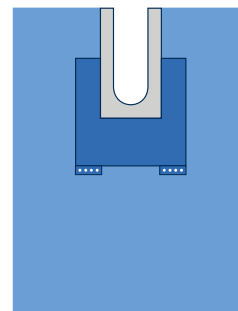

200x260cm

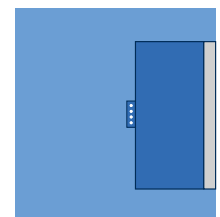

170x180cm

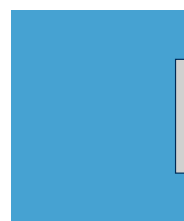

150x180cm

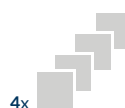

4x

30x30cm



10x50cm



30x60cm



80x145cm

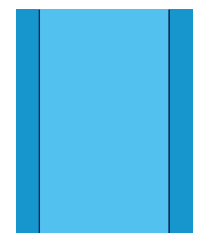

150x190cm

**STERILE R**



5YEARS  
SHELF LIFE

## AT-S-SHLR2-S SHOULDERS SET 2

quantity	dimensions	component
1 pc.	263cm x 406cm	drape with elastic fenestration 13cm x 14cm, integrated fluid collection pouch
4 pcs	30cm x 30cm	absorbent towel
2 pcs	10cm x 50cm	OP tape
1 pc.	22cm x 75cm	elastic limb cover
1 pc.	80cm x 145cm	Mayo stand cover, reinforced - red
1 pc.	150cm x 190cm	instrument table cover, reinforced

 bulk packaging:  
8 sets

 chair position

**STERILE R**

 5 YEARS  
SHELF LIFE

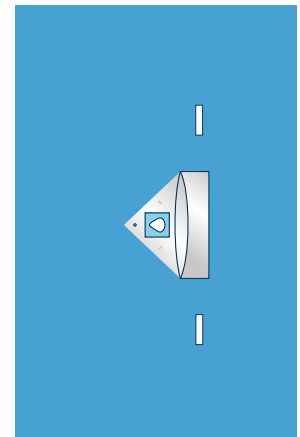
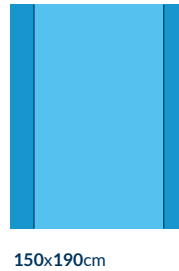
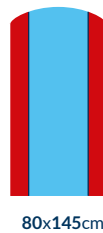
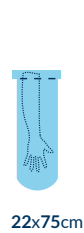

263x406cm

## AT-S-DHS1-IF-SP DYNAMIC HIP SCREW SET 1-IF

quantity	dimensions	component
1 pc.	250cm x 300cm	drape integrated with limb covers and screen cover, two fenestration 14cm x 43cm filled with an incise film, reinforced
1 pc.	50cm x 60cm	adhesive pouch, one-chamber
4 pcs	30cm x 30cm	absorbent towel
1 pc.	10cm x 50cm	adhesive tape
1 pc.	80cm x 145cm	Mayo stand cover, reinforced - red
1 pc.	150cm x 190cm	instrument table cover, reinforced

 bulk packaging:  
10 sets

**STERILE R**

 5 YEARS  
SHELF LIFE

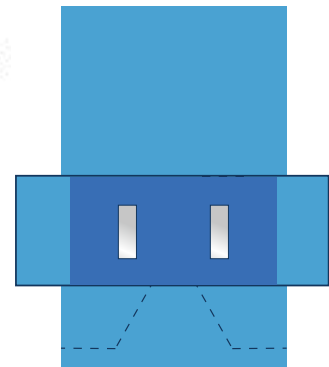
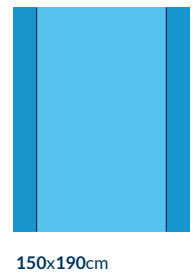
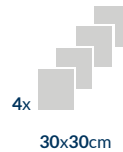

250x300cm

**NEW**

## AT-S-VER1-IP-S VERTICAL ISOLATION SET 1-IP

quantity	dimensions	component
1 pc.	340cm x 240cm	The vertical isolation drape with four self-adhesive tapes of 3.5cm x 60cm along the upper edge, with a self-adhesive fenestration of 30cm x 80cm filled with incise film, integrated with a fluid collection pouch, equipped with a stiffener, a filter and a port enabling the connection of tubing of different diameters. Additionally, equipped with two two-chamber pouches of 40cm x 30cm and two Velcro type tapes of 2cm x 12cm.
4 pcs	30cm x 30cm	
1 pc.	80cm x 145cm	
1 pc.	150cm x 190cm	

 bulk packaging:  
12 sets

 foil

**STERILE R**

 5 YEARS  
SHELF LIFE

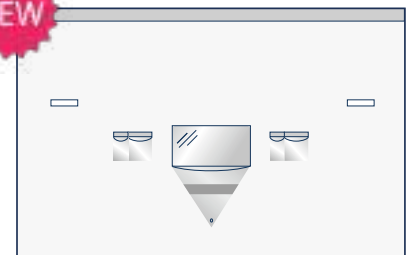
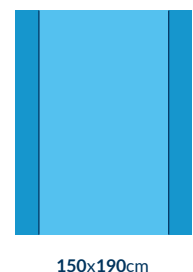
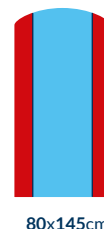

340x240cm

**NEW**



# GYNAECOLOGY AND UROLOGY

## AT-S-GYN1-S GYNAECOLOGY SET 1

quantity	dimensions	component
1 pc.	160/240cm x 180cm	drape integrated with limb covers, adhesive perineal fenestration 10cm x 15cm, integrated fluid collection pouch 35cm x 50cm with formable molder, filter and tubing port
1 pc.	75cm x 90cm	drape without adhesive edge
4 pcs	30cm x 30cm	absorbent towel
1 pc.	10cm x 50cm	OP tape
1 pc.	150cm x 190cm	instrument table cover, reinforced

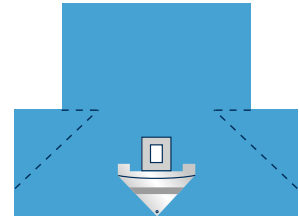

160/240x180cm

bulk packaging:  
6 sets

STERILE R



fluid collection pouch with filter and tubing port



75x90cm

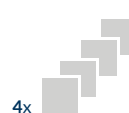

4x  
30x30cm



10x50cm

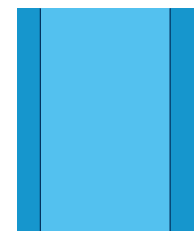

150x190cm

## AT-S-GYN2-C GYNAECOLOGY SET 2 BESTSELLER

quantity	dimensions	component
1 pc.	160/240cm x 180cm	drape integrated with limb covers, adhesive perineal fenestration 10cm x 15cm, integrated fluid collection pouch 35cm x 50cm with formable molder, filter and tubing port, reinforced
1 pc.	75cm x 90cm	drape without adhesive edge
4 pcs	30cm x 30cm	absorbent towel
1 pc.	10cm x 50cm	OP tape
1 pc.	80cm x 145cm	Mayo stand cover, reinforced - red
1 pc.	150cm x 190cm	instrument table cover, reinforced

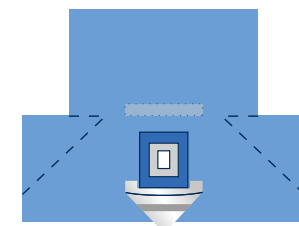

160/240x180cm

bulk packaging:  
6 sets

hydrophobic  
SMS material

highly absorbent  
material

STERILE R



fluid collection pouch with filter and tubing port



75x90cm



4x  
30x30cm



10x50cm



80x145cm

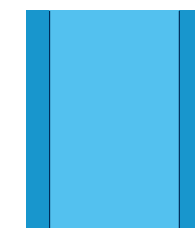

150x190cm

## AT-S-GYN3-C GYNAECOLOGY SET 3

quantity	dimensions	component
1 pc.	170cm x 180cm	drape with adhesive edge, reinforced
2 pcs	100cm x 150cm	drape with adhesive edge
1 pc.	75cm x 90cm	drape with adhesive edge
1 pc.	100cm x 150cm	drape without adhesive edge
4 pcs	30cm x 30cm	absorbent towel
1 pc.	10cm x 50cm	OP tape
2 pcs	70cm x 120cm	limb cover
1 pc.	80cm x 140cm	Mayo stand cover, reinforced - red
1 pc.	150cm x 190cm	instrument table cover, reinforced

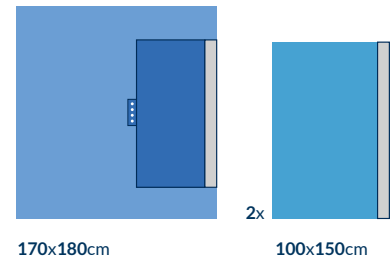

 bulk packaging:  
10 sets



 hydrophobic  
SMS material

 highly absorbent  
material

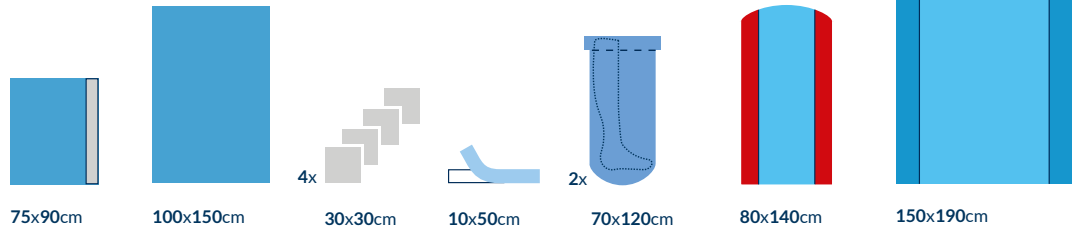

## AT-S-CYST1-S CYSTOSCOPY SET 1

quantity	dimensions	component
1 pc.	75cm x 90cm	drape with adhesive fenestration 6cm x 8cm
2 pcs	70cm x 120cm	limb cover
1 pc.	100cm x 150cm	instrument table cover, reinforced

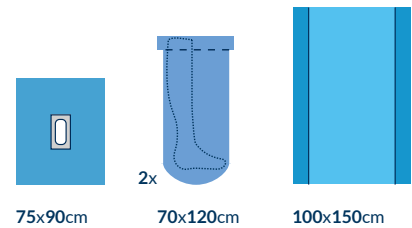

 bulk packaging:  
20 sets



## AT-S-UROG2-S URO/GYNAECOLOGY SET 2

quantity	dimensions	component
1 pc.	160cm x 180cm	drape with adhesive edge
1 pc.	75cm x 100cm	drape with adhesive fenestration 6cm x 14cm
1 pc.	10cm x 50cm	OP tape
2 pcs	70cm x 120cm	limb cover
1 pc.	80cm x 140cm	Mayo stand cover, reinforced - red
1 pc.	150cm x 190cm	instrument table cover, reinforced

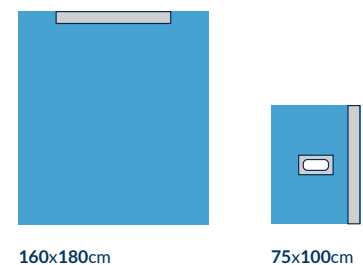

 bulk packaging:  
10 sets

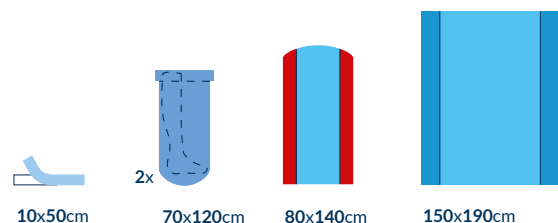



## AT-S-UROG3-S URO/GYNAECOLOGY SET 3

quantity	dimensions	component
1 pc.	75cm x 200cm	drape with adhesive diamond-shaped fenestration 8cm x 12cm
4 pcs	30cm x 30cm	absorbent towel
2 pcs	70cm x 120cm	limb cover
1 pc.	100cm x 150cm	instrument table cover, reinforced

bulk packaging:  
20 sets

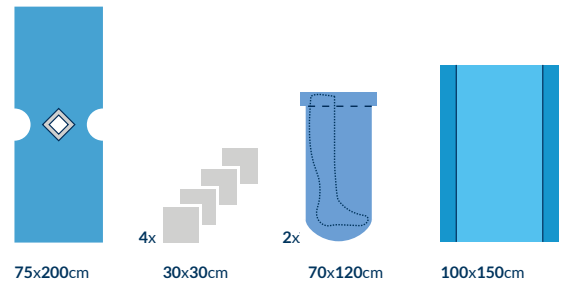

## AT-S-TUR1-IP-C TUR SET 1-IP

quantity	dimensions	component
1 pc.	190cm x 230cm	drape integrated with limb covers, adhesive abdominal fenestration $\varnothing$ 6cm and adhesive perineal fenestration $\varnothing$ 6cm, finger coat, fluid collection pouch with formable mold, filter and tubing port
4 pcs	30cm x 30cm	absorbent towel
1 pc.	10cm x 50cm	OP tape
1 pc.	150cm x 190cm	instrument table cover, reinforced

bulk packaging:  
12 sets

hydrophobic  
SMS material



made of two  
different materials

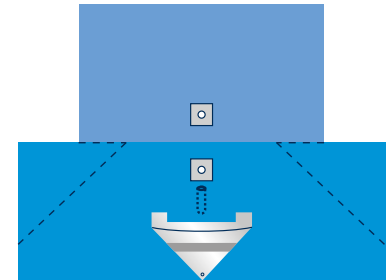

190x230cm

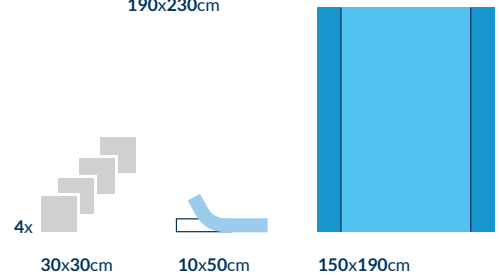

## AT-S-TUR2-IP-C TUR SET 2-IP BESTSELLER

quantity	dimensions	component
1 pc.	175cm x 240cm	drape with integrated leggings, abdominal fenestration, perineal fenestration with finger coat and fluid collection pouch
2 pcs	30cm x 30cm	absorbent towel
1 pc.	2cm x 22cm	surgical tape, Velcro type
1 pc.	150cm x 190cm	instrument table cover, reinforced

bulk packaging:  
15 sets

3-layer drapes  
PREMIUM

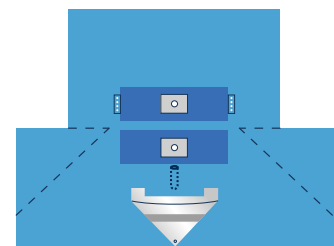

175x240cm

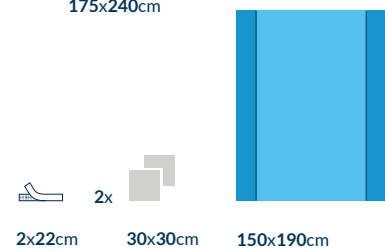

## AT-S-TUR3-IP-S TUR SET 3-IP

quantity	dimensions	component
1 pc.	210cm x 270cm	drape with integrated leggings, abdominal fenestration, perineal fenestration with finger coat and fluid collection pouch
2 pcs	30cm x 30cm	absorbent towel
1 pc.	2cm x 22cm	surgical tape, Velcro type
1 pc.	150cm x 190cm	instrument table cover, reinforced

bulk packaging:  
10 sets

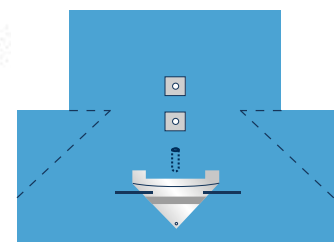

210x270cm

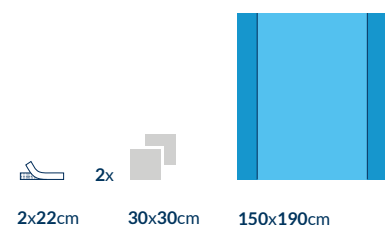

**AT-S-PCNL1-IP-S PERCUTANEOUS LITHOTRIPSY SET 1-IP**



quantity	dimensions	component
1 pc.	180cm x 300cm	drape with adhesive fenestration 21,5cm x 24cm, integrated with long fluid collection pouch
1 pc.	150cm x 190cm	instrument table cover, reinforced

bulk packaging: 12 sets

kidney stone removal set

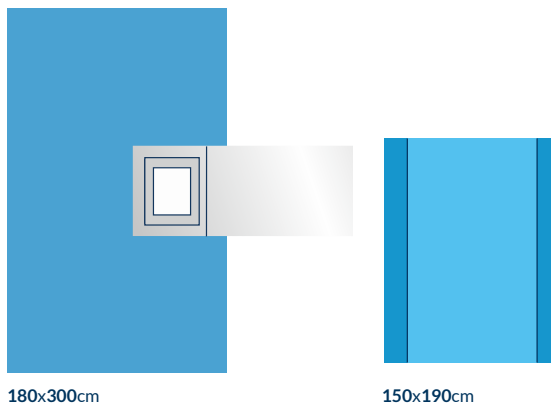

180x300cm

150x190cm

**OBSTETRICS**

**AT-S-CSEC1-IP-C C-SECTION SET 1-IP**

quantity	dimensions	component
1 pc.	200cm x 320cm	drape with adhesive fenestration 25cm x 30cm, integrated with fluid collection pouch 75cm x 85cm with tubing ports
4 pcs	30cm x 30cm	absorbent towel
1 pc.	10cm x 50cm	OP tape
1 pc.	75cm x 80cm	absorbent baby towel
1 pc.	80cm x 145cm	Mayo stand cover, reinforced - red
1 pc.	150cm x 190cm	instrument table cover, reinforced

bulk packaging: 10 sets

hydrophobic SMS material

fluid collection pouch 360°

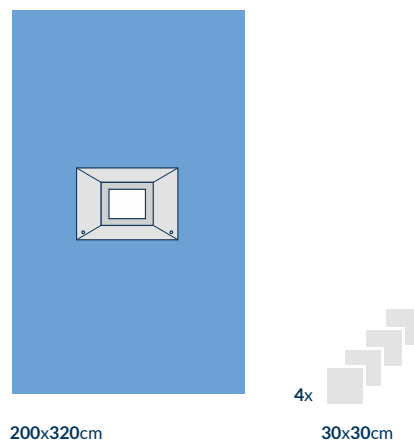

200x320cm

4x

30x30cm

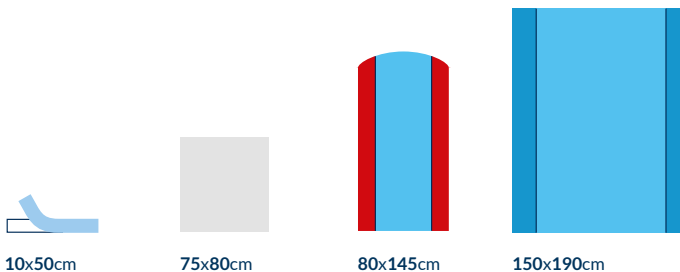

10x50cm

75x80cm

80x145cm

150x190cm

**AT-S-CSEC1-IF-IP-C C-SECTION SET 1-IF-IP**

quantity	dimensions	component
1 pc.	200cm x 320cm	drape with adhesive fenestration 25cm x 30cm filled with an incise film, integrated with fluid collection pouch 75cm x 85cm with tubing ports
4 pcs	30cm x 30cm	absorbent towel
1 pc.	10cm x 50cm	OP tape
1 pc.	75cm x 80cm	absorbent baby towel
1 pc.	80cm x 145cm	Mayo stand cover, reinforced - red
1 pc.	150cm x 190cm	instrument table cover, reinforced

 bulk packaging: 10 sets  
 hydrophobic SMS material  
 fluid collection pouch 360°

 **STERILE R**  
 LATEX  
 PHT  
 5 YEARS SHELF LIFE

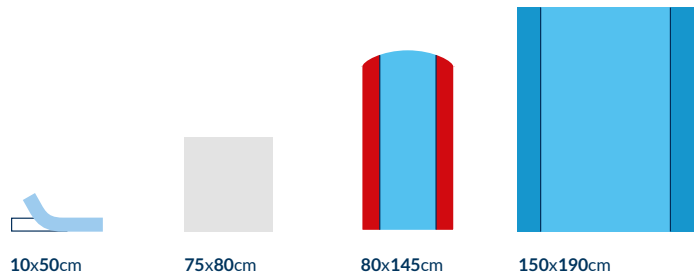
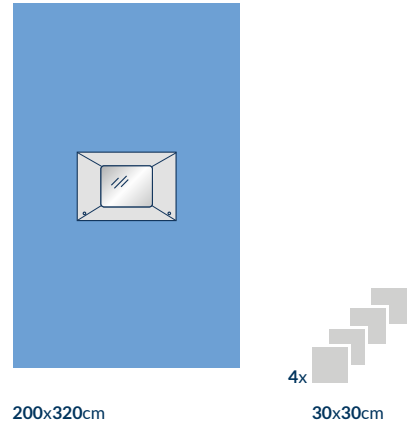

**AT-S-CSEC2-IF-IP-C C-SECTION SET 2-IF-IP**

quantity	dimensions	component
1 pc.	200cm x 320cm	drape with adhesive fenestration 25cm x 30cm filled with an incise film, integrated with fluid collection pouch 75cm x 85cm with tubing ports
4 pcs	30cm x 30cm	absorbent towel
1 pc.	10cm x 50cm	OP tape
1 pc.	2cm x 22cm	surgical tape, Velcro type
1 pc.	75cm x 80cm	absorbent baby towel
10 pcs	40cm x 40cm	gauze lap sponge with X-ray thread and belt
20 pcs	30cm x 30cm	gauze ball
1 pc.	L	surgical gown STANDARD
3 pcs	XL	surgical gown STANDARD
1 pc.	80cm x 140cm	Mayo stand cover, reinforced - red
1 pc.	150cm x 190cm	instrument table cover, reinforced

 bulk packaging: 6 sets  
 hydrophobic SMS material  
 fluid collection pouch 360°  
 ☆☆☆ PREMIUM set

 **STERILE R**  
 LATEX  
 PHT  
 5 YEARS SHELF LIFE

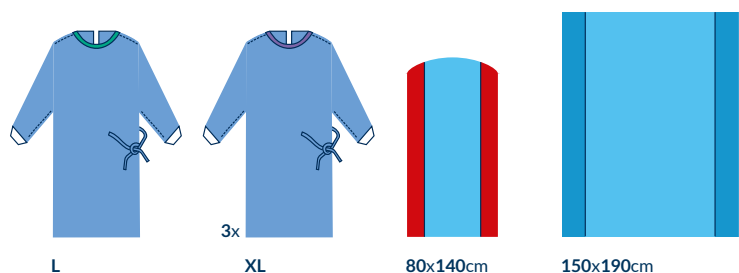
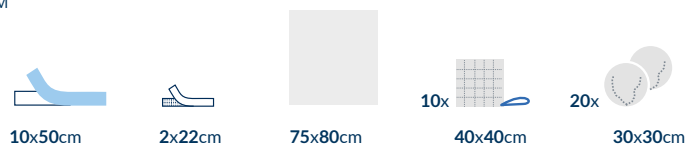
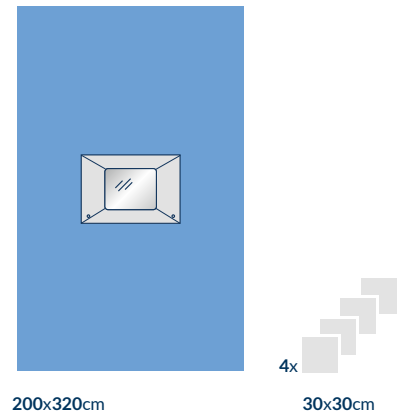

**AT-S-CSEC3-IF-SP/AT-S-CSEC3-IF-IP-SP C-SECTION SET 3-IF/3-IF-IP**

quantity	dimensions	component
1 pc.	180/240cm x 215cm	drape integrated with limb covers, adhesive fenestration 23,5cm x 23,5cm x 22,5cm x 33cm filled with an incise film, integrated with fluid collection pouch 56cm x 80cm with tubing port, reinforced
4 pcs	30cm x 30cm	absorbent towel
1 pc.	10cm x 50cm	OP tape
1 pc.	75cm x 80cm	absorbent baby towel
1 pc.	80cm x 140cm	Mayo stand cover, reinforced - red
1 pc.	150cm x 190cm	instrument table cover, reinforced

bulk packaging:  
10 sets

highly absorbent  
material

**STERILE R**   

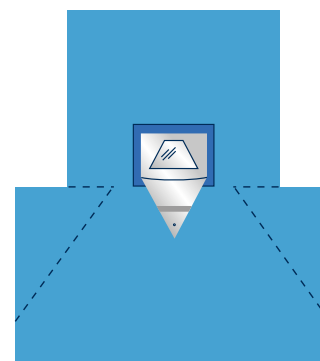

180/240x215cm

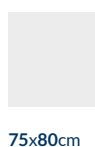

75x80cm



4x  
30x30cm



10x50cm



80x140cm

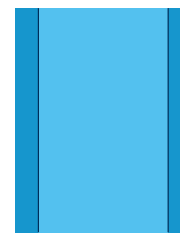

150x190cm

**AT-S-DEL1-S DELIVERY SET 1**

quantity	dimensions	component
1 pc.	90cm x 120cm	drape without adhesive edge
2 pcs	30cm x 30cm	absorbent towel
3 pcs	75cm x 80cm	absorbent baby towel
1 pc.	60cm x 90cm	absorbent underpad
1 pc.	80cm x 130cm	foil apron
2 pcs	-	umbilical cord clamp

bulk packaging:  
20 sets

**STERILE R**   



90x120cm



2x  
30x30cm



3x  
75x80cm



60x90cm



80x130cm



2x

**AT-S-DEL2-S DELIVERY SET 2**

quantity	dimensions	component
2 pcs	90cm x 120cm	drape without adhesive edge
6 pcs	30cm x 30cm	absorbent towel
1 pc.	75cm x 80cm	absorbent baby towel
2 pcs	60cm x 90cm	absorbent underpad

bulk packaging:  
20 sets

**STERILE R**   



2x  
90x120cm



6x  
30x30cm



75x80cm



2x  
60x90cm

**AT-S-DEL3-S**
**DELIVERY SET 3**

quantity	dimensions	component
1 pc.	90cm x 120cm	drape without adhesive edge
2 pcs	30cm x 30cm	absorbent towel
3 pcs	75cm x 80cm	absorbent baby towel
1 pc.	60cm x 90cm	absorbent underpad
1 pc.	80cm x 130cm	foil apron
2 pcs	-	umbilical cord clamp
10 pcs	30cm x 30cm	gauze ball



bulk packaging:  
15 sets

**STERILE R**



90x120cm



2x  
30x30cm



3x  
75x80cm



60x90cm



80x130cm



2x



10x

30x30cm

**AT-S-DEL4-S**
**DELIVERY SET 4**

quantity	dimensions	component
2 pcs	90cm x 120cm	drape without adhesive edge
6 pcs	30cm x 30cm	absorbent towel
1 pc.	75cm x 80cm	absorbent baby towel
1 pc.	60cm x 90cm	absorbent underpad
1 pc.	80cm x 130cm	foil apron
2 pcs	-	umbilical cord clamp



bulk packaging:  
22 sets

**STERILE R**



2x  
90x120cm



6x  
30x30cm



75x80cm



60x90cm



80x130cm



2x

**AT-S-DEL5-SP**
**DELIVERY SET 5**

quantity	dimensions	component
1 pc.	114cm x 150cm	delivery drape integrated with fluid collection pouch 78cm x 80cm with formable mold, filter and tubing port, reinforced
2 pcs	30cm x 30cm	absorbent towel
1 pc.	75cm x 80cm	absorbent baby towel
1 pc.	150cm x 190cm	instrument table cover, reinforced



bulk packaging:  
18 sets

**STERILE R**

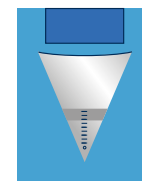

114x150cm



2x  
30x30cm



75x85cm

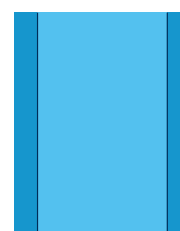

150x190cm

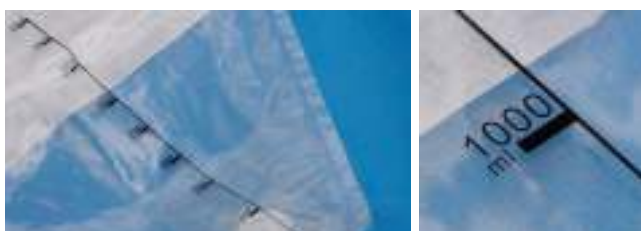

pouch with a very large scale



# OPHTHALMOLOGY

## AT-S-OPHT1-IF-C OPTHALMIC SET 1-IF

quantity	dimensions	component
1 pc.	100cm x 120cm	ophthalmic drape with fenestration 10cm x 10cm filled with an incise film, integrated with 2 fluid collection pouches and with 1 formable molder, reinforced
1 pc.	35cm x 75cm	armboard cover
1 pc.	100cm x 150cm	instrument table cover, reinforced
1 pc.	M	surgical gown STANDARD
1 pc.	L	surgical gown STANDARD

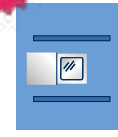

100x120cm

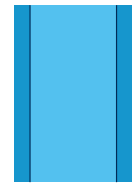

100x150cm



M

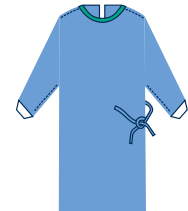

L



35x75cm

bulk packaging:  
10 sets

hydrophobic  
SMS material

STERILE R



## AT-S-OPHT2-IF-C OPTHALMIC SET 2-IF

quantity	dimensions	component
1 pc.	120cm x 170cm	ophthalmic drape with fenestration 10cm x 10cm filled with an incise film, integrated with 2 fluid collection pouches and with 1 formable molder, reinforced
2 pcs	30cm x 30cm	absorbent towel
1 pc.	40cm x 65cm	Phaco tray cover
2 pcs	35cm x 75cm	armboard cover
1 pc.	80cm x 145cm	Mayo stand cover, reinforced - red
1 pc.	150cm x 190cm	instrument table cover, reinforced



120x170cm



2x 30x30cm

bulk packaging:  
12 sets

hydrophobic  
SMS material

STERILE R



40x65cm



2x 35x75cm



80x145cm

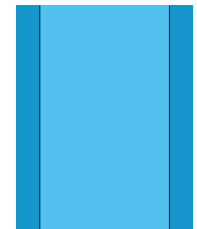

150x190cm

## AT-S-OPHT3-IF-C OPTHALMIC SET 3-IF

quantity	dimensions	component
1 pc.	140cm x 240cm	ophthalmic drape with fenestration 10cm x 10cm filled with an incise film, integrated with 2 fluid collection pouches and with 1 formable molder, reinforced
4 pcs	30cm x 30cm	absorbent towel
1 pc.	40cm x 65cm	Phaco tray cover
2 pcs	35cm x 75cm	armboard cover
1 pc.	L	surgical gown STANDARD
1 pc.	XL	surgical gown STANDARD
1 pc.	80cm x 145cm	Mayo stand cover, reinforced - red
1 pc.	150cm x 190cm	instrument table cover, reinforced



140x240cm



4x 30x30cm



40x65cm

bulk packaging:  
10 sets

hydrophobic  
SMS material

☆☆☆  
PREMIUM  
set

STERILE R



2x 35x75cm



L

XL



80x145cm

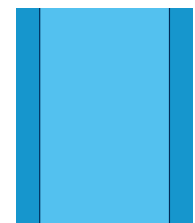

150x190cm



# NEUROSURGERY AND OTOLARYNGOLOGY

## AT-S-OTOL1-C OTOLARYNGOLOGY SET 1

quantity	dimensions	component
1 pc.	200cm x 280cm	drape with adhesive fenestration ø 10cm, reinforced
2 pcs	30cm x 30cm	absorbent towel
1 pc.	10cm x 50cm	OP tape
1 pc.	150cm x 190cm	instrument table cover, reinforced

bulk packaging:  
20 sets

hydrophobic  
SMS material

highly absorbent  
material

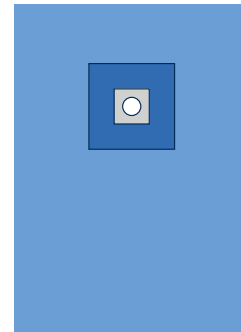

200x280cm

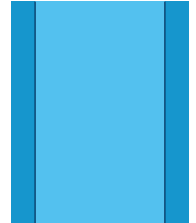

150x190cm

STERILE R



## AT-S-OTOL2-C OTOLARYNGOLOGY SET 2

quantity	dimensions	component
1 pc.	150cm x 200cm	drape with adhesive U-split 6cm x 65cm, reinforced
1 pc.	150cm x 180cm	drape with adhesive edge
1 pc.	75cm x 90cm	drape with adhesive edge
4 pcs	30cm x 30cm	absorbent towel
1 pc.	10cm x 50cm	OP tape
1 pc.	80cm x 145cm	Mayo stand cover, reinforced - red
1 pc.	150cm x 190cm	instrument table cover, reinforced

bulk packaging:  
12 sets

hydrophobic  
SMS material

highly absorbent  
material

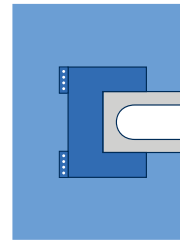

150x200cm

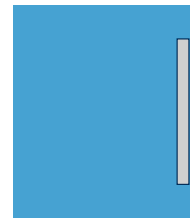

150x180cm

STERILE R



75x90cm

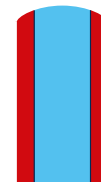

80x145cm

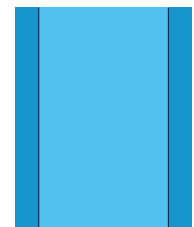

150x190cm

## AT-S-CRA1-IF-IP-SP CRANIOTOMY SET 1-IF-IP

quantity	dimensions	component
1 pc.	230cm x 300cm	drape with adhesive fenestration 24cm x 34cm filled with anincise film, with fluid collection pouch, reinforced
4 pcs	50cm x 50cm	drape with adhesive edge
2 pcs	30cm x 30cm	absorbent towel
1 pc.	10cm x 50cm	OP tape
1 pc.	2cm x 25cm	surgical tape, velcro type
1 pc.	80cm x 145cm	Mayo stand cover, reinforced
1 pc.	150cm x 190cm	instrument table cover, reinforced

bulk packaging:  
16 sets

head surgery

highly absorbent  
material

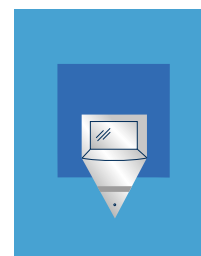

230x300cm



4x 50x50cm

STERILE R



2x25cm



80x145cm

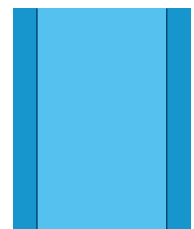

150x190cm



# CARDIOSURGERY AND ANGIOGRAPHY

## AT-S-ABL1-IF-SP ABLATION SET 1-IF

quantity	dimensions	component
1 pc.	180cm x 305cm	drape with 2 adhesive fenestrations 12cm x 15cm filled with an incise film, reinforced
2 pcs	30cm x 30cm	absorbent towel
1 pc.	ø 80cm	circular banded cover for medical equipment
1 pc.	XL	surgical gown STANDARD
1 pc.	150cm x 190cm	instrument table cover, reinforced

 bulk packaging:  
12 sets

 highly absorbent  
material

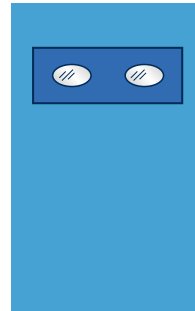

180x305cm



80x80cm



XL



2x

30x30cm

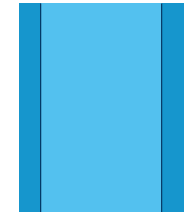

150x190cm

## AT-S-ANG2-C ANGIOGRAPHY SET 2

quantity	dimensions	component
1 pc.	220cm x 320cm	drape with 2 adhesive fenestrations ø 10cm, integrated with transparent foil inserts protecting the control panel reinforced
1 pc.	10cm x 50cm	OP tape
1 pc.	XL	surgical gown STANDARD
1 pc.	100cm x 150cm	drape without adhesive edge
1 pc.	100cm x 150cm	instrument table cover, reinforced

 bulk packaging:  
10 sets

 hydrophobic  
SMS material

 highly absorbent  
material

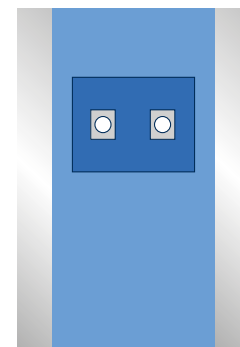

220x320cm



10x50cm

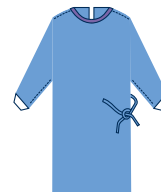

XL



100x150cm

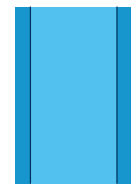

100x150cm

## AT-S-ANG3-SP ANGIOGRAPHY SET 3

quantity	dimensions	component
1 pc.	240cm x 350cm	drape with 2 adhesive femoral fenestrations ø 9,5cm and 2 adhesive radial fenestrations of 6cm x 9cm, integrated with transparent foil inserts protecting the control panel, reinforced
1 pc.	30cm x 30cm	absorbent towel
1 pc.	150cm x 190cm	instrument table cover, reinforced

 bulk packaging:  
20 sets

 hydrophobic  
SMS material

 highly absorbent  
material

 drape available  
in a Omegapack

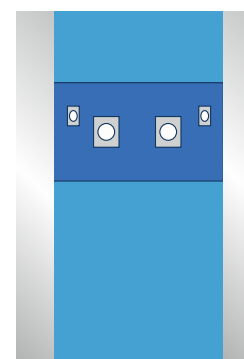

240x350cm



30x30cm

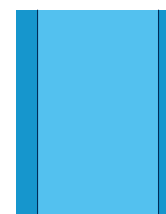

150x190cm



ZARYS

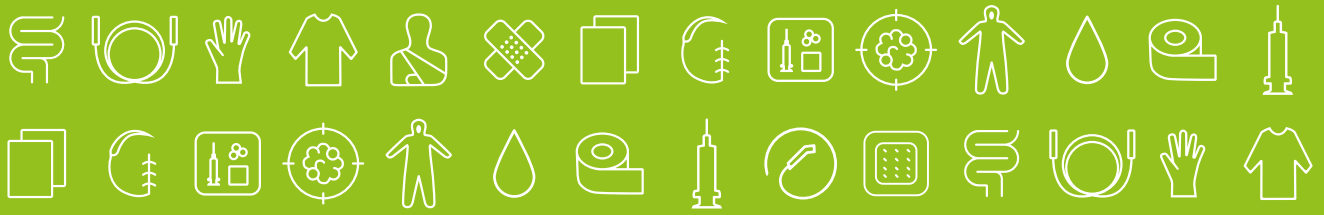

WWW.ZARYS.COM

# SURGICAL GOWNS

## STERILE GOWN NORMAL

REF	size	trimming	packaging unit
AT-SGN-L	L		1 pc.
AT-SGN-XL	XL		1 pc.

 bulk packaging:  
25 pcs

 includes  
**1 absorbent towel**  
40cm x 40cm

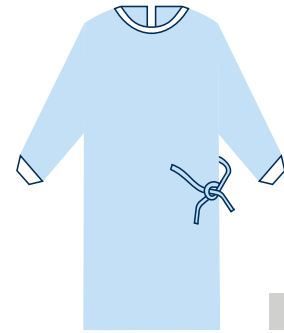

 22 g/m<sup>2</sup>



40x40cm

## STERILE SURGICAL GOWN STANDARD



REF	size	trimming	packaging unit
AT-SGS-M 1	M		1 pc.
AT-SGS-L 1	L		1 pc.
AT-SGS-XL 1	XL		1 pc.
AT-SGS-XXL 1	XXL		1 pc.
AT-SGS-XXXL 1	XXXL		1 pc.

 bulk packaging:  
25 pcs





 includes  
**2 absorbent towels**  
30cm x 30cm

 35 g/m<sup>2</sup>



2x  
30x30cm

## STERILE SURGICAL GOWN STANDARD

REF	size	trimming	packaging unit
AT-SGS-M 1E	M		1 pc.
AT-SGS-L 1E	L		1 pc.
AT-SGS-XL 1E	XL		1 pc.
AT-SGS-XXL 1E	XXL		1 pc.

 bulk packaging:  
25 pcs

 without  
**2 absorbent towels**  
30cm x 30cm

 economic  
version

 35 g/m<sup>2</sup>

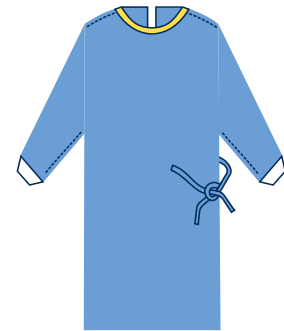

## STERILE SURGICAL GOWN STANDARD

REF	size	trimming	packaging unit
AT-SGS-M 2	M		1 pc.
AT-SGS-L 2	L		1 pc.
AT-SGS-XL 2	XL		1 pc.
AT-SGS-XXL 2	XXL		1 pc.

 bulk packaging:  
25 pcs

 includes  
**2 absorbent towels**  
30cm x 30cm

 40 g/m<sup>2</sup>

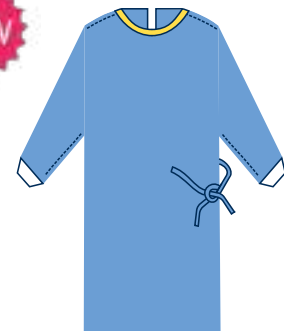

2x  
30x30cm

## STERILE SURGICAL GOWN STANDARD

REF	size	trimming	packaging unit
AT-SGS-M	M		1 pc.
AT-SGS-L	L		1 pc.
AT-SGS-XL	XL		1 pc.
AT-SGS-XXL	XXL		1 pc.

 bulk packaging:  
25 pcs

 includes  
**2 absorbent towels**  
30cm x 30cm

 45 g/m<sup>2</sup>

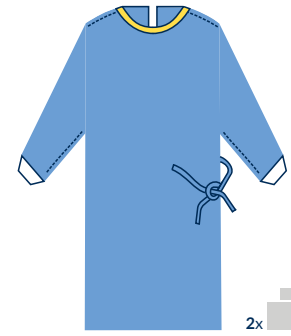





2x   
30x30cm



## STERILE SURGICAL GOWN STANDARD PLUS



REF	size	trimming	packaging unit
AT-SGSP-M 1	M		1 pc.
AT-SGSP-L 1	L		1 pc.
AT-SGSP-XL 1	XL		1 pc.
AT-SGSP-XXL 1	XXL		1 pc.
AT-SGSP-XXXL 1	XXXL		1 pc.

 bulk packaging:  
25 pcs

 includes  
**2 absorbent towels**  
30cm x 30cm





 35 g/m<sup>2</sup>



2x   
30x30cm



## STERILE SURGICAL GOWN STANDARD PLUS

REF	size	trimming	packaging unit
AT-SGSP-M 1E	M		1 pc.
AT-SGSP-L 1E	L		1 pc.
AT-SGSP-XL 1E	XL		1 pc.
AT-SGSP-XXL 1E	XXL		1 pc.

 bulk packaging:  
25 pcs





 without  
**2 absorbent towels**  
30cm x 30cm

 economic  
version

 35 g/m<sup>2</sup>



## STERILE SURGICAL GOWN STANDARD PLUS

REF	size	trimming	packaging unit
AT-SGSP-M 2	M		1 pc.
AT-SGSP-L 2	L		1 pc.
AT-SGSP-XL 2	XL		1 pc.
AT-SGSP-XXL 2	XXL		1 pc.

 bulk packaging:  
25 pcs

 includes  
**2 absorbent towels**  
30cm x 30cm

 40 g/m<sup>2</sup>



**NEW**

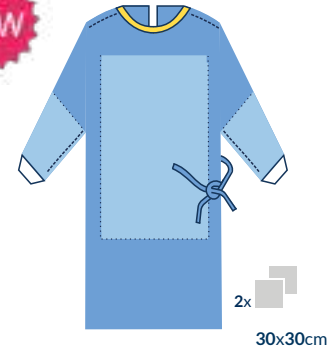

## STERILE SURGICAL GOWN STANDARD PLUS

REF	size	trimming	packaging unit
AT-SGSP-M	M		1 pc.
AT-SGSP-L	L		1 pc.
AT-SGSP-XL	XL		1 pc.
AT-SGSP-XXL	XXL		1 pc.

 bulk packaging:  
25 pcs

 includes  
**2 absorbent towels**  
30cm x 30cm

 45 g/m<sup>2</sup>

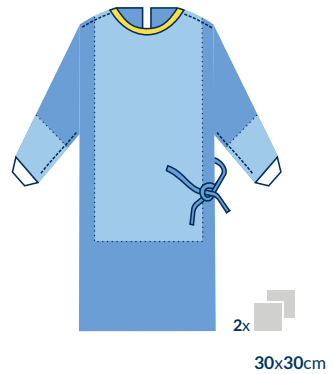

## STERILE SURGICAL GOWN EXTRA SAFE

 **BESTSELLER**

REF	size	trimming	packaging unit
AT-SGES-XXL 1	XXL		1 pc.

 bulk packaging:  
25 pcs



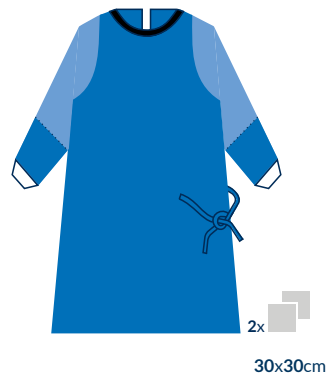

 includes  
**2 absorbent towels**  
30cm x 30cm

 extended  
style

 35 g/m<sup>2</sup>



## STERILE SURGICAL GOWN COMFORT

REF	size	trimming	packaging unit
AT-SGC-M	M		1 pc.
AT-SGC-L	L		1 pc.
AT-SGC-XL	XL		1 pc.
AT-SGC-XXL	XXL		1 pc.

 bulk packaging:  
25 pcs

 includes  
**2 absorbent towels**  
30cm x 30cm

 68 g/m<sup>2</sup>

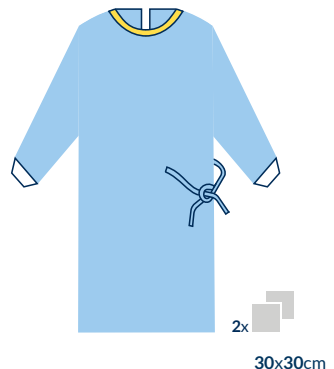

## STERILE SURGICAL GOWN COMFORT PLUS

REF	size	trimming	packaging unit
AT-SGCP-M	M		1 pc.
AT-SGCP-L	L		1 pc.
AT-SGCP-XL	XL		1 pc.
AT-SGCP-XXL	XXL		1 pc.

bulk packaging:  
25 pcs

includes  
**2 absorbent towels**  
30cm x 30cm

68 g/m<sup>2</sup>

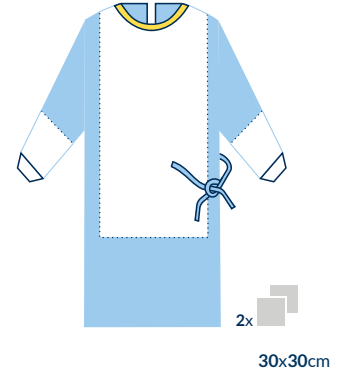

## NON-STERILE SURGICAL GOWNS

### NON-STERILE SURGICAL GOWN STANDARD

REF	size	trimming	packaging unit
AT-NS-SGS-M 1E	M		1 pc.
AT-NS-SGS-L 1E	L		1 pc.
AT-NS-SGS-XL 1E	XL		1 pc.
AT-NS-SGS-XXL 1E	XXL		1 pc.

bulk packaging:  
50 pcs

35 g/m<sup>2</sup>

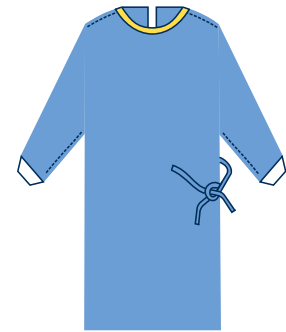

### NON-STERILE SURGICAL GOWN PREMIUM

REF	size	trimming	packaging unit
AT-NS-SGP-L 1E	L		10 pcs
AT-NS-SGP-XL 1E	XL		10 pcs

bulk packaging:  
10 x 10 pcs

fully reinforced  
PP+PE

meet the standards  
of EN 14126

35 g/m<sup>2</sup>

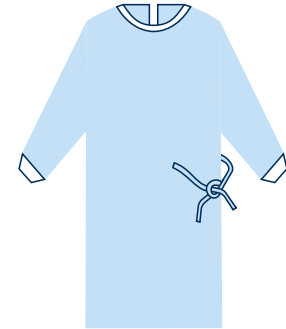





# medical clothing

medical gowns | surgical clothing |  
caps and protective masks | patient  
clothing | shoe covers | bedclothes  
and absorbent underpads



ZARYS

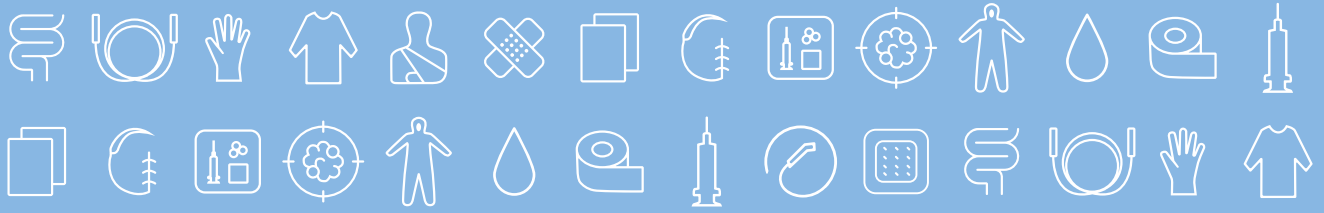

WWW.ZARYS.COM



# MEDICAL GOWNS



# ISOLATION GOWN

## with elastic cuffs, non-woven

### features

- made of polypropylene non-woven 20 g/m<sup>2</sup>, 25 g/m<sup>2</sup>, 30 g/m<sup>2</sup> or 40 g/m<sup>2</sup>
- ties at waist and neck
- long sleeves with elastic cuffs
- breathable
- available sizes: L, XL
- single-use

REF	grammage	size	colour	packaging unit
BT-019-20B3-L	20 g/m <sup>2</sup>	L	blue	10 pcs
BT-019-20B4-XL	20 g/m <sup>2</sup>	XL	blue	10 pcs
BT-019-20G3-L	20 g/m <sup>2</sup>	L	green	10 pcs
BT-019-20G4-XL	20 g/m <sup>2</sup>	XL	green	10 pcs
*BT-019-20W3-L	20 g/m <sup>2</sup>	L	white	10 pcs
BT-019-25B3-L	25 g/m <sup>2</sup>	L	blue	10 pcs
BT-019-25B4-XL	25 g/m <sup>2</sup>	XL	blue	10 pcs
BT-019-25G3-L	25 g/m <sup>2</sup>	L	green	10 pcs
BT-019-25G4-XL	25 g/m <sup>2</sup>	XL	green	10 pcs
*BT-019-25W3-L	25 g/m <sup>2</sup>	L	white	10 pcs
*BT-019-30W3-L	30 g/m <sup>2</sup>	L	white	10 pcs
*BT-019-30G3-L	30 g/m <sup>2</sup>	L	green	10 pcs
*BT-019-30G4-XL	30 g/m <sup>2</sup>	XL	green	10 pcs
*BT-019-30B3-L	30 g/m <sup>2</sup>	L	blue	10 pcs
*BT-019-40B3-L	40 g/m <sup>2</sup>	L	blue	10 pcs
*BT-019-40G3-L	40 g/m <sup>2</sup>	L	green	10 pcs



 bulk packaging:  
10 x 5 pcs

 available colours:  
  

 available  
on request



# ISOLATION GOWN

## with knitted cuffs, non-woven

### features

- made of polypropylene non-woven 20 g/m<sup>2</sup>, 25 g/m<sup>2</sup>, 30 g/m<sup>2</sup> or 40 g/m<sup>2</sup>
- ties at waist and neck
- long sleeves with knitted cuffs
- breathable
- available sizes: L, XL, XXL
- single-use

REF	grammage	size	colour	packaging unit
BT-015-20G3-L	20 g/m <sup>2</sup>	L	green	10 pcs
BT-015-20G4-XL	20 g/m <sup>2</sup>	XL	green	10 pcs
BT-015-25G3-L	25 g/m <sup>2</sup>	L	green	10 pcs
BT-015-25B3-L	25 g/m <sup>2</sup>	L	blue	10 pcs
BT-015-25G4-XL	25 g/m <sup>2</sup>	XL	green	10 pcs
BT-015-30G3-L	30 g/m <sup>2</sup>	L	green	10 pcs
BT-015-30G4-XL	30 g/m <sup>2</sup>	XL	green	10 pcs
BT-015-30G5-XXL	30 g/m <sup>2</sup>	XXL	green	10 pcs
BT-015-40G3-L	40 g/m <sup>2</sup>	L	green	10 pcs
BT-015-40B3-L	40 g/m <sup>2</sup>	L	blue	10 pcs
BT-015-40G4-XL	40 g/m <sup>2</sup>	XL	green	10 pcs



 bulk packaging:  
10 x 5 pcs

 available colours:  
 



ZARYS

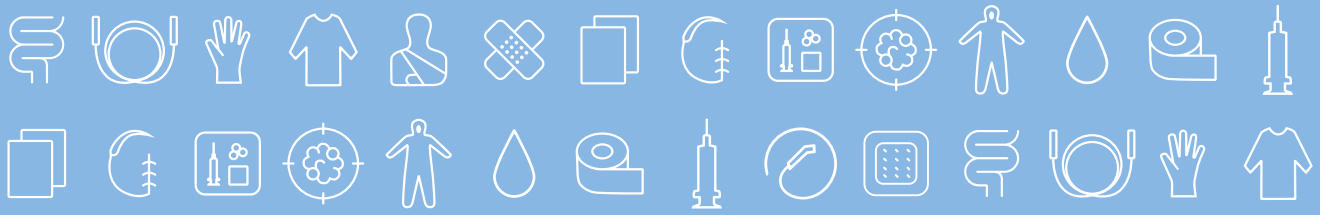

WWW.ZARYS.COM



# SURGICAL CLOTHING

# CLEAN AIR SUIT

single-use, non-woven

## features

- made of SMS non-woven 35 g/m<sup>2</sup>
- short-sleeved shirt with V-neck and 3 pockets
- trousers with guiding ties
- blue shirt and trousers available also in individual packaging
- single-use



### SET (SHIRT + TROUSERS)

REF	size	colour	packaging unit
BT-017-S35B1-S-SMS	S	blue	1 set
BT-017-S35B2-M-SMS	M	blue	1 set
BT-017-S35B3-L-SMS	L	blue	1 set
BT-017-S35B4-XL-SMS	XL	blue	1 set
BT-017-S35B5-XXL-SMS	XXL	blue	1 set
BT-017-S35B6-XXXL-SMS	XXXL	blue	1 set
BT-017-S35B7-XXXXL-SMS	XXXXL	blue	1 set
BT-017-S35G1-S-SMS	S	green	1 set
BT-017-S35G2-M-SMS	M	green	1 set
BT-017-S35G3-L-SMS	L	green	1 set
BT-017-S35G4-XL-SMS	XL	green	1 set
BT-017-S35G5-XXL-SMS	XXL	green	1 set
BT-017-S35V1-S-SMS	S	purple	1 set
*BT-017-S35V2-M-SMS	M	purple	1 set
*BT-017-S35V3-L-SMS	L	purple	1 set
*BT-017-S35V4-XL-SMS	XL	purple	1 set
*BT-017-S35V5-XXL-SMS	XXL	purple	1 set

### SHIRT

REF	size	colour	packaging unit
*BT-018-S35B1-S-SMS	S	blue	1 pc.
*BT-018-S35B2-M-SMS	M	blue	1 pc.
*BT-018-S35B3-L-SMS	L	blue	1 pc.
*BT-018-S35B4-XL-SMS	XL	blue	1 pc.
*BT-018-S35B5-XXL-SMS	XXL	blue	1 pc.

### TROUSERS

REF	size	colour	packaging unit
*BT-018-T35B1-S-SMS	S	blue	1 pc.
*BT-018-T35B2-M-SMS	M	blue	1 pc.
*BT-018-T35B3-L-SMS	L	blue	1 pc.
*BT-018-T35B4-XL-SMS	XL	blue	1 pc.
*BT-018-T35B5-XXL-SMS	XXL	blue	1 pc.

 bulk packaging:  
50 x 1 set

 available colours:  

 available  
on request



# SURGICAL SHIRT SHORT-SLEEVED

non-woven

## features

- made of soft polypropylene non-woven 47 g/m<sup>2</sup>
- short sleeves
- 3 big pockets
- **snap fastener at the neck**
- single-use

REF	size	packaging unit
BT-018-S47B0-XS-SOFT2	XS	1 pc.
BT-018-S47B1-S-SOFT2	S	1 pc.
BT-018-S47B2-M-SOFT2	M	1 pc.
BT-018-S47B3-L-SOFT2	L	1 pc.
BT-018-S47B4-XL-SOFT2	XL	1 pc.
BT-018-S47B5-XXL-SOFT2	XXL	1 pc.
BT-018-S47B6-XXXL-SOFT2	XXXL	1 pc.
BT-018-S47B7-XXXXL-SOFT2	XXXXL	1 pc.

 bulk packaging:  
50 x 1 pc.

 available colours:  



# SURGICAL SHIRT LONG-SLEEVED

non-woven

## features

- made of soft polypropylene non-woven 47 g/m<sup>2</sup>
- long sleeves with knitted cuffs
- 2 big pockets
- **snap fasteners at the front**
- single-use

REF	size	packaging unit
BT-018-O47B1-S-SOFT3	S	1 pc.
BT-018-O47B2-M-SOFT3	M	1 pc.
BT-018-O47B3-L-SOFT3	L	1 pc.
BT-018-O47B4-XL-SOFT3	XL	1 pc.
BT-018-O47B5-XXL-SOFT3	XXL	1 pc.

 bulk packaging:  
50 x 1 pc.

 available colours:  



# SURGICAL TROUSERS, WITH TIES

non-woven

## features

- made of soft polypropylene non-woven 47 g/m<sup>2</sup>
- trousers with guiding ties
- 1 big pocket with snap fastener
- single-use

REF	size	packaging unit
BT-018-T47B0-XS-SOFT1	XS	1 pc.
BT-018-T47B1-S-SOFT1	S	1 pc.
BT-018-T47B2-M-SOFT1	M	1 pc.
BT-018-T47B3-L-SOFT1	L	1 pc.
BT-018-T47B4-XL-SOFT1	XL	1 pc.
BT-018-T47B5-XXL-SOFT1	XXL	1 pc.
*BT-018-T47B6-XXXL-SOFT1	XXXL	1 pc.
*BT-018-T47B7-XXXXL-SOFT1	XXXXL	1 pc.

  
bulk packaging:  
50 x 1 pc.

  
available colours:  

  
\*  
available  
on request



ZARYS

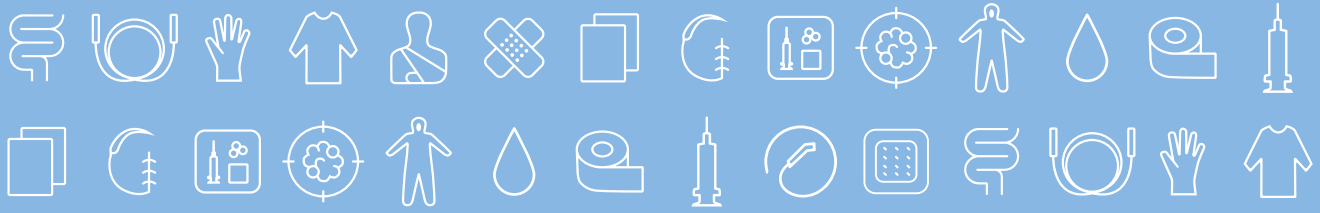

WWW.ZARYS.COM

# CAPS, PROTECTIVE MASKS AND CLOTHING

# SURGICAL BOUFFANT CAP

PP non-woven

## features

- cap with an elastic rubber band
- diameter: approx. 53 cm
- made of airy polypropylene non-woven
- excellent breathability and wearing comfort
- packaging: ergonomic cardboard box to remove individual pieces
- single-use

REF	colour	packaging unit
BT-008-18G	green	100 pcs
BT-008-18B	blue	100 pcs

 bulk packaging:  
10 x 100 pcs

 available colours:  
 



# DONA

## medical bouffant cap

## features

- cap with an elastic rubber band
- diameter: approx. 47 cm
- made of perforated viscose non-woven
- excellent breathability and wearing comfort
- packaging: ergonomic cardboard box to remove individual pieces
- single-use

REF	colour	packaging unit
BT-008-25G-B1-V	green	100 pcs
BT-008-25B-B1-V	blue	100 pcs
BT-008-25G-B1-V-XL	green	100 pcs

 bulk packaging:  
4 x 100 pcs

 available colours:  
 



# LILI

## medical cap with rubber

## features

- cap with an elastic rubber band in the back part
- made of perforated viscose non-woven
- excellent breathability and wearing comfort
- packaging: ergonomic cardboard box to remove individual pieces
- single-use

REF	colour	packaging unit
BT-001-25G-R1-V	green	100 pcs
BT-001-25B-R1-V	blue	100 pcs

 bulk packaging:  
6 x 100 pcs

 available colours:  
 



# POLA

## medical cap with rubber

### features

- cap with an elastic rubber band in the back part
- made of durable Spunlace and polypropylene non-woven
- the used non-woven is characterized by good absorption properties and durability and additionally it is pleasant to the touch, which increases comfort while using
- excellent breathability and wearing comfort
- packaging: ergonomic cardboard box to remove individual pieces
- single-use

REF	packaging unit
BT-001-45B-SPN	100 pcs

 bulk packaging:  
6 x 100 pcs

 available colours:  



# SOL

## medical cap with ties

### features

- cap with ties at the back
- made of perforated viscose non-woven
- excellent breathability and wearing comfort
- packaging: ergonomic cardboard box to remove individual pieces
- single-use

REF	colour	packaging unit
BT-007-25G-T1-V	green	100 pcs
BT-007-25B-T1-V	blue	100 pcs

 bulk packaging:  
6 x 100 pcs

 available colours:  
 



# ABI

## medical cap with ties

### features

- deep cap with ties at the back
- being folded out, the front part creates an additional layer protecting against sweat
- made of perforated viscose non-woven
- excellent breathability and wearing comfort
- packaging: ergonomic cardboard box to remove individual pieces
- single-use

REF	colour	packaging unit
BT-007-25G-T2-V	green	100 pcs
BT-007-25B-T2-V	blue	100 pcs

 bulk packaging:  
6 x 100 pcs

 available colours:  
 



# BEN

## medical cap with ties

### features

- forage cap with ties at the back
- made of perforated Spunlace Mesh non-woven
- excellent breathability and comfort of use
- single-use

REF	packaging unit
BT-007-35B-SPNM	100 pcs

 bulk packaging:  
10 x 100 pcs

 available colours:  





# NINO

## medical cap

### features

- cap without rubber or ties, designed for short-haired people
- two layers of non-woven fabric in the side part
- made of perforated viscose non-woven
- excellent breathability and wearing comfort
- packaging: ergonomic cardboard box to remove individual pieces
- single-use

REF	colour	packaging unit
BT-001-25G-D-V	green	100 pcs
BT-001-25B-D-V	blue	100 pcs

 bulk packaging:  
6 x 100 pcs

 available colours:  
 



# KOKO long

## medical cap with snood

### features

- cap with snood and elastic rubber band in the back part
- optimal protection for long-haired people
- made of perforated viscose non-woven
- excellent breathability and wearing comfort
- packaging: ergonomic cardboard box to remove individual pieces
- single-use

REF	colour	packaging unit
BT-001-25G-S1-V	green	100 pcs
BT-001-25B-S1-V	blue	100 pcs

 bulk packaging:  
6 x 100 pcs

 for long hair

 available colours:  
 



# DORA long

## medical cap with snood

### features

- cap with anti-sweat insert in the forehead area
- special design allows the cap to adjust to the shape of the head and keep one's hair in an excellent manner
- optimal protection for long-haired people
- made of Spunlace and polypropylene non-woven
- excellent breathability and wearing comfort
- packaging: ergonomic cardboard box to remove individual pieces
- single-use

REF	packaging unit
BT-001-45B-S-SPN	50 pcs

 bulk packaging:  
6 x 50 pcs

 anti-sweat insert

 for long hair

 available colours:  



# TOM

## medical cap with ties

### features

- cap with ties at the back
- anti-sweat insert on the whole circumference
- made of polypropylene non-woven 20 g/m<sup>2</sup>
- packaging: ergonomic cardboard box to remove individual pieces
- single-use

REF	packaging unit
BT-007-P20G	100 pcs

 bulk packaging:  
10 x 100 pcs

 anti-sweat insert

available colours: 



# ROS

## medical cap with ties

### features

- cap with ties at the back
- anti-sweat insert in the forehead area
- made of Spunlace and polypropylene non-woven
- packaging: ergonomic cardboard box to remove individual pieces
- single-use

REF	packaging unit
BT-007-P45B	50 pcs

 bulk packaging:  
6 x 50 pcs

 anti-sweat insert

available colours: 



# NURSE'S CAP CLIP TYPE

### features

- made of airy polypropylene non-woven 12 g/m<sup>2</sup>
- cap with an elastic rubber band
- diameter: approx. 53 cm
- provides comfort of wearing
- available colours: blue, green, white
- single-use

REF	.....colour	packaging unit
BT-001-12G-H1-PP	green	100 pcs
BT-001-12B-H1-PP	blue	100 pcs
BT-001-12W-H1-PP	white	100 pcs

 bulk packaging:  
20 x 100 pcs

available colours:   



## MAYA

### medical cap with rubber

#### features

- made of polypropylene non-woven 30 g/m<sup>2</sup>
- forage cap
- cap with an elastic rubber band in the back part
- packaging: ergonomic cardboard box to remove individual pieces
- single-use

REF	packaging unit
BT-007-30C-R1-PP	100 pcs

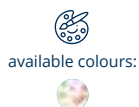

## OLAF

### medical cap with ties

#### features

- made of polypropylene non-woven 30 g/m<sup>2</sup>
- forage cap
- cap with ties at the back
- packaging: ergonomic cardboard box to remove individual pieces
- single-use

REF	packaging unit
BT-007-30C-T1-PP	100 pcs

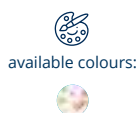

# MEDICAL MASK

## with ties

### features

- made of three layers of dust-free and hypoallergenic non-woven
- modelling nose-piece
- protects operative field against exfoliated epidermis, hair and droplet infections
- provides effective protection in patients against infections transmitted from personnel's mouths and noses
- packaging: ergonomic cardboard box to remove individual pieces
- single-use

REF	colour	packaging unit
BT-046-32G	green	50 pcs
BT-046-32B	blue	50 pcs



 bulk packaging:  
20 x 50 pcs

 three layers

 type II  
as per EN 14683

 available colours:  



# MEDICAL MASK

## with earloops

### features



- made of three layers of non-woven
- modeling nose-piece
- bacteria filtration efficiency BFE ≥ 98%
- packaging: ergonomic cardboard box to remove individual pieces
- single-use

REF	colour	type in accordance with the standard EN 14683	packaging unit
BT-046-31C	pattern	type II	50 pcs



 bulk packaging:  
20 x 50 pcs

 three layers

 available colours:  



# MEDICAL MASK

## with earloops

### features

- made of three layers of dust-free and hypoallergenic non-woven
- modelling nose-piece
- splash resistant
- protects operative field against exfoliated epidermis, hair and droplet infections
- provides effective protection in patients against infections transmitted from personnel's mouths and noses
- packaging: ergonomic cardboard box to remove individual pieces
- single-use

REF	colour	type in accordance with the standard EN 14683	packaging unit
BT-046-31G	green	type II	50 pcs
BT-046-31B	blue	type II	50 pcs
BT-046-R31B	blue	type II R	50 pcs



 bulk packaging:  
20 x 50 pcs

 three layers

 available colours:  



# PE gloves

## features

- made of polyethylene
- coarse surface and tear-resistant weld
- ambidextrous
- elongation min. 130%, tensile strength min. 10 MPa
- approved for contact with food
- single-use
- packaging: 100 pcs/foil bag enabling individual removal of gloves

## indication

- intended for use as a contribution to other gloves (double-gloving) and for minimally invasive procedures such as drug preparation, feeding the patient



REF	size	length
BS-RF-M	M (women)	280 mm
BS-RF-L	L (men)	300 mm



bulk packaging:  
100 x 100 pcs



# PE oversleeves

## features

- made of polyethylene
- ended with a rubber band on bot sides
- colour: blue
- approved for contact with food
- disposable

REF	dimensions	weight	unit packaging
BS-ZF01	22 x 40 cm	2,6 g	100 pcs



ZARYS

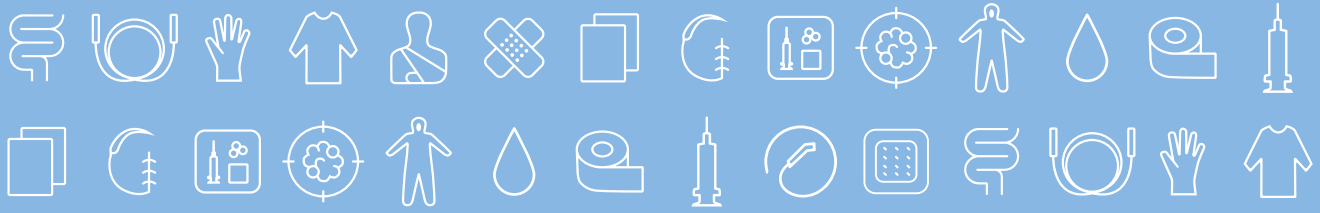

WWW.ZARYS.COM



# PATIENT CLOTHING

## PATIENT'S GOWN

### tied-up, non-woven

#### features

- made of SMS non-woven
- short sleeves
- white ties at waist and neck
- easy putting on and taking off in bed-ridden patients
- universal size
- single-use

REF	material	size	grammage	colour	packaging unit
BT-0022-33B-SMS	SMS non-woven	universal	33 g/m <sup>2</sup>	blue	10 pcs

 bulk packaging:  
10 x 10 pcs

available colours:  



## PATIENT'S GOWN

### Y-neck, non-woven

#### features

- made of polypropylene non-woven
- short sleeves and Y-neck
- slipover
- single-use

REF	material	size	grammage	colour	packaging unit
BT-0022-40DB-PP	PP non-woven	universal	40 g/m <sup>2</sup>	dark blue	10 pcs
BT-0022-40DG-PP	PP non-woven	universal	40 g/m <sup>2</sup>	dark green	10 pcs

 bulk packaging:  
10 x 10 pcs

available colours:  





## PATIENT'S GOWN

### V-neck, non-woven

#### features

- made of Spunlace non-woven
- the used non-woven is characterized by good absorption properties and durability and additionally it is pleasant to the touch, which increases comfort while wearing
- short sleeves and V-neck
- slipover
- single-use

REF	material	size	grammage	colour	packaging unit
BT-0022-45W-SPN	Spunlace non-woven	universal	45 g/m <sup>2</sup>	white	10 pcs
BT-0022-45B-SPN	Spunlace non-woven	universal	45 g/m <sup>2</sup>	blue	10 pcs

 pleasant for the skin

 bulk packaging:  
10 x 10 pcs

available colours:  



## PATIENT'S GOWN

for delivery, SMS non-woven

### features

- made of SMS non-woven
- short sleeves, ties at waist and neck (other models available on request)
- available in 5 sizes: S, M, L, XL, XXL
- single-use

REF	material	size	grammage	packaging unit
BT-0022-35B-SMS-DM-001-S	SMS non-woven	S	35 g/m <sup>2</sup>	10 pcs
BT-0022-35B-SMS-DM-001-M	SMS non-woven	M	35 g/m <sup>2</sup>	10 pcs
BT-0022-35B-SMS-DM-001-L	SMS non-woven	L	35 g/m <sup>2</sup>	10 pcs
BT-0022-35B-SMS-DM-001-XL	SMS non-woven	XL	35 g/m <sup>2</sup>	10 pcs
BT-0022-35B-SMS-DM-001-XXL	SMS non-woven	XXL	35 g/m <sup>2</sup>	10 pcs



## PATIENT'S GOWN, FOR CHILDREN

non-woven

### features

- made of SMS non-woven 35 g/m<sup>2</sup>
- white ties at waist and neck
- single-use

REF	size	grammage	packaging unit
BT-0022-35B-SMS-D1	72 cm x 100 cm	35 g/m <sup>2</sup>	10 pcs



## COLONOSCOPY BOXERS

SMS non-woven

### features

- made of SMS non-woven 35 g/m<sup>2</sup>
- boxers with a slit in the back part
- completely opaque
- single-use

REF	material	size	grammage	packaging unit
BT-0023-35B-SMS	SMS non-woven	universal	35 g/m <sup>2</sup>	10 pcs
BT-0023-35B-SMS-XL	SMS non-woven	XL	35 g/m <sup>2</sup>	10 pcs





# COLONOSCOPY BOXERS

PP non-woven

## features

- made of polypropylene non-woven 40 g/m<sup>2</sup>
- boxers with a slit in the back part
- single-use

REF	material	size	grammage	packaging unit
BT-0023-40DB	PP non-woven	universal	40 g/m <sup>2</sup>	10 pcs

 bulk packaging:  
10 x 10 pcs

available colours:  



# GYNECOLOGICAL SKIRT

non-woven

## features

- made of polypropylene non-woven 40 g/m<sup>2</sup>
- dimensions: 160 cm (at the waist after stretching)
- single-use

REF	material	size	grammage	packaging unit
BT-0025-40DB	PP non-woven	universal	40 g/m <sup>2</sup>	10 pcs
BT-0025-40DG	PP non-woven	universal	40 g/m <sup>2</sup>	10 pcs

 bulk packaging:  
10 x 10 pcs

available colours:  



# ANTI- THROMBOSIS COMPRESSION STOCKINGS

## features

- raw material: polyamide, elastane
- colour: white with color-coding on the heel
- cuff: silicone topband
- compression CCL1: 18mmHg with compression gradient
- reusable, for one patient only

## indication

- for thromboprophylaxis in patients with limited mobility, used before, after and during surgical procedures (perioperative)

REF	size	packaging unit	intermediate packaging
CS1W18AG-XS	XS	1 pair	10 pairs
CS1W18AG-S	S	1 pair	10 pairs
CS1W18AG-M	M	1 pair	10 pairs
CS1W18AG-L	L	1 pair	10 pairs
CS1W18AG-XL	XL	1 pair	10 pairs
CS1W18AG-XXL	XXL	1 pair	10 pairs



 bulk packaging:  
4 x 10 pcs

available colours:  



OEKO-TEX®  
CONFIDENCE IN TEXTILES  
STANDARD 100



ZARYS

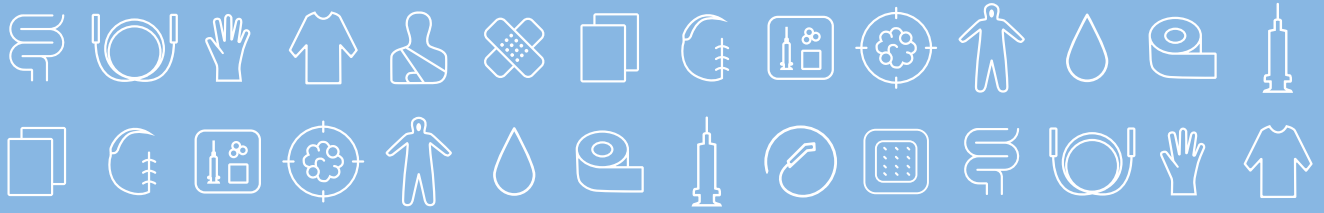

WWW.ZARYS.COM



# SHOE COVERS

# SHOE COVERS

## features

- made of polyethylene or polypropylene non-woven 30 g/m<sup>2</sup> or 40 g/m<sup>2</sup> (for shoe covers with anti-skid layer)
- elastic rubber band at the opening
- protection against contaminating rooms where higher cleanliness standards are required
- increased durability
- single-use



REF	material	grammage	size	colour	packaging unit	bulk packaging
BT-010-G	non-woven	30 g/m <sup>2</sup>	38 cm x 17 cm	green	100 pcs	10 x 100 pcs
BT-010-B	non-woven	30 g/m <sup>2</sup>	38 cm x 17 cm	blue	100 pcs	10 x 100 pcs
BT-011-B	non-woven with anti-skid layer	40 g/m <sup>2</sup>	38 cm x 17 cm	blue	100 pcs	10 x 100 pcs
BT-002-PEB	polyethylene		41 cm x 15 cm	blue	100 pcs	20 x 100 pcs



available colours:



# SHOE COVERS

## calf-high

## features

- made of polypropylene non-woven 30 g/m<sup>2</sup>
- elastic rubber band at the opening
- protection against contaminating rooms where higher cleanliness standards are required
- increased durability
- single-use



REF	material	grammage	size	packaging unit
BT-013-B	PP non-woven	30 g/m <sup>2</sup>	47 cm x 38,5 cm	100 pcs
BT-013-G	PP non-woven	30 g/m <sup>2</sup>	47 cm x 38,5 cm	100 pcs



bulk packaging:  
10 x 100 pcs



available colours:



ZARYS



WWW.ZARYS.COM



**BEDCLOTHES**

## TEXTILE PRODUCTION

Examples of custom made products in below list of available materials:

Sheets, bed sheets (pillowcases, pillowcases, sets), covers, cases, clothes (blouse + pants, shirts, shorts, aprons, dresses, capes, sleeves), screen curtains.

Non-woven polypropylene **green**

▶ 17g ▶ 25g ▶ 30g ▶ 35g ▶ 40g ▶ 45g ▶ 60g

Non-woven polypropylene **white**

▶ 40g

Non-woven polypropylene **black**

▶ 40g

Non-woven polypropylene foiled (waterproof) **green**

▶ 25g ▶ 30g ▶ 40g ▶ 45g

Non-woven SMS **blue**

▶ 35g ▶ 45g



## DISPOSABLE MEDICAL PILLOW CASE

### features

- made of polypropylene non-woven



bulk packaging:  
10 x 50 pcs



available colours:



REF	grammage	size	packaging unit
BT-PP-25G1	25 g/m <sup>2</sup>	60cm x 80 cm	50 pcs
BT-PP-25G6	25 g/m <sup>2</sup>	80cm x 90 cm	50 pcs

## DISPOSABLE MEDICAL QUILT COVER

### features

- made of polypropylene non-woven



bulk packaging:  
10 x 10 pcs



available colours:



REF	grammage	size	packaging unit
BT-PZ-25G1	25 g/m <sup>2</sup>	160cm x 210 cm	10 pcs

## DISPOSABLE MEDICAL BEDDING SET

### features

- made of polypropylene non-woven
- components:
  - bed sheet: 150 cm x 210 cm
  - quilt cover: 160 cm x 210 cm
  - pillow case: 70 cm x 80 cm



bulk packaging:  
25 x 1 set



available colours:



REF	grammage	colour	packaging unit
BT-ZES-25G3	25 g/m <sup>2</sup>	green	1 set
BT-ZES-40G3	40 g/m <sup>2</sup>	green	1 set
BT-ZES-40W3	40 g/m <sup>2</sup>	white	1 set

# DISPOSABLE MEDICAL BED SHEET, REINFORCED

## features

- made of foil laminated paper
- reinforced with 8 or 48 threads
- grammage 40 g/m<sup>2</sup>
- soft, waterproof, absorbent, tough
- white with blue threads
- product put on mattresses, couches, armchairs and other elements that are the equipment of health care units, ie hospitals, outpatient clinics, clinics, etc.
- the products are designed to protect the patient during medical procedures, to prevent the transmission of contaminants and potentially pathogenic microorganisms located in medical rooms, treatment rooms and equipment that furnish these rooms and that may lead to complications of the patient's treatment process. They are a barrier to contamination
- non-sterile
- single use

REF	type	dimensions	packaging unit
BT-PW101	8 threads	80 cm x 210 cm	25 pcs
BT-PW401	48 threads	80 cm x 210 cm	25 pcs

bulk packaging:  
4 x 25 pcs



8 threads



48 threads



# THERMAL PATIENT COVER SOFT

## features

- made of Spunlace non-woven with polyester filling
- ultrasonic seams over the entire surface
- can be heated up in the heating device
- maintaining patient temperature at a stable level
- single use

REF	dimensions	outer material	packaging unit	bulk packaging
BT-TOP-21S	110 cm x 120 cm	Spunlace non-woven	1 pc.	50 x 1 pcs
BT-TOP-22S	110 cm x 210 cm	Spunlace non-woven	1 pc.	25 x 1 pcs



# THERMAL PATIENT COVER

## features

- made of polypropylene non-woven with polyester filling
- ultrasonic seams over the entire surface
- can be heated up in the heating device
- maintaining patient temperature at a stable level
- single use

REF	dimensions	outer material	packaging unit	bulk packaging
BT-TOP-11P	110 cm x 120 cm	polypropylene non-woven	1 pc.	50 x 1 pcs
BT-TOP-12P	110 cm x 210 cm	polypropylene non-woven	1 pc.	25 x 1 pcs
BT-TOP-13P	150 cm x 210 cm	polypropylene non-woven	1 pc.	20 x 1 pcs



ZARYS

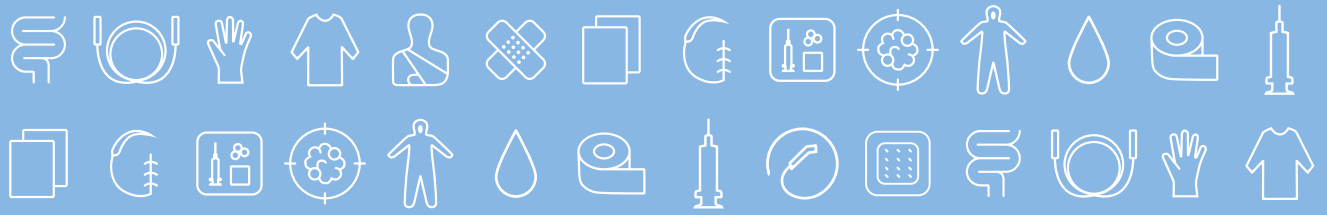

[WWW.ZARYS.COM](http://WWW.ZARYS.COM)



# ABSORBENT UNDERPADS

## DISPOSABLE ABSORBENT UNDERPAD

### features

- composed of five layers: laminate + cellulose wadding + cellulose pulp + cellulose wadding + PP nonwoven
- absorbent insert made of cellulose pulp
- impermeable foiled bottom
- single use

REF	dimensions	packaging unit
BT-PC4060	40 cm x 60 cm	25 pcs
BT-PC6060	60 cm x 60 cm	25 pcs
BT-PC6090	60 cm x 90 cm	25 pcs



 bulk packaging:  
4 x 25 pcs



## DISPOSABLE ABSORBENT UNDERPAD with superabsorbent

### features

- quilted absorbent insert
- composed of layers: polypropylene non-woven, cellulose wadding, cellulose pulp with superabsorbent, cellulose wadding, PE foil
- white absorbent insert
- blue foil layer
- single-use
- non-sterile
- shelf life: 5 years
- packaging - sealed plastic bag

REF	dimensions	packaging unit
BT-PCS4060	40 cm x 60 cm	25 pcs
BT-PCS6060	60 cm x 60 cm	25 pcs
BT-PCS6090	60 cm x 90 cm	25 pcs



 bulk packaging:  
4 x 25 pcs



## DISPOSABLE ABSORBENT UNDERPAD for operating table

### features

- quilted absorbent layer with addition of SAP (superabsorbent)
- composed of five layers: polypropylene non-woven, cellulose wadding, cellulose pulp with superabsorbent SAP, cellulose wadding, PE foil
- impermeable foiled bottom
- single use

REF	dimensions	packaging unit
BT-PC100225	100 cm x 225 cm	10 pcs



 bulk packaging:  
2 x 10 pcs



## ABSORBENT UNDERPAD FOR CHILDREN

### features

- quilted absorbent insert with SAP (superabsorbent)
- white absorbent insert
- film layer with pattern
- single-use

REF	dimensions	packaging unit	bulk packaging
BT-PC6060C	60 cm x 60 cm	30 pcs	10 x 30 pcs
BT-PC6090C	60 cm x 90 cm	15 pcs	10 x 15 pcs



 available colours:





# ABSORBENT MEDICAL PAD



## features

- absorbent pad with superabsorbent material
- composed of five layers
- reduces unpleasant odor
- ensures permanent retention of MRSA and E.Coli bacteria
- antibacterial
- breathable
- absorbent pad in white color
- disposable
- non-sterile
- shelf life: 5 years
- colorful logo on the outside
- packaging - sealed plastic bag

REF	dimensions	packaging unit	bulk packaging
AT-6060	60 cm x 60 cm	15 pcs	8 x 15 pcs
AT-6090	60 cm x 90 cm	10 pcs	8 x 10 pcs
AT-9191	91 cm x 91 cm	10 pcs	4 x 10 pcs



# ABSORBENT MEDICAL UNDERPAD FOR OPERATING TABLE



## features

- absorbent pad with superabsorbent material
- composed of five layers
- reduces unpleasant odor
- ensures permanent retention of MRSA and E.Coli bacteria
- antibacterial
- breathable
- allows for patient transfer
- absorbent pad in white color
- disposable
- non-sterile
- shelf life: 5 years
- colorful logo on the outside
- packaging - sealed plastic bag

REF	dimensions	packaging unit	bulk packaging	transfer capacity
AF-80210	80 cm x 210 cm	5 pcs	4 x 5 pcs	190 kg
AF-100225	100 cm x 225 cm	5 pcs	100 x 225 pcs	230 kg



# HYGIENIC PET UNDERPAD

## features

- underpad with quilted absorbent pad containing superabsorbent
- white colour
- equipped with 4 adhesives for sticking the underpad to the substrate
- absorbs fluid and holds it inside
- foil outer layer prevents leakage
- protects against contamination and soiling of the substrate
- soft
- disposable

REF	dimensions	packaging unit	bulk packaging
PHZ1	60 cm x 60 cm	30 pcs	10 x 30 pcs
PHZ2	60 cm x 90 cm	15 pcs	10 x 15 pcs



Maintaining proper hygiene for patients is crucial in healthcare settings to prevent infections and ensure overall well-being. Good hygiene practices include regular hand washing, proper oral care, and daily bathing or sponge baths for bedridden patients.



patient  
**hygiene**

washcloths and towels



ZARYS



WWW.ZARYS.COM

# WASHCLOTHS AND TOWELS

## wet wipes for children

NEW

### features

- gently cleanse the skin
- leave the skin soft
- care for the skin
- gentle on the skin
- allantoin and panthenol contained in the composition soothe irritation
- comfortable to use
- pleasant fragrance of white tea
- natural pH
- dyes-free and alcohol-free
- packaging with practical lock
- shelf life: 24 months

### indication

- intended for cleanse and care for the delicate skin of newborns, infants and children



REF	dimensions	packaging unit
WCD1-80	15 x 20 cm	80 pcs

bulk packaging:  
16 x 80 pcs



## waterless body wash wipes

NEW

### features

- gently cleanse the skin
- allow making a toilet without using water
- gentle and mild on the skin
- neutralize unpleasant odor
- made of Spunlace non-woven fabric
- water content - 96%
- glycerine and aloe contained in the composition moisturize the skin
- comfortable to use
- also intended for children under 3 years of age
- pH 4,0 - 7,0
- for greater convenience, the closed package can be heated in the microwave (max 800 W) for 15-20 seconds
- laminated resealable packaging
- single-use
- shelf life: 24 months

### indication

- intended for cleanse and care for the entire body of an adult without the use of water or additional washing products



REF	dimensions	packaging unit
WM1-08	20 cm x 30 cm	8 pcs

bulk packaging:  
24 x 8 pcs



## waterless body wash gloves

NEW

### features

- gently cleanse the skin
- allow making a toilet without using water
- gentle and mild on the skin
- neutralize unpleasant odor
- made of Spunlace non-woven fabric
- water content - 96%
- glycerine and aloe contained in the composition moisturize the skin
- comfortable to use
- also intended for children under 3 years of age
- pH 4,0 - 7,0
- for greater convenience, the closed package can be heated in the microwave (max 800 W) for 15-20 seconds
- laminated resealable packaging
- single-use
- shelf life: 24 months

### indication

- intended for cleanse and care for the entire body of an adult without the use of water or additional washing products



REF	dimensions	packaging unit
WR1-08	16 cm x 23 cm	8 pcs

bulk packaging:  
24 x 8 pcs



## waterless hair wash cap

### features

- gently cleanse
- comfortable washing of hair without using water
- gentle on the skin
- water content - 96%
- comfortable to use
- pH 4,0 – 6,0
- for greater convenience, the closed package can be heated in the microwave (max 800 W) for 15-20 seconds
- laminated resealable packaging
- single-use
- shelf life: 24 months

### indication

- intended for cleanse and care for hair and scalp without the use of water



REF	dimensions	packaging unit
WC1-01	one size	1 pcs

bulk packaging:  
24 x 1 pcs



## disposable towel, non-woven

### Spunlace

### features

- made of fibers compacted using the Spunlace technique
- delicate and soft
- tear-resistant disposable
- perfectly absorbs water and oily substances
- disposable

### indication

- intended for dry patients' skin and hair from excess water and to dry soiled flat surfaces and medical equipment and devices.



REF	dimensions	packaging unit	bulk packaging
RH112	30 cm x 40 cm	100 pcs	20 x 100 pcs
RH114	40 cm x 70 cm	100 pcs	8 x 100 pcs
RH118	70 cm x 130 cm	10 pcs	24 x 10 pcs

available colours:  
○



## disposable towel, non-woven

### Spunlace

### features

- made of cellulose fibers using Airlaid technology
- slightly embossed surface
- has Double C structure
- excellent water absorption
- delicate and soft
- tear-resistant disposable

### indication

- intended for dry patients' skin and hair from excess water and to dry soiled flat surfaces and medical equipment and devices.

REF	dimensions	packaging unit	bulk packaging
RH242	30 cm x 40 cm	100 pcs	15 x 100 pcs
RH244	30 cm x 70 cm	100 pcs	6 x 100 pcs

available colours:  
○



# wash glove

## molton

### features

- wash glove in the form of a glove to put on a hand
- made of MOLTON material
- ultrasonic sewing
- soft, smooth, gentle and absorbent
- dry, without cleaning agents
- tear resistant
- single-use

REF	grammage	dimensions	unit packaging
MB11	75 g/m <sup>2</sup>	160 mm x 220 mm	50 pcs

bulk packaging:  
20 x 50 pcs



# wash glove

## Spunlace

### features

- wash glove in the form of a glove to put on a hand
- made of SPUNLACE material
- ultrasonic sewing
- very soft, gentle and absorbent
- dry, without cleaning agents
- tear resistant
- single-use

REF	grammage	dimensions	unit packaging
MB12	80 g/m <sup>2</sup>	160 mm x 220 mm	50 pcs

bulk packaging:  
20 x 50 pcs



# wash glove

## with film lining

### features

- wash glove with film lining in the form of a glove to put on a hand
- made of Airlaid material + PE
- ultrasonic sewing
- gentle and absorbent
- dry, without cleaning agents
- tear resistant
- single-use

REF	grammage	dimensions	unit packaging
MB13PE	80 g/m <sup>2</sup>	160 mm x 220 mm	50 pcs

bulk packaging:  
20 x 50 pcs



# dental brush

## with suction

### features

- made of polypropylene
- soft bristles on one side, foam on the other side
- total length 18 cm
- length of the cleaning part 2,5 cm
- suction opening from both the bristle side and the space between the foam and the bristles
- controlled suction connector at 45° angle for convenient manipulation
- single-use
- packaging: 1 pc./foil

### indication

- hygiene of the patient's oral cavity
- function for simultaneous brushing, rinsing and suction



REF	intermediate packaging
HJM-SO	50 pcs

  
bulk packaging:  
10 x 50 pcs



# oral swab

### features

- overall length 15 cm (+/- 2 mm)
- length of the foam part 2,5 cm
- handle made of polyester
- swab made of polypropylene
- single-use
- packaging: 1 pc./foil

### indication

- intended for oral hygiene in patients partially or completely dependent on medical personnel
- allows the oral mucosa to be kept in proper humidity
- allows you to perform a procedure to prevent pathological changes in the mouth



REF	intermediate packaging
HJM-GB	50 pcs

  
bulk packaging:  
10 x 50 pcs







**vitahealth** line of adhesive plaster sets are designed to provide optimum protection in every situation and to satisfy the needs of the most demanding users. They are an indispensable element for everyday life.

**Always with you and your loved ones**

**Adhesive plaster for cutting is by far the most often chosen form of dressings.**

## S.O.S.

### Compact packaging

set of adhesive handbag plasters

- SLIM packaging
- #MustHave of each handbag



## SENSITIVE

Dedicated to delicate skin  
silicone adhesive

set of adhesive plasters for sensitive skin

- painless removal of the plaster
- correction of application



## NONVIplast

NEW on the market - plaster with scissors

non-woven adhesive plaster for cutting



name	ref	number of pieces in a set	individual packaging	bulk packaging
<b>ACTIVE</b> pro set of adhesive plasters for active people	VH-ZAC	12	1	60
<b>AQUA</b> pro set of adhesive waterproof plasters	VH-ZAQ	18	1	60
<b>UNIVERSAL</b> set of adhesive universal plasters	VH-ZUN	24	1	60
<b>TRANSPARENT</b> set of adhesive transparent plasters	VH-ZTR	24	1	60
<b>HANDS</b> pro set of adhesive hands plasters	VH-ZHA	12	1	60
<b>FAMILY</b> pro set of adhesive family plasters	VH-ZFA	28	1	60
<b>KIDS</b> pro <b>G</b> set of adhesive children's plasters - girl	VH-ZKG	16	1	60
<b>KIDS</b> pro <b>B</b> set of adhesive children's plasters - boy	VH-ZKB	16	1	60
<b>SENSITIVE</b> set of adhesive plasters for sensitive skin	VH-ZSE	12	1	30
<b>S.O.S</b> set of adhesive handbag plasters	VH-ZSO	8	1	1000
<b>NONVI</b> plast non-woven adhesive plaster for cutting	VH-NOP	1 + scissors	1	120
<b>FABRI</b> plast fabric adhesive plaster for cutting	VH-FAP	1+ scissors	1	120
<b>SENSI</b> plast adhesive fabric tape for cutting	VH-SEP	1	1	12x1 (box) 30x12 (carton)
<b>SOFT</b> plast adhesive non-woven tape for cutting	VH-SOP	1	1	12x1 (box) 30x12 (carton)





ZARYS International Group sp. z o.o. sp.k.

We create good solutions



headquarters

Poland





ZARYS worldwide

- ▷ Czech Republic
- ▷ Romania
- ▷ Italy
- ▷ Hungary
- ▷ Portugal
- ▷ United Arab Emirates

Please contact us if you require further details:

 Area	E-mail	Direct Line
Worldwide	<a href="mailto:export@zarys.pl">export@zarys.pl</a>	+48 327970579
Czech Republic	<a href="mailto:info@zarys.cz">info@zarys.cz</a>	+420 737954388
Italy	<a href="mailto:ufficio@zarys.it">ufficio@zarys.it</a>	+39 334 6591844
Portugal	<a href="mailto:geral@zarys.pt">geral@zarys.pt</a>	+351 914183173
Romania	<a href="mailto:office@zarys.ro">office@zarys.ro</a>	+40 371485051
UAE	<a href="mailto:office@zarys.ae">office@zarys.ae</a>	+971 529047753
Hungary	<a href="mailto:iroda@zarys.com">iroda@zarys.com</a>	+36 30/642 9448

### Export Department

-  Ziemska 44, 41-803 Zabrze, Poland
-  +48 32 797 05 79
-  [export@zarys.pl](mailto:export@zarys.pl)

Rev. XII/0710.2024

TÜV Rheinland LGA Products GmbH • 51105 Köln

*ZARYS International Group spółka z ograniczoną odpowiedzialnością spółka komandytowa*  
*ul. Pod Borem 18,*  
*41-808 Zabrze,*  
*Poland*

Contact

Tel. +49 911 655-5225  
Mail: [medical-products@de.tuv.com](mailto:medical-products@de.tuv.com)

Date May 15, 2024

### **Notified Body Confirmation Letter**

Reference. : ZARYS\_PLA0\_HZ\_2024-05-10/ 84965323

To whom it may concern,

**Confirmation of the status of a formal application, written agreement, and appropriate surveillance in the framework of Regulation EU 2023/607 amending Regulations (EU) 2017/745 and (EU) 2017/746 as regards the transitional provisions for certain medical devices and in vitro diagnostic medical devices.**

This letter confirms that **TÜV Rheinland LGA Products GmbH**, a Notified Body (NB) designated against Regulation (EU) 2017/745 (MDR) and identified by the number **0197** on NANDO, has received a formal application in accordance with Section 4.3, first subparagraph of Annex VII of MDR and has signed a written agreement in accordance with Section 4.3, second subparagraph of Annex VII of MDR with the following manufacturer:

ZARYS International Group spółka z ograniczoną odpowiedzialnością spółka komandytowa  
ul. Pod Borem 18,  
41-808 Zabrze,  
Poland  
SRN Number: PL-MF-000000410

The devices covered by the formal application and the written agreement mentioned above are identified in the tables below. Table 1 identifies the devices for which an MDR application has been received, written agreement concluded and for which the NB is also responsible for appropriate surveillance under the applicable Directive. Table 2 identifies the devices for which an MDR application has been received and a written agreement concluded, but the NB has not yet taken the responsibility for appropriate surveillance of the corresponding devices under the applicable Directive.

In the case of devices covered by certificates issued under Directive 90/385/EEC (AIMDD) or Directive 93/42/EEC (MDD) that expired after May 26, 2021 but before March 20, 2023 without having been withdrawn, this letter also confirms that the manufacturer either signed the written agreement under MDR by the date of MDD/AIMDD certificate expiry; or provided evidence that a competent authority of a Member State had granted a derogation or exemption from the applicable conformity assessment procedure in accordance with Article 59(1) of MDR or Article 97(1) of the MDR respectively, by March 20, 2023 for the relevant devices.

TÜV Rheinland  
LGA Products GmbH

Am Grauen Stein  
51105 Köln  
Germany

Headquarter

Tillystraße 2  
90431 Nuremberg

Phone. +49 911 655 5225  
Fax +49 911 655 5226  
[service@de.tuv.com](mailto:service@de.tuv.com)

[www.tuv.com/safety](http://www.tuv.com/safety)

Board of Management

Dipl.-Ing.  
Thomas Weigand, Spokesman

Dipl.-Kfm.  
Dr. Jörg Schlösser

Nuremberg HRB 26013  
VAT No.: DE 811835490

Chairman of the  
Supervisory Board

Dr.-Ing. Michael Fübi

The transition timelines that apply to the devices covered by this letter, subject to the manufacturer's continued compliance to the other conditions specified in Article 120.3c of MDR (as amended by (EU) 2023/607), are shown below:

- May 26, 2026 for Class III custom-made implantable devices
- December 31, 2027 for Class III devices and Class IIb implantable devices excluding Well-established technologies (WET - sutures, staples, dental fillings, dental braces, tooth crowns, screws, wedges, plates, wires, pins, clips and connectors)
- December 31, 2028 for other Class IIb devices, Class IIa, Class I devices placed on the market in sterile condition or have a measuring function
- December 31, 2028 for devices not requiring the involvement of a notified body under MDD but requiring it under MDR (e.g., class I devices that qualify as re-usable surgical instruments)

On behalf of the Notified Body

 Malgorzata Blazniak  
2024.05.15 13:38:01  
+02'00'

AUDIT\_CERT\_REVIEW  
Certification body

**Table 1: Devices covered by this letter and for which the NB is also responsible for appropriate surveillance of the corresponding devices under the applicable Directive:**

Device name or Basic UDI-DI (under MDR application)	MDR Device classification (as proposed by the manufacturer and verified at the pre-application stage)	If the MDR device is a substitute device, identification of the corresponding MDD/AIMDD device	MDD/AIMDD Certificate Reference(s) of the devices under MDR application, and the NB Identification
<b>GAZA lux S Cutting gauze, sterile</b>  Basic UDI-DI: 59079968M02010101-ERR	Class IIa	GAZA lux S Cutting gauze, sterile	DD 1023663-1 NB 0197
<b>GAZA lux S Cutting gauze, sterile</b>  Basic UDI-DI: 59079968M02010101-SSM	Class IIa	GAZA lux S Cutting gauze, sterile	DD 1023663-1 NB 0197
<b>GAZA lux Cutting gauze, non-sterile</b>  Basic UDI-DI: 59079968M02010101-NSB	Class IIa	GAZA lux Cutting gauze, non-sterile	DD 1023663-1 NB 0197
<b>GAZA lux Dressing gauze, non-sterile</b>  Basic UDI-DI: 59079968M020107DG	Class IIa	GAZA lux Dressing gauze, non-sterile	DD 1023663-1 NB 0197
<b>KOMPRI lux S</b>	Class IIa	KOMPRI lux S	DD 1023663-1 NB 0197

<b>Device name or Basic UDI-DI (under MDR application)</b>	<b>MDR Device classification (as proposed by the manufacturer and verified at the pre-application stage)</b>	<b>If the MDR device is a substitute device, identification of the corresponding MDD/AIMDD device</b>	<b>MDD/AIMDD Certificate Reference(s) of the devices under MDR application, and the NB Identification</b>
<b>Gauze swabs without X-ray thread, sterile</b>  <b>Basic UDI-DI: 59079968M02010201-ES4</b>		Gauze swabs without X-ray thread, sterile	
<b>KOMPRI lux S Gauze swabs without X-ray thread, sterile</b>  <b>Basic UDI-DI: 59079968M02010201-SSY</b>	Class IIa	KOMPRI lux S Gauze swabs without X-ray thread, sterile	DD 1023663-1 NB 0197
<b>KOMPRI lux S Gauze swabs with X-ray thread, sterile</b>  <b>Basic UDI-DI: 59079968M02010202-ES9</b>	Class IIa	KOMPRI lux S Gauze swabs with X-ray thread, sterile	DD 1023663-1 NB 0197
<b>KOMPRI lux S Gauze swabs with X-ray thread, sterile</b>  <b>Basic UDI-DI: 59079968M02010202-ST5</b>	Class IIa	KOMPRI lux S Gauze swabs with X-ray thread, sterile	DD 1023663-1 NB 0197
<b>KOMPRI lux Gauze swabs without X-ray thread, non-sterile</b>  <b>Basic UDI-DI: 59079968M02010201-NSN</b>	Class IIa	KOMPRI lux Gauze swabs without X-ray thread, non-sterile	DD 1023663-1 NB 0197
<b>KOMPRI lux Gauze swabs with X-ray thread, non-sterile</b>  <b>Basic UDI-DI: 59079968M02010202-NST</b>	Class IIa	KOMPRI lux Gauze swabs with X-ray thread, non-sterile	DD 1023663-1 NB 0197
<b>SERVI lux S Gauze lap sponges with X-ray thread, sterile</b>  <b>Basic UDI-DI: 59079968M02010302-ESL</b>	Class IIa	SERVI lux S Gauze lap sponges with X-ray thread, sterile	DD 1023663-1 NB 0197
<b>SERVI lux S Gauze lap sponges with X-ray thread, sterile</b>  <b>Basic UDI-DI: 59079968M02010302-STG</b>	Class IIa	SERVI lux S Gauze lap sponges with X-ray thread, sterile	DD 1023663-1 NB 0197
<b>SERVI lux S Gauze lap sponges with X-ray chip, pre-washed, sterile</b>	Class IIa	SERVI lux S Gauze lap sponges with X-ray chip, pre-washed, sterile	DD 1023663-1 NB 0197

<b>Device name or Basic UDI-DI (under MDR application)</b>	<b>MDR Device classification (as proposed by the manufacturer and verified at the pre-application stage)</b>	<b>If the MDR device is a substitute device, identification of the corresponding MDD/AIMDD device</b>	<b>MDD/AIMDD Certificate Reference(s) of the devices under MDR application, and the NB Identification</b>
<b>Basic UDI-DI: 59079968M02010302-PE86</b>			
<b>SERVI lux S Gauze lap sponges with X-ray chip, pre-washed, sterile</b>  <b>Basic UDI-DI: 59079968M02010302-PS92</b>	Class IIa	SERVI lux S Gauze lap sponges with X-ray chip, pre-washed, sterile	DD 1023663-1 NB 0197
<b>SERVI lux Gauze lap sponges with X-ray thread, non-sterile</b>  <b>Basic UDI-DI: 59079968M02010302-NT6</b>	Class IIa	SERVI lux Gauze lap sponges with X-ray thread, non-sterile	DD 1023663-1 NB 0197
<b>SERVI lux Gauze lap sponges with X-ray chip, pre-washed, non-sterile</b>  <b>Basic UDI-DI: 59079968M02010302-PN8Q</b>	Class IIa	SERVI lux Gauze lap sponges with X-ray chip, pre-washed, non-sterile	DD 1023663-1 NB 0197
<b>TUPFER lux S Gauze balls without X-ray thread, sterile</b>  <b>Basic UDI-DI: 59079968M02010501-ET5</b>	Class IIa	TUPFER lux S Gauze balls without X-ray thread, sterile	DD 1023663-1 NB 0197
<b>TUPFER lux S Gauze balls without X-ray thread, sterile</b>  <b>Basic UDI-DI: 59079968M02010501-STZ</b>	Class IIa	TUPFER lux S Gauze balls without X-ray thread, sterile	DD 1023663-1 NB 0197
<b>TUPFER lux S Gauze balls with X-ray thread, sterile</b>  <b>Basic UDI-DI: 59079968M02010502-ETA</b>	Class IIa	TUPFER lux S Gauze balls with X-ray thread, sterile	DD 1023663-1 NB 0197
<b>TUPFER lux S Gauze balls with X-ray thread, sterile</b>  <b>Basic UDI-DI: 59079968M02010502-SU6</b>	Class IIa	TUPFER lux S Gauze balls with X-ray thread, sterile	DD 1023663-1 NB 0197
<b>TUPFER lux Gauze balls without X-ray thread, non-sterile</b>	Class IIa	TUPFER lux Gauze balls without X-ray thread, non-sterile	DD 1023663-1 NB 0197



<b>Device name or Basic UDI-DI (under MDR application)</b>	<b>MDR Device classification (as proposed by the manufacturer and verified at the pre-application stage)</b>	<b>If the MDR device is a substitute device, identification of the corresponding MDD/AIMDD device</b>	<b>MDD/AIMDD Certificate Reference(s) of the devices under MDR application, and the NB Identification</b>
<b>Basic UDI-DI: 59079968M02010501-NTP</b>			
<b>TUPFER lux Gauze balls with X-ray thread, non-sterile</b>  <b>Basic UDI-DI: 59079968M02010502-NTU</b>	Class IIa	TUPFER lux Gauze balls with X-ray thread, non-sterile	DD 1023663-1 NB 0197
<b>SETON lux S Gauze rolls without X-ray thread, sterile</b>  <b>Basic UDI-DI: 59079968M02010701-SUP</b>	Class IIa	SETON lux S Gauze rolls without X-ray thread, sterile	DD 1023663-1 NB 0197
<b>SETON lux S Gauze rolls with X-ray thread, sterile</b>  <b>Basic UDI-DI: 59079968M02010702-ETY</b>	Class IIa	SETON lux S Gauze rolls with X-ray thread, sterile	DD 1023663-1 NB 0197
<b>SETON lux S Gauze rolls with X-ray thread, sterile</b>  <b>Basic UDI-DI: 59079968M02010702-SUU</b>	Class IIa	SETON lux S Gauze rolls with X-ray thread, sterile	DD 1023663-1 NB 0197
<b>SETON lux Gauze rolls without X-ray thread, non-sterile</b>  <b>Basic UDI-DI: 59079968M02010701-NUD</b>	Class IIa	SETON lux Gauze rolls without X-ray thread, non-sterile	DD 1023663-1 NB 0197
<b>SETON lux Gauze rolls with X-ray thread, non-sterile</b>  <b>Basic UDI-DI: 59079968M02010702-NUJ</b>	Class IIa	SETON lux Gauze rolls with X-ray thread, non-sterile	DD 1023663-1 NB 0197
<b>NONVI lux S Non-woven swab, sterile</b>  <b>Basic UDI-DI: 59079968M02020101-ESA</b>	Class IIa	NONVI lux S Non-woven swabs, sterile	DD 1023663-1 NB 0197
<b>NONVI lux S Non-woven swab, sterile</b>  <b>Basic UDI-DI: 59079968M02020101-ST6</b>	Class IIa	NONVI lux S Non-woven swabs, sterile	DD 1023663-1 NB 0197
<b>NONVI lux S Non-woven swabs with X-ray thread, sterile</b>	Class IIa	NONVI lux S Non-woven swabs with X-ray thread, sterile	DD 1023663-1 NB 0197

<b>Device name or Basic UDI-DI (under MDR application)</b>	<b>MDR Device classification (as proposed by the manufacturer and verified at the pre-application stage)</b>	<b>If the MDR device is a substitute device, identification of the corresponding MDD/AIMDD device</b>	<b>MDD/AIMDD Certificate Reference(s) of the devices under MDR application, and the NB Identification</b>
<b>Basic UDI-DI: 59079968M02020102-ESF</b>			
<b>NONVI lux S Non-woven swabs with X-ray thread, sterile</b>  <b>Basic UDI-DI: 59079968M02020102-STB</b>	Class IIa	NONVI lux S Non-woven swabs with X-ray thread, sterile	DD 1023663-1 NB 0197
<b>NONVI lux Non-woven swabs, non-sterile</b>  <b>Basic UDI-DI: 59079968M02020101-NSU</b>	Class IIa	NONVI lux Non-woven swabs, non-sterile	DD 1023663-1 NB 0197
<b>NONVI lux Non-woven swabs with X-ray thread, non-sterile</b>  <b>Basic UDI-DI: 59079968M02020102-NSZ</b>	Class IIa	NONVI lux Non-woven swabs with X-ray thread, non-sterile	DD 1023663-1 NB 0197
<b>paraffiNET Paraffin gauze dressing, sterile</b>  <b>Basic UDI-DI: 59079968M020302DG</b>	Class IIa	paraffiNET Paraffin gauze dressing, sterile	DD 1023663-1 NB 0197
<b>SANVIflon I.V. cannula SANVIflon S I.V. cannula without injection port SANVIflon premium I.V. cannula SANVIflon safe Safety I.V. cannula</b>  <b>Basic UDI-DI: 59079968C0101017F</b>	Class IIa	SANVIflon I.V. cannula SANVIflon S I.V. cannula without injection port SANVIflon premium I.V. cannula SANVIflon safe Safety I.V. cannula	DD 1023663-1 NB 0197
<b>OXYGEN TUBING</b>  <b>Basic UDI-DI: 59079968R03010204LA</b>	Class IIa	OXYGEN TUBING	DD 1023663-1 NB 0197
<b>NEBULIZER with T F/M adaptor, mouthpiece, corrugated tube and tubing</b>  <b>Basic UDI-DI: 59079968R030103-FMV5</b>	Class IIa	NEBULIZER with T F/M adaptor, mouthpiece, corrugated tube and tubing	DD 1023663-1 NB 0197
<b>NEBULIZER mask with tubing</b>  <b>Basic UDI-DI: 59079968R030103-MMN</b>	Class IIa	NEBULIZER with mask and tubing	DD 1023663-1 NB 0197

<b>Device name or Basic UDI-DI (under MDR application)</b>	<b>MDR Device classification (as proposed by the manufacturer and verified at the pre-application stage)</b>	<b>If the MDR device is a substitute device, identification of the corresponding MDD/AIMDD device</b>	<b>MDD/AIMDD Certificate Reference(s) of the devices under MDR application, and the NB Identification</b>
<b>OXYGEN MASK with tubing</b>  <b>Basic UDI-DI: 59079968R03010201L4</b>	Class IIa	OXYGEN MASK with tubing	DD 1023663-1 NB 0197
<b>NON-REBREATHER MASK with tubing</b>  <b>Basic UDI-DI: 59079968R03010206LE</b>	Class IIa	NON-REBREATHER MASK with tubing	DD 1023663-1 NB 0197
<b>VENTURI MASK with adjustable diluter and tubing</b>  <b>Basic UDI-DI: 59079968R03010202-AXK</b>	Class IIa	VENTURI MASK with adjustable diluter and tubing	DD 1023663-1 NB 0197
<b>NASAL OXYGEN CANNULA for adults NASAL OXYGEN CANNULA for children NASAL OXYGEN CANNULA for infants</b>  <b>Basic UDI-DI: 59079968R03010203L8</b>	Class IIa	NASAL OXYGEN CANNULA for adults NASAL OXYGEN CANNULA for children NASAL OXYGEN CANNULA for infants	DD 1023663-1 NB 0197
<b>SUCTION CATHETER SUCTION CATHETER IDEAL SUCTION CATHETER with vacuum control SUCTION CATHETER with vacuum control IDEAL</b>  <b>Basic UDI-DI: 59079968R0501QP</b>	Class IIa	SUCTION CATHETER SUCTION CATHETER IDEAL SUCTION CATHETER with vacuum control SUCTION CATHETER with vacuum control IDEAL	DD 1023663-1 NB 0197
<b>Two-way Foley catheter with rubber valve (silicone-coated latex)</b>  <b>Basic UDI-DI: 59079968U010201-LRXH</b>	Class IIa	TWO-WAY FOLEY CATHETER with rubber valve	DD 1023663-1 NB 0197
<b>Two-way Foley catheter with plastic valve (silicone-coated latex)</b>  <b>Basic UDI-DI: 59079968U010201-LPXD</b>	Class IIa	TWO-WAY FOLEY CATHETER with plastic valve	DD 1023663-1 NB 0197
<b>Two-way Foley catheter with plastic valve (100% silicone, X-ray contrast)</b>	Class IIa	TWO-WAY FOLEY CATHETER with plastic valve	DD 1023663-1 NB 0197

<b>Device name or Basic UDI-DI (under MDR application)</b>	<b>MDR Device classification (as proposed by the manufacturer and verified at the pre-application stage)</b>	<b>If the MDR device is a substitute device, identification of the corresponding MDD/AIMDD device</b>	<b>MDD/AIMDD Certificate Reference(s) of the devices under MDR application, and the NB Identification</b>
<b>Basic UDI-DI: 59079968U010201-SP6</b>			
<b>Three-way Foley catheter with plastic valve (silicone-coated latex)</b>  <b>Basic UDI-DI: 59079968U010201-3LUV</b>	Class IIa	THREE-WAY FOLEY CATHETER with plastic valve	DD 1023663-1 NB 0197
<b>Three-way Foley catheter with plastic valve (100% silicone, X-ray contrast)</b>  <b>Basic UDI-DI: 59079968U010201-3SVB</b>	Class IIa	THREE-WAY FOLEY CATHETER with plastic valve	DD 1023663-1 NB 0197
<b>Two-way Foley catheter with plastic valve, Tiemann tip (silicone-coated latex)</b>  <b>Basic UDI-DI: 59079968U0102R6</b>	Class IIa	TWO-WAY FOLEY CATHETER with plastic valve, Tiemann tip	DD 1023663-1 NB 0197
<b>TIEMANN CATHETER</b>  <b>Basic UDI-DI: 59079968U010106HB</b>	Class IIa	TIEMANN CATHETER	DD 1023663-1 NB 0197
<b>PEZZER CATHETER</b>  <b>Basic UDI-DI: 59079968U010107HD</b>	Class IIa	PEZZER CATHETER	DD 1023663-1 NB 0197
<b>FEEDING TUBE</b>  <b>Basic UDI-DI: 59079968G02020101BU</b>	Class IIa	FEEDING TUBE	DD 1023663-1 NB 0197
<b>STOMACH TUBE DUODENAL TUBE</b>  <b>Basic UDI-DI: 59079968G020201A3</b>	Class IIa	STOMACH TUBE DUODENAL TUBE	DD 1023663-1 NB 0197
<b>SUCTION CANNULA with suction control SUCTION CANNULA without suction control</b>  <b>Basic UDI-DI: 59079968A06010184</b>	Class IIa	SUCTION CANNULA with suction control SUCTION CANNULA without suction control	DD 1023663-1 NB 0197
<b>SUCTION CANNULA with suction control, ball tip SUCTION CANNULA without suction control, ball tip</b>  <b>Basic UDI-DI: 59079968A060101-BA2</b>	Class IIa	SUCTION CANNULA with suction control, ball tip SUCTION CANNULA without suction control, ball tip	DD 1023663-1 NB 0197

Device name or Basic UDI-DI (under MDR application)	MDR Device classification (as proposed by the manufacturer and verified at the pre-application stage)	If the MDR device is a substitute device, identification of the corresponding MDD/AIMDD device	MDD/AIMDD Certificate Reference(s) of the devices under MDR application, and the NB Identification
<b>SURGICAL SUCTION SET with suction control, Yankauer tip</b> <b>SURGICAL SUCTION SET without suction control, Yankauer tip</b>  <b>Basic UDI-DI:</b> <b>59079968A060101039F</b>	Class IIa	SURGICAL SUCTION SET with suction control, Yankauer tip SURGICAL SUCTION SET without suction control, Yankauer tip	DD 1023663-1 NB 0197
<b>SURGICAL SUCTION SET with suction control, funnel-funnel cut-to-fit, Yankauer tip</b> <b>SURGICAL SUCTION SET without suction control, funnel-funnel cut-to-fit, Yankauer tip</b>  <b>Basic UDI-DI:</b> <b>59079968A06010103-FFUC</b>	Class IIa	SURGICAL SUCTION SET with suction control, funnel-funnel cut-to-fit, Yankauer tip SURGICAL SUCTION SET without suction control, funnel-funnel cut-to-fit, Yankauer tip	DD 1023663-1 NB 0197
<b>SURGICAL SUCTION SET with suction control, funnel-funnel cut-to-fit, ball tip</b> <b>SURGICAL SUCTION SET without suction control, funnel-funnel cut-to-fit, ball tip</b>  <b>Basic UDI-DI:</b> <b>59079968A06010103-FFB6J</b>	Class IIa	SURGICAL SUCTION SET with suction control, funnel-funnel cut-to-fit, ball tip SURGICAL SUCTION SET without suction control, funnel-funnel cut-to-fit, ball tip	DD 1023663-1 NB 0197
<b>SUCTION TUBE funnel-funnel</b>  <b>Basic UDI-DI:</b> <b>59079968A060304-FFG4</b>	Class IIa	SUCTION TUBE funnel-funnel	DD 1023663-1 NB 0197
<b>SUCTION TUBE funnel-funnel cut-to-fit</b>  <b>Basic UDI-DI:</b> <b>59079968A060304-FCFW</b>	Class IIa	SUCTION TUBE funnel-funnel cut-to-fit	DD 1023663-1 NB 0197
<b>SUCTION TUBE funnel-Kapkon</b>  <b>Basic UDI-DI:</b> <b>59079968A060304-FKGE</b>	Class IIa	SUCTION TUBE funnel-Kapkon	DD 1023663-1 NB 0197
<b>easyWAY Three-way stopcock</b>	Class IIa	easyWAY Three-way stopcock	DD 1023663-1 NB 0197

<b>Device name or Basic UDI-DI (under MDR application)</b>	<b>MDR Device classification (as proposed by the manufacturer and verified at the pre-application stage)</b>	<b>If the MDR device is a substitute device, identification of the corresponding MDD/AIMDD device</b>	<b>MDD/AIMDD Certificate Reference(s) of the devices under MDR application, and the NB Identification</b>
<b>Basic UDI-DI: 59079968A0703KA</b>			
<b>easyWAY L Three-way stopcock with extension</b>  <b>Basic UDI-DI: 59079968A0703-LA4</b>	Class IIa	easyWAY L Three-way stopcock with extension	DD 1023663-1 NB 0197
<b>easyFLOW LINE Extension tube for infusion pump, phthalate-free</b>  <b>Basic UDI-DI: 59079968A03020178</b>	Class IIa	easyFLOW LINE Extension tube for infusion pump, phthalate-free	DD 1023663-1 NB 0197
<b>easyFLOW LINE AMBER Extension tube for infusion pump, amber, phthalate-free</b>  <b>Basic UDI-DI: 59079968A030201-A8Q</b>	Class IIa	easyFLOW LINE AMBER Extension tube for infusion pump, amber, phthalate-free	DD 1023663-1 NB 0197
<b>easyFLOW IS Infusion set easyFLOW IS ECO Infusion set</b>  <b>Basic UDI-DI: 59079968A03010103-PHT6H</b>	Class IIa	easyFLOW IS Infusion set easyFLOW IS ECO Infusion set	DD 1023663-1 NB 0197
<b>easyFLOW IS Infusion set, phthalate-free easyFLOW IS ECO Infusion set, phthalate-free easyFLOW IS PREMIUM Infusion set, phthalate-free</b>  <b>Basic UDI-DI: 59079968A030101037U</b>	Class IIa	easyFLOW IS Infusion set, phthalate-free easyFLOW IS ECO Infusion set, phthalate-free easyFLOW IS PREMIUM Infusion set, phthalate-free	DD 1023663-1 NB 0197
<b>easyFLOW IS SAFE Safety infusion set, phthalate-free easyFLOW IS SAFE PREMIUM Safety infusion set, phthalate-free</b>  <b>Basic UDI-DI: 59079968A03010103-SG2</b>	Class IIa	easyFLOW IS SAFE Safety infusion set, phthalate-free easyFLOW IS SAFE PREMIUM Safety infusion set, phthalate-free	DD 1023663-1 NB 0197
<b>easyFLOW IS REG Infusion set with precision flow rate regulator, phthalate-free</b>	Class IIa	easyFLOW IS REG Infusion set with precision flow rate	DD 1023663-1 NB 0197

Device name or Basic UDI-DI (under MDR application)	MDR Device classification (as proposed by the manufacturer and verified at the pre-application stage)	If the MDR device is a substitute device, identification of the corresponding MDD/AIMDD device	MDD/AIMDD Certificate Reference(s) of the devices under MDR application, and the NB Identification
Basic UDI-DI: 59079968A03010103-RFY		regulator, phthalate-free	
easyFLOW IS AMBER Infusion set, amber, phthalate-free  Basic UDI-DI: 59079968A03010103-AEW	Class IIa	easyFLOW IS AMBER Infusion set, amber, phthalate-free	DD 1023663-1 NB 0197
ENDOTRACHEAL TUBE UNCUFFED  Basic UDI-DI: 59079968R010301FQ	Class IIa	ENDOTRACHEAL TUBE UNCUFFED	DD 1023663-1 NB 0197
ENDOTRACHEAL TUBE CUFFED  Basic UDI-DI: 59079968R010302FS	Class IIa	ENDOTRACHEAL TUBE CUFFED	DD 1023663-1 NB 0197
REINFORCED ENDOTRACHEAL TUBE CUFFED WITH PRELOADED STYLET  Basic UDI-DI: 59079968R010302-RMF	Class IIa	REINFORCED ENDOTRACHEAL TUBE CUFFED WITH PRELOADED STYLET	DD 1023663-1 NB 0197
BREATHING CIRCUIT FOR CHILDREN with bag, expandable, additional arm BREATHING CIRCUIT FOR ADULTS with bag, expandable, additional arm  Basic UDI-DI: 59079968R0201-BGG	Class IIa	BREATHING CIRCUIT FOR CHILDREN with bag, expandable, additional arm BREATHING CIRCUIT FOR ADULTS with bag, expandable, additional arm	DD 1023663-1 NB 0197
BREATHING CIRCUIT FOR CHILDREN BREATHING CIRCUIT FOR ADULTS  Basic UDI-DI: 59079968R0201Q8	Class IIa	BREATHING CIRCUIT FOR CHILDREN BREATHING CIRCUIT FOR ADULTS	DD 1023663-1 NB 0197
CATHETER MOUNT with double swivel elbow connector, smooth-bore  Basic UDI-DI: 59079968R020202-SMP	Class IIa	CATHETER MOUNT with double swivel elbow connector, smooth-bore	DD 1023663-1 NB 0197
CATHETER MOUNT with double swivel elbow connector, expandable	Class IIa	CATHETER MOUNT with double swivel	DD 1023663-1 NB 0197

<b>Device name or Basic UDI-DI (under MDR application)</b>	<b>MDR Device classification (as proposed by the manufacturer and verified at the pre-application stage)</b>	<b>If the MDR device is a substitute device, identification of the corresponding MDD/AIMDD device</b>	<b>MDD/AIMDD Certificate Reference(s) of the devices under MDR application, and the NB Identification</b>
<b>Basic UDI-DI: 59079968R020202-ELT</b>		elbow connector, expandable	
<b>CATHETER MOUNT with double swivel elbow connector, corrugated</b>	Class IIa	CATHETER MOUNT with double swivel elbow connector, corrugated	DD 1023663-1 NB 0197
<b>Basic UDI-DI: 59079968R020202-CLP</b>			
<b>CATHETER MOUNT with straight connector, smooth-bore</b>	Class IIa	CATHETER MOUNT with straight connector, smooth-bore	DD 1023663-1 NB 0197
<b>Basic UDI-DI: 59079968R020201-SMJ</b>			
<b>CATHETER MOUNT with straight connector, corrugated</b>	Class IIa	CATHETER MOUNT with straight connector, corrugated	DD 1023663-1 NB 0197
<b>Basic UDI-DI: 59079968R020201-CLJ</b>			
<b>CATHETER MOUNT with straight connector, expandable</b>	Class IIa	CATHETER MOUNT with straight connector, expandable	DD 1023663-1 NB 0197
<b>Basic UDI-DI: 59079968R020201-ELN</b>			
<b>CATHETER MOUNT with elbow connector, smooth-bore</b>	Class IIa	CATHETER MOUNT with elbow connector, smooth-bore	DD 1023663-1 NB 0197
<b>Basic UDI-DI: 59079968R0202-SHP</b>			
<b>CATHETER MOUNT with elbow connector, corrugated</b>	Class IIa	CATHETER MOUNT with elbow connector, corrugated	DD 1023663-1 NB 0197
<b>Basic UDI-DI: 59079968R0202-CGP</b>			
<b>CATHETER MOUNT with elbow connector, expandable</b>	Class IIa	CATHETER MOUNT with elbow connector, expandable	DD 1023663-1 NB 0197
<b>Basic UDI-DI: 59079968R0202-EGT</b>			
<b>TRACHEOSTOMY TUBE cuffed</b>	Class IIa	TRACHEOSTOMY TUBE cuffed	DD 1023663-1 NB 0197
<b>Basic UDI-DI: 59079968R010502G4</b>			
<b>TRACHEOSTOMY TUBE uncuffed</b>	Class IIa	TRACHEOSTOMY TUBE uncuffed	DD 1023663-1 NB 0197



<b>Device name or Basic UDI-DI (under MDR application)</b>	<b>MDR Device classification (as proposed by the manufacturer and verified at the pre-application stage)</b>	<b>If the MDR device is a substitute device, identification of the corresponding MDD/AIMDD device</b>	<b>MDD/AIMDD Certificate Reference(s) of the devices under MDR application, and the NB Identification</b>
<b>Basic UDI-DI: 59079968R010501G2</b>			
<b>LARYNGEAL MASK, PVC, disposable</b>  <b>Basic UDI-DI: 59079968R0102-PH6</b>	Class IIa	LARYNGEAL MASK, PVC, disposable	DD 1023663-1 NB 0197
<b>LARYNGEAL MASK, silicone, disposable</b>  <b>Basic UDI-DI: 59079968R0102-SHC</b>	Class IIa	LARYNGEAL MASK, silicone, disposable	DD 1023663-1 NB 0197
<b>AIR CUSHION ANAESTHETIC MASK</b>  <b>Basic UDI-DI: 59079968R030101-CLQ</b>	Class IIa	AIR CUSHION ANAESTHETIC MASK	DD 1023663-1 NB 0197
<b>ANAESTHETIC MASK with open seal</b>  <b>Basic UDI-DI: 59079968R030101-OMG</b>	Class IIa	ANAESTHETIC MASK with open seal	DD 1023663-1 NB 0197
<b>duoNEX Single use syringe, 2-part</b>  <b>Basic UDI-DI: 59079968A0201020101DK</b>	Class IIa	duoNEX Single use syringe, 2-part	DD 1023663-1 NB 0197
<b>dicoNEX Single use syringe, 3-part (luer)</b>  <b>Basic UDI-DI: 59079968A0201020102DM</b>	Class IIa	dicoNEX Single use syringe, 3-part (luer)	DD 1023663-1 NB 0197
<b>Apteczka ABC Strzykawka 3-częściowa</b>  <b>Basic UDI-DI: 59079968A0201020102DM</b>	Class IIa	Apteczka ABC Strzykawka 3-częściowa	DD 1023663-1 NB 0197
<b>dicoNEX Single use syringe, 3-part (luer lock)</b>  <b>Basic UDI-DI: 59079968A0201020201DQ</b>	Class IIa	dicoNEX Single use syringe, 3-part (luer lock)	DD 1023663-1 NB 0197
<b>dicoNEX Single use amber syringe, 3-part (luer lock)</b>  <b>Basic UDI-DI: 59079968A0201020201-AVY</b>	Class IIa	dicoNEX Single use amber syringe, 3-part (luer lock)	DD 1023663-1 NB 0197
<b>dicoNEX</b>	Class IIa	dicoNEX	DD 1023663-1 NB 0197

Device name or Basic UDI-DI (under MDR application)	MDR Device classification (as proposed by the manufacturer and verified at the pre-application stage)	If the MDR device is a substitute device, identification of the corresponding MDD/AIMDD device	MDD/AIMDD Certificate Reference(s) of the devices under MDR application, and the NB Identification
<p>Single use catheter syringe, 3-part</p> <p>Basic UDI-DI: 59079968A020102037G</p>		Single use catheter syringe, 3-part	
<p>dicoNEX MN Single use syringe, 3-piece with mounted needle (luer)</p> <p>dicoNEX SN Single use syringe, 3-piece, with needle alongside the syringe (luer)</p> <p>Basic UDI-DI: 59079968A0201020102-IWA</p>	Class IIa	dicoNEX MN Single use syringe, 3-piece with mounted needle (luer) dicoNEX SN Single use syringe, 3-piece, with needle alongside the syringe (luer)	DD 1023663-1 NB 0197
<p>dicoNEX MN Single use syringe, 3-piece with mounted needle (luer lock)</p> <p>dicoNEX SN Single use syringe, 3-piece, with needle alongside the syringe (luer lock)</p> <p>Basic UDI-DI: 59079968A0201020201-IWG</p>	Class IIa	dicoNEX MN Single use syringe, 3-piece with mounted needle (luer lock) dicoNEX SN Single use syringe, 3-piece, with needle alongside the syringe (luer lock)	DD 1023663-1 NB 0197
<p>dicoNEX MN Single use amber syringe, 3-piece with mounted needle (luer lock)</p> <p>dicoNEX SN Single use amber syringe, 3-piece, with needle alongside the syringe (luer lock)</p> <p>Basic UDI-DI: 59079968A0201020201-IA9D</p>	Class IIa	dicoNEX MN Single use amber syringe, 3-piece with mounted needle (luer lock) dicoNEX SN Single use amber syringe, 3-piece, with needle alongside the syringe (luer lock)	DD 1023663-1 NB 0197
<p>dicoSULIN Insulin syringe</p> <p>Basic UDI-DI: 59079968A02010672</p>	Class IIa	dicoSULIN Insulin syringe	DD 1023663-1 NB 0197
<p>dicoTUBER Tuberculin syringe</p> <p>Basic UDI-DI: 59079968A02010978</p>	Class IIa	dicoTUBER Tuberculin syringe	DD 1023663-1 NB 0197
<p>dispoFINE Injection needle</p>	Class IIa	dispoFINE Injection needle	DD 1023663-1 NB 0197

Device name or Basic UDI-DI (under MDR application)	MDR Device classification (as proposed by the manufacturer and verified at the pre-application stage)	If the MDR device is a substitute device, identification of the corresponding MDD/AIMDD device	MDD/AIMDD Certificate Reference(s) of the devices under MDR application, and the NB Identification
Basic UDI-DI: 59079968A01010102CK			
dispoGUARD Safety injection needle  Basic UDI-DI: 59079968A01010101CH	Class IIa	dispoGUARD Safety injection needle	DD 1023663-1 NB 0197
dispoSULIN Insulin pen needle  Basic UDI-DI: 59079968A010101026Q	Class IIa	dispoSULIN Insulin pen needle	DD 1023663-1 NB 0197
easyFLOW TS Transfusion set  Basic UDI-DI: 59079968A03010102-PHT66	Class IIa	easyFLOW TS Transfusion set	DD 1023663-1 NB 0197
easyFLOW TS Transfusion set, phthalate-free easyFLOW TS PREMIUM Transfusion set, phthalate-free  Basic UDI-DI: 59079968A030101027S	Class IIa	easyFLOW TS Transfusion set, phthalate-free easyFLOW TS PREMIUM Transfusion set, phthalate-free	DD 1023663-1 NB 0197
NEEDLE FREE VALVE blue  Basic UDI-DI: 59079968A0705KE	Class IIa	NEEDLE FREE VALVE blue	DD 1023663-1 NB 0197
NEEDLE FREE VALVE transparent  Basic UDI-DI: 59079968A07050295	Class IIa	NEEDLE FREE VALVE transparent	DD 1023663-1 NB 0197
NEEDLE FREE VALVE transparent with extension line, single NEEDLE FREE VALVE transparent with extension line, double NEEDLE FREE VALVE transparent with extension line, triple NEEDLE FREE VALVE transparent with extension line, quadruple  Basic UDI-DI: 59079968A070502-LCQ	Class IIa	NEEDLE FREE VALVE transparent with extension line, single NEEDLE FREE VALVE transparent with extension line, double NEEDLE FREE VALVE transparent with extension line, triple NEEDLE FREE VALVE transparent with extension line, quadruple	DD 1023663-1 NB 0197

Device name or Basic UDI-DI (under MDR application)	MDR Device classification (as proposed by the manufacturer and verified at the pre-application stage)	If the MDR device is a substitute device, identification of the corresponding MDD/AIMDD device	MDD/AIMDD Certificate Reference(s) of the devices under MDR application, and the NB Identification
<b>safeCARE Surgical gloves, latex, powdered</b>  <b>Basic UDI-DI: 59079968T01010101-RYM</b>	Class IIa	safeCARE Surgical gloves, latex, powdered	DD 1023663-1 NB 0197
<b>safeCARE PF Surgical gloves powder free, sterile</b>  <b>Basic UDI-DI: 59079968T01010102-RYS</b>	Class IIa	safeCARE PF Surgical gloves powder free, sterile	DD 1023663-1 NB 0197
<b>safeCARE basic Surgical gloves latex, powdered</b>  <b>Basic UDI-DI: 59079968T01010101-RYM</b>	Class IIa	safeCARE basic Surgical gloves latex, powdered	DD 1023663-1 NB 0197
<b>safeCARE basic PF Surgical gloves latex, powder-free</b>  <b>Basic UDI-DI: 59079968T01010102-RYS</b>	Class IIa	safeCARE basic PF Surgical gloves latex, powder-free	DD 1023663-1 NB 0197
<b>safeCARE premium Surgical gloves latex, powder-free</b> <b>safeCARE UG Surgical gloves latex, powder-free</b> <b>safeCARE micro Surgical gloves latex, powder-free</b> <b>safeCARE ortho Surgical gloves latex, powder-free</b> <b>safeCARE dual Surgical gloves latex, powder-free</b>  <b>Basic UDI-DI: 59079968T01010102-RYS</b>	Class IIa	safeCARE premium Surgical gloves latex, powder-free safeCARE UG Surgical gloves latex, powder-free safeCARE micro Surgical gloves latex, powder-free safeCARE ortho Surgical gloves latex, powder-free safeCARE dual Surgical gloves latex, powder-free	DD 1023663-1 NB 0197
<b>safeCARE synthetic Surgical gloves neoprene, powder-free</b> <b>safeCARE synthetic UG Surgical gloves neoprene, powder-free</b>  <b>Basic UDI-DI: 59079968T010102-NRWL</b>	Class IIa	safeCARE synthetic Surgical gloves neoprene, powder-free safeCARE synthetic UG Surgical gloves neoprene, powder-free	DD 1023663-1 NB 0197
<b>safeCARE fusion Surgical gloves polyisoprene, powder-free</b>	Class IIa	safeCARE fusion Surgical gloves polyisoprene, powder-free	DD 1023663-1 NB 0197

<b>Device name or Basic UDI-DI (under MDR application)</b>	<b>MDR Device classification (as proposed by the manufacturer and verified at the pre-application stage)</b>	<b>If the MDR device is a substitute device, identification of the corresponding MDD/AIMDD device</b>	<b>MDD/AIMDD Certificate Reference(s) of the devices under MDR application, and the NB Identification</b>
<b>Basic UDI-DI: 59079968T010102-PRWS</b>			
<b>safeCARE virtuo Surgical gloves flexylon, powder-free safeCARE virtuo UG Surgical gloves flexylon, powder-free safeCARE pro protect Surgical gloves flexylon, powder-free</b>  <b>Basic UDI-DI: 59079968T010102-FRVU</b>	Class IIa	safeCARE virtuo Surgical gloves flexylon, powder-free safeCARE virtuo UG Surgical gloves flexylon, powder-free safeCARE pro protect Surgical gloves flexylon, powder-free	DD 1023663-1 NB 0197
<b>safeLANCE Pressure-activated safety lancet</b>  <b>Basic UDI-DI: 59079968V0104RM</b>	Class IIa	safeLANCE Pressure-activated safety lancet	DD 1023663-1 NB 0197
<b>deltaset Procedure kit O</b>  <b>Basic UDI-DI: 59079968V0599-SETA</b>	Class IIa	deltaset Urinary bladder catheterization kit	DD 1023663-1 NB 0197
<b>deltaset Procedure kit O</b>  <b>Basic UDI-DI: 59079968V0599-SHTG</b>	Class IIa	deltaset Urinary bladder catheterization kit	DD 1023663-1 NB 0197
<b>deltaset Procedure kit O</b>  <b>Basic UDI-DI: 59079968V0599-CERS</b>	Class IIa	deltaset Dialysis kit	DD 1023663-1 NB 0197
<b>deltaset Procedure kit O</b>  <b>Basic UDI-DI: 59079968V0599-CHRY</b>	Class IIa	deltaset Dialysis kit	DD 1023663-1 NB 0197
<b>deltaset Procedure kit O</b>  <b>Basic UDI-DI: 59079968V0599-WETN</b>	Class IIa	deltaset Dressing change kit	DD 1023663-1 NB 0197
<b>deltaset Procedure kit O</b>  <b>Basic UDI-DI: 59079968V0599-WHTU</b>	Class IIa	deltaset Dressing change kit	DD 1023663-1 NB 0197
<b>deltaset Procedure kit O</b>	Class IIa	deltaset Suture application kit	DD 1023663-1 NB 0197

<b>Device name or Basic UDI-DI (under MDR application)</b>	<b>MDR Device classification (as proposed by the manufacturer and verified at the pre-application stage)</b>	<b>If the MDR device is a substitute device, identification of the corresponding MDD/AIMDD device</b>	<b>MDD/AIMDD Certificate Reference(s) of the devices under MDR application, and the NB Identification</b>
<b>Basic UDI-DI: 59079968V0599-RET7</b>		deltaset Suture removal kit	
<b>deltaset Procedure kit O</b>  <b>Basic UDI-DI: 59079968V0599-RHTD</b>	Class IIa	deltaset Suture application kit  deltaset Suture removal kit	DD 1023663-1 NB 0197
<b>deltaset Procedure kit O</b>  <b>Basic UDI-DI: 59079968V0599-IESC</b>	Class IIa	deltaset Anasthesia kit  deltaset Puncture kit	DD 1023663-1 NB 0197
<b>deltaset Procedure kit O</b>  <b>Basic UDI-DI: 59079968V0599-IHSJ</b>	Class IIa	deltaset Anasthesia kit  deltaset Puncture kit	DD 1023663-1 NB 0197
<b>elastopor STERIL Non-woven dressing with absorbent pad, self-adhesive, sterile</b> <b>elastoKIDS STERIL Non-woven dressing with absorbent pad, self-adhesive, sterile</b>  <b>Basic UDI-DI: 59079968T0305RB</b>	Class I devices placed on the market in sterile condition	elastopor STERIL Non-woven dressing with absorbent pad, self-adhesive, sterile  elastoKIDS STERIL Non-woven dressing with absorbent pad, self-adhesive, sterile	DD 1023663-1 NB 0197
<b>elastoDERM PAD Foil dressing, with absorbent pad, self-adhesive, sterile</b>  <b>Basic UDI-DI: 59079968M040101-FHU</b>	Class I devices placed on the market in sterile condition	elastoDERM PAD Foil dressing, with absorbent pad, self-adhesive, sterile	DD 1023663-1 NB 0197
<b>elastoSTRIP Wound closure strips, sterile</b>  <b>Basic UDI-DI: 59079968M040499FL</b>	Class I devices placed on the market in sterile condition	elastoSTRIP Wound closure strips, sterile	DD 1023663-1 NB 0197
<b>UMBILICAL CORD CLAMP, sterile</b>  <b>Basic UDI-DI: 59079968V0202RN</b>	Class I devices placed on the market in sterile condition	UMBILICAL CORD CLAMP, sterile	DD 1023663-1 NB 0197
<b>ALPHAtex Procedure gown NORMAL, sterile</b>	Class I devices placed on the market in sterile condition	ALPHAtex Surgical gown NORMAL, sterile	DD 1023663-1 NB 0197

Device name or Basic UDI-DI (under MDR application)	MDR Device classification (as proposed by the manufacturer and verified at the pre-application stage)	If the MDR device is a substitute device, identification of the corresponding MDD/AIMDD device	MDD/AIMDD Certificate Reference(s) of the devices under MDR application, and the NB Identification
<b>Basic UDI-DI:</b> <b>59079968T0205R6</b>			
<b>ALPHAtex Procedure gown NORMAL-P</b>  <b>Basic UDI-DI:</b> <b>59079968T0205R6</b>	Class I devices placed on the market in sterile condition	ALPHAtex Surgical gown NORMAL-P, sterile	HD 1023663-1 NB 0197
<b>ALPHAtex Surgical gown STANDARD, sterile</b> <b>ALPHAtex Surgical gown COMFORT sterile</b>  <b>Basic UDI-DI:</b> <b>59079968T020401HA</b>	Class I devices placed on the market in sterile condition	ALPHAtex Surgical gown STANDARD, sterile ALPHAtex Surgical gown COMFORT sterile	DD 1023663-1 NB 0197
<b>ALPHAtex Surgical gown CLASSIC-P</b> <b>ALPHAtex Surgical gown STANDARD-P</b> <b>ALPHAtex Surgical gown COMFORT-P</b>  <b>Basic UDI-DI:</b> <b>59079968T020401HA</b>	Class I devices placed on the market in sterile condition	ALPHAtex Surgical gown CLASSIC-P, sterile ALPHAtex Surgical gown STANDARD-P, sterile ALPHAtex Surgical gown COMFORT-P sterile	HD 1023663-1 NB 0197
<b>ALPHAtex Surgical gown STANDARD PLUS, with impermeable parts, sterile</b> <b>ALPHAtex Surgical gown COMFORT PLUS, with impermeable parts, sterile</b> <b>ALPHAtex Surgical gown EXTRA SAFE, with impermeable parts, sterile</b>  <b>Basic UDI-DI:</b> <b>59079968T020402HC</b>	Class I devices placed on the market in sterile condition	ALPHAtex Surgical gown STANDARD PLUS, with impermeable parts, sterile ALPHAtex Surgical gown COMFORT PLUS, with impermeable parts, sterile ALPHAtex Surgical gown EXTRA SAFE, with impermeable parts, sterile	DD 1023663-1 NB 0197
<b>ALPHAtex Surgical gown STANDARD PLUS-P, with impermeable parts</b> <b>ALPHAtex Surgical gown COMFORT PLUS-P, with impermeable parts</b> <b>ALPHAtex Surgical gown EXTRA SAFE-P, with impermeable parts</b>  <b>Basic UDI-DI:</b> <b>59079968T020402HC</b>	Class I devices placed on the market in sterile condition	ALPHAtex Surgical gown STANDARD PLUS-P, with impermeable parts, sterile ALPHAtex Surgical gown COMFORT PLUS-P, with impermeable parts, sterile ALPHAtex Surgical gown EXTRA SAFE-P, with impermeable parts, sterile	HD 1023663-1 NB 0197

Device name or Basic UDI-DI (under MDR application)	MDR Device classification (as proposed by the manufacturer and verified at the pre-application stage)	If the MDR device is a substitute device, identification of the corresponding MDD/AIMDD device	MDD/AIMDD Certificate Reference(s) of the devices under MDR application, and the NB Identification
		impermeable parts, sterile	
<p>ALPHAtex Surgical drape, sterile  ALPHAtex 2-layer surgical drape, with cellulose layer, sterile  ALPHAtex 2-layer surgical drape, sterile  ALPHAtex 2-layer surgical drape with adhesive edge, sterile  ALPHAtex 2-layer surgical drape with central fenestration, sterile  ALPHAtex 2-layer surgical drape with central adhesive fenestration, sterile  ALPHAtex 2-layer surgical drape with central, adjustable adhesive fenestration, sterile  ALPHAtex 2-layer epidural surgical drape with adhesive fenestration, sterile  ALPHAtex 3-layer surgical drape, sterile  ALPHAtex 3-layer surgical drape with adhesive edge, sterile  ALPHAtex 3-layer surgical drape with central fenestration, sterile  ALPHAtex 3-layer surgical drape with central adhesive fenestration, sterile  ALPHAtex Reinforced surgical drape with adhesive fenestration, sterile</p> <p>Basic UDI-DI:  59079968T0201QW</p>	<p>Class I devices placed on the market in sterile condition</p>	<p>ALPHAtex Surgical drape, sterile  ALPHAtex 2-layer surgical drape, with cellulose layer, sterile  ALPHAtex 2-layer surgical drape, sterile  ALPHAtex 2-layer surgical drape with adhesive edge, sterile  ALPHAtex 2-layer surgical drape with central fenestration, sterile  ALPHAtex 2-layer surgical drape with central adhesive fenestration, sterile  ALPHAtex 2-layer surgical drape with central, adjustable adhesive fenestration, sterile  ALPHAtex 2-layer epidural surgical drape with adhesive fenestration, sterile  ALPHAtex 3-layer surgical drape, sterile  ALPHAtex 3-layer surgical drape with adhesive edge, sterile  ALPHAtex 3-layer surgical drape with central fenestration, sterile  ALPHAtex 3-layer surgical drape with central adhesive fenestration, sterile  ALPHAtex Reinforced surgical drape with adhesive fenestration, sterile</p>	<p>DD 1023663-1  NB 0197</p>



Device name or Basic UDI-DI (under MDR application)	MDR Device classification (as proposed by the manufacturer and verified at the pre-application stage)	If the MDR device is a substitute device, identification of the corresponding MDD/AIMDD device	MDD/AIMDD Certificate Reference(s) of the devices under MDR application, and the NB Identification
<p><b>ALPHAtex Surgical drape</b>  <b>ALPHAtex 2-layer surgical drape, with cellulose layer</b>  <b>ALPHAtex 2-layer surgical drape</b>  <b>ALPHAtex 2-layer surgical drape with adhesive edge</b>  <b>ALPHAtex 2-layer surgical drape with central fenestration</b>  <b>ALPHAtex 2-layer surgical drape with central adhesive fenestration</b>  <b>ALPHAtex 3-layer surgical drape</b>  <b>ALPHAtex 3-layer surgical drape with adhesive edge</b>  <b>ALPHAtex 3-layer surgical drape with central fenestration</b>  <b>ALPHAtex 3-layer surgical drape with central adhesive fenestration</b></p> <p><b>Basic UDI-DI:</b>  <b>59079968T0201QW</b></p>	<p>Class I devices placed on the market in sterile condition</p>	<p>ALPHAtex Surgical drape, sterile  ALPHAtex 2-layer surgical drape, with cellulose layer, sterile  ALPHAtex 2-layer surgical drape, sterile  ALPHAtex 2-layer surgical drape with adhesive edge, sterile  ALPHAtex 2-layer surgical drape with central fenestration, sterile  ALPHAtex 2-layer epidural surgical drape with adhesive fenestration, sterile  ALPHAtex 3-layer surgical drape, sterile  ALPHAtex 3-layer surgical drape with adhesive edge, sterile  ALPHAtex 3-layer surgical drape with central fenestration, sterile  ALPHAtex 3-layer surgical drape with central adhesive fenestration, sterile</p>	<p>HD 1023663-1  NB 0197</p>
<p><b>ALPHAtex Instrument table cover, sterile</b></p> <p><b>Basic UDI-DI:</b>  <b>59079968T030101-INJ</b></p>	<p>Class I devices placed on the market in sterile condition</p>	<p>ALPHAtex Instrument table cover, sterile</p>	<p>DD 1023663-1  NB 0197</p>
<p><b>ALPHAtex Reinforced Mayo stand cover, sterile</b>  <b>ALPHAtex Reinforced Mayo stand cover, red, sterile</b></p> <p><b>Basic UDI-DI:</b>  <b>59079968T030101-MNS</b></p>	<p>Class I devices placed on the market in sterile condition</p>	<p>ALPHAtex Reinforced Mayo stand cover, sterile  ALPHAtex Reinforced Mayo stand cover, red, sterile</p>	<p>DD 1023663-1  NB 0197</p>

Device name or Basic UDI-DI (under MDR application)	MDR Device classification (as proposed by the manufacturer and verified at the pre-application stage)	If the MDR device is a substitute device, identification of the corresponding MDD/AIMDD device	MDD/AIMDD Certificate Reference(s) of the devices under MDR application, and the NB Identification
<p>ALPHAtex Armboard cover, sterile ALPHAtex Surgical pocket for syringes, sterile</p> <p>Basic UDI-DI: 59079968T030101-NNU</p>	<p>Class I devices placed on the market in sterile condition</p>	<p>ALPHAtex Armboard cover, sterile ALPHAtex Surgical pocket for syringes, sterile</p>	<p>DD 1023663-1 NB 0197</p>
<p>ALPHAtex Camera cables cover, sterile ALPHAtex Circular banded cover for medical devices, sterile ALPHAtex Square banded cover for medical devices, sterile ALPHAtex C-arm cover set, sterile ALPHAtex Lamp handle cover, sterile ALPHAtex Ultrasound cover kits, sterile</p> <p>Basic UDI-DI: 59079968T030101-FNC</p>	<p>Class I devices placed on the market in sterile condition</p>	<p>ALPHAtex Camera cables cover, sterile ALPHAtex Circular banded cover for medical devices, sterile ALPHAtex Square banded cover for medical devices, sterile ALPHAtex C-arm cover set, sterile ALPHAtex Lamp handle cover, sterile ALPHAtex Ultrasound cover kits, sterile</p>	<p>DD 1023663-1 NB 0197</p>
<p>ALPHAtex Absorbent drape, sterile ALPHAtex Absorbent drape for newborn, sterile</p> <p>Basic UDI-DI: 59079968T020199-SRU</p>	<p>Class I devices placed on the market in sterile condition</p>	<p>ALPHAtex Absorbent drape, sterile ALPHAtex Absorbent drape for newborn, sterile</p>	<p>DD 1023663-1 NB 0197</p>
<p>ALPHAtex Absorbent drape, sterile ALPHAtex Absorbent drape for newborn, sterile</p> <p>Basic UDI-DI: 59079968T020199-SRU</p>	<p>Class I devices placed on the market in sterile condition</p>	<p>ALPHAtex Absorbent drape, sterile ALPHAtex Absorbent drape for newborn, sterile</p>	<p>HD 1023663-1 NB 0197</p>
<p>ALPHAtex Limb cover, sterile ALPHAtex Head Turban drape, sterile ALPHAtex Under buttocks drape, sterile</p> <p>Basic UDI-DI: 59079968T020102GV</p>	<p>Class I devices placed on the market in sterile condition</p>	<p>ALPHAtex Limb cover, sterile ALPHAtex Head Turban drape, sterile ALPHAtex Under buttocks drape, sterile</p>	<p>DD 1023663-1 NB 0197</p>
<p>ALPHAtex Adhesive pouch, one-chamber, sterile</p>	<p>Class I devices placed on the</p>	<p>ALPHAtex Adhesive pouch,</p>	<p>DD 1023663-1 NB 0197</p>

Device name or Basic UDI-DI (under MDR application)	MDR Device classification (as proposed by the manufacturer and verified at the pre-application stage)	If the MDR device is a substitute device, identification of the corresponding MDD/AIMDD device	MDD/AIMDD Certificate Reference(s) of the devices under MDR application, and the NB Identification
<p>ALPHAtex Adhesive pouch, two-chamber, sterile  ALPHAtex Arthroscopy fluid collection pouch, cone-shaped, with outlet tip, sterile  ALPHAtex Fluid collection pouch, cone-shaped, with outlet tip, sterile</p> <p>Basic UDI-DI:  59079968T020199-PRN</p>	<p>market in sterile condition</p>	<p>one-chamber, sterile  ALPHAtex Adhesive pouch, two-chamber, sterile  ALPHAtex Arthroscopy fluid collection pouch, cone-shaped, with outlet tip, sterile  ALPHAtex Fluid collection pouch, cone-shaped, with outlet tip, sterile</p>	
<p>ALPHAtex Non-woven surgical tape, adhesive, sterile  ALPHAtex Velcro surgical tape, sterile</p> <p>Basic UDI-DI:  59079968T020199-TRW</p>	<p>Class I devices placed on the market in sterile condition</p>	<p>ALPHAtex Non-woven surgical tape, adhesive, sterile  ALPHAtex Velcro surgical tape, sterile</p>	<p>DD 1023663-1  NB 0197</p>
<p>ALPHAtex Abdominal drape, sterile  ALPHAtex Abdo-Perineal drape, sterile  ALPHAtex Angiography drape, sterile  ALPHAtex Cardiology drape, sterile  ALPHAtex Cardiac drape, sterile  ALPHAtex C-section drape, sterile  ALPHAtex Delivery drape, sterile  ALPHAtex Extremity drape, sterile  ALPHAtex Gynaecology drape, sterile  ALPHAtex Laparoscopy drape, sterile  ALPHAtex Ophthalmic drape, sterile  ALPHAtex Orthopaedic drape, sterile  ALPHAtex Shoulder drape, sterile  ALPHAtex Vertical isolation drape, sterile</p>	<p>Class I devices placed on the market in sterile condition</p>	<p>ALPHAtex Abdominal drape, sterile  ALPHAtex Abdo-Perineal drape, sterile  ALPHAtex Angiography drape, sterile  ALPHAtex Cardiology drape, sterile  ALPHAtex Cardiac drape, sterile  ALPHAtex C-section drape, sterile  ALPHAtex Delivery drape, sterile  ALPHAtex Extremity drape, sterile  ALPHAtex Gynaecology drape, sterile  ALPHAtex Laparoscopy drape, sterile</p>	<p>DD 1023663-1  NB 0197</p>

Device name or Basic UDI-DI (under MDR application)	MDR Device classification (as proposed by the manufacturer and verified at the pre-application stage)	If the MDR device is a substitute device, identification of the corresponding MDD/AIMDD device	MDD/AIMDD Certificate Reference(s) of the devices under MDR application, and the NB Identification
<p><b>Basic UDI-DI:</b> <b>59079968T0202QY</b></p>		<p>ALPHAtex Ophthalmic drape, sterile ALPHAtex Orthopaedic drape, sterile ALPHAtex Shoulder drape, sterile ALPHAtex Vertical isolation drape, sterile</p>	
<p><b>ALPHAtex Abdominal drape, sterile</b> <b>ALPHAtex Abdo-Perineal drape, sterile</b> <b>ALPHAtex Angiography drape, sterile</b> <b>ALPHAtex Cardiology drape, sterile</b> <b>ALPHAtex Cardiac drape, sterile</b> <b>ALPHAtex C-section drape, sterile</b> <b>ALPHAtex Delivery drape, sterile</b> <b>ALPHAtex Extremity drape, sterile</b> <b>ALPHAtex Gynaecology drape, sterile</b> <b>ALPHAtex Laparoscopy drape, sterile</b> <b>ALPHAtex Ophthalmic drape, sterile</b> <b>ALPHAtex Orthopaedic drape, sterile</b> <b>ALPHAtex Shoulder drape, sterile</b> <b>ALPHAtex Vertical isolation drape, sterile</b></p> <p><b>Basic UDI-DI:</b> <b>59079968T0202QY</b></p>	<p>Class I devices placed on the market in sterile condition</p>	<p>ALPHAtex Abdominal drape (from 1 to 100) ALPHAtex Abdo-Perineal drape (from 1 to 100) ALPHAtex Angiography drape (from 1 to 100) ALPHAtex Cardiology drape (from 1 to 100) ALPHAtex Cardiac drape (from 1 to 100) ALPHAtex C-section drape (from 1 to 100) ALPHAtex Delivery drape (from 1 to 100) ALPHAtex Extremity drape (from 1 to 100) ALPHAtex Gynaecology drape (from 1 to 100) ALPHAtex Laparoscopy drape (from 1 to 100) ALPHAtex Ophthalmic drape (from 1 to 100) ALPHAtex Orthopaedic drape (from 1 to 100) ALPHAtex Shoulder drape (from 1 to 100)</p>	<p>HD 1023663-1 NB 0197</p>

Device name or Basic UDI-DI (under MDR application)	MDR Device classification (as proposed by the manufacturer and verified at the pre-application stage)	If the MDR device is a substitute device, identification of the corresponding MDD/AIMDD device	MDD/AIMDD Certificate Reference(s) of the devices under MDR application, and the NB Identification
		ALPHAtex Vertical isolation drape (from 1 to 100)	
<p><b>ALPHAtex Abdominal set, sterile</b>  <b>ALPHAtex Abdo-Perineal set, sterile</b>  <b>ALPHAtex Ablation set, sterile</b>  <b>ALPHAtex Angiography set, sterile</b>  <b>ALPHAtex Arthroscopy set, sterile</b>  <b>ALPHAtex Basic set, sterile</b>  <b>ALPHAtex Cardiology set, sterile</b>  <b>ALPHAtex Cardiac set, sterile</b>  <b>ALPHAtex Craniotomy set, sterile</b>  <b>ALPHAtex C-section set, sterile</b>  <b>ALPHAtex Cystoscopy set, sterile</b>  <b>ALPHAtex Delivery set, sterile</b>  <b>ALPHAtex Dental set, sterile</b>  <b>ALPHAtex Dynamic hip screw set, sterile</b>  <b>ALPHAtex Extremity set, sterile</b>  <b>ALPHAtex Gynaecology set, sterile</b>  <b>ALPHAtex Hip set, sterile</b>  <b>ALPHAtex Laparoscopy set, sterile</b>  <b>ALPHAtex Laryngology set, sterile</b>  <b>ALPHAtex Ophthalmic set, sterile</b>  <b>ALPHAtex Otolaryngology set, sterile</b>  <b>ALPHAtex Pediatric set, sterile</b>  <b>ALPHAtex Percutaneous lithotripsy set, sterile</b>  <b>ALPHAtex Shoulder set, sterile</b>  <b>ALPHAtex Spine set, sterile</b></p>	<p>Class I devices placed on the market in sterile condition</p>	<p>ALPHAtex Vertical isolation drape (from 1 to 100)</p> <p>ALPHAtex Abdominal set, sterile  ALPHAtex Abdo-Perineal set, sterile  ALPHAtex Ablation set, sterile  ALPHAtex Angiography set, sterile  ALPHAtex Arthroscopy set, sterile  ALPHAtex Cardiology set, sterile  ALPHAtex Basic set, sterile  ALPHAtex Cardiac set, sterile  ALPHAtex Craniotomy set, sterile  ALPHAtex C-section set, sterile  ALPHAtex Cystoscopy set, sterile  ALPHAtex Delivery set, sterile  ALPHAtex Dental set, sterile  ALPHAtex Dynamic hip screw set, sterile  ALPHAtex Extremity set, sterile  ALPHAtex Gynaecology set, sterile  ALPHAtex Hip set, sterile  ALPHAtex Laparoscopy set, sterile  ALPHAtex Laryngology set, sterile</p>	<p>DD 1023663-1  NB 0197</p>

Device name or Basic UDI-DI (under MDR application)	MDR Device classification (as proposed by the manufacturer and verified at the pre-application stage)	If the MDR device is a substitute device, identification of the corresponding MDD/AIMDD device	MDD/AIMDD Certificate Reference(s) of the devices under MDR application, and the NB Identification
<p>ALPHAtex Thyroid set, sterile  ALPHAtex TUR set, sterile  ALPHAtex Universal set, sterile  ALPHAtex Uro/gynaecology set, sterile  ALPHAtex Varicose vein set, sterile  ALPHAtex Vertical isolation set, sterile</p> <p>Basic UDI-DI:  59079968T0202QY</p>		<p>ALPHAtex Ophthalmic set, sterile  ALPHAtex Otolaryngology set, sterile  ALPHAtex Pediatric set, sterile  ALPHAtex Percutaneous lithotripsy set, sterile  ALPHAtex Shoulder set, sterile  ALPHAtex Spine set, sterile  ALPHAtex Thyroid set, sterile  ALPHAtex TUR set, sterile  ALPHAtex Universal set, sterile  ALPHAtex Uro/gynaecology set, sterile  ALPHAtex Varicose vein set, sterile  ALPHAtex Vertical isolation set, sterile</p>	
<p>ALPHAtex Abdominal set, sterile  ALPHAtex Abdo-Perineal set, sterile  ALPHAtex Ablation set, sterile  ALPHAtex Angiography set, sterile  ALPHAtex Arthroscopy set, sterile  ALPHAtex Basic set, sterile  ALPHAtex Cardiology set, sterile  ALPHAtex Cardiac set, sterile  ALPHAtex Craniotomy set, sterile  ALPHAtex C-section set, sterile</p>	<p>Class I devices placed on the market in sterile condition</p>	<p>"ALPHAtex Abdominal set (from 1 to 200)  ALPHAtex Abdo-Perineal set (from 1 to 200)  ALPHAtex Ablation set (from 1 to 200)  ALPHAtex Angiography set (from 1 to 200)  ALPHAtex Arthroscopy set (from 1 to 200)  ALPHAtex Basic set (from 1 to 200)  ALPHAtex Cardiology set (from 1 to 200)</p>	<p>HD 1023663-1  NB 0197</p>

Device name or Basic UDI-DI (under MDR application)	MDR Device classification (as proposed by the manufacturer and verified at the pre-application stage)	If the MDR device is a substitute device, identification of the corresponding MDD/AIMDD device	MDD/AIMDD Certificate Reference(s) of the devices under MDR application, and the NB Identification
<p>ALPHAtex Cystoscopy set, sterile  ALPHAtex Delivery set, sterile  ALPHAtex Dental set, sterile  ALPHAtex Dynamic hip screw set, sterile  ALPHAtex Extremity set, sterile  ALPHAtex Gynaecology set, sterile  ALPHAtex Hip set, sterile  ALPHAtex Laparoscopy set, sterile  ALPHAtex Laryngology set, sterile  ALPHAtex Ophthalmic set, sterile  ALPHAtex Otolaryngology set, sterile  ALPHAtex Pediatric set, sterile  ALPHAtex Percutaneous lithotripsy set, sterile  ALPHAtex Shoulder set, sterile  ALPHAtex Spine set, sterile  ALPHAtex Thyroid set, sterile  ALPHAtex TUR set, sterile  ALPHAtex Universal set, sterile  ALPHAtex Uro/gynaecology set, sterile  ALPHAtex Varicose vein set, sterile  ALPHAtex Vertical isolation set, sterile</p> <p>Basic UDI-DI:  59079968T0202QY</p>		<p>ALPHAtex Cardiac set (from 1 to 200)  ALPHAtex Craniotomy set (from 1 to 200)  ALPHAtex C-section set (from 1 to 200)  ALPHAtex Cystoscopy set (from 1 to 200)  ALPHAtex Delivery set (from 1 to 200)  ALPHAtex Dental set (from 1 to 200)  ALPHAtex Dynamic hip screw set (from 1 to 200)  ALPHAtex Extremity set (from 1 to 200)  ALPHAtex Gynaecology set (from 1 to 200)  ALPHAtex Hip set (from 1 to 200)  ALPHAtex Laparoscopy set (from 1 to 200)  ALPHAtex Laryngology set (from 1 to 200)  ALPHAtex Ophthalmic set (from 1 to 200)  ALPHAtex Otolaryngology set (from 1 to 200)  ALPHAtex Pediatric set (from 1 to 200)  ALPHAtex Percutaneous lithotripsy set (from 1 to 200)  ALPHAtex Shoulder set (from 1 to 200)  ALPHAtex Spine set (from 1 to 200)  ALPHAtex Thyroid set (from 1 to 200)</p>	

Device name or Basic UDI-DI (under MDR application)	MDR Device classification (as proposed by the manufacturer and verified at the pre-application stage)	If the MDR device is a substitute device, identification of the corresponding MDD/AIMDD device	MDD/AIMDD Certificate Reference(s) of the devices under MDR application, and the NB Identification
		ALPHAtex TUR set (from 1 to 200) ALPHAtex Universal set (from 1 to 200) ALPHAtex Uro/gynaecology set (from 1 to 200) ALPHAtex Varicose vein set (from 1 to 200) ALPHAtex Vertical isolation set (from 1 to 200)"	
<b>elastoLUMENAL S Eye pad, superabsorbent, multi-layer, sterile</b>  <b>Basic UDI-DI: 59079968M040301-SKC</b>	Class I devices placed on the market in sterile condition	elastoLUMENAL S Eye pad, superabsorbent, multi-layer, sterile	DD 1023663-1 NB 0197
<b>elastopor EYE Eye dressing, non-woven, with absorbent pad, self-adhesive, sterile</b> <b>elastoKIDS EYE Eye dressing, non-woven, with absorbent pad, self-adhesive, sterile</b>  <b>Basic UDI-DI: 59079968M0403NX</b>	Class I devices placed on the market in sterile condition	lastopor EYE Eye dressing, non-woven, with absorbent pad, self-adhesive, sterile elastoKIDS EYE Eye dressing, non-woven, with absorbent pad, self-adhesive, sterile	DD 1023663-1 NB 0197
<b>COMBI STOPPER</b>  <b>Basic UDI-DI: 59079968C01018085</b>	Class I devices placed on the market in sterile condition	COMBI STOPPER	DD 1023663-1 NB 0197
<b>LUER LOCK STOPPER</b>  <b>Basic UDI-DI: 59079968C01018085</b>	Class I devices placed on the market in sterile condition	LUER LOCK STOPPER	DD 1023663-1 NB 0197
<b>elastopor STERIL D Non-woven dressing with absorbent pad, with incision and O-hole, self-adhesive, sterile</b> <b>elastoKIDS STERIL D Non-woven dressing, with absorbent pad, with</b>	Class I devices placed on the market in sterile condition	elastopor STERIL D Non-woven dressing with absorbent pad, with incision and O-hole, self-adhesive, sterile elastopor STERIL D Non-woven	DD 1023663-1 NB 0197



Device name or Basic UDI-DI (under MDR application)	MDR Device classification (as proposed by the manufacturer and verified at the pre-application stage)	If the MDR device is a substitute device, identification of the corresponding MDD/AIMDD device	MDD/AIMDD Certificate Reference(s) of the devices under MDR application, and the NB Identification
<p>incision and X-hole, self-adhesive, sterile</p> <p><b>Basic UDI-DI:</b> 59079968M04010201-DTG</p>		<p>dressing, with absorbent pad, with incision and X-hole, self-adhesive, sterile</p> <p>elastoKIDS STERIL D Non-woven dressing, with absorbent pad, with incision and X-hole, self-adhesive, sterile</p>	
<p><b>NONVI lux S Non-woven swab, with O-incision, sterile</b></p> <p><b>NONVI lux S Non-woven swab, with Y-incision, sterile</b></p> <p><b>Basic UDI-DI:</b> 59079968M04010201-NU4</p>	<p>Class I devices placed on the market in sterile condition</p>	<p>NONVI lux S Non-woven swab, with O-incision, sterile</p> <p>NONVI lux S Non-woven swab, with Y-incision, sterile</p>	<p>DD 1023663-1 NB 0197</p>
<p><b>elastopor IV IV cannula dressing, non-woven, selfadhesive, sterile</b></p> <p><b>elastoKIDS IV IV cannula dressing, non-woven, selfadhesive, sterile</b></p> <p><b>Basic UDI-DI:</b> 59079968M04010201H2</p>	<p>Class I devices placed on the market in sterile condition</p>	<p>elastopor IV IV cannula dressing, non-woven, selfadhesive, sterile</p> <p>elastoKIDS IV IV cannula dressing, non-woven, selfadhesive, sterile</p>	<p>DD 1023663-1 NB 0197</p>
<p><b>elastoDERM F-IV IV cannula dressing, foil, with frame, with U-incision, self-adhesive, sterile</b></p> <p><b>elastoDERM IV IV cannula dressing, foil, selfadhesive, sterile</b></p> <p><b>elastoDERM Foil dressing, self-adhesive, sterile</b></p> <p><b>elastoDERM F Foil dressing, with frame, selfadhesive, sterile</b></p> <p><b>elastoDERM C Foil dressing with a pocket to secure catheter, sterile</b></p> <p><b>Basic UDI-DI:</b> 59079968M04010202H4</p>	<p>Class I devices placed on the market in sterile condition</p>	<p>elastoDERM F-IV IV cannula dressing, foil, with frame, with U-incision, self-adhesive, sterile</p> <p>elastoDERM IV IV cannula dressing, foil, selfadhesive, sterile</p> <p>elastoDERM Foil dressing, self-adhesive, sterile</p> <p>elastoDERM F Foil dressing, with frame, selfadhesive, sterile</p> <p>elastoDERM C Foil dressing with a pocket to secure catheter, sterile</p>	<p>DD 1023663-1 NB 0197</p>

Device name or Basic UDI-DI (under MDR application)	MDR Device classification (as proposed by the manufacturer and verified at the pre-application stage)	If the MDR device is a substitute device, identification of the corresponding MDD/AIMDD device	MDD/AIMDD Certificate Reference(s) of the devices under MDR application, and the NB Identification
<b>MULTIabsorb S ABD pad, non-woven and cellulose, sterile</b>  <b>Basic UDI-DI: 59079968M040201-SJZ</b>	Class I devices placed on the market in sterile condition	MULTIabsorb S ABD pad, non-woven and cellulose, sterile	DD 1023663-1 NB 0197
<b>VAGINAL SPECULUM</b>  <b>Basic UDI-DI: 59079968U089006MJ</b>	Class I devices placed on the market in sterile condition	VAGINAL SPECULUM	DD 1023663-1 NB 0197
<b>URINE BAG</b>  <b>Basic UDI-DI: 59079968A0603038J</b>	Class I devices placed on the market in sterile condition	URINE BAG	DD 1023663-1 NB 0197
<b>URINE BAG with sample port, sterile</b> <b>URINE BAG with sample port 2W, sterile</b>  <b>Basic UDI-DI: 59079968A060303-PBW</b>	Class I devices placed on the market in sterile condition	URINE BAG with sample port, sterile URINE BAG with sample port 2W, sterile	DD 1023663-1 NB 0197
<b>SAMPLES TAKING URINE BAG for boys, with sponge</b> <b>SAMPLES TAKING URINE BAG for boys, without sponge</b> <b>SAMPLES TAKING URINE BAG for girls, with sponge</b> <b>SAMPLES TAKING URINE BAG for girls, without sponge</b> <b>Apteczka ABC Woreczek do pobierania próbek moczu dla dla chłopców z gąbką</b> <b>Apteczka ABC Woreczek do pobierania próbek moczu dla dziewczynek z gąbką</b>  <b>Basic UDI-DI: 59079968A06030301AB</b>	Class I devices placed on the market in sterile condition	<b>SAMPLES TAKING URINE BAG for boys, with sponge</b> <b>SAMPLES TAKING URINE BAG for boys, without sponge</b> <b>SAMPLES TAKING URINE BAG for girls, with sponge</b> <b>SAMPLES TAKING URINE BAG for girls, without sponge</b> <b>Apteczka ABC Woreczek do pobierania próbek moczu dla dla chłopców z gąbką</b> <b>Apteczka ABC Woreczek do pobierania próbek moczu dla dziewczynek z gąbką</b>	DD 1023663-1 NB 0197
<b>ENEMA BAG sterile</b>  <b>Basic UDI-DI: 59079968G020301-SDY</b>	Class I devices placed on the market in sterile condition	ENEMA BAG sterile	DD 1023663-1 NB 0197

Device name or Basic UDI-DI (under MDR application)	MDR Device classification (as proposed by the manufacturer and verified at the pre-application stage)	If the MDR device is a substitute device, identification of the corresponding MDD/AIMDD device	MDD/AIMDD Certificate Reference(s) of the devices under MDR application, and the NB Identification
<b>WOODEN TONGUE DEPRESSOR</b> <b>Sterile</b>  <b>Basic UDI-DI:</b> <b>59079968V9001-SNM</b>	Class I devices placed on the market in sterile condition	WOODEN TONGUE DEPRESSOR sterile	DD 1023663-1 NB 0197
<b>NELATON CATHETER</b> <b>NELATON CATHETER transparent</b>  <b>Basic UDI-DI:</b> <b>59079968U010105H9</b>	Class I devices placed on the market in sterile condition	NELATON CATHETER NELATON CATHETER transparent	DD 1023663-1 NB 0197
<b>GUEDEL AIRWAY</b>  <b>Basic UDI-DI:</b> <b>59079968R010102FG</b>	Class I devices placed on the market in sterile condition	GUEDEL AIRWAY	DD 1023663-1 NB 0197
<b>ENDOTRACHEAL TUBE HOLDER, vertical fixation</b> <b>ENDOTRACHEAL TUBE HOLDER, horizontal fixation</b>  <b>Basic UDI-DI:</b> <b>59079968R010380-SNX</b>	Class I devices placed on the market in sterile condition	ENDOTRACHEAL TUBE HOLDER, vertical fixation ENDOTRACHEAL TUBE HOLDER, horizontal fixation	DD 1023663-1 NB 0197
<b>INTUBATION STYLET TRACHEAL TUBE INTRODUCER CURVED</b>  <b>Basic UDI-DI:</b> <b>59079968R010380-PNR</b>	Class I devices placed on the market in sterile condition	INTUBATION STYLET TRACHEAL TUBE INTRODUCER CURVED	DD 1023663-1 NB 0197
<b>dicoSPIKE Withdrawal cannula with bacteria filter</b> <b>dicoSPIKE Withdrawal cannula with bacteria and particle filter</b> <b>dicoSPIKE Chemo Withdrawal cannula with bacteria and particle filter</b>  <b>Basic UDI-DI:</b> <b>59079968A0704KC</b>	Class I devices placed on the market in sterile condition	dicoSPIKE Withdrawal cannula with bacteria filter dicoSPIKE Withdrawal cannula with bacteria and particle filter dicoSPIKE Chemo Withdrawal cannula with bacteria and particle filter	DD 1023663-1 NB 0197
<b>elastoBAND BASIC S Knitted supporting bandage, sterile</b>  <b>Basic UDI-DI:</b> <b>59079968M030301-SJT</b>	Class I devices placed on the market in sterile condition	elastoBAND BASIC S Knitted supporting bandage, sterile	HD 1023663-1 NB 0197
<b>elastoBAND FLEX S Elastic bandage, sterile</b>	Class I devices placed on the	elastoBAND FLEX S	DD 1023663-1 NB 0197

Device name or Basic UDI-DI (under MDR application)	MDR Device classification (as proposed by the manufacturer and verified at the pre-application stage)	If the MDR device is a substitute device, identification of the corresponding MDD/AIMDD device	MDD/AIMDD Certificate Reference(s) of the devices under MDR application, and the NB Identification
<b>Basic UDI-DI:</b> <b>59079968M030402-SKB</b>	market in sterile condition	Elastic bandage, sterile	
<b>elastoFILM Incise film, self-adhesive, sterile</b> <b>elastoFILM M Incise film, self-adhesive, sterile</b>  <b>Basic UDI-DI:</b> <b>59079968T020101GT</b>	Class I devices placed on the market in sterile condition	elastoFILM Incise film, self-adhesive, sterile elastoFILM M Incise film, self-adhesive, sterile	DD 1023663-1 NB 0197
<b>CERVICAL BRUSH standard</b> <b>CERVICAL BRUSH special</b>  <b>Basic UDI-DI:</b> <b>59079968U090303L7</b>	Class I devices placed on the market in sterile condition	CERVICAL BRUSH standard CERVICAL BRUSH special	DD 1023663-1 NB 0197
<b>omegapack Surgical set B</b>  <b>Basic UDI-DI:</b> <b>59079968V0599-EP2</b>	Class IIb excluding Class IIb implantable non-WET	omegapack Surgical set B Orthopedic surgery set B Universal set B Surgical set B Orthopedic surgery set B Universal set B	HD 1023663-1 NB 0197
<b>omegapack Surgical set B</b>  <b>Basic UDI-DI:</b> <b>59079968V0599-KPE</b>	Class IIb excluding Class IIb implantable non-WET	omegapack Surgical set B Orthopedic surgery set B Universal set B Surgical set B Orthopedic surgery set B Universal set B	HD 1023663-1 NB 0197
<b>omegapack Surgical set</b>  <b>Basic UDI-DI:</b> <b>59079968V0599-ANS</b>	Class IIa	omegapack Surgical set Angiography set C-section set Laparoscopy set Gynecological surgery set Cardiac surgery set Neurosurgical set Orthopedic surgery set Otolaryngologic surgery set Urologic surgery set Delivery set Dressing set	HD 1023663-1 NB 0197

Device name or Basic UDI-DI (under MDR application)	MDR Device classification (as proposed by the manufacturer and verified at the pre-application stage)	If the MDR device is a substitute device, identification of the corresponding MDD/AIMDD device	MDD/AIMDD Certificate Reference(s) of the devices under MDR application, and the NB Identification
		Universal set	
deltaset Procedure kit  Basic UDI-DI: 59079968V0599-WQ6	Class IIa	deltaset Central venous access kit	HD 1023663-1 NB 0197
deltaset Procedure kit  Basic UDI-DI: 59079968V0599-IPA	Class IIa	deltaset Universal kit	HD 1023663-1 NB 0197
deltaset Procedure kit  Basic UDI-DI: 59079968V0599-CNW	Class IIa	deltaset Dialysis kit	HD 1023663-1 NB 0197
deltaset Procedure kit  Basic UDI-DI: 59079968V0599-NPL	Class IIa	deltaset Universal kit	HD 1023663-1 NB 0197
deltaset Procedure kit  Basic UDI-DI: 59079968V0599-OPN	Class IIa	deltaset Universal kit	HD 1023663-1 NB 0197
deltaset Procedure kit  Basic UDI-DI: 59079968V0599-FP4	Class IIa	deltaset Urinary bladder catheterization kit	HD 1023663-1 NB 0197
deltaset Procedure kit  Basic UDI-DI: 59079968V0599-RPU	Class IIa	deltaset Sewing kit Suture removal kit Dressing change kit	HD 1023663-1 NB 0197
deltaset Procedure kit  Basic UDI-DI: 59079968V0599-SPW	Class IIa	deltaset Anesthesia kit	HD 1023663-1 NB 0197
deltaset Procedure kit  Basic UDI-DI: 59079968V0599-NIT3	Class I devices placed on the market in sterile condition	deltaset Universal kit I	HD 1023663-1 NB 0197
deltaset Procedure kit  Basic UDI-DI: 59079968V0599-UITQ	Class I devices placed on the market in sterile condition	deltaset Universal kit I	HD 1023663-1 NB 0197

Device name or Basic UDI-DI (under MDR application)	MDR Device classification (as proposed by the manufacturer and verified at the pre-application stage)	If the MDR device is a substitute device, identification of the corresponding MDD/AIMDD device	MDD/AIMDD Certificate Reference(s) of the devices under MDR application, and the NB Identification
deltaset Procedure kit  Basic UDI-DI: 59079968V0599-BIRX	Class I devices placed on the market in sterile condition	deltaset Dialysis kit	HD 1023663-1 NB 0197
deltaset Procedure kit  Basic UDI-DI: 59079968V0599-MISY	Class I devices placed on the market in sterile condition	deltaset Universal kit I	HD 1023663-1 NB 0197
deltaset Procedure kit  Basic UDI-DI: 59079968V0599-DIS5	Class I devices placed on the market in sterile condition	deltaset Operating field disinfection kit I	HD 1023663-1 NB 0197
deltaset Procedure kit  Basic UDI-DI: 59079968V0599-ZIU7	Class I devices placed on the market in sterile condition	deltaset Suture removal kit I	HD 1023663-1 NB 0197
deltaset Procedure kit  Basic UDI-DI: 59079968V0599-PIT9	Class I devices placed on the market in sterile condition	deltaset Protective kit I Hygiene kit I Neonatal kit I	HD 1023663-1 NB 0197

**Table 2: Devices covered by this letter and for which the NB is NOT responsible for appropriate surveillance of the corresponding devices under the applicable Directive:**

Device name or Basic UDI-DI (under MDR application)	MDR Device classification (as proposed by the manufacturer and verified at the pre-application stage)	If the MDR device is a substitute device, identification of the corresponding MDD/AIMDD device	MDD/AIMDD Certificate Reference(s) of the devices under MDR application, and the NB Identification
none			

**Confirmation Letter Revision History**

Date	NB internal reference traceable to each version of the letter	Action
2024/05/15	ZARYS_CL607_2024-05-15	Initial issue

**EC Certificate**  
**Directive 93/42/EEC Annex V**  
**Production Quality Assurance**  
**Medical Devices**

**Registration No.:** DD 60139535 0001

**Report No.:** 26300232 017

**Manufacturer:** ZARYS International Group  
Spolka z ograniczona odpowiedzialnoscia,  
spolka komandytowa  
ul. Pod Borem 18  
41-808 Zabrze  
Polska

**Products:** (see attachments for products and sites included)  
Replaces EC Certificate, Registration No.: DD 60117020 0001

**Expiry Date:** 2024-05-27

The Notified Body hereby declares that the requirements of Annex V of the directive 93/42/EEC have been met for the listed products. The above named manufacturer has established and applies a quality assurance system, which is subject to periodic surveillance, defined by Annex V, section 4 of the aforementioned directive. For placing on the market of class IIb and class III devices covered by this certificate an EC type-examination certificate according to Annex III is required.

**Effective Date:** 2019-06-09

**Date:** 2019-05-27

Notified Body

Rafal Byczkowski



**TÜV Rheinland LGA Products GmbH - Tillystraße 2 - 90431 Nürnberg**  
TÜV Rheinland LGA Products GmbH is a Notified Body according to Directive 93/42/EEC  
concerning medical devices with the identification number 0197.

**TÜV Rheinland**  
**LGA Products GmbH**  
**Tillystraße 2, 90431 Nürnberg**

Doc. 1/6, Rev. 0

**Attachment to  
Certificate**

**Registration No.:** DD 60139535 0001  
**Report No.:** 26300232 017

**Manufacturer:** ZARYS International Group  
Spolka z ograniczona odpowiedzialnoscia,  
spolka komandytowa  
ul. Pod Borem 18  
41-808 Zabrze  
Polska

Products included:

- Sterile and non-sterile cutting gauze
- Non-sterile dressing gauze
- Sterile and non-sterile gauze swabs  
(with or without X-ray thread)
- Sterile and non-sterile gauze lap sponges  
(with X-ray thread/ with X-ray chip)
- Sterile and non-sterile gauze balls  
(with or without X-ray thread)
- Sterile and non-sterile gauze rolls  
(with or without X-ray thread)
- Sterile and non-sterile non-woven swabs  
(with or without X-ray thread)
- Sterile paraffin gauze dressings
- Sterile three-way stopcocks
- Sterile transfusion sets for single use
- Sterile infusion sets for single use
- Sterile extension tubes for infusion pump

**Notified Body**



**Date: 2019-05-27**

  
**Rafal Byczkowski**



**TÜV Rheinland**  
**LGA Products GmbH**  
**Tillystraße 2, 90431 Nürnberg**

Doc. 2/6, Rev. 0

**Attachment to  
Certificate**

**Registration No.:** DD 60139535 0001  
**Report No.:** 26300232 017

**Manufacturer:** ZARYS International Group  
Spolka z ograniczona odpowiedzialnoscia,  
spolka komandytowa  
ul. Pod Borem 18  
41-808 Zabrze  
Polska

Products included:

- Sterile endotracheal tubes
- Sterile tracheostomy tubes
- Sterile breathing circuits
- Sterile catheter mounts
- Non-sterile anaesthetic masks
- Sterile laryngeal masks
- Sterile oxygen masks
- Sterile Multi-Vent masks
- Sterile non-rebreath masks
- Sterile nebulizer masks
- Sterile nasal oxygen cannulas
- Sterile nebulizer sets
- Sterile oxygen tubing
- Sterile suction catheters
- Sterile abdominal drains
- Sterile feeding tubes
- Sterile stomach and duodenal tubes
- Sterile urology catheters
- Sterile surgical suction sets
- Sterile surgical suction cannulas
- Sterile syringes for single use

**Date: 2019-05-27**

**Notified Body**

  
**Rafal Byczkowski**



**TÜV Rheinland**  
**LGA Products GmbH**  
**Tillystraße 2, 90431 Nürnberg**

**Attachment to  
Certificate**

**Registration No.:** DD 60139535 0001

**Report No.:** 26300232 017

**Manufacturer:** ZARYS International Group  
Spolka z ograniczona odpowiedzialnoscia,  
spolka komandytowa  
ul. Pod Borem 18  
41-808 Zabrze  
Polska

Products included:

- Sterile insulin syringes
- Sterile tuberculin syringes
- Sterile hypodermic needles
- Sterile insulin pen needles
- Sterile blood lancets
- Sterile IV cannulas
- Sterile needle free valves
- Sterile surgical gloves

**Date:** 2019-05-27

**Notified Body**

  
**Rafal Byczkowski**



**TÜV Rheinland**  
**LGA Products GmbH**  
**Tillystraße 2, 90431 Nürnberg**

**Attachment to  
Certificate**

**Registration No.:** DD 60139535 0001

**Report No.:** 26300232 017

**Manufacturer:** ZARYS International Group  
Spolka z ograniczona odpowiedzialnoscia,  
spolka komandytowa  
ul. Pod Borem 18  
41-808 Zabrze  
Polska

Products included:

For the following medical devices the scope covers only the aspects of manufacture concerned with securing and maintaining sterile conditions:

- Adhesive cannula fixation dressings
- Adhesive wound dressings
- Eye pads
- Incise films
- Transparent film dressings
- Foam dressings
- Absorbent wound dressings
- Surgical gowns
- Surgical drapes
- Sets of surgical drapes
- Fluid collection pouches
- Nelaton catheters

Notified Body



**Date: 2019-05-27**

  
**Rafal Byczkowski**

**TÜV Rheinland**  
**LGA Products GmbH**  
**Tillystraße 2, 90431 Nürnberg**

**Attachment to  
Certificate**

**Registration No.:** DD 60139535 0001  
**Report No.:** 26300232 017

**Manufacturer:** ZARYS International Group  
Spolka z ograniczona odpowiedzialnoscia,  
spolka komandytowa  
ul. Pod Borem 18  
41-808 Zabrze  
Polska

Products included:

For the following medical devices the scope covers only the aspects of manufacture concerned with securing and maintaining sterile conditions:

- Vaginal speculums
- Cervical brushes
- Urine bags
- Tongue depressors
- Guedel airways
- Intubation stylets
- Endotracheal tube holders
- Suction tubes
- Withdrawal cannulas
- Alginate dressings
- Cannula stoppers
- Umbilical cord clamps

Notified Body



**Date: 2019-05-27**

**Rafal Byczkowski**

**TÜV Rheinland**  
**LGA Products GmbH**  
**Tillystraße 2, 90431 Nürnberg**

**Attachment to  
Certificate**

**Registration No.:** DD 60139535 0001  
**Report No.:** 26300232 017

**Manufacturer:** ZARYS International Group  
Spolka z ograniczona odpowiedzialnoscia,  
spolka komandytowa  
ul. Pod Borem 18  
41-808 Zabrze  
Polska

Products included:

ZARYS International Group  
Spolka z ograniczona odpowiedzialnoscia,  
spolka komandytowa  
ul. Gustawa Eiffel'a 15  
44-109 Gliwice  
Poland

Activity: Production

**Date: 2019-05-27**

**Notified Body**

**Rafal Byczkowski**



# Certificate

## Quality Management System EN ISO 13485:2016

Registration No.	SX 1023663-1
Certificate Holder	ZARYS International Group Spółka z ograniczoną odpowiedzialnością, spółka komandytowa ul. Pod Borem 18 41-808 Zabrze Poland
Scope	Design and development, production and distribution of sterile surgical sets, procedure kits, surgical drapes, sets of surgical drapes, surgical gowns and knitted bandages. Production and distribution of sterile and non-sterile disposable medical devices and non-sterile reusable medical devices. Distribution of in-vitro diagnostic medical devices.

The Certification Body of TÜV Rheinland LGA Products GmbH certifies that the organization has established and applies a quality management system for medical devices.  
Proof has been furnished that the requirements specified in the abovementioned standard are fulfilled. The quality management system is subject to yearly surveillance.

Report No.	84965698-20
Effective date	2023-06-09
Expiry date	2026-06-08
Issue date	2023-06-06
Replaces certificate SX 1023663-1 issued 2021-05-14	

This certificate can be validated on <https://www.certipedia.com>

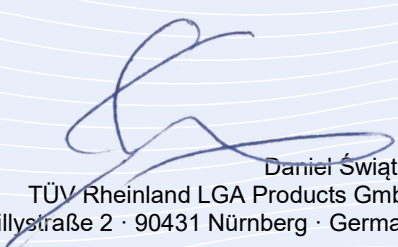
  
Daniel Świątko  
TÜV Rheinland LGA Products GmbH  
Tillystraße 2 · 90431 Nürnberg · Germany

© TÜV, TÜEV and TÜV are registered trademarks. Utilisation and application requires prior approval.

# Certificate

## Quality Management System EN ISO 13485:2016

Registration No. SX 1023663-1  
Certificate Holder ZARYS International Group  
Spółka z ograniczoną odpowiedzialnością,  
spółka komandytowa  
ul. Pod Borem 18  
41-808 Zabrze  
Poland

The scope of certification also covers the following sites:

No.	Facility	Scope
/01	ZARYS International Group Spółka z o.o. sp.k. ul. Pod Borem 18 41-808 Zabrze Poland	Design and development, production and distribution of sterile surgical sets, procedure kits, surgical drapes, sets of surgical drapes, surgical gowns and knitted bandages. Production and distribution of sterile and non-sterile disposable medical devices and non-sterile reusable medical devices. Distribution of in-vitro diagnostic medical devices.
/02	ZARYS International Group Spółka z o.o. sp.k. ul. Guido Henckela Donnersmarcka 1 41-808 Zabrze Poland	Storage, quality control, release and distribution of medical devices.
/03	ZARYS International Group Sp. z o.o. Produkcja sp.k. ul. Pod Borem 18 41-808 Zabrze Poland	Production of sterile: surgical sets, procedure kids, surgical drapes, sets of surgical drapes, surgical gowns and knitted bandages. Production of non-sterile disposable medical devices.

Report No. 84965698-20  
Effective date 2023-06-09  
Expiry date 2026-06-08  
Issue date 2023-06-06

This certificate can be validated on <https://www.certipedia.com>

  
Daniel Świątko  
TÜV Rheinland LGA Products GmbH  
Tillystraße 2 · 90431 Nürnberg · Germany