

UCP™ Stem

Femoral Hip System



Table of Contents

Device Description	II
Surgical Overview	IV
Surgical Protocol	
Pre-operative Planning and Templating	1
A. Femoral Osteotomy	2
B. Femoral Canal Accessing	3
C. Canal Reaming	4
D. Canal Broaching	5
E. Trial Reduction	6
F. Canal Sizing	8
G. Cement Restrictor Insertion	9
H. Stem Insertion	10
I. Femoral Head Impaction	11
Order Information	13

Device Description

UCP Stem –

The UCP (United Cemented Polished) stem can be used in both primary and revision hip arthroplasty. Its cement-friendly design combines tri-tapered geometry and polished surface to help facilitate the prevention of cement failure by reducing bone-cement interface stresses.

Various insertion depth options in the UCP stem allow the surgeon to balance leg length with ease. The stem is available with offset variants and stem length options to attend to a wide variety of clinical challenges.

- 10 available sizes
- Standard and high offset options
- Up to 12 head neck length selections

INDICATIONS

1. Non-inflammatory degenerative joint disease such as osteoarthritis, avascular necrosis, ankylosis, protrusio acetabuli, and painful hip dysplasia.
2. Inflammatory degenerative joint disease such as rheumatoid arthritis.
3. Treatment of nonunion, femoral neck and trochanteric fractures of the proximal femur with head involvement that is unmanageable using other techniques.
4. Revision procedures where other treatments or devices have failed.
5. Patients with acute femoral neck fractures.

This device is a single use implant and intended for cemented use only.

Please refer to the package inserts for important product information, including, but not limited to contraindications, warnings, precautions, and adverse effects.



Surgical Overview

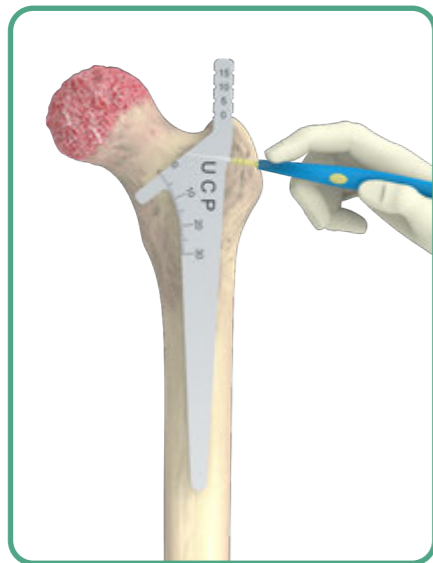

A. Femoral Osteotomy

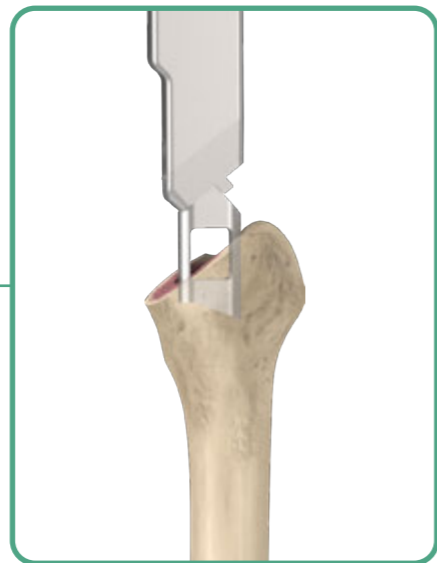

B. Femoral Canal Accessing



C. Canal Reaming

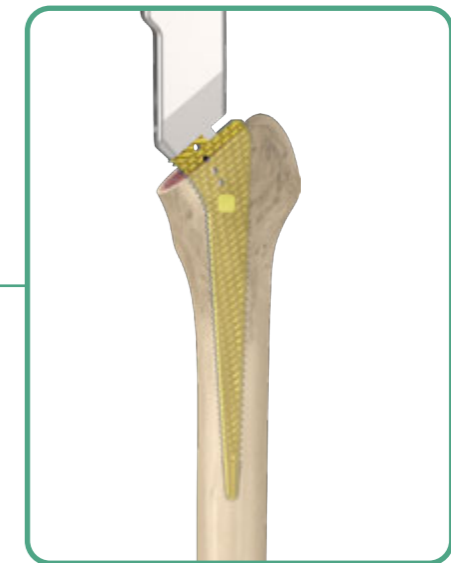

D. Canal Broaching

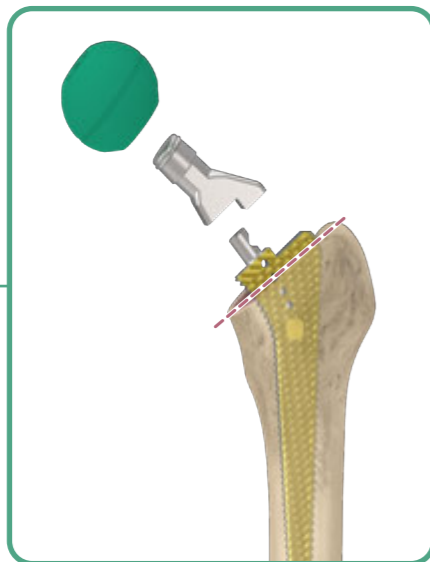

E. Trial Reduction



F. Canal Sizing



G. Cement Restrictor Insertion

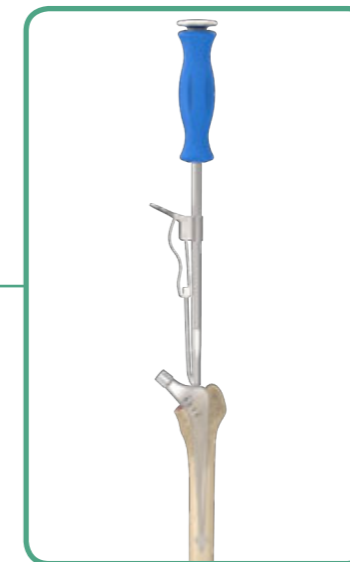

H. Stem Insertion



I. Femoral Head Impaction

Preoperative Planning and Templating

Preoperative planning is essential for determining the optimal stem size, neck resection level and the appropriate neck length. Making an accurate femoral component selection begins with thorough radiographic evaluation of the affected femur, both the A/P view and lateral view. The A/P radiographic image should include bilateral hip joints to help evaluate the affected side. These radiographs provide an estimation of leg length discrepancy, femoral offset and center of rotation needed to reconstruct hip biomechanics.

It is recommended to pre-operatively template the prosthesis size that best fits the metaphysis canal area. Templates show the neck length and offset for each of the head/neck combinations (-3 to +10 mm, depending on head material and diameter).

The final determination of implant choice should take into account the acetabular cup position, cup size, and hip center.



A. Femoral Osteotomy

During preoperative templating, determine the neck resection level by referencing the distance above the lesser trochanter (about 10-15 mm). Intra-operatively, align the **UCP Resection Guide** with the anatomical axis of the femoral canal. Mark the cut line using electrocautery, then complete the femoral neck resection with a power saw. Remove the femoral head with the **Femoral Head Extractor**.

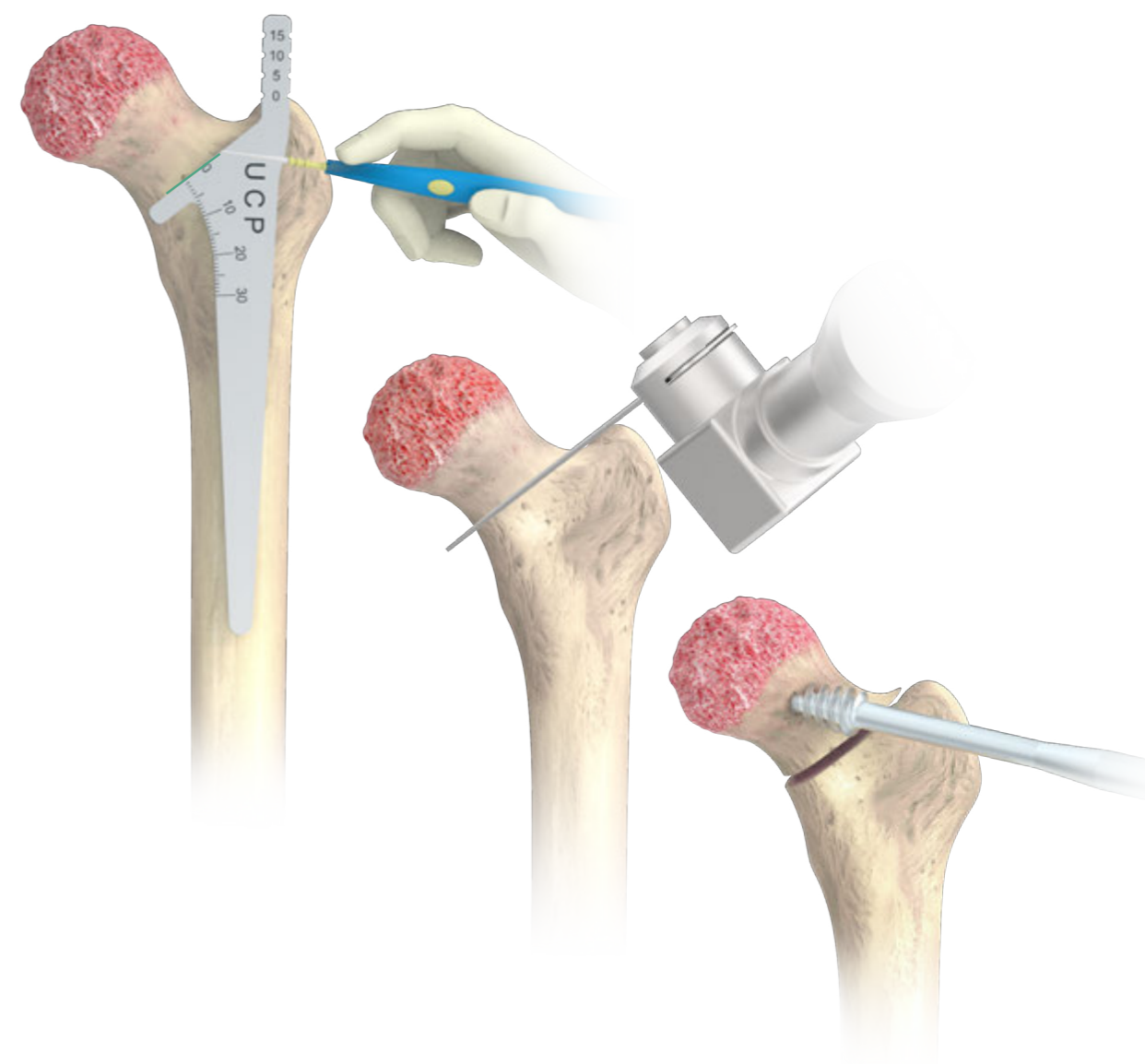

Instruments



Neck Resection Guide



Femoral Head Extractor

B. Femoral Canal Accessing

Utilize the modular **Femoral Cutting Chisel** with **Broach Handle** for adequate lateral/ posterior piriformis fossa initial entry into femoral canal.



Instruments



Femoral Cutting Chisel



Straight Broach Handle

C. Canal Reaming

Use the **UCP Start Reamer** to ensure correct alignment.

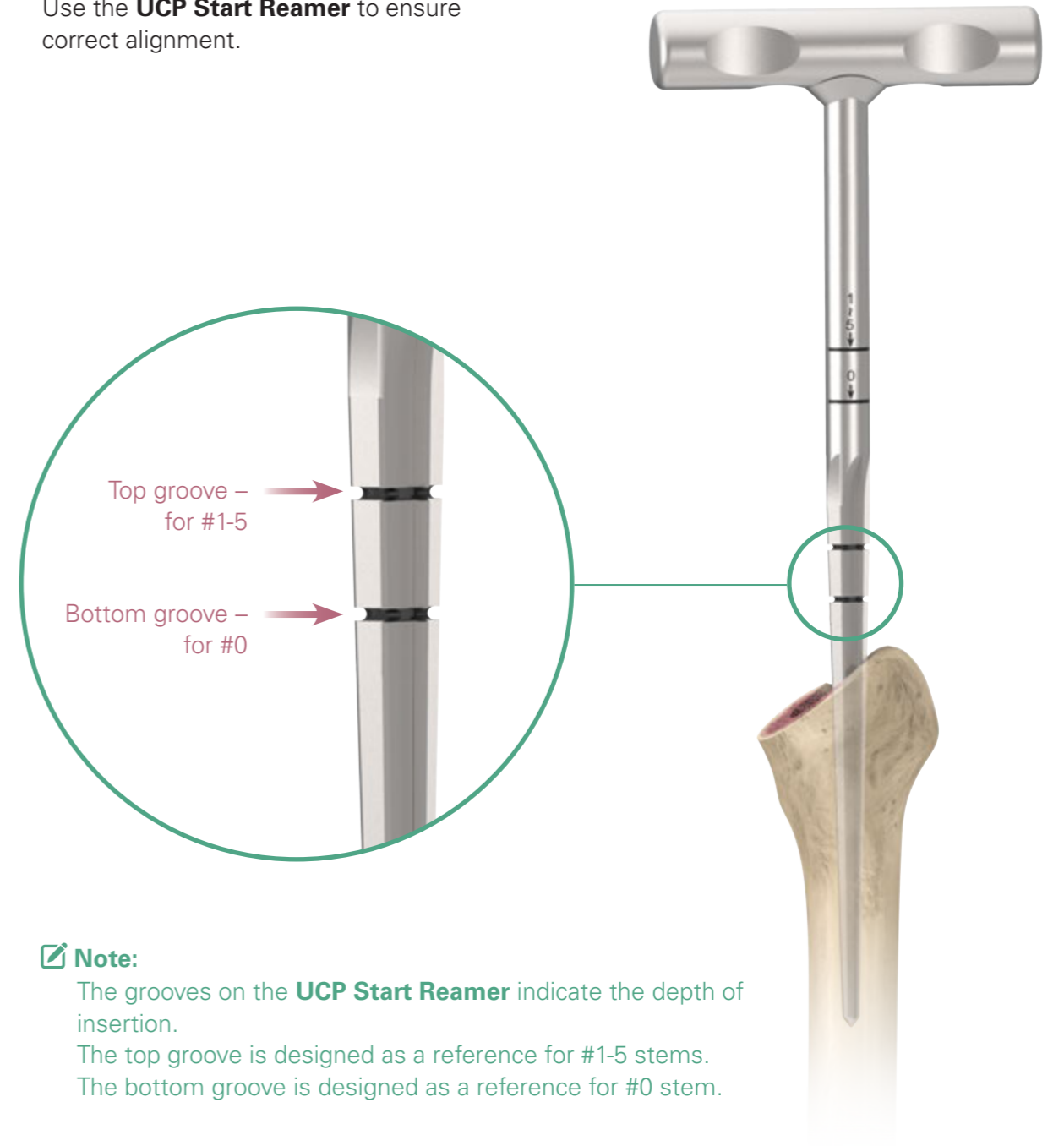

Instruments



T-Handle Stem Reamer

Note:

The grooves on the **UCP Start Reamer** indicate the depth of insertion.

The top groove is designed as a reference for #1-5 stems.

The bottom groove is designed as a reference for #0 stem.

D. Canal Broaching

Attach the smallest size **UCP Broach** to the **Broach Handle**. Start broaching procedure along the axis of the femur and maintain proper orientation of the broach. Lateralization during broaching procedure is critical to ensure neutral placement of broach and implant.

Gradually enlarge the canal with the **UCP Broach** until the planned template size is achieved. Make sure the broach is advanced to the proper depth. The second (from the top) depth indicating hole on the broach should seat in line with the neck resection surface.

Note:

The **UCP Broach** is designed to provide a 2 mm cement mantle proximally and distally, and an additional 2 mm mantle in the proximal medial part. The broach is 15 mm longer than the corresponding implant, which is the space designed for the cement restrictor.

For example, canals of the #3, 210 mm and 230 mm long stem can be prepared through the #3, 180 mm broach.

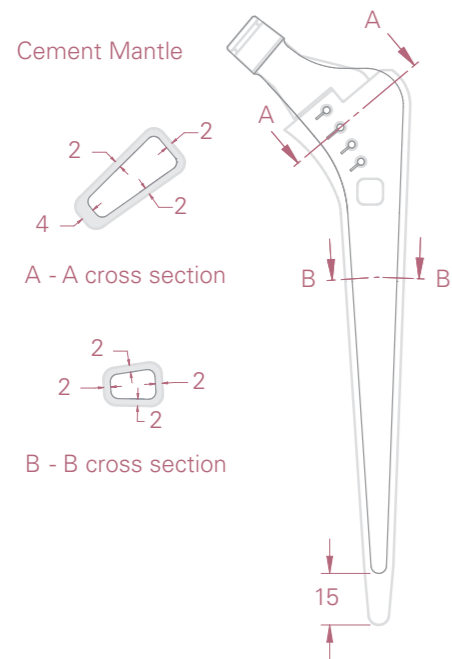

Instruments

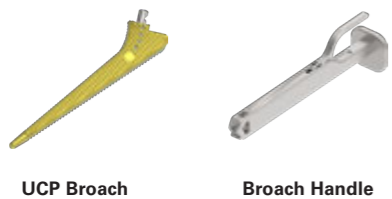

UCP Broach

Broach Handle

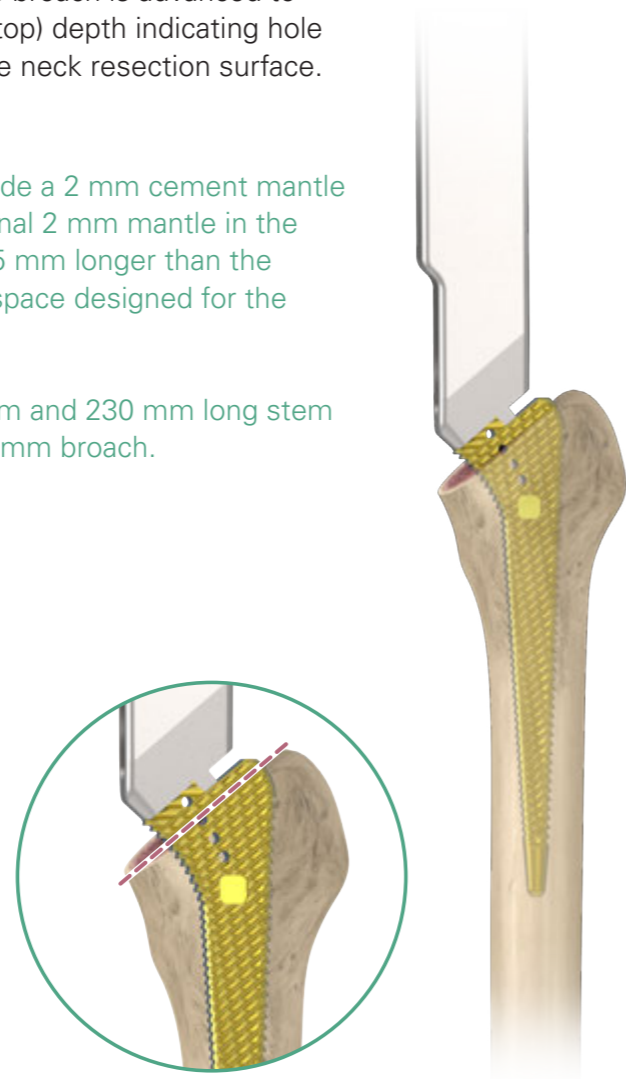

E. Trial Reduction

Assemble the corresponding size of standard or high offset **Neck Trial** onto the broach. Perform the trial reduction using the **Femoral Head Trial** with the desired diameter and neck length.

The UCP stem offers 4 leg adjustment options through different insertion depths, including -5, 0, +5 and +10 mm. If shortening of the leg length is required, further advance the broach until the top indication hole seat is in line with the neck resection surface. Alternatively, extension of the leg length can be achieved by moving the broach upward to third (+5 mm) or fourth (+10 mm) depth indication hole. With the help of **UCP Locator Pin**, the broach can be seated properly.

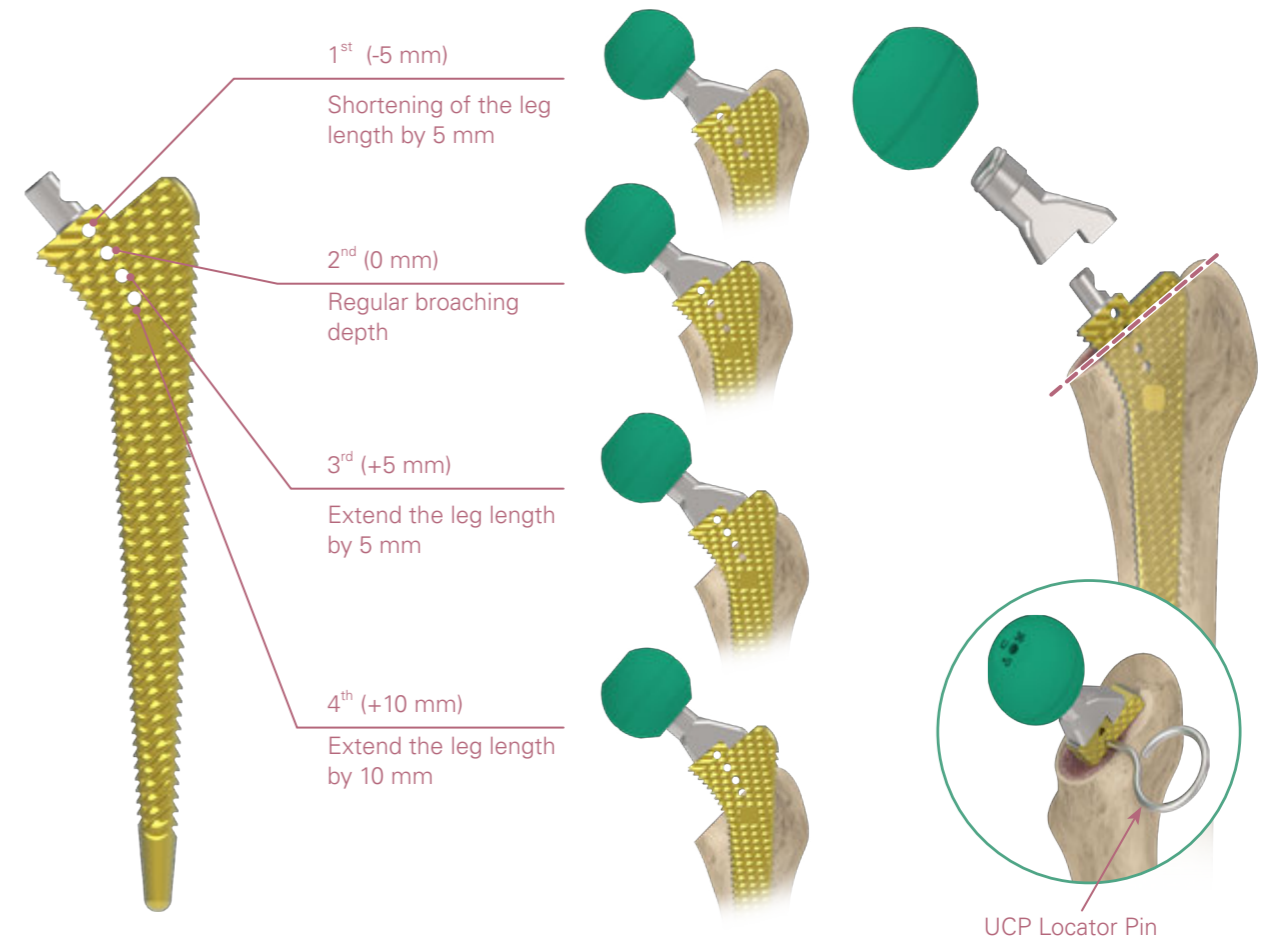

Instruments

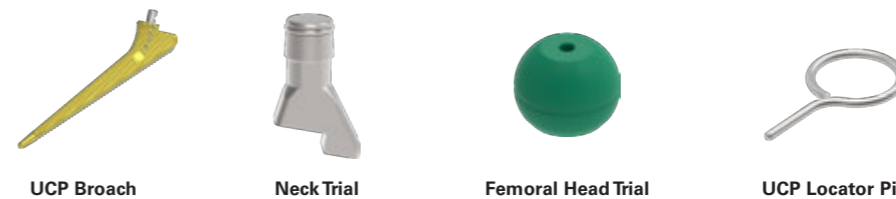

UCP Broach

Neck Trial

Femoral Head Trial

UCP Locator Pin

E. Trial Reduction

Mark the Calcar bone at the position of the depth indicating hole. The marking serves as a guide to proper stem position during implantation. If a 210 or 230 mm stem is selected, specially designed long **Stem Trials** are available to perform a trial reduction. The **Stem Trial** is the same dimension as the correlating implant. Use the **UCP Locator Pin** to place the stem trial in the ideal position during trial reduction.

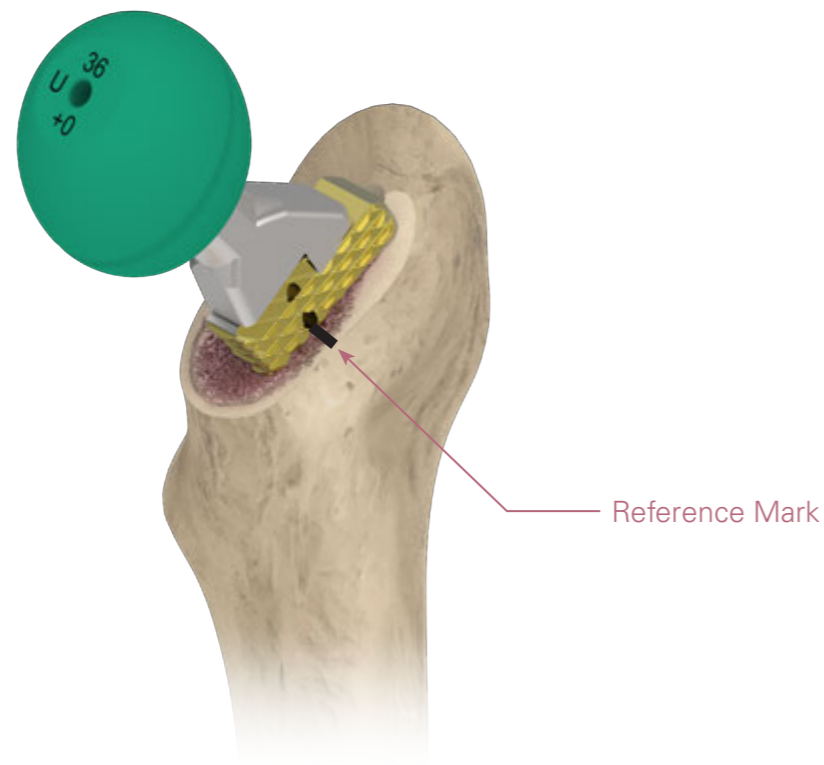

Instruments



UCP Broach



Neck Trial



Femoral Head Trial

F. Canal Sizing

After trial reduction, retrieve the broach from the canal. Assemble the **Canal Sizer** with the **Non-Ratcheting Handle**. Sequential sizing of the canal should be carried out to the proper indicated depth according to selected stem size. The last size of the **Canal Sizer** which passed through the isthmus is the ideal size.



Instruments



Non-Ratcheting Handle



Canal Sizer

G. Cement Restrictor Insertion

Attach the ideal size cement restrictor to the **UCP Restrictor Inserter**. Introduce the restrictor by tapping with the hammer until indicating depth is achieved. Remove the inserter and leave the restrictor in place.

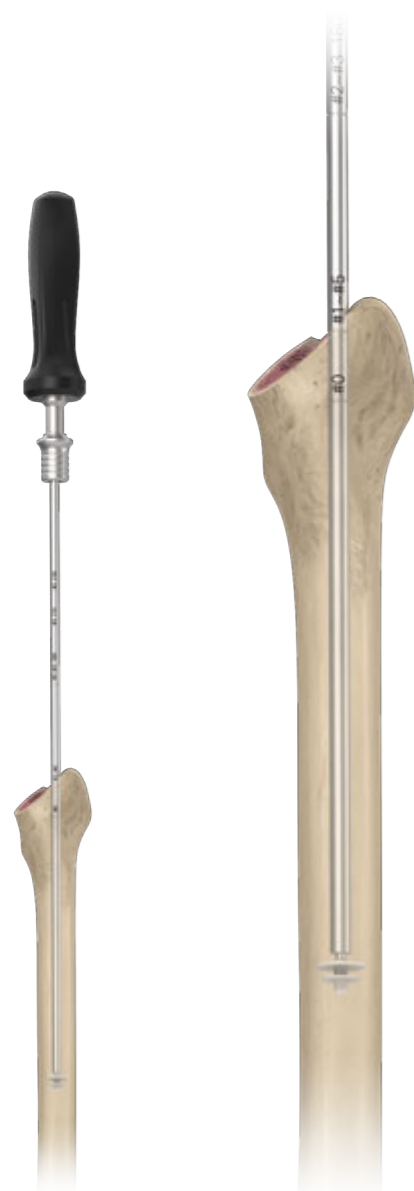

Centralizer **Restrictor, I-Type**



Cat. No.	Size	Canal size (mm)
1907-3008	# 8	8 - 9
1907-3010	# 10	10 - 11
1907-3012	# 12	12 - 13
1907-3014	# 14	14 - 15
1907-3016	# 16	16 - 17
1907-3018	# 18	18 - 19

* The Centralizer and the Cement Restrictor come in one package.

Instruments



Non-Ratcheting Handle



UCP Restrictor Inserter

H. Stem Insertion

Dry the femoral canal before introducing bone cement. The bone cement can be introduced in low viscosity state. Cement can be injected in a retrograde fashion to gradually fill the canal.

The size-matched UCP centralizer is packed together with the UCP cement restrictor. Attach the centralizer to the UCP stem with manual twist. The centralizer can fit with all sizes of UCP stems.

Use the **Quick Connect Holder** to firmly attach the stem and advance it to the depth that is decided during trial reduction. The depth indicator on the stem should align with the mark on the calcar bone and sit in line with the neck resection surface.

Remove excess cement. Hold the stem until the cement is polymerized, and disengage the **Quick Connect Holder**.

Caution: The **Quick Connect Holder** is designed to position the implant and not for final impaction. Please impact gently.



Instruments



U2 Quick Connect Holder

I. Femoral Head Impaction

Perform a final trial reduction to confirm stability and leg length by using the **Femoral Head Trials**. After the appropriate femoral head size has been determined, place it onto the cleaned and dried trunnion by hand.

Connect the **Femoral Head Impactor** and **Universal Handle** and moderately impact the femoral head until it is firmly seated.



Instruments



Femoral Head Trial





Femoral Head Impactor





Universal Handle

Order Information

		Catalog Number		Description	
Standard	High Offset	Standard	High Offset	Size	Medial Length
		1107-3000	1107-3200	# 0	110 mm
		1107-3010	1107-3210	# 1	125 mm
		1107-3020	1107-3220	# 2	125 mm
		1107-3030	1107-3230	# 3	125 mm
		1107-3040	1107-3240	# 4	125 mm
		1107-3050	1107-3250	# 5	125 mm

		Catalog Number		Description	
Long Stem				Size	Medial Length
		1107-3421		# 2	180 mm
		1107-3431		# 3	180 mm
		1107-3432		# 3	210 mm
		1107-3433		# 3	230 mm

		Catalog Number		Description	
Centralizer	Restrictor, I-Type			Restrictor Size	Canal size
		1907-3008		# 8	8 - 9 mm
		1907-3010		# 10	10 - 11 mm
		1907-3012		# 12	12 - 13 mm
		1907-3014		# 14	14 - 15 mm
		1907-3016		# 16	16 - 17 mm
		1907-3018		# 18	18 - 19 mm

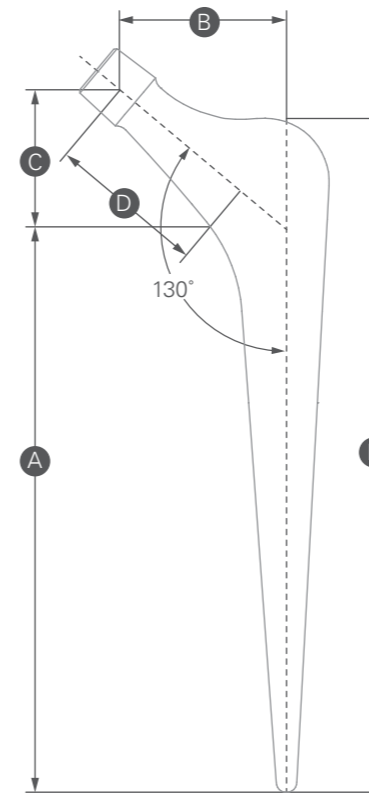

Size	A Medial Length	B Offset		C Vertical Height	D Neck Length		E Lateral Length
		Standard	High Offset		Standard	High Offset	
#0	110	32	37	29	41.8	48.3	132
#1	125	34	39	29	44.4	50.9	147
#2	125	36	41	29	47.0	53.5	147
#3	125	37	42	29	48.3	54.8	147
#4	125	38	43	29	49.6	56.1	147
#5	125	40	45	29	52.2	58.7	147
Long Stem							
#2	180	41		29	53.5		202
#3	180	42		29	54.8		202
#3	210	42		29	54.8		232
#3	230	42		29	54.8		252

Unit: mm

Femoral Head

Catalog Number	Description (mm)
U2 Femoral Head	
1206 - 1122	* Ø 22 + 0
1206 - 1322	* Ø 22 + 3
1206 - 1522	* Ø 22 + 6
1206 - 1722	* Ø 22 + 9
1206 - 1026	Ø 26 - 2
1206 - 1126	Ø 26 + 0
1206 - 1326	Ø 26 + 3
1206 - 1526	Ø 26 + 6
1206 - 1726	Ø 26 + 9
1206 - 1028	Ø 28 - 3
1206 - 1128	Ø 28 + 0
1206 - 1228	Ø 28 + 2.5
1206 - 1428	Ø 28 + 5
1206 - 1628	Ø 28 + 7.5
1206 - 1828	Ø 28 + 10
1206 - 1032	Ø 32 - 3
1206 - 1132	Ø 32 + 0
1206 - 1232	Ø 32 + 2.5
1206 - 1432	Ø 32 + 5
1206 - 1632	Ø 32 + 7.5
1206 - 1832	Ø 32 + 10
1206 - 1036	Ø 36 - 3
1206 - 1136	Ø 36 + 0
1206 - 1236	Ø 36 + 2.5
1206 - 1436	Ø 36 + 5
1206 - 1636	Ø 36 + 7.5
1206 - 1836	Ø 36 + 10



* The actual spherical diameter of a 22 mm metal head is 22.2 mm.

Femoral Head

Catalog Number	Description (mm)
BIOLOX® delta Ceramic Head	
1203 - 5028	Ø 28 S - 2.5
1203 - 5228	Ø 28 M + 1
1203 - 5428	Ø 28 L + 4
1203 - 5032	Ø 32 S - 3
1203 - 5232	Ø 32 M + 1
1203 - 5432	Ø 32 L + 5
1203 - 5632	Ø 32 XL + 8
1203 - 5036	Ø 36 S - 3
1203 - 5236	Ø 36 M + 1
1203 - 5436	Ø 36 L + 5
1203 - 5636	Ø 36 XL + 9
1203 - 5040	Ø 40 S - 3
1203 - 5240	Ø 40 M + 1
1203 - 5440	Ø 40 L + 5
1203 - 5640	Ø 40 XL + 9



*BIOLOX® is a registered trademark of the CeramTec Group, Germany



Each Step
We Care

Please note that this Surgical Technique Guide has been authored in the English language. Any translations into other languages have not been reviewed or approved by United Orthopedic Corporation and their accuracy cannot be confirmed. Any translated guide should be reviewed carefully prior to use and questions regarding a Surgical Technique Guide should be directed to United Orthopedic Corporation at unitedorthopedic.com/contact

The CE mark is valid only if it is also printed on the product label.

