

Accessories for Electrosurgical Unit

Disposable Twin Button Handle



	<p>HD02-01D 3pin Plug, Cable 3m</p>
--	--

Monopolar Handle & Cable





	<p>HD01-01R Silicon Cable 4Φ 3m</p>
	<p>HD01-02R Silicon Cable 4Φ 3m, Banana jack</p>





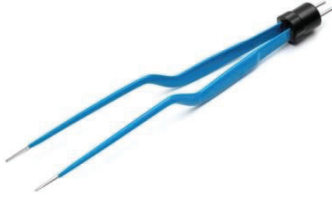



Silicon Patient Plate

		<p>PL02-01R 240mm X 150mm, 6.3 Φ Plug, Cable 3m</p>
		<p>PL02-04R 240mm X 150mm, ValleyLab type Plug, Cable 3m</p>
		<p>PL02-02R 165mm X 90mm, 6.3 Φ Plug, Cable 3m</p>
		<p>PL02-05R 165mm X 90mm, ValleyLab type Plug, Cable 3m</p>
		<p>PL02-03R 110mm X 80mm, 6.3 Φ Plug, Cable 3m</p>
		<p>PL02-06R 110mm X 80mm, ValleyLab type Plug, Cable 3m</p>

Bipolar forceps [EN type]

Bayonet		<ul style="list-style-type: none"> • BF01-01R (17.8cm, 1.0 Tip) • BF01-02R (15.2cm, 1.0 Tip)
Straight		<ul style="list-style-type: none"> • BF02-01R (9cm, 0.5 Tip) • BF02-02R (12.1cm, 1.0 Tip) • BF02-03R (17.8cm, 1.0 Tip)
Angle		<ul style="list-style-type: none"> • BF03-01R (9.0cm, 0.5 Tip) • BF03-02R (17.8cm 1.0 Tip)

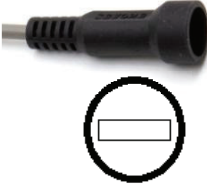

Bipolar Forceps Cable

Code No.	Generator side	Instrument Side	Specification
CA01-01R		 	2pin Plug Cable 3m EN type Connector
CA01-02R		 	2pin Plug Silicon Cable 3m, EN type Connector
CA01-03R		 	2pin Plug Silicon Cable 3m, EU type Connector

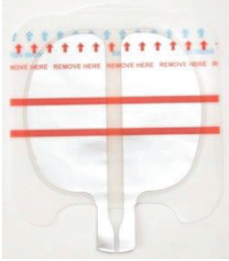
Disposable Patient Plate(Dual)

	<p>PL03-02D Adult Dual(120cm²)</p>
	<p>PL03-03D Pediatric Dual(66cm²)</p>

Patient Return Plate Cable

Code	Generator side	Instrument Side	Specification
CA02-02R			6.3Φ Plug Silicon Cable 3m
CA02-03R			ValleyLab type Plug, Silicon Cable 3m

Patient Return Plate Cable Adaptor

	<p>AD02-01R Valleylab / 6.3Φ</p>
---	---







Double Foot Switch

	<p>FS02-01R 4pin Plug, Cable 4m</p>
---	--

Single Foot Switch

	<p>FS01-01R 3pin Plug, Cable 4m</p>
--	--







Monopolar Connecting Cable

Code	Generator side	Instrument Side	Specification
CA08-01R			3Φ Connector, 4m
CA08-02R			4Φ Connector, 4m
CA08-03R			4.2Φ Connector, 4m

Electrode





Shaft Ø 2.4mm

	EL01-02D	Knife 20mm * 70mm
	EL01-04D	Knife 20mm * 100mm
	EL01-05D	Knife 20mm * 152mm
	EL01-06D	Knife 20mm * 253mm
	EL01-07D	Knife 20mm * 130mm
	EL02-02D	Ball 5mm * 50mm
	EL02-03D	Ball 4mm * 80mm
	EL02-05D	Ball 4mm * 134mm
	EL02-06D	Ball 5mm * 135mm
	EL02-07D	Ball 7mm * 80mm
	EL02-08D	Ball 4mm * 100mm
	EL02-09D	Ball 5mm * 100mm
	EL02-10D	Ball 7mm * 100mm
	EL03-02D	Loop 6mm * 130mm, Semi-circle
	EL03-03D	Loop 8mm * 130mm, Semi-circle
	EL03-04D	Loop 8mm * 80mm, Circle
	EL03-05D	Loop 6mm * 80mm, Circle
	EL03-06D	Loop 10mm *, 130mm, Circle
	EL04-02D	Needle 20mm * 70mm
	EL04-05D	Needle 20mm * 100mm
	EL04-06D	Needle 20mm * 110mm
	EL04-07D	Needle 20mm * 152mm
	EL04-08D	Needle 20mm * 255mm
	EL04-04D	Needle Angled 20mm * 70mm
	EL06-03D	Wire Straight 12mm * 90mm, Wire diameter: 0.3mm

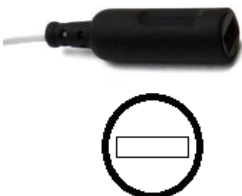
Laparoscopy Bipolar Connecting Cable

Code	Generator side	Instrument Side	Specification
CA01-04R			Silicon Cable, 3m



Bipolar Sealer Cable

Code	Generator side	Instrument Side	Specification
CA01-06R			Silicon Cable 4 ϕ , 3m

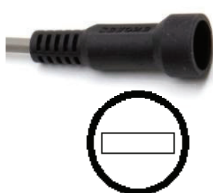

Vessel Sealing Cable

Code	Generator side	Instrument Side	Specification
CA01-07R			2pin Plug, Silicon Cable 3m, EU Type Connector

Bipolar TURP Cable

Code	Generator side	Instrument Side	Specification
CA01-08R		 Pin: 2 ϕ Diameter: 2.4 ϕ	2pin Plug, Silicon Cable 4m, 2.4 ϕ and 2 ϕ plug

Ground Cable

Code	Generator side	Hospital Side	Specification
CA03-01R			Cable 4 Φ , 3m

Disposable Tip Cleaner

	TC1001	5cm * 5cm
---	--------	-----------

Cart

	CT01-01R	W390xD480xH850(mm), Steel with powdercoating, 4 casters with 2 brakes
	CT01-03R	W390xD480xH850(mm), Steel with powdercoating, 4 casters with 2 brakes