

The management system of

**LIFE VASCULAR DEVICES  
BIOTECH, S.L. also trading as  
LVD BIOTECH, S.L.**

Camí de Can Ubach 11, Poligono Industrial Les Fallulles  
08620 Sant Vicenç dels Horts, Barcelona. Spain

has been assessed and certified as meeting the requirements of

**ISO 13485:2016  
EN ISO 13485:2016**

For the following activities

**The scope of registration appears on page 2 of this certificate.**

This certificate is valid from 08 March 2019 until 08 March 2022  
and remains valid subject to satisfactory surveillance audits.

Re certification audit due before 12 December 2021

Issue 4. Certified since 16 January 2015

Authorised by

SGS United Kingdom Ltd  
Rossmore Business Park Ellesmere Port Cheshire CH65 3EN UK  
t +44 (0)151 350-6666 f +44 (0)151 350-6600 [www.sgs.com](http://www.sgs.com)

HC SGS 13485 2016 0118 M2

Page 1 of 2



0005



**LIFE VASCULAR DEVICES  
BIOTECH, S.L. also trading as  
LVD BIOTECH, S.L.**

**ISO 13485:2016  
EN ISO 13485:2016**



Issue 4

Detailed scope

**Design and development, manufacture and distribution  
of sterile percutaneous device for treatment of vascular disease  
and non-active sterile vascular implants.**

**Design and development, manufacturing and distribution of polymer-based  
coatings and application technology for interventional catheters  
with limited exposure ( $\leq 24$  h).**

**Design and development, manufacture and distribution of high-precision  
plastic tubing for medical applications.**

**Diseño, desarrollo, fabricación y distribución de dispositivos  
estériles percutáneos para el tratamiento de enfermedades vasculares  
e implantes vasculares estériles no activos**

**Diseño y desarrollo, fabricación y distribución de recubrimientos  
poliméricos y de la tecnología de aplicación para catéteres  
intervencionista de exposición limitada ( $\leq 24$  h).**

**Diseño y desarrollo, fabricación y distribución de tubos de plástico de alta  
precisión para aplicaciones médicas**



0005



**CERTIFICADO CE DE SISTEMA DE GARANTÍA DE CALIDAD TOTAL**  
**de acuerdo con el Anexo II (excepto punto 4) de la Directiva 93/42/CEE**  
**EC FULL QUALITY ASSURANCE SYSTEM CERTIFICATE**  
*in accordance with Annex II (except Section 4) of Directive 93/42/EEC*

<b>Certificado n°/Certificate no</b> <b>2012 07 0788 CT</b>	<b>Fecha de validez/Date of validity</b> Desde/From <b>31-07-2020</b> Hasta/To <b>26-05-2024</b>	<b>ON n°/NB no</b> <b>0318</b>
--	---	-----------------------------------

**A favor de/In favour of:**

**Fabricante/Manufacturer:**

**Nombre/Name:** LIFE VASCULAR DEVICES BIOTECH S.L (LVD BIOTECH )  
**Dirección/Address:** Camí de Can Ubach, 11; Pol. Ind. Les Fallulles,  
 08620 Sant Vicenç dels Horts- Barcelona-ESPAÑA  
**Representante autorizado ante la UE/Authorized EU representative:** Idem

**Para el producto/For the product:**

**Categoría/Category:** Productos de un solo uso/Single use products  
**Grupo genérico/ Generic group:** Especificado en Anexos de este Certificado/Specified in Annexes to this Certificate/Haga clic o pulse aquí para escribir texto.  
**Tipo/Type:** Especificado en Anexos de este Certificado/Specified in Annexes to this Certificate

**Elaborado en/In the facilities:**

**Camí de Can Ubach, 11; Pol. Ind. Les Fallulles,  
 08620 Sant Vicenç dels Horts- Barcelona-ESPAÑA**

**Fecha inicial/ Initial date:** 27-07-2012

**Fecha de prórroga anterior/ Previous extension date:** 21-07-2017

Este certificado debe ir acompañado por certificado de examen de diseño: en productos de clase III /This certificate must be accompanied by design examination certificate: in class III products

Este certificado es consecuencia de la auditoria del sistema completo de garantía de calidad y del examen de la documentación técnica contenida en el expediente n° 2012 01 0327, y garantiza que los productos descritos cumplen los requisitos de la Directiva./ This certificate is issued on the full quality assurance system audit, and the examination of the technical documentation contained in dossier n° 2012 01 0327, and guarantees that the described products fulfils the requirements of the Directive

Madrid, 30 de julio de 2020

DIRECTORA DE LA AGENCIA ESPAÑOLA DE MEDICAMENTOS Y PRODUCTOS SANITARIOS



agencia española de medicamentos y productos sanitarios

Fdo. Mª Jesús Lamas Díaz

Agencia Española de Medicamentos y Productos Sanitarios (AEMPS)

Fecha de la firma: 30/07/2020

Puede comprobar la autenticidad del documento en la sede de la AEMPS: <https://localizador.aemps.es>

CSV: 2 K S D D N Q A 5 9



CORREO ELECTRÓNICO  
 on0318@aemps.es

Página 1 de 44

C/ CAMPEZO, 1 - EDIFICIO 8  
 28022 MADRID  
 Tel.: (+34) 902.101.322 / (+34) 91.822.59.97  
 Fax: (+34) 91.822.52.89

ORGANISMO NOTIFICADO 0318



**ANEXO N°/ANNEX NO: I**

**CERTIFICADO CE DE SISTEMA DE GARANTÍA DE CALIDAD TOTAL  
de acuerdo con el Anexo II (excepto punto 4) de la Directiva 93/42/CEE**

**EC FULL QUALITY ASSURANCE SYSTEM CERTIFICATE  
in accordance with Annex II (except Section 4) of Directive 93/42/EEC**

Certificado n°/Certificate no	Fecha de validez/Date of validity			ON n°/NB no	
<b>2012 07 0788 CT</b>	Desde/From	<b>31-07-2020</b>	Hasta/To	<b>26-05-2024</b>	<b>0318</b>

**A favor de/In favour of:**

**Fabricante/Manufacturer:**

**Nombre/Name:** LIFE VASCULAR DEVICES BIOTECH S.L (LVD BIOTECH )

**Dirección/Address:** Camí de Can Ubach, 11; Pol. Ind. Les Fallulles,  
08620 Sant Vicenç dels Horts- Barcelona-ESPAÑA

**Representante autorizado ante la UE/Authorized EU representative: Idem**

**Tipo de producto / Devices type:** Los relacionados a continuación/The list below

**Clasificación/Classification:** IIa NANDO: MD 106 y MDS 7006

**1. Catéter balón de dilatación para ATP\* / PTA balloon dilatation catheter**

(\*ATP: Angioplastia transluminal periférica/PTA: Peripheral transluminal angioplasty)

**1.1 Catéter balón de dilatación para ATP para guía de alambre de 0.014" "iVascular oceanus 14"/  
"iVascular oceanus 14" PTA balloon dilatation catheter for 0.014 guidewire**

**1.1.a. Longitud de catéter 100cm/ Catheter length 100cm**

- 1.1.a.1. Balón 1.5 x 40mm/ Balloon 1.5 x 40mm
- 1.1.a.2. Balón 1.5 x 60mm/ Balloon 1.5 x 60mm
- 1.1.a.3. Balón 1.5 x 80mm/ Balloon 1.5 x 80mm
- 1.1.a.4. Balón 2.0 x 40mm/ Balloon 2.0 x 40mm
- 1.1.a.5. Balón 2.0 x 60mm/ Balloon 2.0 x 60mm
- 1.1.a.6. Balón 2.0 x 80mm/ Balloon 2.0 x 80mm
- 1.1.a.7. Balón 2.0 x 120mm/ Balloon 2.0 x 120mm
- 1.1.a.8. Balón 2.0 x 150mm/ Balloon 2.0 x 150mm
- 1.1.a.9. Balón 2.0 x 200mm/ Balloon 2.0 x 200mm
- 1.1.a.10. Balón 2.5 x 40mm/ Balloon 2.5 x 40mm

Agencia Española de Medicamentos y Productos Sanitarios (AEMPS)

Fecha de la firma: 30/07/2020

Puede comprobar la autenticidad del documento en la sede de la AEMPS: <https://localizador.aemps.es>

CSV: 2 K S D D N Q A 5 9



CORREO ELECTRÓNICO  
on0318@aemps.es

Página 2 de 44

C/ CAMPEZO, 1 - EDIFICIO 8

28022 MADRID

Tel.: (+34) 902.101.322 / (+34) 91.822.59.97

Fax: (+34) 91.822.52.89

ORGANISMO NOTIFICADO 0318





**ANEXO N°/ANNEX NO: I**

**CERTIFICADO CE DE SISTEMA DE GARANTÍA DE CALIDAD TOTAL  
de acuerdo con el Anexo II (excepto punto 4) de la Directiva 93/42/CEE**

**EC FULL QUALITY ASSURANCE SYSTEM CERTIFICATE  
in accordance with Annex II (except Section 4) of Directive 93/42/EEC**

Certificado n°/Certificate no	Fecha de validez/Date of validity			ON n°/NB no	
<b>2012 07 0788 CT</b>	Desde/From	<b>31-07-2020</b>	Hasta/To	<b>26-05-2024</b>	<b>0318</b>

- 1.1.a.11. Balón 2.5 x 60mm/ Balloon 2.5 x 60mm
- 1.1.a.12. Balón 2.5 x 80mm/ Balloon 2.5 x 80mm
- 1.1.a.13. Balón 2.5 x 120mm/ Balloon 2.5 x 120mm
- 1.1.a.14. Balón 2.5 x 150mm/ Balloon 2.5 x 150mm
- 1.1.a.15. Balón 2.5 x 200mm/ Balloon 2.5 x 200mm
- 1.1.a.16. Balón 3.0 x 40mm/ Balloon 3.0 x 40mm
- 1.1.a.17. Balón 3.0 x 60mm/ Balloon 3.0 x 60mm
- 1.1.a.18. Balón 3.0 x 80mm/ Balloon 3.0 x 80mm
- 1.1.a.19. Balón 3.0 x 120mm/ Balloon 3.0 x 120mm
- 1.1.a.20. Balón 3.0 x 150mm/ Balloon 3.0 x 150mm
- 1.1.a.21. Balón 3.0 x 200mm/ Balloon 3.0 x 200mm
- 1.1.a.22. Balón 3.5 x 40mm/ Balloon 3.5 x 40mm
- 1.1.a.23. Balón 3.5 x 60mm/ Balloon 3.5 x 60mm
- 1.1.a.24. Balón 3.5 x 80mm/ Balloon 3.5 x 80mm
- 1.1.a.25. Balón 3.5 x 120mm/ Balloon 3.5 x 120mm
- 1.1.a.26. Balón 3.5 x 150mm/ Balloon 3.5 x 150mm
- 1.1.a.27. Balón 3.5 x 200mm/ Balloon 3.5 x 200mm
- 1.1.a.28. Balón 4.0 x 40mm/ Balloon 4.0 x 40mm
- 1.1.a.29. Balón 4.0 x 60mm/ Balloon 4.0 x 60mm
- 1.1.a.30. Balón 4.0 x 80mm/ Balloon 4.0 x 80mm
- 1.1.a.31. Balón 4.0 x 120mm/ Balloon 4.0 x 120mm

**1.1.b Longitud de catéter 150cm/ Catheter length 150cm**

- 1.1.b.1. Balón 1.5 x 40mm/ Balloon 1.5 x 40mm
- 1.1.b.2. Balón 1.5 x 60mm/ Balloon 1.5 x 60mm

Agencia Española de Medicamentos y Productos Sanitarios (AEMPS)

Fecha de la firma: 30/07/2020

Puede comprobar la autenticidad del documento en la sede de la AEMPS: <https://localizador.aemps.es>

CSV: 2 K S D D N Q A 5 9



CORREO ELECTRÓNICO  
on0318@aemps.es

Página 3 de 44

ORGANISMO NOTIFICADO 0318

C/ CAMPEZO, 1 - EDIFICIO 8  
28022 MADRID  
Tel.: (+34) 902.101.322 / (+34) 91.822.59.97  
Fax: (+34) 91.822.52.89



**ANEXO N°/ANNEX NO: I**

**CERTIFICADO CE DE SISTEMA DE GARANTÍA DE CALIDAD TOTAL  
de acuerdo con el Anexo II (excepto punto 4) de la Directiva 93/42/CEE**

**EC FULL QUALITY ASSURANCE SYSTEM CERTIFICATE  
in accordance with Annex II (except Section 4) of Directive 93/42/EEC**

<b>Certificado n°/Certificate no</b>	<b>Fecha de validez/Date of validity</b>			<b>ON n°/NB no</b>	
<b>2012 07 0788 CT</b>	<b>Desde/From</b>	<b>31-07-2020</b>	<b>Hasta/To</b>	<b>26-05-2024</b>	<b>0318</b>

- 1.1.b.3. Balón 1.5 x 80mm/ Balloon 1.5 x 80mm
- 1.1.b.4. Balón 2.0 x 40mm/ Balloon 2.0 x 40mm
- 1.1.b.5. Balón 2.0 x 60mm/ Balloon 2.0 x 60mm
- 1.1.b.6. Balón 2.0 x 80mm/ Balloon 2.0 x 80mm
- 1.1.b.7. Balón 2.0 x 120mm/ Balloon 2.0 x 120mm
- 1.1.b.8. Balón 2.0 x 150mm/ Balloon 2.0 x 150mm
- 1.1.b.9. Balón 2.0 x 200mm/ Balloon 2.0 x 200mm
- 1.1.b.10. Balón 2.5 x 40mm/ Balloon 2.5 x 40mm
- 1.1.b.11. Balón 2.5 x 60mm/ Balloon 2.5 x 60mm
- 1.1.b.12. Balón 2.5 x 80mm/ Balloon 2.5 x 80mm
- 1.1.b.13. Balón 2.5 x 120mm/ Balloon 2.5 x 120mm
- 1.1.b.14. Balón 2.5 x 150mm/ Balloon 2.5 x 150mm
- 1.1.b.15. Balón 2.5 x 200mm/ Balloon 2.5 x 200mm
- 1.1.b.16. Balón 3.0 x 40mm/ Balloon 3.0 x 40mm
- 1.1.b.17. Balón 3.0 x 60mm/ Balloon 3.0 x 60mm
- 1.1.b.18. Balón 3.0 x 80mm/ Balloon 3.0 x 80mm
- 1.1.b.19. Balón 3.0 x 120mm/ Balloon 3.0 x 120mm
- 1.1.b.20. Balón 3.0 x 150mm/ Balloon 3.0 x 150mm
- 1.1.b.21. Balón 3.0 x 200mm/ Balloon 3.0 x 200mm
- 1.1.b.22. Balón 3.5 x 40mm/ Balloon 3.5 x 40mm
- 1.1.b.23. Balón 3.5 x 60mm/ Balloon 3.5 x 60mm
- 1.1.b.24. Balón 3.5 x 80mm/ Balloon 3.5 x 80mm
- 1.1.b.25. Balón 3.5 x 120mm/ Balloon 3.5 x 120mm
- 1.1.b.26. Balón 3.5 x 150mm/ Balloon 3.5 x 150mm
- 1.1.b.27. Balón 3.5 x 200mm/ Balloon 3.5 x 200mm

MODELO-IP ANEXO II CT Cert. 93/42/IP-Rev1805/2020

Agencia Española de Medicamentos y Productos Sanitarios (AEMPS)

Fecha de la firma: 30/07/2020

Puede comprobar la autenticidad del documento en la sede de la AEMPS: <https://localizador.aemps.es>

CSV: 2 K S D D N Q A 5 9



CORREO ELECTRÓNICO  
on0318@aemps.es

Página 4 de 44

ORGANISMO NOTIFICADO 0318

C/ CAMPEZO, 1 - EDIFICIO 8  
28022 MADRID  
Tel.: (+34) 902.101.322 / (+34) 91.822.59.97  
Fax: (+34) 91.822.52.89



**ANEXO N°/ANNEX NO: I**

**CERTIFICADO CE DE SISTEMA DE GARANTÍA DE CALIDAD TOTAL**  
de acuerdo con el Anexo II (excepto punto 4) de la Directiva 93/42/CEE

**EC FULL QUALITY ASSURANCE SYSTEM CERTIFICATE**  
*in accordance with Annex II (except Section 4) of Directive 93/42/EEC*

Certificado n°/Certificate no	Fecha de validez/Date of validity			ON n°/NB no	
<b>2012 07 0788 CT</b>	Desde/From	<b>31-07-2020</b>	Hasta/To	<b>26-05-2024</b>	<b>0318</b>

- 1.1.b.28. Balón 4.0 x 40mm/ Balloon 4.0 x 40mm
- 1.1.b.29. Balón 4.0 x 60mm/ Balloon 4.0 x 60mm
- 1.1.b.30. Balón 4.0 x 80mm/ Balloon 4.0 x 80mm
- 1.1.b.31. Balón 4.0 x 120mm/ Balloon 4.0 x 120mm

**1.2. Catéter balón de dilatación para ATP para guía de alambre de 0.018" "iVascular oceanus 18"/ "iVascular oceanus 18" PTA balloon dilatation catheter for 0.018" guidewire**

**1.2.a Longitud catéter 100cm/ Catheter length 100cm**

- 1.2.a.1 Balón 2.0 x 20mm/ Balloon 2.0 x 20mm
- 1.2.a.2 Balón 2.0 x 40mm/ Balloon 2.0 x 40mm
- 1.2.a.3 Balón 2.0 x 60mm/ Balloon 2.0 x 60mm
- 1.2.a.4 Balón 2.0 x 80mm/ Balloon 2.0 x 80mm
- 1.2.a.5 Balón 2.0 x 120mm/ Balloon 2.0 x 120mm
- 1.2.a.6 Balón 2.0 x 150mm/ Balloon 2.0 x 150mm
- 1.2.a.7 Balón 2.0 x 200mm/ Balloon 2.0 x 200mm
- 1.2.a.8 Balón 2.5 x 20mm/ Balloon 2.5 x 20mm
- 1.2.a.9 Balón 2.5 x 40mm/ Balloon 2.5 x 40mm
- 1.2.a.10 Balón 2.5 x 60mm/ Balloon 2.5 x 60mm
- 1.2.a.11 Balón 2.5 x 80mm/ Balloon 2.5 x 80mm
- 1.2.a.12 Balón 2.5 x 120mm/ Balloon 2.5 x 120mm
- 1.2.a.13 Balón 2.5 x 150mm/ Balloon 2.5 x 150mm
- 1.2.a.14 Balón 2.5 x 200mm/ Balloon 2.5 x 200mm
- 1.2.a.15 Balón 3.0 x 20mm/ Balloon 3.0 x 20mm
- 1.2.a.16 Balón 3.0 x 40mm/ Balloon 3.0 x 40mm
- 1.2.a.17 Balón 3.0 x 60mm/ Balloon 3.0 x 60mm
- 1.2.a.18 Balón 3.0 x 80mm/ Balloon 3.0 x 80mm
- 1.2.a.19 Balón 3.0 x 120mm/ Balloon 3.0 x 120mm

Agencia Española de Medicamentos y Productos Sanitarios (AEMPS)

Fecha de la firma: 30/07/2020

Puede comprobar la autenticidad del documento en la sede de la AEMPS: <https://localizador.aemps.es>

CSV: 2 K S D D N Q A 5 9



CORREO ELECTRÓNICO  
on0318@aemps.es

Página 5 de 44

ORGANISMO NOTIFICADO 0318

C/ CAMPEZO, 1 - EDIFICIO 8  
28022 MADRID  
Tel.: (+34) 902.101.322 / (+34) 91.822.59.97  
Fax: (+34) 91.822.52.89





**ANEXO N°/ANNEX NO: I**

**CERTIFICADO CE DE SISTEMA DE GARANTÍA DE CALIDAD TOTAL**  
de acuerdo con el Anexo II (excepto punto 4) de la Directiva 93/42/CEE

**EC FULL QUALITY ASSURANCE SYSTEM CERTIFICATE**  
*in accordance with Annex II (except Section 4) of Directive 93/42/EEC*

Certificado n°/Certificate no	Fecha de validez/Date of validity			ON n°/NB no	
<b>2012 07 0788 CT</b>	Desde/From	<b>31-07-2020</b>	Hasta/To	<b>26-05-2024</b>	<b>0318</b>

- 1.2.a.20 Balón 3.0 x 150mm/ Balloon 3.0 x 150mm
- 1.2.a.21 Balón 3.0 x 200mm/ Balloon 3.0 x 200mm
- 1.2.a.22 Balón 3.5 x 20mm/ Balloon 3.5 x 20mm
- 1.2.a.23 Balón 3.5 x 40mm/ Balloon 3.5 x 40mm
- 1.2.a.24 Balón 3.5 x 60mm/ Balloon 3.5 x 60mm
- 1.2.a.25 Balón 3.5 x 80mm/ Balloon 3.5 x 80mm
- 1.2.a.26 Balón 3.5 x 120mm/ Balloon 3.5 x 120mm
- 1.2.a.27 Balón 3.5 x 150mm/ Balloon 3.5 x 150mm
- 1.2.a.28 Balón 3.5 x 200mm/ Balloon 3.5 x 200mm
- 1.2.a.29 Balón 4.0 x 20mm/ Balloon 4.0 x 20mm
- 1.2.a.30 Balón 4.0 x 40mm/ Balloon 4.0 x 40mm
- 1.2.a.31 Balón 4.0 x 60mm/ Balloon 4.0 x 60mm
- 1.2.a.32 Balón 4.0 x 80mm/ Balloon 4.0 x 80mm
- 1.2.a.33 Balón 4.0 x 120mm/ Balloon 4.0 x 120mm
- 1.2.a.34 Balón 4.0 x 150mm/ Balloon 4.0 x 150mm
- 1.2.a.35 Balón 4.0 x 200mm/ Balloon 4.0 x 200mm
- 1.2.a.36 Balón 5.0 x 20mm/ Balloon 5.0 x 20mm
- 1.2.a.37 Balón 5.0 x 40mm/ Balloon 5.0 x 40mm
- 1.2.a.38 Balón 5.0 x 60mm/ Balloon 5.0 x 60mm
- 1.2.a.39 Balón 5.0 x 80mm/ Balloon 5.0 x 80mm
- 1.2.a.40 Balón 5.0 x 120mm/ Balloon 5.0 x 120mm
- 1.2.a.41 Balón 5.0 x 150mm/ Balloon 5.0 x 150mm
- 1.2.a.42 Balón 5.0 x 200mm/ Balloon 5.0 x 200mm
- 1.2.a.43 Balón 6.0 x 20mm/ Balloon 6.0 x 20mm
- 1.2.a.44 Balón 6.0 x 40mm/ Balloon 6.0 x 40mm
- 1.2.a.45 Balón 6.0 x 60mm/ Balloon 6.0 x 60mm
- 1.2.a.46 Balón 6.0 x 80mm/ Balloon 6.0 x 80mm
- 1.2.a.47 Balón 6.0 x 120mm/ Balloon 6.0 x 120mm

MODELO-IP ANEXO II CT Cert. 93/42/IP-Rev1805/2020

Agencia Española de Medicamentos y Productos Sanitarios (AEMPS)

Fecha de la firma: 30/07/2020

Puede comprobar la autenticidad del documento en la sede de la AEMPS: <https://localizador.aemps.es>

CSV: 2 K S D D N Q A 5 9



CORREO ELECTRÓNICO  
on0318@aemps.es

Página 6 de 44

C/ CAMPEZO, 1 - EDIFICIO 8  
28022 MADRID

Tel.: (+34) 902.101.322 / (+34) 91.822.59.97  
Fax: (+34) 91.822.52.89

ORGANISMO NOTIFICADO 0318



**ANEXO N°/ANNEX NO: I**

**CERTIFICADO CE DE SISTEMA DE GARANTÍA DE CALIDAD TOTAL  
de acuerdo con el Anexo II (excepto punto 4) de la Directiva 93/42/CEE**

**EC FULL QUALITY ASSURANCE SYSTEM CERTIFICATE  
in accordance with Annex II (except Section 4) of Directive 93/42/EEC**

<b>Certificado n°/Certificate no</b>	<b>Fecha de validez/Date of validity</b>			<b>ON n°/NB no</b>	
<b>2012 07 0788 CT</b>	<b>Desde/From</b>	<b>31-07-2020</b>	<b>Hasta/To</b>	<b>26-05-2024</b>	<b>0318</b>

- 1.2.a.48 Balón 6.0 x 150mm/ Balloon 6.0 x 150mm
- 1.2.a.49 Balón 6.0 x 200mm/ Balloon 6.0 x 200mm
- 1.2.a.50 Balón 7.0 x 20mm/ Balloon 7.0 x 20mm
- 1.2.a.51 Balón 7.0 x 40mm/ Balloon 7.0 x 40mm
- 1.2.a.52 Balón 7.0 x 60mm/ Balloon 7.0 x 60mm
- 1.2.a.53 Balón 7.0 x 80mm/ Balloon 7.0 x 80mm
- 1.2.a.54 Balón 7.0 x 120mm/ Balloon 7.0 x 120mm
- 1.2.a.55 Balón 8.0 x 20mm / Balloon 8.0 x 20mm
- 1.2.a.56 Balón 8.0 x 40mm / Balloon 8.0 x 40mm
- 1.2.a.57 Balón 8.0 x 60mm / Balloon 8.0 x 60mm
- 1.2.a.58 Balón 8.0 x 80mm / Balloon 8.0 x 80mm

**1.2.b. Longitud catéter 140cm/ Catheter length 140cm**

- 1.2.b.1. Balón 5.0 x 20mm/ Balloon 5.0 x 20mm
- 1.2.b.2. Balón 5.0 x 40mm/ Balloon 5.0 x 40mm
- 1.2.b.3. Balón 5.0 x 60mm/ Balloon 5.0 x 60mm
- 1.2.b.4. Balón 5.0 x 80mm/ Balloon 5.0 x 80mm
- 1.2.b.5. Balón 5.0 x 120mm/ Balloon 5.0 x 120mm
- 1.2.b.6. Balón 5.0 x 150mm/ Balloon 5.0 x 150mm
- 1.2.b.7. Balón 5.0 x 200mm/ Balloon 5.0 x 200mm
- 1.2.b.8. Balón 6.0 x 20mm/ Balloon 6.0 x 20mm
- 1.2.b.9. Balón 6.0 x 40mm/ Balloon 6.0 x 40mm
- 1.2.b.10. Balón 6.0 x 60mm/ Balloon 6.0 x 60mm
- 1.2.b.11. Balón 6.0 x 80mm/ Balloon 6.0 x 80mm
- 1.2.b.12. Balón 6.0 x 120mm/ Balloon 6.0 x 120mm
- 1.2.b.13. Balón 6.0 x 150mm/ Balloon 6.0 x 150mm
- 1.2.b.14. Balón 6.0 x 200mm/ Balloon 6.0 x 200mm

MODELO-IP ANEXO II CT Cert. 93/42/IP-Rev1805/2020

Agencia Española de Medicamentos y Productos Sanitarios (AEMPS)

Fecha de la firma: 30/07/2020

Puede comprobar la autenticidad del documento en la sede de la AEMPS: <https://localizador.aemps.es>

CSV: 2 K S D D N Q A 5 9



CORREO ELECTRÓNICO  
on0318@aemps.es

Página 7 de 44

C/ CAMPEZO, 1 - EDIFICIO 8  
28022 MADRID  
Tel.: (+34) 902.101.322 / (+34) 91.822.59.97  
Fax: (+34) 91.822.52.89

ORGANISMO NOTIFICADO 0318



**ANEXO N°/ANNEX NO: I**

**CERTIFICADO CE DE SISTEMA DE GARANTÍA DE CALIDAD TOTAL  
de acuerdo con el Anexo II (excepto punto 4) de la Directiva 93/42/CEE**

**EC FULL QUALITY ASSURANCE SYSTEM CERTIFICATE  
in accordance with Annex II (except Section 4) of Directive 93/42/EEC**

<b>Certificado n°/Certificate no</b>	<b>Fecha de validez/Date of validity</b>			<b>ON n°/NB no</b>	
<b>2012 07 0788 CT</b>	<b>Desde/From</b>	<b>31-07-2020</b>	<b>Hasta/To</b>	<b>26-05-2024</b>	<b>0318</b>

- 1.2.b.15. Balón 7.0 x 20mm/ Balloon 7.0 x 20mm
- 1.2.b.16. Balón 7.0 x 40mm/ Balloon 7.0 x 40mm
- 1.2.b.17. Balón 7.0 x 60mm/ Balloon 7.0 x 60mm
- 1.2.b.18. Balón 7.0 x 80mm/ Balloon 7.0 x 80mm
- 1.2.b.19. Balón 7.0 x 120mm/ Balloon 7.0 x 120mm
- 1.2.b.20. Balón 8.0 x 20mm / Balloon 8.0 x 20mm
- 1.2.b.21. Balón 8.0 x 40mm / Balloon 8.0 x 40mm
- 1.2.b.22. Balón 8.0 x 60mm / Balloon 8.0 x 60mm
- 1.2.b.23. Balón 8.0 x 80mm / Balloon 8.0 x 80mm

**1.2.c. Longitud catéter 150cm/ Catheter length 150cm**

- 1.2.c.1. Balón 2.0 x 20mm/ Balloon 2.0 x 20mm
- 1.2.c.2. Balón 2.0 x 40mm/ Balloon 2.0 x 40mm
- 1.2.c.3. Balón 2.0 x 60mm/ Balloon 2.0 x 60mm
- 1.2.c.4. Balón 2.0 x 80mm/ Balloon 2.0 x 80mm
- 1.2.c.5. Balón 2.0 x 120mm/ Balloon 2.0 x 120mm
- 1.2.c.6. Balón 2.0 x 150mm/ Balloon 2.0 x 150mm
- 1.2.c.7. Balón 2.0 x 200mm/ Balloon 2.0 x 200mm
- 1.2.c.8. Balón 2.5 x 20mm/ Balloon 2.5 x 20mm
- 1.2.c.9. Balón 2.5 x 40mm/ Balloon 2.5 x 40mm
- 1.2.c.10. Balón 2.5 x 60mm/ Balloon 2.5 x 60mm
- 1.2.c.11. Balón 2.5 x 80mm/ Balloon 2.5 x 80mm
- 1.2.c.12. Balón 2.5 x 120mm/ Balloon 2.5 x 120mm
- 1.2.c.13. Balón 2.5 x 150mm/ Balloon 2.5 x 150mm
- 1.2.c.14. Balón 2.5 x 200mm/ Balloon 2.5 x 200mm
- 1.2.c.15. Balón 3.0 x 20mm/ Balloon 3.0 x 20mm

MODELO-IP ANEXO II CT Cert. 93/42/IP-Rev1805/2020

Agencia Española de Medicamentos y Productos Sanitarios (AEMPS)

Fecha de la firma: 30/07/2020

Puede comprobar la autenticidad del documento en la sede de la AEMPS: <https://localizador.aemps.es>

CSV: 2 K S D D N Q A 5 9



CORREO ELECTRÓNICO  
on0318@aemps.es

Página 8 de 44

C/ CAMPEZO, 1 - EDIFICIO 8  
28022 MADRID  
Tel.: (+34) 902.101.322 / (+34) 91.822.59.97  
Fax: (+34) 91.822.52.89

ORGANISMO NOTIFICADO 0318





**ANEXO N°/ANNEX NO: I**

**CERTIFICADO CE DE SISTEMA DE GARANTÍA DE CALIDAD TOTAL  
de acuerdo con el Anexo II (excepto punto 4) de la Directiva 93/42/CEE**

**EC FULL QUALITY ASSURANCE SYSTEM CERTIFICATE  
in accordance with Annex II (except Section 4) of Directive 93/42/EEC**

Certificado n°/Certificate no	Fecha de validez/Date of validity			ON n°/NB no	
<b>2012 07 0788 CT</b>	Desde/From	<b>31-07-2020</b>	Hasta/To	<b>26-05-2024</b>	<b>0318</b>

- 1.2.c.16. Balón 3.0 x 40mm/ Balloon 3.0 x 40mm
- 1.2.c.17. Balón 3.0 x 60mm/ Balloon 3.0 x 60mm
- 1.2.c.18. Balón 3.0 x 80mm/ Balloon 3.0 x 80mm
- 1.2.c.19. Balón 3.0 x 120mm/ Balloon 3.0 x 120mm
- 1.2.c.20. Balón 3.0 x 150mm/ Balloon 3.0 x 150mm
- 1.2.c.21. Balón 3.0 x 200mm/ Balloon 3.0 x 200mm
- 1.2.c.22. Balón 3.5 x 20mm/ Balloon 3.5 x 20mm
- 1.2.c.23. Balón 3.5 x 40mm/ Balloon 3.5 x 40mm
- 1.2.c.24. Balón 3.5 x 60mm/ Balloon 3.5 x 60mm
- 1.2.c.25. Balón 3.5 x 80mm/ Balloon 3.5 x 80mm
- 1.2.c.26. Balón 3.5 x 120mm/ Balloon 3.5 x 120mm
- 1.2.c.27. Balón 3.5 x 150mm/ Balloon 3.5 x 150mm
- 1.2.c.28. Balón 3.5 x 200mm/ Balloon 3.5 x 200mm
- 1.2.c.29. Balón 4.0 x 20mm/ Balloon 4.0 x 20mm
- 1.2.c.30. Balón 4.0 x 40mm/ Balloon 4.0 x 40mm
- 1.2.c.31. Balón 4.0 x 60mm/ Balloon 4.0 x 60mm
- 1.2.c.32. Balón 4.0 x 80mm/ Balloon 4.0 x 80mm
- 1.2.c.33. Balón 4.0 x 120mm/ Balloon 4.0 x 120mm
- 1.2.c.34. Balón 4.0 x 150mm/ Balloon 4.0 x 150mm
- 1.2.c.35. Balón 4.0 x 200mm/ Balloon 4.0 x 200mm

**1.3. Catéter balón de dilatación para ATP para guía de alambre de 0.035" "iVascular oceanus 35"/  
"iVascular oceanus 35" PTA balloon dilatation catheter for 0.035" guidewire**

**1.3.a. Longitud catéter 80cm/ Catheter length 80cm**

**1.3.a.1 Balón 3.0 x 20mm/ Balloon 3.0 x 20mm**

Agencia Española de Medicamentos y Productos Sanitarios (AEMPS)

Fecha de la firma: 30/07/2020

Puede comprobar la autenticidad del documento en la sede de la AEMPS: <https://localizador.aemps.es>

CSV: 2 K S D D N Q A 5 9



CORREO ELECTRÓNICO  
on0318@aemps.es

Página 9 de 44

C/ CAMPEZO, 1 - EDIFICIO 8  
28022 MADRID  
Tel.: (+34) 902.101.322 / (+34) 91.822.59.97  
Fax: (+34) 91.822.52.89

ORGANISMO NOTIFICADO 0318



**ANEXO N°/ANNEX NO: I**

**CERTIFICADO CE DE SISTEMA DE GARANTÍA DE CALIDAD TOTAL**  
de acuerdo con el Anexo II (excepto punto 4) de la Directiva 93/42/CEE

**EC FULL QUALITY ASSURANCE SYSTEM CERTIFICATE**  
in accordance with Annex II (except Section 4) of Directive 93/42/EEC

Certificado n°/Certificate no	Fecha de validez/Date of validity			ON n°/NB no	
<b>2012 07 0788 CT</b>	Desde/From	<b>31-07-2020</b>	Hasta/To	<b>26-05-2024</b>	<b>0318</b>

- 1.3.a.2 Balón 3.0 x 40mm/ Balloon 3.0 x 40mm
- 1.3.a.3 Balón 3.0 x 60mm/ Balloon 3.0 x 60mm
- 1.3.a.4 Balón 3.0 x 80mm/ Balloon 3.0 x 80mm
- 1.3.a.5 Balón 3.0 x 120mm/ Balloon 3.0 x 120mm
- 1.3.a.6 Balón 3.0 x 150mm/ Balloon 3.0 x 150mm
- 1.3.a.7 Balón 3.0 x 200mm/ Balloon 3.0 x 200mm
- 1.3.a.8 Balón 4.0 x 20mm/ Balloon 4.0 x 20mm
- 1.3.a.9 Balón 4.0 x 40mm/ Balloon 4.0 x 40mm
- 1.3.a.10 Balón 4.0 x 60mm/ Balloon 4.0 x 60mm
- 1.3.a.11 Balón 4.0 x 80mm/ Balloon 4.0 x 80mm
- 1.3.a.12 Balón 4.0 x 120mm/ Balloon 4.0 x 120mm
- 1.3.a.13 Balón 4.0 x 150mm/ Balloon 4.0 x 150mm
- 1.3.a.14 Balón 4.0 x 200mm/ Balloon 4.0 x 200mm
- 1.3.a.15 Balón 5.0 x 20mm/ Balloon 5.0 x 20mm
- 1.3.a.16 Balón 5.0 x 40mm/ Balloon 5.0 x 40mm
- 1.3.a.17 Balón 5.0 x 60mm/ Balloon 5.0 x 60mm
- 1.3.a.18 Balón 5.0 x 80mm/ Balloon 5.0 x 80mm
- 1.3.a.19 Balón 5.0 x 120mm/ Balloon 5.0 x 120mm
- 1.3.a.20 Balón 5.0 x 150mm/ Balloon 5.0 x 150mm
- 1.3.a.21 Balón 5.0 x 200mm/ Balloon 5.0 x 200mm
- 1.3.a.22 Balón 6.0 x 20mm/ Balloon 6.0 x 20mm
- 1.3.a.23 Balón 6.0 x 40mm/ Balloon 6.0 x 40mm
- 1.3.a.24 Balón 6.0 x 60mm/ Balloon 6.0 x 60mm
- 1.3.a.25 Balón 6.0 x 80mm/ Balloon 6.0 x 80mm
- 1.3.a.26 Balón 6.0 x 120mm/ Balloon 6.0 x 120mm
- 1.3.a.27 Balón 6.0 x 150mm/ Balloon 6.0 x 150mm
- 1.3.a.28 Balón 6.0 x 200mm/ Balloon 6.0 x 200mm
- 1.3.a.29 Balón 7.0 x 20mm/ Balloon 7.0 x 20mm

MODELO-IP ANEXO II CT Cert. 93/42/IP-Rev1805/2020

Agencia Española de Medicamentos y Productos Sanitarios (AEMPS)

Fecha de la firma: 30/07/2020

Puede comprobar la autenticidad del documento en la sede de la AEMPS: <https://localizador.aemps.es>

CSV: 2 K S D D N Q A 5 9



CORREO ELECTRÓNICO  
on0318@aemps.es

Página 10 de 44

ORGANISMO NOTIFICADO 0318

C/ CAMPEZO, 1 - EDIFICIO 8  
28022 MADRID  
Tel.: (+34) 902.101.322 / (+34) 91.822.59.97  
Fax: (+34) 91.822.52.89



**ANEXO N°/ANNEX NO: I**

**CERTIFICADO CE DE SISTEMA DE GARANTÍA DE CALIDAD TOTAL**  
de acuerdo con el Anexo II (excepto punto 4) de la Directiva 93/42/CEE

**EC FULL QUALITY ASSURANCE SYSTEM CERTIFICATE**  
in accordance with Annex II (except Section 4) of Directive 93/42/EEC

Certificado n°/Certificate no	Fecha de validez/Date of validity			ON n°/NB no	
<b>2012 07 0788 CT</b>	Desde/From	<b>31-07-2020</b>	Hasta/To	<b>26-05-2024</b>	<b>0318</b>

- 1.3.a.30 Balón 7.0 x 40mm/ Balloon 7.0 x 40mm
- 1.3.a.31 Balón 7.0 x 60mm/ Balloon 7.0 x 60mm
- 1.3.a.32 Balón 7.0 x 80mm/ Balloon 7.0 x 80mm
- 1.3.a.33 Balón 7.0 x 120mm/ Balloon 7.0 x 120mm
- 1.3.a.34 Balón 8.0 x 20mm / Balloon 8.0 x 20mm
- 1.3.a.35 Balón 8.0 x 40mm / Balloon 8.0 x 40mm
- 1.3.a.36 Balón 8.0 x 60mm / Balloon 8.0 x 60mm
- 1.3.a.37 Balón 8.0 x 80mm / Balloon 8.0 x 80mm
- 1.3.a.38 Balón 9.0 x 20mm / Balloon 9.0 x 20mm
- 1.3.a.39 Balón 9.0 x 40mm / Balloon 9.0 x 40mm
- 1.3.a.40 Balón 9.0 x 60mm / Balloon 9.0 x 60mm
- 1.3.a.41 Balón 9.0 x 80mm / Balloon 9.0 x 80mm
- 1.3.a.42 Balón 10.0 x 20mm / Balloon 10.0 x 20mm
- 1.3.a.43 Balón 10.0 x 40mm / Balloon 10.0 x 40mm
- 1.3.a.44 Balón 10.0 x 60mm / Balloon 10.0 x 60mm
- 1.3.a.45 Balón 12.0 x 20mm / Balloon 12.0 x 20mm
- 1.3.a.46 Balón 12.0 x 40mm / Balloon 12.0 x 40mm
- 1.3.a.47 Balón 12.0 x 60mm / Balloon 12.0 x 60mm

**1.3.b. Longitud catéter 140cm/ Catheter length 140cm**

- 1.3.b.1 Balón 3.0 x 20mm/ Balloon 3.0 x 20mm
- 1.3.b.2 Balón 3.0 x 40mm/ Balloon 3.0 x 40mm
- 1.3.b.3 Balón 3.0 x 60mm/ Balloon 3.0 x 60mm
- 1.3.b.4 Balón 3.0 x 80mm/ Balloon 3.0 x 80mm
- 1.3.b.5 Balón 3.0 x 120mm/ Balloon 3.0 x 120mm
- 1.3.b.6 Balón 3.0 x 150mm/ Balloon 3.0 x 150mm
- 1.3.b.7 Balón 3.0 x 200mm/ Balloon 3.0 x 200mm
- 1.3.b.8 Balón 4.0 x 20mm/ Balloon 4.0 x 20mm

MODELO-IP ANEXO II CT Cert. 93/42/IP-Rev1805/2020

Agencia Española de Medicamentos y Productos Sanitarios (AEMPS)

Fecha de la firma: 30/07/2020

Puede comprobar la autenticidad del documento en la sede de la AEMPS: <https://localizador.aemps.es>

CSV: 2 K S D D N Q A 5 9



CORREO ELECTRÓNICO  
on0318@aemps.es

Página 11 de 44

ORGANISMO NOTIFICADO 0318

C/ CAMPEZO, 1 - EDIFICIO 8  
28022 MADRID  
Tel.: (+34) 902.101.322 / (+34) 91.822.59.97  
Fax: (+34) 91.822.52.89





**ANEXO N°/ANNEX NO: I**

**CERTIFICADO CE DE SISTEMA DE GARANTÍA DE CALIDAD TOTAL**  
de acuerdo con el Anexo II (excepto punto 4) de la Directiva 93/42/CEE

**EC FULL QUALITY ASSURANCE SYSTEM CERTIFICATE**  
in accordance with Annex II (except Section 4) of Directive 93/42/EEC

Certificado n°/Certificate no	Fecha de validez/Date of validity			ON n°/NB no	
<b>2012 07 0788 CT</b>	Desde/From	<b>31-07-2020</b>	Hasta/To	<b>26-05-2024</b>	<b>0318</b>

- 1.3.b.9 Balón 4.0 x 40mm/ Balloon 4.0 x 40mm
- 1.3.b.10 Balón 4.0 x 60mm/ Balloon 4.0 x 60mm
- 1.3.b.11 Balón 4.0 x 80mm/ Balloon 4.0 x 80mm
- 1.3.b.12 Balón 4.0 x 120mm/ Balloon 4.0 x 120mm
- 1.3.b.13 Balón 4.0 x 150mm/ Balloon 4.0 x 150mm
- 1.3.b.14 Balón 4.0 x 200mm/ Balloon 4.0 x 200mm
- 1.3.b.15 Balón 5.0 x 20mm/ Balloon 5.0 x 20mm
- 1.3.b.16 Balón 5.0 x 40mm/ Balloon 5.0 x 40mm
- 1.3.b.17 Balón 5.0 x 60mm/ Balloon 5.0 x 60mm
- 1.3.b.18 Balón 5.0 x 80mm/ Balloon 5.0 x 80mm
- 1.3.b.19 Balón 5.0 x 120mm/ Balloon 5.0 x 120mm
- 1.3.b.20 Balón 5.0 x 150mm/ Balloon 5.0 x 150mm
- 1.3.b.21 Balón 5.0 x 200mm/ Balloon 5.0 x 200mm
- 1.3.b.22 Balón 6.0 x 20mm/ Balloon 6.0 x 20mm
- 1.3.b.23 Balón 6.0 x 40mm/ Balloon 6.0 x 40mm
- 1.3.b.24 Balón 6.0 x 60mm/ Balloon 6.0 x 60mm
- 1.3.b.25 Balón 6.0 x 80mm/ Balloon 6.0 x 80mm
- 1.3.b.26 Balón 6.0 x 120mm/ Balloon 6.0 x 120mm
- 1.3.b.27 Balón 6.0 x 150mm/ Balloon 6.0 x 150mm
- 1.3.b.28 Balón 6.0 x 200mm/ Balloon 6.0 x 200mm
- 1.3.b.29 Balón 7.0 x 20mm/ Balloon 7.0 x 20mm
- 1.3.b.30 Balón 7.0 x 40mm/ Balloon 7.0 x 40mm
- 1.3.b.31 Balón 7.0 x 60mm/ Balloon 7.0 x 60mm
- 1.3.b.32 Balón 7.0 x 80mm/ Balloon 7.0 x 80mm
- 1.3.b.33 Balón 7.0 x 120mm/ Balloon 7.0 x 120mm
- 1.3.b.34 Balón 8.0 x 20mm / Balloon 8.0 x 20mm
- 1.3.b.35 Balón 8.0 x 40mm / Balloon 8.0 x 40mm
- 1.3.b.36 Balón 8.0 x 60mm / Balloon 8.0 x 60mm

MODELO-IP ANEXO II CT Cert. 93/42/IP-Rev1805/2020

Agencia Española de Medicamentos y Productos Sanitarios (AEMPS)

Fecha de la firma: 30/07/2020

Puede comprobar la autenticidad del documento en la sede de la AEMPS: <https://localizador.aemps.es>

CSV: 2 K S D D N Q A 5 9



CORREO ELECTRÓNICO  
on0318@aemps.es

Página 12 de 44

C/ CAMPEZO, 1 - EDIFICIO 8  
28022 MADRID

Tel.: (+34) 902.101.322 / (+34) 91.822.59.97  
Fax: (+34) 91.822.52.89

ORGANISMO NOTIFICADO 0318



**ANEXO N°/ANNEX NO: I**

**CERTIFICADO CE DE SISTEMA DE GARANTÍA DE CALIDAD TOTAL  
de acuerdo con el Anexo II (excepto punto 4) de la Directiva 93/42/CEE**

**EC FULL QUALITY ASSURANCE SYSTEM CERTIFICATE  
in accordance with Annex II (except Section 4) of Directive 93/42/EEC**

Certificado n°/Certificate no	Fecha de validez/Date of validity			ON n°/NB no	
<b>2012 07 0788 CT</b>	Desde/From	<b>31-07-2020</b>	Hasta/To	<b>26-05-2024</b>	<b>0318</b>

- 1.3.b.37 Balón 8.0 x 80mm / Balloon 8.0 x 80mm
- 1.3.b.38 Balón 9.0 x 20mm / Balloon 9.0 x 20mm
- 1.3.b.39 Balón 9.0 x 40mm / Balloon 9.0 x 40mm
- 1.3.b.40 Balón 9.0 x 60mm / Balloon 9.0 x 60mm
- 1.3.b.41 Balón 9.0 x 80mm / Balloon 9.0 x 80mm
- 1.3.b.42 Balón 10.0 x 20mm / Balloon 10.0 x 20mm
- 1.3.b.43 Balón 10.0 x 40mm / Balloon 10.0 x 40mm
- 1.3.b.44 Balón 10.0 x 60mm / Balloon 10.0 x 60mm
- 1.3.b.45 Balón 12.0 x 20mm / Balloon 12.0 x 20mm
- 1.3.b.46 Balón 12.0 x 40mm / Balloon 12.0 x 40mm
- 1.3.b.47 Balón 12.0 x 60mm / Balloon 12.0 x 60mm

**1.3.c Longitud catéter 170cm/ Catheter length 170cm**

- 1.3.c.1 Balón 6.0 x 20mm/ Balloon 6.0 x 20mm
- 1.3.c.2 Balón 7.0 x 20mm/ Balloon 7.0 x 20mm
- 1.3.c.3 Balón 8.0 x 20mm/ Balloon 8.0 x 20mm
- 1.3.c.4 Balón 9.0 x 20mm/ Balloon 9.0 x 20mm
- 1.3.c.5 Balón 10.0 x 20mm/ Balloon 10.0 x 20mm
- 1.3.c.6 Balón 12.0 x 20mm/ Balloon 12.0 x 20mm

**1.3.d Longitud catéter 200cm/ Catheter length 200cm**

- 1.3.d.1 Balón 6.0 x 20mm/ Balloon 6.0 x 20mm
- 1.3.d.2 Balón 7.0 x 20mm/ Balloon 7.0 x 20mm
- 1.3.d.3 Balón 8.0 x 20mm/ Balloon 8.0 x 20mm
- 1.3.d.4 Balón 9.0 x 20mm/ Balloon 9.0 x 20mm
- 1.3.d.5 Balón 10.0 x 20mm/ Balloon 10.0 x 20mm
- 1.3.d.6 Balón 12.0 x 20mm/ Balloon 12.0 x 20mm

Agencia Española de Medicamentos y Productos Sanitarios (AEMPS)

Fecha de la firma: 30/07/2020

Puede comprobar la autenticidad del documento en la sede de la AEMPS: <https://localizador.aemps.es>

CSV: 2 K S D D N Q A 5 9



CORREO ELECTRÓNICO  
on0318@aemps.es

Página 13 de 44

C/ CAMPEZO, 1 - EDIFICIO 8  
28022 MADRID  
Tel.: (+34) 902.101.322 / (+34) 91.822.59.97  
Fax: (+34) 91.822.52.89

ORGANISMO NOTIFICADO 0318



**ANEXO N°/ANNEX NO: I**

**CERTIFICADO CE DE SISTEMA DE GARANTÍA DE CALIDAD TOTAL**  
de acuerdo con el Anexo II (excepto punto 4) de la Directiva 93/42/CEE

**EC FULL QUALITY ASSURANCE SYSTEM CERTIFICATE**  
*in accordance with Annex II (except Section 4) of Directive 93/42/EEC*

Certificado n°/Certificate no	Fecha de validez/Date of validity			ON n°/NB no	
<b>2012 07 0788 CT</b>	Desde/From	<b>31-07-2020</b>	Hasta/To	<b>26-05-2024</b>	<b>0318</b>

**1.4. Catéter balón de dilatación para ATP, para guía de alambre de 0.014", con marcas radiopacas metálicas/poliméricas "iVascular oceanus 14 pro"/ "iVascular oceanus 14 pro" PTA balloon dilatation catheter for 0.014" guidewire, with metallic/polymeric radiopaque markers**

**1.4.a. Longitud de catéter 100cm/ Catheter length 100cm**

**1.4.a.1 Balón 1.25 x 10mm/ Balloon 1.25 x 10mm**

**1.4.a.2 Balón 1.25 x 15mm/ Balloon 1.25 x 15mm**

**1.4.a.3 Balón 1.25 x 20mm/ Balloon 1.25 x 20mm**

**1.4.a.4 Balón 1.5 x 10mm/ Balloon 1.5 x 10mm**

**1.4.a.5 Balón 1.5 x 15mm/ Balloon 1.5 x 15mm**

**1.4.a.6 Balón 1.5 x 20mm/ Balloon 1.5 x 20mm**

**1.4.a.7 Balón 1.5 x 40mm/ Balloon 1.5 x 40mm**

**1.4.a.8 Balón 1.5 x 60mm/ Balloon 1.5 x 60mm**

**1.4.a.9 Balón 1.5 x 80mm/ Balloon 1.5 x 80mm**

**1.4.a.10 Balón 2.0 x 10mm/ Balloon 2.0 x 10mm**

**1.4.a.11 Balón 2.0 x 15mm/ Balloon 2.0 x 15mm**

**1.4.a.12 Balón 2.0 x 20mm/ Balloon 2.0 x 20mm**

**1.4.a.13 Balón 2.0 x 40mm/ Balloon 2.0 x 40mm**

**1.4.a.14 Balón 2.0 x 60mm/ Balloon 2.0 x 60mm**

**1.4.a.15 Balón 2.0 x 80mm/ Balloon 2.0 x 80mm**

**1.4.a.16 Balón 2.0 x 120mm/ Balloon 2.0 x 120mm**

**1.4.a.17 Balón 2.0 x 150mm/ Balloon 2.0 x 150mm**

**1.4.a.18 Balón 2.0 x 200mm/ Balloon 2.0 x 200mm**

**1.4.a.19 Balón 2.5 x 40mm/ Balloon 2.5 x 40mm**

**1.4.a.20 Balón 2.5 x 60mm/ Balloon 2.5 x 60mm**

**1.4.a.21 Balón 2.5 x 80mm/ Balloon 2.5 x 80mm**

**1.4.a.22 Balón 2.5 x 120mm/ Balloon 2.5 x 120mm**

**1.4.a.23 Balón 2.5 x 150mm/ Balloon 2.5 x 150mm**

MODELO-IP ANEXO II CT Cert. 93/42/IP-Rev1805/2020

Agencia Española de Medicamentos y Productos Sanitarios (AEMPS)

Fecha de la firma: 30/07/2020

Puede comprobar la autenticidad del documento en la sede de la AEMPS: <https://localizador.aemps.es>

CSV: 2 K S D D N Q A 5 9



CORREO ELECTRÓNICO  
on0318@aemps.es

Página 14 de 44

C/ CAMPEZO, 1 - EDIFICIO 8  
28022 MADRID  
Tel.: (+34) 902.101.322 / (+34) 91.822.59.97  
Fax: (+34) 91.822.52.89

ORGANISMO NOTIFICADO 0318



**ANEXO N°/ANNEX NO: I**

**CERTIFICADO CE DE SISTEMA DE GARANTÍA DE CALIDAD TOTAL**  
de acuerdo con el Anexo II (excepto punto 4) de la Directiva 93/42/CEE

**EC FULL QUALITY ASSURANCE SYSTEM CERTIFICATE**  
in accordance with Annex II (except Section 4) of Directive 93/42/EEC

Certificado n°/Certificate no	Fecha de validez/Date of validity			ON n°/NB no	
<b>2012 07 0788 CT</b>	Desde/From	<b>31-07-2020</b>	Hasta/To	<b>26-05-2024</b>	<b>0318</b>

**1.4.a.24 Balón 2.5 x 200mm/ Balloon 2.5 x 200mm**

**1.4.a.25 Balón 3.0 x 40mm/ Balloon 3.0 x 40mm**

**1.4.a.26 Balón 3.0 x 60mm/ Balloon 3.0 x 60mm**

**1.4.a.27 Balón 3.0 x 80mm/ Balloon 3.0 x 80mm**

**1.4.a.28 Balón 3.0 x 120mm/ Balloon 3.0 x 120mm**

**1.4.a.29 Balón 3.0 x 150mm/ Balloon 3.0 x 150mm**

**1.4.a.30 Balón 3.0 x 200mm/ Balloon 3.0 x 200mm**

**1.4.a.31 Balón 3.5 x 40mm/ Balloon 3.5 x 40mm**

**1.4.a.32 Balón 3.5 x 60mm/ Balloon 3.5 x 60mm**

**1.4.a.33 Balón 3.5 x 80mm/ Balloon 3.5 x 80mm**

**1.4.a.34 Balón 3.5 x 120mm/ Balloon 3.5 x 120mm**

**1.4.a.35 Balón 3.5 x 150mm/ Balloon 3.5 x 150mm**

**1.4.a.36 Balón 3.5 x 200mm/ Balloon 3.5 x 200mm**

**1.4.a.37 Balón 4.0 x 40mm/ Balloon 4.0 x 40mm**

**1.4.a.38 Balón 4.0 x 60mm/ Balloon 4.0 x 60mm**

**1.4.a.39 Balón 4.0 x 80mm/ Balloon 4.0 x 80mm**

**1.4.a.40 Balón 4.0 x 120mm/ Balloon 4.0 x 120mm**

**1.4.b. Longitud de catéter 150cm/ Catheter length 150cm**

**1.4.b.1 Balón 1.25 x 10 mm/ Balloon 1.25 x 10mm**

**1.4.b.2 Balón 1.25 x 15mm/ Balloon 1.2 x 15mm**

**1.4.b.3 Balón 1.25 x 20mm/ Balloon 1.25 x 20mm**

**1.4.b.4 Balón 1.5 x 10mm/ Balloon 1.5 x 10mm**

**1.4.b.5 Balón 1.5 x 15mm/ Balloon 1.5 x 15mm**

**1.4.b.6 Balón 1.5 x 20mm/ Balloon 1.5 x 20mm**

**1.4.b.7 Balón 1.5 x 40mm/ Balloon 1.5 x 40mm**

**1.4.b.8 Balón 1.5 x 60mm/ Balloon 1.5 x 60mm**

**1.4.b.9 Balón 1.5 x 80mm/ Balloon 1.5 x 80mm**

Agencia Española de Medicamentos y Productos Sanitarios (AEMPS)

Fecha de la firma: 30/07/2020

Puede comprobar la autenticidad del documento en la sede de la AEMPS: <https://localizador.aemps.es>

CSV: 2 K S D D N Q A 5 9



CORREO ELECTRÓNICO  
on0318@aemps.es

Página 15 de 44

C/ CAMPEZO, 1 - EDIFICIO 8

28022 MADRID

Tel.: (+34) 902.101.322 / (+34) 91.822.59.97

Fax: (+34) 91.822.52.89

ORGANISMO NOTIFICADO 0318





**ANEXO N°/ANNEX NO: I**

**CERTIFICADO CE DE SISTEMA DE GARANTÍA DE CALIDAD TOTAL**  
de acuerdo con el Anexo II (excepto punto 4) de la Directiva 93/42/CEE

**EC FULL QUALITY ASSURANCE SYSTEM CERTIFICATE**  
*in accordance with Annex II (except Section 4) of Directive 93/42/EEC*

Certificado n°/Certificate no	Fecha de validez/Date of validity			ON n°/NB no	
<b>2012 07 0788 CT</b>	Desde/From	<b>31-07-2020</b>	Hasta/To	<b>26-05-2024</b>	<b>0318</b>

- 1.4.b.10 Balón 2.0 x 10mm/ Balloon 2.0 x 10mm
- 1.4.b.11 Balón 2.0 x 15mm/ Balloon 2.0 x 15mm
- 1.4.b.12 Balón 2.0 x 20mm/ Balloon 2.0 x 20mm
- 1.4.b.13 Balón 2.0 x 40mm/ Balloon 2.0 x 40mm
- 1.4.b.14 Balón 2.0 x 60mm/ Balloon 2.0 x 60mm
- 1.4.b.15 Balón 2.0 x 80mm/ Balloon 2.0 x 80mm
- 1.4.b.16 Balón 2.0 x 120mm/ Balloon 2.0 x 120mm
- 1.4.b.17 Balón 2.0 x 150mm/ Balloon 2.0 x 150mm
- 1.4.b.18 Balón 2.0 x 200mm/ Balloon 2.0 x 200mm
- 1.4.b.19 Balón 2.5 x 40mm/ Balloon 2.5 x 40mm
- 1.4.b.20 Balón 2.5 x 60mm/ Balloon 2.5 x 60mm
- 1.4.b.21 Balón 2.5 x 80mm/ Balloon 2.5 x 80mm
- 1.4.b.22 Balón 2.5 x 120mm/ Balloon 2.5 x 120mm
- 1.4.b.23 Balón 2.5 x 150mm/ Balloon 2.5 x 150mm
- 1.4.b.24 Balón 2.5 x 200mm/ Balloon 2.5 x 200mm
- 1.4.b.25 Balón 3.0 x 40mm/ Balloon 3.0 x 40mm
- 1.4.b.26 Balón 3.0 x 60mm/ Balloon 3.0 x 60mm
- 1.4.b.27 Balón 3.0 x 80mm/ Balloon 3.0 x 80mm
- 1.4.b.28 Balón 3.0 x 120mm/ Balloon 3.0 x 120mm
- 1.4.b.29 Balón 3.0 x 150mm/ Balloon 3.0 x 150mm
- 1.4.b.30 Balón 3.0 x 200mm/ Balloon 3.0 x 200mm
- 1.4.b.31 Balón 3.5 x 40mm/ Balloon 3.5 x 40mm
- 1.4.b.32 Balón 3.5 x 60mm/ Balloon 3.5 x 60mm
- 1.4.b.33 Balón 3.5 x 80mm/ Balloon 3.5 x 80mm
- 1.4.b.34 Balón 3.5 x 120mm/ Balloon 3.5 x 120mm
- 1.4.b.35 Balón 3.5 x 150mm/ Balloon 3.5 x 150mm
- 1.4.b.36 Balón 3.5 x 200mm/ Balloon 3.5 x 200mm
- 1.4.b.37 Balón 4.0 x 40mm/ Balloon 4.0 x 40mm

Agencia Española de Medicamentos y Productos Sanitarios (AEMPS)

Fecha de la firma: 30/07/2020

Puede comprobar la autenticidad del documento en la sede de la AEMPS: <https://localizador.aemps.es>

CSV: 2 K S D D N Q A 5 9



CORREO ELECTRÓNICO  
on0318@aemps.es

Página 16 de 44

ORGANISMO NOTIFICADO 0318

C/ CAMPEZO, 1 - EDIFICIO 8  
28022 MADRID  
Tel.: (+34) 902.101.322 / (+34) 91.822.59.97  
Fax: (+34) 91.822.52.89



**ANEXO N°/ANNEX NO: I**

**CERTIFICADO CE DE SISTEMA DE GARANTÍA DE CALIDAD TOTAL  
de acuerdo con el Anexo II (excepto punto 4) de la Directiva 93/42/CEE**

**EC FULL QUALITY ASSURANCE SYSTEM CERTIFICATE  
in accordance with Annex II (except Section 4) of Directive 93/42/EEC**

Certificado n°/Certificate no	Fecha de validez/Date of validity			ON n°/NB no	
<b>2012 07 0788 CT</b>	Desde/From	<b>31-07-2020</b>	Hasta/To	<b>26-05-2024</b>	<b>0318</b>

- 1.4.b.38 Balón 4.0 x 60mm/ Balloon 4.0 x 60mm
- 1.4.b.39 Balón 4.0 x 80mm/ Balloon 4.0 x 80mm
- 1.4.b.40 Balón 4.0 x 120mm/ Balloon 4.0 x 120mm

**Clasificación/Classification: III**

**2. Catéter balón de dilatación para ATP, con liberación de paclitaxel / Paclitaxel eluting PTA balloon dilatation catheter**

**Código NANDO: MD 106, MDS 7001 y 7006**

**2.1. Catéter balón de dilatación para ATP, con liberación de paclitaxel para guía de alambre de 0.014". con marcas radiopacas metálicas "iVascular luminor 14m"/ "iVascular luminor 14m"Paclitaxel eluting PTA balloon dilatation catheter for 0.014" guidewire with metallic radiopaque markers**

**Los siguientes productos se encuentran descritos en el certificado 2015 03 0836 ED/ The followed products are described in the certificate ED 2015 03 0836 ED**

**2.1.a Longitud de catéter 100cm/ Catheter length 100cm**

- 2.1.a.1 Balón 1.5 x 40mm/ Balloon 1.5 x 40mm
- 2.1.a.2 Balón 1.5 x 60mm/ Balloon 1.5 x 60mm
- 2.1.a.3 Balón 1.5 x 80mm/ Balloon 1.5 x 80mm
- 2.1.a.4 Balón 2.0 x 40mm/ Balloon 2.0 x 40mm
- 2.1.a.5 Balón 2.0 x 60mm/ Balloon 2.0 x 60mm
- 2.1.a.6 Balón 2.0 x 80mm/ Balloon 2.0 x 80mm
- 2.1.a.7 Balón 2.0 x 120mm/ Balloon 2.0 x 120mm
- 2.1.a.8 Balón 2.0 x 150mm/ Balloon 2.0 x 150mm
- 2.1.a.9 Balón 2.0 x 200mm/ Balloon 2.0 x 200mm
- 2.1.a.10 Balón 2.5 x 40mm/ Balloon 2.5 x 40mm

Agencia Española de Medicamentos y Productos Sanitarios (AEMPS)

Fecha de la firma: 30/07/2020

Puede comprobar la autenticidad del documento en la sede de la AEMPS: <https://localizador.aemps.es>

CSV: 2 K S D D N Q A 5 9



CORREO ELECTRÓNICO  
on0318@aemps.es

Página 17 de 44

C/ CAMPEZO, 1 - EDIFICIO 8  
28022 MADRID  
Tel.: (+34) 902.101.322 / (+34) 91.822.59.97  
Fax: (+34) 91.822.52.89

**ORGANISMO NOTIFICADO 0318**



**ANEXO N°/ANNEX NO: I**

**CERTIFICADO CE DE SISTEMA DE GARANTÍA DE CALIDAD TOTAL  
de acuerdo con el Anexo II (excepto punto 4) de la Directiva 93/42/CEE**

**EC FULL QUALITY ASSURANCE SYSTEM CERTIFICATE  
in accordance with Annex II (except Section 4) of Directive 93/42/EEC**

Certificado n°/Certificate no	Fecha de validez/Date of validity			ON n°/NB no	
<b>2012 07 0788 CT</b>	Desde/From	<b>31-07-2020</b>	Hasta/To	<b>26-05-2024</b>	<b>0318</b>

- 2.1.a.11 Balón 2.5 x 60mm/ Balloon 2.5 x 60mm
- 2.1.a.12 Balón 2.5 x 80mm/ Balloon 2.5 x 80mm
- 2.1.a.13 Balón 2.5 x 120mm/ Balloon 2.5 x 120mm
- 2.1.a.14 Balón 2.5 x 150mm/ Balloon 2.5 x 150mm
- 2.1.a.15 Balón 2.5 x 200mm/ Balloon 2.5 x 200mm
- 2.1.a.16 Balón 3.0 x 40mm/ Balloon 3.0 x 40mm
- 2.1.a.17 Balón 3.0 x 60mm/ Balloon 3.0 x 60mm
- 2.1.a.18 Balón 3.0 x 80mm/ Balloon 3.0 x 80mm
- 2.1.a.19 Balón 3.0 x 120mm/ Balloon 3.0 x 120mm
- 2.1.a.20 Balón 3.0 x 150mm/ Balloon 3.0 x 150mm
- 2.1.a.21 Balón 3.0 x 200mm/ Balloon 3.0 x 200mm
- 2.1.a.22 Balón 3.5 x 40mm/ Balloon 3.5 x 40mm
- 2.1.a.23 Balón 3.5 x 60mm/ Balloon 3.5 x 60mm
- 2.1.a.24 Balón 3.5 x 80mm/ Balloon 3.5 x 80mm
- 2.1.a.25 Balón 3.5 x 120mm/ Balloon 3.5 x 120mm
- 2.1.a.26 Balón 3.5 x 150mm/ Balloon 3.5 x 150mm
- 2.1.a.27 Balón 3.5 x 200mm/ Balloon 3.5 x 200mm
- 2.1.a.28 Balón 4.0 x 40mm/ Balloon 4.0 x 40mm
- 2.1.a.29 Balón 4.0 x 60mm/ Balloon 4.0 x 60mm
- 2.1.a.30 Balón 4.0 x 80mm/ Balloon 4.0 x 80mm
- 2.1.a.31 Balón 4.0 x 120mm/ Balloon 4.0 x 120mm

**2.1.b. Longitud de catéter 150cm/ Catheter length 150cm**

- 2.1.b.1 Balón 1.5 x 40mm/ Balloon 1.5 x 40mm
- 2.1.b.2 Balón 1.5 x 60mm/ Balloon 1.5 x 60mm
- 2.1.b.3 Balón 1.5 x 80mm/ Balloon 1.5 x 80mm
- 2.1.b.4 Balón 2.0 x 40mm/ Balloon 2.0 x 40mm
- 2.1.b.5 Balón 2.0 x 60mm/ Balloon 2.0 x 60mm

Agencia Española de Medicamentos y Productos Sanitarios (AEMPS)

Fecha de la firma: 30/07/2020

Puede comprobar la autenticidad del documento en la sede de la AEMPS: <https://localizador.aemps.es>

CSV: 2 K S D D N Q A 5 9



CORREO ELECTRÓNICO  
on0318@aemps.es

Página 18 de 44

ORGANISMO NOTIFICADO 0318

C/ CAMPEZO, 1 - EDIFICIO 8  
28022 MADRID  
Tel.: (+34) 902.101.322 / (+34) 91.822.59.97  
Fax: (+34) 91.822.52.89



**ANEXO N°/ANNEX NO: I**

**CERTIFICADO CE DE SISTEMA DE GARANTÍA DE CALIDAD TOTAL  
de acuerdo con el Anexo II (excepto punto 4) de la Directiva 93/42/CEE**

**EC FULL QUALITY ASSURANCE SYSTEM CERTIFICATE  
in accordance with Annex II (except Section 4) of Directive 93/42/EEC**

Certificado n°/Certificate no	Fecha de validez/Date of validity			ON n°/NB no	
<b>2012 07 0788 CT</b>	Desde/From	<b>31-07-2020</b>	Hasta/To	<b>26-05-2024</b>	<b>0318</b>

- 2.1.b.6 Balón 2.0 x 80mm/ Balloon 2.0 x 80mm
- 2.1.b.7 Balón 2.0 x 120mm/ Balloon 2.0 x 120mm
- 2.1.b.8 Balón 2.0 x 150mm/ Balloon 2.0 x 150mm
- 2.1.b.9 Balón 2.0 x 200mm/ Balloon 2.0 x 200mm
- 2.1.b.10 Balón 2.5 x 40mm/ Balloon 2.5 x 40mm
- 2.1.b.11 Balón 2.5 x 60mm/ Balloon 2.5 x 60mm
- 2.1.b.12 Balón 2.5 x 80mm/ Balloon 2.5 x 80mm
- 2.1.b.13 Balón 2.5 x 120mm/ Balloon 2.5 x 120mm
- 2.1.b.14 Balón 2.5 x 150mm/ Balloon 2.5 x 150mm
- 2.1.b.15 Balón 2.5 x 200mm/ Balloon 2.5 x 200mm
- 2.1.b.16 Balón 3.0 x 40mm/ Balloon 3.0 x 40mm
- 2.1.b.17 Balón 3.0 x 60mm/ Balloon 3.0 x 60mm
- 2.1.b.18 Balón 3.0 x 80mm/ Balloon 3.0 x 80mm
- 2.1.b.19 Balón 3.0 x 120mm/ Balloon 3.0 x 120mm
- 2.1.b.20 Balón 3.0 x 150mm/ Balloon 3.0 x 150mm
- 2.1.b.21 Balón 3.0 x 200mm/ Balloon 3.0 x 200mm
- 2.1.b.22 Balón 3.5 x 40mm/ Balloon 3.5 x 40mm
- 2.1.b.23 Balón 3.5 x 60mm/ Balloon 3.5 x 60mm
- 2.1.b.24 Balón 3.5 x 80mm/ Balloon 3.5 x 80mm
- 2.1.b.25 Balón 3.5 x 120mm/ Balloon 3.5 x 120mm
- 2.1.b.26 Balón 3.5 x 150mm/ Balloon 3.5 x 150mm
- 2.1.b.27 Balón 3.5 x 200mm/ Balloon 3.5 x 200mm
- 2.1.b.28 Balón 4.0 x 40mm/ Balloon 4.0 x 40mm
- 2.1.b.29 Balón 4.0 x 60mm/ Balloon 4.0 x 60mm
- 2.1.b.30 Balón 4.0 x 80mm/ Balloon 4.0 x 80mm
- 2.1.b.31 Balón 4.0 x 120mm/ Balloon 4.0 x 120mm

MODELO-IP-ANEXO II CT Cert. 93/42/IP-Rev1805/2020

Agencia Española de Medicamentos y Productos Sanitarios (AEMPS)

Fecha de la firma: 30/07/2020

Puede comprobar la autenticidad del documento en la sede de la AEMPS: <https://localizador.aemps.es>

CSV: 2 K S D D N Q A 5 9



CORREO ELECTRÓNICO  
on0318@aemps.es

Página 19 de 44

C/ CAMPEZO, 1 - EDIFICIO 8  
28022 MADRID

Tel.: (+34) 902.101.322 / (+34) 91.822.59.97  
Fax: (+34) 91.822.52.89

ORGANISMO NOTIFICADO 0318





**ANEXO N°/ANNEX NO: I**

**CERTIFICADO CE DE SISTEMA DE GARANTÍA DE CALIDAD TOTAL  
de acuerdo con el Anexo II (excepto punto 4) de la Directiva 93/42/CEE**

**EC FULL QUALITY ASSURANCE SYSTEM CERTIFICATE  
in accordance with Annex II (except Section 4) of Directive 93/42/EEC**

Certificado n°/Certificate no	Fecha de validez/Date of validity			ON n°/NB no	
<b>2012 07 0788 CT</b>	Desde/From	<b>31-07-2020</b>	Hasta/To	<b>26-05-2024</b>	<b>0318</b>

- 2.2. Catéter balón de dilatación para ATP, con liberación de paclitaxel para guía de alambre de 0.018" "iVascular luminor 18"/ "iVascular luminor 18" Paclitaxel eluting PTA balloon dilatation catheter for 0.018" guidewire**

**Los siguientes productos se encuentran descritos en el certificado 2016 04 0846 ED/  
The followed products are described in the certificate 2016 04 0846 ED**

**2.2.a Longitud catéter 100cm/ Catheter length 100cm**

- 2.2.a.1 Balón 2.0 x 20mm/ Balloon 2.0 x 20mm**
- 2.2.a.2 Balón 2.0 x 40mm/ Balloon 2.0 x 40mm**
- 2.2.a.3 Balón 2.0 x 60mm/ Balloon 2.0 x 60mm**
- 2.2.a.4 Balón 2.0 x 80mm/ Balloon 2.0 x 80mm**
- 2.2.a.5 Balón 2.0 x 120mm/ Balloon 2.0 x 120mm**
- 2.2.a.6 Balón 2.0 x 150mm/ Balloon 2.0 x 150mm**
- 2.2.a.7 Balón 2.0 x 200mm/ Balloon 2.0 x 200mm**
- 2.2.a.8 Balón 2.5 x 20mm/ Balloon 2.5 x 20mm**
- 2.2.a.9 Balón 2.5 x 40mm/ Balloon 2.5 x 40mm**
- 2.2.a.10 Balón 2.5 x 60mm/ Balloon 2.5 x 60mm**
- 2.2.a.11 Balón 2.5 x 80mm/ Balloon 2.5 x 80mm**
- 2.2.a.12 Balón 2.5 x 120mm/ Balloon 2.5 x 120mm**
- 2.2.a.13 Balón 2.5 x 150mm/ Balloon 2.5 x 150mm**
- 2.2.a.14 Balón 2.5 x 200mm/ Balloon 2.5 x 200mm**
- 2.2.a.15 Balón 3.0 x 20mm/ Balloon 3.0 x 20mm**
- 2.2.a.16 Balón 3.0 x 40mm/ Balloon 3.0 x 40mm**
- 2.2.a.17 Balón 3.0 x 60mm/ Balloon 3.0 x 60mm**
- 2.2.a.18 Balón 3.0 x 80mm/ Balloon 3.0 x 80mm**
- 2.2.a.19 Balón 3.0 x 120mm/ Balloon 3.0 x 120mm**
- 2.2.a.20 Balón 3.0 x 150mm/ Balloon 3.0 x 150mm**
- 2.2.a.21 Balón 3.0 x 200mm/ Balloon 3.0 x 200mm**

Agencia Española de Medicamentos y Productos Sanitarios (AEMPS)

Fecha de la firma: 30/07/2020

Puede comprobar la autenticidad del documento en la sede de la AEMPS: <https://localizador.aemps.es>

CSV: 2 K S D D N Q A 5 9



CORREO ELECTRÓNICO  
on0318@aemps.es

Página 20 de 44

C/ CAMPEZO, 1 - EDIFICIO 8  
28022 MADRID  
Tel.: (+34) 902.101.322 / (+34) 91.822.59.97  
Fax: (+34) 91.822.52.89

ORGANISMO NOTIFICADO 0318



**ANEXO N°/ANNEX NO: I**

**CERTIFICADO CE DE SISTEMA DE GARANTÍA DE CALIDAD TOTAL  
de acuerdo con el Anexo II (excepto punto 4) de la Directiva 93/42/CEE**

**EC FULL QUALITY ASSURANCE SYSTEM CERTIFICATE  
in accordance with Annex II (except Section 4) of Directive 93/42/EEC**

<b>Certificado n°/Certificate no</b>	<b>Fecha de validez/Date of validity</b>			<b>ON n°/NB no</b>	
<b>2012 07 0788 CT</b>	<b>Desde/From</b>	<b>31-07-2020</b>	<b>Hasta/To</b>	<b>26-05-2024</b>	<b>0318</b>

- 2.2.a.22 Balón 3.5 x 20mm/ Balloon 3.5 x 20mm
- 2.2.a.23 Balón 3.5 x 40mm/ Balloon 3.5 x 40mm
- 2.2.a.24 Balón 3.5 x 60mm/ Balloon 3.5 x 60mm
- 2.2.a.25 Balón 3.5 x 80mm/ Balloon 3.5 x 80mm
- 2.2.a.26 Balón 3.5 x 120mm/ Balloon 3.5 x 120mm
- 2.2.a.27 Balón 3.5 x 150mm/ Balloon 3.5 x 150mm
- 2.2.a.28 Balón 3.5 x 200mm/ Balloon 3.5 x 200mm
- 2.2.a.29 Balón 4.0 x 20mm/ Balloon 4.0 x 20mm
- 2.2.a.30 Balón 4.0 x 40mm/ Balloon 4.0 x 40mm
- 2.2.a.31 Balón 4.0 x 60mm/ Balloon 4.0 x 60mm
- 2.2.a.32 Balón 4.0 x 80mm/ Balloon 4.0 x 80mm
- 2.2.a.33 Balón 4.0 x 120mm/ Balloon 4.0 x 120mm
- 2.2.a.34 Balón 4.0 x 150mm/ Balloon 4.0 x 150mm
- 2.2.a.35 Balón 4.0 x 200mm/ Balloon 4.0 x 200mm
- 2.2.a.36 Balón 5.0 x 20mm/ Balloon 5.0 x 20mm
- 2.2.a.37 Balón 5.0 x 40mm/ Balloon 5.0 x 40mm
- 2.2.a.38 Balón 5.0 x 60mm/ Balloon 5.0 x 60mm
- 2.2.a.39 Balón 5.0 x 80mm/ Balloon 5.0 x 80mm
- 2.2.a.40 Balón 5.0 x 120mm/ Balloon 5.0 x 120mm
- 2.2.a.41 Balón 5.0 x 150mm/ Balloon 5.0 x 150mm
- 2.2.a.42 Balón 5.0 x 200mm/ Balloon 5.0 x 200mm
- 2.2.a.43 Balón 6.0 x 20mm/ Balloon 6.0 x 20mm
- 2.2.a.44 Balón 6.0 x 40mm/ Balloon 6.0 x 40mm
- 2.2.a.45 Balón 6.0 x 60mm/ Balloon 6.0 x 60mm
- 2.2.a.46 Balón 6.0 x 80mm/ Balloon 6.0 x 80mm
- 2.2.a.47 Balón 6.0 x 120mm/ Balloon 6.0 x 120mm
- 2.2.a.48 Balón 6.0 x 150mm/ Balloon 6.0 x 150mm
- 2.2.a.49 Balón 6.0 x 200mm/ Balloon 6.0 x 200mm

MODELO-IP ANEXO II CT Cert. 93/42/IP-Rev1805/2020

Agencia Española de Medicamentos y Productos Sanitarios (AEMPS)

Fecha de la firma: 30/07/2020

Puede comprobar la autenticidad del documento en la sede de la AEMPS: <https://localizador.aemps.es>

CSV: 2 K S D D N Q A 5 9



CORREO ELECTRÓNICO  
on0318@aemps.es

Página 21 de 44

ORGANISMO NOTIFICADO 0318

C/ CAMPEZO, 1 - EDIFICIO 8  
28022 MADRID  
Tel.: (+34) 902.101.322 / (+34) 91.822.59.97  
Fax: (+34) 91.822.52.89



**ANEXO N°/ANNEX NO: I**

**CERTIFICADO CE DE SISTEMA DE GARANTÍA DE CALIDAD TOTAL  
de acuerdo con el Anexo II (excepto punto 4) de la Directiva 93/42/CEE**

**EC FULL QUALITY ASSURANCE SYSTEM CERTIFICATE  
in accordance with Annex II (except Section 4) of Directive 93/42/EEC**

Certificado n°/Certificate no	Fecha de validez/Date of validity			ON n°/NB no	
<b>2012 07 0788 CT</b>	Desde/From	<b>31-07-2020</b>	Hasta/To	<b>26-05-2024</b>	<b>0318</b>

- 2.2.a.50 Balón 7.0 x 20mm/ Balloon 7.0 x 20mm
- 2.2.a.51 Balón 7.0 x 40mm/ Balloon 7.0 x 40mm
- 2.2.a.52 Balón 7.0 x 60mm/ Balloon 7.0 x 60mm
- 2.2.a.53 Balón 7.0 x 80mm/ Balloon 7.0 x 80mm
- 2.2.a.54 Balón 7.0 x 120mm/ Balloon 7.0 x 120mm
- 2.2.a.55 Balón 8.0 x 20mm / Balloon 8.0 x 20mm
- 2.2.a.56 Balón 8.0 x 40mm / Balloon 8.0 x 40mm
- 2.2.a.57 Balón 8.0 x 60mm / Balloon 8.0 x 60mm
- 2.2.a.58 Balón 8.0 x 80mm / Balloon 8.0 x 80mm

**2.2.b. Longitud catéter 140cm/ Catheter length 140cm**

- 2.2.b.1 Balón 5.0 x 20mm/ Balloon 5.0 x 20mm
- 2.2.b.2 Balón 5.0 x 40mm/ Balloon 5.0 x 40mm
- 2.2.b.3 Balón 5.0 x 60mm/ Balloon 5.0 x 60mm
- 2.2.b.4 Balón 5.0 x 80mm/ Balloon 5.0 x 80mm
- 2.2.b.5 Balón 5.0 x 120mm/ Balloon 5.0 x 120mm
- 2.2.b.6 Balón 5.0 x 150mm/ Balloon 5.0 x 150mm
- 2.2.b.7 Balón 5.0 x 200mm/ Balloon 5.0 x 200mm
- 2.2.b.8 Balón 6.0 x 20mm/ Balloon 6.0 x 20mm
- 2.2.b.9 Balón 6.0 x 40mm/ Balloon 6.0 x 40mm
- 2.2.b.10 Balón 6.0 x 60mm/ Balloon 6.0 x 60mm
- 2.2.b.11 Balón 6.0 x 80mm/ Balloon 6.0 x 80mm
- 2.2.b.12 Balón 6.0 x 120mm/ Balloon 6.0 x 120mm
- 2.2.b.13 Balón 6.0 x 150mm/ Balloon 6.0 x 150mm
- 2.2.b.14 Balón 6.0 x 200mm/ Balloon 6.0 x 200mm
- 2.2.b.15 Balón 7.0 x 20mm/ Balloon 7.0 x 20mm
- 2.2.b.16 Balón 7.0x 40mm/ Balloon 7.0x 40mm
- 2.2.b.17 Balón 7.0x 60mm/ Balloon 7.0 x 60mm

MODELO-IP ANEXO II CT Cert. 93/42/IP-Rev1805/2020

Agencia Española de Medicamentos y Productos Sanitarios (AEMPS)

Fecha de la firma: 30/07/2020

Puede comprobar la autenticidad del documento en la sede de la AEMPS: <https://localizador.aemps.es>

CSV: 2 K S D D N Q A 5 9



CORREO ELECTRÓNICO  
on0318@aemps.es

Página 22 de 44

ORGANISMO NOTIFICADO 0318

C/ CAMPEZO, 1 - EDIFICIO 8  
28022 MADRID  
Tel.: (+34) 902.101.322 / (+34) 91.822.59.97  
Fax: (+34) 91.822.52.89



**ANEXO N°/ANNEX NO: I**

**CERTIFICADO CE DE SISTEMA DE GARANTÍA DE CALIDAD TOTAL**  
**de acuerdo con el Anexo II (excepto punto 4) de la Directiva 93/42/CEE**

**EC FULL QUALITY ASSURANCE SYSTEM CERTIFICATE**  
**in accordance with Annex II (except Section 4) of Directive 93/42/EEC**

<b>Certificado n°/Certificate no</b>	<b>Fecha de validez/Date of validity</b>			<b>ON n°/NB no</b>	
<b>2012 07 0788 CT</b>	<b>Desde/From</b>	<b>31-07-2020</b>	<b>Hasta/To</b>	<b>26-05-2024</b>	<b>0318</b>

**2.2.b.18 Balón 7.0 x 80mm/ Balloon 7.0 x 80mm**

**2.2.b.19 Balón 7.0 x 120mm/ Balloon 7.0 x 120mm**

**2.2.b.20 Balón 8.0 x 20mm / Balloon 8.0 x 20mm**

**2.2.b.21 Balón 8.0 x 40mm / Balloon 8.0 x 40mm**

**2.2.b.22 Balón 8.0 x 60mm / Balloon 8.0 x 60mm**

**2.2.b.23 Balón 8.0 x 80mm / Balloon 8.0 x 80mm**

**2.2.c. Longitud catéter 150cm/ Catheter length 150cm**

**2.2.c.1 Balón 2.0 x 20mm/ Balloon 2.0 x 20mm**

**2.2.c.2 Balón 2.0 x 40mm/ Balloon 2.0 x 40mm**

**2.2.c.3 Balón 2.0 x 60mm/ Balloon 2.0 x 60mm**

**2.2.c.4 Balón 2.0 x 80mm/ Balloon 2.0 x 80mm**

**2.2.c.5 Balón 2.0 x 120mm/ Balloon 2.0 x 120mm**

**2.2.c.6 Balón 2.0 x 150mm/ Balloon 2.0 x 150mm**

**2.2.c.7 Balón 2.0 x 200mm/ Balloon 2.0 x 200mm**

**2.2.c.8 Balón 2.5 x 20mm/ Balloon 2.5 x 20mm**

**2.2.c.9 Balón 2.5 x 40mm/ Balloon 2.5 x 40mm**

**2.3.c.10 Balón 2.5 x 60mm/ Balloon 2.5 x 60mm**

**2.2.c.11 Balón 2.5 x 80mm/ Balloon 2.5 x 80mm**

**2.2.c.12 Balón 2.5 x 120mm/ Balloon 2.5 x 120mm**

**2.2.c.13 Balón 2.5 x 150mm/ Balloon 2.5 x 150mm**

**2.2.c.14 Balón 2.5 x 200mm/ Balloon 2.5 x 200mm**

**2.2.c.15 Balón 3.0 x 20mm/ Balloon 3.0 x 20mm**

**2.2.c.16 Balón 3.0 x 40mm/ Balloon 3.0 x 40mm**

**2.2.c.17 Balón 3.0 x 60mm/ Balloon 3.0 x 60mm**

**2.2.c.18 Balón 3.0 x 80mm/ Balloon 3.0 x 80mm**

**2.2.c.19 Balón 3.0 x 120mm/ Balloon 3.0 x 120mm**

**2.2.c.20 Balón 3.0 x 150mm/ Balloon 3.0 x 150mm**

Agencia Española de Medicamentos y Productos Sanitarios (AEMPS)

Fecha de la firma: 30/07/2020

Puede comprobar la autenticidad del documento en la sede de la AEMPS: <https://localizador.aemps.es>

CSV: 2 K S D D N Q A 5 9



CORREO ELECTRÓNICO  
on0318@aemps.es

Página 23 de 44

ORGANISMO NOTIFICADO 0318

C/ CAMPEZO, 1 - EDIFICIO 8  
28022 MADRID  
Tel.: (+34) 902.101.322 / (+34) 91.822.59.97  
Fax: (+34) 91.822.52.89





**ANEXO N°/ANNEX NO: I**

**CERTIFICADO CE DE SISTEMA DE GARANTÍA DE CALIDAD TOTAL**  
**de acuerdo con el Anexo II (excepto punto 4) de la Directiva 93/42/CEE**

**EC FULL QUALITY ASSURANCE SYSTEM CERTIFICATE**  
**in accordance with Annex II (except Section 4) of Directive 93/42/EEC**

Certificado n°/Certificate no	Fecha de validez/Date of validity			ON n°/NB no	
<b>2012 07 0788 CT</b>	Desde/From	<b>31-07-2020</b>	Hasta/To	<b>26-05-2024</b>	<b>0318</b>

- 2.2.c.21 Balón 3.0 x 200mm/ Balloon 3.0 x 200mm
- 2.2.c.22 Balón 3.5 x 20mm/ Balloon 3.5 x 20mm
- 2.2.c.23 Balón 3.5 x 40mm/ Balloon 3.5 x 40mm
- 2.2.c.24 Balón 3.5 x 60mm/ Balloon 3.5 x 60mm
- 2.2.c.25 Balón 3.5 x 80mm/ Balloon 3.5 x 80mm
- 2.2.c.26 Balón 3.5 x 120mm/ Balloon 3.5 x 120mm
- 2.2.c.27 Balón 3.5 x 150mm/ Balloon 3.5 x 150mm
- 2.2.c.28 Balón 3.5 x 200mm/ Balloon 3.5 x 200mm
- 2.2.c.29 Balón 4.0 x 20mm/ Balloon 4.0 x 20mm
- 2.2.c.30 Balón 4.0 x 40mm/ Balloon 4.0 x 40mm
- 2.2.c.31 Balón 4.0 x 60mm/ Balloon 4.0 x 60mm
- 2.2.c.32 Balón 4.0 x 80mm/ Balloon 4.0 x 80mm
- 2.2.c.33 Balón 4.0 x 120mm/ Balloon 4.0 x 120mm
- 2.2.c.34 Balón 4.0 x 150mm/ Balloon 4.0 x 150mm
- 2.2.c.35 Balón 4.0 x 200mm/ Balloon 4.0 x 200mm

**2.3. Catéter balón de dilatación para ATP, con liberación de paclitaxel para guía de alambre de 0.035" "iVascular luminor 35"/ "iVascular luminor 35" Paclitaxel eluting PTA balloon dilatation catheter for 0.035" guidewire**

Los siguientes productos se encuentran descritos en el certificado 2013 11 0807 ED/The followed products are described in the certificate ED 2013 11 0807

**2.3.a. Longitud catéter 80cm/ Catheter length 80cm**

- 2.3.a.1 Balón 5.0 x 20mm/ Balloon 5.0 x 20mm
- 2.3.a.2 Balón 5.0 x 40mm/ Balloon 5.0 x 40mm
- 2.3.a.3 Balón 5.0 x 60mm/ Balloon 5.0 x 60mm
- 2.3.a.4 Balón 5.0 x 80mm/ Balloon 5.0 x 80mm
- 2.3.a.5 Balón 5.0 x 120mm/ Balloon 5.0 x 120mm

Agencia Española de Medicamentos y Productos Sanitarios (AEMPS)

Fecha de la firma: 30/07/2020

Puede comprobar la autenticidad del documento en la sede de la AEMPS: <https://localizador.aemps.es>

CSV: 2 K S D D N Q A 5 9



CORREO ELECTRÓNICO  
on0318@aemps.es

Página 24 de 44

C/ CAMPEZO, 1 - EDIFICIO 8  
28022 MADRID  
Tel.: (+34) 902.101.322 / (+34) 91.822.59.97  
Fax: (+34) 91.822.52.89

ORGANISMO NOTIFICADO 0318



**ANEXO N°/ANNEX NO: I**

**CERTIFICADO CE DE SISTEMA DE GARANTÍA DE CALIDAD TOTAL**  
de acuerdo con el Anexo II (excepto punto 4) de la Directiva 93/42/CEE

**EC FULL QUALITY ASSURANCE SYSTEM CERTIFICATE**  
in accordance with Annex II (except Section 4) of Directive 93/42/EEC

Certificado n°/Certificate no	Fecha de validez/Date of validity			ON n°/NB no	
<b>2012 07 0788 CT</b>	Desde/From	<b>31-07-2020</b>	Hasta/To	<b>26-05-2024</b>	<b>0318</b>

- 2.3.a.6 Balón 5.0 x 150mm/ Balloon 5.0 x 150mm
- 2.3.a.7 Balón 6.0 x 20mm/ Balloon 6.0 x 20mm
- 2.3.a.8 Balón 6.0 x 40mm/ Balloon 6.0 x 40mm
- 2.3.a.9 Balón 6.0 x 60mm/ Balloon 6.0 x 60mm
- 2.3.a.10 Balón 6.0 x 80mm/ Balloon 6.0 x 80mm
- 2.3.a.11 Balón 6.0 x 120mm/ Balloon 6.0 120mm
- 2.3.a.12 Balón 6.0 x 150mm/ Balloon 6.0 x 150mm
- 2.3.a.13 Balón 7.0 x 20mm/ Balloon 7.0 x 20mm
- 2.3.a.14 Balón 7.0 x 40mm/ Balloon 7.0 x 40mm
- 2.3.a.15 Balón 7.0 x 60mm/ Balloon 7.0 x 60mm
- 2.3.a.16 Balón 7.0 x 80mm/ Balloon 7.0 x 80mm
- 2.3.a.17 Balón 7.0 x 120mm/ Balloon 7.0 x 120mm

**2.3.b Longitud catéter 140cm/ Catheter length 140cm**

- 2.3.b.1 Balón 5.0 x 20mm/ Balloon 5.0 x 20mm
- 2.3.b.2 Balón 5.0 x 40mm/ Balloon 5.0 x40mm
- 2.3.b.3 Balón 5.0 x 60mm/ Balloon 5.0 x 60mm
- 2.3.b.4 Balón 5.0 x 80mm/ Balloon 5.0 x 80mmx
- 2.3.b.5 Balón 5.0 x 120mm/ Balloon 5.0 x 120mm
- 2.3.b.6 Balón 5.0 x 150mm/ Balloon 5.0 x 150mm
- 2.3.b.7 Balón 6.0 x 20mm/ Balloon 6.0 x 20mm
- 2.3.b.8 Balón 6.0 x 40mm/ Balloon 6.0 x 40mm
- 2.3.b.9 Balón 6.0 x 60mm/ Balloon 6.0 x 60mm
- 2.3.b.10 Balón 6.0 x 80mm/ Balloon 6.0 x 80mm
- 2.3.b.11 Balón 6.0 x 120mm/ Balloon 6.0 x 120mm
- 2.3.b.12 Balón 6.0 x 150mm/ Balloon 6.0 x 150mm
- 2.3.b.13 Balón 7.0 x 20mm/ Balloon 7.0 x 20mm
- 2.3.b.14 Balón 7.0 x 40mm/ Balloon 7.0 x 40mm

Agencia Española de Medicamentos y Productos Sanitarios (AEMPS)

Fecha de la firma: 30/07/2020

Puede comprobar la autenticidad del documento en la sede de la AEMPS: <https://localizador.aemps.es>

CSV: 2 K S D D N Q A 5 9



CORREO ELECTRÓNICO  
on0318@aemps.es

Página 25 de 44

ORGANISMO NOTIFICADO 0318

C/ CAMPEZO, 1 - EDIFICIO 8  
28022 MADRID  
Tel.: (+34) 902.101.322 / (+34) 91.822.59.97  
Fax: (+34) 91.822.52.89



**ANEXO N°/ANNEX NO: I**

**CERTIFICADO CE DE SISTEMA DE GARANTÍA DE CALIDAD TOTAL  
de acuerdo con el Anexo II (excepto punto 4) de la Directiva 93/42/CEE**

**EC FULL QUALITY ASSURANCE SYSTEM CERTIFICATE  
in accordance with Annex II (except Section 4) of Directive 93/42/EEC**

Certificado n°/Certificate no	Fecha de validez/Date of validity			ON n°/NB no	
<b>2012 07 0788 CT</b>	Desde/From	<b>31-07-2020</b>	Hasta/To	<b>26-05-2024</b>	<b>0318</b>

- 2.3.b.15 **Balón 7.0 x 60mm/ Balloon 7.0 x 60mm**
- 2.3.b.16 **Balón 7.0 x 80mm/ Balloon 7.0 x 80mm**
- 2.3.b.17 **Balón 7.0 x 120mm/ Balloon 7.0 x 120mm**

**3. Catéter balón de dilatación coronario /Coronary balloon dilatation catheter  
Código NANDO MD 106 y MDS 7006**

**3.1. Catéter balón de dilatación coronario, balón semidistensible "iVascular xperience"/ "iVascular xperience" Coronary balloon dilatation catheter, semi-compliant balloon**

**Los siguientes productos se encuentran descritos en el certificado 2012 12 0796 ED/  
The followed products are described in the certificate 2012 12 0796 ED**

**3.1.a Longitud de catéter 142cm/ Catheter length 142cm**

- 3.1.a.1 **Balón 1.25 x 10mm con una marca radiopaca centrando el balón/ Balloon 1.25 x 10mm with a radiopaque marker centering the balloon**
- 3.1.a.2 **Balón 1.25 x 15mm con una marca radiopaca centrando el balón/ Balloon 1.25 x 15mm with a radiopaque marker centering the balloon**
- 3.1.a.3 **Balón 1.5 x 10mm con una marca radiopaca centrando el balón/ Balloon 1.5 x 10mm with a radiopaque marker centering the balloon**
- 3.1.a.4 **Balón 1.5 x 15mm con una marca radiopaca centrando el balón/ Balloon 1.5 x 15mm with a radiopaque marker centering the balloon**
- 3.1.a.5 **Balón 1.25 x 10mm/ Balloon 1.25x 10mm**
- 3.1.a.6 **Balón 1.25 x 15mm/ Balloon 1.25 x 15mm**
- 3.1.a.7 **Balón 1.25 x 20mm/ Balloon 1.25 x 20mm**
- 3.1.a.8 **Balón 1.5 x 10mm/ Balloon 1.5 x 10mm**
- 3.1.a.9 **Balón 1.5 x 15mm/ Balloon 1.5 x 15mm**
- 3.1.a.10 **Balón 1.5 x 20mm/ Balloon 1.5 x 20mm**

Agencia Española de Medicamentos y Productos Sanitarios (AEMPS)

Fecha de la firma: 30/07/2020

Puede comprobar la autenticidad del documento en la sede de la AEMPS: <https://localizador.aemps.es>

CSV: 2 K S D D N Q A 5 9



CORREO ELECTRÓNICO  
on0318@aemps.es

Página 26 de 44

C/ CAMPEZO, 1 - EDIFICIO 8  
28022 MADRID  
Tel.: (+34) 902.101.322 / (+34) 91.822.59.97  
Fax: (+34) 91.822.52.89

ORGANISMO NOTIFICADO 0318



**ANEXO N°/ANNEX NO: I**

**CERTIFICADO CE DE SISTEMA DE GARANTÍA DE CALIDAD TOTAL**  
de acuerdo con el Anexo II (excepto punto 4) de la Directiva 93/42/CEE

**EC FULL QUALITY ASSURANCE SYSTEM CERTIFICATE**  
in accordance with Annex II (except Section 4) of Directive 93/42/EEC

Certificado n°/Certificate no	Fecha de validez/Date of validity			ON n°/NB no	
<b>2012 07 0788 CT</b>	Desde/From	<b>31-07-2020</b>	Hasta/To	<b>26-05-2024</b>	<b>0318</b>

- 3.1.a.11 Balón 1.5 x 30mm/ Balloon 1.5 x 30mm
- 3.1.a.12 Balón 2.0 x 10mm/ Balloon 2.0 x 10mm
- 3.1.a.13 Balón 2.0 x 15mm/ Balloon 2.0 x 15mm
- 3.1.a.14 Balón 2.0 x 20mm/ Balloon 2.0 x 20mm
- 3.1.a.15 Balón 2.0 x 25mm/ Balloon 2.0 x 25mm
- 3.1.a.1. Balón 2.0 x 30mm/ Balloon 2.0 x 30mm
- 3.1.a.17 Balón 2.0 x 40mm/ Balloon 2.0 x 40mm
- 3.1.a.18 Balón 2.25 x 10mm/ Balloon 2.25 x 10mm
- 3.1.a.19 Balón 2.25 x 15mm/ Balloon 2.25 x 15mm
- 3.1.a.20 Balón 2.25 x 20mm/ Balloon 2.25 x 20mm
- 3.1.a.21 Balón 2.25 x 25mm/ Balloon 2.25 x 25mm
- 3.1.a.22 Balón 2.25 x 30mm/ Balloon 2.25 x 30mm
- 3.1.a.23 Balón 2.25 x 40mm/ Balloon 2.25 x 40mm
- 3.1.a.24 Balón 2.5 x 10mm/ Balloon 2.5 x 10mm
- 3.1.a.25 Balón 2.5 x 15mm/ Balloon 2.5 x 15mm
- 3.1.a.26 Balón 2.5 x 20mm/ Balloon 2.5 x 20mm
- 3.1.a.27 Balón 2.5 x 25mm/ Balloon 2.5 x 25mm
- 3.1.a.28 Balón 2.5 x 30mm/ Balloon 2.5 x 30mm
- 3.1.a.29 Balón 2.5 x 40mm/ Balloon 2.5 x 40mm
- 3.1.a.30 Balón 2.75 x 10mm/ Balloon 2.75 x 10mm
- 3.1.a.31 Balón 2.75x 15mm/ Balloon 2.75 x 15mm
- 3.1.a.32 Balón 2.75 x 20mm/ Balloon 2.75 x 20mm
- 3.1.a.33 Balón 2.75 x 25mm/ Balloon 2.75 x 25mm
- 3.1.a.34 Balón 2.75 x 30mm/ Balloon 2.75 x 30mm
- 3.1.a.35 Balón 2.75 x 40mm/ Balloon 2.75 x 40mm
- 3.1.a.36 Balón 3.0 x 10mm/ Balloon 3.0 x 10mm
- 3.1.a.37 Balón 3.0 x 15mm/ Balloon 3.0 x 15mm
- 3.1.a.38 Balón 3.0 x 20mm/ Balloon 3.0 x 20mm

MODELO-IP ANEXO II CT Cert. 93/42/IP-Rev1805/2020

Agencia Española de Medicamentos y Productos Sanitarios (AEMPS)

Fecha de la firma: 30/07/2020

Puede comprobar la autenticidad del documento en la sede de la AEMPS: <https://localizador.aemps.es>

CSV: 2 K S D D N Q A 5 9



CORREO ELECTRÓNICO  
on0318@aemps.es

Página 27 de 44

ORGANISMO NOTIFICADO 0318

C/ CAMPEZO, 1 - EDIFICIO 8  
28022 MADRID  
Tel.: (+34) 902.101.322 / (+34) 91.822.59.97  
Fax: (+34) 91.822.52.89





**ANEXO N°/ANNEX NO: I**

**CERTIFICADO CE DE SISTEMA DE GARANTÍA DE CALIDAD TOTAL**  
de acuerdo con el Anexo II (excepto punto 4) de la Directiva 93/42/CEE

**EC FULL QUALITY ASSURANCE SYSTEM CERTIFICATE**  
in accordance with Annex II (except Section 4) of Directive 93/42/EEC

Certificado n°/Certificate no	Fecha de validez/Date of validity			ON n°/NB no	
<b>2012 07 0788 CT</b>	Desde/From	<b>31-07-2020</b>	Hasta/To	<b>26-05-2024</b>	<b>0318</b>

- 3.1.a.39 Balón 3.0 x 25mm/ Balloon 3.0 x 25mm
- 3.1.a.40 Balón 3.0 x 30mm/ Balloon 3.0 x 30mm
- 3.1.a.41 Balón 3.0 x 40mm/ Balloon 3.0 x 40mm
- 3.1.a.42 Balón 3.25 x 10mm / Balloon 3.25 x 10mm
- 3.1.a.43 Balón 3.25 x 15mm/ Balloon 3.25 x 15mm
- 3.1.a.44 Balón 3.25 x 20mm/ Balloon 3.25 x 20mm
- 3.1.a.45 Balón 3.25 x 25mm/ Balloon 3.25 x 25mm
- 3.1.a.46 Balón 3.25 x 30mm / Balloon 3.25 x 30mm
- 3.1.a.47 Balón 3.25 x 40mm/ Balloon 3.25 x 40mm
- 3.1.a.48 Balón 3.5 x 10mm/ Balloon 3.5 x 10mm
- 3.1.a.49 Balón 3.5 x 15mm/ Balloon 3.5 x 15mm
- 3.1.a.50 Balón 3.5 x 20mm/ Balloon 3.5 x 20mm
- 3.1.a.51 Balón 3.5 x 25mm/ Balloon 3.5 x 25mm
- 3.1.a.52 Balón 3.5 x 30mm/ Balloon 3.5 x 30mm
- 3.1.a.53 Balón 3.5 x 40mm/ Balloon 3.5 x 40mm
- 3.1.a.54 Balón 3.75 x 10mm/ Balloon 3.75 x 10mm
- 3.1.a.55 Balón 3.75 x 15mm/ Balloon 3.75 x 15mm
- 3.1.a.56 Balón 3.75 x 20mm/ Balloon 3.75 x 20mm
- 3.1.a.57 Balón 3.75 x 25mm/ Balloon 3.75 x 25mm
- 3.1.a.58 Balón 3.75 x 30mm/ Balloon 3.75 x 30mm
- 3.1.a.59 Balón 3.75 x 40mm/ Balloon 3.75 x 40mm
- 3.1.a.60 Balón 4.0 .x 10mm/ Balloon 4.0 x 10mm
- 3.1.a.61 Balón 4.0 x 15mm/ Balloon 4.0 x 15mm
- 3.1.a.62 Balón 4.0 x 20mm/ Balloon 4.0 x 20mm
- 3.1.a.63 Balón 4.0 x 25mm/ Balloon 4.0 x 25mm
- 3.1.a.64 Balón 4.0 x 30mm/ Balloon 4.0 x 30mm
- 3.1.a.65 Balón 4.0 x 40mm/ Balloon 4.0 x 40mm
- 3.1.a.66 Balón 4.25 x 10mm/ Balloon 4.25 x 10mm

MODELO-IP ANEXO II CT Cert. 93/42/IP-Rev1805/2020

Agencia Española de Medicamentos y Productos Sanitarios (AEMPS)

Fecha de la firma: 30/07/2020

Puede comprobar la autenticidad del documento en la sede de la AEMPS: <https://localizador.aemps.es>

CSV: 2 K S D D N Q A 5 9



CORREO ELECTRÓNICO  
on0318@aemps.es

Página 28 de 44

ORGANISMO NOTIFICADO 0318

C/ CAMPEZO, 1 - EDIFICIO 8  
28022 MADRID  
Tel.: (+34) 902.101.322 / (+34) 91.822.59.97  
Fax: (+34) 91.822.52.99



ANEXO N°/ANNEX NO: I

**CERTIFICADO CE DE SISTEMA DE GARANTÍA DE CALIDAD TOTAL**  
de acuerdo con el Anexo II (excepto punto 4) de la Directiva 93/42/CEE

**EC FULL QUALITY ASSURANCE SYSTEM CERTIFICATE**  
*in accordance with Annex II (except Section 4) of Directive 93/42/EEC*

Certificado n°/Certificate no	Fecha de validez/Date of validity			ON n°/NB no	
2012 07 0788 CT	Desde/From	31-07-2020	Hasta/To	26-05-2024	0318

- 3.1.a.67 Balón 4.25 x 15mm/ Balloon 4.25 x 15mm
- 3.1.a.68 Balón 4.25 x 20mm/ Balloon 4.25 x 20mm
- 3.1.a.69 Balón 4.25 x 25mm/ Balloon 4.25 x 25mm
- 3.1.a.70 Balón 4.25 x 30mm/ Balloon 4.25 x 30mm
- 3.1.a.71 Balón 4.25 x 40mm/ Balloon 4.25 x 40mm
- 3.1.a.72 Balón 4.5 x 10mm/ Balloon 4.5 x 10mm
- 3.1.a.73 Balón 4.5 x 15mm/ Balloon 4.5 x 15mm
- 3.1.a.74 Balón 4.5 x 20mm/ Balloon 4.5 x 20mm
- 3.1.a.75 Balón 4.5 x 25mm/ Balloon 4.5 x 25mm
- 3.1.a.76 Balón 4.5 x 30mm/ Balloon 4.5 x 30mm
- 3.1.a.77 Balón 4.5 x 40mm/ Balloon 4.5 x 40mm
- 3.1.a.78 Balón 5.0 x 10mm / Balloon 5.0 x 10mm
- 3.1.a.79 Balón 5.0 x 15mm/ Balloon 5.0 x 15mm
- 3.1.a.80 Balón 5.0 x 20mm/ Balloon 5.0 x 20mm

**3.2. Catéter balón de dilatación coronario, balón no distensible "iVascular NC xperience"/**  
*"iVascular NC xperience" Coronary balloon dilatation catheter, non-compliant balloon*

Los siguientes productos se encuentran descritos en el certificado 2016 11 0856 ED/  
*The followed products are described in the certificate ED 2016 11 0856*

**3.2.a. Longitud de catéter 142cm/ Catheter length 142cm**

- 3.2.a.1 Balón 2.0 x 6mm/ Balloon 2.0 x 6mm
- 3.2.a.2 Balón 2.0 x 8mm/ Balloon 2.0 x 8mm
- 3.2.a.3 Balón 2.0 x 10mm/ Balloon 2.0 x 10mm
- 3.2.a.4 Balón 2.0 x 12mm/ Balloon 2.0 x 12mm
- 3.2.a.5 Balón 2.0 x 15mm/ Balloon 2.0 x 15mm
- 3.2.a.6 Balón 2.0 x 20mm/ Balloon 2.0 x 20mm

Agencia Española de Medicamentos y Productos Sanitarios (AEMPS)

Fecha de la firma: 30/07/2020

Puede comprobar la autenticidad del documento en la sede de la AEMPS: <https://localizador.aemps.es>

CSV: 2 K S D D N Q A 5 9



CORREO ELECTRÓNICO  
on0318@aemps.es

Página 29 de 44

C/ CAMPEZO, 1 - EDIFICIO 8  
28022 MADRID  
Tel.: (+34) 902.101.322 / (+34) 91.822.59.97  
Fax: (+34) 91.822.52.89

ORGANISMO NOTIFICADO 0318



**ANEXO N°/ANNEX NO: I**

**CERTIFICADO CE DE SISTEMA DE GARANTÍA DE CALIDAD TOTAL**  
de acuerdo con el Anexo II (excepto punto 4) de la Directiva 93/42/CEE

**EC FULL QUALITY ASSURANCE SYSTEM CERTIFICATE**  
in accordance with Annex II (except Section 4) of Directive 93/42/EEC

Certificado n°/Certificate no	Fecha de validez/Date of validity			ON n°/NB no	
<b>2012 07 0788 CT</b>	Desde/From	<b>31-07-2020</b>	Hasta/To	<b>26-05-2024</b>	<b>0318</b>

- 3.2.a.7 Balón 2.0 x 25mm/Balloon 2.0 x 25mm
- 3.2.a.8 Balón 2.0 x 30mm/Balloon 2.0 x 30mm
- 3.2.a.9 Balón 2.25 x 6mm/Balloon 2.25 x 6mm
- 3.2.a.10 Balón 2.25 x 8mm/Balloon 2.25 x 8mm
- 3.2.a.11 Balón 2.25 x 10mm/Balloon 2.25 x 10mm
- 3.2.a.12 Balón 2.25 x 12mm/Balloon 2.25 x 12mm
- 3.2.a.13 Balón 2.25 x 15mm/Balloon 2.25 x 15mm
- 3.2.a.14 Balón 2.25 x 20mm/Balloon 2.25 x 20mm
- 3.2.a.15 Balón 2.25 x 25mm/Balloon 2.25 x 25mm
- 3.2.a.16 Balón 2.25 x 30mm/Balloon 2.25 x 30mm
- 3.2.a.17 Balón 2.5 x 6mm/Balloon 2.5 x 6mm
- 3.2.a.18 Balón 2.5 x 8mm/Balloon 2.5 x 8mm
- 3.2.a.19 Balón 2.5 x 10mm/Balloon 2.5 x 10mm
- 3.2.a.20 Balón 2.5 x 12mm/Balloon 2.5 x 12mm
- 3.2.a.21 Balón 2.5 x 15mm/Balloon 2.5 x 15mm
- 3.2.a.22 Balón 2.5 x 20mm/Balloon 2.5 x 20mm
- 3.2.a.23 Balón 2.5 x 25mm/Balloon 2.5 x 25mm
- 3.2.a.24 Balón 2.5 x 30mm/Balloon 2.5 x 30mm
- 3.2.a.25 Balón 2.75 x 6mm/Balloon 2.75 x 6mm
- 3.2.a.26 Balón 2.75 x 8mm/Balloon 2.75 x 8mm
- 3.2.a.27 Balón 2.75 x 10mm/Balloon 2.75 x 10mm
- 3.2.a.28 Balón 2.75 x 12mm/Balloon 2.75 x 12mm
- 3.2.a.29 Balón 2.75 x 15mm/Balloon 2.75 x 15mm
- 3.2.a.30 Balón 2.75 x 20mm/Balloon 2.75 x 20mm
- 3.2.a.31 Balón 2.75 x 25mm/Balloon 2.75 x 25mm
- 3.2.a.32 Balón 2.75 x 30mm/Balloon 2.75 x 30mm
- 3.2.a.33 Balón 3.0 x 6mm/Balloon 3.0 x 6mm
- 3.2.a.34 Balón 3.0 x 8mm/Balloon 3.0 x 8mm

Agencia Española de Medicamentos y Productos Sanitarios (AEMPS)

Fecha de la firma: 30/07/2020

Puede comprobar la autenticidad del documento en la sede de la AEMPS: <https://localizador.aemps.es>

CSV: 2 K S D D N Q A 5 9



CORREO ELECTRÓNICO  
on0318@aemps.es

Página 30 de 44

ORGANISMO NOTIFICADO 0318

C/ CAMPEZO, 1 - EDIFICIO 8  
28022 MADRID  
Tel.: (+34) 902.101.322 / (+34) 91.822.59.97  
Fax: (+34) 91.822.52.89



**ANEXO N°/ANNEX NO: I**

**CERTIFICADO CE DE SISTEMA DE GARANTÍA DE CALIDAD TOTAL**  
de acuerdo con el Anexo II (excepto punto 4) de la Directiva 93/42/CEE

**EC FULL QUALITY ASSURANCE SYSTEM CERTIFICATE**  
in accordance with Annex II (except Section 4) of Directive 93/42/EEC

Certificado n°/Certificate no	Fecha de validez/Date of validity			ON n°/NB no	
<b>2012 07 0788 CT</b>	Desde/From	<b>31-07-2020</b>	Hasta/To	<b>26-05-2024</b>	<b>0318</b>

- 3.2.a.35 Balón 3.0 x 10mm/ Balloon 3.0 x 10mm
- 3.2.a.36 Balón 3.0 x 12mm/ Balloon 3.0 x 12mm
- 3.2.a.37 Balón 3.0 x 15mm/ Balloon 3.0 x 15mm
- 3.2.a.38 Balón 3.0 x 20mm/ Balloon 3.0 x 20mm
- 3.2.a.39 Balón 3.0 x 25mm/ Balloon 3.0 x 25mm
- 3.2.a.40 Balón 3.0 x 30mm/ Balloon 3.0 x 30mm
- 3.2.a.41 Balón 3.25 x 6mm/ Balloon 3.25 x 6mm
- 3.2.a.42 Balón 3.25 x 8mm/ Balloon 3.25 x 8mm
- 3.2.a.43 Balón 3.25 x 10mm/ Balloon 3.25 x 10mm
- 3.2.a.44 Balón 3.25 x 12mm/ Balloon 3.25 x 12mm
- 3.2.a.45 Balón 3.25 x 15mm/ Balloon 3.25 x 15mm
- 3.2.a.46 Balón 3.25 x 20mm/ Balloon 3.25 x 20mm
- 3.2.a.47 Balón 3.25x 25mm/ Balloon 3.25 x 25mm
- 3.2.a.48 Balón 3.25 x 30mm / Balloon 3.25 x 30mm
- 3.2.a.49 Balón 3.5 x 6mm/ Balloon 3.5 x 6mm
- 3.2.a.50 Balón 3.5 x 8mm/ Balloon 3.5 x 8mm
- 3.2.a.51 Balón 3.5 x 10mm/ Balloon 3.5 x 10mm
- 3.2.a.52 Balón 3.5 x 12mm/ Balloon 3.5 x 12mm
- 3.2.a.53 Balón 3.5 x 15mm/ Balloon 3.5 x 15mm
- 3.2.a.54 Balón 3.5 x 20mm/ Balloon 3.5 x 20mm
- 3.2.a.55 Balón 3.5 x 25mm/ Balloon 3.5 x 25mm
- 3.2.a.56 Balón 3.5 x 30mm/ Balloon 3.5 x 30mm
- 3.2.a.57 Balón 3.75 x 6mm/ Balloon 3.75 x 6mm
- 3.2.a.58 Balón 3.75 x 8mm/ Balloon 3.75 x 8mm
- 3.2.a.59 Balón 3.75 x 10mm/ Balloon 3.75 x 10mm
- 3.2.a.60 Balón 3.75 x 12mm/ Balloon 3.75 x 12mm
- 3.2.a.61 Balón 3.75 x 15mm/ Balloon 3.75 x 15mm
- 3.2.a.62 Balón 3.75 x 20mm/ Balloon 3.75 x 20mm

MODELO-IP ANEXO II CT Cert. 93/42/IP-Rev1805/2020

Agencia Española de Medicamentos y Productos Sanitarios (AEMPS)

Fecha de la firma: 30/07/2020

Puede comprobar la autenticidad del documento en la sede de la AEMPS: <https://localizador.aemps.es>

CSV: 2 K S D D N Q A 5 9



CORREO ELECTRÓNICO  
on0318@aemps.es

Página 31 de 44

ORGANISMO NOTIFICADO 0318

C/ CAMPEZO, 1 - EDIFICIO 8  
28022 MADRID  
Tel.: (+34) 902.101.322 / (+34) 91.822.59.97  
Fax: (+34) 91.822.52.89



**ANEXO N°/ANNEX NO: I**

**CERTIFICADO CE DE SISTEMA DE GARANTÍA DE CALIDAD TOTAL**  
**de acuerdo con el Anexo II (excepto punto 4) de la Directiva 93/42/CEE**

**EC FULL QUALITY ASSURANCE SYSTEM CERTIFICATE**  
**in accordance with Annex II (except Section 4) of Directive 93/42/EEC**

Certificado n°/Certificate no	Fecha de validez/Date of validity			ON n°/NB no
	Desde/From	Hasta/To		
<b>2012 07 0788 CT</b>	<b>31-07-2020</b>	<b>26-05-2024</b>		<b>0318</b>

- 3.2.a.63 Balón 3.75 x 25mm/ Balloon 3.75 x 25mm
- 3.2.a.64 Balón 3.75 x 30mm/ Balloon 3.75 x 30mm
- 3.2.a.65 Balón 4.0 x 6mm/ Balloon 4.0 x 6mm
- 3.2.a.66 Balón 4.0 x 8mm/ Balloon 4.0 x 8mm
- 3.2.a.67 Balón 4.0 x 10mm/ Balloon 4.0 x 10mm
- 3.2.a.68 Balón 4.0 x 12mm/ Balloon 4.0 x 12mm
- 3.2.a.69 Balón 4.0 x 15mm/ Balloon 4.0 x 15mm
- 3.2.a.70 Balón 4.0 x 20mm/ Balloon 4.0 x 20mm
- 3.2.a.71 Balón 4.0 x 25mm/ Balloon 4.0 x 25mm
- 3.2.a.72 Balón 4.0 x 30mm/ Balloon 4.0 x 30mm
- 3.2.a.73 Balón 4.5 x 6mm/ Balloon 4.5 x 6mm
- 3.2.a.74 Balón 4.5 x 8mm/ Balloon 4.5 x 8mm
- 3.2.a.75 Balón 4.5 x 10mm/ Balloon 4.5 x 10mm
- 3.2.a.76 Balón 4.5 x 12mm/ Balloon 4.5 x 12mm
- 3.2.a.77 Balón 4.5 x 15mm/ Balloon 4.5 x 15mm
- 3.2.a.78 Balón 4.5 x 20mm/ Balloon 4.5 x 20mm
- 3.2.a.79 Balón 5 x 6mm/ Balloon 5 x 6mm
- 3.2.a.80 Balón 5 x 8mm/ Balloon 5 x 8mm
- 3.2.a.81 Balón 5 x 10mm/ Balloon 5 x 10mm
- 3.2.a.82 Balón 5 x 12mm/ Balloon 5 x 12mm
- 3.2.a.83 Balón 5.0 x 15mm/ Balloon 5.0 x 15mm
- 3.2.a.84 Balón 5.0 x 20mm/ Balloon 5.0 x 20mm

**3.3. Catéter balón de dilatación coronario, balón semidistensible, con marcas radiopacas metálicas,**  
**"iVascular xperience pro"/ "iVascular xperience pro Coronary balloon dilatation catheter, semi-**  
**compliant balloon, with metallic radiopaque markers**

**Los siguientes productos se encuentran descritos en el certificado 2019 06 0892 ED/**  
**The followed products are described in the certificate 2019 06 0892 ED**

Agencia Española de Medicamentos y Productos Sanitarios (AEMPS)

Fecha de la firma: 30/07/2020

Puede comprobar la autenticidad del documento en la sede de la AEMPS: <https://localizador.aemps.es>

CSV: 2 K S D D N Q A 5 9



CORREO ELECTRÓNICO  
on0318@aemps.es

Página 32 de 44

C/ CAMPEZO, 1 - EDIFICIO 8  
28022 MADRID  
Tel.: (+34) 902.101.322 / (+34) 91.822.59.97  
Fax: (+34) 91.822.52.89

ORGANISMO NOTIFICADO 0318





**ANEXO N°/ANNEX NO: I**

**CERTIFICADO CE DE SISTEMA DE GARANTÍA DE CALIDAD TOTAL**  
**de acuerdo con el Anexo II (excepto punto 4) de la Directiva 93/42/CEE**

**EC FULL QUALITY ASSURANCE SYSTEM CERTIFICATE**  
**in accordance with Annex II (except Section 4) of Directive 93/42/EEC**

<b>Certificado n°/Certificate no</b>	<b>Fecha de validez/Date of validity</b>			<b>ON n°/NB no</b>	
<b>2012 07 0788 CT</b>	<b>Desde/From</b>	<b>31-07-2020</b>	<b>Hasta/To</b>	<b>26-05-2024</b>	<b>0318</b>

**3.3.a Longitud de catéter 142cm/ Catheter length 142cm**

- 3.3.a.1 Balón 1.25 x 10mm con una marca radiopaca centrando el balón/ Balloon 1.25 x 10mm with a radiopaque marker centering the balloon**
- 3.3.a.2 Balón 1.25 x 15mm con una marca radiopaca centrando el balón/ Balloon 1.25 x 15mm with a radiopaque marker centering the balloon**
- 3.3.a.3 Balón 1.5 x 10mm con una marca radiopaca centrando el balón/ Balloon 1.5x10mm with a radiopaque marker centering the balloon**
- 3.3.a.4 Balón 1.5 x 15mm con una marca radiopaca centrando el balón/ Balloon 1.5 x 15mm with a radiopaque marker centering the balloon**
- 3.3.a.5 Balón 1.25 x 10mm/ Balloon 1.25 x 10mm**
- 3.3.a.6 Balón 1.25 x 15mm/ Balloon 1.25 x 15mm**
- 3.3.a.7 Balón 1.25 x 20mm/ Balloon 1.25 x 20mm**
- 3.3.a.8 Balón 1.5 x 10mm/ Balloon 1.5 x 10mm**
- 3.3.a.9 Balón 1.5 x 15mm/ Balloon 1.5 x 15mm**
- 3.3.a.10 Balón 1.5 x 20mm/ Balloon 1.5 x 20mm**
- 3.3.a.11 Balón 1.5 x 30mm/ Balloon 1.5 x 30mm**
- 3.3.a.12 Balón 2.0 x 10mm/ Balloon 2.0 x 10mm**
- 3.3.a.13 Balón 2.0 x 15mm/ Balloon 2.0 x 15mm**
- 3.3.a.14 Balón 2.0 x 20mm/ Balloon 2.0 x 20mm**
- 3.3.a.15 Balón 2.0 x 25mm/ Balloon 2.0 x 25mm**
- 3.3.a.16 Balón 2.0 x 30mm/ Balloon 2.0 x 30mm**
- 3.3.a.17 Balón 2.0 x 40mm/ Balloon 2.0 x 40mm**
- 3.3.a.18 Balón 2.25 x 10mm/ Balloon 2.25 x 10mm**
- 3.3.a.19 Balón 2.25 x 15mm/ Balloon 2.25 x 15mm**
- 3.3.a.20 Balón 2.25 x 20mm/ Balloon 2.25 x 20mm**
- 3.3.a.21 Balón 2.25 x 25mm/ Balloon 2.25 x 25mm**
- 3.3.a.22 Balón 2.25 x 30mm/ Balloon 2.25 x 30mm**

Agencia Española de Medicamentos y Productos Sanitarios (AEMPS)

Fecha de la firma: 30/07/2020

Puede comprobar la autenticidad del documento en la sede de la AEMPS: <https://localizador.aemps.es>

CSV: 2 K S D D N Q A 5 9



CORREO ELECTRÓNICO  
on0318@aemps.es

Página 33 de 44

C/ CAMPEZO, 1 - EDIFICIO 8  
28022 MADRID  
Tel.: (+34) 902.101.322 / (+34) 91.822.59.97  
Fax: (+34) 91.822.52.89

ORGANISMO NOTIFICADO 0318



**ANEXO N°/ANNEX NO: I**

**CERTIFICADO CE DE SISTEMA DE GARANTÍA DE CALIDAD TOTAL**  
de acuerdo con el Anexo II (excepto punto 4) de la Directiva 93/42/CEE

**EC FULL QUALITY ASSURANCE SYSTEM CERTIFICATE**  
in accordance with Annex II (except Section 4) of Directive 93/42/EEC

Certificado n°/Certificate no	Fecha de validez/Date of validity			ON n°/NB no	
<b>2012 07 0788 CT</b>	Desde/From	<b>31-07-2020</b>	Hasta/To	<b>26-05-2024</b>	<b>0318</b>

3.3.a.23 Balón 2.25 x 40mm/ Balloon 2.25 x 40mm

3.3.a.24 Balón 2.5 x 10mm/ Balloon 2.5 x 10mm

3.3.a.25 Balón 2.5 x 15mm/ Balloon 2.5 x 15mm

3.3.a.26 Balón 2.5 x 20mm/ Balloon 2.5 x 20mm

3.3.a.27 Balón 2.5 x 25mm/ Balloon 2.5 x 25mm

3.3.a.28 Balón 2.5 x 30mm/ Balloon 2.5 x 30mm

3.3.a.29 Balón 2.5 x 40mm/ Balloon 2.5 x 40mm

3.3.a.30 Balón 2.75 x 10mm/ Balloon 2.75 x 10mm

3.3.a.31 Balón 2.75 x 15mm/ Balloon 2.75 x 15mm

3.3.a.32 Balón 2.75 x 20mm/ Balloon 2.75 x 20mm

3.3.a.33 Balón 2.75 x 25mm/ Balloon 2.75 x 25mm

3.3.a.34 Balón 2.75 x 30mm/ Balloon 2.75 x 30mm

3.3.a.35 Balón 2.75 x 40mm/ Balloon 2.75 x 40mm

3.3.a.36 Balón 3.0 x 10mm/ Balloon 3.0 x 10mm

3.3.a.37 Balón 3.0 x 15mm/ Balloon 3.0 x 15mm

3.3.a.38 Balón 3.0 x 20mm/ Balloon 3.0 x 20mm

3.3.a.39 Balón 3.0 x 25mm/ Balloon 3.0 x 25mm

3.3.a.40 Balón 3.0 x 30mm/ Balloon 3.0 x 30mm

3.3.a.41 Balón 3.0 x 40mm/ Balloon 3.0 x 40mm

3.3.a.42 Balón 3.25 x 10mm / Balloon 3.25 x 10mm

3.3.a.43 Balón 3.25 x 15mm/ Balloon 3.25 x 15mm

3.3.a.44 Balón 3.25 x 20mm/ Balloon 3.25 x 20mm

3.3.a.45 Balón 3.25 x 25mm/ Balloon 3.25 x 25mm

3.3.a.46 Balón 3.25 x 30mm / Balloon 3.25 x 30mm

3.3.a.47 Balón 3.25 x 40mm/ Balloon 3.25 x 40mm

3.3.a.48 Balón 3.5 x 10mm/ Balloon 3.5 x 10mm

3.3.a.49 Balón 3.5 x 15mm/ Balloon 3.5 x 15mm

3.3.a.50 Balón 3.5 x 20mm/ Balloon 3.5 x 20mm

Agencia Española de Medicamentos y Productos Sanitarios (AEMPS)

Fecha de la firma: 30/07/2020

Puede comprobar la autenticidad del documento en la sede de la AEMPS: <https://localizador.aemps.es>

CSV: 2 K S D D N Q A 5 9



CORREO ELECTRÓNICO  
on0318@aemps.es

Página 34 de 44

C/ CAMPEZO, 1 - EDIFICIO 8  
28022 MADRID  
Tel.: (+34) 902.101.322 / (+34) 91.822.59.97  
Fax: (+34) 91.822.52.89

ORGANISMO NOTIFICADO 0318



**ANEXO N°/ANNEX NO: I**

**CERTIFICADO CE DE SISTEMA DE GARANTÍA DE CALIDAD TOTAL**  
de acuerdo con el Anexo II (excepto punto 4) de la Directiva 93/42/CEE

**EC FULL QUALITY ASSURANCE SYSTEM CERTIFICATE**  
in accordance with Annex II (except Section 4) of Directive 93/42/EEC

Certificado n°/Certificate no	Fecha de validez/Date of validity			ON n°/NB no	
<b>2012 07 0788 CT</b>	Desde/From	<b>31-07-2020</b>	Hasta/To	<b>26-05-2024</b>	<b>0318</b>

- 3.3.a.51 Balón 3.5 x 25mm/ Balloon 3.5 x 25mm
- 3.3.a.52 Balón 3.5 x 30mm/ Balloon 3.5 x 30mm
- 3.3.a.53 Balón 3.5 x 40mm/ Balloon 3.5 x 40mm
- 3.3.a.54 Balón 3.75 x 10mm/ Balloon 3.75 x 10mm
- 3.3.a.55 Balón 3.75 x 15mm/ Balloon 3.75 x 15mm
- 3.3.a.56 Balón 3.75 x 20mm/ Balloon 3.75 x 20mm
- 3.3.a.57 Balón 3.75 x 25mm/ Balloon 3.75 x 25mm
- 3.3.a.58 Balón 3.75 x 30mm/ Balloon 3.75 x 30mm
- 3.3.a.59 Balón 3.75 x 40mm/ Balloon 3.75 x 40mm
- 3.3.a.60 Balón 4.0 x 10mm/ Balloon 4.0 x 10mm
- 3.3.a.61 Balón 4.0 x 15mm/ Balloon 4.0 x 15mm
- 3.3.a.62 Balón 4.0 x 20mm/ Balloon 4.0 x 20mm
- 3.3.a.63 Balón 4.0 x 25mm/ Balloon 4.0 x 25mm
- 3.3.a.64 Balón 4.0 x 30mm/ Balloon 4.0 x 30mm
- 3.3.a.65 Balón 4.0 x 40mm/ Balloon 4.0 x 40mm
- 3.3.a.66 Balón 4.25 x 10mm/ Balloon 4.25 x 10mm
- 3.3.a.67 Balón 4.25 x 15mm/ Balloon 4.25 x 15mm
- 3.3.a.68 Balón 4.25 x 20mm/ Balloon 4.25 x 20mm
- 3.3.a.69 Balón 4.25 x 25mm/ Balloon 4.25 x 25mm
- 3.3.a.70 Balón 4.25 x 30mm/ Balloon 4.25 x 30mm
- 3.3.a.71 Balón 4.25 x 40mm/ Balloon 4.25 x 40mm
- 3.3.a.72 Balón 4.5 x 10mm/ Balloon 4.5 x 10mm
- 3.3.a.73 Balón 4.5 x 15mm/ Balloon 4.5 x 15mm
- 3.3.a.74 Balón 4.5 x 20mm/ Balloon 4.5 x 20mm
- 3.3.a.75 Balón 4.5 x 25mm/ Balloon 4.5 x 25mm
- 3.3.a.76 Balón 4.5 x 30mm/ Balloon 4.5 x 30mm
- 3.3.a.77 Balón 4.5 x 40mm/ Balloon 4.5 x 40mm
- 3.3.a.78 Balón 5.0 x 10mm / Balloon 5.0 x 10mm

MODELO-IP ANEXO II CT Cert. 93/42/IP-Rev1805/2020

Agencia Española de Medicamentos y Productos Sanitarios (AEMPS)

Fecha de la firma: 30/07/2020

Puede comprobar la autenticidad del documento en la sede de la AEMPS: <https://localizador.aemps.es>

CSV: 2 K S D D N Q A 5 9



CORREO ELECTRÓNICO  
on0318@aemps.es

Página 35 de 44

ORGANISMO NOTIFICADO 0318

C/ CAMPEZO, 1 - EDIFICIO 8  
28022 MADRID  
Tel.: (+34) 902.101.322 / (+34) 91.822.59.97  
Fax: (+34) 91.822.52.89



**ANEXO N°/ANNEX NO: I**

**CERTIFICADO CE DE SISTEMA DE GARANTÍA DE CALIDAD TOTAL**  
**de acuerdo con el Anexo II (excepto punto 4) de la Directiva 93/42/CEE**

**EC FULL QUALITY ASSURANCE SYSTEM CERTIFICATE**  
**in accordance with Annex II (except Section 4) of Directive 93/42/EEC**

Certificado n°/Certificate no	Fecha de validez/Date of validity			ON n°/NB no	
<b>2012 07 0788 CT</b>	Desde/From	<b>31-07-2020</b>	Hasta/To	<b>26-05-2024</b>	<b>0318</b>

**3.3.a.79** Balón 5.0 x 15mm/ Balloon 5.0 x 15mm

**3.3.a.80** Balón 5.0 x 20mm/ Balloon 5.0 x 20mm

**3.4** Catéter balón de dilatación coronario scoring, “iVascular naviscore”/ “iVascular naviscore”  
coronary scoring balloon dilatation Catheter

Los siguientes productos se encuentran descritos en el certificado CE de diseño 2020 04 0910 ED / The followed products are described in the EC Design Examination Certificate 2020 04 0910 ED

**3.4.a** Longitud de catéter 142cm/ Catheter length 142cm

**3.4.a.1** Balón de 1.5 x 6mm/ Balloon 1.5 x 6mm

**3.4.a.2** Balón de 1.5 x 8mm/ Balloon 1.5 x 8mm

**3.4.a.3** Balón de 1.5 x 10mm/ Balloon 1.5 x 10mm

**3.4.a.4** Balón de 1.5 x 12mm/ Balloon 1.5 x 12mm

**3.4.a.5** Balón de 1.5 x 15mm/ Balloon 1.5 x 15mm

**3.4.a.6** Balón de 2.0 x 6mm/ Balloon 2.0 x 6mm

**3.4.a.7** Balón de 2.0 x 8mm/ Balloon 2.0 x 8mm

**3.4.a.8** Balón de 2.0 x 10mm/ Balloon 2.0 x 10mm

**3.4.a.9** Balón de 2.0 x 12mm/ Balloon 2.0 x 12mm

**3.4.a.10** Balón de 2.0 x 15/ Balloon 2.0 x 15mm

**3.4.a.11** Balón de 2.5 x 6mm/ Balloon 2.5 x 6mm

**3.4.a.12** Balón de 2.5 x 8mm/ Balloon 2.5 x 8mm

**3.4.a.13** Balón de 2.5 x 10mm/ Balloon 2.5 x 10mm

**3.4.a.14** Balón de 2.5 x 12mm/ Balloon 2.5 x 12mm

**3.4.a.15** Balón de 2.5 x 15mm/ Balloon 2.5 x 15mm

**3.4.a.16** Balón de 3.0 x 6mm/ Balloon 3.0 x 6mm

**3.4.a.17** Balón de 3.0 x 8mm/ Balloon 3.0 x 8mm

**3.4.a.18** Balón de 3.0 x 10mm/ Balloon 3.0 x 10mm

Agencia Española de Medicamentos y Productos Sanitarios (AEMPS)

Fecha de la firma: 30/07/2020

Puede comprobar la autenticidad del documento en la sede de la AEMPS: <https://localizador.aemps.es>

CSV: 2 K S D D N Q A 5 9



CORREO ELECTRÓNICO  
on0318@aemps.es

Página 36 de 44

C/ CAMPEZO, 1 - EDIFICIO 8  
28022 MADRID

Tel.: (+34) 902.101.322 / (+34) 91.822.59.97  
Fax: (+34) 91.822.52.89

ORGANISMO NOTIFICADO 0318



**ANEXO N°/ANNEX NO: I**

**CERTIFICADO CE DE SISTEMA DE GARANTÍA DE CALIDAD TOTAL  
de acuerdo con el Anexo II (excepto punto 4) de la Directiva 93/42/CEE**

**EC FULL QUALITY ASSURANCE SYSTEM CERTIFICATE  
in accordance with Annex II (except Section 4) of Directive 93/42/EEC**

Certificado n°/Certificate no	Fecha de validez/Date of validity			ON n°/NB no	
<b>2012 07 0788 CT</b>	Desde/From	<b>31-07-2020</b>	Hasta/To	<b>26-05-2024</b>	<b>0318</b>

- 3.4.a.19 Balón de 3.0 x 12mm/ Balloon 3.0 x 12mm
- 3.4.a.20 Balón de 3.0 x 15mm/ Balloon 3.0 x 15mm
- 3.4.a.21 Balón de 3.5 x 6mm/ Balloon 3.5 x 6mm
- 3.4.a.22 Balón de 3.5 x 8mm/ Balloon 3.5 x 8mm
- 3.4.a.23 Balón de 3.5 x 10mm/ Balloon 3.5 x 10mm
- 3.4.a.24 Balón de 3.5 x 12mm/ Balloon 3.5 x 12mm
- 3.4.a.25 Balón de 3. x 15mm/ Balloon 3.5 x 15mm

**4. Catéter balón de dilatación coronario con liberación de paclitaxel / Paclitaxel eluting coronary balloon dilatation catheter**

**Código NANDO: MD 106, MDS7001 y MDS 7006**

**4.1. Catéter balón de dilatación coronario con liberación de paclitaxel "iVascular essential"/  
"iVascular essential" Paclitaxel eluting coronary balloon dilatation catheter.**

**Los siguientes productos se encuentran descritos en el certificado 2013 11 0806 ED**  
*The followed products are described in the certificate ED 2013 11 0806*

**4.1.a. Longitud de catéter 142cm/ Catheter length 142cm**

- 4.1.a.1 Balón 1.5 x 10mm/ Balloon 1.5 x 10mm
- 4.1.a.2 Balón 1.5 x 15mm/ Balloon 1.5 x 15mm
- 4.1.a.3 Balón 1.5 x 20mm/ Balloon 1.5 x 20mm
- 4.1.a.4 Balón 1.5 x 30mm/ Balloon 1.5 x 30mm
- 4.1.a.5 Balón 2.0 x 10mm/ Balloon 2.0 x 10mm
- 4.1.a.6 Balón 2.0 x 15mm/ Balloon 2.0 x 15mm
- 4.1.a.7 Balón 2.0 x 20mm/ Balloon 2.0 x 20mm
- 4.1.a.8 Balón 2.0 x 25mm/ Balloon 2.0 x 25mm
- 4.1.a.9 Balón 2.0 x 30mm/ Balloon 2.0 x 30mm
- 4.1.a.10 Balón 2.0 x 40mm/ Balloon 2.0 x 40mm
- 4.1.a.11 Balón 2.25 x 10mm/ Balloon 2.25 x 10mm

Agencia Española de Medicamentos y Productos Sanitarios (AEMPS)

Fecha de la firma: 30/07/2020

Puede comprobar la autenticidad del documento en la sede de la AEMPS: <https://localizador.aemps.es>

CSV: 2 K S D D N Q A 5 9



CORREO ELECTRÓNICO  
on0318@aemps.es

Página 37 de 44

ORGANISMO NOTIFICADO 0318

C/ CAMPEZO, 1 - EDIFICIO 8  
28022 MADRID  
Tel.: (+34) 902.101.322 / (+34) 91.822.59.97  
Fax: (+34) 91.822.52.89





**ANEXO N°/ANNEX NO: I**

**CERTIFICADO CE DE SISTEMA DE GARANTÍA DE CALIDAD TOTAL**  
de acuerdo con el Anexo II (excepto punto 4) de la Directiva 93/42/CEE

**EC FULL QUALITY ASSURANCE SYSTEM CERTIFICATE**  
*in accordance with Annex II (except Section 4) of Directive 93/42/EEC*

Certificado n°/Certificate no	Fecha de validez/Date of validity			ON n°/NB no	
<b>2012 07 0788 CT</b>	Desde/From	<b>31-07-2020</b>	Hasta/To	<b>26-05-2024</b>	<b>0318</b>

- 4.1.a.12 Balón 2.25 x 15mm/ Balloon 2.25 x 15mm
- 4.1.a.13 Balón 2.25 x 20mm/ Balloon 2.25 x 20mm
- 4.1.a.14 Balón 2.25 x 25mm/ Balloon 2.25 x 25mm
- 4.1.a.15 Balón 2.25 x 30mm/ Balloon 2.25 x 30mm
- 4.1.a.16 Balón 2.25 x 40mm/ Balloon 2.25 x 40mm
- 4.1.a.17 Balón 2.5 x 10mm/ Balloon 2.5 x 10mm
- 4.1.a.18 Balón 2.5 x 15mm/ Balloon 2.5 x 15mm
- 4.1.a.19 Balón 2.5 x 20mm/ Balloon 2.5 x 20mm
- 4.1.a.20 Balón 2.5 x 25mm/ Balloon 2.5 x 25mm
- 4.1.a.21 Balón 2.5 x 30mm/ Balloon 2.5 x 30mm
- 4.1.a.22 Balón 2.5 x 40mm/ Balloon 2.5 x 40mm
- 4.1.a.23 Balón 2.75 x 10mm/ Balloon 2.75 x 10mm
- 4.1.a.24 Balón 2.75 x 15mm/ Balloon 2.75 x 15mm
- 4.1.a.25 Balón 2.75 x 20mm/ Balloon 2.75 x 20mm
- 4.1.a.26 Balón 2.75 x 25mm/ Balloon 2.75 x 25mm
- 4.1.a.27 Balón 2.75 x 30mm/ Balloon 2.75 x 30mm
- 4.1.a.28 Balón 2.75 x 40mm/ Balloon 2.75 x 40mm
- 4.1.a.29 Balón 3.0 x 10mm/ Balloon 3.0 x 10mm
- 4.1.a.30 Balón 3.0 x 15mm/ Balloon 3.0 x 15mm
- 4.1.a.31 Balón 3.0 x 20mm/ Balloon 3.0 x 20mm
- 4.1.a.32 Balón 3.0 x 25mm/ Balloon 3.0 x 25mm
- 4.1.a.33 Balón 3.0 x 30mm/ Balloon 3.0 x 30mm
- 4.1.a.34 Balón 3.0 x 40mm/ Balloon 3.0 x 40mm
- 4.1.a.35 Balón 3.25 x 10mm / Balloon 3.25 x 10mm
- 4.1.a.36 Balón 3.25 x 15mm/ Balloon 3.25 x 15mm
- 4.1.a.37 Balón 3.25 x 20mm/ Balloon 3.25 x 20mm
- 4.1.a.38 Balón 3.25 x 25mm/ Balloon 3.25 x 25mm
- 4.1.a.39 Balón 3.25 x 30mm / Balloon 3.25 x 30mm

MODELO-IP ANEXO II CT Cert. 93/42/IP-Rev1805/2020

Agencia Española de Medicamentos y Productos Sanitarios (AEMPS)

Fecha de la firma: 30/07/2020

Puede comprobar la autenticidad del documento en la sede de la AEMPS: <https://localizador.aemps.es>

CSV: 2 K S D D N Q A 5 9



CORREO ELECTRÓNICO  
on0318@aemps.es

Página 38 de 44

ORGANISMO NOTIFICADO 0318

C/ CAMPEZO, 1 - EDIFICIO 8  
28022 MADRID  
Tel.: (+34) 902.101.322 / (+34) 91.822.59.97  
Fax: (+34) 91.822.52.89



**ANEXO N°/ANNEX NO: I**

**CERTIFICADO CE DE SISTEMA DE GARANTÍA DE CALIDAD TOTAL  
de acuerdo con el Anexo II (excepto punto 4) de la Directiva 93/42/CEE**

**EC FULL QUALITY ASSURANCE SYSTEM CERTIFICATE  
in accordance with Annex II (except Section 4) of Directive 93/42/EEC**

Certificado n°/Certificate no	Fecha de validez/Date of validity			ON n°/NB no	
<b>2012 07 0788 CT</b>	Desde/From	<b>31-07-2020</b>	Hasta/To	<b>26-05-2024</b>	<b>0318</b>

- 4.1.a.40 Balón 3.25 x 40mm/ Balloon 3.25 x 40mm
- 4.1.a.41 Balón 3.5 x 10mm/ Balloon 3.5 x 10mm
- 4.1.a.42 Balón 3.5 x 15mm/ Balloon 3.5 x 15mm
- 4.1.a.43 Balón 3.5 x 20mm/ Balloon 3.5 x 20mm
- 4.1.a.44 Balón 3.5 x 25mm/ Balloon 3.5 x 25mm
- 4.1.a.45 Balón 3.5 x 30mm/ Balloon 3.5 x 30mm
- 4.1.a.46 Balón 3.5 x 40mm/ Balloon 3.5 x 40mm
- 4.1.a.47 Balón 3.75 x 10mm/ Balloon 3.75 x 10mm
- 4.1.a.48 Balón 3.75 x 15mm/ Balloon 3.75 x 15mm
- 4.1.a.49 Balón 3.75 x 20mm/ Balloon 3.75 x 20mm
- 4.1.a.50 Balón 3.75 x 25mm/ Balloon 3.75 x 25mm
- 4.1.a.51 Balón 3.75 x 30mm/ Balloon 3.75 x 30mm
- 4.1.a.52. Balón 3.75 x 40mm/ Balloon 3.75 x 40mm
- 4.1.a.53 Balón 4.0.x 10mm/ Balloon 4.0 x 10mm
- 4.1.a.54 Balón 4.0 x 15mm/ Balloon 4.0 x 15mm
- 4.1.a.55 Balón 4.0 x 20mm/ Balloon 4.0 x 20mm
- 4.1.a.56 Balón 4.0 x 25mm/ Balloon 4.0 x 25mm
- 4.1.a.57 Balón 4.0 x 30mm/ Balloon 4.0 x 30mm
- 4.1.a.58 Balón 4.0 x 40mm/ Balloon 4.0 x 40mm
- 4.1.a.59 Balón 4.25 x 10mm/ Balloon 4.25 x 10mm
- 4.1.a.60 Balón 4.25 x 15mm/ Balloon 4.25 x 15mm
- 4.1.a.61 Balón 4.25 x 20mm/ Balloon 4.25 x 20mm
- 4.1.a.62 Balón 4.25 x 25mm/ Balloon 4.25 x 25mm
- 4.1.a.63 Balón 4.25 x 30mm/ Balloon 4.25 x 30mm
- 4.1.a.64 Balón 4.25 x 40mm/ Balloon 4.25 x 40mm
- 4.1.a.65 Balón 4.5 x 10mm/ Balloon 4.5 x 10mm
- 4.1.a.66 Balón 4.5 x 15mm/ Balloon 4.5 x 15mm
- 4.1.a.67 Balón 4.5 x 20mm/ Balloon 4.5 x 20mm

MODELO-IP ANEXO II CT Cert. 93/42/IP-Rev1805/2020

Agencia Española de Medicamentos y Productos Sanitarios (AEMPS)

Fecha de la firma: 30/07/2020

Puede comprobar la autenticidad del documento en la sede de la AEMPS: <https://localizador.aemps.es>

CSV: 2 K S D D N Q A 5 9



CORREO ELECTRÓNICO  
on0318@aemps.es

Página 39 de 44

ORGANISMO NOTIFICADO 0318

C/ CAMPEZO, 1 - EDIFICIO 8  
28022 MADRID  
Tel.: (+34) 902.101.322 / (+34) 91.822.59.97  
Fax: (+34) 91.822.52.89



**ANEXO N°/ANNEX NO: I**

**CERTIFICADO CE DE SISTEMA DE GARANTÍA DE CALIDAD TOTAL  
de acuerdo con el Anexo II (excepto punto 4) de la Directiva 93/42/CEE**

**EC FULL QUALITY ASSURANCE SYSTEM CERTIFICATE  
in accordance with Annex II (except Section 4) of Directive 93/42/EEC**

Certificado n°/Certificate no	Fecha de validez/Date of validity			ON n°/NB no	
<b>2012 07 0788 CT</b>	Desde/From	<b>31-07-2020</b>	Hasta/To	<b>26-05-2024</b>	<b>0318</b>

**4.1.a.68. Balón 4.5 x 25mm/ Balloon 4.5 x 25mm**

**4.1.a.69 Balón 4.5 x 30mm/ Balloon 4.5 x 30mm**

**4.1.a.70 Balón 4.5 x 40mm/ Balloon 4.5 x 40mm**

**4.2 Catéter balón de dilatación coronario, con liberación de paclitaxel, y marcas radiopacas metálicas “iVascular essential pro”/ “iVascular essential pro” Paclitaxel eluting coronary balloon dilatation catheter, with metallic radiopaque markers**

**Los siguientes productos se encuentran descritos en el certificado 2020 05 0916 ED/  
The followed products are described in the certificate 2020 05 0916 ED**

**4.2.a. Longitud de catéter 142cm/ Catheter length 142cm**

**4.2.a.1 Balón 1.5 x 10mm/ Balloon 1.5 x 10mm**

**4.2.a.2. Balón 1.5 x 15mm/ Balloon 1.5 x 15mm**

**4.2.a.3 Balón 1.5 x 20mm/ Balloon 1.5 x 20mm**

**4.2.a.4 Balón 1.5 x 30mm/ Balloon 1.5 x 30mm**

**4.2.a.5 Balón 2.0 x 10mm/ Balloon 2.0x 10mm**

**4.2.a.6 Balón 2.0 x 15mm/ Balloon 2.0x 15mm**

**4.2.a.7 Balón 2.0 x 20mm/ Balloon 2.0x 20mm**

**4.2.a.8 Balón 2.0 x 25mm/ Balloon 2.0x 25mm**

**4.2.a.9. Balón 2.0 x 30mm/ Balloon 2.0x 30mm**

**4.2.a.10 Balón 2.0 x 40mm/ Balloon 2.0 x 40mm**

**4.2.a.11 Balón 2.25 x 10mm/ Balloon 2.25 x 10mm**

**4.2.a.12 Balón 2.25 x 15mm/ Balloon 2.25 x 15mm**

**4.2.a.13 Balón 2.25 x 20mm/ Balloon 2.25 x 20mm**

**4.2.a.14 Balón 2.25 x 25mm/ Balloon 2.25 x 25mm**

**4.2.a.15 Balón 2.25 x 30mm/ Balloon 2.25 x 30mm**

**4.2.a.16 Balón 2.25 x 40mm/ Balloon 2.25 x 40mm**

**4.2.a.17 Balón 2.5 x 10mm/ Balloon 2.5 x 10mm**

Agencia Española de Medicamentos y Productos Sanitarios (AEMPS)

Fecha de la firma: 30/07/2020

Puede comprobar la autenticidad del documento en la sede de la AEMPS: <https://localizador.aemps.es>

CSV: 2 K S D D N Q A 5 9



CORREO ELECTRÓNICO  
on0318@aemps.es

Página 40 de 44

C/ CAMPEZO, 1 - EDIFICIO 8  
28022 MADRID  
Tel.: (+34) 902.101.322 / (+34) 91.822.59.97  
Fax: (+34) 91.822.52.89

ORGANISMO NOTIFICADO 0318



**ANEXO N°/ANNEX NO: I**

**CERTIFICADO CE DE SISTEMA DE GARANTÍA DE CALIDAD TOTAL**  
de acuerdo con el Anexo II (excepto punto 4) de la Directiva 93/42/CEE

**EC FULL QUALITY ASSURANCE SYSTEM CERTIFICATE**  
*in accordance with Annex II (except Section 4) of Directive 93/42/EEC*

Certificado n°/Certificate no	Fecha de validez/Date of validity			ON n°/NB no	
<b>2012 07 0788 CT</b>	Desde/From	<b>31-07-2020</b>	Hasta/To	<b>26-05-2024</b>	<b>0318</b>

- 4.2.a.18 **Balón 2.5 x 15mm/ Balloon 2.5 x 15mm**
- 4.2.a.19 **Balón 2.5 x 20mm/ Balloon 2.5 x 20mm**
- 4.2.a.20 **Balón 2.5 x 25mm/ Balloon 2.5 x 25mm**
- 4.2.a.21 **Balón 2.5 x 30mm/ Balloon 2.5 x 30mm**
- 4.2.a.22 **Balón 2.5 x 40mm/ Balloon 2.5 x 40mm**
- 4.2.a.23 **Balón 2.75 x 10mm/ Balloon 2.75 x 10mm**
- 4.2.a.24 **Balón 2.75 x 15mm/ Balloon 2.75 x 15mm**
- 4.2.a.25 **Balón 2.75 x 20mm/ Balloon 2.75 x 20mm**
- 4.2.a.26 **Balón 2.75 x 25mm/ Balloon 2.75 x 25mm**
- 4.2.a.27 **Balón 2.75 x 30mm/ Balloon 2.75 x 30mm**
- 4.2.a.28 **Balón 2.75 x 40mm/ Balloon 2.75 x 40mm**
- 4.2.a.29 **Balón 3.0 x 10mm/ Balloon 3.0 x 10mm**
- 4.2.a.30 **Balón 3.0 x 15mm/ Balloon 3.0 x 15mm**
- 4.2.a.31 **Balón 3.0 x 20mm/ Balloon 3.0 x 20mm**
- 4.2.a.32 **Balón 3.0 x 25mm / Balloon 3.0 x 25mm**
- 4.2.a.33 **Balón 3.0 x 30mm/ Balloon 3.0 x 30mm**
- 4.2.a.34 **Balón 3.0 x 40mm/ Balloon 3.0 x 40mm**
- 4.2.a.35 **Balón 3.25 x 10mm/ Balloon 3.25 x 10mm**
- 4.2.a.36 **Balón 3.25 x 15mm/ Balloon 3.25 x 15mm**
- 4.2.a.37 **Balón 3.25 x 20mm/ Balloon 3.25 x 20mm**
- 4.2.a.38 **Balón 3.25 x 25mm/ Balloon 3.25 x 25mm**
- 4.2.a.39 **Balón 3.25 x 30mm/ Balloon 3.25 x 30mm**
- 4.2.a.40 **Balón 3.25 x 40mm/ Balloon 3.25 x 40mm**
- 4.2.a.41 **Balón 3.5 x 10mm/ Balloon 3.50 x 10mm**
- 4.2.a.42 **Balón 3.5 x 15mm/ Balloon 3.5 x 15mm**
- 4.2.a.43 **Balón 3.5 x 20mm/ Balloon 3.5 x 20mm**
- 4.2.a.44 **Balón 3.5 x 25mm/ Balloon 3.5 x 25mm**
- 4.2.a.45 **Balón 3.5 x 30mm/ Balloon 3.5 x 30mm**

MODELO-IP ANEXO II CT Cert. 93/42/IP-Rev1805/2020

Agencia Española de Medicamentos y Productos Sanitarios (AEMPS)  
Fecha de la firma: 30/07/2020  
Puede comprobar la autenticidad del documento en la sede de la AEMPS: <https://localizador.aemps.es>

CSV: 2 K S D D N Q A 5 9



CORREO ELECTRÓNICO  
on0318@aemps.es

Página 41 de 44

C/ CAMPEZO, 1 - EDIFICIO 8  
28022 MADRID  
Tel.: (+34) 902.101.322 / (+34) 91.822.59.97  
Fax: (+34) 91.822.52.89

ORGANISMO NOTIFICADO 0318



**ANEXO N°/ANNEX NO: I**

**CERTIFICADO CE DE SISTEMA DE GARANTÍA DE CALIDAD TOTAL  
de acuerdo con el Anexo II (excepto punto 4) de la Directiva 93/42/CEE**

**EC FULL QUALITY ASSURANCE SYSTEM CERTIFICATE  
in accordance with Annex II (except Section 4) of Directive 93/42/EEC**

Certificado n°/Certificate no	Fecha de validez/Date of validity			ON n°/NB no	
<b>2012 07 0788 CT</b>	Desde/From	<b>31-07-2020</b>	Hasta/To	<b>26-05-2024</b>	<b>0318</b>

- 4.2.a.46 Balón 3.5 x 40mm/ Balloon 3.5 x 40mm
- 4.2.a.47 Balón 3.75 x 10mm/ Balloon 3.75 x 10mm
- 4.2.a.48 Balón 3.75 x 15mm/ Balloon 3.75 x 15mm
- 4.2.a.49 Balón 3.75 x 20mm/ Balloon 3.75 x 20mm
- 4.2.a.50 Balón 3.75 x 25mm/ Balloon 3.75 x 25mm
- 4.2.a.51 Balón 3.75 x 30mm/ Balloon 3.75 x 30mm
- 4.2.a.52 Balón 3.75 x 40mm/ Balloon 3.75 x 40mm
- 4.2.a.53 Balón 4.0 x 10mm/ Balloon 4.0 x 10mm
- 4.2.a.54 Balón 4.0 x 15mm/ Balloon 4.0 x 15mm
- 4.2.a.55 Balón 4.0 x 20mm/ Balloon 4.0 x 20mm
- 4.2.a.56 Balón 4.0 x 25mm/ Balloon 4.0 x 25mm
- 4.2.a.57 Balón 4.0 x 30mm/ Balloon 4.0 x 30mm
- 4.2.a.58 Balón 4.0 x 40mm/ Balloon 4.0 x 40mm
- 4.2.a.59 Balón 4.5 x 10mm/ Balloon 4.5 x 10mm
- 4.2.a.60 Balón 4.5 x 15mm/ Balloon 4.5 x 15mm
- 4.2.a.61 Balón 4.5 x 20mm/ Balloon 4.5 x 20mm
- 4.2.a.62 Balón 4.5 x 25mm/ Balloon 4.5 x 25mm
- 4.2.a.63 Balón 4.5 x 30mm/ Balloon 4.5 x 30mm
- 4.2.a.64 Balón 4.5 x 40mm/ Balloon 4.5 x 40mm

**5. Catéter extractor de trombos/ Thrombus extraction catheter**

**Código NANDO: MD 106 y MDS 7006**

**5.1. Catéter extractor de trombos para guía de 0.014" "iVascular capturer"/ "iVascular capturer"  
Thrombus extraction catheter, for 0.014" guidewire**

**Los siguientes componentes se encuentran descritos en el certificado 2013 06 0799 ED  
/The followed components are described in the certificate 2013 06 0799 ED**

Agencia Española de Medicamentos y Productos Sanitarios (AEMPS)

Fecha de la firma: 30/07/2020

Puede comprobar la autenticidad del documento en la sede de la AEMPS: <https://localizador.aemps.es>

CSV: 2 K S D D N Q A 5 9



CORREO ELECTRÓNICO  
on0318@aemps.es

Página 42 de 44

C/ CAMPEZO, 1 - EDIFICIO 8  
28022 MADRID  
Tel.: (+34) 902.101.322 / (+34) 91.822.59.97  
Fax: (+34) 91.822.52.89

ORGANISMO NOTIFICADO 0318





**ANEXO N°/ANNEX NO: I**

**CERTIFICADO CE DE SISTEMA DE GARANTÍA DE CALIDAD TOTAL  
de acuerdo con el Anexo II (excepto punto 4) de la Directiva 93/42/CEE**

**EC FULL QUALITY ASSURANCE SYSTEM CERTIFICATE  
in accordance with Annex II (except Section 4) of Directive 93/42/EEC**

Certificado n°/Certificate no	Fecha de validez/Date of validity			ON n°/NB no	
<b>2012 07 0788 CT</b>	Desde/From	<b>31-07-2020</b>	Hasta/To	<b>26-05-2024</b>	<b>0318</b>

**5.1.a. Longitud de catéter 140cm/ Catheter length 140cm**

**5.1.a.1. Compatible con catéter guía de 6F/ 6F guide catheter compatible**

**5.1.a.2. Compatible con catéter guía de 7F/ 7F guide catheter compatible**

**Accesorios del producto/Product accessories:**

- Una llave de una vía/ One stopcock
- Una alargadera/ One extension line
- Dos cestos filtrantes/ Two filter baskets
- Dos jeringas de vacío de 30cc con émbolo de bloqueo/Two 30cc vacuum syringes with locking plunger

**5.2 Catéter extractor de trombos 10F para guía de 0.035 “iVascular nautilus”/iVascular nautilus  
Thrombus extraction catheter 10F, 0.035” guidewire**

**Los siguientes componentes se encuentran descritos en el certificado 2018 02 0870 ED  
/The followed components are described in the certificate 2018 02 0870 ED**

**Accesorios del producto/Product accessories:**

- Jeringa 60cc/One 60cc syringe
- Alargadera con regulador de flujo/One extension line with flow regulator
- Llave de tres vías/ Three Way Key

**6. Microcatéter/ Microcatheter**

**Los siguientes productos se encuentran descritos en el certificado ED 2018 11 0877 ED/  
The followed products are described in the certificate ED 2018 11 0877**

**6.1 Microcatéter coronario, “iVascular navitian”/ “iVascular navitian” Coronary microcatheter**

**6.1.a Compatible con guía de alambre 0.014” y longitud útil 135cm/ 0.014” guidewire  
compatible, useful length 135cm**

Agencia Española de Medicamentos y Productos Sanitarios (AEMPS)  
Fecha de la firma: 30/07/2020  
Puede comprobar la autenticidad del documento en la sede de la AEMPS:<https://localizador.aemps.es>

CSV: 2 K S D D N Q A 5 9



CORREO ELECTRÓNICO  
on0318@aemps.es

Página 43 de 44

C/ CAMPEZO, 1 - EDIFICIO 8  
28022 MADRID  
Tel.: (+34) 902.101.322 /(+34) 91.822.59.97  
Fax: (+34) 91.822.52.89

ORGANISMO NOTIFICADO 0318



**ANEXO N°/ANNEX NO: I**

**CERTIFICADO CE DE SISTEMA DE GARANTÍA DE CALIDAD TOTAL  
de acuerdo con el Anexo II (excepto punto 4) de la Directiva 93/42/CEE**

**EC FULL QUALITY ASSURANCE SYSTEM CERTIFICATE  
in accordance with Annex II (except Section 4) of Directive 93/42/EEC**

Certificado n°/Certificate no	Fecha de validez/Date of validity			ON n°/NB no	
<b>2012 07 0788 CT</b>	Desde/From	<b>31-07-2020</b>	Hasta/To	<b>26-05-2024</b>	<b>0318</b>

**6.1.b Compatible con guía de alambre 0.014" y longitud útil 150cm/ 0.014" guidewire compatible, useful length 150 cm**

**Este certificado ampara todas las marcas de estos productos incluidas por el fabricante en su declaración de conformidad.**

*This certificate covers all trademarks of these products included by the manufacturer in his declaration of conformity.*

Madrid, 30 de julio de 2020

DIRECTORA DE LA AGENCIA ESPAÑOLA DE MEDICAMENTOS Y PRODUCTOS SANITARIOS

 **agencia española de  
medicamentos y  
productos sanitarios**

Fdo. Mª Jesús Lamas Díaz

MODELO-IP ANEXO II CT Cert. 93/42/IP-Rev1805/2020

Agencia Española de Medicamentos y Productos Sanitarios (AEMPS)

Fecha de la firma: 30/07/2020

Puede comprobar la autenticidad del documento en la sede de la AEMPS: <https://localizador.aemps.es>

CSV: 2 K S D D N Q A 5 9



CORREO ELECTRÓNICO  
on0318@aemps.es

Página 44 de 44

C/ CAMPEZO, 1 - EDIFICIO 8  
28022 MADRID  
Tel.: (+34) 902.101.322 / (+34) 91.822.59.97  
Fax: (+34) 91.822.52.89

ORGANISMO NOTIFICADO 0318

**CERTIFICADO CE DE SISTEMA DE GARANTÍA DE CALIDAD TOTAL**  
**de acuerdo con el Anexo II (excepto punto 4) de la Directiva 93/42/CEE**  
**EC FULL QUALITY ASSURANCE SYSTEM CERTIFICATE**  
**in accordance with Annex II (except Section 4) of Directive 93/42/EEC**

<b>Certificado n°/Certificate no</b> <b>2013 07 0801 CT</b>	<b>Fecha de validez/Date of validity</b> <b>Desde/From 31-07-2020 Hasta/To 26-05-2024</b>	<b>ON n°/NB no</b> <b>0318</b>
--	--	-----------------------------------

**A favor de/In favour of:**

**Fabricante/Manufacturer:**

**Nombre/Name:** LIFE VASCULAR DEVICES BIOTECH S.L. (LVD BIOTECH)

**Dirección/Address:** Camí de Can Ubach, 11; Pol. Ind. Les Fallulles  
 08620 Sant Vicenç dels Horts- Barcelona-ESPAÑA

**Representante autorizado ante la UE/Authorized EU representative:** Idem

**Para el producto/For the product:**

**Categoría/Category:** Productos sanitarios implantables no activos/*Non-active implantable medical devices*

**Grupo genérico/ Generic group:** Especificado en Anexos de este Certificado/*Specified in Annexes to this Certificate/Haga clic o pulse aquí para escribir texto.*

**Tipo/Type:** Especificado en Anexos de este Certificado/*Specified in Annexes to this Certificate*

**Elaborado en/In the facilities:**

**Camí de Can Ubach, 11; Pol. Ind. Les Fallulles , 08620 Sant Vicenç dels Horts- Barcelona-ESPAÑA**

**Fecha inicial/ Initial date:** 3 -07-2013

**Fecha de prórroga anterior/ Previous extension date:** 21-07-2017

Este certificado debe ir acompañado por certificado de examen de diseño: en productos de clase III /*This certificate must be accompanied by design examination certificate: in class III products*

Este certificado es consecuencia de la auditoria del sistema completo de garantía de calidad y del examen de la documentación técnica contenida en el expediente nº 2012 01 0327, y garantiza que los productos descritos cumplen los requisitos de la Directiva./ *This certificate is issued on the full quality assurance system audit, and the examination of the technical documentation contained in dossier nº 2012 01 0327, and guarantees that the described products fulfils the requirements of the Directive*

Madrid, 29 de julio de 2020

DIRECTORA DE LA AGENCIA ESPAÑOLA DE MEDICAMENTOS Y PRODUCTOS SANITARIOS



agencia española de medicamentos y productos sanitarios

Fdo. Mª Jesús Lamas Díaz

Agencia Española de Medicamentos y Productos Sanitarios (AEMPS)

Fecha de la firma: 29/07/2020

Puede comprobar la autenticidad del documento en la sede de la AEMPS: <https://localizador.aemps.es>

CSV: BVEJQY597B



CORREO ELECTRÓNICO  
 on0318@aemps.es

Página 1 de 16

C/ CAMPEZO, 1 - EDIFICIO 8  
 28022 MADRID  
 Tel.: (+34) 902.101.322 / (+34) 91.822.59.97  
 Fax: (+34) 91.822.52.89

ORGANISMO NOTIFICADO 0318



**ANEXO N°/ANNEX NO: I**

**CERTIFICADO CE DE SISTEMA DE GARANTÍA DE CALIDAD TOTAL  
de acuerdo con el Anexo II (excepto punto 4) de la Directiva 93/42/CEE**

**EC FULL QUALITY ASSURANCE SYSTEM CERTIFICATE  
in accordance with Annex II (except Section 4) of Directive 93/42/EEC**

Certificado n°/Certificate no	Fecha de validez/Date of validity			ON n°/NB no	
<b>2013 07 0801 CT</b>	Desde/From	<b>31-07-2020</b>	Hasta/To	<b>26-05-2024</b>	<b>0318</b>

**A favor de/In favour of:**

**Fabricante/Manufacturer:**

**Nombre/Name:** LIFE VASCULAR DEVICES BIOTECH S.L. (LVD BIOTECH)

**Dirección/Address:** Camí de Can Ubach, 11; Pol. Ind. Les Fallulles  
08620 Sant Vicenç dels Horts- Barcelona-ESPAÑA

**Representante autorizado ante la UE/Authorized EU representative: Idem**

**Tipo de producto / Devices type:** Los relacionados a continuación/The list below

**Clasificación/Classification:** IIb

**1. Sistema de stent periférico / Peripheral stent system Código NANDO: MD 0201 y MDS 7006**

**1.1. Sistema de stent periférico CoCr para guía de 0.035” "iVascular restorer"/ "iVascular restorer"  
Peripheral CoCr stent system for 0.035” guidewire**

**1.1.a. Longitud de catéter 80cm/ Catheter length 80cm**

- 1.1.a.1. Stent 5.0 x 18mm/ Stent 5.0 x 18mm
- 1.1.a.2. Stent 5.0 x 28mm/ Stent 5.0 x 28mm
- 1.1.a.3. Stent 5.0 x 38mm/ Stent 5.0 x 38mm
- 1.1.a.4. Stent 5.0 x 58mm/ Stent 5.0 x 58mm
- 1.1.a.5. Stent 6.0 x 18mm/ Stent 6.0 x 18mm
- 1.1.a.6. Stent 6.0 x 28mm/ Stent 6.0 x 28mm
- 1.1.a.7. Stent 6.0 x 38mm/ Stent 6.0 x 38mm
- 1.1.a.8. Stent 6.0 x 58mm/ Stent 6.0 x 58mm
- 1.1.a.9. Stent 7.0 x 18mm/ Stent 7.0 x 18mm
- 1.1.a.10. Stent 7.0 x 28mm/ Stent 7.0 x 28mm
- 1.1.a.11. Stent 7.0 x 38mm/ Stent 7.0 x 38mm
- 1.1.a.12. Stent 7.0 x 58mm/ Stent 7.0 x 58mm
- 1.1.a.13. Stent 8.0 x 18mm/ Stent 8.0 x 18mm
- 1.1.a.14. Stent 8.0 x 28mm/ Stent 8.0 x 28mm
- 1.1.a.15. Stent 8.0 x 38mm/ Stent 8.0 x 38mm

Agencia Española de Medicamentos y Productos Sanitarios (AEMPS)

Fecha de la firma: 29/07/2020

Puede comprobar la autenticidad del documento en la sede de la AEMPS: <https://localizador.aemps.es>

CSV: BVEJQY597B



CORREO ELECTRÓNICO  
on0318@aemps.es

Página 2 de 16

C/ CAMPEZO, 1 - EDIFICIO 8  
28022 MADRID  
Tel.: (+34) 902.101.322 / (+34) 91.822.59.97  
Fax: (+34) 91.822.52.89

ORGANISMO NOTIFICADO 0318



**ANEXO N°/ANNEX NO: I**

**CERTIFICADO CE DE SISTEMA DE GARANTÍA DE CALIDAD TOTAL  
de acuerdo con el Anexo II (excepto punto 4) de la Directiva 93/42/CEE**

**EC FULL QUALITY ASSURANCE SYSTEM CERTIFICATE  
in accordance with Annex II (except Section 4) of Directive 93/42/EEC**

<b>Certificado n°/Certificate no</b>	<b>Fecha de validez/Date of validity</b>			<b>ON n°/NB no</b>	
<b>2013 07 0801 CT</b>	<b>Desde/From</b>	<b>31-07-2020</b>	<b>Hasta/To</b>	<b>26-05-2024</b>	<b>0318</b>

- 1.1.a.16. Stent 8.0 x 58mm/ Stent 8.0 x 58mm
- 1.1.a.17. Stent 9.0 x 18mm/ Stent 9.0.x 18mm
- 1.1.a.18. Stent 9.0 x 28mm/ Stent 9.0.x 28mm
- 1.1.a.19. Stent 9.0 x 38mm/ Stent 9.0 x 38.mm
- 1.1.a.20. Stent 9.0 x 58mm/ Stent 9.0 x 58mm
- 1.1.a.21. Stent 10.0 x 18mm/ Stent 10.0 x 18mm
- 1.1.a.22. Stent 10.0 x 28mm/ Stent 10.0 x 28mm
- 1.1.a.23. Stent 10.0 x 38mm/ Stent 10.0 x 38mm
- 1.1.a.24. Stent 10.0 x 58mm/ Stent 10.0 x 58mm

**1.1.b Longitud de catéter 140cm/ Catheter length 140cm**

- 1.1.b.1 Stent 5.0 x 18mm/ Stent 5.0 x 18mm
- 1.1.b.2 Stent 5.0 x 28mm/ Stent 5.0 x 28mm
- 1.1.b.3 Stent 5.0 x 38mm/ Stent 5.0 x 38mm
- 1.1.b.4 Stent 5.0 x 58mm/ Stent 5.0 x 58mm
- 1.1.b.5 Stent 6.0 x 18mm/ Stent 6.0 x 18mm
- 1.1.b.6 Stent 6.0 x 28mm/ Stent 6.0 x 28mm
- 1.1.b.7 Stent 6.0 x 38mm/ Stent 6.0 x 38mm
- 1.1.b.8 Stent 6.0 x 58mm/ Stent 6.0 x 58mm
- 1.1.b.9 Stent 7.0 x 18mm/ Stent 7.0 x 18mm
- 1.1.b.10 Stent 7.0 x 28mm/ Stent 7.0 x 28mm
- 1.1.b.11 Stent 7.0 x 38mm/ Stent 7.0 x 38mm
- 1.1.b.12 Stent 7.0 x 58mm/ Stent 7.0 x 58mm
- 1.1.b.13 Stent 8.0 x 18mm/ Stent 8.0 x 18mm
- 1.1.b.14 Stent 8.0 x 28mm/ Stent 8.0 x 28mm
- 1.1.b.15 Stent 8.0 x 38mm/ Stent 8.0 x 38mm
- 1.1.b.16 Stent 8.0 x 58mm/ Stent 8.0 x 58mm
- 1.1.b.17 Stent 9.0 x 18mm/ Stent 9.0 x 18mm

Agencia Española de Medicamentos y Productos Sanitarios (AEMPS)

Fecha de la firma: 29/07/2020

Puede comprobar la autenticidad del documento en la sede de la AEMPS: <https://localizador.aemps.es>

CSV: BVEJQY597B



CORREO ELECTRÓNICO  
on0318@aemps.es

Página 3 de 16

C/ CAMPEZO, 1 - EDIFICIO 8  
28022 MADRID  
Tel.: (+34) 902.101.322 / (+34) 91.822.59.97  
Fax: (+34) 91.822.52.89

ORGANISMO NOTIFICADO 0318





**ANEXO N°/ANNEX NO: I**

**CERTIFICADO CE DE SISTEMA DE GARANTÍA DE CALIDAD TOTAL  
de acuerdo con el Anexo II (excepto punto 4) de la Directiva 93/42/CEE**

**EC FULL QUALITY ASSURANCE SYSTEM CERTIFICATE  
in accordance with Annex II (except Section 4) of Directive 93/42/EEC**

Certificado n°/Certificate no	Fecha de validez/Date of validity	ON n°/NB no
<b>2013 07 0801 CT</b>	<b>Desde/From 31-07-2020 Hasta/To 26-05-2024</b>	<b>0318</b>

- 1.1.b.18 Stent 9.0 x 28mm/ Stent 9.0 x 28mm
- 1.1.b.19 Stent 9.0 x 38mm/ Stent 9.0 x 38mm
- 1.1.b.20 Stent 9.0 x 58mm/ Stent 9.0 x 58mm
- 1.1.b.21 Stent 10.0 x 18mm/ Stent 10.0 x 18mm
- 1.1.b.22 Stent 10.0 x 28mm/ Stent 10.0 x 28mm
- 1.1.b.23 Stent 10.0 x 38mm/ Stent 10.0 x 38mm
- 1.1.b.24 Stent 10.0x 58mm/ Stent 10. 0x 58mm

**2. Sistema de stent periférico autoexpandible/ Self expanding peripheral stent system**

**2.1. Sistema de stent periférico autoexpandible NiTi para guía de 0.035” "iVascular iVolution” /  
“iVascular iVolution” NiTi self expanding peripheral stent system for 0.035” guidewire**

**1.1.a. Longitud de catéter 80cm/ Catheter length 80cm**

- 1.1.a.1. Stent 5.0 x 40mm/ Stent 5.0 x 40mm
- 1.1.a.2. Stent 5.0 x 60mm/ Stent 5.0 x 60mm
- 1.1.a.3. Stent 5.0 x 80mm/ Stent 5.0 x 80mm
- 1.1.a.4. Stent 5.0 x100mm/Stent 5.0 x 100mm
- 1.1.a.5. Stent 5.0 x 150mm/ Stent 5.0 x 150mm
- 1.1.a.6. Stent 5.0 x 200mm/Stent 5.0 x 200mm
- 1.1.a.7. Stent 6.0 x 40mm/Stent 6.0 x 40mm
- 1.1.a.8. Stent 6.0 x 60mm/ Stent 6.0 x 60mm
- 1.1.a.9. Stent 6.0 x 80mm/Stent 6.0 x 80mm
- 1.1.a.10. Stent 6.0 x 100mm/Stent 6.0 x 100mm
- 1.1.a.11. Stent 6.0 x 150mm/ Stent 6.0 x 150mm
- 1.1.a.12. Stent 6.0 x 200mm/Stent 6.0 x 200mm
- 1.1.a.13. Stent 7.0 x 40mm/ Stent 7.0 x 40mm
- 1.1.a.14. Stent 7.0 x 60mm/ Stent 7.0.x 60mm
- 1.1.a.15. Stent 7.0 x 80mm/ Stent 7.0 x 80mm

Agencia Española de Medicamentos y Productos Sanitarios (AEMPS)

Fecha de la firma: 29/07/2020

Puede comprobar la autenticidad del documento en la sede de la AEMPS:<https://localizador.aemps.es>

CSV: BVEJQY597B



CORREO ELECTRÓNICO  
on0318@aemps.es

Página 4 de 16

ORGANISMO NOTIFICADO 0318

C/ CAMPEZO, 1 - EDIFICIO 8  
28022 MADRID  
Tel.: (+34) 902.101.322 /(+34) 91.822.59.97  
Fax: (+34) 91.822.52.89



**ANEXO N°/ANNEX NO: I**

**CERTIFICADO CE DE SISTEMA DE GARANTÍA DE CALIDAD TOTAL  
de acuerdo con el Anexo II (excepto punto 4) de la Directiva 93/42/CEE**

**EC FULL QUALITY ASSURANCE SYSTEM CERTIFICATE  
in accordance with Annex II (except Section 4) of Directive 93/42/EEC**

<b>Certificado n°/Certificate no</b>	<b>Fecha de validez/Date of validity</b>			<b>ON n°/NB no</b>	
<b>2013 07 0801 CT</b>	<b>Desde/From</b>	<b>31-07-2020</b>	<b>Hasta/To</b>	<b>26-05-2024</b>	<b>0318</b>

- 1.1.a.16. Stent 7.0 x 100mm/ *Stent 7.0 x 100mm*
- 1.1.a.17. Stent 7.0 x 150mm/ *Stent 7.0 x 150mm*
- 1.1.a.18. Stent 7.0 x 200mm/ *Stent 7.0 x 200mm*
- 1.1.a.19. Stent 8.0 x 40mm/ *Stent 8.0 x 40mm*
- 1.1.a.20. Stent 8.0 x 60mm/ *Stent 8.0 x 60mm*
- 1.1.a.21. Stent 8.0 x 80mm/ *Stent 8.0 x 80mm*
- 1.1.a.22. Stent 8.0 x 100mm/ *Stent 8.0 x 100mm*
- 1.1.a.23. Stent 8.0 x 150mm/ *Stent 8.0 x 150mm*
- 1.1.a.24. Stent 9.0 x 40mm/ *Stent 9.0 x 40mm*
- 1.1.a.25. Stent 9.0 x 60mm/ *Stent 9.0 x 60mm*
- 1.1.a.26. Stent 9.0 x 80mm/ *Stent 9.0 x 80mm*
- 1.1.a.27. Stent 9.0 x 100mm/ *Stent 9.0 x 100mm*
- 1.1.a.28. Stent 10.0 x 40mm/ *Stent 10.0 x 40mm*
- 1.1.a.29. Stent 10.0 x 60mm/ *Stent 10.0 x 60mm*
- 1.1.a.30. Stent 10.0 x 80mm/ *Stent 10.0 x 80mm*
- 1.1.a.31. Stent 10.0 x 100mm/ *Stent 10.0 x 100mm*

**2.1.b. Longitud de catéter 140cm/ *Catheter length 140cm***

- 2.1.b.1 Stent 5.0 x 40mm/ *Stent 5.0 x 40mm*
- 2.1.b.2 Stent 5.0 x 60mm/ *Stent 5.0 x 60mm*
- 2.1.b.3 Stent 5.0 x 80mm/ *Stent 5.0 x 80mm*
- 2.1.b.4 Stent 5.0 x 100mm/ *Stent 5.0 x 100mm*
- 2.1.b.5 Stent 5.0 x 150mm/ *Stent 5.0 x 150mm*
- 2.1.b.6 Stent 5.0 x 200mm/ *Stent 5.0 x 200mm*
- 2.1.b.7 Stent 6.0 x 40mm/ *Stent 6.0 x 40mm*
- 2.1.b.8 Stent 6.0 x 60mm/ *Stent 6.0 x 60mm*
- 2.1.b.9 Stent 6.0 x 80mm/ *Stent 6.0 x 80mm*
- 2.1.b.10 Stent 6.0 x 100mm/ *Stent 6.0 x 100mm*

MODELO-IP ANEXO II CT Cert. 93/42/IP-Rev1805/2020

Agencia Española de Medicamentos y Productos Sanitarios (AEMPS)

Fecha de la firma: 29/07/2020

Puede comprobar la autenticidad del documento en la sede de la AEMPS: <https://localizador.aemps.es>

CSV: BVEJQY597B



CORREO ELECTRÓNICO  
on0318@aemps.es

Página 5 de 16

ORGANISMO NOTIFICADO 0318

C/ CAMPEZO, 1 - EDIFICIO 8  
28022 MADRID  
Tel.: (+34) 902.101.322 / (+34) 91.822.59.97  
Fax: (+34) 91.822.52.89



**ANEXO N°/ANNEX NO: I**

**CERTIFICADO CE DE SISTEMA DE GARANTÍA DE CALIDAD TOTAL  
de acuerdo con el Anexo II (excepto punto 4) de la Directiva 93/42/CEE**

**EC FULL QUALITY ASSURANCE SYSTEM CERTIFICATE  
in accordance with Annex II (except Section 4) of Directive 93/42/EEC**

Certificado n°/Certificate no	Fecha de validez/Date of validity	ON n°/NB no
<b>2013 07 0801 CT</b>	<b>Desde/From 31-07-2020 Hasta/To 26-05-2024</b>	<b>0318</b>

- 2.1.b.11 Stent 6.0 x 150mm/ Stent 6.0 x 150mm
- 2.1.b.12 Stent 6.0 x 200mm/ Stent 6.0 x 200mm
- 2.1.b.13 Stent 7.0 x 40mm/ Stent 7.0 x 40mm
- 2.1.b.14 Stent 7.0 x 60mm/ Stent 7.0 x 60mm
- 2.1.b.15 Stent 7.0 x 80mm/ Stent 7.0 x 80mm
- 2.1.b.16 Stent 7.0 x 100mm/ Stent 7.0 x 100mm
- 2.1.b.17 Stent 7.0 x 150mm/ Stent 7.0 x 150mm
- 2.1.b.18 Stent 7.0 x 200mm/ Stent 7.0 x 200mm
- 2.1.b.19 Stent 8.0 x 40mm/ Stent 8.0 x 40mm
- 2.1.b.20 Stent 8.0 x 60mm/ Stent 8.0 x 60mm
- 2.1.b.21 Stent 8.0 x 80mm/ Stent 8.0 x 80mm
- 2.1.b.22 Stent 8.0 x 100mm/ Stent 8.0 x 100mm
- 2.1.b.23 Stent 8.0 x 150mm/ Stent 8.0 x 150mm
- 2.1.b.24 Stent 9.0 x 40mm/ Stent 9.0 x 40mm
- 2.1.b.25 Stent 9.0 x 60mm/ Stent 9.0 x 60mm
- 2.1.b.26 Stent 9.0 x 80mm/ Stent 9.0 x 80mm
- 2.1.b.27 Stent 9.0 x 100mm/ Stent 9.0 x 100mm
- 2.1.b.28 Stent 10.0 x 40mm/ Stent 10.0 x 40mm
- 2.1.b.29 Stent 10.0 x 60mm/ Stent 10.0 x 60mm
- 2.1.b.30 Stent 10.0 x 80mm/ Stent 10.0 x 80mm
- 2.1.b.31 Stent 10.0 x 100mm/ Stent 10.0 x 100mm

**2.2 Sistema de stent periférico autoexpandible NiTi para guía de 0.035”, iVascular iVolution pro /  
iVascular iVolution pro, NiTi self expanding peripheral stent system for 0.035” guidewire**

**2.2.a Longitud de catéter 80cm/ Catheter length 80cm**

- 2.2.a.1 Stent 5.0 x 40mm/ Stent 5.0 x 40mm
- 2.2.a.2 Stent 5.0 x 60mm/ Stent 5.0 x 60mm
- 2.2.a.3 Stent 5.0 x 80mm/ Stent 5.0 x 80mm

Agencia Española de Medicamentos y Productos Sanitarios (AEMPS)

Fecha de la firma: 29/07/2020

Puede comprobar la autenticidad del documento en la sede de la AEMPS: <https://localizador.aemps.es>

CSV: BVEJQY597B



CORREO ELECTRÓNICO  
on0318@aemps.es

Página 6 de 16

ORGANISMO NOTIFICADO 0318

C/ CAMPEZO, 1 - EDIFICIO 8  
28022 MADRID  
Tel.: (+34) 902.101.322 / (+34) 91.822.59.97  
Fax: (+34) 91.822.52.89



**ANEXO N°/ANNEX NO: I**

**CERTIFICADO CE DE SISTEMA DE GARANTÍA DE CALIDAD TOTAL  
de acuerdo con el Anexo II (excepto punto 4) de la Directiva 93/42/CEE**

**EC FULL QUALITY ASSURANCE SYSTEM CERTIFICATE  
in accordance with Annex II (except Section 4) of Directive 93/42/EEC**

<b>Certificado n°/Certificate no</b>	<b>Fecha de validez/Date of validity</b>			<b>ON n°/NB no</b>	
<b>2013 07 0801 CT</b>	<b>Desde/From</b>	<b>31-07-2020</b>	<b>Hasta/To</b>	<b>26-05-2024</b>	<b>0318</b>

- 2.2.a.4 Stent 5.0 x 100mm/ Stent 5.0 x 100mm
- 2.2.a.5 Stent 5.0 x 150mm/ Stent 5.0 x 150mm
- 2.2.a.6 Stent 5.0 x 200mm/ Stent 5.0 x 200mm
- 2.2.a.7 Stent 6.0 x 40mm/ Stent 6.0 x 40mm
- 2.2.a.8 Stent 6.0 x 60mm/ Stent 6.0 x 60mm
- 2.2.a.9 Stent 6.0 x 80mm/ Stent 6.0 x 80mm
- 2.2.a.10 Stent 6.0 x 100mm/ Stent 6.0 x 100mm
- 2.2.a.11 Stent 6.0 x 150mm/ Stent 6.0 x 150mm
- 2.2.a.12 Stent 6.0 x 200mm/ Stent 6.0 x 200mm
- 2.2.a.13 Stent 7.0 x 40mm/ Stent 7.0 x 40mm
- 2.2.a.14 Stent 7.0 x 60mm/ Stent 7.0 x 60mm
- 2.2.a.15 Stent 7.0 x 80mm/ Stent 7.0 x 80mm
- 2.2.a.16 Stent 7.0 x 100mm/ Stent 7.0 x 100mm
- 2.2.a.17 Stent 7.0 x 150mm/ Stent 7.0 x 150mm
- 2.2.a.18 Stent 7.0 x 200mm/ Stent 7.0 x 200mm
- 2.2.a.19 Stent 8.0 x 40mm/ Stent 8.0 x 40mm
- 2.2.a.20 Stent 8.0 x 60mm/ Stent 8.0 x 60mm
- 2.2.a.21 Stent 8.0 x 80mm/ Stent 8.0 x 80mm
- 2.2.a.22 Stent 8.0 x 100mm/ Stent 8.0 x 100mm
- 2.2.a.23 Stent 8.0 x 150mm/ Stent 8.0 x 150mm
- 2.2.a.24 Stent 9.0 x 40mm/ Stent 9.0 x 40mm
- 2.2.a.25 Stent 9.0 x 60mm/ Stent 9.0 x 60mm
- 2.2.a.26 Stent 9.0 x 80mm/ Stent 9.0 x 80mm
- 2.2.a.27 Stent 9.0 x 100mm/ Stent 9.0 x 100mm
- 2.2.a.28 Stent 10.0 x 40mm/ Stent 10.0 x 40mm
- 2.2.a.29 Stent 10.0 x 60mm/ Stent 10.0 x 60mm
- 2.2.a.30 Stent 10.0 x 80mm/ Stent 10.0 x 80mm
- 2.2.a.31 Stent 10.0 x 100mm/ Stent 10.0 x 100mm

MODELO-IP ANEXO II CT Cert. 93/42/IP-Rev1805/2020

Agencia Española de Medicamentos y Productos Sanitarios (AEMPS)

Fecha de la firma: 29/07/2020

Puede comprobar la autenticidad del documento en la sede de la AEMPS: <https://localizador.aemps.es>

CSV: BVEJQY597B



CORREO ELECTRÓNICO  
on0318@aemps.es

Página 7 de 16

C/ CAMPEZO, 1 - EDIFICIO 8  
28022 MADRID  
Tel.: (+34) 902.101.322 / (+34) 91.822.59.97  
Fax: (+34) 91.822.52.89

ORGANISMO NOTIFICADO 0318



**ANEXO N°/ANNEX NO: I**

**CERTIFICADO CE DE SISTEMA DE GARANTÍA DE CALIDAD TOTAL  
de acuerdo con el Anexo II (excepto punto 4) de la Directiva 93/42/CEE**

**EC FULL QUALITY ASSURANCE SYSTEM CERTIFICATE  
in accordance with Annex II (except Section 4) of Directive 93/42/EEC**

<b>Certificado n°/Certificate no</b>	<b>Fecha de validez/Date of validity</b>			<b>ON n°/NB no</b>	
<b>2013 07 0801 CT</b>	<b>Desde/From</b>	<b>31-07-2020</b>	<b>Hasta/To</b>	<b>26-05-2024</b>	<b>0318</b>

**2.2.b. Longitud de catéter 130cm/ Catheter length 130cm**

- 2.2.b.1 Stent 5.0 x 40mm/ Stent 5.0 x 40mm
- 2.2.b.2 Stent 5.0 x 60mm/ Stent 5.0 x 60mm
- 2.2.b.3 Stent 5.0 x 80mm/ Stent 5.0 x 80mm
- 2.2.b.4 Stent 5.0 x 100mm/ Stent 5.0 x 100mm
- 2.2.b.5 Stent 5.0 x 150mm/ Stent 5.0 x 150mm
- 2.2.b.6 Stent 5.0 x 200mm/ Stent 5.0 x 200mm
- 2.2.b.7 Stent 6.0 x 40mm/ Stent 6.0 x 40mm
- 2.2.b.8 Stent 6.0 x 60mm/ Stent 6.0 x 60mm
- 2.2.b.9 Stent 6.0 x 80mm/ Stent 6.0 x 80mm
- 2.2.b.10 Stent 6.0 x 100mm/ Stent 6.0 x 100mm
- 2.2.b.11 Stent 6.0 x 150mm/ Stent 6.0 x 150mm
- 2.2.b.12 Stent 6.0 x 200mm/ Stent 6.0 x 200mm
- 2.2.b.13 Stent 7.0 x 40mm/ Stent 7.0 x 40mm
- 2.2.b.14 Stent 7.0 x 60mm/ Stent 7.0 x 60mm
- 2.2.b.15 Stent 7.0 x 80mm/ Stent 7.0 x 80mm
- 2.2.b.16 Stent 7.0 x 100mm/ Stent 7.0 x 100mm
- 2.2.b.17 Stent 7.0 x 150mm/ Stent 7.0 x 150mm
- 2.2.b.18 Stent 7.0 x 200mm/ Stent 7.0 x 200mm
- 2.2.b.19 Stent 8.0 x 40mm/ Stent 8.0 x 40mm
- 2.2.b.20 Stent 8.0 x 60mm/ Stent 8.0 x 60mm
- 2.2.b.21 Stent 8.0 x 80mm/ Stent 8.0 x 80mm
- 2.2.b.22 Stent 8.0 x 100mm/ Stent 8.0 x 100mm
- 2.2.b.23 Stent 8.0 x 150mm/ Stent 8.0 x 150mm
- 2.2.b.24 Stent 9.0 x 40mm/ Stent 9.0 x 40mm
- 2.2.b.25 Stent 9.0 x 60mm/ Stent 9.0 x 60mm
- 2.2.b.26 Stent 9.0 x 80mm/ Stent 9.0 x 80mm
- 2.2.b.27 Stent 9.0 x 100mm/ Stent 9.0 x 100mm

Agencia Española de Medicamentos y Productos Sanitarios (AEMPS)

Fecha de la firma: 29/07/2020

Puede comprobar la autenticidad del documento en la sede de la AEMPS: <https://localizador.aemps.es>

CSV: BVEJQY597B



CORREO ELECTRÓNICO  
on0318@aemps.es

Página 8 de 16

C/ CAMPEZO, 1 - EDIFICIO 8  
28022 MADRID  
Tel.: (+34) 902.101.322 / (+34) 91.822.59.97  
Fax: (+34) 91.822.52.89

ORGANISMO NOTIFICADO 0318





ANEXO N°/ANNEX NO: I

**CERTIFICADO CE DE SISTEMA DE GARANTÍA DE CALIDAD TOTAL**  
de acuerdo con el Anexo II (excepto punto 4) de la Directiva 93/42/CEE

**EC FULL QUALITY ASSURANCE SYSTEM CERTIFICATE**  
in accordance with Annex II (except Section 4) of Directive 93/42/EEC

Certificado n°/Certificate no	Fecha de validez/Date of validity	ON n°/NB no
<b>2013 07 0801 CT</b>	<b>Desde/From 31-07-2020 Hasta/To 26-05-2024</b>	<b>0318</b>

- 2.2.b.28 Stent 10.0 x 40mm/ Stent 10.0 x 40mm
- 2.2.b.29 Stent 10.0 x 60mm/ Stent 10.0 x 60mm
- 2.2.b.30 Stent 10.0 x 80mm/ Stent 10.0 x 80mm
- 2.2.b.31 Stent 10.0 x 100mm/ Stent 10.0 x 100mm

**Clasificación/Classification: III**

**3. Sistema de stent coronario / Coronary stent system Código NANDO: MD 0201 y MDS 7006**

**3.1. Sistema de stent coronario CoCr "iVascular architect"/"iVascular architect" CoCr coronary stent system**

Los siguientes productos se encuentran descritos en el certificado 2013 03 0797 ED/ The followed products are described in the certificate 2013 03 0797 ED.

**3.1.a. Longitud de catéter 142cm/ Catheter length 142cm**

- 3.1.a.1 Stent 2.0 x 9mm/ Stent 2.0 x 9mm
- 3.1.a.2 Stent 2.0 x 14mm/ Stent 2.0 x 14mm
- 3.1.a.3 Stent 2.0 x 16mm/ Stent 2.0 x 16mm
- 3.1.a.4 Stent 2.0 x 19mm/ Stent 2.0 x 19mm
- 3.1.a.5 Stent 2.0 x 24mm/ Stent 2.0 x 24mm
- 3.1.a.6 Stent 2.0 x 29mm/ Stent 2.0 x 29mm
- 3.1.a.7 Stent 2.0 x 34mm/ Stent 2.0 x 34mm
- 3.1.a.8 Stent 2.0 x 39mm/ Stent 2.0 x 39mm
- 3.1.a.9 Stent 2.25 x 9mm/ Stent 2.25 x 9mm
- 3.1.a.10 Stent 2.25 x 14mm/ Stent 2.25 x 14mm
- 3.1.a.11 Stent 2.25 x 16mm/ Stent 2.25 x 16mm
- 3.1.a.12 Stent 2.25 x 19mm/ Stent 2.25 x 19mm
- 3.1.a.13 Stent 2.25 x 24mm/ Stent 2.25 x 24mm
- 3.1.a.14 Stent 2.25 x 29mm/ Stent 2.25 x 29mm
- 3.1.a.15 Stent 2.25 x 34mm/ Stent 2.25 x 34mm
- 3.1.a.16 Stent 2.25 x 39mm/ Stent 2.25 x 39mm

Agencia Española de Medicamentos y Productos Sanitarios (AEMPS)

Fecha de la firma: 29/07/2020

Puede comprobar la autenticidad del documento en la sede de la AEMPS: <https://localizador.aemps.es>

CSV: BVEJQY597B



CORREO ELECTRÓNICO  
on0318@aemps.es

Página 9 de 16

ORGANISMO NOTIFICADO 0318

C/ CAMPEZO, 1 - EDIFICIO 8  
28022 MADRID  
Tel.: (+34) 902.101.322 / (+34) 91.822.59.97  
Fax: (+34) 91.822.52.89



**ANEXO N°/ANNEX NO: I**

**CERTIFICADO CE DE SISTEMA DE GARANTÍA DE CALIDAD TOTAL**  
**de acuerdo con el Anexo II (excepto punto 4) de la Directiva 93/42/CEE**

**EC FULL QUALITY ASSURANCE SYSTEM CERTIFICATE**  
**in accordance with Annex II (except Section 4) of Directive 93/42/EEC**

<b>Certificado n°/Certificate no</b>	<b>Fecha de validez/Date of validity</b>			<b>ON n°/NB no</b>	
<b>2013 07 0801 CT</b>	<b>Desde/From</b>	<b>31-07-2020</b>	<b>Hasta/To</b>	<b>26-05-2024</b>	<b>0318</b>

- 3.1.a.17 Stent 2.5 x 9mm/ Stent 2.5 x 9mm
- 3.1.a.18 Stent 2.5 x 14mm/ Stent 2.5 x 14mm
- 3.1.a.19 Stent 2.5 x 16mm/ Stent 2.5 x 16mm
- 3.1.a.20 Stent 2.5 x 19mm/ Stent 2.5 x 19mm
- 3.1.a.21 Stent 2.5 x 24mm/ Stent 2.5 x 24mm
- 3.1.a.22 Stent 2.5 x 29mm/ Stent 2.5 x 29mm
- 3.1.a.23 Stent 2.5 x 34mm/ Stent 2.5 x 34mm
- 3.1.a.24 Stent 2.5 x 39mm/ Stent 2.5 x 39mm
- 3.1.a.25 Stent 2.75 x 9mm/ Stent 2.75 x 9mm
- 3.1.a.26 Stent 2.75 x 14mm/ Stent 2.75 x 14mm
- 3.1.a.27 Stent 2.75 x 16mm/ Stent 2.75 x 16mm
- 3.1.a.28 Stent 2.75 x 19mm/ Stent 2.75 x 19mm
- 3.1.a.29 Stent 2.75 x 24mm/ Stent 2.75 x 24mm
- 3.1.a.30 Stent 2.75 x 29mm/ Stent 2.75 x 29mm
- 3.1.a.31 Stent 2.75 x 34mm/ Stent 2.75 x 34mm
- 3.1.a.32 Stent 2.75 x 39mm/ Stent 2.75 x 39mm
- 3.1.a.33 Stent 3.0 x 9mm/ Stent 3.0 x 9mm
- 3.1.a.34 Stent 3.0 x 14mm/ Stent 3.0 x 14mm
- 3.1.a.35 Stent 3.0 x 16mm/ Stent 3.0 x 16mm
- 3.1.a.36 Stent 3.0 x 19mm/ Stent 3.0 x 19mm
- 3.1.a.37 Stent 3.0 x 24mm/ Stent 3.0 x 24mm
- 3.1.a.38 Stent 3.0 x 29mm/ Stent 3.0 x 29mm
- 3.1.a.39 Stent 3.0 x 34mm/ Stent 3.0 x 34mm
- 3.1.a.40 Stent 3.0 x 39mm/ Stent 3.0 x 39mm
- 3.1.a.41 Stent 3.5 x 9mm/ Stent 3.5 x 9mm
- 3.1.a.42 Stent 3.5 x 14mm/ Stent 3.5 x 14mm
- 3.1.a.43 Stent 3.5 x 16mm/ Stent 3.5 x 16mm
- 3.1.a.44 Stent 3.5 x 19mm/ Stent 3.5 x 19mm
- 3.1.a.45 Stent 3.5 x 24mm/ Stent 3.5 x 24mm
- 3.1.a.46 Stent 3.5 x 29mm/ Stent 3.5 x 29mm
- 3.1.a.47 Stent 3.5 x 34mm/ Stent 3.5 x 34mm
- 3.1.a.48 Stent 3.5 x 39mm/ Stent 3.5 x 39mm

Agencia Española de Medicamentos y Productos Sanitarios (AEMPS)

Fecha de la firma: 29/07/2020

Puede comprobar la autenticidad del documento en la sede de la AEMPS: <https://localizador.aemps.es>

CSV: BVEJQY597B



CORREO ELECTRÓNICO  
on0318@aemps.es

Página 10 de 16

ORGANISMO NOTIFICADO 0318

C/ CAMPEZO, 1 - EDIFICIO 8  
28022 MADRID  
Tel.: (+34) 902.101.322 / (+34) 91.822.59.97  
Fax: (+34) 91.822.52.89



**ANEXO N°/ANNEX NO: I**

**CERTIFICADO CE DE SISTEMA DE GARANTÍA DE CALIDAD TOTAL  
de acuerdo con el Anexo II (excepto punto 4) de la Directiva 93/42/CEE**

**EC FULL QUALITY ASSURANCE SYSTEM CERTIFICATE  
in accordance with Annex II (except Section 4) of Directive 93/42/EEC**

Certificado n°/Certificate no	Fecha de validez/Date of validity	ON n°/NB no
<b>2013 07 0801 CT</b>	<b>Desde/From 31-07-2020 Hasta/To 26-05-2024</b>	<b>0318</b>

- 3.1.a.49 Stent 4.0 x 9mm/ Stent 4.0 x 9mm
- 3.1.a.50 Stent 4.0 x 14mm/ Stent 4.0 x 14mm
- 3.1.a.51 Stent 4.0 x 16mm/ Stent 4.0 x 16mm
- 3.1.a.52 Stent 4.0 x 19mm/ Stent 4.0 x 19mm
- 3.1.a.53 Stent 4.0 x 24mm/ Stent 4.0 x 24mm
- 3.1.a.54 Stent 4.0 x 29mm/ Stent 4.0 x 29mm
- 3.1.a.55 Stent 4.0 x 34mm/ Stent 4.0 x 34mm
- 3.1.a.56 Stent 4.0 x 39mm/ Stent 4.0 x 39mm
- 3.1.a.57 Stent 4.5 x 14mm/ Stent 4.5 x 14mm
- 3.1.a.58 Stent 4.5 x 16mm/ Stent 4.5 x 16mm
- 3.1.a.59 Stent 4.5 x 19mm/ Stent 4.5 x 19mm
- 3.1.a.60 Stent 4.5 x 24mm/ Stent 4.5 x 24mm
- 3.1.a.61 Stent 4.5 x 29mm/ Stent 4.5 x 29mm
- 3.1.a.62 Stent 4.5 x 34mm/ Stent 4.5 x 34mm
- 3.1.a.63 Stent 4.5 x 39mm/ Stent 4.5 x 39mm

**4. Sistema de stent coronario con liberación de sirolimus / Sirolimus eluting coronary stent system**

**Código NANDO: MD 0201, MDS 7001 y MDS 7006**

**4.1. Sistema de stent coronario con liberación de sirolimus, con stent de CoCr y polímero bioestable "iVascular angiolute"/"iVascular angiolute" Sirolimus eluting coronary stent system, with CoCr stent and permanent polymer**

**Los siguientes productos se encuentran descritos en el certificado 2014 12 0833 ED/ The followed products are described in the certificate 2014 12 0833 ED.**

**4.1.a. Longitud de catéter 142cm/ Catheter length 142cm**

- 4.1.a.1 Stent 2.0 x 9mm/ Stent 2.0 x 9mm
- 4.1.a.2 Stent 2.0 x 14mm/ Stent 2.0 x 14mm
- 4.1.a.3 Stent 2.0 x 16mm/ Stent 2.0 x 16mm
- 4.1.a.4 Stent 2.0 x 19mm/ Stent 2.0 x 19mm
- 4.1.a.5 Stent 2.0 x 24mm/ Stent 2.0 x 24mm

Agencia Española de Medicamentos y Productos Sanitarios (AEMPS)

Fecha de la firma: 29/07/2020

Puede comprobar la autenticidad del documento en la sede de la AEMPS: <https://localizador.aemps.es>

CSV: BVEJQY597B



CORREO ELECTRÓNICO  
on0318@aemps.es

Página 11 de 16

C/ CAMPEZO, 1 - EDIFICIO 8  
28022 MADRID  
Tel.: (+34) 902.101.322 / (+34) 91.822.59.97  
Fax: (+34) 91.822.52.89

ORGANISMO NOTIFICADO 0318



**ANEXO N°/ANNEX NO: I**

**CERTIFICADO CE DE SISTEMA DE GARANTÍA DE CALIDAD TOTAL**  
de acuerdo con el Anexo II (excepto punto 4) de la Directiva 93/42/CEE

**EC FULL QUALITY ASSURANCE SYSTEM CERTIFICATE**  
*in accordance with Annex II (except Section 4) of Directive 93/42/EEC*

Certificado n°/Certificate no	Fecha de validez/Date of validity	ON n°/NB no
<b>2013 07 0801 CT</b>	<b>Desde/From 31-07-2020 Hasta/To 26-05-2024</b>	<b>0318</b>

- 4.1.a.6 Stent 2.0 x 29mm/ Stent 2.0 x 29mm
- 4.1.a.7 Stent 2.0 x 34mm/ Stent 2.0 x 34mm
- 4.1.a.8 Stent 2.0 x 39mm/ Stent 2.0 x 39mm
- 4.1.a.9 Stent 2.25 x 9mm/ Stent 2.25 x 9mm
- 4.1.a.10 Stent 2.25 x 14mm/ Stent 2.25 x 14mm
- 4.1.a.11 Stent 2.25 x 16mm/ Stent 2.25 x 16mm
- 4.1.a.12 Stent 2.25 x 19mm/ Stent 2.25 x 19mm
- 4.1.a.13 Stent 2.25 x 24mm/ Stent 2.25 x 24mm
- 4.1.a.14 Stent 2.25 x 29mm/ Stent 2.25 x 29mm
- 4.1.a.15 Stent 2.25 x 34mm/ Stent 2.25 x 34mm
- 4.1.a.16 Stent 2.25 x 39mm/ Stent 2.25 x 39mm
- 4.1.a.17 Stent 2.5 x 9mm/ Stent 2.5 x 9mm
- 4.1.a.18 Stent 2.5 x 14mm/ Stent 2.5 x 14mm
- 4.1.a.19 Stent 2.5 x 16mm/ Stent 2.5 x 16mm
- 4.1.a.20 Stent 2.5 x 19mm/ Stent 2.5 x 19mm
- 4.1.a.21 Stent 2.5 x 24mm/ Stent 2.5 x 24mm
- 4.1.a.22 Stent 2.5 x 29mm/ Stent 2.5 x 29mm
- 4.1.a.23 Stent 2.5 x 34mm/ Stent 2.5 x 34mm
- 4.1.a.24 Stent 2.5 x 39mm/ Stent 2.5 x 39mm
- 4.1.a.25 Stent 2.5 x 44mm / Stent 2,5 x 44mm
- 4.1.a.26 Stent 2.5 x 49mm/ Stent 2,5 x 49mm
- 4.1.a.27 Stent 2.75 x 9mm/ Stent 2.75 x 9mm
- 4.1.a.28 Stent 2.75 x 14mm/ Stent 2.75 x 14mm
- 4.1.a.29 Stent 2.75 x 16mm/ Stent 2.75 x 16mm
- 4.1.a.30 Stent 2.75 x 19mm/ Stent 2.75 x 19mm
- 4.1.a.31 Stent 2.75 x 24mm/ Stent 2.75 x 24mm
- 4.1.a.32 Stent 2.75 x 29mm/ Stent 2.75 x 29mm
- 4.1.a.33 Stent 2.75 x 34mm/ Stent 2.75 x 34mm
- 4.1.a.34 Stent 2.75 x 39mm/ Stent 2.75 x 39mm
- 4.1.a.35 Stent 2.75 x 44mm/ Stent 2,75 x 44mm
- 4.1.a.36 Stent 2.75 x 49mm/ Stent 2,75 x 49mm
- 4.1.a.37 Stent 3.0 x 9mm/ Stent 3.0 x 9mm

MODELO-IP ANEXO II CT Cert. 93/42/IP-Rev1805/2020

Agencia Española de Medicamentos y Productos Sanitarios (AEMPS)

Fecha de la firma: 29/07/2020

Puede comprobar la autenticidad del documento en la sede de la AEMPS: <https://localizador.aemps.es>

CSV: BVEJQY597B



CORREO ELECTRÓNICO  
on0318@aemps.es

Página 12 de 16

ORGANISMO NOTIFICADO 0318

C/ CAMPEZO, 1 - EDIFICIO 8  
28022 MADRID  
Tel.: (+34) 902.101.322 / (+34) 91.822.59.97  
Fax: (+34) 91.822.52.89



**ANEXO N°/ANNEX NO: I**

**CERTIFICADO CE DE SISTEMA DE GARANTÍA DE CALIDAD TOTAL  
de acuerdo con el Anexo II (excepto punto 4) de la Directiva 93/42/CEE**

**EC FULL QUALITY ASSURANCE SYSTEM CERTIFICATE  
in accordance with Annex II (except Section 4) of Directive 93/42/EEC**

<b>Certificado n°/Certificate no</b>	<b>Fecha de validez/Date of validity</b>			<b>ON n°/NB no</b>	
<b>2013 07 0801 CT</b>	<b>Desde/From</b>	<b>31-07-2020</b>	<b>Hasta/To</b>	<b>26-05-2024</b>	<b>0318</b>

- 4.1.a.38 Stent 3.0 x 14mm/ Stent 3.0 x 14mm
- 4.1.a.39 Stent 3.0 x 16mm/ Stent 3.0 x 16mm
- 4.1.a.40 Stent 3.0 x 19mm/ Stent 3.0 x 19mm
- 4.1.a.41 Stent 3.0 x 24mm/ Stent 3.0 x 24 mm
- 4.1.a.42 Stent 3.0 x 29mm/ Stent 3.0 x 29mm
- 4.1.a.43 Stent 3.0 x 34mm/ Stent 3.0 x 34mm
- 4.1.a.44 Stent 3.0 x 39mm/ Stent 3.0 x 39mm
- 4.1.a.45 Stent 3.0 x 44mm/ Stent 3 mm x 44mm
- 4.1.a.46 Stent 3.0 x 49mm/ Stent 3 mm x 49mm
- 4.1.a.47 Stent 3.5 x 9mm/ Stent 3.50 x 9mm
- 4.1.a.48 Stent 3.5 x 14mm/ Stent 3.5 x 14mm
- 4.1.a.49 Stent 3.5 x 16mm/ Stent 3.5 x 16mm
- 4.1.a.50 Stent 3.5 x 19mm/ Stent 3.5 x 19mm
- 4.1.a.51 Stent 3.5 x 24mm/ Stent 3.5 x 24mm
- 4.1.a.52 Stent 3.5 x 29mm/ Stent 3.5 x 29mm
- 4.1.a.53 Stent 3.5 x 34mm/ Stent 3.5 x 34mm
- 4.1.a.54 Stent 3.5 x 39mm/ Stent 3.5 x 39mm
- 4.1.a.55 Stent 3.5 x 44mm/ Stent 3,5 x 44mm
- 4.1.a.56 Stent 3.5 x 49mm/ Stent 3.5 x 49mm
- 4.1.a.57 Stent 4.0 x 9mm/ Stent 4.0 x 9mm
- 4.1.a.58 Stent 4.0 x 14mm/ Stent 4.0 x 14mm
- 4.1.a.59 Stent 4.0 x 16mm/ Stent 4.0 x 16mm
- 4.1.a.60 Stent 4.0 x 19mm/ Stent 4.0 x 19mm
- 4.1.a.61 Stent 4.0 x 24mm/ Stent 4.0 x 24mm
- 4.1.a.62 Stent 4.0 x 29mm/ Stent 4.0 x 29mm
- 4.1.a.63 Stent 4.0 x 34mm/ Stent 4.0 x 34mm
- 4.1.a.64 Stent 4.0 x 39mm/ Stent 4.0 x 39mm
- 4.1.a.65 Stent 4.0 x 44mm/ Stent 4.0 mm x 44mm
- 4.1.a.66 Stent 4.0 x 49mm/ Stent 4.0mm x 49mm
- 4.1.a.67 Stent 4.5 x 14mm/ Stent 4.5 x 14mm
- 4.1.a.68 Stent 4.5 x 16mm/ Stent 4.5 x 16mm
- 4.1.a.69 Stent 4.5 x 19mm/ Stent 4.5 x 19mm

Agencia Española de Medicamentos y Productos Sanitarios (AEMPS)

Fecha de la firma: 29/07/2020

Puede comprobar la autenticidad del documento en la sede de la AEMPS: <https://localizador.aemps.es>

CSV: BVEJQY597B



CORREO ELECTRÓNICO  
on0318@aemps.es

Página 13 de 16

C/ CAMPEZO, 1 - EDIFICIO 8  
28022 MADRID  
Tel.: (+34) 902.101.322 / (+34) 91.822.59.97  
Fax: (+34) 91.822.52.89

ORGANISMO NOTIFICADO 0318





**ANEXO N°/ANNEX NO: I**

**CERTIFICADO CE DE SISTEMA DE GARANTÍA DE CALIDAD TOTAL  
de acuerdo con el Anexo II (excepto punto 4) de la Directiva 93/42/CEE**

**EC FULL QUALITY ASSURANCE SYSTEM CERTIFICATE  
in accordance with Annex II (except Section 4) of Directive 93/42/EEC**

Certificado n°/Certificate no	Fecha de validez/Date of validity	ON n°/NB no
<b>2013 07 0801 CT</b>	<b>Desde/From 31-07-2020 Hasta/To 26-05-2024</b>	<b>0318</b>

- 4.1.a.70 Stent 4.5 x 24mm/ Stent 4.5 x 24mm
- 4.1.a.71 Stent 4.5 x 29mm/ Stent 4.5 x 29mm
- 4.1.a.72 Stent 4.5 x 34mm/ Stent 4.5 x 34mm
- 4.1.a.73 Stent 4.5x39mm/ Stent 4.5x39mm

**5. Sistema de stent periférico con liberación de sirolimus / Sirolimus eluting peripheral stent system**

**Código NANDO: MD 0201, MDS 7001 y MDS 7006**

**5.1. Sistema de stent periférico con liberación de sirolimus, con stent de CoCr y polímero bioestable "iVascular angiolute btk"/"iVascular angiolute btk" Sirolimus eluting peripheral stent system, with CoCr stent and permanent polymer**

**Los siguientes productos se encuentran descritos en el certificado 2017 07 0862 ED / The followed products are described in the certificate 2017 07 0862 ED**

**5.1.a. Longitud catéter 142cm/ Catheter length 142cm**

- 5.1.a.1 Stent 2.0 x 9mm/ Stent 2.0 x 9mm
- 5.1.a.2 Stent 2.0 x 14mm/ Stent 2.0 x 14mm
- 5.1.a.3 Stent 2.0 x 16mm/ Stent 2.0 x 16mm
- 5.1.a.4 Stent 2.0 x 19mm/ Stent 2.0 x 19mm
- 5.1.a.5 Stent 2.0 x 24mm/ Stent 2.0 x 24mm
- 5.1.a.6 Stent 2.0 x 29mm/ Stent 2.0 x 29mm
- 5.1.a.7 Stent 2.0 x 34mm/ Stent 2.0 x 34mm
- 5.1.a.8 Stent 2.0 x 39mm/ Stent 2.0 x 39mm
- 5.1.a.9 Stent 2.25 x 9mm/ Stent 2.25 x 9mm
- 5.1.a.10 Stent 2.25 x 14mm/ Stent 2.25 x 14mm
- 5.1.a.11 Stent 2.25 x 16mm/ Stent 2.25 x 16mm
- 5.1.a.12 Stent 2.25 x 19mm/ Stent 2.25 x 19mm
- 5.1.a.13 Stent 2.25 x 24mm/ Stent 2.25 x 24mm
- 5.1.a.14 Stent 2.25 x 29mm/ Stent 2.25 x 29mm
- 5.1.a.15 Stent 2.25 x 34mm / Stent 2.25 x 34mm

Agencia Española de Medicamentos y Productos Sanitarios (AEMPS)

Fecha de la firma: 29/07/2020

Puede comprobar la autenticidad del documento en la sede de la AEMPS: <https://localizador.aemps.es>

CSV: BVEJQY597B



CORREO ELECTRÓNICO  
on0318@aemps.es

Página 14 de 16

C/ CAMPEZO, 1 - EDIFICIO 8  
28022 MADRID  
Tel.: (+34) 902.101.322 / (+34) 91.822.59.97  
Fax: (+34) 91.822.52.89

ORGANISMO NOTIFICADO 0318



**ANEXO N°/ANNEX NO: I**

**CERTIFICADO CE DE SISTEMA DE GARANTÍA DE CALIDAD TOTAL**  
de acuerdo con el Anexo II (excepto punto 4) de la Directiva 93/42/CEE

**EC FULL QUALITY ASSURANCE SYSTEM CERTIFICATE**  
in accordance with Annex II (except Section 4) of Directive 93/42/EEC

Certificado n°/Certificate no	Fecha de validez/Date of validity	ON n°/NB no
<b>2013 07 0801 CT</b>	<b>Desde/From 31-07-2020 Hasta/To 26-05-2024</b>	<b>0318</b>

- 5.1.a.16 Stent 2.25 x 39mm/ Stent 2.25 x 39mm
- 5.1.a.17 Stent 2.5 x 9mm/ Stent 2.5 x 9mm
- 5.1.a.18 Stent 2.5 x 14mm/ Stent 2.5 x 14mm
- 5.1.a.19 Stent 2.5 x 16mm/ Stent 2.5 x 16mm
- 5.1.a.20 Stent 2.5 x 19mm/ Stent 2.5 x 19mm
- 5.1.a.21 Stent 2.5 x 24mm/ Stent 2.5 x 24mm
- 5.1.a.22 Stent 2.5 x 29mm/ Stent 2.5 x 29mm
- 5.1.a.23 Stent 2.5 x 34mm/ Stent 2.5 x 34mm
- 5.1.a.2 Stent 2.5 x 39mm/ Stent 2.5 x 39mm
- 5.1.a.25 Stent 2.75 x 9mm/ Stent 2.75 x 9mm
- 5.1.a.26 Stent 2.75 x 14mm/ Stent 2.75x 14mm
- 5.1.a.27 Stent 2.75 x 16mm/ Stent 2.75 x 16mm
- 5.1.a.28 Stent 2.75 x 19mm/ Stent 2.75 x 19mm
- 5.1.a.29 Stent 2.75 x 24mm/ Stent 2.75 x 24mm
- 5.1.a.30 Stent 2.75 x 29mm/ Stent 2.75 x 29mm
- 5.1.a.31 Stent 2.75 x 34mm/ Stent 2.75 x 34mm
- 5.1.a.32 Stent 2.75 x 39mm/ Stent 2.75 x 39mm
- 5.1.a.33 Stent 3.0 x 9mm/ Stent 3.0x9mm
- 5.1.a.34 Stent 3.0 x 14mm/ Stent 3.0 x 14mm
- 5.1.a.35 Stent 3.0 x 16mm/ Stent 3.0 x 16mm
- 5.1.a.36 Stent 3.0 x 19mm/ Stent 3.0 x 19mm
- 5.1.a.37 Stent 3.0 x 24mm/ Stent 3.0 x 24mm
- 5.1.a.38 Stent 3.0 x 29mm/ Stent 3.0 x 29mm
- 5.1.a.39 Stent 3.0 x 34mm/ Stent 3.0 x 34mm
- 5.1.a.40 Stent 3.0 x 39mm/ Stent 3.0 x 39mm
- 5.1.a.41 Stent 3.5 x 9mm/ Stent 3.5 x 9mm
- 5.1.a.42 Stent 3.5 x 14mm/ Stent 3.5 x 14mm
- 5.1.a.43 Stent 3.5 x 16mm/ Stent 3.5 x 16mm
- 5.1.a.44 Stent 3.5 x 19mm/ Stent 3.5 x 19mm
- 5.1.a.45 Stent 3.5 x 24mm/ Stent 3.5 x 24mm
- 5.1.a.46 Stent 3.5 x 29mm/ Stent 3.5 x 29mm
- 5.1.a.47 Stent 3.5 x 34mm/ Stent 3.5 x 34mm

MODELO-IP ANEXO II CT Cert. 93/42/IP-Rev1805/2020

Agencia Española de Medicamentos y Productos Sanitarios (AEMPS)

Fecha de la firma: 29/07/2020

Puede comprobar la autenticidad del documento en la sede de la AEMPS: <https://localizador.aemps.es>

CSV: BVEJQY597B



CORREO ELECTRÓNICO  
on0318@aemps.es

Página 15 de 16

ORGANISMO NOTIFICADO 0318

C/ CAMPEZO, 1 - EDIFICIO 8  
28022 MADRID  
Tel.: (+34) 902.101.322 /(+34) 91.822.59.97  
Fax: (+34) 91.822.52.89



ANEXO N°/ANNEX NO: I

**CERTIFICADO CE DE SISTEMA DE GARANTÍA DE CALIDAD TOTAL**  
de acuerdo con el Anexo II (excepto punto 4) de la Directiva 93/42/CEE

**EC FULL QUALITY ASSURANCE SYSTEM CERTIFICATE**  
*in accordance with Annex II (except Section 4) of Directive 93/42/EEC*

Certificado n°/Certificate no	Fecha de validez/Date of validity	ON n°/NB no
2013 07 0801 CT	Desde/From 31-07-2020 Hasta/To 26-05-2024	0318

- 5.1.a.48 Stent 3.5 x 39mm/ Stent 3.5 x 39mm
- 5.1.a.49 Stent 4.0 x 9mm/ Stent 4.0 x 9mm
- 5.1.a.50 Stent 4.0 x 14mm/ Stent 4.0 x 14mm
- 5.1.a.51 Stent 4.0 x 16mm/ Stent 4.0 x 16mm
- 5.1.a.52 Stent 4.0 x 19mm/ Stent 4.0 x 19mm
- 5.1.a.53 Stent 4.0 x 24mm/ Stent 4.0 x 24mm
- 5.1.a.54 Stent 4.0 x 29mm/ Stent 4.0 x 29mm
- 5.1.a.55 Stent 4.0 x 34mm/ Stent 4.0 x 34mm
- 5.1.a.56 Stent 4.0 x 39mm/ Stent 4.0 x 39mm
- 5.1.a.57 Stent 4.5 x 14mm/ Stent 4.5 x 14mm
- 5.1.a.58 Stent 4.5 x 16mm/ Stent 4.5 x 16mm
- 5.1.a.59 Stent 4.5 x 19mm/ Stent 4.5 x 19mm
- 5.1.a.60 Stent 4.5 x 24mm/ Stent 4.5 x 24mm
- 5.1.a.61 Stent 4.5 x 29mm/ Stent 4.5 x 29mm
- 5.1.a.62 Stent 4.5 x 34mm/ Stent 4.5 x 34mm
- 5.1.a.63 Stent 4.5 x 39mm/ Stent 4.5 x 39mm

Este certificado ampara todas las marcas de estos productos incluidas por el fabricante en su declaración de conformidad.

*This certificate covers all trademarks of these products included by the manufacturer in his declaration of conformity.*

Madrid, 29 de julio de 2020

DIRECTORA DE LA AGENCIA ESPAÑOLA DE MEDICAMENTOS Y PRODUCTOS SANITARIOS

 **agencia española de  
medicamentos y  
productos sanitarios**

Fdo. M<sup>a</sup> Jesús Lamas Díaz

Agencia Española de Medicamentos y Productos Sanitarios (AEMPS)

Fecha de la firma: 29/07/2020

Puede comprobar la autenticidad del documento en la sede de la AEMPS: <https://localizador.aemps.es>

CSV: BVEJQY597B



CORREO ELECTRÓNICO  
on0318@aemps.es

Página 16 de 16

ORGANISMO NOTIFICADO 0318

C/ CAMPEZO, 1 - EDIFICIO 8  
28022 MADRID  
Tel.: (+34) 902.101.322 / (+34) 91.822.59.97  
Fax: (+34) 91.822.52.89



## TECHNICAL DATA SHEET

# angiolute

### DESCRIPTION

The sirolimus-eluting coronary stent Angiolite from LVD Biotech SL is made from a cobalt chromium alloy called L605, coated with a mix of sirolimus and biostable polymers. The stent is pre-mounted on the delivery system that will allow implantation on the coronary lesion to treat through the inflation of a balloon at the distal end of the catheter.

The stent is manufactured from a metal tube that is laser cut and subsequently subjected to various treatments that will give the surface a smooth, glossy finish. The stent design is based on a concatenation of cells in the circumferential direction that are connected to each other axially by means of links to obtain different longitudinal configurations. Moreover, the adjustment of the number of cells in the radial direction allows the stent to be expanded to different diameters. The result is an open cell design.

The stent delivery system is a rapid exchange balloon catheter also called RX, having a single lumen configuration on the proximal part and a coaxial double lumen configuration on the distal part. The catheter has an inflatable segment (balloon) in its distal end. The balloon is designed to achieve different diameters and lengths, engaging the stent in its different configurations and covering the range of lesions to be treated. Before positioning, the balloon is folded and the stent is compressed over it. There are radiopaque markers delimiting the length of the stent and to facilitate observation under fluoroscopy. When the balloon reaches the lesion and is inflated, the stent expands against the artery. Subsequently, the balloon is deflated and removed and the stent remains permanently implanted.

The distal part of the catheter is coated with a durable hydrophilic coating to minimize friction and improve its trackability.



## TECHNICAL DATA SHEET

# angiolute

STENT CHARACTERISTICS	
STENT MATERIAL	CoCr L605
WALL THICKNESS	75 microns for stent 2 to 2.5mm 80 microns for stent 2.75 to 3.5mm 85 microns for stent 4 to 4.5mm
% RECOIL	< 6%
% FORESHORTENING	< 4%
% SURFACE IN CONTACT WITH ARTERY	10-20%
VESSEL CONFORMABILITY	High

DRUG COATING FEATURES	
DRUG	Sirolimus
DRUG DOSE	1,4 µg/mm <sup>2</sup>
POLYMER	Biostable





## TECHNICAL DATA SHEET

# angiolute

CHARACTERISTICS OF THE STENT PRE-MOUNTED ON BALLOON	
<b>MATERIAL</b>	Nylon and Pebax. Final product without latex components
<b>BALLOON</b>	Semi-compliant
<b>NOMINAL PRESSURE</b>	9/10/11 atm
<b>RATED BURST PRESSURE (RBP)</b>	16 atm
<b>AVERAGE BURST PRESSURE (ABP)</b>	22 atm
<b>STENT CROSSING PROFILE (at max. length of the stent)</b>	
Diameter (mm)	INCHES –mm-FRENCH
2.00	0.041 – 1.05 – 3.15
2.25	0.041 – 1.05 – 3.15
2.50	0.041 – 1.05 – 3.15
2.75	0.044 – 1.13 – 3.39
3.00	0.044 – 1.13 – 3.39
3.50	0.045 – 1.15 – 3.45
4.00	0.047 – 1.20 – 3.60
4.50	0.049 – 1.25 – 3.75
<b>RADIOPAQUE MARKERS</b>	
2 metallic markers on the catheter delimiting the stent	
<b>GUIDING CATHETER COMPATIBILITY</b>	5F



## TECHNICAL DATA SHEET

# angiolute

SYSTEM DIMENSIONS	
Working length of the catheter	142 cm
Catheter shaft (diameter)	2F Proximal 2.6F Middle 2.6F Distal
Distance guidewire entry to tip	25 cm
Entry profile	0.016 inch
Recommended guidewire	0.014 inch
Deflation times	< 10 s
Available diameters	2.0 a 4.5 mm
Available lengths	9 a 49 mm

MAXIMUM DIAMETER mm <sup>1</sup>	SMALL	MEDIUM	LARGE
STENT OVEREXPANSION	4.00	5.25	6.00
CELL OF THE SIDE BRANCH ACCESS	3.50	3.75	5.00

<sup>1</sup> These diameters have not been fatigue tested.



## TECHNICAL DATA SHEET

# angiolute

		STENT DIAMETERS (mm)							
		2.00	2.25	2.50	2.75	3.00	3.50	4.00	4.50
STENT LENGTHS (mm)	9	X	X	X	X	X	X	X	
	14	X	X	X	X	X	X	X	X
	16	X	X	X	X	X	X	X	X
	19	X	X	X	X	X	X	X	X
	24	X	X	X	X	X	X	X	X
	29	X	X	X	X	X	X	X	X
	34	X	X	X	X	X	X	X	X
	39	X	X	X	X	X	X	X	X
	44			X	X	X	X	X	
49			X	X	X	X	X		

### STORAGE & TRANSPORT CONDITIONS

**STORAGE:** Store in a cool and dry place, away from direct sunlight  
Storage temperature: between **15°C and 30°C**

**TRANSPORT:** During the transport the temperature could reach 40°C



iVascular  
therapies for living

# angiolite

Sirolimus-eluting coronary stent system

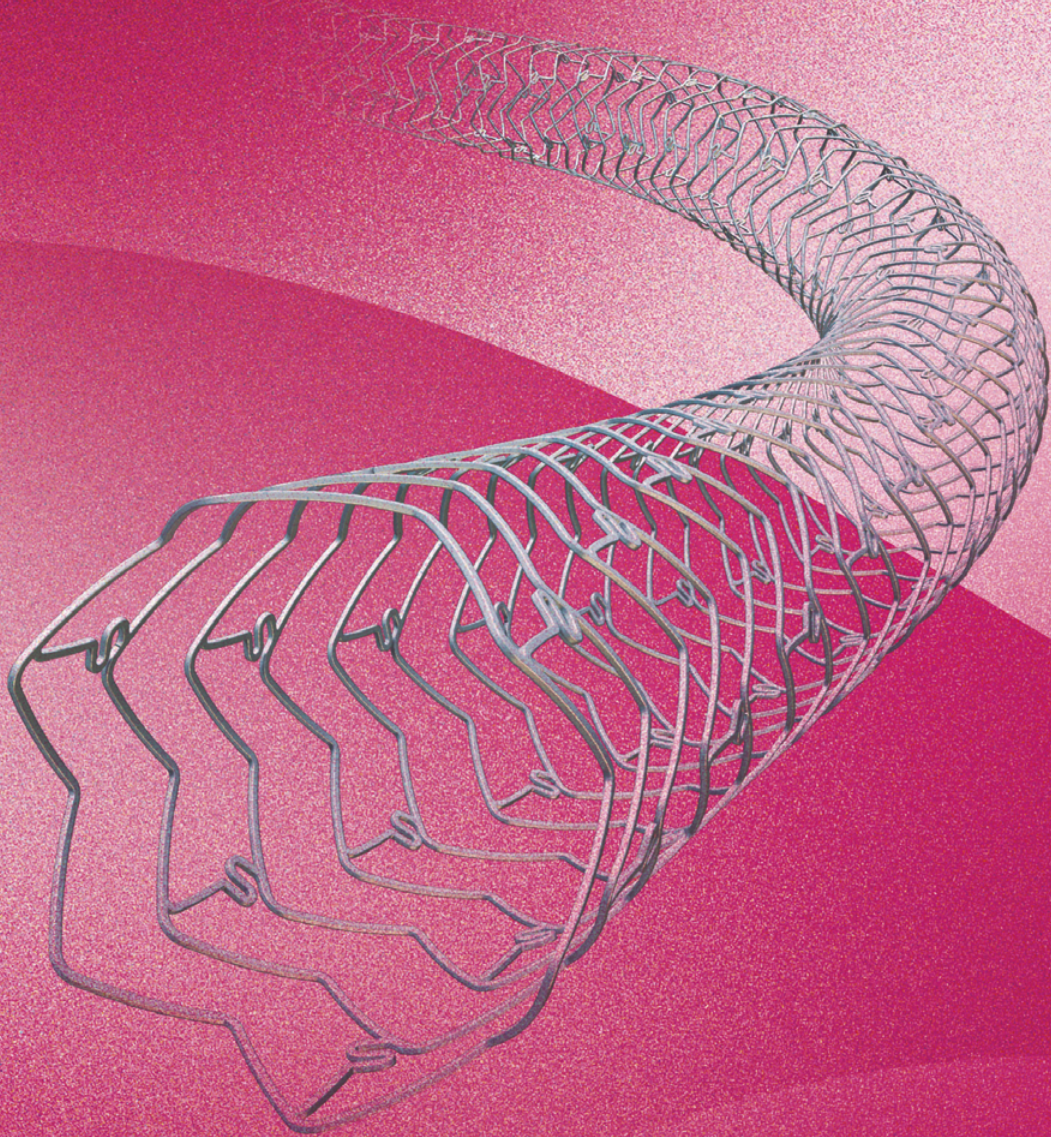

The DES we trust



[www.ivascular.global](http://www.ivascular.global)



# Outstanding safety and efficacy profile



## ANCHOR FIM STUDY<sup>(1)</sup>

Observational, prospective,  
multicenter study  
103 patients; 2 years follow-up

Angiolite demonstrates  
favorable early healing  
properties

---

Strut coverage at  
**3 months**

**86.3%**

---

**These outcomes  
demonstrate  
Angiolite's excellent  
performance\***

[Click here](#)

(1) Puri R, Otaegui I, Sabaté M,  
et al. *Catheter Cardiovasc Interv.*  
2017;1-9.

\* Main conclusion of the study





## ANGIOLITE RCT<sup>(2)</sup>

Randomized, non-inferiority, observational, prospective, multicenter trial  
223 patients; 2 years follow-up

Angiolite demonstrates non inferiority vs. EES with extraordinary antiproliferative efficacy

---

LLL at  
**6 months**  
**0.04mm**

---

**Angiolite belongs to the new DES generation<sup>\*\*</sup>**

[Click here](#)

(2) Moreu J. et al. EuroIntervention Dec 2019;15:e1081-e1089  
<sup>\*\*</sup>Author conclusion presented at EuroPCR 2018



## RANGO REGISTRY<sup>(3)</sup>

Prospective, single arm, multicenter observational registry  
646 patients; 5 years follow-up

Angiolite shows high efficacy and a completely safe profile, even in a high risk population

---

TLF and ST<sup>\*\*</sup> at  
**2 years**  
**3.4% and 0.9%**

---

**The real-world use of Angiolite warrants the safe use of this potent DES in broader, unselected populations<sup>\*\*\*</sup>**

(3) RANGO registry accepted in REC Interv Cardiol.  
<sup>\*\*</sup> Stent thrombosis  
<sup>\*\*\*</sup> Author conclusion presented at EuroPCR 2021

# Excellent performance even in compromised situations

Left main and long bifurcations:  
Angiolite offers a high overexpansion capacity\*

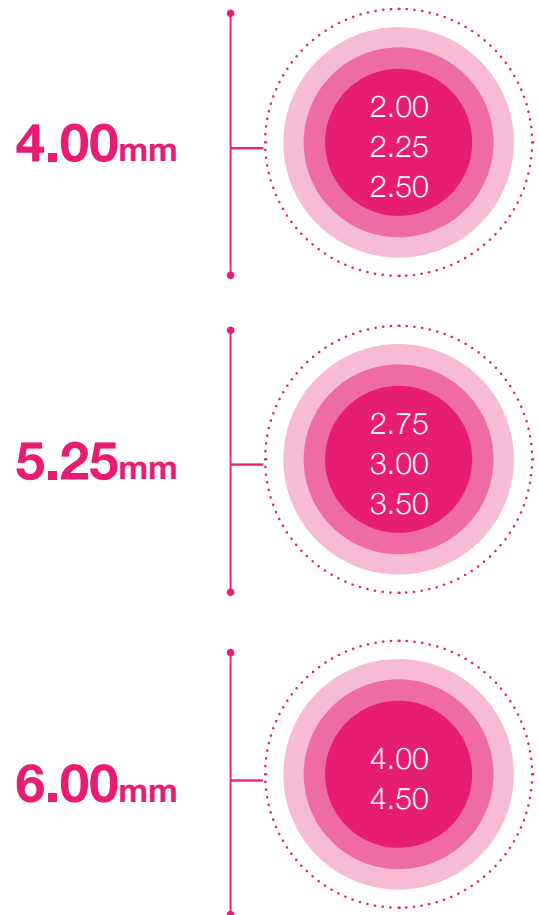

Calcified lesions:  
Angiolite offers outstanding arterial support  
due to an optimal radial force

**40%**  
Higher radial force  
than competitors\*\*

\* Angiolite has 3 designs related to stent diameter: S: 2.00 - 2.50mm; M: 2.75 - 3.5mm; L: 4.00 - 4.50mm

\*\* Data on file at iVascular SLU. Average radial force vs Resolute Onyx (Medtronic), Synergy (Boston Scientific) Ultimaster Tansei (Terumo), Orsiro (Biotronik)

## Small vessels: Angiolite adapts to the arteries' needs with thin struts

reducing arterial injury  
and inflammation score<sup>(4)\*\*</sup>

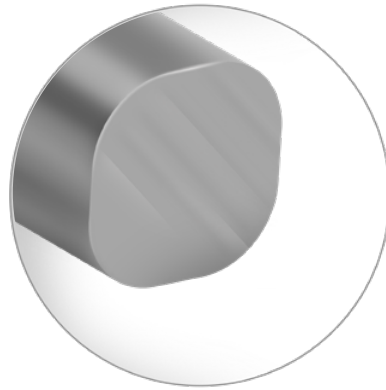

**75**μm

## Bifurcations: Angiolite offers excellent side branch access

**Stent diameter**

**Side branch  
maximum cell  
diameter**

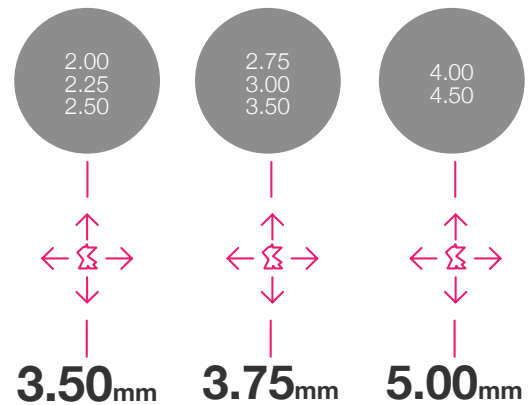

## Diffuse lesions: **new long** lengths

Angiolite 49mm, one of  
the longest lengths  
available on the market

**44 and 49**mm



\*\* For diameters < 2.75mm

(4) Sripal Bangalore, et al. Circulation. 2018; 138:2216-2226

# High quality of healing

## 1 Angiolite provides low rates of restenosis and inflammation score<sup>(5)</sup>



**TransferWise**  
Ensuring homogenous drug elution

TransferWise 3-layer nanotechnology ensures homogenous drug elution

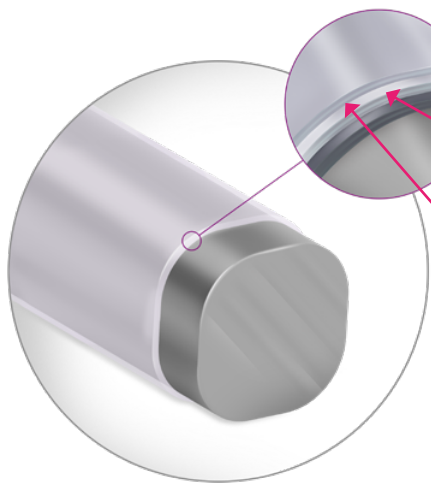

1st layer: Acrylate

Ensures adhesion to the stent

2nd layer: Sirolimus + Fluoro-acrylate polymer

Provides homogenous drug dispersion along the stent

3rd layer: Fluoro-acrylate polymer

Guarantees controlled drug elution

---

## Specific Design



**Alternating links** ensure homogenous arterial coverage along the whole stent, which **positively influences the reduction of restenosis and inflammation of the lesion**<sup>(5)</sup>

## 2 Angiolite shows low rates of stent thrombosis<sup>(1,2,3)</sup>

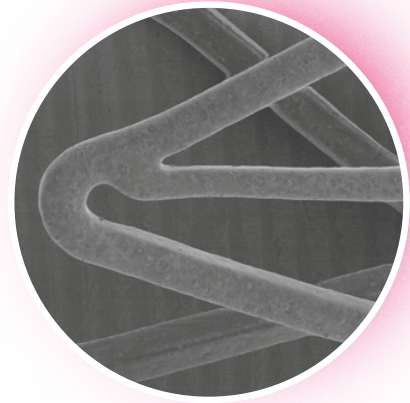

**Our fluoro-acrylate polymer provides an early endothelialization and creates a thromboresistant layer. This mechanism suggest to reduce stent thrombosis<sup>(6,7,8)</sup>**

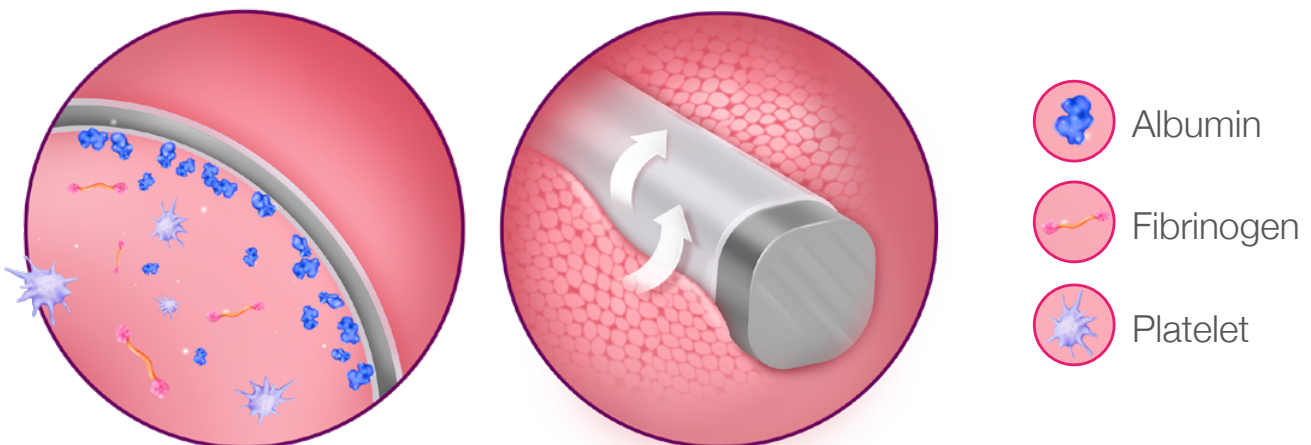

Albumin binds to the fluoro-acrylate polymer, displacing other proteins such as fibrinogen, which is thrombogenic, and creates a thromboresistant layer<sup>(7,8,9,10)</sup>

(6) In vitro test, data on file iVascular

(7) Ao PY, et al. Eur J Vasc Endovasc Surg. 2000;20:241-249.

(8) Kumaran Kolandaivelu, et al. Circulation. 2011 Apr 5;123(13):1400-9.

(9) Fumiyuki Otsuka, et al. JACC Cardiovasc Interv. 2015 Aug 17;8(9):1248-1260

(10) Otsuka F, et al. Jacc: cardiovascular interventions vol.8, N°. 9, 2015 Aug 17, 2015: 1248 – 60



# Angiolite Features

- Rapid Exchange Catheter (RX)
- Compatible with 0.014" guide wire
- Compatible with 5F guiding catheter
- 2 Radiopaque Makers (Pt - Ir)
- Overexpansion capacity: S: 4.00mm | M: 5.25mm \ L: 6.00mm
- NP: 9-11 atm | RBP: 16 atm | ABP: 22 atm
- Fluoro-acrylate proprietary polymer
- Side Branch access: S: 3.50mm | M: 3.75mm \ L: 5.00mm

Product with CE mark, certified by Notified Body 0318

Stent Diameter (mm)	Effective catheter length 142 cm									
	Stent Length (mm)									
	9	14	16	19	24	29	34	39	44	49
2.00	SCCDSR1415020009	SCCDSR1415020014	SCCDSR1415020016	SCCDSR1415020019	SCCDSR1415020024	SCCDSR1415020029	SCCDSR1415020034	SCCDSR1415020039	-	-
2.25	SCCDSR14150225009	SCCDSR14150225014	SCCDSR14150225016	SCCDSR14150225019	SCCDSR14150225024	SCCDSR14150225029	SCCDSR14150225034	SCCDSR14150225039	-	-
2.50	SCCDSR14150250009	SCCDSR14150250014	SCCDSR14150250016	SCCDSR14150250019	SCCDSR14150250024	SCCDSR14150250029	SCCDSR14150250034	SCCDSR14150250039	SCCDSR14150250044	SCCDSR14150250049
2.75	SCCDSR14150275009	SCCDSR14150275014	SCCDSR14150275016	SCCDSR14150275019	SCCDSR14150275024	SCCDSR14150275029	SCCDSR14150275034	SCCDSR14150275039	SCCDSR14150275044	SCCDSR14150275049
3.00	SCCDSR14150300009	SCCDSR14150300014	SCCDSR14150300016	SCCDSR14150300019	SCCDSR14150300024	SCCDSR14150300029	SCCDSR14150300034	SCCDSR14150300039	SCCDSR14150300044	SCCDSR14150300049
3.50	SCCDSR14150350009	SCCDSR14150350014	SCCDSR14150350016	SCCDSR14150350019	SCCDSR14150350024	SCCDSR14150350029	SCCDSR14150350034	SCCDSR14150350039	SCCDSR14150350044	SCCDSR14150350049
4.00	SCCDSR14150400009	SCCDSR14150400014	SCCDSR14150400016	SCCDSR14150400019	SCCDSR14150400024	SCCDSR14150400029	SCCDSR14150400034	SCCDSR14150400039	SCCDSR14150400044	SCCDSR14150400049
4.50	-	SCCDSR14150450014	SCCDSR14150450016	SCCDSR14150450019	SCCDSR14150450024	SCCDSR14150450029	SCCDSR14150450034	SCCDSR14150450039	-	-

The availability of each reference for the sale is linked to the authorization of commercialization in the country of destination

Distributed by:



Manufactured by:  
**Life Vascular Devices Biotech S.L**  
[www.ivascular.global](http://www.ivascular.global)  
[info@ivascular.global](mailto:info@ivascular.global)



**angiolite**  
 Sirolimus-eluting coronary stent system  
**The DES we trust**





**iVascular**<sup>®</sup>  
therapies for living

# essential pro

Paclitaxel eluting coronary balloon dilatation catheter



The novel reliable DCB



[www.ivascular.global](http://www.ivascular.global)

**essen**  
the novel



**Outstanding visibility** with  
metallic radiopaque markers

---



**Fast deflation time**  
due to an optimized design

---

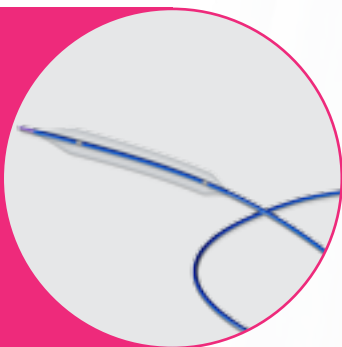

**Optimal navigation** due to the innovative combination of  
materials and proprietary hydrophilic coating *hydrax plus*

---



**The latest** balloon design

# essential pro

reliable DCB

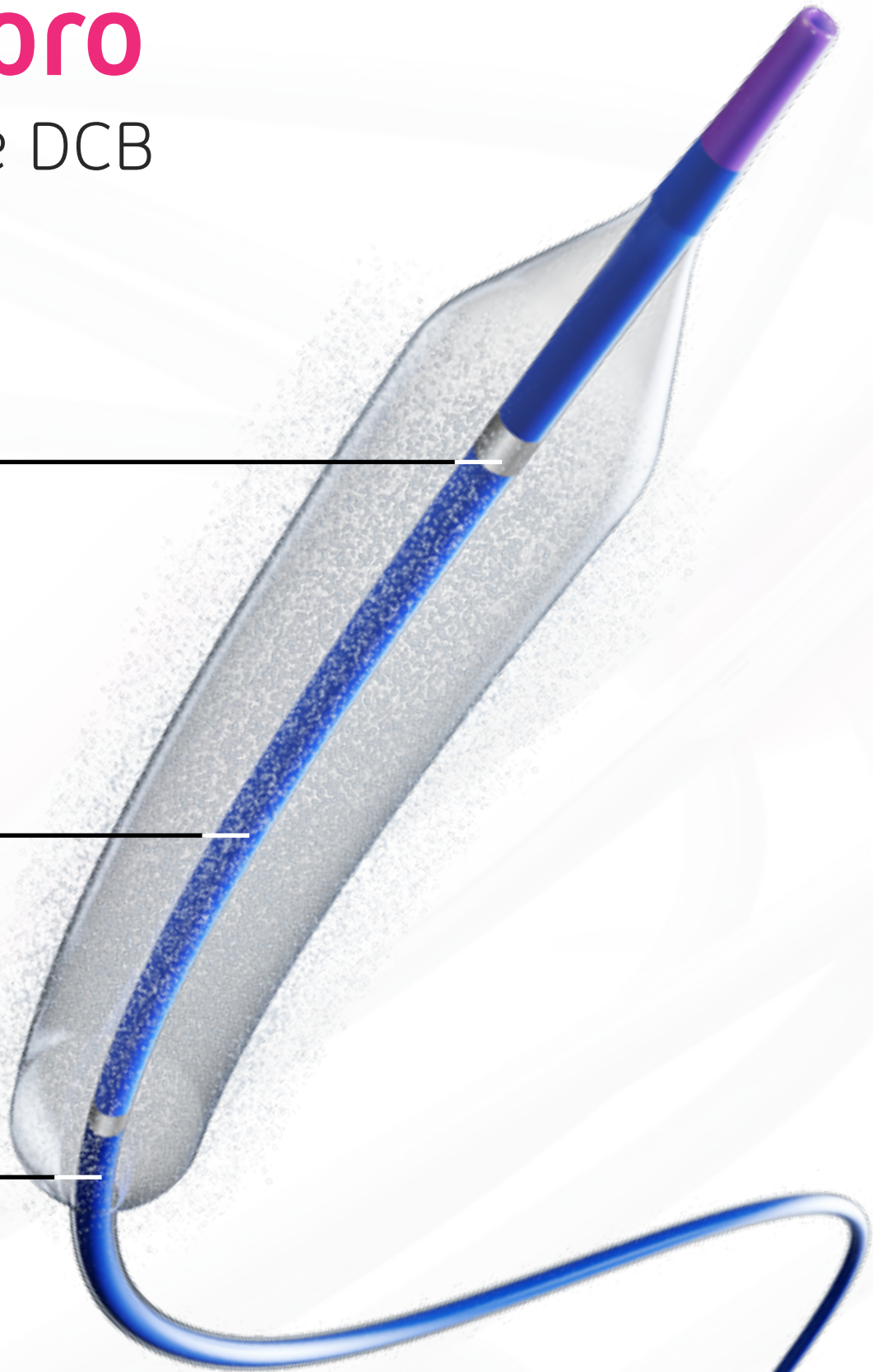



# Trans

Last generati

Clinical

**Low drug loss** during navigation  
**Low stress** on the coating  
**Homogeneous distribution** drug



## The 3<sup>rd</sup> DCB



20% Excipient  
80% Paclitaxel

Ultrasound Pulse



Ultrasound

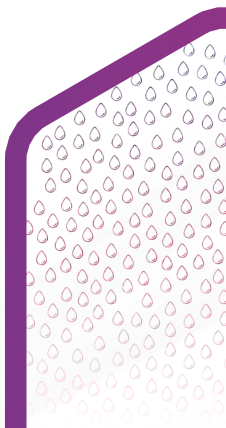

Spray Te

# ferTech

on nanotechnology

benefits



**EFFECTIVENESS**

**Fast absorption** and transfer  
High retention time improving **quality of healing**

generation

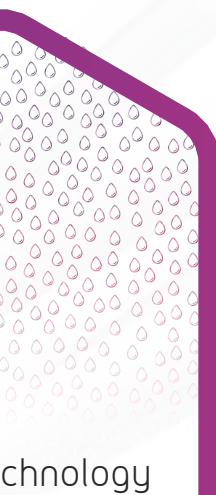

Ultrathin Multi-Layer  
Technology

Dry-off

- Microcrystalline structure
- Optimal drug transfer within 30-60 seconds.





## essential in small vessels\*

Observational, prospective and multicenter registry in small vessels.



Very small diameter of reference (<2.5mm) and high risk patients (56% diabetics) with only a 12.7% of bailout stenting



**TLF at 12-month** as a primary endpoint



**MACE at 12-month** as a secondary endpoint

The **RELIABLE ALTERNATIVE** for small coronary vessels

\*n = 71  
Registry published in Sept. 2018:  
Rodés-Cabau J. et. Al. Coronary Artery Disease. 29(6): 477-481, Sept. 2018

## essential in stent restenosis<sup>\*\*</sup>

Investigator initiated, observational, prospective and multicenter study.



DES restenosis was treated in 67% of the cases and a 94% of DCB angiographic success was achieved with only 2 additional stenting



**In-segment maximal area stenosis at 6-month** as a primary endpoint



**TLF at 24-month** as a secondary endpoint

**GOOD and SUSTAINED EFICACCY for treatment of ISR**

# essential pro features

- > **Rapid exchange catheter (RX)**
- > Guide wire compatibility: **max. 0.014"**
- > **2 distal shafts:** 2.6F ( $\varnothing \leq 3$ ), 2.7F ( $\varnothing \geq 3.25$ )
- > NP: **6 atm** | RBP: **16 atm**
- > **2 Pt/Ir radiopaque markers**
- > **hydrophilic coating hydrax plus**

Product with CE mark, certified by Notified Body 0318

Balloon diameter (mm)	Working catheter length: 142 cm					
	Balloon length (mm)					
	10	15	20	25	30	40
1.50	BC DPRI4N 150 150 010	BC DPRI4N 150 150 015	BC DPRI4N 150 150 020	-	BC DPRI4N 150 150 030	-
2.00	BC DPRI4N 150 200 010	BC DPRI4N 150 200 015	BC DPRI4N 150 200 020	BC DPRI4N 150 200 025	BC DPRI4N 150 200 030	BC DPRI4N 150 200 040
2.25	BC DPRI4N 150 225 010	BC DPRI4N 150 225 015	BC DPRI4N 150 225 020	BC DPRI4N 150 225 025	BC DPRI4N 150 225 030	BC DPRI4N 150 225 040
2.50	BC DPRI4N 150 250 010	BC DPRI4N 150 250 015	BC DPRI4N 150 250 020	BC DPRI4N 150 250 025	BC DPRI4N 150 250 030	BC DPRI4N 150 250 040
2.75	BC DPRI4N 150 275 010	BC DPRI4N 150 275 015	BC DPRI4N 150 275 020	BC DPRI4N 150 275 025	BC DPRI4N 150 275 030	BC DPRI4N 150 275 040
3.00	BC DPRI4N 150 300 010	BC DPRI4N 150 300 015	BC DPRI4N 150 300 020	BC DPRI4N 150 300 025	BC DPRI4N 150 300 030	BC DPRI4N 150 300 040
3.25	BC DPRI4N 150 325 010	BC DPRI4N 150 325 015	BC DPRI4N 150 325 020	BC DPRI4N 150 325 025	BC DPRI4N 150 325 030	BC DPRI4N 150 325 040
3.50	BC DPRI4N 150 350 010	BC DPRI4N 150 350 015	BC DPRI4N 150 350 020	BC DPRI4N 150 350 025	BC DPRI4N 150 350 030	BC DPRI4N 150 350 040
3.75	BC DPRI4N 150 375 010	BC DPRI4N 150 375 015	BC DPRI4N 150 375 020	BC DPRI4N 150 375 025	BC DPRI4N 150 375 030	BC DPRI4N 150 375 040
4.00	BC DPRI4N 150 400 010	BC DPRI4N 150 400 015	BC DPRI4N 150 400 020	BC DPRI4N 150 400 025	BC DPRI4N 150 400 030	BC DPRI4N 150 400 040
4.50	BC DPRI4N 150 450 010	BC DPRI4N 150 450 015	BC DPRI4N 150 450 020	BC DPRI4N 150 450 025	BC DPRI4N 150 450 030	BC DPRI4N 150 450 040

The availability of each reference for the sale is linked to the authorization of commercialization in the country of destination

Distributed by:

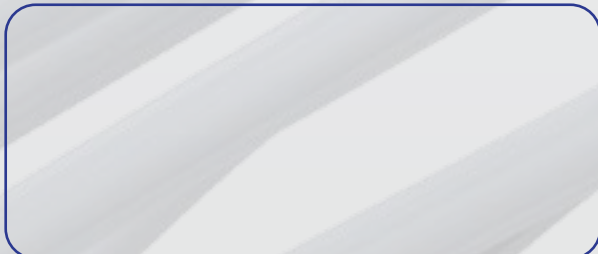

Manufactured by:

Life Vascular Devices Biotech S.L  
[www.ivascular.global](http://www.ivascular.global)  
[info@ivascular.global](mailto:info@ivascular.global)

# iVascular<sup>®</sup>

therapies for living

## capturer 6F & 7F

Thrombus extraction catheter

PTFE inner layer

specifically designed to  
minimize friction and  
assure fast thrombus  
removal

Innovative tip

guarantees  
aspiration power in  
all circumstances

**HYDRAX**



Durable hydrophilic coating  
for sustainable performance  
and full control



[www.ivascular.global](http://www.ivascular.global)



## Quick access

Flat-wire braiding  
Stiffening mandrel  
Hydrophilic coating on the distal part of the device

Increased pushability without kinking to cope with the most tortuous anatomy

## Forceful

Superior extraction capability:  
**0.99 mm<sup>2</sup> (6F) - 1.39 mm<sup>2</sup> (7F)**  
**PTFE inner layer** specially designed to minimize friction and assure fast thrombus removal  
**Wire mesh** through the catheter to avoid collapsing during aspiration

## Secure

**2 radiopaque markers** ensure accurate positioning at all times

# Capturer features

- > Rapid exchange length: **17.5 cm**
- > Usable length: **140 cm**
- > Entry profile: **0.021" (6F) - 0.025" (7F)**
- > Guiding catheter compatibility **6F & 7F**
- > Guidewire compatibility: **0.014"**
- > **RO** markers

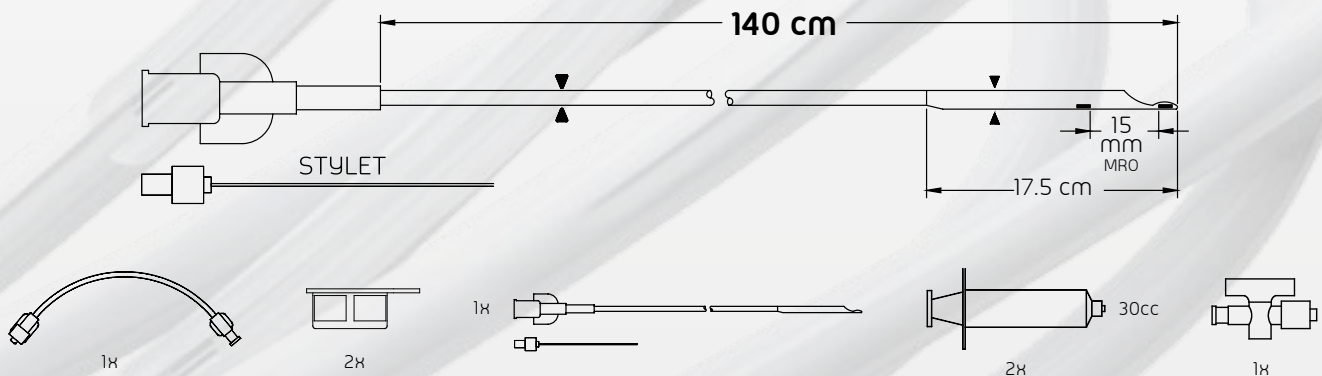

Product with CE mark, certified by Notified Body 0318

## References

Capturer 6F	DET R14 145 601
Capturer 7F	DET R14 145 701

Distributed by:



Manufactured by:

Life Vascular Devices Biotech S.L  
[www.ivascular.global](http://www.ivascular.global)  
[info@ivascular.global](mailto:info@ivascular.global)

# NC xperience

Coronary balloon dilatation catheter

**RBP up to 20 atm**

Perfect for post-dilatation

**The best tip profile**  
on the market

Ultra-low  
**crossing profile**

to cross through stent struts  
and calcified lesions

Outstanding  
**trackability**

excellent pushability  
and flexibility

**HYDRAX**



Hydrophilic  
durable coating





## Kissing balloon technique 6F compatible

The low transition profile between the hypotube and the distal shaft allows 6F kissing balloon technique



## Indications:

- All types of dilatation even the most calcified lesions requiring high pressure inflations to improve myocardial perfusion
- Stent post dilatation to enhance stent artery wall apposition and improve angiographic results

# NC xperience features

- > Rapid Exchange catheter (RX)
- > Compatible with **0.014"** guidewire
- > Compatible with **5F** guiding catheter
- > Nominal pressure: **12 atm** | ABP: **25 atm**
- > RBP: **20 atm** ( $\varnothing < 4.50\text{mm}$ ) **18 atm** ( $\varnothing \geq 4.50\text{mm}$ )
- > Tip profile: **0.016"**
- > Balloon crossing profile: **from 0.029" up to 0.037"**
- > **2 metallic platinum iridium radiopaque markers**
- > **Compliance: 7% max**
- > **Deflation rate: 3s average**

Product with CE mark, certified by Notified Body 0318

Balloon diameter (mm)	Usable catheter length: 142 cm							
	Balloon length (mm)							
	6	8	10	12	15	20	25	30
2.00	BC TRI4 150 200 006	BC TRI4 150 200 008	BC TRI4 150 200 010	BC TRI4 150 200 012	BC TRI4 150 200 015	BC TRI4 150 200 020	BC TRI4 150 200 025	BC TRI4 150 200 030
2.25	BC TRI4 150 225 006	BC TRI4 150 225 008	BC TRI4 150 225 010	BC TRI4 150 225 012	BC TRI4 150 225 015	BC TRI4 150 225 020	BC TRI4 150 225 025	BC TRI4 150 225 030
2.50	BC TRI4 150 250 006	BC TRI4 150 250 008	BC TRI4 150 250 010	BC TRI4 150 250 012	BC TRI4 150 250 015	BC TRI4 150 250 020	BC TRI4 150 250 025	BC TRI4 150 250 030
2.75	BC TRI4 150 275 006	BC TRI4 150 275 008	BC TRI4 150 275 010	BC TRI4 150 275 012	BC TRI4 150 275 015	BC TRI4 150 275 020	BC TRI4 150 275 025	BC TRI4 150 275 030
3.00	BC TRI4 150 300 006	BC TRI4 150 300 008	BC TRI4 150 300 010	BC TRI4 150 300 012	BC TRI4 150 300 015	BC TRI4 150 300 020	BC TRI4 150 300 025	BC TRI4 150 300 030
3.25	BC TRI4 150 325 006	BC TRI4 150 325 008	BC TRI4 150 325 010	BC TRI4 150 325 012	BC TRI4 150 325 015	BC TRI4 150 325 020	BC TRI4 150 325 025	BC TRI4 150 325 030
3.50	BC TRI4 150 350 006	BC TRI4 150 350 008	BC TRI4 150 350 010	BC TRI4 150 350 012	BC TRI4 150 350 015	BC TRI4 150 350 020	BC TRI4 150 350 025	BC TRI4 150 350 030
3.75	BC TRI4 150 375 006	BC TRI4 150 375 008	BC TRI4 150 375 010	BC TRI4 150 375 012	BC TRI4 150 375 015	BC TRI4 150 375 020	BC TRI4 150 375 025	BC TRI4 150 375 030
4.00	BC TRI4 150 400 006	BC TRI4 150 400 008	BC TRI4 150 400 010	BC TRI4 150 400 012	BC TRI4 150 400 015	BC TRI4 150 400 020	BC TRI4 150 400 025	BC TRI4 150 400 030
4.50	BC TRI4 150 450 006	BC TRI4 150 450 008	BC TRI4 150 450 010	BC TRI4 150 450 012	BC TRI4 150 450 015	BC TRI4 150 450 020		
5.00	BC TRI4 150 500 006	BC TRI4 150 500 008	BC TRI4 150 500 010	BC TRI4 150 500 012	BC TRI4 150 500 015	BC TRI4 150 500 020		

The availability of each reference for the sale is linked to the authorization of commercialization in the country of destination

Distributed by:

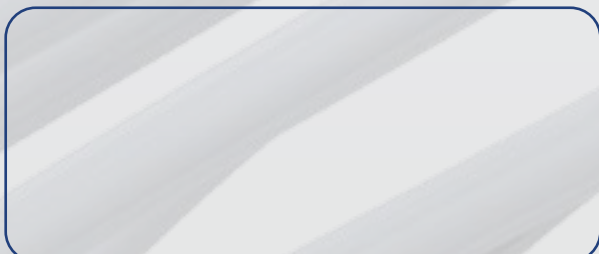

Manufactured by:

Life Vascular Devices Biotech S.L  
[www.ivascular.global](http://www.ivascular.global)  
[info@ivascular.global](mailto:info@ivascular.global)

**iVascular**<sup>®</sup>  
therapies for living

# navitian

Coronary microcatheter



The navigation you need



[www.ivascular.global](http://www.ivascular.global)

Navitian, the needed microcatheter to arrive to the most challenging lesions.

**Its exceptional design brings benefits as:**

**Outstanding trackability**  
through the small and  
tortuous arteries due to  
hydrophilic coating  
HYDRAX PLUS

**Optimal flexibility,  
pushability and resistance  
to kinking** provided by a  
full length variable braided  
pattern

**Complete  
guidewire control**  
ensured by its  
conical transition

**Superior crossability and  
penetration capacity** due to  
its optimized tip profile and  
shape with double c-cut  
radiopaque markers

## navitian features

- > **Over the wire catheter (OTW)**
- > **Guidewire compatibility** 0.014"
- > **Usable catheter length** 135 and 150 cm
- > **Radiopaque markers**
- > **Internal PTFE layer**
- > **Hydrophilic coating:** 70 and 90 cm

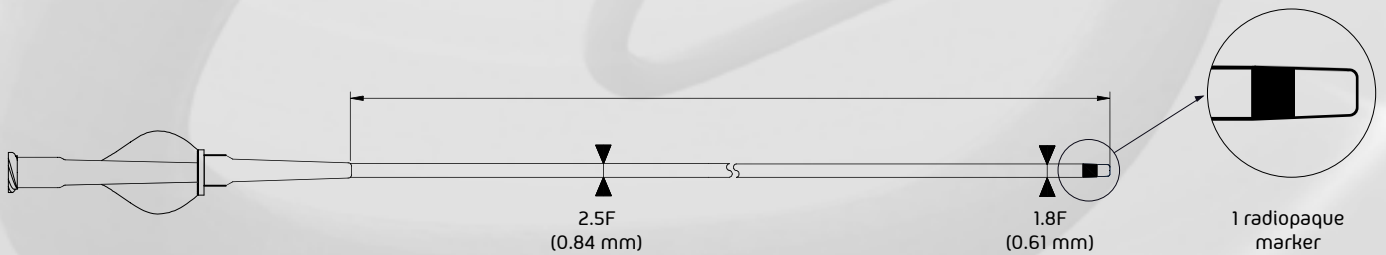

Product with CE mark, certified by Notified Body 0318

### References

Usable length 135 cm
Usable length 150 cm

MCC C14 135 001
MCC C14 150 001

The availability of each reference for the sale is linked to the authorization of commercialization in the country of destination

Distributed by:

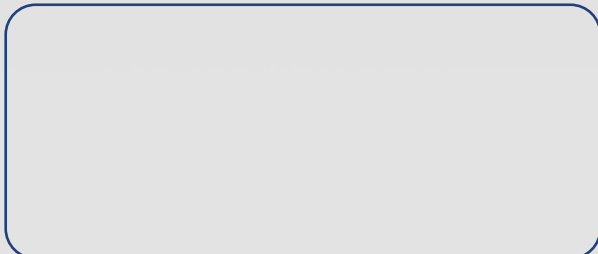

Manufactured by:

**Life Vascular Devices Biotech S.L**  
[www.ivascular.global](http://www.ivascular.global)  
[info@ivascular.global](mailto:info@ivascular.global)



**iVascular**<sup>®</sup>  
therapies for living

# xperience pro

Coronary balloon dilatation catheter



The balloon that crosses all lesions



[www.ivascular.global](http://www.ivascular.global)

# The latest balloon technology

---

## Outstanding visibility

Metallic radiopaque markers with optimized crimping technology

**0.024"\***

The lowest  
crossing profile

**<3 seconds\*\***

The fastest deflation time  
even for big balloons due to  
its optimized shaft design



# xperience pro ensures the capacity to reach the most distal and complex lesions

1

**Crossing all lesions** due to a very low tip entry profile

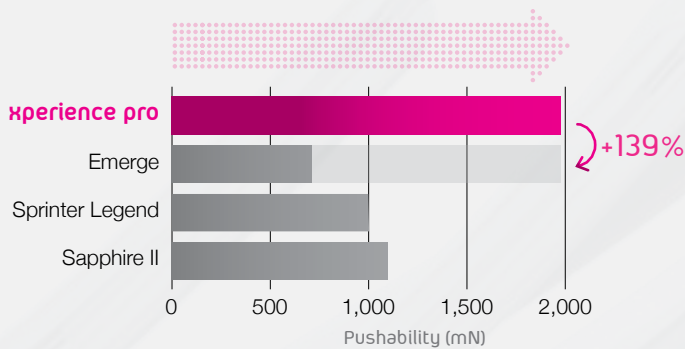

**The highest pushability**<sup>\*\*\*</sup>

Innovative material combination created with our proprietary technology makes the difference

2

3

**Deliverability ensured** by a new design with 2 distal shafts

**2.6F** | For small balloons ≤ 3mm

**2.7F** | For big balloons ≥ 3.25mm



Proprietary formula

**Optimal trackability** due to our durable hydrophilic coating

4

# xperience pro features

- > **Rapid Exchange** catheter (RX)
- > Compatible with **5F guiding catheter**
- > NP: **6 atm** | RBP: **16 atm**
- > **Semi-compliant:** 10-15%
- > **2 Pt/Ir metallic radiopaque markers**

Product with CE mark, certified by Notified Body 0318

Balloon diameter (mm)	Usable catheter length: 142 cm					
	Balloon length (mm)					
	10	15	20	25	30	40
1.25	BC PRI4N 150 125 010	BC PRI4N 150 125 015	BC PRI4N 150 125 020	-	-	-
	BC PRI4N 150 125 110 *	BC PRI4N 150 125 115 *	-	-	-	-
1.50	BC PRI4N 150 150 010	BC PRI4N 150 150 015	BC PRI4N 150 150 020	-	BC PRI4N 150 150 030	-
	BC PRI4N 150 150 110 *	BC PRI4N 150 150 115 *	-	-	-	-
2.00	BC PRI4N 150 200 010	BC PRI4N 150 200 015	BC PRI4N 150 200 020	BC PRI4N 150 200 025	BC PRI4N 150 200 030	BC PRI4N 150 200 040
2.25	BC PRI4N 150 225 010	BC PRI4N 150 225 015	BC PRI4N 150 225 020	BC PRI4N 150 225 025	BC PRI4N 150 225 030	BC PRI4N 150 225 040
2.50	BC PRI4N 150 250 010	BC PRI4N 150 250 015	BC PRI4N 150 250 020	BC PRI4N 150 250 025	BC PRI4N 150 250 030	BC PRI4N 150 250 040
2.75	BC PRI4N 150 275 010	BC PRI4N 150 275 015	BC PRI4N 150 275 020	BC PRI4N 150 275 025	BC PRI4N 150 275 030	BC PRI4N 150 275 040
3.00	BC PRI4N 150 300 010	BC PRI4N 150 300 015	BC PRI4N 150 300 020	BC PRI4N 150 300 025	BC PRI4N 150 300 030	BC PRI4N 150 300 040
3.25	BC PRI4N 150 325 010	BC PRI4N 150 325 015	BC PRI4N 150 325 020	BC PRI4N 150 325 025	BC PRI4N 150 325 030	BC PRI4N 150 325 040
3.50	BC PRI4N 150 350 010	BC PRI4N 150 350 015	BC PRI4N 150 350 020	BC PRI4N 150 350 025	BC PRI4N 150 350 030	BC PRI4N 150 350 040
3.75	BC PRI4N 150 375 010	BC PRI4N 150 375 015	BC PRI4N 150 375 020	BC PRI4N 150 375 025	BC PRI4N 150 375 030	BC PRI4N 150 375 040
4.00	BC PRI4N 150 400 010	BC PRI4N 150 400 015	BC PRI4N 150 400 020	BC PRI4N 150 400 025	BC PRI4N 150 400 030	BC PRI4N 150 400 040
4.50	BC PRI4N 150 450 010	BC PRI4N 150 450 015	BC PRI4N 150 450 020	BC PRI4N 150 450 025	BC PRI4N 150 450 030	BC PRI4N 150 450 040
5.00	BC PRI4N 150 500 010	BC PRI4N 150 500 015	BC PRI4N 150 500 020	-	-	-

The availability of each reference for the sale is linked to the authorization of commercialization in the country of destination  
\* Reference with one radiopaque marker centered in the balloon

Distributed by:

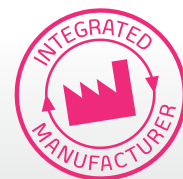

Manufactured by:

**Life Vascular Devices Biotech S.L**  
[www.ivascular.global](http://www.ivascular.global)  
[info@ivascular.global](mailto:info@ivascular.global)