

PROGNOST F

X-ray system table

Model/ID: 7041-5-8701L

User Manual

Ident. Nr. 5041-0-8002



CE

**NOTE**

All sheets of this document contain proprietary and confidential information of PROTEC GmbH & Co. KG and is intended for exclusive use by current PROTEC GmbH & Co. KG customers. Copying, disclosure to other or other use is prohibited without the express written authorization of PROTEC's law department. Report any violations of this requirement to PROTEC GmbH & Co. KG.

© 2019 PROTEC GmbH & Co. KG, Oberstenfeld

These accompanying documents were created and distributed by the documentation department.
Comments and questions about the documentation, please contact:

PROTEC GmbH & Co. KG

In den Dorfwiesen 14 | 71720 Oberstenfeld
Deutschland

Phone: (+ 49) 7062 – 92 55 0

Fax: (+ 49) 7062 – 92 55 60

E-Mail: protec@protec-med.com

Internet: www.protec-med.com

Table of contents

	Page
Table of contents	3
Document Effectivity	5
General Notes	6
Mechanical – Electric Warning	6
To the User	6
1 Product description	7
1.1 Introduction.....	7
1.2 Description.....	7
1.2.1 Models.....	7
1.2.2 Installation.....	8
1.2.2.1 Floor capacity.....	8
1.3 Product specific characteristics.....	8
1.4 Intended use.....	8
1.5 Indication and Contraindication.....	9
1.5.1 Indication.....	9
1.5.2 Contraindication.....	9
1.6 Intended user group.....	9
1.7 Conformity.....	10
2 Safety Instructions	11
2.1 General safety notice.....	12
2.1.1 Requirements for operation.....	12
2.1.2 Operating of the radiographic system.....	12
2.1.3 Operating personnel.....	12
2.1.4 Pinching and Collision Hazards.....	13
2.1.5 Explosion protection.....	13
2.1.6 Interaction with external devices.....	13
3 Control elements and device displays	14
3.1 Operation.....	14
3.2 Components.....	14
3.3 Bucky from the PROTEC series.....	15
4 Handling / Operation	16
4.1 Operation PROGNOST F.....	16
4.1.1 Releasing the table top brake (positioning the table top).....	16
4.1.2 Operation at the PROGNOST F.....	16
4.2 Function of the PROGNOST F.....	17
4.2.1 Switching On/Off the PROGNOST F.....	17
5 Safety and Maintenance	18
5.1 Introduction.....	18
5.2 Cleaning and disinfection.....	18
5.2.1 Cleaning.....	18
5.2.2 Disinfection.....	18
5.3 Check-up and maintenance.....	19
5.3.1 Daily Controls (prior to or during the unit operation).....	19
5.3.2 Regular controls.....	19
5.3.3 Maintenance.....	19
5.3.4 Warranty.....	19
5.3.5 Product life time.....	19
5.3.6 Further Information.....	19
5.3.7 Applied Parts and parts which get handled like an application part.....	19
5.3.8 Disposal.....	20
6 n/a	21
7 Technical Data	22

7.1	Dimensions.....	22
7.1.1	Movement and dimension.....	23
7.1.2	Total weight.....	23
7.2	Attenuation Equivalent.....	23
7.3	Protection Art and Protection Class.....	23
7.4	Environmental	23
7.4.1	Environmental conditions during operation	23
7.4.2	Environmental Conditions for Shipping and Storage	23
8	Description of symbols, labels and abbreviations	24
8.1	Symbols	24
8.2	Identification label.....	25
8.3	Labels	25
8.4	Position symbols and labels.....	27
8.5	Abbreviations	27

**NOTE**

The information contained in this document conforms to the configuration of the equipment as of the date of manufacture. Revisions to the equipment subsequent to the date of manufacture will be addressed in service updates distributed to the PROTEC Technical Service Organization.

Document Effectivity

Revision No.	Date	List of effective pages	Comments
1.0	2019-05-14	all	Newly created. Replace document 5041-0-0002_Rev05
2.0	2019-08-07	Page 21 chap. 3.2 Chap. 8.2	Intended use updated Changed illustration dimension Renamed Identification label updated

General Notes

**WARNING!**

No changes of the ME device!

Mechanical – Electric Warning

**WARNING!**

All of the movable assemblies and parts of this equipment should be operated with care and routinely inspected in accordance with the manufacturer's recommendations contained in the equipment Accompanying Documents.

Maintenance and service is only to be performed by Customers authorized by PROTEC GmbH & Co. KG.

Live electrical terminals are deadly.

Do not remove flexible high-tension cables from X-ray tube housing or high-tension generator and/or access covers from X-ray generator.

For all components of the equipment protective earthing means must be provided in compliance with the national regulations.

Failure to comply with the foregoing may result in serious or fatal bodily injuries to the operator or those in the area.

To the User

**NOTE**

The user of this Document is directed to read and carefully review the instructions, warnings and cautions contained herein prior to beginning operation, installation or service activities.

While you may have previously operated equipment similar to that described in this Document, changes in design, manufacture or procedure may have occurred which significantly affect the present operation.

Although the product was subject to a risk analysis and the design corresponds to the current state of the art, residual risk will remain in clinical use. These are displayed in the following user manual by application limitations, contraindications, warnings and precautions.

The installation and service of equipment described herein is to be performed by authorized, qualified **PROTEC GmbH & Co. KG** Customers.

Assemblers and other Customers not employed by nor directly affiliated with **PROTEC GmbH & Co. KG** technical services are directed to contact the local **PROTEC GmbH & Co. KG** office before attempting installation or service procedures.

For Installations and service procedures it is necessary to read the „technical description“ of the product and to observe any containing point in it.

1 Product description

1.1 Introduction

This user manual describes the special features and operational aspects of the PROGNOST F, knowledge of which are required for efficient and effective use of the radiographic system.

Prior to working with the PROGNOST F, it is required that the user read the safety notes as well as the chapter regarding operation.

1.2 Description

The PROGNOST F consists of a moving grid table with a floating table top. It is prepared for the installation of a running grid device with electronic drive for an anti-scatter grid, which can be moved manually in longitudinal direction, and a 3-field measuring chamber for operation with automatic exposure control.

The floating, flat table top of the barrel grid table is locked in the resting position by highly effective pedo-mechanical brakes in longitudinal and transverse direction. Both directions of movement can be released by an ergonomically easy to reach brake arm. The ease of movement of the table top and its large adjustment range allow comfortable positioning of the patient.

1.2.1 Models

PROGNOST F

7041-5-8701L

Device components

The X-ray system table PROGNOST F consists of the following components:

- Table base body F
- Front panel F
- Intermediate frame for table top width 755mm
- Table top composite fibre 2260x755mm

Options

- Table top carbon
- Two different table top sizes

Optional accessories

- Long hand grip RAL5021 (ID: 7036-0-0611), for mounting on the back of the table top, as a hand grip to facilitate patient ascent and descent
- Short hand grip (ID: 7303-0-1100), short hand grip adjustable (ID: 7303-0-1150), for mounting on the front of the table top, as operating aid for easy moving of the table top.
- Corner protection set table top (ID: 7303-0-1700)
- Shock protection profile (ID 7303-0-1510), for rear table top accessory rail
- Compression band (ID 7755-0-4001)
- Mattress (ID: 7765-0-402x)

Integratable components (independent products) and possible combinations

These parts are not supplied with the PROGNOST F but can be combined with it.

- Bucky or Grid entity of the PROTEC series
- 3-field measuring chamber
- Anti-scatter grid

Accessories that can influence the EMC conditions

- Network cable (note the max. cable length in the component documentation)

1.2.2 Installation

See separate "Installation manual" PROGNOST F.

Contact information of persons which are qualified to make installations are requestable at:

PROTEC GmbH & Co. KG
In den Dorfwiesen 14 | 71720 Oberstenfeld
Telephone: +49 (0) 7062 – 92 55 0
Fax: +49 (0) 7062 – 92 55 60
E-Mail: protec@protec-med.com
Internet: www.protec-med.com

1.2.2.1 Floor capacity



NOTE

The X-ray system table PROGNOST F is primarily made of metal pieces. This has a main role in the weight of the device.

The X-ray system table PROGNOST F has a max. weight of 132 kg.

Every technician is obliged to check the ground load. Also double bottoms and hollow floors have to be taken into account.

1.3 Product specific characteristics

- Variable table top size
 - Standard: 226 x 75,5 cm
 - Optional: 220 x 75.5 cm
- Floating table top
- Table top colour – white
- Wide range of applications
- Table height suitable for patients, 70 cm
- Long hand grip at the back of the table top (standard)
- Center marking for the transverse movement on the table top
- A low (optimized) distance between the table top surface and the film (detector) surface
- Large adjustment range of the table top for position of the patient
- High reliability
- Side profile rails on the long sides of the table top for attaching accessories
- Prepared for the installation of a Bucky with anti-scatter grid and 3-field measuring chamber intended for the use with automatic exposure control
- Extensive cassette program including Format 13 cm x 18 cm up to Format 35.6 cm x 43 cm

1.4 Intended use

PROGNOST F is an X-ray system table with a floating, mechanically adjustable table top for use in medical rooms. As a component of a stationary basic diagnostic X-ray system PROGNOST F is intended to position and support a patient during a variety of routine planar procedures requiring a diagnostic X-ray system in human medicine.

1.5 Indication and Contraindication

1.5.1 Indication

The X-ray system component PROGNOST F, considered as a single component, has no indication and no contraindication. Since this X-ray system component is intended for connection with other X-ray system components, the indication and contraindication of an entire X-ray system are considered.

A complete list of indications is unrealisable for conventional radiography, because the spectrum of conventional X-rays is very diverse and can vary in the course of medical-technical progress.

Some examples of indications for an X-ray examination may be:

- For the diagnosis of a bone fracture or bony injuries of the skeletal system or pathological changes of hard tissues.
- To control the bone setting.
- For the diagnosis of luxations and ligament ruptures of the locomotor system.
- For the diagnosis of degenerative, inflammatory, traumatic and tumorous diseases and changes of the locomotor system.
- For diagnostic of malformations and malalignments of the skeletal system.
- For the diagnosis of thoracic and pulmonary symptoms (thorax exposures)
- For the diagnosis of sclerotherapy.
- For the diagnosis of inflammatory and expansive processes of the mucosa, cranial bones and paranasal extension.
- For the diagnosis of the abdomen (e.g. acute abdomen, plain abdominal radiography, urethrogram, cystogram).

According to §83 of the German radiation protection law (StrlSchG), an X-ray examination is only justified if the patients benefit from x-ray diagnostics outweighs the radiation risk. The examination method, means the conventional X-ray with the PRS 500 system, must be suitable to answer the diagnostic question and no other more suitable alternative method is available.

1.5.2 Contraindication

- There are no absolute contraindications for conventional X-rays.
- But it is not allowed to make any exposures on humans when they are not medically indicated
- For pregnant women and children it is important to consider if the exposure is really necessary. It should be avoided if possible.

1.6 Intended user group

The PROGNOST F is exclusively designated for use by professional users who are trained to operate diagnostic X-ray equipment, in accordance with the corresponding national regulations, and who were instructed in the proper (certified) use, application and operation as well as in the permissible connection with other medical devices, objects and accessories.

Suitable user groups could include the following: Radiologist, radiology assistants, radiology technicians, doctors and other medically trained personnel.

1.7 Conformity



This product is in conformity with the requirements of the European Community Medical Device Directive 93/42/EEC from 06/14/1993 including all current revision standards.

The declaration of conformity is available directly from PROTEC:

PROTEC GmbH & Co. KG
In den Dorfwiesen 14 | 71720 Oberstenfeld
Telephone: +49 (0) 7062 – 92 55 0
Fax: +49 (0) 7062 – 92 55 60
E-Mail: protec@protec-med.com
Internet: www.protec-med.com

2 Safety Instructions



NOTE

Contains information that are relevant to the usage.

xxx



CAUTION!

Contains information that can cause damage to properties at non conformity.

xxx



WARNING!

Contains information that can cause personal injuries at nonconformity.

xxx



WARNING!

Warning of radioactive substances or ionising rays. Contains information that can cause personal injuries at non conformity.

xxx

Adjustments and calibrations that are not described within the user manual must be made with the aid of the technical description of the device by the **PROTEC GmbH & Co. KG** customer service department or a PROTEC GmbH & Co. KG authorized service technician.



NOTE

Every delivered manual has to be read and the safety notes have to be observed.



NOTE

After installation the commissioning have to be recorded with the PROTEC acceptance protocol.



NOTE

The commissioning of the PROGNOST F can only be done if all safety notes and user securities have been met. The user securities can be: end stops, protective covers, brakes etc.



CAUTION!

The manual contains every safety relevant information for the commissioning of the PROGNOST F. Operating the device is exclusively for special trained staff. In this context there are on every operating element relevant safety symbols. Further information are on the delivered document-CD. Those information count as additional information and have to be observed.

**NOTE**

Every operating elements are described in the corresponding manual.

2.1 General safety notice

2.1.1 Requirements for operation

**WARNING!****Protection Class I ME device**

To reduce the risk of electric shock, this unit is designated exclusively for connection to a supply network with protective earth.

In use with an X-ray generator:

The power for the components of the x-ray system table PROGNOST F is designated to be exclusively supplied through a direct connection to the available X-Ray generator. The X-Ray generator is required to offer a minimum of two connection ports with 230V 50/60Hz.

The X-ray system table PROGNOST F is a Class I ME product (according to EN 60601-1). To reduce the risk of electric shock, this unit is designated exclusively for connection to a supply network with protective earth.

This device contains no on/off switch. The PROGNOST F is directly connected to the X-Ray generator and is switched on/off through the switching on and off of the generator itself. In order to disconnect the PROGNOST F from the power the connected X-Ray generator must be shut off.

2.1.2 Operating of the radiographic system

In case of functional disturbance, e.g. due to electromagnetic interference, the PROGNOST F shall no longer be used and the customer service department of PROTEC or a service company authorized by PROTEC should be informed.

2.1.3 Operating personnel

The PROGNOST F should only be operated by personnel who are trained in accordance with the corresponding national regulations in the use and operation of diagnostic X-Ray systems.

**NOTE**

Only properly trained and authorized personnel are allowed to work with the PROGNOST F.

The user, as well as the service personnel, must pay attention to the warnings, notices and safety instructions located on the device and in the user manual. Failure to comply with the information provided can lead to injury.

**NOTE**

Operating personnel are required to acquaint themselves with all warnings (warning signs) located on the device. They serve to ensure the safety of the operator as well as others and set a basic for orderly operation.

2.1.4 Pinching and Collision Hazards



CAUTION!

Ensure that while using any product that can be lowered, raised or moved in different directions, neither yourself (operator), the patient or any third party finds themselves in a hazardous position (area of movement). Remove all objects (e.g. chairs, pushcarts) from known collision areas. Failure to observe this can lead to physical injury (crushing, bruising etc.) or damage to the device as well as objects.

2.1.5 Explosion protection

The PROGNOST F is not designated for use within areas with explosive hazards.

2.1.6 Interaction with external devices

Unwanted interaction with external devices are not known.

3 Control elements and device displays

3.1 Operation

By actuating the brake arm (Figure 3-1/4) with the foot, the brakes of the table top (Figure 3-1/2) are released, whereby the table top can be moved floating by hand.

The hand grip (Figure 3-1/1) facilitates patient ascent and descent.

3.2 Components

- 1 Long hand grip RAL 6021 (accessory)
- 2 Table top
- 3 Short hand grip (accessory)
- 4 Brake pedestal
- 5 Bucky unit
- 6 Corner protection (accessory)
- 7 Compression band (accessory, see Figure 3-2)

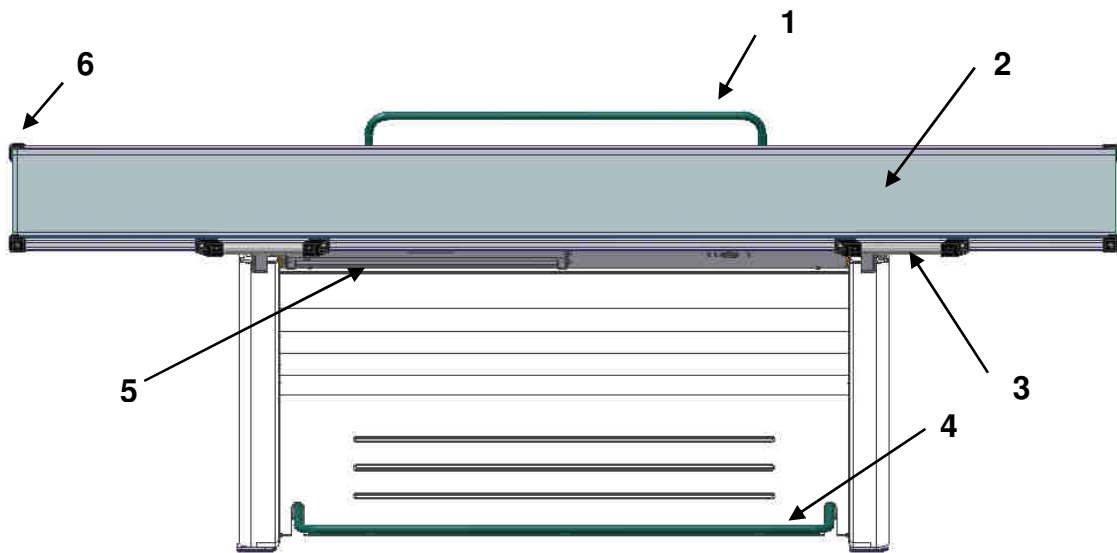

Figure 3-1



CAUTION!

Before the patient gets on and off, move the table top (Fig.3-1/2) to the front position.

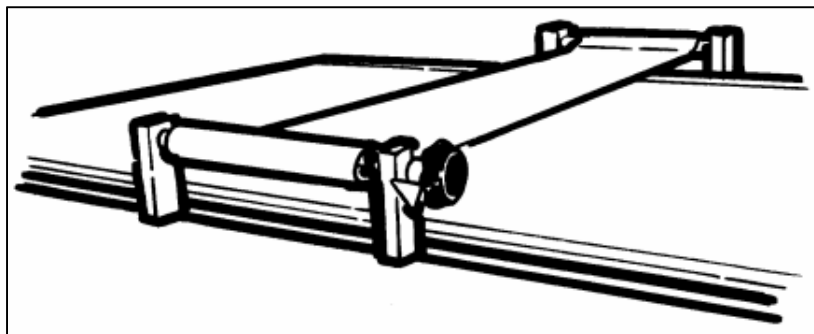

Figure 3-2

The compression band is inserted into the PA profile rails of the table top. With the transparent band-shaped compressorium a pressure can be exerted on the body part to be examined or the body part can be held in rest position. The tractive force is self-locking.

3.3 Bucky from the PROTEC series

The cassette tray (Fig. 3-3) is used to hold the X-ray film cassettes.

After pulling out the cassette tray (Fig. 3-3; 1) from the handle (Fig. 3-3; 3) of the Bucky as far as it will go, the cassette can be inserted. The cassette is clamped by the clamping device (Fig. 3-3; 2). The cassette is automatically centered in the transverse direction. In the longitudinal direction, the cassette can be positioned manually by aligning it with the center markings or by adjusting the cassette positioner (Fig. 3-3; 4) to the appropriate cassette size.

The movement range of the Bucky is 545 mm.

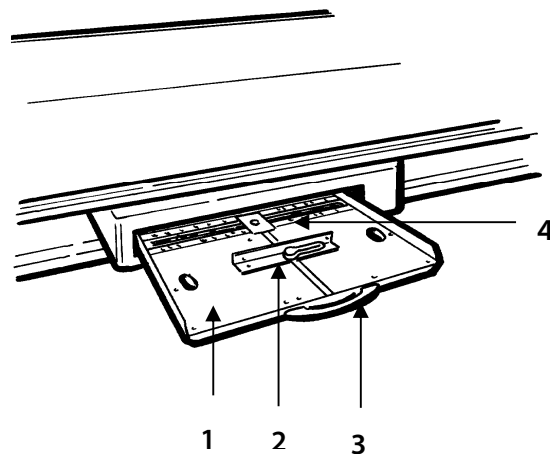

Figure 3-3

4 Handling / Operation

4.1 Operation PROGNOST F

4.1.1 Releasing the table top brake (positioning the table top)

By actuating the brake arm (Figure 3-1/4) with the foot, the brakes of the table top (Figure 3-1/2) are released, whereby the table top can be moved floating by hand.



CAUTION!

The corner of the table top are relatively sharp.

When moving the table top horizontally as well as when getting on and off the patient, the corners of the table top must be observed. Additional protective parts are available as optional accessories (see chapter 3.2).

The table top displacement is from the central position in:

Transverse direction	± 150 mm
Longitudinal direction	± 330 mm (2m table top)
	± 460 mm (2.26 m table top)

Prior to patient positioning, the X-ray unit must be brought into the required exposure position.

4.1.2 Operation at the PROGNOST F

- Move the table to a position in which the patient can climb onto the table surface as easily as possible.



CAUTION!

Der PROGNOST F is only used for positioning the patient during the examination.

The patient may only ascend and descend under the supervision or assistance of the examiner, otherwise there is a risk of injury! Help patients to climb up.

If the patient weights more than 150 kg, the user must follow the steps for ascending and descending the patient as described in chapter 4.1.2

- Ascent and descent of the patient (see Fig. 4-1)
 - Slide the table top all the way to one side (left or right).
 - Push the Bucky cassette tray to the other side.
 - Position the table top as centred as possible (rear/front).
 - The patient should ascend and descend in the middle of the table top (green arrow).

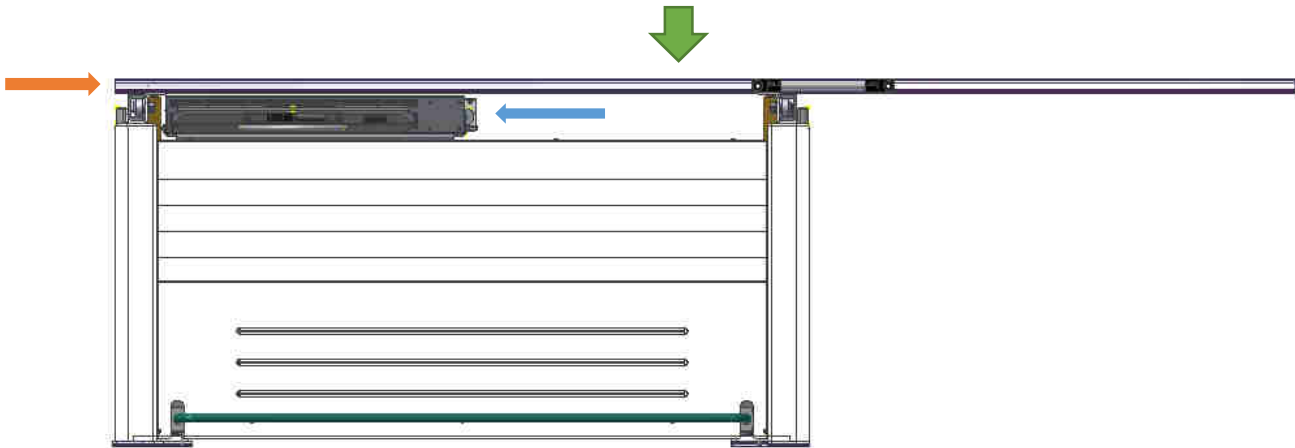

Figure 4-1

- Position patients for admission. If necessary (e.g. open wounds), cover the table surface with suitable cloths or disposable care pads.

**WARNING!**

Danger of crushing at the table edges and clamping on and below the table top!

When the table top is moved horizontally, extremities can be trapped between a table edge and a fixed obstacle (wall, column, X-ray equipment). Therefore: When using the PROGNOST F, make sure that neither the patient nor the personnel are in the direction of movement. In particular, make sure that no extremities of the patient protrude over the edge of a table. This must be taken into account with every patient and the patient must also be informed that all body parts on the table top should remain unmoved.

4.2 Function of the PROGNOST F

4.2.1 Switching On/Off the PROGNOST F

The PROGNOST F starts automatically when the system is switched on and is not started separately. The PROGNOST F switches off automatically when the system is switched off and is not switched off separately.

5 Safety and Maintenance



WARNING!

Caution Electrocutation hazard!

Disconnect the power supply.

If the component is to be supplied via X-ray system or generator, then switch off the whole X-ray system.

5.1 Introduction

In this chapter, you will find details regarding safety and maintenance, which is required to ensure the correct and reliable function of the radiographic system following initial installation.

5.2 Cleaning and disinfection



NOTE

Caution

Changes to material are possible!

Pay attention that, during cleaning and/ or disinfection, no fluids find their way into the main housing of the X-ray system table. This reduces the risk of short circuits and corrosion.

5.2.1 Cleaning

Cleaning of the PROGNOST F is very easy due to its high-quality surface coating. As a rule, this can be done with a dry cloth.

The use of corrosive or abrasive cleaning agents as well as solvents is not allowed. These materials can cause damage to the outer surface of the unit or to the coating of the individual components.

Clean the outer surfaces of the unit and all painted components using a damp towel and a mild – light alkaline cleaning agent (e.g. RBS* Neutral T). Dry the components off following cleaning.

Chrome components should be cleaned by being wiped down with a dry wool cloth.

5.2.2 Disinfection

Disinfection must be performed in accordance with the applicable legal requirements and guidelines corresponding to disinfection and explosion protection.

For reasons related to safety, the use of spray disinfection is not allowed. The mist from such disinfection dispenser systems can find its way into the unit, resulting in short circuiting and/ or corrosive build up.

All components within the X-ray system table PROGNOST F, including unit accessories, should undergo a wipe down disinfection using appropriate surface disinfection agents (e.g. Melsept* SF, 15 min. reaction time with a concentration of 2%). The information provided by the disinfectant manufacturer in regard to concentration and reaction time must be closely followed.

No disinfection agent, which is classified as flammable, can be utilized.

Should explosive gas and / or vapors be created through the use of the chosen disinfection agents, the unit can only be switched on when the gas/vapors have 100% dispersed.

5.3 Check-up and maintenance



WARNING!

It's forbidden to make any checkup or maintenance services while the PROGNOST F is in use with a patient! Any checkup or maintenance services can only be done by people who got trained or authorized by PROTEC.

5.3.1 Daily Controls (prior to or during the unit operation)

Prior to operation (creation of X-Ray images), the operator must ensure that all safety related mechanisms, indicators and/or switches described within the user manual are fully functional and that the device is overall operationally ready.

- Check that the table top moves smoothly when the table top brake is released.
- Check the table top brake if it is not released

5.3.2 Regular controls

Quality assurance measures for X-ray equipment must be carried out at regular intervals in accordance with national regulations, e.g. by means of a monthly constancy test.

- Check the surface of the table tops for damage or cracks.

5.3.3 Maintenance

Required maintenance must be performed at 6-month intervals by PROTEC Service or specific authorized service provider to ensure the safe and reliable operation of the equipment. In the event that scheduled maintenance is not performed, PROTEC GmbH & Co. KG will not be responsible for damages incurred by the user or third parties if such damages are the result of improper or omitted maintenance.

See Technical Description off the X-ray-system table PROGNOST F and off all integral components. Only original spare parts are to be used in situations requiring component replacement.

5.3.4 Warranty



NOTE

The current conditions of guarantee are deposited in the order papers or in the valid pricelist to the time of purchase.

All repairs and replacement of components because of misuse and/or incorrect operation are excluded from the warranty.

Only authorized technicians may do service and maintenance work.

5.3.5 Product life time

The PROGNOST F has an expected product life of 10 years when used in accordance with the product specifications/ limitations and provided that maintenance through the PROTEC service department or a PROTEC authorized service provider has be completed. After reaching the life span the further usage of the device happens on own risk.

5.3.6 Further Information

Further information to the chapters and for a safe usage, transport or storage are in the technical description of the PROGNOST F.

5.3.7 Applied Parts and parts which get handled like an application part

Part	Definition (as applied part or parts which get handled like an application part but not defined as applied part)
Table top	Application part
Table housing	Component can come in contact with the patient-no application part

5.3.8 Disposal



The X-ray system table PROGNOST F contains different plastics and metals. At disposal of exchange parts or the whole system the current regulations have to be observed. Please contact your contractual partner or the service company, or a company specialized for disposing the components.

6 n/a

7 Technical Data

7.1 Dimensions

**100kg TP Carbon
 200 POUNDS TP CARBON
 75kg TP Verbundstoff 2m
 165 POUNDS TP COMPOSITE FIBRE 2m
 60kg TP Verbundstoff 2,26m
 132 POUNDS TP COMPOSITE FIBRE 2,26m

**100kg TP Carbon
 200 POUNDS TP CARBON
 75kg TP Verbundstoff 2m
 165 POUNDS TP COMPOSITE FIBRE 2m
 60kg TP Verbundstoff 2,26m
 132 POUNDS TP COMPOSITE FIBRE 2,26m

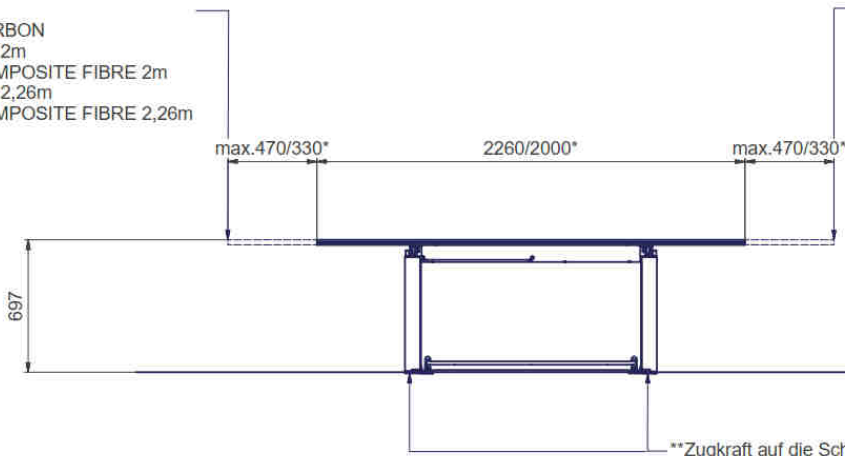

**Zugkraft auf die Schrauben der Bodenbefestigung 2500N bei Belastung der max. ausgefahrenen Tischplatte an ihrem Ende mit 100kg.
 TENSILE FORCE TO THE SCREW OF THE FLOOR ATTACHMENT 5500 POUND IN CASE LOAD OF 220 POUND AFFECT OF THE END OF THE TABLE TOP WHEN THE TABLE TOP IS MAXIMUM EXTENDED.

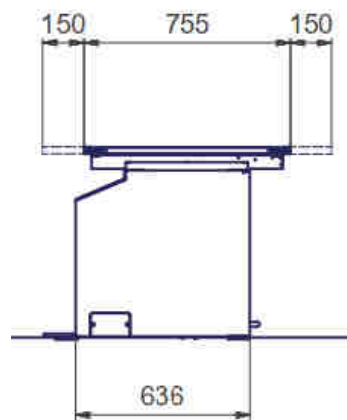
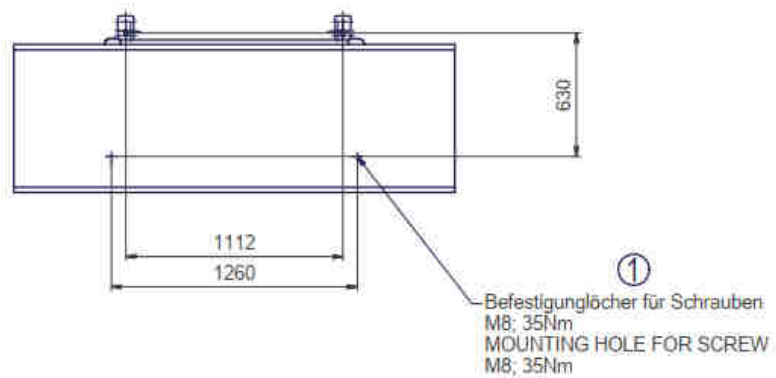

7.1.1 Movement and dimension

Table top dimensions (L x W):	226 cm x 75.5 cm or 200 cm x 75,5cm
Max. Patient weight (line load)	230 kg (standard) 250 kg (optional)
Table height:	697 mm
Tabletop transverse movement from center pos.:	± 150 mm
Tabletop longitudinal movement from center pos.:	± 330 mm (200 cm table top)
Tabletop longitudinal movement from center pos.:	± 470 mm (226 cm table top)

The brakes of the table top are actuated by a Bowden cable.

7.1.2 Total weight

The maximum total weight of the PROGNOST F without Bucky is 132 kg.

7.2 Attenuation Equivalent



WARNING!

The X-ray system table PROGNOST F can be delivered with different options on the Grid Entity/Bucky.

The attenuation factor must be determined at the final inspection at the customer. The variables like X-ray tube, Collimator etc. have influence to the factor. The attenuation value of the components can be read out of the accompanying documents of the component. The attenuation value has to be determined at the technical specifications. If the limits can't be kept please inform PROTEC immediately. If additional accessories are use it has a negative influence to the quality of the X-ray image.

The table top is defined as application part.

The aluminium attenuation equivalent of the table top is typically 0,7 < 0,8 Al mm for carbon / 0,85 mm Al for composite fibre, according to EN 60601-1-3. Tested at 100 kV with a first half-value layer thickness (HVL) of 3,7 mm Al and typically 0,6 mm Al und <0,8mm Al according 21CFR § 1020-30 (n) with 100 kV and a first half-value layer thickness (HVL) of 2,7mm Al.

7.3 Protection Art and Protection Class

The PROGNOST F is consistent with a protection class 1 device and contains Applied Part of Type B (according to EN 60601-1).

7.4 Environmental

7.4.1 Environmental conditions during operation









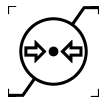

Ambient Temperature	+ 10°C to + 40°C
Relative humidity	30% to 75% (non-condensing)
Atmospheric pressure	700 hPa to 1060hPa

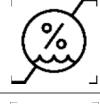
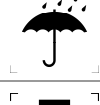
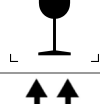



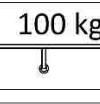
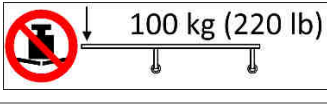
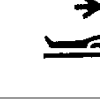
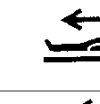

7.4.2 Environmental Conditions for Shipping and Storage

Ambient Temperature	- 10°C to + 70°C
Relative humidity	10% to 95% (non-condensing)
Atmospheric pressure	500 hPa to 1060hPa

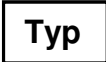
8 Description of symbols, labels and abbreviations

8.1 Symbols

	Limitation atmospheric pressure
	Limitation temperature
	Limitation humidity
	Keep dry
	Fragile, Handle with care
	This way up
	Attention, consult accompanying documents
	Refer to user manual
	CE-Mark
	Classification according to EN 60601-1 (Applied Part Type B)
	Caution: pinch-/crushing hazard for hands and fingers
	Do not exceed the maximum indicated weight
	Do not exceed the maximum indicated weight
	Table top movement for recording position
	Table top longitudinal movement
	Table top transverse movement

	Manufacturer
	Trade name
	Order number
	Serial number
	Date of manufacture
 www.protec-med.com/download	With this symbol we point out that Usage instructions of the corresponding product is on our Homepage
	Notes on disposal; WEEE , Waste of Electrical and Electronic Equipment
	Protective ground (Earth)

8.2 Identification label

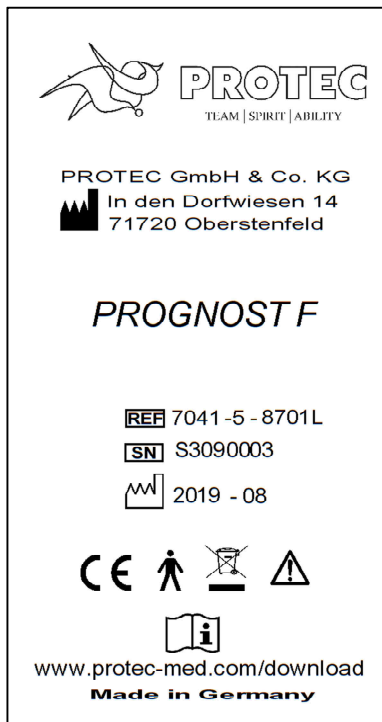

8.3 Labels

Labels on the side of the table top

Carbon table top

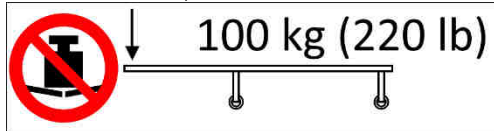

Composite-fibre table top 200cm

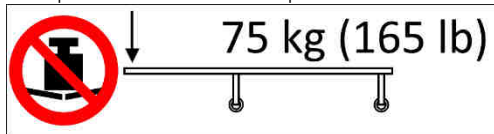

Composite-fibre table top 226cm

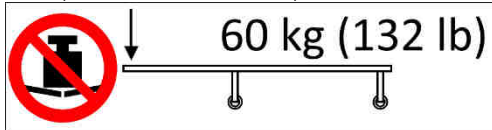

Labels on top of the table top



Caution: Possible pinch-/crushing hazard for the hands and fingers while moving the table top, table and or X-Ray tube assembly unit.



Maximum allowable Patient weight (distributed load) for the table top (Composite-fibre table top).



Maximum allowable Patient weight (distributed load) for the table top (Carbon table top).

Labels on the front plate x-ray system table



Company label

8.4 Position symbols and labels

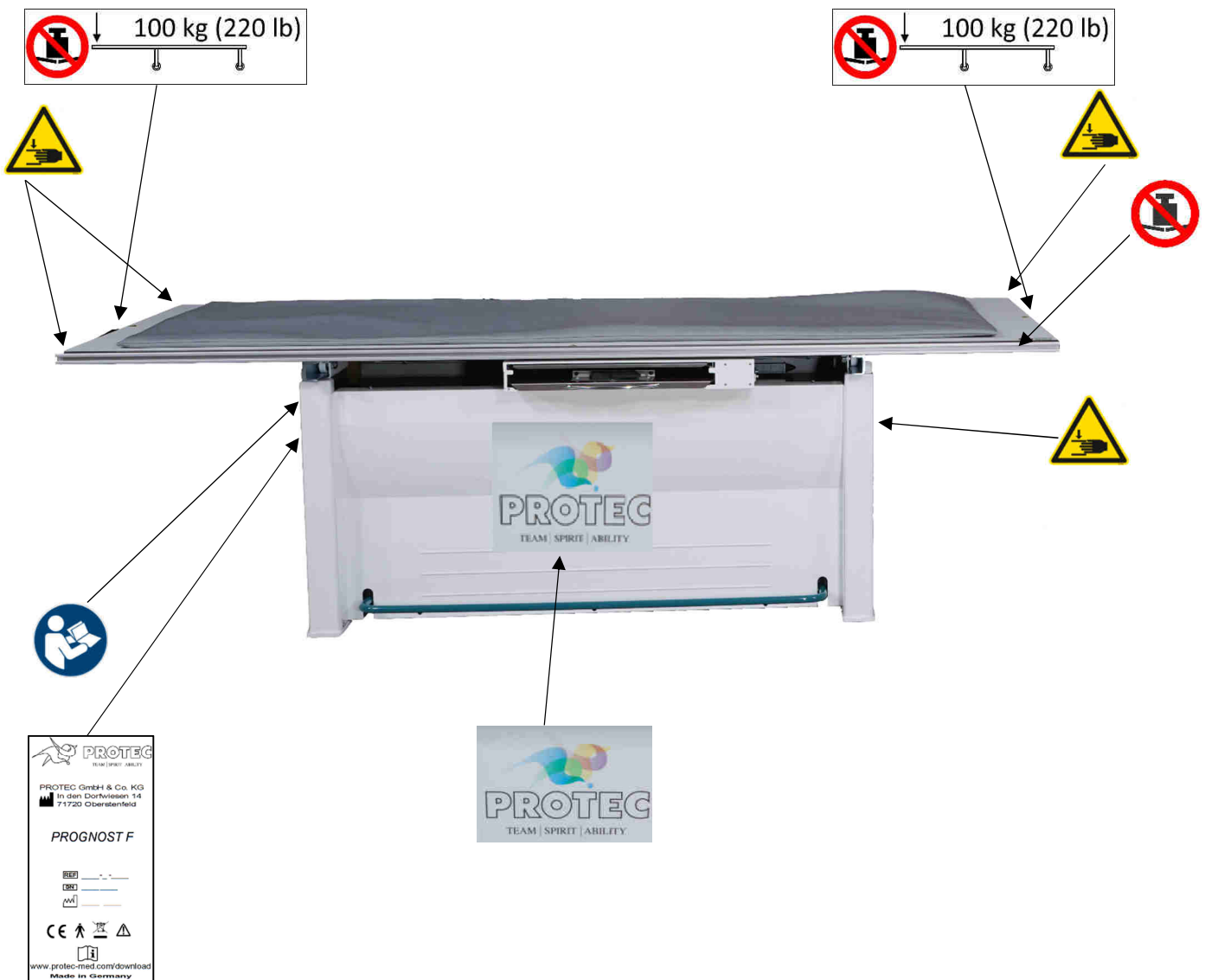

8.5 Abbreviations

mm	Millimeter
cm	Centimeter
lb.	Pound
kg	Kilogram
°C	Degree -Celsius
hPa	Hectopascal
DIN	German Industry Standard
EN	European Standard
CE	CE-Mark
Hz	Hertz
ED	Duty cycle
A	Ampere
SN	Serial number
V AC	Volt (alternating current)
V DC	Volt (direct current)
inch	Inches