



KNOCHENCHIRURGIE – BONE SURGERY

By

Fizza Surgical International



QUALITY POLICY : CUSTOMER'S SATISFACTION

MISSION STATEMENT : TO BECOME TOP MOST MEDICAL COMPANY IN PAKISTAN

Brief History of the company: Fizza Surgical International has made revolutionary changes in its manufacturing procedures from hand-made to modern machinery during the last 3 decades. Highly skilled workers are Proficiently working on these machinery multiplying production figures on one hand and having improved the quality of products to entire satisfaction of the customers.

Materials used in production : The materials used in production of these medical instruments conform to internationally recognized standards; viz. Grade AISI-410, Grade AISI-420 and Grade AISI-304. We use Japanese, German and French stainless steels.

Amputations- und Resektionssägen
Amputating and resection saws
Scies à amputation et résection
Sierra para amputación y resección
Seghe per amputazione



CHARRIERE

350 mm – 13³/₄"

BS 14-10-00



12 mm

BS 14-10-01

15 mm

BS 14-10-02

Ersatzsägeblätter
Spare saw blades



HELFERICH - BIER

390 mm – 15¹/₂"

BS 14-15-00



3 mm

BS 14-15-01

5 mm

BS 14-15-02

7 mm

BS 14-15-03

Ersatzsägeblätter
Spare saw blades

Amputations- und Resektionssägen
Amputating and resection saws
Scies à amputation et résection
Sierra para amputación y resección
Seghe per amputazione



1:2

SATTERLEE

310 mm - 12¹/₄"

BS 14-20-01



1:2

LANGENBECK

230 mm - 9"

BS 14-25-01



CHARRIERE

270 mm - 10³/₄"

BS 14-24-01

300 mm - 12"

BS 14-24-02

340 mm - 13¹/₂"

BS 14-24-03

Raspeln, Feilen

Rasps, files

Râpes, limes

Escofinas, limas

Raspe, lime



PUTTI

270 mm – 10 ³ / ₄ "	BS 14-30-01	BS 14-31-01
300 mm – 12"	BS 14-30-02	BS 14-31-02

280 mm – 11"	BS 14-35-01
--------------	-------------

halbrund
semicircular

245 mm – 9 ³ / ₄ "	x = 13 mm	BS 14-36-01
--	-----------	-------------

halbrund
semicircular

220 mm – 8 ³ / ₄ "	x = 20 mm	BS 14-37-01
--	-----------	-------------

flach
flat

Hämmer ;Mallets
Maillets ;Martillos
Martelli



DOYEN

	195 mm - 7 ³ / ₄ "
25 mm Ø - 120 g	BS 14-40-01
30 mm Ø - 180 g	BS 14-40-02
35 mm Ø - 260 g	BS 14-40-03



COLLIN

	200 mm - 8"
30 mm Ø - 220 g	BS 14-45-01

1:2



HAJEK

	215 mm - 8 ¹ / ₂ "
27 mm Ø - 140 g	BS 14-50-01

1:2



KIRK

	190 mm - 7 ¹ / ₂ "
38 mm Ø - 750 g	BS 14-55-01

1:2



PARTSCH

	180 mm - 7"
22 mm Ø - 200 g	BS 14-55-01

1:2



LUCANE

	190 mm - 7 ¹ / ₂ "
19 mm Ø - 230 g	BS 14-60-01
25 mm Ø - 260 g	BS 14-60-02

1:2

Hämmer ;Mallets
Maillets ;Martillos
Martelli



1:2
BERGMANN
245 mm – 9¾"
45 mm Ø – 300 g
BS 14-65-01



1:2
OMBREDANNE
240 cm – 9½"
40 mm Ø – 550 g
BS 14-70-01



HEATH

40 mm Ø – 700 g	180 mm – 7"	BS 14-75-01
45 mm Ø – 1000 g	200 mm – 8"	BS 14-75-02

Kupferfüllung
Copper filled head

**Hämmer ;Mallets
Maillets ;Martillos
Martelli**



1:2

190 mm - 7½"
250 mm Ø - 205 g
BS 14-80-01

Solid steel, with plastic faces

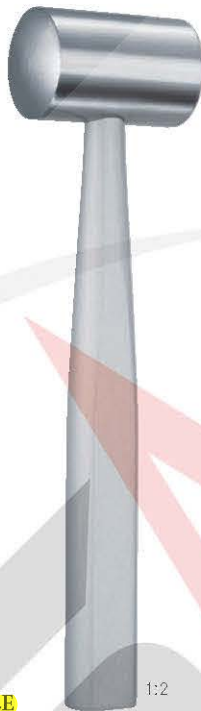

1:2

COTTLE

185 mm - 7¼"
30 mm Ø - 240 g
BS 14-85-01

1 side flat / 1 side convex



WILLIGER

240 mm - 9½"
28 mm Ø - 340 g
BS 14-90-01
30 mm Ø - 400 g
BS 14-90-02

lead filled



1:2

WILLIGER

165 mm - 6½"
20 mm Ø - 140 g
BS 14-95-01



1:2

MEAD

170 mm - 6¾"
26 mm Ø - 320 g
BS 14-100-01

*Stahl massiv, mit Kunststoffbacken
Steel solid, with plastic faces*

Knochenhebel ; Leviers à os
Elevadores para huesos
Elevatori per ossa



HOHMANN

220 mm – 8 ³ / ₄ "	240 mm – 9 ¹ / ₂ "	240 mm – 9 ¹ / ₂ "	240 mm – 9 ¹ / ₂ "
x = 8 mm	x = 18 mm	x = 43 mm	x = 70 mm
BS 14-125-01	BS 14-126-01	BS 14-127-01	BS 14-128-01

Knochenhebel ; Leviers à os
Elevadores para huesos
Elevatori per ossa



HOHMANN

245 mm - 9¾"	260 mm - 10¼"	280 mm - 11"	265 mm - 10½"	260 mm - 10¼"
x = 43 mm	x = 22 mm	x = 33 mm	x = 24 mm	x = 22 mm
BS 14-129-01	BS 14-130-01	BS 14-131-01	BS 14-132-01	BS 14-133-01

Knochenheber ; Leviers à os
Elevadores para huesos
Elevatori per ossa



MINI - HOHMANN

	6 mm	8 mm
160 mm - 6 ¹ / ₄ "	BS 14-135-01	BS 14-136-01

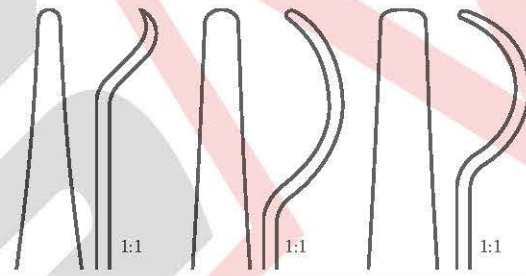
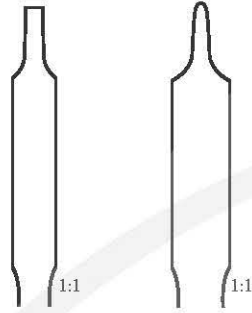

	2.8 mm	4.5 mm	6 mm
140 mm - 5 ¹ / ₂ "	BS 14-140-01	BS 14-141-01	BS 14-142-01



BRISTOW

230 mm - 9"	BS 14-145-01
-------------	--------------

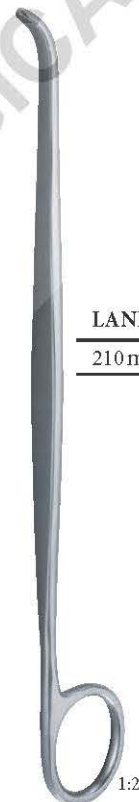

LANE

210 mm - 8 ¹ / ₄ "	BS 14-150-01
--	--------------

Knochenhebel ; Leviers à os
Elevadores para huesos
Elevatori per ossa

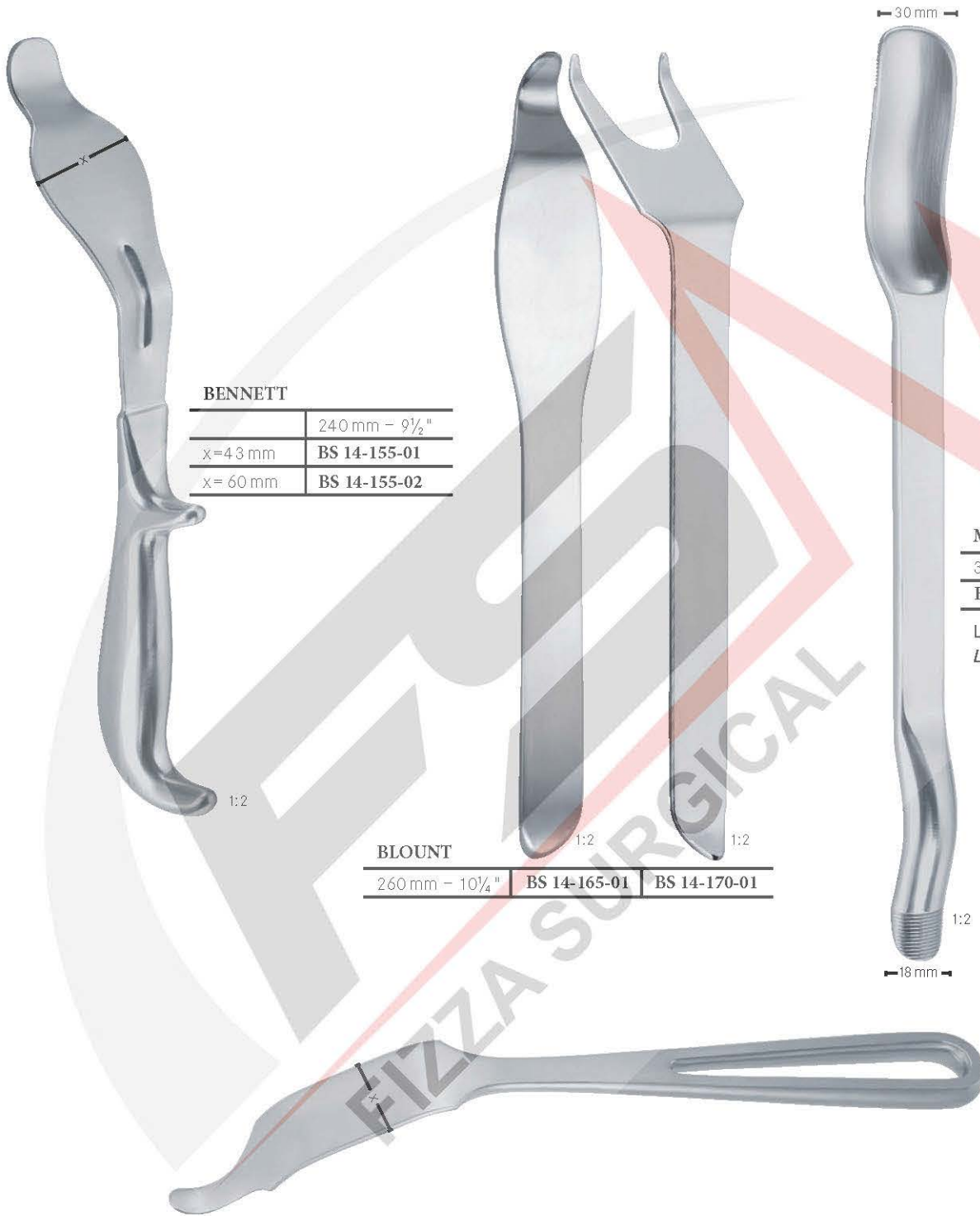

BENNETT

	240 mm - 9½"
x=43 mm	BS 14-155-01
x= 60 mm	BS 14-155-02

1:2

BLOUNT

260 mm - 10¼"	BS 14-165-01	BS 14-170-01
---------------	--------------	--------------

1:2

1:2

MURPHY-LANE

340 mm - 13½"
BS 14-160-01

Luxationshebel
Luxation lever

1:2

**LANGE -
HOHMANN MOD.**

265 mm - 10½"	280 mm - 11"
x= 30 mm	x= 33 mm
BS 14-175-01	BS 14-175-02

Knochenhebel ; Leviers à os
Elevadores para huesos
Elevatori per ossa



**HOHMANN-
WILLIGER**

160 mm – 6¼"

BS 14-180-01

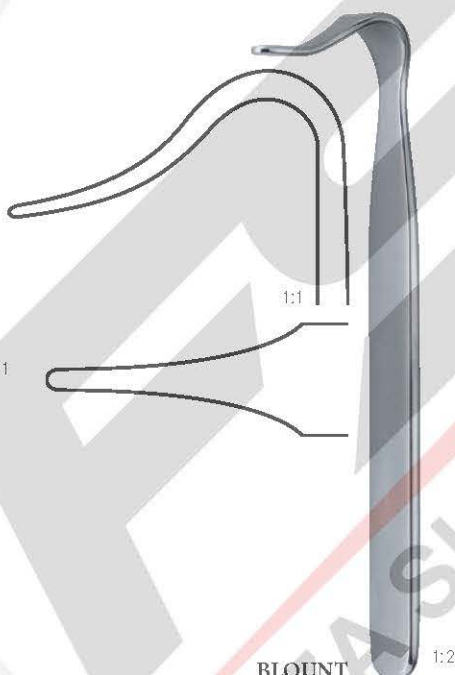

BLOUNT

175 mm – 7"

BS 14-185-01



TAYLOR

	165 mm – 6½"
--	--------------

a = 75 mm – b = 30 mm	BS 14-190-01
-----------------------	---------------------

a = 100 mm – b = 30 mm	BS 14-190-02
------------------------	---------------------

Knochenmeißel
Ciseaux-burins, gouges
Cinceles, gubias
Scalpelli, sgorbi

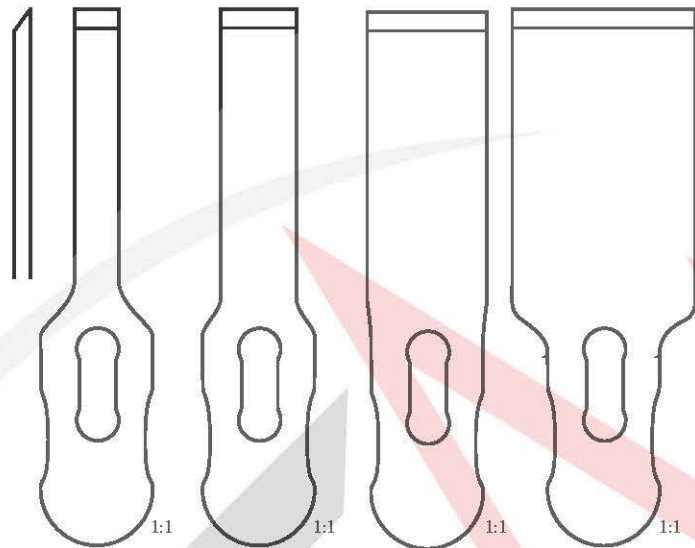

	5mm	10 mm	16mm	25mm
85 mm - 3 1/4"	BS 14-195-01	BS 14-195-02	BS 14-195-03	BS 14-195-04

Chisel blades, interchangeable



1:2

185 mm - 7 1/4"

BS 14-195-00

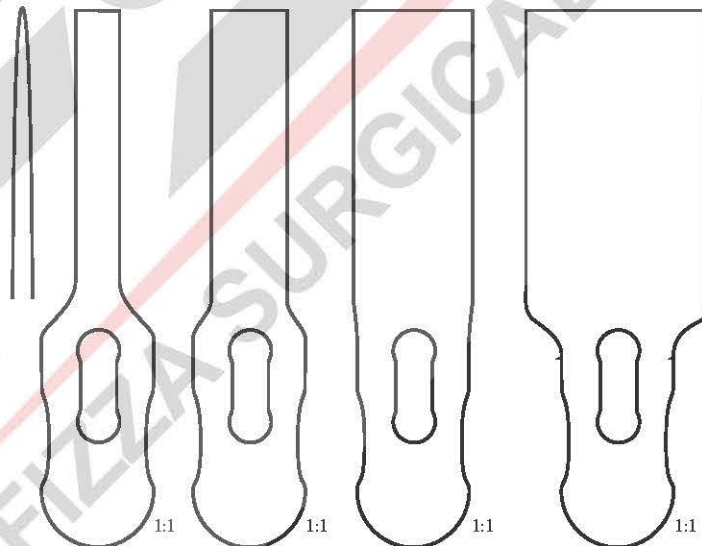

	5mm	10 mm	16mm	25mm
85 mm - 3 1/4"	BS 14-195-05	BS 14-195-06	BS 14-195-07	BS 14-195-08

Osteotome blades, interchangeable



1:2

90 mm - 3 1/2"

BS 14-200-01

Spannschlüssel
Key

Knochenmeißel
Ciseaux-burins, gouges
Cinceles, gubias
Scalpelli, sgorbi

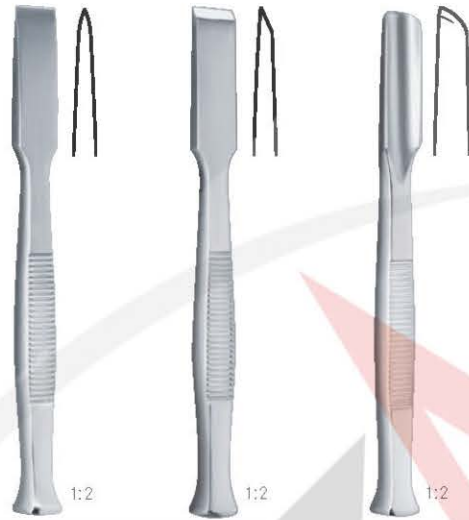

	135 mm – 5¼"	135 mm – 5¼"	135 mm – 5¼"
8 mm	BS 14-205-01	BS 14-206-01	BS 14-207-01
10 mm	BS 14-205-02	BS 14-206-02	BS 14-207-02
12 mm	BS 14-205-03	BS 14-206-03	BS 14-207-03
14 mm	BS 14-205-04	BS 14-206-04	BS 14-207-04
16 mm	BS 14-205-05	BS 14-206-05	BS 14-207-05



LUCAS	160 mm – 6¼"	160 mm – 6¼"
3 mm	BS 14-210-01	BS 14-211-01
4 mm	BS 14-210-02	BS 14-211-02
5 mm	BS 14-210-03	BS 14-211-03
6 mm	BS 14-210-04	BS 14-211-04

Chisel

Gouge



ALEXANDER	180 mm – 7"	180 mm – 7"
4 mm	BS 14-215-01	BS 14-216-01
6 mm	BS 14-215-02	BS 14-216-02
8 mm	BS 14-215-03	BS 14-216-03
10 mm	BS 14-215-04	BS 14-216-04
12 mm	BS 14-215-05	BS 14-216-05
14 mm	BS 14-215-06	BS 14-216-06

Knochenmeißel
Ciseaux-burins, gouges
Cinceles, gubias
Scalpelli, sgorbi



PARTSCH

	115 mm - 4½"	135 mm - 5¼"	170 mm - 6¾"
2 mm	BS 14-220-01	BS 14-221-01	BS 14-222-01
3 mm	BS 14-220-02	BS 14-221-02	BS 14-222-02
4 mm	BS 14-220-03	BS 14-221-03	BS 14-222-03
5 mm	BS 14-220-04	BS 14-221-04	BS 14-222-04
6 mm	BS 14-220-05	BS 14-221-05	BS 14-222-05
7 mm	BS 14-220-06	BS 14-221-06	BS 14-222-06
8 mm	BS 14-220-07	BS 14-221-07	BS 14-222-07

	115 mm - 4½"	135 mm - 5¼"	170 mm - 6¾"
	BS 14-225-01	BS 14-226-01	BS 14-227-01
	BS 14-225-02	BS 14-226-02	BS 14-227-02
	BS 14-225-03	BS 14-226-03	BS 14-227-03
	BS 14-225-04	BS 14-226-04	BS 14-227-04
	BS 14-225-05	BS 14-226-05	BS 14-227-05
	BS 14-225-06	BS 14-226-06	BS 14-227-06
	BS 14-225-07	BS 14-226-07	BS 14-227-07

Knochenmeißel
Ciseaux-burins, gouges
Cinceles, gubias
Scalpelli, sgorbi



LAMBOTTE

	250 mm – 9¾"	250 mm – 9¾"
6 mm	BS 14-230-01	BS 14-231-01
8 mm	BS 14-230-02	BS 14-231-02
10 mm	BS 14-230-03	BS 14-231-03
13 mm	BS 14-230-04	BS 14-231-04
15 mm	BS 14-230-05	BS 14-231-05
20 mm	BS 14-230-06	BS 14-231-06
25 mm	BS 14-230-07	BS 14-231-07
30 mm	BS 14-230-08	BS 14-231-08
38 mm	BS 14-230-09	BS 14-231-09
44 mm	BS 14-230-10	BS 14-231-10
50 mm	BS 14-230-11	BS 14-231-11



MINI-LAMBOTTE

	125 mm – 5"	170 mm – 6¾"
3 mm	BS 14-235-01	BS 14-236-01
4 mm	BS 14-235-02	BS 14-236-02
6 mm	BS 14-235-03	BS 14-236-03
8 mm	BS 14-235-04	BS 14-236-04
10 mm	BS 14-235-05	BS 14-236-05
12 mm	BS 14-235-06	BS 14-236-06
15 mm	BS 14-235-07	BS 14-236-07

Knochenmeißel
Ciseaux-burins, gouges
Cinceles, gubias
Scalpelli, sgorbi



LEXER

	220 mm – 8¾"	300 mm – 12"	220 mm – 8¾"	300 mm – 12"
7 mm	BS 14-240-01	BS 14-241-01	BS 14-242-01	
10 mm	BS 14-240-02	BS 14-241-02	BS 14-242-02	
15 mm	BS 14-240-03	BS 14-241-03	BS 14-242-03	
20 mm	BS 14-240-04	BS 14-241-04	BS 14-242-04	
25 mm	BS 14-240-05	BS 14-241-05	BS 14-242-05	
30 mm	BS 14-240-06	BS 14-241-06	BS 14-242-06	

Ferrozell handle

MINI-LEXER

	180 mm – 7"	180 mm – 7"
4 mm	BS 14-245-01	BS 14-246-01
6 mm	BS 14-245-02	BS 14-246-02
8 mm	BS 14-245-03	BS 14-246-03
10 mm	BS 14-245-04	BS 14-246-04
12 mm	BS 14-245-05	BS 14-246-05

Ferrozell handle

Knochenmeißel
Ciseaux-burins, gouges
Cinceles, gubias
Scalpelli, sgorbi



STILLE



	200 mm – 8 "	200 mm – 8 "	200 mm – 8 "	200 mm – 8 "	200 mm – 8 "
10 mm	BS 14-250-01	BS 14-251-01	BS 14-252-01	BS 14-253-01	BS 14-254-01
15 mm	BS 14-250-02	BS 14-251-02	BS 14-252-02	BS 14-253-02	BS 14-254-02
20 mm	BS 14-250-03	BS 14-251-03	BS 14-252-03	BS 14-253-03	BS 14-254-03
25 mm	BS 14-250-04	BS 14-251-04	BS 14-252-04	BS 14-253-04	BS 14-254-04

1:2



**SMITH-
PETERSEN**



	200 mm – 8 "	200 mm – 8 "	200 mm – 8 "	200 mm – 8 "
6 mm	BS 14-255-01	BS 14-256-01	BS 14-257-01	BS 14-258-01
9 mm	BS 14-255-02	BS 14-256-02	BS 14-257-02	BS 14-258-02
13 mm	BS 14-255-03	BS 14-256-03	BS 14-257-03	BS 14-258-03
16 mm	BS 14-255-04	BS 14-256-04	BS 14-257-04	BS 14-258-04
19 mm	BS 14-255-05	BS 14-256-05	BS 14-257-05	BS 14-258-05
25 mm	BS 14-255-06	BS 14-256-06	BS 14-257-06	BS 14-258-06
32 mm	BS 14-255-07	BS 14-256-07	BS 14-257-07	BS 14-258-07

1:2

Knochenmeißel
Ciseaux-burins, gouges
Cinceles, gubias
Scalpelli, sgorbi



HIBBS

	240mm-9½"	240mm-9½"	240mm-9½"	240mm-9½"	240mm-9½"
6 mm	BS 14-260-01	BS 14-261-01	BS 14-262-01	BS 14-263-01	BS 14-264-01
13 mm	BS 14-260-02	BS 14-261-02	BS 14-262-02	BS 14-263-02	BS 14-264-02
19 mm	BS 14-260-03	BS 14-261-03	BS 14-262-03	BS 14-263-03	BS 14-264-03
25 mm	BS 14-260-04	BS 14-261-04	BS 14-262-04	BS 14-263-04	BS 14-264-04
32 mm	BS 14-260-05	BS 14-261-05	BS 14-262-05	BS 14-263-05	BS 14-264-05

1:2

Knochenmeißel
Ciseaux-burins, gouges
Cinceles, gubias
Scalpelli, sgorbi



FREER

	150 mm – 6"	160 mm – 6¼"
6 mm	BS 14-265-01	BS 14-266-01
4 mm	BS 14-265-02	BS 14-266-02

Gouge

Chisel



BALLENGER

	160 mm – 6¼"
4 mm	BS 14-270-01
6 mm	BS 14-270-02
8 mm	BS 14-270-03

**MANNERFELT
MODIF.**

	155 mm – 6"	155 mm – 6"
3 mm	BS 14-275-01	BS 14-276-01
4 mm	BS 14-275-02	BS 14-276-02
6 mm	BS 14-275-03	BS 14-276-03
8 mm	BS 14-275-04	BS 14-276-04

Osteotomes

Gouge



1:2

**Meißel zur Nasenplastik
Ostéotomes, ciseaux-burins pour
rhinoplastique Cinceles para
rhinoplastica
Scalpelli per plastica nasale**

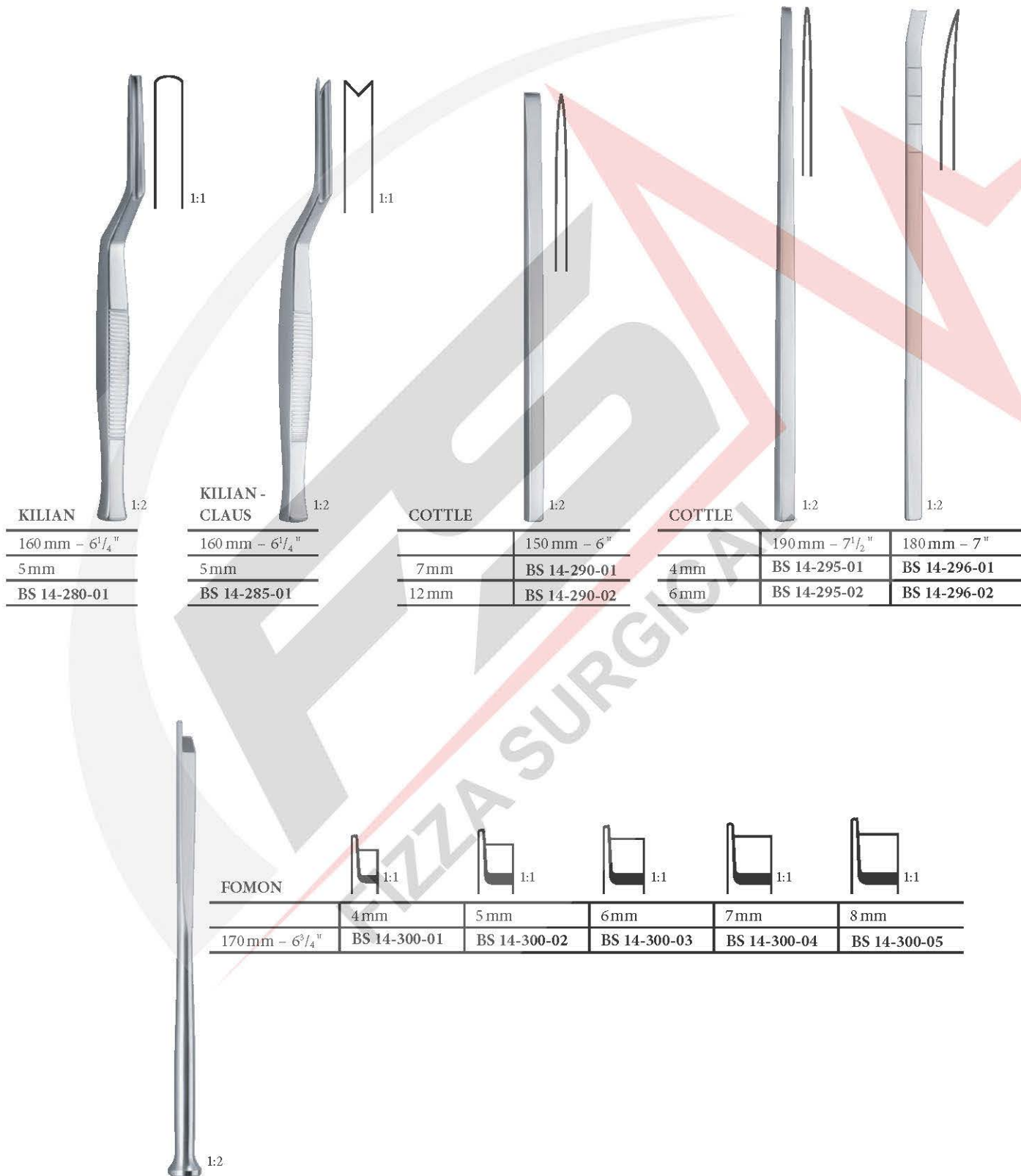

Meißel zur Nasenplastik
Ostéotomes, ciseaux-burins pour
rhinoplastique Cinceles para
rhinoplastica
Scalpelli per plastica nasale



CINELLI

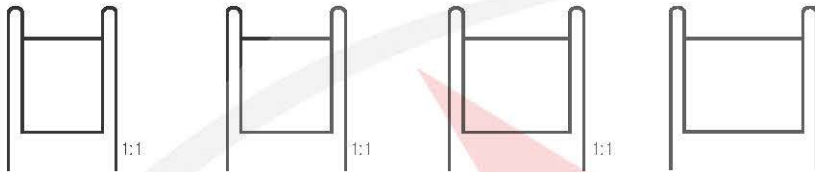

	10 mm	12 mm	14 mm	16 mm
180 mm – 7"	BS 14-305-01	BS 14-305-02	BS 14-305-03	BS 14-305-04



COTTLE



	4 mm	7 mm	9 mm	12 mm
180 mm – 7"	BS 14-310-01	BS 14-310-02	BS 14-310-03	BS 14-310-04

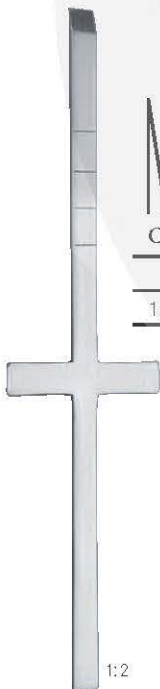

COTTLE



	4 mm	7 mm	9 mm	12 mm
180 mm – 7"	BS 14-310-01	BS 14-310-02	BS 14-310-03	BS 14-310-04

Meißel zur Nasenplastik
Ostéotomes, ciseaux-burins pour
rhinoplastique Cinceles para
rhinoplastica
Scalpelli per plastica nasale







COTTLE	6 mm	16 mm	16 mm
180 mm - 7"	BS 14-315-01	BS 14-316-01	BS 14-317-01





RUBIN	10 mm	12 mm	14 mm
180 mm - 7"	BS 14-320-01	BS 14-321-01	BS 14-322-01

Meißel zur Nasenplastik
Ostéotomes, ciseaux-burins pour
rhinoplastique Cinceles para
rhinoplastica
Scalpelli per plastica nasale











COTTLE	 1:1	 1:1	 1:1	 1:1
		4 mm	7 mm	9 mm
200 mm – 8"	BS 14-325-01	BS 14-325-02	BS 14-325-03	BS 14-325-04



WALTER	 1:1	 1:1
		3 mm
190 mm – 7½"	BS 14-330-01	BS 14-330-02



SHEEHAN	 1:1	 1:1	 1:1	 1:1
		2 mm	4 mm	6 mm
160 mm – 6¼"	BS 14-335-01	BS 14-335-02	BS 14-335-03	BS 14-335-04

 1:1	 1:1	 1:1	 1:1
10 mm	12 mm	15 mm	18 mm
BS 14-335-05	BS 14-335-06	BS 14-335-07	BS 14-335-08

Meißel zur Nasenplastik
 Ostéotomes, ciseaux-burins pour
 rhinoplastique Cinceles para
 rinoplastica
 Scalpelli per plastica nasale

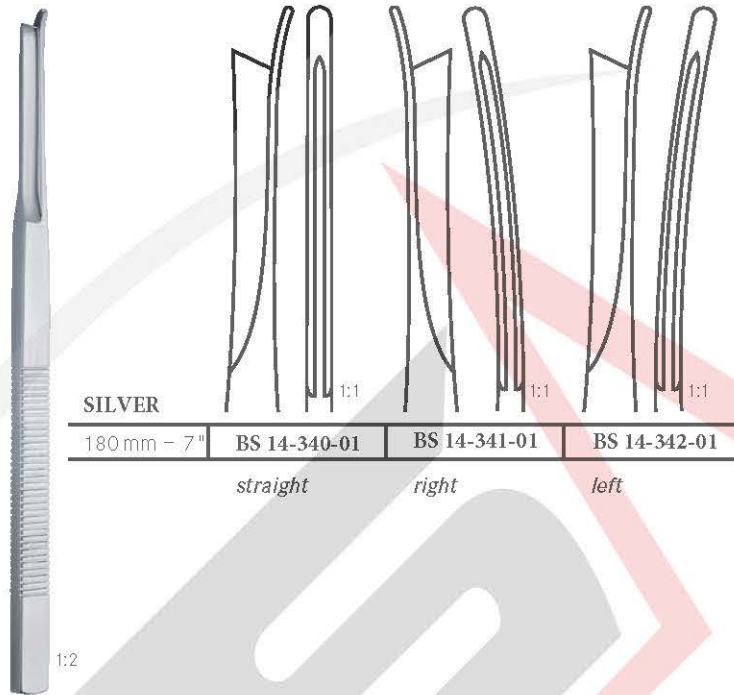

SILVER			
180 mm - 7"	BS 14-340-01	BS 14-341-01	BS 14-342-01
	<i>straight</i>	<i>right</i>	<i>left</i>

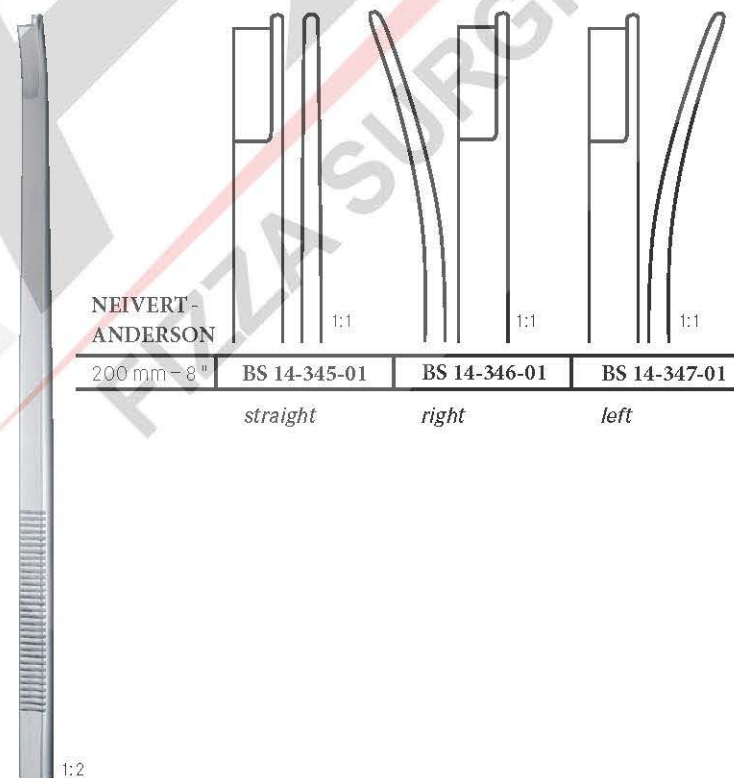

NEIVERT-ANDERSON			
200 mm - 8"	BS 14-345-01	BS 14-346-01	BS 14-347-01
	<i>straight</i>	<i>right</i>	<i>left</i>

Meißel für die Kieferchirurgie
Ostéotomes pour la chirurgie maxillo-faciale
Cinceles para la cirugía maxilofacial
Scalpelli per chirurgia massilofaciale



OBWEGESER

235 mm – 9¹/₄"

11 mm

BS 14-350-01

1:2



1:1

1:2



1:1

1:2

OBWEGESER







7 mm	10 mm
215 mm – 8 ¹ / ₂ "	BS 14-355-01
	BS 14-355-02

7 mm	10 mm
215 mm – 8 ¹ / ₂ "	BS 14-355-01
	BS 14-355-02

Stößel
Pilons
Punzones
Pestoni





1:2

	 1:1	 1:1	 1:1	 1:1	 1:1	 1:1	 1:1
	2 mm Ø	3 mm Ø	4 mm Ø	5 mm Ø	6 mm Ø	8 mm Ø	10 mm Ø
155 mm - 6"	BS 14-360-01	BS 14-360-02	BS 14-360-03	BS 14-360-04	BS 14-360-05	BS 14-360-06	BS 14-360-07





1:2

PASSOW	 1:1	 1:1
	Fig. 1	Fig. 2
	2.5 mm x 2.5 mm	3.5 mm x 3.5 mm
120 mm - 4 3/4"	BS 14-365-01	BS 14-365-02





1:2

CASPAR	 1:1	 1:1	 1:1
	3 mm Ø	5 mm Ø	8 mm Ø
200 mm - 8"	BS 14-370-01	BS 14-370-02	BS 14-370-03













1:2

	 1:1	 1:1	 1:1
	12 mm Ø	14 mm Ø	16 mm Ø
200 mm - 8"	BS 14-370-04	BS 14-370-05	BS 14-370-06





Scharfe Löffel
 Curettes tranchantes
 Cucharillas cortantes
 Cucchiaini taglienti





VOLKMANN	 1:1	 1:1	 1:1	 1:1	 1:1
	Fig. 0000	Fig. 000	Fig. 00	Fig. 0	Fig. 1
170mm – 6 ³ / ₄ "	BS 14-375-01	BS 14-375-02	BS 14-375-03	BS 14-375-04	BS 14-375-05

 1:1	 1:1	 1:1	 1:1	 1:1
Fig. 2	Fig. 3	Fig. 4	Fig. 5	Fig. 6
BS 14-375-06	BS 14-375-07	BS 14-375-08	BS 14-375-09	BS 14-375-10









SCHEDI	 1:1	 1:1	 1:1	 1:1	 1:1
	Fig. 000	Fig. 00	Fig. 0	Fig. 1	Fig. 2
170 mm – 6 ³ / ₄ "	BS 14-380-01	BS 14-380-02	BS 14-380-03	BS 14-380-04	BS 14-380-05



 1:1	 1:1
Fig. 3	Fig. 4
BS 14-380-06	BS 14-380-07

Scharfe Löffel
Curettes tranchantes
Cucharillas cortantes
Cucchiai taglienti





SPRATT	 1:1	 1:1	 1:1
	Fig. 0000	Fig. 000	Fig. 00
170 mm - 6 3/4"	BS 14-385-01	BS 14-385-02	BS 14-385-03



 1:1	 1:1	 1:1
Fig. 0	Fig. 1	Fig. 2
BS 14-385-04	BS 14-385-05	BS 14-385-06

 1:1	 1:1	 1:1
Fig. 3	Fig. 4	Fig. 5
BS 14-385-07	BS 14-385-08	BS 14-385-09



BRUNS	 1:1	 1:1	 1:1
	Fig. 000	Fig. 00	Fig. 0
160 mm - 6 1/4"	BS 14-390-01	BS 14-390-02	BS 14-390-03

 1:1	 1:1	 1:1
Fig. 1	Fig. 2	Fig. 3
BS 14-390-04	BS 14-390-05	BS 14-390-06





 1:1	 1:1	 1:1
Fig. 4	Fig. 5	Fig. 6
BS 14-390-07	BS 14-390-08	BS 14-390-09

Scharfe Löffel
Curettes tranchantes
Cucharillas cortantes
Cucchiai taglienti



VOLKMANN	 1:1	 1:1	 1:1	 1:1	 1:1	 1:1
	Fig. 0000	Fig. 000	Fig. 00	Fig. 0	Fig. 1	Fig. 2
185 mm – 7¼"	BS 14-395-01	BS 14-395-02	BS 14-395-03	BS 14-395-04	BS 14-395-05	BS 14-395-06



oval, with plastic handle

	 1:1	 1:1	 1:1	 1:1
	Fig. 3	Fig. 4	Fig. 5	Fig. 6
190 mm – 7½"	BS 14-396-01	BS 14-396-02	BS 14-396-03	BS 14-396-04

	 1:1	 1:1	 1:1	 1:1	 1:1
	Fig. 0	Fig. 1	Fig. 2	Fig. 3	Fig. 4
275 mm – 10¾"	BS 14-397-01	BS 14-397-02	BS 14-397-03	BS 14-397-04	BS 14-397-05

Scharfe Löffel
Curettes tranchantes
Cucharillas cortantes
Cucchiai taglienti





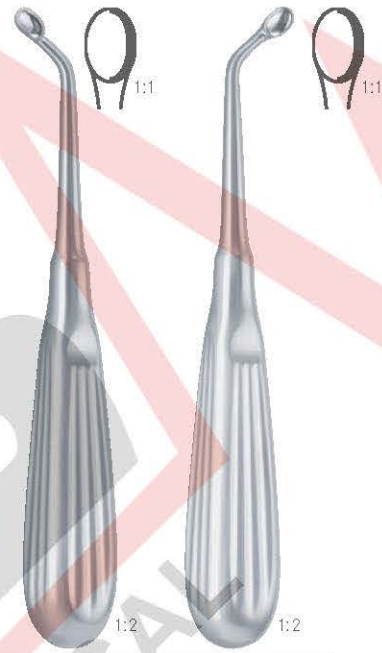

HALLE	 1:1	 1:1	 1:1
	Fig. 1	Fig. 2	Fig. 3
	210 mm – 8 ³ / ₄ "	BS 14-400-01	BS 14-400-02

flexible







UFFENORDE	 1:1	 1:1
	Fig. 1	Fig. 2
	170 mm – 6 ³ / ₄ "	BS 14-405-01



BRUNS	 1:1	 1:1	 1:1	 1:1
	Fig. 00	Fig. 0	Fig. 1	Fig. 2
	230 mm – 9"	BS 14-410-01	BS 14-410-02	BS 14-410-03

solid

 1:1	 1:1	 1:1	 1:1
Fig. 3	Fig. 4	Fig. 5	Fig. 6
BS 14-410-05	BS 14-410-06	BS 14-410-07	BS 14-410-08

Scharfe Löffel
Curettes tranchantes
Cucharillas cortantes
Cucchiai taglienti



SCHROEDER

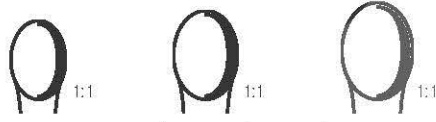

	Fig. 1	Fig. 2	Fig. 3
300 mm – 12"	BS 14-415-01	BS 14-415-02	BS 14-415-03

sharp / rigid

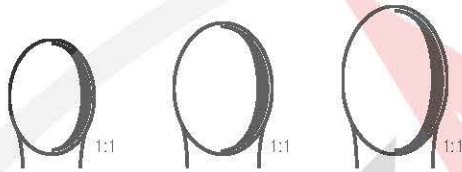

Fig. 4	Fig. 5	Fig. 6
BS 14-415-04	BS 14-415-05	BS 14-415-06



SIMON



Fig. 0000	Fig. 000	Fig. 00	Fig. 0
240 mm – 9½"	BS 14-420-01	BS 14-420-02	BS 14-420-03

sharp / rigid

SIMON



Fig. 1	Fig. 2	Fig. 3
250 mm – 9¾"	BS 14-425-01	BS 14-425-02

sharp / rigid

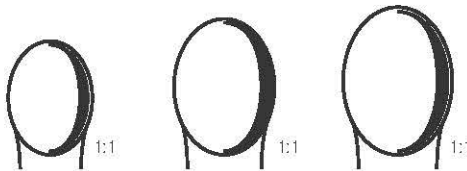





Fig. 4	Fig. 5	Fig. 6
BS 14-425-04	BS 14-425-05	BS 14-425-06



Scharfe Löffel
Curettes tranchantes
Cucharillas cortantes
Cucchiai taglienti



	 1:1	 1:1	 1:1
	Fig. 000	Fig. 00	Fig. 0
200 mm – 8"	BS 14-430-01	BS 14-430-02	BS 14-430-03

straight



	 1:1	 1:1	 1:1
	Fig. 1	Fig. 2	Fig. 3
	BS 14-430-04	BS 14-430-05	BS 14-430-06



	 1:1	 1:1	 1:1
	Fig. 4	Fig. 5	Fig. 6
	BS 14-430-07	BS 14-430-08	BS 14-430-09



	 1:1	 1:1	 1:1
	Fig. 000	Fig. 00	Fig. 0
200 mm – 8"	BS 14-435-01	BS 14-435-02	BS 14-435-03





curved

	 1:1	 1:1	 1:1
	Fig. 1	Fig. 2	Fig. 3
	BS 14-435-04	BS 14-435-05	BS 14-435-06

	 1:1	 1:1	 1:1
	Fig. 4	Fig. 5	Fig. 6
	BS 14-435-07	BS 14-435-08	BS 14-435-09

Scharfe Löffel
Currettes tranchantes
Cucharillas cortantes
Cucchiai taglienti



	 1:1	 1:1	 1:1	 1:1
	Fig. 000	Fig. 00	Fig. 0	Fig. 1
	3.6 mm	4.4 mm	5.2 mm	6.8 mm
250 mm – 9 3/4"	BS 14-440-01	BS 14-440-02	BS 14-440-03	BS 14-440-04

straight





	 1:1	 1:1	 1:1	 1:1
DAUBENSPECK	Fig. 0000	Fig. 000	Fig. 00	Fig. 0
	2.8 mm	3.6 mm	4.4 mm	5.2 mm
200 mm – 8"	BS 14-445-01	BS 14-445-02	BS 14-445-03	BS 14-445-04

1:2

Scharfe Löffel
Curettes tranchantes
Cucharillas cortantes
Cucchiai taglienti



SCOVILLE	 1:1	 1:1	 1:1
	Fig. 1	Fig. 2	Fig. 3
250 mm – 9¾"	BS 14-450-01	BS 14-450-02	BS 14-450-03
<i>oval</i>			



LEMPERT	 1:1	 1:1	 1:1	 1:1	 1:1
	Fig. 00000	Fig. 0000	Fig. 000	Fig. 00	Fig. 0
	1.8 mm	2.0 mm	2.4 mm	2.6 mm	2.8 mm
215 mm – 8½"	BS 14-455-01	BS 14-455-02	BS 14-455-03	BS 14-455-04	BS 14-455-05

Scharfe Löffel
Curettes tranchantes
Cucharillas cortantes
Cucchiai taglienti

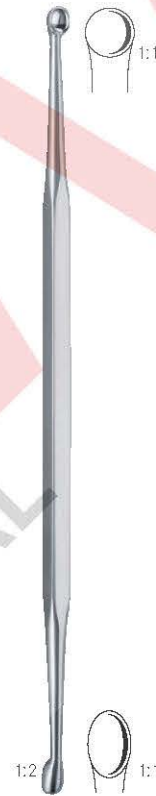

VOLKMANN

130 mm - 5"	BS 14-460-01	BS 14-461-01
140 mm - 5½"	BS 14-460-02	BS 14-461-02
160 mm - 6¼"	BS 14-460-03	BS 14-461-03
170 mm - 6¾"	BS 14-460-04	BS 14-461-04
200 mm - 8"	BS 14-460-05	BS 14-461-05

oval / oval

round / oval



210 mm - 8¼"

BS 14-465-01

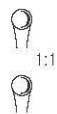

round / oval

Scharfe Löffel
Curettes tranchantes
Cucharillas cortantes
Cucchiai taglienti

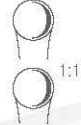



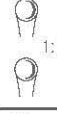

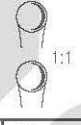
	 1:1	 1:1	 1:1
MARTINI			
	Fig. 00	Fig. 0	Fig. 1
	Fig. 0	Fig. 1	Fig. 2
135 mm – 5¼"	BS 14-470-01	BS 14-470-02	BS 14-470-03



	 1:1	 1:1	 1:1
MARTINI			
	Fig. 00	Fig. 0	Fig. 1
	Fig. 00	Fig. 0	Fig. 1
155 mm – 6"	BS 14-475-01	BS 14-475-02	BS 14-475-03

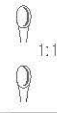
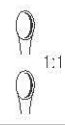

	 1:1	 1:1	 1:1
WILLIGER			
	Fig. 00	Fig. 0	Fig. 1
	Fig. 0	Fig. 1	Fig. 2
135 mm – 5¼"	BS 14-480-01	BS 14-480-02	BS 14-480-03

	 1:1	 1:1	 1:1
WILLIGER			
	Fig. 00	Fig. 0	Fig. 1
	Fig. 00	Fig. 0	Fig. 1
155 mm – 6"	BS 14-485-01	BS 14-485-02	BS 14-485-03

Raspatorien für die Kieferchirurgie
Rugines – Décolleurs pour la chirurgie maxillo-faciale
Periostótomos para la cirugía maxilofacial
Raspatori per chirurgia massilofaciale

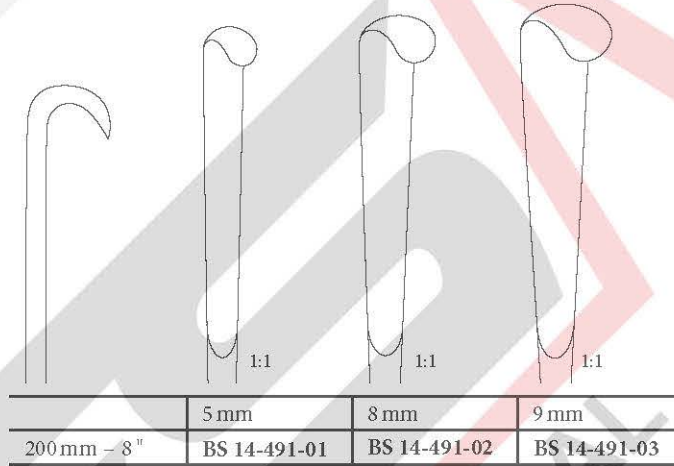
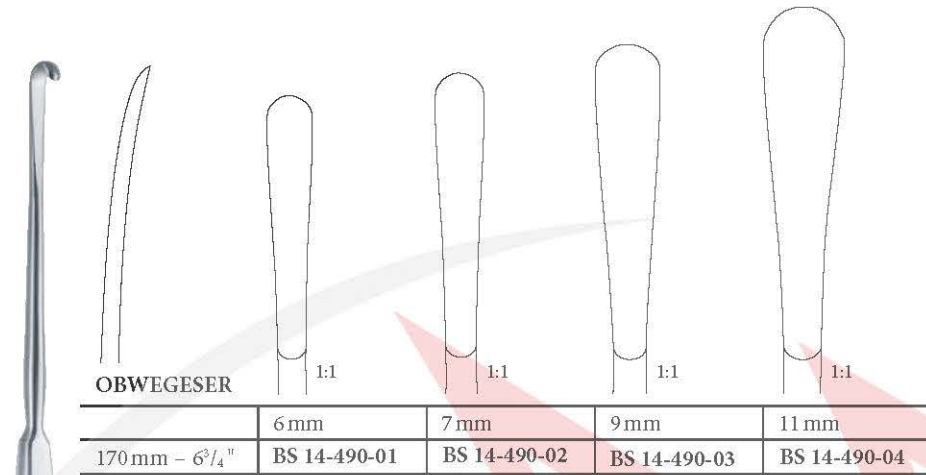

Raspatorien für die Kieferchirurgie
 Rugines – Décolleurs pour la chirurgie maxillo-
 faciale Periostótomos para la cirugía maxilofacial
 Raspatori per chirurgia massilofaciale

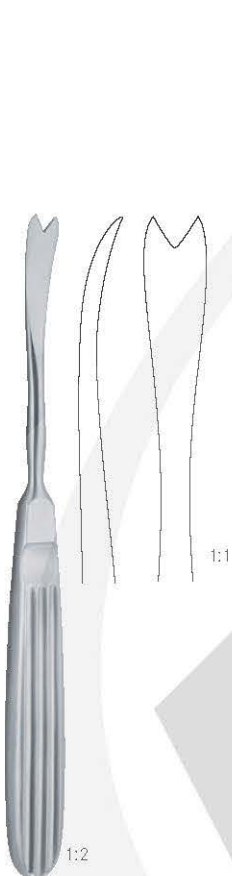

OBWEGESER

175 mm – 7"

BS 14-500-01



OBWEGESER

230 mm – 9"

BS 14-505-01



OBWEGESER

180 mm – 7"

BS 14-510-01



OBWEGESER

140 mm – 5½"

BS 14-515-01

Raspatorien – Elevatorien
 Rugines – Elevateurs Raspatorios – Elevadores
 Periostotomi – Elevatori



DOYEN

170 mm – 6³/₄"

left

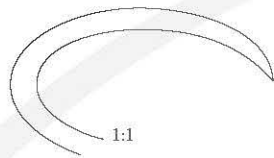

1:1

BS 14-520-01

for adults

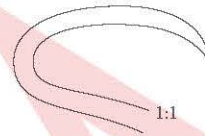

1:1

BS 14-520-01

for children

1:2



DOYEN

170 mm – 6³/₄"

right



1:1

BS 14-525-01

for adults

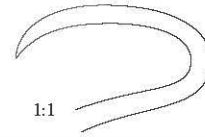

1:1

BS 14-525-02

for children

1:2

Raspatorien – Elevatorien
 Rugines – Elevateurs
 Raspatorios – Elevadores
 Periostotomi – Elevatori



QUERVAIN
195 mm – 7 ³ / ₄ ''
x = 6 mm
BS 14-530-01

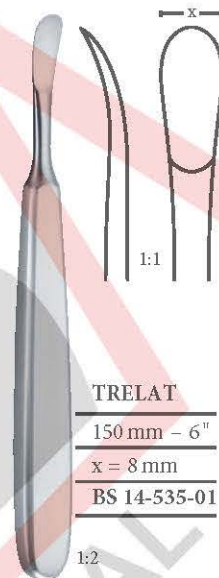

TRELAT
150 mm – 6''
x = 8 mm
BS 14-535-01

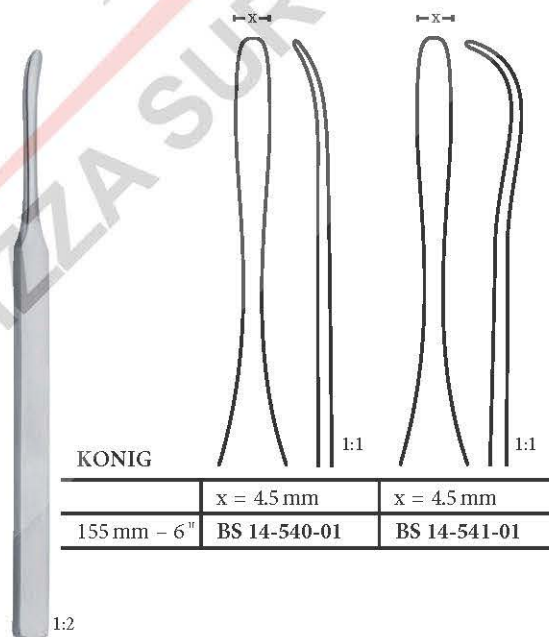

KONIG	x = 4.5 mm	x = 4.5 mm
155 mm – 6''	BS 14-540-01	BS 14-541-01

Raspatorien – Elevatorien
 Rugines – Elevateurs
 Raspatorios – Elevadores
 Periostotomi – Elevatori

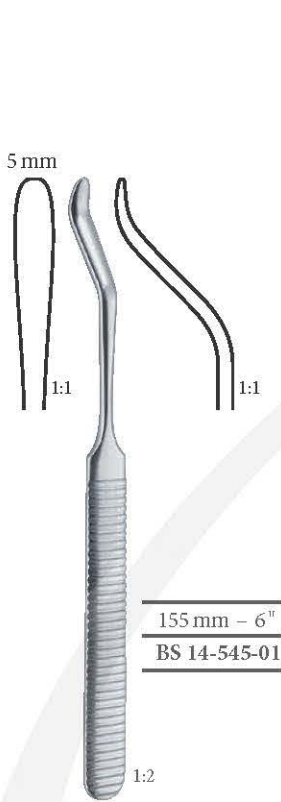

155 mm – 6"
 BS 14-545-01

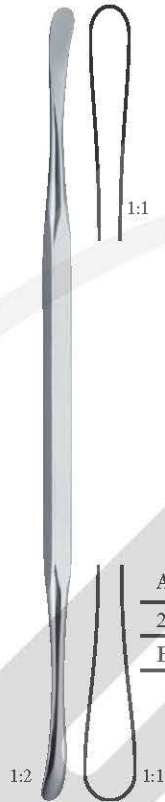

ALDERDYCE
 210 mm – 8 1/4"
 BS 14-550-01

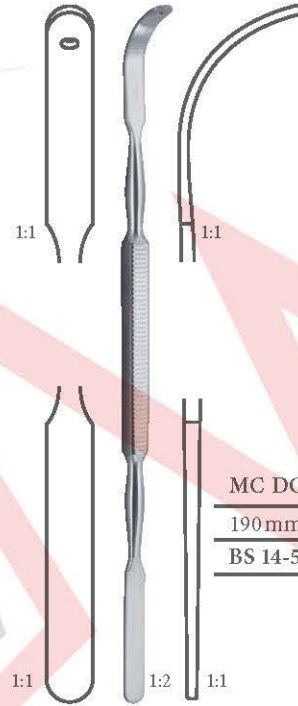

MC DONALD
 190 mm – 7 1/2"
 BS 14-555-01

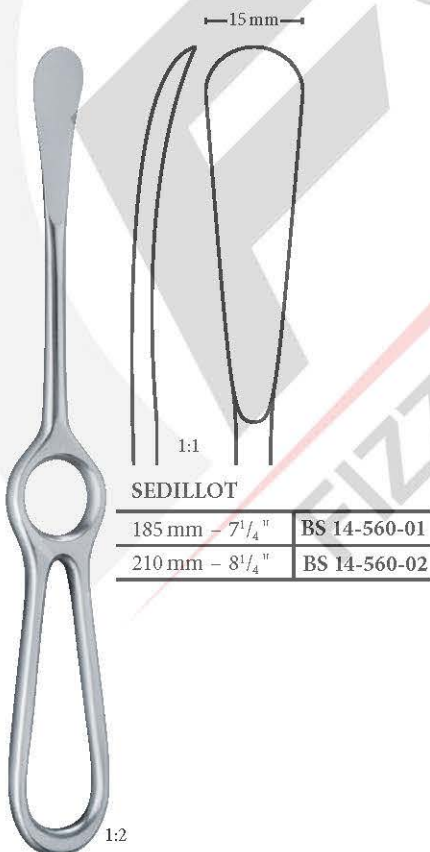

SEDILLOT
 185 mm – 7 1/4" BS 14-560-01
 210 mm – 8 1/4" BS 14-560-02

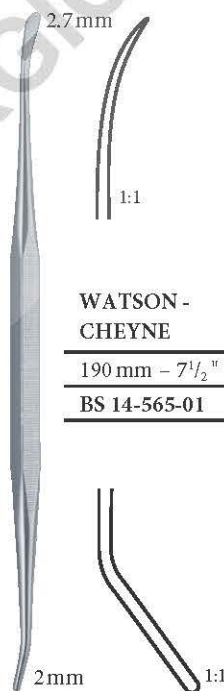

WATSON -
 CHEYNE
 190 mm – 7 1/2"
 BS 14-565-01

Raspatorien - Elevatorien
 Rugines - Elevateurs
 Raspatorios - Elevadores
 Periostotomi - Elevatori

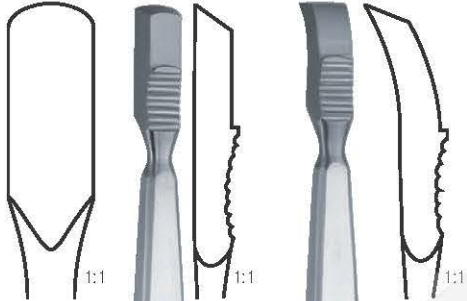

FARABEUF

150 mm - 6"	BS 14-570-01	BS 14-571-01
	<i>straight</i>	<i>curved</i>

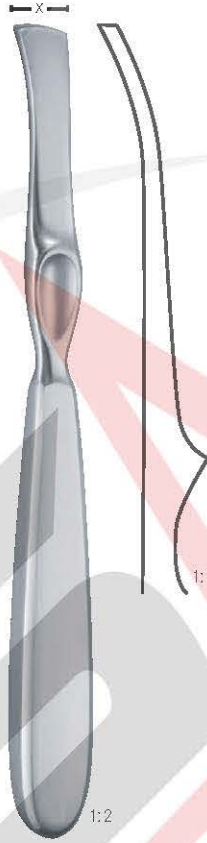

LAMBOTTE

	210 mm - 8 1/4"
x = 5 mm	BS 14-575-01
x = 10 mm	BS 14-575-02
x = 15 mm	BS 14-575-03
x = 20 mm	BS 14-575-04
x = 25 mm	BS 14-575-05

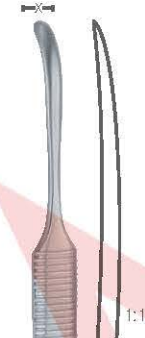

WILLIGER

	x = 5 mm
130 mm - 5"	BS 14-585-01



ADSON

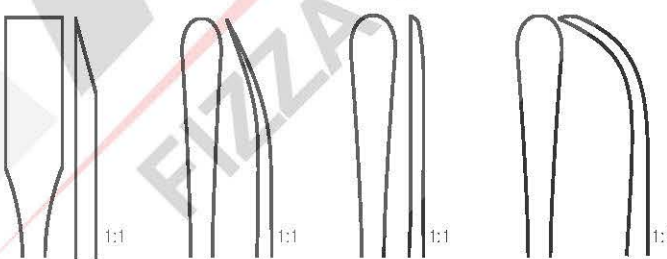

	Fig. 1	Fig. 2	Fig. 3	Fig. 4
170 mm - 6 3/4"	BS 14-580-01	BS 14-580-02	BS 14-580-03	BS 14-580-04



WILLIGER

	160 mm - 6 1/4"
x = 4 mm	BS 14-590-01
x = 6 mm	BS 14-590-02

Raspatorien – Elevatorien
 Rugines – Elevateurs
 Raspatorios – Elevadores
 Periostotomi – Elevatori

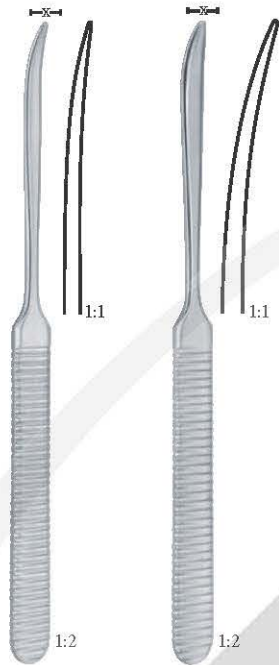

WILLIGER

	x = 5 mm	x = 6,5 mm
160 mm – 6 ¹ / ₄ "	BS 14-595-01	BS 14-596-01



FARABEAUF-COLLIN

	x = 11 mm	x = 11 mm
160 mm – 6 ¹ / ₄ "	BS 14-600-01	BS 14-601-01

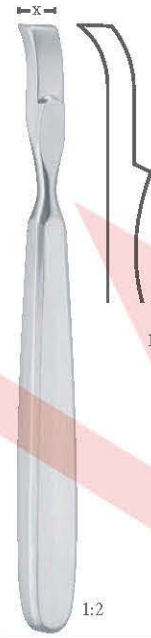

OBWEGESER

	2.5 mm	4 mm
150 mm – 6"	BS 14-605-01	BS 14-606-01



OBWEGESER

	185 mm – 7 ¹ / ₄ "
BS 14-610-01	



OBWEGESER

	185 mm – 7 ¹ / ₄ "
BS 14-611-01	

Raspatorien – Elevatorien
 Rugines – Elevateurs
 Raspatorios – Elevadores
 Periostotomi – Elevatori



SEMB	 1:2	 1:2	 1:2	 1:2	 1:2	 1:2
	175 mm – 7"	210 mm – 8 ¹ / ₄ "	175 mm – 7"	210 mm – 8 ¹ / ₄ "	225 mm – 8 ³ / ₄ "	220 mm – 8 ³ / ₄ "
	12 mm	12 mm	13 mm	13 mm	13 mm	15 mm
	BS 14-615-01	BS 14-615-02	BS 14-615-03	BS 14-615-04	BS 14-615-05	BS 14-615-06



HOWARTH

215 mm – 8¹/₂"

BS 14-620-01

sharp / blunt

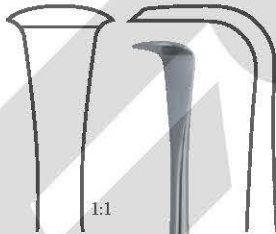

LANGEN-BECK

180 mm – 7"

BS 14-625-01

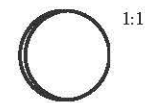
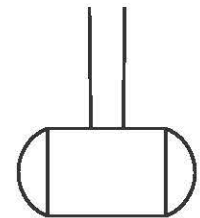

ALEXANDER

200 mm – 8"

BS 14-635-01

Raspatorien – Elevatorien
Rugines – Elevateurs
Raspatorios – Elevadores
Periostotomi – Elevatori



LANGENBECK

	x = 8 mm	x = 10 mm
200 mm – 8"	BS 14-640-01	BS 14-645-01

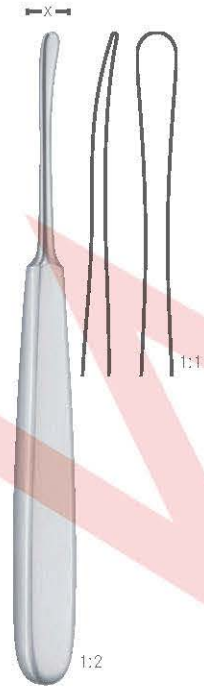
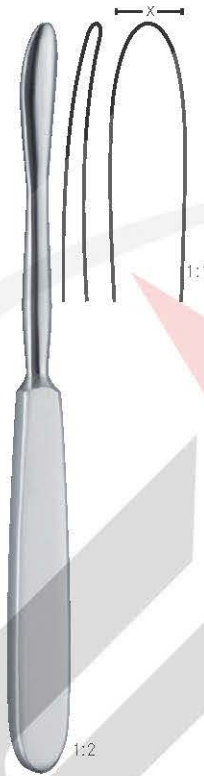

SEBILEAU

	x = 5 mm
175 mm – 7"	BS 14-650-01



BS 14-655-01



extrem leicht
extremely light
extrêmement léger
extremamente ligero
estremamente leggera





COBB

	290 mm – 11 1/2"
x = 10 mm	BS 14-660-01
x = 13 mm	BS 14-660-02
x = 19 mm	BS 14-660-03

Spinal raspatory
Rugine vertebraal

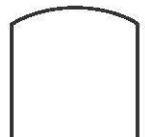
KEY			
	180 mm – 7"	190 mm – 7 1/2"	190 mm – 7 1/2"
	x = 6 mm	x = 10 mm	x = 12 mm
	BS 14-665-01	BS 14-665-02	BS 14-665-03

	
200 mm – 8"	210 mm – 8 1/4"
x = 19 mm	x = 25 mm
BS 14-665-04	BS 14-665-05

Meniskotome
Bistouries à ménisques
Bisturios para meniscos
Bisturi per menisco



BIRCHER

190 mm – 7½" | **BS 14-670-01**

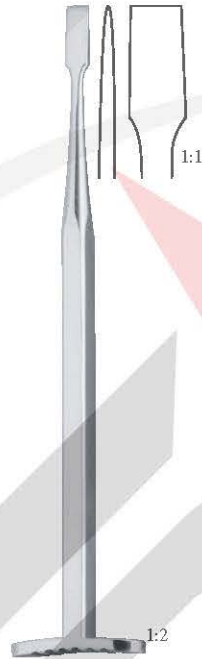

SMILLIE

170 mm – 6¾" | **BS 14-675-01**



BS 14-675-02

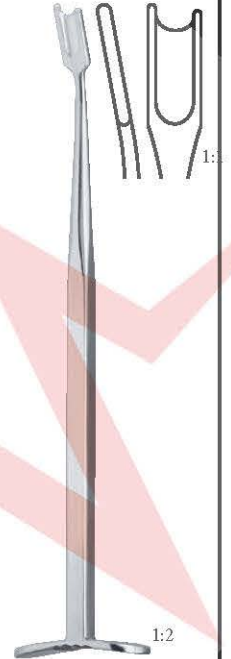

BS 14-675-03



**KANADISCHES
MODELL**

Fig. 1
BS 14-680-01



Fig. 2
BS 14-680-02



180 mm – 7" | **BS 14-680-03**



NEFF
220 mm – 8¾"



BS 14-685-01

links
left



BS 14-685-02

rechts
right

Sehnenstripper
Instruments à écorcher les tendons
Enucleadores de tendones
Scollatendini



1:1
4.0 mm Ø
230 mm – 9" **BS 14-690-01**

Schaft biegsam
Malleable shaft

Tige malléable
Tija maleable
Asta malleabile

1:1
4.5 mm Ø
BS 14-690-02

1:1
5.5 mm Ø
BS 14-690-03



BUNNELL 1:1
Fig. 1
150 mm – 6" **BS 14-695-01**

1:1
Fig. 2
BS 14-695-02

1:1
Fig. 3
BS 14-695-03

1:1
Fig. 4
BS 14-695-04

1:1
Fig. 5
BS 14-695-05



1:1

KLEINERT-KUTZ
200 mm – 8"
20 mm Ø
BS 14-700-01



1:1

BUNNELL
230 mm – 9"
BS 14-705-01
Tendon passer



1:1

FISCHER
310 mm – 12 1/4"
BS 14-710-01



1:2





1:2



1:2

Sehnenfazzangen
 Pinces pour saisir les tendons
 Pinzas para coger tendones
 Pinze per afferrare tendini





BRAND	 1:1	 1:1	 1:1
	150 mm – 6"	190 mm – 7½"	240 mm – 9½"
	BS 14-715-01	BS 14-715-02	BS 14-715-03



130 mm – 5"
BS 14-720-01

1:1



 1:1	 1:1
150 mm – 6"	BS 14-725-01
	BS 14-726-01

Hohlmeißelzangen
 Pinces gouges
 Pinzas gubias
 Pinze sgorbie



LUER

Fig. 1
150 mm - 6"
BS 14-730-01

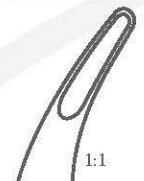

Fig. 2
BS 14-731-01



LUER

Fig. 1
170 mm - 6 ³ / ₄ "
BS 14-735-01



BS 14-736-01



MINI-FRIEDMANN

120 mm - 4 ³ / ₄ "
BS 14-740-01



FRIEDMANN

140 mm - 5 ¹ / ₂ "
BS 14-745-01



BLUMENTHAL

Fig. 1	Fig. 2
155 mm - 6"	BS 14-750-02
BS 14-750-01	

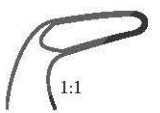
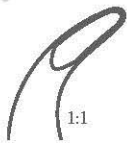
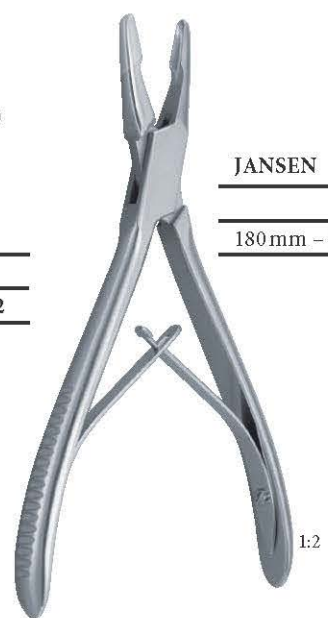

Fig. 3
BS 14-750-03



JANSEN

Fig. 1
180 mm - 7"
BS 14-755-01



Fig. 2
BS 14-755-02

Hohlmeißelzangen
Pincés gouges
Pinzas gubias
Pinze sgorbie

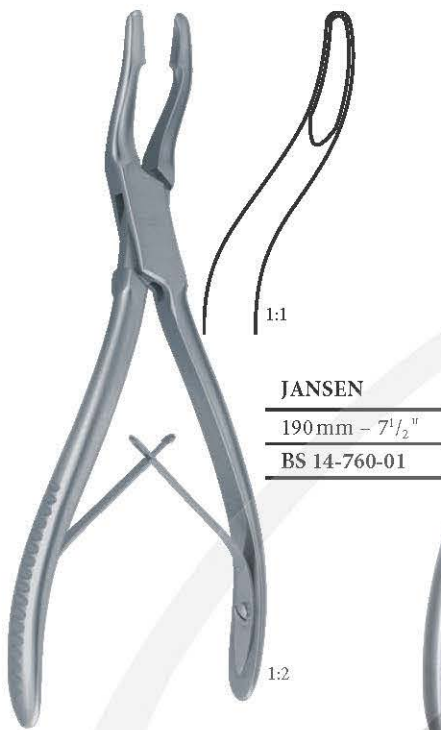

JANSEN
190 mm – 7¹/₂"
BS 14-760-01



ADSON
200 mm – 8"
BS 14-765-01



BACON
210 mm – 8¹/₄"
BS 14-770-01



LEMPERT
190 mm – 7¹/₂" | BS 14-775-01

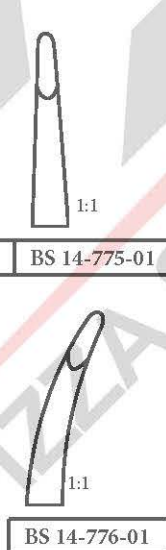

BS 14-776-01



STELLBRINK
175 mm – 7" | BS 14-780-01

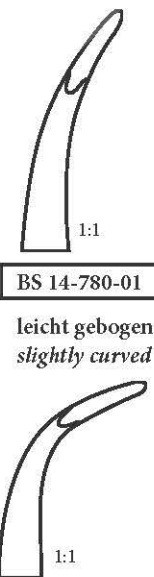

leicht gebogen
slightly curved

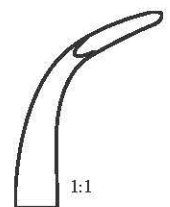

BS 14-781-01

stark gebogen
strongly curved

Hohlmeißelzangen
 Pincés gouges
 Pinzas gubias
 Pinze sgorbie



OLIVECRONA
 205 mm - 8"
 BS 14-785-01

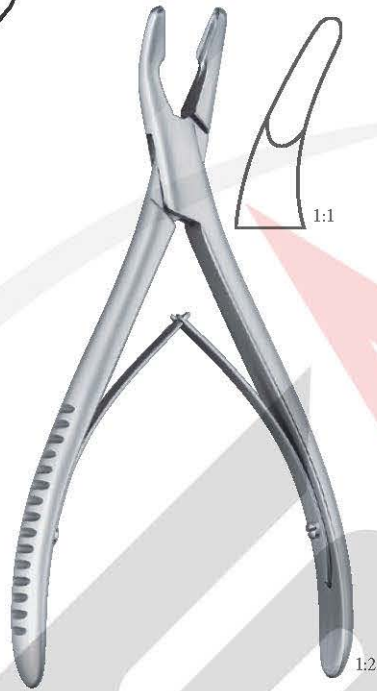

HARTMANN
 175 mm - 7"
 BS 14-790-01



MEAD
 165 mm - 6 1/2"
 BS 14-795-01



Cleveland
 170 mm - 6 3/4"
 BS 14-800-01



CLEVELAND
 140 mm - 5 1/2"
 BS 14-805-01



BOHLER
 150 mm - 6" BS 14-810-01

BS 14-811-01

Hohlmeißelzangen
Pinces gouges
Pinzas gubias
Pinze sgorbie



BEYER
180 mm - 7"
BS 14-815-01



RUSKIN
180 mm - 7"
BS 14-820-01



MAYFIELD
175 mm - 7"
BS 14-825-01

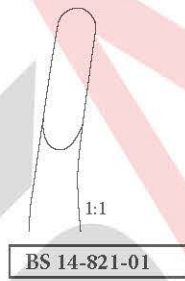

BS 14-821-01



ZAUFAL-JANSEN
180 mm - 7"
BS 14-830-01



MARQUARDT
200 mm - 8"
BS 14-835-01

Hohlmeißelzangen
 Pinces gouges
 Pinzas gubias
 Pinze sgorbie



**STILLE -
RUSKIN**

230 mm - 9" **BS 14-840-01**

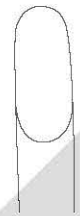
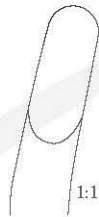

BS 14-841-01



STILLE

1:1

4 mm
230 mm - 9" BS 14-845-01



6 mm

BS 14-845-02



8 mm

BS 14-845-03



LEKSELL

240 mm - 9 1/2" **BS 14-850-01**

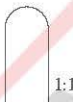

6 mm

BS 14-850-02



8 mm

BS 14-850-03



STILLE-LUER

220 mm - 8 3/4" **BS 14-855-01**



BS 14-856-01

Hohlmeißelzangen
 Pincés gouges
 Pinzas gubias
 Pinze sgorbie



**ROTTGEN-
RUSKIN**

230 mm – 9"

BS 14-860-01

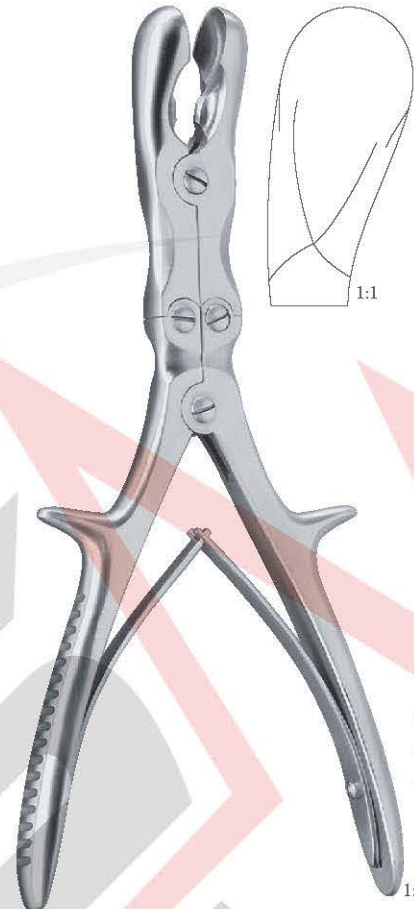

SEMB

240 mm – 9¹/₂"

BS 14-865-01



ECHLIN

230 mm – 9"

BS 14-870-01

BS 14-870-02



FRYKHOLM

240 mm – 9¹/₂"

BS 14-875-01

Hohlmeißelzangen
 Pinces gouges
 Pinzas gubias
 Pinze sgorbie



SAUERBRUCH

	 1:1	 1:1
	Fig. 1	Fig. 2
300 mm – 12"	BS 14-880-01	BS 14-881-01

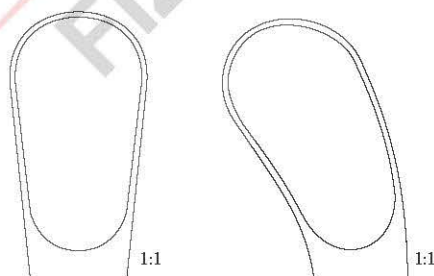

LUER-STILLE

270 mm – 10 ³ / ₄ "	BS 14-885-01	BS 14-886-01
---	--------------	--------------



Knochensplitterzangen
Pinces coupantes à os
Pinzas cortantes para huesos
Cesoie per ossa

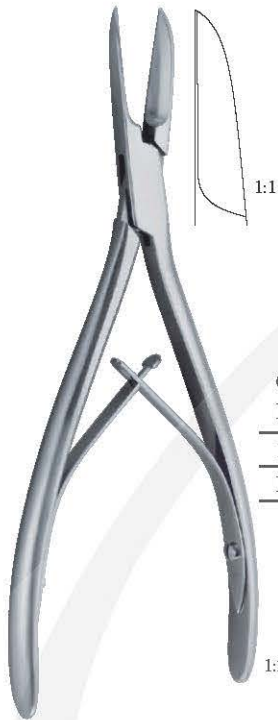

**COTTLE-
KAZANJIAN**
 190 mm – 7½"
 BS 14-890-01



LISTON

140 mm – 5½"	BS 14-895-01	BS 14-896-01
170 mm – 6¾"	BS 14-895-02	BS 14-896-02
190 mm – 7½"	BS 14-895-03	BS 14-896-03
220 mm – 8¾"	BS 14-895-04	BS 14-896-04

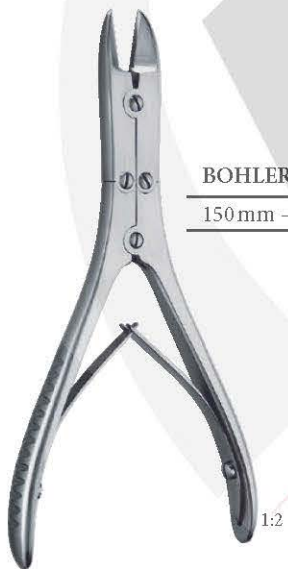

BOHLER

150 mm – 6"	BS 14-900-01	BS 14-901-01
-------------	--------------	--------------



RUSKIN- LISTON

185 mm – 7¼"	BS 14-905-01	BS 14-906-01
--------------	--------------	--------------

Knochensplitterzangen
Pinces coupantes à os
Pinzas cortantes para huesos
Cesoie per ossa



SEMB
 240 mm – 9¹/₂"
 BS 14-910-01



LISTON-KEY HORSLEY
 270 mm – 10³/₄"
 BS 14-915-01

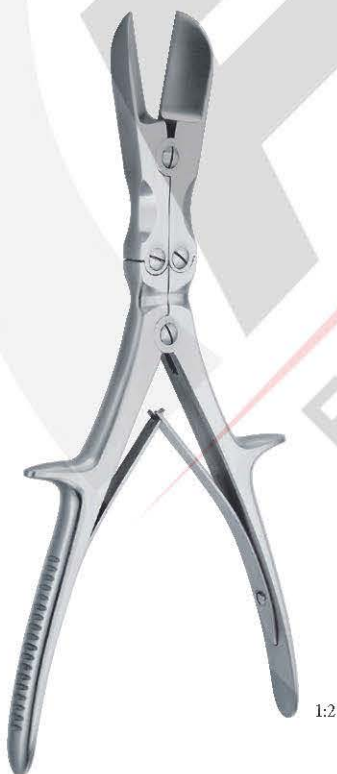

STILLE-LISTON

270 mm – 10³/₄"

BS 14-920-01

BS 14-921-01

BS 14-922-01

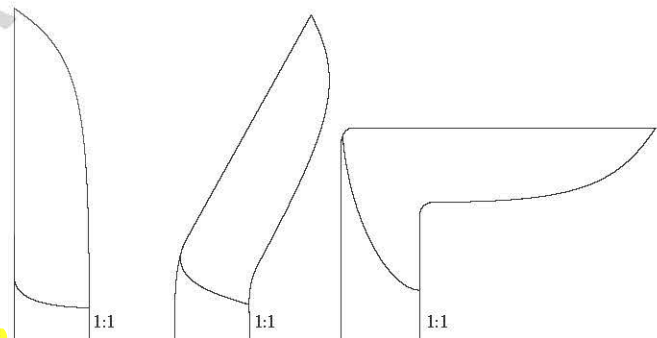

Knochenhalte­zangen – Repositionszangen
Daviers porte-os – Pincas de reposition
Pinzas para huesos – Pinzas para reposición
Tenaglie per ossa – Pinze per riposizioni



135 mm – 5¹/₄"
BS 14-925-01



LEWIN
175 mm – 7"
BS 14-930-01

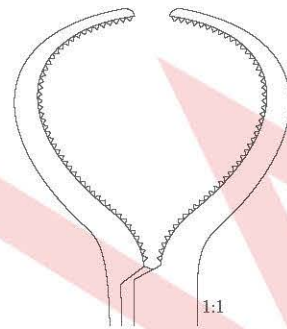

1:1



1:1

140 mm – 5¹/₂"
BS 14-935-01

1:2

BONE SURGERY - Bone Holding Clamps – Bone Holding Forceps

Knochenhalteklammern – Knochenhaltezangen

Daviers à os – Daviers porte-os

Pinzas porta huesos – Pinzas para huesos

Tenaglie per ossa



FERGUSSON

210 mm – 8¹/₄"

BS 14-940-01



VAN BUREN

230 mm – 9"

BS 14-945-01

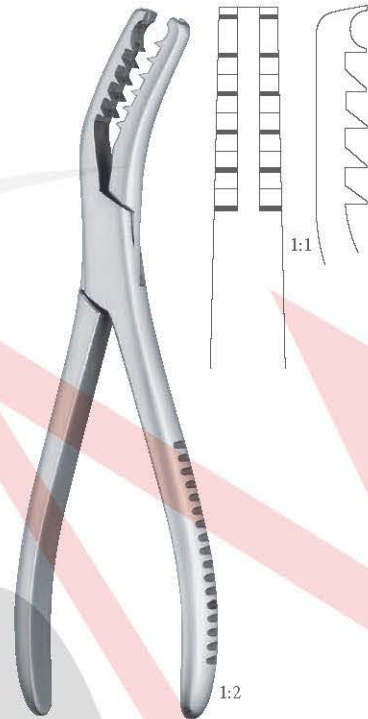

SEMB

190 mm – 7¹/₂"

BS 14-950-01



LANGENBECK

210 mm – 8¹/₄"

BS 14-955-01



DINGMANN

190 mm – 7¹/₂"

BS 14-960-01



200 mm – 8"

BS 14-965-01

BS 14-966-01

Sequesterzange
Sequestrum forceps

Knochenhalte­zangen
Daviers porte-os
Pinzas para huesos
Tenaglie per ossa



FARABEUF

230 mm – 9"	BS 14-970-01
260 mm – 10 ¹ / ₄ "	BS 14-970-02



FARABEUF - LAMBOTTE

260 mm – 10 ¹ / ₄ "
BS 14-975-01

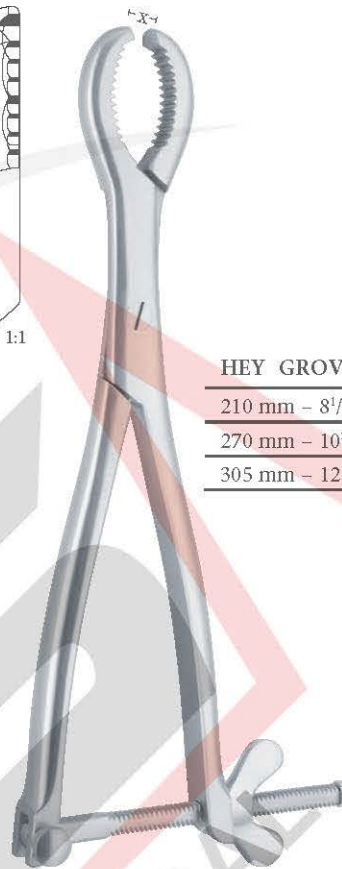

HEY GROVES

210 mm – 8 ¹ / ₄ "	x = 6.5 mm	BS 14-980-01
270 mm – 10 ³ / ₄ "	x = 7.5 mm	BS 14-980-02
305 mm – 12"	x = 8.5 mm	BS 14-980-03

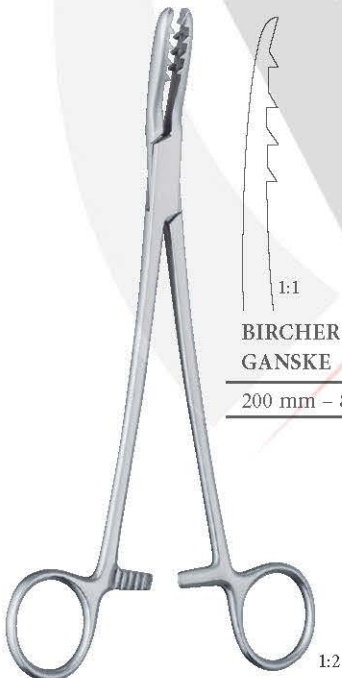

BIRCHER - GANSKE

200 mm – 8"	BS 14-985-01	BS 14-986-01
-------------	--------------	--------------

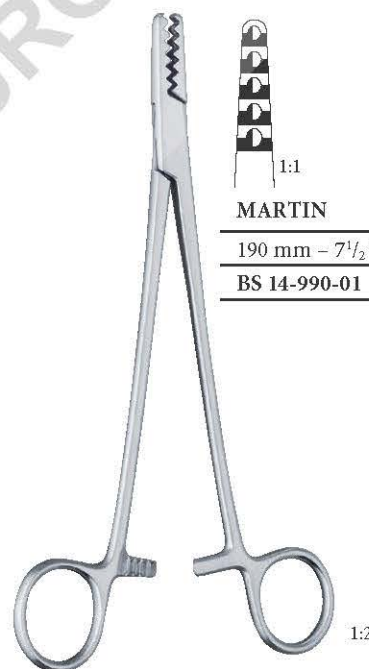

MARTIN

190 mm – 7 ¹ / ₂ "
BS 14-990-01

Knochenhaltezangen
Daviers porte-os
Pinzas para huesos
Tenaglie per ossa

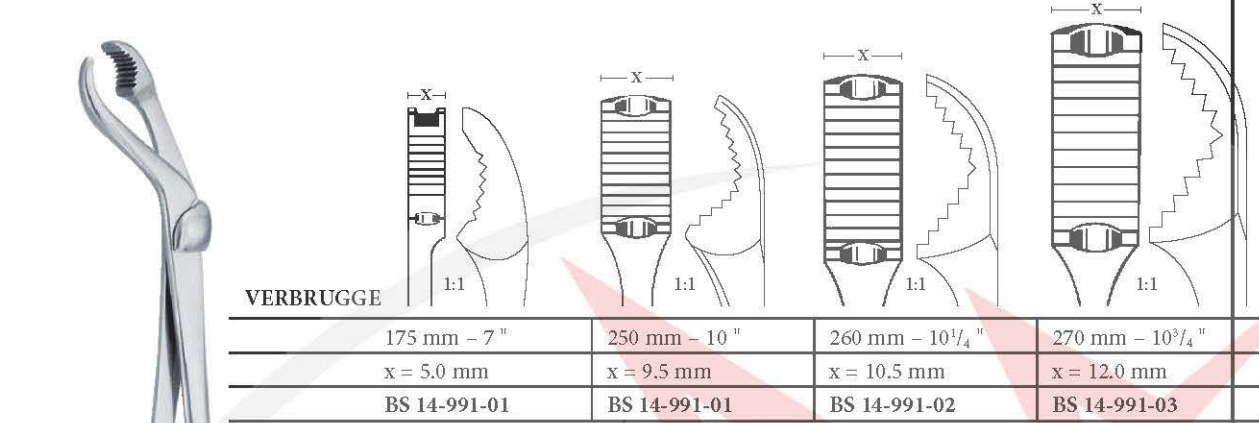

KERN

170 mm - 6 ³ / ₄ "	BS 14-992-01	BS 14-993-01
210 mm - 8 ¹ / ₄ "	BS 14-992-02	BS 14-993-02

Knochenhalte­zangen
Daviers porte-os
Pinzas para huesos
Tenaglie per ossa

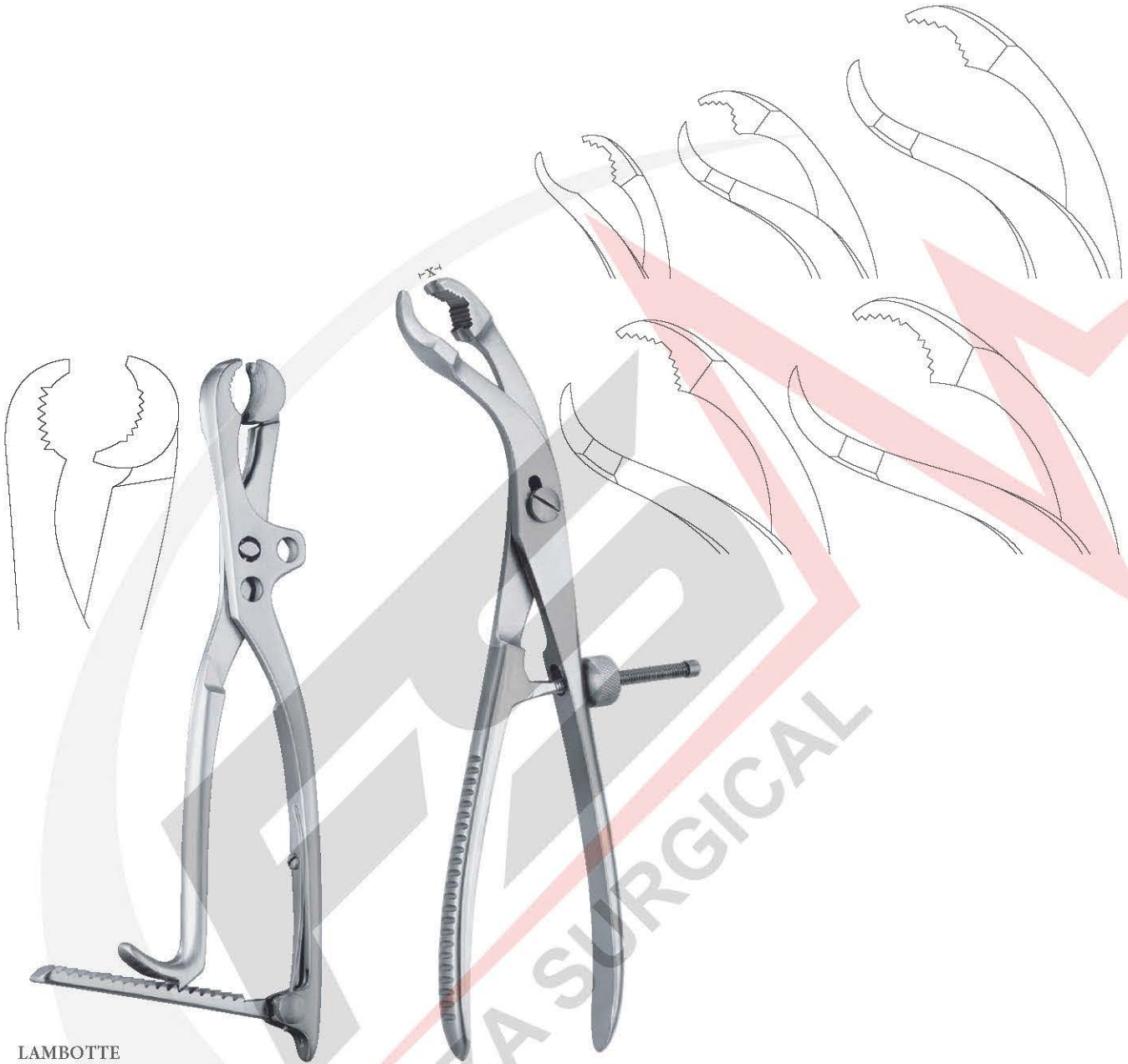

LAMBOTTE

220 mm – 8 ³ / ₄ ″	BS 14-994-01
270 mm – 10 ³ / ₄ ″	BS 14-994-02
300 mm – 12 ″	BS 14-994-03

One Jaw Mobile

150 mm – 6 ″	x = 2.5 mm	BS 14-995-01
190 mm – 7 ¹ / ₂ ″	x = 6.5 mm	BS 14-995-02
240 mm – 9 ¹ / ₂ ″	x = 9.5 mm	BS 14-995-03
260 mm – 10 ¹ / ₄ ″	x = 10.0 mm	BS 14-995-04
280 mm – 11 ″	x = 11.0 mm	BS 14-995-05

Self-Centering

Knochenhalte­zangen
Daviers porte-os
Pinzas para huesos
Tenaglie per ossa



LANE

330 mm - 13 "	BS 14-996-01	BS 14-997-01
450 mm - 17 ³ / ₄ "	BS 14-996-02	BS 14-997-02

Knochenhaltezaugen
Daviers porte-os
Pinzas para huesos
Tenaglie per ossa

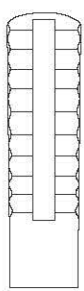

ULRICH

230 mm – 9"	BS 14-998-01	BS 14-999-01
250 mm – 9 ³ / ₄ "	BS 14-998-02	BS 14-999-02
280 mm – 11"	BS 14-998-03	BS 14-999-03

Angular

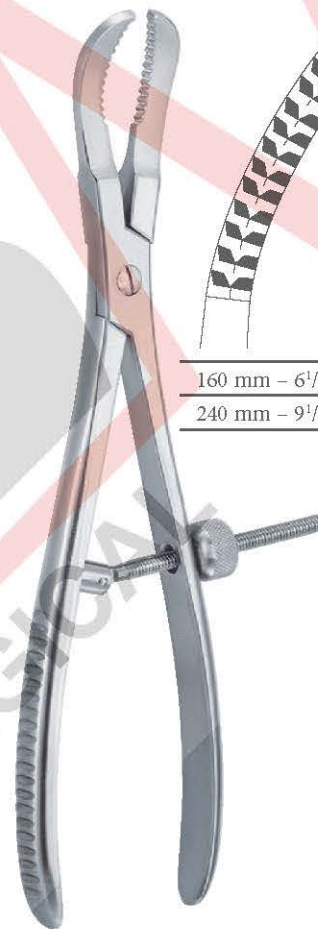

160 mm – 6 ¹ / ₄ "	BS 14-1000-01
240 mm – 9 ¹ / ₂ "	BS 14-1000-02

Knochenhaltezangen – Repositionszangen
Daviers porte-os – Pinces de reposition
Pinzas para huesos – Pinzas para reposición
Tenaglie per ossa – Pinze per riposizione



135 mm – 5¼"
BS 14-1005-01



REILL
170 mm – 6¾"
BS 14-1006-01

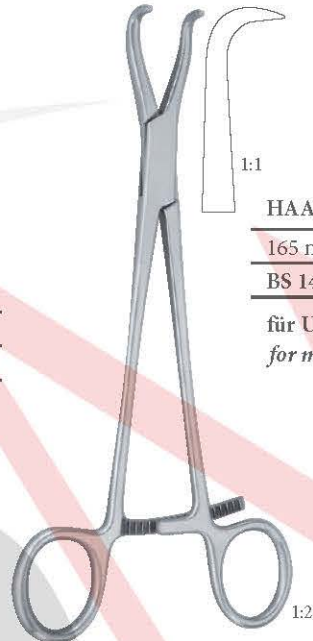

HAASE
165 mm – 6½"
BS 14-1007-01
für Unterkieferfrakturen
for mandibular fractures

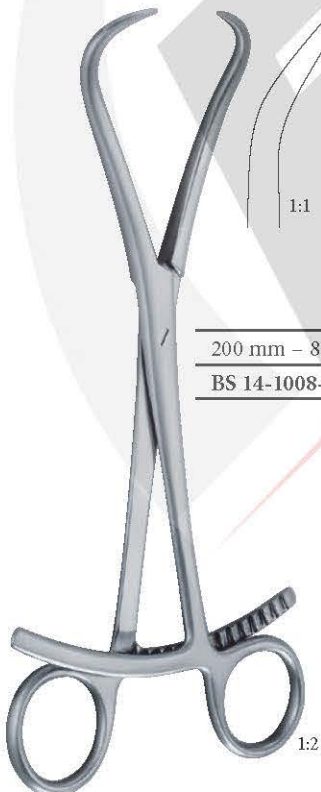

200 mm – 8"
BS 14-1008-01

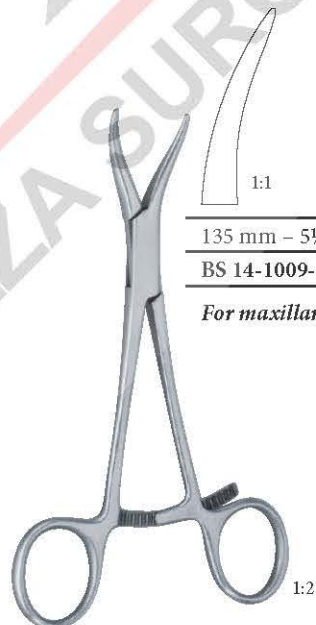

135 mm – 5¼"
BS 14-1009-01
For maxillary

Repositionszangen
 Pincers de
 reposition Pinzas
 para reposición
 Pinze per
 riposizione

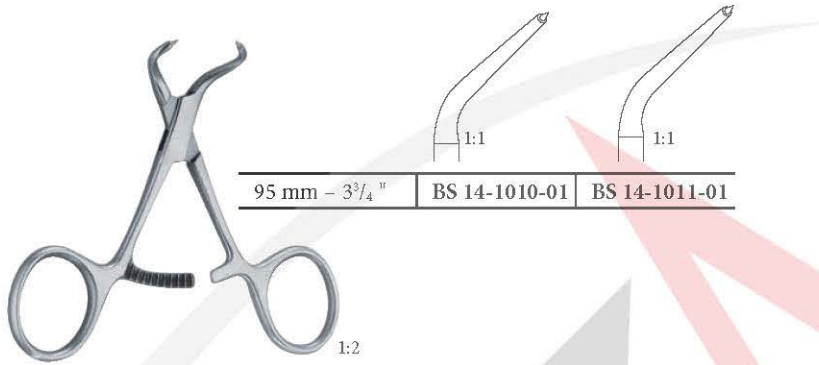

Draht-Instrumentarium
Instruments pour cerclage
Instrumental para cerclaje
Strumenti per filo di cerchiaggio



DEMEL

1:2

	280 mm - 11"
x = 32 mm	BS 14-1014-01
x = 45 mm	BS 14-1014-02
x = 62 mm	BS 14-1014-03



DEMEL

1:2

	280 mm - 11"
	BS 14-1015-01

Drahtschneidezangen
 Pinces coupantes
 Alicates para cortar alambre
 Pinze taglia filo



220 mm - 8 ³ / ₄ "	BS 14-1016-01
--	---------------

For hard wires up to 2.2 mm Ø, for soft wires up to 3 mm Ø

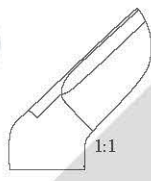

1:2

220 mm - 8 ³ / ₄ "	BS 14-1020-01
--	---------------

For hard wires up to 2.2 mm Ø, for soft wires up to 2.8 mm Ø



1:2

1:2

230 mm - 9"	BS 14-1025-01
-------------	---------------

For hard wires up to 2.2 mm Ø, for soft wires up to 3 mm Ø

Drahtschneidezangen
Pinces coupantes
Alicates para cortar alambre
Pinze taglia filo



180 mm – 7"	BS 14-1030-01
-------------	---------------

For soft wires up to 2 mm Ø



180 mm – 7"	BS 14-1035-01
-------------	---------------

For hard wires up to 1.7 mm Ø, for soft wires up to 2 mm Ø



150 mm – 6"	BS 14-1040-01
-------------	---------------

For hard wires up to 1 mm Ø, For soft wires up to 1.5 mm Ø



185 cm – 7 ¹ / ₄ "	BS 14-1050-01
--	---------------

Wire cutting forceps for hard wires up to 1.6 mm Ø



145 mm – 5 ³ / ₄ "	BS 14-1045-01
--	---------------

For hard wires up to 1 mm Ø

Drahtschneidezangen
Pincés coupantes
Alicates para cortar alambre
Pinze taglia filo



1:3

570 mm - 22 $\frac{1}{2}$ " | BS 14-1055-01

For Kirschner wires and Steinmann pins up to 6 mm Ø

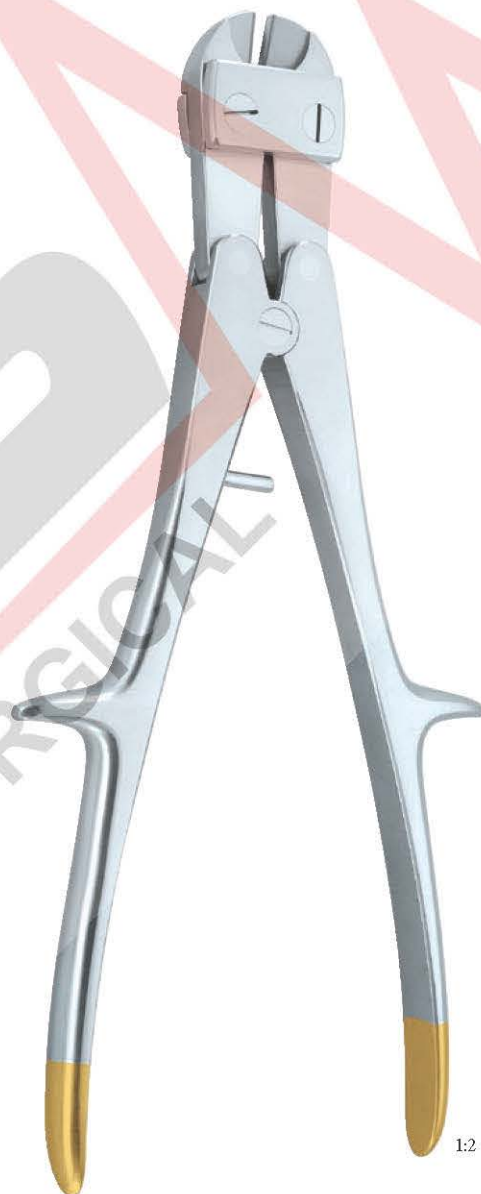

1:2

260 mm - 10 $\frac{1}{4}$ " | BS 14-1060-01

For hard wires up to 3 mm Ø

**Technische Zangen
Pinces techniques
Pinzas tecnicas
Pinze tecniche**



130 mm – 5"	BS 14-1065-01
180 mm – 7"	BS 14-1065-02



140 mm – 5 1/2"	BS 14-1070-01
170 mm – 6 3/4"	BS 14-1070-02



	180 mm – 7"	180 mm – 7"
x = 5 mm	BS 14-1075-01	BS 14-1076-01
x = 7 mm	BS 14-1075-02	BS 14-1076-02

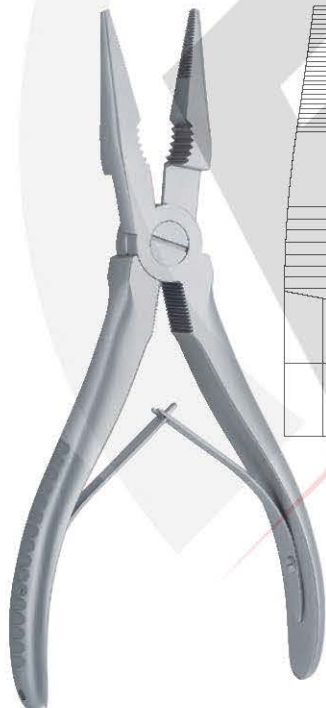

170 mm – 6 3/4"	BS 14-1080-01
-----------------	---------------



220 mm – 8 3/4"	BS 14-1085-01
-----------------	---------------

Grip-Zange, kombiniert mit TC-Schneider Grip forceps, combined with



190 mm – 7 1/2"	BS 14-1090-01
-----------------	---------------

Technische Zange, verstellbar
Technical forceps, adjustable

Technische Zangen
 Pinces techniques
 Pinzas tecnicas
 Pinze tecniche



185 mm – 7 ¹ / ₄ "	BS 14-1095-01
--	---------------

Wire bending forceps



185 mm – 7 ¹ / ₄ "	BS 14-1100-01
--	---------------

Flat nose plier, parallel grip, incorporated cutter, for hard wires up to 1.6mm Ø



180 mm – 7"	BS 14-1105-01
200 mm – 8"	BS 14-1105-02
240 mm – 9 ¹ / ₂ "	BS 14-1105-03

Locking plier

Technische Zangen
 Pinces techniques
 Pinzas tecnicas
 Pinze tecniche

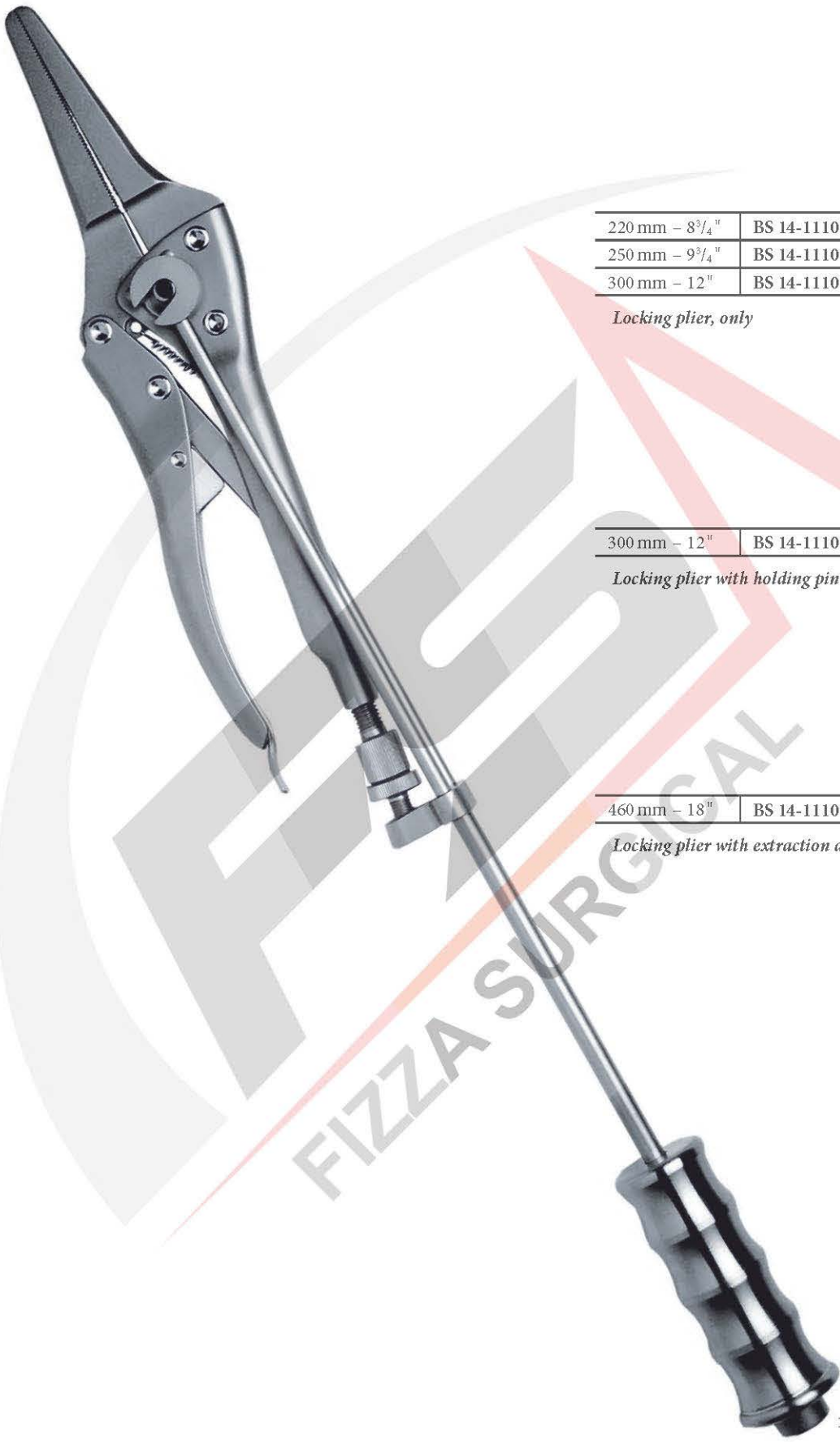

220 mm – 8 ³ / ₄ "	BS 14-1110-01
250 mm – 9 ³ / ₄ "	BS 14-1110-02
300 mm – 12"	BS 14-1110-03

Locking plier, only

300 mm – 12"	BS 14-1110-04
--------------	---------------

Locking plier with holding pins

460 mm – 18"	BS 14-1110-05
--------------	---------------

Locking plier with extraction device

1:2

Technische Zangen
Pincés técnicas
Pinzas técnicas
Pinze tecniche



200 mm - 8"	BS 14-1115-01
-------------	---------------

Plate bending plier for plates up to 2.7 mm

240 mm - 9 1/2"	BS 14-1115-02
-----------------	---------------

Plate bending plier for plates up to 4 mm

Spiralbohrer – Pfrieme
 Mèches – Alènes
 Taladros espirales – Escariadores
 Punte a spirale – Perforatori a mano

