

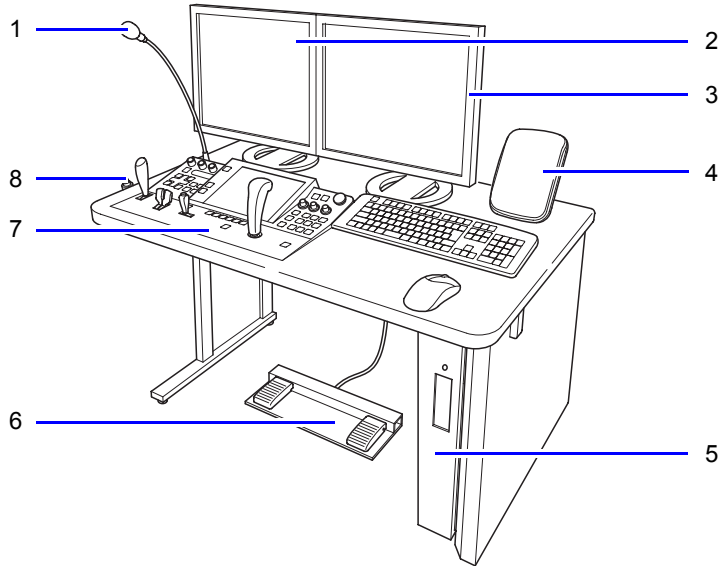



2.3 Remote Control Desk and Remote Console

2.3.1 Remote Control Desk



No.	Name	Function
1	Microphone	Your voice is heard from the speaker in the examination room when the intercom foot switch is being pressed down.
2	Acquisition monitor	Images being acquired are displayed in real time.
3	Reference monitor	Displays images whose acquisition is complete and examination control data.
4	Speaker	Transmits sound from the examination room.
5	Operation cabinet	This is the control cabinet of the digital radiography unit.
6	Foot switch	<p>The microphone is enabled when the intercom foot switch (left) is pressed down.</p> <p>Fluoroscopy is performed when the fluoroscopy foot switch (right) is pressed down while the remote console's  button is lit up.</p> <div style="text-align: center;"> </div>
7	Remote console	<p>This is a console to operate the equipment from outside the examination room.</p> <p> Reference P.2-8</p>

2 Configuration

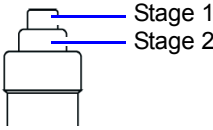
No.	Name	Function
8	Hand switch	<p>This is a two-stage switch for X-ray radiography.</p> <p>When  on the remote console is lit and this switch is pushed down to the first level, the equipment is in a state of readiness for radiography. When this switch is pushed down to the second level, radiography is performed.</p> 

2.3.2 Remote Console

This is a console to operate the equipment from outside the examination room.

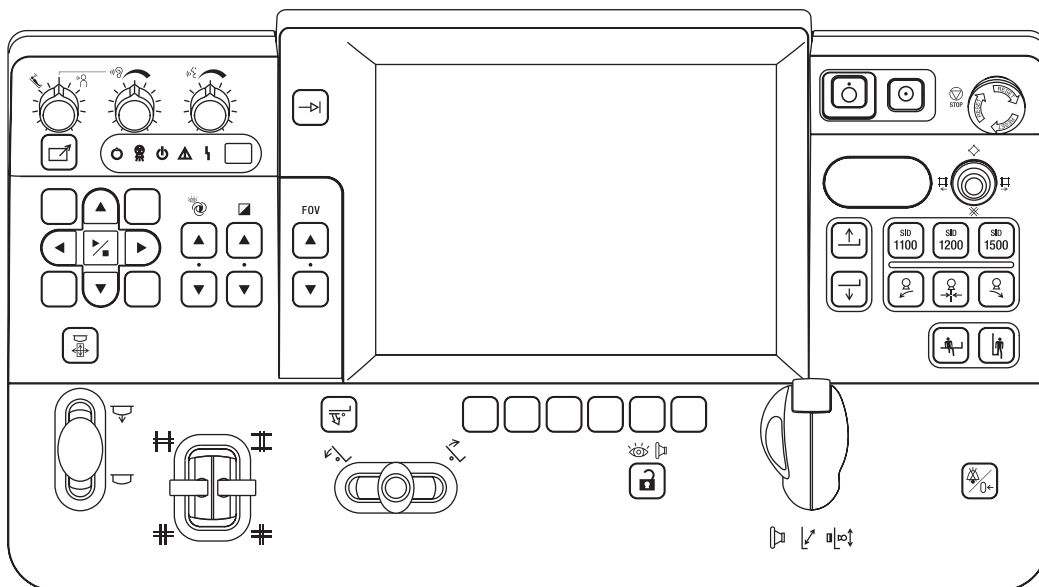

Some of the buttons and levers on the console are connected with the movement of the X-ray diagnostic table and some are connected with X-ray irradiation. They are explained according to function.





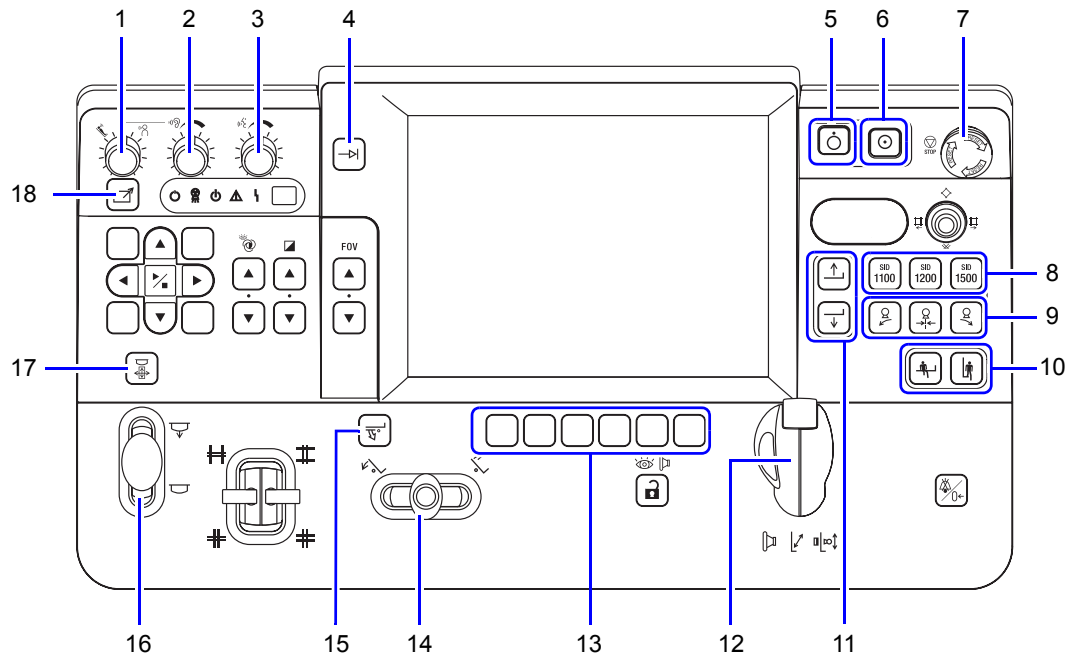















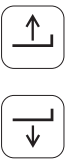

 **Reference** ["Controls that Operate the X-ray Diagnostic Table" P.2-9](#)
["Controls Related to Fluoroscopy and Radiography" P.2-12](#)

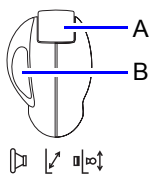





Controls that Operate the X-ray Diagnostic Table

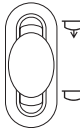

No.	Form	Name	Function
1		Balance adjustment dial	Adjusts the mixing balance between the microphone installed in the tabletop and the auxiliary microphone. Mixing is increased for the tabletop microphone when the dial is turned towards , and increased for the auxiliary microphone when the dial is turned towards . Reference P.4-60
2		Control room speaker volume adjustment dial	Adjusts the volume of the control room speaker. Turning it to the right increases the volume, and turning it to the left lowers the volume. Reference P.4-60
3		Examination room speaker volume adjustment dial	Adjusts the volume of the examination room speaker. Turning it to the right increases the volume, and turning it to the left lowers the volume. Reference P.4-60
4		Set button *1	Used with the position memory function. Reference P.4-46
5		Power OFF button	Turns the system's power off. Reference P.4-28
6		Power ON button	Turns the system's power on. Reference P.4-28
7		Emergency stop button	Brings the movement of the X-ray diagnostic table to an emergency stop. Reference P.5-2

2 Configuration

No.	Form	Name	Function
8		SID switchover buttons	<p>Sets the distance of the FPD input surface from the focal spot of the X-ray tube unit.</p> <p> Reference P.4-45</p>
9		Oblique projection buttons* ¹	<p>Controls the oblique projection angle of the X-ray tube unit.</p> <p> slants the X-ray tube unit towards the patient's head and  slants it towards the feet.</p> <p> returns the X-ray tube unit back to the center from the slanted position.</p> <p> Reference P.4-45</p>
10		Tabletop return buttons* ¹	<p>Returns the tabletop slant and height to the set position.</p> <p> returns the tabletop to the horizontal position and to the height set when it was installed.  moves the tabletop to the vertical position.</p> <p> Reference P.4-46</p>
11		Raise tabletop button* ¹ Lower tabletop button* ¹	<p> raises the tabletop and  lowers it.</p> <p> Reference P.4-40</p>
12		Tabletop and imaging unit control lever* ¹	<p>When tilted to the left or right, the tabletop moves to the left or right.</p> <p>When tilted up or down, the imaging unit moves up or down.</p> <p>A: Radiography button B: Button to change the speed of the tabletop's movement to the left or right</p> <p> Reference P.4-39, P.4-44</p>
13		Customizable buttons	<p>You can assign frequently used functions to these buttons.</p> <p> Reference P.2-25</p>
14		Tabletop tilting lever* ¹	<p>Tilts the tabletop. It is operated while holding down the button on the top of the lever.</p> <p>When it is moved to the right, the tabletop is tilted in a vertical direction. It is tilted in the opposite direction when the lever is moved to the left.</p> <p> Reference P.4-36</p>
15		Tabletop reverse tilt check button	<p>Press when reversing the tilt of the tabletop. When the button is pressed and lit up, the tilt can be reversed using the tabletop tilting lever.</p> <p> Reference P.4-37</p>

No.	Form	Name	Function
16		Compression unit control lever *1	Controls the compression unit. Push forward to apply compression on the patient. Pull towards you to return the compression unit to its original position.  Reference P.4-50
17		Squeeze compression button	Use this when applying "squeeze compression".  Reference P.4-51
18		Operational button	When this button is lit up, the X-ray diagnostic table and X-ray exposure can be controlled by the remote console.  Reference P.4-35

*1:Only moves while the button is being pressed or the lever is being operated.

Controls Related to Fluoroscopy and Radiography

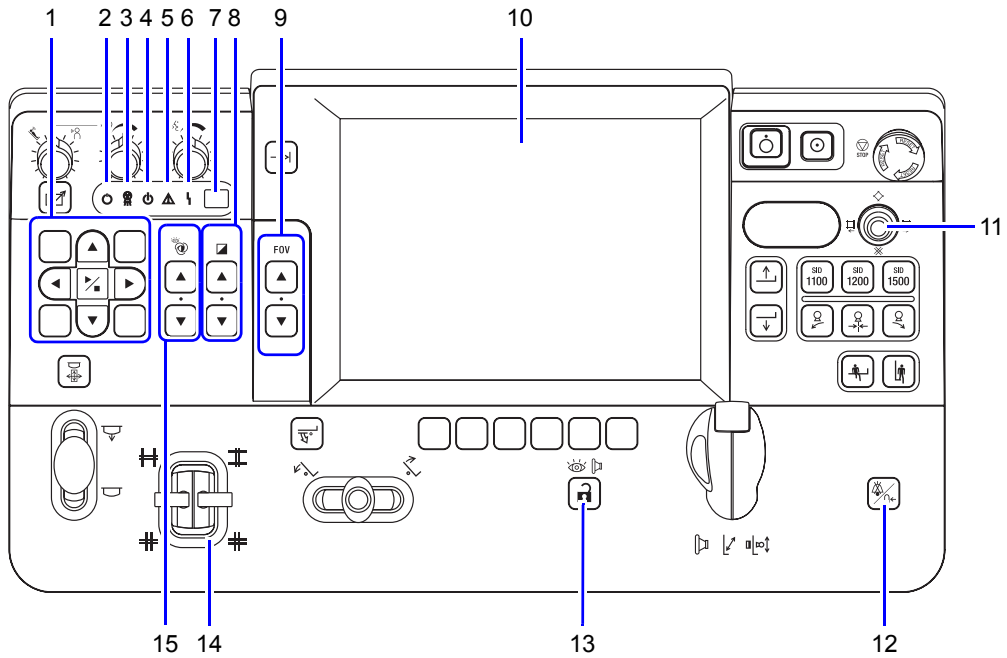

No.	Form	Name	Function
1		Image control buttons	<p>These are used when looking at the taken images on the acquisition monitor. Their operations vary according to the image display style (display of one frame or display of multiple frames).</p> <p>When one frame is displayed:</p> <ul style="list-style-type: none"> displays the previous image and displays the next image. displays the previous frame and displays the next frame. starts or stops video playback. <p>When multiple frames are displayed:</p> <ul style="list-style-type: none"> selects the upper frame and selects the lower frame. selects the left-hand frame and selects the right-hand frame. displays the selected frames one at a time. <p>Refer to "M517-E210 Digital Radiography System DR-300 Instruction Manual (Image Acquisition)" for details.</p> <p>The surrounding four buttons () are customizable buttons. You can assign frequently used functions to these buttons.</p> <p> Reference P.2-25</p>
2		Ready for radiography display	The green light comes on when the preparations for radiography are complete.

No.	Form	Name	Function
3		X-ray irradiating display	The yellow light comes on during X-ray irradiation.
4		System standby status display	The green light comes on when X-rays can be radiated. The light goes off when X-rays cannot be radiated, for example due to a failure.
5		Caution display	The red light comes on when the interlock is on for the X-ray diagnostic table movement or X-ray irradiation.
6		Failure display	The red light comes on when the system's protective circuit is in operation, or when an error has occurred in the system's functions.
7		Caution/failure code display	Displays the caution/failure code when the caution or failure display is lit up. Reference P.5-13
8		Density buttons	These adjust the density during AEC radiography in 11 stages, from -5 to 5. increases density and reduces density. Reference P.4-80
9		Magnification size switchover buttons	Changes the FPD magnification size through 5 levels. increases the magnification and decreases it. Reference P.4-54
10		Touch panel	Sets the fluoroscopy and radiography conditions. Operated by touching the screen display. Reference P.2-14
11		Collimator open/close switch	Controls the collimator irradiation field. Controls the C-leaf collimator (optional) and independent mask collimator (optional). Reference P.4-56
12		Fluoroscopy timer button	Turns off the fluoroscopy timer alarm, and restarts the timer count from 0. Reference P.4-70
13		X-ray irradiation clearance button	Lights up when pressed, signalling that X-ray irradiation is permitted.
14		Collimator open/close lever	Controls the collimator irradiation field. Controls the collimator in a horizontal/vertical direction. Reference P.4-55
15		Fluoroscopy density buttons	Adjust the brightness of the fluoroscopy images during IBS fluoroscopy. brightens the image and darkens it. Reference P.4-68