

RESPIRATORY
PRODUCTS

Plasti-med
"supporting healthy life"

SOLUNUM
ÜRÜNLERİ



FİRMAMIZ

TARİHÇE

Plasti-med 1995 yılında kurulmuştur. Anestezi, Drenaj, Üroloji, Jinekoloji ve Genel kullanıma uygun tek kullanımlık tıbbi malzemeler üretmektedir. Türkiye'nin önemli tek kullanımlık medikal malzeme üreticilerinden birisidir. Dünya genelinde 70'den fazla ülkeye ihracat yapmaktadır.

KALİTE POLİTİKAMIZ

Hedefimiz Yüksek kalitede, rekabet edebilir fiyatlarla ve müşteri memnuniyetini hedef alan hizmet anlayışımızla, standartlara uygun ürünler üretmektir.

ÜRÜNLERİMİZ

Plasti-med ürün yelpazesinde bulunan ürünlerde ciddi pazar payları elde etmiştir. Sektör ihtiyaçlarına göre ürün geliştirme ve kalite yükseltme çabaları sonucu ürünleri "Plasti-med" markası ile istenir duruma gelmiştir. Üretimde kullanılan malzemelerin tamamı MDD gerekliliklerine uygun ve sektörde tanınan ve kabul gören tedarikçilerden sağlanmaktadır. Üretim araç ve gereçleri yine MDD, GMP ve PLASTİ-MED kuralları gereği en yüksek kalitede dünyada bilinen ve kabul görmüş markalar arasından seçilmektedir.

STANDARTLARIMIZ

Plasti-med kurulduğu günden beri ilgili standartları rehber edinerek üretim yapmaktadır. Ürünler MDD 93/42/ECC (2007/47/EC) ve GMP kurallarına uygun olarak üretilmektedir. Kalite sistemi ISO 9001:2008 ve ISO 13485:2003 sertifikasına ve Tüm ürünler CE sertifikasına sahiptir.

İNSAN KAYNAKLARI

Kalite hedeflerini ve hizmet anlayışını sürdürebilmek için iyi eğitim almış, tecrübeli, yaptığı işinin bilincinde olan Personel ile çalışmak Plasti-med'in insan kaynakları politikasının temelini oluşturur.

ABOUT US

HISTORY

Plasti-Med Company has been established in 1995. Production focuses on disposable medical supplies having main product groups as Anesthesia, Drainage, Urology, Gynecology and General disposables. Plasti-Med Company takes place among the biggest producers of medical disposables in Turkey. At the same time exporting its products over 70 countries all over the globe.

QUALITY POLICY

Our goal is to continually supply high quality medical devices to healthcare professionals the world over and to ensure that these products fully comply to both international and national regulatory and customer requirements. All our devices are manufactured in compliance to the Council Directive 93/42/EEC.

PRODUCTS

A specialist in Anaesthesiology products, Plasti-med has gained an ever increasing share in the marketplace for over 15 years. With extensive experience in the design, development and manufacture of premium quality medical devices, the product range continues to grow. All products supplied by Plasti-med undergo strict quality control to ensure complete customer satisfaction. Plasti-med commits to Research and Development of new products, in addition to the current wide range on offer – aiming to be at the forefront of technological advances. Our Customer Service department is on hand to offer further details on any of our products – for more information please contact us.

STANDARDS

Plasti-med has long been accustomed to operating in a highly regulated environment with regards to design and development of medical products. All Plasti-med devices are manufactured to the highest possible standards and have been bearing the CE mark since 2003 – demonstrating compliance with the Medical Device Directive 93/42/EEC. The Plasti-med Quality Management System is certified according to and regularly audited against ISO 9001:2008 & ISO 13485 (2003). It is this commitment to Quality Assurance which enables us to serve and satisfy all our customers' expectations.

İÇİNDEKİLER

CONTENTS

Anestezi & Solunum Devreleri Anesthesia & Ventilation Circuits	2-17
Havayolu Yönetimi Airway Management	18-19
Filtreler Filters	20-22
Oksijen ve Aerosol Maskeler Oxygen and Aerosol Masks	23-25
Yastıklı ve Silikon Maskeler Air Cushion and Silicone Masks	26-27
Nebulizer Setler 'T' Parçalı ve Nazal Kanüller Nebuliser Sets 'T' Part ve nasal cannula	28-29
Acil Bakım Emergency Care	30-31
CPAP / BIPAP Maskeler CPAP / BIPAP Masks	32-33
Aksesuarlar Accessories	34-35
Konnektörler Connectors	36-37

* Özel ölçüler için bize müracaat ediniz. İstek üzerine steril ürünler üretilmektedir.
Special and sterile products can be manufactured upon request.

Plasti-med
"supporting healthy life"

SOLUNUM SİSTEMLERİ
BREATHING SYSTEMS



ANESTEZİ DEVRELERİ - KORUGE / ANESTHESIA CIRCUITS - CORRUGATED

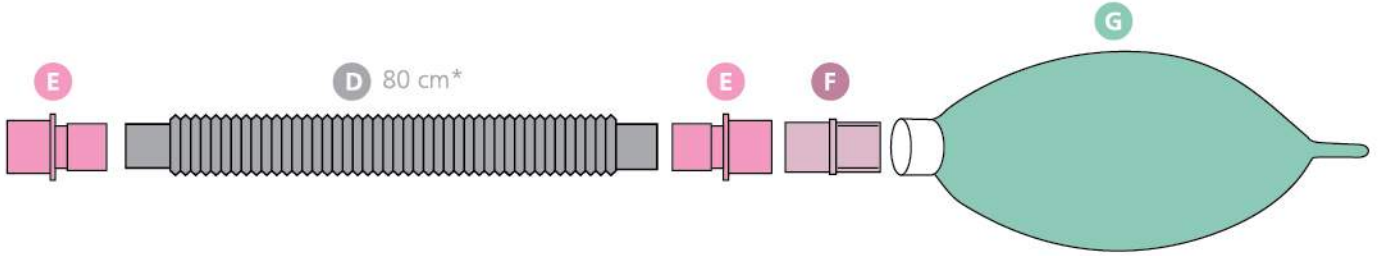
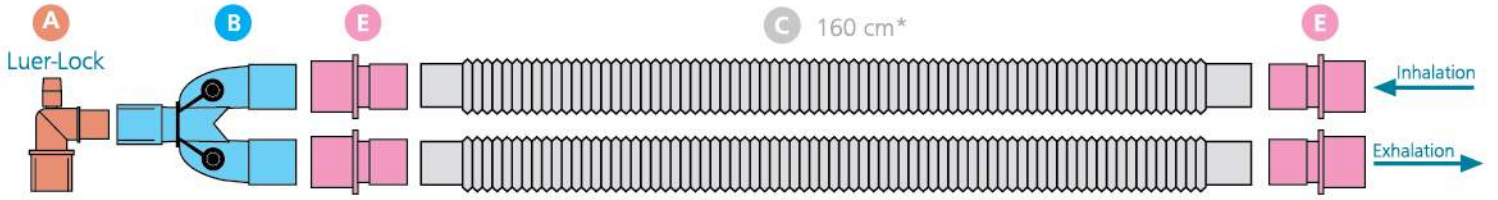

	KOD / CODE	A	B	C	D	E	F	G
YETİŞKİN ADULT (Ø 22mm)	480 001	1	1	2	-	4	-	-
	480 101	1	1	2	1	6	1	-
	480 201	1	1	2	1	6	1	1
PEDIATRİK PEDIATRIC (Ø 15mm)	480 301	1	1	2	-	4	-	-
	480 401	1	1	2	1	6	1	-
	480 501	1	1	2	1	6	1	1

- A: Dirsek - Luerlock-Elbow/Luerlock (22M/15F-15M)
 B: Y Konnektör - Wye Connector (22M/15F-22M)
 C: Hortum - Tubing (Ø 22mm, Ø 15mm)
 D: Ara Hortum - Limb (Ø 22mm, Ø 15mm)
 E: Düz Konnektör - Straight Connector (22F-22M)
 F: Düz Konnektör - Straight Connector (22M-22M/15F)
 G: Anestezi Balonu - Breathing Bag (22F) (0.5L, 1L, 2L, 3L)

*Özel uzunluklar isteğe göre üretilmektedir. Tablodaki rakamlar devre içeriklerini göstermektedir.
 *Special lengths can be manufactured upon request. The figures in the table show the contents of the circuit.

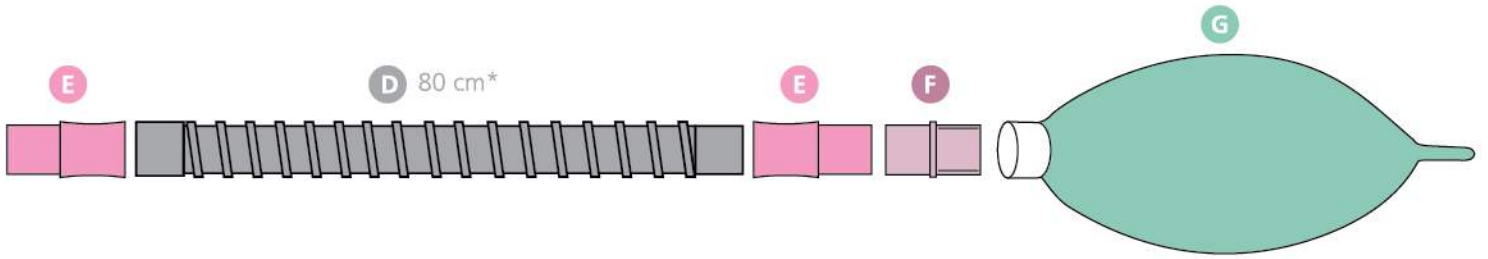
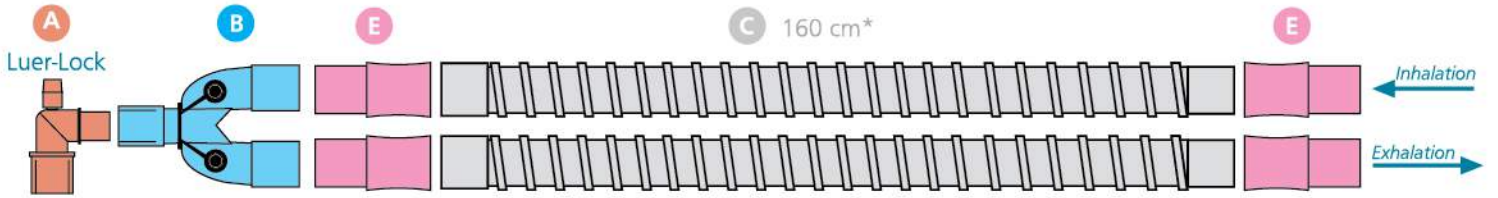

	KOD / CODE	A	B	C	D	E	F	G
YETİŞKİN ADULT Ø 19mm	481 001	1	1	2	-	4	-	-
	481 101	1	1	2	1	6	1	-
	481 201	1	1	2	1	6	1	1
PEDİATRİK PEDIATRIC Ø 15mm	481 301	1	1	2	-	4	-	-
	481 401	1	1	2	1	6	1	-
	481 501	1	1	2	1	6	1	1

- A: Dirsek - Luerlock-Elbow/Luerlock (22M/15F-15M)
 B: Y Konnektör - Wye Connector (22M/15F-22M)
 C: Hortum - Tubing (Ø 22mm, Ø 15mm)
 D: Ara Hortum - Limb (Ø 22mm, Ø 15mm)
 E: Düz Konnektör - Straight Connector (22F-22M)
 F: Düz Konnektör - Straight Connector (22M-22M/15F)
 G: Anestezi Balonu - Breathing Bag (22F) (0.5L, 1L, 2L, 3L)

*Özel uzunluklar isteğe göre üretilmektedir. Tablodaki rakamlar devre içeriklerini göstermektedir.
 *Special lengths can be manufactured upon request. The figures in the table show the contents of the circuit.

ANESTEZİ DEVRELERİ - AYARLANABİLİR / ANESTHESIA CIRCUITS - EXTENDABLE

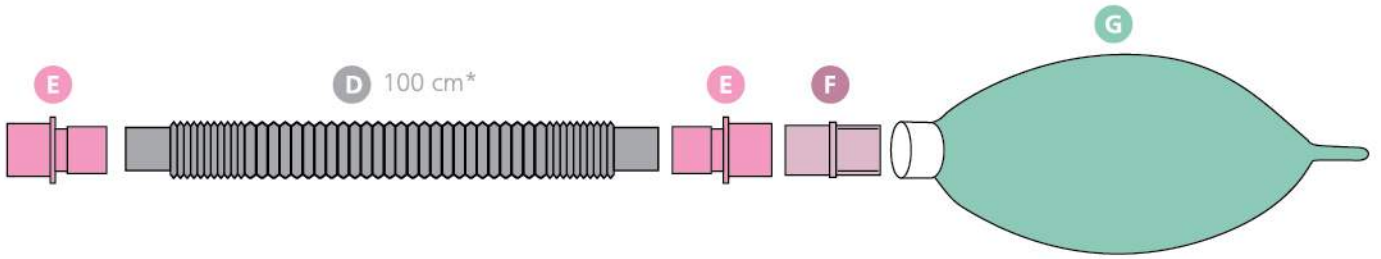
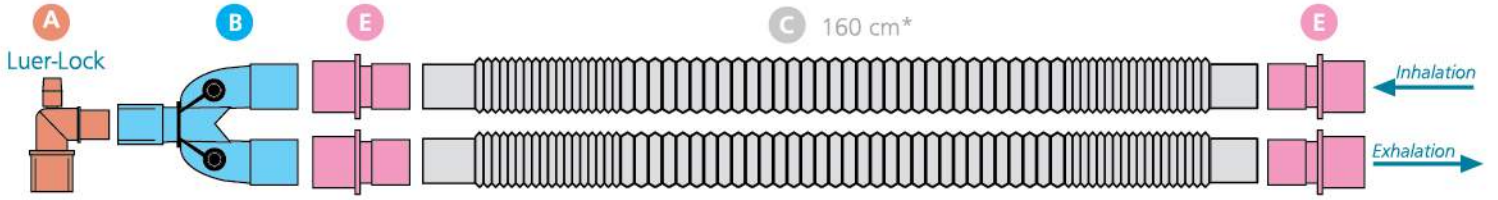

	KOD / CODE	A	B	C	D	E	F	G
YETİŞKİN ADULT Ø 22mm	482 001	1	1	2	-	4	-	-
	482 101	1	1	2	1	6	1	-
	482 201	1	1	2	1	6	1	1
PEDIATRİK PEDIATRIC (Ø 15mm)	482 301	1	1	2	-	4	-	-
	482 401	1	1	2	1	6	1	-
	482 501	1	1	2	1	6	1	1

- A: Dirsek - Luerlock-Elbow/Luerlock (22M/15F-15M)
 B: Y Konnektör - Wye Connector (22M/15F-22M)
 C: Hortum - Tubing (Ø 22mm, Ø 15mm)
 D: Ara Hortum - Limb (Ø 22mm, Ø 15mm)
 E: Düz Konnektör - Straight Connector (22F-22M)
 F: Düz Konnektör - Straight Connector (22M-22M/15F)
 G: Anestezi Balonu - Breathing Bag (22F) (0.5L, 1L, 2L, 3L)

*Özel uzunluklar isteğe göre üretilmektedir. Tablodaki rakamlar devre içeriklerini göstermektedir.

*Special lengths can be manufactured upon request. The figures in the table show the contents of the circuit.

Plasti-med
"supporting healthy life"

SOLUNUM SİSTEMLERİ
BREATHING SYSTEMS



SOLUNUM DEVRELERİ - KORUGE / VENTILATION CIRCUITS - CORRUGATED

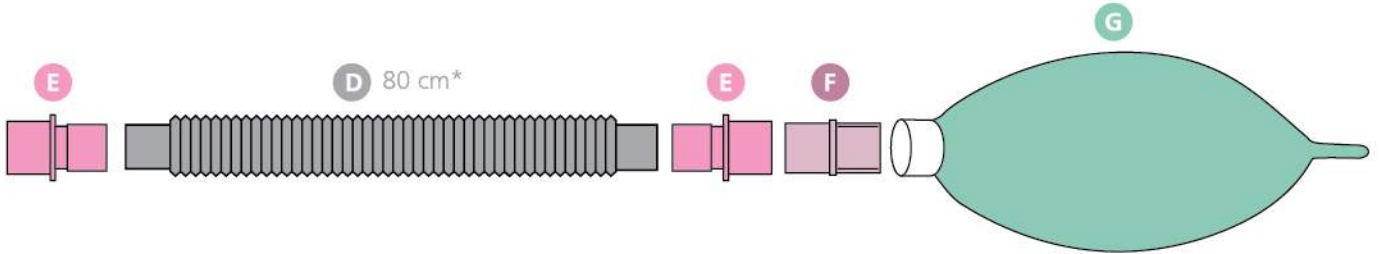
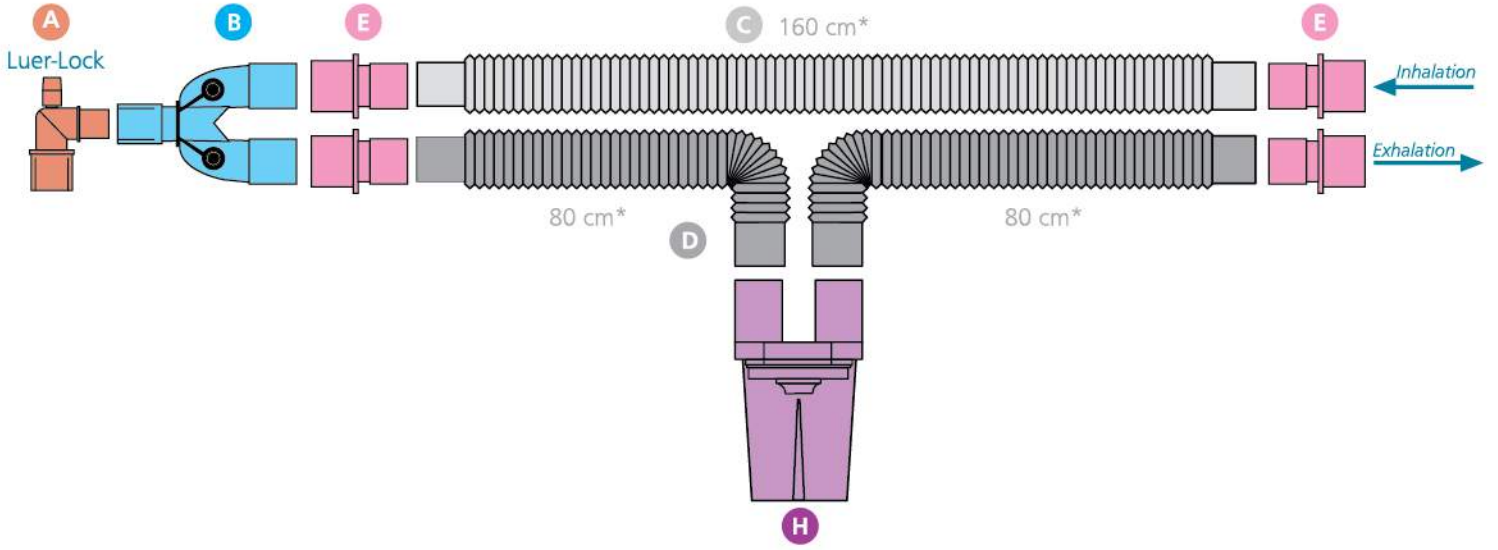

	KOD / CODE	A	B	C	D	E	F	G	H
YETİSKİN ADULT Ø 22mm	483 001	1	1	1	2	4	-	-	1
	483 101	1	1	1	3	6	1	-	1
	483 201	1	1	1	3	6	1	1	1
PEDIATRİK PEDIATRIC Ø 15mm	484 001	1	1	1	2	4	-	-	1
	484 101	1	1	1	3	6	1	-	1
	484 201	1	1	1	3	6	1	1	1

- A: Dirsek - Luerlock-Elbow/Luerlock (22M/15F-15M)
 B: Y Konnektör - Wye Connector (22M/15F-22M)
 C: Hortum - Tubing (Ø 22mm, Ø 15mm)
 D: Ara Hortum - Limb (Ø 22mm, Ø 15mm)
 E: Düz Konnektör - Straight Connector (22F-22M)
 F: Düz Konnektör - Straight Connector (22M-22M/15F)
 G: Anestezi Balonu - Breathing Bag (22F) (0.5L, 1L, 2L, 3L)
 H: Su Tuzağı - Water Trap (22M)

*Özel uzunluklar isteğe göre üretilmektedir. Tablodaki rakamlar devre içeriklerini göstermektedir.
 *Special lengths can be manufactured upon request. The figures in the table show the contents of the circuit.

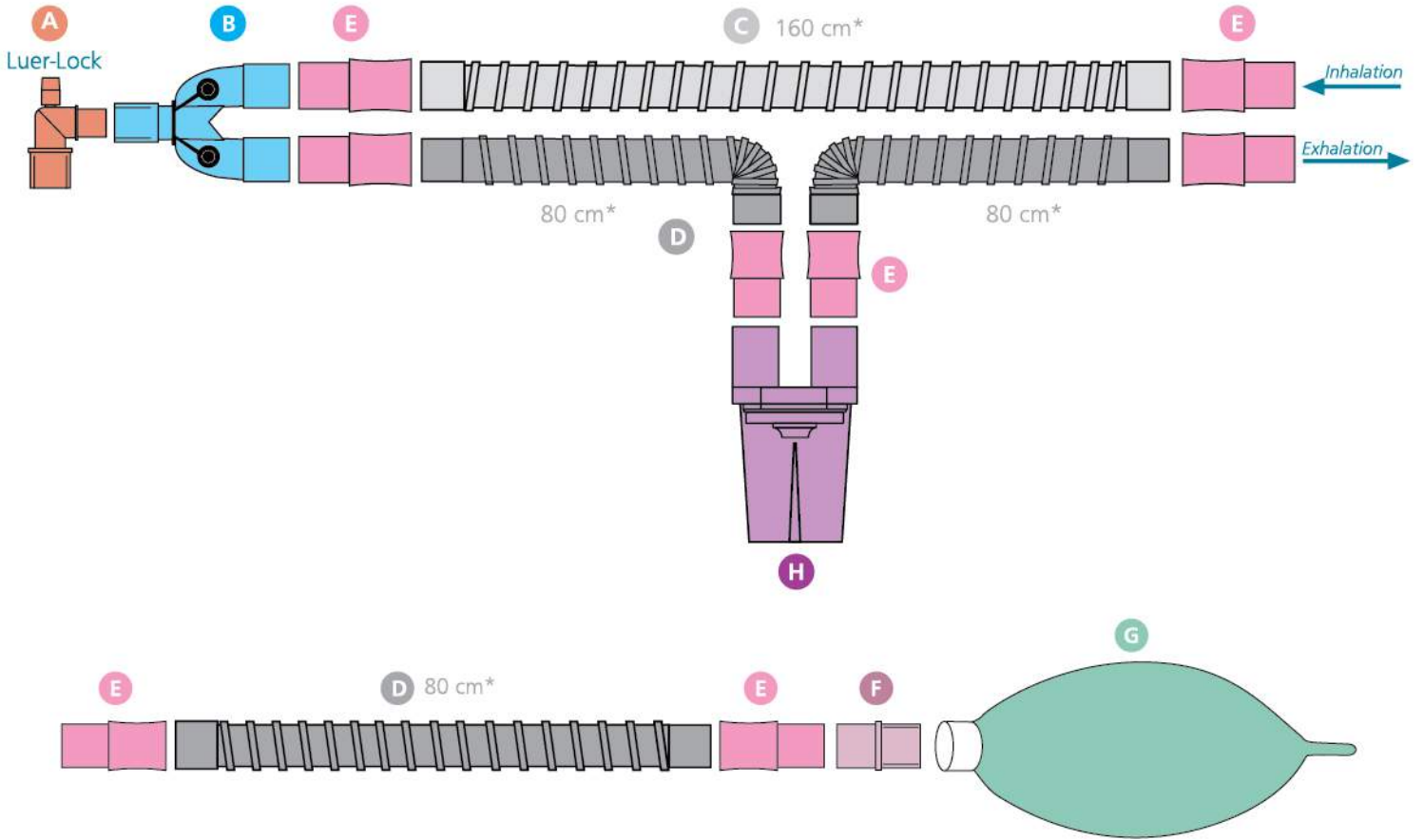

	KOD / CODE	A	B	C	D	E	F	G	H
YETİŞKİN ADULT Ø 19mm	485 001	1	1	1	2	6	-	-	1
	485 101	1	1	1	3	8	1	-	1
	485 201	1	1	1	3	8	1	1	1
PEDIATRİK PEDIATRIC Ø 15mm	486 001	1	1	1	2	6	-	-	1
	486 101	1	1	1	3	8	1	-	1
	486 201	1	1	1	3	8	1	1	1

- A: Dirsek - Luerlock-Elbow/Luerlock (22M/15F-15M)
 B: Y Konnektör - Wye Connector (22M/15F-22M)
 C: Hortum - Tubing (Ø 22mm, Ø 15mm)
 D: Ara Hortum - Limb (Ø 22mm, Ø 15mm)
 E: Düz Konnektör - Straight Connector (22F-22M)
 F: Düz Konnektör - Straight Connector (22M-22M/15F)
 G: Anestezi Balonu - Breathing Bag (22F) (0.5L, 1L, 2L, 3L)
 H: Su Tuzağı - Water Trap (22M)

*Özel uzunluklar isteğe göre üretilmektedir. Tablodaki rakamlar devre içeriklerini göstermektedir.

*Special lengths can be manufactured upon request. The figures in the table show the contents of the circuit.

SOLUNUM DEVRELERİ - AYARLANABİLİR / VENTILATION CIRCUITS - EXTENDABLE

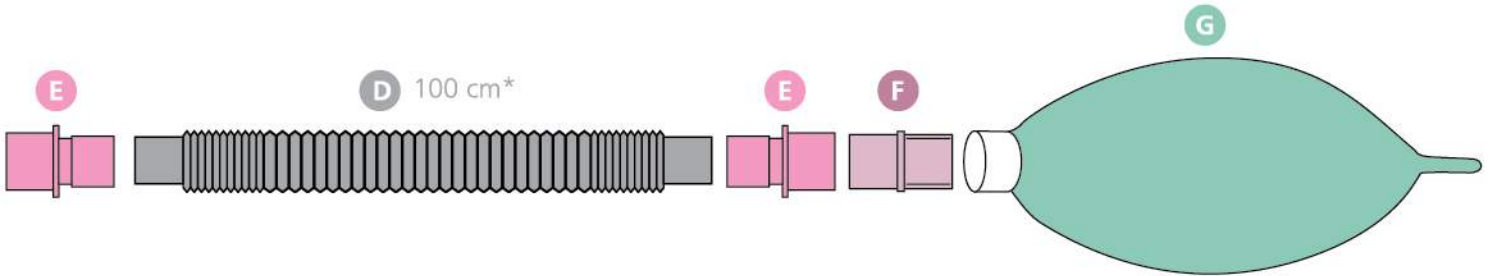
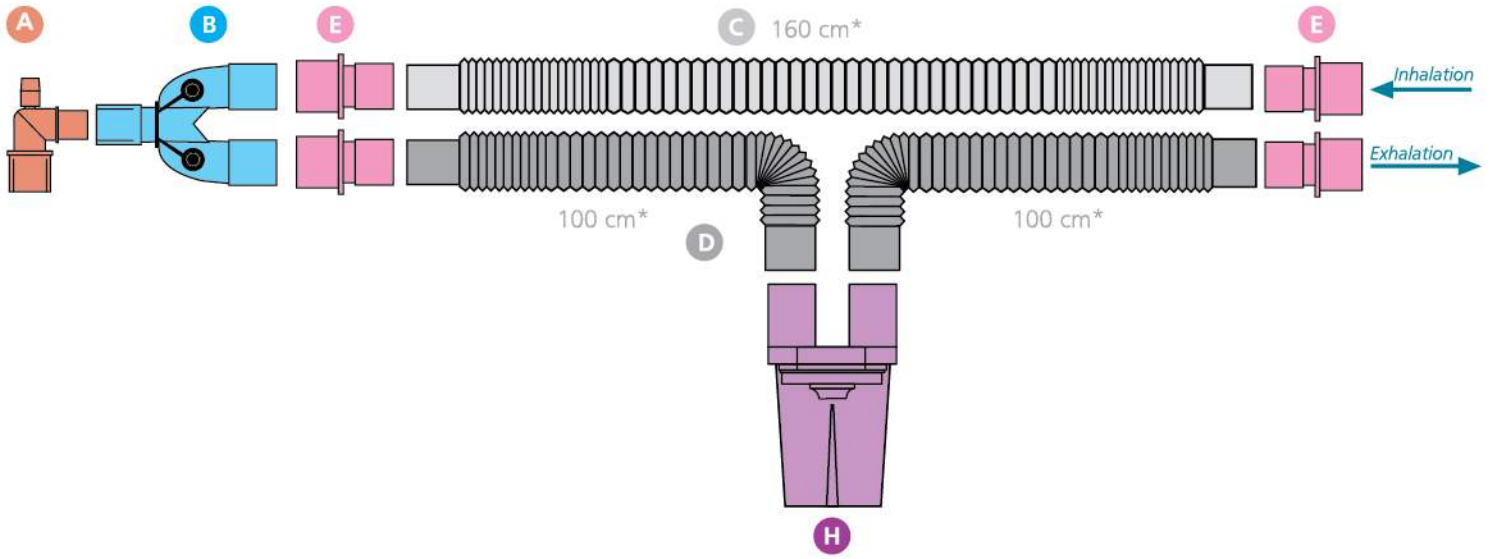

	KOD / CODE	A	B	C	D	E	F	G	H
YETİŞKİN ADULT Ø 22mm	487 001	1	1	1	2	4	-	-	1
	487 101	1	1	1	3	6	1	-	1
	487 201	1	1	1	3	6	1	1	1
PEDIATRİK PEDIATRIC Ø 15mm	488 001	1	1	1	2	4	-	-	1
	488 101	1	1	1	3	6	1	-	1
	488 201	1	1	1	3	6	1	1	1

- A: Dirsek - Luerlock-Elbow/Luerlock (22M/15F-15M)
 B: Y Konnektör - Wye Connector (22M/15F-22M)
 C: Hortum - Tubing (Ø 22mm, Ø 15mm)
 D: Ara Hortum - Limb (Ø 22mm, Ø 15mm)
 E: Düz Konnektör - Straight Connector (22F-22M)
 F: Düz Konnektör - Straight Connector (22M-22M/15F)
 G: Anestezi Balonu - Breathing Bag (22F) (0.5L, 1L, 2L, 3L)
 H: Su Tuzağı - Water Trap (22M)

*Özel uzunluklar isteğe göre üretilmektedir. Tablodaki rakamlar devre içeriklerini göstermektedir.

*Special lengths can be manufactured upon request. The figures in the table show the contents of the circuit.

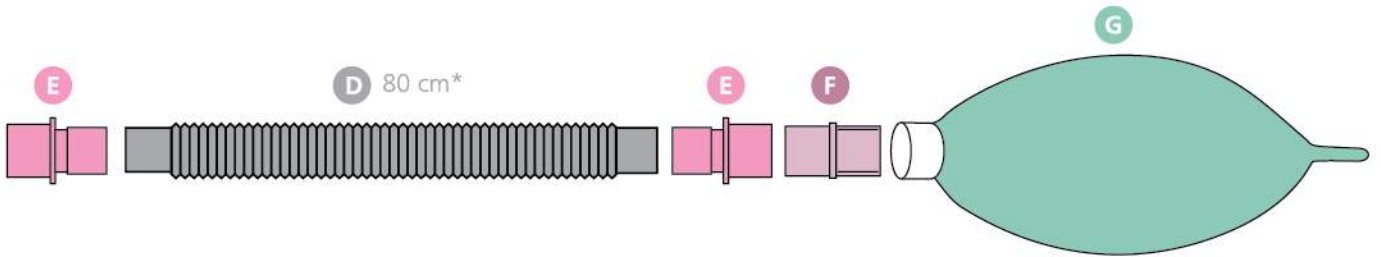
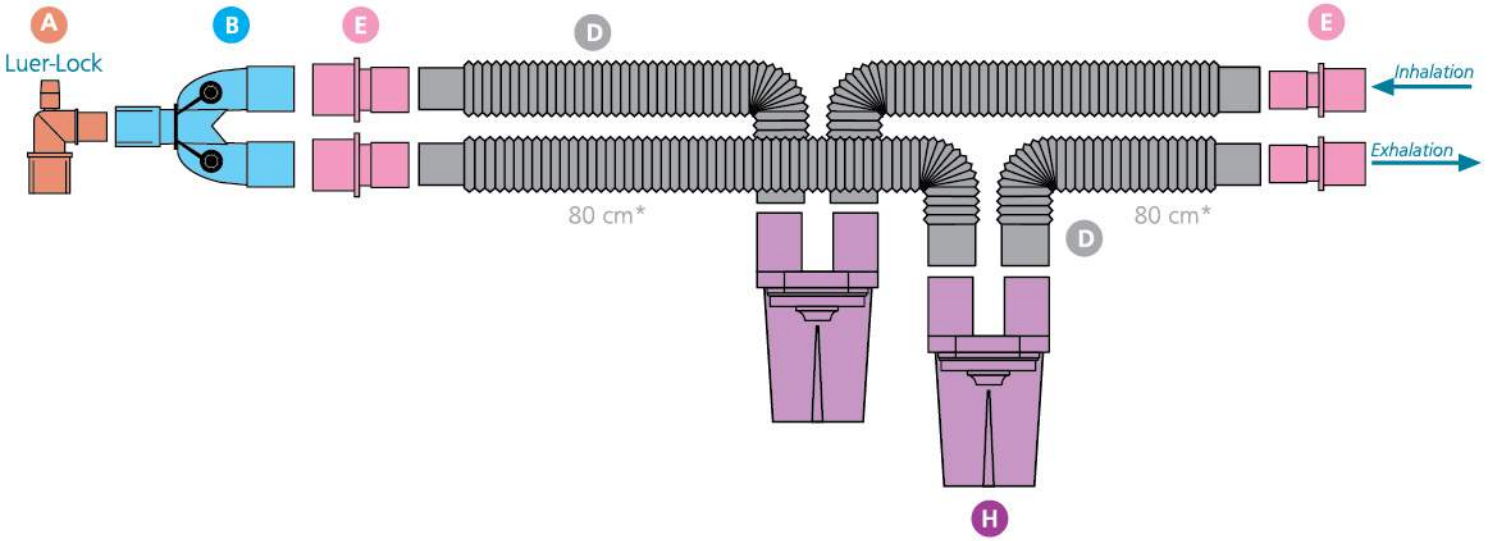

	KOD / CODE	A	B	C	D	E	F	G	H
YETİŞKİN ADULT Ø 22mm	483 301	1	1	-	4	4	-	-	2
	483 401	1	1	-	5	6	1	-	2
	483 501	1	1	-	5	6	1	1	2
PEDIATRİK PEDIATRIC Ø 15mm	484 301	1	1	-	4	4	-	-	2
	484 401	1	1	-	5	6	1	-	2
	484 501	1	1	-	5	6	1	1	2

- A: Dirsek - Luerlock-Elbow / Luerlock (22M/15F-15M)
 B: Y Konnektör - Wye Connector (22M/15F-22M)
 D: Ara Hortum - Limb (Ø 22mm, Ø 15mm)
 E: Düz Konnektör - Straight Connector (22F-22M)
 F: Düz Konnektör - Straight Connector (22M-22M/15F)
 G: Anestezi Balonu - Breathing Bag (22F) (0.5L, 1L, 2L, 3L)
 H: Su Tuzağı - Water Trap (22M)

*Özel uzunluklar isteğe göre üretilmektedir. Tablodaki rakamlar devre içeriklerini göstermektedir.

*Special lengths can be manufactured upon request. The figures in the table show the contents of the circuit.



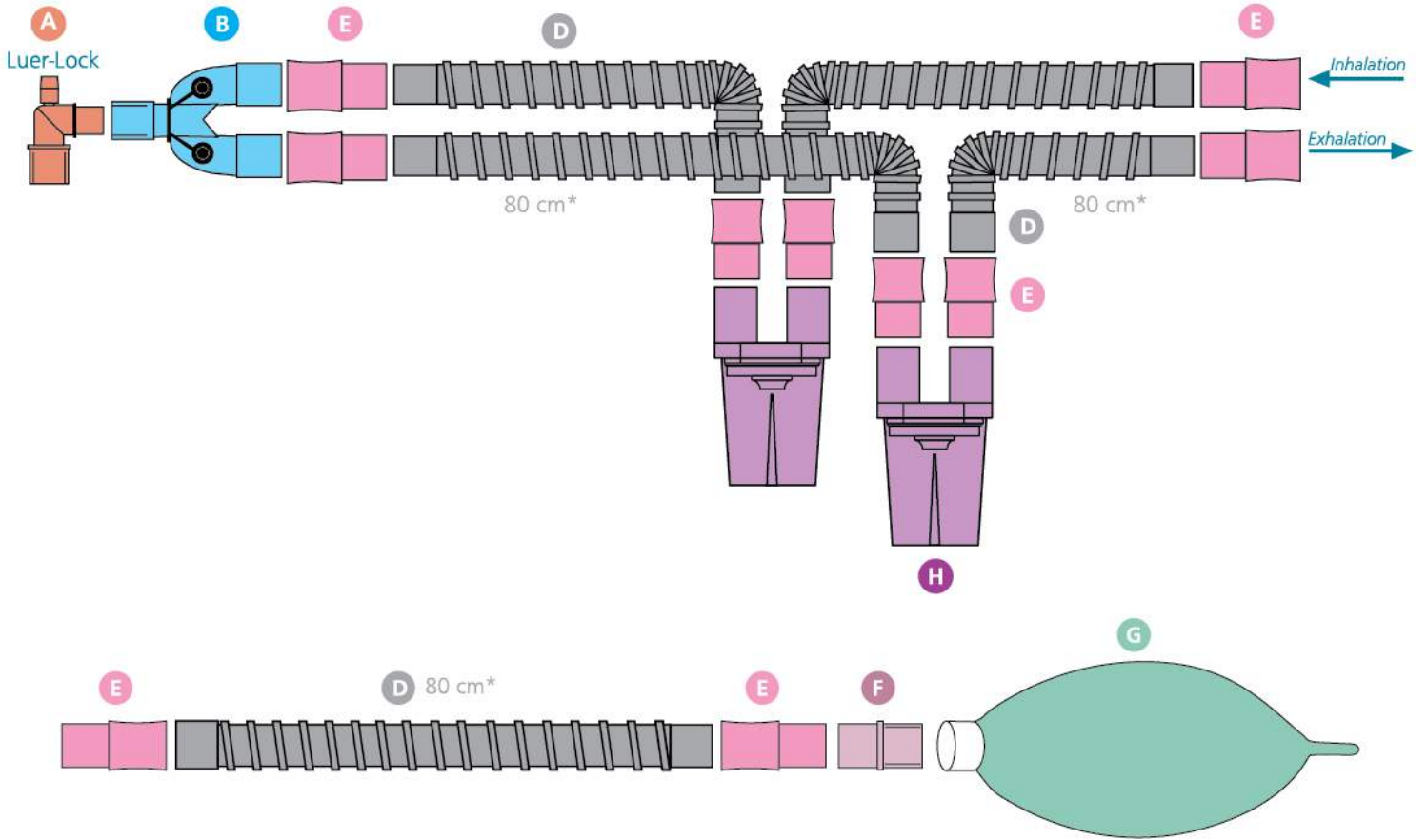

	KOD / CODE	A	B	C	D	E	F	G	H
YETİŞKİN ADULT Ø 19mm	485 301	1	1	-	4	8	-	-	2
	485 401	1	1	-	5	10	1	-	2
	485 501	1	1	-	5	10	1	1	2
PEDIATRİK PEDIATRIC Ø 15mm	486 301	1	1	-	4	8	-	-	2
	486 401	1	1	-	5	10	1	-	2
	486 501	1	1	-	5	10	1	1	2

- A: Dirsek - Luerlock-Elbow/Luerlock (22M/15F-15M)
- B: Y Konnektör - Wye Connector (22M/15F-22M)
- D: Ara Hortum - Limb (Ø 22mm, Ø 15mm)
- E: Düz Konnektör - Straight Connector (22F-22M)
- F: Düz Konnektör - Straight Connector (22M-22M/15F)
- G: Anestezi Balonu - Breathing Bag (22F) (0.5L, 1L, 2L, 3L)
- H: Su Tuzağı - Water Trap (22M)

*Özel uzunluklar isteğe göre üretilmektedir. Tablodaki rakamlar devre içeriklerini göstermektedir.
*Special lengths can be manufactured upon request. The figures in the table show the contents of the circuit.

SOLUNUM DEVRELERİ - AYARLANABİLİR / VENTILATION CIRCUITS - EXTENDABLE

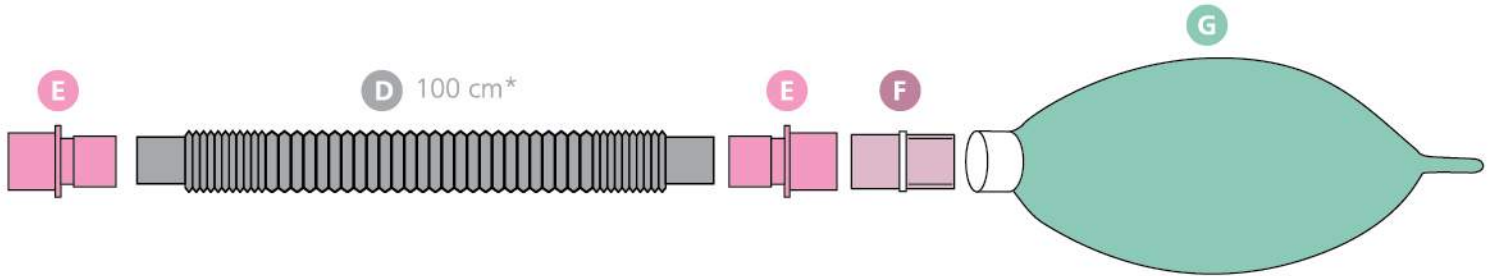
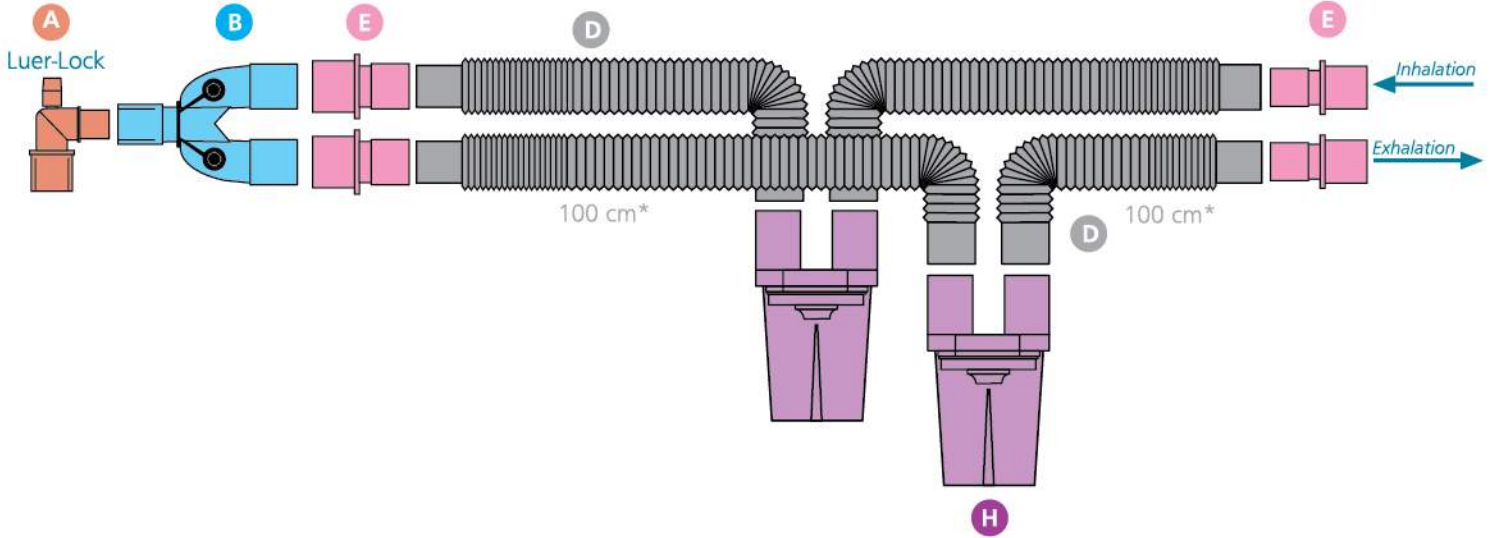

	KOD / CODE	A	B	C	D	E	F	G	H
YETİŞKİN ADULT (Ø 22mm)	487 301	1	1	-	4	4	-	-	2
	487 401	1	1	-	5	6	1	-	2
	487 501	1	1	-	5	6	1	1	2
PEDIATRİK PEDIATRIC (Ø 15mm)	488 301	1	1	-	4	4	-	-	2
	488 401	1	1	-	5	6	1	-	2
	488 501	1	1	-	5	6	1	1	2

- A: Dirsek - Luerlock-Elbow/Luerlock (22M/15F-15M)
 B: Y Konnektör - Wye Connector (22M/15F-22M)
 D: Ara Hortum - Limb (Ø 22mm, Ø 15mm)
 E: Düz Konnektör - Straight Connector (22F-22M)
 F: Düz Konnektör - Straight Connector (22M-22M/15F)
 G: Anestezi Balonu - Breathing Bag (22F) (0.5L, 1L, 2L, 3L)
 H: Su Tuzağı - Water Trap (22M)

*Özel uzunluklar isteğe göre üretilmektedir. Tablodaki rakamlar devre içeriklerini göstermektedir.
 *Special lengths can be manufactured upon request. The figures in the table show the contents of the circuit.

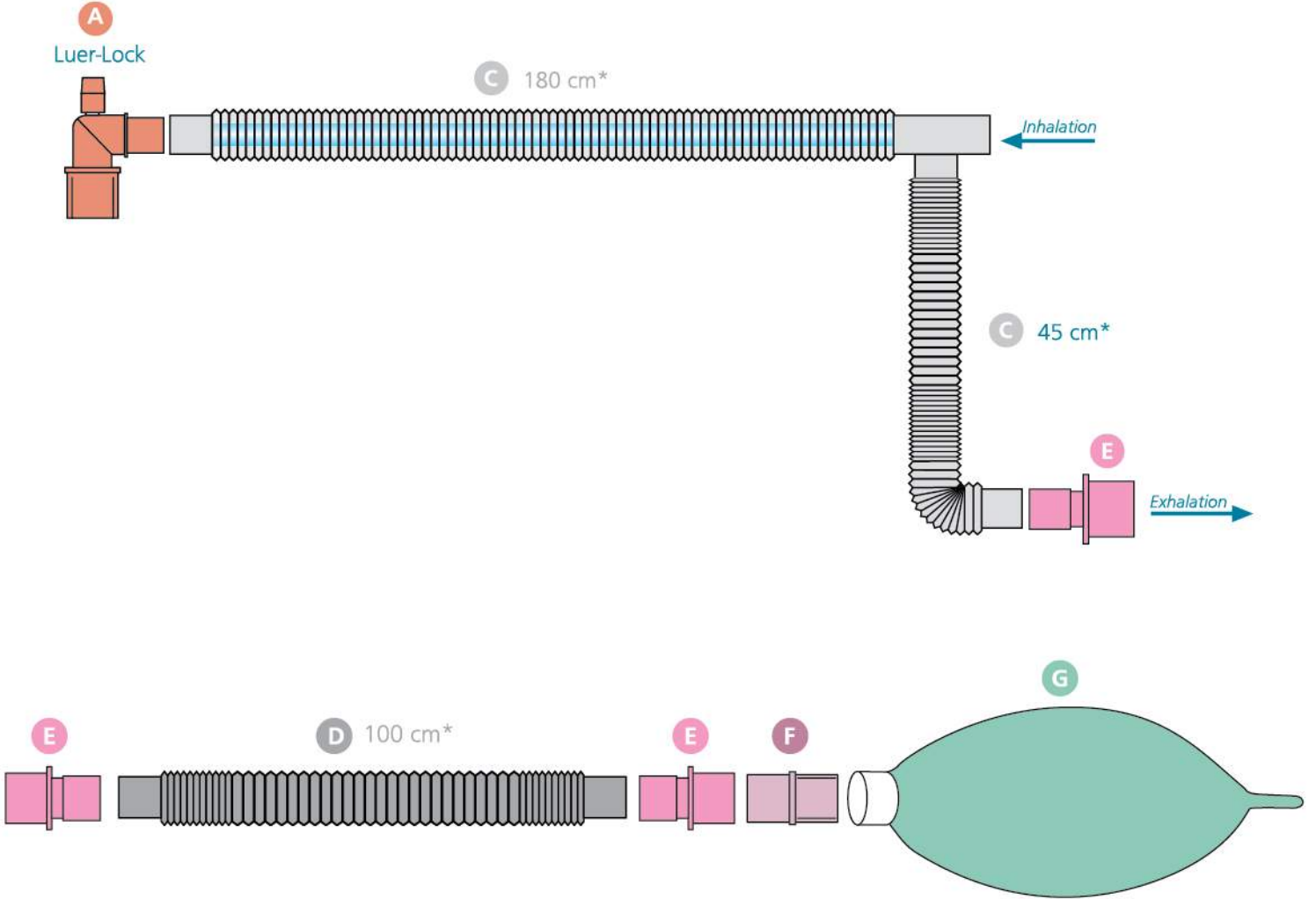

	KOD / CODE	A	C	D	E	F	G
YETİŞKİN ADULT (Ø 22 mm)	489 301	1	1	-	1	-	-
	489 302	1	1	1	3	1	-
	489 303	1	1	1	3	1	1
PEDIATRİK PEDIATRIC (Ø 15 mm)	489 311	1	1	-	1	-	-
	489 312	1	1	1	3	1	-
	489 313	1	1	1	3	1	1

- A: Dirsek - Luerlock-Elbow/Luerlock (22M/15F-15M)
 B: Y Konnektör - Wye Connector (22M/15F-22M)
 C: Hortum - Tubing (Ø 22mm, Ø 15mm)
 D: Ara Hortum - Limb (Ø 22mm, Ø 15mm)
 E: Düz Konnektör - Straight Connector (22F-22M)
 F: Düz Konnektör - Straight Connector (22M-22M/15F)
 G: Anestezi Balonu - Breathing Bag (22F) (0.5L, 1L, 2L, 3L)

*Özel uzunluklar isteğe göre üretilmektedir. Tablodaki rakamlar devre içeriklerini göstermektedir.

*Special lengths can be manufactured upon request. The figures in the table show the contents of the circuit.

IPPB DEVRELERİ / IPPB (INTERMITTENT POSITIVE PRESSURE BREATHING) CIRCUITS

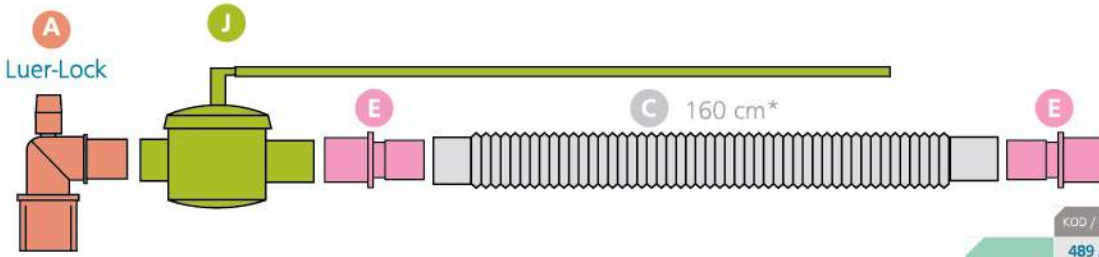

KOD / CODE		A	C	E	J
YETİSKİN ADULT (Ø 22mm)	489 231 (Koruge)	1	1	2	1
	489 251 (Smoothbore)	1	1	2	1
	489 271 (Ayarlanabilir)	1	1	2	1
PEDIATRİK PEDIATRİK (Ø 15mm)	489 235 (Koruge)	1	1	2	1
	489 255 (Smoothbore)	1	1	2	1
	489 275 (Ayarlanabilir)	1	1	2	1

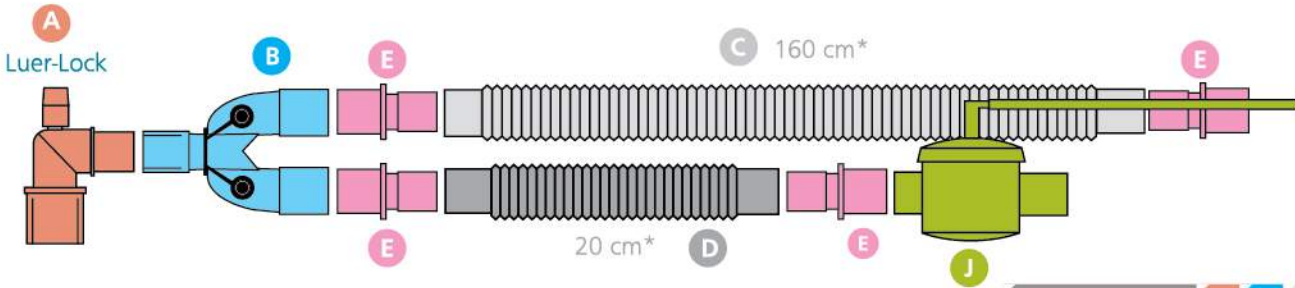

- A: Dirsek - Luerlock-Elbow/Luerlock (22M/15F-15M)
 B: Y Konnektör - Wye Connector (22M/15F-22M)
 C: Hortum - Tubing (Ø 22mm, Ø 15mm)
 D: Hortum - Tubing (Ø 22mm, Ø 15mm)
 E: Düz Konnektör - Straight Connector (22F-22M)
 I: Ekshalasyon Valfi 2 - Exhalation Valve 2 (22M-22M/15F)
 J: Ekshalasyon Valfi 1 - Exhalation Valve 1 (22M-22M/15F)

KOD / CODE		A	B	C	D	E	J
YETİSKİN ADULT (Ø 22mm)	489 286 (Koruge)	1	1	1	1	4	1
	489 287 (Smoothbore)	1	1	1	1	4	1
	489 288 (Ayarlanabilir)	1	1	1	1	4	1
PEDIATRİK PEDIATRİK (Ø 15mm)	489 289 (Koruge)	1	1	1	1	4	1
	489 290 (Smoothbore)	1	1	1	1	4	1
	489 291 (Ayarlanabilir)	1	1	1	1	4	1



*Özel uzunluklar isteğe göre üretilmektedir. Tablodaki rakamlar devre içeriklerini göstermektedir.

*Special lengths can be manufactured upon request. The figures in the table show the contents of the circuit.

TAŞINABİLİR VENTİLATÖR DEVRELERİ / TRANSPORT VENTILATION CIRCUITS

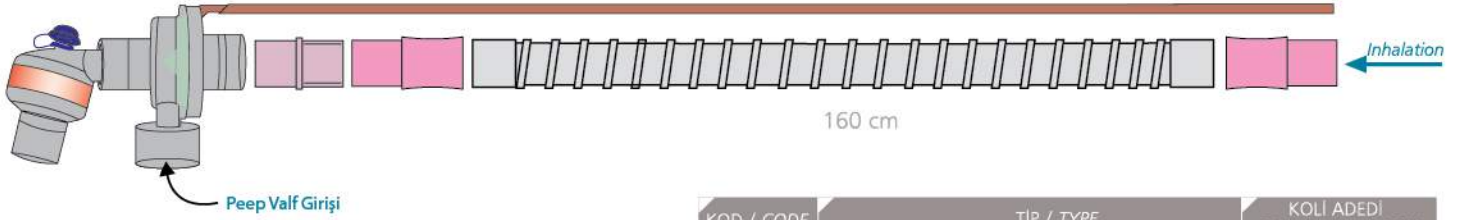

KOD / CODE	TIP / TYPE	KOLİ ADEDİ QUANTITY PER BOX
489 292	Transport Ventilatör Devresi Transport Ventilation Circuit	10

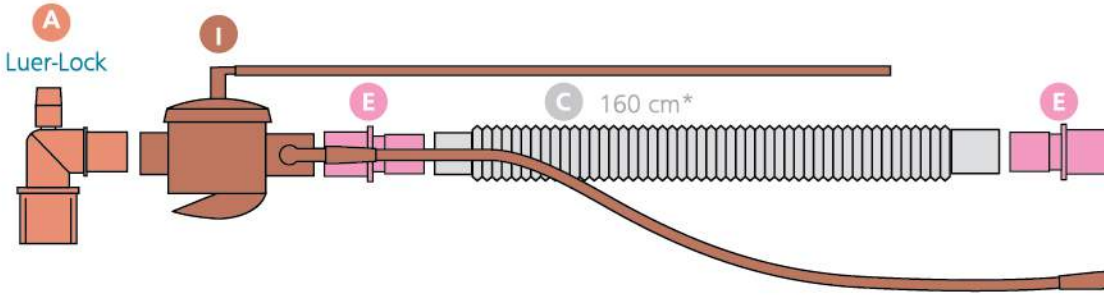

	KOD / CODE	A	C	E	I
YETİSKİN ADULT (Ø 22mm)	489 241 (Koruge)	1	1	2	1
	489 261 (Smoothbore)	1	1	2	1
	489 281 (Ayarlanabilir)	1	1	2	1
PEDIATRİK PEDIATRIC (Ø 15mm)	489 245 (Koruge)	1	1	2	1
	489 265 (Smoothbore)	1	1	2	1
	489 285 (Ayarlanabilir)	1	1	2	1



* Ambulanslarda bulunan taşınabilir ventilatör cihazları ile uyumlu çalışmaktadır.
Suitable for portable ventilation machines in Ambulances.





KATETER MOUNT / CATHETER MOUNT · AIRWAY / AIRWAY

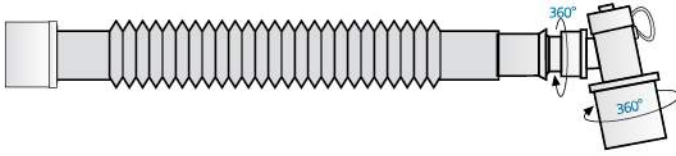

- 15 cm hortum
- Çift döner konnektör
- 360° dönme özelliği
- 22M/15F hasta konnektörü
- 22F ventilatör konnektörü

- 15 cm tubing
- Double swivel connector
- 360° rotatable
- 22M/15F patient connector
- 22F ventilator connector

KOD / CODE	HORTUM - TUBING	KOLI ADEDİ QUANTITY PER BOX
489 501	KORUGE - CORRUGATED	150
489 521	SMOOTHBORE - SMOOTHBORE	150
489 541	AYARLANABİLİR - EXTENDABLE	150

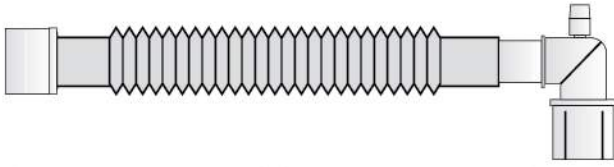

- 15 cm hortum
- 22M/15F hasta konnektörü
- 22F ventilatör konnektörü

- 15 cm tubing
- 22M/15F patient connector
- 22F ventilator connector

KOD / CODE	HORTUM - TUBING	KOLI ADEDİ QUANTITY PER BOX
489 561	KORUGE - CORRUGATED	150
489 571	SMOOTHBORE - SMOOTHBORE	150
489 581	AYARLANABİLİR - EXTENDABLE	150

SMOOTHBORE 15 cm

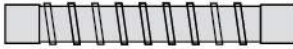

CORRUGATED 15 cm



EXTENDABLE 15 cm

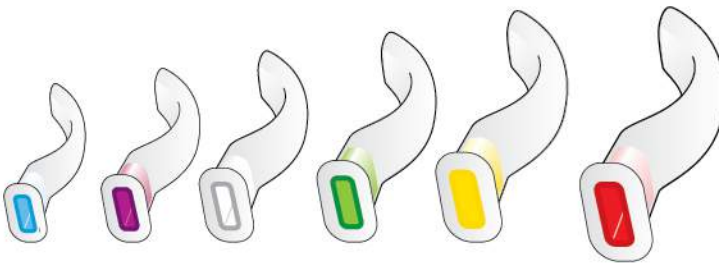

- Anatomik dizayn
- Atravmatik yuvarlatılmış kenarlar
- Renk kodlu ısırma bloğu
- Steril

- Anatomically designed
- Atraumatic soft rounded edges
- Color coded bite block
- Sterile

AIRWAY / AIRWAY

KOD / CODE	NUMARA NUMBER	KOLI ADEDİ QUANTITY PER BOX
200 103	0/50	750
200 104	1/60	600
200 105	2/70	600
200 106	3/80	500
200 107	4/90	400
200 108	5/100	300



FİLTRELER / FILTERS

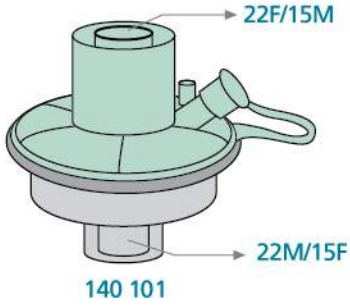

140 101

- BFE (Bakteriyel Filtre Etkinliği) %99.99998
- VFE (Viral Filtre Etkinliği) %99.9998
- Gaz Örnek Alma Portu
- Düşük Ölü Boşluk
- Düşük Akış Direnci
- Steril

- BFE (Bacterial Filtration Efficiency) %99.99998
- VFE (Viral Filtration Efficiency) %99.9998
- Gas Sampling Port
- Low Dead Space
- Low Flow Resistance
- Sterile

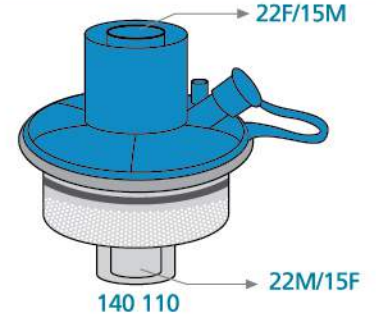

140 110

- BFE (Bakteriyel Filtre Etkinliği) %99.99998
- VFE (Viral Filtre Etkinliği) %99.9998
- 500 ml Tidal Hacim ile Nem Çıkış Değeri 33.2 mg/lt
- Gaz Örnek Alma Portu
- Düşük Ölü Boşluk
- Düşük Akış Direnci
- Steril

- BFE (Bacterial Filtration Efficiency) %99.99998
- VFE (Viral Filtration Efficiency) %99.9998
- Moisture Output at 500 ml Tidal Volume 33.2mg/lt
- Gas Sampling Port
- Low Dead Space
- Low Flow Resistance
- Sterile

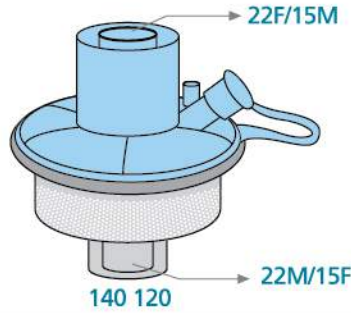

140 120

- 500 ml Tidal Hacim ile Nem Çıkış Değeri 33.2 mg/lt
- Gaz Örnek Alma Portu
- Düşük Ölü Boşluk
- Düşük Akış Direnci
- Steril

- Moisture Output at 500 ml Tidal Volume 33.2mg/lt
- Gas Sampling Port
- Low Dead Space
- Low Flow Resistance
- Sterile

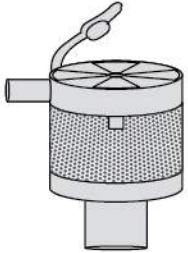

142 210

- 500 ml Tidal Hacim ile Nem Çıkış Değeri 24 hr: 28.8 mg/1 lt H₂O
- Aspirasyon Portu
- Oksijen Portu
- Düşük Ölü Boşluk
- Düşük Akış Direnci
- Steril

- Moisture Output at 500 ml Tidal Volume 24 hr: 28.8 mg/1 lt H₂O
- Suction Port
- Oxygen Port
- Low Dead Space
- Low Flow Resistance
- Sterile

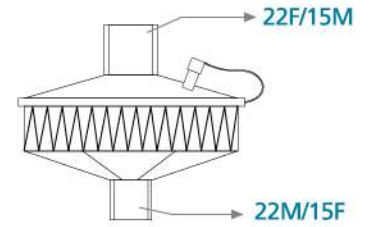

140 130

- BFE (Bakteriyel Filtre Etkinliği) %99.9999
- VFE (Viral Filtre Etkinliği) %99.9999
- Gaz Örnek Alma Portu
- Düşük Ölü Boşluk
- Düşük Akış Direnci
- Steril

- BFE (Bacterial Filtration Efficiency) %99.9999
- VFE (Viral Filtration Efficiency) %99.9999
- Gas Sampling Port
- Low Dead Space
- Low Flow Resistance
- Sterile

KOD / CODE	TIP / TYPE	KOLI ADEDİ QUANTITY PER BOX
140 101	Bakteri Filtresi Bacterial Filter	100
140 110	HMEF (Bakteri ve Nem) Filtre HMEF (Bacterial and Moisture) Filter	100
140 120	HME (Nem) Filtre HME (Moisture) Filter	100
140 130	Hepa Filtre Hepa Filter	100
142 210	Trakeostomi HME Filtre Tracheostomy HME Filter	400

SOLUNUM SİSTEMLERİ BREATHING SYSTEMS

S.F.T. FİLTRELERİ / S.F.T. FILTERS • SOLUNUM EGZERSİZ CİHAZI / RESPIRATORY EXERCISER

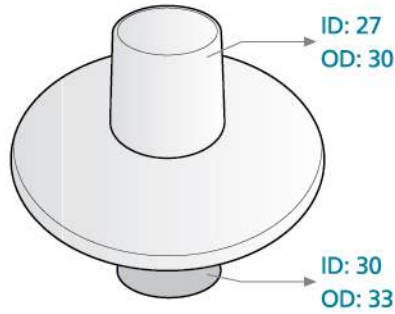
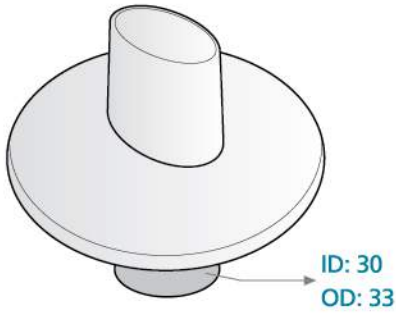

KOD / CODE	TIP / TYPE	KOLI ADEDİ QUANTITY PER BOX
141 102	ELİPS / ELLIPTIC	70
141 103	DAİRESEL / CIRCULAR	70

KOD / CODE	OD (mm)	UZUNLUK(mm) LENGTH
141 228	28	65
141 230	30	65
141 233	33	65

KOD / CODE	TIP / TYPE
141 110	Burun Mandalı / Nose Clip

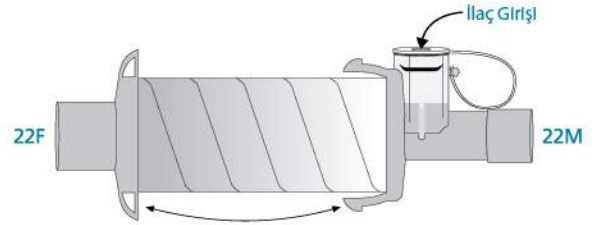
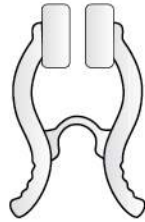

KOD / CODE	TIP / TYPE
489 641	Inhalasyon Tedavi Çemberi (Aerovent)

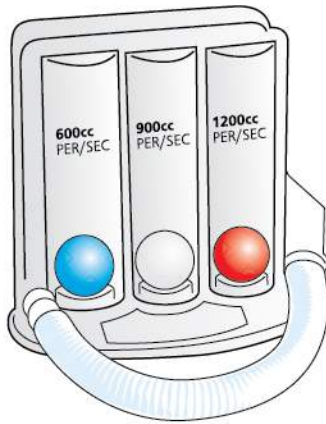

- 600-900-1200ml
- Anatomik dizayn
- Üç toplu
- 600-900-1200ml
- Anatomically designed
- Three balls

KOD / CODE	TIP / TYPE	KOLI ADEDİ QUANTITY PER BOX
180 101	Solunum egzersiz cihazı Respiratory exerciser	28

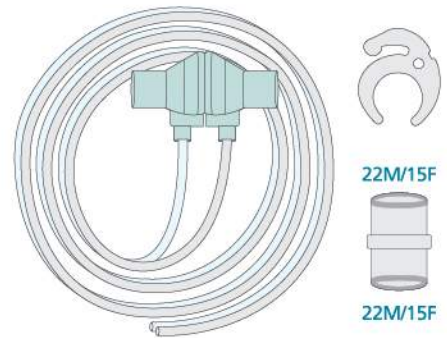

KOD / CODE	TIP / TYPE
100 22 36	Akış Sensörü Flow Sensor



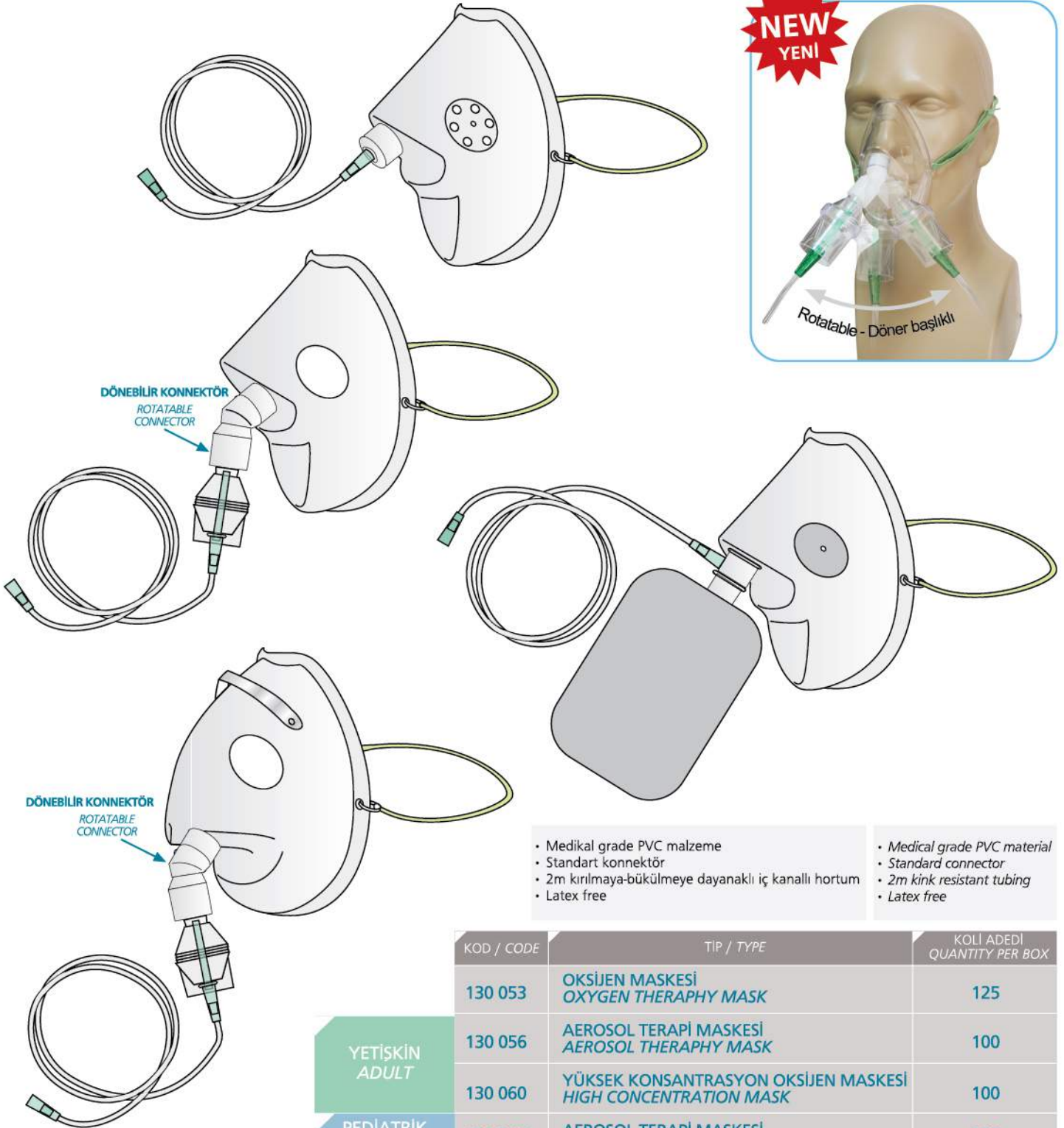

- Medikal grade PVC malzeme
- Standart konnektör
- 2m kırılmaya-bükülmeye dayanıklı iç kanallı hortum
- Latex free

- Medical grade PVC material
- Standard connector
- 2m kink resistant tubing
- Latex free

KOD / CODE	TIP / TYPE	KOLİ ADEDİ QUANTITY PER BOX
130 053	OKSİJEN MASKESİ OXYGEN THERAPY MASK	125
130 056	AEROSOL TERAPİ MASKESİ AEROSOL THERAPY MASK	100
130 060	YÜKSEK KONSANTRASYON OKSİJEN MASKESİ HIGH CONCENTRATION MASK	100
130 057	AEROSOL TERAPİ MASKESİ AEROSOL THERAPY MASK	125

YETİŞKİN
ADULT

PEDİATRİK
PEDIATRIC

OKSİJEN VE AEROSOL MASKELER / OXYGEN and AEROSOL MASKS

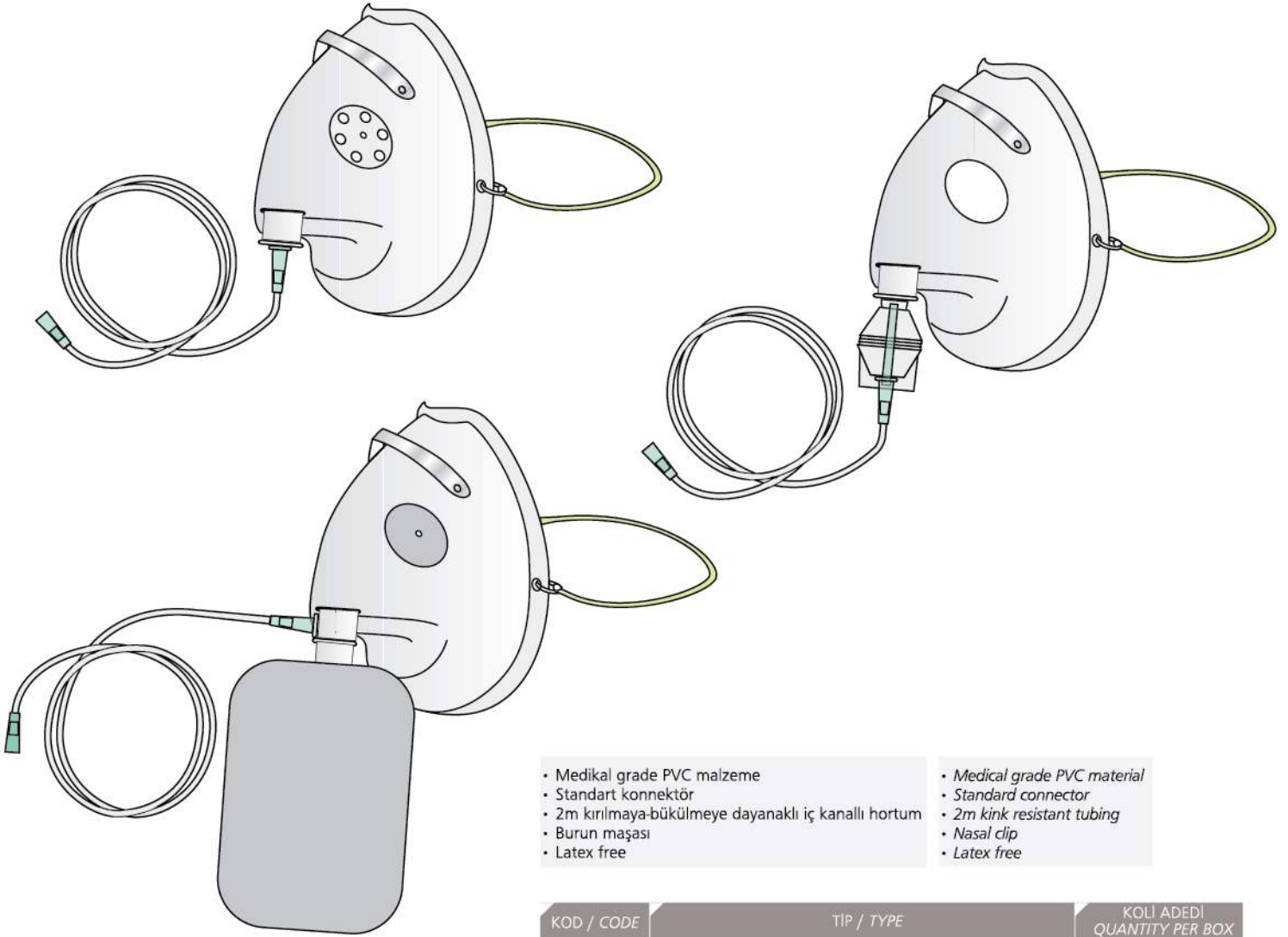

- Medikal grade PVC malzeme
- Standart konnektör
- 2m kırılmaya-bükülmeye dayanaklı iç kanallı hortum
- Burun maşası
- Latex free

- Medical grade PVC material
- Standard connector
- 2m kink resistant tubing
- Nasal clip
- Latex free

	KOD / CODE	TIP / TYPE	KOLI ADEDİ QUANTITY PER BOX
	130 103	OKSİJEN MASKESİ OXYGEN THERAPY MASK	125
YETİŞKİN ADULT	130 106	AEROSOL TERAPİ MASKESİ AEROSOL THERAPY MASK	100
	130 110	YÜKSEK KONSANTRASYON OKSİJEN MASKESİ HIGH CONCENTRATION MASK	100
	130 104	OKSİJEN MASKESİ OXYGEN THERAPY MASK	150
PEDİATRİK PEDIATRIC	130 107	AEROSOL TERAPİ MASKESİ AEROSOL THERAPY MASK	125
	130 111	YÜKSEK KONSANTRASYON OKSİJEN MASKESİ HIGH CONCENTRATION MASK	125



ŞİŞİRİLEBİLİR VE SİLİKON MASKELER / INFLATABLE AND SILICONE MASKS

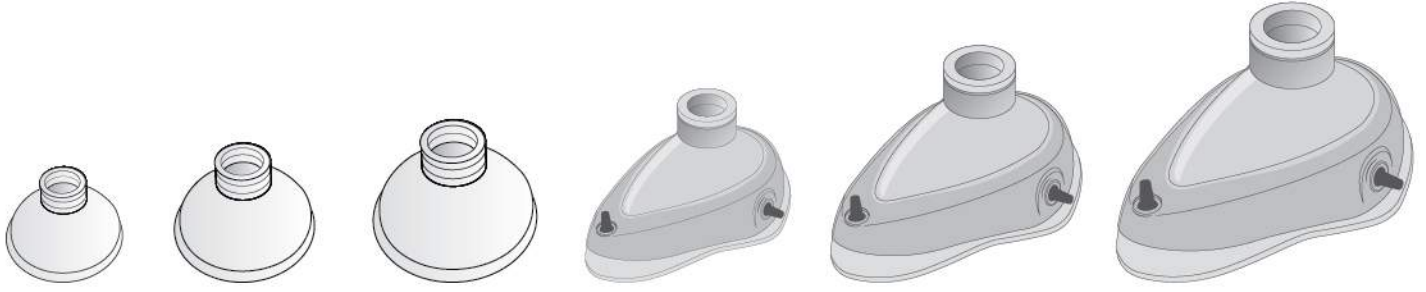

- Silikon malzeme
- 134 °C'ye kadar otoklavlanabilir
- 25 kez steril edilebilir

- *Silicone material*
- *Autoclavable until 134°C*
- *It can be sterilized for 25 times*

KOD / CODE	NO	Tip / Type	KOLI ADEDİ QUANTITY PER BOX
130 220	0	Neonatal	50
130 221	1	Infant	50
130 222	2	Pediatric	50
130 223	3	Child	50
130 224	4	Adult Small	40
130 225	5	Adult	35

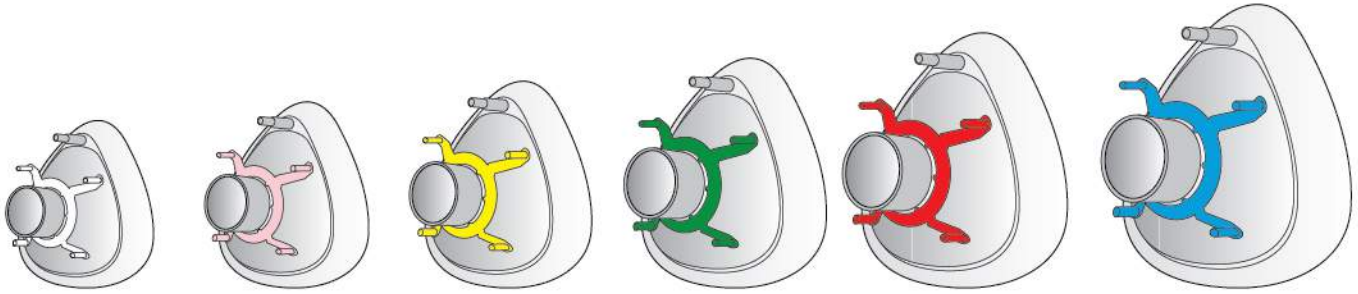

- Şişirilebilir yastıklı
- Renk kodlu

- *Inflatable cushion*
- *Color coded*

KOD / CODE	NO	Tip / Type	KOLI ADEDİ QUANTITY PER BOX
130 210	0	Neonatal	30
130 211	1	Infant	30
130 212	2	Pediatric	30
130 213	3	Child	30
130 214	4	Adult Small	30
130 215	5	Adult	25

KOD / CODE	TIP / TYPE	KOLI ADEDİ QUANTITY PER BOX
130 219	Silikon baş bandı Headstrap	1000



SOLUNUM SİSTEMLERİ
BREATHING SYSTEMS

NEBULİZER SET 'T' PARÇALI / NEBULIZER SET 'T' PART

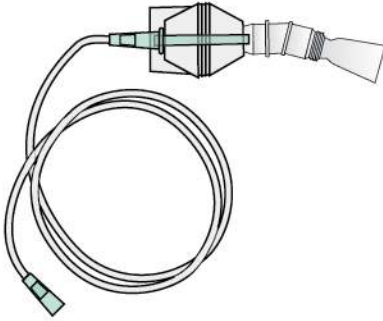

- Medikal grade PVC malzeme
- Standart konnektör
- 2m kırılmaya-bükülmeye dayanıklı iç kanallı hortum
- Nebulizer kap
- Latex free

- Medical grade PVC material
- Standard connector
- 2m kink resistant tubing
- Nebuliser cup
- Latex free

KOD / CODE	TIP / TYPE	KOLI ADEDİ QUANTITY PER BOX
130 108	Nebulizer set ağızlıklı yarım dirsekli <i>Nebuliser set with moutpiece half elbow</i>	150

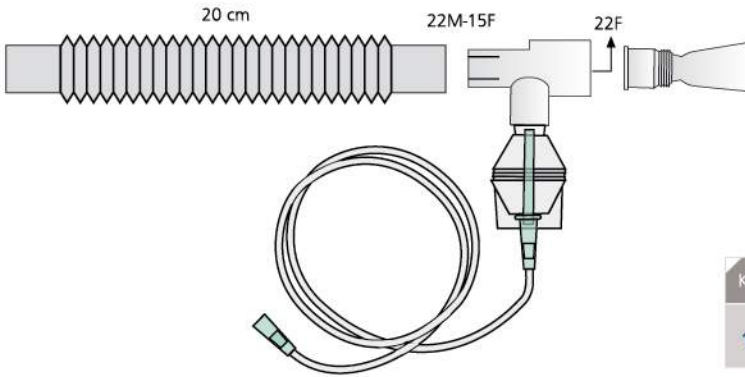

- Medikal grade PVC malzeme
- "T" konnektör
- 2m kırılmaya-bükülmeye dayanıklı iç kanallı hortum
- Nebulizer kap
- Latex free

- Medical grade PVC material
- "T" connector
- 2m kink resistant tubing
- Nebuliser cup
- Latex free

KOD / CODE	TIP / TYPE	KOLI ADEDİ QUANTITY PER BOX
130 109	T parçalı nebulizer set <i>Nebuliser set with T part</i>	150

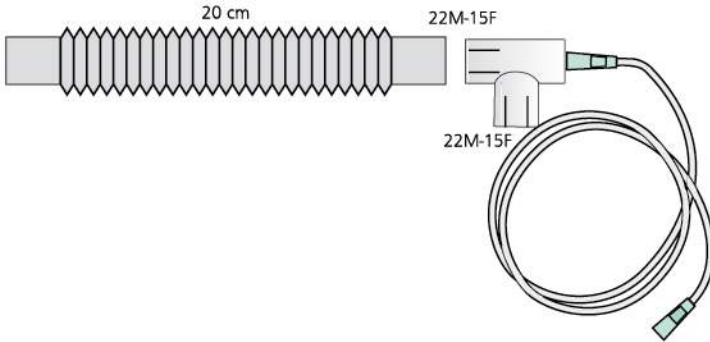

- Medikal grade PVC malzeme
- "T" konnektör
- 2m kırılmaya-bükülmeye dayanıklı iç kanallı hortum
- Latex free

- Medical grade PVC material
- "T" connector
- 2m kink resistant tubing
- Latex free

KOD / CODE	TIP / TYPE	KOLI ADEDİ QUANTITY PER BOX
489 601	Solunum devresi "T" tüpü <i>Breathing circuit "T" tube</i>	150

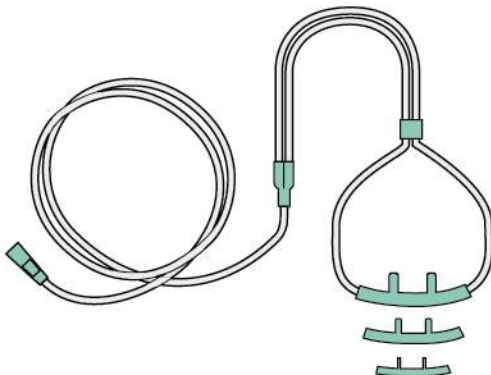

- Medikal grade PVC malzeme
- Pediatrik yumuşak tip burnu tahriş etmeyen kanül
- Kırılmaya-bükülmeye dayanıklı iç kanallı hortum

- Medical grade PVC material
- Neonatal soft tip curved nasal cannula
- Kink resistant of tubing

KOD / CODE	TIP / TYPE	KOLI ADEDİ QUANTITY PER BOX
130 101	Nazal kanül yetişkin <i>Nazal cannula adult</i>	300
130 102	Nazal kanül pediatrik <i>Nazal cannula pediatric</i>	300
130 113	Nazal kanül neonatal <i>Nazal cannula neonatal</i>	200



SOLUNUM SİSTEMLERİ BREATHING SYSTEMS

ACİL BAKIM / EMERGENCY CARE



Ambu torbası 1500 ml
Resuscitator bag



Ambu torbası 550 ml
Resuscitator bag

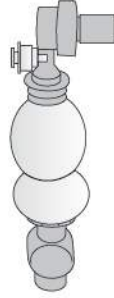

Ambu torbası 280 ml
Resuscitator bag



* PVC rezervuar
PVC reservoir

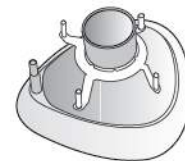

*Şişirilebilir yastıklı maske
Inflatable air cushion mask

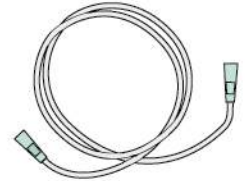

2m oksijen hortumu
2m oxygen tubing

TEK KULLANIMLIK / DISPOSABLE

- Ambu torbası
- PVC rezervuar
- 2m oksijen hortumu
- Şişirilebilir yastıklı maske
- Resuscitator bag
- PVC reservoir
- 2m oxygen tubing
- Inflatable air cushion mask

* Şişirilebilir yastıklı maske : Yetişkin no:5, Pediatrik no:3, Neonatal no:1 / Inflatable air cushion mask : Adult no:5, Pediatric no:3, Neonatal no:1
* Pvc rezervuar : Yetişkin 2000 cc, Pediatrik 2000 cc, Neonatal 1600 cc / Pvc reservoir : Adult 2000 cc, Pediatric 2000 cc, Neonatal 1600 cc

	KOD / CODE	TIP / TYPE	KOLI ADEDİ QUANTITY PER BOX
YETİŞKİN ADULT	130 255	1700 ml ambu seti 1700 ml ambu set	20
PEDİATRİK PEDIATRIC	130 254	500 ml ambu seti 500 ml ambu set	20
NEONATAL NEONATAL	130 253	340 ml ambu seti 340 ml ambu set	20



Ambu torbası 1500 ml
Resuscitator bag



Ambu torbası 550 ml
Resuscitator bag

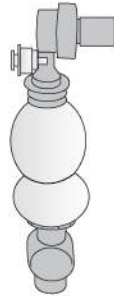

Ambu torbası 280 ml
Resuscitator bag



* PVC rezervuar
PVC reservoir



* Silikon maske
Silicone mask



2m oksijen hortumu
2m oxygen tubing

ÇOK KULLANIMLIK / REUSABLE

- Ambu torbası
- PVC rezervuar
- 2m oksijen hortumu
- Silikon maske
- 134 °C'ye kadar otoklavlanabilir
- 25 kez steril edilebilir
- Resuscitator bag
- PVC reservoir
- 2m oxygen tubing
- Silicone mask
- Autoclavable until 134°C
- It can be sterilized for 25 times

* Silikon maske : Yetişkin no:5, Pediatrik no:3, Neonatal no:1 / Silicone mask : Adult no:5, Pediatric no:3, Neonatal no:1
* Pvc rezervuar : Yetişkin 2000 cc, Pediatrik 2000 cc, Neonatal 1600 cc / Pvc reservoir : Adult 2000 cc, Pediatric 2000 cc, Neonatal 1600 cc

	KOD / CODE	TIP / TYPE	KOLI ADEDİ QUANTITY PER BOX
YETİŞKİN ADULT	130 252	1700 ml ambu seti 1700 ml ambu set	10
PEDİATRİK PEDIATRIC	130 251	500 ml ambu seti 500 ml ambu set	10
NEONATAL NEONATAL	130 250	340 ml ambu seti 340 ml ambu set	10



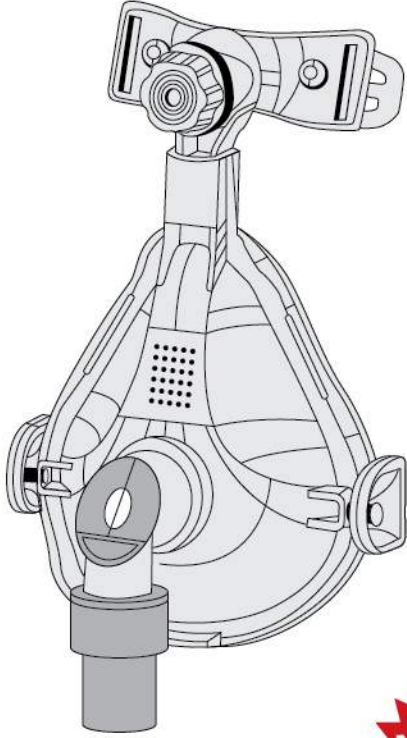

KOD / CODE	TIP / TYPE	KOLI ADEDİ QUANTITY PER BOX
57814 L	CPAP/ BIPAP Ora-Nazal Maske Büyük CPAP/BIPAP Ora-Nasal Mask Large	25
57814 M	CPAP/ BIPAP Ora-Nazal Maske Orta CPAP/BIPAP Ora-Nasal Mask Medium	25
57814 S	CPAP/ BIPAP Ora-Nazal Maske Küçük CPAP/BIPAP Ora-Nasal Mask Small	25



- %100 anti-alerjenik kokusuz medikal silikon
- Kırılmaz esnek polikarbon gövde
- 360° dönebilen hortum konektörü
- Kaçağı önleyen çift katlı silikon tasarımı
- Silikon yastıklı, ayarlanabilir alın desteği
- Dört noktadan kafa bandı bağlantısı
- Elastik ve ayarlanabilir kafa bandı
- Oksijen girişi
- Klips sistemi ile kolay montaj

- 100% anti-allergenic odorless medical silicone
- Unbreakable flexible polycarbonate body
- 360° rotatable tube connector
- Prevent leakage double-layer silicone design
- Silicone cushion adjustable forehead support
- Four-point headband connection
- Elastic and adjustable headband
- Oxygen input
- Easy assembly by clip system

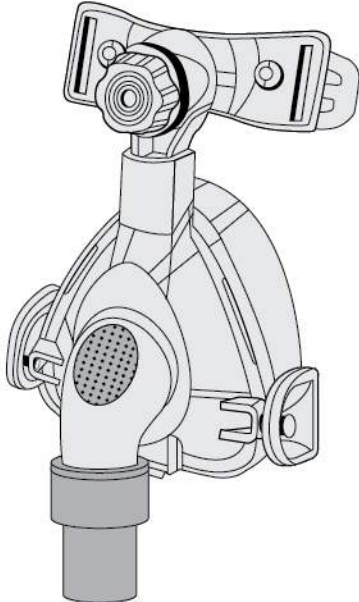

KOD / CODE	TIP / TYPE	KOLI ADEDİ QUANTITY PER BOX
57815 L	CPAP/ BIPAP Nazal Maske Büyük CPAP/BIPAP Nasal Mask Large	25
57815 M	CPAP/ BIPAP Nazal Maske Orta CPAP/BIPAP Nasal Mask Medium	25
57815 S	CPAP/ BIPAP Nazal Maske Küçük CPAP/BIPAP Nasal Mask Small	25





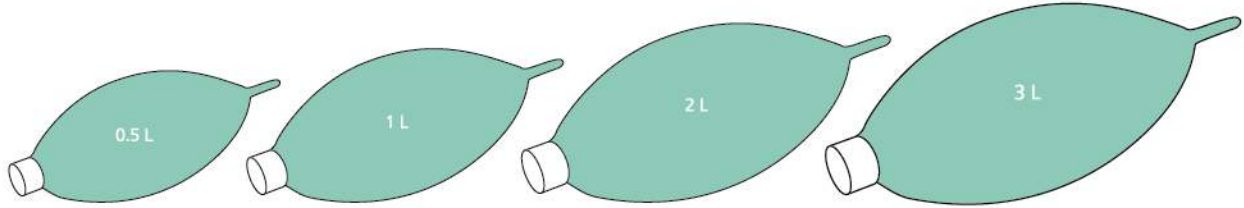

TEK KULLANIMLIK / DISPOSABLE

KOD / CODE	TİP / TYPE	KOD / CODE	TİP / TYPE
SSDE 070	Anestezi balonu 0,5 L Anesthesia balloon	SSDE 072	Anestezi balonu 2 L Anesthesia balloon
SSDE 071	Anestezi balonu 1 L Anesthesia balloon	SSDE 073	Anestezi balonu 3 L Anesthesia balloon

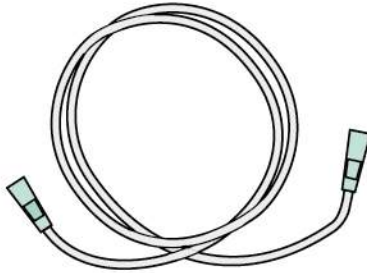

KOD / CODE	TİP / TYPE
130 112	Oksijen hortumu Oxygen tubing

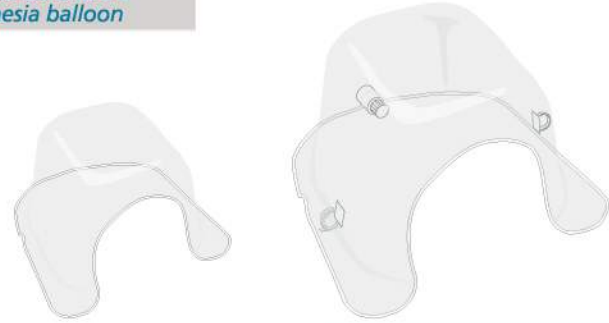

KOD / CODE	TİP / TYPE
470 101	Hood başlığı büyük Hood cap large
470 111	Hood başlığı küçük Hood cap small

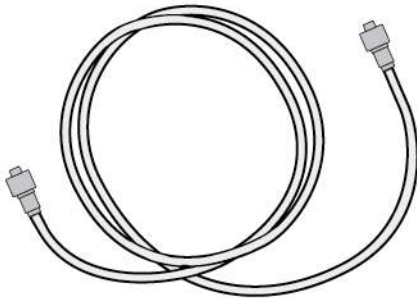

KOD / CODE	TİP / TYPE
320 XXX	*Uzatma hortumu Extension line

* M/M, M/F, F/M, F/F olarak üretilmektedir.
* Manufactured as M/M, M/F, F/M, F/F



KOD / CODE	TİP / TYPE
142 200	Mukus Toplama Kabı 25 ml Filtreli Mucus Extractor 25 ml with Filter
142 202	Mukus Toplama Kabı 25 ml Filtresiz Mucus Extractor 25 ml without Filter

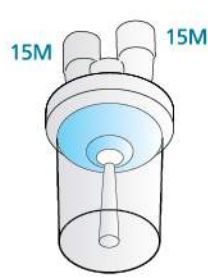

KOD / CODE	TIP / TYPE
480 501 50	Su tutucu 22M Water trap
480 501 51	Su tutucu 19M Water trap
480 501 52	Su tutucu 15M Water trap

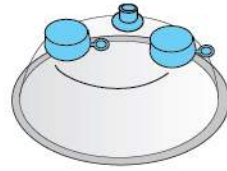
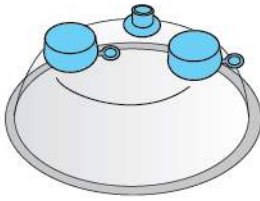

KOD / CODE	TIP / TYPE
SSDE 091	Yetişkin Chamber
SSDE 092	Pediyatrik Chamber

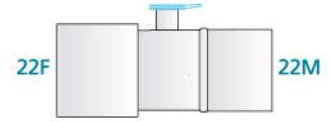
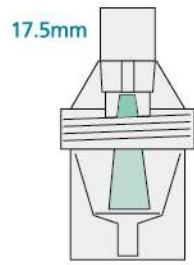
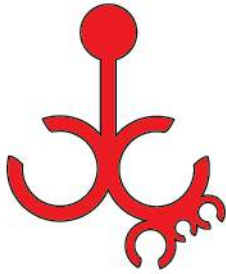

KOD / CODE	TIP / TYPE
480 501 80	Askı Clip

KOD / CODE	TIP / TYPE
130 106 05	Nebulizer kap Nebuliser cap
130 106 09	Nebulizer Yeni Nebuliser new

KOD / CODE	TIP / TYPE
SSDE 111	MDI konnektör MDI connector

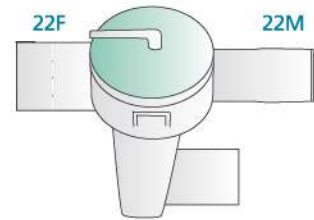
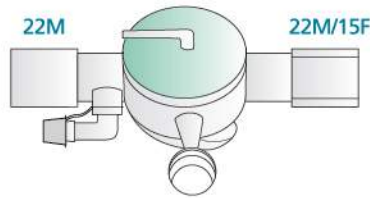
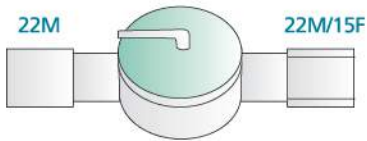

KOD / CODE	TIP / TYPE
SSDE 082	Ekshalasyon valfi tip 1 Exhalation valve type 1

KOD / CODE	TIP / TYPE
SSDE 080	Ekshalasyon valfi tip 2 Exhalation valve type 2

KOD / CODE	TIP / TYPE
SSDE 081	Ekshalasyon valfi tip 3 Exhalation valve type 3



KONNEKTÖRLER / CONNECTORS

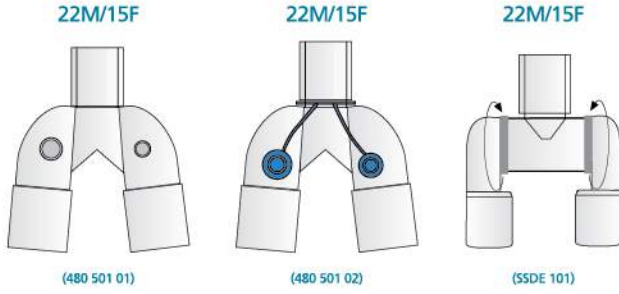

KOD / CODE	TİP / TYPE
480 501 01	Y Konnektör (portsuz) Y Connector (without port)
480 501 02	Y Konnektör (portlu) Y Connector (with port)
SSDE 101	Y Konnektör (ayarlanabilir) Y Connector (swivel)

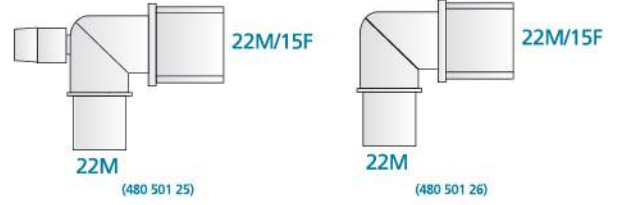

KOD / CODE	TİP / TYPE
480 501 25	Dirsek konnektör (portlu) Elbow connector (with port)
480 501 26	Dirsek konnektör (portsuz) Elbow connector (without port)

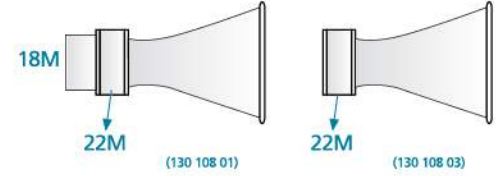
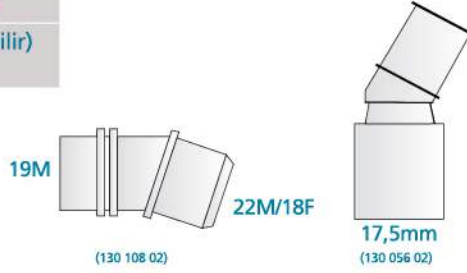
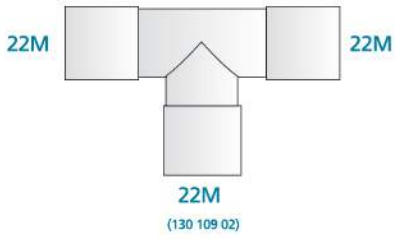

KOD / CODE	TİP / TYPE
130 108 02	Maske dirseği Mask elbow
130 056 02	Döner başlıklı dirsek Rotatable elbow

KOD / CODE	TİP / TYPE
130 108 01	Ağızlık Mouth piece
130 108 03	Ağızlık (T konnektör için) Mouth piece (For T connector)

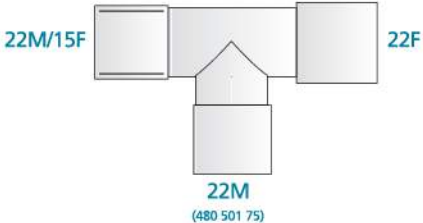
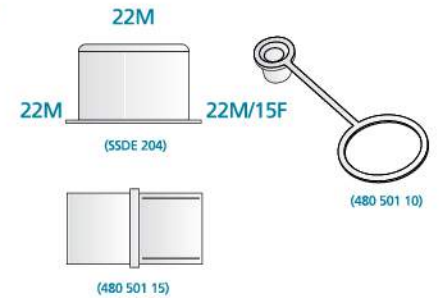
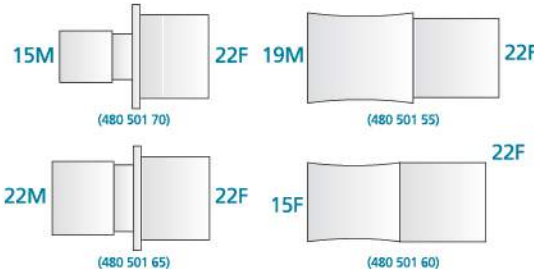
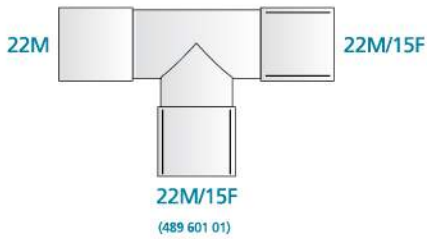

KOD / CODE	TİP / TYPE
480 501 70	Pediyatrik koruge konnektör Pediatric corrugated connector
480 501 65	Yetişkin koruge konnektör Adult corrugated connector
480 501 60	Pediyatrik Smoothbore konnektör Pediatric Smoothbore connector
480 501 55	Yetişkin Smoothbore konnektör Adult Smoothbore connector

KOD / CODE	TİP / TYPE
SSDE 204	Mavi koruma kapağı Blue protection cap
480 501 15	Balon konnektörü Balloon connector
480 501 10	Y konnektör port kapağı Y connector port cap

KOD / CODE	TİP / TYPE
130 109 02	T Konnektör tip 1 T Connector type 1
489 601 01	T Konnektör tip 2 T Connector type 2
480 501 75	T Konnektör tip 3 T Connector type 3

RESPIRATORY PRODUCTS

Plasti-med
"supporting healthy life"

Plasti-med

Plastik Medikal Ürünler San. ve Tic. Ltd. Şti.

Deri OSB Mahallesi
Yan Sanayi Caddesi No:13
Tuzla/İSTANBUL - TÜRKİYE

Tel : +90 (216) 591 04 91

Fax : +90 (216) 591 04 90

info@plasti-med.com

www.plasti-med.com



SOLUNUM
ÜRÜNLERİ



CERTIFICATE



EC Certificate

Production Quality Assurance System according to Medical Devices Directive 93/42/EEC Annex-V

Certificate Number: 1984-MDD-11-104

We hereby declare that an examination has been carried out following the requirements of the national legislation to which the undersigned is subject, transposing Annex-V of the Directive 93/42/EEC on medical devices. We certify that the production quality system conforms with the relevant provisions of the aforementioned legislation.

Organization:

PLASTİ-MED PLASTİK MEDİKAL ÜRÜNLER SANAYİ VE TİCARET LİMİTED ŞİRKETİ

Deri OSB Mahallesi Yan Sanayi Cad. No:13 Tuzla/İstanbul/Turkey

Products: Pediatric Urine Bag, Vaginal Speculum, Camera Cover, Endotracheal Stylet, Spirometer Filter Accessories, Vomit Bag, Respiratory Exercise Device

The products defined at the enclosure which is the part of this certificate and contains one page. The certificate is valid till expiration date, subject to successful completion of periodical surveillance audits. Please contact Kiwa for details.

Report Number: M.3567.08
Date of first issue: 26 July 2011
Date of last issue: 26 July 2019
Revision Number: 05
Expiry Date: 27 May 2024

Kiwa Belgelendirme Hizmetleri A.Ş. has audited the quality system restricted to the aspects of manufacture concerned with the conformity of the devices with metrological requirements for Class Im devices and with securing and maintaining sterile conditions in accordance with MDD Annex V for Class Is devices covered by this certificate and found that the quality system meets the applicable requirements in MDD Annex V.

Muhtesem Gökhan Yücel
Head of Notified Body

26 July 2019, Istanbul, Turkey



CERTIFICATE



Enclosure of the EC Certificate:

Page 1/1

Production Quality Assurance System according to

Medical Devices Directive 93/42/EEC Annex-V

Certificate Number: 1984-MDD-11-104, Revision Number: 05

Concerned medical devices;

Product Name	Types	Class
Pediatric Urine Bag	Pediatric Urine Bag Male	Is & Im
	Pediatric Urine Bag Female	Is & Im
Vaginal Speculum	Large, Medium, Screw Medium	Is
Camera Cover	170101	Is
Endotracheal Stylet	04-06-08-10-12-16 CH	Is
Spirometer Filter Accessories	Spirometer Mouth - 22-30-33 mm	Is
Vomit Bag	950021	Im
Respiratory Exercise Device	Three Balls	Im

Kiwa Belgelendirme Hizmetleri A.Ş. is Notified Body under Council Directive 93/42/EEC concerning medical devices with identification number: 1984

Muhteşem Gökhan Yücel
Head of Notified Body

26 July 2019, Istanbul, Turkey

EC Certificate

Full Quality Assurance System according to Medical Devices Directive 93/42/EEC Annex-II Section 3

Certificate Number: 1984-MDD-11-100

We hereby declare that an examination of the under mentioned full quality assurance system has been carried out following the requirements of the national legislation to which the undersigned is subjected, transposing annex II (with the exemption of section 4) of the Directive 93/42/EEC on medical devices. We certify that the full quality assurance system conforms with the relevant provisions of the aforementioned directive.

Organization:

PLASTİ-MED PLASTİK MEDİKAL ÜRÜNLER SANAYİ VE TİCARET LİMİTED ŞİRKETİ

Deri OSB Mahallesi. Yan Sanayi Cad. No:13 Tuzla/İstanbul/Turkey

The products defined at the enclosure which is the part of this certificate and contains six pages. The certificate is valid till expiration date, subject to successful completion of periodical surveillance audits. Please contact Kiwa for details.

Report Number: M.3567.09
Date of first issue: 25 July 2011
Date of last issue: 25 May 2021
Revision Number: 11
Expiry Date: 27 May 2024

Kiwa Belgelendirme Hizmetleri A.Ş. has audited the quality system restricted to the aspects of manufacture concerned with securing and maintaining sterile conditions in accordance with MDD Annex II for Class Is devices covered by this certificate and found that the quality system meets the requirements of MDD Annex II.



Muhtesem Gökhan Yücel
Head of Notified Body

25 May 2021, Istanbul, Turkey

Enclosure of the EC Certificate:

Full Quality Assurance System according to

Medical Devices Directive 93/42/EEC Annex-II Section 3

Certificate Number: 1984-MDD-11-100, Revision Number: 11

Concerned medical devices;

Sterile medical devices

Product Name	Types
Stone Baskets	Nitinol Helical
	Nitinol Flat Wire
	Nitinol Triprong
	Nitinol Tipless
	Nitinol Percutaneous Basket
	3 Wires
	Spiral Stone Holder
Urodynamic Catheters And Sets	Urodynamic Cystometry Catheter and Set
	Hydrophilic Urodynamic Cystometry Catheter
	Urodynamic Cystometry Catheter & UPP Catheter
	Hydrophilic Urodynamic Cystometry Catheter & UPP Catheter
Renal Dilator And Sets	Amplatz Renal Sheat
	Amplatz Renal Dilatör and Sheat Set
	Fascial Dilator and Sets
	Percutaneous Tract Dilatation Kit with Nephrostomy Balloon Dilator
	Screw Dilator
	Percutaneous Tract Dilatation Kit with Amplatz Renal Dilator Set
Ureteral Catheters	Dual Lumen Ureteral Catheters
	Ureteral Catheters
	Hydrophilic Ureteral Catheters
Ureteral Access Sheat And Dilator Sets	Hydrophilic Ureteral Access Sheat& Dilator Set
	Ureteral Access Sheat& Dilator Set
	Nottingham Dilator Catheter
	Ureteral Dilators and Sets

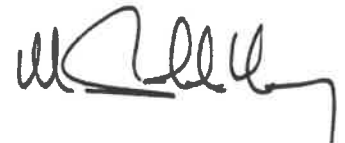

Muhtesem Gökhan Yücel
Head of Notified Body

25 May 2021, Istanbul, Turkey



Enclosure of the EC Certificate:

Page 2/6

Full Quality Assurance System according to

Medical Devices Directive 93/42/EEC Annex-II Section 3

Certificate Number: 1984-MDD-11-100, Revision Number: 11

Concerned medical devices;

Sterile medical devices

Product Name	Types
IUI Catheter	IUI Catheters
	IUI Catheter Cannula
Suprapubic Catheter And Sets	Suprapubic Catheters and Sets
	Silicone Suprapubic catheter and Sets
	Suprapubic Catheter Set-Standard
	Suprapubic Catheter Set With Balloon
Needles	TLA Introducer Needle
	Initial Puncture Needles
	Chiba Needle
Guide Wires	Guide Wire- Nitinol
	Hydrophilic Guide Wire- Nitinol
	Zebra Guide Wire- Nitinol
	Guide Wire-PTFE
	Guide Wire J Type
	Ocean Touch Hydrophilic Tip Zebra Guidewire
Ballon Dilator Catheters	Ureteral Balloon Dilator
	Nephrostomy Balloon Dilator
	Transureteroscopic Balloon Dilator
	Transureteroscopic Ureteral Balloon Dilator and Sets With Hydrophilic Tip
	Ureteral Balloon Dilator and Sets With Hydrophilic Tip
	Occlusion Balloon Catheter
Malecot Nephrostomy Catheter And Sets	Malecot Nephrostomy Catheter and Sets
	Re-Entry Malecot Catheter

Muhteşem Gökhan Yücel
Head of Notified Body

25 May 2021, Istanbul, Turkey

Enclosure of the EC Certificate:

Page 3/6

Full Quality Assurance System according to
Medical Devices Directive 93/42/EEC Annex-II Section 3

Certificate Number: 1984-MDD-11-100, Revision Number: 11

Concerned medical devices;

Sterile medical devices

Product Name	Types
Nephrostomy Catheter And Sets	Nephrostomy Pigtail Catheter and Sets
	Nephrostomy Pigtail Catheter and Sets with Trocar Needle
	Nephrostomy Pigtail Catheter and Sets with Locking
	Nephrostomy Pigtail Catheter and Sets With Trocar Needle, Locking
	Hydrophilic Multi Purpose Pigtail Drainage Catheter and Sets Locking, with Needle
Nephrostomy Balloon Dilatation Catheter Set	-
	-
Nephrostomy Balloon Dilatation Catheter Kit	-
	-
Intracavitary Hyperthermia Catheter Set	-
Closed Wound Drainage Systems And Accessories	Wound Drainage Sets
	Soft Drains with Drainage Bag
	Wound Drainage Sets with Reservoirs and with Flat Drains
	Flat Drains
	Wound Drainage Reservoir
	Round Silicone Drains
Yankauer Suction Sets And Accessories	Yankauer Suction Sets
	Yankauer Suction Handles
	Aspirator Connecting Tube



Muhteşem Gökhan Yücel
Head of Notified Body

25 May 2021, Istanbul, Turkey

Enclosure of the EC Certificate:

Page 4/6

Full Quality Assurance System according to

Medical Devices Directive 93/42/EEC Annex-II Section 3

Certificate Number: 1984-MDD-11-100, Revision Number: 11

Concerned medical devices;

Sterile medical devices

Product Name	Types
Biopsy Punch	-
Airway (Guedel Type)	
Poche Perforator	-
Umbilical Cord Clamp	-
Bacterial Filters	Bacterial Filter
	Hmef Filter
	Hme Filter
	Hepa Filter
	Bacterial Filter
	HMEF Filter- Elite
HME Filter- Elite	
Smear Brush & Smear Brush Endocervical	Smear Brush Smear Brush Endocervical
Karman Cannula	-
Suction Bag & Canister And Accessories	Suction Bags
	Suction Bag Tubes
	Kapkon Connector
Extension Line	
Three Way Stopcock	-
Breathing And Anesthesia Circuits	Breathing Circuits
	Anesthesia Circuits
	Catheter Mount
	Breathing Inhalation- Threatment Chamber
	Breathing and Anesthesia Circuit Accessories



Muhteşem Gökhan Yücel
Head of Notified Body

25 May 2021, İstanbul, Turkey

Enclosure of the EC Certificate:

Page 5/6

**Full Quality Assurance System according to
Medical Devices Directive 93/42/EEC Annex-II Section 3
Certificate Number: 1984-MDD-11-100, Revision Number: 11**

Concerned medical devices;
Sterile medical devices

Product Name	Types
Arthroscopy Set Y (T.U.R)	Arthroscopy Set Y (T.U.R.)
	Arthroscopy Set with Manual Pressure Pump (T.U.R.)
Blood Gas Syringe With Needle	-
Endometrial Cell Sampler	-
Disposable Oral Swab	-
Sponge Swab	-
Ureteral Stents And Sets	Ureteral Stent and Sets
	Long Term Ureteral Stent and Sets
	Hydrophilic Ureteral Stent and Sets
	Multilenght Ureteral Stent and Sets
	Hydrophilic Multilenght Ureteral Stent and Sets
	Silicone Multilenght Ureteral Stents and Sets
	Endopylotomy Stent and Sets
Cutting Electrodes	Cutting Electrodes Single Stem
Enteral Feeding Bag	Single
	Double
Sterile Karman Syringe	Single Valve, Single Valve Set-Sterile
	Double Valve, Double Valve Set-Sterile

Non- Sterile medical Devices

Product Name	Types
Manual Resuscitator	Reusable Manuel Resuscitator
	Disposable Manuel Resuscitator
	Reusable Manuel Resuscitator Sets
	Disposable Manuel Resuscitator Sets



Muhteşem Gökhan Yücel
Head of Notified Body

25 May 2021, Istanbul, Turkey

Enclosure of the EC Certificate:
Full Quality Assurance System according to
Medical Devices Directive 93/42/EEC Annex-II Section 3
Certificate Number: 1984-MDD-11-100, Revision Number: 11

Concerned medical devices;
Non-Sterile medical devices

Product Name	Types
Disposable Air Cushion Mask	Neonatal
	Infant
	Pediatric
	Child
	Small Adult
Silicone Mask	Adult
	Neonatal
	Infant
	Pediatric
	Child
Respiratory Masks and Accessories	Small Adult
	Adult
	Oxygen Masks and Accessories
	Nebulizer Set and Accessories
Karman Syringe	High Concentration Oxygen Mask
	Nasal Oxygen Cannula
Suction Bag & Canister And Accessories	Single Valve, Single Valve Set
	Double Valve, Double Valve Set
Breathing And Anesthesia Circuits	Suction Bags
	Suction Canister
	Breathing Circuits
	Anesthesia Circuits
	Catheter Mount
CPAP BPAP Masks	Breathing Inhalation- Treatment Chamber
	Breathing and Anesthesia Circuit Accessories
	Ora-Nasal
	Nasal

Kiwa Belgelendirme Hizmetleri A.Ş. is Notified Body under Council Directive 93/42/EEC concerning medical devices with identification number: 1984



Muhteşem Gökhan Yücel
Head of Notified Body

25 May 2021, Istanbul, Turkey

Plasti-med®

"supporting healthy life"

PLASTİ-MED PLASTİK MEDİKAL ÜRÜNLER SANAYİ VE TİCARET LİMİTED ŞİRKETİ

Deri OSB Mahallesi Yan Sanayi Cad. No:13 Tuzla/Istanbul/Turkey

with a scope of

Design, manufacture, sterilization and sale of Sterile and Non Sterile Respiratory and Anesthesia Products, Sterile Urology Products, Sterile and Non Sterile Aspiration and Drainage Systems, Sterile and Non Sterile Gynecology Products, Sterile and Non Sterile Disposable Oral Swab, Other Sterile Medical Devices (Camera Cover, Blood Gas Syringe With Needle, Extension Line, Sponge Swab, Umbilical Cord Clamp, Biopsy Punch), Other Non Sterile Medical Devices (Vomit Bag, Kidney Bowl, Enema Set, Sterile and Non Sterile IVD Devices (Blood Gas Syringe, Smear Cup) and the service of sub-contract Ethylene Oxide sterilization

Has established a quality management system in accordance
with international standard.

" Following elements of the standard are excluded "

" None "

ISO 9001:2015

Certificate No : M 11239
Initial Certification Date : 09 April 2019
Certification Date : 09 April 2019
Expiration Date : 08 April 2022

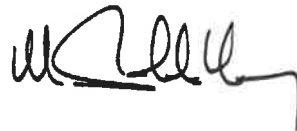

General Manager

Kiwa Certification Services Inc.
ITOSB 9. Cadde No. 15 Tepeören Tuzla - Istanbul - Turkey
Tel: + 90 216 593 25 75 Faks : + 90 216 593 25 74
Web: www.kiwa.com.tr E-mail: info@kiwa.com.tr

Certificate is valid till expiration date, subject to successful completion of periodical surveillance audits.

Please contact above numbers for detailed information.

Plasti-med®

"supporting healthy life"

PLASTI-MED PLASTİK MEDİKAL ÜRÜNLER SANAYİ VE TİCARET LİMİTED ŞİRKETİ

Deri OSB Mahallesi Yan Sanayi Cad. No:13 Tuzla/Istanbul/Turkey

with a scope of

Design, manufacture, sterilization and sale of Sterile and Non Sterile Respiratory and Anesthesia Products, Sterile Urology Products, Sterile and Non Sterile Aspiration and Drainage Systems, Sterile and Non Sterile Gynecology Products, Sterile and Non Sterile Disposable Oral Swab, Other Sterile Medical Devices (Camera Cover, Blood Gas Syringe With Needle, Extension Line, Sponge Swab, Umbilical Cord Clamp, Biopsy Punch), Other Non Sterile Medical Devices (Vomit Bag, Kidney Bowl, Enema Set, Sterile and Non Sterile IVD Devices (Blood Gas Syringe, Smear Cup) and the service of sub-contract Ethylene Oxide sterilization

Medical devices - Quality management systems - Requirements for regulatory purposes

"Following elements of the standard are excluded"
"7.5.3" "7.5.4" "7.5.9.2"

EN ISO 13485:2016

Certificate No : M 10712
Initial Certification Date : 21 June 2017
Certification Date : 09 June 2020
Expiration Date : 08 June 2023



Medical Device Q M S
TS EN ISO/IEC 17021-1
AB-0006-YS



TÜRKAK BDS NO
YS-1535-5352



General Manager

Kiwa Certification Services Inc.

ITOSB 9. Cadde No. 15 Tepeören Tuzla - Istanbul - Turkey

Tel: + 90 216 593 25 75 Faks : + 90 216 593 25 74

Web: www.kiwa.com.tr E-mail: info@kiwa.com.tr

Certificate is valid till expiration date, subject to successful completion of periodical surveillance audits.

Please contact above numbers for detailed information.