

  
**Delacroix-Chevalier**  
*Paris*



## Minimally Invasive Surgery Instruments

*Instruments de Chirurgie Mini-Invasive - Instrumentos de Cirugía Mini-Invasiva*

**2021**

For all information :

Pour tout renseignement :

Para más información :



Tel. (World -Mundo) : +33 3 25 02 10 35

Tél. (France) : 03 25 02 10 10

Monday to Friday - Du lundi au vendredi - De lunes a viernes

From 8:00 am to 6:00 pm (non stop) - De 8 heures à 18 heures - De las 8 a las 18



contact@landanger.com



Corporate office - Siège - Sede

**LANDANGER**

217 Rue du Faubourg Saint-Honoré

75008 Paris

FRANCE

Manufacturing & Logistic - Production et Logistique - Fabricación y logística

Rue Renée et Louis Landanger

52000 Chaumont

FRANCE

Delacroix-Chevalier® is a brand of LANDANGER Company

Contact - Contact - Contacto :

---

---

---

---

---



Delacroix-Chevalier

---

*Paris*

*Since - Depuis - Desde*  
*1920*





Code Référence Referencia	Page Page Página	Code Référence Referencia	Page Page Página	Code Référence Referencia	Page Page Página	Code Référence Referencia	Page Page Página	Code Référence Referencia	Page Page Página
DC30159-00	131	DC80022-36	90	DC80132-36	39	DC80231-36	11	DC80995-26	83
DC30212-20	63	DC80023-30	90	DC80132-43	39	DC80232-30	8	DC80995-32	83
DC30222-38	63	DC80023-36	90	DC80133-25	39	DC80232-36	8	DC80995-36	83
DC30223-43	63	DC80024-30	90	DC80133-30	39	DC80233-30	14	DC80996-26	83
DC30300-00	63	DC80024-36	90	DC80133-36	39	DC80233-36	14	DC80996-32	83
DC30600-00	60	DC80025-30	94	DC80133-43	39	DC80234-30	14	DC80996-36	83
DC30800-00	64	DC80025-36	94	DC80140-40	31	DC80234-36	14	DC80997-26	84
DC30810-25	64	DC80040-28	88	DC80200-24	8	DC80235-30	15	DC80997-32	84
DC30811-35	64	DC80100-30	34	DC80200-28	8	DC80235-36	15	DC80997-36	84
DC30812-45	64	DC80100-36	34	DC80200-30	8	DC80240-28	5	DC80998-26	84
DC30813-55	64	DC80101-30	34	DC80200-36	8	DC80241-40	13	DC80998-32	84
DC32300-00	58	DC80101-36	34	DC80200-43	8	DC80242-40	78	DC80998-36	84
DC32900-00	59	DC80101-43	34	DC80201-30	8	DC80300-30	102	DC81000-00	59
DC71337-33	114	DC80102-30	34	DC80201-36	8	DC80300-36	102	DC81010-00	65
DC71337-33-C	114	DC80102-36	34	DC80201-43	8	DC80302-30	102	DC81020-00	65
DC71337-33-S	114	DC80102-43	34	DC80202-25	10	DC80302-36	102	DC81050-00	47
DC71710-50	104	DC80103-30	30	DC80202-30	10	DC80303-30	102	DC81050-01	47
DC80009-25	96	DC80103-36	30	DC80202-36	10	DC80303-36	102	DC81050-02	47
DC80009-30	96	DC80104-30	30	DC80202-43	10	DC80304-30	102	DC81050-03	47
DC80009-36	96	DC80104-36	30	DC80203-28	4	DC80304-36	102	DC81115-00	48
DC80009-43	96	DC80105-28	28	DC80203-30	4	DC80417-24	118	DC81117-94	48
DC80010-30	92	DC80105-30	28	DC80204-30	9	DC80418-36	118	DC81118-50	48
DC80010-36	92	DC80106-28	28	DC80204-36	9	DC80419-36	118	DC81118-60	48
DC80011-30	92	DC80106-30	28	DC80204-43	9	DC80420-24	118	DC81118-70	48
DC80011-36	92	DC80107-30	34	DC80205-28	4	DC80459-28	106	DC81301-00	72
DC80012-25	93	DC80107-36	34	DC80205-30	4	DC80459-34	106	DC81301-01	72
DC80012-30	93	DC80109-28	32	DC80205-36	9	DC80459-38	106	DC81301-30	72
DC80012-36	93	DC80109-30	32	DC80207-30	9	DC80461-27C	43	DC81302-00	72
DC80012-43	93	DC80110-30	37	DC80207-36	9	DC80461-27S	43	DC81302-30	72
DC80013-25	93	DC80110-36	37	DC80207-43	9	DC80461-29	43	DC81303-33	74
DC80013-30	93	DC80110-44	37	DC80208-30	8	DC80461-34	43	DC81304-00	72
DC80013-36	93	DC80111-25	35	DC80208-36	8	DC80462-22	44	DC81304-30	72
DC80013-44	93	DC80112-25	35	DC80208-43	8	DC80462-29	44	DC81305-21	73
DC80014-28	87	DC80113-30	30	DC80209-36	9	DC80700-30	115	DC81305-30	73
DC80014-30	93	DC80113-36	30	DC80220-30	6	DC80701-30	115	DC81307-00	72
DC80014-36	93	DC80114-30	27	DC80220-36	6	DC80702-30	115	DC81307-30	72
DC80015-28	89	DC80115-30	27	DC80221-30	6	DC80710-23	116	DC81308-00	103
DC80015-36	89	DC80116-28	25	DC80221-36	6	DC80710-30	116	DC81308-28	103
DC80017-28	89	DC80117-28	25	DC80222-30	7	DC80711-23	116	DC81308-35	103
DC80017-36	89	DC80120-30	33	DC80222-36	7	DC80711-30	116	DC81310-00	112
DC80018-28	87	DC80121-30	33	DC80224-30	6	DC80730-30	117	DC81310-28	112
DC80018-36	87	DC80122-30	33	DC80224-36	6	DC80731-30	117	DC81320-38	110
DC80019-25	96	DC80123-30	29	DC80227-30	6	DC80915-29	43	DC81322-38	110
DC80019-30	96	DC80124-30	29	DC80227-36	6	DC80915-42	43	DC81323-21	103
DC80019-36	96	DC80127-30	33	DC80228-30	3	DC80993-26	82	DC81323-30	103
DC80019-43	96	DC80130-30	36	DC80228-36	3	DC80993-26C	82	DC81330-00	119
DC80020-30	91	DC80130-36	36	DC80229-30	3	DC80993-32	82	DC81330-01	119
DC80020-36	91	DC80131-30	36	DC80229-36	3	DC80993-36	82	DC81330-33	119
DC80021-30	91	DC80131-36	36	DC80230-30	3	DC80994-26	82	DC81331-33	119
DC80021-36	91	DC80132-25	39	DC80230-36	3	DC80994-32	82	DC81363-24	48
DC80022-30	90	DC80132-30	39	DC80231-30	11	DC80994-36	82	DC81364-36	48

Code Référence Referencia	Page Page Página	Code Référence Referencia	Page Page Página	Code Référence Referencia	Page Page Página	Code Référence Referencia	Page Page Página	Code Référence Referencia	Page Page Página
DC81400-00	113	DC82120-95	56	DC82163-40	52	DC83201-44	12	DC84204-35	20
DC81400-01	113	DC82121-16	56	DC82163-50	52	DC83202-36	12	DC84204-41	20
DC81410-28	111	DC82121-20	56	DC82164-30	52	DC83202-44	12	DC84207-35	20
DC81410-36	111	DC82122-22	57	DC82164-40	52	DC83207-36	12	DC84207-41	20
DC81900-05	131	DC82122-24	57	DC82164-50	52	DC83207-44	12	DC84240-26	18
DC81901-00	135	DC82122-26	57	DC82165-35	52	DC83208-36	17	DC84241-45	22
DC81902-00	135	DC82124-30	56	DC82169-00	51, 136	DC83208-44	17	DC84242-45	81
DC81903-00	134	DC82125-05	56	DC82200-00	61	DC83209-36	17	DC84243-45	81
DC81904-00	134	DC82130-00	55	DC82210-00	62	DC83209-44	17	DC84244-45	22
DC81907-00	136	DC82131-30	55	DC82940-38	66	DC83210-36	80	DC84300-35	105
DC81908-00	137	DC82131-40	55	DC82940-40	66	DC83210-44	80	DC84300-41	105
DC81910-01	132	DC82131-50	55	DC82950-38	67	DC83211-36	80	DC89100-00	121
DC81910-02	132	DC82132-30	55	DC82960-07	68	DC83211-44	80	DC89100-01	121
DC81910-03	132	DC82132-40	55	DC82960-10	68	DC83213-36	79	DC89100-02	121
DC81912-01	130	DC82132-50	55	DC82961-07	68	DC83213-36WR	79	DC89100-19	121
DC81912-02	130	DC82133-30	55	DC82961-10	68	DC83213-44	79	DC89101-00	121
DC81912-03	130	DC82133-40	55	DC82962-07	68	DC83213-44WR	79	DC89111-01	121
DC81913-01	133	DC82133-50	55	DC82962-10	68	DC83216-36	77	DC89111-01	121
DC81913-02	133	DC82141-30	55	DC82963-07	68	DC83216-44	77	DC89111-10	121
DC81913-03	133	DC82141-40	55	DC82963-10	68	DC83221-44	79	DC89112-01	121
DC81914-00	48, 137	DC82141-50	55	DC82964-07	68	DC83221-44WR	79	DC89112-05	121
DC81930-01	120	DC82142-30	55	DC82964-10	68	DC83224-36	16	E229006	71
DC81930-02	120	DC82142-40	55	DC82965-70	69	DC83224-44	16	E229011	71
DC82100-00	53	DC82142-50	55	DC82966-07	68	DC83225-36	16	E229013	71
DC82100-01	54	DC82143-30	55	DC82966-10	68	DC83225-44	16	E229015	71
DC82100-02	54	DC82143-40	55	DC82970-07	69	DC84010-41	100	E229121	69
DC82100-99	53	DC82143-50	55	DC82970-10	69	DC84011-41	100	J00011	26
DC82101-30	53	DC82150-00	50	DC82980-07	70	DC84012-35	101	J00012	26
DC82101-40	53	DC82150-01	50	DC82981-07	70	DC84012-41	101	J00021	109
DC82101-50	53	DC82151-20	49	DC82981-10	70	DC84013-33	101	J00022	109
DC82102-30	53	DC82151-20	50	DC82982-07	70	DC84013-35	101	O600406	47
DC82102-40	53	DC82151-30	49	DC82982-10	70	DC84013-41	101		
DC82102-50	53	DC82151-30	50	DC82983-07	70	DC84017-41	99		
DC82103-30	53	DC82151-40	49	DC82983-10	70	DC84040-26	98		
DC82103-40	53	DC82151-40	50	DC82984-07	70	DC84101-35	42		
DC82103-50	53	DC82152-00	49	DC82984-10	70	DC84101-41	42		
DC82104-40	54	DC82152-99	49	DC83002-36	95	DC84102-35	42		
DC82111-30	53	DC82153-30	49	DC83002-44	95	DC84102-41	42		
DC82111-40	53	DC82153-30	50	DC83003-36	95	DC84116-26	40		
DC82111-50	53	DC82160-00	51	DC83003-44	95	DC84117-26	40		
DC82112-30	53	DC82160-00	51	DC83009-36	97	DC84140-45	41		
DC82112-40	53	DC82160-99	52	DC83019-36	97	DC84141-45	41		
DC82112-50	53	DC82161-30	51	DC83110-02	37	DC84200-35	19		
DC82113-30	53	DC82161-40	51	DC83110-12	38	DC84200-41	19		
DC82113-40	53	DC82161-50	51	DC83110-36	38	DC84200-41R	19		
DC82113-50	53	DC82161-60	51	DC83110-44	38	DC84201-35	19		
DC82114-40	54	DC82161-70	51	DC83112-36	37	DC84201-41	19		
DC82115-40	54	DC82162-30	52	DC83112-44	37	DC84202-35	21		
DC82120-30	56	DC82162-40	52	DC83200-36	12	DC84202-41	21		
DC82120-50	56	DC82162-50	52	DC83200-44	12	DC84202-41R	21		
DC82120-90	56	DC82163-30	52	DC83201-36	12	DC84203-26	18		

DISSECTING FORCEPS / PINCES À DISSECTION / PINZAS PARA DISECCIÓN

Ø 2,7 mm



P 3

Ø 3,5 mm



P 4 - 5

Ø 3,5 mm / Ø 5 mm



P 6 - 7

Ø 5 mm



P 8 - 11

Ø 5 mm



Titanium

P 12

DISSECTORS / DISSECTEURS / DISECTORES

HF DISSECTORS / DISSECTEURS HF / HF DISECTORES

Ø 3.5 mm



Titanium

P 13

Ø 5 mm



P 14 - 16

Ø 5 mm



Titanium

P 17

MICROMICS DISSECTING FORCEPS / PINCES À DISSECTION MICROMICS / PINZAS PARA DISECCIÓN MICROMICS

Ø 5 mm



P 18 - 21

MICROMICS DISSECTORS / DISSECTEURS MICROMICS / DISECTORES MICROMICS

Ø 3,5 mm / Ø 5 mm



P 22





TC Inserts

Ø 2.7 mm

NEW  
NOUVEAU  
NUEVO

Patent  
Breveté  
Patentado

Straight  
Droite  
Recta

1 mm  
1-1



**DC80228-30**

L : 300 mm - 11 4/5"



**DC80228-36**

L : 360 mm - 14 1/5"

Only One Mobile Jaw  
Un Seul Mors Mobile  
Sólo Una Boca Móvil



10°

1 mm  
1-1



**DC80229-30**

L : 300 mm - 11 4/5"

**DC80229-36**

L : 360 mm - 14 1/5"

25°

1 mm  
1-1



**DC80230-30**

L : 300 mm - 11 4/5"

**DC80230-36**

L : 360 mm - 14 1/5"



Dissecting Forceps / Pincés à Dissection / Pinzas para Disección

Ø 3.5 mm



DeBakey

Straight  
Droite  
Recta

2.75 mm



DC80203-28

L : 280 mm - 11"

DC80203-30

L : 300 mm - 11 <sup>4</sup>/<sub>5</sub>"

Only One Mobile Jaw  
Un Seul Mors Mobile  
Sólo Una Boca Móvil



Angled on Flat  
Coudée sur le Plat  
Angulada en el Plano

1.5 mm

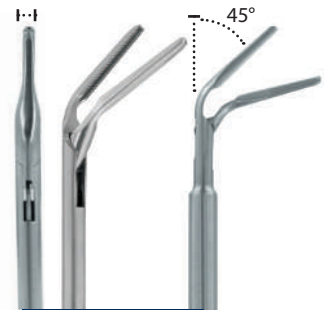

DC80205-28

L : 280 mm - 11"

DC80205-30

L : 300 mm - 11 <sup>4</sup>/<sub>5</sub>"



Diamonite

Ø 3.5 mm

NEW  
NOUVEAU  
NUEVO



Straight  
Droite  
Recta

2 mm



6 mm

DC80240-28

L : 280 mm - 11"



Dissecting Forceps / Pincés à Dissection / Pinzas para Disección

Ø 3.5 mm / Ø 5 mm



DeBakey

Straight  
Droite  
Recta

1.5 mm



**DC80221-30**

L : 300 mm - 11 4/5"

**DC80221-36**

L : 360 mm - 14 1/4"

NEW  
NOUVEAU  
NUEVO

2.75 mm



**DC80220-30**

L : 300 mm - 11 4/5"

**DC80220-36**

L : 360 mm - 14 1/5"

NEW  
NOUVEAU  
NUEVO

Curved  
Courbe  
Curva

2.75 mm



**DC80224-30**

L : 300 mm - 11 4/5"

**DC80224-36**

L : 360 mm - 14 1/5"

NEW  
NOUVEAU  
NUEVO

2.75 mm



**DC80227-30**

L : 300 mm - 11 4/5"

**DC80227-36**

L : 360 mm - 14 1/5"

NEW  
NOUVEAU  
NUEVO

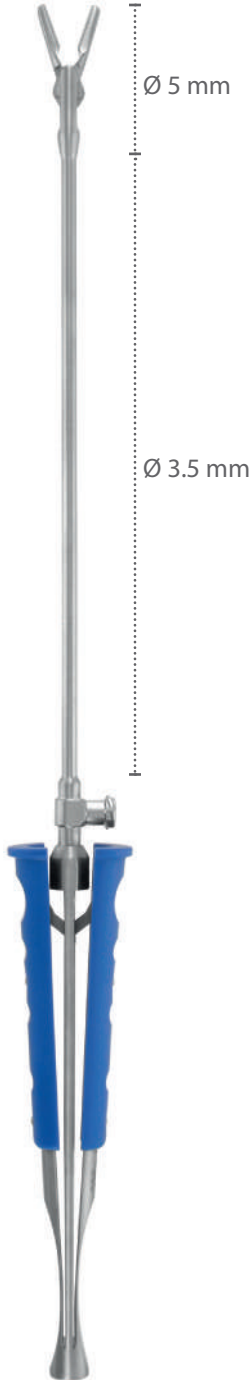



Ø 3.5 mm / Ø 5 mm



Resano

Straight  
Droite  
Recta

2.9 mm  
|---|



DC80222-30

L : 300 mm - 11 4/5"

DC80222-36

L : 360 mm - 14 1/5"

NEW  
NOUVEAU  
NUEVO

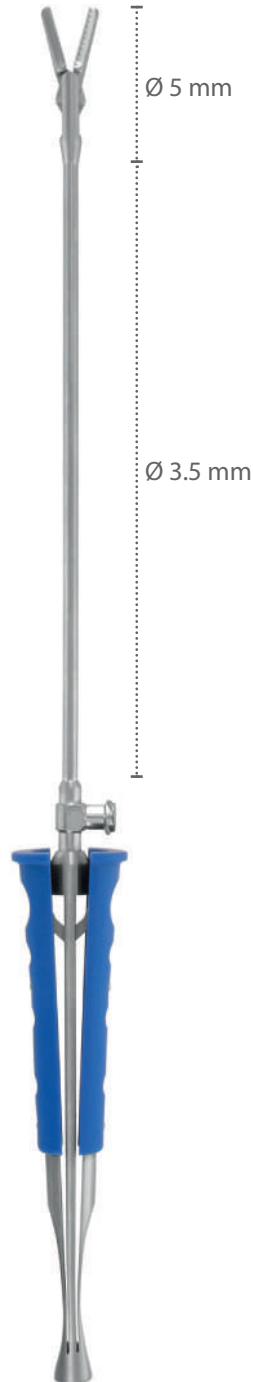

Dissecting Forceps / Pincés à Dissection / Pinzas para Disección

Ø 5 mm



DeBakey

Straight  
Droite  
Recta

1.5 mm



**DC80201-30**

L : 300 mm - 11 4/5"

**DC80201-36**

L : 360 mm - 14 1/5"

**DC80201-43**

L : 430 mm - 17"

2.75 mm



**DC80200-24**

L : 240 mm - 9 1/2"

**DC80200-28**

L : 280 mm - 11"

**DC80200-30**

L : 300 mm - 11 4/5"



**DC80200-36**

L : 360 mm - 14 1/5"

**DC80200-43**

L : 430 mm - 17"

**NEW  
NOUVEAU  
NUEVO**

**NEW  
NOUVEAU  
NUEVO**



3/5

Straight  
Droite  
Recta

Only One Mobile Jaw  
Un Seul Mors Mobile  
Sólo Una Boca Móvil

Teeth / Dents / Dientes : 2 x 3

5 mm



**DC80208-30**

L : 300 mm - 11 4/5"



**DC80208-36**

L : 360 mm - 14 1/5"

**DC80208-43**

L : 430 mm - 17"

**NEW  
NOUVEAU  
NUEVO**

**NEW  
NOUVEAU  
NUEVO**

2.8 mm

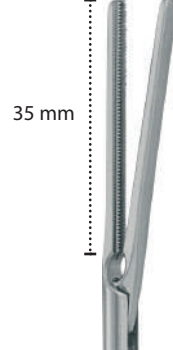

35 mm

**DC80232-30**

L : 300 mm - 11 4/5"

**DC80232-36**

L : 360 mm - 14 1/5"

**NEW  
NOUVEAU  
NUEVO**

**NEW  
NOUVEAU  
NUEVO**



DeBailey

Curved  
Courbe  
Curva



**DC80207-30**

L : 300 mm - 11 <sup>4</sup>/<sub>5</sub>"

**DC80207-36**

L : 360 mm - 14 <sup>1</sup>/<sub>5</sub>"

**DC80207-43**

L : 430 mm - 17"

NEW  
NOUVEAU  
NUEVO

Angled  
Angulés  
Anguladas



**DC80204-30**

L : 300 mm - 11 <sup>4</sup>/<sub>5</sub>"

**DC80204-36**

L : 360 mm - 14 <sup>1</sup>/<sub>5</sub>"

**DC80204-43**

L : 430 mm - 17"

NEW  
NOUVEAU  
NUEVO

Very Curved  
Très Courbe  
Muy Curva



**DC80209-36**

L : 360 mm - 14 <sup>1</sup>/<sub>5</sub>"

Angled on Flat - Only One Mobile Jaw  
Coudée sur le Plat - Un seul Mors Mobile  
Angulada en el plano - Sólo Una Boca Móvil

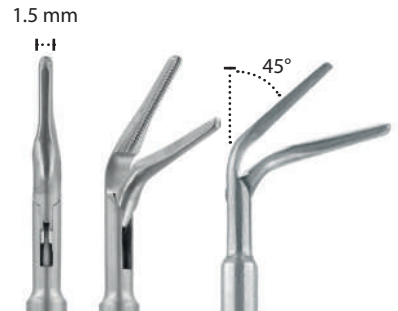

**DC80205-36**

L : 360 mm - 14 <sup>1</sup>/<sub>5</sub>"

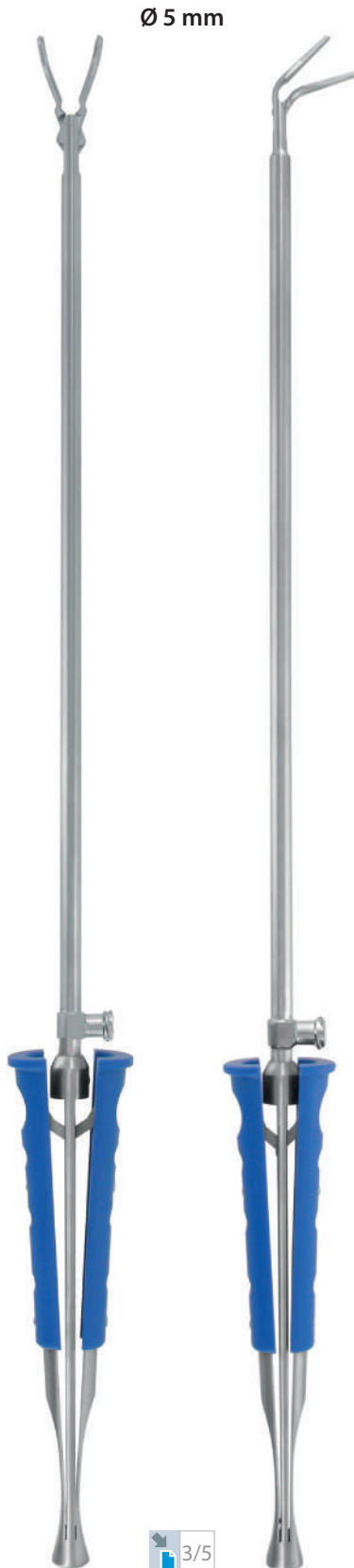

Ø 5 mm

3/5

Dissecting Forceps / Pincès à Dissection / Pinzas para Disección



Resano

Ø 5 mm

Straight  
Droite  
Recta

2.9 mm  
t...t



**DC80202-25**

L: 250 mm - 10"

NEW  
NOUVEAU  
NUEVO

**DC80202-30**

L: 300 mm - 11 <sup>4</sup>/<sub>5</sub>"



**DC80202-36**

L: 360 mm - 14 <sup>1</sup>/<sub>5</sub>"

**DC80202-43**

L: 430 mm - 17"

NEW  
NOUVEAU  
NUEVO



Ø 5 mm

Smooth Jaws  
Mors Lisses  
Mandibulas Lisas

NEW  
NOUVEAU  
NUEVO

4.3 mm



DC80231-30

L : 300 mm - 11 <sup>4</sup>/<sub>5</sub>"



DC80231-36

L : 360 mm - 14 <sup>1</sup>/<sub>5</sub>"



3/5

Dissecting Forceps With Ratchet / Pincés à Dissection à Crémaillère / Pinzas para Dissección con Cremallera



DeBailey

Straight  
Droite  
Recta

2.75 mm



**DC83200-36**

L : 360 mm - 14 1/5"

**DC83200-44**

L : 440 mm - 17 1/3"

Ø 5 mm



Registered Design  
Modèle déposé  
Diseño registrado

Curved  
Courbe  
Curva

2.75 mm



**DC83207-36**

L : 360 mm - 14 1/5"

**DC83207-44**

L : 440 mm - 17 1/3"

1.5 mm



**DC83201-36**

L : 360 mm - 14 1/5"

**DC83201-44**

L : 440 mm - 17 1/3"



Resano

Straight  
Droite  
Recta

2.9 mm



**DC83202-36**

L : 360 mm - 14 1/5"

**DC83202-44**

L : 440 mm - 17 1/3"

NEW  
NOUVEAU  
NUEVO

NEW  
NOUVEAU  
NUEVO

**Titanium**

Progressive Locking System  
Crémaillère Progressive  
Cremallera Progressiva



Ø 3.5 mm

NEW  
NOUVEAU  
NUEVO  
Patent  
Breveté  
Patentado

MARYLAND

Curved  
Courbe  
Curva



DC80241-40  
L : 400 mm - 15 3/4"



Ø 5 mm

Serrated Jaws  
Mors Striés  
Mandíbulas Serradas

NEW  
NOUVEAU  
NUEVO

With Ratchet  
Avec Verrou  
Con Cerrojo

Without Ratchet  
Sans Verrou  
Sin Cerrojo



**DC80233-30**  
L : 300 mm - 11 4/5"

**DC80233-36**  
L : 360 mm - 14 1/5"

**DC80234-30**  
L : 300 mm - 11 4/5"

 **DC80234-36**  
L : 360 mm - 14 1/5"





Ø 5 mm

Smooth Jaws  
Mors Lisses  
Mandibulas Lisas

NEW  
NOUVEAU  
NUEVO



1.2 mm

DC80235-30

L : 300 mm - 11 <sup>4</sup>/<sub>5</sub>"



DC80235-36

L : 360 mm - 14 <sup>1</sup>/<sub>5</sub>"



3/5

Patent  
Breveté  
Patentado

Ø 5 mm

90°



 **DC83225-36**

L : 360 mm - 14 1/5"

**DC83225-44**

L : 440 mm - 17 1/3"

To be Used with Oval 16x25mm  
Trocar DC82970-70

À Utiliser avec un Trocart Oval  
de 16 x 25 mm DC82970-70  
Usar con un Óvalo Trocar de  
16 x 25 mm DC82970-70

Very Curved Jaws  
Mors Très Courbes  
Bocas Muy Curvas



**DC83224-36**

L : 360 mm - 14 1/5"

**DC83224-44**

L : 440 mm - 17 1/3"



**Titanium**<sup>line</sup>

 3/5

Ø 5 mm

Patent  
Breveté  
Patentado

Maryland

Curved  
Courbe  
Curva



DC83208-36 \*

L : 360 mm - 14 1/5"

DC83208-44 \*

L : 440 mm - 17 1/3"

Gossot

Long Curved Jaws  
Mors Courbes Longs  
Bocas Curvas Largas



DC83209-36 \*

L : 360 mm - 14 1/5"

DC83209-44 \*

L : 440 mm - 17 1/3"

To be Used with Ø 10mm Trocar  
À Utiliser avec un Trocart de Ø 10 mm  
Usar con un Trocar de Ø 10 mm



Titanium  
line

3/5

\* For regulatory reason, please check with your distributor for availability in your country

\* Por razones reglamentarias, por favor póngase en contacto con su distribuidor para conocer la disponibilidad en su país

MicroMICS Dissecting Forceps / Pinces à Dissection MicroMICS / Pinzas para Disección MicroMICS

Yilmaz  
Ø 3.5 mm

NEW  
NOUVEAU  
NUEVO

Registered Design  
Modèle déposé  
Diseño registrado



Diamonite

Straight  
Droite  
Recta



DC84240-26

WL: 90 mm - 3 1/2"  
L: 260 mm - 10"



DeBakey

Straight  
Droite  
Recta



DC84203-26

WL: 90 mm - 3 1/2"  
L: 260 mm - 10"

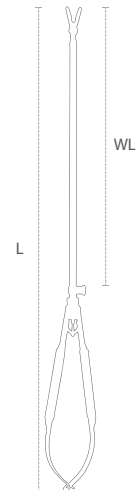



DeBakey

Ø 5 mm

NEW  
NOUVEAU  
NUEVO

Registered Design  
Modèle déposé  
Diseño registrado

Straight  
Droite  
Recta

1.5 mm



**DC84201-35**

WL: 180 mm - 7"  
L: 350 mm - 13<sup>4/5</sup>"

**DC84201-41**

WL: 240 mm - 9<sup>1/2</sup>"  
L: 410 mm - 16"

Straight  
Droite  
Recta

2.75 mm



**DC84200-35**

WL: 180 mm - 7"  
L: 350 mm - 13<sup>4/5</sup>"

 **DC84200-41**

WL: 240 mm - 9<sup>1/2</sup>"  
L: 410 mm - 16"

With Ratchet  
Avec Verrou  
Con Sistema de Cierre

**DC84200-41R**

WL: 240 mm - 9<sup>1/2</sup>"  
L: 410 mm - 16"



MicroMICS Dissecting Forceps / Pinces à Dissection MicroMICS / Pinzas para Disección MicroMICS



DeBakey

Ø 5 mm

NEW  
NOUVEAU  
NUEVO

Registered Design  
Modèle déposé  
Diseño registrado

Anguled  
Angulés  
Anguladas



DC84204-35

WL: 180 mm - 7"  
L: 350 mm - 13 4/5"

DC84204-41

WL: 240 mm - 9 1/2"  
L: 410 mm - 16"

Curved  
Courbe  
Curva



DC84207-35

WL: 180 mm - 7"  
L: 350 mm - 13 4/5"

DC84207-41

WL: 240 mm - 9 1/2"  
L: 410 mm - 16"





Resano

Ø 5 mm

NEW  
NOUVEAU  
NUEVO

Registered Design  
Modèle déposé  
Diseño registrado

Straight  
Droite  
Recta

2.9 mm  
I-I



DC84202-35

WL: 180 mm - 7"  
L: 350 mm - 13<sup>4/5</sup>"



DC84202-41

WL: 240 mm - 9<sup>1/2</sup>"  
L: 410 mm - 16"

With Ratchet  
Avec Verrou  
Con Sistema de Cierre

DC84202-41R

WL: 240 mm - 9<sup>1/2</sup>"  
L: 410 mm - 16"



1/2

MicroMICS Dissectors / Dissecteurs MicroMICS / Disectores MicroMICS

Yilmaz

MARYLAND

NEW  
NOUVEAU  
NUEVO

Registered Design  
Modèle déposé  
Diseño registrado

Curved  
Courbe  
Curva

Ø 3.5 mm



 DC84241-45

WL: 280 mm - 11"  
L: 450 mm - 17<sup>4</sup>/<sub>5</sub>"

Curved  
Courbe  
Curva

Ø 5.0 mm

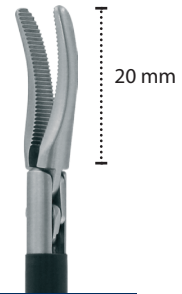

DC84244-45

WL: 280 mm - 11"  
L: 450 mm - 17<sup>4</sup>/<sub>5</sub>"





ANGLED SCISSORS / CISEAUX ANGULÉS / TIJERAS ANGULADAS

Ø 2 mm / Ø 2.5 mm



P 25

Ø 2 mm / Ø 2.5 mm

Angled shaft / Tube angulé / Tubo anguladas



P 26

Ø 3 mm



P 27

Ø 3,5 mm



P 28

Ø 3,5 mm / Ø 5 mm



P 29

Ø 5 mm



P 30

CURVED SCISSORS / CISEAUX COURBES / TIJERAS CURVAS

Ø 3,5 mm



P 31

Ø 3,5 mm



P 32

Ø 3,5 mm / Ø 5 mm



P 33

Ø 5 mm



P 34 - 35

Ø 5 mm



P 36

Ø 5 mm / Ø 7 mm



P 39

TC blades / Lames TC / Hojas TC

HANDLES FOR SCISSORS TIPS / MANCHES POUR EMBOUTS CISEAUX / MANGOS PARA PUNTAS DE TIJERAS

Ø 5mm



P 37

HF HANDLES FOR SCISSORS TIPS / MANCHES HF POUR EMBOUTS CISEAUX / MANGOS HF PARA PUNTAS DE TIJERAS

Ø 5mm



P 38

MICROMICS SCISSORS / CISEAUX MICROMICS / TIJERAS MICROMICS

Ø 2 mm / Ø 2,5 mm



P 40

Ø 3,5 mm



P 41

Ø 5 mm



P 41 - 42

TRANSTHORACIC SCISSORS / CISEAUX TRANSTHORACIQUES / TIJERAS TRANSTORÁDICAS

Ø 10 mm



P 43 - 44

Angled Scissors / Ciseaux Angulés / Tijeras Anguladas

Ø 2 mm / Ø 2.5 mm



Angled Scissors / Ciseaux Angulés / Tijeras Anguladas

Ø 2 mm / Ø 2.5 mm

Angled Shaft / Tube Angulé / Tubo Angulado

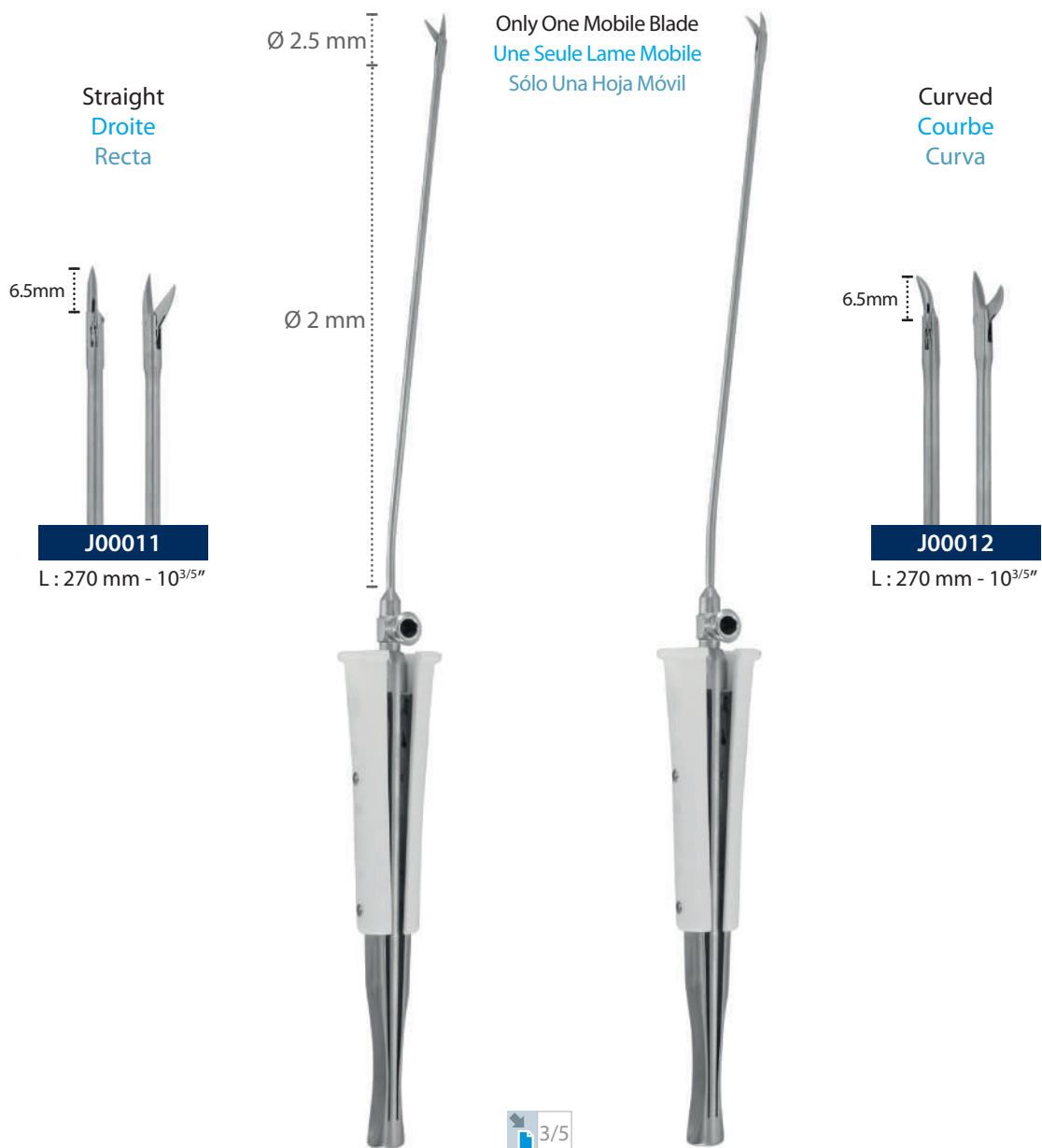

Angled Scissors / Ciseaux Angulés / Tijeras Anguladas

Ø 3 mm

Only One Mobile Blade  
Une Seule Lame Mobile  
Sólo Una Hoja Móvil

45°



 **DC80114-30**

L : 300 mm - 11 <sup>4</sup>/<sub>5</sub>"

120°



**DC80115-30**

L : 300 mm - 11 <sup>4</sup>/<sub>5</sub>"



Angled Scissors / Ciseaux Angulés / Tijeras Anguladas

Ø 3.5 mm

45°



**DC80105-28**

L : 280 mm - 11"

**DC80105-30**

L : 300 mm - 11<sup>4/5</sup>"

Only One Mobile Blade  
Une Seule Lame Mobile  
Sólo Una Hoja Móvil



125°



 **DC80106-28**

L : 280 mm - 11"

**DC80106-30**

L : 300 mm - 11<sup>4/5</sup>"

Angled Scissors / Ciseaux Angulés / Tijeras Anguladas

Ø 3.5 mm / Ø 5 mm

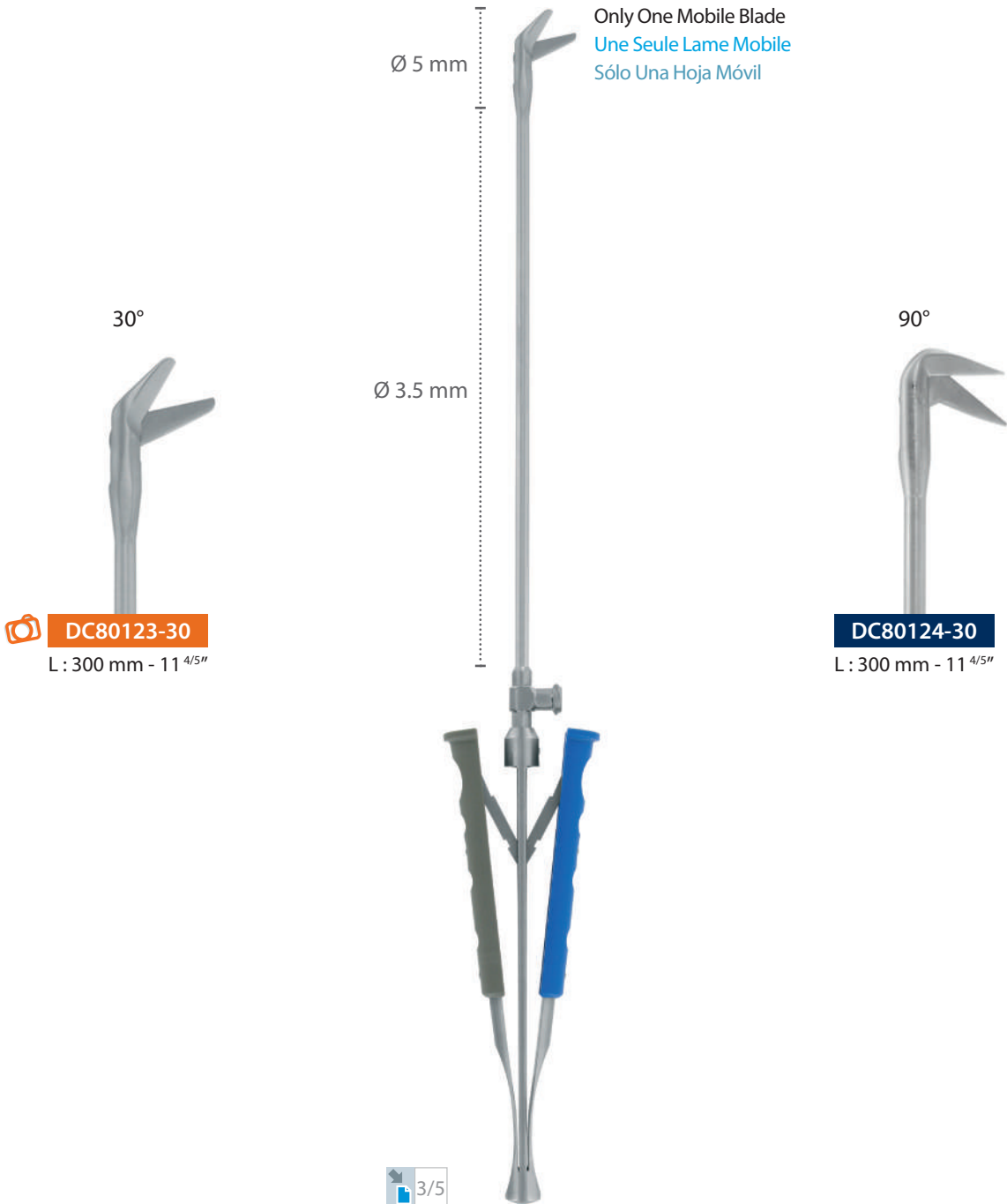

Angled Scissors / Ciseaux Angulés / Tijeras Anguladas

Ø 5 mm

30°



**DC80113-30**

L : 300 mm - 11 4/5"

**DC80113-36**

L : 360 mm - 14 1/5"

NEW  
NOUVEAU  
NUEVO

45°



**DC80103-30**

L : 300 mm - 11 4/5"



**DC80103-36**

L : 360 mm - 14 1/5"

90°



**DC80104-30**

L : 300 mm - 11 4/5"

**DC80104-36**

L : 360 mm - 14 1/5"



3/5



Ø 3.5 mm

NEW  
NOUVEAU  
NUEVO



Curved Scissors / Ciseaux Courbes / Tijeras Curvas

Ø 3.5 mm

Curved  
Courbe  
Curva



DC80109-28

L : 280 mm - 11"

DC80109-30

L : 300 mm - 11<sup>4/5</sup>"

Only One Mobile Blade  
Une Seule Lame Mobile  
Sólo Una Hoja Móvil



Curved Scissors / Ciseaux Courbes / Tijeras Curvas

Ø 3.5 mm / Ø 5 mm

Curved - Only One Mobile Blade  
Courbe - Une Seule Lame Mobile  
Curva - Sólo Una Hoja Móvil



**DC80127-30**

L : 300 mm - 11<sup>4/5</sup>"

Curved  
Courbe  
Curva



**DC80121-30**

L : 300 mm - 11<sup>4/5</sup>"

Lightly Curved  
Légèrement Courbes  
Ligeramente Curvas



**DC80120-30**

L : 300 mm - 11<sup>4/5</sup>"

Strongly Curved  
Très Courbes  
Muy C urvas



**DC80122-30**

L : 300 mm - 11<sup>4/5</sup>"

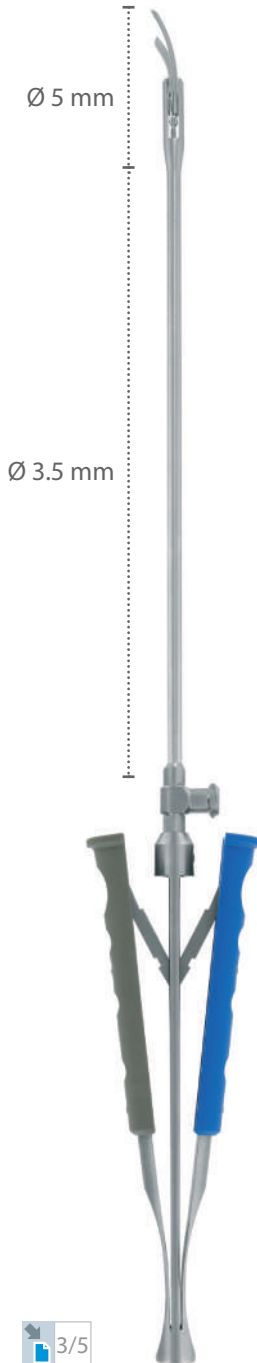

3/5

Curved Scissors / Ciseaux Courbes / Tijeras Curvas

Curved - Only One Mobile Blade  
Courbe - Une Seule Lame Mobile  
Curva - Sólo Una Hoja Móvil



**DC80107-30**

L : 300 mm - 11 4/5"

**DC80107-36**

L : 360 mm - 14 1/5"

Lightly Curved  
Légèrement Courbes  
Ligeramente Curvas



**DC80100-30**

L : 300 mm - 11 4/5"

**DC80100-36**

L : 360 mm - 14 1/5"

Ø 5 mm



3/5

Curved  
Courbe  
Curva



**DC80101-30**

L : 300 mm - 11 4/5"



**DC80101-36**

L : 360 mm - 14 1/5"

**DC80101-43**

L : 430 mm - 17"

Strongly Curved  
Très Courbes  
Muy Curvas



**DC80102-30**

L : 300 mm - 11 4/5"

**DC80102-36**

L : 360 mm - 14 1/5"

**DC80102-43**

L : 430 mm - 17"

Curved Scissors / Ciseaux Courbes / Tijeras Curvas

Ø 5 mm

With Reduced Spring Action Force  
Avec Effort de Fermeture Réduit  
Con Fuerza de Cierre Reducida

Curved  
Courbe  
Curva



DC80111-25

L : 250 mm - 10"

Strongly Curved  
Très Courbes  
Muy Curvas



DC80112-25

L : 250 mm - 10"



Curved Scissors with TC blades / Ciseaux Courbes avec Lames TC / Tijeras Curvas con Hojas TC



TC Insert

Ø 5 mm

TC Blades  
Lames TC  
Hojas TC

Lightly Curved  
Légèrement Courbes  
Ligeramente Curvas



**DC80130-30**

L : 300 mm - 11 <sup>4</sup>/<sub>5</sub>"



**DC80130-36**

L : 360 mm - 14 <sup>1</sup>/<sub>5</sub>"

Curved  
Courbe  
Curva



**DC80131-30**

L : 300 mm - 11 <sup>4</sup>/<sub>5</sub>"

**DC80131-36**

L : 360 mm - 14 <sup>1</sup>/<sub>5</sub>"



Handles for Scissors Tips / Manches pour Embouts Ciseaux / Mangos para Puntas de Tijeras

Ø 5 mm

Patent  
Breveté  
Patentado

Reusable Curved Metzenbaum Scissors  
Ciseaux Metzenbaum Courbes Réutilisables  
Tijeras Metzenbaum Curvas Desechables



15 mm

DC83110-02

Ø : 5 mm

Registered Design  
Modèle déposé  
Diseño registrado



DC80110-30

L : 300 mm - 11 4/5"



DC80110-36

L : 360 mm - 14 1/5"

DC80110-44

L : 440 mm - 17 1/4"

NEW  
NOUVEAU  
NUEVO



DC83112-36

L : 360 mm - 14 1/5"

DC83112-44

L : 440 mm - 17 1/4"

NEW  
NOUVEAU  
NUEVO

NEW  
NOUVEAU  
NUEVO



Titanium *line*



HF Monopolar Handles for Scissors Tips / Manches HF Monopolaires pour Embouts Ciseaux  
Mangos HF Monopolares para Puntas de Tijeras

Patent  
Breveté  
Patentado

Reposable Curved Metzenbaum Scissors  
Ciseaux Metzenbaum Courbes Réutilisables  
Tijeras Metzenbaum Curvas Desechables



DC83110-12 \*

Ø : 5 mm

Box of 10 tips

Boîte de 10 embouts

Caja de 10 puntas

Straight Shaft

Tube droit

Tubo recto



DC83110-36 \*

L : 360 mm - 14 1/5"

DC83110-44 \*

L : 440 mm - 17 1/3"

Ø 5 mm



Titanium<sup>line</sup>





Ø 5 mm / Ø 7 mm

Very Strong Cutting Force  
Pouvoir de Coupe Élevé  
Fuerza de Corte muy Fuerte

**Curved**  
Courbe  
Curva

**DC80132-25** NEW NOUVEAU NUEVO  
L : 250 mm - 10"

**DC80132-30**  
L : 300 mm - 11<sup>4/5</sup>"

**DC80132-36** NEW NOUVEAU NUEVO  
L : 360 mm - 14<sup>1/5</sup>"

**DC80132-43** NEW NOUVEAU NUEVO  
L : 430 mm - 17"

**Strongly Curved**  
Très Courbes  
Muy Curvas

**DC80133-25** NEW NOUVEAU NUEVO  
L : 250 mm - 10"

**DC80133-30** NEW NOUVEAU NUEVO  
L : 300 mm - 11<sup>4/5</sup>"

**DC80133-36** NEW NOUVEAU NUEVO  
L : 360 mm - 14<sup>1/5</sup>"

**DC80133-43** NEW NOUVEAU NUEVO  
L : 430 mm - 17"

Ø 7 mm

Ø 5 mm

3/5

YILMAZ

Ø 2 mm / Ø 2.5 mm

Only One Mobile Blade  
Une Seule Lame Mobile  
Sólo Una Hoja Móvil

NEW  
NOUVEAU  
NUEVO

Registered Design  
Modèle déposé  
Diseño registrado



45°



DC84116-26

WL: 90 mm - 3 1/2"  
L : 260 mm - 10"

125°

DC84117-26

WL: 90 mm - 3 1/2"  
L : 260 mm - 10"

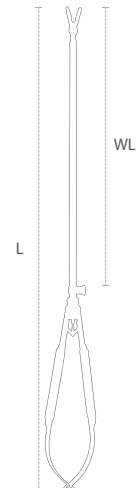

YILMAZ

METZENBAUM

NEW  
NOUVEAU  
NUEVO

Registered Design  
Modèle déposé  
Diseño registrado

Ø 3.5 mm



 DC84140-45

WL: 180 mm - 11"  
L: 450 mm - 17<sup>4/5</sup>"

Ø 5.0 mm



DC84141-45

WL: 180 mm - 11"  
L: 450 mm - 17<sup>4/5</sup>"



 2/5

Ø 5 mm

Curved  
Courbe  
Curva



**DC84101-35**

WL: 180 mm - 7"  
L : 350 mm - 13 <sup>4</sup>/<sub>5</sub>"



**DC84101-41**

WL: 240 mm - 9 <sup>1</sup>/<sub>2</sub>"  
L : 410 mm - 16"



**NEW  
NOUVEAU  
NUEVO**

**Registered Design  
Modèle déposé  
Diseño registrado**

Strongly Curved  
Très Courbes  
Muy Curvas



**DC84102-35**

WL: 180 mm - 7"  
L : 350 mm - 13 <sup>4</sup>/<sub>5</sub>"

**DC84102-41**

WL: 240 mm - 9 <sup>1</sup>/<sub>2</sub>"  
L : 410 mm - 16"

Transthoracic Scissors / Ciseaux Transthoraciques / Tijeras Transtorácicas

Curved Blades  
Lames Courbes  
Lamas Curvas



NEW  
NOUVEAU  
NUEVO

Curved Blades  
Lames Courbes  
Cuchillas Curvas



DC80462-22

L : 220 mm - 8<sup>3</sup>/<sub>5</sub>"

DC80462-29

L : 290 mm - 11<sup>1</sup>/<sub>2</sub>"

NEW  
NOUVEAU  
NUEVO

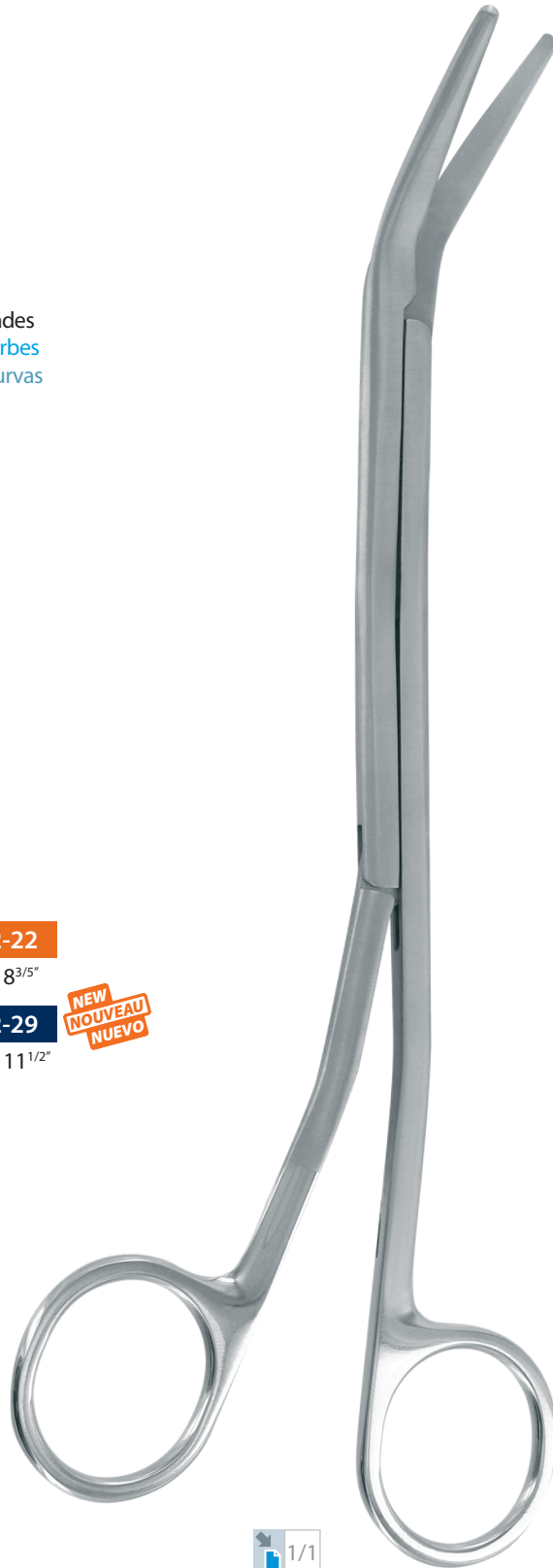

BOUCHOT RETRACTORS / ÉCARTEURS BOUCHOT / SEPARADORES BOUCHOT

Bouchot



P 47

RETRACTORS / ÉCARTEURS / SEPARADORS

Obadia



P 48

RING RETRACTORS / ÉCARTEURS CIRCULAIRES / SEPARADORES CIRCULAR

Obadia

C Ring Retractor/ Écarteur en C / C Separador

Ring Retractor/ Écarteur Circulaire / Separador Circular



P 49



P 50

RETRACTORS / ÉCARTEURS / SEPARADORES

Yan

Mini-Access

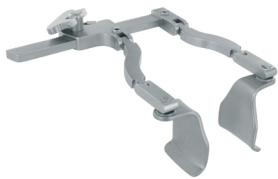

P 51 - 52

ThorAccess

Intercostal / Intercostal / Intercostal



P 53 - 54

ThorAccess

Sternal / Sternal / Esternal



P 55

Accessories / Accessoires / Accesorios



P 56 - 57

MIS

Double Hinged / Double Articulation / Doble Articulación

MIS Retractors / Écarteurs / Separadores



P 58



P 59

Mini Finochietto-Mathey



P 60

RETRACTORS / ÉCARTEURS / SEPARADORES

MIDAccess

Small Thoracotomy

Mini Sternotomy

Direct Vision



P 61



P 62



P 63



P 64

APPROXIMATOR / APPROXIMATEUR / APROXIMADORES

Yilmaz

Sarraj



P 65



P 65

RETRACTORS / ÉCARTEURS / SEPARADORES

Gossot



P 66

P 67

TROCARS / TROCARTS / TROCARES

Gossot

Trocars for Thoracoscopy / Trocarts pour Thoracoscopie / Trocares para Toracosopia



Magnetic Trocars  
Trocarts magnétiques  
Trocares magnéticos

P 68 - 71

HOOKS / CROCHETS / GANCHOS

Obadia

Hooks / Crochets / Ganchos



P 72

Yilmaz

Hooks / Crochets / Ganchos



P 73

Obadia

Double hooks / Double crochets / Doble ganchos



P 74



Bouchot Retractors / Écarteurs Bouchot / Separadores Bouchot

Bouchot

Reposable  
Usage Court  
Uso Corto

NEW  
NOUVEAU  
NUEVO

Registered Design  
Modèle déposé  
Diseño registrado



DC81050-00

Ø 36 mm



DC81050-01

Ø 40 mm



DC81050-02

Ø 44 mm



DC81050-03

Ø 48 mm



No Scale / Pas d'Échelle / Sin Escala

O600406

Recommended Sterilization Tray  
Panier de Stérilisation Recommandé  
Cesta de Esterilización Recomendada

3D Retractor / Écarteur 3D / Separador 3D

**DC81115-00**

Included

Incluses

Incluidas

DC81116-30 : 35 mm x 30 mm

DC81116-40 : 35 mm x 40 mm

DC81116-50 : 35 mm x 50 mm

**DC81117-94**

L: 94 mm

Flexible Additional Blades for DC81115-00

Valves Additionnelle Flexible pour DC81115-00

Válvulas Adicionales Flexibles para DC81115-00



Optional Blades for DC81115-00

Valves Optionnelles pour DC81115-00

Valvas Opcionales para DC81115-00



**DC81118-50**

40 mm x 50 mm

NEW  
NOUVEAU  
NUEVO



**DC81118-60**

40 mm x 60 mm

NEW  
NOUVEAU  
NUEVO



**DC81118-70**

40 mm x 70 mm

NEW  
NOUVEAU  
NUEVO

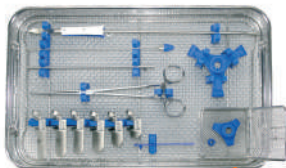

No Scale / Pas d'Échelle / Sin Escala

**DC81914-00**

Special Tray for Full Retractor System

Provided with Lid and Accessories, Instruments not Included

Panier Spécial pour le Système d'Écarteur Complet

Livré avec Couvercle et Accessoires, Instruments non Inclus

Cesto Especial para el Sistema Retractor Completo

Entregado con Tapa y Accesorios, Instrumentos no Incluidos

Obadia



Registered Design  
Modèle déposé  
Diseño registrado

Illustration Picture  
Image d'illustration  
Imagen de Ilustración

Forceps for DC81117-94

Pince pour DC81117-94

Pinza para DC81117-94

Forceps for Blades  
Pince Pose Valves  
Pinza para Colocar Valvas

1/4

**DC81363-24**

L: 240 mm - 9 1/2"

1/4

**DC81364-36**

L: 360 mm - 14 1/5"

3/4

"C-Ring" Retractors / Écarteurs en "C" / "C" Separadores

Obadia

Illustration Picture  
Image d'illustration  
Imagen de Ilustración

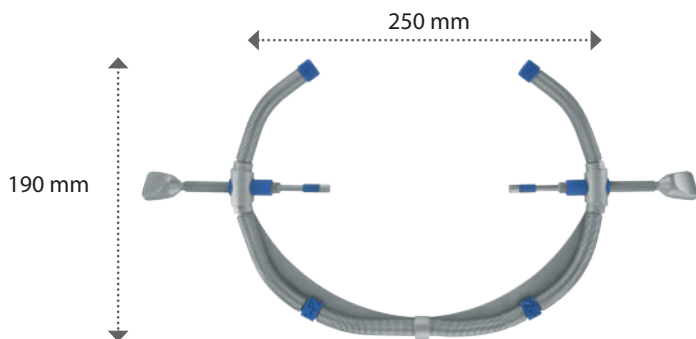

**DC82152-99**

c max with Blades DC82153-30 : 70 mm  
c max avec Valves DC82153-30 : 70 mm  
c max con Valvas DC82153-30 : 70 mm



**DC82153-30**

a : 70 mm - b : 30 mm

1 Pair of Blades - 1 Paire de Valves - 1 Pares de Valvas

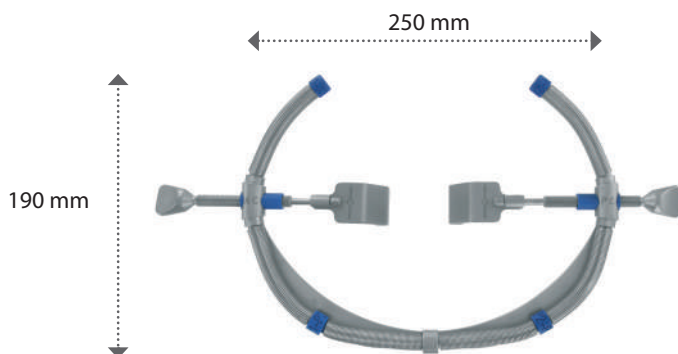

**DC82152-00**

c max : 100 mm



DC82151-20

DC82151-30

DC82151-40

Included 3 Pairs of Blades - 3 Paires de Valves Incluses - 3 Pares de Valvas Incluidas:

**DC82151-20**

+

**DC82151-30**

+

**DC82151-40**

a : 27 mm - b : 20 mm

a : 27 mm - b : 30 mm

a : 27 mm - b : 40 mm

Ring Retractors / Écarteurs Circulaires / Separadores Circular

Obadia



**DC82150-00**

Ø : 220 mm - 8<sup>2/3</sup>" - c max : 85 mm

Included 3 Pairs of Blades - 3 Paires de Valves Incluses - 3 Pares de Valvas Incluidas:

**DC82151-20**

a : 27 mm - b : 20 mm

+

**DC82151-30**

a : 27 mm - b : 30 mm

+

**DC82151-40**

a : 27 mm - b : 40 mm



**DC82150-01**

With Luer Lock - Avec Raccord Luer Lock - Con Conexión Luer Lock

Included the same 3 Pairs of Blades

3 mêmes Paires de Valves Incluses

3 mismos Pares de Valvas Incluidas

Also Compatible with this Version of Obadia Ring Retractor  
Également Compatible avec cette Version de l'Écarteur Circulaire Obadia  
También es Compatible con esta Versión del Separador Circular Obadia



**DC82153-30**

a : 70 mm - b : 30 mm

1 Pair of Blades - 1 Paire de Valves - 1 Pares de Valvas

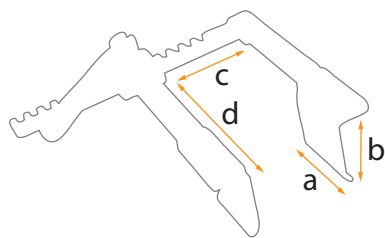



Yan Mini-Access Retractor / Écarteur Mini-Access Yan / Separador Mini-Access Yan

**DC82160-00**

c : 108 mm - d : 96 mm

Included - **Inclus - Incluidos**

DC82161-30 (pair / paire / par)

DC82161-40 (pair / paire / par)

DC82161-50 (pair / paire / par)

Prof. Yan Blades

Valves Pr Yan

Valvas Pr Yan

**DC82161-30**

a : 36 mm - b : 30 mm



**DC82161-40**

a : 36 mm - b : 40 mm

**DC82161-50**

a : 36 mm - b : 50 mm

**DC82161-60**

a : 36 mm - b : 60 mm

**DC82161-70**

a : 36 mm - b : 70 mm

NEW  
NOUVEAU  
NUEVO

NEW  
NOUVEAU  
NUEVO



**DC82160-00**

c : 108 mm - d : 96 mm

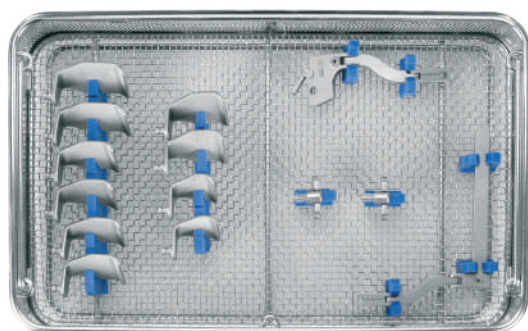

**DC82169-00**

NEW  
NOUVEAU  
NUEVO

Special Tray for Full Retractor System

Provided with Lid and Accessories, Instruments not Included

Panier Spécial pour le Système d'Écarteur Complet

Livré avec Couvercle et Accessoires, Instruments non Inclus

Cesto Especial para el Sistema Retractor Completo

Entregado con Tapa y Accesorios, Instrumentos no Incluidos

No Scale / Pas d'Échelle / Sin Escala

Products presented on this page are **NOT** compatible with ThorAccess retractors  
Les produits de cette page ne sont **PAS** compatibles avec les écarteurs ThorAccess  
Los productos de esta página **NO** son compatibles con separadores ThorAccess

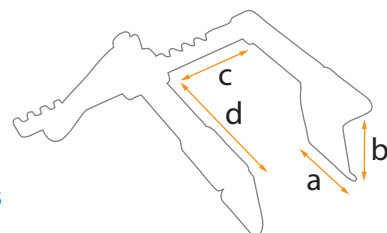

Yan Mini-Access Retractor / Écarteur Mini-Access Yan / Separador Mini-Access Yan

Yan

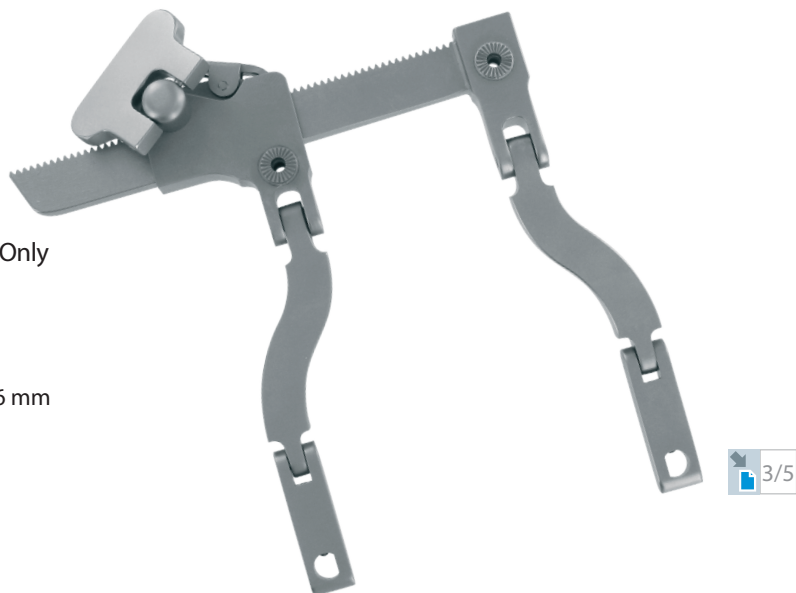

Retractor Frame Only  
Cadre Seul  
Base Solo

**DC82160-99**

c : 108 mm - d : 96 mm



Standard Blades  
Valves Standards  
Valvas Estándar



**DC82162-30**

a : 36 mm - b : 30 mm



**DC82162-40**

a : 36 mm - b : 40 mm

**DC82162-50**

a : 36 mm - b : 50 mm

Dr. Yilmaz Blades  
Valves Dr Yilmaz  
Valvas Dr Yilmaz



**DC82163-30**

a : 15 mm - b : 30 mm



**DC82163-40**

a : 15 mm - b : 40 mm

**DC82163-50**

a : 15 mm - b : 50 mm



**DC82164-30**

a : 20 mm - b : 30 mm



**DC82164-40**

a : 20 mm - b : 40 mm

**DC82164-50**

a : 20 mm - b : 50 mm

Key Handle  
Poignée  
Manejar

**DC82165-35**

L : 35 mm

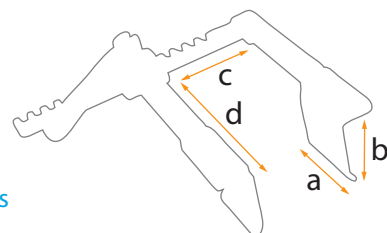

Products presented on this page are **NOT** compatible with ThorAccess retractors  
Les produits de cette page ne sont **PAS** compatibles avec les écarteurs ThorAccess  
Los productos de esta página **NO** son compatibles con separadores ThorAccess

**DC82100-00**

c : 160 mm - d : 96 mm

Included - Inklus - Incluidos

DC82102-30 (pair / paire / par)

DC82102-40 (pair / paire / par)

DC82102-50 (pair / paire / par)

DC82120-30

DC82121-16

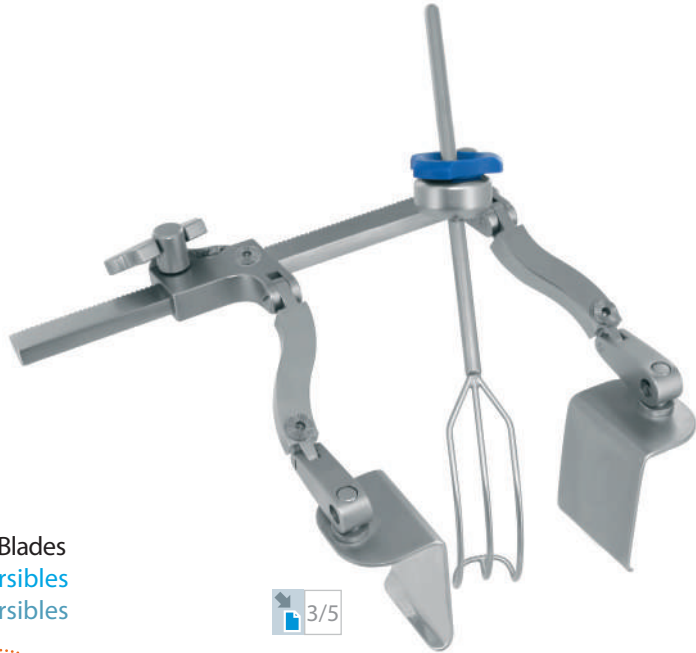

3/5

Swivel Standard Blades  
Valves Standard Rotatives  
Valvas Rotativas Estándar



Up & Down Blades  
Valves Réversibles  
Valvas Reversibles



Retractor Frame Only  
Cadre Seul  
Base Solo

**DC82100-99**

c : 160 mm - d : 96 mm

**DC82101-30**

a : 28 mm - b : 30 mm

**DC82101-40**

a : 28 mm - b : 40 mm

**DC82101-50**

a : 28 mm - b : 50 mm

**DC82102-30**

a : 36 mm - b : 30 mm



**DC82102-40**

a : 36 mm - b : 40 mm

**DC82102-50**

a : 36 mm - b : 50 mm

**DC82103-30**

a : 44 mm - b : 30 mm

**DC82103-40**

a : 44 mm - b : 40 mm

**DC82103-50**

a : 44 mm - b : 50 mm

**DC82111-30**

a : 28 mm - b : 30 mm

**DC82111-40**

a : 28 mm - b : 40 mm

**DC82111-50**

a : 28 mm - b : 50 mm

**DC82112-30**

a : 36 mm - b : 30 mm



**DC82112-40**

a : 36 mm - b : 40 mm

**DC82112-50**

a : 36 mm - b : 50 mm

**DC82113-30**

a : 44 mm - b : 30 mm

**DC82113-40**

a : 44 mm - b : 40 mm

**DC82113-50**

a : 44 mm - b : 50 mm

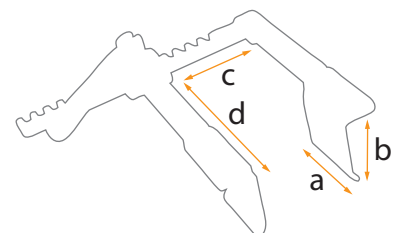

Intercostal ThorAccess Retractors / Écarteurs ThorAccess Intercostaux / Separadores ThorAccess Intercostal

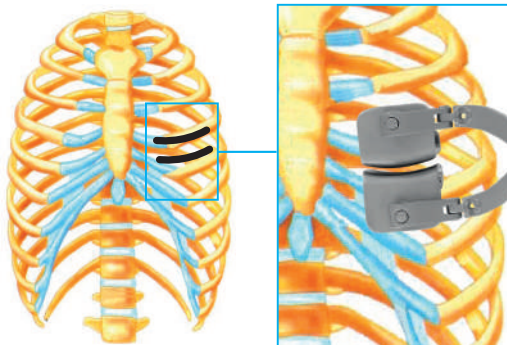

ThorAccess Retractor with Anatomical Blades  
Écarteur ThorAccess avec Valves Anatomiques  
ThorAccess Separador con Valvas Anatómicas

Reversible ThorAccess Retractor with Anatomical Blades  
Écarteur ThorAccess Réversible avec Valves Anatomiques  
ThorAccess Reversible Separador con Valvas Anatómicas

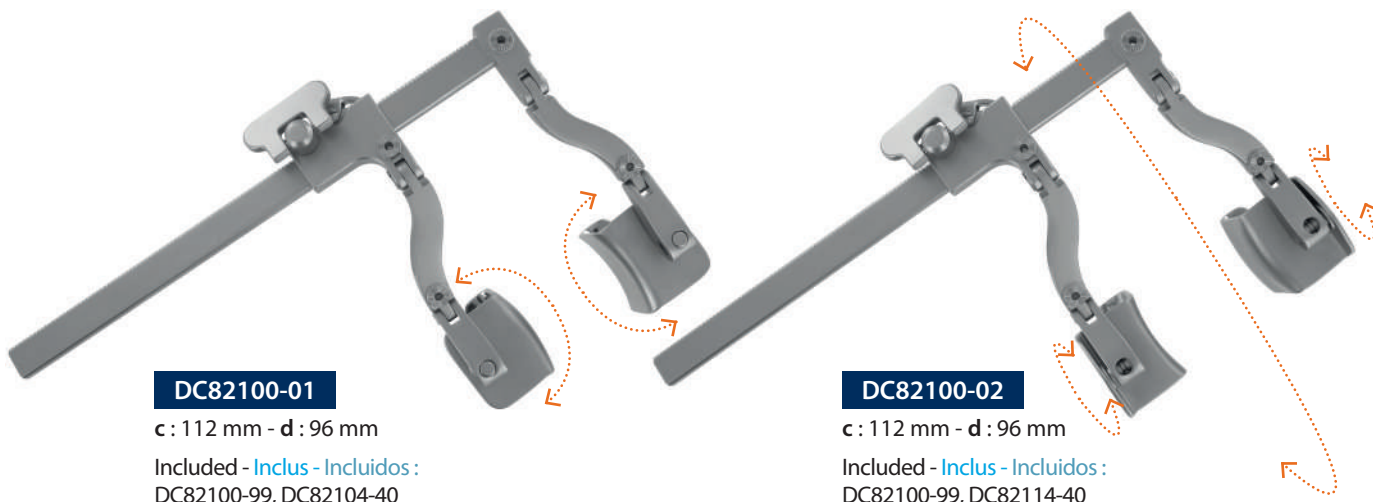

**DC82100-01**

c : 112 mm - d : 96 mm

Included - Inklus - Incluidos :  
DC82100-99, DC82104-40

**DC82100-02**

c : 112 mm - d : 96 mm

Included - Inklus - Incluidos :  
DC82100-99, DC82114-40

Swivel Standard Blades  
Valves Standard Rotatives  
Valvas Rotativas Estándar



**DC82104-40**

a : 36 mm - b : 40 mm

Up & Down Blades  
Valves Réversibles  
Valvas Reversibles



**DC82114-40**

a : 36 mm - b : 40 mm

Up & Down Blades With Light  
Valves Lumineuses et Rotatives  
Valvas Luminosas y reversibles



**DC82115-40**

a : 36 mm - b : 40 mm

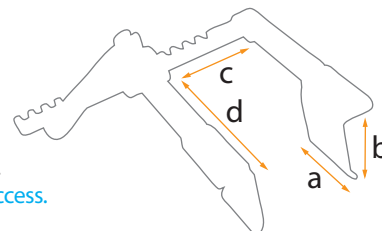

All products on this page are compatible with each other - They are not compatible with SternAccess.  
Tous les produits de cette page sont compatibles entre eux - Non compatibles avec la version SternAccess.  
Todos los productos de esta página son compatibles entre sí - No son compatibles con SternAccess.



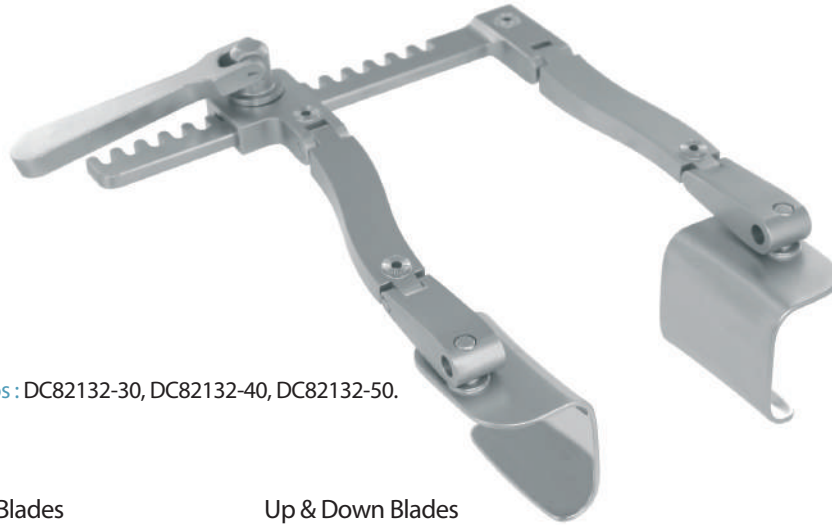

**DC82130-00**

c : 115 mm - d : 130 mm

Included - Inklus - Incluidos : DC82132-30, DC82132-40, DC82132-50.

Swivel Standard Blades  
Valves Standard Rotatives  
Valvas Rotativas Estándar



**DC82131-30**

a : 36 mm - b : 30 mm

**DC82131-40**

a : 36 mm - b : 40 mm

**DC82131-50**

a : 36 mm - b : 50 mm

**DC82132-30**

a : 50 mm - b : 30 mm

 **DC82132-40**

a : 50 mm - b : 40 mm

**DC82132-50**

a : 50 mm - b : 50 mm

**DC82133-30**

a : 64 mm - b : 30 mm

**DC82133-40**

a : 64 mm - b : 40 mm

**DC82133-50**

a : 64 mm - b : 50 mm

Up & Down Blades  
Valves Réversibles  
Valvas Reversibles



**DC82141-30**

a : 36 mm - b : 30 mm

**DC82141-40**

a : 36 mm - b : 40 mm

**DC82141-50**

a : 36 mm - b : 50 mm

**DC82142-30**

a : 50 mm - b : 30 mm

 **DC82142-40**

a : 50 mm - b : 40 mm

**DC82142-50**

a : 50 mm - b : 50 mm

**DC82143-30**

a : 64 mm - b : 30 mm

**DC82143-40**

a : 64 mm - b : 40 mm

**DC82143-50**

a : 64 mm - b : 50 mm

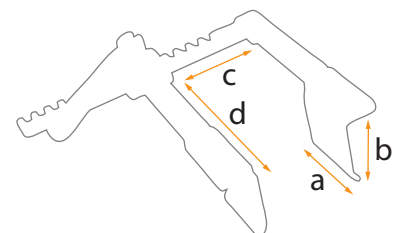

Connectors - Fixations - Fijaciones



**DC82120-30**

3D Arm - Bras 3D - Brazo 3D  
L : 30 mm



**DC82120-50**

3D Arm - Bras 3D - Brazo 3D  
L : 50 mm



**DC82120-90**

3D Arm - Bras 3D - Brazo 3D  
L : 30 mm - 90°



**DC82120-95**

Additional 3D Arm - Bras 3D Additionnel - Brazo 3D Adicional  
L : 90 mm



**DC82125-05**

Attachment bracket Extension - Bras de Fixation - Brazo de Fijación  
L : 115 mm

Accessories - Accessoires - Accesorios



**DC82121-16**

Wire Hook - Valve en Fil - Valva en Hilo  
L : 160 mm - a : 19 mm - b : 28 mm

**DC82121-20**

Wire Hook - Valve en Fil - Valva en Hilo  
L : 200 mm - a : 28 mm - b : 38 mm



**DC82124-30**

Additional Blade - Valve Additionnelle - Valva Adicional  
L : 155 mm - a : 35 mm - b : 30 mm

\* Compatible with / Compatibles avec / Compatibles con :

DC82100-00, DC82100-01, DC82100-02, DC82100-99, DC82130-00, DC82160-00, DC82160-99

Malleable Spatula - Spatule Malléable - Espátula Maleable



**DC82122-22**

L : 220 mm - a : 15 mm - b : 65 mm



**DC82122-24**

L : 240 mm - a : 20 mm - b : 80 mm



**DC82122-26**

L : 260 mm - a : 25 mm - b : 95 mm

\* Compatible with / Compatibles avec / Compatibles con :  
DC82100-00, DC82100-01, DC82100-02, DC82100-99, DC82130-00, DC82160-00, DC82160-99

Double Hinged Retractor / Écarteur Double Articulation / Separador de Doble Articulación



**DC32300-00**

c max : 130 mm - d : 100 mm

Included 3 Pairs of Blades - 3 Paires de Valves Incluses - 3 Pares de Valvas Incluidas

a : 35 mm - b : 35 mm

a : 35 mm - b : 50 mm

a : 35 mm - b : 63 mm

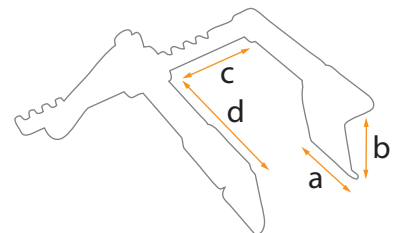

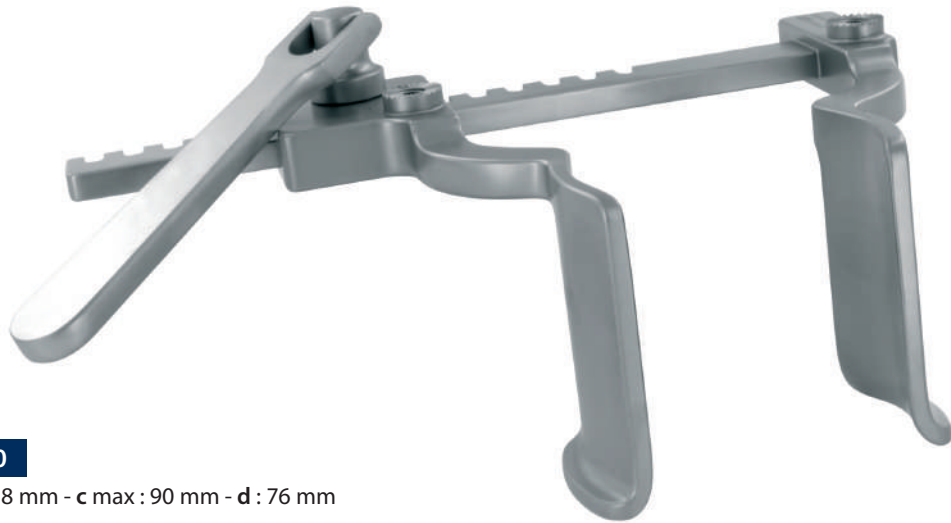

**DC81000-00**

a : 37 mm - b : 58 mm - c max : 90 mm - d : 76 mm



**DC32900-00**

Fixation System with Wire Hook for MIS Retractor

Valve en Fil et Système de Fixation pour Écarteur de Chirurgie Mini-Invasive

Valva en Hilo y Sistema de Fijación para Separador de Cirugía Mínimamente-Invasiva

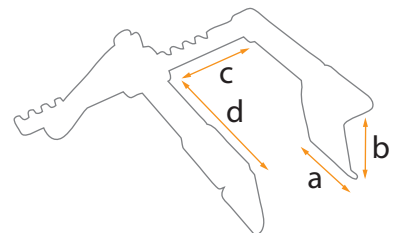

FINOCHIETTO-MATHEY

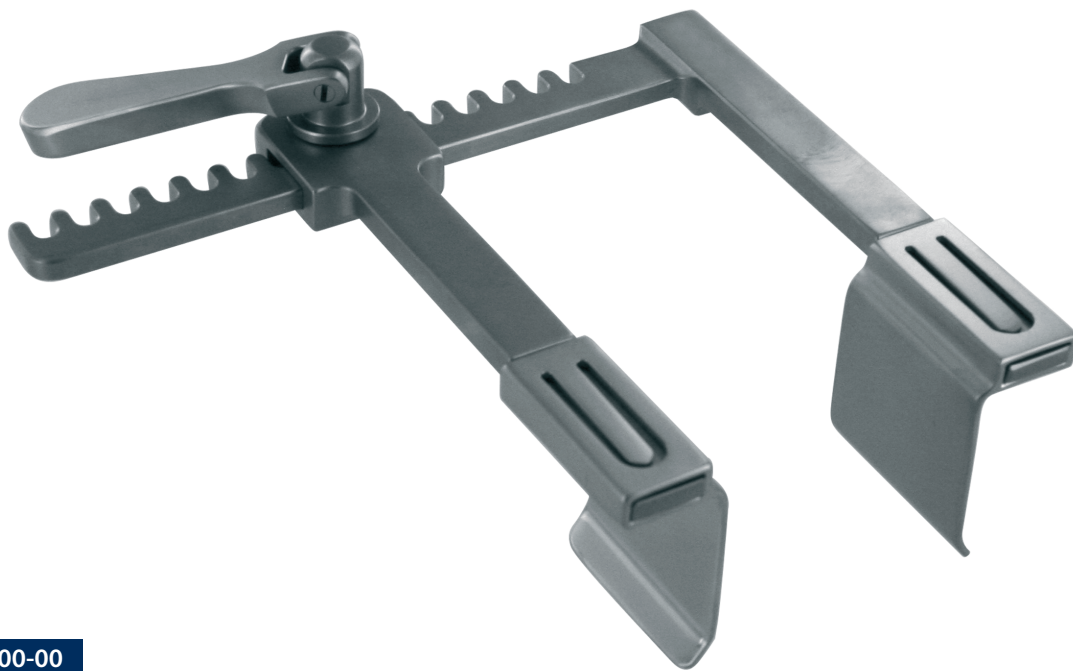

**DC30600-00**

c max : 130 mm - d : 105 mm

Included 3 Pairs of Blades - 3 Paires de Valves Incluses - 3 Pares de Valvas Incluidas

a : 40 mm - b : 25 mm

a : 40 mm - b : 35 mm

a : 40 mm - b : 40 mm

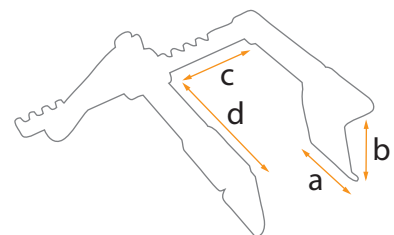



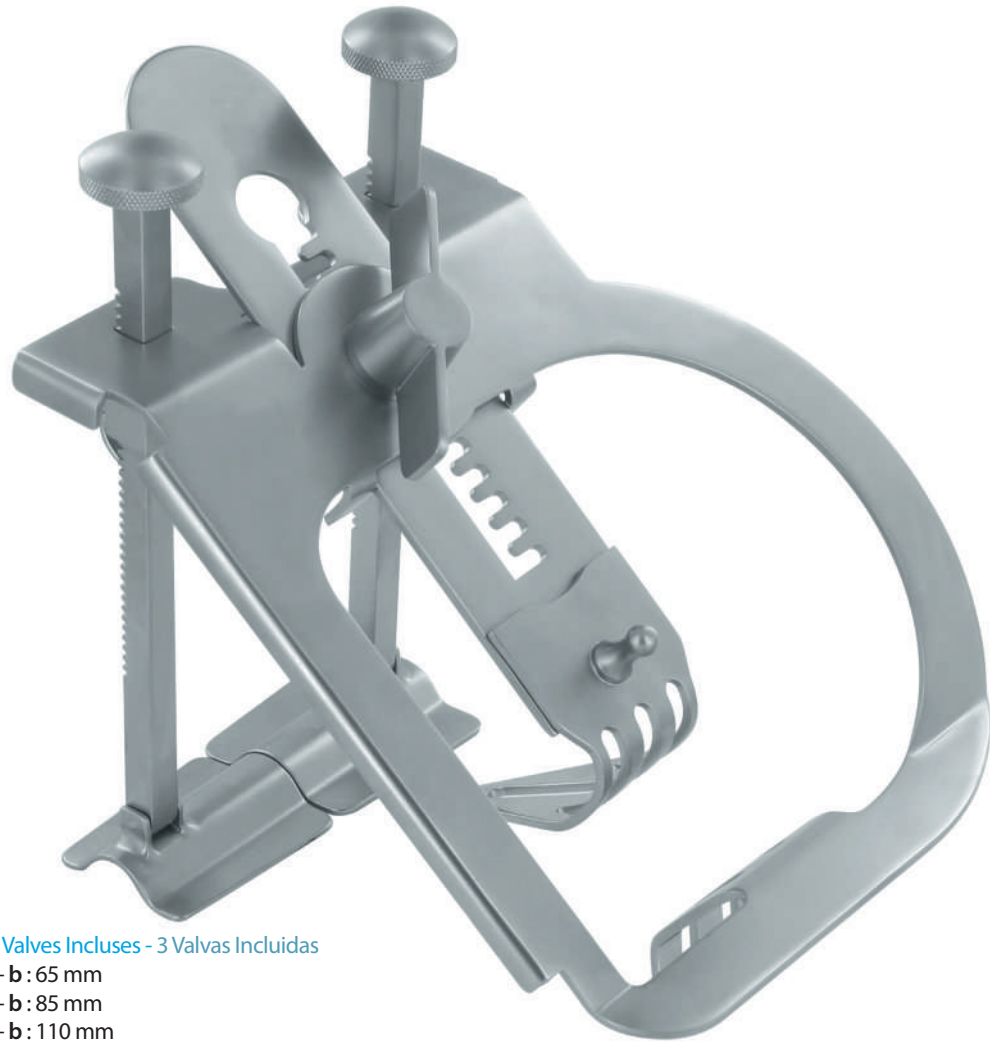

**DC82200-00**

Included 3 Blades - 3 Valves Incluses - 3 Valvas Incluidas

- a : 40 mm - b : 65 mm
- a : 40 mm - b : 85 mm
- a : 40 mm - b : 110 mm

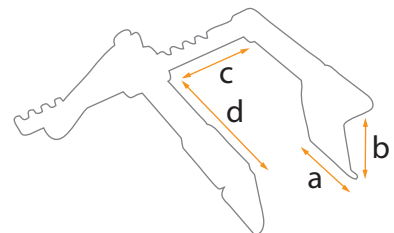

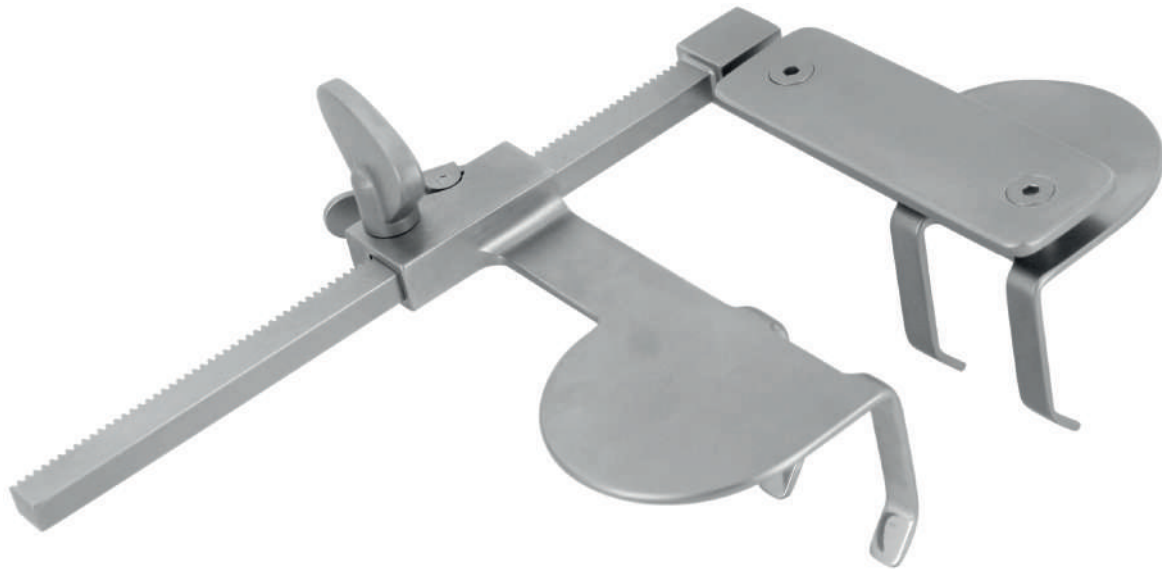

**DC82210-00**

a : 34 mm - b : 34 mm - c max : 110 mm - d : 82 mm

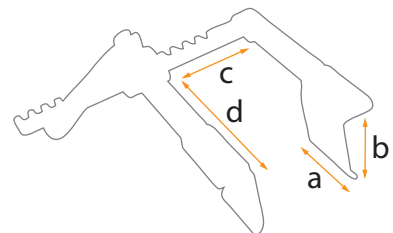



Mini-Sternotomy Retractor / Écarteur pour Mini-Sternotomie / Separador para Mini-Esternotomía

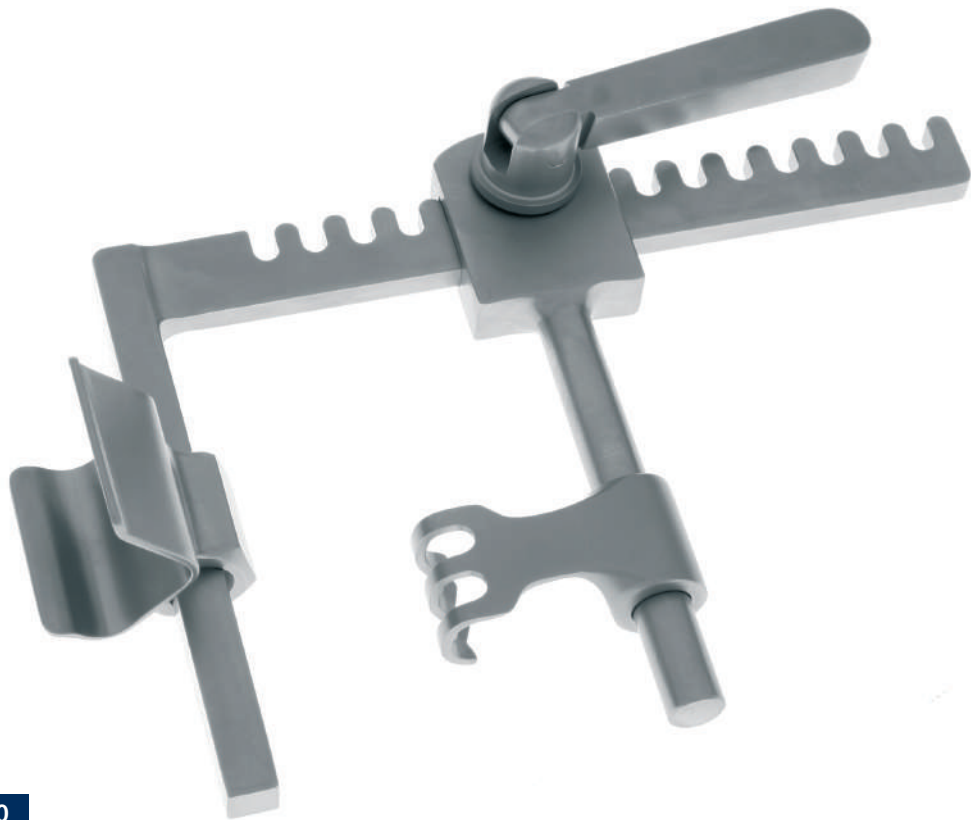

**DC30300-00**

a : 30 mm - b : 20 mm - c max : 120 mm - d : 75 mm

Included - Inklus - Incluidos : DC30222-38 - Hook - Crochet - Gancho - L : 38 mm  
DC30223-43 - Hook - Crochet - Gancho - L : 43 mm  
DC30212-20 - "U" shape Blade - Valve "U" - Válvula "U" - a : 38 mm

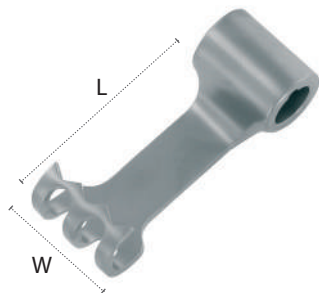

**DC30222-38**

L : 38 mm - W : 20 mm

**DC30223-43**

L : 43 mm - W : 20 mm



"U" Shape  
Valve "U"  
Válvula "U"

**DC30212-20**

a : 38 mm

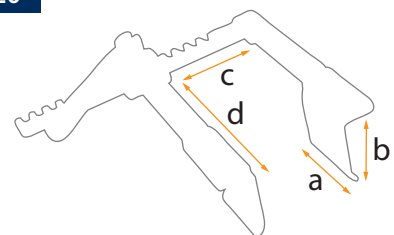

Direct Vision Intercostal Retractor / Écarteur Intercostal Direct Vision / Separador Intercostal Direct Visión

Soft Tissue Malleable Blades  
Lames Malléables pour Tissus Mous .....  
Hojas Maleables para Tejidos Blandos

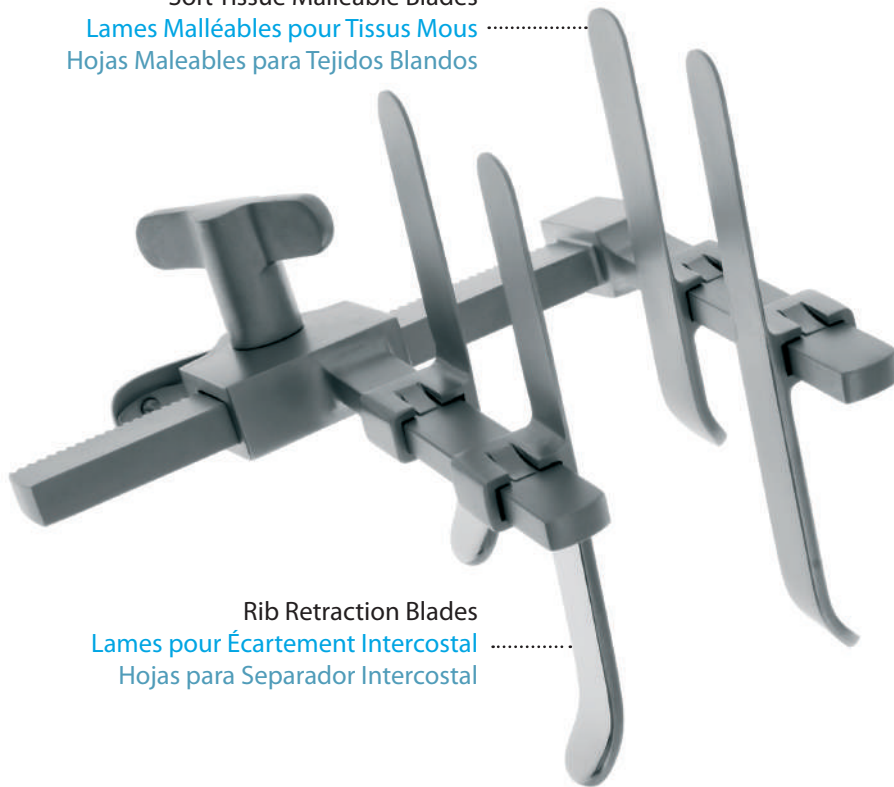

Rib Retraction Blades  
Lames pour Écartement Intercostal .....  
Hojas para Separador Intercostal

**DC30800-00**

a : 11 mm - c max : 90 mm - d : 80 mm

Included - Inklus - Incluidos : DC30810-25 (pair / paire / pares) - a : 11 mm - b : 25 mm  
DC30813-55 (pair / paire / pares) - a : 11 mm - b : 55 mm



**DC30810-25**

a : 11 mm - b : 25 mm



**DC30811-35**

a : 11 mm - b : 35 mm



**DC30812-45**

a : 11 mm - b : 45 mm



**DC30813-55**

a : 11 mm - b : 55 mm

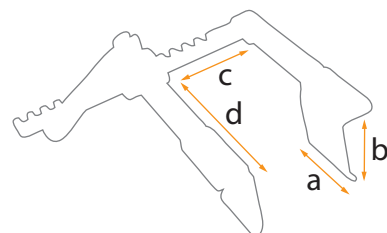

Yilmaz



**DC81010-00**  
L : 220 mm - 8 1/5"



Sarraj



**DC81020-00**  
L : 210 mm - 8"

**NEW**  
**NOUVEAU**  
**NUEVO**

**Registered Design**  
**Modèle déposé**  
**Diseño registrado**

Gossot

NEW  
NOUVEAU  
NUEVO

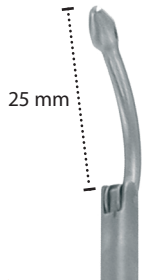

 **DC82940-38**  
L : 380 mm - 15"

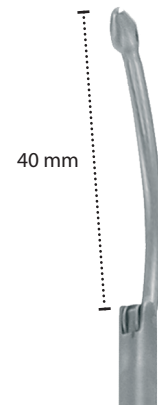

**DC82940-40**  
L : 400 mm - 16"

Gossot



**DC82950-38**

L : 380 mm - 15" - Ø : 10 mm

Gossot

Reusable / Réutilisable / Reutilizable

Serrated Tube - Tube Strié - Tubo Acanalado



**DC82960-07**

L: 70 mm - 2<sup>3/4</sup>" - Ø: 3,5 mm

**DC82960-10**

L: 100 mm - 4" - Ø: 3,5 mm

**DC82961-07**

L: 70 mm - 2<sup>3/4</sup>" - Ø: 5 mm

**DC82961-10**

L: 100 mm - 4" - Ø: 5 mm

**DC82962-07**

L: 70 mm - 2<sup>3/4</sup>" - Ø: 10 mm

**DC82962-10**

L: 100 mm - 4" - Ø: 10 mm



**DC82963-07**

L: 70 mm - 2<sup>3/4</sup>" - Ø: 12 mm

**DC82963-10**

L: 100 mm - 4" - Ø: 12 mm

**DC82966-07**

L: 70 mm - 2<sup>3/4</sup>" - Ø: 6 mm



**DC82966-10**

L: 100 mm - 4" - Ø: 6 mm



DC82966 Compatible with Robust 6 mm Jaws Needle Holder  
DC82966 Compatible avec Porte Aiguille Robuses Mors 6 mm  
DC82966 Compatible sin Portaaguja Robusto Serradas de 6 mm

Threaded Tube - Tube Fileté - Tubo Roscado



**DC82964-07**

L: 70 mm - 2<sup>3/4</sup>" - Ø: 10 mm

**DC82964-10**

L: 100 mm - 4" - Ø: 10 mm

Gossot

Reusable / Réutilisable / Reutilizable

Flexible - Flexible - Flexible



DC82965-70

L : 70 mm - 2<sup>3/4</sup>" - Ø : 5 mm

Smooth Tube - Tube Lisse - Tubo Liso



DC82970-07

L : 70 mm - 2<sup>3/4</sup>" - Ø : 16 x 25 mm

DC82970-10

L : 100 mm - 4" - Ø : 16 x 25 mm

Disposable / Usage Unique / Desechable

Blood Deflecting Trocar - Trocart Anti-Goutte - Trócar Deflector de Sangre



Registered Design  
Modèle déposé  
Diseño registrado



E229121 \*

L : 70 mm - 2<sup>3/4</sup>" - Ø : 12 mm

For Ø 10mm Endoscope

Pour Endoscope Ø 10 mm

Para endoscopio de Ø 10 mm

\* For regulatory reason, please check with your distributor for availability in your country

\* Por razones reglamentarias, por favor póngase en contacto con su distribuidor para conocer la disponibilidad en su país



Gossot

Magnetic Trocars / Trocarts Magnétiques / Trocares Magnéticos

Serrated Tube - Tube Strié - Tubo Acanalado



**DC82980-07**

L: 70 mm - 2<sup>3/4</sup>" - Ø: 3.5 mm

NEW  
NOUVEAU  
NUEVO

**DC82981-07**

L: 70 mm - 2<sup>3/4</sup>" - Ø: 5 mm

**DC82981-10**

L: 100 mm - 4" - Ø: 5 mm

**DC82982-07**

L: 70 mm - 2<sup>3/4</sup>" - Ø: 10 mm



**DC82982-10**

L: 100 mm - 4" - Ø: 10 mm

**DC82983-07**

L: 70 mm - 2<sup>3/4</sup>" - Ø: 12 mm

**DC82983-10**

L: 100 mm - 4" - Ø: 12 mm

**DC82984-07**

L: 70 mm - 2<sup>3/4</sup>" - Ø: 6 mm

NEW  
NOUVEAU  
NUEVO

**DC82984-10**

L: 100 mm - 4" - Ø: 6 mm

NEW  
NOUVEAU  
NUEVO

DC82984 Compatible with Robust 6 mm Jaws Needle Holder  
DC82984 Compatible avec Porte Aiguille Robuses Mors 6 mm  
DC82984 Compatible sin Portaagujas Robusto Serradas de 6 mm



Disposable / Usage Unique / Uso único

NEW  
NOUVEAU  
NUEVO



**E229006** \*

L: 70 mm - 2<sup>3/4"</sup> - Ø: 6 mm



**E229011** \*

L: 70 mm - 2<sup>3/4"</sup> - Ø: 11 mm

**E229013** \*

L: 70 mm - 2<sup>3/4"</sup> - Ø: 13 mm

**E229015** \*

L: 70 mm - 2<sup>3/4"</sup> - Ø: 15 mm

Obadia

Adjustable Length - [Longueur Réglable](#) - [Longitud Ajustable](#)



**DC81301-00**

L mini : 290 mm - 11<sup>2/5</sup>" - L maxi : 360 mm - 14<sup>1/5</sup>"

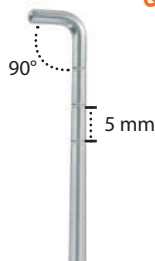

Adjustable Length - [Longueur Réglable](#) - [Longitud Ajustable](#)

**DC81301-01**

L mini : 200 mm - 7<sup>4/5</sup>" - L maxi : 270 mm - 10<sup>3/5</sup>"

Fixed Length - [Longueur Fixe](#) - [Longitud Fija](#)

**DC81301-30**

L : 300 mm - 11<sup>4/5</sup>"

Adjustable Length - [Longueur Réglable](#) - [Longitud Ajustable](#)

**DC81304-00**

L mini : 290 mm - 11<sup>2/5</sup>" - L maxi : 360 mm - 14<sup>1/5</sup>"

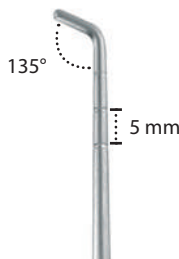

Fixed Length - [Longueur Fixe](#) - [Longitud Fija](#)

**DC81304-30**

L : 300 mm - 11<sup>4/5</sup>"

With Ball Tip - [À Embout Sphérique](#) - [Con Punta Esférica](#)

Adjustable Length - [Longueur Réglable](#) - [Longitud Ajustable](#)

**DC81302-00**

L mini : 290 mm - 11<sup>2/5</sup>" - L maxi : 360 mm - 14<sup>1/5</sup>"

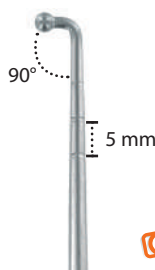

Fixed Length - [Longueur Fixe](#) - [Longitud Fija](#)



**DC81302-30**

L : 300 mm - 11<sup>4/5</sup>"

With Sabot - [À Sabot](#) - [Con Retorno](#)

Adjustable Length - [Longueur Réglable](#) - [Longitud Ajustable](#)

**DC81307-00**

L mini : 290 mm - 11<sup>2/5</sup>" - L maxi : 360 mm - 14<sup>1/5</sup>"

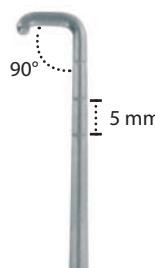

Fixed Length - [Longueur Fixe](#) - [Longitud Fija](#)

**DC81307-30**

L : 300 mm - 11<sup>4/5</sup>"

Adjustable Length  
[Longueur Réglable](#)  
Longitud ajustable

DC81301-00

DC81302-30



Yilmaz



Fixed Length  
Longueur Fixe  
Longitud Fija

Ø : 0.5 mm



 **DC81305-21**

L : 210 mm - 8 <sup>1</sup>/<sub>5</sub>"

**DC81305-30**

L : 300 mm - 11 <sup>4</sup>/<sub>5</sub>"



Obadia

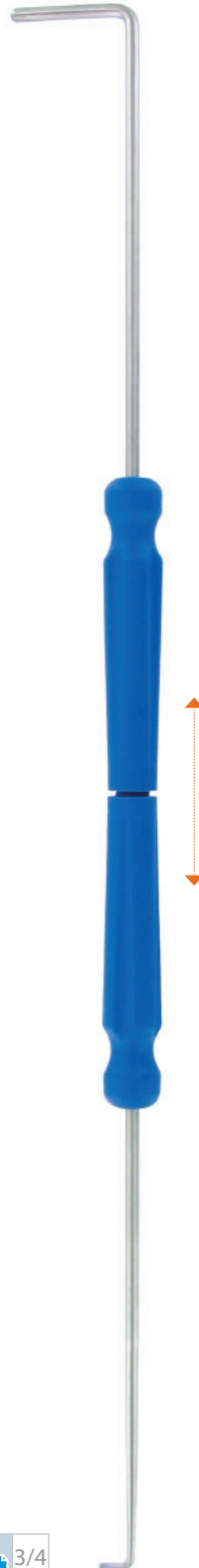

With Sliding Handle  
Avec Manche Coulissant  
Con Mango Corredero



**DC81303-33**

L : 330 mm - 13"



Clamp Chapter / Chapitre Clamps / Capítulo Pinzas

GRASPING FORCEPS / PINCES À PRÉHENSION / PINZAS DE AGARRE



MICROMICS GRASPING FORCEPS / PINCES À PRÉHENSION MICROMICS / PINZAS DE AGARRE MICROMICS

Ø 3.5 mm / Ø 5 mm



TRANSTHORACIC CLAMPS / PINCES À PRÉHENSION / PINZAS DE AGARRE

DeBakey

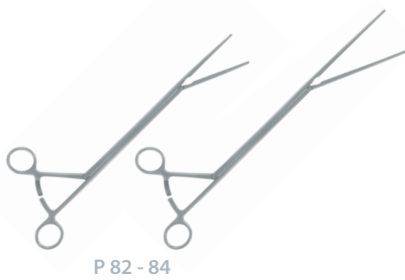



Ø 3 mm



Only One Mobile Jaw  
Un Seul Mors Mobile  
Sólo Una Boca Móvil

Registered Design  
Modèle déposé  
Diseño registrado

Straight  
Droite  
Recta



DC83216-36

L : 360 mm - 14 1/5"

DC83216-44

L : 440 mm - 17 1/3"

NEW  
NOUVEAU  
NUEVO

Progressive Locking System  
Crémaillère Progressive  
Cremallera Progressiva

Titanium *line*

Ø 3.5 mm



Straight  
Droite  
Recta

3.5 mm



20 mm

DC80242-40

L : 400 mm - 15 3/4"





Grasping Fenestrated Forceps / Pinces à Préhension Fenêtrées / Pinzas de Agarre Fenestradas

Registered Design  
Modèle déposé  
Diseño registrado

Ø 5 mm

To be Used with  
Flexible Trocar DC82965-70  
À Utiliser avec un  
Trocart Flexible DC82965-70  
Usar con un  
Trocar Flexible DC82965-70

Straight  
Droite  
Recta

Curved Shaft  
Tube Courbe  
Tubo curvado

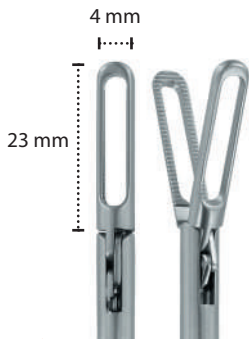

DC83213-36

L : 360 mm - 14 1/5"

**DC83213-44**

L : 440 mm - 17 1/3"

Progressive Locking System  
Crémaillère Progressive  
Cremallera Progressiva

DC83221-44

L : 440 mm - 17 1/3"

Without Locking System  
Sans Crémaillère  
Sin Cremallera

**DC83213-36WR**

L : 360 mm - 14 1/5"

**DC83213-44WR**

L : 440 mm - 17 1/3"

NEW  
NOUVEAU  
NUEVO

NEW  
NOUVEAU  
NUEVO

NEW  
NOUVEAU  
NUEVO

Titanium *line*



Lymph Node Forceps / Pincas à Ganglions / Pinzas para Ganglio

Registered Design  
Modèle déposé  
Diseño registrado

Gossot  
Ø 5 mm

Straight  
Droite  
Recta



DC83210-36

L : 360 mm - 14 1/5"

DC83210-44

L : 440 mm - 17 1/3"

Straight  
Droite  
Recta



DC83211-36

L : 360 mm - 14 1/5"

DC83211-44

L : 440 mm - 17 1/3"



Progressive Locking System  
Crémaillère Progressive  
Cremallera Progressiva

Titanium *line*

Yilmaz

**NEW**  
**NOUVEAU**  
**NUEVO**

**Registered Design**  
**Modèle déposé**  
**Diseño registrado**

Straight  
Droite  
Recta

Ø 3.5 mm

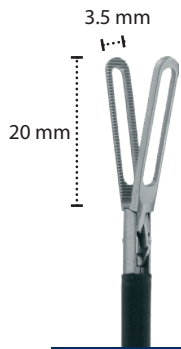

**DC84242-45**

WL: 280 mm - 11"  
L : 450 mm - 17<sup>4/5</sup>"

Straight  
Droite  
Recta

Ø 5.0 mm

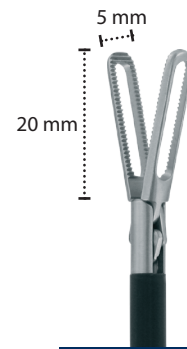

**DC84243-45**

WL: 280 mm - 11"  
L : 450 mm - 17<sup>4/5</sup>"

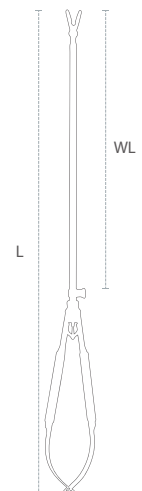

CHITWOOD DEBAKEY

1x2 DeBakey

65mm Jaws Length  
Longueur Mors 65 mm  
Longitud Bocas 65 mm

2x3 DeBakey



**DC80993-26**

L : 265 mm - 10 1/2"

**DC80993-32**

L : 320 mm - 12 3/4"



**DC80993-36**

L : 360 mm - 14 1/4"



**DC80994-26**

L : 265 mm - 10 1/2"

**DC80994-32**

L : 320 mm - 12 3/4"

**DC80994-36**

L : 360 mm - 14 1/4"

45° Angled Shanks  
Branches Coudées 45°  
Bocas Anguladas 45°

**DC80993-26C**

L : 260 mm - 10 1/2"



CHITWOOD DEBAKEY

1x2 DeBakey

80 mm Jaws Length  
Longueur Mors 80 mm  
Longitud Bocas 80 mm

2x3 DeBakey



**DC80995-26**

L : 265 mm - 10 1/2"

**DC80995-32**

L : 320 mm - 12 3/4"

 **DC80995-36**

L : 360 mm - 14 1/4"



**DC80996-26**

L : 265 mm - 10 1/2"

**DC80996-32**

L : 320 mm - 12 3/4"

**DC80996-36**

L : 360 mm - 14 1/4"

CHITWOOD DEBAKEY

100 mm Jaws Length  
Longueur Mors 100 mm  
Longitud Bocas 100 mm

1x2 DeBakey

2x3 DeBakey



**DC80997-26**

L : 265 mm - 10<sup>1</sup>/<sub>2</sub>"

**DC80997-32**

L : 320 mm - 12<sup>3</sup>/<sub>4</sub>"



**DC80997-36**

L : 360 mm - 14<sup>1</sup>/<sub>4</sub>"



**DC80998-26**

L : 265 mm - 10<sup>1</sup>/<sub>2</sub>"

**DC80998-32**

L : 320 mm - 12<sup>3</sup>/<sub>4</sub>"

**DC80998-36**

L : 360 mm - 14<sup>1</sup>/<sub>4</sub>"

NEEDLE HOLDERS / PORTE-AIGUILLES / PORTA AGUJAS

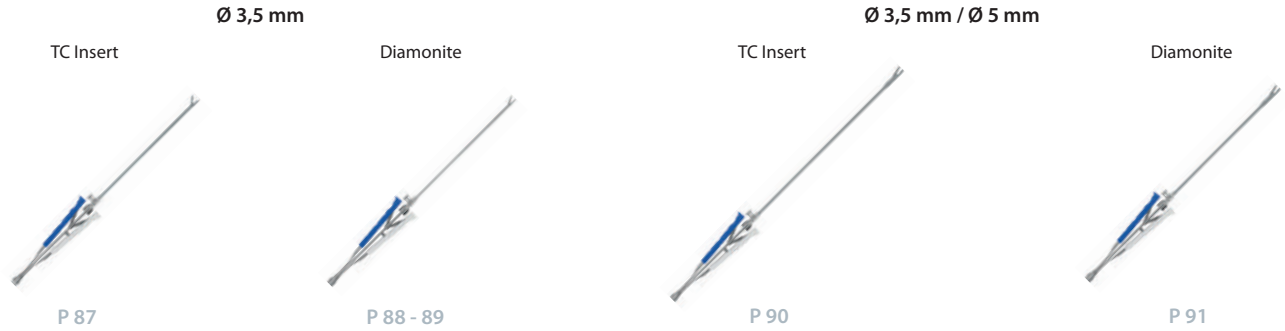

MICROMICS NEEDLE HOLDERS / PORTE-AIGUILLES MICROMICS / PORTA AGUJAS MICROMICS



KNOT PUSHERS / POUSSE-NOEUDS / EMPUJA NUDOS



MICROMICS KNOT PUSHERS / POUSSE-NOEUDS MICROMICS/ EMPUJA NUDOS MICROMICS

Ø 5 mm



P 105

TRANSTHORACIC KNOT PUSHERS / POUSSE-NOEUDS TRANSTHORACIQUES / EMPUJA NUDOS TRANSTORÁCICA

Ø 5 mm



P 106



Tungsten Carbide Needle Holders / Porte-Aiguilles Tungstène / Porta Agujas de Tungsteno

Ø 3.5 mm



TC Inserts



Easy Lock System

Patent  
Breveté  
Patentado

Suture from 9/0 to 6/0  
Suture de 9/0 à 6/0  
Sutura desde 9/0 hasta 6/0

Straight  
Droit  
Recta

Ryder



**DC80014-28**

L : 280 mm - 11"

Curved  
Courbe  
Curva



**DC80018-28**

L : 280 mm - 11"

**DC80018-36**

L : 360 mm - 14 1/5"

NEW  
NOUVEAU  
NUEVO

Diamonite Needle Holders / Porte-Aiguilles Diamonite / Porta Agujas de Diamonite

Ø 3.5 mm

Patent  
Breveté  
Patentado



Diamonite



Easy Lock  
System

Suture from 9/0 to 6/0  
Suture de 9/0 à 6/0  
Sutura desde 9/0 hasta 6/0

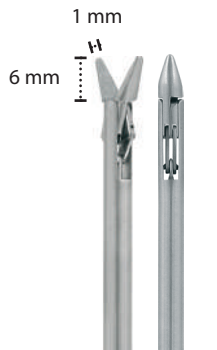

DC80040-28

L : 280 mm - 11"

NEW  
NOUVEAU  
NUEVO



Ø 3.5 mm

Patent  
Breveté  
Patentado



Diamonite



Easy Lock System

Suture from 9/0 to 6/0  
Suture de 9/0 à 6/0  
Sutura desde 9/0 hasta 6/0

Curved  
Courbe  
Curva

2.1 mm



**DC80017-28**

L : 280 mm - 11"

**DC80017-36**

L : 360 mm - 14<sup>1/5</sup>"

1.3 mm



**DC80015-28**

L : 280 mm - 11"

**DC80015-36**

L : 360 mm - 14<sup>1/5</sup>"

Tungsten Carbide Needle Holders / Porte-Aiguilles Tungstène / Porta Agujas de Tungsteno



TC Inserts



Easy Lock System

Ø 3.5 mm / Ø 5 mm

Suture from 8/0 to 5/0  
Suture de 8/0 à 5/0  
Sutura desde 8/0 hasta 5/0

Patent  
Breveté  
Patentado

Straight  
Droit  
Recta



DC80023-30

L : 300 mm - 11 4/5"

DC80023-36

L : 360 mm - 14 1/5"

NEW  
NOUVEAU  
NUEVO

Curved  
Courbe  
Curva



DC80022-30

L : 300 mm - 11 4/5"

DC80022-36

L : 360 mm - 14 1/5"



Ryder



DC80024-30

L : 300 mm - 11 4/5"

DC80024-36

L : 360 mm - 14 1/5"

NEW  
NOUVEAU  
NUEVO

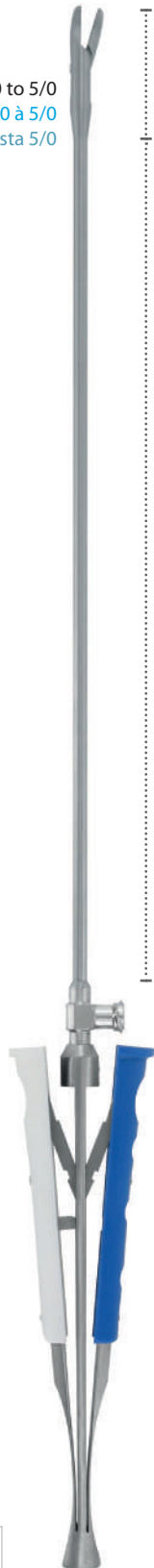

Ø 5 mm

Ø 3.5 mm

Diamonite Needle Holders / Porte-Aiguilles Diamonite / Porta Agujas de Diamonite



Diamonite



Easy Lock System

Patent  
Breveté  
Patentado

Ø 3.5 mm / Ø 5 mm

Suture from 8/0 to 5/0  
Suture de 8/0 à 5/0  
Sutura desde 8/0 hasta 5/0

Straight  
Droit  
Recta



DC80021-30

L : 300 mm - 11 4/5"

DC80021-36

L : 360 mm - 14 1/5"

NEW  
NOUVEAU  
NUEVO

NEW  
NOUVEAU  
NUEVO

Curved  
Courbe  
Curva



DC80020-30

L : 300 mm - 11 4/5"

DC80020-36

L : 360 mm - 14 1/5"

NEW  
NOUVEAU  
NUEVO

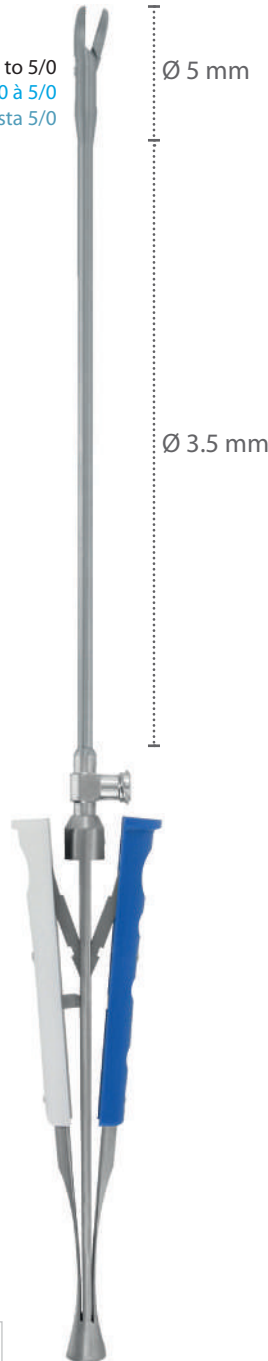

Diamonite Needle Holders / Porte-Aiguilles Diamonite / Porta Agujas de Diamonite



Diamonite



Easy Lock System

Ø 5 mm

Suture from 7/0 to 4/0  
Suture de 7/0 à 4/0  
Sutura desde 7/0 hasta 4/0

Patent  
Breveté  
Patentado

Straight  
Droit  
Recta



DC80011-30

L : 300 mm - 11 4/5"

NEW  
NOUVEAU  
NUEVO



DC80011-36

L : 360 mm - 14 1/5"

Curved  
Courbe  
Curva



DC80010-30

L : 300 mm - 11 4/5"

NEW  
NOUVEAU  
NUEVO

DC80010-36

L : 360 mm - 14 1/5"

Tungsten Carbide Needle Holders / Porte-Aiguilles Tungstène / Porta Agujas de Tungsteno



TC Inserts



Easy Lock System

Straight  
Droit  
Recta



**DC80013-25**

L : 250 mm - 10"

**DC80013-30**

L : 300 mm - 11 <sup>4</sup>/<sub>5</sub>"

**DC80013-36**

L : 360 mm - 14 <sup>1</sup>/<sub>5</sub>"

**DC80013-44**

L : 440 mm - 17 <sup>1</sup>/<sub>3</sub>"

Ryder



**DC80014-30**

L : 300 mm - 11 <sup>4</sup>/<sub>5</sub>"

**DC80014-36**

L : 360 mm - 14 <sup>1</sup>/<sub>5</sub>"

Ø 5 mm

Suture from 6/0 to 3/0  
Suture de 6/0 à 3/0  
Sutura desde 6/0 hasta 3/0



Patent  
Breveté  
Patentado

Curved  
Courbe  
Curva



**DC80012-25**

L : 250 mm - 10"

**DC80012-30**

L : 300 mm - 11 <sup>4</sup>/<sub>5</sub>"



**DC80012-36**

L : 360 mm - 14 <sup>1</sup>/<sub>5</sub>"

**DC80012-43**

L : 430 mm - 17"

Tungsten Carbide Needle Holders / Porte-Aiguilles Tungstène / Porta Agujas de Tungsteno



TC Inserts



Easy Lock System

Ø 5 mm

Suture from 6/0 to 3/0  
Suture de 6/0 à 3/0  
Sutura desde 6/0 hasta 3/0

NEW  
NOUVEAU  
NUEVO

Patent  
Breveté  
Patentado

Angles Upward  
Angulé vers le Haut  
Angulada Ariba





Tungsten Carbide Needle Holders / Porte-Aiguilles Tungstène / Porta Agujas de Tungsteno



TC Inserts

Ø 5 mm

Suture from 6/0 to 3/0  
Suture de 6/0 à 3/0  
Sutura desde 6/0 hasta 3/0

Straight  
Droit  
Recta



DC83003-36

L : 360 mm - 14 1/5"

DC83003-44

L : 440 mm - 17 1/3"

Curved  
Courbe  
Curva



DC83002-36

L : 360 mm - 14 1/5"

DC83002-44

L : 440 mm - 17 1/3"



Titanium  
*line*





TC Inserts



Easy Lock System

**Very Strong Tightening**  
**Préhension Puissante**  
**Apriete Muy Sólido**

Ø 5 mm / Ø 6 mm

Suture from 5/0 to 2/0  
Suture de 5/0 à 2/0  
Sutura desde 5/0 hasta 2/0

Patent  
Breveté  
Patentado

Straight  
Droit  
Recta



DC80009-25

L : 250 mm - 10"

DC80009-30

L : 300 mm - 11 4/5"

DC80009-36

L : 360 mm - 14 1/5"

DC80009-43

L : 430 mm - 17"

NEW  
NOUVEAU  
NUEVO

NEW  
NOUVEAU  
NUEVO

NEW  
NOUVEAU  
NUEVO

Curved  
Courbe  
Curva



DC80019-25

L : 250 mm - 10"

DC80019-30

L : 300 mm - 11 4/5"

DC80019-36

L : 360 mm - 14 1/5"

DC80019-43

L : 430 mm - 17"

NEW  
NOUVEAU  
NUEVO

NEW  
NOUVEAU  
NUEVO



TC Inserts

Ø 5 mm / Ø 6 mm

Suture from 5/0 to 2/0  
Suture de 5/0 à 2/0  
Sutura desde 5/0 hasta 2/0

Ø 6 mm

NEW  
NOUVEAU  
NUEVO

Patent  
Breveté  
Patentado

**Very Strong Tightening**  
**Préhension Puissante**  
**Apriete Muy Sólido**

Straight  
Droit  
Recta



DC83009-36

L : 360 mm - 14 1/5"

Curved  
Courbe  
Curva



DC83019-36

L : 360 mm - 14 1/5"

Ø 5 mm



Titanium *line*



Diamonite

Yilmaz  
Ø 3.5 mm

NEW  
NOUVEAU  
NUEVO

Registered Design  
Modèle déposé  
Diseño registrado

Two Mobile Jaws  
Deux Mors Mobiles  
Dos Bocas Moviles

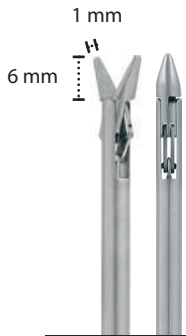

DC84040-26

WL : 90 mm - 3 1/2"  
L : 260 mm - 10"

Suture from 10/0 to 7/0  
Suture de 10/0 à 7/0  
Sutura desde 10/0 hasta 7/0

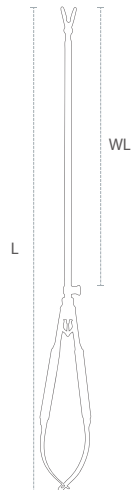

MicroMICS Needle Holder / Porte-Aiguilles MicroMICS / Porta-Agujas MicroMICS



Diamonite

Ø 3.5 mm

Suture from 9/0 to 6/0  
Suture de 9/0 à 6/0  
Sutura desde 9/0 hasta 6/0

NEW  
NOUVEAU  
NUEVO

Registered Design  
Modèle déposé  
Diseño registrado

2.1 mm



DC84017-41

WL : 240 mm - 9 1/2"  
L : 410 mm - 16"



MicroMICS Needle Holder / Porte-Aiguilles MicroMICS / Porta-Agujas MicroMICS



Diamonite

Ø 5 mm

Suture from 8/0 to 5/0  
Suture de 8/0 à 5/0  
Sutura desde 8/0 hasta 5/0

NEW  
NOUVEAU  
NUEVO

Registered Design  
Modèle déposé  
Diseño registrado

Straight  
Droite  
Recta



DC84011-41

WL : 240 mm - 9 1/2"  
L : 410 mm - 16"

Curved  
Courbe  
Curva



DC84010-41

WL : 240 mm - 9 1/2"  
L : 410 mm - 16"



MicroMICS Needle Holder / Porte-Aiguilles MicroMICS / Porta-Agujas MicroMICS



TC Inserts

Ø 5 mm

Suture from 7/0 to 4/0  
Suture de 7/0 à 4/0  
Sutura desde 7/0 hasta 4/0

NEW  
NOUVEAU  
NUEVO

Registered Design  
Modèle déposé  
Diseño registrado

Straight  
Droite  
Recta



**DC84013-33**

WL : 160 mm - 6 1/2"  
L : 330 mm - 12 4/5"

**DC84013-35**

WL : 180 mm - 7"  
L : 350 mm - 13 4/5"

**DC84013-41**

WL : 240 mm - 9 1/2"  
L : 410 mm - 16"

Curved  
Courbe  
Curva



**DC84012-35**

WL : 180 mm - 7"  
L : 350 mm - 13 4/5"

 **DC84012-41**

WL : 240 mm - 9 1/2"  
L : 410 mm - 16"



Active Knot Pushers / Pousse-Noeuds Actifs / Empuja-Nudos

Ø 3.5 mm / Ø 5 mm

Ø 5 mm

Ø 3.5 mm

Ø 5 mm

Patent  
Breveté  
Patentado



**DC80302-30**

L : 300 mm - 11 4/5"

NEW  
NOUVEAU  
NUEVO

**DC80302-36**

L : 360 mm - 14 1/5"

With Ratchet  
Avec Verrou  
Con Cerrojo

**DC80303-30**

L : 300 mm - 11 4/5"

NEW  
NOUVEAU  
NUEVO



**DC80303-36**

L : 360 mm - 14 1/5"

Without Ratchet  
Sans Verrou  
Sin Cerrojo

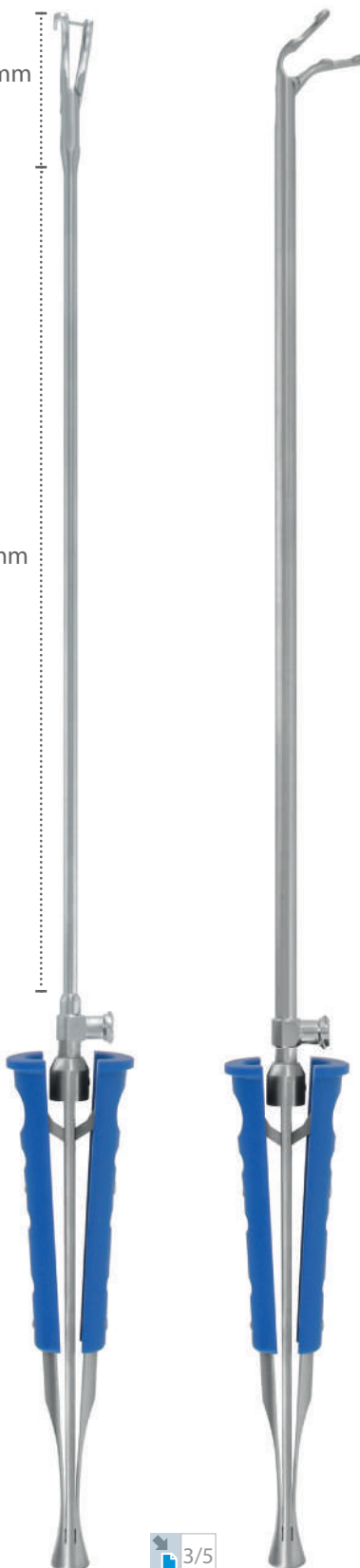

3/5



**DC80304-30**

L : 300 mm - 11 4/5"

NEW  
NOUVEAU  
NUEVO

**DC80304-36**

L : 360 mm - 14 1/5"

With Ratchet  
Avec Verrou  
Con Cerrojo

NEW  
NOUVEAU  
NUEVO

**DC80300-30**

L : 300 mm - 11 4/5"



**DC80300-36**

L : 360 mm - 14 1/5"

Without Ratchet  
Sans Verrou  
Sin Cerrojo



Knot Pushers / Pousse-Noeuds / Empuja-Nudos

Obadia

Yilmaz

Fixed Length  
Longueur Fixe  
Longitud Fija



**DC81308-28**

L : 280 mm - 11"

**DC81308-35**

L : 350 mm - 13<sup>3/4</sup>"

Adjustable Length  
Longueur Réglable  
Longitud Adjustable



**DC81308-00**

L mini : 290 mm - 11<sup>2/5</sup>"

L maxi : 360 mm - 14<sup>1/5</sup>"



Fixed Length  
Longueur Fixe  
Longitud Fija  
Ø 2 mm



**DC81323-21**

L : 210 mm - 8<sup>1/5</sup>"

**DC81323-30**

L : 300 mm - 11<sup>4/5</sup>"



Yan



**DC71710-50**

L : 50 mm - 2"

Ø 5 mm

NEW  
NOUVEAU  
NUEVO

Registered Design  
Modèle déposé  
Diseño registrado



**DC84300-35**

WL : 180 mm - 7"  
L : 350 mm - 13 <sup>4</sup>/<sub>5</sub>"



**DC84300-41**

WL : 240 mm - 9 <sup>1</sup>/<sub>2</sub>"  
L : 410 mm - 16"

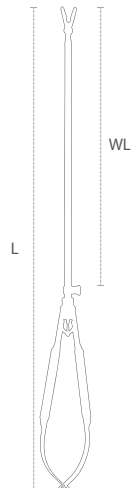
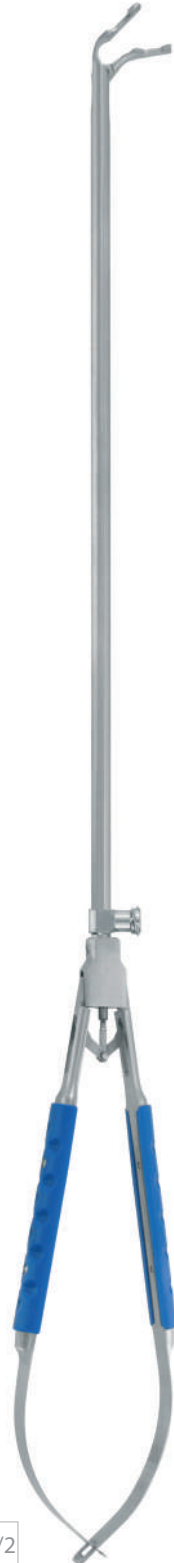

Knot-Pusher with Suture Cutter  
Pousse-noeuds avec Coupe-Suture  
Empuja-Nudos con Cortador de Suturas



DC80459-28

L: 280 mm - 11"

NEW  
NOUVEAU  
NUEVO



DC80459-34

L: 330 mm - 13"

DC80459-38

L: 380 mm - 14"

NEW  
NOUVEAU  
NUEVO

BIOPSY FORCEPS / PINCES À BIOPSIE / PINZAS DE BIOPSIA

Ø 2 mm / Ø 2.5 mm



P 109

SUTURE RULER / GABARITS / PLANTILLAS



P 110

ACCESSORIES / ACCESSOIRES / ACCESORIOS

Suture Catcher / Crochet à Suture / Gancho para Sutura

Needles Retriever / Récupérateur à Aiguilles / Recuperador de Agujas

Suture Ring / Anneau à Sutures / Anillo para Sutura



P 111



P 112



P 113

MIS CANNULAS / CANULE D'ASPIRATION MIS / CÁNULA DE ASPIRACIÓN MIS



P 114

MIS RONGEURS / RONGEURS MIS / GUBIAS



P 115



P 116



P 117

TUBE PASSERS / PASSES TUBES / TUBOS PAS    SCALPEL BLADE HANDLES / MANCHES DE BISTOURI / MANGOS DE BISTURÍ



P 118



P 119

INSTRUMENTS HOLDERS / PORTE INSTRUMENTS / SOPORTE DEL INSTRUMENTO

Gossot



P 120

TRAINER+ / TRAINER+ / TRAINER+



P 121

Ø 2 mm / Ø 2.5 mm

Round Angled Cupules Ø 2 mm  
Cupules Rondes Angulées Ø 2 mm  
Redondo Angulado Cupula Ø 2 mm



Angled Jaws 2x4 mm  
Mors Angulés 2x4 mm  
Bocas Anguladas 2x4 mm

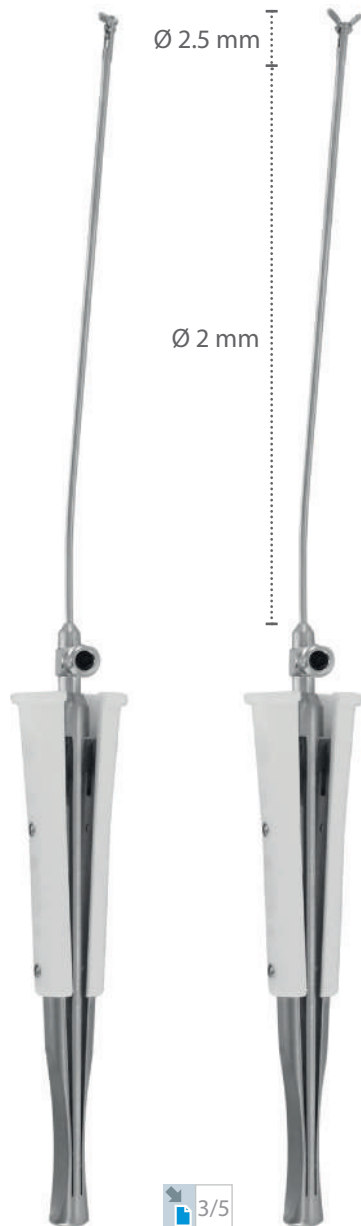

Obadia



Straight  
Droite  
Recta

**DC81320-38**

L : 380 mm - 15"

Laser Graduated  
Graduation au Laser  
Graduación Laser



Curved  
Courbe  
Curva

**DC81322-38**

L : 380 mm - 15"



Suture Catchers / Crochets à Suture / Ganchos para Sutura

Ø 2.5 mm



DC81410-28

L: 280 mm - 11"

DC81410-36

L: 360 mm - 14<sup>1/5</sup>"

NEW  
NOUVEAU  
NUEVO



Needles Retrievers / Récupérateurs à Aiguilles / Recuperadores de Aguja



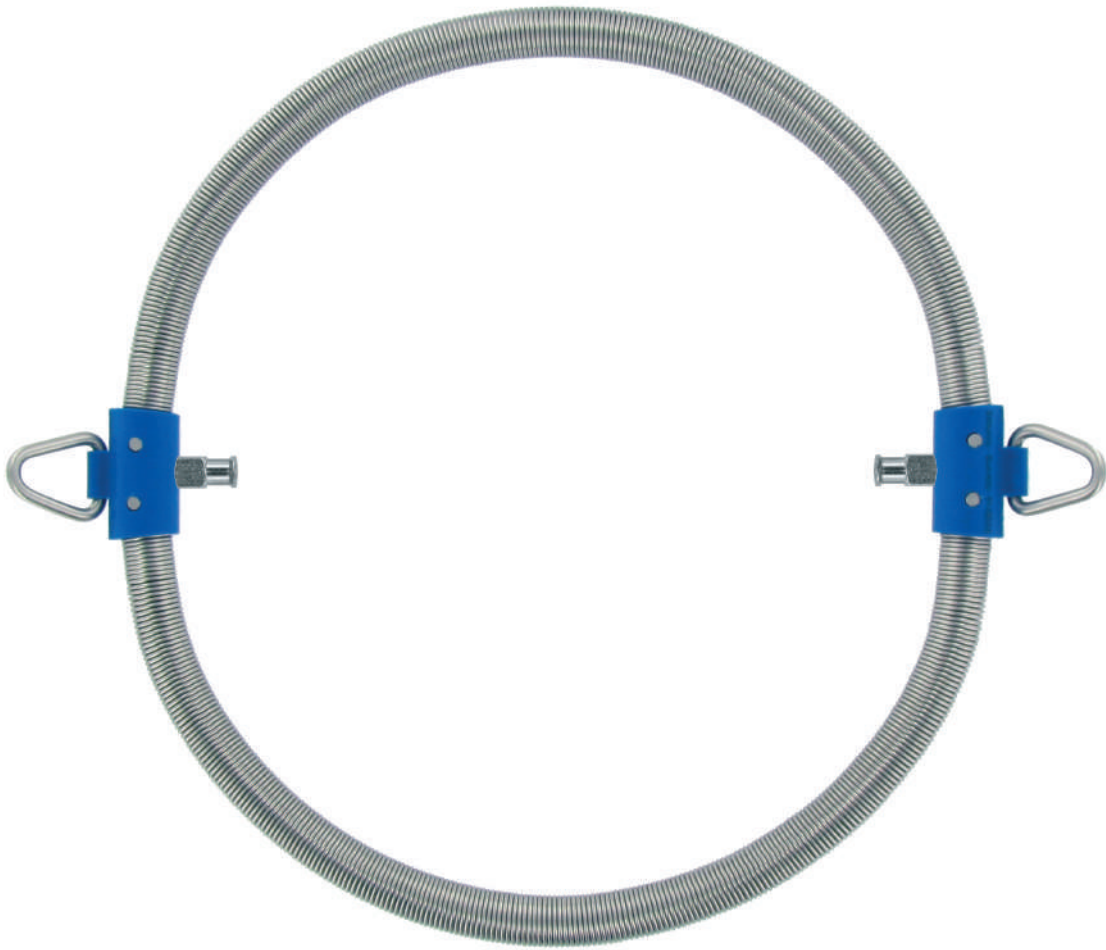

**DC81400-00**

Ø : 220 mm - 8<sup>2/3</sup>"

Without Luer Lock

Sans Raccord Luer Lock

Sin Conexión Luer Lock



**DC81400-01**

Ø : 220 mm - 8<sup>2/3</sup>"

With Luer Lock

Avec Raccord Luer Lock

Con Conexión Luer Lock

MIS Cannulas / Canules d'Aspiration MIS / Cánulas de Aspiración MIS

8 mm



\* For regulatory reason, please check with your distributor for availability in your country

\* Por razones reglamentarias, por favor póngase en contacto con su distribuidor para conocer la disponibilidad en su país

Straight / Droit / Recta

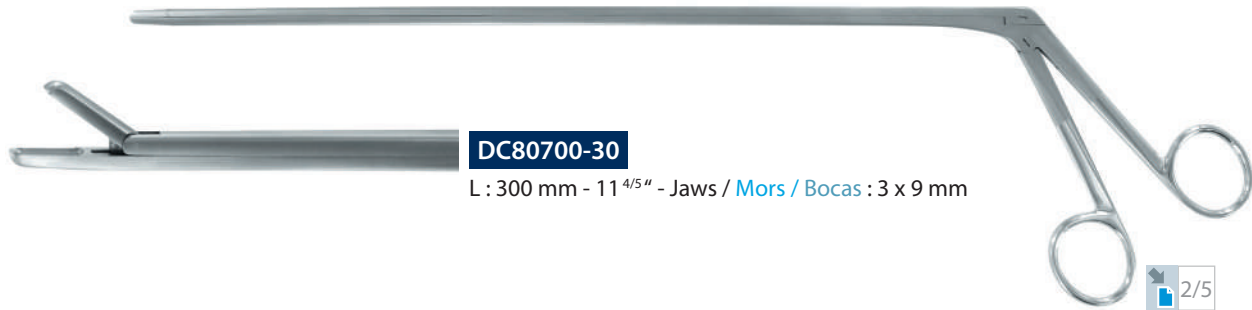

Angled Upwards 30° / Angulé Vers le Haut de 30° / Angulado Hacia Arriba de 30°



Angled Downwards 30° / Angulé Vers le Bas de 30° / Angulado Hacia Abajo de 30°



Straight / Droit / Recta



**DC80710-23** 

L : 230 mm - 9" - Jaws / Mors / Bocas : 6 x 12 mm

**DC80710-30**

L : 300 mm - 11 <sup>4</sup>/<sub>5</sub>" - Jaws / Mors / Bocas : 6 x 12 mm



Angled Upwards 45° / Angulé Vers le Haut de 45° / Angulado Hacia Arriba de 45°

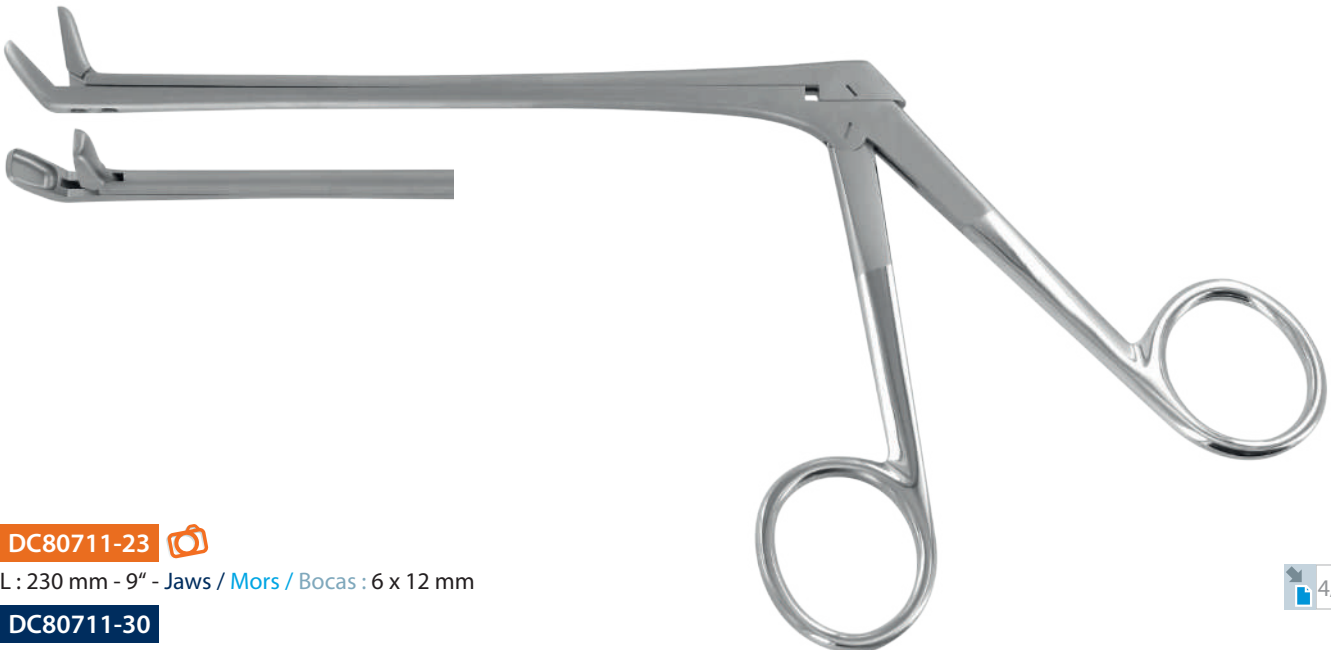

**DC80711-23** 

L : 230 mm - 9" - Jaws / Mors / Bocas : 6 x 12 mm

**DC80711-30**

L : 300 mm - 11 <sup>4</sup>/<sub>5</sub>" - Jaws / Mors / Bocas : 6 x 12 mm



Ø 5 mm

Straight  
Droit  
Recta



 **DC80730-30**  
L : 300 mm - 11 <sup>4</sup>/<sub>5</sub>''



 3/5

30°



**DC80731-30**   
L : 300 mm - 11 <sup>4</sup>/<sub>5</sub>''



 **DC80420-24**

L : 240 mm - 9 1/2"  
With Ratchet  
Avec Crémaillère  
Con Cremallera

**DC80417-24**

L : 240 mm - 9 1/2"  
Without Ratchet  
Sans Crémaillère  
Sin Cremallera

**DC80419-36**

L : 355 mm - 14"  
With Ratchet  
Avec Crémaillère  
Con Cremallera

**DC80418-36**

L : 355 mm - 14"  
Without Ratchet  
Sans Crémaillère  
Sin Cremallera





Scalpel Blade Handles / Manches de Bistouri / Mangos de Bisturí

Beaver

For Beaver Blades  
Pour Lames Beaver  
Para Hojas Beaver

For Blades Models  
Pour Modèles de Lames  
Para modelos de Hojas



- 10
- 11P
- 12
- 15S
- 18
- 19

Adjustable Length  
Longueur Réglable  
Longitud ajustable

**DC81330-00**

L mini : 290 mm - L maxi : 360 mm

**DC81330-01**

L mini : 180 mm - L maxi : 250 mm

Fixed Length  
Longueur Fixe  
Longitud Fija

 **DC81330-33**

L : 330 mm - 13"

**DC81331-33**

L : 330 mm - 13"



Gossot

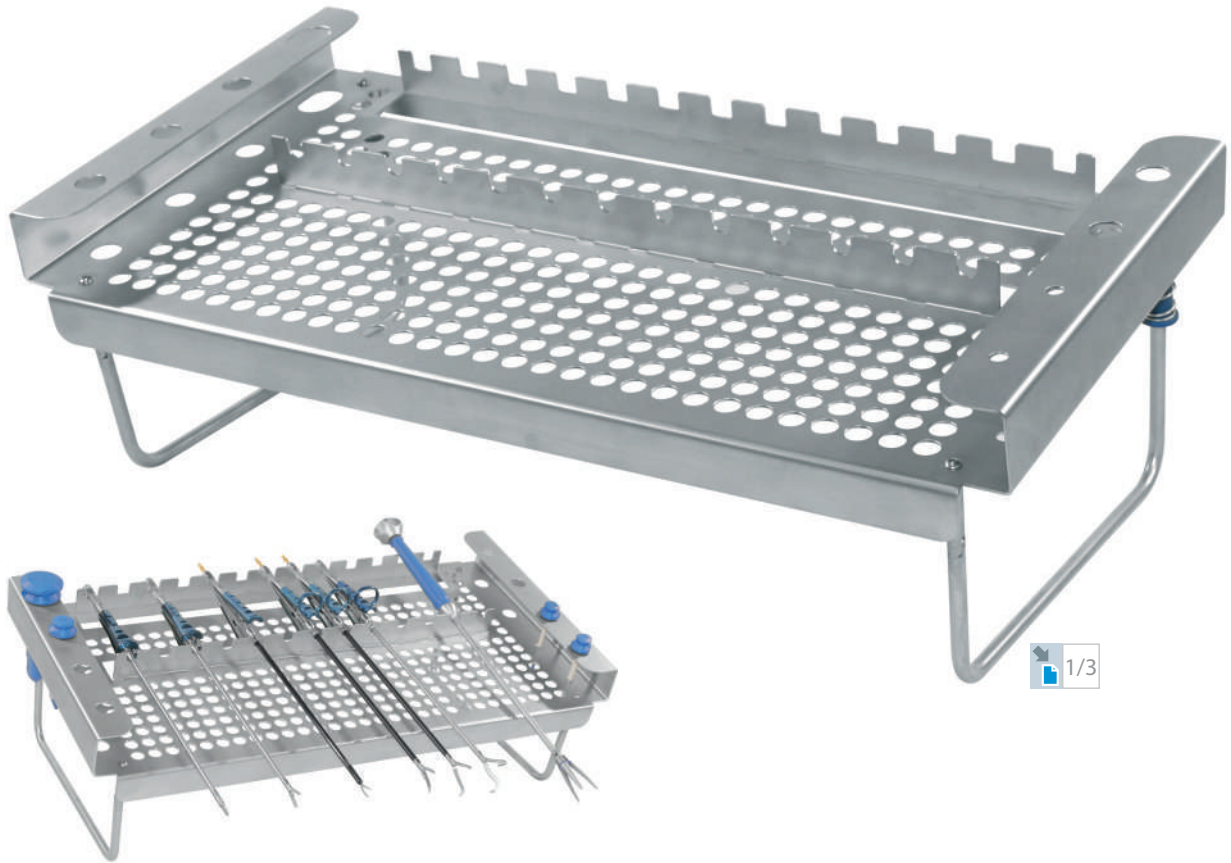

Comfort Model / [Modèle Confort](#) / [Modelo de Confort](#)

 **DC81930-01**

L : 543 mm x l : 277 mm x h : 84 mm

Instruments not Included / [Instruments non Inclus](#) / [Instrumentos no Incluidos](#)

Reduced Size Version for Sterilization in Container

[Version Réduite pour Stérilisation en Conteneur](#)

[Versión Reducida para Esterilización en Contenedores](#)

**DC81930-02**

L : 511 mm x l : 245 mm x h : 84 mm

Instruments not Included / [Instruments non Inclus](#) / [Instrumentos no Incluidos](#)

Trainer+ Pack / Pack Trainer+ / Paquete Trainer+



**DC89100-00**

Trainer+ Pack / Pack Trainer+ / Paquete Trainer+



Trainer+ holder  
Support Trainer+  
Soporte Trainer+

**DC89100-01**



Holder  
Support  
Soporte

**DC89100-02**



1 Sample  
1 Échantillon  
1 Muestra

**DC89111-01**



Trainer+ Bag  
Valise Trainer+  
Maleta Trainer+

Accessories / Accessoires / Accesorios



**DC89111-10**

10 Samples  
10 Échantillons  
10 Muestras

**DC89111-01**

1 Sample  
1 Échantillon  
1 Muestra



**DC89112-05**

5 Samples  
5 Échantillons  
5 Muestras

**DC89112-01**

1 Sample  
1 Échantillon  
1 Muestra

Options / Options / Opciones



**DC89101-00**

Endoscope holder  
Porte-Endoscope  
Soporte endoscopio

**DC89100-19**

Grommet for DC89100-01  
Joint pour DC89100-01  
Ojal para DC89100-01



INSTRUMENT PLATFORMS / KITS D'INSTRUMENTS / KITS DE INSTRUMENTOS

YAN



Prof. Yan Instrument Platform  
Kit d'Instruments du Pr. Yan  
Kit de Instrumentos del Prof. Yan

P 125

ADAMS



Dr. Adams Instrument Platform  
Kit d'Instruments du Dr. Adams  
Kit de Instrumentos del Dr. Adams

P 126

OBADIA II



Prof. Obadia Instrument Platform  
Kit d'Instruments du Pr. Obadia  
Kit de Instrumentos del Prof. Obadia

P 127

YILMAZ

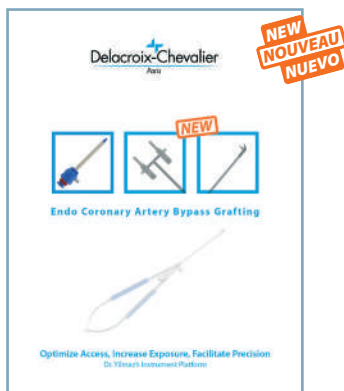

Dr. Yilmaz Instrument Platform  
Kit d'Instruments du Dr. Yilmaz  
Kit de Instrumentos del Dr. Yilmaz

P 128

GOSSOT

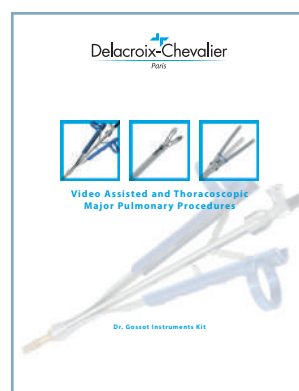

Dr. Gossot Instrument Platform  
Kit d'Instruments du Dr. Gossot  
Kit de Instrumentos del Dr. Gossot

P 129



STERILIZATION TRAYS / PANIERS DE STÉRILISATION / CESTA DE ESTERILIZACIÓN

YAN

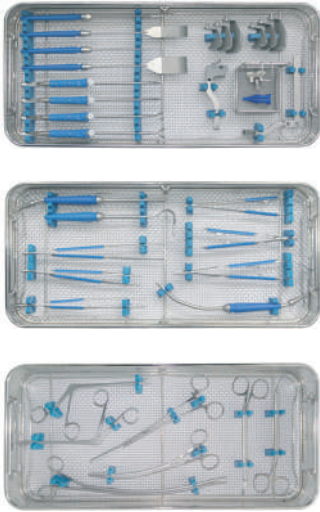

P 130

ADAMS



P 131

OBADIA II

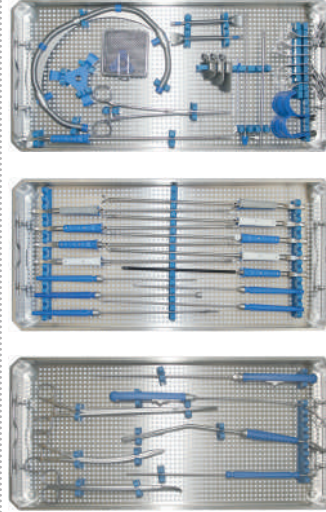

P 132

YILMAZ

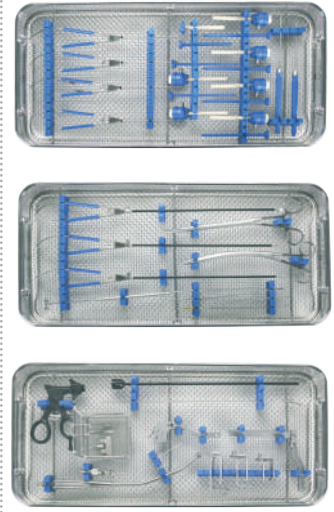

P 133

GOSSOT

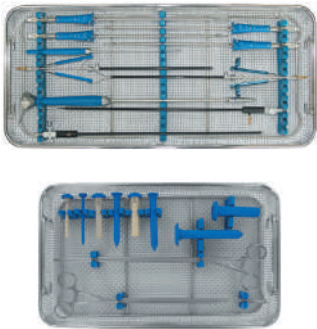

P 134

MIS

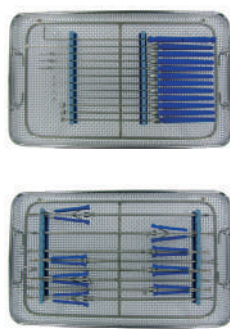

P 135

MIDACCESS

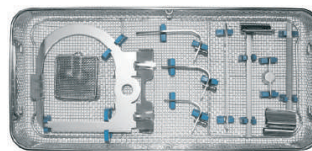

YAN



P 136

STERNACCESS



OBADIA

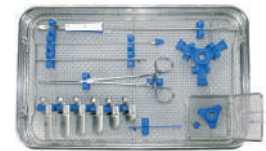

P 137

**YAN**

**DC82160-00:**

Yan Mini-Access Retractor

Écarteur Yan Mini-Access Etroit - Separador Mini-Access Yan

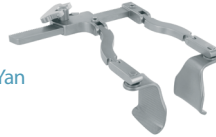

**DC81330-01:**

Scalpel Blade Handle

Manche de Bistouri MIS - Mangos de Bisturí MIS



**DC33010-25:**

Artery Protector

Protecteur d'Artère - Protección de la Arteria



**DC40087-26:**

Atraumatic Cross Clamp

Clamp Atraumatique - Pinza Atraumatic



**DC13030-21S:**

Strong Hybrid Forceps

Pince à Dissection Hybride - Pinzas de Disección Híbridas



**DC13030-24S:**

Strong Hybrid Forceps

Pince à Dissection Hybride - Pinzas de Disección Híbridas



**DC80710-23:**

Straight Rongeur

Rongeur - Droit - Gubias - Recta



**DC80711-23:**

45° Upper-cut Rongeur

Rongeur - 45° - Gubias - 45°



**DC21120-22:**

Curved Supercut Scissors

Ciseaux Supercut Courbes - Tijeras Supercut Curvas



**DC80132-25:**

MIS Robust Scissors, Curved

Ciseaux MIS Robustes, Courbes - Tijeras Robustas MIS, Curvadas



**DC80133-25:**

MIS Robust Scissors, Strongly Curved

Ciseaux MIS Robustes, Très Courbes - Tijeras Robustas MIS, Muy Curvadas



**DC81301-01:**

MIS Suture Hook

Crochet MIS - Gancho MIS



**DC12550-24S:**

Supergrip Micro Forceps

Micro Pince à Dissection Supergrip - Micro Pinzas de Disección



**DC33020-20:**

Narrow Hand Held Retractor

Écarteur à Main Etroit - Separador Estrecho



**DC33020-30:**

Broad Hand Held Retractor

Écarteur à Main Large - Separador Largo



**DC71337-33-S: \***

MIS Straight Sucker

Canule d'Aspiration Droite - Cánula de Aspiración Recta



**DC71337-33-C: \***

MIS Curved Sucker

Canule d'Aspiration Courbe - Cánula de Aspiración Curva



**DC71710-50:**

Finger-Extension Knot Pusher

Pousse-Nœuds à Doigt - Empuja Nudos a Dedo



**DC50644-23S:**

Yan Heavy Style SuperGrip Needle Holder

Porte-Aiguilles Supergrip Modèle Fort Yan

Porta Aguja Supergrip Modelo Fuerte



**DC50644-25S:**

Yan Heavy Style SuperGrip Needle Holder

Porte-Aiguilles Supergrip Modèle Fort Yan

Porta Aguja Supergrip Modelo Fuerte



**DC80019-25:**

MIS Robust Needle Holder, Curved

Porte-Aiguilles MIS Robuste, Courbe - Porta Aguja Robusto MIS, Curvado



**DC80009-25:**

MIS Robust Needle Holder, Straight

Porte-Aiguilles MIS Robuste, Droit - Porta Aguja Robusto MIS, Recto



**DC80419-36:**

Chest Tube Passer

Passe-Drains - Tubo Pase

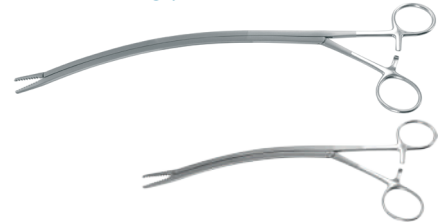

**DC80420-24:**

Chest Tube Passer

Passe-Drains - Tubo Pase



**DC50203-23S:**

Fine Supergrip Micro Needle Holder

Micro Porte-Aiguilles Supergrip Fin - Micro Supergrip Porta Aguja



\* For regulatory reason, please check with your distributor for availability in your country

\* Por razones reglamentarias, por favor póngase en contacto con su distribuidor para conocer la disponibilidad en su país

**NEW**  
**NOUVEAU**  
**NUEVO**

**ADAMS**

*Example: Rack Down Configuration - Progressive Blade Sizes*

**DC30149-01:**  
Adams Retractor  
Écarteur Adams - Separador Adams



**DC30147-00:**  
Transverse Rail  
Barre Transversale - Carril Transversal



**DC30145-30:**  
Sternal Blades  
Valves Sternales - Espadas Esternales



**DC30159-02 x3:**  
Attachment Bracket for Hooks  
Système de Fixation pour Crochet - Soporte de Fijación Para Ganchos



**DC30145-40:**  
Sternal Blades  
Valves Sternales - Espadas Esternales



**DC30153-27 x2:**  
Long and Thin Hook  
Crochet Long et Fin - Gancho Auricular Larga y Delgada



**DC30145-70:**  
Sternal Blades  
Valves Sternales - Espadas Esternales



**DC30154-25:**  
Medium Hook  
Crochet Moyen - Gancho Auricular Medio



**DC30148-00:**  
Medial Rail System With Screw  
Mât avec Vis - Sistema de Riel Medial con Tornillo



**Adams Instruments and Accessories**

**DC80200-30 x2:**  
MIS DeBakey Forceps  
Pince à Dissection DeBakey MIS - Pinza DeBakey MIS



**DC80019-30 x2:**  
MIS Robust Needle Holder, Curved  
Porte-Aiguilles MIS Robuste, Courbe - Porta Agujas Robusto MIS, Curvado



**DC80202-30:**  
MIS Resano Forceps  
Pince à Dissection Resano MIS - Pinza Resano MIS



**DC81301-00:**  
MIS Hook  
Crochet MIS - Gancho MIS



**DC80132-30:**  
MIS Robust Scissors, Curved  
Ciseaux MIS Robustes, Courbes - Tijeras Robustas MIS, Curvadas



**DC81308-00:**  
MIS Knot Pusher  
Pousse-Noeuds MIS Obadia - Empujador de Nudos MIS



**DC80133-30:**  
MIS Robust Scissors, Strongly Curved  
Ciseaux MIS Robustes, Très Courbes - Tijeras Robustas MIS, Muy Curvadas



**DC81330-00:**  
MIS Scalpel Blade Holder  
Manche de Bistouri MIS - Soporte de Hoja de Bisturí MIS





OBADIA II

**DC81115-00:**  
3D Retractor with Flexible Blade  
Écarteur pour Lamelle Souple Additionnelle  
Retractor para Lamelle Flexible Adicional



**DC82152-99:**  
C-Ring Retractor  
Anneau écarteur en C  
Anillo Separador en C



**Included - Inclus - Incluido:**

**DC81116-30:** Blade - Valve - Válva 35 x 30 mm  
**DC81116-40:** Blade - Valve - Válva 35 x 40 mm  
**DC81116-50:** Blade - Valve - Válva 35 x 50 mm



**DC82153-30:**  
Soft Intercostal Blade (pair)  
Valve Souple Intercostale  
Válva Intercostal Flexible



**Optional Blades - Valves Optionnelles - Cuchillas opcionales:**

**DC81118-80:** Blade - Valve - Válva 40 x 50 mm  
**DC81118-60:** Blade - Valve - Válva 40 x 60 mm  
**DC81118-70:** Blade - Valve - Válva 40 x 70 mm



**DC81117-94:**  
Flexible Additional Atrial Blade  
Lamelle Souple Additionnelle - Lamelle Flexible Adicional



**DC81310-28:**  
MIS Magnetic Retriever  
Récupérateur à Aimant - Recuperador de agujas



**DC81364-36:**  
Forceps for Flexible Additional Atrial Blade  
Pince pour Lamelle Souple Additionnelle - Pinzas para Lamelle Flexible Adicional



**DC81330-33:**  
MIS Scalpel Blade Holder  
Manche de Bistouri MIS - Mangos de Bisturí MIS



**DC81363-24:**  
Forceps for Atrial Blade  
Pince pour Valve Atriale - Pinzas para Valvula Mitral



**DC81302-30:**  
MIS Hook for Nerves and Vessel  
Crochet pour Nerfs et Vaisseaux MIS - Ganchos Intracardíacos



**DC80200-36:**  
MIS DeBakey Forceps  
Pince DeBakey MIS - Pinzas DeBakey MIS



**DC81303-33:**  
MIS Double Hook for Nerves and Vessel  
Crochet Double pour Nerfs et Vaisseaux  
Doble Gancho Intracardíaco



**DC80202-36:**  
MIS Atraumatic Resano Forceps  
Pince Atraumatique Resano MIS - Pinza Atraumatica Resano MIS



**DC81322-38:**  
MIS Curved Suture Ruler  
Gabarit Courbe  
Plantillas Curvas



**DC80132-36:**  
MIS Robust Scissors, Curved  
Ciseaux MIS Robustes, Courbes - Tijeras Robustas MIS, Curvadas



**B25925:**  
Double Curved Scissors  
Ciseaux Double Courbure - Tijeras Doble Curva



**DC80133-36:**  
MIS Robust Scissors, Strongly Curved  
Ciseaux MIS Robustes, Très Courbes - Tijeras Robustas MIS, Muy Curvadas



**DC80996-32:**  
MIS DeBakey Intercostal Clamp  
Clamp Intercostal DeBakey MIS  
Pinzas Transtorácicas MIS DeBakey



**DC80009-36:**  
MIS Robust Needle Holder, Straight  
Porte-Aiguilles MIS Robuste, Droit - Porta Agujas Robusto MIS, Recto



**DC71337-33:\***  
MIS Suction Tube  
Canule d'Aspiration MIS  
Cánula de Aspiración MIS



**DC80019-36:**  
MIS Robust Needle Holder, Curved  
Porte-Aiguilles MIS Robuste, Courbe - Porta Agujas Robusto MIS, Curvado



**DC80420-24:**  
Tube Passer  
Passe Drain - Tubo Pase



**DC81410-28:**  
MIS Suture Catcher  
Crochet à Suture MIS - Gancho para sutura



\* For regulatory reason, please check with your distributor for availability in your country

\* Por razones reglamentarias, por favor póngase en contacto con su distribuidor para conocer la disponibilidad en su país

**NEW**  
**NOUVEAU**  
**NUEVO**

**YILMAZ**

**E01AB2000: \***

Endoscope  
Endoscope - Endoscopio



**DC84244-45:**

MicroMICS Maryland Dissector  
Dissecteur Maryland MicroMICS - Disector de Maryland MicroMICS



**E0621121 + E0621122:**

Horizon Clip Applier  
Applicateur de clip rotatif Horizon - Aplicador de clip Horizon



**DC84243-45:**

MicroMICS Fenestrated Forceps  
Pince Fénêtrée MicroMICS - Pinzas fenestradas MicroMICS



**DC82981-07 x6:**

Magnetic Trocar  
Trocart Magnétique - Trocar Magnético



**DC84141-45:**

MicroMICS Metzenbaum Scissors  
Ciseaux Metzenbaum MicroMICS - Tijeras Metzenbaum MicroMICS



**DC82160-99:**

Yan Mini-Access Retractor  
Écarteur Yan Mini-Access - Separador Mini-Access Yan  
+ DC82163-30 + DC82163-40 + DC82163-50:  
Narrow Blades  
Valves étroites - Cuchillas Estrechas



**DC14900-18:**

Cushing Forceps  
Pince à dissection Cushing - Pinzas Cushing



**DC71337-33-C: \***

MIS Suction Tube  
Canule d'Aspiration MIS - Tubo de Succión MIS



**DC13202-20:**

DeBakey Forceps  
Pince à dissection DeBakey - Pinzas DeBakey



**DC71350-05: \***

45° Frazier Suction Tube  
Canule d'aspiration Frazier 45° - Tubo de Succión de Frazier 45°



**DC84240-26:**

MicroMICS Grasping Forceps  
Pince à dissection MicroMICS - Pinzas de Agarre MicroMICS



**DC84040-26:**

MicroMICS Needle Holder  
Porte-aiguilles MicroMICS - Porta-agujas MicroMICS



**DC84116-26:**

MicroMICS Potts 45° Scissors  
Ciseaux MicroMICS Potts 45° - Tijeras MicroMICS Potts 45°



**DC81305-21:**

MIS Hook  
Crochet MIS - Gancho MIS



**DC84117-26:**

MicroMICS Potts 125° Scissors  
Ciseaux Metzenbaum MicroMICS - Tijeras Metzenbaum MicroMICS



**DC81323-21:**

MIS Knot Pusher  
Pousse-nœuds MIS - Empuja-Nudos MIS



**DC80996-26:**

MIS DeBakey Intercostal Clamp  
Clamp Intercostal DeBakey MIS - Pinzas Transtorácicas MIS DeBakey



**E0616008 + E0633002 + E0633442:**

Fenestrated Forceps  
Pince Fenêtrée Démontable - Pinzas Fenestradas



**DC41029-40 x2:**

Diethrich Bulldog Clamp  
Clamp Culldog Diethrich - Pinzas Culldog Diethrich



**DC82120-90:**

90° 3D Connector  
Bras 3D pour écarteur Yan Mini-Access - Pinzas fenestradas MicroMICS



**DC82961-07:**

Trocar for Thoracoscopy  
Trocart - Trocar Para Toracosopia



**DC81010-00:**

Approximator  
Approximateur - Aproximador



**Accessories**

**DC80420-24:**

Chest Tube Passer  
Passe Drain Courbe - Tubo Pase



**E500005: \***

Surgical Arm with Rail Clamp  
Bras articulé avec étau - Brazo articulado con vicio



**GOSSOT**

**Trocars**

Thoracic Trocars  
Trocarts pour Thoroscopie  
Trocares para Toracosopia

DC82961-07: (Ø 5 mm)  
DC82966-07: (Ø 6 mm)  
DC82962-07: (Ø 10 mm)



Magnetic Trocars - Serrated Tube  
Trocarts Magnétique - Tube strié  
Trocares Magnéticos - Tubo Rayado

DC82981-07: (Ø 5 mm)  
DC82984-07: (Ø 6 mm)  
DC82982-07: (Ø 10 mm)



DC82970-07: (Ø 16 x 25 mm)

E229121: (Ø 12 mm) \*

DC82965-70: (Ø 5 mm)



**Dissection Instruments**

DC83208-36: \*  
Maryland dissector  
Dissecteur Maryland - Disector Maryland



DC83209-36: \*  
Maryland dissector  
Dissecteur Maryland - Disector Maryland



DC83200-36:  
Straight DeBakey Forceps  
Pince DeBakey Droite - Pinza DeBakey Recta



DC83201-36:  
Straight DeBakey Forceps  
Pince DeBakey Droite - Pinza DeBakey Recta



DC83207-36:  
Curved DeBakey Forceps  
Pince DeBakey Courbe - Pinza DeBakey Curva



E0623001: \*  
Dissecting Monopolar Hook  
Crochet à Dissection Monopolaire - Gancho para Disección Monopolar



E0623004: \*  
Button tip HF Suction Tube  
Tube d'Aspiration à Électrode Boule - Tubo de Aspiración con Electrodo Bola



DC83224-36:  
Double Curved Dissector  
Dissecteur Double Courbe - Disector Doble Curva



DC83225-36:  
MIS 90° Dissector  
Dissecteur 90° MIS - Disector 90° MIS



DC83110-36: \*  
Handle for Disposable Scissors Tips  
Manche pour embouts ciseaux - Mango para Punta Tijeras



DC83110-12: \*  
Reusable Curved Scissors Tips  
Embouts ciseaux à usage court - Puntas de Tijeras Reutilizable



DC82940-38:  
Ligature Carrier Retractor  
Retrateur passe-lac - Retractor Portador de Ligadura



DC82940-40:  
Ligature Carrier Retractor  
Retrateur passe-lac - Retractor Portador de Ligadura



**Prehension Instruments**

DC83213-36:  
Fenestrated Forceps  
Pince Fenêtrée - Pinza Fenestrada



DC83216-36:  
Fenestrated Forceps  
Pince Fenêtrée - Pinza Fenestrada



**Instruments for Lymph Node Resection**

DC83210-36:  
Lymph Node Forceps  
Pince à Ganglions - Pinza para Ganglios



DC82950-38:  
3 Legs Retractor  
Ecarteur à 3 Branches - Separador con 3 Ramas



DC83211-36:  
Lymph Node Forceps  
Pince à Ganglions - Pinza para Ganglios



**Additional Instruments**

DC83003-36:  
MIS Needle Holder, Straight  
Porte-Aiguilles MIS, Droit - Porta Agujas MIS, Recto



DC81330-33:  
Scalpel Blade Holder  
Manche de Bistouri - Mango de Bisturí



DC83009-36:  
MIS Robust Needle Holder, Straight  
Porte-Aiguilles MIS Robuste, Droit - Porta Agujas Robusto MIS, Recto



DC83221-44:  
Grasping Fenestrated Forceps  
Pincas à Préhension Fenêtrées - Pinzas de Agarre Fenestradas



DC83019-36:  
MIS Robust Needle Holder, Curved  
Porte-Aiguilles MIS Robuste, Courbe - Porta Agujas Robusto MIS, Curvado



DC80996-36:  
Curved Parenchyma Clamp  
Clamp Courbe à Parenchyme - Pinza Curva para Parénquima



\* For regulatory reason, please check with your distributor for availability in your country

\* Por razones reglamentarias, por favor póngase en contacto con su distribuidor para conocer la disponibilidad en su país

## Prof. Yan Instrument Platform - Trays Kit d'Instruments du Pr. Yan - Paniers / Kit de Instrumentos del Prof. Yan - Cestas

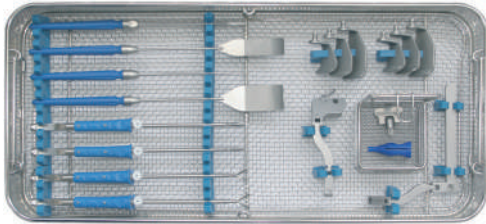

**DC81912-01** \*

540 x 250 x 70 mm

Provided with Lid, Instruments not Included

Livré avec Couvercle, Instruments non Inclus

Entregado con Tapa, Instrumentos no Incluidos

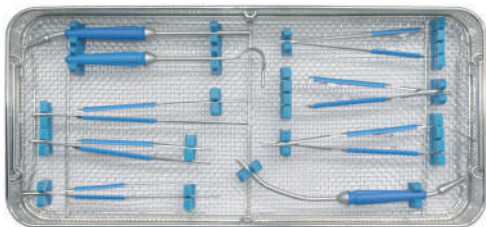

**DC81912-02** \*

540 x 250 x 70 mm

Provided with Lid, Instruments not Included

Livré avec Couvercle, Instruments non Inclus

Entregado con Tapa, Instrumentos no Incluidos

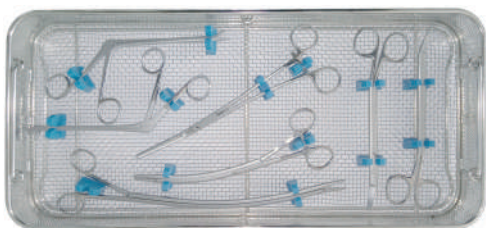

**DC81912-03** \*

540 x 250 x 70 mm

Provided with Lid, Instruments not Included

Livré avec Couvercle, Instruments non Inclus

Entregado con Tapa, Instrumentos no Incluidos

\* For regulatory reason, please check with your distributor for availability in your country

\* Por razones reglamentarias, por favor póngase en contacto con su distribuidor para conocer la disponibilidad en su país



## Dr. Adams Instrument Platform - Trays

### Kit d'Instruments du Dr. Adams - Paniers / Kit de Instrumentos del Dr. Adams - Cestas

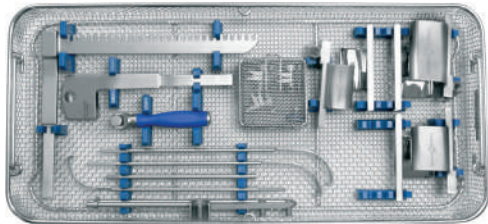

**DC30159-00** \*

540 x 250 x 100 mm

Provided with Lid, Instruments not Included

Livré avec Couvercle, Instruments non Inclus

Entregado con Tapa, Instrumentos no Incluidos

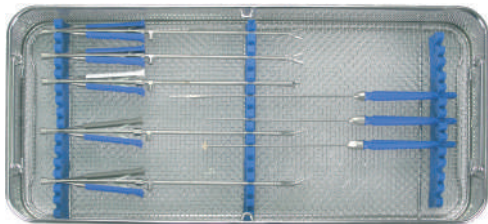

**DC81900-05** \*

535 x 250 x 70 mm

Provided with Lid, Instruments not Included

Livré avec Couvercle, Instruments non Inclus

Entregado con Tapa, Instrumentos no Incluidos

\* For regulatory reason, please check with your distributor for availability in your country

\* Por razones reglamentarias, por favor póngase en contacto con su distribuidor para conocer la disponibilidad en su país

## Prof. Obadia Instrument Platform - Trays Kit d'Instruments du Pr. Obadia - Paniers / Kit de Instrumentos del Prof. Obadia - Cestas

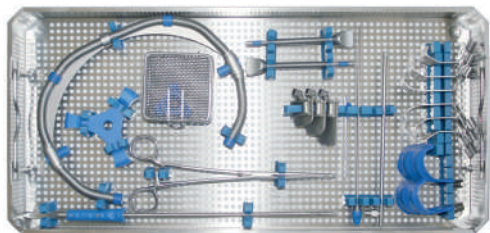

**DC81910-01** \*

540 x 250 x 70 mm  
Provided with Lid, Instruments not Included  
Livré avec Couvercle, Instruments non Inclus  
Entregado con Tapa, Instrumentos no Incluidos



**DC81910-02** \*

540 x 250 x 70 mm  
Provided with Lid, Instruments not Included  
Livré avec Couvercle, Instruments non Inclus  
Entregado con Tapa, Instrumentos no Incluidos

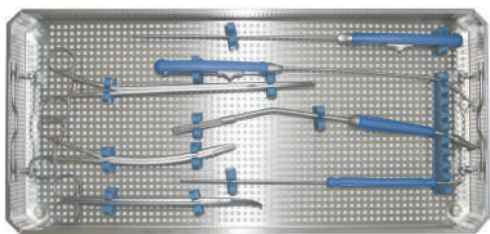

**DC81910-03** \*

540 x 250 x 70 mm  
Provided with Lid, Instruments not Included  
Livré avec Couvercle, Instruments non Inclus  
Entregado con Tapa, Instrumentos no Incluidos

\* For regulatory reason, please check with your distributor for availability in your country

\* Por razones reglamentarias, por favor póngase en contacto con su distribuidor para conocer la disponibilidad en su país

## Dr. Yilmaz Instrument Platform - Trays

### Kit d'Instruments du Dr. Yilmaz - Paniers / Kit de Instrumentos del Dr. Yilmaz - Cestas

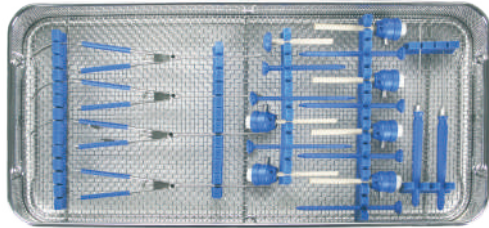

**DC81913-01** \*

NEW  
NOUVEAU  
NUEVO

540 x 250 x 70 mm

Provided with Lid, Instruments not Included

Livré avec Couvercle, Instruments non Inclus

Entregado con Tapa, Instrumentos no Incluidos

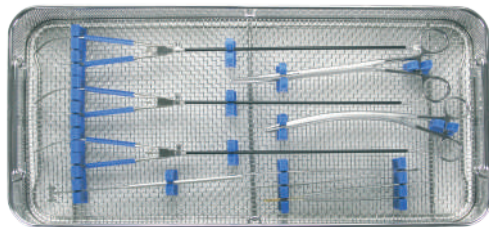

**DC81913-02** \*

NEW  
NOUVEAU  
NUEVO

540 x 250 x 70 mm

Provided with Lid, Instruments not Included

Livré avec Couvercle, Instruments non Inclus

Entregado con Tapa, Instrumentos no Incluidos

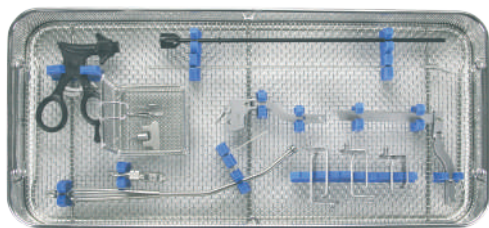

**DC81913-03** \*

NEW  
NOUVEAU  
NUEVO

540 x 250 x 70 mm

Provided with Lid, Instruments not Included

Livré avec Couvercle, Instruments non Inclus

Entregado con Tapa, Instrumentos no Incluidos

\* For regulatory reason, please check with your distributor for availability in your country

\* Por razones reglamentarias, por favor póngase en contacto con su distribuidor para conocer la disponibilidad en su país

## Dr. Gossot Instrument Platform - Trays

### Kit d'Instruments du Dr. Gossot - Paniers / Kit de Instrumentos del Dr. Gossot - Cestas

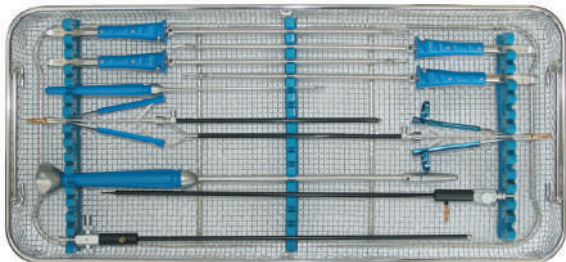

**DC81903-00** \*

540 x 250 x 70 mm

Provided with Lid, Instruments not Included

*Livré avec Couvercle, Instruments non Inclus*

Entregado con Tapa, Instrumentos no Incluidos

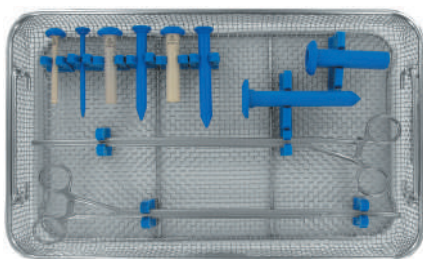

**DC81904-00** \*

405 x 250 x 70 mm

Provided with Lid, Instruments not Included

*Livré avec Couvercle, Instruments non Inclus*

Entregado con Tapa, Instrumentos no Incluidos

\* For regulatory reason, please check with your distributor for availability in your country

\* Por razones reglamentarias, por favor póngase en contacto con su distribuidor para conocer la disponibilidad en su país



## MIS Instruments Trays Paniers Instruments MIS / Cestas Instrumentos MIS

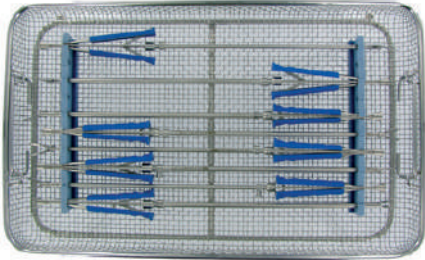

**DC81901-00** \*

405 x 250 x 50 mm

Provided without Lid, Instruments not Included

Livré sans Couvercle, Instruments non Inclus

Entregado sin Tapa, Instrumentos no Incluidos

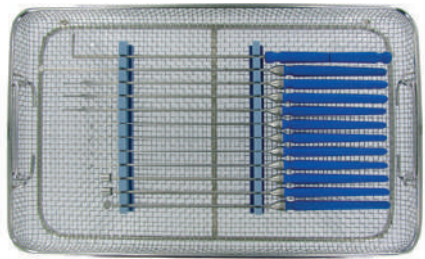

**DC81902-00** \*

405 x 250 x 50 mm

Provided without Lid, Instruments not Included

Livré sans Couvercle, Instruments non Inclus

Entregado sin Tapa, Instrumentos no Incluidos

\* For regulatory reason, please check with your distributor for availability in your country

\* Por razones reglamentarias, por favor póngase en contacto con su distribuidor para conocer la disponibilidad en su país

## MidAccess Retractor Trays **Paniers Écarteur Mid Access / Cestas Separador Mid Access**

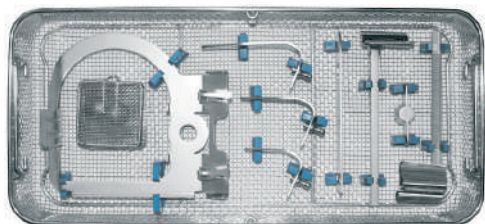

**DC81907-00** \*

540 x 250 x 70 mm

Provided with Lid, Instruments not Included

**Livré avec Couvercle, Instruments non Inclus**

Entregado con Tapa, Instrumentos no Incluidos

## Yan Mini-Access Retractor Tray **Panier Écarteur Yan Mini-Access / Cesta Separador Yan Mini-Access**

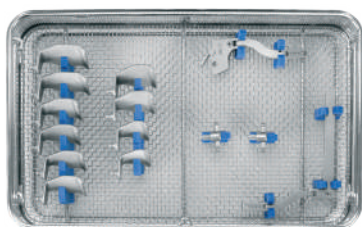

**DC82169-00** \*

**NEW  
NOUVEAU  
NUEVO**

405 x 250 x 70 mm

Provided with Lid, Instruments not Included

**Livré avec Couvercle, Instruments non Inclus**

Entregado con Tapa, Instrumentos no Incluidos

## Sternal ThorAccess Retractor Tray Panier Écarteur Sternal ThorAccess / Cesta Separador Esternal ThorAccess

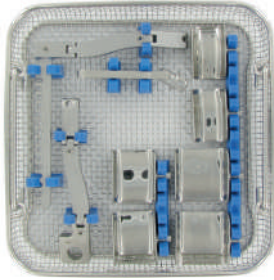

**DC81908-00** \*

250 x 250 x 50 mm

Provided with Lid, Instruments not Included

Livré avec Couvercle, Instruments non Inclus

Entregado con Tapa, Instrumentos no Incluidos

## Full 3D Retractor Tray Panier Écarteur 3D Complet / Cesta Separador 3D Completo

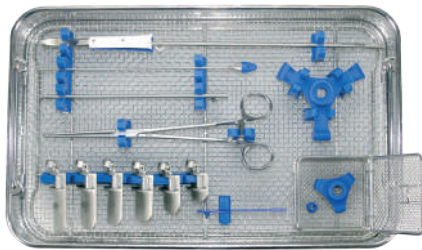

**DC81914-00** \*

NEW  
NOUVEAU  
NUEVO

405 x 250 x 70 mm

Provided with Lid, Instruments not Included

Livré avec Couvercle, Instruments non Inclus

Entregado con Tapa, Instrumentos no Incluidos

\* For regulatory reason, please check with your distributor for availability in your country

\* Por razones reglamentarias, por favor póngase en contacto con su distribuidor para conocer la disponibilidad en su país







### Important notice

The content of this catalogue (including the trademarks, the texts, the drawings, illustrations, layouts, etc.) is, unless otherwise specified, the exclusive property of LANDANGER. It is not allowed to reproduce, represent, display, modify, adapt an/or translate - whether in part or in whole and whether for free or for financial consideration - the catalogue and/or any material composing the catalogue, without the prior and written consent of LANDANGER.

We can at any time recall the catalogue, in case that it has been not used according to our interests, i.e. sale or purchase of our products. We preserve the right for further steps in that case. Patterns are subject to change.

The instruments in this catalog are medical devices, CE marked, of classes I, IIa and IIb, manufactured by Landanger, ZI La Vendue, 52000 Chaumont, France .

Before any use, please read carefully the instructions on the label and / or the instructions and / or the technical sheet to ensure the correct use of the devices.

Document reserved for healthcare professionals.

### Indications importantes

Le contenu de ce catalogue de vente (y compris les marques, les textes, les dessins, illustrations, présentations, etc.) est, sauf mention contraire, la propriété exclusive de la société LANDANGER. Toute reproduction, représentation, modification, adaptation, et/ou traduction de ce catalogue - qu'elle soit totale ou partielle, à titre gratuit ou onéreux - est interdite sans l'accord préalable écrit de la société LANDANGER.

Nous pouvons demander le retour du catalogue dans le cas où celui-ci n'est pas utilisé conformément à nos intérêts, pour la vente ou l'achat de nos produits. Dans ce cas nous nous réservons le droit de mener des actions juridiques.

Sous réserve des modifications techniques.

Les instruments présents dans ce catalogue sont des dispositifs médicaux, marqués CE, de classes I, IIa et IIb, fabriqués par Landanger, ZI La Vendue, 52000 Chaumont, France.

Avant toute utilisation, veuillez lire attentivement les instructions figurant sur l'étiquette et/ou la notice et/ou la fiche technique pour s'assurer de la correcte utilisation des dispositifs.

Dispositifs non pris en charge au titre des produits et prestations remboursable par la sécurité sociale.

Document réservé aux professionnels de santé.

### Indicaciones importantes

El contenido de este catálogo (marcas, textos, dibujos, ilustraciones, presentaciones incluidos, etc.) es, excepto mención contraria, exclusiva propiedad de la empresa LANDANGER. Toda reproducción, representación, modificación, adaptación, y/o traducción de este catálogo - que sea total o parcial, gratuitamente o pagando - esta prohibida sin el acuerdo escrito de la empresa LANDANGER.

Podemos pedir el retorno del catálogo en caso de que este no sea usado conforme a nuestro interés, para la venta o la compra de nuestros productos. En aquel caso, nos reservamos el derecho de dirigir acciones jurídicas.

Bajo reserva de modificaciones técnicas.

Los instrumentos de este catálogo son dispositivos médicos, con marcado CE, de las clases I, IIa et IIb, fabricados por Landanger, ZI La Vendue, 52000 Chaumont, France .

Antes de cualquier uso, lea detenidamente las instrucciones en la etiqueta y / o las instrucciones y / o la hoja técnica para garantizar el uso correcto de los dispositivos.

Documento reservado para profesionales de la salud.

Intellectual Property - **Propriété Intellectuelle** - Propiedad Intelectual:

N° 002444083-0001, N° 001919895-002, N° 001919895-003, N° 003433846-0001, N° 2018 2372, N° 005501871-0001, N° 005501871-0002.

Patent Number - **Numéro de Brevet** - Número de Patente:

FR3010626.

### Version 2020-11 - Catalogue de vente - ZA-B00007

Concept and design - **Conception et design** - Concepto y diseño : Copyright©LANDANGER - 2009 - 2021.

All rights reserved - **Tous droits réservés** - Todos derechos reservados.

The photos and pictures are not contractual - **Photos et illustrations non contractuelles** - Fotos e ilustraciones no contractuales.





  
**Delacroix-Chevalier**  
Paris

Corporate Office - *Siège - Sede*

217 rue du Faubourg Saint-Honoré - 75008 Paris - France

Manufacturing and logistic - *Production et logistique - Fabricacion y logistica*

**Rue Renée et Louis Landanger**  
52000 Chaumont - France

Phone : +33 (0) 3 25 02 10 35 - Fax : +33 (0) 3 25 02 10 20  
Email : [export@delacroix-chevalier.com](mailto:export@delacroix-chevalier.com) [www.delacroix-chevalier.com](http://www.delacroix-chevalier.com)