

# INSPIRAL



**OPERATING LIGHTS  
OPERATING TABLES**



New generation, LED Technology





## OPERATING LIGHTS

Model: LD20.53

Double Head with Arm Mounted 24" Medical Monitor (With Camera)

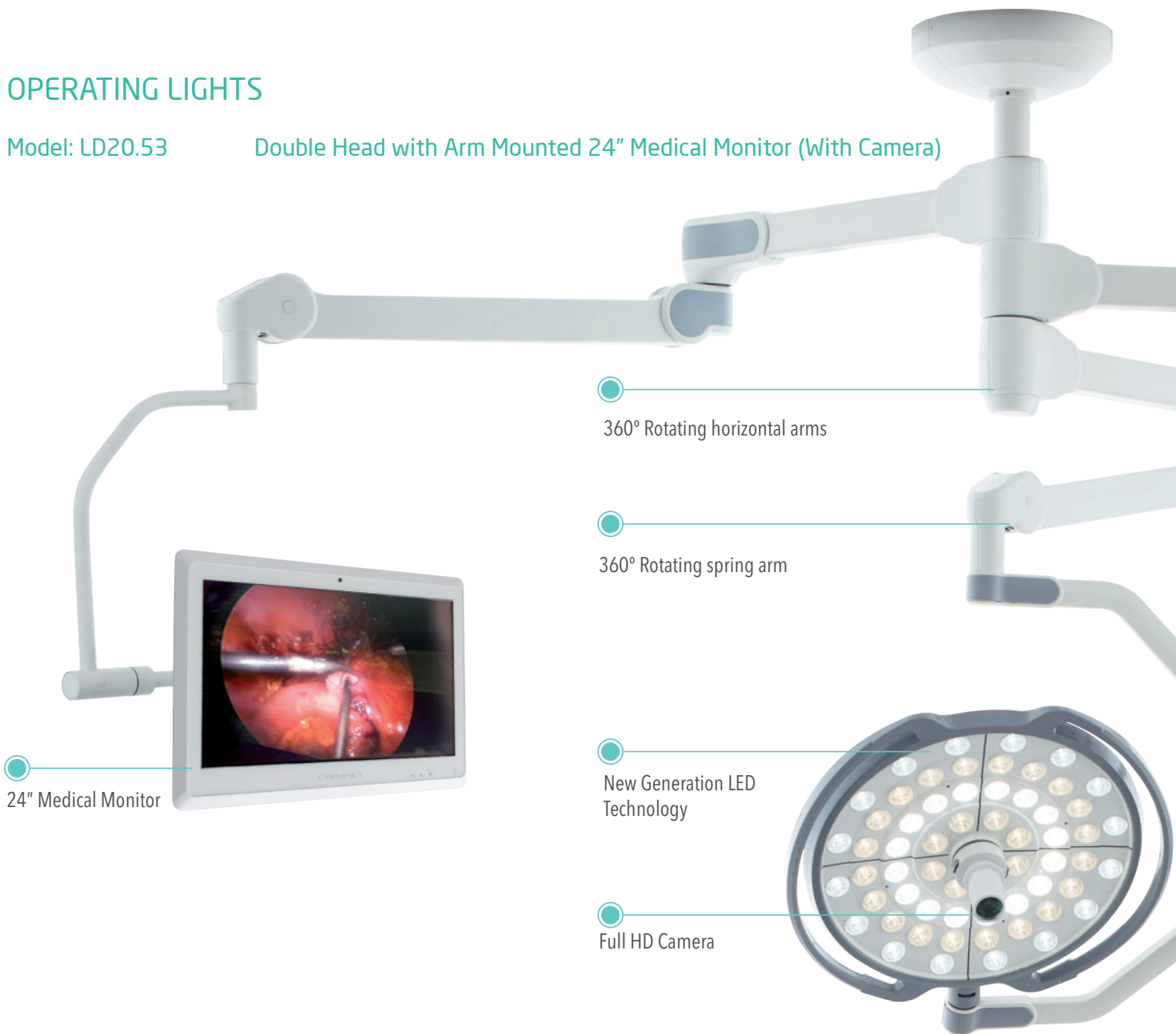

24" Medical Monitor

360° Rotating horizontal arms

360° Rotating spring arm

New Generation LED Technology

Full HD Camera



### Full HD Surgical Camera

- ◆ Surgical videos taken by Full HD cameras provide clear images taken from the operator's point of view, allowing vital intraoperative findings to be clearly illustrated and comprehensively explained



### New Generation LED Technology

- ◆ Warm /cold white LEDs combined with unique high-tech lenses provide brilliant, homogenous light. Each LED module can be replaced individually in case of any failure

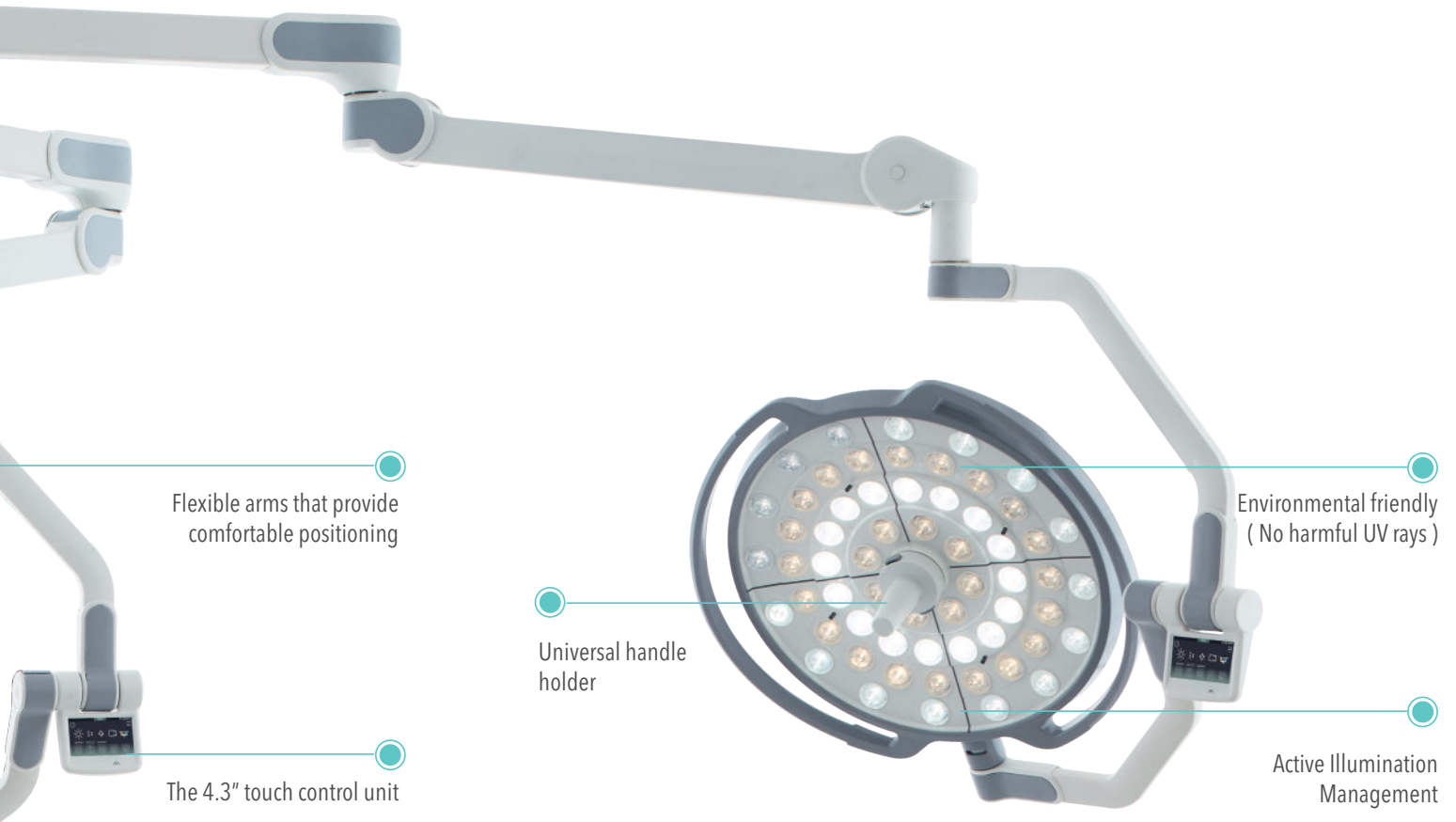

Flexible arms that provide comfortable positioning

Universal handle holder

The 4.3" touch control unit

Environmental friendly (No harmful UV rays)

Active Illumination Management

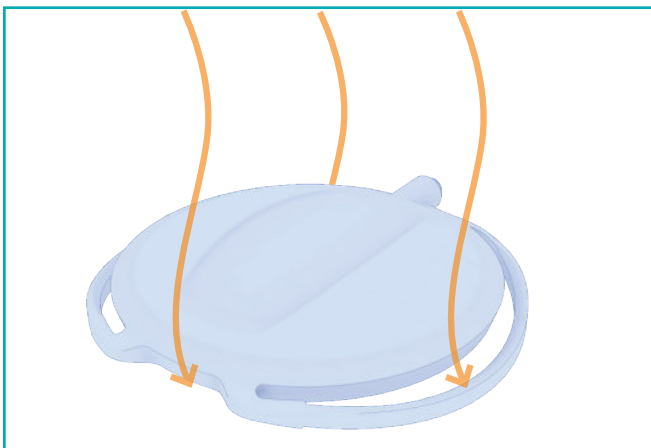

### Special Lamp Head Design

- ◆ The special slim elliptic head design allows unobstructed flow of clean air through the light head to dissipate accumulated heat and surgical smoke. Degree of turbulence is lower than 29 % at surgical field.

### Adjustable Light Field Diameter

- ◆ Innovative beam design offers you an extremely wide range of adjustable light field size from 130 mm to 360 mm. The light patch can be easily matched to the wound size.



**Endo Light Mode / StandBy Mode**

- ◆ Lamp can be switched to the endolight mode by a single button.
- ◆ Stylish blue LED strips in stand by mode



**Boost Function**

- ◆ In case of an unpredictable high illumination need, light intensity can be adjusted to 100% maximum level by a single touch

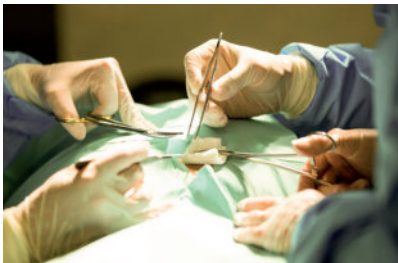

- ◆ 3000 K

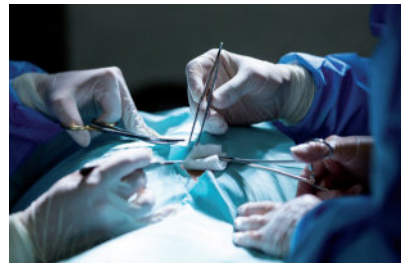

- ◆ 5000 K

**Wide Range of Adjustable Color Temperature**

- ◆ The color temperature can be perfectly adjusted between 3000 K to 5000 K by 250 K steps according to the specific operations



### Touch Screen Pro Control Unit

- ◆ Inspital Unique tablet application allows to control all functions via wider Touch Screen Pro Control Unit. Optional tablet can be used as a wall control unit with its wall stand.



### Medical Monitor

- ◆ Watch as you record with wide range of medical grade LED monitors from 19" to 55" sizes



### Laser Positioning



- ◆ The laser guide is available to easily position the head at the right distance and place for efficient surgeries.

### Automatic Distance Management (ADM)



- ◆ ADM system measures the distance between patient and light head automatically between 90-110cm and ensure that the surgical site always appears in the best light, literally.



### Active Illumination Management (AIM)

- ◆ Inspital LED light technology provides the best illumination, even when surgeons are blocking the LEDs. The loss of illumination when certain LEDs are obstructed is automatically compensated by the AIM system.

## Touch Screen Control Unit



### Touch Screen Control Unit

- ◆ *Standard 4.3" LCD touch screen panel to control all functions intuitively and clearly by tapping and swiping the applicable icons.*





Model: LD20.24  
Model: LD20.52

Double Head with 24" Wall Medical Monitor (With Camera)  
Double Head with Camera (Without Monitor)



Model: LD10.03

Triple Head Operating Lights



*High-Tech, maximum light*

**Illumination Stability Function**

- ◆ *The ISF system prevents the intensity of the LED technology from falling, and maintains constant lighting levels by applying an automatic compensation. Guarantee optimum operating conditions in all circumstances.*



Model: LD10.02 Double Head Operating Lights



Model: LD10.01 Single Head Operating Lights



Model: LD05.06 Mobile with Battery  
Battery back up system provides 2,5 hours of energy

## OPERATING LIGHTS

INSPITAL LED operating lights are designed to meet all surgical illumination requirements of operating theatres. New generation LED technology helps the surgeons to operate and view the surgery area clearly. INSPITAL LED lights can be adapted in any size of operating theatres including large hybrid types with variety of models & combinations.

### TECHNICAL SPECIFICATIONS

• Max. Illumination power, in 1 m	: 160.000 Lux
• Diameter of lighthouse	: Ø670 mm
• Color temperature	: 3000 K - 5000 K
• Color rendering index, Ra CRI	: 96%
• Dimming Range	: % 1 - 100
• Light Field Diameter d10	: 24 - 36 cm / 9.5" - 14.2"
• Light Field Diameter d50	: 13 - 28 cm / 5.1" - 11"
• Number of LED modules	: 60
• Lifetime of LED	: >60.000 h
• Degree of turbulence (standard value 37.5% max.)	: 29%
• Depth of the volume of light L1 + L2 at 20%	: 130 cm / 51.2"
• Depth of the volume of light L1 + L2 at 60%	: 76 cm / 30"
• Camera	: 1080p Full HD Camera
• Irradiance at nominal illuminance	: 200 W/m <sup>2</sup>
• Additional options	: Touch Screen Pro Control Unit, Camera, Monitor, Battery Back Up

◆ All values are measured according to IEC 60601-2-41.

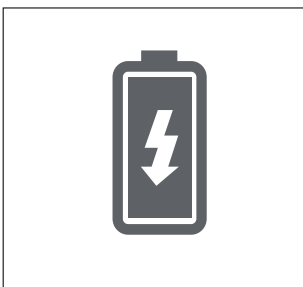

#### Battery

- ◆ External battery can be added for ceiling type operating lights  
A.C. : LD05.05



Operating Together for Life

INSPIRAL



## ELECTRO-HYDRAULIC OPERATING TABLE OT80.20

Three layers visco mattress  
for ensuring patient comfort

Long and strong  
rail line for accessories

Hand and column  
control units

Column Control Panel

T-Base design for  
maximum approach



INSPI TAL operating tables are designed to meet all special requirements of operating theaters with its powerful and stable electro-hydraulic systems. Wide range of accessories makes them very flexible for different surgical disciplines.

Bariatric version of INSPI TAL tables with wider table top and higher lifting capacity (360 kgs) can meet specific requirements of this kind of operations.

Durable, long life  
PU mattress

Optimum X-Ray image quality

Curved design PU mattress



Telescopic stainless  
steel column

Visco mattress, optional



Stainless steel t-base, optional



Bariatric, optional





## ELECTRO-HYDRAULIC OPERATING TABLE OT80.25



Antibacterial surface coating technology is easy to clean, highly resistant to corrosion and has the effect of preventing the production and settlement of blood and body fluids on the surface.



### Optimal Clearance In Surgical Area

- ◆ Maximum surgical area visibility with its kidney elevator, integrated on the table and adjustable up to 150° (70 mm)



### Sliding

- ◆ Image reception ability in a wide area without disturbing the sterile environment by its sliding feature within 300 mm on horizontal plane

## DAY SURGERY TABLE OT80.10

INSPIRAL day surgery table is an all-in-one manual surgery table for transport, preoperative care, surgery and recovery. It is an ideal and cost effective solution for busy day surgery needs.



### Functional Design

- ◆ Easy to handle modular design for different surgical disciplines



### Accessory Positioning

- ◆ Stainless steel rail attachments integrated on both sides of the table, enabling accessory mounting without removing existing accessories



### Different Mattress Options

- ◆ Compact material table top with high X-ray permeability that allows high-quality image reception
- ◆ Visco or polyurethane mattress options that ensure the patient's comfort by taking its body shape, thus preventing decubitus prophylaxis



### T-Base Specifications

- ◆ T-Base enables table optimal approach for the surgical team and equipment
- ◆ ABS Material with break and corrosion resistance



### Easy Approach for C-Arm

- ◆ Complete access to all table areas and its X-ray permeable table top allow high image quality
- ◆ Suitable base structure for easy access and approach of the C-arm scopy and surgical microscopes

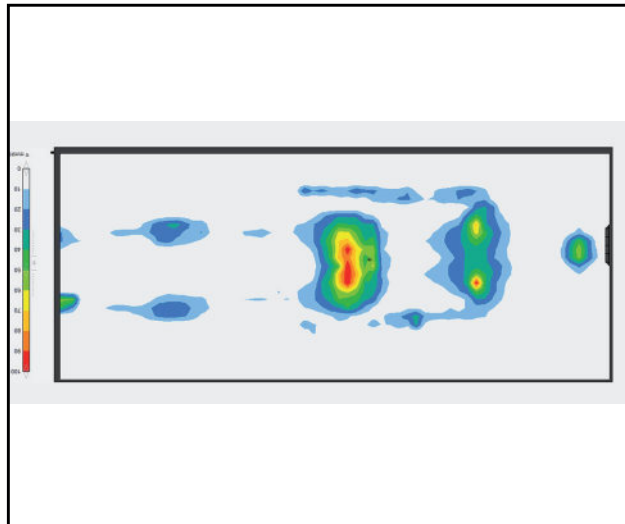

### Optimum Mattress Performance

- ◆ INSPITAL operating table mattresses are designed and manufactured according to the Pressure Mapping test results.



### Control Feature

- ◆ Hand control mechanical brake system
- ◆ Full function hand control for 7 different movements



### Column Control Panel

- ◆ Full function column control panel for emergency and secondary use
- ◆ Emergency stop button



### Wide Range of Accessory Options

- ◆ Wide range of accessories enables variety of positions for general and special surgeries
- ◆ Trolley options to carry and store the accessories



Left Lateral Tilt Position



Struma Surgery Position



Reflex Position



Flex Position



Chest (Breast) Surgery Position



Chest Surgery Position



Gynecologic and Urologic Surgery Position

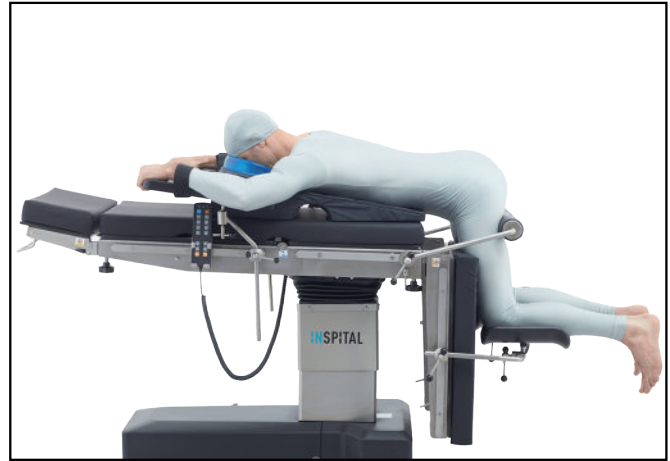

Spinal, Proctologic Surgery Position



Meniscus Surgery Position



Ophthalmology Position



Arthroscopic Position



Orthopedic Fracture Surgery Position



### Orthopedic Traction Set

Orthopedic traction set is suitable for use with all INSPITAL operating tables in orthopedic surgeries.

- ◆ Made of 304 quality stainless steel
- ◆ Leg strainer function by mechanical lever
- ◆ Traction boots with up & down movement and rotation capability around its own axis

A.C:OT60.90



### Neurosurgery Head Rest with Pin & Horseshoe Head Rest

A.C: OT60.80 SET

Neurosurgery head rest especially designed for use in neurosurgery operations.

- ◆ Extremely durable and rigid construction from aluminum alloy
- ◆ 3 pcs fixing system with pins and completely adjustable skull clamps
- ◆ Adjustment mechanism from 4 different points
- ◆ Easily mountable horse shoe head rest accessory



### Cross Bar Adapter

A.C:OT60.82

- ◆ Can be used with skull fixing pins or horseshoe head rest accessories



## Arthroscopy Shoulder Support

Designed for use in arthroscopy operations and suitable for use with all operating tables

- ◆ 7 stage back rest adjustment
- ◆ Head fixing section with up & down movement
- ◆ Special design offering easy reach to shoulder area
- ◆ Body fixing strap

A.C:OT60.76



## Leg Positioning Boot

An accessory designed for use in branches that require leg positioning

- ◆ Positioning system with one hand control and self-brakes
- ◆ Special booths for foot comfort

A.C:OT60.77







**Arm Support, Single**

A.C.:OT60.01

- ◆ Including fixing clamp and strap
- ◆ Rotatable and tiltable armboard
- ◆ Adjustable height
- ◆ Made of stainless steel

**Strap:**

A.C.:OT60.02

- ◆ Adjustable length, easy to fix

**Arm Adaptor**

A.C.:OT60.34

- ◆ Arm extension apparatus



**Anaesthesia Screen, Fixed Size**

A.C.:OT60.03

- ◆ Including fixing clamp
- ◆ Fixed width: Ø12x820x640 mm
- ◆ Made of stainless steel



**Body Fixing Strap**

A.C.: OT60.07

- ◆ Total length: 2300 mm
- ◆ Large cushion for body
- ◆ Easily adjustable length



**IV Stand, 2 hooks**

A.C.: OT60.05

- ◆ Including fixing clamp
- ◆ 2 hooks
- ◆ Adjustable height
- ◆ Made of stainless steel



**IV Stand, 4 hooks**

A.C.: OT60.06

- ◆ Including fixing clamp
- ◆ 4 hooks
- ◆ Adjustable height
- ◆ Made of stainless steel



**Anaesthesia Screen, Adjustable**

A.C.: OT60.04

- ◆ Including fixing clamp
- ◆ Extendible to both sides
- ◆ Adjustable height
- ◆ Made of stainless steel



**Patient Heating System**

A.C.: OT60.71

- ◆ Displays adjustable and measured temperature simultaneously
- ◆ Advanced alarm and security system
- ◆ Provides safe use with key lock
- ◆ Temperature sensitivity 0.1°
- ◆ Polyurethane fabric and carbonfiber heating layer



**Geopel Leg Rest**

A.C.: OT60.08

- ◆ Pair
- ◆ Including fixing clamps
- ◆ Rotatable and tiltable
- ◆ Adjustable height
- ◆ Made of stainless steel



**Irrigation Bowl, Rectangle Form** A.C.: OT60.11

- ◆ Including fixing clamp
- ◆ 2 joints rotatable arms
- ◆ Adjustable height
- ◆ Sizes: 325x265x95 mm
- ◆ Made of stainless steel



**Irrigation Bowl With Drainage, Rectangle Form**  
A.C.: OT60.12

- ◆ Including fixing clamp
- ◆ Including drainage tube
- ◆ 2 joints rotatable arms
- ◆ Adjustable height
- ◆ Sizes: 325x265x95 mm
- ◆ Made of stainless steel



**Waste Bin** A.C.: OT60.14

- ◆ 20 L capacity
- ◆ Compatible with irrigation bowls with drainage
- ◆ Tube hole on the cover
- ◆ 5 castors and rubber bumper
- ◆ Including carriage handle and cover
- ◆ Made of stainless steel



**Irrigation Bowl With Drainage, Round Form**  
A.C.: OT60.13

- ◆ Including fixing clamp
- ◆ Including drainage tube
- ◆ 2 joints rotatable arms
- ◆ Adjustable height
- ◆ Ø260x80 mm
- ◆ Made of stainless steel



**Clamp, Rotatable & Adjustable Jaw**

**A.C.:OT60.17**

- ◆ For rod type accessories
- ◆ 360° rotatable
- ◆ Single lever for total lock
- ◆ Suitable for 25x10 mm rails
- ◆ Made of stainless steel



**Clamp, Rotatable**

**A.C.:OT60.18**

- ◆ For rod type accessories
- ◆ 360° rotatable
- ◆ Double locking lever
- ◆ Suitable for 25x10 mm rails
- ◆ Made of stainless steel



**Clamp, Easy Fix**

**A.C.: OT60.15**

- ◆ Easy to fix type. No need to slide from one side of the rail
- ◆ Suitable for 25x10 mm rails
- ◆ Made of aluminium



**Clamp**

**A.C.: OT60.16**

- ◆ For round rod type accessories
- ◆ Suitable for 25x10 mm rails
- ◆ Made of stainless steel



**Shoulder Support**

A.C.: OT60.09

- ◆ Pair
- ◆ Including fixing clamps
- ◆ Extendible
- ◆ Adjustable height
- ◆ Made of stainless steel



**Lateral Support**

A.C.: OT60.10

- ◆ Pair
- ◆ Including fixing clamps
- ◆ Extendible
- ◆ Rotatable and tiltable
- ◆ Adjustable height
- ◆ Made of stainless steel



**Foot Support Plate**

A.C.: OT60.19

- ◆ Pair
- ◆ Including fixing clamps
- ◆ Made of stainless steel



**Proctology Set**

A.C.: OT60.20

- ◆ Set of rectoscopy roll and knee supports
- ◆ Including fixing clamps
- ◆ Rotatable and tiltable knee support
- ◆ Height and angle adjustable rectoscopy roll
- ◆ Made of stainless steel



**Ophthalmologic Head and Wrist Support A.C.: OT60.21**

- ◆ Rotatable and tiltable head support and wrist support
- ◆ Height and angle adjustable
- ◆ Made of stainless steel



**Weinberger Hand Traction Set A.C.: OT60.22**

- ◆ For the secure fixation of hand and upper arm
- ◆ Height and distance adjustable hand cuff
- ◆ Height adjustable arm extension roll
- ◆ Including fixing clamps
- ◆ Made of stainless steel



**Leg Strap**

**A.C.: OT60.23**

- ◆ Pair
- ◆ Adjustable



**Meniscus Positioning Roll**

**A.C.: OT60.24**

- ◆ Including fixing clamp
- ◆ Adjustable height
- ◆ Made of stainless steel



**Knee Arthroscopy Support**

A.C.: OT60.72

- ◆ Including fixing clamp
- ◆ Adjustable height
- ◆ Made of stainless steel



**Carbonfiber Extension Board**

A.C.: OT60.73

- ◆ Fixing from the leg section
- ◆ Carbonfiber material



**Sliding Handles**

A.C.:OT60.25

- ◆ Designed for easy movement
- ◆ Pair
- ◆ Including fixing clamps
- ◆ Made of stainless steel



**Arm Surgery Extension**

A.C.: OT60.26

- ◆ Including fixing clamps
- ◆ Height adjustable
- ◆ 2 support leg with brake castors
- ◆ Made of stainless steel



**Hand Control Unit**

A.C.: OT60.27

- ◆ Full function hand control unit

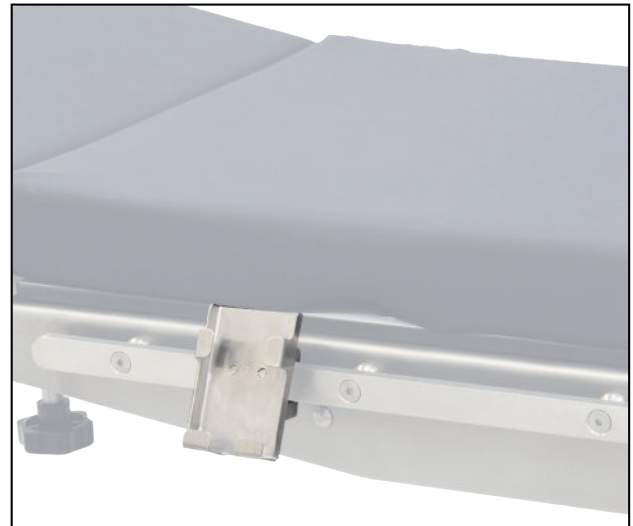

**Support for Hand Control Unit**

A.C.: OT60.29

- ◆ Easy to fix to accessory rail
- ◆ Made of stainless steel



**X-Ray Cassette Support**

A.C.: OT60.30

- ◆ Used to fix and support X-Ray cassettes
- ◆ Including fixing clamp
- ◆ Made of stainless steel



**X-Ray Cassette Tray**

A.C.: OT60.31

- ◆ Used to carry and position the X-Ray cassettes
- ◆ Including fixing clamp
- ◆ Made of stainless steel





**Orthopedic Traction Set Trolley** A.C.: OT60.33

- ◆ For the storage and easy installation of orthopedic traction set
- ◆ Large basket for smaller accessories
- ◆ Four castors, two with brake
- ◆ Made of stainless steel



**Accessory Trolley** A.C.: OT60.32

- ◆ For the storage of table accessories
- ◆ Four rails to hang all accessories
- ◆ Four castors, two with brake
- ◆ Made of stainless steel



**Step, Double**

A.C.: BS10.20

- ◆ Sizes: 640x600x400 mm
- ◆ Made of stainless steel



**Step, Single**

A.C.: BS10.10

- ◆ Sizes: 600x350x180 mm
- ◆ Made of stainless steel



**Wilson Frame Set**

A.C.: OT60.61

- ◆ Consist of 1 piece of large cushion and 4 pieces of gel pads

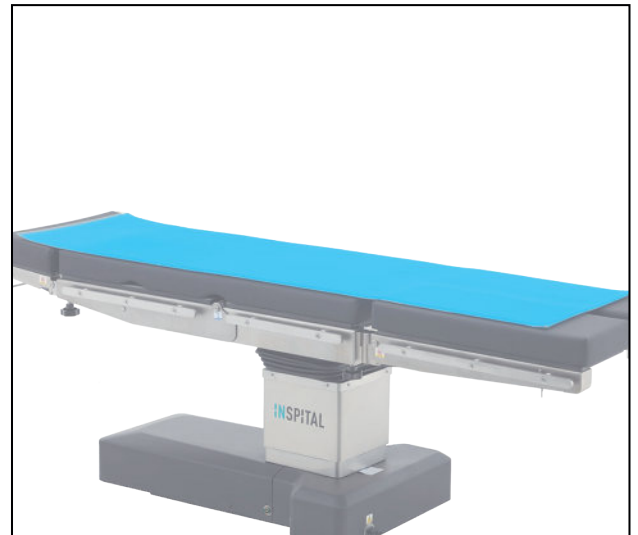

**Gel Mattress, Adult**

A.C.: OT60.62

- ◆ Sizes: 1830x500x100 mm
- ◆ Made of gel

**Gel Mattress, Pediatric**

A.C.: OT60.63

- ◆ Sizes: 660x310x130 mm
- ◆ Made of gel

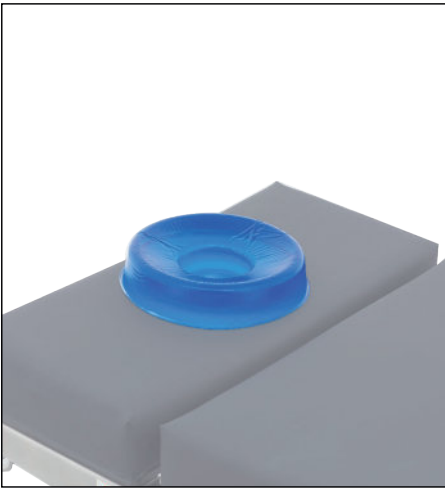

**Head Rest, Gel, Adult** A.C.: OT60.50

- ◆ Sizes: 200x75x45 mm
- ◆ Made of gel

**Head Rest, Gel, Pediatric** A.C.: OT60.51

- ◆ Sizes: 140x60x35 mm
- ◆ Made of gel

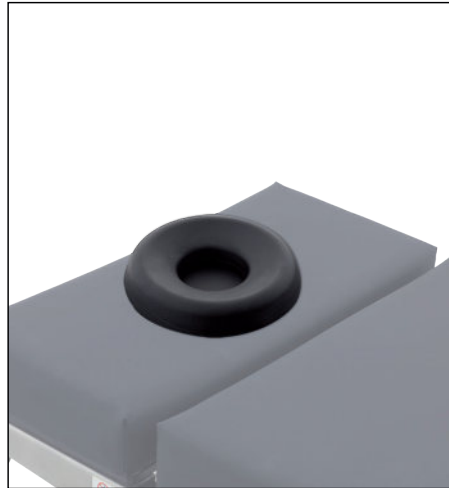

**Head Rest, PU, Adult** A.C.: OT60.40

- ◆ Sizes: 195x85x40 mm
- ◆ Made of PU



**Arm Rest, Gel** A.C.: OT60.54

- ◆ Sizes: 400x130x20 mm
- ◆ Made of gel

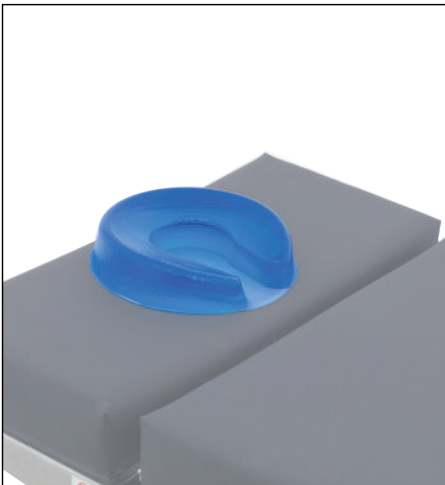

**Horseshoe Head Rest, Gel, Adult** A.C.: OT60.52

- ◆ Sizes: 200x75x45 mm
- ◆ Made of gel

**Horseshoe Head Rest, Gel, Pedi.** A.C.: OT60.53

- ◆ Sizes: 140x60x35 mm
- ◆ Made of gel

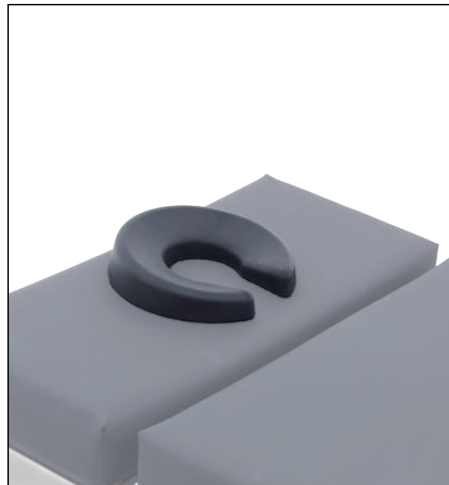

**Horseshoe Head Rest, PU, Adult** A.C.: OT60.41

- ◆ Sizes: 195x80x45 mm
- ◆ Made of PU

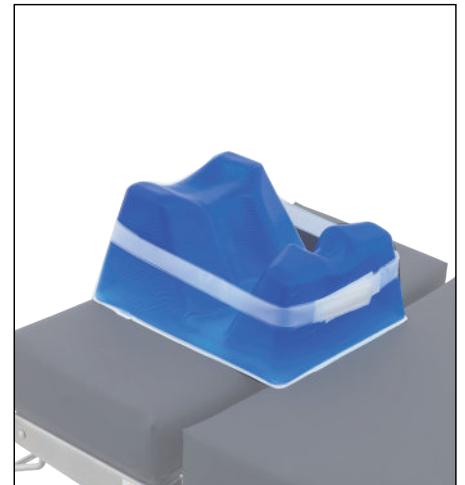

**Prone Head Support, Gel** A.C.: OT60.57

- ◆ Sizes: 280x230x145 mm
- ◆ Made of gel

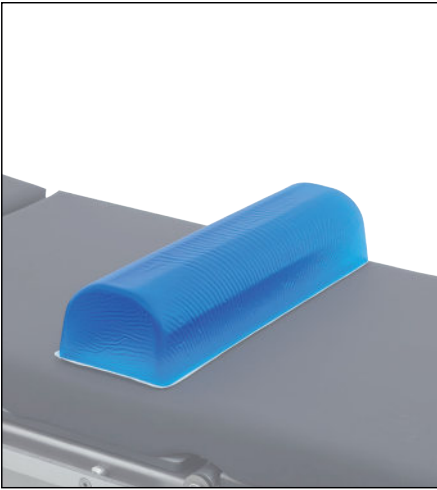

**Chest Roll, Gel, Adult** A.C.: OT60.55

- ◆ Sizes: 515 x170x100mm
- ◆ Made of gel

**Chest Roll, Gel, Pediatric** A.C.: OT60.56

- ◆ Sizes: 420x170x170mm
- ◆ Made of gel

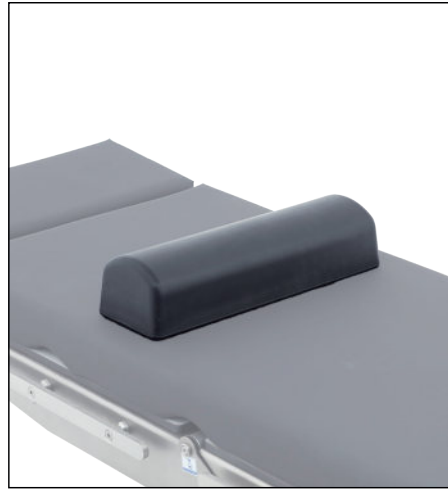

**Chest Roll, PU** A.C.: OT60.42

- ◆ Sizes: 440x135x100 mm
- ◆ Made of PU

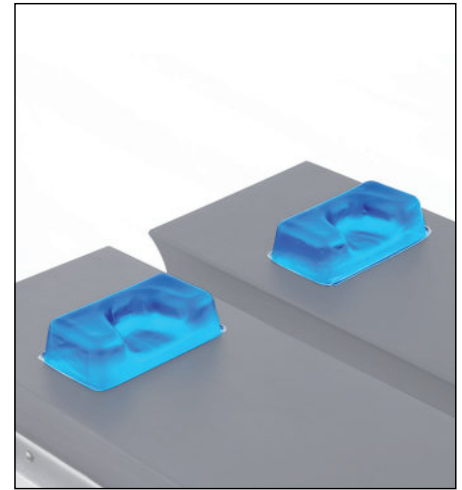

**Heel Support, Gel** A.C.: OT60.59

- ◆ Sizes: 170x110x50 mm
- ◆ Pair
- ◆ Made of gel

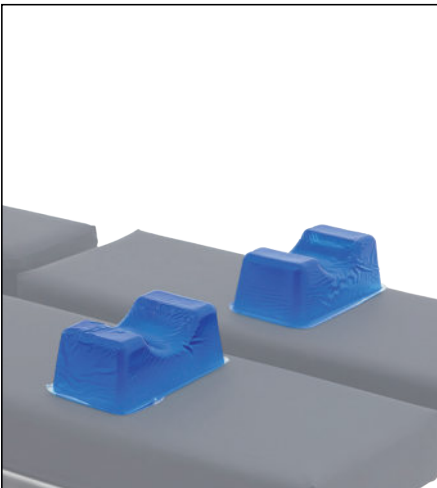

**Foot Wrist Support, Gel** A.C.: OT60.58

- ◆ Sizes: 100x110x70 mm
- ◆ Pair
- ◆ Made of gel

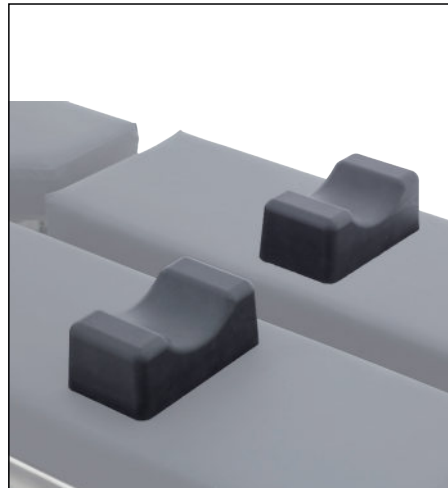

**Foot Wrist Support, PU** A.C.: OT60.43

- ◆ Sizes: 175x95x70 mm
- ◆ Pair
- ◆ Made of PU

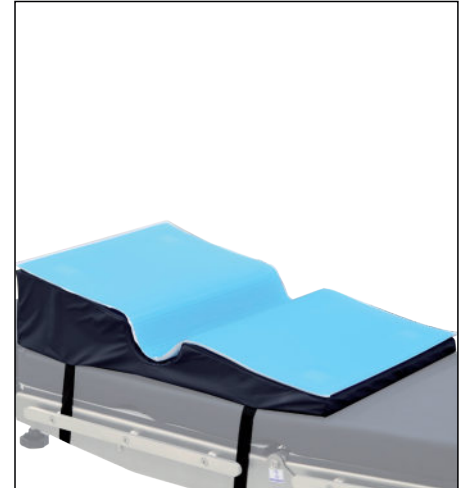

**Lateral Positioner, Gel** A.C.: OT60.60

- ◆ Consist of 1 piece of large cushion and 1 piece of gel pad
- ◆ Sizes: 720x500x100 mm