

altech[®]

Breathing Systems

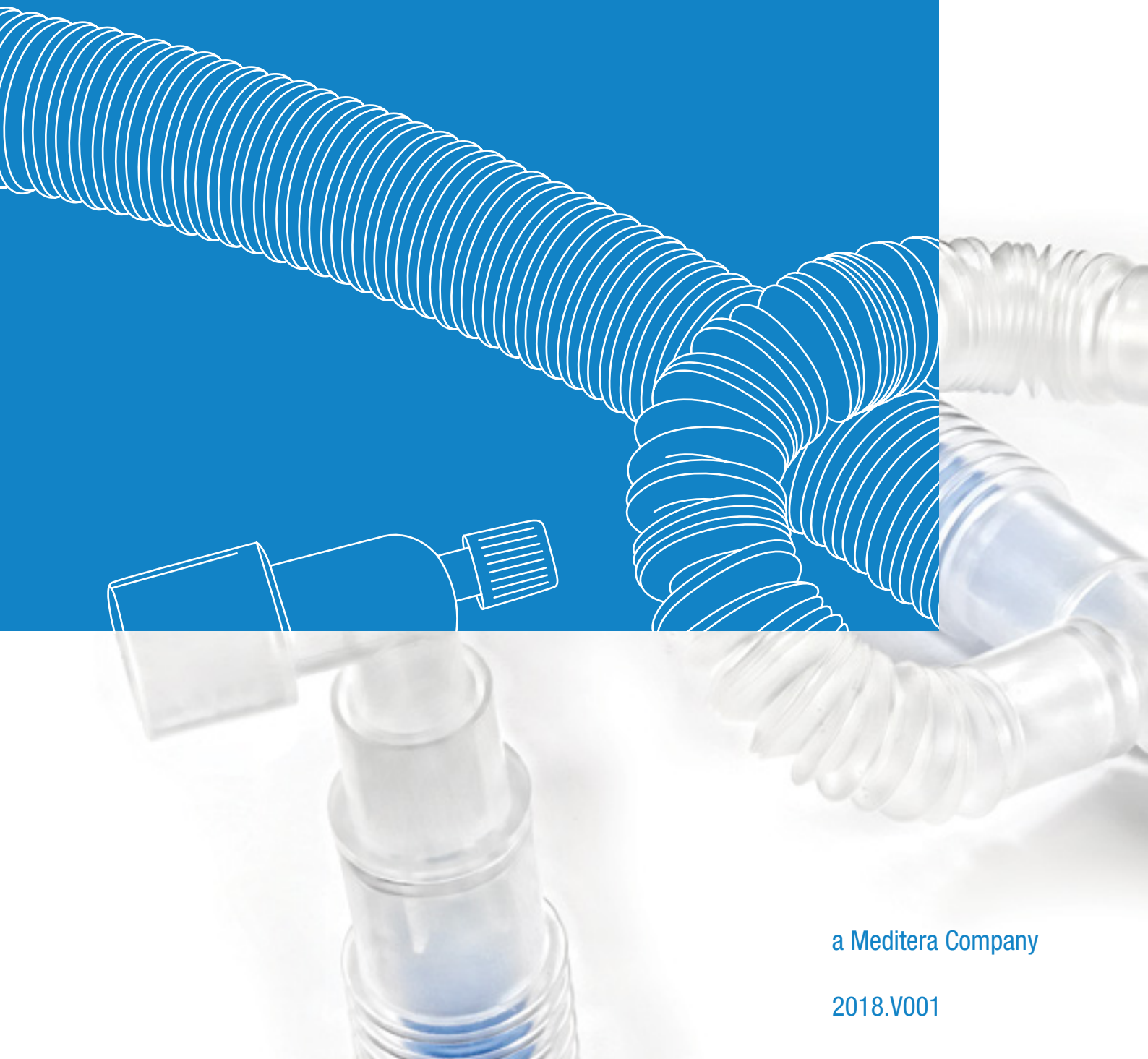

a Meditera Company

2018.V001



altech[®]



a Meditera Company

altech®

a Meditera Company

- Facility in Tire Organized Industrial Zone, İzmir
 - 60.000 m² total area
 - 30.000 m² production area
 - 6.400 m² Clean Rooms
 - CE, ISO 13485 & ISO 14001
- Injection Molding and Tube Extrusion
 - Design and Production of Molding
- Production and Assembling of Respiratory Disposables
 - Ethylene Oxide Sterilization Units



Company Profile

Our job is to make yours easier

Altera A.S. was founded in 1999 as a manufacturing company of Meditera Group by Pharmacist Atilla Sevincli. Since its foundation, Altera has been devoted to developing, designing and manufacturing range of respiratory products that meet market demands, top quality, good service and each day better quality. Our success is based on our knowledge.



The company is specialized in the healthcare sector and located in İzmir, Turkey. Altera is devoted to production and assembling of the Disposable Medical Consumables with the Altech® brand manufacturing in 11 clean rooms (10.000 and 100.000 class). The products are CE marked and comply with ISO 13485 & 14001

Altech stands for modern respiratory treatment of quality and safety when it comes to the care and treatment of patients

INDEX

Breathing Circuits	10 - 29
Patented Products	32 - 37
Catheter Mounts	40 - 41
Filters	44 - 47
Oxygen and Aerosol Therapy Products	50 - 51
Gas Sampling Lines	54 - 55
Masks & Resuscitators	58 - 59
Infection Prevention	62 - 63
Certifications	65

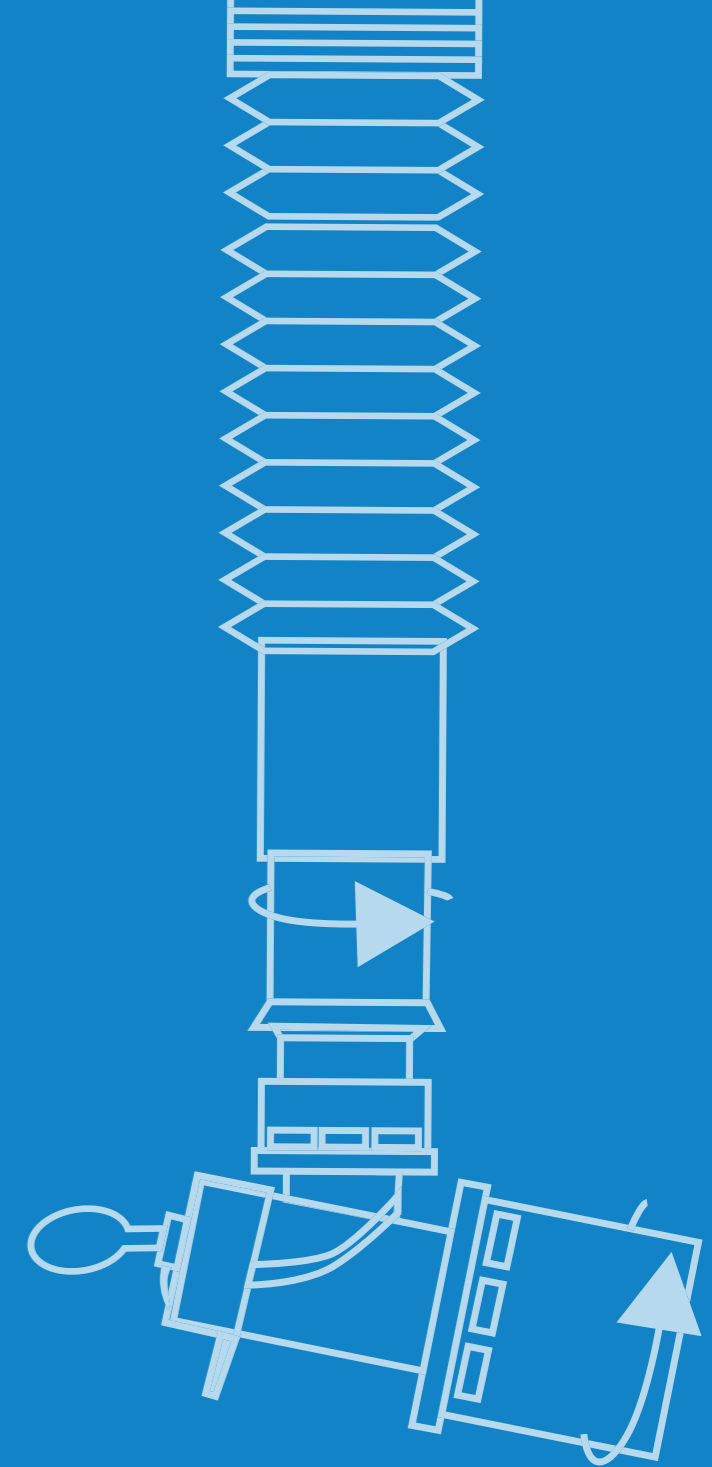

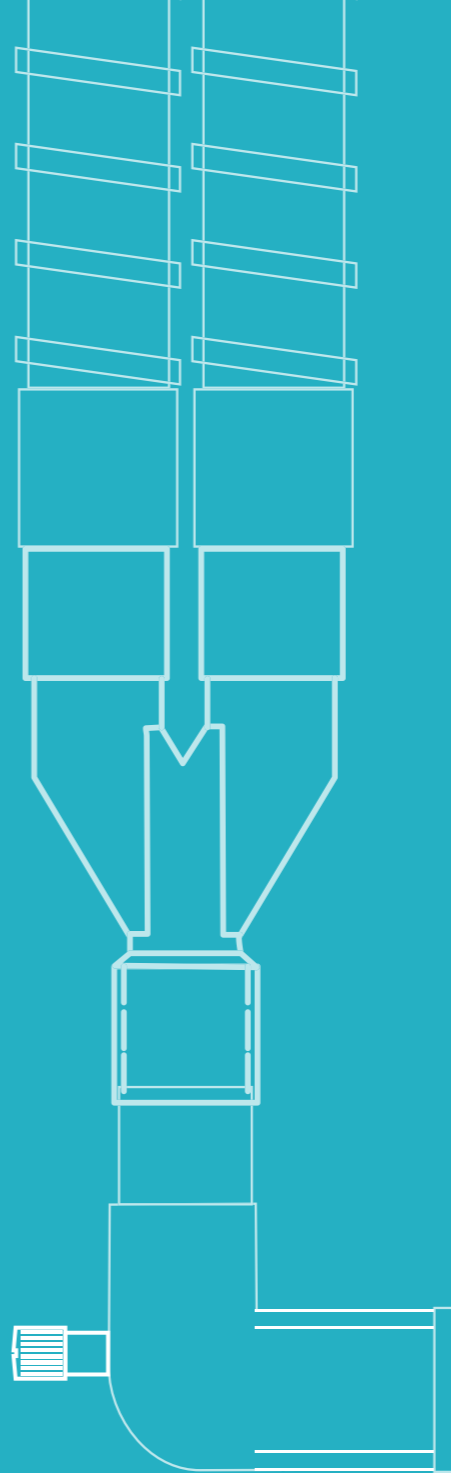

Breathing Circuits

altech[®]

a Meditera Company

Anesthesia Circuits

- Altech offers a wide range of anesthesia circuits available in different lengths and configurations for anesthesiology, operating and recovery room. We ensure to offer the proper anesthetic breathing circuit for you according to your clinical needs and requirements.
- Circuits are available in;
 - Different sizes: (Adult, pediatric and neonatal)
 - Different tubing types: Corrugated PE / Extendible PP / Smoothbore PVC
 - With Y & Elbow Connectors (with or without ports)
 - Sterile or Clean manufactured
- All circuits are manufactured in 10.000 or 100.000 Class clean rooms.
- All products are CE marked and comply with ISO 13485 regulations.



Anesthesia Circuits

- Flexibility – Corrugated Tube (Polyethylene)**
 - Lightweight and cost effective
 - Directly bonded connectors to the tube for avoiding leakage risks
 - Available in White and Blue Color
- Adjust&Extend – Polypropylene (PP) Extendible Tube**
 - Extendible tubes may be extended up to 3 times their packed length and allow system to be set to the desired length and position optimising the compressible volume
 - Extendible tubings maintain their position set by healthcare professional as long as desired thus minimise the strain on the airway connection
 - Available in adult 22mm and pediatric 15mm sizes
- Smooth Inside – Smoothbore PVC Tube**
 - Lower tubing compliance
 - Transparent tube makes viewing tube inside easier
 - Inner smooth surface allows easy drainage of condensed water and contributes to reduce the risk of interruptions in anesthesia,
 - Soft, flexible connectors ensure a perfect seal with anesthesia machine inlet and outlet.

ANESTHESIA CIRCUIT

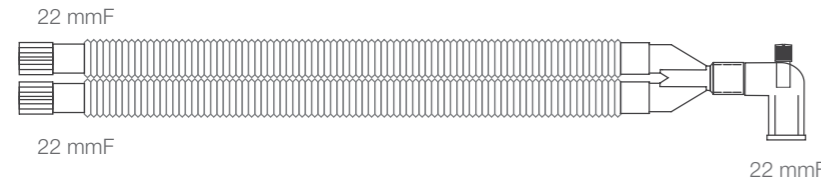

Corrugated			
	Length	Code	Qty/Box
Adult	160 cm/63"	AL-1100	40
Pediatric	160 cm/63"	AL-1400	50
Neonatal	160 cm /63"	AL-1700	50

Extendible			
	Length	Code	Qty/Box
Adult	160 cm/63"	AL-1300	70
Pediatric	150 cm/59"	AL-1600	70

Smoothbore			
	Length	Code	Qty/Box
Adult	180 cm /71"	AL-1200	40
Pediatric	150 cm/59"	AL-1500	50
Neonatal	150 cm/59"	AL-1800	50

Corrugated			
	Length	Code	Qty/Box
Adult	160 cm/63"	AL-1101-060	30
Pediatric	160 cm/63"	AL-1401-060	50
Neonatal	160 cm/63"	AL-1701-060	50

Extendible			
	Length	Code	Qty/Box
Adult	180 cm /71"	AL-1303-060	70
Pediatric	150 cm/59"	AL-1603-060	70

Smoothbore			
	Length	Code	Qty/Box
Adult	180 cm /71"	AL-1202-060	40
Pediatric	150 cm /59"	AL-1502-060	50
Neonatal	150 cm /59"	AL-1802-060	50

ANESTHESIA CIRCUIT WITH LIMB & BREATHING BAG

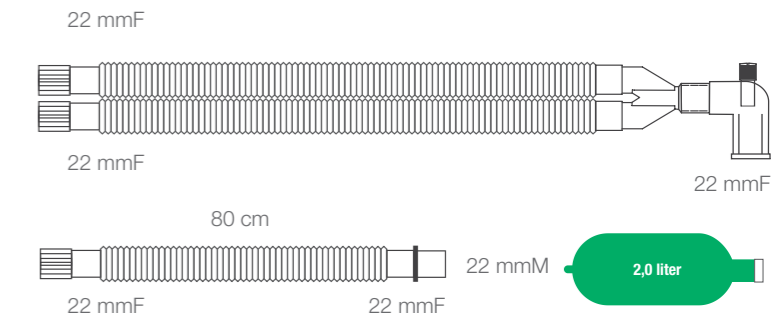

ANESTHESIA CIRCUIT WITH LIMB

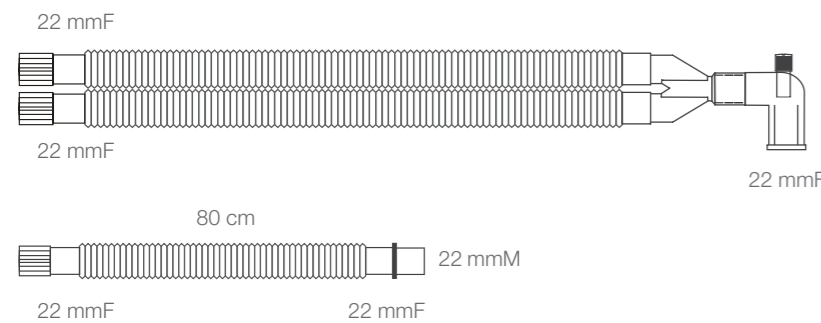

Corrugated			
	Length	Code	Qty/Box
Adult	160 cm/63"	AL-1101	30
Pediatric	160 cm/63"	AL-1401	50
Neonatal	160 cm /63"	AL-1701	50

Extendible			
	Length	Code	Qty/Box
Adult	160 cm/63"	AL-1303	70
Pediatric	160 cm/63"	AL-1603	70

Smoothbore			
	Length	Code	Qty/Box
Adult	180 cm /71"	AL-1202	30
Pediatric	150 cm/59"	AL-1502	50
Neonatal	150 cm/59"	AL-1802	50

Extendible			
	Length	Code	Qty/Box
Adult	300 cm /118"	AL-1300-100/9	60

Nitrous oxide is the most commonly used inhalation anesthetic in dentistry and is commonly used in emergency centers and ambulatory surgery centers as well to provide minimal and moderate sedation. The gas (equal parts of nitrous oxide and oxygen) is administered via a special circuit and inhaled by the patient using either a face mask or a mouthpiece.

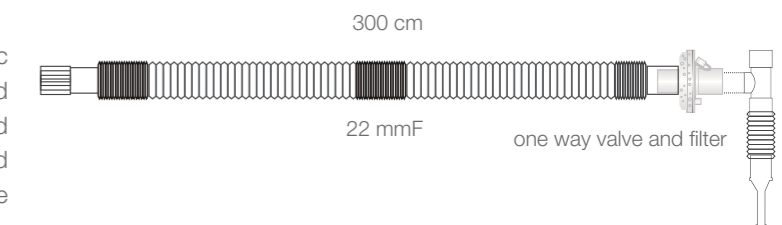

Anesthesia Circuits

Tailor Made Solutions

- Tubing lengths may be customized by the end user
- Complete package solutions depending on the clinical needs

Easy & Secure Connections

- 22mm Female machine inlet connectors ensures a secure fit to the anaesthetic machine. The soft, lightweight and flexible materials enhances a secure seal while still allowing ease of connection and disconnection.



Low-Flow Anesthesia Parallel Circuit

- Effective and safe sidestream measurement of CO₂ during low-flow anesthesia
- Coextruded, double layer gas sampling line. Inner tube PE for accurate measurement / outer tube PVC to avoid kinking
- Precise sampling of CO₂
- Delivering an accurate and quantitative reading.

ANESTHESIA CIRCUIT WITH LIMB BREATHING BAG / BACTERIAL-VIRAL FILTER

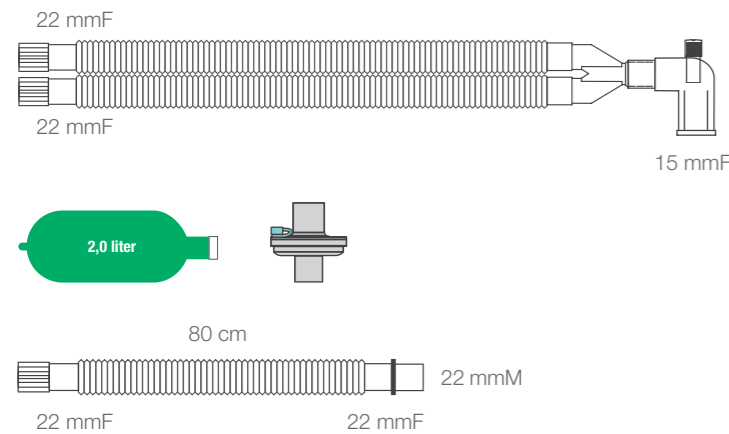

Corrugated			
	Length	Code	Qty/Box
Adult	160 cm/63"	AL-1101-160	30
Pediatric	160 cm/63"	AL-1401-160	50
Neonatal	160 cm/63"	AL-1701-160	40

Extendible			
	Length	Code	Qty/Box
Adult	180 cm/71"	AL-1303-160	50
Pediatric	150 cm/59"	AL-1603-160	60

Smoothbore			
	Length	Code	Qty/Box
Adult	180 cm/71"	AL-1202-160	30
Pediatric	150 cm/59"	AL-1502-160	30
Neonatal	150 cm/59"	AL-1802-160	40

ANESTHESIA CIRCUIT WITH LIMB BREATHING BAG / BACTERIAL VIRAL FILTER / CO₂ SAMPLING LINE

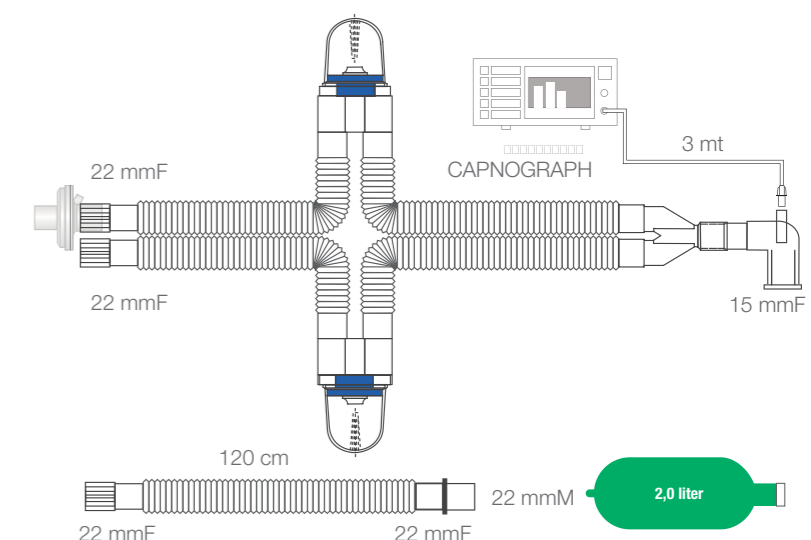

Corrugated			
	Length	Code	Qty/Box
Adult	160 cm/63"	AL-1121-160/5	30
Pediatric	160 cm/63"	AL-1421-160/5	50
Neonatal	160 cm/63"	AL-1721-160/5	50

Extendible			
	Length	Code	Qty/Box
Adult	180 cm/71"	AL-1323-160/5	50
Pediatric	150 cm/59"	AL-1623-160/5	60

Smoothbore			
	Length	Code	Qty/Box
Adult	180 cm/71"	AL-1222-160/5	30
Pediatric	150 cm/59"	AL-1522-160/5	50
Neonatal	150 cm/59"	AL-1822-160/5	50

ANESTHESIA CIRCUIT WITH LIMB BREATHING BAG / BACTERIAL-VIRAL FILTER / MASK/CO₂ SAMPLING LINE

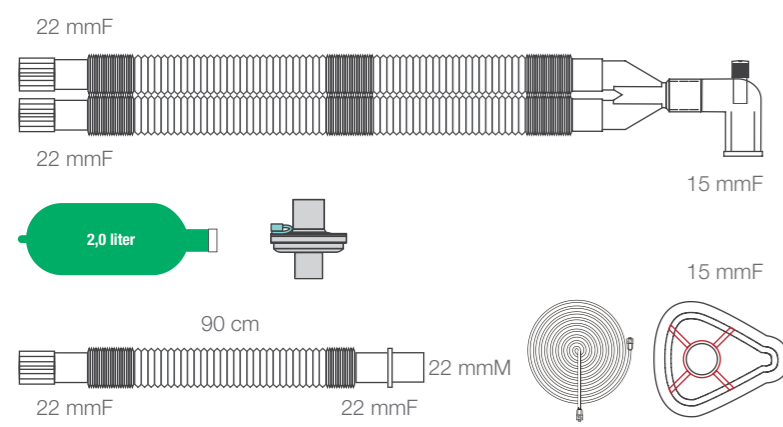

Corrugated			
	Length	Code	Qty/Box
Adult	160 cm/63"	AL-1101-170/5	30
Pediatric	160 cm/63"	AL-1401-170/5	40
Neonatal	160 cm/63"	AL-1701-170/5	50

Extendible			
	Length	Code	Qty/Box
Adult	180 cm/71"	AL-1303-170/5	40
Pediatric	150 cm/59"	AL-1603-170/5	40

Smoothbore			
	Length	Code	Qty/Box
Adult	180 cm /71"	AL-1202-170/5	40
Pediatric	150 cm /59"	AL-1502-170/5	40
Neonatal	150 cm /59"	AL-1802-170/5	40

Corrugated			
	Length	Code	Qty/Box
Adult	160 cm/63"	AL-1121-160/6	50
Pediatric	160 cm/63"	AL-1421-160/6	50
Neonatal	160 cm/63"	AL-1721-160/6	50

Extendible			
	Length	Code	Qty/Box
Adult	180 cm/71"	AL-1323-160/6	50
Pediatric	150 cm/59"	AL-1623-160/6	50

Smoothbore			
	Length	Code	Qty/Box
Adult	180 cm /71"	AL-1222-160/6	40
Pediatric	150 cm /59"	AL-1522-160/6	40
Neonatal	150 cm /59"	AL-1822-160/6	40

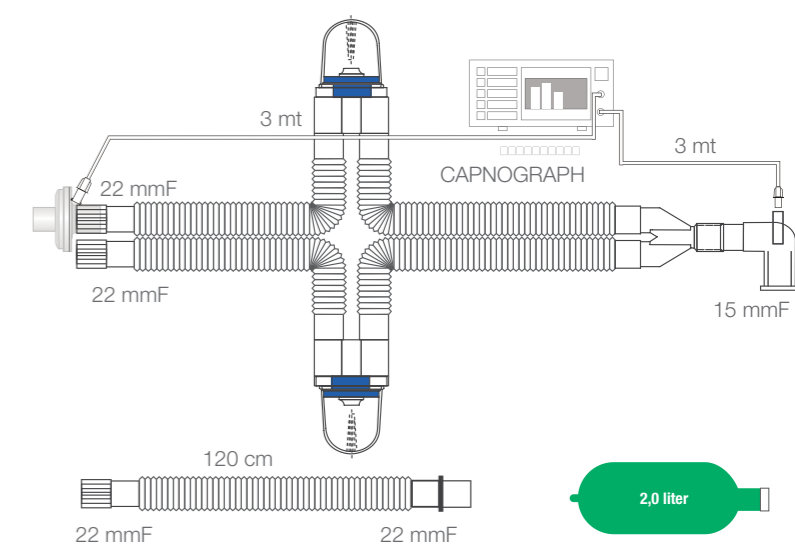

Complete and efficient anesthesia circuit pack

Coaxial Circuits

- Reliable, convenient and designed for enhancing natural warming of inspired gases, coaxial circuits with their streamlined tube-within-a-tube design eliminates the drag on the patient .
- The system provides increased circuit mobility and low weight in comparison with a traditional circle circuit.
- The best advantage of this coaxial design is to provide a self-contained, thermally efficient atmosphere where inspired gasses are naturally warmed and humidified.
- All fittings comply with ISO 5356 standard.
- Although coaxial circuit has been designed as an anesthesia circle system, it has also proven to be suitable in the ICU as providing a desired level of humidity



Coaxial Anesthesia Circuits with Water Trap

- Altech coaxial (tube-within-a-tube) breathing system ideal for use within both operating room and ICU. It is well suited to low flow anaesthesia.
- Water trap on this circuit with its unique design withdraws condensation from the circuit to secure the machine and contributes ventilation by preventing resistance to air which occurs due to water condensation.
- Water traps also eliminate the possible infection risk in ICU leading to sepsis caused by condensation accumulation within the inspiratory and expiratory lines.
- Optional CO2 monitoring line collects end tidal CO2 from the tip of the patient elbow connector. This provides accurate gas sampling.

MEDI-FLOW CIRCUIT

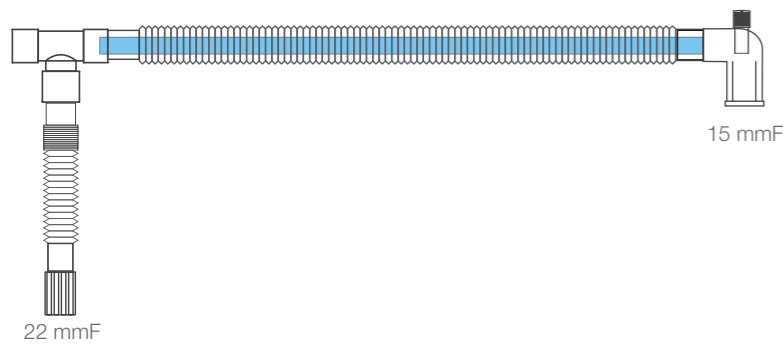

Corrugated			
	Length	Code	Qty/Box
Adult	180 cm/71"	AL-1900	40
Pediatric	150 cm/59"	AL-P1900	40

COAXIAL CIRCUIT W/INTEGRATED WATER TRAP

Corrugated			
	Length	Code	Qty/Box
Adult	180 cm/71"	AL-1913-060	30
Pediatric	150 cm/59"	AL-P1913-060	30

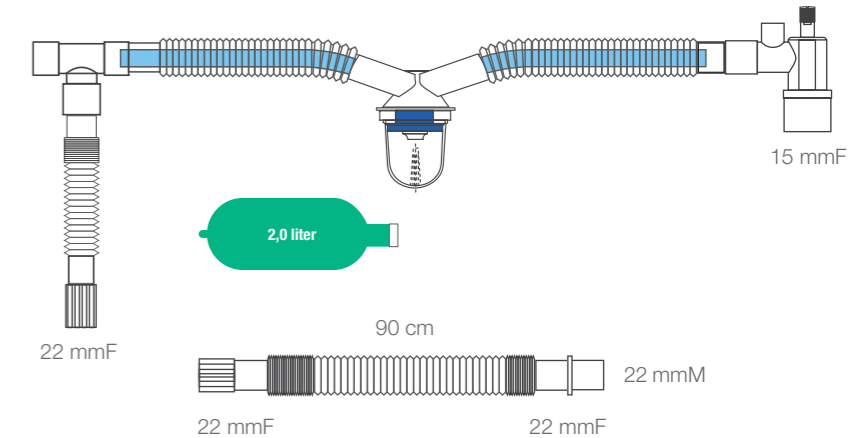

MEDI-FLOW CIRCUIT WITH LIMB & BREATHING BAG

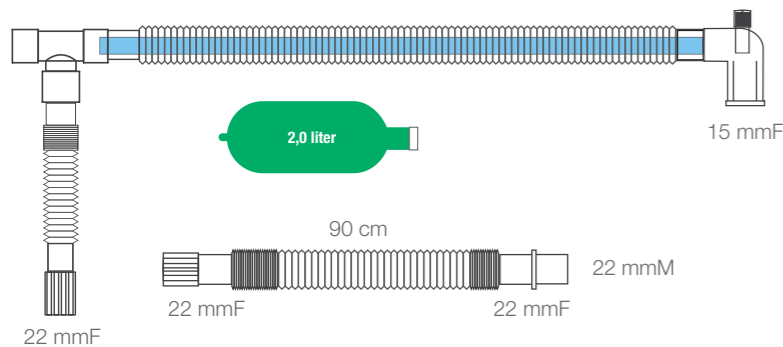

Corrugated			
	Length	Code	Qty/Box
Adult	180 cm/71"	AL-1903-060	30
Pediatric	150 cm/59"	AL-P1903-060	30

LOW - FLOW COAXIAL CIRCUIT W/INTEGRATED DOUBLE WATER TRAP

Corrugated			
	Length	Code	Qty/Box
Adult	180 cm/71"	AL-1923-060	30
Pediatric	150 cm/59"	AL-P1923-060	30

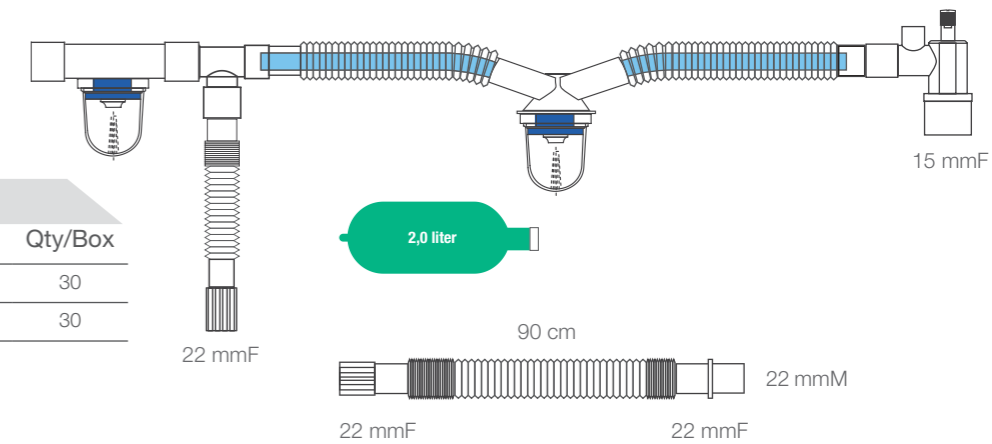

MEDI-FLOW CIRCUIT WITH LIMB BREATHING BAG / BACTERIAL FILTER/GAS SAMPLING LINE

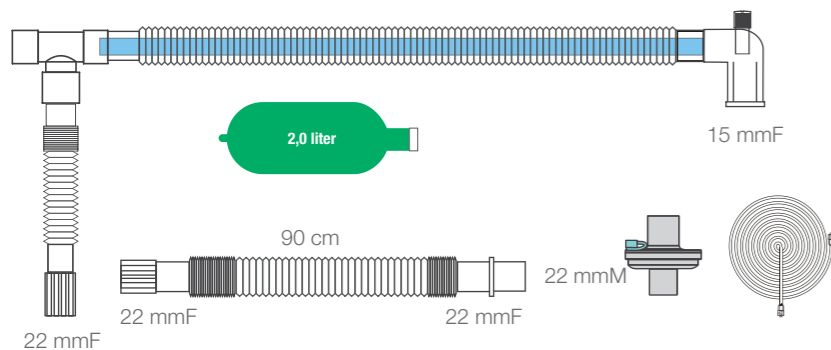

Corrugated			
	Length	Code	Qty/Box
Adult	180 cm/71"	AL-1903-160/5	30
Pediatric	150 cm/59"	AL-P1903-160/5	30

Semi-Closed Circuits

- Mapleson Circuits
- Modified Jackson Rees Circuits
- Bain Circuits
- Circuits with APL Valve



Semi-Closed Circuits

- Mapleson Circuits
- Modified Jackson Rees Circuits
- Bain Circuits
- Circuits with APL Valve

MAPLESON D-DELUXE BAIN CIRCUIT

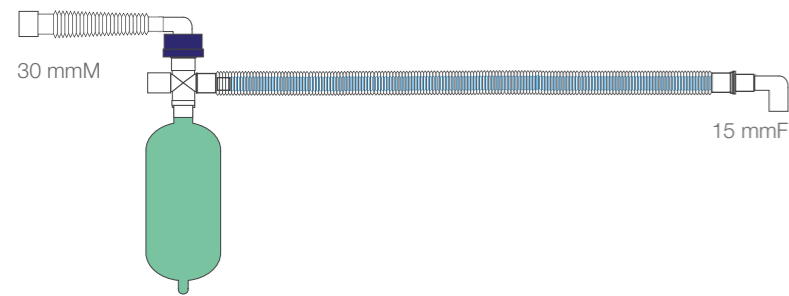

	Corrugated		
	Length	Code	Qty/Box
Adult	140 cm/55"	AL-0030	30

	Corrugated		
	Length	Code	Qty/Box
Adult	140 cm/55"	AL-0110-040/7	50
Pediatric	160 cm/63"	AL-0410-040/7	50

MODIFIED JACKSON REES FRESH GAS LINE
NORMAN MASK ELBOW, TAIL BLEED VALVE
WITH BREATHING BAG

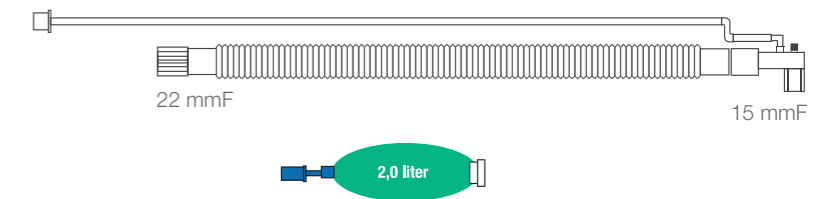

MAPLESON A CIRCUIT

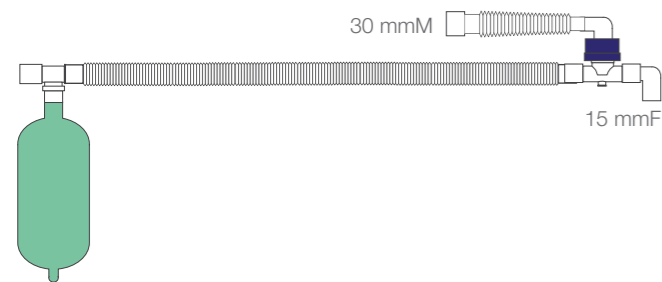

	Corrugated		
	Length	Code	Qty/Box
Adult	140 cm/55"	AL-0031	30

	Corrugated		
	Length	Code	Qty/Box
Adult	140 cm/55"	AL-0140-010/7	50
Pediatric	140 cm/55"	AL-0440-010/7	50

MAPLESON D CIRCUIT
WASHINGTON TEE, WITH BREATHING BAG

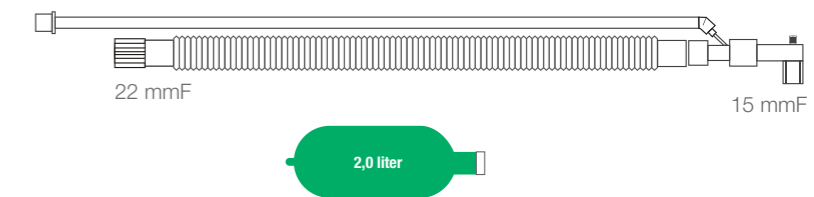

MAPLESON C CIRCUIT

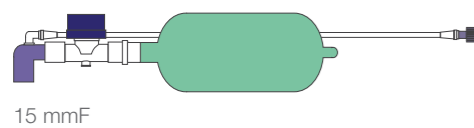

	Corrugated		
	Length	Code	Qty/Box
Adult	110 cm/43"	AL-0032	30

	Corrugated		
	Length	Code	Qty/Box
Adult	140 cm/55"	AL-0150-010	50
Pediatric	160 cm/63"	AL-0450-010	50

BAIN CIRCUITS STANDART
1/4" BARBED FRESH GAS CONNECTO,
WITH BREATHING BAG

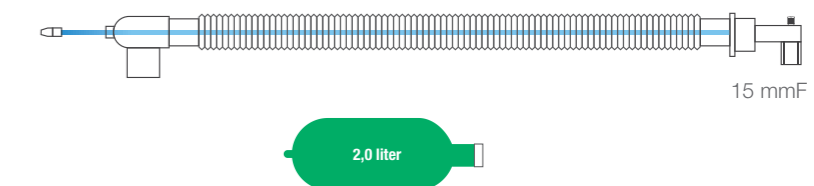

Ventilation Circuits

- Altech ventilation circuit range is specifically designed with low compliance tubes for patients requiring mechanical ventilation in Intensive Care Units.
- A wide variety of ICU Breathing Systems are offered to meet individual requirements without compromising the patient and healthcare workers safety.

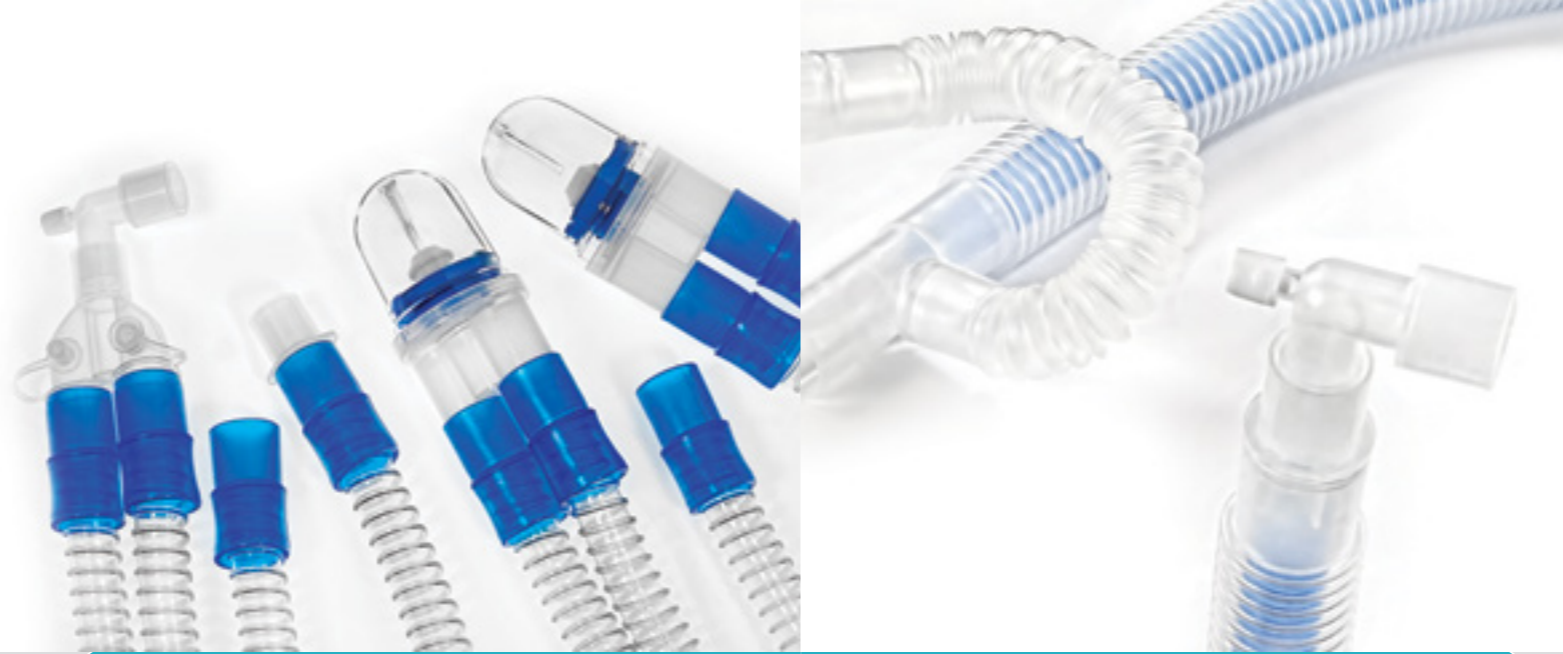

Fully Closed Ventilation Circuits

CONTINUITY OF MECHANICAL VENTILATION and MINIMUM INFECTION RISK
 Proper humidification of mechanically ventilated patients is very important. Active humidification commonly used for adequate humidification comes with challenge of water condensation in the circuit. Condensation that collects in the ventilation circuit is considered to be contaminated and it should be handled and removed carefully for infection control purposes. If the system is opened to drain the condensate; consequences such as contamination of interior of the circuit; exposure of caregiver to contaminated condensate; cross-contamination of other patients and possible collapse of the alveoli due to breakage of the circuit increase the risk of interruption and failure of clinicians' therapy. Collection and drainage of the condensate with a closed system is crucial to eliminate challenges above and to prevent infection (VAP and sepsis). Altech fully closed ventilation circuits contribute to continuous ventilation therapy without interruption and with minimized infection risk.

VENTILATION CIRCUITS WITH INSP. & EXP. WATER TRAP & BACTERIAL HME FILTER & CATHETER MOUNT & LIMB

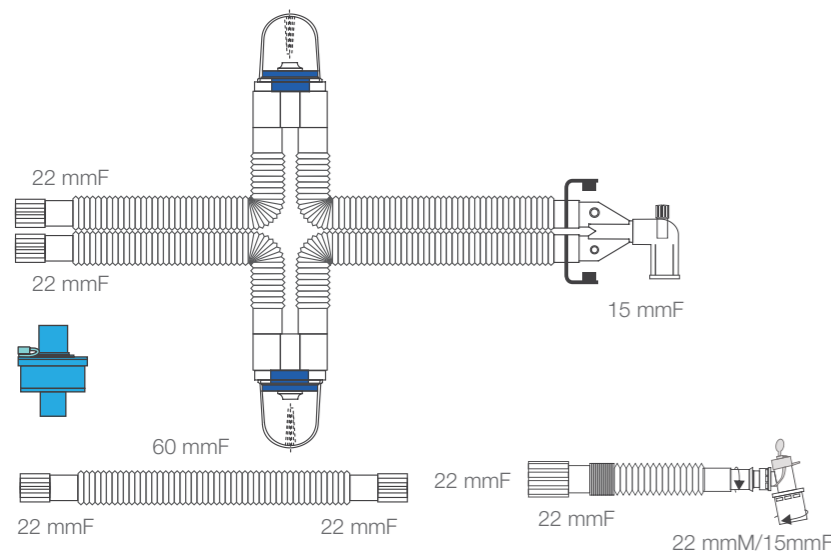

Corrugated			
	Length	Code	Qty/Box
Adult	160 cm/63"	AL-1121-206	30
Pediatric	160 cm/63"	AL-1421-206	30

Extendible			
	Length	Code	Qty/Box
Adult	180 cm/71"	AL-1323-206	40
Pediatric	150 cm/59"	AL-1623-206	40

Smoothbore			
	Length	Code	Qty/Box
Adult	180 cm/71"	AL-1222-206	30
Pediatric	150 cm/59"	AL-1522-206	30

VENTILATION CIRCUITS WITH LIMB&MDI CHAMBER

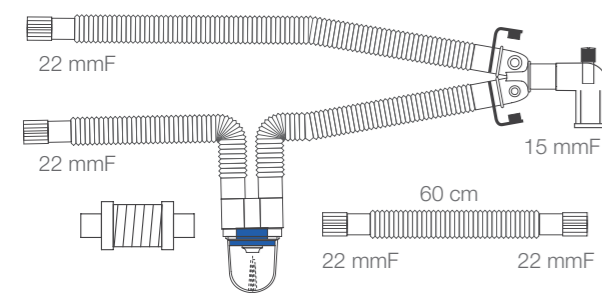

Corrugated			
	Length	Code	Qty/Box
Adult	160 cm/63"	AL-1111-000/3	30
Pediatric	160 cm/63"	AL-1411-000/3	30

Smoothbore			
	Length	Code	Qty/Box
Adult	160 cm/63"	AL-1212-000/3	30
Pediatric	160 cm/63"	AL-1512-000/3	30

VENTILATION CIRCUITS WITH LIMB & MDI CHAMBER

- A special circuit for delivering aerosoled bronchodilators through ventilator circuit thanks to a specially designed collapsible holding chamber to be left in the inspiratory limb of a ventilator circuit, and can be collapsed when not in use without interruption of continuous mechanical ventilation.
- Improved Medication Delivery
- 22M/22F connections
- Can be used with all commonly prescribed MDI canisters

COAXIAL VENTILATION CIRCUIT W/INTEGRATED NEEDLE FREE WATER TRAP

Corrugated			
	Length	Code	Qty/Box
Adult	180 cm/71"	AL-1923-000/9 .V002	50
Pediatric	180 cm/71"	AL-P1923-000/9.V002	50

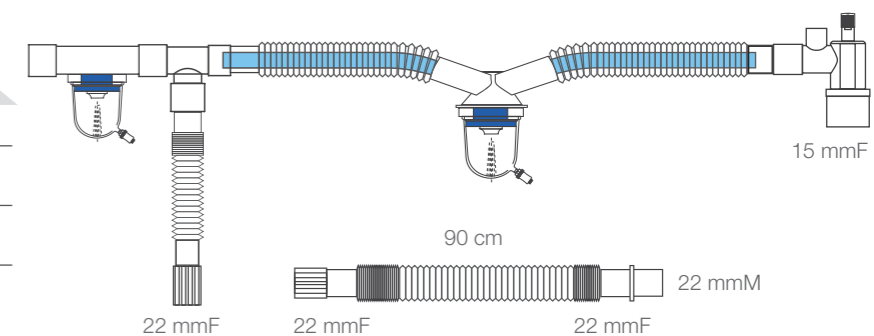

COAXIAL VENTILATION CIRCUIT W/INTEGRATED NEEDLE FREE WATER TRAP

Corrugated			
	Length	Code	Qty/Box
Adult	180 cm/71"	AL-1923-000/9 .V001	50
Pediatric	180 cm/71"	AL-P1923-000/9 .V001	50

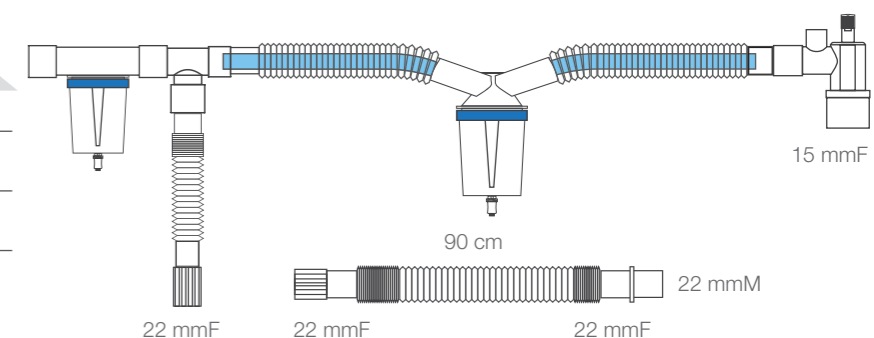

PARALLEL VENTILATION CIRCUIT W/INTEGRATED NEEDLE FREE WATER TRAP

Corrugated			
	Length	Code	Qty/Box
Adult	160 cm/63"	AL-1111-000/9 .V001	50
Pediatric	160 cm/63"	AL-1411-000/9 .V001	50

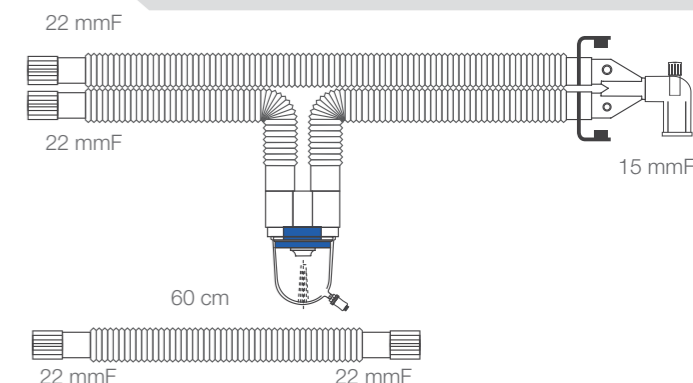

Ventilation Circuits

Safety

- Offering a wide range of water traps
- The self-sealing closure allows the water trap to be emptied without interrupting flow.
- As the base of water trap is opened the internal valve automatically shuts down and
- Avoids possible air leakages



IPPB Circuits

- We offer a range of disposable adult IPPB breathing systems for use with the majority of transport ventilators to be used with inter hospital patient transfer.
- For use with all IPPB machines.
- Mouth piece, cateter mount, nebulizer or other accessories may be adapted while assembling.
- Exhalation valve with clear cap and expiratory flow diverter.

VENTILATION CIRCUIT W/WATER TRAP LIMB & BACTERIAL HME FILTER & CATHETER MOUNT

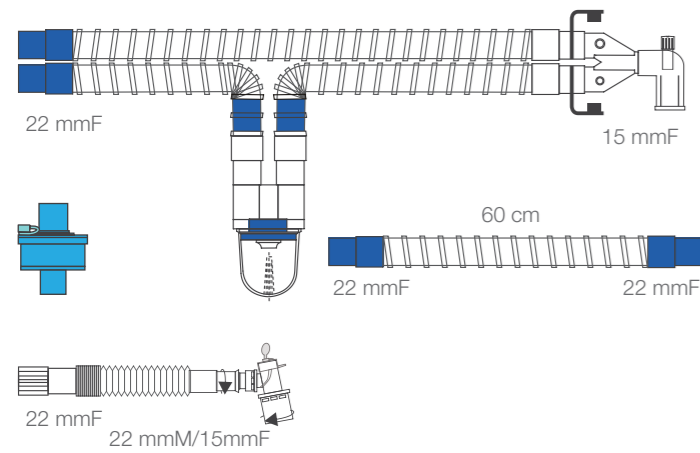

Corrugated

	Length	Code	Qty/Box
Adult	160 cm/63"	AL-1111-206	25
Pediatric	160 cm/63"	AL-1411-206	25

Smoothbore

	Length	Code	Qty/Box
Adult	180 cm/71"	AL-1212-206	30
Pediatric	150 cm/59"	AL-1512-206	30

Extendible

	Length	Code	Qty/Box
Adult	180 cm/71"	AL-1313-206	40
Pediatric	150 cm/59"	AL-1613-206	40

VENTILATION CIRCUIT W/WATER TRAPS LIMB & BACTERIAL HME FILTER & CATHETER MOUNT

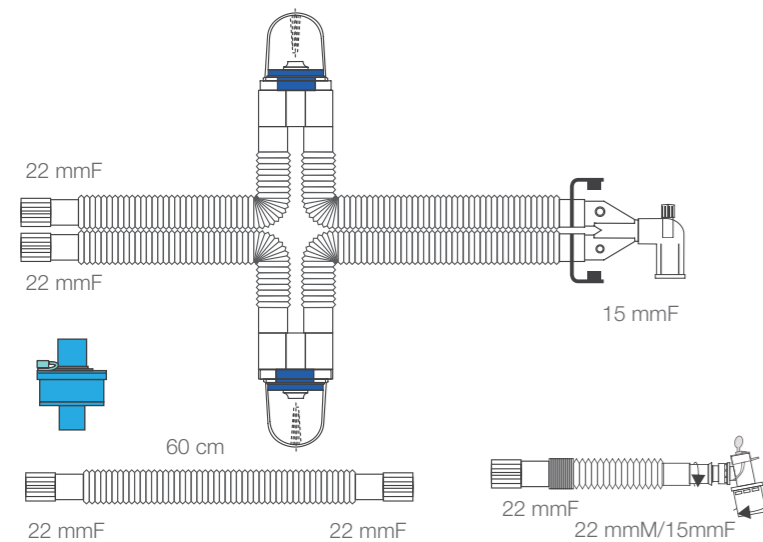

Corrugated

	Length	Code	Qty/Box
Adult	160 cm/63"	AL-1121-206	30
Pediatric	160 cm/63"	AL-1421-206	40

Smoothbore

	Length	Code	Qty/Box
Adult	180 cm/71"	AL-1222-206	30
Pediatric	150 cm/59"	AL-1522-206	40

Extendible

	Length	Code	Qty/Box
Adult	180 cm/71"	AL-1323-206	40
Pediatric	150 cm/59"	AL-1623-206	50

IPPB CIRCUITS

Corrugated

	Length	Code	Qty/Box
Adult	160 cm/63"	AL-3110-026	40

Smoothbore

	Length	Code	Qty/Box
Adult	160 cm/63"	AL-3210-026	40

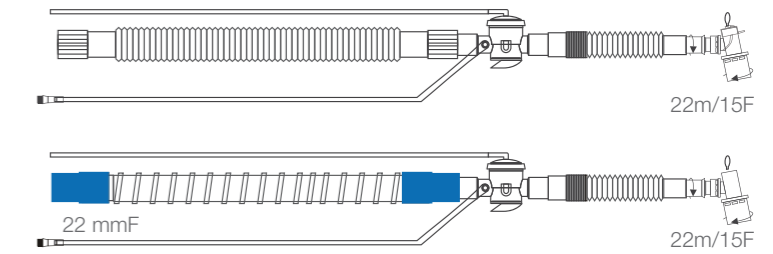

IPPB CIRCUITS WITH NEBULISER

Corrugated

	Length	Code	Qty/Box
Adult	160 cm/63"	AL-3110-026/4	30

Smoothbore

	Length	Code	Qty/Box
Adult	160 cm/63"	AL-3210-026/4	30

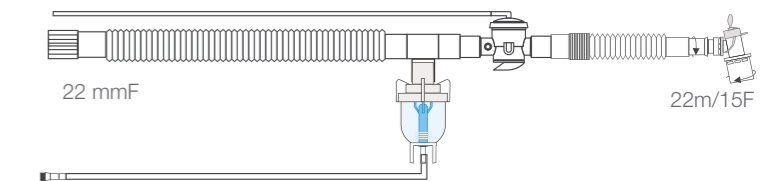

IPPB CIRCUITS

Corrugated

	Length	Code	Qty/Box
Adult	160 cm/63"	AL-3120-026	50

Smoothbore

	Length	Code	Qty/Box
Adult	160 cm/63"	AL-3220-026	50

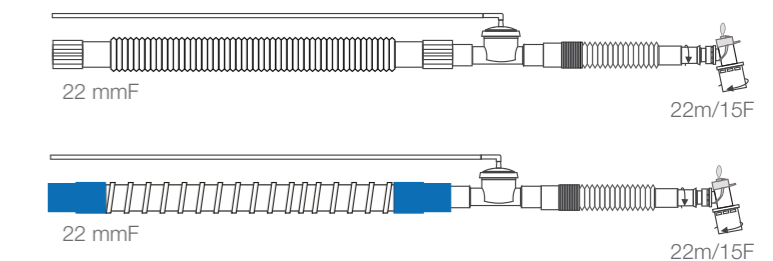

Heated Wire Circuits

- Compatible with MR500,600,730, Coancha 4 Vital Signs SCT3000
- Compatible with MR850 inspiratory, limb
- Compatible with MR850 expiratory, limb



Embedded Heated Wire Circuits

- Uniform heating along the length of the tube
- Very effective in avoiding condensation
- No substrate for bacterial VAP
- Wires have no direct contact with air flow
- Minimizing condensate related ventilator alarms
- Extremely low compliance and flow resistance due to smooth interior tube

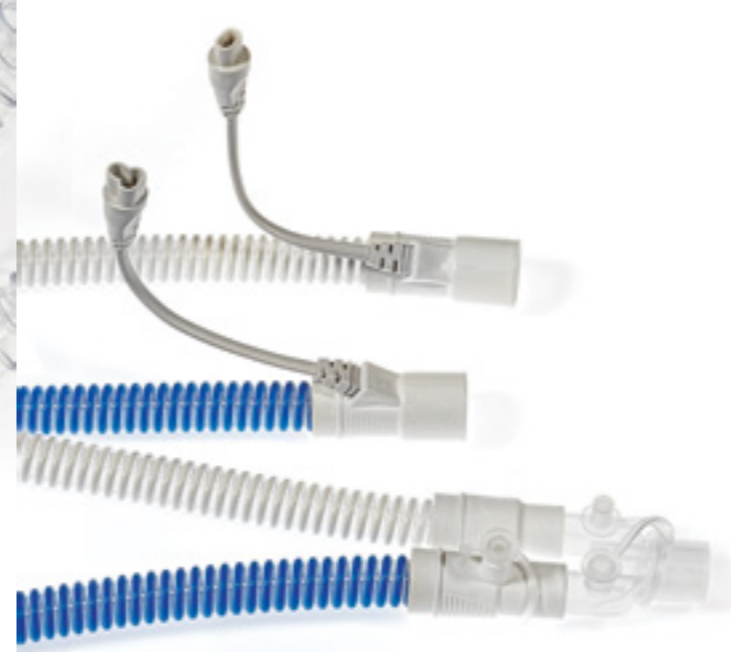

HEATED WIRE CIRCUITS, DOUBLE HEATED WIRE WITH LIMB FOR MR800 SERIES HUMIDIFIER

EMBEDDED ADULT HEATED WIRE CIRCUIT WITH AUTOFEED HUMIDIFIER CHAMBER

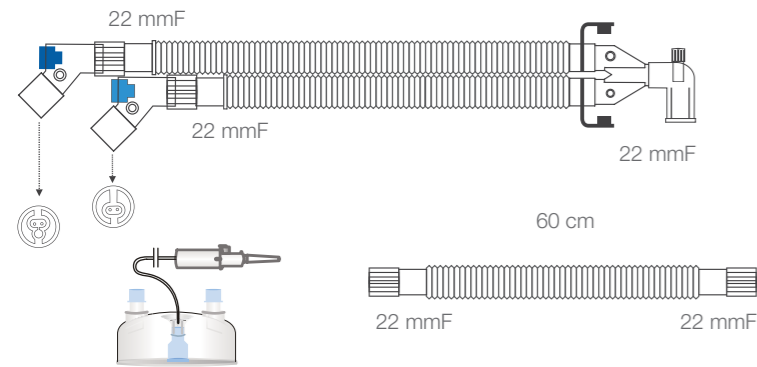

Corrugated			
	Length	Code	Qty/Box
Adult	180 cm/71"	AL-5101-020/2	30
Pediatric	180 cm/71"	AL-5401-020/2	30

Smoothbore			
	Length	Code	Qty/Box
Adult	180 cm/71"	AL-5202-020/2	30
Pediatric	180 cm/71"	AL-5502-020/2	30

Smoothbore			
	Length	Code	Qty/Box
Adult	180 cm/71"	AL-52602-020/2	25

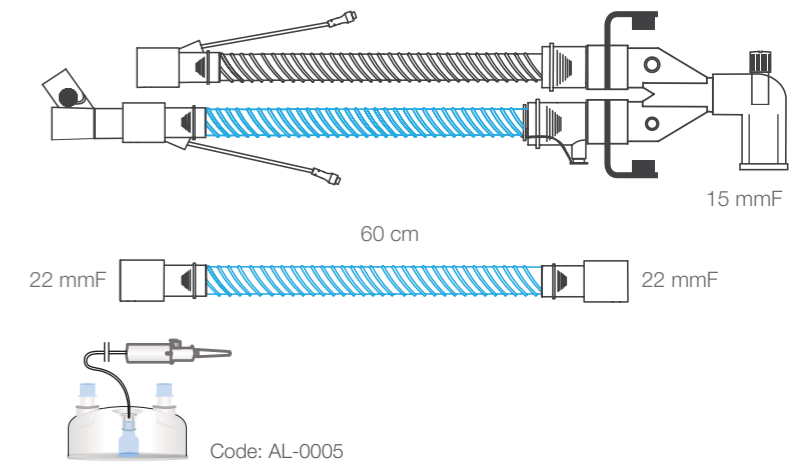

HEATED WIRE CIRCUITS, DOUBLE HEATED WIRE WITH LIMB FOR MR800 SERIES HUMIDIFIER

EMBEDDED PEDIATRIC HEATED WIRE CIRCUIT WITH AUTOFEED HUMIDIFIER CHAMBER

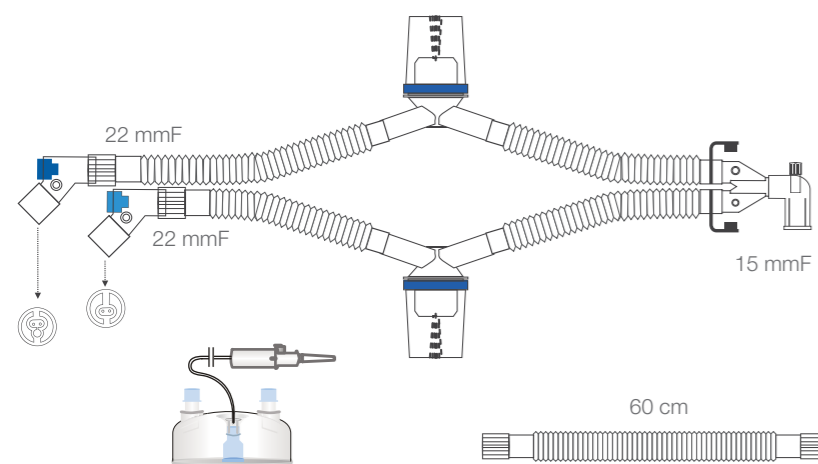

Corrugated			
	Length	Code	Qty/Box
Adult	180 cm/71"	AL-5121-020/2	30
Pediatric	180 cm/71"	AL-5421-020/2	30

Smoothbore			
	Length	Code	Qty/Box
Adult	180 cm/71"	AL-5222-020/2	30
Pediatric	180 cm/71"	AL-5522-020/2	30

Smoothbore			
	Length	Code	Qty/Box
Pediatric	180 cm/71"	AL-52702-020/2	25

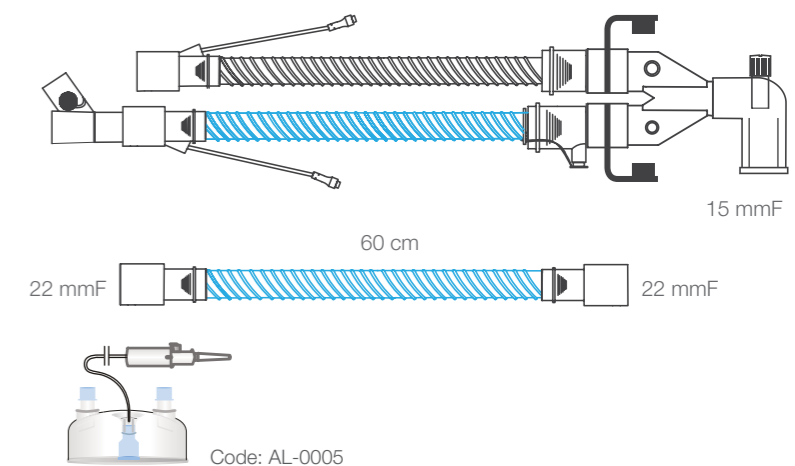

Embedded Heated Wire Circuits

- Uniform heating along the length of the tube
- Very effective in avoiding condensation
- No substrate for bacterial VAP
- Wires have no direct contact with air flow
- Minimizing condensate related ventilator alarms
- Extremely low compliance and flow resistance due to smooth interior tube

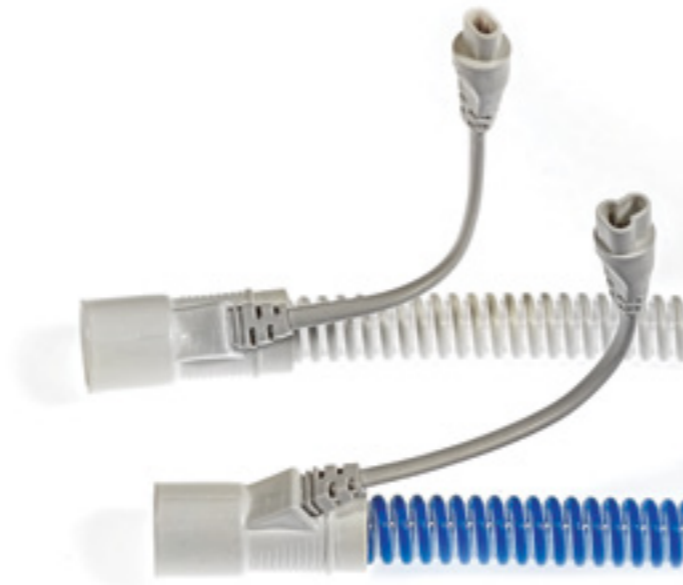

CPAP Circuits

- CPAP (Continuous Positive Airway Pressure)
- CPAP is the method of ventilating a patient applying a higher pressure than environmental atmospheric pressure to the airways of the patient to improve oxygenation via ventilator or a CPAP machine.
 - CPAP prevents early end-expiratory closure of the airways and alveolar collapse.
 - Today CPAP is routinely used for mechanically ventilated patients or spontaneously breathing respiratory patients to improve the oxygenation.
 - Today CPAP therapy is the first choice in the treatment and prevention of postoperative atelectasis, early stages of ARDS and obstructive sleep apnea.

EMBEDDED NEONATAL HEATED WIRE CIRCUIT WITH AUTOFEED HUMIDIFIER CHAMBER

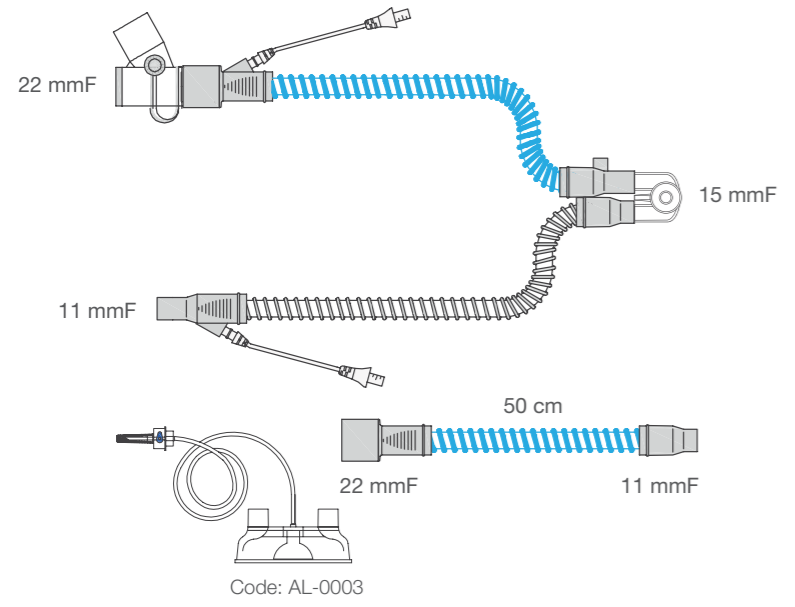

	Smoothbore		
	Length	Code	Qty/Box
Neonatal	180 cm/71"	AL-52802-020/2	25

	Corrugated		
	Length	Code	Qty/Box
Adult	160 cm/63"	AL-7100-011	30

CPAP CIRCUIT FOR NON-INVASIVE VENTILATION

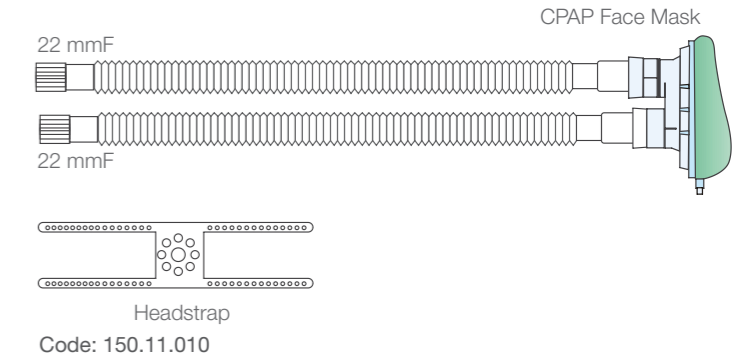

EMBEDDED NEONATAL HEATED WIRE CIRCUIT WITH AUTOFEED HUMIDIFIER CHAMBER

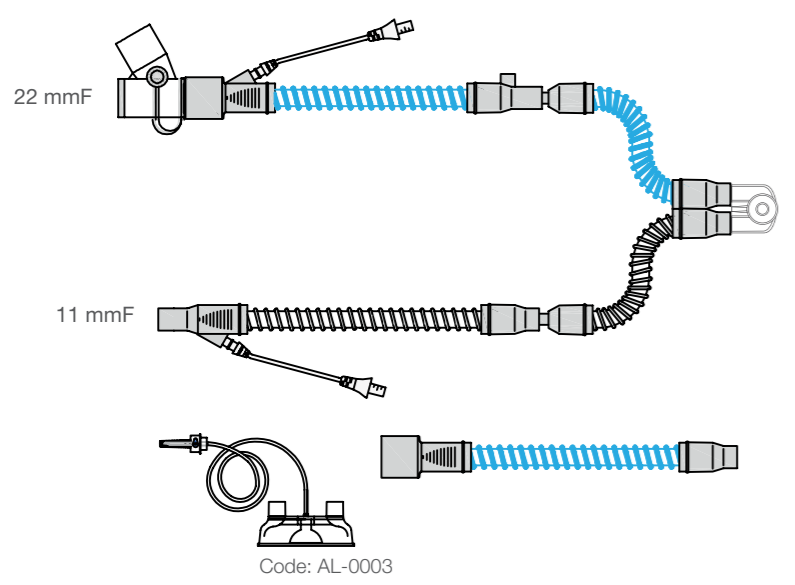

	Smoothbore		
	Length	Code	Qty/Box
Neonatal	180 cm/71"	AL-52902-020/2	25

	Corrugated		
	Length	Code	Qty/Box
Adult	160 cm/63"	AL-6120-011	30

CPAP CIRCUIT FOR FLOW GENERATORS

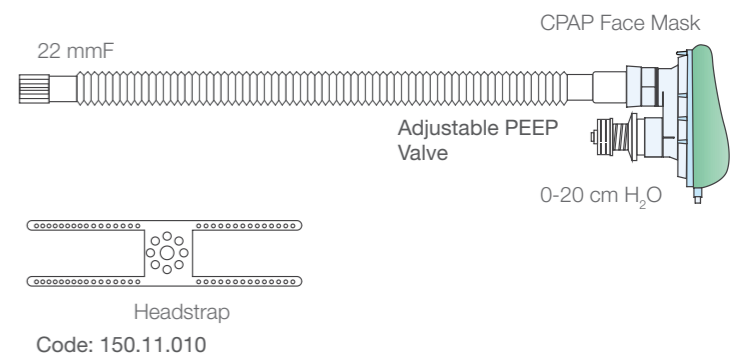

BPAP Circuits

• (BPAP) Bilevel Positive Airway Pressure Bilevel positive airway pressure (BPAP) is a modified version of the continuous positive airway pressure (CPAP). It is a mode of ventilation with cycling variations between two continuous positive airway pressure levels. This mode offers two different levels of air pressure: increased pressure during inhalation and decreased pressure during exhalation.



BPAP Circuits

• BPAPs may work better for those individuals who cannot comfortably breathe out against the fixed pressure of the standard device. Therefore BPAP is used for patients with restrictive or obstructive disorders, and for patients with sleep apnea who cannot tolerate the high pressure of CPAP.

BPAP CIRCUITS, FULL FACE MASK

BPAP CIRCUITS

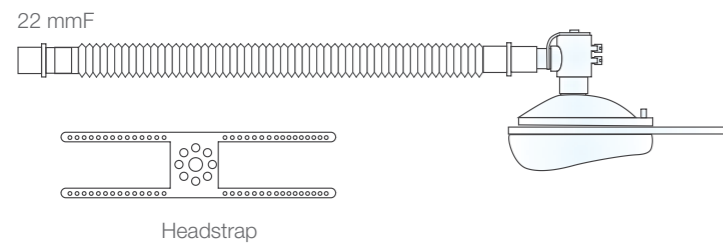

Corrugated			
	Length	Code	Qty/Box
Adult	180 cm/71"	AL-8190-014	40

Smoothbore			
	Length	Code	Qty/Box
Adult	180 cm/71"	AL-8290-014	40

Smoothbore			
	Length	Code	Qty/Box
Adult	180 cm/71"	AL-8290-005/7	50

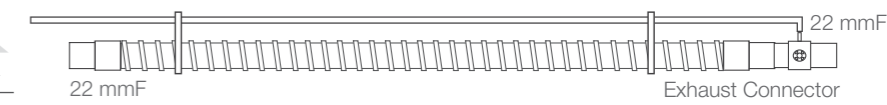

Breathing system for use with Respirationics BiPAP®VISION AND S/T-D

BPAP CIRCUITS, NASAL MASK WITH EXHAUST CONNECTOR

BPAP CIRCUITS

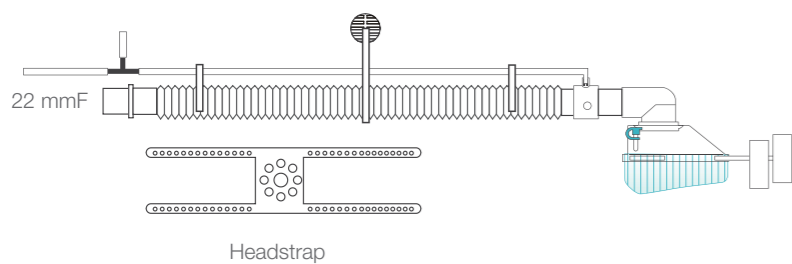

Corrugated			
	Length	Code	Qty/Box
Adult	180 cm/71"	AL-8190-014/9	30

Smoothbore			
	Length	Code	Qty/Box
Adult	180 cm/71"	AL-8290-014/9	30

Smoothbore			
	Length	Code	Qty/Box
Adult	180 cm/71"	AL-8290-105/9	40

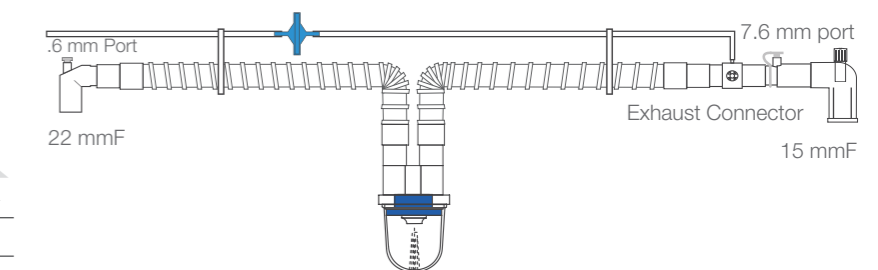

Breathing system for use with Respirationics BiPAP®VISION AND S/T-D

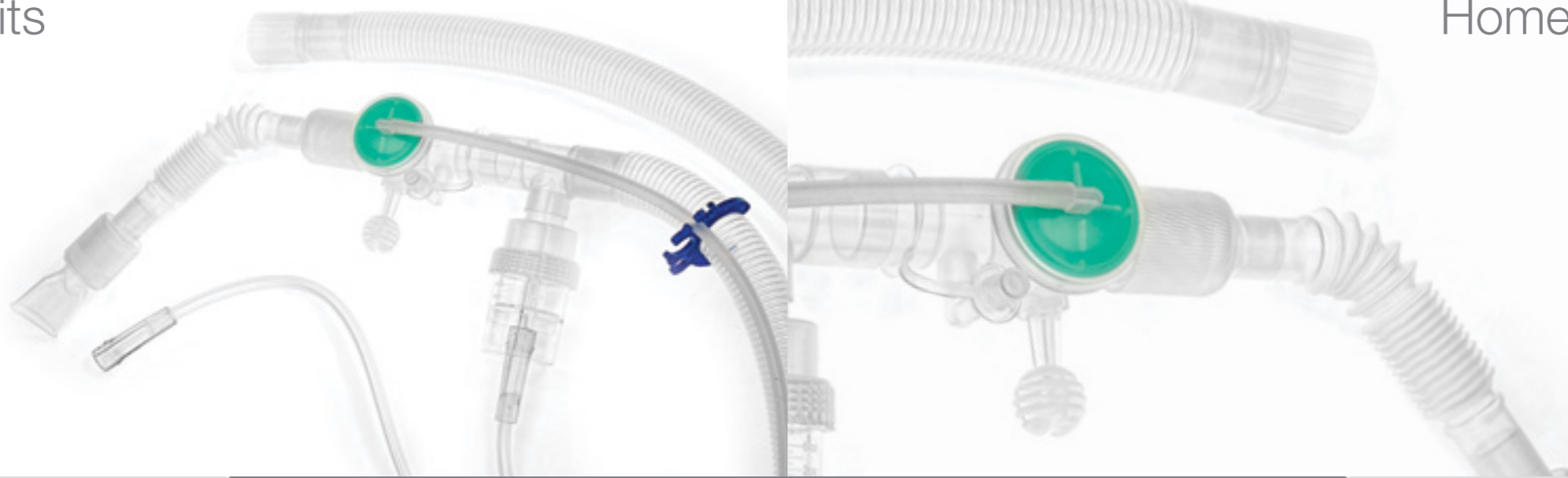

HOME CARE CIRCUITS WITH WATER TRAP, TEMPERATURE ADAPTOR

HOME CARE CIRCUITS WITH WATER TRAP

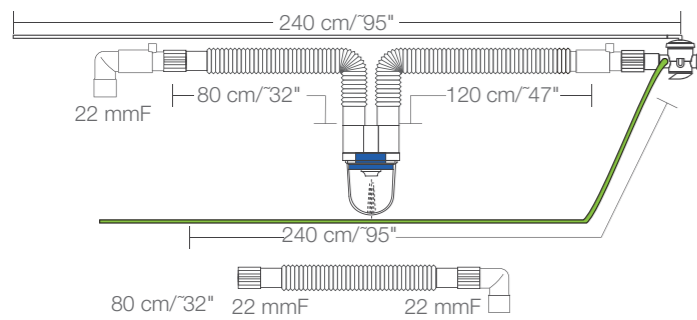

	Corrugated		
	Length	Code	Qty/Box
Adult	200 cm/79"	AL-3111-040	30

Breathing system for use with Legend Air

	Corrugated		
	Length	Code	Qty/Box
Adult	200 cm/79"	AL-3111-050	30

Breathing system for use with Saime Ultra V/S200 cm/79"

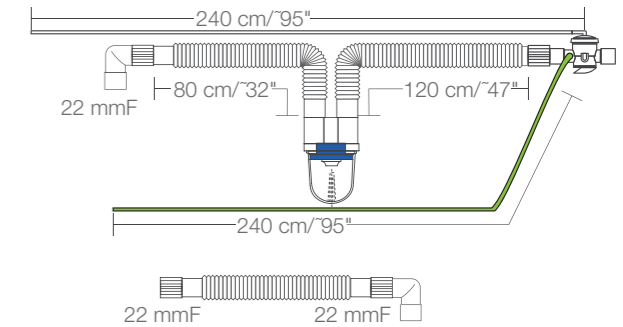

HOME CARE CIRCUITS

HOME CARE CIRCUITS WITH WATER TRAP, TEMPERATURE ADAPTOR

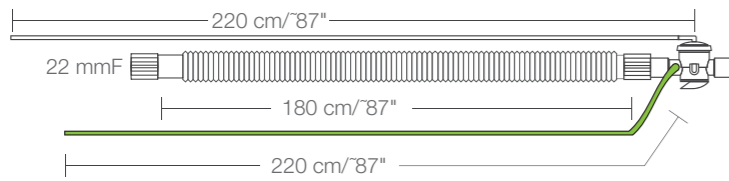

	Corrugated		
	Length	Code	Qty/Box
Adult	180 cm/71"	AL-3110	40

Breathing system for use with Legend Air

	Corrugated		
	Length	Code	Qty/Box
Adult	200 cm/79"	AL-3111-040	30

Breathing system for use with ELISE150

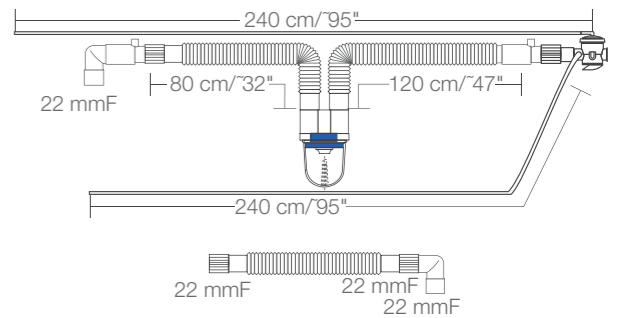

HOME CARE CIRCUITS

HOME CARE CIRCUITS

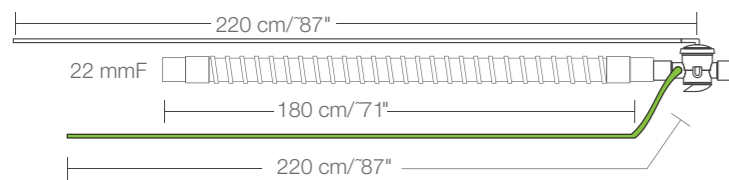

	Smoothbore		
	Length	Code	Qty/Box
Adult	180 cm/71"	AL-3210	50

Breathing system for use with Legend Air and Saime Ultra V/S

	Smoothbore		
	Length	Code	Qty/Box
Adult	180 cm/71"	AL-3210	50

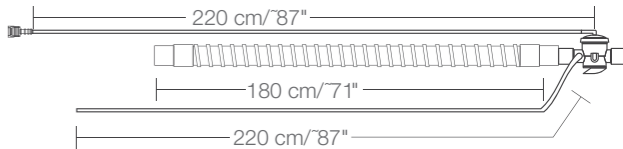

Ø ID: 4.00
Ø ID: 4.80

Ø ID: 4.80 Ø ID: 4.00

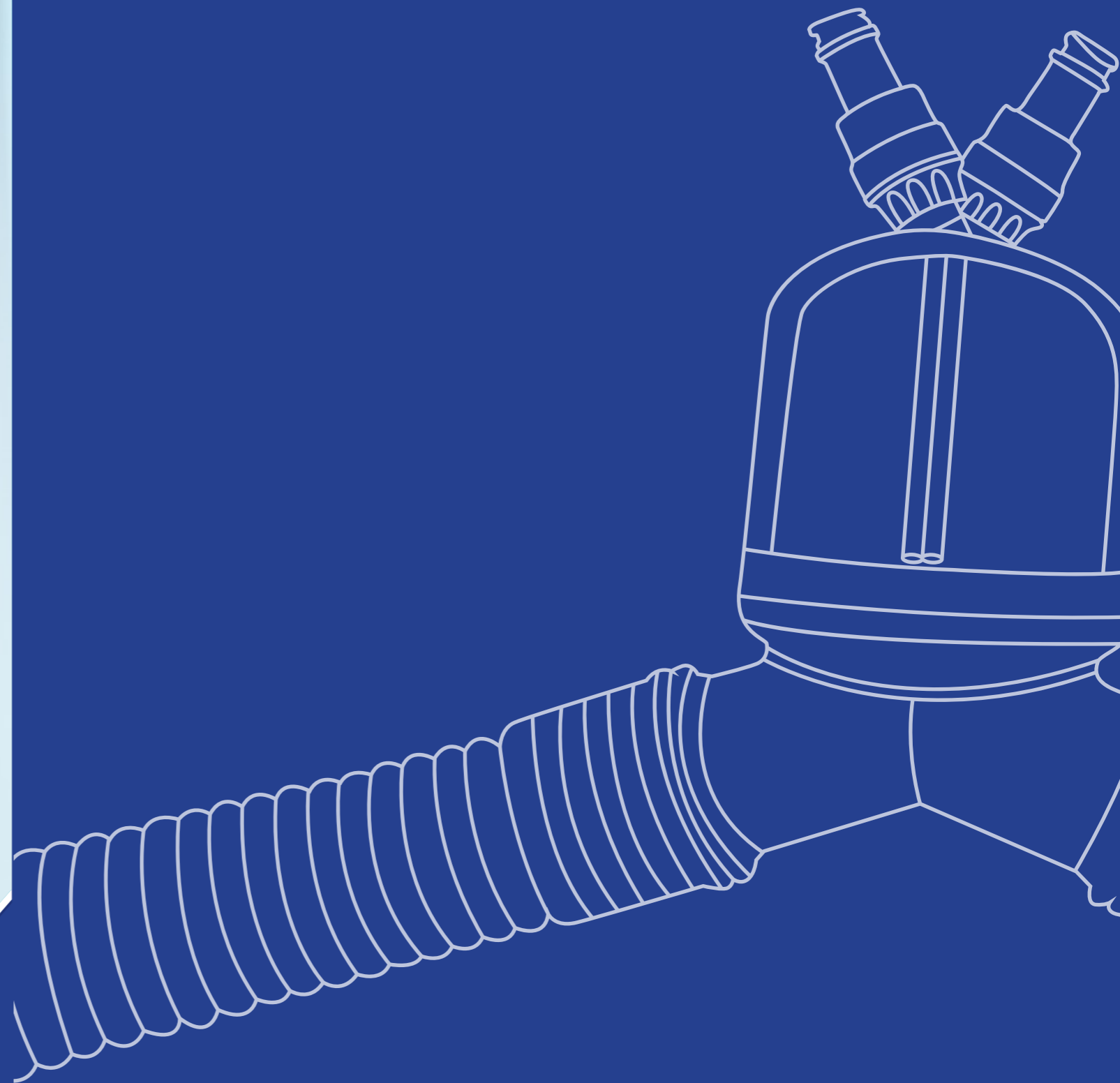

Patented
Products

altech[®]

a Meditera Company

ALTECH SEPTIFLOW

Natural Warming & Humidifying Of The Inhaled Gases

Dry gas flowing from the ventilator and anesthesia machine may cause problems when delivered to a patient's lungs during respiratory therapy. The warm, moist climate in the nose and mouth are by-passed by the ET-tube and the gas is still dry and cool when it reaches the lower airways. Dry breathing gas dries respiratory mucosa, resulting in higher risk of mucosa injury, obstruction and infection.

Altech Septiflow single limb circuit's lightweight tube is divided into two (expiratory and inspiratory) lines with a longitudinal flexible septum that runs all through the tube. This septum allows the transfer of heat from the expiratory to the inspiratory line. Inspiratory air hence is naturally warmed and moistened.

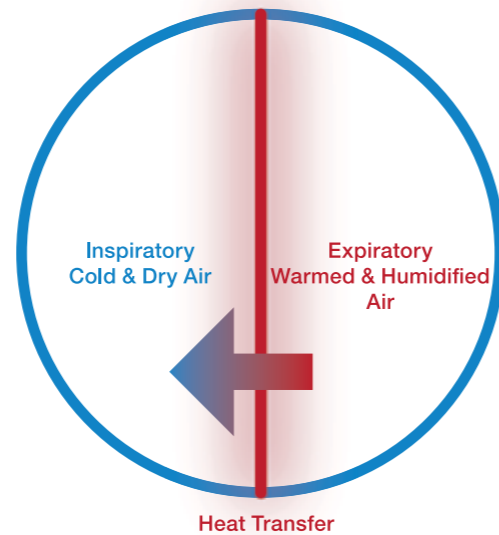
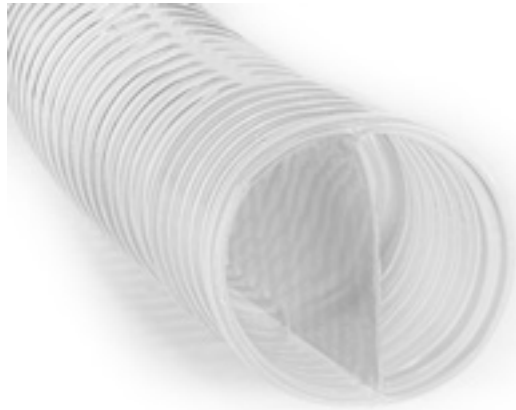

Low Flow

During inhalation anaesthesia, use of low fresh gas flow has some important clinical, economical, technological and environmental advantages. Although low flow anesthesia technique increases humidification and warming of anaesthetic gases, if continued for an extended duration, condensation may occur in the expiratory line of the circuit leading to equipment malfunction such as failure of the valves and gas monitor of the anesthesia machine.

While Altech Septiflow naturally warms and moistens the inhaled air by allowing transfer of heat from expiratory to inspiratory line; patented integrated inspiratory and expiratory self sealed water traps avoid accumulation of the condensation. Integrated CO₂ Gas Sampling Line also allows precise measurement of end tidal CO₂ through capnography device hence eliminating the low flow anesthesia's rebreathing risk.



Integrated CO₂ Sampling Line

FULLY CLOSED VENTILATION

Condensation that collects in the ventilation circuit is considered to be contaminated and it should be handled and removed carefully for infection control purposes. If the system is opened to drain the condensate, consequences such as contamination of interior of the circuit; exposure of caregiver to contaminated condensate; crosscontamination of other patients and possible collapse of the alveoli due to breakage of the circuit may occur and increase the risk of interruption and failure of therapy.

Collection and drainage of the condensate with a closed system is crucial to eliminate challenges above and to prevent infection (VAP and sepsis). Altech Septiflow's patented and integrated water trap contribute to continuous ventilation therapy without interruption and with minimized infection risk by withdrawing the contaminated condensate through a truly closed system.

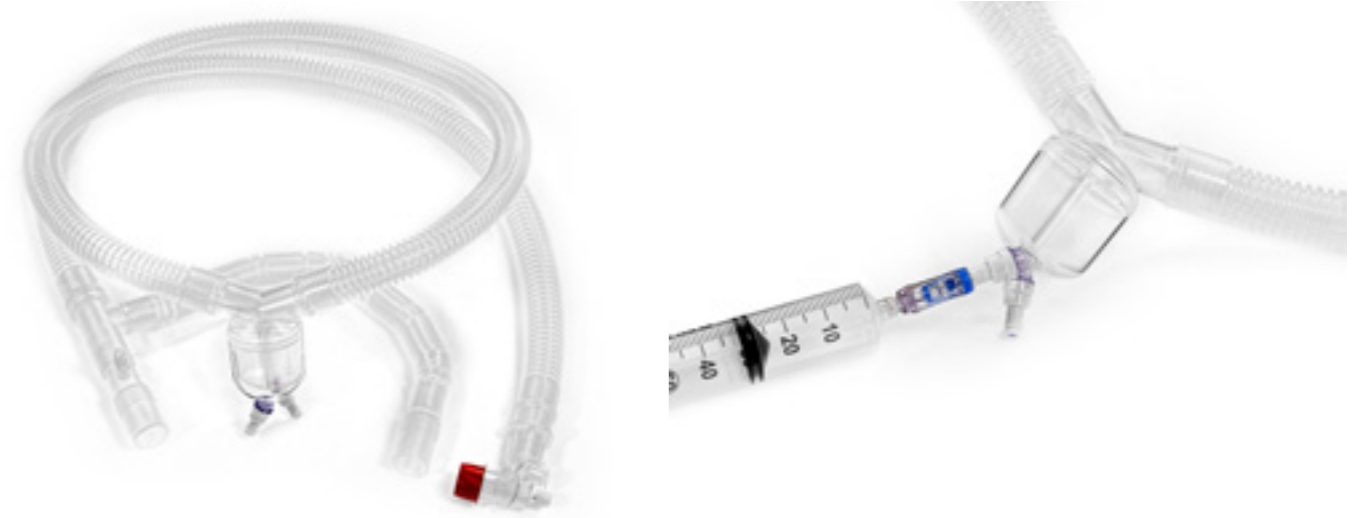

Inventory Consolidation & Cost Effective

One Circuit for Anesthesia and ICU
One Circuit for Adult and Pediatric Patients

Altech Septiflow's patented integrated water trap enables patients to be transferred to the ICU with the same circuit after inhalation anesthesia.

Altech Septiflow may be used both for adult and pediatric patient population.

Altech Septiflow saves time by eliminating the need to change circuits between anesthesia and ICU in both adult and pediatric patient groups.

Less Plastic & Environment Friendly

Altera Tibbi Malzeme San.Tic.A.S is ISO 14001 certified for years and established an environmental management system that is appropriate in scope and scale to our manufacturing operations.

During the manufacturing process of Altech Septiflow less plastic is used hence less plastic waste is disposed.

Less Weight & Torque

Less plastic results in less weight and less torque on the patient's artificial airway device.

Altech Septiflow weighs approximately %25 less than conventional two limb circle circuits

Low Compliance

Altech Septiflow single limb circuit's lightweight tube is divided into two longitudinally by flexible septum running the length of the tube and the septum along with the stiffness of the tubing decreases compliance thereby increasing the total volume delivered to the patient

"What you set is what you get"

ALTECH SEPTIFLOW

STANDART SINGLE LIMB CIRCUIT

	Length	Code	Qty/Box
Adult & Pediatric	180 cm/71"	AL-11103-160	30

Latex Free

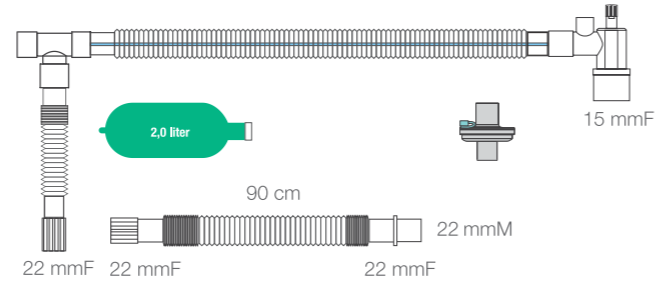

SINGLE LIMB CIRCUIT WITH INTEGRATED CO₂ SAMPLING LINE

	Length	Code	Qty/Box
Adult & Pediatric	180 cm/71"	AL-11103-160/5	30

Latex Free

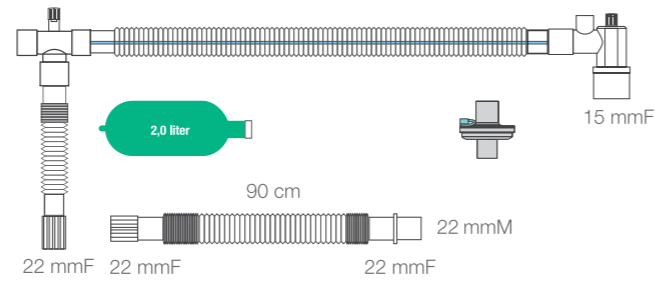

SINGLE LIMB CIRCUIT WITH NEEDLE FREE WATER TRAP

	Length	Code	Qty/Box
Adult & Pediatric	180 cm/71"	AL-11121-200/9	30

Latex Free

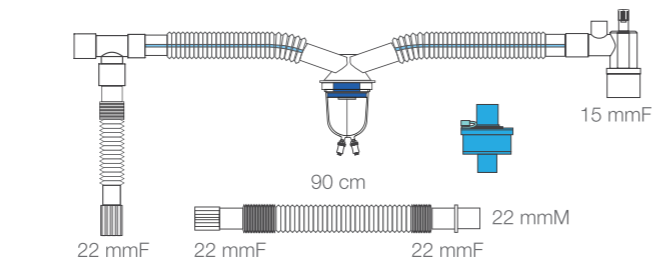

	Length	Code	Qty/Box
Adult & Pediatric	180 cm/71"	AL-11121-206/9	30

Latex Free

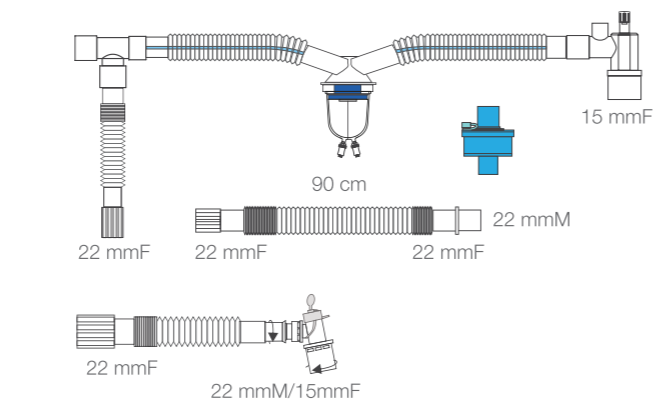

COAXIAL CIRCUITS WITH WATER TRAP

General Features

- Reliable, convenient and designed for enhancing natural warming of inspired gases, coaxial circuits with their streamlined tube within a tube design eliminates the drag on the patient.
- The best advantage of this coaxial design is to provide a self-contained, thermally efficient atmosphere where inspired gasses are naturally warmed and humidified.
- The system provides increased circuit mobility and low weight in comparison with a traditional circle circuit.
- All fittings comply with ISO 5356 standard.

Coaxial Circuits in Low Flow Anesthesia

- Although low-flow anaesthesia increases humidification and warming of anaesthetic gases, if continued for an extended duration, condensation may occur in the circuit leading to equipment malfunction such as failure of the valves and gas monitor.
- Especially in long term operations high temperature and humidity of anesthetic gases cause condensation in the circuit.
- Coaxial Circuit with water trap collects the condensate, minimises the risk of malfunction and can be safely used in low flow anesthesia.

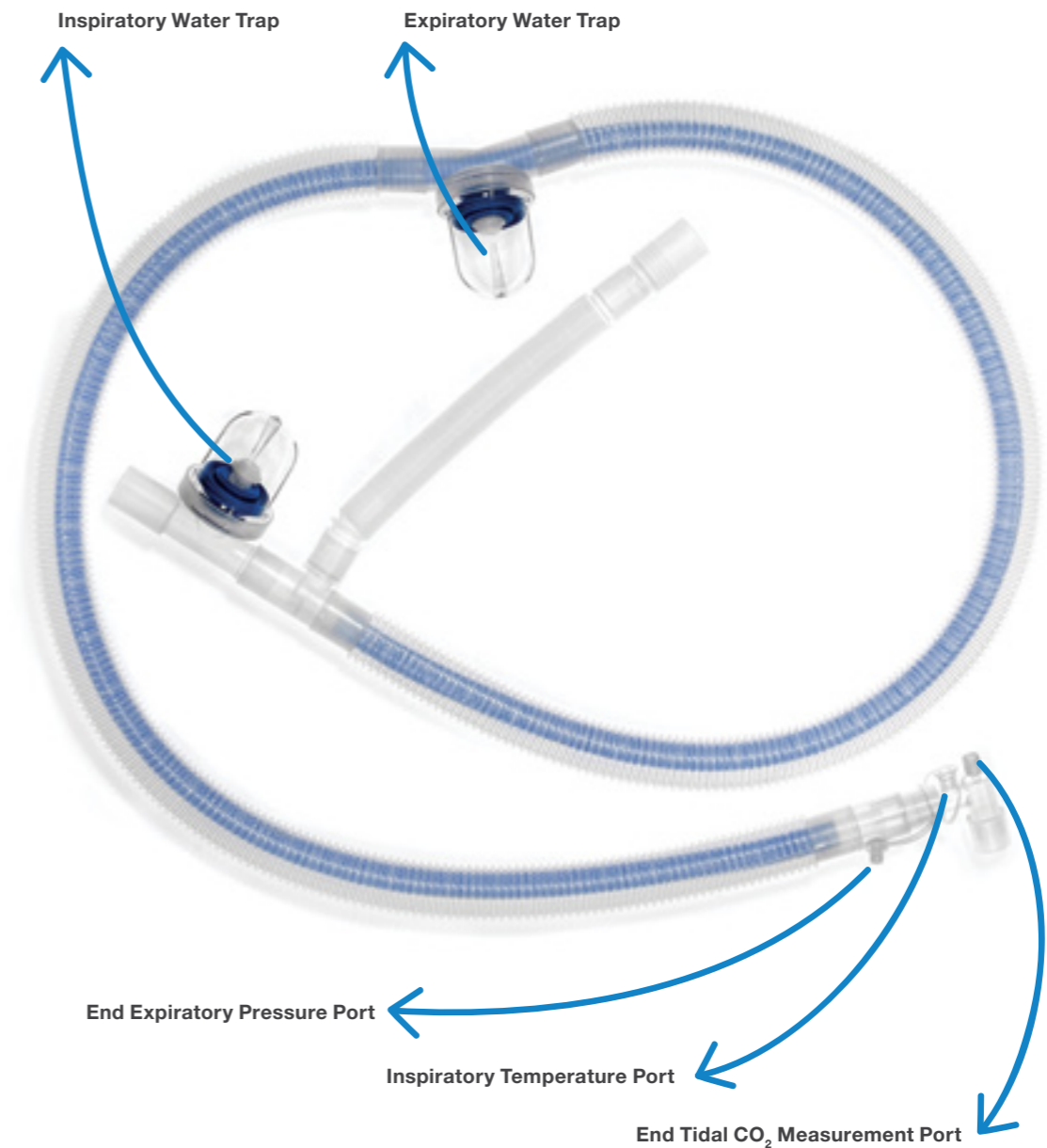

Altech Coaxial Circuits with Water Trap

- Can be used safely in anesthesiology. Special designed self sealed water traps on both inspiratory and expiratory lines protects the machine and the patient.
- Allows end-tidal CO₂, temperature end –expiratory pressure measurements via on device ports. a
- Can continue to be used in PACU if the patient needs to be mechanically ventilated after surgery.

FULLY CLOSED COAXIAL CIRCUITS WITH WATER TRAP

- Although coaxial circuit has been designed as an anesthesia circle system, it has also proven to be suitable in the ICU as providing a desired level of humidity. Altech coaxial (tube within a tube) breathing system ideal for use within both operating room and ICU.
- The system provides increased circuit mobility and low weight in comparison with a traditional circle circuit.
- Water traps also eliminate the possible infection risk in ICU leading to sepsis caused by condensation accumulation within the inspiratory and expiratory lines.

- Water trap on this circuit with its unique design withdraws condensation from the circuit to secure the machine and contributes ventilation by preventing resistance to air which occurs due to water condensation.
- Optional CO2 monitoring line collects end tidal CO2 from the tip of the patient elbow connector. This provides accurate gas sampling.

FULLY CLOSED VENTILATION CIRCUIT IS YOUR CLOSEST ALLY IN PREVENTION OF SEPSIS MOST COMMON, LEAST KNOWN AND HIGHEST MORTALITY RISKED DISEASE

Fully Closed Condensation Drainage Syringe

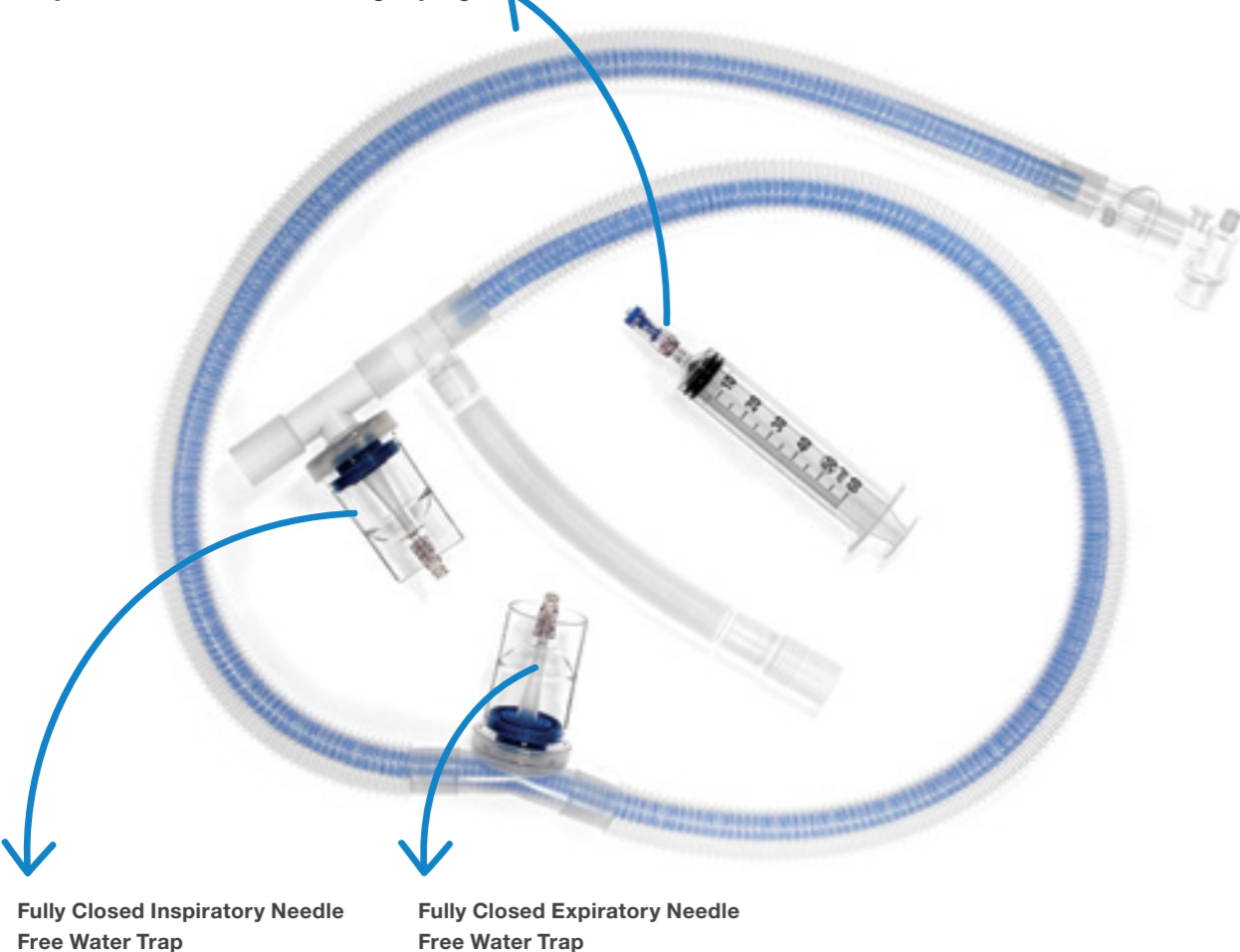

Fully Closed Inspiratory Needle Free Water Trap

Fully Closed Expiratory Needle Free Water Trap

CONTINUITY OF MECHANICAL VENTILATION and MINIMUM INFECTION RISK

Proper humidification of mechanically ventilated patients is very important. Active humidification commonly used for adequate humidification comes with challenge of water condensation in the circuit.

Condensation that collects in the ventilation circuit is considered to be contaminated and it should be handled and removed carefully for infection control purposes. If the system is opened to drain the condensate; consequences such as contamination of interior of the circuit; exposure of caregiver to contaminated condensate; crosscontamination of other patients and possible collapse of the

alveoli due to breakage of the circuit increase the risk of interruption and failure of clinicians' therapy.

Collection and and drainage of the condensate with a closed system is crucial to eliminate challenges above and to prevent infection (VAP and sepsis). Altech fully closed ventilation circuits contribute to continuous ventilation therapy without interruption and with minimized infection risk.

COAXIAL ANESTHESIA CIRCUITS WITH WATER TRAP

COAXIAL ANESTHESIA CIRCUIT WITH WATER TRAP

	Length	Code	Qty/Box
Adult	180 cm/71"	AL-1913-060	30
Pediatric	150 cm/59"	AL-P1913-060	30

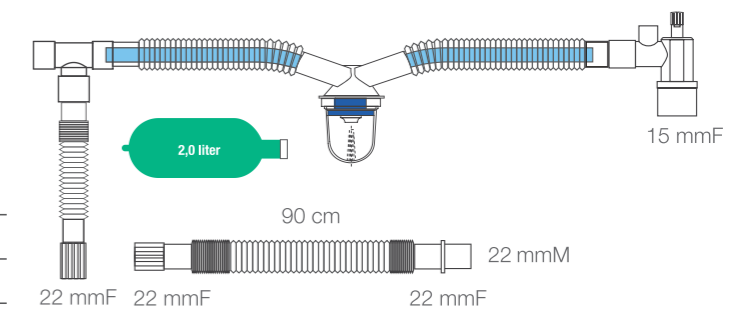

LOW-FLOW COAXIAL ANESTHESIA CIRCUIT WITH WATER TRAP

	Length	Code	Qty/Box
Adult	180 cm/71"	AL-1923-060	30
Pediatric	150 cm/59"	AL-P1923-060	30

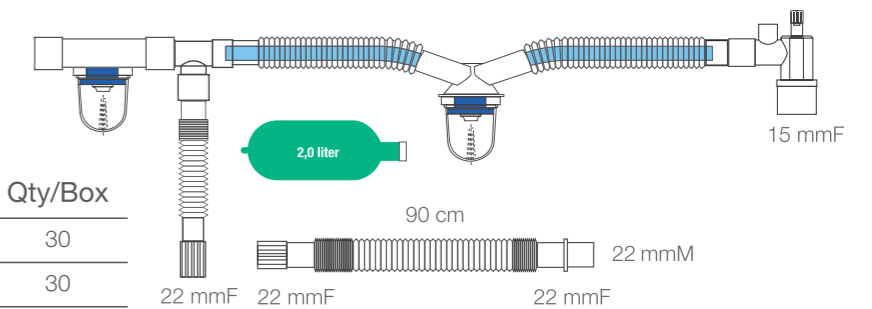

FULLY CLOSED COAXIAL VENTILATION CIRCUITS

COAXIAL VENTILATION CIRCUIT WITH NEEDLE FREE WATER TRAP

	Length	Code	Qty/Box
Adult	180 cm/71"	AL-1923-000/9 .V002	50
Pediatric	180 cm/71"	AL-P1923-000/9 .V002	50

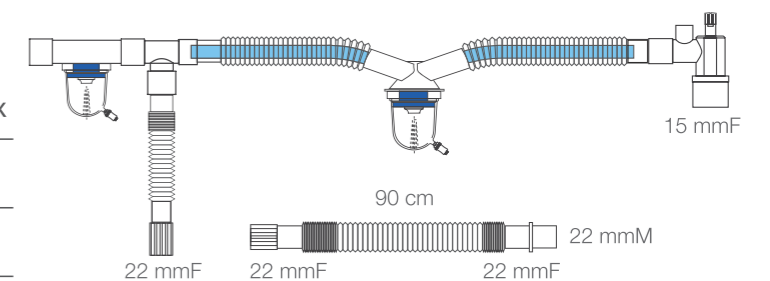

	Length	Code	Qty/Box
Adult	180 cm/71"	AL-1923-000/9 .V001	50
Pediatric	180 cm/71"	AL-P1923-000/9 .V001	50

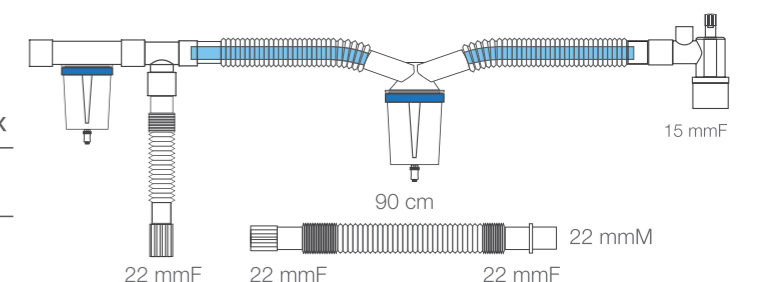

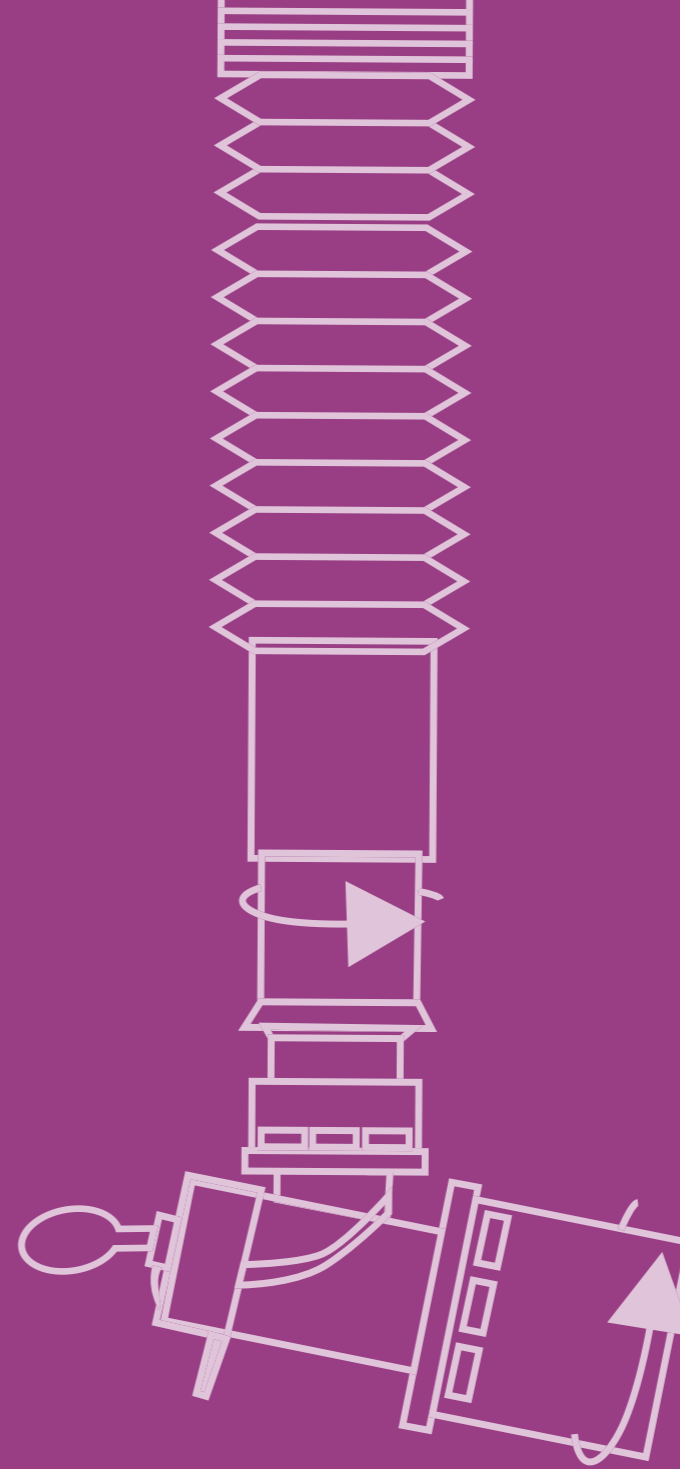

Catheter Mounts

altech[®]

a Meditera Company

Catheter Mounts

- Altech range of catheter mounts includes a wide choice of smoothbore PVC and extendible configurations
- Smoothbore products provide low resistance to flow while external coil reduces kinks and blockages. Besides they prevent fluid build up reducing risks of bacterial growth thanks to smooth inner surface.
 - Extendible PP product provides a lightweight and flexible solution and allows clinician to adjust the position of the catheter mount
 - 360 degree double swivel connector increases ease of use
 - Double cap helps to maintain PEEP during suctioning or bronchoscopy.
 - Luer lock port for gas sampling
 - 15M or 22F adapters available

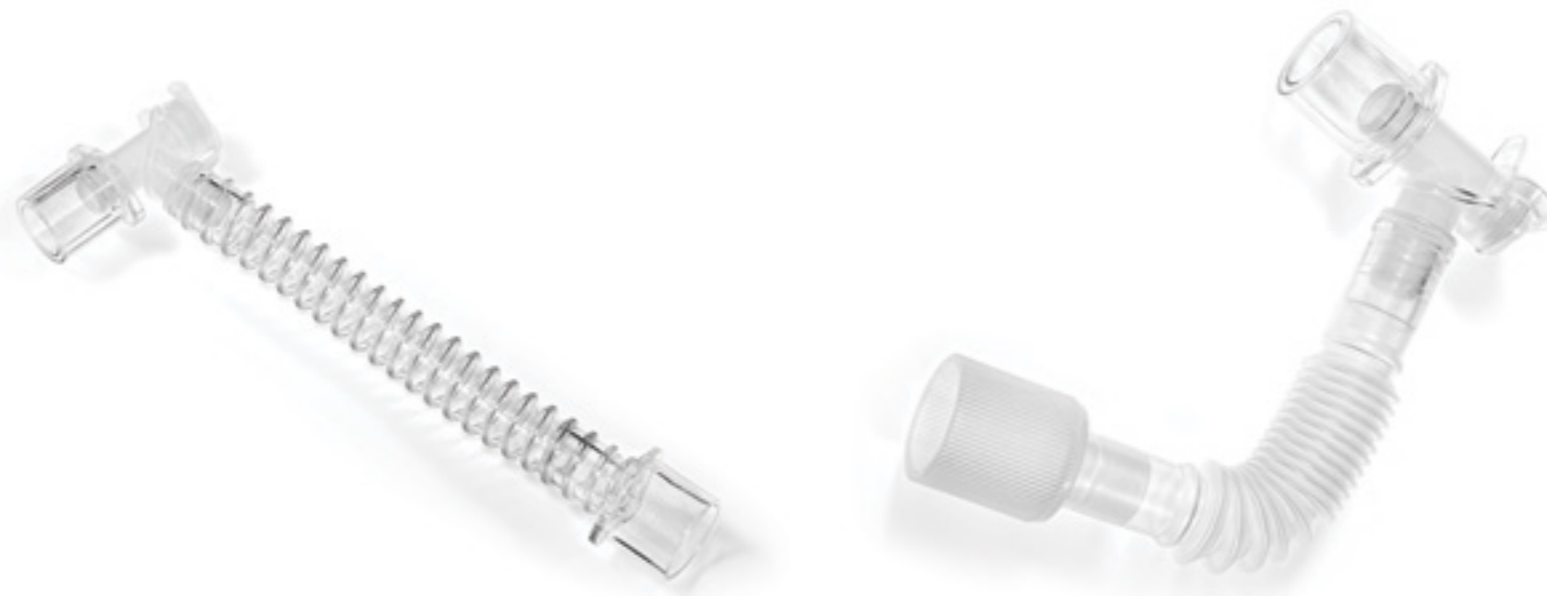

Catheter Mounts

CATHETER MOUNT EXTENDIBLE

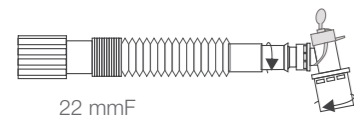

Dead space (ml): Close: 25, Open: 40

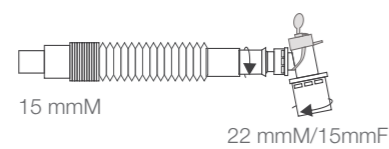

Dead space (ml): Close: 25, Open: 40

Extendible

Length	Code	Qty/Box
15 cm/6"	AL-17300	50
15 cm/6"	AL-13300	50

CATHETER MOUNTS

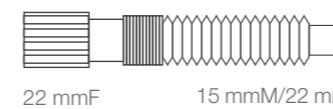

EXTENDIBLE TUBE

CODE: 67300
QTY/Box: 50
Dead space (ml):
Close: 22, Open: 37

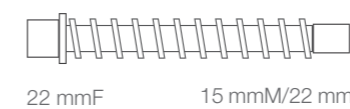

SMOOTH BORE TUBE

CODE: 66300
PVC-FREE CODE: P66300
QTY/Box: 50
Dead space (ml): 27

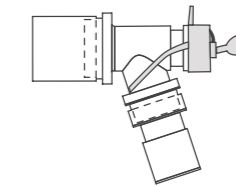

SWIVEL CATHETER MOUNT

CODE: AL-10000
QTY/Box: 100
Dead space (ml): 3

CATHETER MOUNT SMOOTH BORE

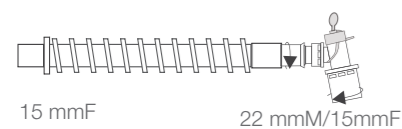

Dead space (ml): 30

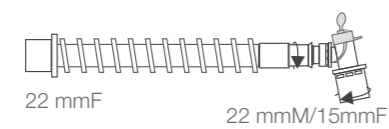

Dead space (ml): 30

Smoothbore

Length	Code	Qty/Box
15 cm/6"	AL-12300	50
15 cm/6" (PVC-free)	AL-P12300	50

Smoothbore

Length	Code	Qty/Box
15 cm/6"	AL-16300	50
15 cm/6" (PVC-free)	AL-P16300	50

Smoothbore

Length	Code	Qty/Box
15 cm/6"	AL-22300	50
15 cm/6" (PVC-free)	AL-P22300	50

Smoothbore

Length	Code	Qty/Box
15 cm/6"	AL-26300	50
15 cm/6" (PVC-free)	AL-P26300	50

CATHETER MOUNT SMOOTH BORE

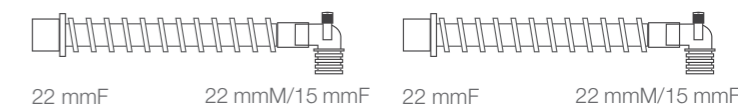

Dead space (ml): 30

CATHETER MOUNT & FILTER

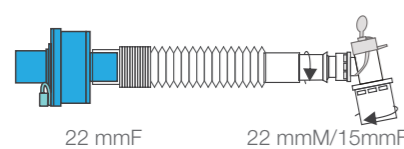

Dead space (ml): Close: 103, Open: 117

Extendible

Length	Code	Qty/Box
15 cm/6"	AL-17380	20

Extendible

Length	Code	Qty/Box
15 cm/6"	AL-27300	50

CATHETER MOUNT EXTENDIBLE

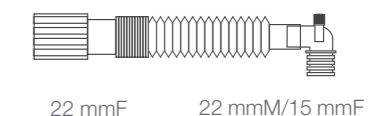

Dead space (ml): Close: 25, Open: 40



Filters

altech[®]

a Meditera Company

Bacterial Viral Filters

- Dedicated to the quality, committed to enhancing patient care Altera provides you with simple, cost effective, secure solutions and the best filtration efficiency for your respiratory patient.
- To help you minimize filtration challenges, we offer a comprehensive line of high-performance breathing filters.
- Each Altech branded filter provides its own unique advantages to maximize the clinical outcomes for filtration when used with multiple ventilator applications, such as noninvasive, invasive or anesthesia procedures.
- Our filters may help reduce the risk of possible hospital- or ventilator-acquired patient infections and may help create a safer environment for the caregiver by minimizing bacterial and viral particle penetration.



Bacterial Viral HME Filters

- Bacterial Efficiency %99.9999
- High level of moisture output
- Small and paediatric versions
- Coupled with a hydrophobic bacterial viral filter membrane
- Rounded ergonomic housing
- Sterile or Clean
- Standart Retainable Monitoring Cap
- High level of moisture output(>33mgH₂O/L)
- Hygroscopic cellulose or foam HME Media
- ISO Standart Connectors
- Individually Packed

BACTERIAL VIRAL FILTERS

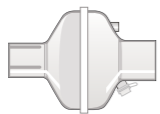
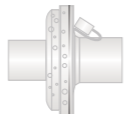
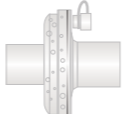
			
	BACTERIAL-VIRAL FILTER	BACTERIAL-VIRAL FILTER	BACTERIAL-VIRAL FILTER
	SBC raw material	SBC raw material	PP raw material
Code	AL-08002	AL-08018	AL-08023
Sterile Code	AL-080029	AL-080189	AL-080239
Qty/Box	50	50	50
Tidal volume (ml)	150-1500	150-1500	150-1500
Dead Space (ml)	77	33	33
Bacterial Efficiency	>99,9999%	>99,9999%	>99,9999%
Viral Efficiency	>99,999%	>99,999%	>99,999%
Resistance to Flow	30 L/min 4,1 mm H ₂ O 60 L/min 11,6 mm H ₂ O 90 L/min 24,6 mm H ₂ O	30 L/min 4,3 mm H ₂ O 60 L/min 12 mm H ₂ O 90 L/min 25 mm H ₂ O	30 L/min 5 mm H ₂ O 60 L/min 14 mm H ₂ O 90 L/min 27,6 mm H ₂ O
Weight (gr)	23	19	21
Fittings	22mmM-15/22mmMF	22mmM - 15/22mmMF	22mmM - 15/22mmMF

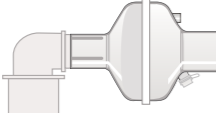
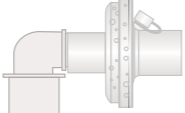
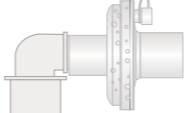
			
	BACTERIAL-VIRAL FILTER Angled	BACTERIAL-VIRAL FILTER Angled	BACTERIAL-VIRAL FILTER Angled
	SBC raw material	SBC raw material	PP raw material
Code	AL-08002/1	AL-08018/1	AL-08023/1
Sterile Code	AL-080029/1	AL-080189/1	AL-080239/1
Qty/Box	45	45	45
Tidal volume (ml)	150-1500	150-1500	150-1500
Dead Space (ml)	80	36	36
Bacterial Efficiency	>99,9999%	>99,9999%	>99,9999%
Viral Efficiency	>99,999%	>99,999%	>99,999%
Resistance to Flow	30 L/min 4,5 mm H ₂ O 60 L/min 12 mm H ₂ O 90 L/min 25 mm H ₂ O	30 L/min 4,5 mm H ₂ O 60 L/min 12,5 mm H ₂ O 90 L/min 25,5 mm H ₂ O	30 L/min 5,5 mm H ₂ O 60 L/min 14,5 mm H ₂ O 90 L/min 28 mm H ₂ O
Weight (gr)	28,5	24,5	26,5
Fittings	22mmM-15/22mmMF	22 mmM -15/22 mmMF	22 mmM -15/22 mmMF

BACTERIAL VIRAL HME FILTERS

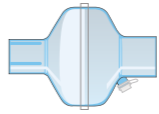
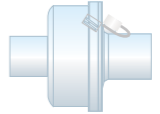
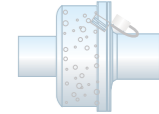
			
	BACTERIAL-VIRAL/HME Filter	BACTERIAL-VIRAL/HME Filter with paper HME	BACTERIAL-VIRAL/HME Filter with foam HME
	SBC raw material	SBC raw material	SBC raw material
Code	AL-08006	AL-08016	AL-08020
Sterile Code	AL-080069	AL-080169	AL-080209
Qty/Box	50	50	50
Tidal volume (ml)	150-1500	150-1500	150-1500
Dead Space (ml)	77	53	53
Bacterial Efficiency	>99,9999%	>99,9999%	>99,9999%
Viral Efficiency	>99,999%	>99,999%	>99,999%
Resistance to Flow	30 L/min 8,4 mm H ₂ O 60 L/min 19,9 mm H ₂ O 90 L/min 38,2 mm H ₂ O	30 L/min 9,4 mm H ₂ O 60 L/min 23,2 mm H ₂ O 90 L/min 42 mm H ₂ O	30 L/min 6 mm H ₂ O 60 L/min 16,5 mm H ₂ O 90 L/min 32 mm H ₂ O
Weight (gr)	24	30	24
Fittings	22 mmM-15/22 mmMF	22 mmM -15/22 mmMF	22 mmM -15/22 mmMF
Humidification efficiency	38,6mgH ₂ O/L (@500 ml tid. vol.)	36,8 mgH ₂ O/L (@500 ml tid. vol.)	37,5 mgH ₂ O/L (@500 ml tid. vol.)

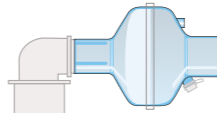
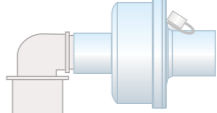
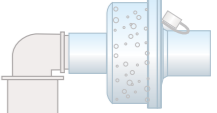
			
	BACTERIAL-VIRAL/HME Filter Angled	BACTERIAL-VIRAL/HME Filter Angled	BACTERIAL-VIRAL/HME Filter Angled
	SBC raw material	SBC raw material	PP raw material
Code	AL-08006/1	AL-08016/1	AL-08020/1
Sterile Code	AL-080069/1	AL-080169/1	AL-080209/1
Qty/Box	45	45	45
Tidal volume (ml)	150-1500	150-1500	150-1500
Dead Space (ml)	80	55	55
Bacterial Efficiency	>99,9999%	>99,9999%	>99,9999%
Viral Efficiency	>99,999%	>99,999%	>99,999%
Resistance to Flow	30 L/min 4 mm H ₂ O 60 L/min 17 mm H ₂ O 90 L/min 32 mm H ₂ O	30 L/min 9,5 mm H ₂ O 60 L/min 23,5 mm H ₂ O 90 L/min 42,5 mm H ₂ O	30 L/min 6,5 mm H ₂ O 60 L/min 17 mm H ₂ O 90 L/min 32,5 mm H ₂ O
Weight (gr)	29,5	36	29,5
Fittings	22 mmM -15/22 mmMF	22 mmM-15/22 mmMF	22 mmM-15/22 mmMF
Humidification efficiency	33,6mgH ₂ O/L (@500 ml tid. vol.)	35 mgH ₂ O/L (@500 ml tid. vol.)	37,1 mgH ₂ O/L (@500 ml tid. vol.)

Bacterial Viral HME Filters

- Bacterial Efficiency %99.9999
- High level of moisture output
- Small and paediatric versions
- Coupled with a hydrophobic bacterial viral filter membrane
- Rounded ergonomic housing
- Sterile or Clean
- Standart Retainable Monitoring Cap
- High level of moisture output(>33mgH₂O/L)
- Hygroscopic cellulose or foam HME Media
- ISO Standart Connectors
- Individually Packed



Pediatric & Neonatal Filters

- Ideal electrostatic filtration performance
- Flat ergonomic design
- Small and light weight
- Cost effective
- Gas sampling port
- Optimised for pediatric and infant patients
- Effective solution on patient undergoing short term ventilation
- Latex free

BACTERIAL VIRAL HME FILTERS

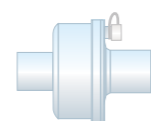

BACTERIAL-VIRAL/HME Filter with paper

	BACTERIAL-VIRAL/HME Filter with paper	BACTERIAL-VIRAL/HME Filter with foam HME
	PP raw material	PP raw material
Code	AL-08022	AL-08021
Sterile Code	AL-080229	AL-080219
Qty/Box	50	50
Tidal volume (ml)	150-1500	150-1500
Dead Space (ml)	55	55
Bacterial-Viral Efficiency	>99,9999%	>99,9999%
Viral Efficiency	>99,999%	>99,999%
Resistance to Flow	30lt/min 8,2 mm H ₂ O 60lt/min 21,4 mm H ₂ O 90lt/min 39,5 mm H ₂ O	30lt/min 6,5 mm H ₂ O 60lt/min 17,2 mm H ₂ O 90lt/min 33 mm H ₂ O
Weight (gr)	35,6	28,5
Fittings	22mmM - 15/22mmMF	22mmM - 15/22mmMF
Humidification efficiency	37 mg H ₂ O/L (@500 ml tid. vol.)	35,5 mg H ₂ O/L (@500 ml tid. vol.)

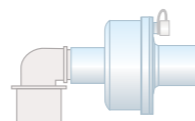

BACTERIAL-VIRAL/HME Filter with foam HME

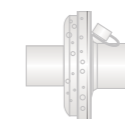

BACTERIAL VIRAL FILTER PEDIATRIC

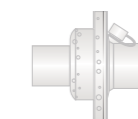

BACTERIAL VIRAL HME FILTER PEDIATRIC

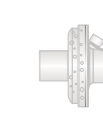

BACTERIAL VIRAL HME FILTER NEONATAL

	BACTERIAL VIRAL FILTER PEDIATRIC	BACTERIAL VIRAL HME FILTER PEDIATRIC	BACTERIAL VIRAL HME FILTER NEONATAL
	SBC raw material	SBC raw material	SBC raw material
Code	AL-08030	AL-08031	AL-08032
Sterile Code	AL-080309	AL-080319	AL-080329
Qty/Box	50	50	50
Tidal volume (ml)	150-1200 ml	75-300ml	30-100 ml
Dead Space (ml)	31 ml	29 ml	10 ml
Bacterial-Viral Efficiency	%99,9999	%99,9999	%99,9999
Viral Efficiency	%99,999	%99,999	%99,999
Resistance to Flow	30L/min - 8 mm H ₂ O	15L/min - 6 mm H ₂ O	5L/min - 6 mm H ₂ O
Weight (gr)	19	21	9
Fittings	22F-15M / 22M-15F	22F-15M / 22M-15F	15 M-15F
Humidification efficiency	-	@250ml TV 31 mg H ₂ O/L	@50ml TV 29 mg H ₂ O/L

PEDIATRIC & NEONATAL FILTERS

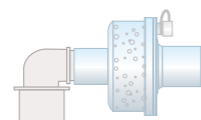

BACTERIAL-VIRAL/HME Filter Angled with paper

	BACTERIAL-VIRAL/HME Filter Angled with paper	BACTERIAL-VIRAL/HME Filter Angled with foam
	PP raw material	PP raw material
Code	AL-08022/1	AL-08021/2/1
Sterile Code	AL-080229/1	AL-080219/1
Qty/Box	45	45
Tidal volume (ml)	150-1500	150-1500
Dead Space (ml)	57	57
Bacterial-Viral Efficiency	>99,9999%	>99,9999%
Viral Efficiency	>99,999%	>99,999%
Resistance to Flow	30lt/min 8,5 mm H ₂ O 60lt/min 21,5 mm H ₂ O 90lt/min 40 mm H ₂ O	30lt/min 7 mm H ₂ O 60lt/min 17,5 mm H ₂ O 90lt/min 33,5 mm H ₂ O
Weight (gr)	41	34
Fittings	22mmM - 15/22mmMF	22mmM - 15/22mmMF
Humidification efficiency	37,5 mg H ₂ O/L (@500 ml tid. vol.)	36,5 mg H ₂ O/L (@500 ml tid. vol.)

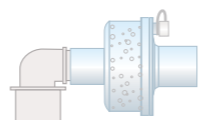

BACTERIAL-VIRAL/HME Filter Angled with foam

TRACHEOSTOMY HME

Tracheostomy HME



- Central port for suctioning & sampling
- Extreme low resistance
- Suitable for adult and children
- Recommended use; for patients over 15kg.
- Paper Media

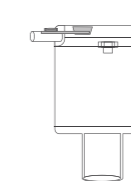

Tracheostomy HME

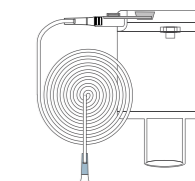

Tracheostomy HME with Oxygen Tubing

	Tracheostomy HME	Tracheostomy HME with Oxygen Tubing
Code	AL-08025	AL-08026
Sterile Code	AL-080259	AL-080269
Qty/Box	100	50
Moisture exchange surf.	500 cm ²	500 cm ²
Dead Space (ml)	15	15
Humidification efficiency	1hr: 27,5mgH ₂ O/L 24hr: 28,8mgH ₂ O/L	1hr: 27,5mgH ₂ O/L 24hr: 28,8mgH ₂ O/L
Resistance to Flow initial	0.63 cmH ₂ O (30L/min) 1.8 cmH ₂ O (60 L/min) 3.5 cmH ₂ O (90 L/min)	0.63 cmH ₂ O (30L/min) 1.8 cmH ₂ O (60 L/min) 3.5 cmH ₂ O (90 L/min)
Weight (gr)	8,4	10
Connections	15F, oxygen port: 5,5mm, suctioning port: 6,1mm	15F, oxygen port: 5,5mm, suctioning port: 6,1mm

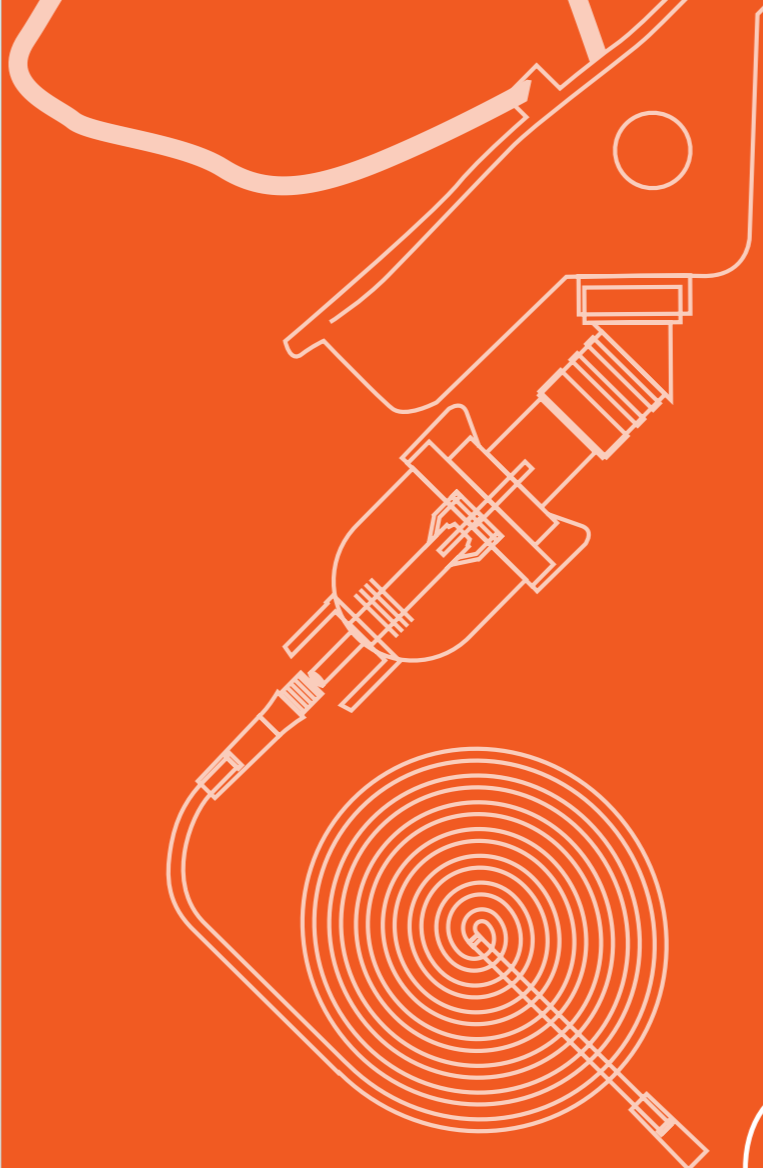

Oxygen
and aerosol
therapy
products

altech[®]

a Meditera Company

Oxygen and Aerosol Therapy Products



Oxygen and Aerosol Therapy Products

OXYGEN and AEROSOL THERAPY PRODUCTS

OXYGEN and AEROSOL THERAPY PRODUCTS

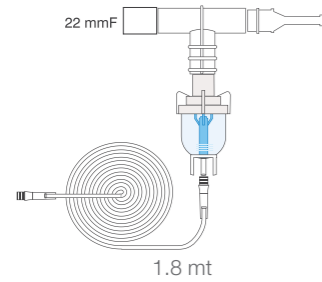

Description	Length	Code	Qty/Box
Flex hose, Nebulizer, Mouth piece, O₂ tubing	180 cm/71"	AL-30120	20/125

Description	Length	Code	Qty/Box
Adult, Oxygen mask, 1,8 mt O₂ tubing	180 cm/71"	AL-31200	20/125
Pediatric, Oxygen mask, 1,8 mt O₂ tubing	180 cm/71"	AL-32200	20/150

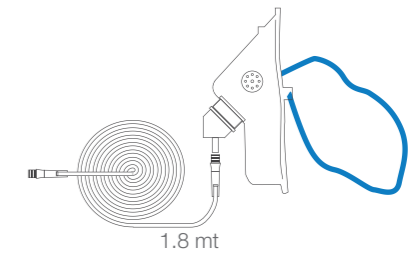

OXYGEN and AEROSOL THERAPY PRODUCTS

NON-REBREATHING MASK

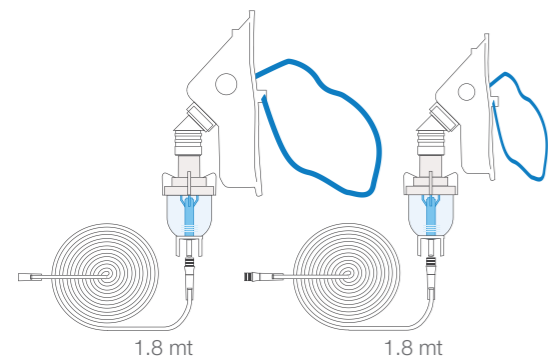

Description	Length	Code	Qty/Box
Adult, Nebulizer, Aerosol mask, O₂ tubing	180 cm/71"	AL-33210	20/125
Pediatric, Nebulizer, Aerosol dragon mask, O₂ tubing	180 cm/71"	AL-34210	20/150

Description	Length	Code	Qty/Box
Adult, High concentration, Non-rebreather mask, O₂ tubing	180 cm/71"	AL-35200	20/125
Pediatric, High concentration, Non-rebreather mask, O₂ tubing	180 cm/71"	AL-36200	20/150

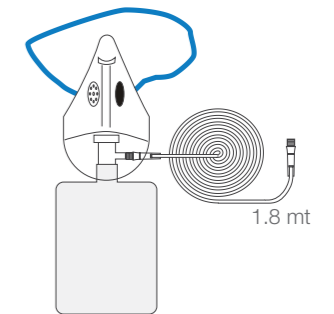

T CIRCUITS

Corrugated			
	Length	Code	Qty/Box
Adult	160 cm/63"	AL-9111	100

Extendible with Port			
	Length	Code	Qty/Box
Adult	160 cm/63"	AL-9313	100

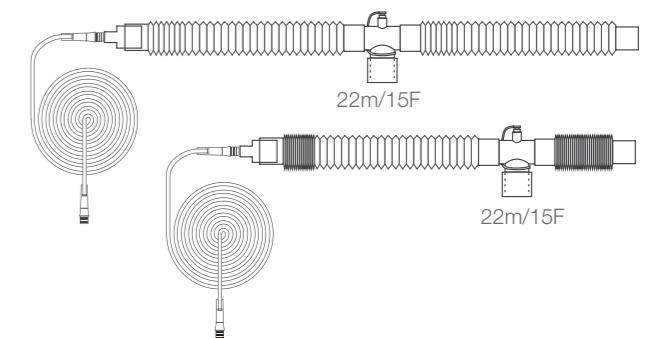

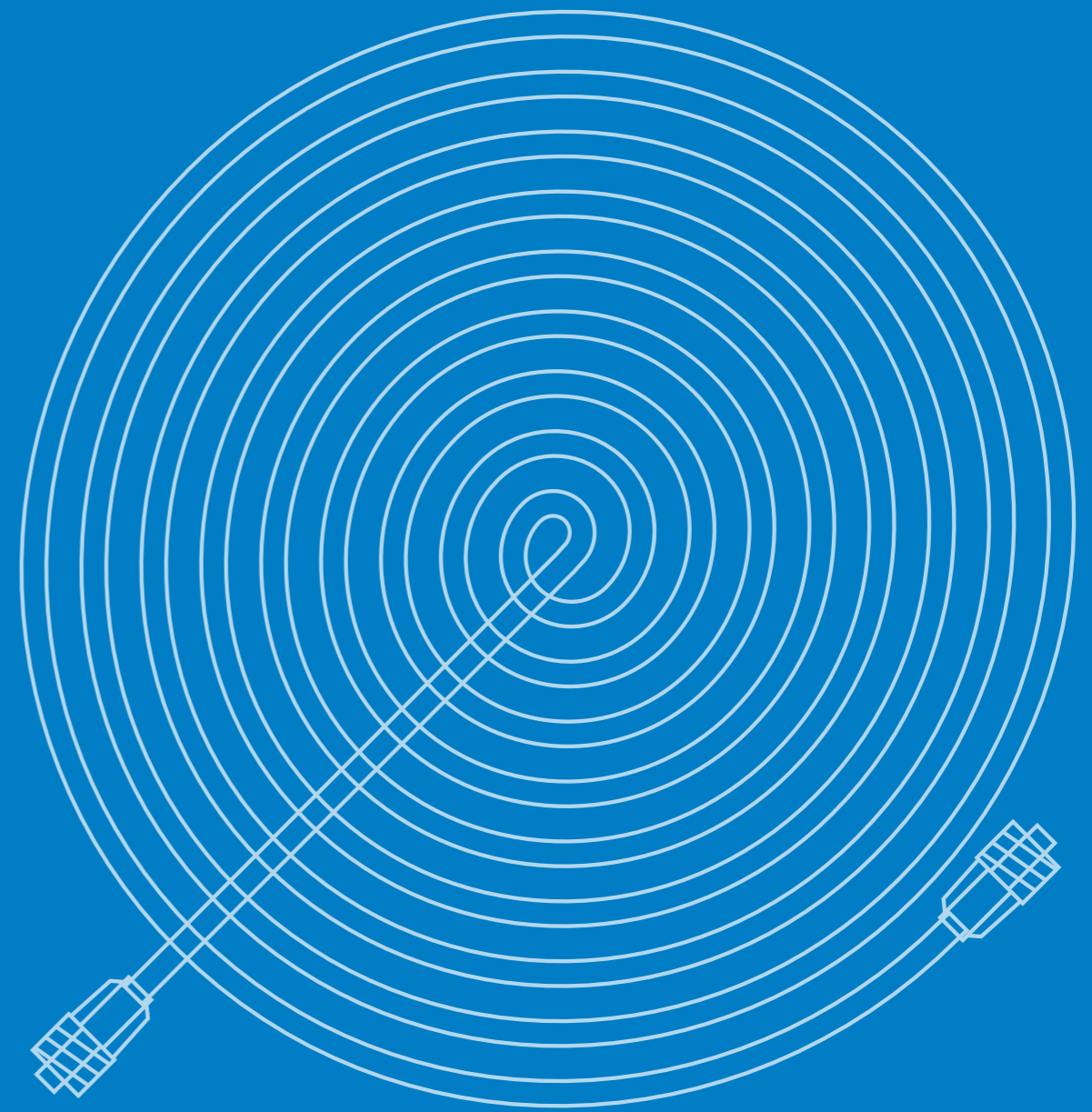

Gas sampling lines

altech[®]

a Meditera Company

Gas Sampling Lines

- Disposable, Single Patient Use, medical grade tubing.
- Non-Sterile
- %100 Flow/occlusion Tested.
- Latex-Free

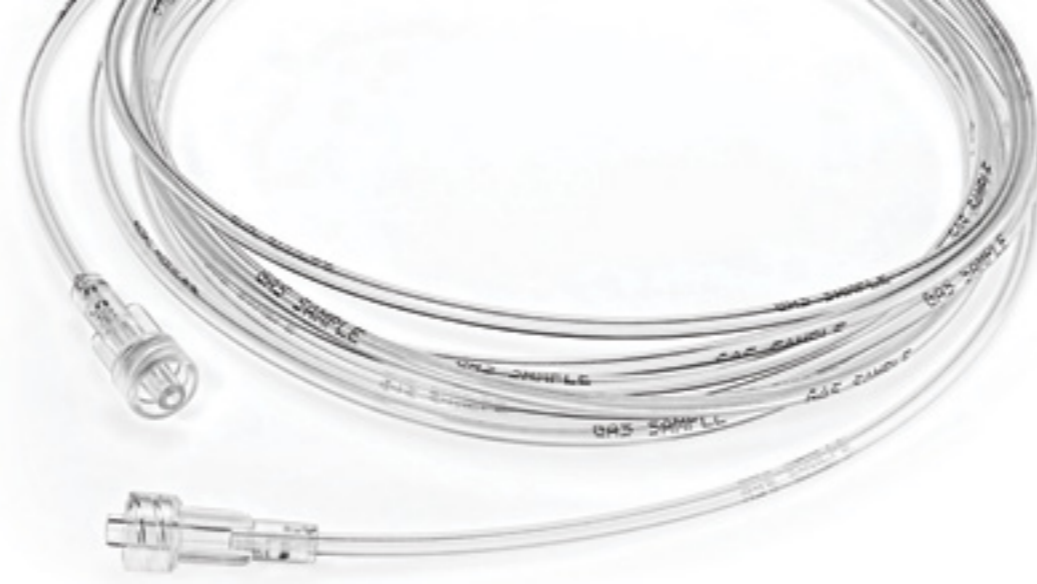

Gas Sampling Lines

- Gas sampling lines used to monitor CO, O, and NO levels.
- Optional filters for absorption of water and protection from particulates.
- 2 layer tubing to prevent diffusion of anesthetic gasses. (PE/PVC)
- Tubing lengths can be customized.

GAS SAMPLING LINES

GAS SAMPLING LINES

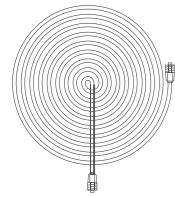

Description		Length	Code	Qty/Box
Gas Monitoring Lines	1,20 mmID X 2,80 mmOD Tubing male - male connector	3 m/118"	AL-0512	100
Gas Monitoring Lines	1,57 mmID X 3,17 mmOD Tubing male - male connector	3 m/118"	AL-0527	100

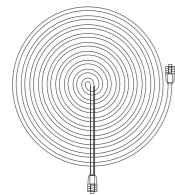

Description		Length	Code	Qty/Box
Gas Monitoring Lines	1,20 mmID X 2,80 mmOD Tubing male - male connector	2 m/79"	AL-0519	100
Gas Monitoring Lines	1,57 mmID X 3,17 mmOD Tubing male - male connector	2 m/79"	AL-0528	100

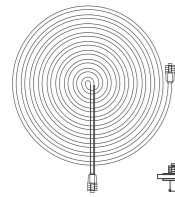

Description		Length	Code	Qty/Box
Gas Monitoring Lines + 0,5 micron filter	1,20 mmID X 2,80 mmOD Tubing male - male connector	3 m/118"	AL-0522	100

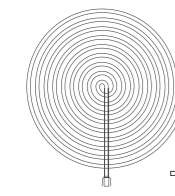

Description		Length	Code	Qty/Box
Gas Monitoring Lines + 0,5 micron filter	1,20 mmID X 2,80 mmOD Tubing male - female connector	3 m/118"	AL-0523	100

Description		Length	Code	Qty/Box
Gas Monitoring Lines	1,20 mmID X 2,80 mmOD Tubing male - female connector	3 m/118"	AL-0513	100

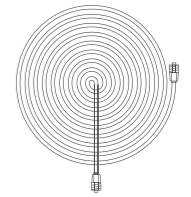

Description		Length	Code	Qty/Box
Gas Monitoring Lines	1,20 mmID X 2,80 mmOD Tubing male - female connector	2 m/79"	AL-0521	100

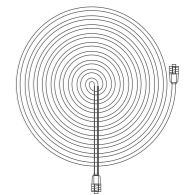

Description		Length	Code	Qty/Box
Gas Monitoring Lines	1,20 mmID X 2,80 mmOD Tubing male - female connector	2,5 m/98"	AL-0532	100

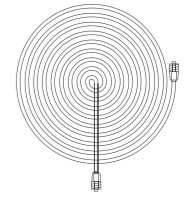



Masks & Resuscitators

altech[®]

a Meditera Company

Anesthesia Masks

- Color coded
- Standard & scented Mask Design Latex free
- Available in 6 different sizes for different indications
- Inflatable Cushion
- Transparent to allow easy observation



Oronasal NIV Masks

Designed to provide a good seal when fitted to the patient whilst providing maximum comfort.
 Safety valve for inspiration should the flow rate be insufficient or if the inspiratory line be occluded.
 Inflatable Cushion for perfect sealing
 Transparent design for visual inspection the patient



STANDART MASKS

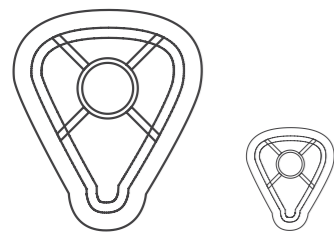

Description	Code	Size	Weight	Dead Space	Qty/Box
Respiratory, anesthesia mask #5	AL-09005	Large	55,5 gr	250 ml	25
Respiratory, anesthesia mask #4	AL-09004	Medium	51 gr	220 ml	25
Respiratory, anesthesia mask #3	AL-09003	Small	37,5 gr	180 ml	25
Respiratory, anesthesia mask #2	AL-09002	Child	27 gr	85 ml	50
Respiratory, anesthesia mask #1	AL-09001	Infant	17,5 gr	45 ml	60
Respiratory, anesthesia mask #0	AL-09000	Neonatal	14,5 gr	25 ml	60

CPAP MASKS

Description	Code	Size	Weight	Dead Space	Qty/Box
CPAP Air Cushion Face Mask	AL-09014	Large Adult	67,5 gr	245 ml	20
CPAP Air Cushion Face Mask	AL-09016	Medium Adult	68,5 gr	215 ml	20

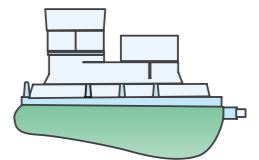

Description	Code	Size
Deluxe full face mask	AL-09058	Medium SW
Deluxe full face mask	AL-09059	Large SW
Deluxe full face mask	AL-09060	Small SW

- Latex-Free
- Scented
- Available in 3 sizes
- High Transparency
- Medical Grade PVC
- Offers high patient comfort
- Safety Valve on the mask

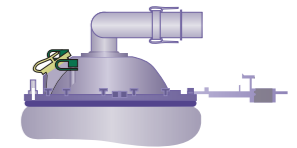

PVC FREE MASKS

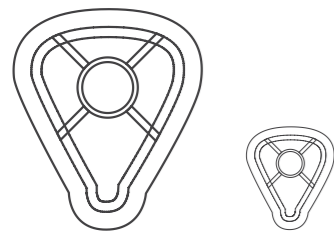

Description	Code	Product Description	Qty/Box
Respiratory, anesthesia mask #5 PVC Free	AL-09051	Large Adult	50
Respiratory, anesthesia mask #4 PVC Free	AL-09056	Medium Adult	50
Respiratory, anesthesia mask #3 PVC Free	AL-09055	Small Adult	50
Respiratory, anesthesia mask #2 PVC Free	AL-09054	Pediatric	75
Respiratory, anesthesia mask #1 PVC Free	AL-09053	Infant	75
Respiratory, anesthesia mask #0 PVC Free	AL-09052	Neonatal	75

ACCESSORIES
CO2 exhalation connector
 Code: 150.11.100

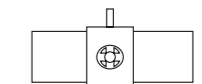

BVM RESUSCITATORS

- Medical grade PVC material.
- Disposable.
- Latex-Free
- 3 different sizes, Adult, Pediatric, Infant.
- Pressure Pop Off Valve
 a. 60 cm H₂O for adult and ped.
 b. 40 cm H₂O for neonates
- Suitable for Peep Valve connection with PEEP set
- ISO standart connectors.

BVM RESUSCITATOR LARGE, MASK, O2 TUBING

Qty/Box	Qty/Box
AL-0806-1/7	30

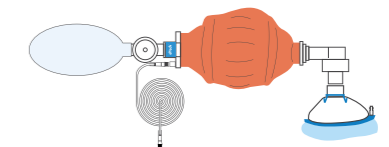

BVM RESUSCITATOR MEDIUM, MASK, O2 TUBING

Qty/Box	Qty/Box
AL-0807-1/7	40

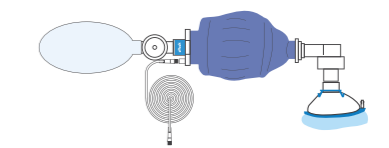

BVM RESUSCITATOR SMALL, MASK, O2 TUBING

Qty/Box	Qty/Box
AL-0808-1/7	50

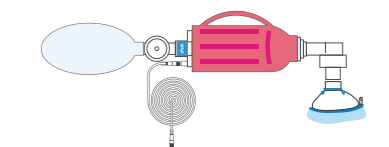

SCENTED MASKS

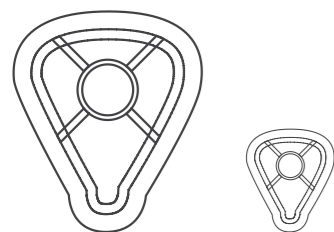

Description	Code	Size	Weight	Dead Space	Qty/Box
Respiratory, anesthesia mask #6	AL-09096	Ultra Large	59,5 gr	310 ml	20
Respiratory, anesthesia mask #5	AL-09095	Large	55,5 gr	250 ml	20
Respiratory, anesthesia mask #4	AL-09094	Medium	51 gr	220 ml	20
Respiratory, anesthesia mask #3	AL-09093	Small	37,5 gr	180 ml	20
Respiratory, anesthesia mask #2	AL-09092	Child	27 gr	85 ml	40
Respiratory, anesthesia mask #1	AL-09091	Infant	17,5 gr	45 ml	40
Respiratory, anesthesia mask #0	AL-09090	Neonatal	14,5 gr	25 ml	40



Infection Prevention

altech[®]

a Meditera Company

altech® BODY CLEANSING FOAM

Altech skin cleansing foam is especially suitable for very strained and irritated skin as it can be used without water, soap or washing lotions. It leaves a nourishing protective layer on the skin.

The provitamine D-panthenol eases skin irritations and redness hence offering special care for chapped skin. The foam has an excellent moisturizing effect and absorbs quickly into the skin due to its small molecule structure. Together with allantoin the moisturising effect supports the regeneration of extremely.

Altech skin cleansing foam is suitable for the mild skin cleansing and skin care without using water, soap or washing lotion. Enhances optimal healing environment for very strained and irritated skin of bedridden patients, for incontinent patients and for ICU patients.

SIZES / SPECIFICATION

- 500 ml Aerosol Can
- 125 ml Aerosol Can with wiping gloves



altech® BARRIER CREAM

A unique moisturising concentrated barrier cream for intact skin that provides skin protection from body fluids

- Protecting 'at risk' skin from damage associated with incontinence.
- Protecting intact skin from damage associated with chronic incontinence.
- Acting as a moisturiser for severely dry skin.
- Helps protect the skin from damage caused by friction or shear
- Helps prevent maceration
- Altech Barrier Cream is a concentrated barrier cream that provides long-lasting, protection from body fluids whilst moisturising the skin.

SIZES / SPECIFICATION

- 100 Gr per tube



altech® SYRINGE SAFETY LOCK

DRUG COMPOUNDING SECURITY SYSTEM

When securely placed on a luer lock syringe and verified by the healthcare worker, unused syringes may be returned to the pharmacy to be re-dispensed. Altech syringe safety lock assists healthcare staff in enhancing medication safety and reducing waste and associated costs.

- Healthcare Professional can feel confident that the integrity of the filled syringe is protected.
- Ideal for use with syringes containing controlled substances, chemo drugs, pain medications and TPN solutions.
- Unused medication syringes can be safely returned to the pharmacy and re-dispensed, reducing the cost of medication waste.



STEP 1

Safely connect the syringe lock on the syringe clockwise

STEP 2

In case of drug use turn the syringe lock counter clockwise and rip the cap off.

altech® PVOISEPTIN® SCRUB BRUSH

Poviseptin® Scrub Brush is a surgical scrub brush impregnated with Poviseptin® Scrub. Poviseptin® Scrub containing 7.5% povidone-iodine is used for surgical hand and skin disinfection with its bactericidal, virucidal, fungicidal effects. Iodine in the polyvinylpyrrolidone iodine complex is released slowly and thus provides the antiseptic effect. Foams easily and can be cleaned with water without leaving any stains.

Surgical Scrub Brush Containing Poviseptin® Scrub

- Contains antimicrobial hand and skin cleanser liquid soap (7.5% Povidone Iodine).
- Compatible with skin pH.
- Protects and moisturizes the skin.
- Suitable for sensitive skin and frequent use.
- Fingernails are cleaned thoroughly thanks to its ergonomic brush design.



altech® CHLORHEXIDAL® SCRUB BRUSH

Chlorhexidal® Scrub Brush is a surgical scrub brush impregnated with Chlorhexidal Scrub hand and skin cleanser. Chlorhexidal Scrub containing 4% chlorhexidine gluconate is an ideal antiseptic liquid soap for skin and mucous membrane disinfection with its permanent, rapid and broad-spectrum effect on the skin. Chlorhexidine is a topical antiseptic and disinfectant that has biguanide structure.

Surgical Scrub Brush Containing Chlorhexidal Scrub

- Antimicrobial hand and skin cleanser
- Hand and skin cleanser
- Antiseptic liquid soap with permanent, rapid and broad-spectrum.
- Compatible with skin pH.
- Protects and moisturizes the skin.
- Suitable for sensitive skin and frequent use.
- Stabilizes the skin flora, removes unpleasant odors.
- Fingernails are cleaned thoroughly thanks to its ergonomic brush design.
- Does not contain alcohol, triclosans and SLS.



altech®

Breathing Systems

Factory

Adress: Tire Organize Sanayi Bölgesi, Tire 35900 IZMIR / TURKEY

Telephone: +90 232 513 51 10 (pbx) **Fax:** +90 232 513 51 14

Headquarter

Adress: 5758 Sk. No: 4/C Kat: 2-3 Karabağlar - IZMIR / TURKEY

Telephone: +90 232 237 59 49 (pbx) **Fax:** +90 232 253 94 04

info@altech.com.tr

www.altech.com.tr

a Meditera Company

April 2018

Ver.: 1