



HEINE
Master catalogue 2024

General medicine, ENT & VET

Ophthalmic instruments

Combined diagnostic sets

Laryngoscopes

Dermatoscopes

Sphygmomanometers and stethoscopes

Proctological instruments

Examination lights

Loupes and headlights

Light and power sources

Carrying cases and storage cases

Better illumination.

Superior

colour rendering.

Greater magnification.

HEINE otoscopes Overview

It goes without saying that all of our otoscopes are premium products. But, still, they differ in one or two details. Read on for a summary of what these different details are and all their benefits:



	BETA 400 F.O. High-end otoscope	BETA 200 F.O. Standard otoscope	K180 F.O. Basic otoscope	mini 3000 F.O. Pocket otoscope	mini 3000 Pocket otoscope
	Very detailed	Quick overview		Compact & mobile	Compact & mobile
Level of detail	very high	high	adequate	good	adequate
Viewing window	glass		acrylic		
Magnification	4,2x	3x			
Illumination	F.O. XHL or LED ^{HQ}		F.O. XHL	F.O. XHL or LED ^{HQ}	direct XHL
Housing construction	metal		polycarbonate		
Handle options power sources	battery handle (XHL only), USB rechargeable handle, rechargeable handle with table charger, EN 200 EN 200-1			battery handle, rechargeable handle with table charger	
Tips specula	reusable tips, AllSpec disposable tips				
Pneumatic testing of tympanum mobility	insufflation port available			insufflation port available, connector required	–
Catalogue page	7	9	11	13	18

HEINE BETA® 400 LED F.O. otoscope

Our high-end instrument with 4.2x magnification



Exceptional durability combined with our highest 4.2x magnification. LED^{HQ} provides particularly bright illumination. BETA otoscopes are the result of ongoing optimisation and further development down to the smallest detail – where we leave nothing to chance.

EXTREMELY DETAILED VIEW

- ▶ Easy identification of anatomical structures and foreign bodies due to 4.2x magnification
- ▶ Very good spatial representation due to high depth of field
- ▶ High-resolution images due to precision optics
- ▶ Natural colour rendering
- ▶ Even and reflex-free illumination due to fiber optic technology
- ▶ Particularly bright due to LED^{HQ}

EXTREME DURABILITY

- ▶ Solid metal housing
- ▶ Scratch-proof glass lenses
- ▶ Consistently good view over many years
- ▶ No need to ever exchange the LED thanks to LED^{HQ}

INTUITIVE OPERABILITY

- ▶ Practical one-finger operation
- ▶ Always the ideal light intensity due to patented and continuous brightness control
- ▶ Easy instrumentation due to a fixed optical system to be flipped open
- ▶ Safe, hygienic reprocessing
- ▶ Pneumatic eardrum testing by means of an integrated insufflation port

FLEXIBLE POWER SOURCE OPTIONS

- ▶ Rechargeable battery: with USB or table charger
- ▶ Full functionality of the BETA 400 LED is guaranteed with the current BETA rechargeable handles and the EN 200 | EN 200-1 wall transformers

- ▶ Practical and expandable with other HEINE instrument heads

- ▶ **A tip for a better future.** HEINE AllSpec disposable tips – made of recycled plastic. Read more on [page 15](#)

- ▶ **Also available with XHL xenon halogen illumination**

Bright illumination and authentic colour rendering; for other technical specifications see BETA 400 LED F.O. otoscope

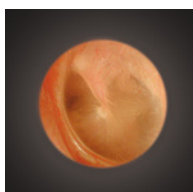

BETA 400 LED F.O.
with 4,2x magnification

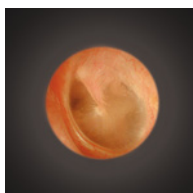

Conventional otoscope

HEINE BETA® 400 LED F.O. otoscope

Diagnostic sets | kits

Set includes: BETA 400 F.O. otoscope,

1 set (4 pcs.) of reusable tips, 10 AllSpec disposable tips 4 mm Ø, spare bulb for XHL version, hard case



[01]

	2.5V XHL	LED
BETA battery handle	B-143.10.118	-
BETA4 USB rechargeable handle with USB cord and plug-in power supply	-	B-143.28.388
BETA4 NT rechargeable handle with NT4 table charger [01]	-	B-143.24.420

Kit includes: BETA 400 F.O. otoscope,

10 AllSpec disposable tips 4 mm Ø



[02]

	2.5V XHL	LED
BETA battery handle	B-010.10.118	-
BETA4 USB rechargeable handle with USB cord and plug-in power supply [02]	-	B-010.28.388
BETA4 NT rechargeable handle with NT4 table charger	-	B-010.24.420

- ▶ You can find information on our combined diagnostic sets and kits on [pages 74 to 78.](#)
- ▶ For information on HEINE battery and rechargeable handles and the EN 200 wall transformer, see [pages 150-160.](#)

HEINE BETA® 200 LED F.O. otoscope

Standard instrument for a quick overview



Exceptional durability combined with optimum magnification. Particularly bright illumination due to LED^{HQ}. BETA otoscopes are the result of ongoing optimisation and further development down to the smallest detail – where we leave nothing to chance.

QUICK OVERVIEW

- ▶ Very good spatial representation due to maximum depth of field
- ▶ High-resolution and distortion-free images due to multi-coated glass viewing window
- ▶ 3x magnification
- ▶ Natural colour rendering
- ▶ Even and reflex-free illumination due to fiber optic technology
- ▶ Particularly bright due to LED^{HQ}

EXTREME DURABILITY

- ▶ Solid metal housing
- ▶ Scratch-proof glass lenses
- ▶ Consistently good view over many years
- ▶ No need to ever exchange the LED thanks to LED^{HQ}

INTUITIVE OPERABILITY

- ▶ Practical one-finger operation
- ▶ Always the ideal light intensity due to patented and continuous brightness control
- ▶ Easy instrumentation due to fixed, swivelling viewing window
- ▶ Safe, hygienic reprocessing
- ▶ Pneumatic eardrum testing by means of an integrated insufflation port

FLEXIBLE POWER SOURCE OPTIONS

- ▶ Rechargeable battery: with USB or table charger
- ▶ Full functionality of the BETA 200 LED is guaranteed with the current BETA rechargeable handles and the EN 200 | EN 200-1 wall transformers
- ▶ Practical and expandable with other HEINE instrument heads
- ▶ **A tip for a better future.** HEINE AllSpec disposable tips – made of recycled plastic. Read more on [page 15](#)
- ▶ **Also available with XHL xenon halogen illumination**
Bright illumination and authentic colour rendering; for other technical specifications see BETA 200 LED F.O. otoscope

HEINE BETA® 200 LED F.O. otoscope

Diagnostic sets | kits

Set includes: BETA 200 F.O. otoscope,

1 set (4 pcs.) of reusable tips, 10 AllSpec disposable tips 4 mm Ø,
spare bulb for XHL version, hard case



[01]

	2,5V XHL	3,5V XHL	LED
BETA battery handle	B-141.10.118	-	-
BETA4 USB rechargeable handle with USB cord and plug-in power supply	-	B-141.27.388	B-141.28.388
BETA4 NT rechargeable handle with NT4 table charger [01]	-	B-141.23.420	B-141.24.420



[02]

Kit includes: BETA 200 F.O. otoscope,

10 AllSpec disposable tips 4 mm Ø

	2,5V XHL	LED
BETA battery handle	B-011.10.118	-
BETA4 USB rechargeable handle with USB cord and plug-in power supply [02]	-	B-011.28.388
BETA4 NT rechargeable handle with NT4 table charger	-	B-011.24.420

- ▶ You can find information on our combined diagnostic sets and kits on [pages 74 to 78.](#)
- ▶ For information on HEINE battery and rechargeable handles and the EN 200 wall transformer, see [pages 150-160.](#)

HEINE K180 F.O. otoscope

Standard instrument for a smaller budget



Otoscope with xenon halogen illumination and fiber optic technology.
Housing made of lightweight, shockproof polycarbonate.

DETAILED VIEW

- ▶ High-resolution and distortion-free images due to acrylic viewing window
- ▶ 3x magnification
- ▶ True-to-life colour rendering
- ▶ Even and reflex-free illumination due to fiber optic technology
- ▶ Xenon halogen illumination (XHL)

ENHANCED DURABILITY

- ▶ Sturdy polycarbonate housing
- ▶ Lightweight yet durable

INTUITIVE OPERABILITY

- ▶ Practical one-finger operation
- ▶ Always the ideal light intensity thanks to continuous brightness control
- ▶ Easy instrumentation due to fixed, swivelling viewing window
- ▶ Safe, hygienic reprocessing
- ▶ Pneumatic eardrum testing by means of an integrated insufflation port

FLEXIBLE POWER SOURCE OPTIONS

- ▶ Rechargeable battery: with USB or table charger
- ▶ EN 200 | EN 200-1 wall transformer
- ▶ Replaceable batteries

- ▶ **A tip for a better future.** HEINE AllSpec disposable tips – made of recycled plastic. Read more on [page 15](#)

HEINE K180 F.O. otoscope

Diagnostic sets | kits



Set includes: K180 F.O. otoscope,
1 set (4 pcs.) of reusable tips, soft pouch

	2,5V XHL	3,5V XHL
BETA battery handle	B-181.10.118	-
BETA4 USB rechargeable handle with USB cord and plug-in power supply [01]	-	B-181.27.388



[01]

Kit includes: K180 F.O. otoscope with

	2,5V XHL
BETA battery handle [02]	B-012.10.118



[02]

- ▶ You can find information on our combined diagnostic sets and kits on [pages 74 to 78.](#)
- ▶ For information on HEINE battery and rechargeable handles and the EN 200 wall transformer, see [pages 150-160.](#)

HEINE mini 3000® LED F.O. otoscope

HEINE quality in pocket format



Compact otoscope with especially bright illumination and authentic colour rendering due to LED^{HQ} (no need to ever exchange the LED). Exclusive design. Sturdy housing. Always close to hand. Available in black or blue. It is impossible to get much more in such a small housing.

INTUITIVE OPERABILITY

- ▶ Always close to hand with practical attachment clip
- ▶ Switches off automatically as soon as it is clipped to the pocket
- ▶ Easy instrumentation. Viewing window fixed and can be swivelled to the side
- ▶ Pneumatic eardrum testing by means of an integrated insufflation port
- ▶ Sturdy and non-slip due to a high-quality handle housing

DETAILED VIEW

- ▶ High-resolution images, minimal reflection
- ▶ 3x magnification
- ▶ Natural colour rendering
- ▶ Even and reflex-free illumination due to fiber optic technology
- ▶ Particularly bright due to LED^{HQ}



FLEXIBLE POWER SOURCE OPTIONS

- ▶ Rechargeable battery: with mini NT table charger
- ▶ Replaceable batteries
- ▶ Operating time of typically 10 hours: Fewer battery changes, rechargeable batteries last longer
- ▶ Practical and expandable with other mini 3000 instrument heads
- ▶ **Also available with XHL xenon halogen illumination**
Bright illumination and authentic colour rendering; for other technical specifications see mini 3000 LED otoscope
- ▶ **A tip for a better future.** HEINE AllSpec disposable tips – made of recycled plastic. Read more on [page 15](#)

HEINE mini 3000® F.O. otoscope

Diagnostic sets | kits

Set | kit includes: mini 3000 F.O. otoscope,

1 set (4 pcs.) of reusable tips, 10 AllSpec disposable tips 4 mm Ø.

Optionally with or without hard case



[01]

	2,5V XHL	2,5V LED
mini 3000 battery handle (with batteries), hard case [01]	D-851.10.021	D-885.20.021
mini 3000 battery handle (with batteries), without case	D-001.70.120	D-008.70.120



[02]

Kit includes: mini 3000 F.O. otoscope,

10 AllSpec disposable tips 4 mm Ø

	2,5V XHL	2,5V LED
mini 3000 battery handle with batteries [02]	D-001.70.110	D-008.70.110
mini 3000 rechargeable handle (please order mini NT table charger separately)	D-001.70.301	D-008.70.301



- ▶ Available in black or blue. Please specify the colour you prefer when ordering. If not otherwise specified, we will supply black instruments.
- ▶ You can find information on our combined diagnostic sets and kits on [pages 74 to 78](#).
- ▶ To upgrade to a rechargeable instrument with mini NT table charger, please see [page 161](#).

HEINE AllSpec disposable tips made of recycled plastic

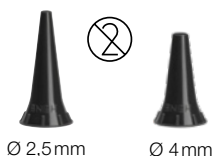

- ▶ The **renowned HEINE Quality** is now saving tons of CO₂
- ▶ **For a particularly secure fit, best light transmission and hygiene**
- ▶ **Assured quality.** No sharp edges
- ▶ Read about what else we're doing for the environment here: www.heine.com/csr



[01]



[02]



[03]



[04]

AllSpec disposable tips for BETA 400, BETA 200, K180, mini 3000 F.O. and mini 3000 otoscopes

pack of 1,000 pcs. Ø 2.5 mm (infants) [01]	B-000.11.128
pack of 1,000 pcs. Ø 4 mm (adults)	B-000.11.127
case of 10 packs of 1,000 pcs, Ø 2,5 mm (infants)	B-000.11.138
case of 10 packs of 1,000 pcs, Ø 4 mm (adults)	B-000.11.137
dispenser pack, single, of 250 tips, Ø 2.5 mm (infants) [02]	B-000.11.153
dispenser pack, single, of 250 tips, Ø 4 mm (adults)	B-000.11.152
case of 10 dispenser packs of 250 tips, Ø 2.5 mm (infants)	B-000.11.151
case of 10 dispenser packs of 250 tips, Ø 4 mm (adults)	B-000.11.150

AllSpec tip dispenser incl. tips Ø 2.5 mm and 4 mm.

The right size, visible and instantly available. A clean new tip for each and every patient.

AllSpec tip dispenser (2 x 50 tips) [03]	B-000.11.149
--	---------------------

Tip adaptor for BETA 100* and K100*

adaptor for AllSpec disposable tips for use with diagnostic otoscope (BETA 100, K100) [04]	B-000.11.306
---	---------------------

*Instrument no longer available.

⊗: Single use only.

Reusable tips for the most secure fit

- ▶ **For the most secure fit, best light transmission and hygiene,** we recommend the use of HEINE otoscope tips
- ▶ **Made of high-density SANALON S plastic with smooth external finish.**
Easy to clean. Common germicides can be used. Autoclavable at up to 134 °C
- ▶ **Ergonomic shape.** Painless atraumatic insertion



Reusable tips for BETA 400, BETA 200, K180, mini 3000 F.O. and mini 3000 otoscopes

1 set = 4 pcs. reusable tips (2.4 – 5 mm Ø)	B-000.11.111	
	1 piece	50 pieces
reusable tip Ø 2.4 mm	B-000.11.107	B-000.11.207
reusable tip Ø 3.0 mm	B-000.11.108	B-000.11.208
reusable tip Ø 4.0 mm	B-000.11.109	B-000.11.209
reusable tip Ø 5.0 mm	B-000.11.110	B-000.11.210

Further articles | accessories for otoscopes with fiber optic (F.O.) illumination



Soft disposable tips: Fits over the end of the tip to protect the auditory canal

soft disposable tip Ø 3 mm, 40 pcs. 1 pack	B-000.11.141
soft disposable tip Ø 5 mm, 40 pcs. 1 pack	B-000.11.142

☒: Single use only.



BETA 400 F.O. otoscope head	2,5V XHL	3,5V XHL	LED
with 4 reusable tips, without handle	B-001.11.401	B-002.11.401	B-008.11.401
without handle and accessories	B-001.11.400	B-002.11.400	B-008.11.400



BETA 200 F.O. otoscope head	2,5V XHL	3,5V XHL	LED
with 4 reusable tips, without handle	B-001.11.501	B-002.11.501	B-008.11.501
without handle and accessories	B-001.11.500	B-002.11.500	B-008.11.500



K180 F.O. otoscope head	2,5V XHL	3,5V XHL
with 4 reusable tips, without handle	B-001.11.551	B-002.11.551
without handle and accessories	B-001.11.550	B-002.11.550



mini 3000 F.O. otoscope head	2,5V XHL	2,5V LED
without handle and accessories*	D-001.70.106	D-008.70.106

*Available in black or blue. Please specify the colour you prefer when ordering. If not otherwise specified, we will supply black instruments.



XHL xenon halogen spare bulb	2,5V XHL	3,5V XHL
for BETA 400, BETA 200 and K180	X-001.88.077	X-002.88.078
for mini 3000 F.O.	X-001.88.105	-



[01]



[02]

Insufflation bulb for pneumatic testing

insufflation bulb for BETA 400, BETA 200, K180, BETA 100*, K100* [01]	B-000.11.240
insufflation bulb for mini 3000 F.O. otoscope with connector	D-000.80.102
insufflation port connector for mini 3000 F.O. otoscope [02]	D-000.80.101

*Instrument no longer available.

HEINE mini 3000® otoscope

HEINE quality in pocket format, with direct illumination



Compact otoscope with improved xenon halogen (XHL) illumination. Exclusive design. Sturdy housing. Always close to hand. Available in black or blue. It is impossible to get much more in such a small housing. Except maybe in the mini 3000 LED otoscope.

INTUITIVE OPERABILITY

- ▶ Always close to hand with practical attachment clip
- ▶ Switches off automatically as soon as it is clipped to the pocket
- ▶ Easy instrumentation. Viewing window fixed and can be swivelled to the side
- ▶ Sturdy and non-slip due to a high-quality handle housing

DETAILED VIEW

- ▶ Eliminates reflections due to the head's black inner coating
- ▶ High-resolution images
- ▶ 3x magnification
- ▶ Natural colour rendering

FLEXIBLE POWER SOURCE OPTIONS

- ▶ Rechargeable battery: with mini NT table charger
- ▶ Replaceable batteries
- ▶ Practical and expandable with other mini 3000 instrument heads
- ▶ **A tip for a better future.** HEINE AllSpec disposable tips – made of recycled plastic. Read more on [page 15](#)



HEINE mini 3000® otoscope

Diagnostic sets | kits



[01]



[02]

Set|kit includes: mini 3000 otoscope,
1 set (4 pcs.) reusable tips, 10 AllSpec disposable tips 4 mm Ø

	2,5V XHL
mini 3000 battery handle (with batteries), hard case [01]	D-851.20.021
mini 3000 battery handle (with batteries), without case [02]	D-001.70.220
mini 3000 battery handle (with batteries), without case, without reusable tips	D-001.70.210



- ▶ Available in black or blue. Please specify the colour you prefer when ordering. If not otherwise specified, we will supply black instruments.
- ▶ You can find information on our combined diagnostic sets and kits on [pages 74 to 78](#).
- ▶ To upgrade to a rechargeable instrument with mini NT table charger, please see [page 161](#).

Further articles | accessories for HEINE otoscopes



mini 3000 otoscope head	2,5V XHL
without handle and accessories*	D-001.70.206

* Available in black or blue. Please specify the colour you prefer when ordering. If not otherwise specified, we will supply black instruments.



XHL xenon halogen spare bulb	2,5V XHL
for mini 3000	X-001.88.110

Reusable specula for BETA 100* and K100*



Ø 2,2mm [01] Ø 10mm [02]

1 set = 5 ear specula, 1 nose speculum	B-000.11.221
3 ear specula Ø 3.5 4.5 5.5 mm	B-000.11.222
ear speculum Ø 2.2mm [01]	B-000.11.215
ear speculum Ø 2.8mm	B-000.11.216
ear speculum Ø 3.5 mm	B-000.11.217
ear speculum Ø 4.5 mm	B-000.11.218
ear speculum Ø 5.5 mm	B-000.11.219
nose speculum Ø 10 mm [02]	B-000.11.220



Ø 2,5mm [03]



[04]

UniSpec disposable specula for BETA 100* and K100*

pack of 1,000, Ø 2.5 mm (infants) 1,000 pcs. 1 pack [03]	B-000.11.242
pack of 1,000, Ø 4 mm (adults) 1,000 pcs. 1 pack	B-000.11.241
UniSpec tip dispenser [04]	B-000.11.146

*Instrument no longer available.

⊗: Single use only.

Tongue-blade holder for wooden tongue-blades

- ▶ **XHL xenon halogen technology.** Concentrated illumination of oral cavity and pharynx
- ▶ **Light-guide for bulb.** Avoids dazzle



Kit includes: tongue-blade holder with	2,5V XHL	3,5V XHL
BETA battery handle	B-015.10.118	–
BETA4 USB rechargeable handle with USB cord and plug-in power supply	–	B-015.27.388

Tongue-blade holder with blade ejector for use with HEINE disposable tongue-blades

- ▶ **XHL xenon halogen technology.** Concentrated illumination of oral cavity and pharynx
- ▶ **Light-guide for bulb.** Avoids dazzle
- ▶ **Blade ejector.** Finger-tip pressure releases the used blade. No need to touch used blades
- ▶ **Only for HEINE disposable plastic tongue-blades.** Strong and hygienic



Kit includes: tongue-blade holder with	2,5V XHL	3,5V XHL
BETA battery handle	B-016.10.118	–
BETA4 USB rechargeable handle with USB cord and plug-in power supply	–	B-016.27.388

HEINE mini 3000® tongue-blade holder with blade ejector for HEINE disposable tongue-blades



- ▶ **Finger-tip pressure releases the used blade.** No need to touch the blade after use
- ▶ **XHL xenon halogen technology.** Concentrated illumination of oral cavity and pharynx
- ▶ **Only for HEINE disposable tongue-blades.** Durable and hygienic

Kit includes: mini 3000 tongue-blade holder with	2,5V XHL
mini 3000 battery handle* (with batteries), 5 disposable blades	D-001.74.118

*Available in black or blue. Please specify the colour you prefer when ordering.
If not otherwise specified, we will supply black instruments.

Further articles | accessories for HEINE tongue-blade holder



Tongue-blade holder head for wooden tongue-blades	2,5V XHL	3,5V XHL
without handle and accessories	B-001.12.302	B-002.12.302



Tongue-blade holder head for disposable tongue-blades	2,5V XHL	3,5V XHL
without handle and accessories	B-001.12.305	B-002.12.305



mini 3000 tongue-blade holder head	2,5V XHL	
without handle and accessories		D-001.74.100



XHL xenon halogen spare bulb	2,5V XHL	3,5V XHL
for tongue-blade holder	X-001.88.037	X-002.88.049
for mini 3000 tongue-blade holder	X-001.88.037	–



Replacement light-guide for tongue-blade holder	
light-guide for bulb	B-000.12.308



Disposable plastic tongue-blades	
pack of 100 disposable plastic tongue-blades	B-000.12.304

HEINE mini-c hand-held examination light | mini-e ear light



Robust, durable examination light in a compact pocket size.
Bright, concentrated light – with unique LED^{HQ}.

- ▶ **Safe examination of the eyes** due to tested photobiological safety
- ▶ **Comfortable and ergonomic**
- ▶ **Natural colours and virtually unlimited operating life of the LED^{HQ}**
- ▶ **Switches off automatically when placed in the pocket**
- ▶ **20,000 on/off cycles guaranteed**
- ▶ **Replaceable batteries** (size: AAA)



[01]



[02]

mini-c mini-e kits	LED
mini-c hand-held examination light incl. batteries [01]	D-008.73.109
mini-e ear light incl. batteries [02] for otoplasty. The ear light is used to ensure that hearing aids fit correctly.	D-008.73.103

HEINE mini 3000® clip lamp

Compact, long-life pocket diagnostic light



Sturdy, long-life pocket diagnostic light in a compact, modern design with chrome head. Bright, concentrated light thanks to unique XHL xenon halogen lens-bulb. Can only be used with the mini 3000 handle system. Handle available in black or blue.

- ▶ **Compact, oval, attractive light.** Lies ergonomically in the hand
- ▶ **2-piece handle and head.** Easy to maintain, flexible. Compatible with other mini 3000 instrument heads
- ▶ **Enhanced XHL xenon halogen lens-bulb with 100 % more light compared to conventional bulbs.** Bright, focused light
- ▶ **High-quality handle: Chrome-finish upper section / refined plastic.** Shockproof, sturdy, non-slip
- ▶ **Attachment clip with integrated on|off switch.** Secure. Switches off automatically when replaced in the pocket. 20,000 switch cycles guaranteed
- ▶ **Replaceable batteries.** (Size AA) or optional rechargeable battery with mini NT table charger*
- ▶ **Ear light for otoplasty [02].** The ear light is used to ensure that hearing aids fit correctly. See order information accessories on [page 27](#)



[01]

[02]

mini 3000 clip lamp with	2,5V XHL
mini 3000 battery handle (with batteries) [01]	D-001.73.131

- ▶ Available in black or blue. Please specify the colour you prefer when ordering. If not otherwise specified, we will supply black instruments.
- ▶ *To upgrade to a rechargeable instrument with mini NT table charger, please see [page 161](#).

HEINE mini 3000® combi lamp

Compact, all purpose illuminator with integrated tongue-blade holder



Sturdy, long-life pocket diagnostic light in a compact, modern design. Bright, concentrated light thanks to unique XHL xenon halogen lens-bulb.

Can only be used with the mini 3000 handle system. Available in black or blue.

- ▶ **Many applications.** Can be used as a general illuminator and as an illuminated tongue-blade holder for wooden blades and HEINE disposable blades
- ▶ **2-piece handle and head.** Easy to maintain, flexible. Compatible with other mini 3000 instrument heads
- ▶ **Enhanced XHL xenon halogen lens-bulb with 100 % more light compared with conventional bulbs.** Bright, focused light
- ▶ **High-quality handle: Chrome-finish upper section|refined plastic**
Shockproof, sturdy, non-slip
- ▶ **Attachment clip with integrated on|off switch.** Secure. Switches off automatically when replaced in the pocket. 20,000 switch cycles guaranteed
- ▶ **Replaceable batteries.** (Size AA), or optional rechargeable battery with mini NT table charger*

mini 3000 combi lamp with	2,5V XHL
mini 3000 battery handle (with batteries) and 5 disposable blades	D-001.76.120



- ▶ Available in black or blue. Please specify the colour you prefer when ordering. If not otherwise specified, we will supply black instruments.
- ▶ *To upgrade to a rechargeable instrument with mini NT table charger, please see [page 161](#).

Further articles | accessories for HEINE pocket diagnostic lights



mini 3000 clip lamp head	2,5V XHL
without handle and accessories	D-001.73.130



mini 3000 combi lamp head	2,5V XHL
without handle and accessories	D-001.76.101

Available in black or blue. Please specify the colour you prefer when ordering. If not otherwise specified, we will supply black instruments.



XHL xenon halogen spare bulb	2,5V XHL
for mini 3000 clip lamp and combi lamp	X-001.88.107



Ear light for mini 3000 clip lamp	
ear light, 6 pieces in blister pack	D-000.73.105



Disposable tongue-blades for mini 3000 combi lamp	
pack of 100 disposable tongue-blades	B-000.12.304

► For information on HEINE mini 3000 battery and rechargeable handles, see [pages 160-161](#).

HEINE veterinary ENT diagnostic instruments

Overview

It goes without saying that all of our special veterinary instruments are premium products. But, still, they differ in one or two details. Read on for a summary of what these different details are and all their benefits:



	G100 slit illumination head	BETA 200 VET F.O. otoscope
Housing construction	metal	
Magnification	1,6x	2,5x
Illumination	F.O. XHL or LED ^{HQ}	F.O. XHL or LED ^{HQ}
Instrument size	professional	
Handle options power sources	battery handle (XHL only), USB rechargeable handle, rechargeable handle with table charger, EN 200 EN 200-1	
Tips specula	long, closed specula, slit metal specula, open, short, closed specula, UniSpec VET disposable tips with adaptor	VET reusable specula
Pneumatic testing of tympanum mobility	–	insufflation port available
Catalogue page	29	31

HEINE G100 LED slit illumination head with LED illumination in HEINE Quality



Unimpaired working during the examination. Can be combined with different specula as attachments. Head with solid metal design and scratch-proof swivel lens, guaranteeing a long instrument life and high-quality patient assessments. Particularly bright illumination due to LED^{HQ} (no need to ever exchange the LED).

QUICK OVERVIEW

- ▶ Ideal for instrumentation with magnification and illumination due to slit head design
- ▶ 1.6x magnification
- ▶ Natural colour rendering
- ▶ Homogeneous exposure due to fiber-optic technology
- ▶ Particularly bright due to LED^{HQ}

EXTREME DURABILITY

- ▶ Solid metal housing
- ▶ Scratch-proof swivel lens
- ▶ Consistently good view over many years. No need to ever exchange the LED thanks to LED^{HQ}
- ▶ Specula fit securely due to double locking mechanism

INTUITIVE OPERABILITY

- ▶ Practical one-finger operation
- ▶ Always the ideal light intensity due to patented and continuous brightness control
- ▶ Safe, hygienic reprocessing

FLEXIBLE POWER SOURCE OPTIONS

- ▶ Rechargeable handle: with USB or table charger
- ▶ Full functionality of the G100 LED slit illumination head is guaranteed with the current BETA rechargeable handles and the EN 200 | EN 200-1 wall transformers
- ▶ Practical and expandable with other HEINE instrument heads
- ▶ **Also available with XHL xenon halogen illumination**
Bright illumination and authentic colour rendering; for other technical specifications see G100 LED F.O. slit illumination head

HEINE G100 slit illumination head

Diagnostic sets | kits

Set includes: G100 slit illumination head,

1 set long, closed specula (57 mm x 4 mm Ø, 65 mm x 6 mm Ø, 90 mm x 7 mm Ø),
1 spare bulb for XHL version, hard case



[01]

	2,5V XHL	3,5V XHL	LED
BETA battery handle [01]	G-112.10.118	-	-
BETA4 USB rechargeable handle with USB cord and plug-in power supply	-	G-112.27.388	G-112.28.388
BETA4 NT rechargeable handle with NT4 table charger	-	G-112.23.420	G-112.24.420



[02]

Kit includes: G100 slit illumination head with	LED
BETA4 USB rechargeable handle with USB cord and plug-in power supply [02]	G-010.28.388
BETA4 NT rechargeable handle with NT4 table charger	G-010.24.420

- ▶ For information on our combined diagnostic sets and kits see [pages 74-78](#).
- ▶ For information on HEINE battery and rechargeable handles and the EN 200 wall transformer, see [pages 150-160](#).

HEINE BETA® 200 LED VET F.O. otoscope

Our best otoscope for veterinary medicine with LED^{HQ}



The ideal instrument for examining disorders of the ear canal in animals. Exceptional durability combined with optimum magnification. Particularly bright illumination due to LED^{HQ}. HEINE BETA VET otoscopes are the result of ongoing optimisation and further development down to the smallest detail – where we leave nothing to chance.

QUICK OVERVIEW

- ▶ Very good spatial representation due to glass lenses developed specifically for veterinary medicine
- ▶ 2.5x magnification
- ▶ Natural colour rendering
- ▶ Even and reflex-free illumination due to fiber-optic technology
- ▶ Particularly bright due to LED^{HQ}

EXTREME DURABILITY

- ▶ Solid metal housing
- ▶ Scratch-proof, large viewing window
- ▶ Consistently good view over many years. No need to ever exchange the LED thanks to LED^{HQ}

INTUITIVE OPERABILITY

- ▶ Practical one-finger operation
- ▶ Always the ideal light intensity due to patented and continuous brightness control
- ▶ Easy instrumentation due to fixed, swivelling viewing window
- ▶ Safe, hygienic reprocessing
- ▶ Pneumatic eardrum testing by means of an integrated insufflation port

FLEXIBLE POWER SOURCE OPTIONS

- ▶ Rechargeable handle: with USB or table charger
- ▶ Full functionality of the BETA 200 LED VET is guaranteed with the current BETA rechargeable handles and the EN 200 | EN 200-1 wall transformers
- ▶ Practical and expandable with other HEINE instrument heads
- ▶ **Also available with XHL xenon halogen illumination.**
Bright illumination and authentic colour rendering; for other technical specifications see BETA 200 LED VET F.O. otoscope

HEINE BETA® 200 VET Diagnostic kits



Kit includes: HEINE BETA 200 VET F.O. otoscope with

	2,5V XHL	LED
BETA battery handle	G-011.10.118	-
BETA4 USB rechargeable handle with USB cord and plug-in power supply [01]	-	G-011.28.388
BETA4 NT rechargeable handle with NT4 table charger	-	G-011.24.420

Long, closed metal specula



- ▶ **Metal construction, chrome-plated.** Easy to clean, disinfect and sterilize
- ▶ **Double bayonet lock for specula.** Firm mounting of specula to head

Closed specula for G100|G100 LED slit illumination head

57 mm long, Ø 4 mm [01]	G-000.21.330
65 mm long, Ø 6 mm	G-000.21.331
90 mm long, Ø 7 mm	G-000.21.332
170 mm long, Ø 10 mm [02]	G-000.21.350

Slit, open metal specula

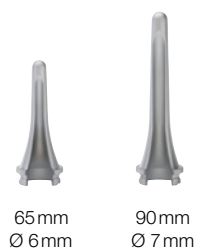

- ▶ **High-quality chrome-plated metal construction.** Easy to clean, disinfect and sterilize
- ▶ **Matte internal surfaces.** Reduced reflexes
- ▶ **60° opening with rounded edges.** Ideal for instrumentation, atraumatic insertion
- ▶ **Double bayonet fitting.** Positive fit

Slit metal specula for G100|G100 LED slit illumination head

65 mm long, Ø 6 mm	G-000.21.341
90 mm long, Ø 7 mm	G-000.21.342

Short, closed specula

- ▶ **Made of high-density SANALON S with a smooth external surface**
Dust and germs are easily removed. Common germicides can be used
Autoclavable at up to 134 °C
- ▶ **Ergonomic shape.** Painless atraumatic insertion
- ▶ **Matte internal surfaces.** Reduced reflexes
- ▶ **Integral metal ring with 2 bayonet locks.** Firm mounting of specula
to head

Short, closed SANALON S specula for G100|G100 LED slit illumination head and BETA 100 VET* otoscope



[01] Ø 2,2mm [02] Ø 5,5mm

1 set = 5 veterinary specula in SANALON S	G-000.21.316
40mm long, Ø 2.2mm [01]	G-000.21.310
40mm long, Ø 2.8mm	G-000.21.311
40mm long, Ø 3.5mm	G-000.21.312
40mm long, Ø 4.5mm	G-000.21.313
40mm long, Ø 5.5mm [02]	G-000.21.314

*Instrument no longer available.

HEINE reusable VET specula

A VET adaptor [03] is required for use on the BETA 100 VET*.

- ▶ **Made of high-density SANALON S with a smooth external surface**
Dust and germs are easily removed. Common germicides can be used
Autoclavable at up to 134 °C
- ▶ **Ergonomic shape.** Painless atraumatic insertion
- ▶ **Convenient fixation system.** Positive fit to otoscope head
- ▶ **Double bayonet fitting.** Positive fit



[01] Ø 4mm [02] Ø 9mm



[03]

Reusable SANALON S specula for BETA 200 VET|BETA 100 VET*

1 set = 3 reusable SANALON S specula	G-000.21.213
61 mm long, Ø 4 mm [01]	G-000.21.210
61 mm long, Ø 6 mm	G-000.21.211
61 mm long, Ø 9 mm [02]	G-000.21.212
Adaptor for reusable SANALON S VET specula [03]	G-000.21.214

HEINE UniSpec disposable specula



Ø 2,5mm



[04]



[05]

The adaptor illustrated [04] is necessary when using UniSpec specula with the G100|G100 LED slit illumination head.

- ▶ **No cleaning necessary.** Saves time
- ▶ **Hygienic and safe.** Eliminates cross-infection
- ▶ **Packed in units of 1,000.** Assures a competitive price
- ▶ **Original HEINE design and manufacture.** Guaranteed good fit to the instrument head

UniSpec disposable specula for BETA 100 VET*, operating otoscope* and G100|G100 LED slit illumination head

Pack of 1,000 UniSpec disposable specula Ø 2.5mm	B-000.11.242
Pack of 1,000 UniSpec disposable specula Ø 4 mm	B-000.11.241
Adaptor for use with slit illumination head [04]	G-000.21.302
UniSpec tip dispenser [05]	B-000.11.146

*Instrument no longer available.

⊗: Single use only.

Further articles | accessories for veterinary ENT diagnostic instruments

Reusable specula for operating otoscope*



1 set = 5 ear specula and 1 nose speculum	B-000.11.221
3 ear speculum Ø 3.5 4.5 5.5mm	B-000.11.222
ear speculum Ø 2.2mm [01]	B-000.11.215
ear speculum Ø 2.8mm	B-000.11.216
ear speculum Ø 3.5mm	B-000.11.217
ear speculum Ø 4.5mm	B-000.11.218
ear speculum Ø 5.5mm	B-000.11.219
nose speculum Ø 10mm [02]	B-000.11.220

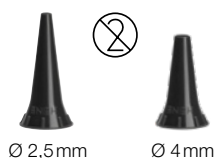

AllSpec disposable tips made of recycled plastic for BETA 100 VET* and operating otoscope*



pack of 1,000 pcs. Ø 2.5mm [03]	B-000.11.128
pack of 1,000 pcs. Ø 4mm	B-000.11.127
case of 10 packs of 1,000 pcs, Ø 2.5mm (infants)	B-000.11.138
case of 10 packs of 1,000 pcs, Ø 4mm (adults)	B-000.11.137
dispenser pack, single, of 250 tips, Ø 2.5mm [04]	B-000.11.153
dispenser pack, single, of 250 tips, Ø 4mm	B-000.11.152
case of 10 dispenser packs of 250 tips, Ø 2.5mm	B-000.11.151
case of 10 dispenser packs of 250 tips, Ø 4mm	B-000.11.150
adaptor for AllSpec tips [05]	B-000.11.306
AllSpec tip-dispenser (2x 50 tips) [06]	B-000.11.149

*Instrument no longer available.

⊗: Single use only.

Further articles | accessories for veterinary ENT diagnostic instruments



G100 slit illumination head	2,5V XHL	3,5V XHL	LED
with swivel lens, without handle	G-001.21.301	G-002.21.301	G-008.21.301



BETA 200 VET F.O. otoscope head	2,5V XHL	3,5V XHL	LED
without handle, without accessories	G-001.21.250	G-002.21.250	G-008.21.250



XHL xenon halogen spare bulb	2,5V XHL	3,5V XHL
for G100 and BETA 200 VET	X-001.88.077	X-002.88.078
for operating otoscope* and BETA 100 VET*	X-001.88.037	X-002.88.049



Swivel lens for G100 slit illumination head	
swivel lens, single	G-000.21.209



Insufflation bulb for pneumatic testing	
insufflation bulb for BETA 200 VET and BETA 100 VET* otoscopes	B-000.11.240

*Instrument no longer available.

**| Helping the
| human eye.**

HEINE direct ophthalmoscopes

Overview

It goes without saying that all of our ophthalmoscopes are premium products. But, still, they differ in one or two details. Read on for a summary of what these different details are and all their benefits:



	BETA 200S	BETA 200	K180 Opt. 1	K180 Opt. 2	mini 3000
Optical system	aspherical		conventional		
Illumination	XHL or LED ^{HQ}	XHL or LED ^{HQ}	XHL		XHL or LED ^{HQ}
Apertures					
Corrective lenses	- 36 to +38D, 74 single diopter steps, 28 lenses	- 35 to +40D, 27 diopter steps, 27 lenses			- 20 to +20D, 18 diopter steps, 18 lenses
Dust protection	dustproof		dust protected		
Frame system made of	aluminium		plastic		
Instrument size	professional				compact
Handle options power sources	battery handle (XHL only), USB rechargeable handle, rechargeable handle with table charger, EN 200 EN 200-1				battery handle, rechargeable handle with table charger
Catalogue page	42	44	46		48

The „Aspherical Optical System“ (AOS) from HEINE

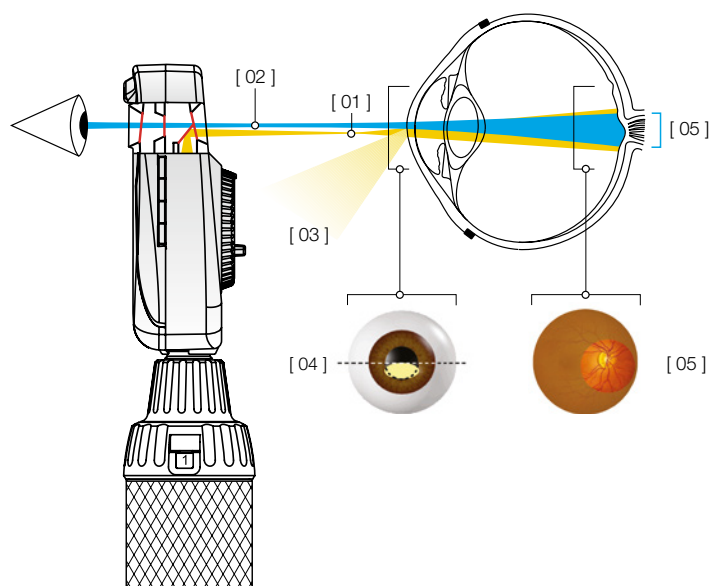

„Aspherical Optical System“ (AOS) exclusively from HEINE eliminates corneal and iris reflexes to provide large, crisp and glare-free fundus images.

- ▶ Flat, elliptical illumination beam produced by HEINE's aspherical optical system [01]
- ▶ Observation path [02]
- ▶ Redirected iris and corneal reflexes [03]
- ▶ The elliptical light beam enters through the lower half of the cornea. The illumination beam has been separated from the observation beam (Gullstrand-Principle). All reflexes are diverted away from the observation beam due to the curvature of the reflective cornea. Due to the flat, compressed form of the light beam, a maximum amount of light enters through the pupil [04]
- ▶ Once past the anterior chamber, the light beam opens up dramatically to illuminate a large area of the retina [05]



HEINE AOS film

HEINE BETA® 200S LED ophthalmoscope with outstanding durability, perfect for small pupils



Accurate diagnosis at first glance. Direct ophthalmoscope with special optical system that provides a particularly clear and bright image of the fundus. Sturdy and handy – ideal for mobile use. 7 different apertures – always the right setting for different examination situations. Particularly bright and dimmable due to LED^{HQ} with virtually unlimited working life – no need to ever exchange the LED.

RELIABLE DIAGNOSIS

- ▶ Clear, bright and non-reflective image due to AOS (Aspherical Optical System)
- ▶ No light reflections, since the illumination beam and the observation path are separate
- ▶ The instrument head fits precisely to the eye socket, blocking out ambient light
- ▶ Very good refractive compensation due to 74 single step design on the non-continuous lens wheel (- 36 to + 38 D)
- ▶ This prevents extreme jumps from one dioptre to another
- ▶ Can be used for both dilated and non-dilated or particularly small pupils due to the pinhole aperture
- ▶ 7 different apertures – can also be used with red-free filter

OPTIMUM ILLUMINATION

- ▶ Patented and exclusive continuous dimmability between 3 and 100 %
- ▶ No stray light thanks to the recessed, multi-coated viewing window
- ▶ Helpful when examining cloudy lenses, as LED^{HQ} provides particularly bright illumination

EXCEPTIONAL DURABILITY

- ▶ Maintenance-free use due to dustproof design
- ▶ Impact-resistant due to a cast aluminium frame that the optical components are embedded in
- ▶ No need to ever exchange the LED thanks to LED^{HQ}
- ▶ 5-year guarantee

EASY TO USE

- ▶ Instrument can be operated with one hand
- ▶ Flexibility during the examination due to the ergonomic design

FLEXIBLE POWER SOURCE OPTIONS

- ▶ Rechargeable battery: with USB or table charger
- ▶ Full functionality of the BETA 200S LED is guaranteed with the current BETA rechargeable handles and the EN 200 | EN 200-1 wall transformers

▶ Also available with XHL xenon halogen illumination

Bright illumination and authentic colour rendering; for other technical specifications see BETA 200S LED ophthalmoscope

BETA 200S with 7 apertures



Cobalt blue filter, fixation star with polar coordinates, large spot, small spot, pinhole, slit, hemispherical



With red-free filter

HEINE BETA® 200S ophthalmoscope

Diagnostic sets|kits

Set includes: BETA 200S ophthalmoscope,
1 spare bulb for XHL version, hard case



[01]

	2.5V XHL	3.5V XHL	LED
BETA battery handle [01]	C-261.10.118	–	–
BETA4 USB rechargeable handle with USB cord and plug-in power supply	–	–	C-261.28.388
BETA4 NT rechargeable handle with NT4 table charger	–	C-261.23.420	C-261.24.420



[02]

BETA 200S ophthalmoscope with

	LED
BETA4 USB rechargeable handle with USB cord and plug-in power supply [02]	C-010.28.388

Set includes: BETA 200S ophthalmoscope and BETA 200 LED streak retinoscope, hard case, spare bulb for BETA 200S XHL ophthalmoscope



[03]

	2.5V XHL LED*	3.5V LED
BETA battery handle [03]	C-262.10.118	–
BETA4 USB rechargeable handle with USB cord and plug-in power supply	–	C-262.28.388
BETA4 NT rechargeable handle with NT4 table charger	–	C-262.24.420

*BETA 200S ophthalmoscope with XHL illumination and BETA 200 LED streak retinoscope with LED illumination

- ▶ For further information on the HEINE BETA 200 retinoscope, please see [page 51](#).
- ▶ You can find information on our combined diagnostic sets and kits on [pages 74 to 78](#).
- ▶ For information on HEINE battery and rechargeable handles and the EN 200 wall transformer, see [pages 150-160](#).

HEINE BETA® 200 LED ophthalmoscope with outstanding durability



Accurate diagnosis at first glance. Direct ophthalmoscope with special optical system that provides a particularly clear and bright image of the fundus. Sturdy and handy – ideal for mobile use. 6 different apertures – always the right setting for different examination situations. Particularly bright and dimmable due to LED^{HQ} with virtually unlimited working life – no need to ever exchange the LED.

RELIABLE DIAGNOSIS

- ▶ Clear, bright and non-reflective image due to AOS (Aspherical Optical System)
- ▶ No light reflections, since the illumination beam and the observation path are separate
- ▶ The instrument head fits precisely to the eye socket, blocking out ambient light
- ▶ Good refractive compensation due to 27 single step design on the non-continuous lens wheel (- 35 to + 40 D)
- ▶ 6 different apertures – can also be used with red-free filter

OPTIMUM ILLUMINATION

- ▶ Patented and exclusive continuous dimmability between 3 and 100 %
- ▶ No stray light thanks to the recessed, multi-coated viewing window
- ▶ Particularly bright due to LED^{HQ}

EXCEPTIONAL DURABILITY

- ▶ Maintenance-free use due to dustproof design
- ▶ Impact-resistant due to a cast aluminium frame that the optical components are embedded in
- ▶ No need to ever exchange the LED thanks to LED^{HQ}
- ▶ 5-year guarantee

BETA 200 with 6 apertures



Slit, fixation star with polar coordinates, cobalt blue filter, large spot, small spot, hemispherical spot



With red-free filter

EASY TO USE

- ▶ Instrument can be easily operated with one hand
- ▶ Flexibility during the examination due to the ergonomic design

FLEXIBLE POWER SOURCE OPTIONS

- ▶ Rechargeable battery: with USB or table charger
- ▶ Full functionality of the BETA 200 LED is guaranteed with the current BETA rechargeable handles and the EN 200 | EN 200-1 wall transformers

▶ Also available with XHL xenon halogen illumination

Bright illumination and authentic colour rendering; for other technical specifications see BETA 200 LED ophthalmoscope

HEINE BETA® 200 ophthalmoscope

Diagnostic sets|kits

Set includes: BETA 200 ophthalmoscope,
1 spare bulb for XHL version, hard case



[01]

	2.5V XHL	3.5V XHL	LED
BETA battery handle [01]	C-144.10.118*	-	-
BETA4 USB rechargeable handle with USB cord and plug-in power supply	-	C-144.27.388	C-144.28.388
BETA4 NT rechargeable handle with NT4 table charger	-	C-144.23.420	C-144.24.420

* Also available with large battery handle X-001.99.120 (doesn't fit into hard cases). Please specify with your order



[02]

Kit includes: BETA 200 ophthalmoscope with

	2.5V XHL	LED
BETA battery handle [02]	C-011.10.118	-
BETA4 USB rechargeable handle with USB cord and plug-in power supply	-	C-011.28.388

Set includes: BETA 200 ophthalmoscope and BETA 200 LED streak retinoscope, hard case, spare bulb for BETA 200 XHL ophthalmoscope



[03]

	2.5V XHL LED**	3.5V LED
BETA battery handle [04]	C-145.10.118	-
BETA4 USB rechargeable handle with USB cord and plug-in power supply	-	C-145.28.388
BETA4 NT rechargeable handle with NT4 table charger	-	C-145.24.420

** BETA 200 ophthalmoscope with XHL illumination and BETA 200 LED streak retinoscope with LED illumination

- ▶ For further information on the HEINE BETA 200 LED retinoscope, please see [page 51](#).
- ▶ You can find information on our combined diagnostic sets and kits on [pages 74 to 78](#).
- ▶ For information on HEINE battery and rechargeable handles and the EN 200 wall transformer, see [pages 150-160](#).

HEINE K180 ophthalmoscope

Standard instrument for a smaller budget



Sturdy ophthalmoscope with XHL (xenon halogen illumination) and low-reflection optics for reliable diagnosis. Bright, white light, for a clear image of the fundus. High functionality and good value for money.

RELIABLE DIAGNOSIS

- ▶ Low-reflection view due to spherical precision optics
- ▶ Ambient light is blocked out thanks to the instrument head's precise fit to the eye socket
- ▶ Good refractive compensation due to 27 single step design on the non-continuous lens wheel (- 35 to + 40 D)
- ▶ 5 different apertures in 2 variants

EXCELLENT ILLUMINATION

- ▶ Can be used for both dilated and non-dilated pupils
- ▶ Xenon halogen illumination XHL

HIGH DURABILITY

- ▶ Dustproof, sturdy polycarbonate housing
- ▶ 5-year guarantee

FLEXIBLE POWER SOURCE OPTIONS

- ▶ Rechargeable battery: with USB or table charger
- ▶ EN 200 | EN 200-1 wall transformer
- ▶ Replaceable batteries



Aperture wheel 1

slit, red-free filter, fixation star with polar coordinates, large spot, small spot



Aperture wheel 2

slit, red-free filter, cobalt blue filter, large spot, small spot

HEINE K180 ophthalmoscope

Diagnostic sets|kits

Set includes: K180 ophthalmoscope with aperture wheel 1, soft pouch



[01]

	2.5V XHL	3.5V XHL
BETA battery handle [01]	C-182.10.118	-
BETA4 USB rechargeable handle with USB cord and plug-in power supply	-	C-182.27.388

Set includes: K180 ophthalmoscope with aperture wheel 2, soft pouch



[02]

	2.5V XHL	3.5V XHL
BETA battery handle [02]	C-183.10.118	-
BETA4 USB rechargeable handle with USB cord and plug-in power supply	-	C-183.27.388

- ▶ You can find information on our combined diagnostic sets and kits on [pages 74 to 78.](#)
- ▶ For information on HEINE battery and rechargeable handles and the EN 200 wall transformer, see [pages 150-160.](#)

HEINE mini 3000® LED ophthalmoscope

Maximum quality with minimum dimensions



Fixation star, large spot,
small spot,
hemispherical spot, red-free filter

Modern pocket ophthalmoscope with LED^{HQ}. Concentrated, bright light for optimum illumination, a brilliant image and authentic colour rendering. Fixation star aperture with grey filter to reduce light intensity. Excellent optics and outstanding colour rendering with the smallest dimensions – perfect for when you're out and about and on your rounds. Can be combined with the mini 3000 handle system. Available in black or blue.

RELIABLE DIAGNOSIS

- ▶ Simple examination process possible without pupil dilation
- ▶ Clear, high-resolution image with minimal reflections
- ▶ 18 lenses ranging from - 20 to + 20 D prevent higher refractive errors
- ▶ Fixation star including grey filter for patients who are sensitive to light
- ▶ 5 different apertures

INTUITIVE OPERABILITY

- ▶ Switches off automatically as soon as it is clipped to the pocket
- ▶ Practical one-finger operation
- ▶ Handle and head are in 2 parts – for easy servicing and expandability

FLEXIBLE POWER SOURCE OPTIONS

- ▶ Rechargeable battery with mini NT table charger
- ▶ Replaceable batteries

▶ Also available with XHL xenon halogen illumination.

Bright illumination and authentic colour rendering; for other technical specifications see mini 3000 LED ophthalmoscope

HEINE mini 3000® LED ophthalmoscope

Diagnostic sets|kits



[01]

Set includes: mini 3000 ophthalmoscope, hard case

	2.5V XHL	2.5V LED
mini 3000 battery handle (with batteries) [01]	D-852.10.021	D-885.21.021



[02]

Kit includes: mini 3000 ophthalmoscope with

	2.5V XHL	2.5V LED
mini 3000 battery handle (with batteries) [02]	D-001.71.120	D-008.71.120
mini 3000 rechargeable handle (please order mini NT table charger separately)	-	D-008.71.200



- ▶ You can find information on our combined diagnostic sets and kits on [pages 74 to 78](#).
- ▶ Available in black or blue. Please specify the colour you prefer when ordering. If not otherwise specified, we will supply black instruments.
- ▶ To upgrade to a rechargeable instrument with mini NT table charger, please see [page 161](#).

HEINE ophthalmoscopes

Further articles | accessories



BETA 200S ophthalmoscope head	2.5V XHL	3.5V XHL	LED
without handle and accessories	C-001.30.120	C-002.30.120	C-008.30.120



BETA 200 ophthalmoscope head	2.5V XHL	3.5V XHL	LED
without handle and accessories	C-001.30.100	C-002.30.100	C-008.30.100



K180 ophthalmoscope head	2.5V XHL	3.5V XHL
with aperture wheel 1, without handle accessories	C-001.30.206	C-002.30.206
with aperture wheel 2, without handle accessories	C-001.30.207	C-002.30.207



mini 3000 ophthalmoscope head	2.5V XHL	2.5V LED
without handle and accessories*	D-001.71.105	D-008.71.105

* Available in black and blue. Please specify the colour you prefer when ordering. If not otherwise specified, we will supply black instruments.



XHL xenon halogen spare bulb	2.5V XHL	3.5V XHL
for BETA 200S, BETA 200 and for BETA 200 M2	X-001.88.069	X-002.88.070
for K180	X-001.88.084	X-002.88.086
for mini 3000	X-001.88.106	-

► For information on HEINE battery and rechargeable handles and the EN 200 wall transformer, see [pages 150-160](#).

HEINE BETA® 200 LED retinoscope with HEINE ParaStop®

Quick and easy observation of the fundus reflex



Hand-held retinoscope for objective refraction with totally even LED^{HQ} illumination for a precise streak. Enables quick and easy recognition of the fundus reflex.

RELIABLE DIAGNOSIS

- ▶ Reliable measurement of the eye's refraction
- ▶ Precise adjustment of the parallel beam path due to ParaStop
- ▶ Very bright and clearly visible fundus reflex due to a very bright, precise streak with a line width of typically 1.1 mm (ISO 12865 standard < 1.5 mm) and a line length of 35 mm
- ▶ Particularly bright and even light due to LED^{HQ}
- ▶ Patented and exclusive continuous dimmability between 3 and 100 %
- ▶ Polarisation filter eliminates stray light and internal reflections
- ▶ Minimised light leaks due to good eye socket coverage

ENHANCED DURABILITY

- ▶ Exceptional durability due to metal controls
- ▶ Maintenance-free and dustproof
- ▶ LED^{HQ} with virtually unlimited working life
- ▶ 5-year guarantee

INTUITIVE OPERABILITY

- ▶ Practical one-finger operation
- ▶ Convenient thumb operation with a single control for vergence and line rotation
- ▶ Holder for fixation cards for dynamic retinoscopy (optional)

FLEXIBLE POWER SOURCE OPTIONS

- ▶ Rechargeable battery: with USB or table charger
- ▶ Full functionality of the BETA 200 LED is guaranteed with the current BETA rechargeable handles and the EN 200 | EN 200-1 wall transformers

HEINE BETA® 200 LED retinoscope

Diagnostic sets | kits



[01]



[02]

Set includes: BETA 200 LED streak retinoscope, hard case

	2.5V LED	3.5V LED
BETA battery handle	C-034.10.118*	-
BETA4 USB rechargeable handle with USB cord and plug-in power supply [01]	-	C-034.28.388
BETA4 NT rechargeable handle with NT4 table charger	-	C-034.24.420

*Also available with large battery handle X-001.99.120 (doesn't fit into hard cases). Please specify with your order

Kit includes: BETA 200 LED streak retinoscope

	2.5V LED	3.5V LED
BETA battery handle	C-014.10.118	-
BETA4 USB rechargeable handle with USB cord and plug-in power supply [02]	-	C-014.28.388

Set includes: BETA 200S ophthalmoscope and BETA 200 LED streak retinoscope, hard case, spare bulb for BETA 200S XHL ophthalmoscope



[03]

	2.5V XHL LED**	3.5V LED
BETA battery handle [03]	C-262.10.118	-
BETA4 USB rechargeable handle with USB cord and plug-in power supply	-	C-262.28.388
BETA4 NT rechargeable handle with NT4 table charger	-	C-262.24.420

Set includes: BETA 200 ophthalmoscope and BETA 200 LED streak retinoscope, hard case, spare bulb for BETA 200 XHL ophthalmoscope



[04]

	2.5V XHL LED**	3.5V LED
BETA battery handle [04]	C-145.10.118	-
BETA4 USB rechargeable handle with USB cord and plug-in power supply	-	C-145.28.388
BETA4 NT rechargeable handle with NT4 table charger	-	C-145.24.420

**BETA 200S | BETA 200 ophthalmoscope with XHL illumination and BETA 200 LED streak retinoscope with LED illumination

HEINE HSL 150 hand-held slit lamp

The lightest slit lamp of its kind



Portable hand-held slit lamp for examining the anterior segment of the eye. Compact and lightweight – ideal for situations in which a conventional slit lamp is not available or is impractical. For human and veterinary medicine.

RELIABLE DIAGNOSIS

- ▶ Continuously variable gap size from 0.2 mm x 10 mm to 4 mm x 14 mm
- ▶ Detailed view due to 6x magnification
- ▶ Switchable blue interference filter (FITC) for examining the cornea
- ▶ Optimum light transmission due to multi-coated optics
- ▶ Precise view due to particularly bright, white light – comparable to the light intensity of a classic slit lamp
- ▶ Xenon halogen illumination XHL

LIGHTWEIGHT AND PORTABLE

- ▶ The head weighs only approx. 70 g
- ▶ Ideal for home visits and flexible use

FLEXIBLE POWER SOURCE OPTIONS

- ▶ Rechargeable battery with table charger
- ▶ Replaceable batteries



[01]

Set includes: HSL 150 hand-held slit lamp, soft pouch

	2.5V XHL
BETA SLIM battery handle [01]	C-252.10.105



[02]

Set includes: HSL 150 hand-held slit lamp, spare bulb, hard case

	3.5V XHL
BETA4 SLIM NT rechargeable handle and NT4 table charger* [02]	C-266.20.471

*NT4 table charger incl. reducer insert

- ▶ For information on HEINE battery and rechargeable handles and the EN 200 wall transformer, see [pages 150-160](#).

HEINE LAMBDA 100 retinometer

A precision instrument for looking into the future



High diagnostic reliability and easy handling. The LAMBDA 100 retinometer is the first compact instrument for determining a patient's potential visual acuity after surgery to treat cataracts or other opacities.

SIMPLE AND SAFE DIAGNOSIS

- ▶ Glare-free examination due to brightness control
- ▶ Easy examination due to clear controls
- ▶ Three steps to determine potential visual acuity:
 - ▷ Switch on the instrument, select the visual acuity level, set the line pattern, and darken the room
 - ▷ Rest the retinometer against the patient's forehead. Search for a gap in the cloudy media by moving the red dots of light until the patient recognises the line pattern
 - ▷ Make the lines finer and finer – by changing the orientation – until the patient can no longer distinguish between them. The last value the patient recognises is their potential visual acuity
- ▶ Xenon halogen illumination XHL
- ▶ Available in two configurations: Kit 1 with 20 | 300 to 20 | 25 fraction scale (scale 2), Kit 2 with 0.06 to 0.8 decimal scale (scale 1)

LIGHTWEIGHT AND PORTABLE

- ▶ Compact dimensions
- ▶ Flexible use – also for bedridden patients, for example

PRACTICAL CHARGING OPTION

- ▶ USB rechargeable handle with USB 2.0 cord and plug-in power supply

Kit includes: Kit enthält: LAMBDA 100 retinometer,

1 patient card, BETA4 USB rechargeable handle with USB cord and plug-in power supply, spare bulb



	3.5V XHL
kit 1: acuity scale 20 300 to 20 25 (scale 2)	C-037.27.388
kit 2: decimal scale 0.06 to 0.8 (scale 1)	C-038.27.388

HEINE ophthalmic examination lamp

For examination of the anterior segment and cornea in focal light



- ▶ **Small and light.** Ideal for house calls and rounds
- ▶ **5 different apertures.** Helps detect erosion, edema and foreign bodies on the cornea
- ▶ **Apertures focused at 100 mm working distance**

Kit includes: ophthalmic examination lamp with

	3.5V XHL
BETA4 USB rechargeable handle with USB cord and plug-in power supply [01]	C-018.27.388



Slit, three different spots, cobalt blue filter for fluorescence examination



[01]

- ▶ For information on HEINE battery and rechargeable handles and the EN 200 wall transformer, see [pages 150-160](#).

HEINE Finoff transilluminator For scleral transillumination



Detachable cobalt blue filter, suitable for fluorescence examinations.
Finoff transilluminator for scleral transillumination with

	LED
BETA4 USB rechargeable handle with USB cord and plug-in power supply [01]	C-019.27.388
BETA4 NT rechargeable handle (without NT4 table charger)	C-019.23.396



[01]

Further articles | accessories

HEINE ophthalmic instruments



[01]

BETA 200 LED retinoscope head	2.5V LED	3.5V LED
without handle [01]	C-001.15.353	C-008.15.353

Fixation cards for BETA 200 LED retinoscope

fixation cards with holder for dynamic retinoscopy, without instrument [02]

C-000.15.360



[02]

LED module	2.5V LED	3.5V LED
for BETA 200 retinoscope [03]	X-028.88.130	X-008.88.131



[03]

HSL 150 hand-held slit lamp head

without handle [04]

C-001.14.602

C-002.14.602



[04]

HSL 10 x loupe attachment for HSL 150

loupe attachment with 10x magnification, without instrument [05]

C-000.14.606



[05]

XHL xenon halogen spare bulb	2.5V XHL	3.5V XHL
for HSL 150 hand-held slit lamp [06]	X-001.88.098	X-002.88.099



[06]

► For information on HEINE battery and rechargeable handles and the EN 200 wall transformer, see [pages 150-160](#).

Further articles | accessories

HEINE ophthalmic instruments



[01]

LAMBDA 100 retinometer head	2.5V XHL	3.5V XHL
with acuity scale 20 300 to 20 25 (scale 2), without handle [01]	C-001.35.015	C-002.35.015
with decimal scale 0.06 to 0.8 (scale 1), without handle	C-001.35.010	C-002.35.010



[02]

Patient card for LAMBDA 100 retinometer	
patient card [02]	C-000.35.005



[03]

XHL xenon halogen spare bulb	2.5V XHL	3.5V XHL
for LAMBDA 100 retinometer [03]	X-001.88.077	X-002.88.078



[04]

Ophthalmic examination lamp head	2.5V XHL	3.5V XHL
without handle [04]	C-001.14.400	C-002.14.400



[05]

XHL xenon halogen spare bulb	2.5V XHL	3.5V XHL
for ophthalmic examination lamp [05]	X-001.88.032	X-002.88.047



[06]

Finoff transilluminator head	LED
Finoff for scleral transillumination, without handle [06]	C-002.17.080

Aperture for Finoff transilluminator	
aperture with cobalt blue filter for Finoff transilluminator	C-000.17.081

► For information on HEINE battery and rechargeable handles and the EN 200 wall transformer, see [pages 150-160](#).

HEINE indirect ophthalmoscopes

Overview

It goes without saying that all of our indirect ophthalmoscopes are premium products. But, still, they differ in one or two details. Read on for a summary of what these different details are and all their benefits:



	OMEGA 600	OMEGA 500	SIGMA 250	SIGMA 250 M2
Convergence and parallax adjustment	synchronized		separate	
Apertures				
Integrated filters			red-free filter is integrated in aperture row	
Illumination	LED ^{HO}			
Wearing options	headband		S-FRAME spectacle frame	
Further articles	teaching mirror, fundus charts		teaching mirror, blue filter and yellow filter, diffusor, fundus charts	
Product variants	–	with integrated camera	–	
Brightness control	on the instrument; visionBOOST	on the instrument	on the power source	
Mobile power supply operating time	rechargeable battery integrates into the headband typ. 8 hours	headband-mounted battery mPack UNPLUGGED typ. 7 hours, mPack typ. 13 hours	mPack mini typ. 11 hours	
Stationary power supply	CW1 wall charger, CC1 charging case, E4-USBC power supply	EN 50 table- or wall transformer, plug-in transformer	–	
Catalogue page	60	62	64	

HEINE OMEGA® 600 binocular indirect ophthalmoscope

Discover more. With less weight



Red-free, yellow and cobalt blue filter



Diffuser HEINE, small spot, medium and large



[HEINE OMEGA 600 operation film](#)

THE LIGHTEST HIGH-END INDIRECT OPHTHALMOSCOPE WORLDWIDE

- ▶ Best wearing comfort
- ▶ Personalized fit
 - ▷ Ergonomic positioning of controls and levers
 - ▷ Adaptable for right and left handed users
 - ▷ Flip-up optics unit

MOST PRECISE DIAGNOSTIC, UP TO THE FAR RETINAL PERIPHERY

- ▶ Significantly better diagnostics due to unique visionBOOST – even in dense cataracts
- ▶ Sharpest fundus image due to superior glass optics
- ▶ Brightest fundus image with true colour rendering thanks to our unique LED^{HQ} – now in even more natural colours
- ▶ Best 3D imaging due to our unique stereoscopic adjustment technology
 - ▷ in dilated and undilated pupils
 - ▷ even with prematures and newborns

LONG-LASTING INVESTMENT DUE TO ITS ROBUST DESIGN

- ▶ Maintenance-free, dustproof optics
- ▶ Legendary HEINE durability
- ▶ 5-year guarantee

EASY AND EFFECTIVE DISINFECTION THANKS TO SMOOTHSURFACE

- ▶ No openings
- ▶ Integrated electronics



Flip-up function of the optics unit

For more convenient patient interactions



Eyepieces

To best accommodate your view, exchange the initially mounted eyepieces +2 D with the neutral lenses 0 D (supplied with the instrument)



Width adjustment

HEINE OMEGA® 600

Sets | kits

	OMEGA 600 sets	LED
 [01]	OMEGA 600 wall charger set: indirect ophthalmoscope (with battery and +2 D eyepiece) [01], E4-USBC [02], eyepiece 0 D*, CW1 wall charger [03]	C-008.33.612
 [02]	OMEGA 600 traveller set: indirect ophthalmoscope (with battery and +2 D eyepiece), E4-USBC, eyepiece 0 D*, traveller bag [04]	C-008.33.613
 [03]	OMEGA 600 student set: indirect ophthalmoscope (with battery and +2 D eyepiece), E4-USBC, eyepiece 0 D*, TM2 teaching mirror [05], traveller bag	C-008.33.614
 [04]	OMEGA 600 kit: indirect ophthalmoscope (with battery and +2 D eyepiece), E4-USBC, eyepiece 0 D*	C-008.33.610
 [05] [06]	OMEGA 600 charging set: CC1 charging case, CB1 charging battery [06]	X-000.99.090

*Eyepieces: To best accommodate your view, you can exchange the initially mounted eyepieces +2 D with the neutral lenses 0 D (supplied with the instrument).

HEINE OMEGA® 500 LED indirect binocular ophthalmoscope The predecessor of the OMEGA 600

With its LED^{HQ} and perfect colour rendering, the OMEGA 500 has set the standard for reliability and performance.



Set includes: OMEGA 500, HC 50L headband rheostat, connecting cord cinch, pad with 50 fundus charts, teaching mirror, in hard case

	6V LED
plug-in transformer for HC 50L headband rheostat	C-283.41.320
mPack with plug-in transformer (incl. 90° angled adaptor)	C-283.41.670



Set includes: OMEGA 500 UNPLUGGED, HC 50L headband rheostat, pad with 50 fundus charts, teaching mirror, in hard case

	6V LED
mPack UNPLUGGED and plug-in transformer UNPLUGGED	C-284.41.670



[01]

Kit includes: OMEGA 500 UNPLUGGED, HC 50L headband rheostat. Without case

	6V LED
kit 5: Plug-in transformer UNPLUGGED, 1 x mPack UNPLUGGED	C-008.33.535
kit 6: Wall unit EN 50 UNPLUGGED charger, 2 x mPack UNPLUGGED	C-008.33.536
kit 7: Wall unit EN 50 UNPLUGGED charger, 1 x mPack UNPLUGGED [01]	C-008.33.537

- ▶ Carrying cases and storage cases may deviate in shape and colour.
- ▶ For information on HEINE EN 50 UNPLUGGED and mPack UNPLUGGED see [page 164-165](#).

HEINE OMEGA® 500 with DV1 digital video camera High-resolution digital imaging of the fundus

HIGH-RESOLUTION DIGITAL IMAGING OF THE FUNDUS



HEINE OMEGA 500
with DV1 film

- ▶ **5 MP resolution.** Capable of capturing high-resolution videos or still shots of examinations. No disturbing picture noise due to increased light sensitivity of the camera – also suitable for the examination of premature babies. Perfect for sharing the examiner’s view with a wider audience, educating patients on the diagnosis, recording techniques for presentations, and patient records
- ▶ **Interface and software.** Will plug into any laptop or computer via USB 2.0 interface. Supplied with software program for video recording and image capture
- ▶ **Integrated camera design.** The integrated camera system ensures precise alignment with the optical system of the Indirect ophthalmoscope. Robust, dustproof design. No further adjustment of mirrors necessary for digital imaging

For more information, please refer to www.heine.com/omega500dv1

OMEGA 500 with DV1 sets | kits



Set includes: OMEGA 500 with DV1 digital video camera,
HC 50L headband rheostat, USB 2.0 cord, pad with 50 fundus charts, in hard case

	6V LED
mPack UNPLUGGED and plug-in transformer	C-176.41.670



Kit includes: OMEGA 500 with DV1 digital video camera,
HC 50L headband rheostat, USB 2.0 cord. Without case

	6V LED
mPack UNPLUGGED with plug-in transformer	C-008.33.561
2 x mPack UNPLUGGED with EN 50 UNPLUGGED	C-008.33.562

HEINE SIGMA® 250 indirect ophthalmoscope

Spectacle-mounted ophthalmoscope – with LED^{HQ} illumination



SIGMA 250 apertures



Large spot, small spot,
red-free filter

SIGMA 250 M2 apertures



Large spot, pinhole,
red-free filter

Simplified diagram of various
beam configurations
Large pupil – Small pupil –
Peripheral view

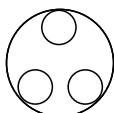

Large pupil



Small pupil



Peripheral view

The spectacle-mounted indirect ophthalmoscope to suit any pupil size. Two separate controls for selecting the ideal setting of parallax and convergence guarantee completely illuminated stereo views in pupils up to 2 mm, as well as viewing in the periphery.

- ▶ **Power source mPack mini – compact and light power source with USB charging option.** With a weight of just 95 g and dimensions of 44x23x101 mm, this mobile power source is now approx. 70 % smaller and lighter than its predecessor. Typ. 11 hours in continuous operation at maximum power
Please note: The SIGMA 250 is compatible only with mPack mini
- ▶ **Extremely light, 110 g without frame.** Light and comfortable
- ▶ **There's LED. And there's LED^{HQ}.** HEINE has set a new standard which maintains that only the best is good enough, from the selection of materials to processing, from light intensity to dimmability, and from thermal management to a colour rendering index as high as possible. **That's what we call LED in HEINE Quality – or LED^{HQ}**
- ▶ **Lightweight frame.** High tensile carbon fiber construction is lightweight and has excellent stability
- ▶ **Illumination beam adjustable $\pm 3^\circ$.** Eliminates reflexes
- ▶ **Integrated red-free filter.** Improves contrast
- ▶ **Optional blue and yellow filter**
- ▶ **Large and small apertures**
- ▶ **Dust proof.** Maintenance-free
- ▶ **PD selection from 47 to 72 mm.** Suits any user
- ▶ **Optics on swivel mount.** Unrestricted view
- ▶ **Optional clip-in correction frame** for prescription lenses

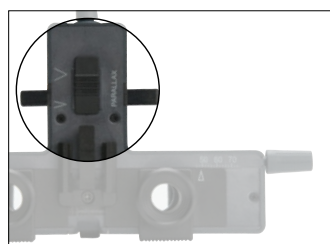

Parallax adjustment



Convergence adjustment

▶ For further information on the mPack mini, please see [page 168](#).

HEINE SIGMA® 250

Sets | kits



[01]

Set includes: SIGMA 250 with S-FRAME spectacle frame,
mPack mini with E4-USB plug-in transformer and USB cord,
mPack mini belt clip, teaching mirror, blue and yellow filters,
diffusor, retaining cord, case [01]

	LED
SIGMA 250	C-281.41.671
SIGMA 250 M2 (with micro spot aperture instead of small aperture)	C-279.41.671

Kit includes: SIGMA 250 with S-FRAME spectacle frame,
mPack mini with E4-USB plug-in transformer and USB cord,
mPack mini belt clip, retaining cord [02]



[02]

	LED
SIGMA 250	C-008.33.341
SIGMA 250 M2 (with micro spot aperture instead of small aperture)	C-008.33.346

► Carrying cases and storage cases may deviate in shape and colour.

HEINE hand-held indirect ophthalmoscope, MONOCULAR

Compact monocular ophthalmoscope



An unusually compact instrument, which is recommended for visits and mobile use.

- ▶ **Durable metal construction.** Long working life
- ▶ **Built-in interference red-free filter.** Improves contrast
- ▶ **All optical components made of coated optical glass.** Precise images and high light intensity
- ▶ **Adjustable light beam.** Useful for small pupils
- ▶ **One hand operation.** All control elements can be easily reached with the thumb
- ▶ **+3D lens attachment.** An aid to accommodation, magnifies the image

HEINE hand-held indirect ophthalmoscope

MONOCULAR kits

Hand-held indirect ophthalmoscope, MONOCULAR with

	3.5V XHL
BETA4 USB rechargeable handle with USB cord and plug-in power supply	C-020.27.388
BETA4 NT rechargeable handle with NT4 table charger [01]	C-020.23.420



[01]

- ▶ For information on HEINE battery and rechargeable handles and the EN 200 wall transformer, see [pages 150-160](#).

Model eyes

HEINE skia-| retinoscope trainer

This model eye is ideal for teaching and practice. The pupil diameter and refractive error can be set exactly and are therefore reproducible. The front lens compartment holder accepts up to two trial lenses. The cylinder can be read from the graduated scale.



- ▶ **Scale:** 0°– 180° for cylinder determination
- ▶ **Diameter of pupil.** Variable 2, 3, 4, 5, 6, 8 mm
- ▶ **Optics:** Optical glass, achromatic lens, focal length $F = 32$ mm
- ▶ **Trainer body.** Made of metal – extremely stable and durable
- ▶ **Angle of examination** variable

Model eye

skia-|retinoscope trainer

C-000.33.011

Model eyes

HEINE ophthalmoscope trainer

This model eye was developed for the teaching environment. It is the first adjustable model from HEINE to mimic the human eye. Precise, durable and with a multitude of uses, it simplifies the learning process and encourages the student to practice with the ophthalmoscope.



- ▶ **Diameter of pupil.** Variable 2, 3, 4, 5, 6, 8 mm
- ▶ **Aspheric optical glass lens.** Focal length $F = 18$ mm. Lens curvature matches that of the retina
- ▶ **Trainer body.** Made of metal – extremely stable and durable
- ▶ **Angle of examination** variable

Model eye

ophthalmoscope trainer

C-000.33.010

HEINE A.R. aspheric ophthalmoscopy lenses With anti-reflex A.R. coating



- ▶ **Advanced triple multicoating.** Reduced reflection, excellent light transmission
- ▶ **Lens curvature matches that of the retina.** Perfect, distortion-free retinal image
- ▶ **Large diameter.** Significant increase in field of view without magnification loss
- ▶ **Aspheric surfaces.** Reduced distortion of the periphery

Ophthalmoscopy lens with case

A.R. 30D Ø 46mm	C-000.17.231
-----------------	--------------



[01]

Combi case | hard case



[02]

Combi case respectively hard case for indirect binocular ophthalmoscopes.
Features a deep, dense foam insert to protect instruments.



[03]

Combi case|hard case*

OMEGA 600 traveller bag [01] (Can be worn over the shoulder or as a backpack.)	C-080.00.000
---	--------------

combi case [02] for OMEGA 500	C-079.03.000
-------------------------------	--------------

hard case [03] for OMEGA 500	C-079.00.000
------------------------------	--------------



[04]

case for SIGMA 250 (270 mm x 270 mm x 150 mm) [04]	C-000.32.553
--	--------------

*Carrying cases and storage cases may deviate in shape and colour.

Accessories for HEINE indirect ophthalmoscopes



[05]

Fundus charts

pad with 50 pcs. [05]	C-000.33.208
-----------------------	--------------

Further articles | accessories

HEINE indirect ophthalmoscopes



OMEGA 600 ophthalmoscope

CC1 charging case [02]	X-000.99.091
------------------------	--------------



CB1 charging battery [01]	X-007.99.687
---------------------------	--------------



E4-USBC power supply with cable [03]	X-000.99.300
--------------------------------------	--------------

CW1 wall charger (without OMEGA 600) [04]	X-095.17.320
---	--------------



TM2 teaching mirror [05]	C-000.33.212
--------------------------	--------------



OMEGA 600 traveller bag [06]	C-080.00.000
------------------------------	--------------



► For information on HEINE power sources see [pages 162-163](#).

Further articles | accessories

HEINE indirect ophthalmoscopes



OMEGA 500 ophthalmoscope	6V LED
on headband with HC 50L headband rheostat and connecting cord cinch	C-008.33.502



[01]

Accessories OMEGA 500 ophthalmoscope

upgrade-kit OMEGA 500 with LED module [01] and HC 50L [02]	X-008.16.325
--	---------------------

LED module for OMEGA 500 [01]	X-008.87.200
-------------------------------	---------------------



[02]

HC 50L headband rheostat (without plug-in transformer)	X-095.16.325
--	---------------------

plug-in transformer for HC 50L headband rheostat	X-095.16.330
--	---------------------

teaching mirror [03]	C-000.33.209
----------------------	---------------------



[03]

extension cord cinch-cinch, 2m [04]	C-000.33.510
-------------------------------------	---------------------

connecting cord cinch to EN 50 charger mPack plug-in transformer for HC 50L, 1.6m [05]	X-000.99.667
--	---------------------

extension cord from plug-in transformer UNPLUGGED to mPack UNPLUGGED, 2m [06]	X-000.99.668
---	---------------------



[04]

USB 2.0 cord for OMEGA 500 with DV1	X-000.99.206
-------------------------------------	---------------------



[05]



[06]

► For information on HEINE power sources see [pages 162-168](#).

Further articles | accessories

HEINE indirect ophthalmoscopes



SIGMA 250 ophthalmoscope	LED
SIGMA 250 with S-FRAME, retaining cord	C-008.33.340
SIGMA 250 M2 (with micro spot aperture instead of small aperture) with S-FRAME, retaining cord	C-008.33.345



[01]



[02]



[03]



[04]



[05]



[06]

Accessories SIGMA 250 ophthalmoscope

teaching mirror [01]	C-000.33.302
blue filter [02]	C-000.33.313
yellow filter [03]	C-000.33.314
diffusor [04]	C-000.33.315
case for filters, empty [05]	C-000.33.316
clip-in correction frame for prescription lenses [06]	C-000.32.309



[07]

Hand-held indirect ophthalmoscope, MONOCULAR

Hand-held indirect ophthalmoscope, MONOCULAR	3.5V XHL
with + 3 D lens attachment and orbit rest extension, without handle	C-002.33.001

Accessories hand-held indirect ophthalmoscope, MONOCULAR

+ 3 D lens attachment only [07]	C-000.33.101
orbit rest extension, for spectacle wearers only	C-000.33.104
XHL xenon halogen spare bulb	X-002.88.050

► For information on HEINE battery and rechargeable handles and the EN 200 wall transformer, see [pages 150-160](#).

**Your ears will
be all eyes:
Diagnostic sets
with otoscope and
ophthalmoscope.**

Combined diagnostic sets | kits

HEINE BETA® 400 F.O. otoscope and BETA 200 ophthalmoscope

Set includes: BETA 400 F.O. otoscope and BETA 200 ophthalmoscope,
1 set (4 pcs.) of reusable tips, 10 AllSpec disposable tips 4 mm Ø,
one spare bulb each for XHL version, hard case



[01]

	2.5V XHL	3.5V XHL	LED
BETA battery handle [01]	A-153.10.118	-	-
BETA4 USB rechargeable handle with USB cord and plug-in power supply	-	A-153.27.388	A-153.28.388



Kit includes: BETA 400 F.O. otoscope and BETA 200 ophthalmoscope,
1 set (4 pcs.) of reusable tips,
10 AllSpec disposable tips 4 mm Ø

	LED
2 x BETA4 NT rechargeable handle with NT4 table charger	A-153.24.422



Kit includes: EN 200 wall transformer,
BETA 400 F.O. otoscope, BETA 200 ophthalmoscope

	3.5V XHL	LED
without additional accessories	A-095.12.214	A-095.12.218

► **For further information:**
HEINE BETA 400 otoscope [page 7](#), HEINE BETA 200 ophthalmoscope [page 44](#), HEINE battery and rechargeable handles and the EN 200 wall transformer, see [pages 150-160](#).

Combined diagnostic sets | kits

HEINE BETA® 200 F.O. otoscope and BETA 200 ophthalmoscope

Set includes: BETA 200 F.O. otoscope and BETA 200 ophthalmoscope,
1 set (4 pcs.) of reusable tips, 10 AllSpec disposable tips 4 mm Ø,
one spare bulb each for XHL version, hard case



[01]

	2.5V XHL	3.5V XHL	LED
BETA battery handle	A-132.10.118	–	–
BETA4 USB rechargeable handle with USB cord and plug-in power supply [01]	–	A-132.27.388	A-132.28.388

Kit includes: BETA 200 F.O. otoscope and BETA 200 ophthalmoscope,
1 set (4 pcs.) of reusable tips,
10 AllSpec disposable tips 4 mm Ø



	LED
2 x BETA4 NT rechargeable handle with NT4 table charger	A-132.24.422

Kit includes: EN 200 wall transformer,
BETA 200 F.O. otoscope, BETA 200 ophthalmoscope



	3.5V XHL	LED
without additional accessories	A-095.12.215	A-095.12.219

► For further information:

HEINE BETA 200 otoscope [page 9](#), HEINE BETA 200 ophthalmoscope
[page 44](#), HEINE battery and rechargeable handles and the EN 200
wall transformer, see [pages 150-160](#).

Combined diagnostic sets | kits

HEINE K180 F.O. otoscope and K180 ophthalmoscope

Set includes: K180 F.O. otoscope and K180 ophthalmoscope,
1 set (4 pcs.) of reusable tips, hard case



[01]

	2.5V XHL	3.5V XHL
BETA battery handle [01]	A-279.10.118	-
BETA4 USB rechargeable handle with USB cord and plug-in power supply	-	A-279.27.388

Kit includes: EN 200 wall transformer,
K180 F.O. otoscope, K180 ophthalmoscope



	3.5V XHL
without additional accessories	A-095.12.220

► For further information:
HEINE K180 otoscope [page 11](#), HEINE K180 ophthalmoscope [page 46](#),
HEINE battery and rechargeable handles and the EN 200 wall transformer,
see [pages 150-160](#).

Combined diagnostic sets | kits

HEINE mini 3000® otoscope and mini 3000 ophthalmoscope

Set includes: mini 3000 F.O. otoscope and mini 3000 ophthalmoscope,
1 set (4 pcs.) of reusable tips, 10 AllSpec disposable tips 4 mm Ø,
hard case



	2.5V XHL	LED
2 mini 3000 battery handles (with batteries)	D-873.11.021	D-886.11.021

Set includes: mini 3000 otoscope, mini 3000 ophthalmoscope,
1 set (4 pcs.) reusable tips, 10 AllSpec disposable tips 4 mm Ø,
hard case



	2.5V XHL
2 mini 3000 battery handles (with batteries)	D-873.21.021

Kit includes: mini 3000 F.O. otoscope and mini 3000 ophthalmoscope,
10 AllSpec disposable tips 4 mm Ø



	2.5V XHL	LED
2 mini 3000 rechargeable handles and mini NT table charger	D-859.11.022	D-860.11.022

These kits are only available in black

► **For further information:**

HEINE mini 3000 F.O. otoscope [page 13](#), HEINE mini 3000 otoscope [page 18](#),
HEINE mini 3000 ophthalmoscope [page 48](#).

Combined diagnostic sets | kits

HEINE G100 VET slit illumination head and BETA 200 ophthalmoscope

Set includes: G100 slit illumination head, BETA 200 ophthalmoscope,
1 set long, closed specula (57mm x 4 mm Ø, 65mm x 6 mm Ø and
90mm x 7 mm Ø), 1 spare bulb for XHL version, hard case



[01]

	2.5V XHL	3.5V XHL	LED
BETA battery handle	G-148.10.118	-	-
BETA4 USB rechargeable handle with USB cord and plug-in power supply	-	G-148.27.388	G-148.28.388
BETA4 NT rechargeable handle with NT4 table charger [01]	-	G-148.23.420	G-148.24.420

- For further information:
HEINE G100 slit illumination head [page 29](#), HEINE BETA 200 ophthalmoscope
[page 44](#), HEINE battery and rechargeable handles and the EN 200 wall trans-
former, see [pages 150-160](#).

**You can
count on our
laryngoscopes.
Always.**

HEINE visionPRO® video laryngoscope

With very, very, very good image quality

For fast and reliable intubation, nothing is more important than the best view of the glottis. The HEINE visionPRO video laryngoscope provides just that with the and one of a kind HEINE allBRIGHT display – even in very bright ambient light. At the same time, the HEINE visionPRO is extremely robust, reliable and durable. To be as environmentally friendly as possible, we chose a rechargeable lithium battery and are the first to provide a blade made from upcycled material.



BRIGHT AND SHARP IMAGE

- ▶ Unique worldwide: HEINE transfective allBRIGHT display adapts to even the brightest ambient light
- ▶ Excellent 3,2" display in practical portrait format
- ▶ Low-reflection intubation thanks to an adjustable display angle
- ▶ Realistic colour representation thanks to smart image processing
- ▶ HEINE LED^{HO}

QUICK AND COMPREHENSIVE ORIENTATION

- ▶ Situational field of view of the glottis and the relevant surrounding anatomy

EXTREMELY DURABLE AND LONG-LASTING

- ▶ Grip head and display frame made of anodised aluminium
- ▶ Stainless steel handle and camera arm
- ▶ Highly protective cover glass



[HEINE visionPRO videos](#)

SAFE: DISPLAY AND HANDLE CAN BE SEPARATED FOR NUMEROUS VALIDATED REPROCESSING METHODS

- ▶ Assembled instrument: low level | wipe disinfection reprocessing
- ▶ Handle: from wipe disinfection to immersion and sterilisation

ECOLOGICAL AND ECONOMICAL

- ▶ Blade made from upcycled material
- ▶ Rechargeable battery
- ▶ Cost reduction through economic procurement management



HEINE visionPRO Mac 3 single-use laryngoscope blades made from upcycled material



[01]



[02]

visionPRO set Mac

visionPRO video laryngoscope consisting of visionPRO HR1 Mac handle and visionPRO DS1 display unit, visionPRO CS1 charging station with plug-in power supply [01]	F-270.95.862
visionPRO Mac 3 single-use laryngoscope blades, box of 50	F-000.22.253
visionPRO Mac 4 single-use laryngoscope blades, box of 50	F-000.22.254
visionPRO Mac 3 single-use laryngoscope blades, box of 10 [02]	F-000.22.243
visionPRO Mac 4 single-use laryngoscope blades, box of 10	F-000.22.244
visionPRO HyMac 3 single-use laryngoscope blades, box of 10	F-000.22.246

HEINE laryngoscopes blades

Overview

It goes without saying that all of our laryngoscope blades are premium products. But, still, they differ in one or two details. Read on for a summary of what these different details are and all their benefits:



	Classic+ Macintosh	Classic+ Miller	Classic+ Paed	XP Macintosh	XP Miller
Blade size	0, 1, 2, 3, 3m, 4, 5	00, 0, 1, 2, 3, 4	0, 1	1, 2, 3, 4	0, 1, 2, 3, 4
Material	stainless steel			polycarbonate	
Diameter of HiLite fiber bundle in mm	4,3	3,7	3,6	-	
Reprocessing	reusable, sterilisation without disassembly			⊗	
Recommendations	-			suitable for low ambient temperatures	
Guarantee	10 years guarantee and 4,000 autoclave cycles			⊗	
Catalogue page	82	83		84	

⊗: Single use only.

HEINE Classic+ Macintosh fiber optic (F.O.) blades

Innovative fiber optic technology for advanced performance



Our innovative manufacturing technology achieves even better illumination and a longer service life.

- ▶ **The HEINE HiLite fiber optic (F.O.) fiber bundle, optimised for use** – with up to 6,500 individual fibers and refined directional characteristics, achieves the best possible illumination of the pharynx even after 4,000 sterilisation cycles. For simple and safe intubation
- ▶ **The one-piece design from chrome-plated, stainless, high-grade steel** makes the Classic+ F.O. blade even more resistant to the oxidation and/or corrosion damage that can occur in the reprocessing process due to intense use
- ▶ **The clean shape without any edges or corners** is easy to clean, disinfect and sterilise
- ▶ **HEINE Classic+ blades have no screwed joints, no external bundles and no openings that could contaminate**
- ▶ **Compatible with all handles** to the ISO 7376 (green standard)
- ▶ **10 years guarantee.** (After 4,000 autoclave cycles of 134 °C / 4 min, illumination of at least 1,000 lux.)

Size	Overall length	Blade length	Distal width	
Mac 0 [01]	82 mm	66 mm	9 mm	F-000.22.100
Mac 1 [02]	94 mm	78 mm	10 mm	F-000.22.101
Mac 2 [03]	114 mm	98 mm	14 mm	F-000.22.102
Mac 3m* [04]	134 mm	118 mm	14 mm	F-000.22.143
Mac 3 [05]	134 mm	118 mm	14 mm	F-000.22.103
Mac 4 [06]	155 mm	139 mm	15 mm	F-000.22.104
Mac 5 [07]	177 mm	161 mm	15 mm	F-000.22.105

* stronger curve

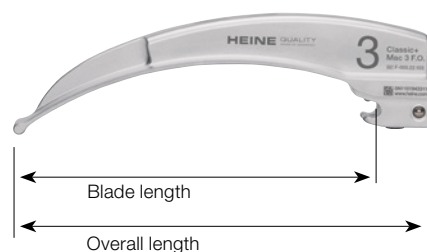

HEINE Classic+ Miller and Paed fiber optic (F.O.) blades

Innovative fiber optic technology for advanced performance

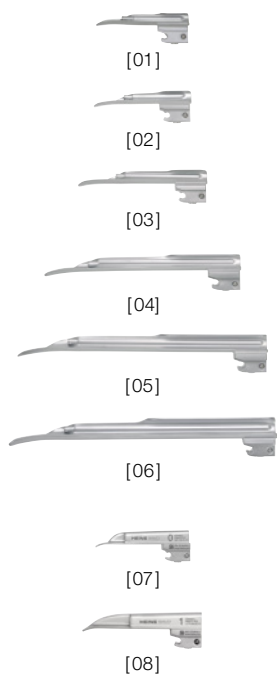

- ▶ **The Miller Classic+ blades with improved geometry simplify intubation.**
The shortened shoulder of the blade dramatically improves the anesthetist's view of the epiglottis and vocal cords. The distal lip of the blade features a special atraumatic shape
- ▶ **HEINE HiLite fiber bundle** with up to 6,500 individual microfibers for improved light transmission and longer life
- ▶ **Both ends of the large fiber bundle** are protected – for life
- ▶ **HEINE Classic+ blades have no screwed joints, no external fiber bundles and no openings that could contaminate**
- ▶ **The clean shape without any edges or corners** is easy to clean, disinfect and sterilise. These blades need no maintenance – ever
- ▶ **Compatible with all handles** to the ISO 7376 (green standard)
- ▶ **High-quality design** from chrome-plated, stainless, high-grade steel
- ▶ **10 years guarantee.** (After 4,000 autoclave cycles of 134 °C / 4 min, illuminance of at least 1,000 lux.)
- ▶ **HEINE Paed laryngoscopes** have been developed specifically for the intubation of neonates and infants

Size	Overall length	Blade length	Distal width	
Miller 00 [01]	76mm	51mm	10mm	F-000.22.119
Miller 0 [02]	80mm	55mm	11 mm	F-000.22.120
Miller 1 [03]	100mm	78mm	12 mm	F-000.22.121
Miller 2 [04]	152mm	130mm	13 mm	F-000.22.122
Miller 3 [05]	192mm	170mm	13mm	F-000.22.123
Miller 4 [06]	207mm	185mm	16mm	F-000.22.124

Paed 0 [07]	82mm	65mm	12mm	F-000.22.110
Paed 1 [08]	95mm	78mm	13mm	F-000.22.111

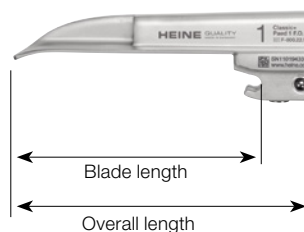
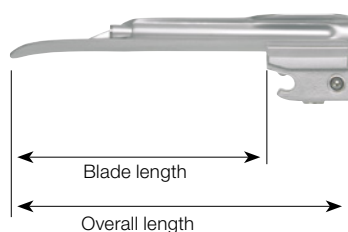

HEINE XP disposable laryngoscope blades

Eliminate cross-infection

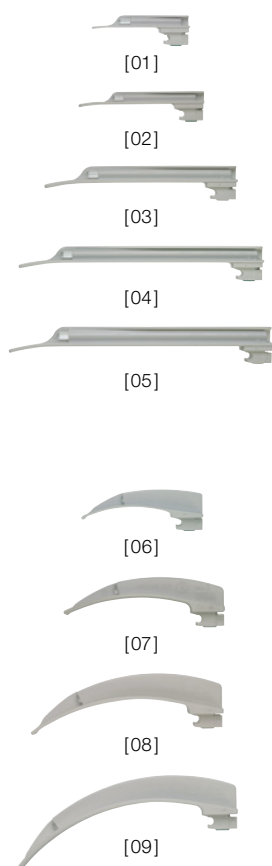

The disposable laryngoscope blade features the HEINE Classic+ blade shape of the world's best-selling integral fiber optic blade. With proper use the disposable XP blade avoids cross-infection from one patient to the next.

- ▶ **No danger of cross-infection**
- ▶ **Hygienic and safe**
- ▶ **Optimum light transmission** by oversize light guide
- ▶ **Extremely bright:** Highest level of illuminance with HEINE 2.5 V or 3.5 V LED illuminance within laryngoscope insert
- ▶ **Blade shape optimized** to ease the passage of the tube
- ▶ **Patient-friendly with reduced risk of injury or damage to teeth**
- ▶ **Extreme torsional stiffness**, practically unbreakable
- ▶ **Blades do not “freeze”** or stick to the tongue at low temperatures
- ▶ **Compatible with all handles** to the ISO 7376 (green standard)

XP blade	Overall length	Blade length	Distal width	
Miller 0 [01]	80mm	62mm	10mm	F-000.22.771*
Miller 1 [02]	104mm	85mm	10mm	F-000.22.772*
Miller 2 [03]	155mm	136mm	13mm	F-000.22.773*
Miller 3 [04]	195mm	177mm	13mm	F-000.22.774*
Miller 4 [05]	221mm	194mm	14mm	F-000.22.775*
Mac 1 [06]	90mm	72mm	9mm	F-000.22.761*
Mac 2 [07]	114mm	96mm	10mm	F-000.22.762*
Mac 3 [08]	134mm	116mm	14mm	F-000.22.763*
Mac 4 [09]	154mm	136mm	14mm	F-000.22.764*

* 25 disposable blades individually packed in dispenser box.

⊗: Single use only.

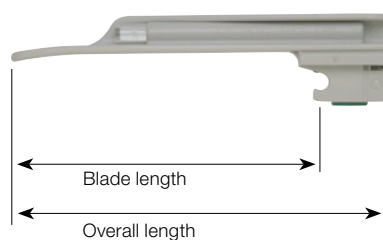

▶ For HEINE XP emergency set, please see [page 92](#).

HEINE XP disposable laryngoscope handle shell

Eliminates cross-infection



The disposable laryngoscope handle shell with the globally distributed laryngoscope insert is powered by the best-selling battery insert for HEINE F.O. handles. The laryngoscope insert can be removed from the handle shell after intubation without risk of contamination.

XP disposable laryngoscope handle shell with bottom insert

without laryngoscope insert, pack of 25	F-000.22.926		
Standard F.O. laryngoscope insert	2.5V	3.5V NiMH	3.5V Li-ion
with XHL illumination and standard F.O. bottom insert	F-001.22.858	F-002.22.868	–
with LED illumination and standard F.O. bottom insert	F-008.22.858	F-008.22.868	–
with XHL illumination and standard F.O.4 NT bottom insert	–	–	F-007.22.893*
with LED illumination and standard F.O.4 NT bottom insert	–	–	F-008.22.893*
XHL xenon halogen spare bulb	X-001.88.035	X-002.88.044	X-002.88.044

*Please note: The laryngoscope insert with the HEINE F.O.4 NT bottom insert can only be charged in the HEINE NT4 table charger. (X): Single use only.

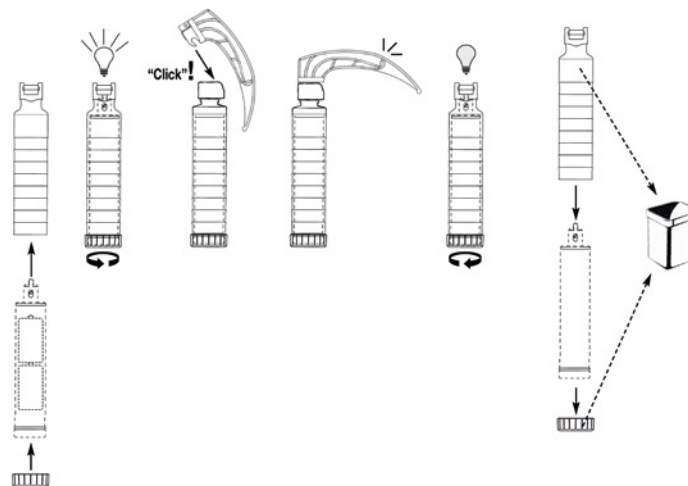

The XP disposable handle shell was especially designed for use with HEINE laryngoscope inserts. The HEINE laryngoscope insert is placed inside the disposable handle shell and the light is activated by turning the bottom insert. Following intubation, the user simply unscrews the bottom insert and the laryngoscope insert can be removed with no risk of contamination. The handle shell, the bottom insert and the XP blade are all disposed of.

HEINE EasyClean® LED laryngoscope handle

All three handle sizes STANDARD, SLIM and SHORT



STANDARD



SLIM



SHORT

The HEINE EasyClean LED laryngoscope handle was developed to allow even simpler, faster and safer hygienic reprocessing of the handle – no complex disassembling and assembling of batteries and light unit. This saves the technical service personnel a great deal of time, and reduces the training and maintenance effort.

SIMPLE, FAST AND SAFE CLEANING

- ▶ **Non-slip “wave design”** improves the reliability of the wipe disinfectant for the handle after use (‘intermediate disinfection’)
- ▶ **100 % waterproof.** In the case of immersion disinfection (‘high-level disinfection’) or low temperature sterilisation processes (STERRAD®, VHP® (Steris)), neither the batteries nor the LED light unit need to be removed
- ▶ **Autoclavable LED technology:** No removal of the light unit required for use in autoclaves, just batteries

PERFECT VIEW

- ▶ **There’s LED. And there’s LED^{HO}.** HEINE has set a new standard which maintains that only the best is good enough, from the selection of materials to processing, from light intensity and thermal management to a colour rendering index as high as possible. **That’s what we call LED in HEINE Quality – or LED^{HO}**
- ▶ **Maximum brightness:** 3 x brighter than conventional halogen light
- ▶ **Virtually unlimited hours of working life**

FAIL-SAFE

- ▶ **Typ. 10 hours of operating time** (EasyClean LED laryngoscope handle in continuous operation)
- ▶ **Fade-out feature:** brightness reduces slowly as battery operating time diminishes, for even more efficient battery use
- ▶ **Compatible with all laryngoscope blades** according to ISO 7376 (green standard)

HEINE EasyClean® LED laryngoscope handle

All three handle sizes STANDARD, SLIM and SHORT



[01]

EasyClean LED laryngoscope handle	LED
EasyClean LED laryngoscope handle suitable for 2 x C-batteries (LR14), compl.* [01]	F-008.22.820
EasyClean LED SLIM laryngoscope handle suitable for 2 x AA-batteries (LR6), compl.* [02]	F-008.22.821
EasyClean LED SHORT laryngoscope handle, suitable for 3 x AAA-batteries (LR03), compl.* [03]	F-008.22.822

* Delivery without batteries



[02]

HYGIENIC REPROCESSING OPTIONS**

Reprocessing process	Wipe disinfection	Manual immersion disinfection	Low temperature gas plasma sterilisation (STERRAD® VHP® (Steris))	Mechanical cleaning + disinfection (thermal disinfectant)	Steam sterilisation autoclave
Temperature	cold	< 60 °C	< 60 °C	max. 93 °C	max. 134 °C 4 min
with batteries	✓	✓	✓	batteries removed previously	batteries removed previously
with HEINE LED	✓	✓	✓	✓	✓

** Detailed cleaning instructions can be found in our instructions for use at www.heine.com



[03]

HEINE F.O.4 NT laryngoscope handles

Li-ion in all handle sizes

XHL or LED^{HQ} illumination



[01]

- ▶ **Compatible with all laryngoscope blades to the ISO 7376 (green standard)**
- ▶ **HEINE standard F.O. laryngoscope handles can be converted from battery to rechargeable handles by simply exchanging the bottom insert**
- ▶ **Fade-out feature:** brightness reduces slowly even with low residual capacity, for even more efficient use of dry or rechargeable batteries
- ▶ **There's LED. And there's LED^{HQ}.** HEINE has set a new standard which maintains that only the best is good enough, from the selection of materials to processing, from light intensity and thermal management to a colour rendering index as high as possible. **That's what we call LED in HEINE Quality – or LED^{HQ}**



[02]



[03]

Standard F.O.4 NT laryngoscope handle *

	3.5V XHL Li-ion	3.5V LED Li-ion
standard F.O.4 NT handle, compl. [01]	F-007.22.894	F-008.22.894
laryngoscope insert without bottom insert [02] + [03]	F-002.22.859	F-008.22.890
bottom insert F.O.4 NT [04]*	F-002.22.884	F-002.22.884
rechargeable battery [06]	X-007.99.383	X-007.99.383
handle shell	F-000.22.824	F-000.22.824
spare bulb	X-002.88.044	-
NT4 table charger, without handle	X-002.99.494	X-002.99.494



[04]



[05]



[06]



* charge status indicator in the bottom insert

Typ. XHL 2.5 hours operating time
Typ. LED 7 hours operating time

Standard F.O. laryngoscope battery handle

	2.5V XHL	2.5V LED
standard F.O. handle suitable for 2 x C-batteries (LR14), compl.** [01]	F-001.22.860	F-008.22.860
bottom insert [05]	F-001.22.861	F-001.22.861

** Delivery without batteries.

Please note: All Li-ion versions can only be charged with the NT4 table charger.

HEINE F.O.4 NT laryngoscope handles

Li-ion in all handle sizes

XHL or LED^{HQ} illumination



F.O.4 SLIM NT laryngoscope handle	3.5V XHL Li-ion	2.5V LED Li-ion
F.O.4 SLIM NT handle, complete [01]	F-007.22.804	F-008.22.804
laryngoscope insert without bottom insert [02] + [03]	F-002.22.801	F-008.22.801
bottom insert F.O.4 SLIM NT [04]	F-000.22.854	F-000.22.854
rechargeable battery [06] + [07]	X-007.99.380	X-007.99.104
handle shell [08]	F-000.22.804	F-000.22.804
spare bulb	X-002.88.044	–
NT4 table charger, without handle	X-002.99.494	X-002.99.494
set of two adaptors	X-000.99.086	X-000.99.086



F.O. SLIM laryngoscope battery handle	2.5V XHL	2.5V LED
F.O. SLIM handle suitable for 2 x AA-batteries (LR6), compl.** [01]	F-001.22.800	F-008.22.800
bottom insert [05]	F-000.22.851	F-000.22.851



F.O.4 SHORT NT laryngoscope handle	3.5V XHL Li-ion	2.5V LED Li-ion
F.O.4 SHORT NT handle, complete [01]	F-007.22.424	F-008.22.424
charging module [02] + [03]	X-007.99.394	X-007.99.304
spare bulb	X-002.88.044	–
NT4 table charger, without handle	X-002.99.494	X-002.99.494



F.O. SHORT laryngoscope battery handle	2.5V XHL	2.5V LED
F.O. SHORT handle suitable for 2 x AA-batteries (LR6), compl.** [04]	F-001.22.812	F-008.22.812

**Delivery without batteries.

Please note: All Li-ion versions can only be charged with the NT4 table charger.

HEINE NT4 table charger and adaptors

HEINE F.O. upgrade kit

All rechargeable HEINE F.O.4 NT laryngoscope handles can only be charged with the NT4 table charger. The use of an adaptor is required for some handles. For detailed information about the NT4 table charger and adaptor, please see [page 154](#).



NT4 table charger

without handle, with adaptors for standard F.O.4 NT laryngoscope Insert and F.O.4 SHORT NT laryngoscope handle	X-002.99.494
set of two adaptors for F.O.4 SLIM NT laryngoscope rechargeable handle [01]	X-000.99.086

FOR CONVERTING TO HEINE F.O.4 CHARGING TECHNOLOGY

For converting a standard F.O. or standard F.O. LED laryngoscope rechargeable handle to a standard F.O.4 NT solution.

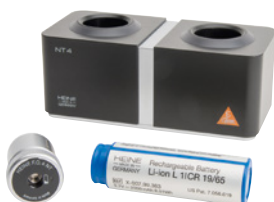

Upgrade kit F.O.4 NT	3.5V Li-ion
bottom insert standard F.O.4 NT, Li-ion L rechargeable battery, NT4 table charger	F-011.99.420

HEINE Classic+ fiber optic (F.O.) laryngoscope sets



[01]

Set complete with: Paed 1, Mac 2, Mac 3 blades, spare XHL xenon halogen bulb, zipper case

	2.5V	3.5V Li-ion
with standard F.O. battery handle [01]	F-119.10.860	–
with standard F.O.4 NT rechargeable handle with Li-ion battery and NT4 table charger	–	F-119.23.865*



[02]

As above, but with LED illumination, without spare bulb

	2.5V	3.5V Li-ion
with standard F.O. LED battery handle	F-119.18.860	–
with standard F.O.4 LED NT rechargeable handle with Li-ion battery and NT4 table charger	–	F-119.94.865*
with EasyClean LED battery handle [02]	F-119.18.820	



[03]

Set complete with: Paed 1, Mac 2, Mac 3, Mac 4 blades, spare XHL xenon halogen bulb, zipper case

	2.5V	3.5V Li-ion
with standard F.O. battery handle [03]	F-120.10.860	–
with standard F.O.4 NT rechargeable handle with Li-ion battery and NT4 table charger	–	F-120.23.865*



[04]

As above, but with LED illumination, without spare bulb

	2.5V	3.5V Li-ion
with standard F.O. LED battery handle	F-120.18.860	–
with standard F.O.4 LED NT rechargeable handle with Li-ion battery and NT4 table charger	–	F-120.94.865*
with EasyClean LED battery handle [04]	F-120.18.820	

* Please note: The 3.5 V Li-ion version will be delivered with the HEINE F.O.4 NT bottom insert and can only be charged in the HEINE NT4 table charger.

HEINE XP emergency set with XP disposable blades



Specially-developed for emergency-use featuring the HEINE XP disposable laryngoscope blades. These sets are equipped with XP blades of the same anatomically-correct shape as the Classic+ blade, the world's best-selling F.O. blade with integrated fiber optic bundle. With proper use the disposable XP blade avoids cross-infection from one patient to the next.

The HEINE XP emergency laryngoscope set is complete with the 5 most frequently-used blade types and sizes for infants and adults. Instantly-ready for use with XP disposable laryngoscope handle shell included standard F.O. laryngoscope insert with XHL illumination and alkaline batteries.

XP emergency set	2.5V XHL
with blades Miller 0, Miller 1, Mac 2, Mac 3, Mac 4, XP disposable laryngoscope handle shell, standard F.O. laryngoscope insert, two alkaline batteries, in case	F-258.10.858



XP blades	Overall length	Distal width	
Miller 0	80 mm	10 mm	F-000.22.771*
Miller 1	104 mm	10 mm	F-000.22.772*
Mac 2	114 mm	10 mm	F-000.22.762*
Mac 3	134 mm	14 mm	F-000.22.763*
Mac 4	154 mm	14 mm	F-000.22.764*

*25 disposable blades ☉ individually packed in dispenser box.

XP emergency set refill assortment	2.5V XHL
refill assortment with XP disposable laryngoscope handle shell and XP blades, Miller 0, 1, Mac 2, 3, 4 (one each)	F-000.22.739

**Skin has many
stories to tell.
You just need to be
able to read them.**

HEINE dermatoscopes Overview

It goes without saying that all of our dermatoscopes are premium products. But, still, they differ in one or two details. Read on for a summary of what these different details are and all their benefits:



	DELTA 30 PRO	DELTA 30	DELTAone	iC1	DELTA 20T	mini 3000
Polarisation	polarised + non-polarised (switchable)					non-polarised (immersion)
Illumination	LED ^{HQ} with colorSHIFT	LED ^{HQ}				XHL or LED ^{HQ}
Free field of view – diameter in contact mode	30mm	30mm	21mm	digital	20mm	14mm
Magnification	10x	10x	10x	up to 40x digital	10x	10x
Handle options power sources	USB cable, table charger		USB cable		battery handle, USB rechargeable handle, rechargeable handle with table charger, EN 200 EN 200-1	battery handle, rechargeable handle with table charger
Contact plate	contact plate with scale				contact plate with scale, contact plate without scale	
Small contact plate*	optional			–	optional	
HEINE distance working ring	optional		–			
Digital documentation	with adaptor and app			with iPhone iPod touch** and app	with optional SLR photo adaptor	–
Catalogue page	96	98	99	100	101	102

* for difficult-to-access pigmented lesions

**The Apple iPhone or iPod touch is not included in the scope of delivery. Apple, the Apple logo, iPhone and iPod touch are trademarks of Apple Inc., registered in the U.S. and other countries. App Store is a service mark of Apple Inc.

Invented to discover.



The new DELTA 30 PRO dermatoscope.

Since the LED^{HQ} elements have been repositioned in our new high-end dermatoscope, the light reaches deeper layers of the skin. This gives an extremely vivid, spatial impression of lesions – similar to a 3D image. So even the details of the details stand out.

The HEINE colorSHIFT function is a genuine world first. It allows you to easily adjust the colour temperature to suit your own viewing habits. Go from warm white to bluish white in 4 stages.

Regardless of whether you prefer working close-up or further away, the image is always sharp and crystal clear.



NEW | **HEINE DELTA® 30 PRO dermatoscope**
High-end dermatoscope with our best imaging



Since the LED^{HQ} elements have been repositioned, the light reaches deeper layers of the skin too. This gives an extremely vivid, spatial impression of lesions – similar to a 3D image. The HEINE colorSHIFT function is a genuine world first. It allows you to easily adjust the colour temperature to suit your own viewing habits.

HEINE diSTANCE working ring: The stable working ring enables the user to examine and manage a lesion under magnification by maintaining a constant distance between the skin and the dermatoscope without contact. (optional)

EXTREMELY VIVID, SPATIAL IMPRESSION OF LESIONS

- ▶ Very good assessment of lesions' spatial structure possible due to deeper light penetration thanks to angled and directional LED^{HQ} arrangement
- ▶ Easier to distinguish between dark and white structures and patterns during polarisation
- ▶ Switch between polarised and non-polarised light at the touch of a button = toggle function
- ▶ Crystal-clear image, no matter whether you prefer to work close-up or further away
- ▶ Large field of view with 'real' 30 mm Ø due to 32 mm lens

CHOOSE THE LIGHT COLOUR TO SUIT YOUR OWN PREFERENCES WITH HEINE colorSHIFT

- ▶ 4 colour temperature stages from warm white to bluish white
- ▶ Adjustable to suit your own habits and preferences or the challenges posed by the lesion to be examined

STURDY AND DURABLE

- ▶ Particularly resistant to disinfectants due to new plastics
- ▶ Improved battery life

INTUITIVE AND ERGONOMIC

- ▶ Ergonomic handling due to angled product design
 - ▶ Scale on eyepiece shows the focus setting – for easy preselection of certain settings for specific users and/or for use with a camera or smartphone
 - ▶ Easy charging due to USB-C
 - ▶ Rechargeable battery with Li-ion technology
 - ▶ Fast change from contact to non-contact examination
 - ▶ Custom light intensity: 3 degrees of luminous intensity
 - ▶ 10x magnification
 - ▶ No cross-contamination: autoclavable contact plate with scale
 - ▶ Small contact plate for hard-to-reach lesions
- ▶ **Digital documentation:** Image and data management convenient and intuitive. More information can be found on our website: www.heine.com/en/digital



HEINE diSTANCE working ring



[HEINE DELTA 30 PRO](#)
film

NEW | **HEINE DELTA® 30 PRO dermatoscope**
Sets



[01]

DELTA 30 PRO dermatoscope	LED
with contact plate with scale, E4-USBC power supply with cable, hard case [01]	K-235.28.305
with contact plate with scale, small contact plate, E4-USBC power supply with cable, charger 30 table charging station, universal smartphone adapter, hard case [02]	K-236.28.306
HEINE diSTANCE working ring [03]	K-000.34.103



[02]



[03]



► **DIGITAL DOCUMENTATION: REMEMBER EACH AND EVERY MOLE**

Image and data management convenient and intuitive. More information can be found on our website: www.heine.com/en/digital

► [Accessories can be found on page 104.](#)

HEINE DELTA® 30 dermatoscope

Reliable diagnostics



Digital documentation
by HEINE

Not only would the HEINE DELTA 30 win any beauty pageant, but stands out due to its very good imaging. Combined with a field of view measuring a veritable 30 millimetres and unprecedented colour rendering, in LED^{HQ} of course. Polarisation provides glare-free and non-reflective working conditions. Above all else, it is comfortable to operate with its angled, ergonomic design and intuitive control.

HEINE diSTANCE working ring: The stable working ring enables the user to examine and manage a lesion under magnification by maintaining a constant distance between the skin and the dermatoscope without contact. (optional)

- ▶ **Large true field of view of 30mm** (lens 32mm)
- ▶ **Crystal-clear image** with the achromatic HEINE optical system
- ▶ **Fast change from contact- to non-contact examination**
- ▶ **Ergonomic handling** thanks to the angled product design
- ▶ **Operate with just one hand:** individual focusing dioptre compensation approximately -4 to +4 dpt.
- ▶ **Excellent colour rendering** due to LED^{HQ}
- ▶ **Digital documentation:** Image and data management convenient and intuitive. More information on our website: www.heine.com/en/digital
- ▶ **Glare-free and non-reflective working conditions** thanks to polarisation
- ▶ **Custom light intensity:** 3 degrees of luminous intensity
- ▶ **10x magnification**
- ▶ **Switch between polarised and non-polarised light at the touch of a button** = toggle function. For more information, please visit heine.com/en/Toggle
- ▶ **No cross-contamination:** autoclavable contact plate with scale
- ▶ **Maintenance-free** due to our dustproof design
- ▶ **Rechargeable battery with Li-ion technology:** no memory effect; you can safely recharge the battery regardless of its charge state



[01]



[02]

DELTA 30 dermatoscope	LED
DELTA 30 with contact plate with scale, USB cord with medical approved plug-in power supply, hard case [01]	K-230.28.305
Charger 30 table charging station	X-002.99.212
HEINE diSTANCE working ring [02]	K-000.34.103

▶ Accessories can be found on [page 104](#).

HEINE DELTAone dermatoscope

Uniting diagnostic precision and mobility



Digital documentation
by HEINE

Small on the outside, big on the inside. This mobile marvel is taking medical professionals by storm. The crystal-clear image was accomplished using the achromatic HEINE optical system. What's more, it produces extraordinary colour rendering, due to the quality of our LED^{HQ}. Examinations are now particularly comfortable due to the polarisation allowing doctors to work glare-free and without disrupting reflections. These three features – clarity, LED^{HQ} and non-reflective working – plus the small dimensions, naturally, are what turn the DELTAone into a vital working tool wherever you go.

- ▶ **Fits into any pocket**
- ▶ **Crystal-clear image** with the achromatic HEINE optical system
- ▶ **Fast change from contact to non-contact examination**
- ▶ **Excellent colour rendering** due to LED^{HQ}
- ▶ **Glare-free and non-reflective working conditions** thanks to polarisation
- ▶ **Operate with just one hand:** individual focusing dioptre compensation approximately -4 to +4 dpt.
- ▶ **Digital documentation:** Image and data management convenient and intuitive
More information on our website: www.heine.com/en/digital
- ▶ **Field of view of real 21 mm** (lens 22 mm)
- ▶ **Custom light intensity:** 3 degrees of luminous intensity
- ▶ **10x magnification**
- ▶ **Switch between polarised and non-polarised light at the touch of a button** = toggle function. For more information, please visit heine.com/en/Toggle
- ▶ **No cross-contamination:** autoclavable contact plate with scale
- ▶ **Maintenance-free** due to our dustproof design
- ▶ **Rechargeable battery with Li-ion technology:** no memory effect; you can safely recharge the battery regardless of its charge state



DELTAone dermatoscope	LED
with contact plate with scale, USB cord with medical approved plug-in power supply, hard case. Standard Edition (black-silver)	K-210.28.305
with contact plate with scale, USB cord with medical approved plug-in power supply, hard case. White Edition (white-silver)	K-211.28.305

▶ **Accessories can be found on [page 104](#).**

HEINE iC1 dermatoscope

The digital dermatoscope



Digital documentation
by HEINE



- ▶ **Sharp, sharper, sharpest.** The HEINE iC1 is a device designed for capturing clinical and dermatoscopic images for documenting and supporting differential diagnosis of melanomas and other skin lesions. Developed in our unrivalled HEINE quality, the iC1 delivers sharp, shadow-free images.
Thanks, to both our precise, aspherical optical system and, the 12-megapixel image quality when using an iPhone® 6s or later model
- ▶ **Digital documentation:** Image and data management convenient and intuitive. More information on our website: www.heine.com/en/digital
- ▶ **Big, bigger, biggest.** The high-quality aspherical optical system with up to 40x true magnification offers everything you need in a practice
- ▶ **There's LED. And there's LED^{HQ}.** HEINE has set a new standard which maintains that only the best is good enough, from the selection of materials to processing, from light intensity and thermal management to a colour rendering index as high as possible. **That's what we call LED in HEINE Quality – or LED^{HQ}**
- ▶ **At the press of a button – the toggle function.** With two switching buttons, the option to switch back and forth between polarisation and immersion images is always within easy reach, regardless of the working position.
For more information, please visit heine.com/en/Toggle
- ▶ **Many see a smartphone. We see an exceptional camera and first-class display.** We've opted for the iPhone® for reasons of quality, user orientation and costs. From our perspective it offers the best camera, a display with the highest resolution and the most progressive touchscreen technology

iC1	LED
with contact plate with scale, mounting case smartphone iC1/5 for Apple iPhone 5s* and SE 1st generation*, USB cord with medical approved plug-in power supply	K-271.28.305
with contact plate with scale, mounting case smartphone iC1/6 for Apple iPhone 6/6s*, USB cord with medical approved plug-in power supply	K-270.28.305
with contact plate with scale, mounting case smartphone iC1/7 for Apple iPhone 7*, 8* and SE 2nd generation*, USB cord with medical approved plug-in power supply	K-273.28.305
with contact plate with scale, mounting case smartphone iC1/12 Pro for Apple iPhone 12 Pro*, USB cord with medical approved plug-in power supply	K-277.28.305

* The Apple iPhone is not included in the scope of delivery.
Apple, the Apple logo, iPhone and iPod touch are trademarks of Apple Inc., registered in the U.S. and other countries. App Store is a service mark of Apple Inc.

HEINE DELTA® 20T dermatoscope

The classic



- ▶ **Crystal clear, high-resolution images** thanks to the high-quality achromatic optical system. The focusing system delivers 10 to 16x magnification for a detailed view of even the smallest structures
- ▶ **Toggle function for switching between polarised and non-polarised illumination mode.** With the press of a button. No exchange of contact plates necessary. The additional diagnostic function allows detection of “blink signs” when viewing crystalline structures and milia. For more information, please visit heine.com/en/Toggle
- ▶ **Glare-free and reflection-free view thanks to polarisation, even without immersion fluid.** For fast and flexible work
- ▶ **With just one hand:** individual focusing, range of correction approximately -6 to +6 dpt.
- ▶ **There's LED. And there's LED^{HQ}.** HEINE has set a new standard which maintains that only the best is good enough, from the selection of materials to processing, from light intensity and thermal management to a colour rendering index as high as possible. **That's what we call LED in HEINE Quality – or LED^{HQ}**
- ▶ **The DELTA 20T is also capable of digital documentation:** using the HEINE digital camera lens system, the dermatoscope can be connected to the SLR cameras of major brands without any issues. Specially developed photo adaptor lenses combine the camera and DELTA 20T to create an unbeatable pair



HEINE DELTA 20T
film



[01]

DELTA 20T dermatoscope	LED
with contact plate with scale, BETA4 USB rechargeable handle with USB cord and plug-in power supply [01]	K-010.28.388
with contact plate with scale, EN 200-1 wall transformer (single unit with one handle) as single module with long USB cord and E4-USB plug-in power supply [02]	K-010.28.252



[02]

- ▶ **Accessories can be found on [page 105](#).**
- ▶ **For information on HEINE battery and rechargeable handles and the EN 200 wall transformer, see [pages 150-160](#).**

HEINE mini 3000® dermatoscope

Compact pocket dermatoscope with XHL or LED^{HQ} illumination



Modern pocket dermatoscope with concentrated, bright light for uniform illumination with exact colour rendering. Unique, compact design with high quality optics. 10x magnification with focusing optics, metal instrument head. Can be used with the mini 3000 handle system. Handle available in black and blue, instrument head only available in black|silver.

FEATURES FOR BOTH INSTRUMENTS (XHL AND LED):

- ▶ **Modern pocket dermatoscope with handy dimensions:** small on the outside, but big on the inside
- ▶ **10x magnification**
- ▶ **Focus setting for compensation of ametropia: ± 4 dpt.**
- ▶ **Instrument head made of metal**
- ▶ **20,000 ON|OFF switch cycles guaranteed**
- ▶ **Distortion-free image** with high resolution edge to edge thanks to high-quality, colour-neutral achromatic optical system
- ▶ **Special small contact plate** for the examination of difficult-to-access pigmented lesions, for instance between the fingers or toes

SPECIAL FEATURES OF THE LED INSTRUMENTS:

- ▶ **There's LED. And there's LED^{HQ}.** HEINE has set a new standard which maintains that only the best is good enough, from the selection of materials to processing, from light intensity and thermal management to a colour rendering index as high as possible. **That's what we call LED in HEINE Quality – or LED^{HQ}**
- ▶ **Twice as bright** as a conventional XHL (xenon halogen) dermatoscope
- ▶ **Maintenance-free LED^{HQ} illumination** – no longer a need to replace the light source
- ▶ **Exclusive battery performance indicator:** When the instrument is switched on, the maximum light intensity is shown, then the light intensity is regulated down to the level that corresponds to the current charge status of the battery so you know when your batteries need changing
- ▶ **Fade-out feature: brightness reduces slowly even with low residual capacity,** for even more efficient use of dry or rechargeable batteries

HEINE mini 3000® dermatoscope sets | kits



Set includes: mini 3000 dermatoscope,
with contact plate with or without scale, zipper case

	2.5V LED
mini 3000 battery handle (with batteries), with contact plate with scale	D-888.78.021



Kit includes: mini 3000 dermatoscope, with contact plate with
or without scale

	2.5V XHL	2.5V LED
mini 3000 battery handle (with batteries), with contact plate with scale	D-001.78.109	D-008.78.109
mini 3000 battery handle (with batteries), with contact plate without scale	D-001.78.107	D-008.78.107

Dermatoscopes

Further articles | accessories



[01]



[02]



[03]



[04]



[05]



[06]

DELTA 30 | DELTA 30 PRO

contact plate with scale [01]	K-000.34.220
small contact plate [02] for the examination of difficult-to-access pigmented lesions	K-000.34.206
HEINE diSTANCE working ring [03]	K-000.34.103
charger 30 table charging station [04]	X-002.99.212

DELTAone

contact plate with scale [05]	K-000.34.222
small contact plate [06] for the examination of difficult-to-access pigmented lesions	K-000.24.207

DELTA 30 | DELTA 30 PRO and DELTAone

The currently available iPhone* mounting cases [07] for DELTA 30, DELTA 30 PRO and DELTAone can be found at www.heine.com/en/mounting-case-smartphone



[07]

universal smartphone adapter to clamp-on [08]
suitable for practically every smartphone with and without case

for DELTA 30 DELTA 30 PRO	K-000.34.272
for DELTAone	K-000.34.271



[08]



[09]

universal smartphone connector adhesive [09]
fits many common smartphone cases with smooth surface
made of hard plastic, the camera must not protrude from the case

iC1 dermatoscope

contact plate with scale [10]	K-000.34.201
USB cord with E4-USB medical approved plug-in power supply	X-000.99.303



[10]

The currently available iPhone* mounting cases for iC1 can be found at www.heine.com/en/mounting-case-smartphone

*Apple, the Apple Logo, iPhone and iPod touch are trademarks of Apple Inc., registered in the U.S. and other countries.

Dermatoscopes

Further articles | accessories

DELTA 20T



[01]

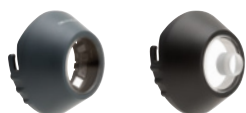

[02]

[03]



[04]



[05]

dermatoscope head with contact plate Ø 23mm with scale, without handle [01]	K-008.34.221
dermatoscope head with contact plate Ø 23mm without scale, without handle	K-008.34.222
contact plate 23mm Ø with scale [02]	K-000.34.216
contact plate 23mm Ø without scale	K-000.34.217
small contact plate, 8 mm Ø [03] for the examination of difficult-to-access pigmented lesions	K-000.34.205
SLR photo adaptor for Canon [04]	K-000.34.185
SLR photo adaptor for Nikon	K-000.34.186
adaptor cord (1.3m) for DELTA 20T handle	X-000.99.231
photo accessory set for Canon (includes SLR photo adaptor, adaptor cord, distance ring and BETA belt clip) [05]	K-000.34.190
photo accessory set for Nikon (includes SLR photo adaptor, adaptor cord, distance ring and BETA belt clip)	K-000.34.191
BETA belt clip for BETA handle	X-000.99.008

► For information on HEINE battery and rechargeable handles and the EN 200 wall transformer, see [pages 150-160](#).

Dermatoscopes

Further articles | accessories



[01]

mini 3000	2.5V XHL	2.5V LED
dermatoscope head* with contact plate with scale, without handle [01]	D-001.78.108	D-008.78.108

* only available in black | silver



[02]

XHL xenon halogen spare bulb [02]	X-001.88.109	-
-----------------------------------	--------------	---



[03]

[04]

contact plate with scale [03]	D-000.78.117
contact plate without scale	D-000.78.116
small contact plate, 8mm Ø for the examination of difficult-to-access pigmented lesions [04]	K-000.34.008
zipper case [05]	D-887.00.000



[05]

**It's sure to increase
your heartbeat.
Out of pure joy.**

HEINE sphygmomanometers and stethoscopes

SHOCKPROOF

- ▶ Shockproof double-walled construction with unique manometer protection. [01]

The robust double-walled construction with a unique triple manometer mount gives ideal protection against shocks. Meets the requirements of european standard EN ISO 81060-1 and ANSI | AAMI | ISO 81060-1

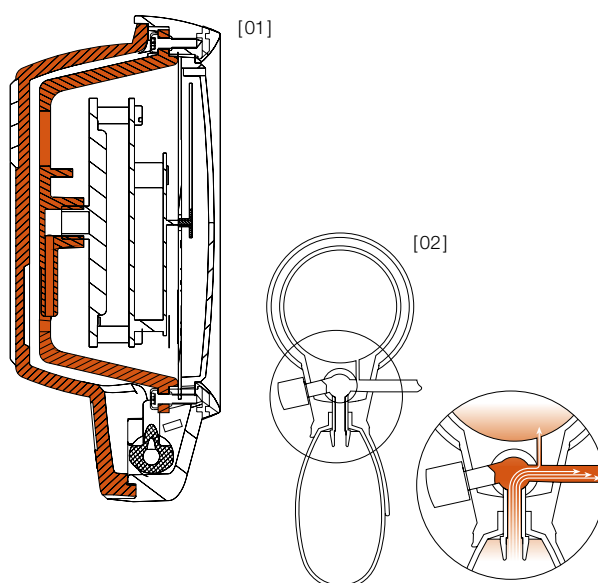

AIR PRESSURE DISTRIBUTION SYSTEM

- ▶ Single-tube construction with air pressure distribution system [02]



HEINE GAMMA® G7

The model with aluminium alloy construction and precision valve



- ▶ **Shockproof**
- ▶ **Latex-free**
- ▶ **Unique pressure measuring system**
- ▶ **Pressure-proof manometer**
- ▶ **Micro filter.** Protects valve and manometer
- ▶ **Large diameter scale.** 56 mm diameter black-on-white scale is easy to read
- ▶ **High quality indicator.** Precisely calibrated, durable and shock resistant
- ▶ **Large insufflation bulb.** 50 % larger bulb volume for fast inflation of the cuff
- ▶ **Exclusive air-release valve.** Provides fine and precise air release rate adjustment, quick deflation, and extreme durability.
- ▶ **Upper housing made of aluminium alloy** with a shock absorbing ring protecting indicator and glass
- ▶ **Lower housing is moulded of shockproof plastic** with shock absorbing, anti-slip coating
- ▶ **Light alloy, adjustable spoon.** For both right- or left-handed operation
- ▶ **High quality, single-tube cuff with velcro fastener.** Washable
- ▶ **Ergonomic design.** G7 is perfectly balanced for comfort and ease of use
- ▶ **10 year guarantee***

* against defects in design, materials and workmanship for a period of 10 years from the date of purchase.

GAMMA G7

complete with adult cuff, in zipper pouch	M-000.09.232
complete with child cuff, in zipper pouch	M-000.09.233
practice kit with child, adult and small adult cuff in zipper pouch	M-000.09.554
complete with adult cuff without zipper pouch, box of 10	M-000.09.560

HEINE GAMMA® G5

The HEINE standard sphygmomanometer



Combines all design and quality features of the GAMMA G7, except:

- ▶ **Housing is moulded of shockproof plastic** with shock absorbing, anti-slip coating
- ▶ **Adjustable spoon (plastic)**. For both right or left-handed operation
- ▶ **5 year guarantee***

* against defects in design, materials and workmanship for a period of 5 years from the date of purchase.

GAMMA G5

complete with adult cuff, in zipper pouch	M-000.09.230
complete with child cuff, in zipper pouch	M-000.09.231
practice kit with child, adult and small adult cuff in zipper pouch	M-000.09.555
complete with adult cuff without zipper pouch, box of 10	M-000.09.561

HEINE GAMMA GP

The HEINE standard sphygmomanometer with push-button valve



Combines all design and quality features of the GAMMA G5, but with a push-button valve:

► **Innovative push-button valve.** Fine and precise air-release rate adjustment, ultra-fast air-release, practically wear-free. Easy to operate by both left and right-handed users

► **5 year guarantee***

* against defects in design, materials and workmanship for a period of 5 years from the date of purchase.

GAMMA GP

complete with adult cuff, in zipper pouch	M-000.09.242
complete with child cuff, in zipper pouch	M-000.09.243
practice kit with child, adult and small adult cuff in zipper pouch	M-000.09.556
complete with adult cuff without zipper pouch, box of 10	M-000.09.562

HEINE GAMMA® XXL LF

The top-quality professional model

Since the GAMMA XXL LF is non-mercurial, it is both safe and environmentally-friendly.



- ▶ **Latex-free**
- ▶ **Durable polycarbonate construction.** Will hold up in the busiest hospital and practice environments
- ▶ **Oversized 130 mm diameter scale.** Can be pivoted for clear, easy reading from any angle
- ▶ **Long spiral inflation tube (3 m).** For increased working distance
- ▶ **High quality indicator.** Precisely-calibrated and durable
- ▶ **Precision air-release valve.** Fine and precise air release
- ▶ **Maintenance-free,** precise and durable manometer
- ▶ **Mercury-free.** Environmentally friendly
- ▶ **Wall, desk, rail and wheeled stand.** Adjustable height
- ▶ **10 year guarantee***

*against defects in design, materials and workmanship for a period of 10 years from the date of purchase.

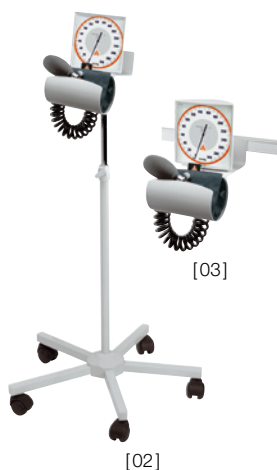

GAMMA XXL LF

GAMMA XXL LF-W wall complete with adult cuff [01]	M-000.09.323
GAMMA XXL LF-S wheeled stand complete with adult cuff [02]	M-000.09.326
GAMMA XXL LF-R rail complete with adult cuff [03]	M-000.09.325
GAMMA XXL LF-T desk complete with adult cuff (non-spiral insufflation tube) [04]	M-000.09.322
GAMMA XXL LF-WB for wallboard, see page 159 [05]	M-000.09.327



Accessories

cuff-holder for GAMMA XXL LF-T	M-000.09.141
desk stand for GAMMA XXL LF-T	M-000.09.142
adjustable wheeled stand for GAMMA XXL LF-S (height 80 – 125 cm)	M-000.09.145
universal mounting plate for GAMMA XXL LF-R, -S, -W	M-000.09.306
rail clamp for GAMMA XXL LF-R	M-000.09.307

Blood-pressure cuffs

Latex-free blood-pressure cuffs

Cuffs for GAMMA G7 | G5 | GP | XXL LF sphygmomanometers.



- ▶ **Latex-free**
- ▶ **Fit the most widely used sphygmomanometers**
- ▶ **High-quality velcro cuffs.** Physiologically tested
- ▶ **Double-sewn**
- ▶ **Washable**
- ▶ **Index mark for exact positioning**
- ▶ **Clear indication of size and control mark for arm circumference**
- ▶ **Extra thick, highly flexible tube.** For a long life
- ▶ **Proven reliability.** Absolutely airtight system

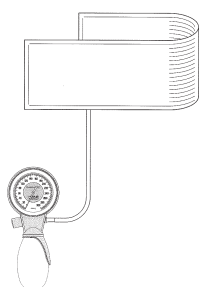

GAMMA G7 G5 GP	Single-tube cuffs (cpl.)		
	Size	Circumference cm	
infant [01]	6x28	8–13	M-000.09.700
child [02]	10x34	13–20	M-000.09.702
adult small [03]	14x53	20–29	M-000.09.704
adult [04]	14x58	29–41	M-000.09.619
adult large [05]	17x70	35–47	M-000.09.706
thigh [06]	20x86	41–59	M-000.09.615

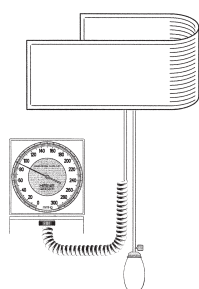

GAMMA XXL LF	Twin-tube cuffs (cpl.)		
	Size	Circumference cm	
infant [01]	6x28	8–13	M-000.09.701
child [02]	10x34	13–20	M-000.09.703
adult small [03]	14x53	20–29	M-000.09.705
adult [04]	14x58	29–41	M-000.09.629
adult large [05]	17x70	35–47	M-000.09.631
thigh [06]	20x86	41–59	M-000.09.625



HEINE GAMMA®

stethoscopes



- ▶ **Solid chest piece** and ideal weight avoid stray noise from manipulation and ensure excellent resonance. Hygienic matt chrome finish
- ▶ **Chest piece with non-chill rims for the comfort of the patients**
- ▶ **Ergonomic, chrome-plated binaurals.** Individually adjustable
- ▶ **High-quality Y-piece tubing** for perfect acoustics and sound reproduction. Length 56 cm
- ▶ **Latex-free materials**

GAMMA 3.1 pulse stethoscope

For fine acoustic performance



- ▶ **Stethoscope with solid flat chest piece.** The chest piece can be easily inserted under the sphygmomanometer cuff
- ▶ **High-quality membrane,** 44 mm diameter
- ▶ **Single-tube construction** with excellent sound transmission
- ▶ **Includes ear olives** (large|soft) for sound insulation
- ▶ **Optional available:** ear olives (small|hard) (M-000.09.946)

GAMMA 3.1

M-000.09.941

GAMMA® 3.2 acoustic stethoscope

For excellent acoustic performance



Technical data as GAMMA 3.1, but with a double chest piece.

- ▶ **Combined double chest piece** with two different frequency ranges to choose from: A high-quality membrane on one side and a conical acoustic head on the other side
- ▶ **High-quality membrane**, 44 mm diameter for excellent acoustic performance and sound transmission
- ▶ **Cone diameter 30mm**

GAMMA 3.2

M-000.09.942

GAMMA 3.3 acoustic stethoscope

For the examination of children



Technical data as GAMMA 3.2

- ▶ **Reduced contact area** of 31 mm makes GAMMA 3.3 ideal for examining children

GAMMA 3.3

M-000.09.943

**| We bring
| light into the dark.**

Instrument head for HEINE UniSpec® tubes

Illumination by fiber optic cable and projector or 3.5 V BETA handle with illumination adaptor see accessories on [page 120](#).

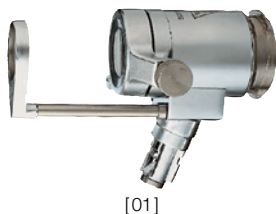

[01]

- ▶ **Annular fiber optic illumination.** Bright, reflex-free illumination
- ▶ **Magnifying lens 1.5 x.** High-resolution image
- ▶ **Hinged viewing window with insufflation port.** Improved vision by insufflation
- ▶ **Stainless steel**



[02]

Instrument head for UniSpec disposable tubes

complete with viewing window and swivel lens 1,5 x [01]	E-003.18.100
without viewing window and swivel lens	E-003.18.098
viewing window only [02]	E-003.18.099
swivel lens 1.5 x, only (for sigmoidoscopes) [03]	E-003.18.096
same, but 1.8 x (only suitable for proctoscopes and anoscopes)	E-003.19.099



[03]

HEINE UniSpec® disposable tubes

- ▶ **Disposable.** No cross-infection
- ▶ **No cleaning required.** Saves time
- ▶ **Moulded in patient-friendly thermoplastic.** No cold sensation on insertion
- ▶ **Light transmission through the tube wall.** Distal annular light exit. Bright, homogeneous illumination of the area examined, reflex reduction
- ▶ **Graduated inside the tube for patient comfort.** Indication of insertion length



UniSpec disposable anoscopes (85 x 20 mm) [01]

pack of 25 disposable anoscopes	E-003.19.925
box of 100 (4 packs of 25) anoscopes	E-003.19.911

UniSpec disposable proctoscopes (130 x 20 mm) [02]

pack of 25 disposable proctoscopes	E-003.19.825
box of 100 (4 packs of 25) proctoscopes	E-003.19.811

UniSpec disposable sigmoidoscopes (250 x 20 mm) [03]

pack of 25 disposable sigmoidoscopes	E-003.18.825
box of 100 (4 packs of 25) sigmoidoscopes	E-003.18.811

⊗: Single use only.

HEINE hygiene filter for single use

Disposable hygiene filter minimises contamination of the double bulb insufflator



disposable hygiene filters 25 pcs pack	E-000.18.116
--	--------------

⊗: Single use only.

HEINE illumination adaptor for proctological HEINE F.O. instruments

Can be attached to any HEINE 3.5 V power source to illuminate any HEINE fiber optic instrument, e.g. anoscope, proctoscope or sigmoidoscope.



illumination adaptor	3.5V XHL
illumination adaptor	X-002.98.002
XHL xenon halogen spare bulb	X-002.88.078

► Due to local regulations, some products may not be available in your country.

**| Let there be
| light.**

HEINE EL 10 LED® examination light

A real highlight in all respects with LED^{HQ} illumination



The EL 10 LED examination light distinguishes itself through an absolutely homogeneous field of light. The light intensity can be regulated continuously. The diameter of the spot size can be freely adjusted between 8.5 and 14 cm, with a working distance of 30 cm. Controls with ergonomic grip allow for intuitive and fast adjustment of brightness and spot size. The compact illumination head (Ø approx. 60 mm) allows an almost coaxial illumination, particularly in difficult application situations.



[01]



[02]



[03]



[04]

- ▶ **Bright and homogeneous.** Perfect illumination in every examination situation
- ▶ **There's LED. And there's LED^{HQ}.** HEINE has set a new standard which maintains that only the best is good enough, from the selection of materials to processing, from light intensity to dimmability, and from thermal management to a colour rendering index as high as possible. **That's what we call LED in HEINE quality – or LED^{HQ}**
- ▶ **3 different mounting options.** Wall mounting, clamp for table-top mounting or on a wheeled stand
- ▶ **Solid construction.** Reliable operation and illumination power for many years
- ▶ **Hygiene.** Easy and efficient cleaning and disinfection
- ▶ **Coiled goose neck.** Easy and intuitive adjustment
- ▶ **An electrical control system** monitors all functions and guarantees safety

EL 10 LED examination light	LED
with wall mount [01]	J-008.27.001
with clamp for table-top mounting [02]	J-008.27.002
with wheeled stand, metal base [03]	J-008.27.003

clamp for table-top mounting for EL 10 LED	J-000.27.013
wheeled stand, metal base with mount for EL 10 LED (height 80 cm)	Y-096.50.010
mount for wheeled stand [04]	J-000.27.014

HEINE EL3 LED examination light

Simply bright LED illumination in LED^{HQ}



- ▶ **Simply bright.** The EL3 LED provides bright, shadow-free illumination precisely at the point of interest
- ▶ **There's LED. And there's LED^{HQ}.** HEINE has set a new standard which maintains that only the best is good enough, from the selection of materials to processing, from light intensity and thermal management to a colour rendering index as high as possible. **That's what we call LED in HEINE quality – or LED^{HQ}**
- ▶ **Shadow-free illumination.** The compact illumination head (Ø approx. 60 mm) allows convenient, precise positioning, particularly in difficult application situations. Optimal positioning eliminates unwanted shadows in the illuminated field
- ▶ **Maintenance-free and easy to clean.** Cool-Touch closed head design makes disinfection safe and easy
- ▶ **Optimal positioning.** The light weight head and stable goose neck allow easy and intuitive adjustment and keep the light exactly in the required position
- ▶ **Various mounting options.** Wall mounting, clamp for table-top mounting or on a wheeled stand



[01]



[02]

EL3 LED examination light	LED
with wall mount [01]	J-008.27.011
with clamp for table-top mounting [02]	J-008.27.013
with wheeled stand, metal base [03]	J-008.27.014



[03]

[04]

clamp for table-top mounting for EL3 LED	J-000.27.013
wheeled stand, metal base with mount for EL3 LED (height 80 cm)	Y-096.50.010
mount for wheeled stand [04]	J-000.27.014

**Once you've
tried it, you'll
never want to do
without it again.**

HEINE binocular loupes

Overview

It goes without saying that all of our binocular loupes are premium products. But, still, they differ in one or two details. Read on for a summary of what these different details are and all their benefits:



	HR	HRP	C
Magnification working distance	2.5x 340mm 2.5x 420mm 2.5x 520mm	3.5x 420mm 4x 340mm 6x 340mm	2.3x 340mm 2.3x 450mm
Mounting options	S-FRAME spectacle frame [01], professional L headband [02]		lightweight headband [04]
Further articles	protective lenses, close-up lenses (to reduce the working distance from 340mm to 250mm), LoupeLight2 [03] (pages 135 136)	protective lenses, LoupeLight2 [03] (pages 135 136)	protective lenses
Features	i-View function*, modular, water-resistant, achromatic optics, optional prescription correction		–
Catalogue page	128-129	130-131	132

*i-View function: Provides any angle of view and flips up the optics independently of the illumination beam.



[01]



[02]



[03]



[04]

HEINE binocular loupes

How to choose the correct loupe

Various magnifications (from 2.3 x to 6 x), working distances, wearing options (unique S-FRAME, Lightweight headband and Professional L headband) and LoupeLight2 illumination systems are available. They provide homogeneous, reflex-free illumination even in deep cavities. State-of-the-art LED^{HQ} technology and design!

HEINE binocular loupes are used in many disciplines: e.g. general medicine, dermatology, surgery, cosmetic surgery, neurosurgery, ENT, ophthalmology, veterinary medicine, dentistry etc.

DEFINITIONS:

Working distance (x)

The distance, at which the optics of a loupe are sharply-focused.

Depth of field (y)

The range over which the image remains sharply-focused.

Field of view (z)

The area that can be seen under magnification at the nominal working distance.

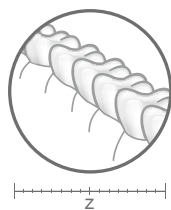
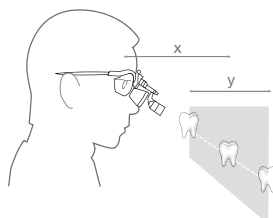

More information can be found on www.heine.com

CHOOSE YOUR MAGNIFICATION

Choose the lowest magnification that meets your needs. The lower the magnification, the larger the field of view and the easier the loupe will be to use.

CHOOSE YOUR OPTICS

HR: High resolution achromatic optics with excellent optical qualities.

HRP: High resolution prismatic optics with excellent optical qualities for 3.5 x magnification and higher.

C: Economy.

CHOOSE YOUR WORKING DISTANCE

This is an individual choice depending on the examiner's size and working position. The longer the working distance, the bigger the field of view.

CHOOSE YOUR MOUNTING OPTION

Spectacle frame or headband.

ADD ILLUMINATION

Coaxial bright light is especially-important when using magnification.

HEINE HR 2.5x high resolution binocular loupes With i-View loupe mount

HR 2.5X OPTICS WITH i-VIEW



- ▶ **Achromatic optics** for crisp, bright images with colour-correction
- ▶ **Lightweight** (51 g)
- ▶ **Water-resistant**
- ▶ **Independent adjustment** of left and right optics for perfect PD adjustment
- ▶ **High magnification with a large field of view and excellent depth of field**
- ▶ **i-View loupe mount** provides any angle of view and flips up the optics independently of the optional LoupeLight2

HR 2.5x specifications

Working distance in mm	340	420	520
Field of view in mm	90	130	180
Depth of field in mm	110	180	260



Optional
clip-in correction frame

Mounting options:

HEINE S-FRAME

- ▶ **Maximum comfort** with a modern, ergonomic design
- ▶ **Malleable temples and nose pad** can be customized to fit any face perfectly
- ▶ **Innovative materials:** Carbon-Kynetium reduces weight (24 g)
- ▶ **Tough polycarbonate protective lenses**
- ▶ **Optional clip-in correction frame** for prescription lenses



Professional L headband
with S-GUARD

HEINE PROFESSIONAL L HEADBAND WITH S-GUARD

- ▶ **S-GUARD splash protection**
- ▶ **Ergonomic nose pad** for comfort during long procedures
- ▶ **Fully-adjustable for height and width to fit any head**
- ▶ **Hygienic and comfortable leather cushions**
- ▶ **Optional clip-in correction frame** for prescription lenses



Professional L headband
without S-GUARD

HEINE PROFESSIONAL L HEADBAND WITHOUT S-GUARD

- ▶ **Ideal for spectacle-wearers in combination with their own spectacles**
- ▶ **Fully-adjustable for height and width to fit any head**
- ▶ **Hygienic and comfortable leather cushions**

HEINE HR 2.5x high resolution binocular loupes With i-View loupe mount

HR 2.5x sets with i-View loupe mount



Set A

Working distance in mm	340	420	520
Set A: HR 2.5x optics with i-View on S-FRAME protective lenses 2 sterilisable swivel levers retaining cord cleaning cloth carrying case	C-000.32.355	C-000.32.356	C-000.32.567



Set B with S-GUARD

Set B: HR 2.5x optics with i-View on Professional L headband S-GUARD splash protection protective lenses 2 sterilisable swivel levers cleaning cloth	C-000.32.365	C-000.32.366	C-000.32.367
--	---------------------	---------------------	---------------------



Set C without S-GUARD

Set C (without S-GUARD): HR 2.5x optics with i-View on Professional L Kopfband protective lenses 2 sterilisable swivel levers	C-000.32.865	C-000.32.866	C-000.32.867
---	---------------------	---------------------	---------------------

► For details of accessories and LoupeLight2 see [pages 134-136](#).

HEINE HRP high resolution prismatic binocular loupes With i-View loupe mount

HRP OPTICS WITH i-VIEW



- ▶ **Achromatic optics** for crisp, bright images from edge-to-edge
- ▶ **Lightweight** (85 g)
- ▶ **Water-resistant**
- ▶ **Independent adjustment** of left and right optics for perfect PD adjustment
- ▶ **Highest magnification:** Choice of 3.5 x, 4 x and 6 x
- ▶ **i-View loupe mount** provides any angle of view and flips up the optics independently of the optional LoupeLight2

HRP specifications

Working distance in mm	HRP 3.5x 420	HRP 4x 340	HRP 6x 340
Field of view in mm	65	50	40
Depth of field in mm	60	40	30



Optional
clip-in correction frame

Mounting options:

HEINE S-FRAME

- ▶ **Maximum comfort** with a modern, ergonomic design
- ▶ **Malleable temples and nose pad** can be customized to fit any face perfectly
- ▶ **Innovative materials:** Carbon-Kynetium reduces weight (24 g)
- ▶ **Tough polycarbonate protective lenses**
- ▶ **Optional clip-in correction frame** for prescription lenses



with S-GUARD

HEINE PROFESSIONAL L HEADBAND WITH S-GUARD

- ▶ **S-GUARD splash protection**
- ▶ **Ergonomic nose pad** for comfort during long procedures
- ▶ **Fully-adjustable for height and width to fit any head**
- ▶ **Hygienic and comfortable leather cushions**
- ▶ **Optional clip-in correction frame** for prescription lenses



without S-GUARD

HEINE PROFESSIONAL L HEADBAND WITHOUT S-GUARD

- ▶ **Ideal for spectacle-wearers in combination with their own spectacles**
- ▶ **Fully-adjustable for height and width to fit any head**
- ▶ **Hygienic and comfortable leather cushions**

HEINE HRP high resolution prismatic binocular loupes With i-View loupe mount

HRP sets with i-View loupe mount



Set A

Working distance in mm	HRP 3.5x 420	HRP 4x 340	HRP 6x 340
Set A: HRP optics with i-View on S-FRAME protective lenses 2 sterilisable swivel levers retaining cord cleaning cloth carrying case	C-000.32.430	C-000.32.431	C-000.32.432



Set B with S-GUARD

Set B: HRP optics with i-View on Professional L headband S-GUARD splash protection protective lenses 2 sterilisable swivel levers cleaning cloth	C-000.32.440	C-000.32.441	C-000.32.442
---	---------------------	---------------------	---------------------



Set C without S-GUARD

Set C (without S-GUARD): HRP optics with i-View on Professional L headband protective lenses 2 sterilisable swivel levers	C-000.32.840	C-000.32.841	C-000.32.842
--	---------------------	---------------------	---------------------

► For details of accessories and LoupeLight2 see [pages 134-136](#).

HEINE C2.3K binocular loupes

The cost-effective all-purpose loupe



Ideal for dental laboratories and general medical examination.

- ▶ **Crisp, clear images.** Multi-coated, scratch-resistant silica glass lenses produce crisp, clear images
- ▶ **Flexibility for precise adjustment.** Independently adjustable PD controls ensure precise alignment of the optics
- ▶ **The ideal all-purpose loupe.** The feather-light weight, low-profile design and low cost of the C2.3K loupe make it the ideal all-purpose loupe
- ▶ **Working distance.** 340mm or 450mm (13 or 18 inches)

Specifications	C2.3K 340mm	C2.3K 450mm
Magnification	2.3x	2.3x
Working distance	340mm	450mm
Field of view Ø	110mm	130mm
Weight	160g	160g
Depth of field	120mm	190mm

User's refractive error	Effective working distance C2.3x 340mm	Effective working distance C2.3x 450mm
+2	440mm	670mm
+1	390mm	560mm
0	340mm	450mm
-1	300mm	420mm
-2	270mm	370mm

Important information for those who wear glasses:

The C2.3K loupe can be worn with spectacles. Should you prefer to examine without glasses, the charts illustrate how your refractive error will affect the loupe working distance. If you are unsure of your prescription, please consult your eye care provider.

C2.3K binocular loupes

C2.3K 340 headband loupe in case	C-000.32.230
C2.3K 450 headband loupe in case	C-000.32.231



Detachable protective lenses for C2.3K to protect the optic	C-000.32.097
---	--------------

HEINE binocular loupes

Ordering information



Optics with i-View loupe mount for S-FRAME in carrying case

Working distance in mm	340mm	420mm	520mm
HR 2.5x	C-000.32.595	C-000.32.596	C-000.32.597



HRP 3.5x	–	C-000.32.720	–
HRP 4x	C-000.32.721	–	–
HRP 6x	C-000.32.722	–	–



Optics with i-View and S-GUARD for Professional L headband

Working distance in mm	340mm	420mm	520mm
HR 2.5x	C-000.32.585	C-000.32.586	C-000.32.587

HRP 3.5x	–	C-000.32.710	–
HRP 4x	C-000.32.711	–	–
HRP 6x	C-000.32.712	–	–



Optics with i-View for Professional L headband (without S-GUARD)

Working distance in mm	340mm	420mm	520mm
HR 2.5x	C-000.32.733	C-000.32.734	C-000.32.735

HRP 3.5x	–	C-000.32.736	–
HRP 4x	C-000.32.737	–	–
HRP 6x	C-000.32.738	–	–

Accessories for HEINE binocular loupes

Ordering information



[01]



[02]



[03]



[04]



[05]



[06]



[07]



[08]



[09]



[10]



[11]

Mounting options

S-FRAME* for HR and HRP binocular loupes incl. retaining cord [01]	C-000.32.302
Professional L headband for HR and HRP optics [02]	C-000.32.549

* with protective lenses, large (lg).

Accessories for optics

HR close-up lenses in case for HR 2.5x 340mm. The close-up lenses reduce the working distance of the binocular loupes HR 2.5x 340mm to 250mm [03]	C-000.32.523
---	--------------

Protective lenses to protect the optics of the HR and the HRP loupes

protective lenses for HR loupes (5 pairs) [04]	C-000.32.537
protective lenses for HRP loupes [05]	C-000.32.027
sterilisable swivel levers for HR and HRP loupes with i-View [06]	C-000.32.551
carrying case for binocular loupe optics or for all sets with S-FRAME [07]	C-000.32.552

Carrying cases and storage cases may deviate in shape and colour.

Accessories for S-FRAME

S-FRAME retaining cord [08]	C-000.32.305
S-FRAME replacement part set with side rubbers, nose pad (1 piece) and screw [09]	C-000.32.308
clip-in correction frame for prescription lenses [10]	C-000.32.309
protective lenses, large (lg), 1 pair (standard) [11]	C-000.32.306
protective lenses, small (sm), 1 pair	C-000.32.307

HEINE LoupeLight2 Compact LED^{HQ} headlight



- ▶ **There's LED. And there's LED^{HQ}.** HEINE has set a new standard which maintains that only the best is good enough, from the selection of materials to processing, from light intensity to dimmability, and from thermal management to a colour rendering index as high as possible. **That's what we call LED in HEINE quality – or LED^{HQ}**
- ▶ **Compact, lightweight (50 g).** Ensures perfect comfort
- ▶ **Aluminium housing.** Exclusive aluminium housing protects the optics against dust and moisture to ensure an extraordinary long lifespan and optimal thermal management
- ▶ **Coaxial illumination.** Compact coaxial design ensures a completely shadow-free image and allows for excellent illumination of difficult to see areas
- ▶ **Optional filter.** Polarisation filter P2 improves contrast and yellow filter reduces blue light
- ▶ **Replaceable connecting cord** with high-quality splashproof threaded connector with a length of 1.5 m. Connects the LoupeLight2 with the mPack mini
- ▶ **Incl. coloured attachment clips for personalisation.** To fixate the cable and to identify your LoupeLight

Technical specification

Illumination	typ. 55,000 lux*
Colour temperature	typ. 4,000 kelvin
LED operating life	typ. 50,000 hours
Spot size	the illuminated field is designed to complement the HR HRP loupes. 81 mm Ø at 420 mm, 95 mm Ø at 520 mm working distance
Angle of declination	stepless and individually adjustable for every examination
Operating time	typ. 9 h with mPack mini (in continuous operation at full power typ. 4 hours)

*Measured at a working distance of 180mm from the light emission to the object.



[01] Conventional system
[02] HEINE precision 4-lens system

- ▶ **Precision multiple lens optical system** consisting of four high-quality lenses. Completely homogeneous illumination of the whole field of view and a clearly defined light spot

HEINE LoupeLight2 sets with mPack mini and E4-USB plug-in transformer

LoupeLight2 sets with HR binocular loupes



Magnification working distance in mm	HR 2.5x 340	HR 2.5x 420	HR 2.5x 520
HR 2.5 x optics with i-View on S-FRAME and LoupeLight2 detachable yellow filter mPack mini mPack mini belt clip E4-USB plug-in transformer connecting cord protective lenses 2 sterilisable levers retaining cord, cleaning cloth, case	C-008.32.450	C-008.32.451	C-008.32.452

LoupeLight2 sets with HRP binocular loupes



Magnification working distance in mm	HRP 3.5x 420	HRP 4x 340	HRP 6x 340
HRP optics with i-View on S-FRAME and LoupeLight2 detachable yellow filter mPack mini mPack mini belt clip E4-USB plug-in transformer connecting cord protective lenses 2 sterilisable levers retaining cord, cleaning cloth, case	C-008.32.453	C-008.32.454	C-008.32.455

Carrying cases and storage cases may deviate in shape and colour.

- ▶ For further information on the mPack mini, please see [pages 141 and 168](#).
- ▶ Power supplies may deviate in size and shape.

HEINE LoupeLight2 and accessories

Ordering information



[01]

[02]

LoupeLight2

LoupeLight2 for HR / HRP loupes for i-View loupe mount* [01]	C-008.32.226
detachable yellow filter [02]	C-000.32.241
polarisation filter P2 for LoupeLight2 and HR loupes [03] + [04]	C-000.32.535
spare polarisation filter P2 for HR loupes (2 pairs) [04]	C-000.32.536
connecting cord SC1 (1.5m Ø 2.4 mm) for LoupeLight2 mPack mini [05]	C-000.32.240
connecting cord SC2 (1.5m Ø 3.2 mm) for LoupeLight2 mPack mini [06]	C-000.32.243



[03]

[04]



[05]



[06]

LoupeLight2 with power source for i-View loupe mount (HR|HRP)

LoupeLight2 with mPack mini and E4-USB plug-in transformer* [07]	C-008.32.265
mPack mini belt clip [08]	X-000.99.006



[07]



[08]

*Not suitable for HR | HRP loupes with a rigid loupe mount.

HEINE mPack mini

Compact and lightweight power source for LoupeLight2 | MicroLight2



- ▶ **Operating time typ. 9 hours.** In continuous operation at full power typ. 4 hours
- ▶ **Charging time typ. 4 hours**
- ▶ **Compact and lightweight.** With a weight of just 95 g and dimensions of 44 x 23 x 101 mm the power source can be easily stowed

HEINE headlights

Overview

It goes without saying that all of our headlights are premium products. But, still, they differ in one or two details. Read on for a summary of what these different details are and all their benefits:



	MicroLight2	ML4 LED HeadLight
Illumination	LED ^{HQ}	
Light intensity*	typ. 55,000 lux	typ. 90,000 lux
Colour temperature (kelvin)	typ. 4,000K	typ. 5,500K
Spot size	81 mm	30 – 80mm
Power sources operating time	mPack mini typ. 9 hours	mPack UNPLUGGED typ. 3.5 hours mPack typ. 8.5 Std.
Weight	80g with S-FRAME spectacle frame 190g with Lightweight headband	260g 460g with mPack UNPLUGGED
Angle of declination	fully-adjustable	
Brightness control	0 – 100%	
Features	waterproof, optional yellow filter, head- or spectacle-worn,	adjustable spot size, optional yellow filter, polarisation filter, expandable with HR and HRP loupes, head-worn,
Catalogue page	139-140	143-144

*Measured at a working distance of 180mm from the light emission to the object.

HEINE MicroLight2 Compact LED^{HQ} headlight



- ▶ **There's LED. And there's LED^{HQ}.** HEINE has set a new standard which maintains that only the best is good enough, from the selection of materials to processing, from light intensity to dimmability, and from thermal management to a colour rendering index as high as possible. **That's what we call LED in HEINE quality – or LED^{HQ}**
- ▶ **Compact and lightweight.** Ensures perfect comfort
- ▶ **Aluminium housing.** Exclusive aluminium housing protects the optics against dust and moisture to ensure an extraordinary long lifespan and optimal thermal management
- ▶ **Coaxial illumination.** Compact coaxial design ensures a completely shadow-free image and allows for excellent illumination of difficult to see areas
- ▶ **Homogeneity.** An absolutely bright light spot that is uniform from edge-to-edge for the perfect illumination in all examination situations
- ▶ **Replaceable connecting cord** with high-quality splashproof threaded connector with a length of 1.5 m. Connects the MicroLight2 with the mPack mini
- ▶ **Incl. coloured attachment clips for personalisation.** To fixate the cable on the S-FRAME and to identify your headlight

Technical specification

Illumination	typ. 55,000 lux*
Colour temperature	typ. 4,000 kelvin
LED operating life	typ. 50,000 hours
Weight	80g together with S-FRAME, 190g together with lightweight headband
Angle of declination	stepless and individually adjustable for every examination
Operating time	typ. 9 h with mPack mini (in continuous operation at full power typ. 4 hours)

* Measured at a working distance of 180 mm from the light emission to the object.

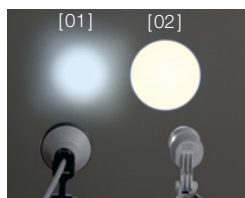

[01] Conventional system
[02] HEINE precision
4-lens system

- ▶ **Precision multiple lens optical system** consisting of four high-quality lenses. Completely homogeneous illumination of the whole field of view, and a clearly defined light spot

HEINE MicroLight2

Mounting options

HEINE S-FRAME



- ▶ **Maximum comfort** with a modern, ergonomic design
- ▶ **Malleable temples and nose pad.** Can be customized to fit any face perfectly
- ▶ **Innovative materials:** Carbon-Kynetium reduces weight (80g together with MicroLight2)
- ▶ **Tough polycarbonate protective lenses**

HEINE LIGHTWEIGHT HEADBAND



- ▶ **Lightweight** (190 g together with MicroLight2). Ideal for spectacle wearers
- ▶ **Fully-adjustable for width to fit any head**
- ▶ **Hygienic and comfortable leather cushions**

HEINE mPack mini

Compact and lightweight power source for LoupeLight2 | MicroLight2



- ▶ **Freedom from cables** that tie the user to desk, wall or static power supplies
- ▶ **Operating time typ. 9 hours.** In continuous operation at full power typ. 4 hours
- ▶ **Charging time typ. 4 hours**
- ▶ **Charge status indicator.** Display of remaining battery power with three LEDs. The flashing of the last LED indicates that immediate charging is required. During charging the LEDs light up one after the other
- ▶ **Stepless light intensity control.** Optimum brightness setting between 100 % and 3 % reduces reflexes
- ▶ **USB cord** with E4-USB medical approved plug-in power supply
- ▶ **The integrated galvanic separation module** protects the battery and the user against the consequences of defective power supplies, thus preventing the possibility of the full mains voltage flowing directly to the housing. We recommend the use of a medical approved plug-in power supply
- ▶ **Simple cleaning.** Closed housing, no seams at the sides, few edges
- ▶ **Compact and lightweight.** With a weight of just 95 g and dimensions of 44 x 23 x 101 mm the power source can be easily stowed
- ▶ **Optimised mPack mini belt clip** for easy attachment of the power source to the belt or coat pocket. The mPack mini can also be charged in the belt clip [01]
- ▶ **Li-ion technology.** No „memory effect“, without worrying about charge level or battery condition
- ▶ **Integrated rechargeable battery.** Can be exchanged at authorised specialist dealers



[01]

▶ For further information on the mPack mini, please see [page 168](#).

HEINE MicroLight2

Ordering information



[01]

MicroLight2

on S-FRAME with mPack mini, mPack mini belt clip, E4-USB plug-in transformer with USB cord, connecting cord, retaining cord, in case [01]	J-008.31.276
---	---------------------

on Lightweight headband with mPack mini, mPack mini belt clip, E4-USB plug-in transformer with USB cord, connecting cord, in case [02]	J-008.31.277
--	---------------------



[02]

detachable yellow filter [03]	C-000.32.241
-------------------------------	---------------------

connecting cord SC1 (1.5m Ø 2.4mm) for MicroLight2 mPack mini [04]	C-000.32.240
--	---------------------

connecting cord SC2 (1.5m Ø 3.2mm) for MicroLight2 mPack mini [05]	C-000.32.243
--	---------------------

Carrying cases and storage cases may deviate in shape and colour.



[03]



[04]



[05]

HEINE ML4 LED HeadLight

Ultra bright coaxial LED^{HQ} illumination



- ▶ **There's LED. And there's LED^{HQ}.** HEINE has set a new standard which maintains that only the best is good enough, from the selection of materials to processing, from light intensity to dimmability, and from thermal management to a colour rendering index as high as possible. **That's what we call LED in HEINE quality – or LED^{HQ}**
- ▶ **Adjustable illumination spot size:** 30 mm to 80 mm spot size range (at 420 mm working distance) to fit any examination situation
- ▶ **Bright and homogenous illumination.** Absolutely bright light spot that is uniform from edge-to-edge for the perfect illumination in all examination situations
- ▶ **Flexibility.** Flexible power source options: 100 % mobility with a choice of cable-free mPack UNPLUGGED head-worn battery or mPack belt-worn battery pack
- ▶ **Comfortable and secure fit.** The Professional L headband has multiple adjustment points and soft padding for comfort and stability – even during long examinations
- ▶ **Optional filters.** Polarisation filter P2 improves contrast and yellow filter reduces blue light

Technical specification

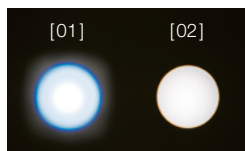

[01] Competitor product
[02] HEINE ML4 LED HeadLight

Illumination	typ. 90,000 lux*
Colour temperature	typ. 5,500 kelvin
LED operating life	typ. 50,000 hours
Spot adjustment	30 mm to 80 mm at 420 mm working distance
Angle of declination	stepless and individually adjustable for every examination
Rheostat	headband-mounted
Operating time	typ. 8.5 hours with mPack and typ. 3.5 hours with mPack UNPLUGGED of continuous ON time at full power

* Measured at a working distance of 180 mm from the light emission to the object.

HEINE ML4 LED HeadLight

Power options

HEINE mPACK



- ▶ **Portable power pack.** Does not tie the user to desk, wall or static power supplies
- ▶ **Li-ion technology. Triple capacity** compared with current NiCd systems. No memory effect, autonomy for typ. 8.5 hours of continuous ON time at full power
- ▶ **Fast charge.** Charges to full capacity in typ. 2 hours
- ▶ **Charge status indicator.** Always lets you know how much operating charge you have left
- ▶ **Brightness control.** Optimal adjustment of light intensity
- ▶ **Flexible charging options.** EN 50 desk and wall charger, or plug-in transformer
- ▶ **Intelligent.** Can be used as mains power supply even while in “charge” mode
- ▶ **100 – 240 V compatible transformer** incl. 4 plugs for world wide compatibility

HEINE mPACK UNPLUGGED HEADBAND-MOUNTED RECHARGEABLE BATTERY



- ▶ **Wireless.** 100 % mobility for absolute freedom of movement
- ▶ **Rechargeable battery integrated on the headband**
- ▶ **Lightweight with balanced weight distribution.** High level of comfort
- ▶ **Charge status indicator** indicates remaining operating time
- ▶ **Intelligent.** Can be used as mains power supply even in “charge” mode
- ▶ **Fast charge.** Charges to full capacity in typ. 2 hours. Operating time typ. 3.5 hours of continuous ON time at full power
- ▶ **Top safety standards.** Integrated charge and performance checks during operation. Lithium polymer technology. UL compliant

▶ For the optional EN 50 table | wall unit please see [page 167](#).

HEINE ML4 LED HeadLight

Ordering information



[01]



[02]



[03]



[04]



[05]



[06]

[07]



[08]

[09]

ML4 LED HeadLight with Professional L headband

ML4 LED HeadLight (without power source) [01]	J-008.31.410
ML4 LED HeadLight with plug-in transformer [01] + [02]	J-008.31.411
ML4 LED HeadLight with mPack and plug-in transformer [01]+ [03]	J-008.31.413
ML4 LED HeadLight with mPack UNPLUGGED and plug-in transformer UNPLUGGED [01] + [04]	J-008.31.415
ML4 LED HeadLight with wall mounted EN 50 UNPLUGGED charger and 2 x mPack UNPLUGGED [01] + [05]	J-008.31.416

ML4 LED HeadLight accessories

detachable yellow filter [06]	J-000.31.321
extension cord from plug-in transformer UNPLUGGED to mPack UNPLUGGED, 2m [07]	X-000.99.668
polarisation filter P2 for ML4 LED and HR loupes [08] + [09]	J-000.31.326
spare polarisation filter P2 for HR loupes (2 pairs) [09]	C-000.32.536

Power supplies may deviate in size and shape.

HEINE ML4 LED HeadLight with HR|HRP binocular loupes

The ML4 LED HeadLight is optionally supplied with HR|HRP binocular loupes incl. i-View loupe mount and with or without S-GUARD. The binocular loupe is fully adjustable for every examiner and for every examination axis.

- ▶ **HEINE S-GUARD:** Rapid and simple symmetric adjustment of binocular loupes with splash protection by protective lenses
- ▶ **HEINE i-View for ML4 LED HeadLight:** Provides any angle of view and flips up the optics independently of the illumination beam



ML4 LED HeadLight kits with S-GUARD and power source

The following kits contain: ML4 LED HeadLight on Professional L headband, HR|HRP optics with i-View and S-GUARD, mPack and plug-in transformer

Kit 1:	with HR binocular loupe	2.5x 340 mm	J-008.31.440
Kit 2:	with HR binocular loupe	2.5x 420 mm	J-008.31.441
Kit 11:	with HR binocular loupe	2.5x 520 mm	J-008.31.450
Kit 3:	with HRP binocular loupe	3.5x 420 mm	J-008.31.442
Kit 4:	with HRP binocular loupe	4x 340 mm	J-008.31.443
Kit 5:	with HRP binocular loupe	6x 340 mm	J-008.31.444



ML4 LED HeadLight kits with power source without S-GUARD

The following kits contain: ML4 LED HeadLight on Professional L headband, HR|HRP optics with i-View, mPack and plug-in transformer

Kit 1c:	with HR binocular loupe	2.5x 340 mm	J-008.31.452
Kit 2c:	with HR binocular loupe	2.5x 420 mm	J-008.31.453
Kit 11c:	with HR binocular loupe	2.5x 520 mm	J-008.31.463
Kit 3c:	with HRP binocular loupe	3.5x 420 mm	J-008.31.454
Kit 4c:	with HRP binocular loupe	4x 340 mm	J-008.31.456
Kit 5c:	with HRP binocular loupe	6x 340 mm	J-008.31.457

HEINE ML4 LED HeadLight UNPLUGGED with HR|HRP binocular loupes



ML4 LED HeadLight UNPLUGGED kits with S-GUARD and power source

The following kits contain: ML4 LED HeadLight on Professional L headband, HR|HRP optics with i-View and S-GUARD, wall transformer EN 50 UNPLUGGED, 2x mPack UNPLUGGED

Kit 6:	with HR binocular loupe	2.5x 340mm	J-008.31.445
Kit 7:	with HR binocular loupe	2.5x 420mm	J-008.31.446
Kit 12:	with HR binocular loupe	2.5x 520mm	J-008.31.451
Kit 8:	with HRP binocular loupe	3.5x 420mm	J-008.31.447
Kit 9:	with HRP binocular loupe	4x 340mm	J-008.31.448
Kit 10:	with HRP binocular loupe	6x 340mm	J-008.31.449



ML4 LED HeadLight UNPLUGGED kits with power source without S-GUARD

The following kits contain: ML4 LED HeadLight on Professional L headband, HR|HRP optics with i-View, wall transformer EN 50 UNPLUGGED, 2x mPack UNPLUGGED

Kit 6c:	with HR binocular loupe	2.5x 340mm	J-008.31.458
Kit 7c:	with HR binocular loupe	2.5x 420mm	J-008.31.459
Kit 12c:	with HR binocular loupe	2.5x 520mm	J-008.31.464
Kit 8c:	with HRP binocular loupe	3.5x 420mm	J-008.31.460
Kit 9c:	with HRP binocular loupe	4x 340mm	J-008.31.461
Kit 10c:	with HRP binocular loupe	6x 340mm	J-008.31.462

HR|HRP binocular loupes – retrofitting sets

For HEINE ML4 LED HeadLight



Pos. 1



Pos. 2



[01]

Retrofitting set HR|HRP binocular loupes for ML4 LED HeadLight

The sets enable you to equip your existing ML4 LED HeadLight with a binocular loupe. The set contains HR|HRP optics with i-View splash protection

		with S-GUARD splash protection	without S-GUARD splash protection
with HR binocular loupe	2.5x 340mm	J-000.31.370	J-000.31.287
with HR binocular loupe	2.5x 420mm	J-000.31.371	J-000.31.288
with HR binocular loupe	2.5x 520mm	J-000.31.365	J-000.31.292
with HRP binocular loupe	3.5x 420mm	J-000.31.372	J-000.31.289
with HRP binocular loupe	4x 340mm	J-000.31.373	J-000.31.290
with HRP binocular loupe	6x 340mm	J-000.31.374	J-000.31.291
5 sterilisable swivel levers for i-View loupe mount for ML4 LED HeadLight [01]			C-000.32.399

HEINE ML4 LED HeadLight

Power sources



[01]



[02]



[03]

mPack and plug-in transformer [01]	X-007.99.672
Plug-in transformer for ML4 LED HeadLight [02]	X-095.16.330
mPack with EN 50 table wall unit (incl. 90° angled adaptor, instrument support for Professional L headband) [03]	X-095.17.302

Power supplies may deviate in size and shape.

Original handles.

Original power sources.

Original bulbs.

100 % HEINE.

HEINE BETA® 4 handle range

Next-generation energy management



- ▶ **One handle for all applications** – a well thought out range combines everybody's needs and all technologies. Choice of power sources from basic alkaline batteries up to latest Li-ion technology
- ▶ **4 handle options:**
 - ▷ **BETA drycell handle**
 - ▷ **BETA4 USB rechargeable handle** with USB cord and medical approved plug-in power supply
 - ▷ **BETA4 NT and BETA4 SLIM NT rechargeable handle** for NT4 table charger
- ▶ **Compatibility during your entire career.** The BETA4 rechargeable handles are compatible with all 3.5 V XHL and LED HEINE instruments
- ▶ **Complete freedom of choice:** One basic handle for any situation. Decide between dry-cell or rechargeable; enhanced mobility with USB charging or convenient desk charging in the HEINE NT4 table charger

HEINE BETA®

handle module



The **handle module X-000.99.010**, 145 mm x 30 mm Ø, is the basis of every BETA handle. By adding the appropriate bottom inserts it is possible to assemble any of the handles shown on this page. A BETA battery handle can also be converted to a rechargeable handle in this way. All BETA handles feature short-circuit protection and a continuous ceramic brightness control.

BETA handle module	X-000.99.010
--------------------	--------------

HEINE BETA® battery handle



BETA battery handle	2.5V
battery handle complete with bottom insert (batteries not included, appropriate batteries: IEC LR14)	X-001.99.118
BETA bottom insert	X-000.99.119
BETA belt clip	X-000.99.008

HEINE BETA SLIM battery handle



Dimensions: 135mm x 19mm Ø. Weight: 180g

A compact handle with automatic connector for those who prefer a slim handle. Batteries not included.

BETA SLIM battery handle	2.5V
for 2 alkali-manganese batteries, size AA	X-001.99.105

HEINE BETA®4 rechargeable handles

Next-generation energy management



- ▶ **High-quality metal construction** for strength and durability
- ▶ **Exclusive automatic connector with locking design.** No metal on metal friction which can wear out over time, for a secure fit for the lifetime of your instruments
- ▶ **Deep battery discharge protection:** Integrated safety system protects your investment by preventing batteries from completely draining; thus ensuring maximum battery life
- ▶ **Familiar brightness control:** Rheostat for continuous brightness control with power level indicator
- ▶ **Li-ion technology:** no “memory effect”. Charge your handle how you like without worrying about charge level or battery condition
- ▶ **Extended ON time:** work typ. 6 weeks between recharging with LED instruments
- ▶ **Quick charge**
- ▶ Slightly knurled finish of the handle provides a **non-slip grip** but is **easy to clean and disinfect**
- ▶ **Charge status indicator** in the bottom insert: the indicator shines orange if the battery needs to be recharged. In the BETA4 USB handle the indicator blinks green during the charging process and shines permanently green as soon as it is fully charged

HEINE BETA®4 NT rechargeable handle

For NT4 table charger



[01]

- ▶ **Ready-to-use function.** Handles switch ON & OFF automatically when placed into charger. Set your desired brightness level once and it stays there every time you use your instrument. Also prevents battery damage and premature bulb burn outs if the instruments are accidentally left on
- Not compatible with the NT 300 table charger and the previous generations.

BETA4 NT rechargeable handle for NT4 table charger	3.5V Li-ion
rechargeable handle complete with Li-ion rechargeable battery and BETA4 NT bottom insert	X-007.99.396
BETA4 NT bottom insert	X-002.99.394
Li-ion rechargeable battery for BETA4 rechargeable handle	X-007.99.383
BETA belt clip [01]	X-000.99.008

HEINE BETA®4 USB

Li-ion rechargeable handle



- ▶ **Maximum safety.** You can charge your HEINE BETA4 USB handle with any USB plug or other USB power source, with absolute peace of mind. The BETA4 USB handle has an integrated, exclusive galvanic separation module that protects the handle, and the user, even if a faulty or inferior plug is used; thus preventing the possibility of the full mains voltage flowing directly to the handle. We do however recommend the use of a medical approved plug-in power supply



[01]

[02]



[03]

BETA4 USB Li-ion rechargeable handle	3.5V Li-ion
rechargeable handle complete with Li-ion rechargeable battery, BETA4 USB bottom insert, USB cord with medical approved plug-in power supply and handle rest	X-007.99.388
Li-ion rechargeable battery for BETA4 rechargeable handle	X-007.99.383
BETA4 USB bottom insert	X-002.99.395
USB cord [01] with E4-USB plug-in power supply [02]	X-000.99.303
E4-USB medical approved plug-in power supply [02]	X-000.99.305
BETA belt clip [03]	X-000.99.008

HEINE BETA®4 SLIM NT

rechargeable handle

Dimensions: 135mm x 19mm Ø. Weight: 180g

A compact handle with automatic connector for those who prefer a slim handle.

Rechargeable in NT4 table charger fitted with the small adaptor ring.



BETA4 SLIM NT rechargeable handle	3.5V Li-ion
rechargeable handle complete with rechargeable battery M3Z 4NT Li-ion and BETA4 SLIM NT bottom insert	X-007.99.474
BETA4 SLIM NT bottom insert	X-000.99.110
rechargeable battery M3Z 4NT Li-ion	X-007.99.380

- ▶ Power supplies may deviate in size and shape.
- ▶ For information on HEINE laryngoscope handles, see [pages 88-90](#).

HEINE NT4 table charger

Dimensions: width 142 mm, height 61 mm, depth 66 mm.

With the appropriate adaptor set all BETA4 NT and BETA4 SLIM NT rechargeable handles can be charged in the NT4 table charger.

The same applies to all Standard F.O.4 NT, F.O.4 SLIM NT and F.O.4 SHORT NT laryngoscope rechargeable handles.



- ▶ **Innovative, compact design.** Practical and space-saving
- ▶ **Two independent charging wells.** Complete functionality for one or two handles at a time
- ▶ **Automatic charging.** Independent of the state of charge of the rechargeable battery. Guarantees extended battery life
- ▶ **Cannot be overcharged.** Charger switches off automatically when the battery is fully charged
- ▶ **Charge status indicator.** Light pulses from the charging well to confirm the charging mode. Continuous light indicates that the charging process has been completed

NT4 table charger

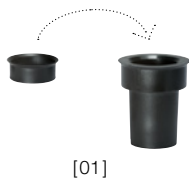

without handle, with adaptor. For BETA4 NT rechargeable handles, standard F.O.4 NT and F.O.4 SHORT NT laryngoscope rechargeable handles. BETA4 SLIM NT rechargeable handles and F.O.4 SLIM NT laryngoscope rechargeable handles (adaptor set required X-000.99.086)

X-002.99.494

adaptor set (two pieces) for BETA4 SLIM NT rechargeable handles and F.O.4 SLIM NT laryngoscope rechargeable handles [01]

X-000.99.086

- ▶ **Not suitable for rechargeable handles of the previous generations such as BETA L, BETA NT, BETA SLIM and Standard | Small | Short F.O. laryngoscope handle.**

HEINE BETA[®]4 upgrade kits

For converting to HEINE BETA4 charging technology

For simple conversion of an older HEINE BETA R rechargeable handle or a BETA TR rechargeable handle (both discontinued) to the current generation of BETA4 USB rechargeable handles featuring modern Li-ion technology.



Upgrade kit BETA4 USB

BETA4 USB bottom insert, Li-ion L rechargeable battery, E4-USB plug-in power supply and USB cord, handle rest

3.5V Li-ion

X-010.99.388

For simple conversion of a BETA L rechargeable handle to the current BETA4 NT generation of handles.



Upgrade kit BETA4 NT

BETA4 NT bottom insert, NT4 table charger

3.5V Li-ion

X-010.99.420

For simple conversion of a BETA NT rechargeable handle (with NiMH rechargeable battery) to a BETA4 NT rechargeable handle with modern Li-ion technology.

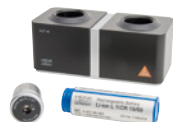

Upgrade kit BETA4 NT

BETA4 NT bottom insert, Li-ion L rechargeable battery, NT4 table charger

3.5V Li-ion

X-011.99.420

HEINE EN 200 diagnostic centre

Modern, energy efficient wall system

- ▶ **Excellent energy efficiency.** Lower power consumption saves costs and is environmentally-friendly
 - ▶ **Simultaneous use of handles.** The handles can be operated optimally with LED and | or XHL instruments. Due to the galvanic separation, two doctors can use the devices for examination purposes independently of each other
 - ▶ **Multiple diagnostic possibilities.** Compatible with all HEINE instruments (LED or XHL) with AV connector
 - ▶ **Maximum safety for user and patient.** The integrated galvanic separation protects the handles from unwanted electrical interaction
 - ▶ **Optimal reprocessing.** Flat, space-saving housing without any openings allows optimal hygienic reprocessing. The absence of a mechanical switch reduces the risk of cross-contamination
 - ▶ **Ready-to-use function.** Due to cutting-edge technology in the HEINE EN 200 the handle switches on and off automatically when taken off or returned to the unit. Set your brightness level once and it stays there every time you use your instrument. When not in use or when not returned to the unit, the illumination switches off after 15 minutes
 - ▶ **Connectivity ready.** The device offers a USB port and can be expanded with HEINE modules such as the EN 200-1
 - ▶ **Soft start technology** protects bulbs in the critical switch-on phase (prevents current surge) and prolongs bulb life
 - ▶ **Continuous brightness control** between 100 % and 3 % for both XHL and LED illumination
 - ▶ **Integrated anti-theft system** by means of a locking screw prevents unauthorised instrument head removal
-
- ▶ **The EN 200-1.** As an add-on or if only a single instrument is needed [01]



[01]

**HEINE EN 200 diagnostic centre set
with GAMMA XXL LF-WB
analogue sphygmomanometer**



EN 200 diagnostic centre with GAMMA XXL LF-WB

GAMMA XXL LF-WB analogue sphygmomanometer cuff basket EN 200 wall transformer BETA 400 LED F.O. otoscope BETA 200 LED ophthalmoscope AllSpec tip dispenser wallboard (mounting material included)	A-095.12.950
see above, but with BETA 200 LED F.O. otoscope	A-095.12.951

HEINE EN 200 diagnostic centre kits



[01]

EN 200 kits*	3.5 V LED	3.5 V XHL
with EN 200 wall transformer, BETA 400 LED F.O. otoscope, BETA 200 LED ophthalmoscope [01]	A-095.12.218	–
with EN 200 wall transformer, BETA 400 F.O. otoscope, BETA 200 ophthalmoscope	–	A-095.12.214
with EN 200 wall transformer, BETA 200 LED F.O. otoscope, BETA 200 LED ophthalmoscope	A-095.12.219	–
with EN 200 wall transformer, BETA 200 F.O. otoscope, BETA 200 ophthalmoscope	–	A-095.12.215
with EN 200 wall transformer, K180 F.O. otoscope, K180 ophthalmoscope	–	A-095.12.220

* without additional accessories

HEINE EN 200-1 dermatoscope kit



EN 200-1 dermatoscope kit	LED
DELTA 20T dermatoscope with contact plate with scale, EN 200-1 wall transformer (single unit with one handle) as single module with long USB cord and E4-USB plug-in power supply	K-010.28.252

HEINE EN 200 diagnostic centre – individual



[01]

[02]

Put together your individual diagnostic centre:

The EN 200 wall transformer and additional components such as the AllSpec tip dispenser and the GAMMA XXL sphygmomanometer can be combined in a modular system. You can also select the instruments you need (3.5 V XHL or LED version) individually from the HEINE range and customise your diagnostic centre to meet your individual requirements.



[03]

[04]



[05]

[06]

EN 200 diagnostic centre	
EN 200 wall transformer* [01]	X-095.12.250
EN 200-1 wall transformer* (extension unit with one handle) for use with the EN 200 wall transformer (with short USB cord) [02]	X-095.12.251
EN 200-1 wall transformer* (single unit with one handle) as single module with long USB cord and E4-USB plug-in power supply [02]	X-095.12.252
AllSpec tip dispenser, for EN 200 [03]	B-000.11.149
GAMMA XXL LF-W analogue sphygmomanometer [04]	M-000.09.323
GAMMA XXL LF-WB analogue sphygmomanometer (without cuff-holder) [05]	M-000.09.327
cuff basket for storing blood pressure cuffs [06]	M-000.09.140
wallboard for device combination EN 200 tip dispenser [07]	X-095.12.006
wallboard for device combination GAMMA XXL LF-W EN 200 tip dispenser [08]	X-095.12.007
wallboard for device combination GAMMA XXL LF-WB cuff basket EN 200 tip dispenser [09]	X-095.12.008

*without instruments



[07]

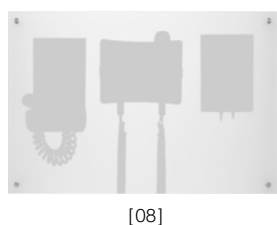

[08]

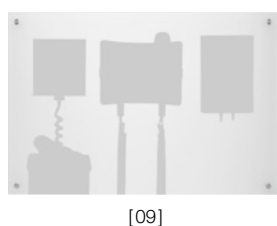

[09]

► For further information on HEINE sphygmomanometers and blood pressure cuffs, please refer to [pages 108-112](#).

HEINE

large battery handle



Dimensions: 165 mm x 37 mm Ø. Weight: 212 g without batteries, 505 g with batteries.

A large handle for 2 alkali-manganese batteries IEC LR20|D cells. Designed for countries where larger batteries are still preferred. (Only suitable for certain instrument cases.) Batteries not included.

Large battery handle	2.5V
for 2 alkali-manganese batteries, size D	X-001.99.120

HEINE

mini 3000® battery handle



Innovative, compact battery handle in a high-quality, modern design. Suitable for all mini 3000 instruments.

- ▶ **Oval, compact, stylish shape.** Lies ergonomically in the hand
- ▶ **High-quality handle: Chrome-finish upper section / refined plastic.**
Shockproof, sturdy, non-slip
- ▶ **Attachment clip with integrated on|off switch.** Secure. Switches off automatically when returned to the pocket. 20.000 switch cycles guaranteed
- ▶ **Screw-on end cap.** For easy battery change
- ▶ **Threaded connector made of metal.** Prevents wear
- ▶ **Replaceable batteries.** Size AA, or optional rechargeable battery with mini NT table charger
- ▶ **Complete range of mini 3000 instruments.** Versatile range
- ▶ **Registered design**
- ▶ **Rechargeable mini 3000 handle.** The mini 3000 battery handle can be retrofitted with the mini rechargeable battery 2.5 V NiMH and the bottom insert to update to the mini 3000 rechargeable handle. Fully-automatic charging with the mini NT table charger

mini 3000 battery handle	2,5V
with two dry batteries IEC LR6 (AA size)*	D-001.79.021



*All non-rechargeable mini handles are fitted with batteries (IEC LR 6 AA size). mini 3000 handles can be supplied in black or blue. Please specify the colour you prefer when ordering. If not otherwise specified, we will supply black instruments.

HEINE mini NT charger set for mini 3000

Compact charging technology



mini NT charger set 2.5V: Consists of the mini NT table charger, 2 mini NT rechargeable batteries and 2 bottom inserts for the mini 3000 rechargeable handles. With this set, existing mini 3000 handles can be updated to the 2.5 V rechargeable system.

mini NT table charger: width: 112 mm, height: 50 mm, depth: 52 mm, weight 404 g.

- ▶ **Innovative, compact design.** Practical and space-saving
 - ▶ **Two independent charging wells.** Complete functionality for one or two handles at a time
 - ▶ **Fast charge feature.** Typ. 4 hours to recharge a mini 3000 NiMH 2.5 V rechargeable battery
 - ▶ **Automatic charging.** Independent of the state of charge of the rechargeable battery. Guarantees extended battery life
 - ▶ **Cannot be overcharged.** Charger switches off automatically when the battery is fully charged
 - ▶ **Charge status indicator.** Light pulses from the charging well to confirm the charging mode. Continuous light indicates that the charging process has been completed
 - ▶ **No memory effect.** Full power at any time without loss of capacity
- ▶ **Please note:** Suitable only for 2.5 V NiMH rechargeable battery



mini NT table charger and accessories

mini NT charger, only [01]	X-001.99.484
mini 3000 rechargeable handle complete* [02]	D-001.79.022
rechargeable battery NiMH 2Z, only [03]	X-001.99.487
bottom insert for mini 3000 rechargeable handle, only [04]	X-001.99.488



mini NT charger set for 2 mini 3000 handles

With this set, existing mini 3000 handles can be updated to the 2.5 V rechargeable system. It contains:

mini NT table charger [01], 2 rechargeable batteries NiMH 2Z [02], 2 bottom inserts for mini 3000 rechargeable handle [03]	X-001.99.485
--	--------------



*HEINE mini 3000 pocket instruments – a complete range of quality diagnostic instruments for your pocket. Available in black or blue. Please specify the colour you prefer when ordering. If not otherwise specified, we will supply black instruments.

HEINE CC1 charging case for OMEGA 600

The CC1 charging case allows you to charge a second battery while you continue working with your instrument. Charging time typ. 1.5 hours.



CC1 charging case	X-000.99.091
-------------------	--------------

HEINE CB1 charging battery for OMEGA 600

The CB1 charging battery for OMEGA 600 is a compact, lightweight lithium polymer battery. It has an operating time of up to 8 hours depending on illumination intensity. An extra battery offers you even more flexibility as you can charge one battery while you continue working with your instrument. Can be charged separately from the OMEGA 600 in the CC1 charging case.



CB1 charging battery	X-007.99.687
----------------------	--------------

HEINE charging set OMEGA 600

The OMEGA 600 charging set includes a CC1 charging case and CB1 charging battery. This set offers you even more flexibility as you can charge the second battery while you continue working with your instrument.



OMEGA 600 charging set: CC1 charging case and CB1 charging battery	X-000.99.090
---	--------------

HEINE E4-USBC power supply for OMEGA 600



Easy plug-in power supply with USB-C cable for charging the OMEGA 600.
Approved for medical use.

E4-USBC power supply with cable

X-000.99.300

HEINE CW1 wall charger for OMEGA 600



The CW1 wall charger offers a convenient charging possibility between examinations to make sure your OMEGA 600 is always charged and ready to use when you need it. The design of the charger protects the OMEGA 600 from accidental fall.

- ▶ The OMEGA 600 can be charged directly at the CW1 wall charger
- ▶ Automatic switch-off of the OMEGA 600 in the wall charger
- ▶ Charging time typ. 1.5 hours

CW1 wall charger (without OMEGA 600)

X-095.17.320

▶ Power supplies may deviate in size and shape.

HEINE HC 50L headband rheostat Fingertip illumination control for OMEGA 500



[01]

- ▶ **Left or right sided mounting options** – on the OMEGA headband
- ▶ **Can be combined** with EN 50 and mPack (with connection cord X-000.99.667)
- ▶ **100 – 240 V compatible transformer**
- ▶ **For use with OMEGA 500 LED^{HQ} illumination**



[02]

HC 50L headband rheostat	6V
HC 50L headband rheostat (without plug-in transformer and connecting cord) [01]	X-095.16.325
plug-in transformer for HC 50L headband rheostat [02]	X-095.16.330
connecting cord cinch to EN 50 charger mPack plug-in transformer for HC 50L, 1,6m [03]	X-000.99.667



[03]

HEINE EN 50 UNPLUGGED wall transformer Intelligent charger for mPack UNPLUGGED

- ▶ **Charger and wall-mount in one.** The wall transformer serves as an instrument holder and a charger at the same time
- ▶ **Intelligent charging system.** The instrument automatically switches off and goes into charging mode when placed in wall transformer. It is impossible to overcharge the mPack UNPLUGGED; the process ends automatically when charging is completed
- ▶ **Simultaneous charging.** The charging system charges the battery on the headband as well as an additional single spare battery
- ▶ **Compatible transformer (100 – 240V).** Multi-voltage power supply unit incl. 4 different mains adaptors
- ▶ **Registered design**



EN 50 UNPLUGGED wall transformer (without mPack UNPLUGGED) 6V	X-095.17.310
---	--------------

- ▶ **Power supplies may deviate in size and shape.**

HEINE mPack UNPLUGGED

Headband-mounted rechargeable battery

Rechargeable battery for OMEGA 500 indirect binocular ophthalmoscope UNPLUGGED and ML4 LED HeadLight UNPLUGGED (system voltage 6 V).



[01]



[02]



[03]

LI POL

- ▶ **Lightweight with balanced weight distribution.** High level of comfort
- ▶ **Charge status indicator.** Display of remaining operating time
- ▶ **Can be recharged by wall- or plug-in transformer**
- ▶ **Direct operation possible while charging** through the use of the mobile plug-in transformer
- ▶ **Charging time:** typ. 2 hours
- ▶ **Operating time:** typ. 3.5 hours for ML4 LED HeadLight, typ. 7 hours for OMEGA 500 UNPLUGGED
- ▶ **Intelligent charging system.** Automatic changeover from operating to charging mode (in the wall unit)
- ▶ **Top safety standards.** Integrated charge and performance checks during operation. Lithium polymer technology. UL-compliant
- ▶ **Registered design**

mPack UNPLUGGED

mPack UNPLUGGED [01]	X-007.99.665
transformer UNPLUGGED for mPack UNPLUGGED [02]	X-095.16.316
lithium polymer rechargeable battery for mPack UNPLUGGED	X-007.99.680
extension cord from plug-in transformer UNPLUGGED to mPack UNPLUGGED, 2 m [03]	X-000.99.668

- ▶ **Power supplies may deviate in size and shape.**

HEINE mPACK

Portable power pack for OMEGA 500 and ML4 HeadLight



[01]



[02]



[03]

- ▶ **Freedom from cables** that tie the user to desk, wall or static power supplies
- ▶ **Triple the capacity with Li-ion technology.** Compared with current NiCd systems. When fully charged at least 3 x the capacity of conventional NiCd systems. More than double of other Li-ion systems. No memory effect
- ▶ **Fast charge.** Charges to full capacity in typ. 2 hours
- ▶ **Charge status indicator.** Always lets you know how much operating charge you have left
- ▶ **Operating time:** typ. 8.5 hours for ML4 LED HeadLight, typ. 13 hours for OMEGA 500
- ▶ **Flexible charging options.** Charge in the EN 50 charger base station, or with mobile plug-in transformer
- ▶ **Intelligent.** Automatically switches to “charge” mode when inserted in EN 50. Can also be used as mains power supply even while in “charge” mode
- ▶ **Automatic remote power adjustment** for compatibility with all HEINE 6 V and selected LED instruments
- ▶ **Stepless light intensity control 0.5 – 100 %.** Optimum brightness setting prevents reflexes
- ▶ **100 – 240 V compatible transformer** incl. 4 plugs for world wide compatibility

mPack	6V
EN 50-m charger wall table unit with mPack, (incl. 90° angled adaptor, Instrument support for Professional L headband [01])	X-095.17.302
mPack with Li-ion rechargeable battery and plug-in transformer	X-007.99.672
mPack with Li-ion rechargeable battery, without transformer	X-007.99.671
Li-ion rechargeable battery for mPack	X-007.99.686
plug-in transformer for mPack [02]	X-095.16.315
plug-in 90° angled adaptor (for EN 50 charger mPack) [03]	C-000.33.509

- ▶ **Power supplies may deviate in size and shape.**

HEINE EN 50 wall | table-transformer Modular power supply system | charger

The HEINE modular power supply system offers unsurpassed flexibility and innovative features. The EN 50 powers OMEGA 500 and ML4 LED HeadLight. Furthermore, all other HEINE 6 V products are compatible. The EN 50 charger, the mPack and HC 50L headband mounted rheostat can be combined in every conceivable configuration.



[01]

- ▶ **Modular, compact design** functions as the base for tabletop or wall mounted use and as charging base for the mPack mobile charging system
- ▶ **Upgradeable.** mPack charging base by simple removal of the control module
- ▶ **Soft start technology.** A gradual introduction of current reduces bulb “shock” and extends bulb life
- ▶ **100 – 240 V compatible transformer** incl. 4 plugs for world wide compatibility
- ▶ **Registered design**



[02]



[03]

EN 50 charger	6V
EN 50 transformer wall table unit with rheostat control module (incl. 90° angled adaptor, extension cord cinch-cinch 2 m, instrument support) [01]	X-095.17.301
rheostat control module for EN 50	X-095.17.305
EN 50 base unit (without rheostat control module) [02]	X-095.17.300
plug-in 90° angled adaptor (for EN 50 mPack) [03]	C-000.33.509
instrument support for headband	C-000.33.511

HEINE mPack mini

Power source for LoupeLight2|MicroLight2 and SIGMA 250



- ▶ **Freedom from cables** that tie the user to desk, wall or static power supplies
- ▶ **Operating time LoupeLight2|MicroLight2:** Typ. 9 hours in everyday practical use. In continuous operation at full power typ. 4 hours
- ▶ **Operating time SIGMA 250:** Typ. 11 hours in continuous operation at maximum power.
- ▶ **Charging time typ. 4 hours**
- ▶ **Charge status indicator.** Display of remaining battery power with three LEDs. The flashing of the last LED indicates that immediate charging is required. During charging the LEDs light up one after the other
- ▶ **Stepless light intensity control.** Optimum brightness setting between 100 % and 3 % reduces reflexes
- ▶ **USB cord** with E4-USB medical approved plug-in power supply
- ▶ **The integrated galvanic separation module** protects the battery and the user against the consequences of defective power supplies, thus preventing the possibility of the full mains voltage flowing directly to the housing. We recommend the use of a medical approved plug-in power supply
- ▶ **Simple cleaning.** Closed housing, no seams at the sides, few edges
- ▶ **Compact and lightweight.** With a weight of just 95 g and dimensions of 44 x 23 x 101 mm the power source can be easily stowed
- ▶ **Optimised mPack mini belt clip** for simple attachment of the power source to the belt or waistband. The mPack mini can also be charged in the belt clip [01]
- ▶ **Li-ion technology.** No „memory effect“, without worrying about charge level or battery condition
- ▶ **Integrated rechargeable battery.** Can be exchanged at authorised specialist dealers



[01]

mPack mini	6V
mPack mini with Li-ion rechargeable battery and E4-USB plug-in transformer	X-007.99.650
mPack mini with Li-ion rechargeable battery, without E4-USB plug-in transformer	X-007.99.649
mPack mini belt clip [02]	X-000.99.006
USB cord [03] with E4-USB plug-in transformer [04]	X-000.99.303
E4-USB medical approved plug-in power supply for USB cord [04]	X-000.99.305



[02]



[03]

[04]

- ▶ **Power supplies may deviate in size and shape.**

HEINE bulbs

For optimum performance and cost-effectiveness

Each HEINE bulb is specifically designed as an integral part of the HEINE instrument it powers, based upon the following parameters:

COLOUR TEMPERATURE:

Based on advanced HEINE XHL xenon halogen technology, each bulb is designed to provide the ideal colour temperature for the diagnosis the instrument is intended for. This ensures a proper balance between illumination brightness and true tissue colour for the most accurate diagnosis.

BULB LIFE:

HEINE bulbs last up to 50 % longer compared with conventional bulbs, providing long life, optimum performance and cost-effectiveness.

SAFETY:

Advanced design and manufacturing procedures prevent dangerous bulb implosions.

OPTICAL PERFORMANCE:





The performance of each HEINE optical instrument depends on the bulb that powers it. Lenses built into the glass bulb envelope, precision filament placement and homogeneous light projection are major factors in ensuring the satisfactory performance of your HEINE instrument. We can only guarantee the performance and safety of your instrument if the appropriate HEINE bulb powers it. If a non-original copy of a HEINE bulb is used, the safety and performance of the HEINE instrument will be compromised and the manufacturer's guarantee will no longer be valid.







All XHL xenon halogen bulbs are available singly in individual blister packs. Insist on genuine HEINE replacement bulbs and parts to ensure the correct performance of your HEINE precision instrument.

HEINE XHL® xenon halogen bulbs

For optimum performance and cost-effectiveness

GENERAL MEDICINE AND ENT INSTRUMENTS

Otosopes	2.5V	3.5V
 alpha*	X-001.88.037	–
 alpha+* F.O., BETA 100*, mini 2000* F.O., K100*	X-001.88.037	X-002.88.049
 BETA 200, BETA 400, K180	X-001.88.077	X-002.88.078
 mini 2000*, minilux*	X-001.88.056	–
 mini 3000 F.O.	X-001.88.105	–
 mini 3000	X-001.88.110	–

ENT instruments	2.5V	3.5V
 alpha* tongue blade holder and mini 3000 tongue blade holder	X-001.88.037	–
 alpha+* tongue blade holder	X-001.88.037	X-002.88.049
 curved laryngeal mirror*	X-001.88.037	X-002.88.062
 straight laryngeal mirror*	X-001.88.057	X-002.88.063
 mini* tongue blade holder	X-001.88.037	–
 tongue blade holder (BETA)	X-001.88.037	X-002.88.049

*Instrument no longer available.

HEINE XHL® xenon halogen bulbs

For optimum performance and cost-effectiveness



Cliplights and combi lamps	2.5V	3.5V
HEINE Clilight*	X-001.88.094	–
mini 2000* clip lamp, mini 1000* clip lamp, mini 2000* combi lamp, mini* Fibrilux	X-001.88.041	–
mini 3000 clip lamp, mini 3000 combi lamp	X-001.88.107	–
mini 3000 laryngeal mirror*	X-001.88.057	–
mini-c* clip lamp	X-001.88.108	–

OPHTHALMIC INSTRUMENTS

















Direct ophthalmoscopes	2.5V	3.5V
alpha*	X-001.88.042	–
alpha+*	X-001.88.042	X-002.88.101
AUTOFOC*	X-001.88.032	X-002.88.047
BETA 200S, BETA 200, BETA 200 M2	X-001.88.069	X-002.88.070
K180	X-001.88.084	X-002.88.086
mini 2000*, mini Miroflex*	X-001.88.042	–
mini 3000	X-001.88.106	–
Miroflex*	X-001.88.038	X-002.88.046

*Instrument no longer available.

HEINE XHL® xenon halogen bulbs

For optimum performance and cost-effectiveness

OPHTHALMIC INSTRUMENTS





	2.5V	3.5V
Retinoscopes		
 alpha+* spot retinoscope	X-001.88.088	X-002.88.090
 alpha+* streak retinoscope	X-001.88.087	X-002.88.089
Other hand-held ophthalmic instruments		
 alpha* Focalux	X-001.88.042	–
 alpha* ophthalmic examination light	X-001.88.043	X-002.88.102
 alpha+* Finoff transilluminator	X-001.88.035	X-002.88.044
 alpha+* Focalux	X-001.88.042	X-002.88.101
 alpha+* HSL 150 hand-held slit lamp	X-001.88.098	X-002.88.099
 alpha+* ophthalmic examination light	X-001.88.043	X-002.88.102
 Focalux*	X-001.88.039	X-002.88.091
 Glaucotest*	X-001.88.035	X-002.88.044
 HSL 100* and HSL 150 hand-held slit lamp	X-001.88.098	X-002.88.099
 LAMBDA 100 retinometer, Finoff transilluminator (2.5V and 3.5V XHL)*	X-001.88.077	X-002.88.078
 mini 2000* and mini 3000* Focalux	X-001.88.042	–
 ophthalmic examination lamp	X-001.88.032	X-002.88.047

*Instrument no longer available.



HEINE XHL® xenon halogen bulbs

For optimum performance and cost-effectiveness



OPHTHALMIC INSTRUMENTS

	3.5V	6V
 Indirect ophthalmoscopes		
indirect hand-held ophthalmoscope	X-002.88.050	X-004.88.081
 OMEGA 100*, 150*, 180*, 200*, video OMEGA 2C video ophthalmoscope*	–	X-004.88.068
 OMEGA 500 5W (standard equipment)	–	X-004.88.111
 SIGMA 150K*, 150 M2* headworn ophthalmoscope, SIGMA 150* ophthalmoscope	–	X-004.88.093

VET INSTRUMENTS

	2.5V	3.5V
 BETA 100 VET* otoscope, operating otoscope*	X-001.88.037	X-002.88.049
 BETA 200 VET otoscope, slit illumination head	X-001.88.077	X-002.88.078

LARYNGOSCOPES





	2.5V	3.5V
 F.O. laryngoscope handles, Angled F.O. laryngoscope handle*	X-001.88.035	X-002.88.044
 F.O. SP laryngoscope lamp handle*	X-001.88.035	–



* Instrument no longer available.

HEINE XHL® xenon halogen bulbs





For optimum performance and cost-effectiveness

DERMATOSCOPES AND ILLUMINATED LOUPES

	2.5V	3.5V
 Dermatoscopes		
alpha+*	X-001.88.034	X-002.88.053
 DERMAPHOT* 2,2V vacuum bulb	X-000.88.082	-
 DELTA 10*	X-001.88.038	X-002.88.046
 mini 2000*	X-001.88.034	-
 mini 3000	X-001.88.109	-

	2.5V	3.5V
 alpha+* illuminated loupe 5x, 8x	X-001.88.034	X-002.88.053
 illuminated loupe* 5x, 8x (BETA)	X-001.88.038	X-002.88.046

PROCTOLOGICAL INSTRUMENTS

	2.5V	3.5V
 illumination adaptor for F.O. instruments	-	X-002.88.078
 proctoscope head for proximal illumination*, anoscope- proctoscope illumination head*	X-001.88.040	X-002.88.051
 spreadable anal speculum*	X-001.88.035	X-002.88.044
		6V
 lamp handle*		X-004.88.060

*Instrument no longer available.

HEINE XHL® xenon halogen bulbs

For optimum performance and cost-effectiveness

EXAMINATION LIGHTS



Headlights	6V
SL 350*	X-004.88.068
UBL 100* spectacle-mounted illuminator for binocular loupes	X-004.88.080

Examination lights	12V
HL 5000*, 50W halogen bulb	J-005.27.111

PROJECTORS



	Halogen
F.O. projector HK 6000*, 7000*, 7000D* 150W	Y-096.15.102
F.O. projector mini* 20W	Y-096.14.103
F.O. projector uno*, endo*, multi* 150W	Y-096.11.103

* Instrument no longer available.

**How to bring
structure
to your life.**

HEINE

Carrying cases and storage cases



[01]

soft pouch for otoscopes | ophthalmoscopes
(60 mm x 230 mm x 40 mm) [01]

A-180.01.000



[02]

zipper pouch for otoscopes
(110 mm x 200 mm x 30 mm) [02]

B-237.00.000



[03]

case for binocular loupe sets
(270 mm x 230 mm x 85 mm) [03]

C-000.32.552



[04]

case for LoupeLight2 | MicroLight2 on S-FRAME
and SIGMA 250 (270 mm x 270 mm x 150 mm) [04]

C-000.32.553



[05]

case for MicroLight2 on headband
(270 mm x 270 mm x 150 mm) [05]

C-000.32.554



[06]

hard case for ophthalmic diagnostic sets C-034
(185 mm x 116 mm x 50 mm) [06]

C-034.00.000

HEINE

Carrying cases and storage cases



[07]

hard case for indirect ophthalmoscope sets C-283 and C-284 (470 mm x 400 mm x 190 mm) [07]	C-079.00.000
---	---------------------



[08]

combi-case for indirect ophthalmoscope sets C-283 and C-284 (432 mm x 330 mm x 197 mm) [08]	C-079.03.000
--	---------------------



[09]

hard case for ophthalmic diagnostic sets C-261 and C-144 (185 mm x 116 mm x 50 mm) [09]	C-144.06.000
--	---------------------



[10]

hard case for ophthalmic diagnostic sets C-262 and C-145 (235 mm x 135 mm x 50 mm) [10]	C-145.00.000
--	---------------------



[11]

OMEGA 600 traveller bag [11] (Can be worn over the shoulder or as a backpack.)	C-080.00.000
---	---------------------



[12]

hard case for LAMBDA 100 retinometer set (235 mm x 135 mm x 50 mm) [12]	C-187.06.000
--	---------------------

HEINE

Carrying cases and storage cases



[13]

soft pouch for mini (95 mm x 185 mm x 35 mm) [13]	D-861.00.000
--	--------------



[14]

zipper case for mini 3000 dermatoscope (205 mm x 95 mm x 55 mm) [14]	D-887.00.000
---	--------------



[15]

zipper case for laryngoscopes (170 mm x 280 mm x 50 mm) [15]	F-179.00.000
---	--------------

► Further cases on request.

Carrying cases and storage cases may deviate in shape and colour.

Page	Index
A	
90 154	Adaptors for NT4 table charger
B	
125–133	Binocular loupes
132	- C2.3K
128 129	- HR
130 131	- HRP
134	Binocular loupe accessories
134	- Spectacle frame S-FRAME
134	- Headband
135 136	- LoupeLight2
170–176	- Bulbs, XHL xenon halogen technology
C	
178–180	Cases
	Chargers
161	- mini NT
154	- NT4 and adaptor
24–26	Clip lamps
24	- mini-c hand-held examination light
25	- mini 3000 clip lamp
26	- mini 3000 combi lamp
27	Clip lamps accessories
D	
93–103	Dermatoscopes
95–97	- DELTA 30 PRO
98	- DELTA 30
99	- DELTAone
101	- DELTA 20T
100	- iC1
102 103	- mini 3000
102 103	- mini 3000 LED
104–106	Dermatoscope accessories
104	- DELTA 30 PRO accessories
104	- DELTA 30 accessories
104	- DELTAone accessories
105	- DELTA 20T accessories
104	- iC1 accessories
106	- mini 3000 mini 3000 LED accessories
156–159	Diagnostic centre EN 200
E	
86 87	EasyClean LED laryngoscope handles
121–123	Examination lights
122	- EL 10 LED
123	- EL3 LED
F	
56 58	Finoff transilluminator
68	Fundus charts

Page	Index
H	
53	Hand-held slit lamps
53	- HSL 150
57	Hand-held slit lamp accessories
57	- HSL 10x loupe attachment
	Handles
150	- BETA handle module
151	- BETA battery handle
152	- BETA4 NT rechargeable handle
152 153	- BETA4 USB rechargeable handle
153	- BETA4 SLIM NT rechargeable handle
151	- BETA SLIM battery handle
87	- EasyClean LED laryngoscope handle SHORT
87	- EasyClean LED laryngoscope handle SLIM
87	- EasyClean LED laryngoscope handle standard
88 89	- F.O.4 SHORT XHL LED NT laryngoscope handle
88 89	- F.O.4 SLIM XHL LED NT laryngoscope handle
88 89	- Standard F.O.4 XHL LED NT laryngoscope handle
160	- Large battery handle
160	- mini 3000 battery handle
161	- mini 3000 rechargeable handle
85	- XP disposable laryngoscope handle shell
138–147	Headlights
138–142	- MicroLight2
143–147	- ML4 LED HeadLight
143–147	- ML4 LED HeadLight UNPLUGGED
L	
	Lamps
24	- mini-c hand-held examination light
26	- mini 3000 combi lamp
79–92	Laryngoscopes
	Laryngoscopes Classic+ F.O.
82	- Macintosh F.O.
83	- Miller F.O.
83	- Paed F.O.
91	- Sets
	Laryngoscopes XP, disposable
92	- Emergency set
84	- Macintosh
84	- Miller
80	visionPRO video laryngoscope
M	
161	mini NT table charger
166	mPack
168	mPack mini
165	mPack UNPLUGGED
O	
55 58	Ophthalmic examination lamp
40–50	Ophthalmoscopes, direct
44 45	- BETA 200
44 45	- BETA 200 LED

Page	Index	Page	Index
42 43	- BETA 200S	119	- Anoscopes
42 43	- BETA 200S LED	118	- Instrument head for UniSpec tubes
46 47	- K180	119	- UniSpec disposable tubes
48 49	- mini 3000	120	Proctology accessories
48 49	- mini 3000 LED	120	- Illumination adaptor
50	Ophthalmoscopes, direct; accessories		
50	- BETA 200		
59–66	Ophthalmoscopes, indirect		
66	- MONOKULAR, hand-held		
62	- OMEGA 500, binocular, head-worn		
62	- OMEGA 500 UNPLUGGED		
63	- OMEGA 500 with DV1		
60 61	- OMEGA 600		
64 65	- SIGMA 250, binocular, spectacle-worn		
67 69	Ophthalmoscopes, indirect; accessories		
67	- Trainer, model eye		
68	- Ophthalmoscopy lens A.R.		
68	- Combi-case hard case		
5–20	Otoscopies		
9 10	- BETA 200 F.O.		
9 10	- BETA 200 LED F.O.		
7 8	- BETA 400 F.O.		
7 8	- BETA 400 LED F.O.		
31	- BETA 200 LED VET F.O. (veterinary)		
31	- BETA 200 VET F.O. (veterinary)		
11 12	- K180 F.O.		
13 14	- mini 3000 F.O.		
13 14	- mini 3000 LED F.O.		
18 19	- mini 3000		
15–17	Otoscopies with F.O. illumination accessories		
17	- Insufflation bulb for BETA 200, BETA 400, K180		
17	- Insufflation bulb for mini 3000 F.O.		
15 16	- Tips specula		
20	Otoscopies with direct illumination, accessories		
20	- Insufflation bulb for BETA 100, K100		
20	- Tips specula		
33–37	Otoscopies VET, accessories		
37	- Insufflation bulb for BETA 100, 200 VET		
33–36	- Tips specula		
	P		
150–168	Power sources		
150–153	- BETA handles		
156–159	- EN 200 wall transformer		
167	- EN 50 wall table transformer		
164	- EN 50 UNPLUGGED wall transformer		
164	- HC 50L headband rheostat		
166	- mPack		
168	- mPack mini		
165	- mPack UNPLUGGED		
160	- mini 3000 battery handle		
161	- mini 3000 rechargeable handle		
161	- mini NT table charger		
154	- NT4 table charger		
117–120	Proctology		
			R
			Rechargeable batteries
		152 153	- Li-ion rechargeable battery
		153	- M3Z rechargeable battery
		161	- NiMH 2Z rechargeable battery
		54	Retinometer LAMBDA 100
		51 52	Retinoscope BETA 200
		51 52	Retinoscope BETA 200 LED
		57	Retinoscope BETA 200, accessories
		67	- Trainer, model eye
			S
		134	S-FRAME spectacle frame
		28–30	Slit illumination head G100/G100 LED (veterinary)
		33–37	- Slit ill. head G100/G100 LED accessories
			Specula tips
		15 16	- mini 3000 F.O., mini 3000 with direct illumination
		15 16	- Otoscopes with F.O. illumination
		15 16	- Otoscopes with direct illumination
		33–36	- Veterinary diagnostic instruments
		108–112	Sphygmomanometers GAMMA latex-free
		110	- GAMMA G5
		109	- GAMMA G7
		111	- GAMMA GP
		112	- GAMMA XXL LF
		113	- Cuffs GAMMA latex-free
		114–115	Stethoscopes GAMMA latex-free
			T
		15	Tip-adaptor (for AllSpec)
		21–23	Tongue-blade holder
			V
		28–30	Veterinary, slit illumination head
		80	visionPRO video laryngoscope

HEINE – Simply the best guarantee in the market!

HEINE offers you a guarantee which reflects the quality and reliability of our products. All products conform to the European Directive 93/42/EEC or the Medical Devices Regulation (MDR) concerning medical devices. They carry the CE mark.



STANDARD 5 YEAR PARTS AND LABOR GUARANTEE

All HEINE products carry a 5 year parts and labor guarantee against defects in design, materials and workmanship.* Excluded from this are wear and tear, single-use items and consumables as well as rechargeable batteries and exposed and accessible control and supply cables with corresponding plug connection. For details please visit www.heine.com

PRODUCT-RELATED GUARANTEE CONDITIONS:

- ▶ HEINE iC1 dermatoscope
HEINE grants a 5 year guarantee only if the product has been purchased through an authorized dealer and is registered within 6 months from the date of purchase. To register please go here www.heine.com/register. The guarantee provides coverage against defects in design, materials and workmanship. Rechargeable battery and mobile phone case are not included in this guarantee.
- ▶ HEINE fiber optic laryngoscopes
HEINE Classic+ F.O. laryngoscope blades have an extended guarantee of 10 years on the faultlessness from material, processing and construction defects, for blades manufactured on or after 01/01/2020 or with serial number SN1105228000 or higher. The 10-year guarantee ensures that output will not fall below 1,000 lux, even after repeated autoclave cycles (based on 4,000 cycles at 134 °C/4 min.) The guarantee covers HEINE Classic+ laryngoscope blades which are cleaned, disinfected and/or sterilised in accordance with the instructions for reprocessing. HEINE Classic+ F.O. laryngoscope blades manufactured prior to 01/01/2020 and FlexTip+ blades are subject to the same guarantee conditions provided above, with a 5-year guarantee period.
- ▶ HEINE GAMMA G-series
HEINE GAMMA G7 and HEINE GAMMA XXL LF sphygmomanometers carry an extended guarantee of 10 years for the faultlessness from material, processing and construction defects. Wear parts and metrological control are not included.
- ▶ *HEINE Cube
For the Cube HEINE grants a guarantee of 2 years.
- ▶ *HEINE visionPRO video laryngoscope
For the HEINE visionPRO video laryngoscope HEINE grants a guarantee of 2 years.

**Many HEINE products are protected by
international patents including registered designs**

TRADEMARK



HEINE logo design mark, AllSpec, BETA, DELTA, FlexTip, GAMMA, HEINE, HEINE AllSpec, HEINE BETA, HEINE EasyClean, HEINE EL 10 LED, HEINE OMEGA, HEINE SIGMA, HEINE XHL, HEINE XHL Halogen, mini 3000, OMEGA, ParaStop, SANALON, SIGMA, UniSpec, XHL

**GERMAN AND FOREIGN PATENTS AND REGISTERED DESIGNS FOR (TO NAME
BUT A FEW EXAMPLES):**

BETA 400, EN 50|mPack, EN 50 UNPLUGGED, GAMMA G, i-View, LED Laryngoscope Handle LoupeLight2, mini NT, mini ZZ Battery, mini 3000 Battery Handle, mPack UNPLUGGED, SIGMA 250, Stepless dimming, XP Handle Shell

Due to local regulations, some products may not be available in your country.

© HEINE Optotechnik GmbH & Co. KG. Printed in Germany, 01/2024, as part of an environmentally friendly process with vegetable oil-based inks on 100% recycled paper.

All information, specifications and illustrations contained in this catalogue are based on the latest product information available at the time of publication. Errors and omissions excepted. HEINE Optotechnik GmbH & Co. KG reserves the right to change specifications and design at any time without prior notice.

This document must not be copied, reprinted or reproduced in any form, either wholly or in part without the written consent of HEINE Optotechnik GmbH & Co. KG.

Please observe the General Terms and Conditions of HEINE Optotechnik GmbH & Co. KG. For our General Terms and Conditions, please refer to: www.heine.com

Quality made in Germany.

We live and breathe quality. In everything we do. Every product we make. Every lens we polish. Every screw we tighten. Every optic fiber we bundle. Always. Every day.

The durability of our primary diagnostic instruments is legendary. Every single instrument is the result of decades of product development, continuous improvements, production and a 100 % quality control in our own facilities. We make certain that our high expectations of quality are maintained.

It is how we ensure that our high-end products meet our claim of providing the most accurate and earliest possible diagnosis.

No more, no less.

HEINE Optotechnik GmbH & Co. KG

Domierstr. 6, 82205 Gilching, Germany

www.heine.com



We reserve the right to change specification without notice.

01|24. A-000.00.100 EN – Nominal fee 11,00 Euro

