



## PRODUCT DATA SHEET

CREATED ON 20.04.2026 ON WWW.GEISTER.COM

### 38-7822

Atraumatic Tissue Forceps, tube-shaft 1.5mm 1x2 18mm Ø5 25cm Type: DeBaKey ValveGate™PRO

Material: ...

GTIN Number: 04057034131947

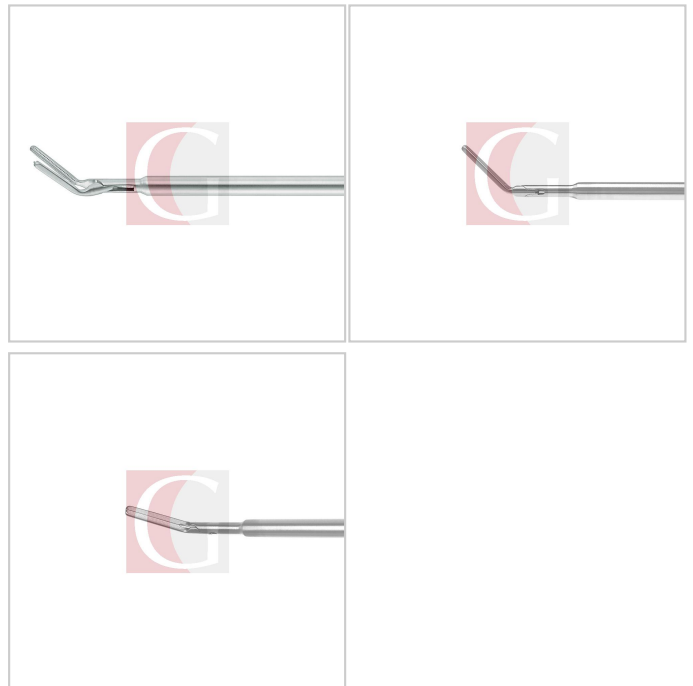

Illustrations, technical changes and the like are subject to product changes and are therefore not binding.



## PRODUCT DATA SHEET

CREATED ON 20.04.2026 ON WWW.GEISTER.COM

**24-0126**

Needle Holder, TC 18cm TC (N) Type: Wire-Twister

**Material:** 1.4021

**GTIN Number:** 04057034064221

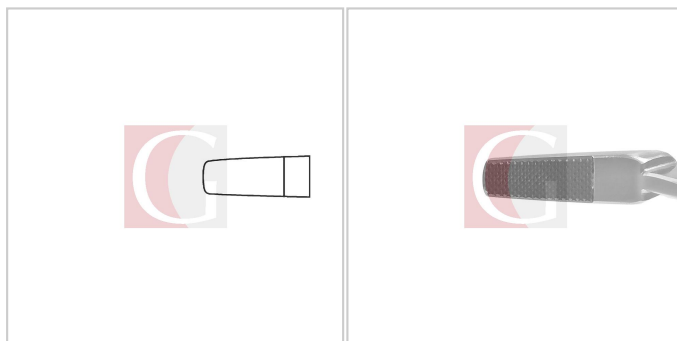

Illustrations, technical changes and the like are subject to product changes and are therefore not binding.



## PRODUCT DATA SHEET

CREATED ON 20.04.2026 ON WWW.GEISTER.COM

### 24-0228

Microsurgical Needle Holder, TC, ratchet 22cm TC (M) [ $\leq 5-0$ ] Type: Castroviejo

**Material:** 1.4021

**GTIN Number:** 04057034065044

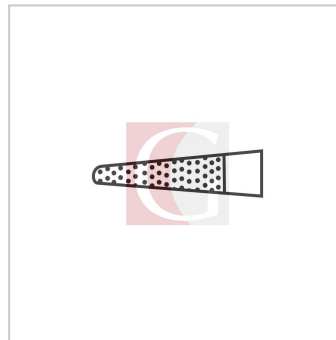

Illustrations, technical changes and the like are subject to product changes and are therefore not binding.



## PRODUCT DATA SHEET

CREATED ON 20.04.2026 ON WWW.GEISTER.COM

**29-0154**

Rib Spreader (transient use) 45x62mm/65x62mm Type: Burford

**Material: ...**

**GTIN Number: 04057034088715**



Illustrations, technical changes and the like are subject to product changes and are therefore not binding.



## PRODUCT DATA SHEET

CREATED ON 20.04.2026 ON WWW.GEISTER.COM

### 29-0154.RS

Rib Spreader (transient use) 45x62mm/65x62mm Type: Burford

Material: ...

GTIN Number: 04057034088722

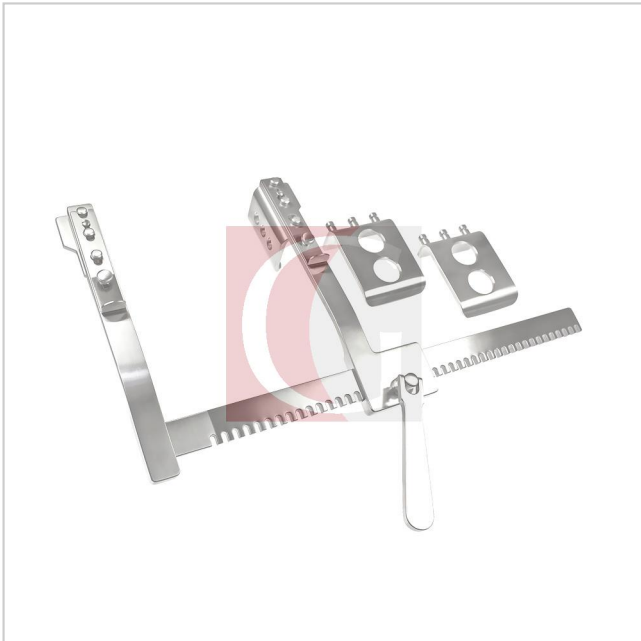

Illustrations, technical changes and the like are subject to product changes and are therefore not binding.



## PRODUCT DATA SHEET

CREATED ON 20.04.2026 ON WWW.GEISTER.COM

**29-0156**

Rib Spreader (transient use) 45x62mm/65x62mm Type: Burford

**Material: ...**

**GTIN Number: 04057034088753**



Illustrations, technical changes and the like are subject to product changes and are therefore not binding.



## PRODUCT DATA SHEET

CREATED ON 20.04.2026 ON WWW.GEISTER.COM

### 29-0156.RS

Rib Spreader (transient use) 45x62mm/65x62mm Type: Burford

Material: ...

GTIN Number: 04057034088760

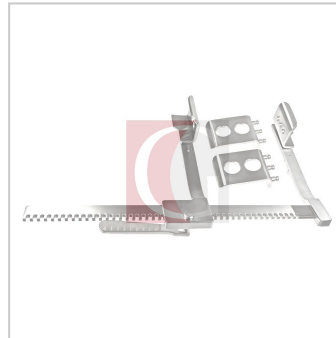
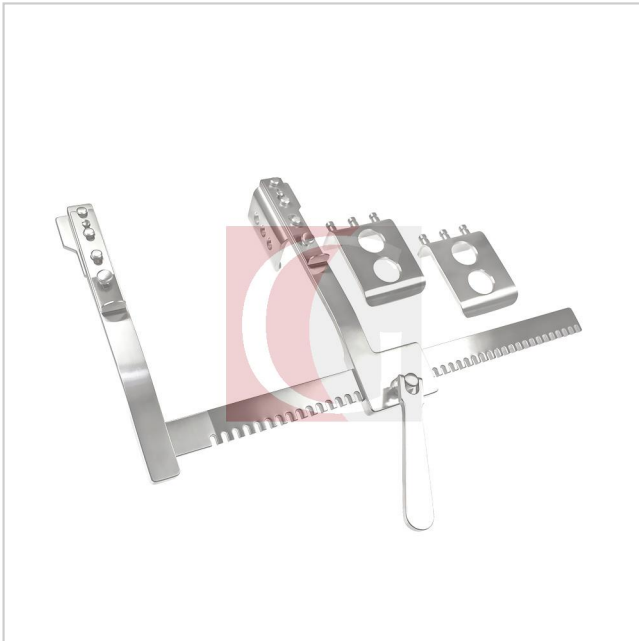

Illustrations, technical changes and the like are subject to product changes and are therefore not binding.



## PRODUCT DATA SHEET

CREATED ON 20.04.2026 ON WWW.GEISTER.COM

### 30-0231

Hand-held Retractor 60x45 Type: St. Marks

**Material:** ...

**GTIN Number:** 04057034105917

Illustrations, technical changes and the like are subject to product changes and are therefore not binding.





## PRODUCT DATA SHEET

CREATED ON 20.04.2026 ON WWW.GEISTER.COM

### 26-0123.DF

Dissecting Scissors, TC 18cm curved Type: Metzenbaum-Fino Pandor™

**Material:** 1.4117

**GTIN Number:** 04057034078174

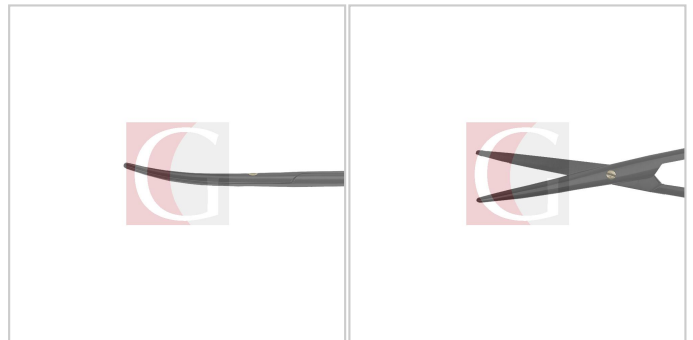
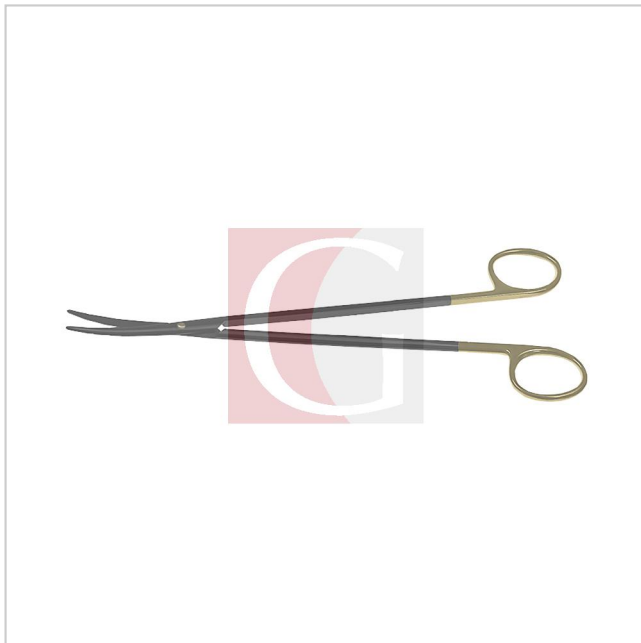

Illustrations, technical changes and the like are subject to product changes and are therefore not binding.



## PRODUCT DATA SHEET

CREATED ON 20.04.2026 ON WWW.GEISTER.COM

**26-0041.DF**

Scissors, TC 16cm curved Type: Mayo-Lexer Pandor™

**Material:** 1.4117

**GTIN Number:** 04057034077474



Illustrations, technical changes and the like are subject to product changes and are therefore not binding.



## PRODUCT DATA SHEET

CREATED ON 20.04.2026 ON WWW.GEISTER.COM

### 10-3730

Microsurgical Tissue Forceps, round hdl. counterbalanced 21.0cm tip 1.0mm Type: DeBakey

**Material:** 1.4021

**GTIN Number:** 04057034026526

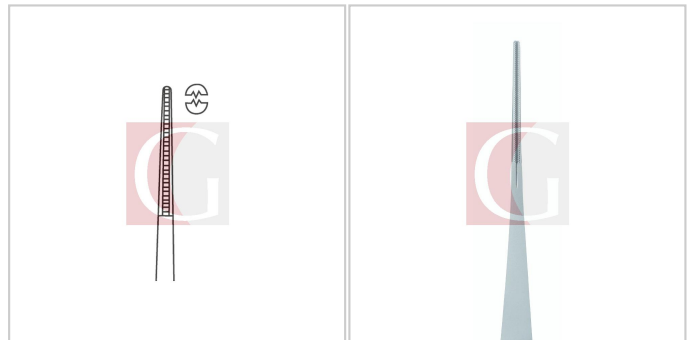

Illustrations, technical changes and the like are subject to product changes and are therefore not binding.



## PRODUCT DATA SHEET

CREATED ON 20.04.2026 ON WWW.GEISTER.COM

**20-0378**

Applying Forceps for Bulldog Clamps 24cm 50° angled

**Material:** 1.4021

**GTIN Number:** 04057034043820



Illustrations, technical changes and the like are subject to product changes and are therefore not binding.



## PRODUCT DATA SHEET

CREATED ON 20.04.2026 ON WWW.GEISTER.COM

**28-0306**

Extraktor, Phlebektomie 17cm Mini Type: Varady

**Material: ...**

**GTIN Number: 04057034088111**

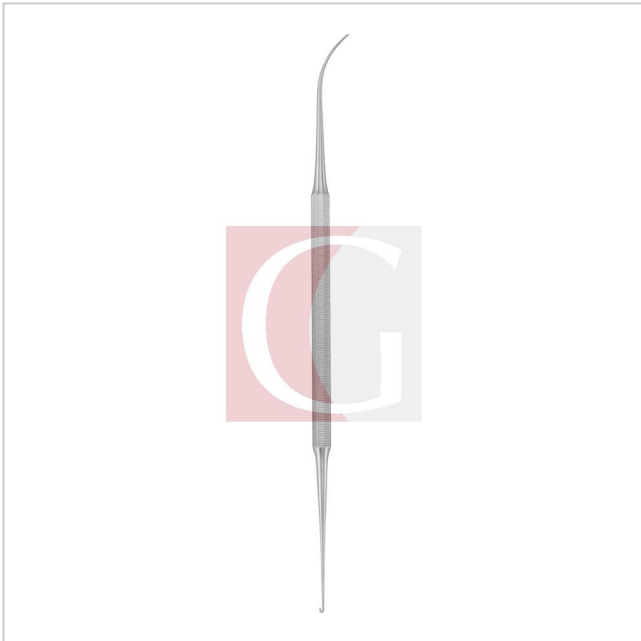

Illustrations, technical changes and the like are subject to product changes and are therefore not binding.



## PRODUCT DATA SHEET

CREATED ON 20.04.2026 ON WWW.GEISTER.COM

**34-7286**

Atraumatic Clamp (transient use) 75mm with ring-handle Type: DeBakey ValveGate™

**Material: ...**

**GTIN Number: 04057034385487**

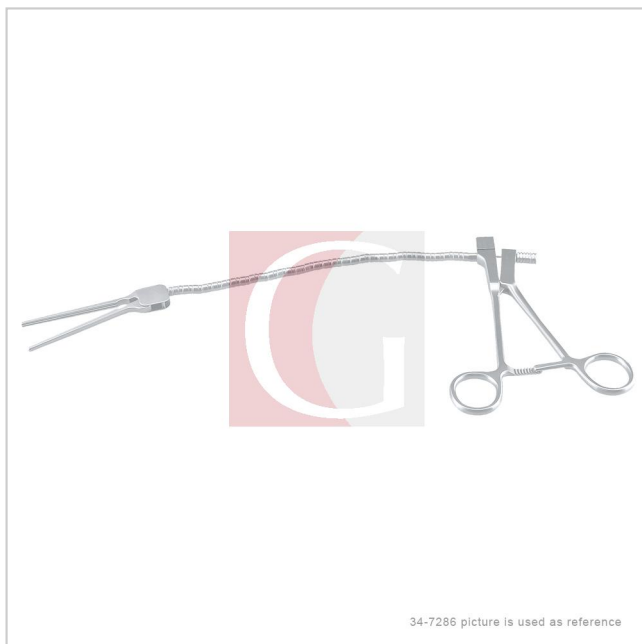

Illustrations, technical changes and the like are subject to product changes and are therefore not binding.



## PRODUCT DATA SHEET

CREATED ON 20.04.2026 ON WWW.GEISTER.COM

**24-0126**

Needle Holder, TC 18cm TC (N) Type: Wire-Twister

**Material:** 1.4021

**GTIN Number:** 04057034064221

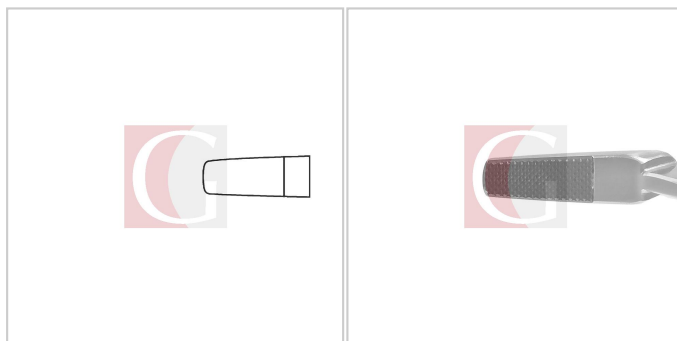

Illustrations, technical changes and the like are subject to product changes and are therefore not binding.



## PRODUCT DATA SHEET

CREATED ON 20.04.2026 ON WWW.GEISTER.COM

### 26-0500G

Ligature Scissors, TC 18cm closed shanks gold/black

**Material:** 1.4117

**GTIN Number:** 04057034079188

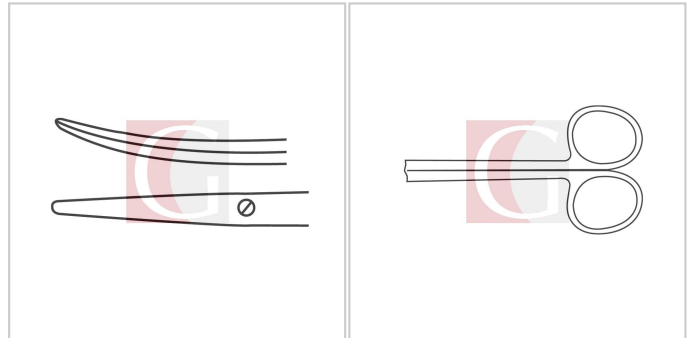
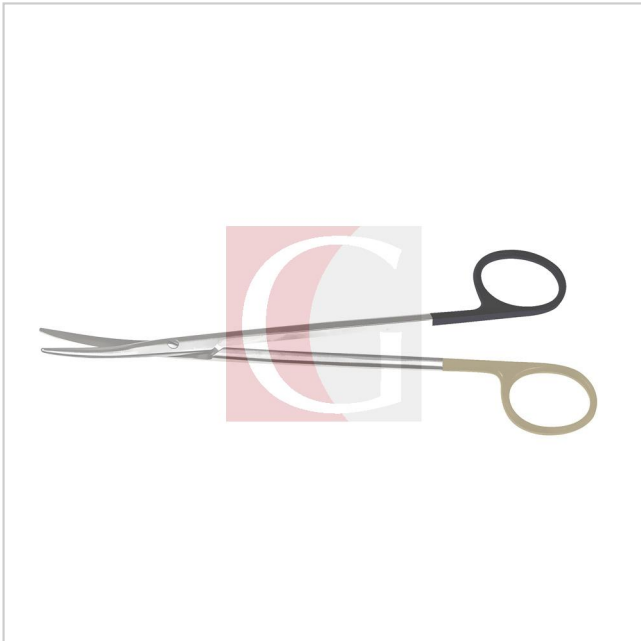

Illustrations, technical changes and the like are subject to product changes and are therefore not binding.





## PRODUCT DATA SHEET

CREATED ON 20.04.2026 ON WWW.GEISTER.COM

### 30-0643

Wound Retractor (transient use) 3x4 16cm blunt 18mm Type: Cone

**Material:** 1.4021

**GTIN Number:** 04057034109656



Illustrations, technical changes and the like are subject to product changes and are therefore not binding.



## PRODUCT DATA SHEET

CREATED ON 20.04.2026 ON WWW.GEISTER.COM

### 30-0662

Wound Retractor (transient use) 7x7 prongs 32cm sharp 50mm Type: Beckmann-Eaton

**Material:** 1.4021

**GTIN Number:** 04057034109779

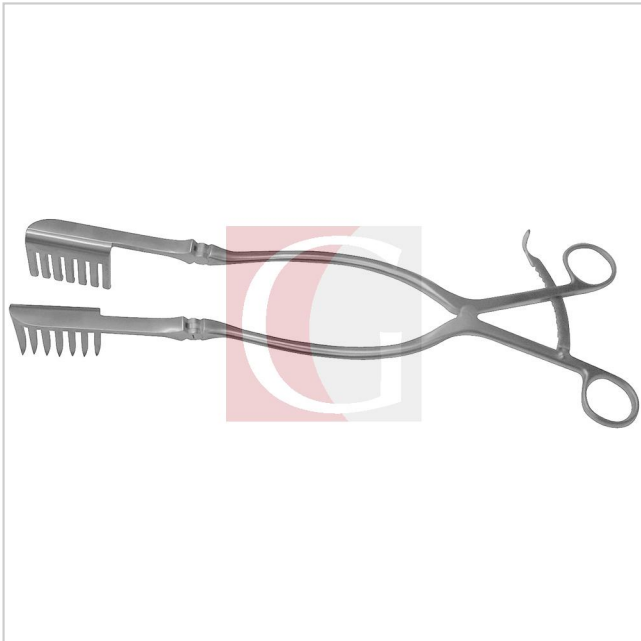

Illustrations, technical changes and the like are subject to product changes and are therefore not binding.



## PRODUCT DATA SHEET

CREATED ON 20.04.2026 ON WWW.GEISTER.COM

**16-0034**

Scalpel Handle, for microblades 18.0cm Fig. 3K

**Material: ...**

**GTIN Number: 04057034037881**



Illustrations, technical changes and the like are subject to product changes and are therefore not binding.



## PRODUCT DATA SHEET

CREATED ON 20.04.2026 ON WWW.GEISTER.COM

**22-1231**

Atraumatic Clamp (transient use) 16cm curved Type: DeBakey-Rankin

**Material: ...**

**GTIN Number: 04057034059135**

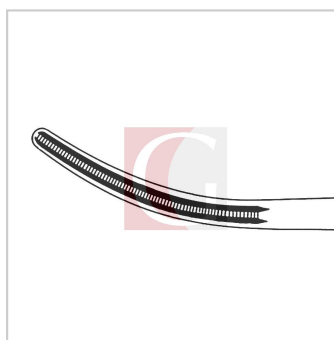
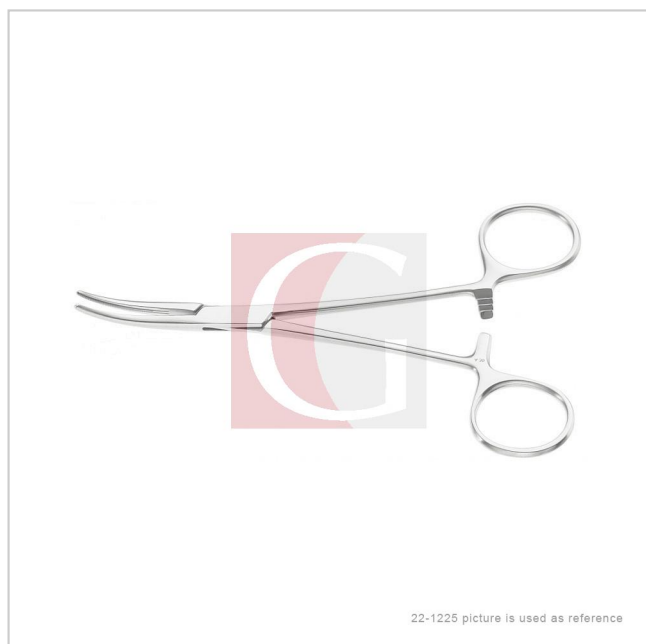

Illustrations, technical changes and the like are subject to product changes and are therefore not binding.



## PRODUCT DATA SHEET

CREATED ON 20.04.2026 ON WWW.GEISTER.COM

### 26-0118.DF

Dissecting Scissors, TC 17.5cm curved delicate Type: Toennis-Adson Pandor™

**Material:** 1.4117

**GTIN Number:** 04057034078068



Illustrations, technical changes and the like are subject to product changes and are therefore not binding.



## PRODUCT DATA SHEET

CREATED ON 20.04.2026 ON WWW.GEISTER.COM

**26-0125**

Dissecting Scissors, TC 20cm curved Type: Metzenbaum-Fino

**Material:** 1.4117

**GTIN Number:** 04057034078235

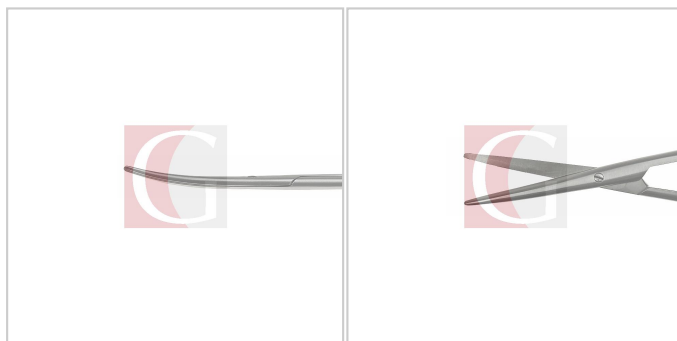
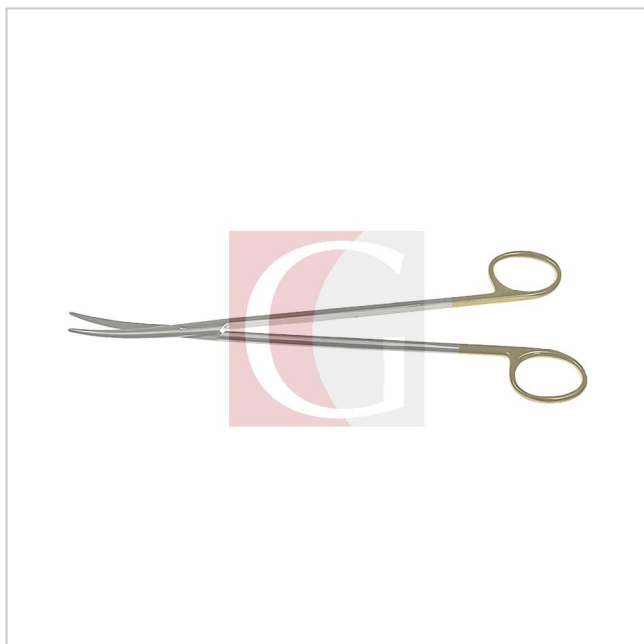

Illustrations, technical changes and the like are subject to product changes and are therefore not binding.



## PRODUCT DATA SHEET

CREATED ON 20.04.2026 ON WWW.GEISTER.COM

**26-0221**

Vascular Scissors, TC 23cm 60° Type: DeBakey

**Material:** 1.4117

**GTIN Number:** 04057034078914



Illustrations, technical changes and the like are subject to product changes and are therefore not binding.



## PRODUCT DATA SHEET

CREATED ON 20.04.2026 ON WWW.GEISTER.COM

**26-4176**

Vascular Scissors 17cm 45° Type: DeBakey

**Material:** 1.4117

**GTIN Number:** 04057034080900

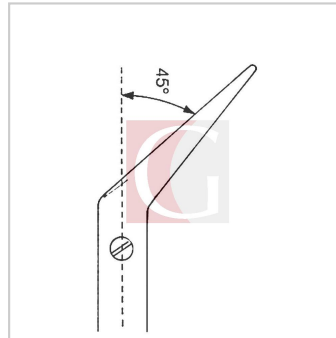
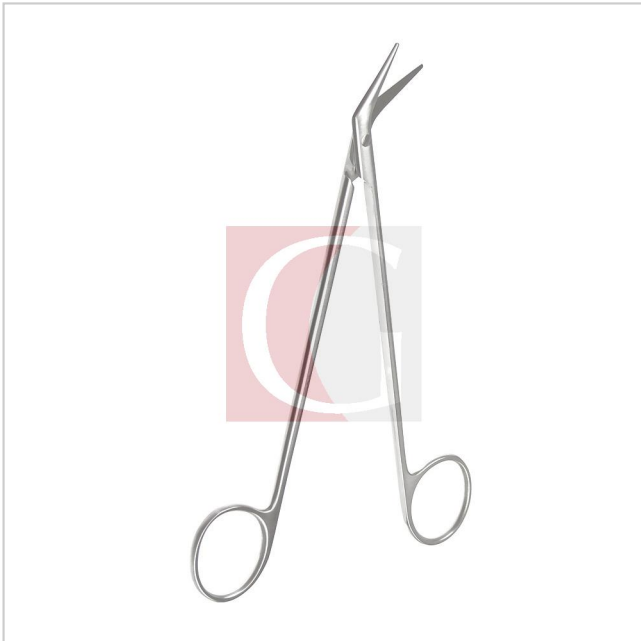

Illustrations, technical changes and the like are subject to product changes and are therefore not binding.





## PRODUCT DATA SHEET

CREATED ON 20.04.2026 ON WWW.GEISTER.COM

### 20-0350

Bulldog Clamp (transient use) 80mm 25mm Type: DeBakey

**Material:** 1.4021

**GTIN Number:** 04057034043424

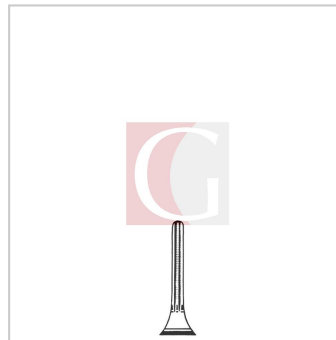
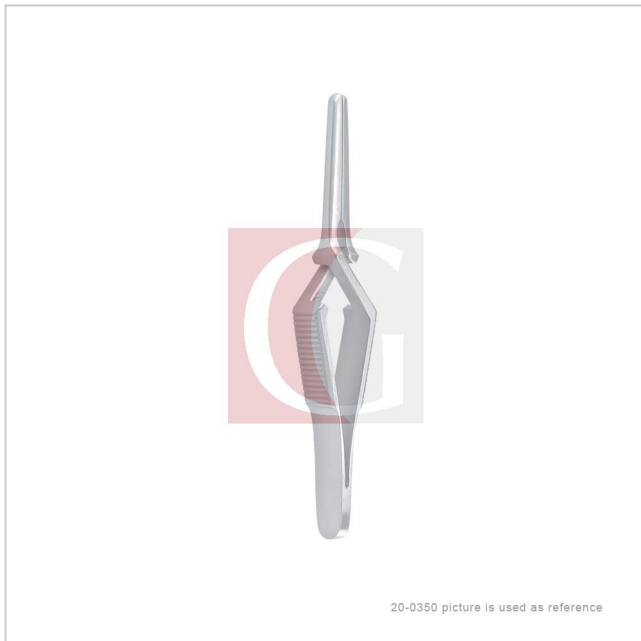

Illustrations, technical changes and the like are subject to product changes and are therefore not binding.



## PRODUCT DATA SHEET

CREATED ON 20.04.2026 ON WWW.GEISTER.COM

### 20-0352

Bulldog Clamp (transient use) 105mm 50mm Type: DeBakey

**Material:** 1.4021

**GTIN Number:** 04057034043486

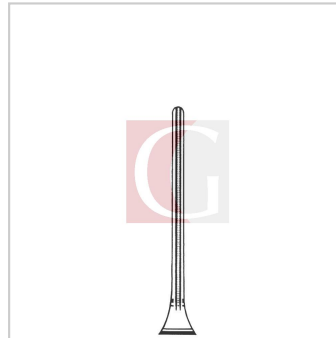

Illustrations, technical changes and the like are subject to product changes and are therefore not binding.



## PRODUCT DATA SHEET

CREATED ON 20.04.2026 ON WWW.GEISTER.COM

**28-0050**

Dissector, Skin and Vascular 17cm Type: Lemmon

**Material: ...**

**GTIN Number: 04057034087442**

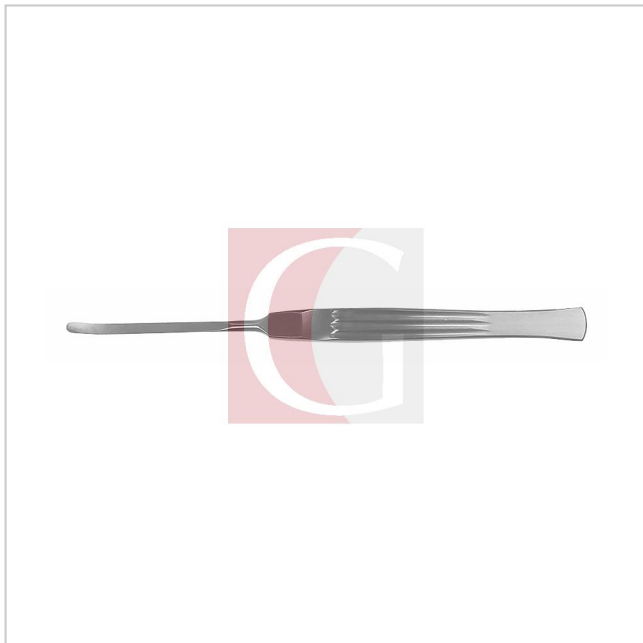

Illustrations, technical changes and the like are subject to product changes and are therefore not binding.



## PRODUCT DATA SHEET

CREATED ON 20.04.2026 ON WWW.GEISTER.COM

**28-0071**

Elevator, Skin and Vascular 20cm sp/st 5.0/5.0mm curved Type: Freer

**Material: ...**

**GTIN Number: 04057034087558**

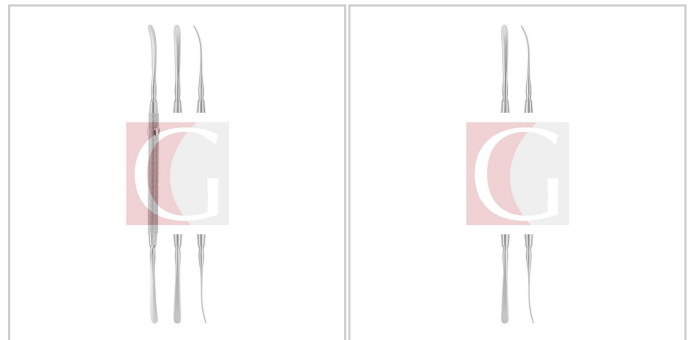
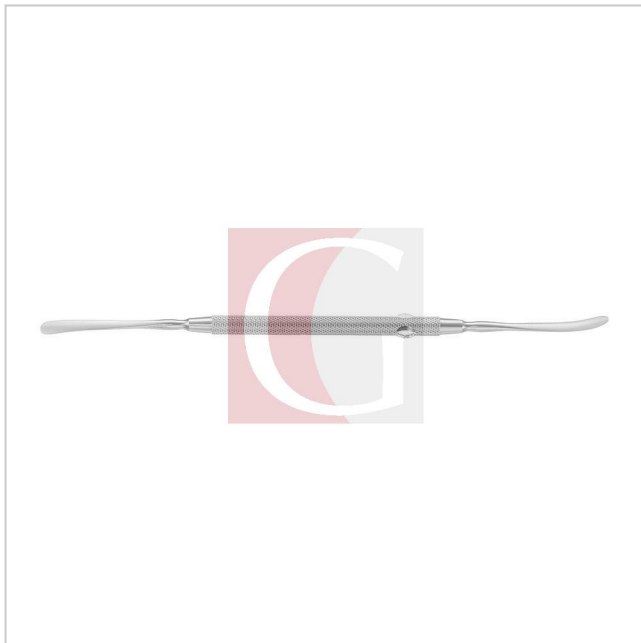

Illustrations, technical changes and the like are subject to product changes and are therefore not binding.



## PRODUCT DATA SHEET

CREATED ON 20.04.2026 ON WWW.GEISTER.COM

**28-0044**

Dissector, Skin and Vascular Fig. 4 20.5cm

**Material:** 1.4021

**GTIN Number:** 04057034087404

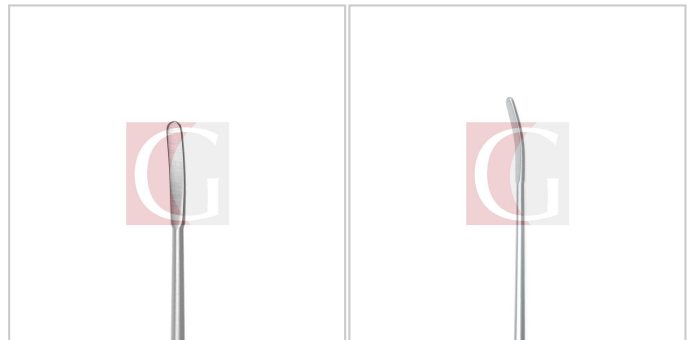

Illustrations, technical changes and the like are subject to product changes and are therefore not binding.



## PRODUCT DATA SHEET

CREATED ON 20.04.2026 ON WWW.GEISTER.COM

### 10-0054

Atraumatic Tissue Forceps ultralight 24.0cm tip 1.0mm Type: DeBakey

**Material:** 1.4024

**GTIN Number:** 04057034017920

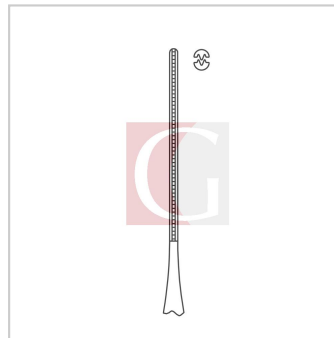

Illustrations, technical changes and the like are subject to product changes and are therefore not binding.



## PRODUCT DATA SHEET

CREATED ON 20.04.2026 ON WWW.GEISTER.COM

**22-0285**

Atraumatic Clamp (transient use) 31cm curved Type: DeBakey

**Material:** 1.4021

**GTIN Number:** 04057034054154

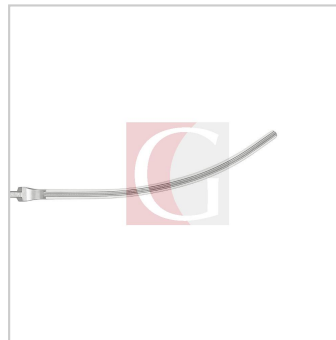
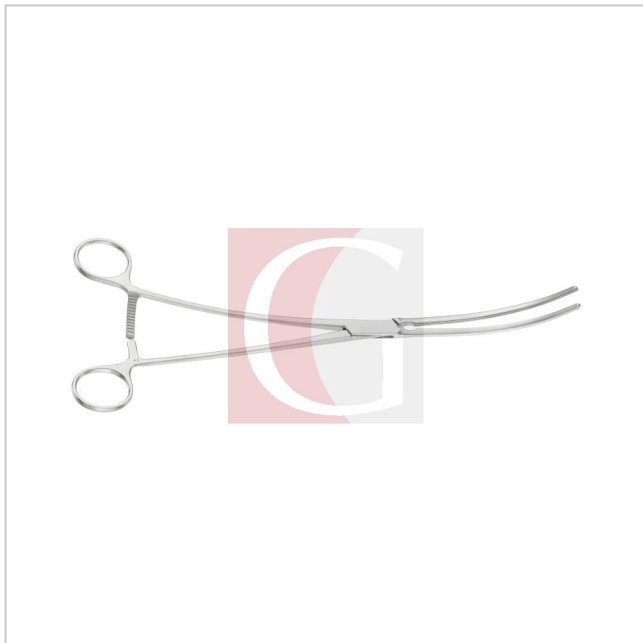

Illustrations, technical changes and the like are subject to product changes and are therefore not binding.



## PRODUCT DATA SHEET

CREATED ON 20.04.2026 ON WWW.GEISTER.COM

**22-0345**

Atraumatic Clamp (transient use) 28cm angled Type: DeBakey

**Material:** 1.4021

**GTIN Number:** 04057034054857

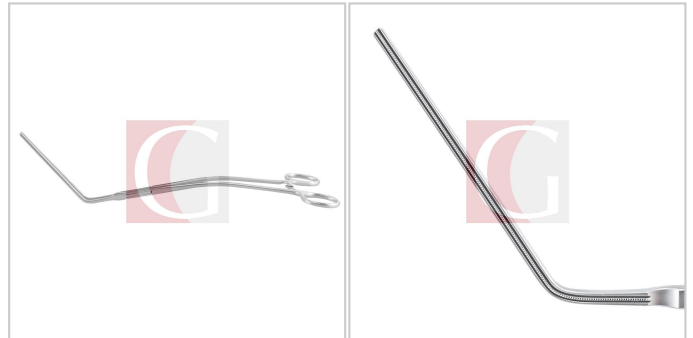
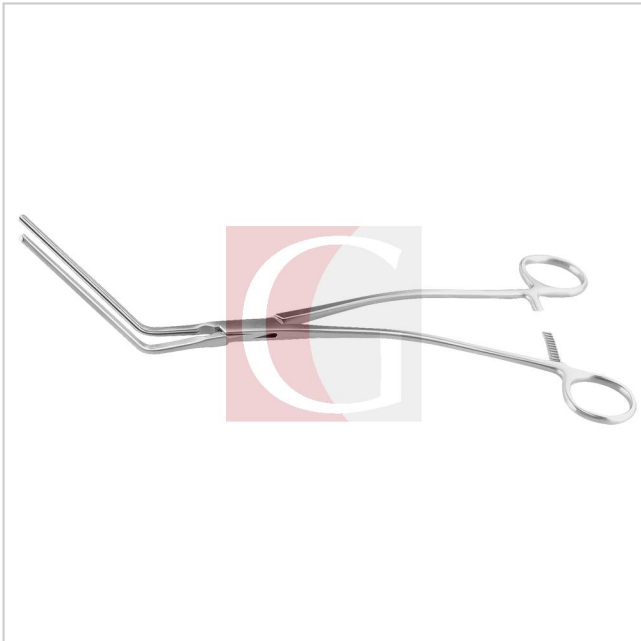

Illustrations, technical changes and the like are subject to product changes and are therefore not binding.





## PRODUCT DATA SHEET

CREATED ON 20.04.2026 ON WWW.GEISTER.COM

**22-0301**

Atraumatic Clamp (transient use) 25.5cm curved Type: Bahnson

**Material:** 1.4021

**GTIN Number:** 04057034054413

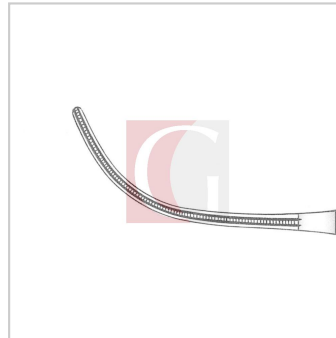
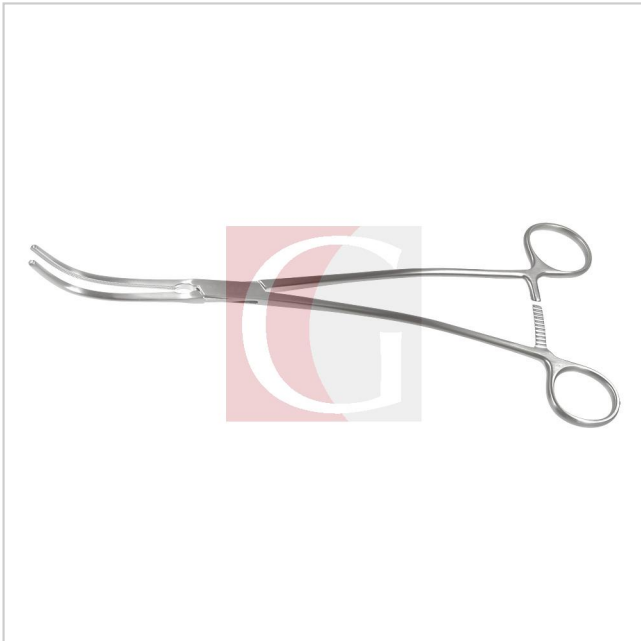

Illustrations, technical changes and the like are subject to product changes and are therefore not binding.



## PRODUCT DATA SHEET

CREATED ON 20.04.2026 ON WWW.GEISTER.COM

### 22-0310

Atraumatic Clamp (transient use) 26.5cm curved Type: DeBaKey

**Material:** 1.4021

**GTIN Number:** 04057034054482

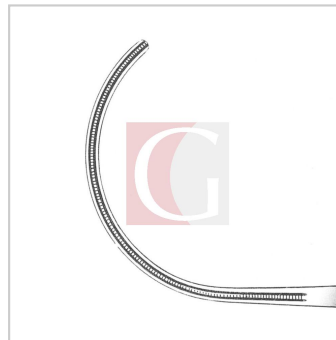
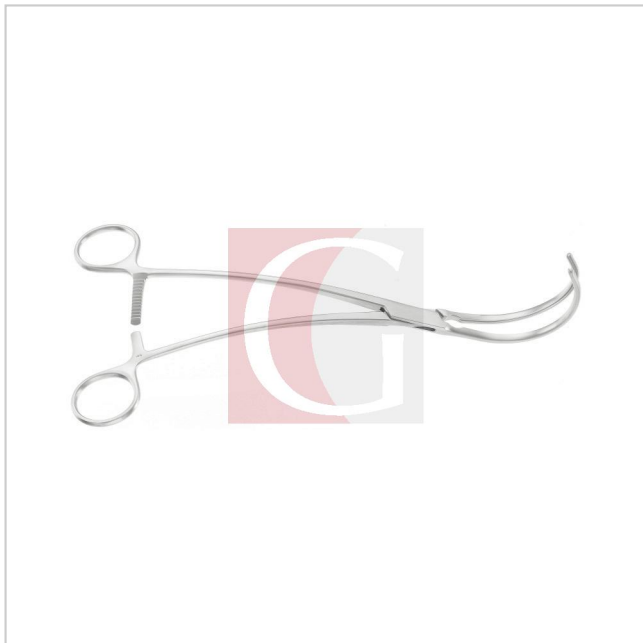

Illustrations, technical changes and the like are subject to product changes and are therefore not binding.



## PRODUCT DATA SHEET

CREATED ON 20.04.2026 ON WWW.GEISTER.COM

**22-0374**

Atraumatic Clamp (transient use) 26cm angled Type: DeBakey

**Material:** 1.4021

**GTIN Number:** 04057034055212

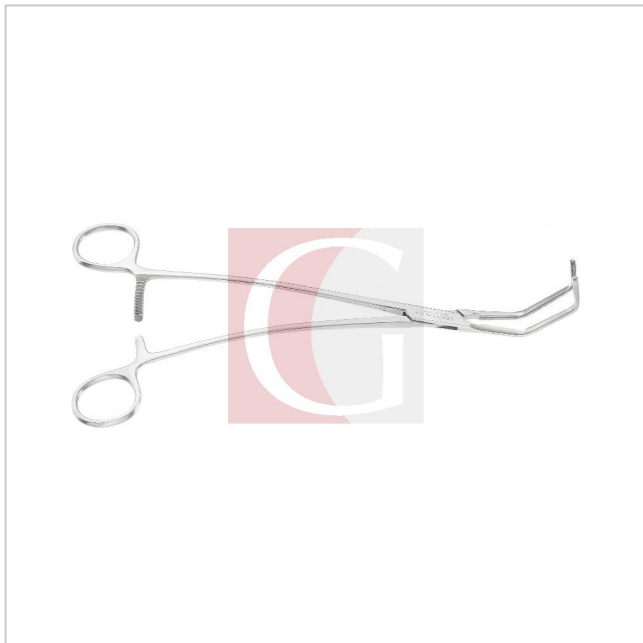

Illustrations, technical changes and the like are subject to product changes and are therefore not binding.



## PRODUCT DATA SHEET

CREATED ON 20.04.2026 ON WWW.GEISTER.COM

**22-0551**

Atraumatic Clamp (transient use) 23cm curved Type: DeBakey

**Material:** 1.4021

**GTIN Number:** 04057034056738

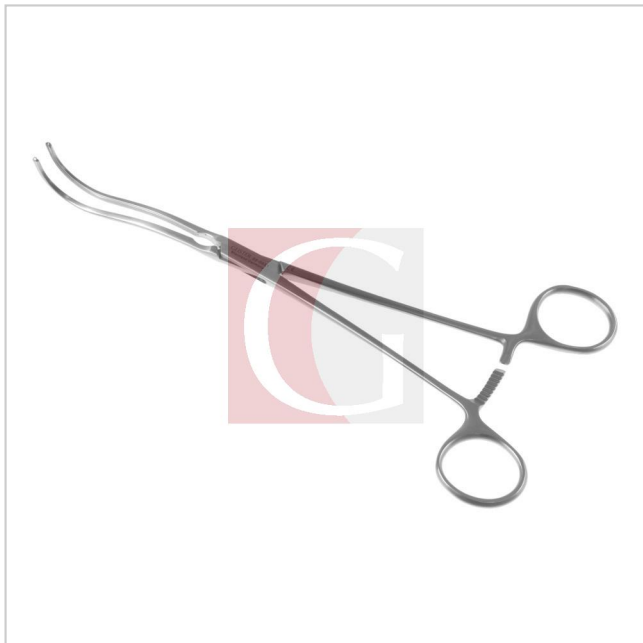

Illustrations, technical changes and the like are subject to product changes and are therefore not binding.



## PRODUCT DATA SHEET

CREATED ON 20.04.2026 ON WWW.GEISTER.COM

**22-0131**

Atraumatic Clamp (transient use) 22cm angled Type: Glover

**Material:** 1.4021

**GTIN Number:** 04057034052716



Illustrations, technical changes and the like are subject to product changes and are therefore not binding.



## PRODUCT DATA SHEET

CREATED ON 20.04.2026 ON WWW.GEISTER.COM

**22-0180**

Atraumatic Clamp (transient use) 19cm angled Type: DeBakey

**Material:** 1.4021

**GTIN Number:** 04057034053157

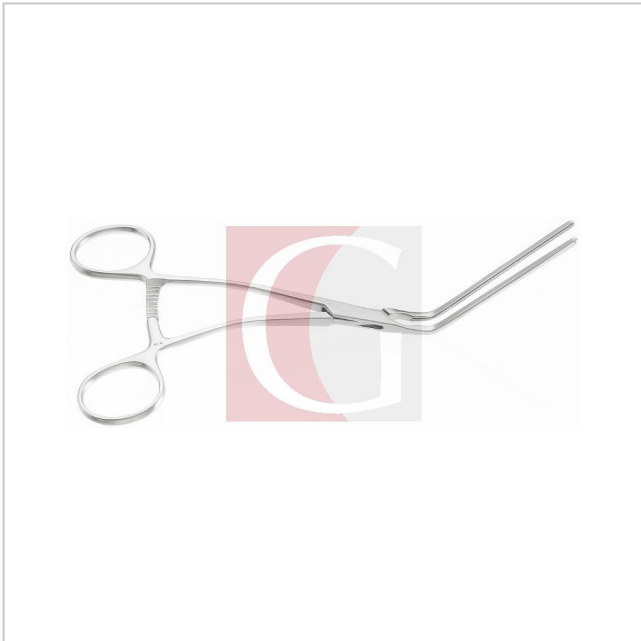

Illustrations, technical changes and the like are subject to product changes and are therefore not binding.



## PRODUCT DATA SHEET

CREATED ON 20.04.2026 ON WWW.GEISTER.COM

**22-0492**

Atraumatic Clamp (transient use) 17cm angled Type: DeBakey-Derra

**Material:** 1.4021

**GTIN Number:** 04057034056363

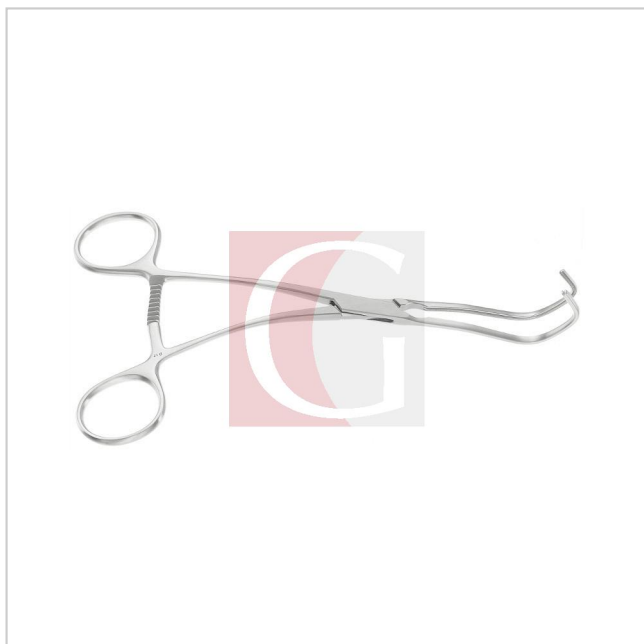

Illustrations, technical changes and the like are subject to product changes and are therefore not binding.



## PRODUCT DATA SHEET

CREATED ON 20.04.2026 ON WWW.GEISTER.COM

**22-0491**

Atraumatic Clamp (transient use) 17cm angled Type: DeBakey-Derra

**Material:** 1.4021

**GTIN Number:** 04057034056332

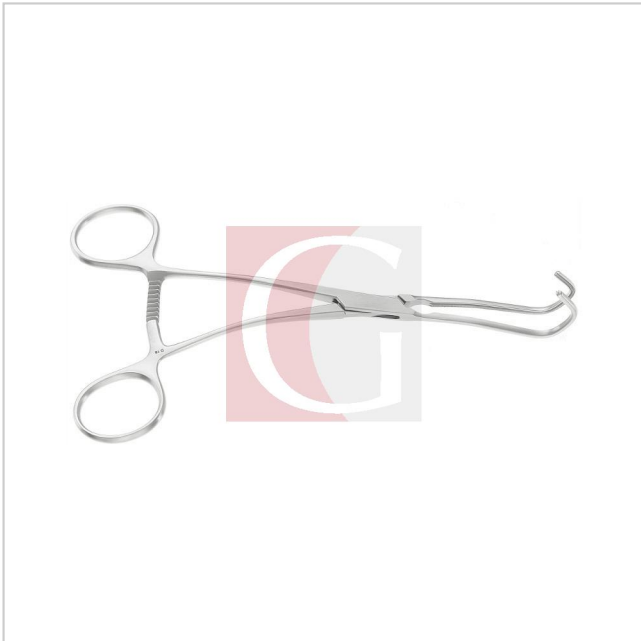

Illustrations, technical changes and the like are subject to product changes and are therefore not binding.





## PRODUCT DATA SHEET

CREATED ON 20.04.2026 ON WWW.GEISTER.COM

**22-0490**

Atraumatic Clamp (transient use) 17cm angled Type: DeBakey-Derra

**Material:** 1.4021

**GTIN Number:** 04057034056301



Illustrations, technical changes and the like are subject to product changes and are therefore not binding.



## PRODUCT DATA SHEET

CREATED ON 20.04.2026 ON WWW.GEISTER.COM

### 22-0270

Atraumatic Clamp (transient use) 19.5cm angled Type: Diethrich

**Material:** 1.4021

**GTIN Number:** 04057034053928

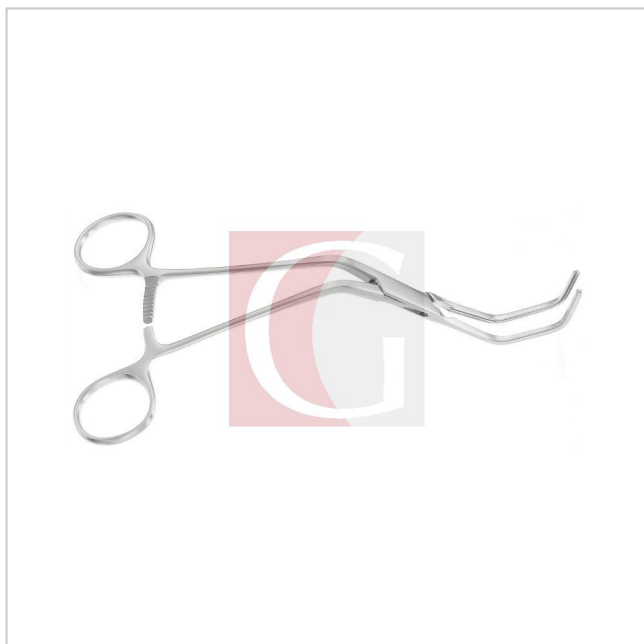

Illustrations, technical changes and the like are subject to product changes and are therefore not binding.



## PRODUCT DATA SHEET

CREATED ON 20.04.2026 ON WWW.GEISTER.COM

**23-0528**

Atraumatic Clamp (transient use) 27cm Type: Cooley

**Material:** 1.4021

**GTIN Number:** 04057034061503



Illustrations, technical changes and the like are subject to product changes and are therefore not binding.



## PRODUCT DATA SHEET

CREATED ON 20.04.2026 ON WWW.GEISTER.COM

**24-0352**

Needle Holder, TC 20cm TC (M) Type: Mikrovaskular

**Material:** 1.4021

**GTIN Number:** 04057034066010

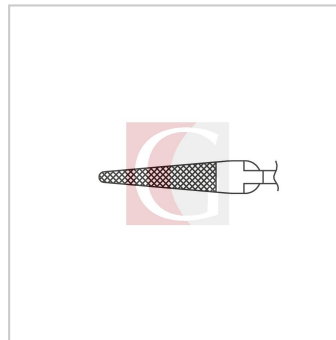

Illustrations, technical changes and the like are subject to product changes and are therefore not binding.



## PRODUCT DATA SHEET

CREATED ON 20.04.2026 ON WWW.GEISTER.COM

**24-0352**

Needle Holder, TC 20cm TC (M) Type: Mikrovaskular

**Material:** 1.4021

**GTIN Number:** 04057034066010

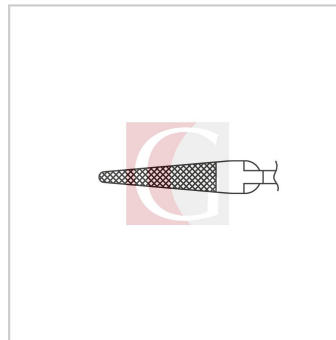
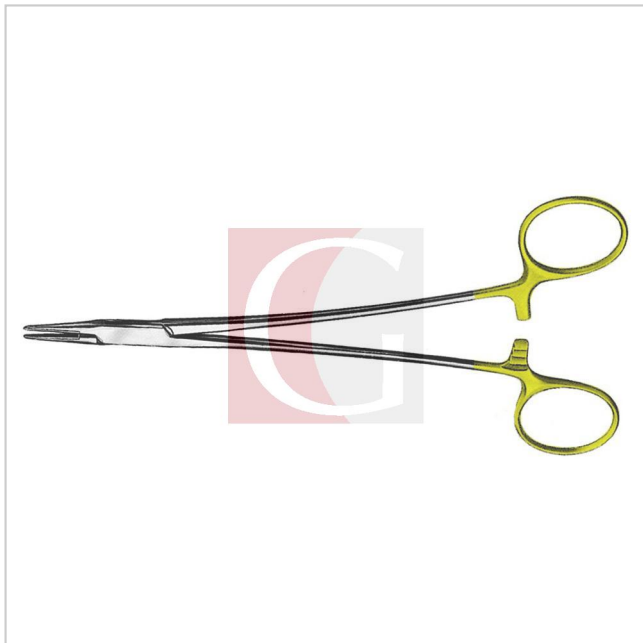

Illustrations, technical changes and the like are subject to product changes and are therefore not binding.



## PRODUCT DATA SHEET

CREATED ON 20.04.2026 ON WWW.GEISTER.COM

### 10-0134

Atraumatic Tissue Forceps 24.0cm tip 3.5mm Type: DeBakey

**Material:** 1.4024

**GTIN Number:** 04057034018835

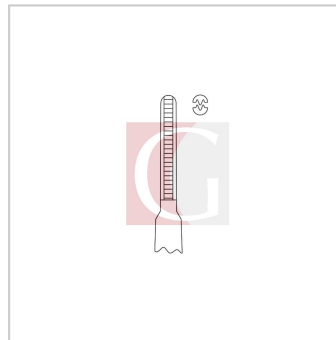

Illustrations, technical changes and the like are subject to product changes and are therefore not binding.



## PRODUCT DATA SHEET

CREATED ON 20.04.2026 ON WWW.GEISTER.COM

### 10-0114

Atraumatic Tissue Forceps 24.0cm tip 2.0mm Type: DeBakey

**Material:** 1.4024

**GTIN Number:** 04057034018439

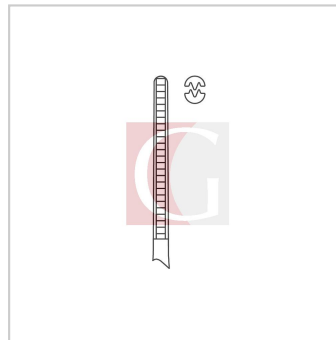

Illustrations, technical changes and the like are subject to product changes and are therefore not binding.



## PRODUCT DATA SHEET

CREATED ON 20.04.2026 ON WWW.GEISTER.COM

### 10-0132

Atraumatic Tissue Forceps 19.5cm tip 3.5mm Type: DeBakey

**Material:** 1.4024

**GTIN Number:** 04057034018811

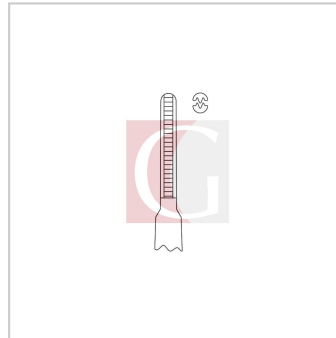

Illustrations, technical changes and the like are subject to product changes and are therefore not binding.





## PRODUCT DATA SHEET

CREATED ON 20.04.2026 ON WWW.GEISTER.COM

**10-0075.20**

Atraumatic Tissue Forceps 20cm tip 1.0mm Type: Gerald

**Material:** 1.4024

**GTIN Number:** 04057034017975

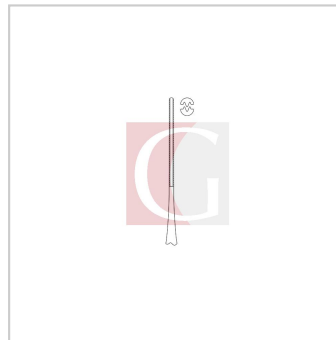

Illustrations, technical changes and the like are subject to product changes and are therefore not binding.



## PRODUCT DATA SHEET

CREATED ON 20.04.2026 ON WWW.GEISTER.COM

### 10-0106

Atraumatic Tissue Forceps 15.0cm tip 1.5mm Type: DeBakey

**Material:** 1.4024

**GTIN Number:** 04057034018255

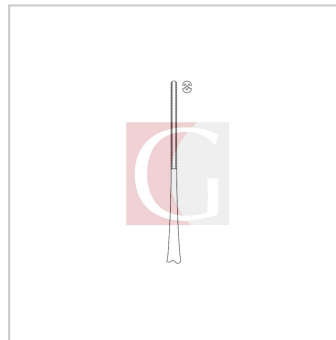

Illustrations, technical changes and the like are subject to product changes and are therefore not binding.



## PRODUCT DATA SHEET

CREATED ON 20.04.2026 ON WWW.GEISTER.COM

### 10-3720

Microsurgical Tissue Forceps, round hdl. counterbalanced 18.0cm tip 1.0mm Type: DeBakey

**Material:** 1.4021

**GTIN Number:** 04057034026502

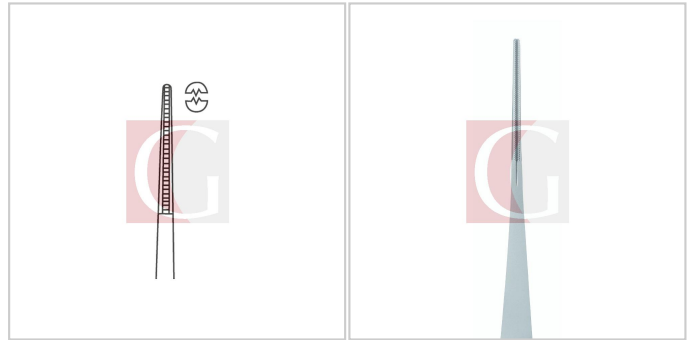

Illustrations, technical changes and the like are subject to product changes and are therefore not binding.



## PRODUCT DATA SHEET

CREATED ON 20.04.2026 ON WWW.GEISTER.COM

**24-0363**

Needle Holder, TC 26cm TC (F) Type: DeBakey

**Material:** 1.4021

**GTIN Number:** 04057034066133

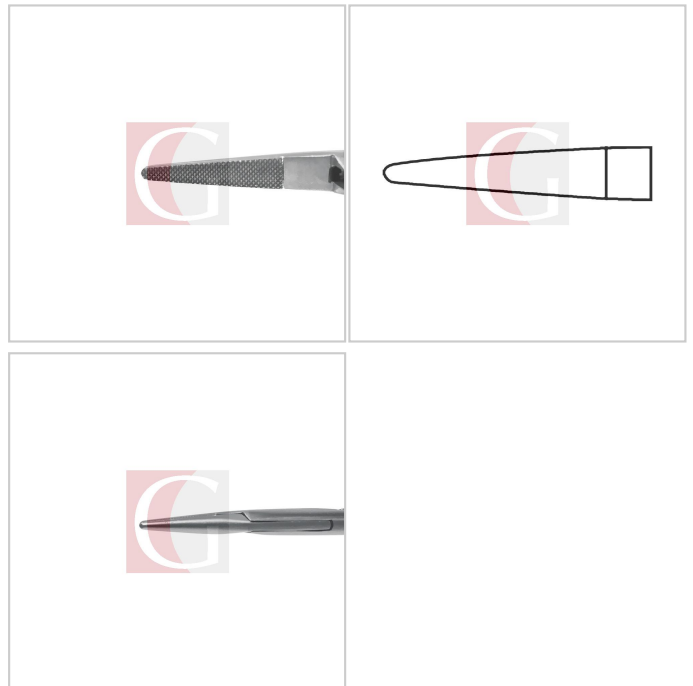
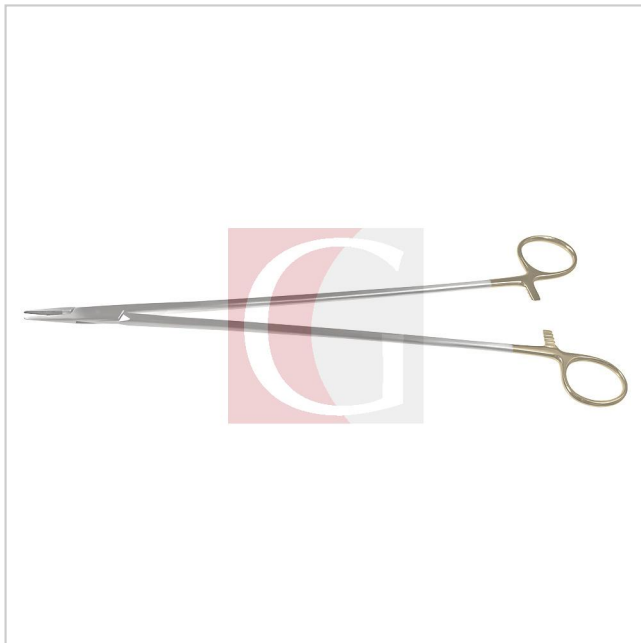

Illustrations, technical changes and the like are subject to product changes and are therefore not binding.



## PRODUCT DATA SHEET

CREATED ON 20.04.2026 ON WWW.GEISTER.COM

**24-0362**

Needle Holder, TC 23cm TC (F) Type: DeBaKey

**Material:** 1.4021

**GTIN Number:** 04057034066119

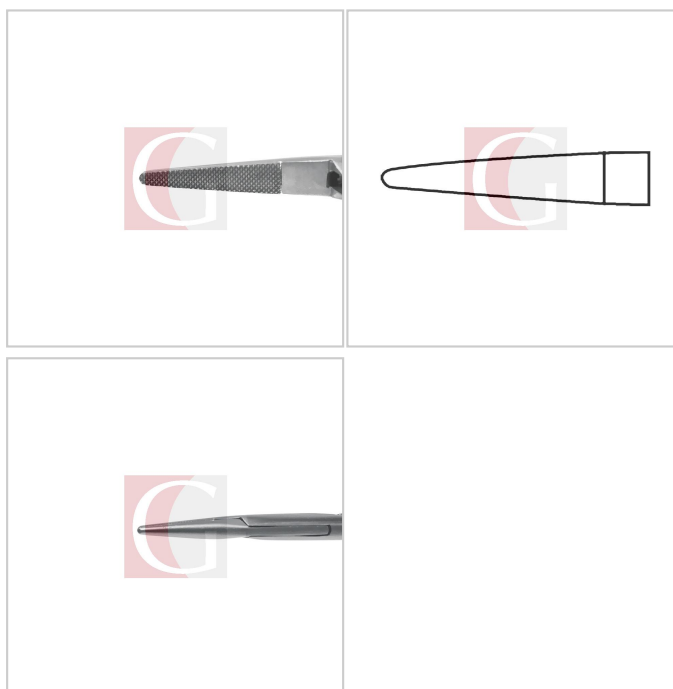
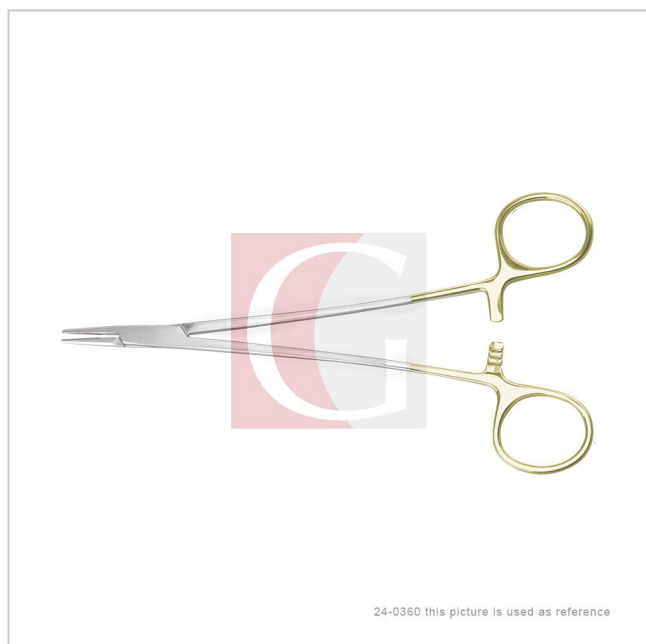

Illustrations, technical changes and the like are subject to product changes and are therefore not binding.



## PRODUCT DATA SHEET

CREATED ON 20.04.2026 ON WWW.GEISTER.COM

**24-0150**

Needle Holder, TC 20cm TC (N) Type: Hegar

**Material:** 1.4021

**GTIN Number:** 04057034064658

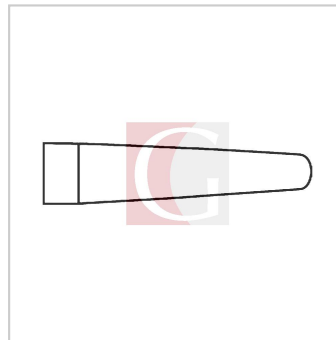

Illustrations, technical changes and the like are subject to product changes and are therefore not binding.



## PRODUCT DATA SHEET

CREATED ON 20.04.2026 ON WWW.GEISTER.COM

**24-0360**

Needle Holder, TC 18cm TC (F) Type: DeBaKey

**Material:** 1.4021

**GTIN Number:** 04057034066072

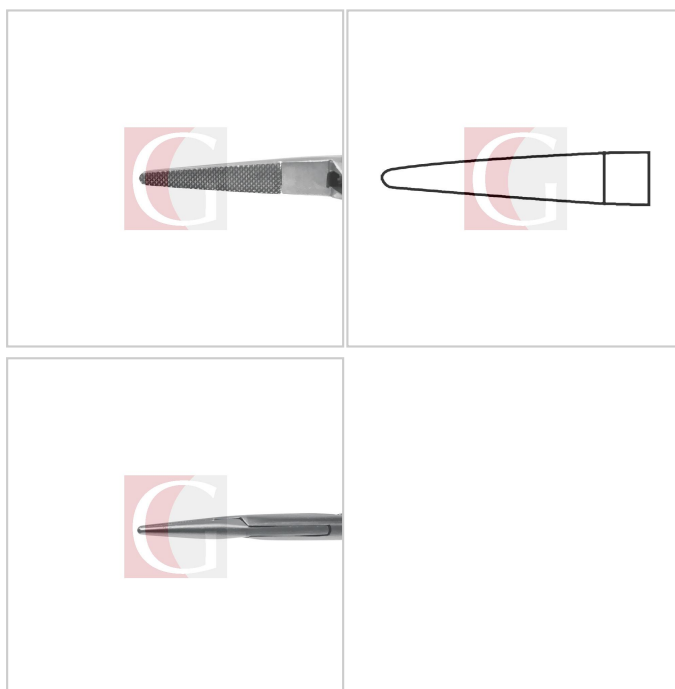
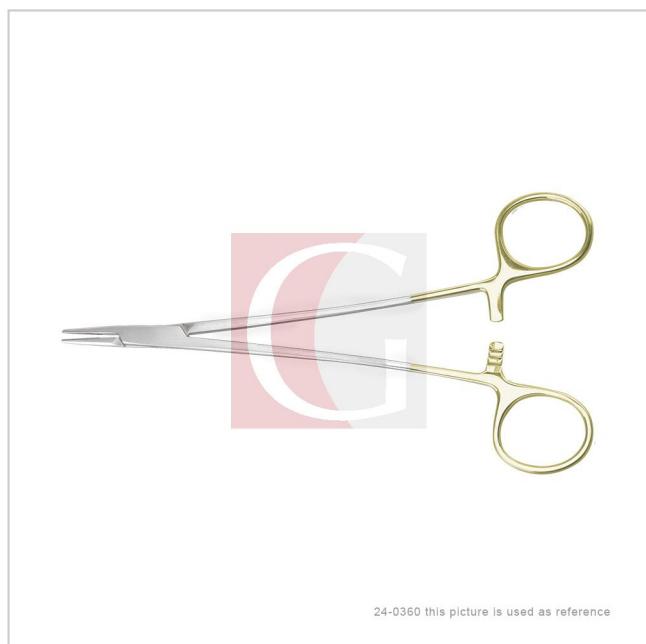

Illustrations, technical changes and the like are subject to product changes and are therefore not binding.



## PRODUCT DATA SHEET

CREATED ON 20.04.2026 ON WWW.GEISTER.COM

**24-0351**

Needle Holder, TC 18cm TC (M) Type: Mikrovaskular

**Material:** 1.4021

**GTIN Number:** 04057034065976

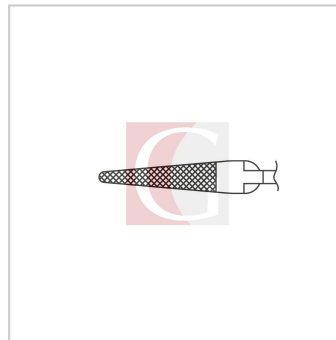

Illustrations, technical changes and the like are subject to product changes and are therefore not binding.





## PRODUCT DATA SHEET

CREATED ON 20.04.2026 ON WWW.GEISTER.COM

**24-0350**

Needle Holder, TC 15cm TC (M) Type: Mikrovaskular

**Material:** 1.4021

**GTIN Number:** 04057034065945

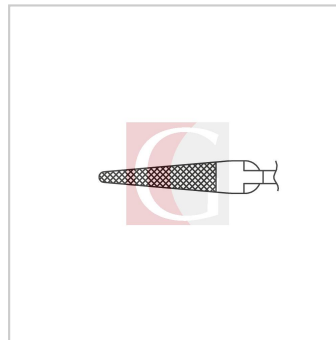

Illustrations, technical changes and the like are subject to product changes and are therefore not binding.



## PRODUCT DATA SHEET

CREATED ON 20.04.2026 ON WWW.GEISTER.COM

**24-0414**

Needle Holder, TC 20cm TC (M) Type: Mini-Ryder

**Material:** 1.4021

**GTIN Number:** 04057034066454

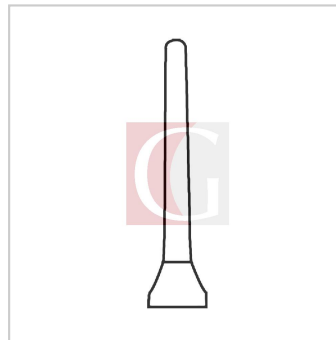

Illustrations, technical changes and the like are subject to product changes and are therefore not binding.



## PRODUCT DATA SHEET

CREATED ON 20.04.2026 ON WWW.GEISTER.COM

**25-0152**

Dissecting Forceps (transient use) 20cm strongly curved Type: Heiss

**Material:** 1.4021

**GTIN Number:** 04057034070437

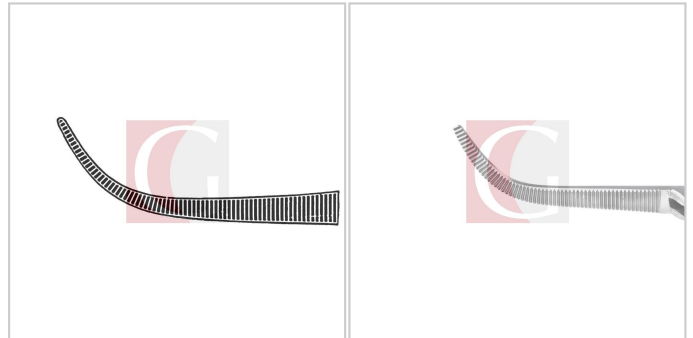
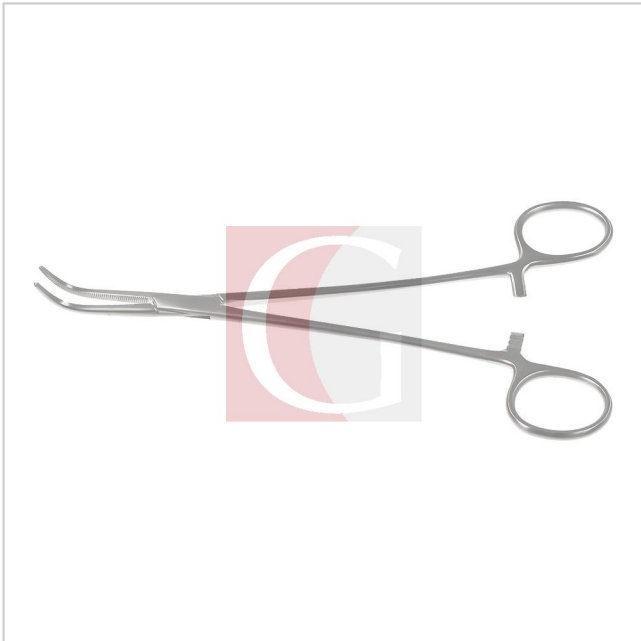

Illustrations, technical changes and the like are subject to product changes and are therefore not binding.



## PRODUCT DATA SHEET

CREATED ON 20.04.2026 ON WWW.GEISTER.COM

### 25-1363

Artery Forceps (transient use) 18cm heavy model Type: Mixer-Baby

**Material:** 1.4021

**GTIN Number:** 04057034073698

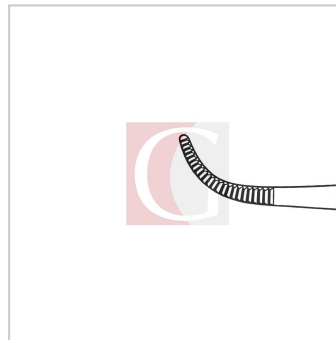

Illustrations, technical changes and the like are subject to product changes and are therefore not binding.



## PRODUCT DATA SHEET

CREATED ON 20.04.2026 ON WWW.GEISTER.COM

### 25-0104

Dissecting Forceps (transient use) 23cm Type: Gemini

**Material:** 1.4021

**GTIN Number:** 04057034069974

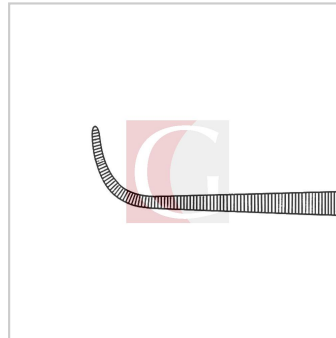
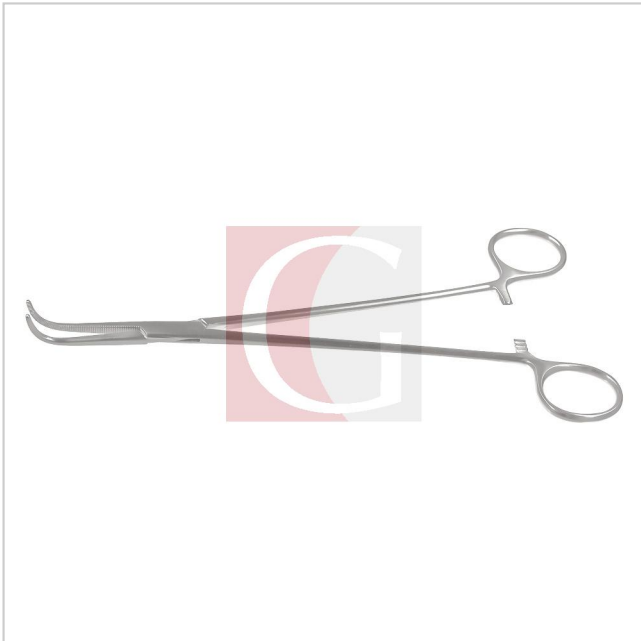

Illustrations, technical changes and the like are subject to product changes and are therefore not binding.



## PRODUCT DATA SHEET

CREATED ON 20.04.2026 ON WWW.GEISTER.COM

**25-1201**

Artery Forceps (transient use) 14cm curved Type: Crile

**Material:** 1.4021

**GTIN Number:** 04057034072929

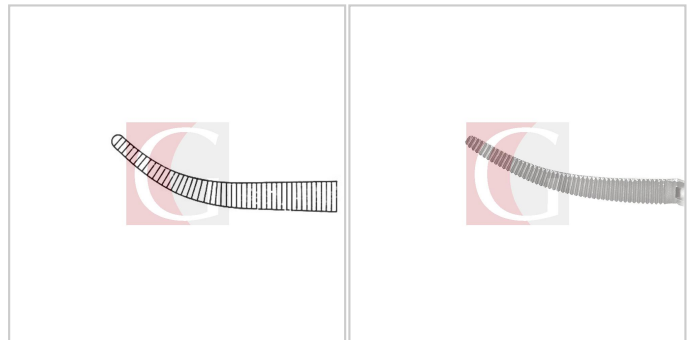
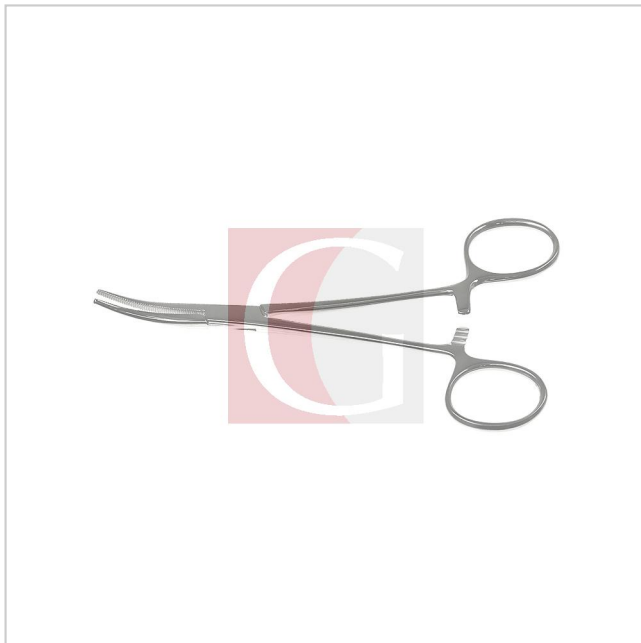

Illustrations, technical changes and the like are subject to product changes and are therefore not binding.



## PRODUCT DATA SHEET

CREATED ON 20.04.2026 ON WWW.GEISTER.COM

**25-0201**

Artery Forceps (transient use) 24cm curved Type: Bengolea

**Material:** 1.4021

**GTIN Number:** 04057034070659

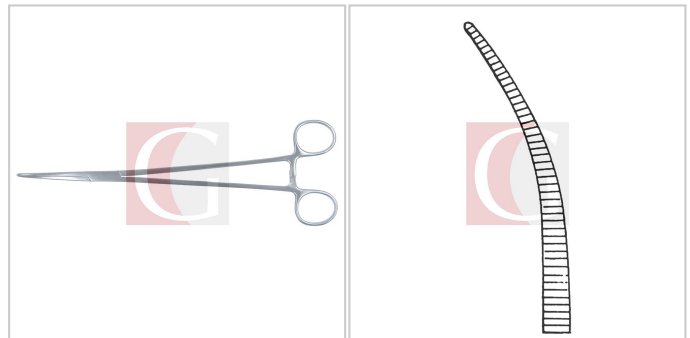
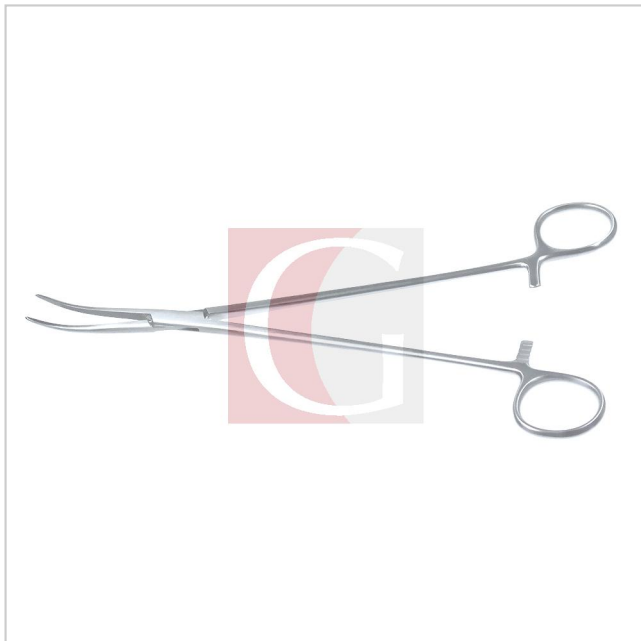

Illustrations, technical changes and the like are subject to product changes and are therefore not binding.



## PRODUCT DATA SHEET

CREATED ON 20.04.2026 ON WWW.GEISTER.COM

### 25-1021

Artery Forceps (transient use) 12.5cm curved Type: Mikro-Halstead

**Material:** 1.4021

**GTIN Number:** 04057034071694

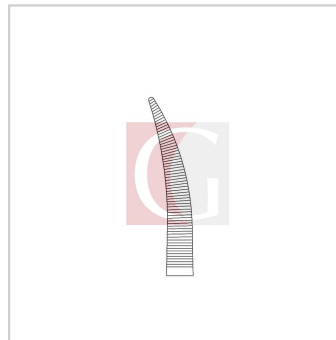

Illustrations, technical changes and the like are subject to product changes and are therefore not binding.





## PRODUCT DATA SHEET

CREATED ON 20.04.2026 ON WWW.GEISTER.COM

**25-1211**

Artery Forceps (transient use) 16cm curved Type: Crile-Rankin

**Material:** 1.4021

**GTIN Number:** 04057034072998

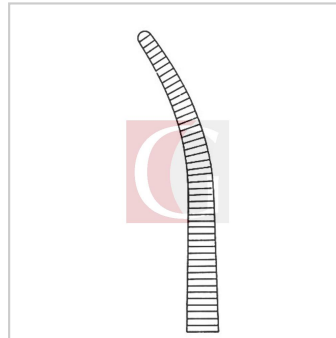

Illustrations, technical changes and the like are subject to product changes and are therefore not binding.



## PRODUCT DATA SHEET

CREATED ON 20.04.2026 ON WWW.GEISTER.COM

### 03-0510

Microsurgical Needle Holder, ratchet round handle 21cm 1.2mm [ $\leq 5-0$ ] Type: Jacobson Soft-Touch

**Material:** 1.4021

**GTIN Number:** 04057034007358



Illustrations, technical changes and the like are subject to product changes and are therefore not binding.



## PRODUCT DATA SHEET

CREATED ON 20.04.2026 ON WWW.GEISTER.COM

### 20-0310

Micro Bulldog Clamp (transient use) serrated 43mm 8mm angled 95g Type: Diethrich

**Material:** 1.4024

**GTIN Number:** 04057034042762

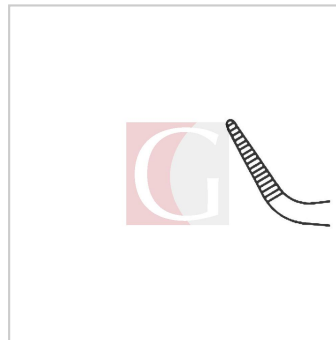

Illustrations, technical changes and the like are subject to product changes and are therefore not binding.



## PRODUCT DATA SHEET

CREATED ON 20.04.2026 ON WWW.GEISTER.COM

### 10-0050

Atraumatic Tissue Forceps ultralight 15.0cm tip 1.0mm Type: DeBakey

**Material:** 1.4024

**GTIN Number:** 04057034017869

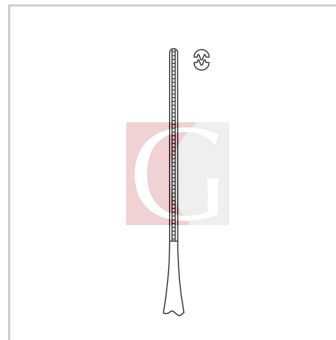

Illustrations, technical changes and the like are subject to product changes and are therefore not binding.