

Aria



 Signature
ORTHOPAEDICS

Table of Contents

Introduction	3
Aria Stem Features	4
Surgical Technique	5
<i>Preoperative Planning</i>	5
<i>Femoral Neck Resection</i>	6
<i>Femoral Preparation</i>	7
<i>Broaching</i>	8
<i>Calcar Reaming</i>	8
<i>Trial Reduction</i>	9
<i>Femoral Component Insertion</i>	10
<i>Femoral Head Impaction</i>	11
Aria Implant Sizing Guide	12
Aria Instrument Tray	13
Aria Instruments	14
Aria Preoperative Templates	17
Aria Implants	18
Appendix: Broaching Techniques and Tips	20

Introduction

The Signature Orthopaedics Aria Instrument system is an optimised instrument set for implantation of the Signature Orthopaedics Aria cementless hip stem. The Aria instrument set features an adaptable broach handle that quick-connects to several instrument attachments to reduce the overall number of instruments and minimize the size and weight of the instrument tray.

Indications

Signature Orthopaedics' hip replacement range is intended to replace a hip joint where bone stock is sufficient to support the implant. When a surgeon has selected prosthetic replacement as the preferred treatment, the devices are indicated for:

- Non-inflammatory degenerative joint disease including osteoarthritis or avascular necrosis
- Inflammatory joint disease including rheumatoid arthritis (excluding TSI stem)
- Correction of functional deformity including congenital hip dysplasia
- Traumatic injury involving the hip joint including traumatic arthritis or femoral head or neck fracture
- Failed previous hip surgery including internal fixation or joint fusion, reconstruction, hemiarthroplasty, surface replacement, or total replacement.

Contraindications

In general, prosthetic components require adequate bone support for correct fit and function. The use of prosthetic components is therefore contraindicated where any pathological condition may reduce the quantity and or strength of the bone which is supporting the prosthesis. Some contraindications are relative to the extent and severity of conditions and the benefits of prosthetic arthroplasty should be considered based on the patient's overall evaluation and the possibility of alternative treatment. Examples of such conditions include; osteoporosis, osteomalacia, osteogenesis imperfecta, or hypophosphatemia. Other contraindications include:

- Conditions limiting blood supply to the bone or joint.
- Systemic or local infection.
- Previous high dose radiotherapy.
- Psychological or neurological conditions which would restrict the patient's ability or compliance in restricting physical activity.
- Skeletal immaturity
- Conditions or activity which may place excessive load on the components such as; obesity, muscle, tendon & ligament deficiencies, multiple joint disabilities, and Charcot joints.

Aria Stem Features

Cementless Hip Stem

- Clinically proven geometry, material and coating (Ti6Al4V with titanium plasma spray coating).
- Threaded proximal feature aids in positioning and removal.

1. Standard and High offset versions

2. 12/14 Taper

3. Low-profile lateral shoulder

Enables easy insertion in reduced insertion techniques, including anterior approach.

4. Tapered geometry

Wedge-shaped stem improves initial fixation and proximal bone loading.

5. Titanium Plasma Spray Coating

- Tensile Strength > 22MPa
- Shear Strength > 22MPa
- Coating Thickness 70-130 microns.

6. Distal reduced options

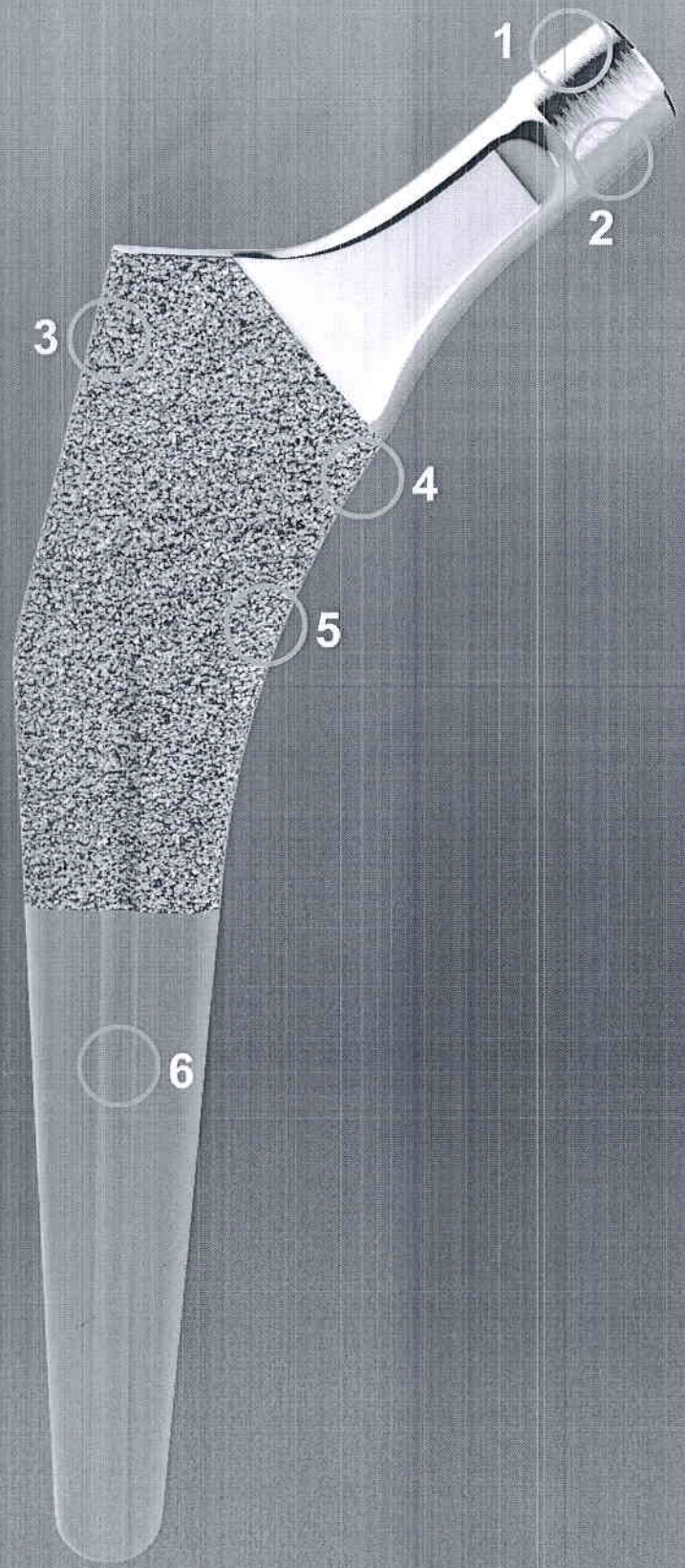

Aria coating x100

1

Preoperative Planning

Aria X-Ray templates can be used over anterior/posterior and lateral radiographs to help determine the correct size to restore the patient's anatomy. Templates are 120% magnification.

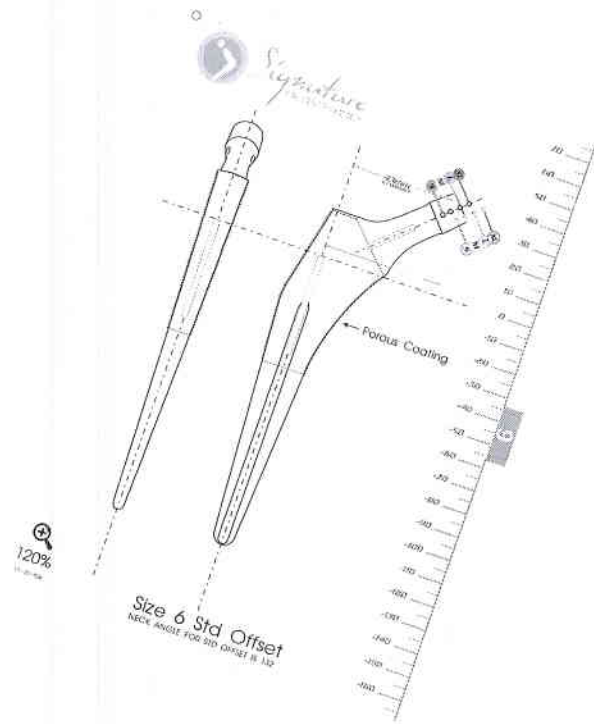

2

Preoperative Planning

The Logical cup can be used with any surgical approach that the surgeon selects.

- a. Posterior approach
- b. Posterolateral/anterolateral approach
- c. Anterior approach

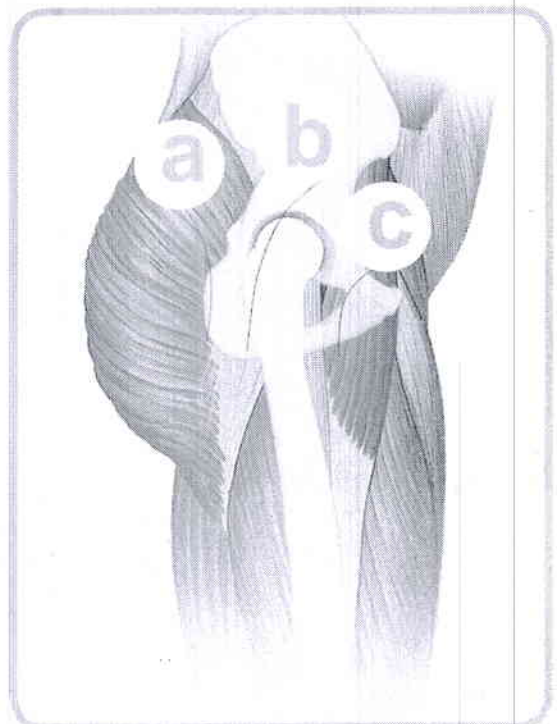

Note:

Prior to the following steps, complete all steps detailed in 111-12-0003 for the Logical acetabular cup implantation.

3

Femoral Neck Resection

The osteotomy guide should be used in conjunction with preoperative planning, to determine the level of the femoral neck resection. This can be performed in multiple steps, depending on surgeon preference.

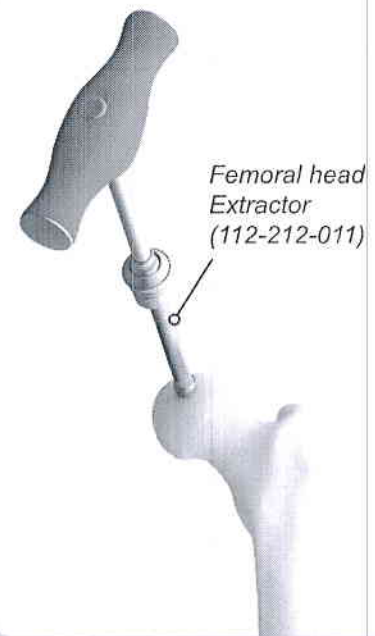
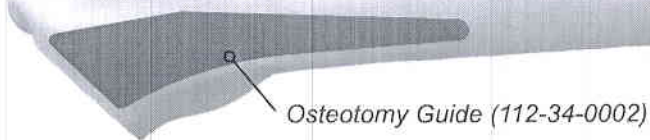
**Optional technique:**

The femoral head extractor may be used with the T-handle or under power to aid in the removal of the resected head, especially during an anterior approach technique.

4

Femoral Preparation

Enter the femoral canal as laterally as possible with the Box Osteotome to initiate access to the medullary canal. The Canal Reamer may be used as needed to open the natural axis of the femoral canal for broach preparation.

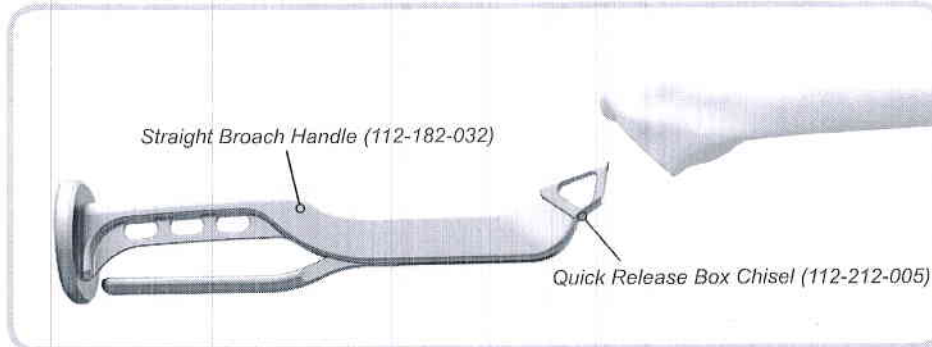

Optional technique:

While the Aria system is intended to be a broach-only system, the Aria instrument tray contains instruments for optional use to ensure proper axial alignment along the femoral canal and to induce lateral bias where needed:

- a. Starter broach induces lateral bias by rasping beneath the greater trochanter
- b. Canal reamer creates a guide hole for the distal end of the trochanteric reamer
- c. Trochanteric reamer removes trochanteric bone tissue laterally to ensure neutral alignment with the femoral axis during broaching

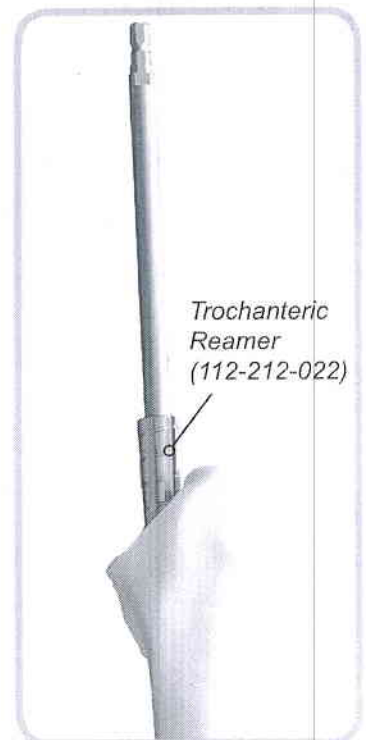
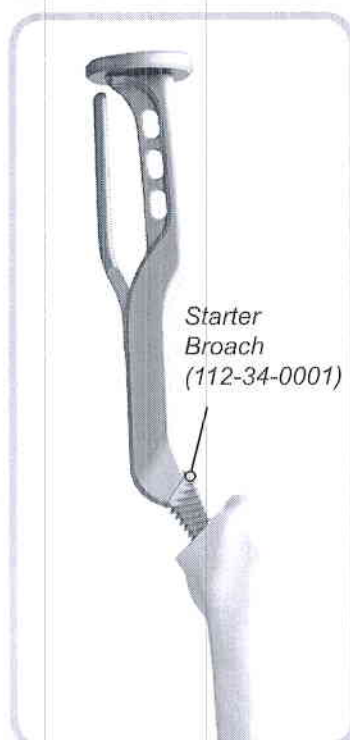

7.

5

Broaching

The broach should run parallel to the posterior cortex following the natural anatomy of the femur. Begin with the smallest broach and increase the size of the broach sequentially until longitudinal and rotational stability is achieved: broaching should then be stopped. Careful preoperative planning is key to help selection of the final broach size. The version will be determined by the natural version of the femur.

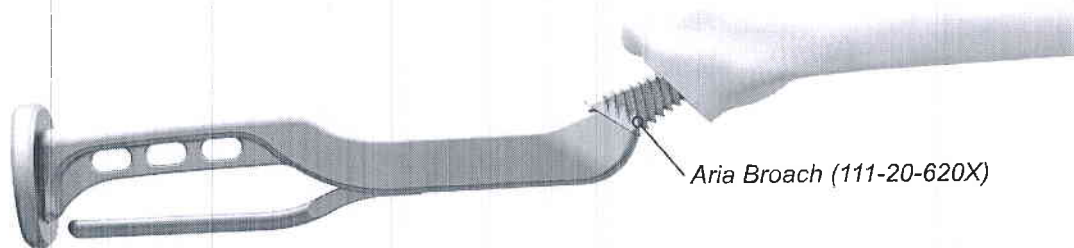
**Note:**

Refer to Appendix: Broaching Techniques and Tips for detail on the theory of compaction broaching, why this technique is used for Aria stems, and how to form a bed of compacted bone that will maximize the longevity and stability of Aria stems in many bone types.

6

Calcar Reaming

With the broach in situ, use the Calcar Reamer to achieve a flat resection surface. Slide the reamer over the broach quick connect fitting to maintain the resection angle. Carefully advance the reamer towards the broach face and into the resected edge of the femur until it bottoms out against the broach face.

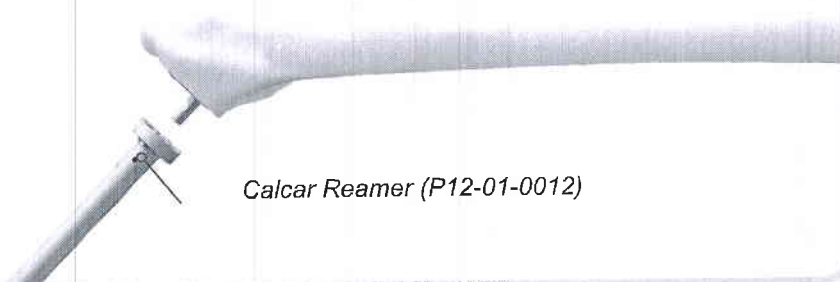

8.

7

Trial Reduction

With the final broach still in situ, attach the appropriate trial neck and trial head. Reduce the hip and assess what adjustments, if any, are required to provide stability through a full range of motion. Remove the trial head, trial neck and final broach. DO NOT irrigate or dry the femoral canal. This will help to preserve the compacted cancellous bone quality and encourage biological fixation of the stem.

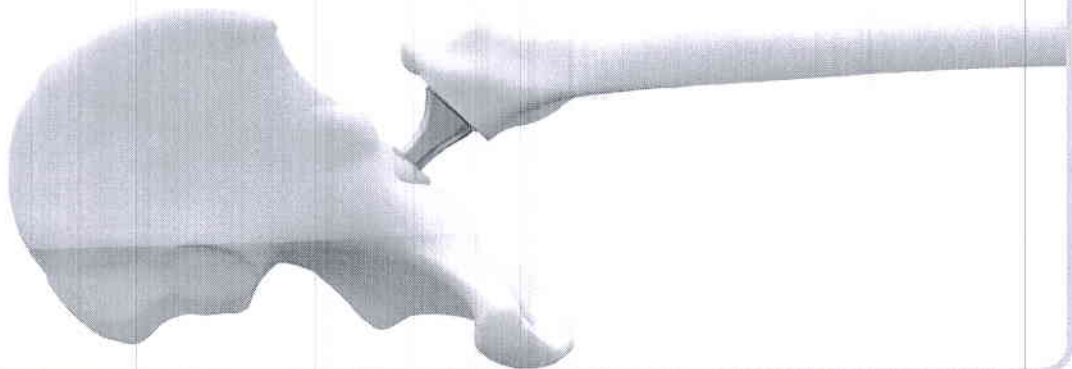
**Instrument Identification:**

Trial heads are colour coded based on offset. Refer to Aria Implants Sizing Guide in this surgical technique for more details.

8

Femoral Component Insertion

When implanting the definitive stem (same size as final broach) in the femoral canal, ensure that it is directed in by hand. This will help avoid changing the version as a precautionary measure. There should be no more than 15-20mm between the resection line and the top of the porous coating on the stem. If the stem does not readily go down this far, the surgeon should broach again. Once the stem is placed, lightly tap the stem impactor to fully seat. **DO NOT** over-impact as this may lead to splitting of the femur.

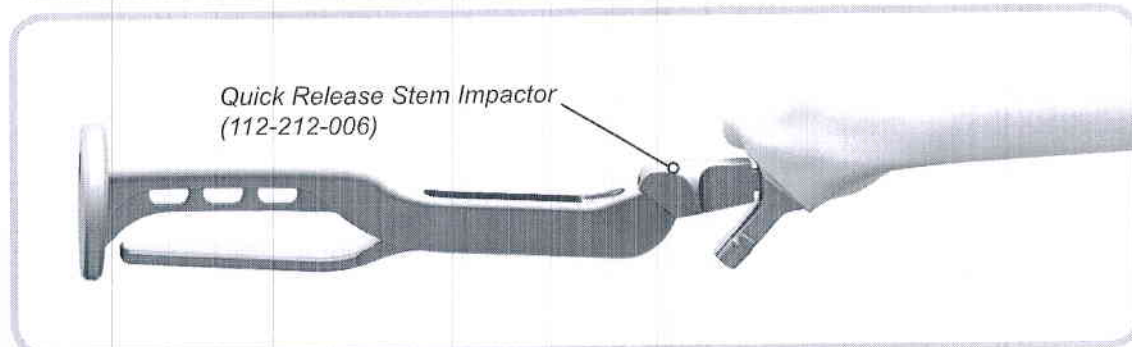
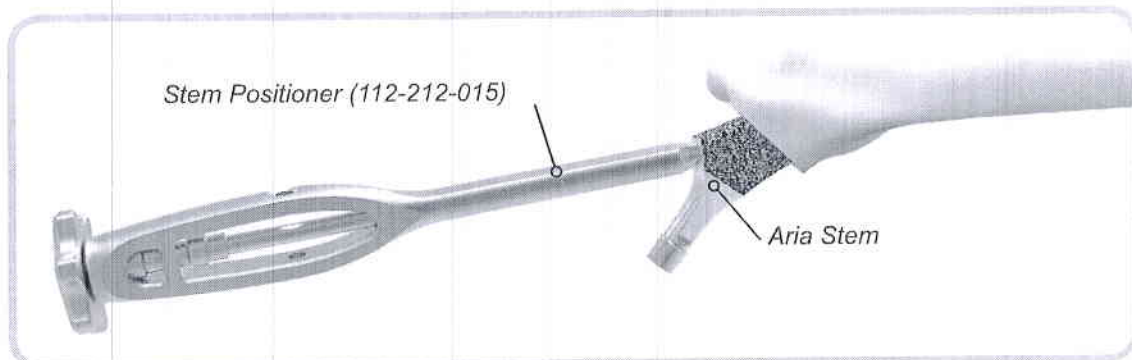

Instrument operation:

To connect the Aria stem to the stem positioner, first slide the inner shaft of the positioner through the outer shaft, spinning the strikeplate so the inner shaft threads in and falls through. Turn the threaded tip of the inner shaft into the female threads on the Aria stem until a snug hold is achieved to prevent damage to the threads.

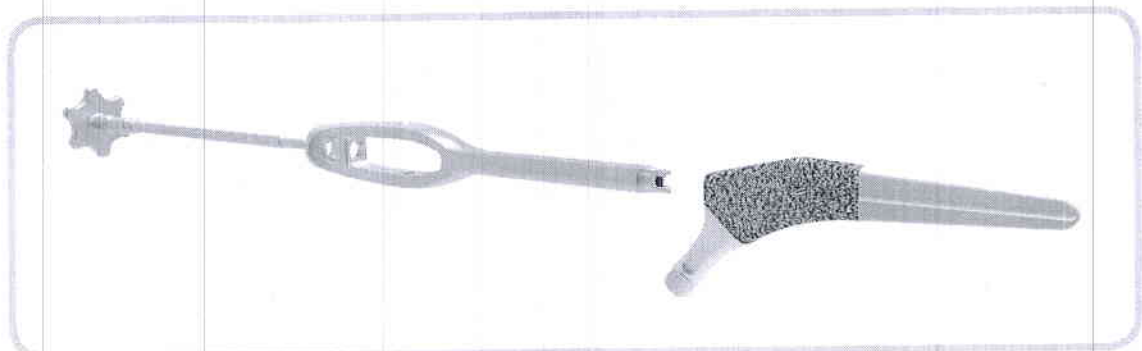

9

Femoral Head Impaction

A final trial reduction is carried out to confirm joint stability and range of motion. Clean and dry the stem taper to remove any particulate matter or debris. Place the femoral head onto the taper and lightly tap it using the head impactor. Ensure that bearing surfaces are clean and finally reduce the hip.

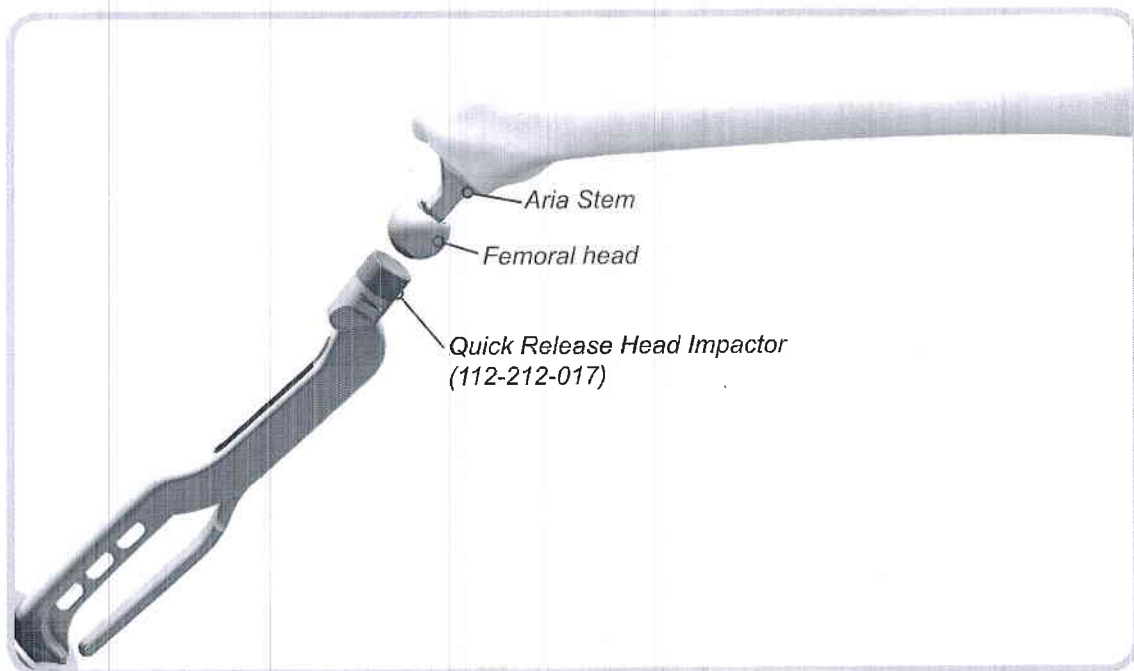

Aria Implant Sizing Guide

Cementless Hip Stems and Femoral Heads

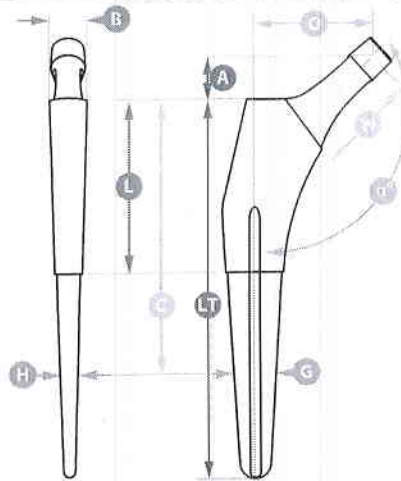

SIZE	OFFSET	LT	L	W	O	α	G	H	C	B	A
0	Standard Offset Head Neck	126	51	30.5	22.8	137	4.8	4.4	128	11.3	11.4
	Head Neck	129	54	30.5	22.8	137	4.8	4.4	128	11.3	11.4
1	Standard Offset Head Neck	134	41	30.5	22.8	137	3.8	4.4	130	11.8	12.2
	Head Neck	136	41	30.5	22.8	137	3.8	4.4	130	11.8	12.2
2	Standard Offset Head Neck	133	41	30.5	22.8	137	3.8	4.4	130	11.8	12.2
	Head Neck	133	41	30.5	22.8	137	3.8	4.4	130	11.8	12.2
3	Standard Offset Head Neck	138	54	30.5	22.8	137	3.2	3.8	132	12.2	12.4
	Head Neck	138	54	30.5	22.8	137	3.2	3.8	132	12.2	12.4
4	Standard Offset Head Neck	134	55	30.5	22.8	137	3.8	4.4	130	11.8	12.2
	Head Neck	134	55	30.5	22.8	137	3.8	4.4	130	11.8	12.2
5	Standard Offset Head Neck	140	65	30.5	22.8	137	3.2	3.8	132	12.2	12.4
	Head Neck	140	65	30.5	22.8	137	3.2	3.8	132	12.2	12.4
6	Standard Offset Head Neck	143	67	30.5	22.8	137	3.8	4.4	130	11.8	12.2
	Head Neck	143	67	30.5	22.8	137	3.8	4.4	130	11.8	12.2
7	Standard Offset Head Neck	143	65	30.5	22.8	137	3.2	3.8	132	12.2	12.4
	Head Neck	143	65	30.5	22.8	137	3.2	3.8	132	12.2	12.4
8	Standard Offset Head Neck	148	70	30.5	22.8	137	3.8	4.4	130	11.8	12.2
	Head Neck	148	70	30.5	22.8	137	3.8	4.4	130	11.8	12.2
9	Standard Offset Head Neck	151	71	30.5	22.8	137	3.2	3.8	132	12.2	12.4
	Head Neck	151	71	30.5	22.8	137	3.2	3.8	132	12.2	12.4
10	Standard Offset Head Neck	153	72	30.5	22.8	137	3.8	4.4	130	11.8	12.2
	Head Neck	153	72	30.5	22.8	137	3.8	4.4	130	11.8	12.2
11	Standard Offset Head Neck	154	74	30.5	22.8	137	3.2	3.8	132	12.2	12.4
	Head Neck	154	74	30.5	22.8	137	3.2	3.8	132	12.2	12.4
12	Standard Offset Head Neck	163	76	30.5	22.8	137	3.8	4.4	130	11.8	12.2
	Head Neck	163	76	30.5	22.8	137	3.8	4.4	130	11.8	12.2

			Ø28	Ø32	Ø36	Ø40			
S	Ceramic	-3.5	111-152-011	-4.0	111-152-021	-4.0	111-152-031	-4.0	111-152-041
		Stainless Steel	111-152-611	111-152-621	111-152-631	111-152-641			
M	Ceramic	+0.0	111-152-012	+0.0	111-152-022	+0.0	111-152-032	+0.0	111-152-042
		Stainless Steel	111-152-612	111-152-622	111-152-632	111-152-642			
L	Ceramic	+4.0	111-152-013	+4.0	111-152-023	+4.0	111-152-033	-4.0	111-152-043
		Stainless Steel	111-152-613	111-152-623	111-152-633	111-152-643			
XL	Ceramic	+7.0	111-152-024	+8.0	111-152-034	+8.0	111-152-044		
		Stainless Steel	111-152-624	111-152-634	111-152-644				

Aria Instrument

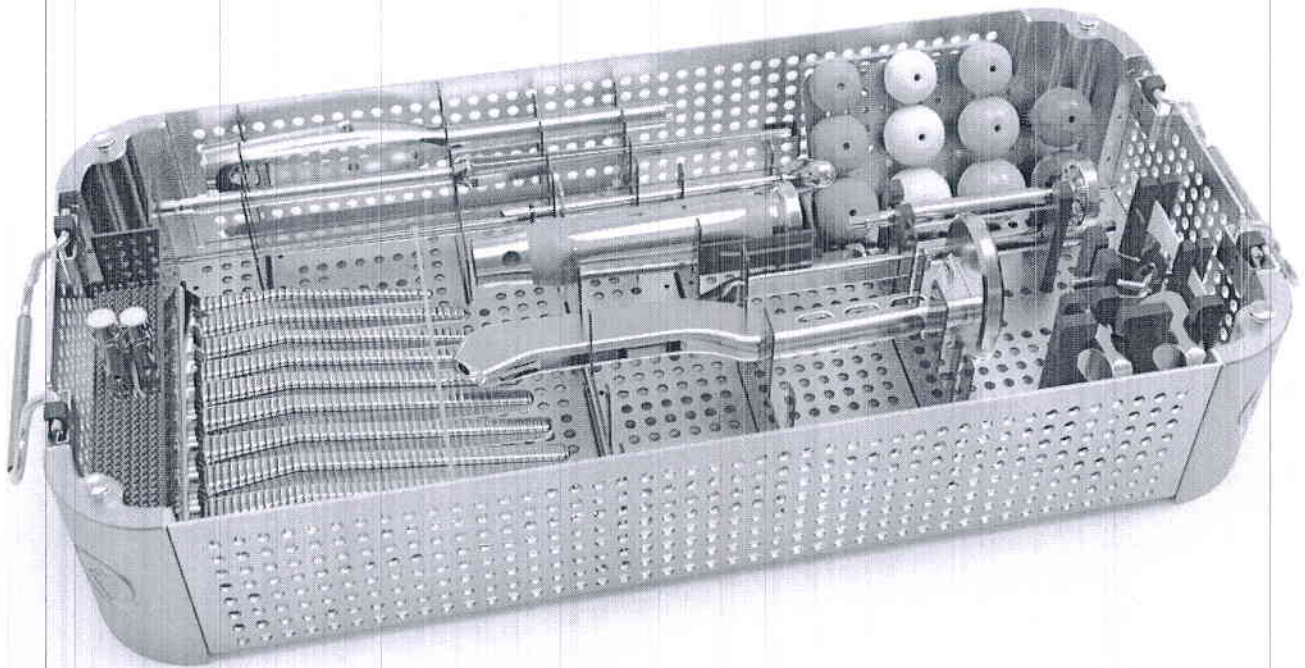

Aria Instruments

Straight Broach Handle

112-182-032

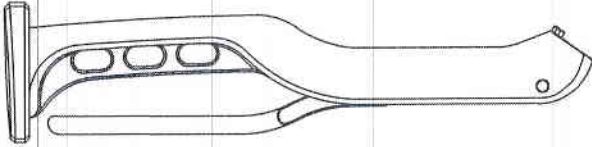

Curved Broach Handle

112-182-001

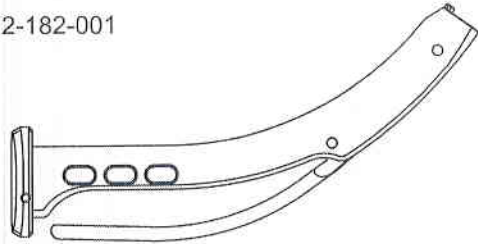

Calcar Reamer

P12-01-0012

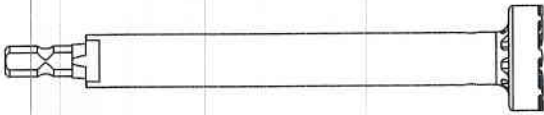

Osteotomy Guide

112-34-0002

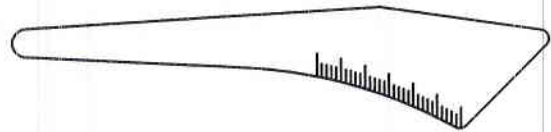

Quick Release Box Chisel

112-212-005

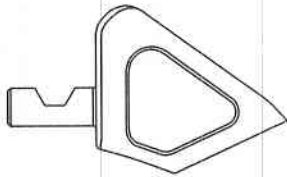

Quick Release Head Impactor

112-212-017

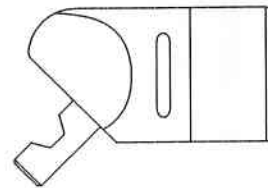

Quick Release Stem Impactor

112-212-006

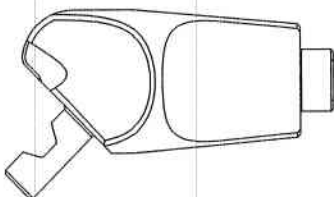

Aria Instruments

Stem Positioner

112-182-027 Outer
112-182-028 Inner

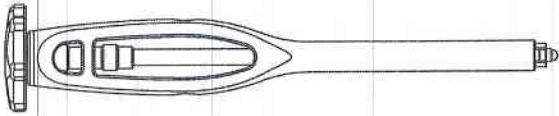

Stem Positioner UniBody

112-212-026

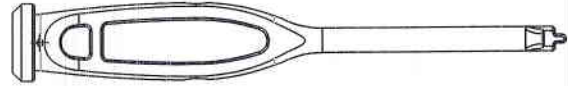

Modular Stem Impactor

112-25-0080 Curved
112-25-0092 Offset
112-25-0093 Bullet Tip

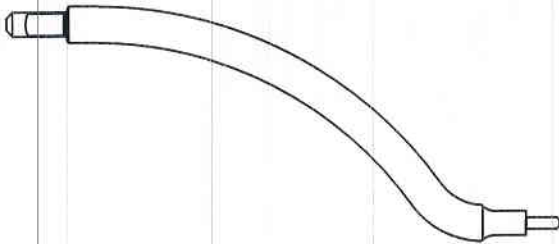

Canal Reamer

112-212-023



Trochanteric Canal Reamer

112-212-022



Stepped Entry Reamer

112-162-001

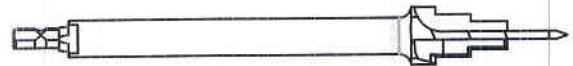

IM Drill

112-182-087



Tapered Pin Reamer

112-182-013



Starter Broach

112-34-0001

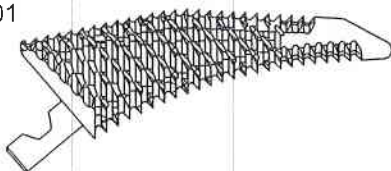

Femoral Head Extractor

112-182-117

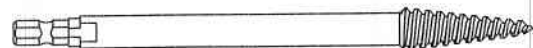

Aria Instruments

Aria Broaches

111-20-6200	Size 0
111-20-6201	Size 1
111-20-6202	Size 2
111-20-6203	Size 3
111-20-6204	Size 4
111-20-6205	Size 5
111-20-6206	Size 6
111-20-6207	Size 7
111-20-6208	Size 8
111-20-6209	Size 9
111-20-6210	Size 10
111-20-6211	Size 11
111-20-6212	Size 12

Aria Trial Necks

111-20-6250	Size 0 Standard Offset
111-20-6260	Size 0 High Offset
111-20-6251	Size 1 Standard Offset
111-20-6261	Size 1 High Offset
111-20-6252	Size 2-3 Standard Offset
111-20-6262	Size 2-3 High Offset
111-20-6253	Size 4-7 Standard Offset
111-20-6263	Size 4-7 High Offset
111-20-6254	Size 8-12 Standard Offset
111-20-6264	Size 8-12 High Offset

Trial Femoral Heads

112-35-0003	Ø22mm -3.5mm Green
112-35-0004	Ø22mm 0.0mm Yellow
112-35-0005	Ø22mm +3.5mm Orange
111-182-040	Ø28mm -3.5mm Green
111-182-041	Ø28mm 0.0mm Yellow
111-182-042	Ø28mm +4.0mm Orange
111-182-017	Ø32mm -4.0mm Green
111-182-018	Ø32mm 0.0mm Yellow
111-182-019	Ø32mm +4.0mm Orange
111-182-020	Ø32mm +7.0mm Red
111-182-021	Ø36mm -4.0mm Green
111-182-022	Ø36mm 0.0mm Yellow
111-182-023	Ø36mm +4.0mm Orange
111-182-024	Ø36mm +8.0mm Red
111-182-043	Ø40mm -4.0mm Green
111-182-044	Ø40mm 0.0mm Yellow
111-182-045	Ø40mm +4.0mm Orange
111-182-046	Ø40mm +8.0mm Red

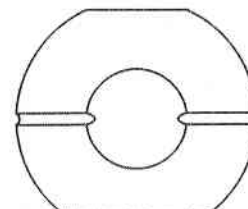
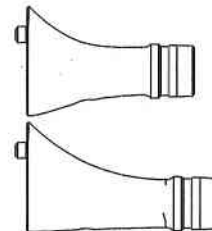
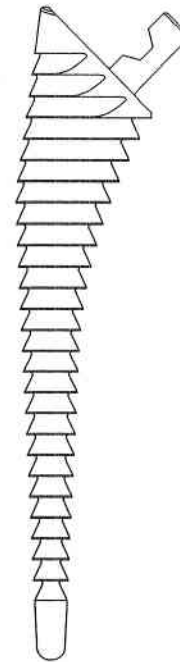

Aria Instruments

Aria Preoperative Templates

- 111-201-500 Size 0 Template
- 111-201-501 Size 1 Template
- 111-201-502 Size 2 Template
- 111-201-503 Size 3 Template
- 111-201-504 Size 4 Template
- 111-201-505 Size 5 Template
- 111-201-506 Size 6 Template
- 111-201-507 Size 7 Template
- 111-201-508 Size 8 Template
- 111-201-509 Size 9 Template
- 111-201-510 Size 10 Template
- 111-201-511 Size 11 Template
- 111-201-512 Size 12 Template

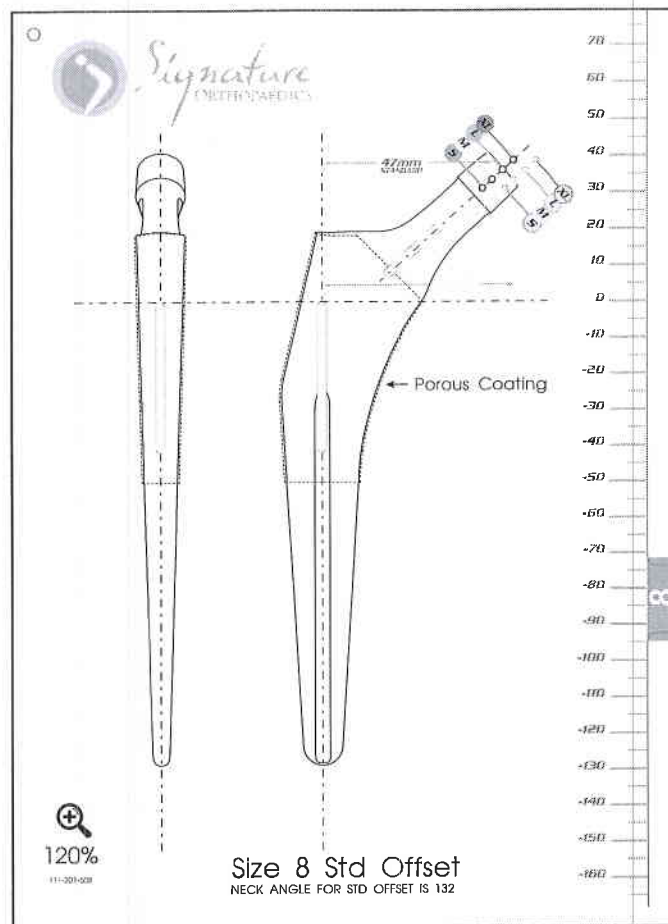

Aria Implants

Aria Standard Offset Stem

111-20-6000	Size 0
111-20-6001	Size 1
111-20-6002	Size 2
111-20-6003	Size 3
111-20-6004	Size 4
111-20-6005	Size 5
111-20-6006	Size 6
111-20-6007	Size 7
111-20-6008	Size 8
111-20-6009	Size 9
111-20-6010	Size 10
111-20-6011	Size 11
111-20-6012	Size 12

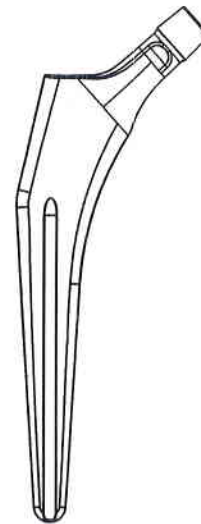

Aria High Offset Stem

111-20-6100	Size 0
111-20-6101	Size 1
111-20-6102	Size 2
111-20-6103	Size 3
111-20-6104	Size 4
111-20-6105	Size 5
111-20-6106	Size 6
111-20-6107	Size 7
111-20-6108	Size 8
111-20-6109	Size 9
111-20-6110	Size 10
111-20-6111	Size 11
111-20-6112	Size 12

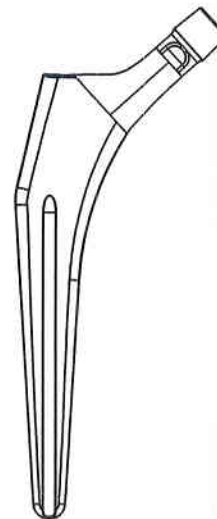

Aria Stem, Standard Offset – Reduced Distal

111-20-6303	Size 3
111-20-6304	Size 4
111-20-6305	Size 5
111-20-6306	Size 6
111-20-6307	Size 7
111-20-6308	Size 8
111-20-6309	Size 9
111-20-6310	Size 10
111-20-6311	Size 11
111-20-6312	Size 12

Aria Implants

Aria Stem, High Offset – Reduced Distal

111-20-6333	Size 3
111-20-6334	Size 4
111-20-6335	Size 5
111-20-6336	Size 6
111-20-6337	Size 7
111-20-6338	Size 8
111-20-6339	Size 9
111-20-6340	Size 10
111-20-6341	Size 11
111-20-6342	Size 12

Signature Ceramic Femoral Head

111-152-611	Size 28mm S
111-152-612	Size 28mm M
111-152-613	Size 28mm L
111-152-621	Size 32mm S
111-152-622	Size 32mm M
111-152-623	Size 32mm L
111-152-624	Size 32mm XL
111-152-631	Size 36mm S
111-152-632	Size 36mm M
111-152-633	Size 36mm L
111-152-634	Size 36mm XL
111-152-641	Size 40mm S
111-152-642	Size 40mm M
111-152-643	Size 40mm L
111-152-644	Size 40mm XL
111-152-651	Size 44mm S
111-152-652	Size 44mm M
111-152-653	Size 44mm L
111-152-654	Size 44mm XL
20507	Size 28mm S
20508	Size 28mm M
20509	Size 28mm L
20510	Size 32mm S
20511	Size 32mm M
20512	Size 32mm L
20513	Size 32mm XL
20514	Size 36mm S
20515	Size 36mm M
20516	Size 36mm L
20517	Size 36mm XL
20518	Size 40mm S
20519	Size 40mm M
20520	Size 40mm L
20521	Size 40mm XL
20522	Size 44mm S
20523	Size 44mm M
20524	Size 44mm L
20525	Size 44mm XL

Aria Implants

Signature SS Femoral Head

111-151-101	Size 22mm S
111-151-102	Size 22mm M
111-151-103	Size 22mm L
111-152-111	Size 28mm S
111-152-112	Size 28mm M
111-152-113	Size 28mm L
111-152-121	Size 32mm S
111-152-122	Size 32mm M
111-152-123	Size 32mm L
111-152-124	Size 32mm XL
111-152-131	Size 36mm S
111-152-132	Size 36mm M
111-152-133	Size 36mm L
111-152-134	Size 36mm XL
111-152-141	Size 40mm S
111-152-142	Size 40mm M
111-152-143	Size 40mm L
111-152-144	Size 40mm XL

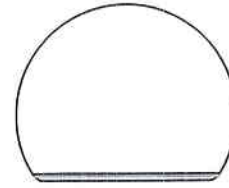

Signature CoCr Femoral Head

111-152-001	Size 22mm S
111-152-002	Size 22mm M
111-152-003	Size 22mm L
111-152-011	Size 28mm S
111-152-012	Size 28mm M
111-152-013	Size 28mm L
111-152-021	Size 32mm S
111-152-022	Size 32mm M
111-152-023	Size 32mm L
111-152-024	Size 32mm XL
111-152-031	Size 36mm S
111-152-032	Size 36mm M
111-152-033	Size 36mm L
111-152-034	Size 36mm XL
111-152-041	Size 40mm S
111-152-042	Size 40mm M
111-152-043	Size 40mm L
111-152-044	Size 40mm XL

Aria Implants

Ti6Al4V Fusion Taper Sleeve

111-37-0001	Ti6Al4V Fusion Taper Sleeve, Size -4mm Offset (S)
111-37-0002	Ti6Al4V Fusion Taper Sleeve, Size 0mm Offset (M)
111-37-0003	Ti6Al4V Fusion Taper Sleeve, Size +4mm Offset (L)
111-37-0004	Ti6Al4V Fusion Taper Sleeve, Size +8mm Offset (XL)
111-37-0005	Ti6Al4V Fusion Taper Sleeve, Size +8mm Offset (Extended)

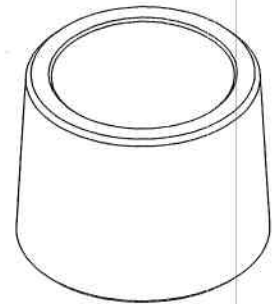

Fusion CoCr Femoral Head

111-37-0028	Size 28mm
111-37-0032	Size 32mm
111-37-0036	Size 36mm
111-37-0040	Size 40mm

Fusion Ceramic Femoral Head

111-22-0511	Size 28mm
111-22-0512	Size 32mm
111-22-0513	Size 36mm
111-22-0514	Size 40mm

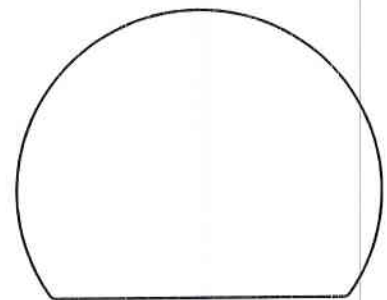

Appendix: Broaching Techniques and Tips

It is better to stop broaching when stability is achieved with a slightly countersunk broach than to attempt to force as oversized broach into the canal. The coating limit line on the implant stem will sit below the resection line but the stem will achieve exceptional stability. Consider a longer neck or higher head offset.

Managing Different Femoral Canal Geometries

The Dorr femur type system classifies femurs based on a ratio that relates to the geometry of the femoral canal:

$$R = D_2/D_1$$

see figures at the bottom left

An R-value less than ~0.5 implies a very fluted canal that will more likely bind distally if the canal is not over-reamed. Preoperative templating is especially important for this reason. Refer to the Aria Implant Sizing guide in this technique to help decide what size reamer to use. The three types are as follows.

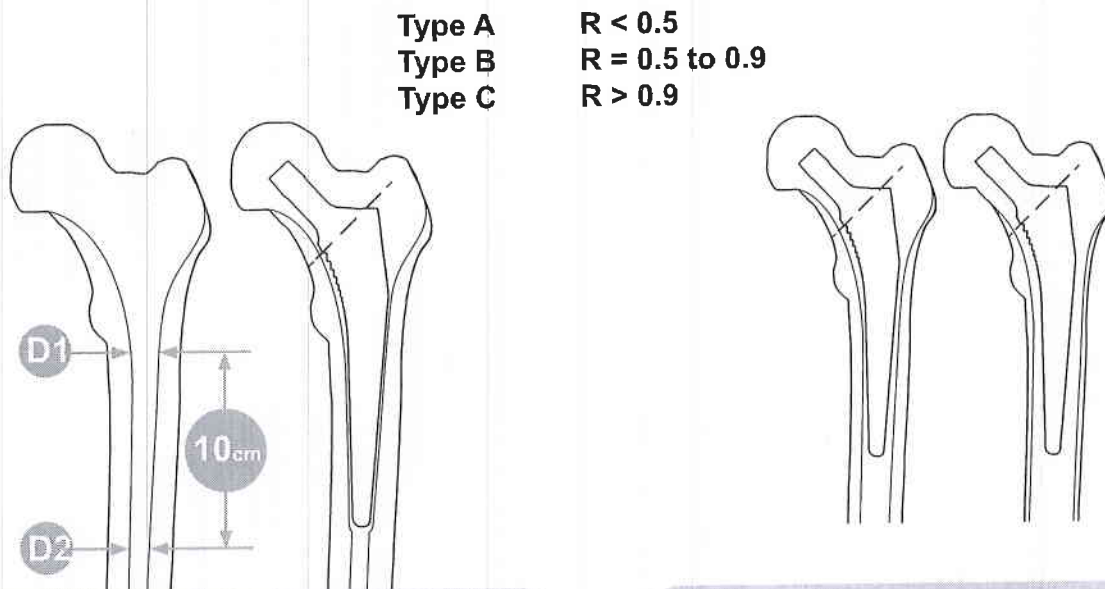

Type A

Reaming the femoral canal to the distal lip of the definitive stem ensures good compaction of the metaphyseal cancellous bone and prevents binding against the cortical wall, which can lead to stress shielding and an ill-sealed stem.

Types B & C

The Aria broaches preserve the natural anatomy of the femoral canal. Rotational and axial stability and a change in pitch indicate an appropriate amount of compaction broaching.



Signature Orthopaedics
7 Sirius Rd
Lane Cove West, Sydney, 2066
NSW, Australia



Signature
ORTHOPAEDICS

CE
0123