



DigiPla 80/DigiPla 90

Plasma Separator

Service Manual

Contents

Contents	i
Intellectual Property	I
Version Information	I
Suitable Users	I
Maintenance Service	II
Sales Service Department	II
Statement	II
1 Preface	1-1
1.1 Symbols Meaning	1-1
1.2 Symbols on Equipment	1-1
1.3 Security Codes	1-3
1.3.1 Electrical Safety	1-3
1.3.2 Machinery Safety	1-4
1.3.3 Personnel Security	1-4
1.3.4 Others	1-4
2 Installation Preparation	2-1
2.1 Expected Use	2-1
2.1.1 Product Description	2-1
2.1.2 External size and Weigh.....	2-1
2.2 Specification and Conditions of Installation	2-1
2.2.1 System Environment.....	2-1
2.2.2 Electrical requirements	2-2
2.3 Facility Requirements	2-3
2.3.1 Space Planning	2-3
2.3.2 Network Requirements.....	2-3
2.3.3 nstallation Confirmation	2-3
3 System Installation	3-1
3.1 Brief Introduction to Installation	3-1
3.2 Unpacking and Inspection	3-1
3.2.1 Unpacking procedures.....	3-1
3.2.2 Inspection	3-1
3.3 Whole Set Installation.....	3-2
3.3.1 Front View	3-2
3.3.2 Side Rear View	3-4

3.3.3	Installation	3-5
3.4	Peripheral Installation	3-8
3.4.1	PC Data Management Software	3-8
3.4.2	ID scanner.....	3-9
3.4.3	UPS (Uninterrupted Power Supply).....	3-10
3.5	System Configuration	3-11
3.5.1	Power on and operation	3-11
3.5.2	System Introduction.....	3-11
3.5.3	Function set.....	3-18
4	Function Inspection and Test	4-1
4.1	Preparation.....	4-1
4.2	Equipment Status Inspection	4-1
4.2.1	Running status	4-1
4.2.2	Runtime Environment.....	4-1
4.3	Regular Check.....	4-2
4.3.1	Check Procedure	4-2
4.3.2	Inspection Contents	4-2
4.4	Function Inspection	4-4
4.4.1	Inspection Procedures	4-4
4.4.2	Inspection Contents	4-4
4.5	Performance Test	4-6
5	Software Upgrade.....	5-8
5.1	System Software.....	5-8
5.1.1	Upgrade Equipment.....	5-8
5.1.2	Pre-upgrade Installation.....	5-8
5.1.3	Programming Software.....	5-9
5.2	Control Software.....	5-10
5.2.1	Upgrade Equipment.....	5-10
5.2.2	Pre-upgrade Installation.....	5-10
5.2.3	Programming Software.....	5-10
6	Hardware System.....	6-11
6.1	System Composition.....	6-11
6.1.1	Human-computer Interaction System.....	6-12
6.1.2	Collection System	6-12
6.1.3	Power System.....	6-13
6.2	Function Board Card Introduction.....	6-14
6.2.1	System Board	6-14
6.2.2	Control Panel, Driver Panel and Backplane.....	6-15
6.2.3	Power Panel	6-18
7	Structure and Dismounting	7-1

7.1	Whole Set Structure.....	7-1
7.1.1	Exploded View of the Whole Set.....	7-1
7.1.2	Exploded View of Components.....	7-2
7.2	Structure Dismounting.....	7-4
7.2.1	Dismounting Tools.....	7-5
7.2.2	Marking Instruction.....	7-5
7.2.3	Personnel requirements.....	7-5
7.2.4	Preparation for Dismounting.....	7-5
7.2.5	Dismounting of Host Assembly.....	7-5
7.2.6	Board Card Dismounting.....	7-8
7.2.7	Dismounting of Components.....	7-11
8	System Diagnosis and Support.....	8-16
8.1	Starting Up.....	8-16
8.2	Components Fault and Test.....	8-16
8.2.1	Tools required for Maintenance.....	8-16
8.2.2	Power Pack.....	8-17
8.2.3	Weigher (Electronic Scale).....	8-17
8.2.4	Cuff.....	8-18
8.2.5	DPM.....	8-18
8.2.6	Pipeline Detector.....	8-18
8.2.7	Solenoid Valve.....	8-19
8.2.8	Pump.....	8-19
8.2.9	Centrifuge.....	8-19
8.2.10	Air Detector.....	8-20
8.3	Alarm and Abnormal Information.....	8-20
9	Care and Maintenance.....	9-1
9.1	Summary.....	9-1
9.1.1	Purpose.....	9-1
9.1.2	Tools, measuring equipment and Disposable.....	9-1
9.1.3	Care and Maintenance Frequency.....	9-2
9.2	Cleaning System.....	9-3
9.2.1	Cleaning Procedures.....	9-3
9.2.2	Content.....	9-3
9.3	Maintenance Check.....	9-6
9.3.1	System Function.....	9-6
9.3.2	Inspection of Peripherals and Fittings.....	9-6
9.4	System Maintenance.....	9-7
9.4.1	Electrical Safety Maintenance.....	9-7
9.4.2	Machinery Safety Maintenance.....	9-10

Intellectual Property

The intellectual property of this operator's manual and its corresponding products belongs to Sichuan Nigale Biotechnology Co., Ltd. (here in after refers to as "Nigale").

Without prior written consent of Nigale, any person or organization may not copy, modify, or translate any part of this service manual.



, and **NIGALE** are registered trademarks or trademarks of Nigale.

Version Information

The version number of this service manual is subject to upgrade due to the change of software or technical specifications without prior notice. The version information of this service manual is as follows:

Version Number	Issue Date	Reasons for Revision
EE	2015.903.2305	Revise the pictureaddress

© 2015 Sichuan Nigale Biotechnology Co., Ltd. All Rights Reserved

Suitable Users

This service manual is suitable for customer service engineers, authorized maintenance personnel and after-sales service representatives who are responsible for the product maintenance.

Maintenance Service

Scope of free services:

All products according with the warranty service regulations can enjoy free services.

Scope of paid services:

- 1 For all products exceeding the warranty service regulations, services will be charged by Nigale.
- 2 Even under the warranty period, maintenance services caused by the following reasons will be charged: man-made damages; misoperation; network voltage exceeds the prescribed limit of product; irresistible natural disaster; replace parts or Disposable without permission of Nigale or maintain the product by personnel not authorized by Nigale.



Warning:

If each plasma station, hospital or organization responsible for using of this equipment cannot provide a satisfactory repair/maintenance plan, it may cause abnormal equipment failure, or even may endanger human health.

Sales Service Department

Sales service department of Sichuan Nigale Biotechnology Co., Ltd.

Address: 4th F, No.2 Factory Building, Shiyang Industrial Park, No.55, Section 5th, Qingyun village, Hi-Tech District, Chengdu.

Zip Code: 610041

24-hours Service Hotline (China Mainland Only): 400-606-9696

Fax: +86 28-85130655

Statement



This service manual introduces our products based on the most complete configuration, so some contents may not apply to the product under your maintenance. Please direct any inquiries to the after-sales service department of the company.



Please read through this service manual carefully before product maintenance and make sure the contents are fully understood to ensure correct maintenance work and avoid damage of products or personal injury.

1 Preface

This chapter mainly describes a series of safety information adopted by the system and gives detailed introduction to safety signs and symbols used on the equipment.

1.1 Symbols Meaning

This service manual may use the following symbols  **Danger**,  **Warning**, **Caution** and **Prompt** as instructions regarding safety and other important matters. Specific meanings are as follows:















Symbol and vocabulary	Meaning
 Danger	It indicates there will be an imminently hazardous situation which, if not avoided, will result in death or serious injury.
 Warning	Personal injury may occur in the place, including warn the operator against potential danger.
Caution	Provide additional information may be useful to the operator at different steps. Please note that it may include non-critical information, however, the operator should always review background information.
Prompt	Inform conditions that may damage the product, affect the result or cause unnecessary alarms.

1.2 Symbols on Equipment

The following table describes the locations of safety signs, warning signs and general symbols used on the equipment and related important information provided by these symbols respectively, please read carefully and remember them.

No.	Symbol	Definition	Location
1		BF-type device	On labels and above cuff connectors

Error! Use the Home tab to apply 标题 1 to the text that you want to appear here. 1-1

No.	Symbol	Definition	Location
2		Caution: Please operate according to the operator's manual, so as to avoid safety accidents.	On the upper cover of the host closing to the centrifuge switch
3		High voltage: There are high-voltage electric fields nearby the power supply, so keep away from the electrified part of the device or electrified maintenance device.	High-voltage label —On the rear cover of the power pack
4		Read the information after use	On product labels
5		Product's serial number	
6		Product's manufacturing date	
7		This electronic information product contains some toxic and harmful substances, and can be used assuredly within 20 years of environment-friendly use period, after which, it shall be recycled.	
8		AC (alternating current)	
9		Manufacturer information	
10		Power off	
11		Power on	
12		Serial port	At the bottom left of the rear cover of the host
13		Network interface	
14		USB interface	
15		Fuse	Underneath the power switch

1-2 Error! Use the Home tab to apply 标题 1 to the text that you want to appear here.

1.3 Security Codes

To ensure the safety of users and operators, please strictly abide by the following safety codes when using the product.

⚠ Danger: Do not use the product in environment with inflammable gases (such as anesthetic gases, oxygen and hydrogen) or flammable liquid (such as ethanol), or there may cause an explosion.

1.3.1 Electrical Safety

⚠ Warning:

1. It is necessary to connect the power plugs of this product as well as its external connected devices to the power socket on the wall directly, and the socket must be well grounded and meet the rated power requirement on the identification plate. Using a multi-function socket may affect the ground connection and make the leakage current exceed safety requirements. Be sure to use the power cable provided together with the product.
2. Before cleaning the product, please shut down the product's power switch and unplug the power plug to avoid electrical shock hazard.
3. In maintenance and assembly process, it is necessary to confirm other wires are connected correctly before connecting the power cable, otherwise the machine might be burned out due to hot plug.
4. Do not use this product in areas where water may enter the case, because this product is not equipped with any waterproofing equipment. To avoid risk of electric shock, do not pour any liquid on the product or let the liquid flow into the product.

Caution:

1. It is prohibited to directly unplug the product's power plug when the power switch is not shutting down, or this may cause damage to the product or electrical shock.
2. When using this product for performance testing, please be sure that the product is safe from the interference of electromagnetic radiation.

3. Avoid direct hand contact closing to the electrostatic sensitive area, if necessary, please wear electrostatic protective gloves.

1.3.2 Machinery Safety

- ⚠Warning:**
1. When the product has to be carried, please take down the bag weigher and hold the handle.
 2. Don't let the display or the structural parts of the machine knocked or pressed to avoid damage.

- Caution:**
1. Don't put overmuch vibration on the product (e.g., when handling equipment) to prevent the product from falling down, crashing, strong variation or other damages caused by external mechanical forces.
 2. Ensure that the product is in a horizontal position when it is installed.

1.3.3 Personnel Security

- Caution:**
1. Operators are neither allowed to open the shell or the panel of this product nor disassembling the machine.
 2. Maintenance services must be completed by professional maintenance staffs authorized by Nigale.
 3. Only the personnel specially trained by Nigale can maintain the equipment.

1.3.4 Others

- Caution:** Please refer to the Product Manual for detailed instructions about the plasma separator and other information thereof.

2 Installation Preparation

2.1 Expected Use

2.1.1 Product Description

DigiPla 80/DigiPla 90 plasma separator adopts advanced computer technology, peristaltic pump technology of transmitting pollution-free fluid and blood centrifugal separation technology, to complete raw material plasma collection for clinical and biological products.

Applicable people are plasma providers meeting the requirements of the Blood Donation Law of People's Republic of China.

2.1.2 External size and Weigh

Name	High(mm)	Length(mm)	Width(mm)	Weigh(Kg)
Value	770	510 540	510	29

2.2 Specification and Conditions of Installation

2.2.1 System Environment

Item	Operating Environment	Storage and Transportation Environment
Temperature	10°C~30°C	-20°C~55°C
Humidity	≤70%	≤93%
Atmospheric pressure	86kPa~106kPa	50kPa~106kPa



Warning:

Do not use, store or transport the product except for in the specified environmental conditions.

Caution:

Please do not install the plasma plasma separator in the following areas:

- 1.near heat sources
2. high-humidity atmosphere
3. with the existence of flammable gas

2.2.2 Electrical requirements

2.2.2.1 Requirements to Power Supply

Supply voltage:	Frequency	Output power	Fuse
198-242V ~230 V/~ 99-121 115V~	50/60Hz±1Hz	500VA	T 4A H 250V, Φ5×20

2.2.2.2 Requirements to Stabilized Power Supply

Due to varying degrees of stability of power supply from place to place, users are suggested to use stabilized power supply with superior quality and performance.

2.2.2.3 Grounding Requirements

The power cord of the machine is a triaxial cable, wherein the ground protection terminal is connected with the ground protection of the power system. Please make sure that the ground protection of the power system operates smoothly.



Warning:

Please connect the equipment to a socket with separate fuse and protection switches. If it shares the same fuse and protection switch with other equipment, trip might be resulted in once the machine break down or overcurrent occurred or a momentary impulse current generated during boot.

2.3 Facility Requirements

2.3.1 Space Planning

Please put the product with necessary accessories in the appropriate position for convenient operation:

1. Please put the product in a well-ventilated environment or an air conditioned room;
2. The door of the room should be no less than 0.8m wide to move equipment into the room easily;
3. A space of 0.2m must be reserved around the equipment for effective heat dissipation;

2.3.2 Network Requirements

The product supports wireless or wired LAN connection.

In the process of the software configuration management (PC management software) of the product, the network connection of the product should be confirmed: the wired connection is to connect the Ethernet port at the bottom left of the rear cover of the host with the corresponding port by network cables (twisted pair); and the wireless connection is to communicate with the wireless router via an internal WIFI module (on the system board card) of the product. At the same time, it is necessary to confirm that the user's network configuration matches the product requirements.

2.3.3 Installation Confirmation

Before installation, please confirm:

1. The language used by the installation site and the country
2. The power frequency voltage used by the installation site and the country
3. Other settings of the installation site and the country different from the default value of the manufacturer
4. The product configuration and optional fittings

Please confirm the above information before installation to facilitate correct settings of the equipment based on general settings of the installation site and the country.

Error! Use the Home tab to apply 标题 1 to the text that you want to appear here.

3 System Installation

3.1 Brief Introduction to Installation

Installation tools: cross screwdriver (at random).

3.2 Unpacking and Inspection

3.2.1 Unpacking procedures

1. Take down the upper cover of the packing box;
2. Take out the cover plate, the cushion block equipped with random files and the cushion block containing attachments in turn from top to bottom;
3. Use the handles on both sides of the product to lift the plasma separator out from the box.

3.2.2 Inspection

1. Please check objects in the box one by one against the packing list to ensure that no component is missed, wrong or damaged;
2. Please make sure the machine was not damaged in the process of storage and transportation, the appearance of the machine has no stain, damage, indentation or score break. Please direct any discrepancy to the after-sales service department of Nigale.

3.3 Whole Set Installation

3.3.1 Front View

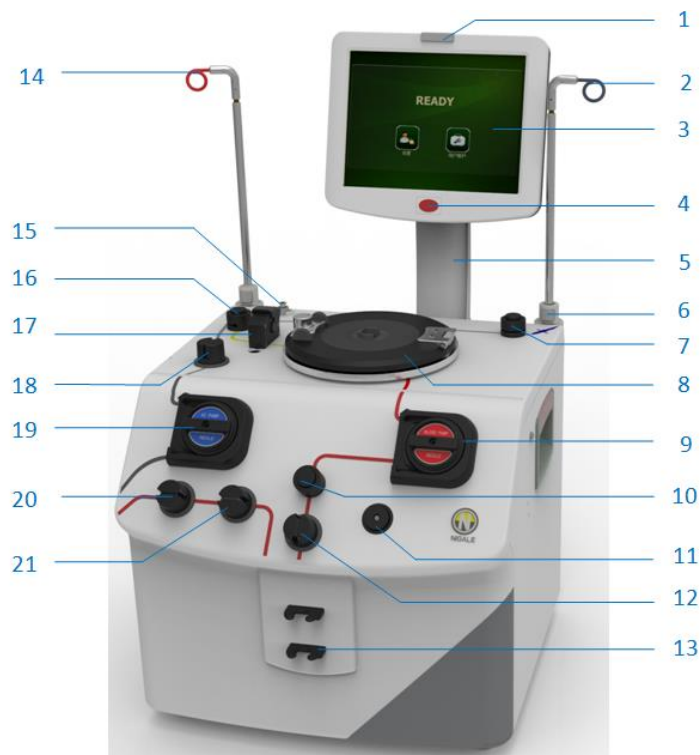

No.	Part Name	Purpose
1	Indicator light	Send light prompt when there is prompt information or an alarm.
2	Saline pole	Hang saline container.
3	Display screen	Display image and parameters and other information.
4	Stop Key	Stop the separator operation, as well as the pump and centrifuge.
5	Display arm	Connect to the display and cabinet.
6	Pole button	Fix the pole.
7	Saline valve	Control the open and close of saline pipeline.
8	Centrifuge	The centrifuge will drive the centrifuge bowl rotating at high speed when operating.

3-2 Error! Use the Home tab to apply 标题 1 to the text that you want to appear here.

9	Blood pump	Transfer anticoagulated blood and blood components in the pipeline between donor and centrifuge bowl.
10	Blood valve	Control the open and close of blood pipeline.
11	Donor pressure monitor (DPM)	Monitor the pressure in the blood pipeline of donor during draw and return phase, adjust the pump speed according to pressure. The pressure change is displayed on the LCD screen on bar chart.
12	Blood line air detector	Monitor the pipeline between the blood filter and centrifuge bowl.
13	Filter bracket for blood and blood components	Support and fix the blood filter.
14	Anticoagulant pole	Hang the anticoagulant container.
15	Weigher	Can be assembled with bottle or bag weigher, It can monitor the net weight of plasma in collection bottle/bag, and the unit is in g/ml.
16	Plasma valve	Control the open and close of plasma pipeline.
17	Line sensor	Detect the overflow of red blood cells in plasma collection process.
18	Anticoagulant line air detector (ALAD)	Monitor the air in the anticoagulant pipeline.
19	Anticoagulant pump	Transfer anticoagulant in the pipeline between anticoagulant bag and blood collection joints.
20	Donor line air detector 1 (DLAD1)	Monitor the air in the pipeline between the donor and blood filter.

21	Donor line air detector 2 (DLAD2)	Monitor the air in the pipeline between the donor and blood filter.
----	-----------------------------------	---

3.3.2 Side Rear View



No.	Part Name	Purpose
1	Protective cap slot	Fix the protective cap of needle
2	Blood pressure indicator light (option)	Blood pressure indicator light : green lamp on: moderate pressure. green lamp flashing: low pressure, the blood pump entering into the automatic speed control state, but in an acceptable range, reminding the donors making a fist. red lamp on: pressure too low, the blood pump stop and low pressure alarm.
3	Handle	Convenient for separator moving
4	Cuff trough	Place cuff
5	Power switch	Turn on/off the power
6	AC power input socket	Connect with the system power line

3-4 Error! Use the Home tab to apply 标题 1 to the text that you want to appear here.

7	Waste liquid bag	Collect the leaking liquid in centrifuge
8	Drain connector	Connect with waste bag at the leakage collector exit of separator
9	Cuff Connector	Connect with pressure cuff
10	USB interface	Connect with external equipment such as code scanner
11	Serial port	Maintain and test product
12	Ethernet port	Connect with the network

3.3.3 Installation

3.3.3.1 Installation of Display Components

 —removed parts (screw for example)

 —direction of the move

 —installed parts

1. Preparation:

After the rising and fixture of anticoagulant poll and Saline poll, screwdriver is used for the removal of the 5 screws (M4×8) on the rear cabinet of the host and the 4 sunk screws (M4×8) on the host shelf.



Figure 3-1 Removal of the Host Rear Cabinet

2. Installing Display Component

(1) Hold the component bracket with one hand, and put the communication cable coming from the bracket through the round hole in the back of the host with the other hand.

Error! Use the Home tab to apply 标题 1 to the text that you want to appear here.

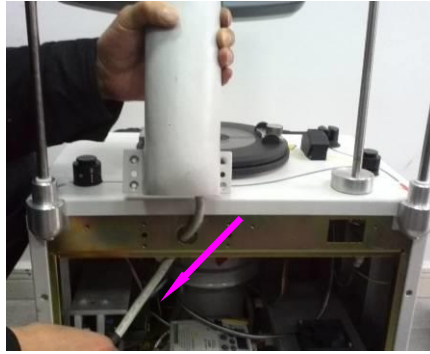

Figure 3-2 Communication Cable Threading

- (2) Use the screw in 1 to install the display component onto the host shelf.



Figure 3-3 Display and Host Connection

- (3) Connect the communication cable to the communication board on the rear cabinet, fix the grounding line of the communication cable on to the M3 stud on the rear cabinet and also check whether the fan wire connector is well connected to the control communication cable plug.

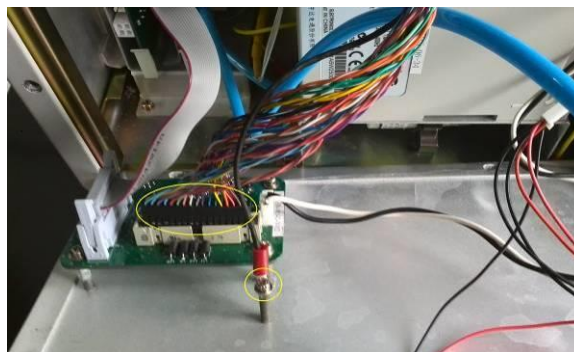

Figure 3-4 Communication Board wiring diagram

- (4) Connect the rear cabinet of the host to the host shelf with the screw in 1.

3-6 Error! Use the Home tab to apply 标题 1 to the text that you want to appear here.



Figure 3-5 Host Rear Cabinet Installation

3.3.3.2 Installation of Accessory

(1) Connection of cuff components

When the cuff connector pressing-piece on the host rear cabinet is pressed, insert the connector into the cuff hose and the connection is done after the sound of clickety-clack is heard.



Figure 3-6 Cuff Component Connection

(2) Installation of weighers:

As showed in the pictures (bag weigher or bottle weigher)

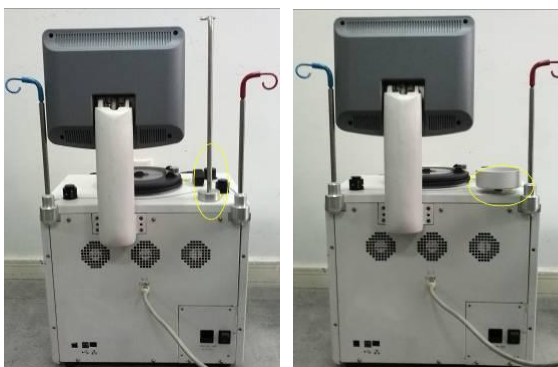

Figure 3-7 Weigher Connection

(3) Installation of barcode scanner bracket

Error! Use the Home tab to apply 标题 1 to the text that you want to appear here.

- Remove the M6×10 sunk screw connecting bracket and cork base on the bracket components.
- Connect the 2 M3x10 sunk screws on the cork base to the hole on the right plate of the host.
- Then connect the bracket to the cork base.

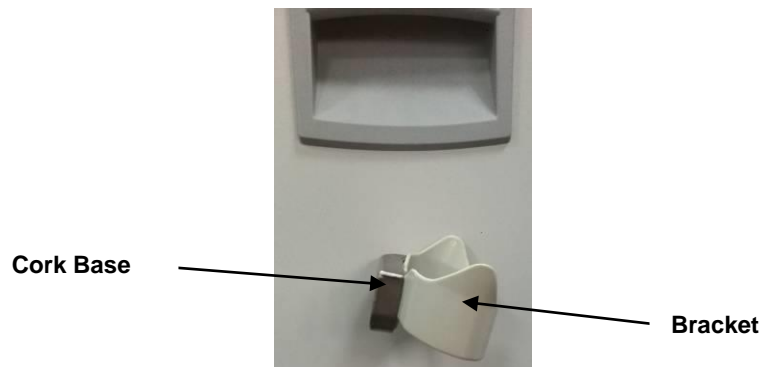
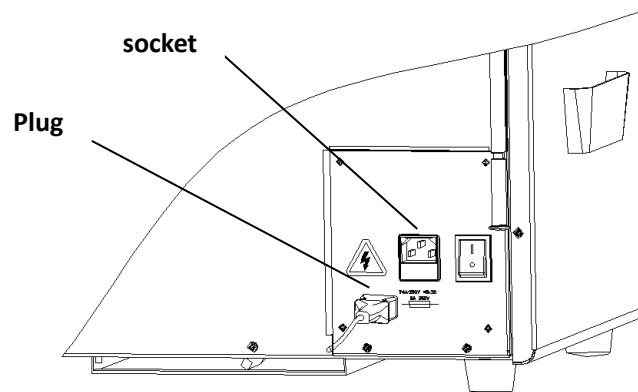

Figure 3-8 Barcode Scanner Bracket Connection

3.3.3.3 Install power cable

Plug the power cable into the socket as shown:



3.4 Peripheral Installation

3.4.1 PC Data Management Software

The PC data management software is a software system used to manage the collection result data of the plasma separator.

Copy the DigiPlaDMS folder from the CD-ROM to the local hard disk. Just double-click DigiPlaDMS.exe to open the software. Before installation, please ensure that there is sufficient local hard disk storage space.

3-8 Error! Use the Home tab to apply 标题 1 to the text that you want to appear here.

PC Minimum Configuration	
Operating system	Windows XP / Windows 7
CPU	1GHz
Memory RAM	512M
Hard disk storage	20G

3.4.2 ID scanner

Plasma Separator supports to connect an ID scanner in USB connection mode, such as barcode scanning gun, which is used to complete the input of ID of personnel, Disposable and accessories configured in the system.

1. According to the structure chart of a scanner as shown, key positions of an ID scanner comprises: an LED indicator, a scan window and a scan trigger switch;

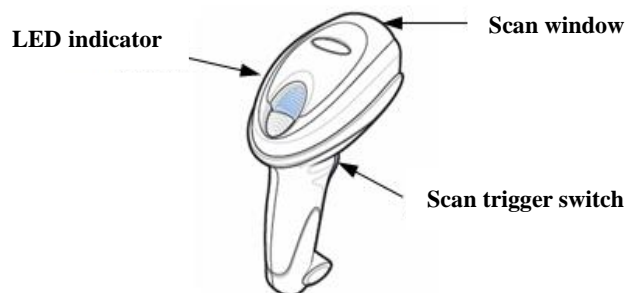

2. Connect one end of the scanner cable and the scanner to a socket underneath a handle;

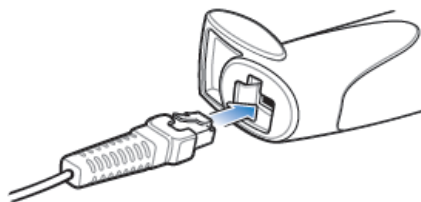

3. Connect the other end (USB terminal) of the cable to a USB interface of the equipment, now the indicator light of a barcode scanner is on;

Error! Use the Home tab to apply 标题 1 to the text that you want to appear here.

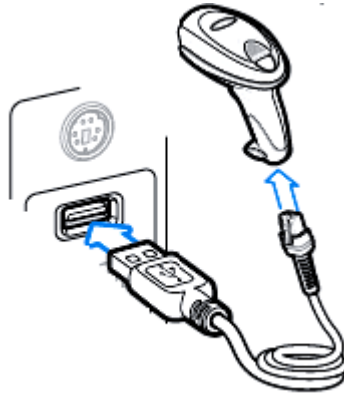

4. Press the scanning trigger switch to scan the barcode information when the equipment is operating. Please refer to the barcode scanner instructions for other application methods;
5. Put the well connected scanner on a bracket at the right of the host (as shown in the figure) to avoid breaking the scanner accidentally.

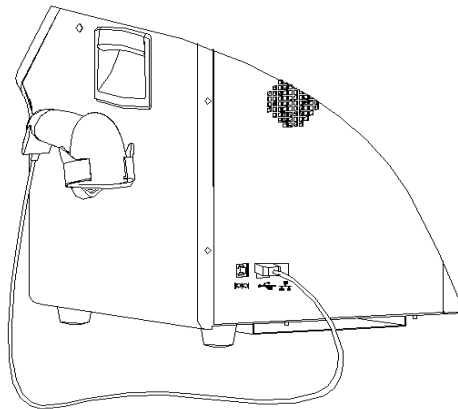

3.4.3 UPS (Uninterrupted Power Supply)

When the power supply system fails, the Plasma separator can be connected with the external device's UPS (Uninterrupted Power Supply), so as to continue the operation of plasma separator. For operating hours and use method of UPS, see the operator's manual of the product. The connection mode is as shown in the following figure:

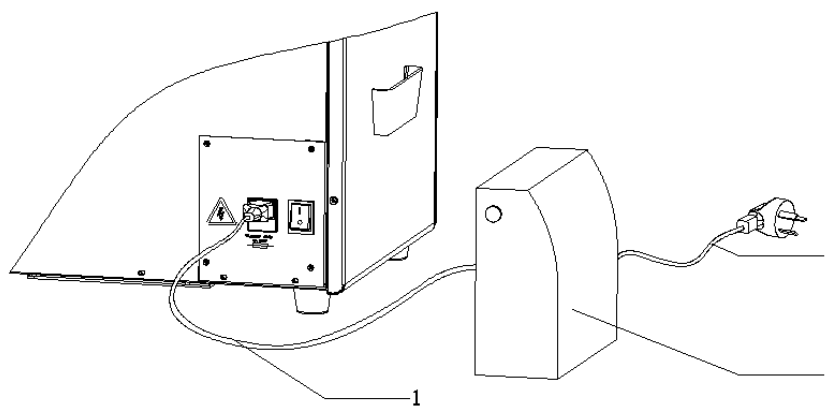

Connect the power plug of power cable 1 of the plasma separator to the socket of UPS 2, and connect the power plug of power cable 3 of the UPS to the power socket on the wall.

3.5 System Configuration

3.5.1 Power on and operation

1. Connect the power supply plug to the AC power supply and confirm the connections of the system and the optional parts of the product are correct;
2. Turn on the power switch at the bottom right of the rear side of the case and then a startup screen will be displayed after starting the system normally: display the Logo of the Company, make a sound of boot and give a boot light (blue, light on for about 40 seconds);
3. Power-on self-test: self-test the components;
4. After finishing the self-test, the system enters to an interface of ready state.

3.5.2 System Introduction

After a series of initialized actions, the system will go straightly to the power-on self-test interface after startup, and self-test components according to the progress prompt on the interface, in the end of the self-test, participate in to complete switch check of the centrifuge manually according to the interface prompt, by this time the progress reaches 100% and the system enters into the interface of ready state.

3.5.2.1 Collection System

1. Collection System

Press the button of **Draw** at the interface of ready state to enter the plasma collection system, wherein the operation procedures are as follows:



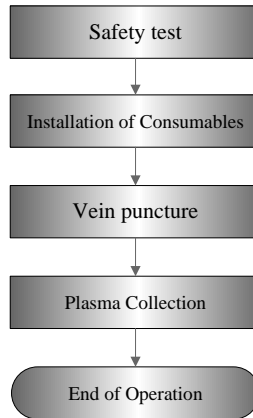



Error! Use the Home tab to apply 标题 1 to the text that you want to appear here.

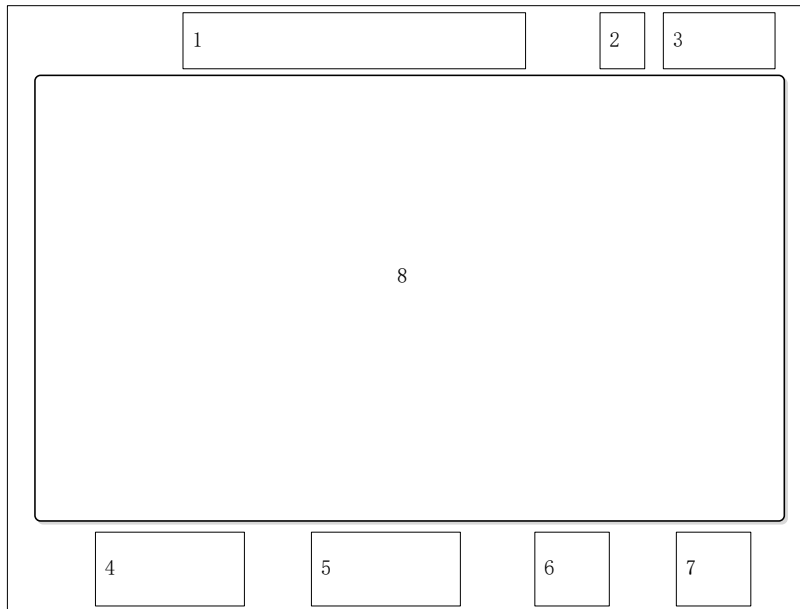













The ID information and collection parameters can be modified or set in plasma collection stage.

2. Collection Interface



No.	Display Content Description
1	<p>Current collection status of the system: Installation of Disposable -> collection preparation -> collection process -> finish collection</p> <p>  Disposable installation stage  Collection preparation stage  Collection stage  Centrifuge braking  Return stage  Disposable removing stage. The current lighted icons represent the current state. </p>

3-12 Error! Use the Home tab to apply 标题 1 to the text that you want to appear here.

No.	Display Content Description
2	Current networking status of the system: wired connection success/failure   , wireless connection success/failure  /  .
3	Current date and time of the system.
4	Quick setting button of the Pump , including On  / Off  , and speed up  /slow down  (adjust the step value to 5).
5	Quick setting button of Cuff , including On  / Off  , and add  /reduce  pressure (adjust the step value to 5).
6	ID button. Pop up a window to query or modify the ID information of personnel, Disposable and accessories and other information. The ID input is a configured item
7	Setting button. Click this button to pop up a window for setting collection parameters: Click here and the window pops out; then set the current collection process parameter.

3.5.2.2 System Configuration

Click **Configuration** in the ready interface, input the set password (initial password is 8888) to enter the user configuration interface and the interface consists of the following element: Language, Unit, Set Time, Set Params, Set Password and Set ID-input.

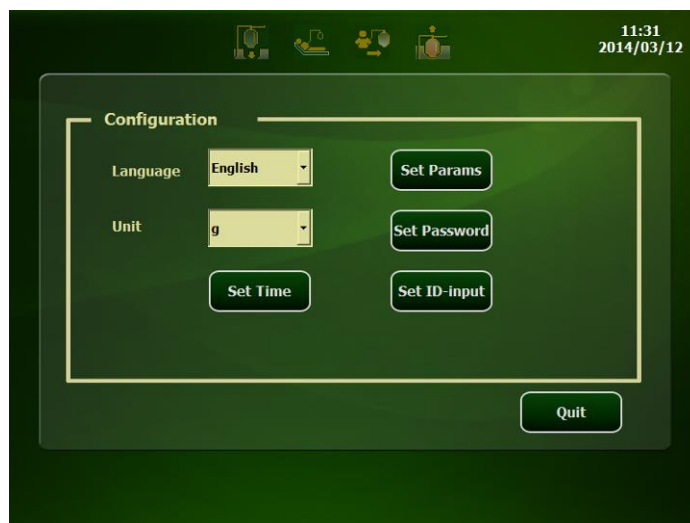

1. Language: select language of the user interface;

Error! Use the Home tab to apply 标题 1 to the text that you want to appear here.

2. Unit : select the unit of measurement for the product under collection, g/ml;
3. Set Time: modify or set the system time;



4. Set Params: set general collection parameters according to user requirements;

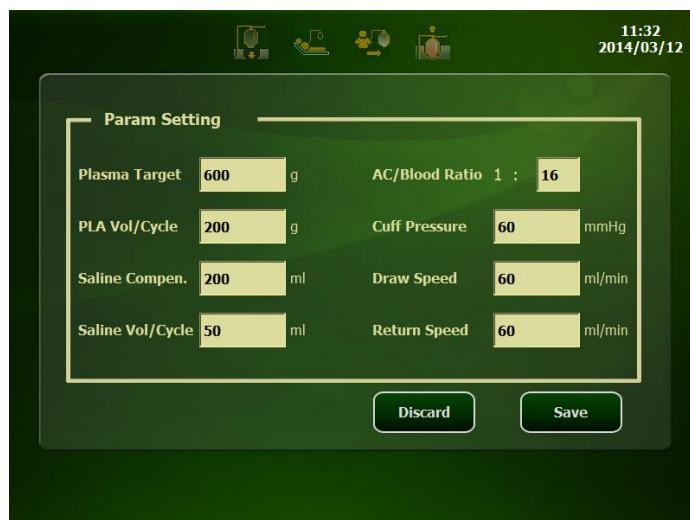

5. Set Password: change the configured password (initial password is 8888);

3-14 Error! Use the Home tab to apply 标题 1 to the text that you want to appear here.



6. Set ID-input: Choose whether to input the IDs in the list. When all or part of ID input items of Disposable and accessories are selected, the ID input interface will be popped up after safety check; when all or part of ID input items of personnel are selected, the ID input interface will be popped up in the vein-puncture interface.

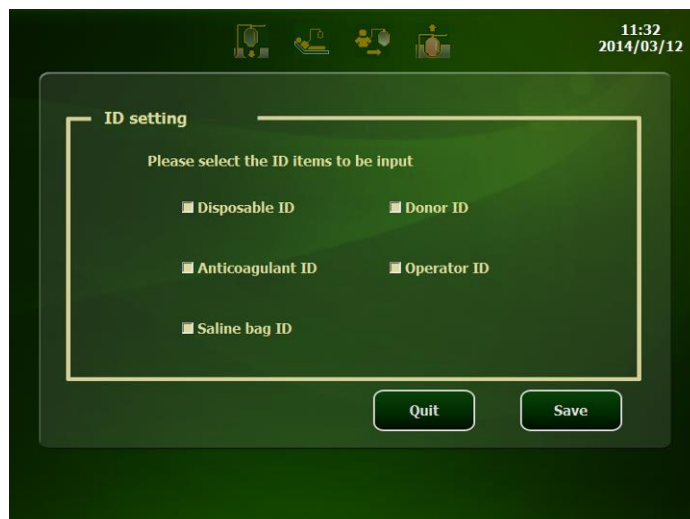

3.5.2.3 System Maintenance

This system is used only by a maintenance engineer for product maintenance and repair. Press the **Configure** at the interface of ready state and then input the maintenance password (12348888) to enter the maintenance interface:

Error! Use the Home tab to apply 标题 1 to the text that you want to appear here.



1. Linesensor Trip%

This item defines the sensitivity of a line detector, it is used for monitoring the purity of the plasma, that's the blood cells mixed in the plasma, wherein the definable range is 80-95% and the factory default is 85%.

2. Configuration

The method of application is the same as that of System Configuration.

3. Network setting

The network can be set while choosing the use management software (DigiPladMS):

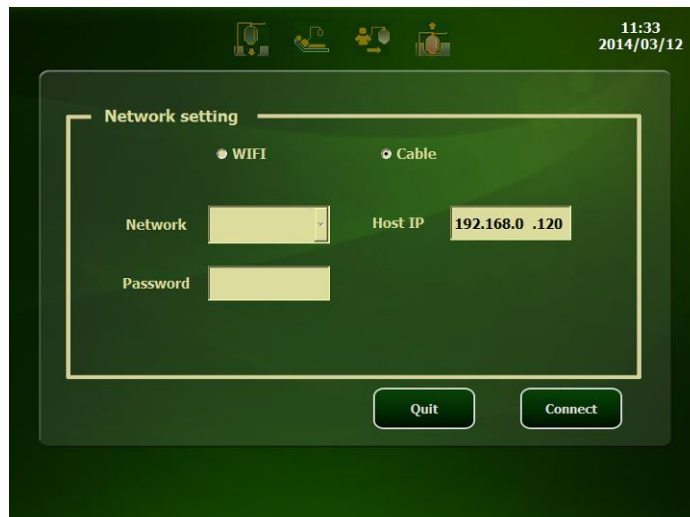

4. Touch screen calibration

In the condition that the click position on the display screen is imprecision, the touch screen calibration can be carried out according to processes as follows:

3-16 **Error! Use the Home tab to apply 标题 1 to the text that you want to appear here.**

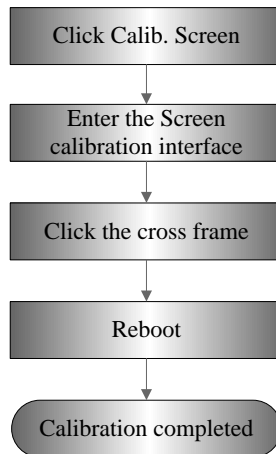

5. Weight calibrate

At the weigher calibrate interface, enter the Target Weight (200~1000g) and put weights on the chassis of the bag weigher or the tray of a bottle type weigher for calibration according to the interface prompt:

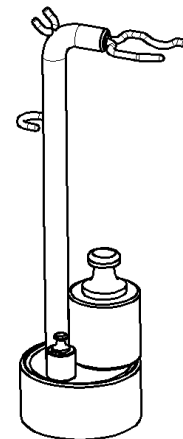
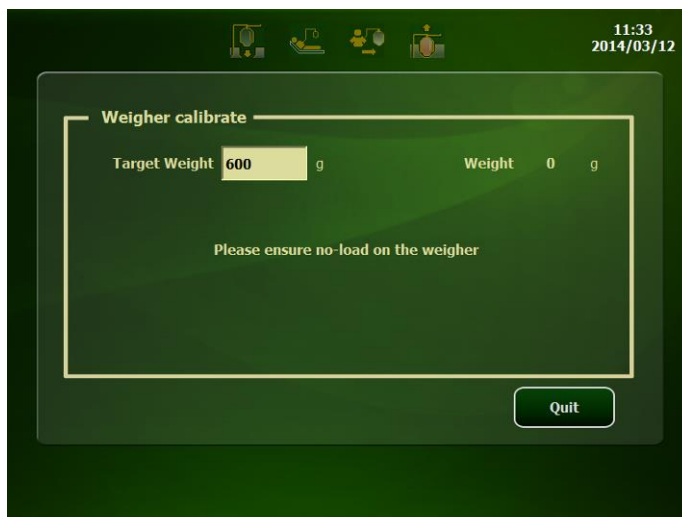

6. Restore factory settings

In restore factory settings, the following parameters will restore to the factory default: Equipment No., Unit, Set Params, Set Password, Set ID-input, DigiPlaDMS, Linesensor Trip% and Set Network.

7. Version information

The system version is the version of the software system while the components version is the version of the control software. The version information will be updated according to the software upgrade.

Caution: The system information must be confirmed before and after the software maintenance

8. Debug

Error! Use the Home tab to apply 标题 1 to the text that you want to appear here.

Click the **Debug** button, the interface will load to the debugging interface, or, after the failure of start-up self-test, one can press the stop button to enter the debugging interface.

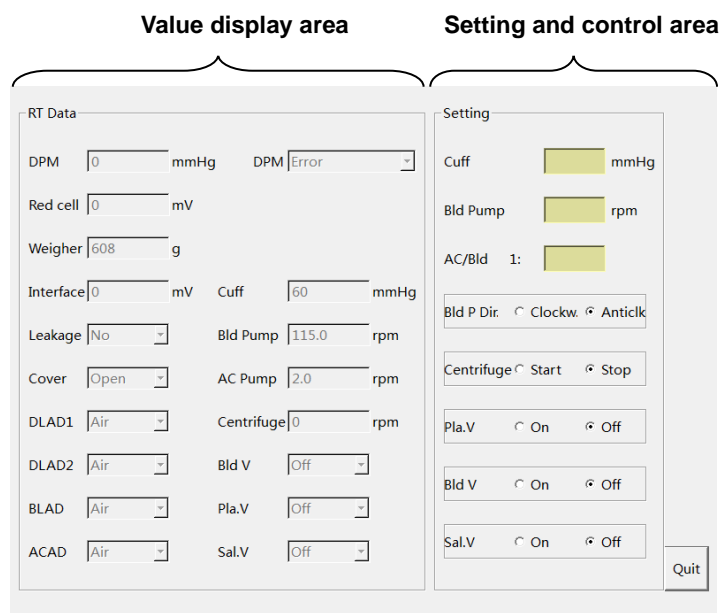

3.5.3 Function set

3.5.3.1 Management software preset

This item should be configured at the maintenance interface synchronously after mounting data management software on PC.

3-18 Error! Use the Home tab to apply 标题 1 to the text that you want to appear here.

3.5.3.2 Network preset

The plasma separator support wired and wireless connection modes: for wired connection, connect the Ethernet port on the back of plasma separator with the corresponding port of the router through network cable (twisted-pair); for wireless connection, communication is carried out by the WiFi module inside the plasma separator and the wireless router. The automatic management of collection results of the product is realized by the PC management software.

The network settings are as follows:

1. Click **Configuration** in the ready interface and input the maintenance password to enter the maintenance interface; then click **Network Setting** to enter the setting interface;
2. Only one of wired or wireless connection to a LAN can be chose at the same time;
3. For wireless connection, choose the router to be connected in the available wireless router list and input the correct connection password for connection;
4. There are for connection status as shown in follows:

1) Wired connection, connection succeeded. The corresponding icon is 

2) Wired connection, connection failed. The corresponding icon is 

3) Wireless connection, connection succeeded. The corresponding icon is 

4) Wireless connection, connection failed. The corresponding icon is 

4 Function Inspection and Test

4.1 Preparation

Inspection and test items of said part can be done by professional maintenance staff and users jointly.

4.2 Equipment Status Inspection

4.2.1 Running status

- After power on the plasma separator, the fan runs normally at once without making any abnormal noise. The system runs normally without any abnormal sound and condition.
- Enter the system maintenance interface to check the product settings, the optional fittings, the software version and other basic information of the system.
- Check the following items jointly with the user to confirm the system status:
 1. Any abnormal situation when the system is running.
 2. Occasional abnormal situations.
 3. Other items per requirements of the customer.

4.2.2 Runtime Environment

Check the runtime environment and the indoor temperature and humidity. The measurement associated with security features is very sensitive to moisture, the measuring position and the measurement circuit.

If insulation properties of a machine deteriorate as the increase of service life or faults of the machine, the fluctuation range of the measurement results may enlarge with the increase of humidity.

4.3 Regular Check

4.3.1 Check Procedure

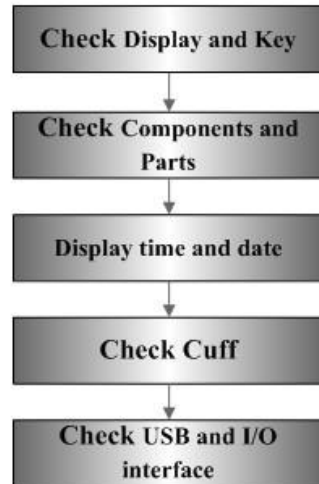

4.3.2 Inspection Contents

4.3.2.1 Display and Key

Steps	Standards
Display works normally	Pure color, clear and complete pictures, proper brightness, no-defocus and color missing, stable pictures.
When the display is at the maximum elevation, it will not affect the operation of centrifuge cover	After the display reaches the maximum elevation, the opening and closing of the centrifuge cover will not cause/ interference.
The click position is imprecise.	After completing the starting up self-inspection, click Configuration button and the password input test screen precision.
The stop key is valid.	In the process of starting up self-test, load water pipe into any air detector; test will be failure, pressing stop and entering the debugging

	interface.
--	------------

4.3.2.2 Components and Parts

Steps	Standards
Starting-up self-inspection test	Entering the starting-up self-test by opening power switch system can complete a 100% self-test process and enter the Ready interface.

4.3.2.3 Display time and date

Steps	Standards
At the Ready interface, check the time and date at the upper right corner of the display screen; or enter the configuration system and click Time Settings for checkup.	Confirm the displayed time and date and if they are not right, reset them.

4.3.2.4 Cuff

Steps	Standards
Open the cuff switch and check the air inflation.	Click Cuff at vein puncture interface or insert pressure value at the cuff pressure bar of the debugging interface to inflate the cuff and observe whether cuff inflation is normal or not.

4.3.2.5 USB and I/O interface

Steps	Standards
Barcode scanner and USB interfaces: After the barcode scanner is normally connected to the USB interface, check its status at ID entering interface.	After double click (cursor shall occur with no key board) is made within bar code input box at ID entering interface, scan with barcode scanner to show a right result (11 figures at most).
UPS: Connect UPS to the plasma separator; cut	In the process of plasma separator operation, unplug the power cable plug at the socket and the device

Error! Use the Home tab to apply 标题 1 to the text that you want to appear here.

off the power after starting up and check its status.	can still run normally (30 minutes at most).
Ethernet port: Debug wired and wireless networks	On the premise of selection management software, carrying out wired and wireless network connection settings can realize the transferring of data.

4.4 Function Inspection

Caution: This part lists the inspection items of a system with complete optional functions and gives detailed description to the key itmes, however, if a function is not selected, the corresponding inspection items can be ignored.

4.4.1 Inspection Procedures

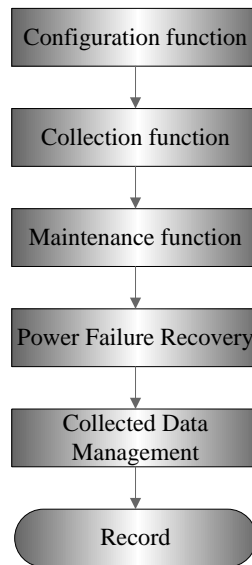









4.4.2 Inspection Contents

4.4.2.1 Configuration function

Enter the configuration interface, revise or set the language, unit, set params, set password and the set ID-input and other items used in collection per custom requirements.

4.4.2.2 Collection function

Enter the collection mode, complete the consumable items installation according to the interface prompt, take water as the collection medium, and inspect the following items after entering the collection interface:

Inspection Content	Inspection Standards
Pump speed adjustment	At the collection or return interface, click the setting button of blood pump On  /Off  , and add  /reduce  buttons to regulate the pump (adjust the step value to 5).
Cuff pressure adjustment	At the vein-puncture or collection interface, click the cuff On  /Off  , and add  /reduce  buttons to adjust the cuff (adjust the step value to 5).
ID modification	At the collection or return interface,click the ID button.Enter the ID modification interface, display the inputted ID, click the edit box to pop-up a keyboard, use the keyboard to input legal characters, and click Enter on the keyboard to complete the input.
Parameter modification	At the collection or return interface, click the Setting button.Enter the parameter modification interface, display the configured parameters, click the edit box to pop-up a keyboard, use the keyboard to input legal characters, and click Enter on the keyboard to complete the input.
Check the collection result	After the plasma separator completes the total preset collection, it will make a noise prompt and display the collection result report on the screen.

4.4.2.3 Maintenance function

Enter the maintenance interface to configure the DigiPlaDMS, modify parameters of the Linesensor Trip% and other items and check the version information, see 3.5.2.3 for the inspection method.

Error! Use the Home tab to apply 标题 1 to the text that you want to appear here.

4.4.2.4 Power Failure Recovery

If there is a power failure in the plasma collection process, the operating interface will provide three options (**Draw/Return/Exit**) after recover the power supply and restart the equipment. The plasma separator can automatically memorize the operating status and operating parameters, click the button of relevant procedure to continue to the next step; or click **Exit** to enter the summary of collection results.

4.4.2.5 Collected Data Management

After completing a collection process via test materials and confirming a report of the collection result, the corresponding result can be checked on a PC equipped with data management software.

4.5 Performance Test

This test should be performed at the debugging interface under the collection status:

Inspection Content	Inspection Standards
Valve block	Hang a plasma bag full of water upside down on the bracket of anticoagulants, enclose the outlet line into a electromagnetic valve, enter the debugging interface to set the status of the valve, and each valve in the closed state shall ensure that the water in the plasma bag does not leak
Weigher	In the maintenance mode, click on the Calib. Weigher button to enter the calibration interface, wait till the reset of an electronic scale, put weights of 200g, 600g, 1000g respectively, and the difference between the value displayed on the screen and the actual weight is less than or equal to 5g
Centrifuge cup leakage alarm	In the collection process, press the stop button when the machine runs normally to suspend the operation of the centrifuge, open the centrifuge cap, use cotton swab to dip in a good amount of clean water, apply the water on a leakage detector of the centrifuge, the system gives sound and light alarm and makes prompts on the screen.
Air alarm	In the collection or return process, take out the pipeline from the air detector, the system gives sound and light alarm and makes prompts on

	the screen
Pressure alarm	<ul style="list-style-type: none"> ● Low pressure: in the process of collection, clamp the blood inlet pipeline of the blood member with haemostatic forceps, the Differential Pressure Manometer (DPM) on the interface falls gradually, the color will changes from blue to red until disappear; the system gives sound and light alarm and makes prompts on the screen. ● High pressure: in the process of feedback, clamp the blood inlet pipeline at the air detector of the blood member with haemostatic forceps, the Differential Pressure Manometer (DPM) on the interface rise gradually to the top, the system gives sound and light alarm and makes prompts on the screen

5 Software Upgrade

5.1 System Software

Caution: The version information of the system software after upgrading can be checked at the interface of ready state or the maintenance interface.

5.1.1 Upgrade Equipment

1. Under the sdfuse catalog, copy the SD cards with three files of the system software upgrade packages;
2. A piece of serial port line;
3. A PC (personal computer).

5.1.2 Pre-upgrade Installation

1. Copy or download the serial port software  to the desk of a connected PC;
2. Double-click to open the software, configure the baud rate as 115200, wherein the serial port number might be COM1~COM4 (depending on the port to which the PC is connected), and click Open to Open the serial port;

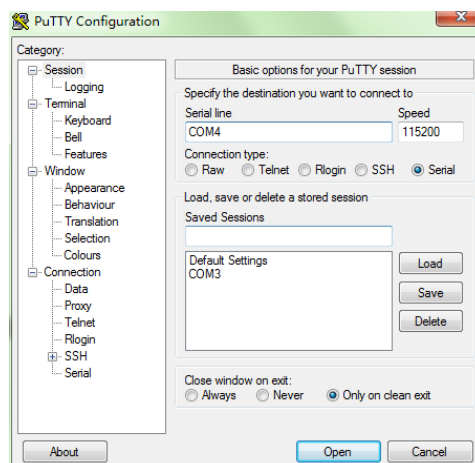

3. Plug the SD card into the SD card seat on the system board and connect the serial port line to the serial port DB9 and the PC serial port of the system board respectively;

5.1.3 Programming Software

1. Open the power switch of the plasma separator, when the software interface of the PC becomes countdown, and press the **Enter** key on the PC keyboard before the end of the 3 seconds countdown. The display interface is as follows:

```
U-Boot 1.3.4 (Oct 24 2012 - 16:31:19) for SMDKV210

CPU: S5PV210@1000MHz (OK)
      APLL = 1000MHz, HclkMsys = 200MHz, PclkMsys = 100MHz
      MPLL = 667MHz, EPLL = 80MHz
           HclkDsys = 166MHz, PclkDsys = 83MHz
           HclkPsys = 133MHz, PclkPsys = 66MHz
           SCLKA2M  = 200MHz

Serial = CLKUART
Board: SMDKV210
DRAM: 512 MB
Flash: 0 kB
SD/MMC: 3781MB
NAND: *maf_id = 236, dev_id = 220
512 MB
*** Warning - using default environment

In: serial
Out: serial
Err: serial
checking mode for fastboot ...
Hit any key to stop autoboot: 0
SMDKV210 #
```

2. Type the command of *sdfuse flashall* in the software interface. Wait for the completion of the software programming, which will last for a few minutes. When the screen shows the word 100% complete, it shows that the programming is completed and the software will restart;

```
NAND write: device 0 offset 0x600000, size 0xbc05140

Writing data at 0xbc52000 -- 100% complete.
197153088 bytes written: OK
partition 'system' flashed
reset...

OK
```

3. Take down the SD card and the serial port line;
4. Reboot the Separator Plasma, and the software upgrade is completed if a startup picture displays.

Error! Use the Home tab to apply 标题 1 to the text that you want to appear here.

5.2 Control Software

- Caution:**
1. Operators should wear electrostatic rings in the process of programming.
 2. Make sure the footstand of the adapter is dry and clean to avoid oxidation.
 3. The version of the new upgraded software is the components version information in the maintenance system.

5.2.1 Upgrade Equipment

1. Programming unit: MPLAB PM3
2. Adapter: AC164323

5.2.2 Pre-upgrade Installation

1. Install the adapter (AC164323) on a socket module connector on a programming unit (MPLAB PM3). Align the connector on the socket module at the connector on the MPLAB PM3, and downward push the socket module with constant speed to make it closely matching with the connector;
2. Align the SD card stored a appropriate version of object code software (HEX file) at the SD card slot at the back of the MPLAB PM3 programming unit, and insert the notch end of the card into the slot. The card is locked and can only be inserted along one direction. Push the card into the slot (push the SD card inwardly at first to release it before pulling it out).

5.2.3 Programming Software

1. Power on the programming unit (MPLAB PM3).
2. Select option Select Device on the main menu to specify the series of the device and then select the device to be programmed.
3. Select option Program/Verify Device, and then program the device in the socket module and verify it.
4. The software upgrade is completed.

6 Hardware System

6.1 System Composition

The hardware system of the separator plasma adopts the hardware structure of an upper computer and a lower computer composed by two CPUs.

The upper computer is provided with an embedded operating system, it is concentrated on the human-computer interaction, data management and other user applications, and it support and extend the input/output peripherals, such as the Ethernet interface, the USB interface, the audio interface, etc. The lower computer is concentrated on applications control, comprising the operations of various peripherals (pump, valve, centrifuges, etc.), and the monitoring and alarm to various signals (the switching valve and the analog quantity).

The communication between the upper computer and the lower computer is achieved by the serial port, wherein the upper computer directs the operating status of the lower computer through different commands while the lower computer gives feedback about the corresponding executing state and results.

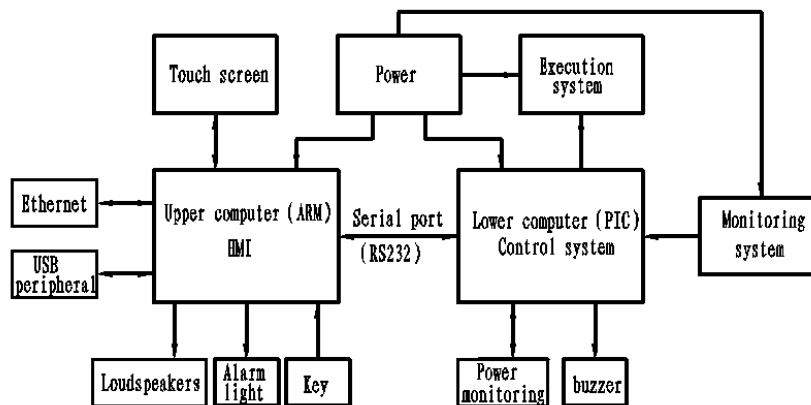

Figure 6-1 Block Diagram of the Hardware System Structure

Figure 6-1 is the structure diagram of the hardware system, which gives signs to various components and divides the plasma separator into 3 major components according to structure: the human-computer interaction system (the human machine interface and data management), the collection system (to complete the collection function) and the power supply system (provide power support to the whole machine), wherein the collection system is composed of a control

Error! Use the Home tab to apply 标题 1 to the text that you want to appear here.

system (the collection process control), an execution system (actuated) and a monitoring system (sensing signal collection).

6.1.1 Human-computer Interaction System

The human-computer interaction system (upper computer) is focused on human-computer interaction HMI (Human Machine Interface) and faces the operator directly, it is an interface for mutual communication and conveying and receiving information between the operator and the plasma separator. The user controls and participates in the plasma collection process through the human-computer interaction system. The system takes an inner core microprocessor ARM Cortex-A8 and a peripheral circuit as the core to configure peripheral interfaces that are necessary for certain functions.

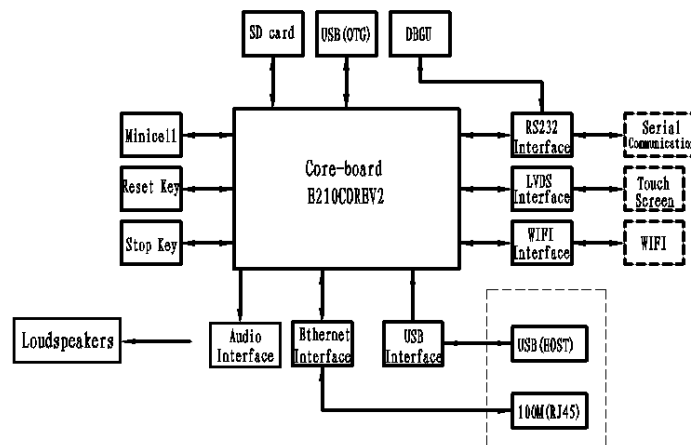

Figure6-2 Block Diagram of the Human-computer Interaction System

6.1.2 Collection System

The Collection system is composed of a control system, an execution system and a monitoring system, and the function thereof is to complete the plasma collection. The Control system is composed of a PIC32 micro controller and related peripheral interface circuits, and it is responsible for controlling the whole plasma collection process; the execution system comprises a centrifuge, a peristaltic pump, a pump drive circuit and a pipeline pressure indication circuit; the monitoring system completes the measuring of all relative physical quantities in the collection process by an analog quantity or switching valve interface circuit via multiple different kinds of sensors. At the same time, the collection system receives the upper computer instructions and upload data via serial communication. Fig 6-3 Block Diagram of Collection System

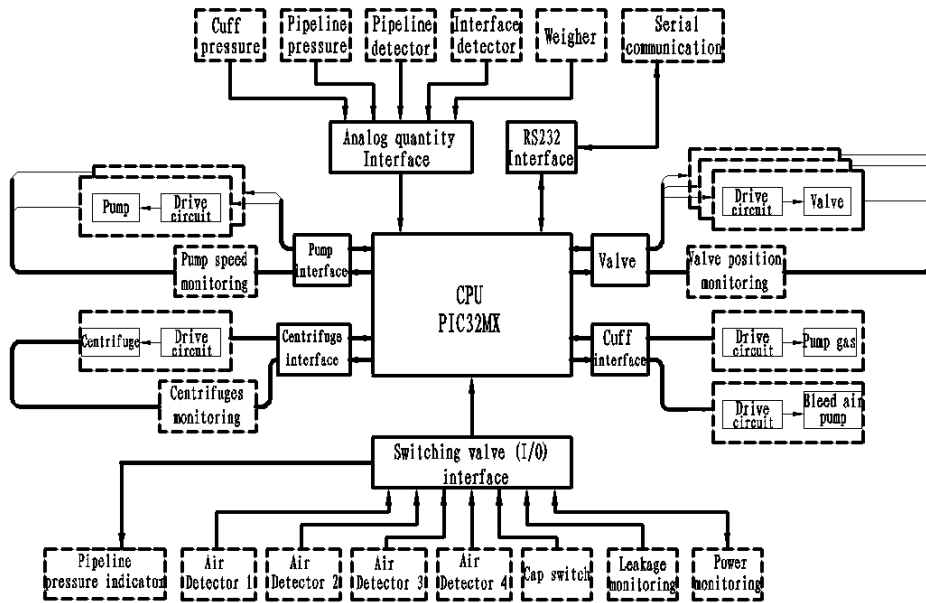

Figure6-3 Block Diagram of Collection System

6.1.3 Power System

The power system is divided into two independent ways. One way is outputted by the grid power supply via an isolating transformer to provide a centrifuge AC driver with power; the other power supply is provide by the other grid power supply via the switching power (AC/DC) supply and then different DC/DC power supplies are generated through various DC switching circuits.

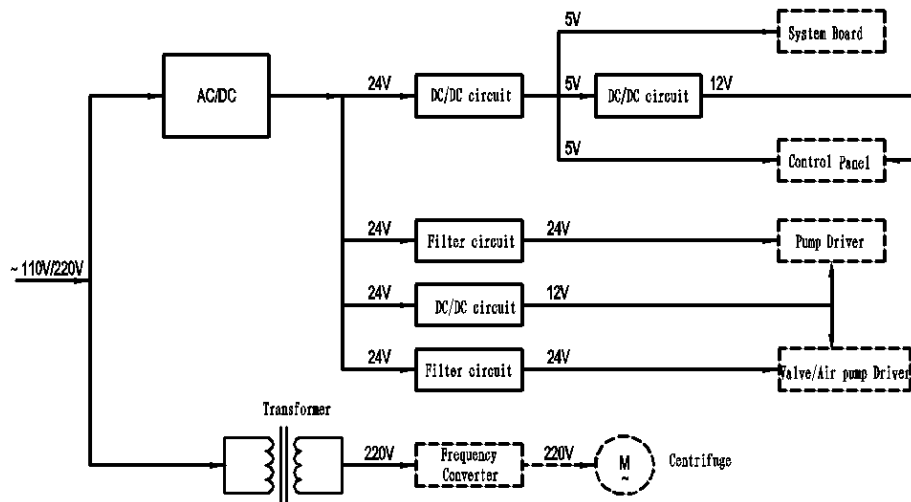

Figure6-4 Block Diagram of Power Supply System

Error! Use the Home tab to apply 标题 1 to the text that you want to appear here.

6.2 Function Board Card Introduction

A control board and a driver board achieve signal transmission via a backplane, and the main monitoring components are connected to the control panel via a connector on the backplane while all execution units are connected via a driving plate. The power panel, the control panel, the driver board and the backplane are arranged in a case, a communication board is mounted on the back shroud of the case and a system board is installed in the display. The communication signal wires of the system board and the control panel are switched over through the communication board. Figure 6-5 Schematic Diagram of Board Card Connection.

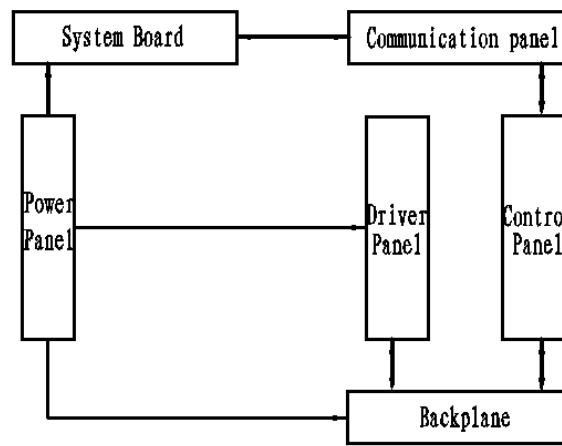

Figure 6-5 Schematic Diagram of Board Card Connection

6.2.1 System Board

As the main part of the display of a plasma separator, the main function of the system board is the human-computer interaction (HMI) application and to complete the hardware platform required by the human-computer interaction. The functions thereof are achieving the communication between it and the lower computer, real-time displaying the acquired information, completing the input and display of the interactive information, and generating corresponding alarm information. It can be divided into a core-board module, a power supply module, an alarm module, a SD card module, a WIFI module, an alarm sound module, a display module, a touch screen module and a lower computer module according to functions.

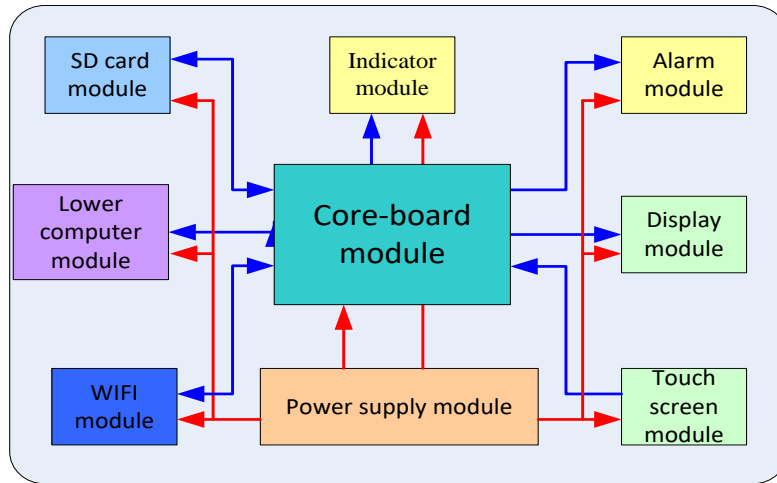

Figure6-6 Logic Block Diagram of System Board

6.2.2 Control Panel, Driver Panel and Backplane

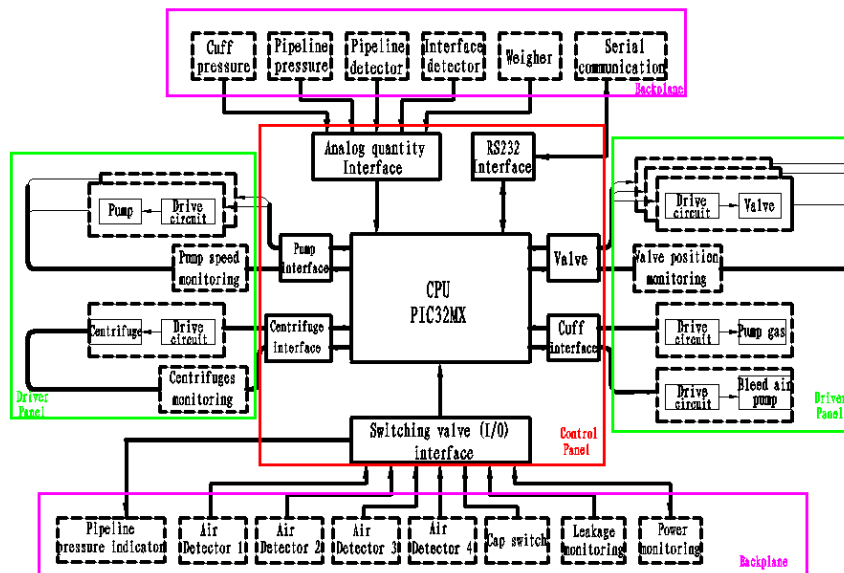

Figure6-7 Logic Block Diagram of Control Panel, Driver Panel and Backplane

6.2.2.1 Control Panel

The control panel is a hardware platform used for controlling and monitoring the collection process. The functions thereof comprise achieving the communication between it and the upper machine, receiving control commands from the upper computer and making correct response, real-time controlling various peripherals and real-time monitoring various sensing signals in the collection process, and sending the acquired information up to the upper computer.

Function paths:

Error! Use the Home tab to apply 标题 1 to the text that you want to appear here.

- A low-pass filter is composed of an operational amplifier and the analog quantity interface is completed by a 5V-3.3V level translator;
- The level switch of the serial port communication is achieved through a serial port conversion chip MAX3232;
- Valve interfaces and pump interfaces are completed by I/O port directly, and the control section and the drive section are isolated by optical coupling, wherein the pump speed control and feedback should be completed by high-speed optical coupling;
- Cuff interfaces and centrifuge interfaces are completed by I/O port directly, and the control section and the drive section are isolated by optical coupling.
- The data storage of the control panel consists of EEPROM, and the master controller is communicated with EEPROM through the SPI communication protocol;
- The isolation and logic level switch of the outward RS485 communication of the control panel is achieved by chip ADM2587.

6.2.2.2 Driver Panel

The driver board is a hardware board card used for driving main collection functional units of the plasma separator and giving signal feedback, the control signal input and feedback signal output thereof are both pointed to the control panel. The functions thereof comprise achieving the electric drive and position signal feedback of the electromagnetic valve, the electric drive and speed & directional signal feedback of the peristaltic pump, the start-stop control and the speed signal feedback of the centrifuge machine, the drive force to the air pump and vent valve of the cuff, and it also provides a cuff pressure sensor signal collection channel.

Function paths:

- The standard 5.0V power supply of the cuff pressure sensor is provided by chip TL431;
- The solenoid valve is drove by chip DRV101F, the sustaining voltage of the solenoid valve is controlled by the PWM output DRV101F and can be adjusted by changing divider resistances;
- The position monitoring of the solenoid valve is achieved by the optical coupling on the triode BC846B driver control panel;
- LM7805 provides +5V power supply for the logic control of the pump;

- The direction monitoring of the pump is achieved by a phase discriminator composed of CD4011 and CD4044 by outputting signals to group A and group B motor encoders, and the results are feedback to the control panel in the manner of high and low levels;
- LM7805 provides a +5V power supply to the release valve of the cuff.

6.2.2.3 Backplane

The main function of the backplane is to serve as a signal connection channel between the control panel and the driver board, wherein the channel is achieved by the board to board connectors on three board cards, at the same time, it is also the input channel of the multi-channel analog and the switching value and, the power input channel of the control panel.

The relationships among the backplane, the control panel and the driver board:

- All the analog input channels of the control panel are connected with the exterior through the backplane, comprising the electronic scale, the pipeline pressure, the cuff pressure and the pipeline detector output;
- All the switching value input channels of the control panel are connected with the exterior through the backplane, comprising the cap switch status, and the connector status of the leakage sensor and the pipeline pressure detector;
- The solenoid valve, the bold pump, the anticoagulation pump and the cuff control channel of the driver board are all connected with the control panel through the backplane.

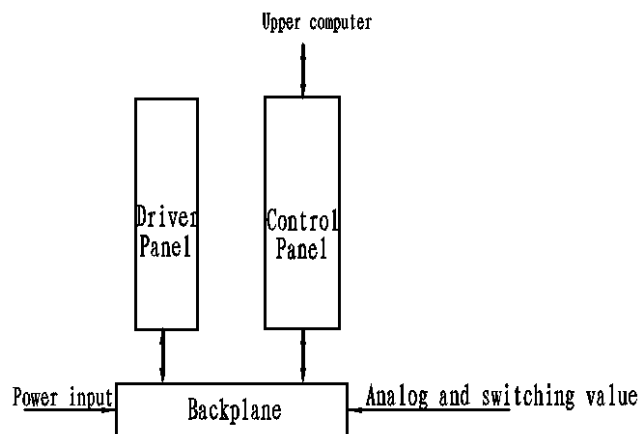

Figure 6-8 Block Diagram of the Connection Relationship of the Backplane, the Control Panel and the Driver Board

6.2.3 Power Panel

The power panel is composed of a 24V/5V (DC/DC) power module, 24V/12V (DC/DC) switching circuit and a 5V/12V (DC/DC) switching circuit.

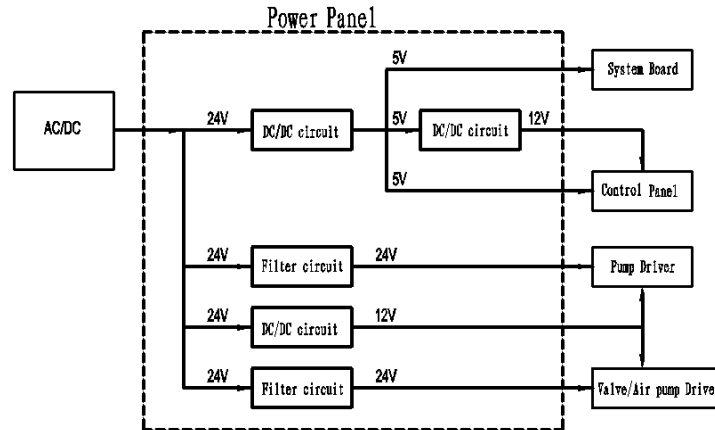

Figure 6-8 Logic Block Diagram of Power Panel

6.2.3.1 24V/5V (DC/DC) Power Module

Power module model: WD25-24S05D1. The module completes the transformation from DC 24V to DC 5V, and the control parts (the upper computer and the lower computer) of the whole hardware system are both provided by the 5V. The leading indicators are as follows:

- 1) Input voltage range: DC18V~DC24V;
- 2) Output voltage accuracy: $5V \pm 1\%$;
- 3) Transfer efficiency: typical value 85%;
- 4) Over current and short circuit protection, and automatic recovery function;
- 5) Switch frequency: 300KHz.

The maximum rated output current of the module is 5.0 A while the maximum load demand is rated maximum current 3.0 A.

6.2.3.2 24V/12V (DC/DC) Switching Circuit

The control circuit part of the peristaltic pump needs a 12V DC power, wherein said part is composed of an integrated circuit LM2575 and some peripheral devices.

6.2.3.3 5V/12V (DC/DC) Switching Circuit

Since the control part has only a group of separate isolated 5V power supply, a 12V power supply should be provided to the sensor on basis of a DC/DC booster circuit of the 5V power supply. The input voltage range of the chip is 2.7V to 14V, the maximum output voltage can be adjusted to 20V, and the maximum load capacity is 1.4A.

7 Structure and Dismounting

7.1 Whole Set Structure

7.1.1 Exploded View of the Whole Set

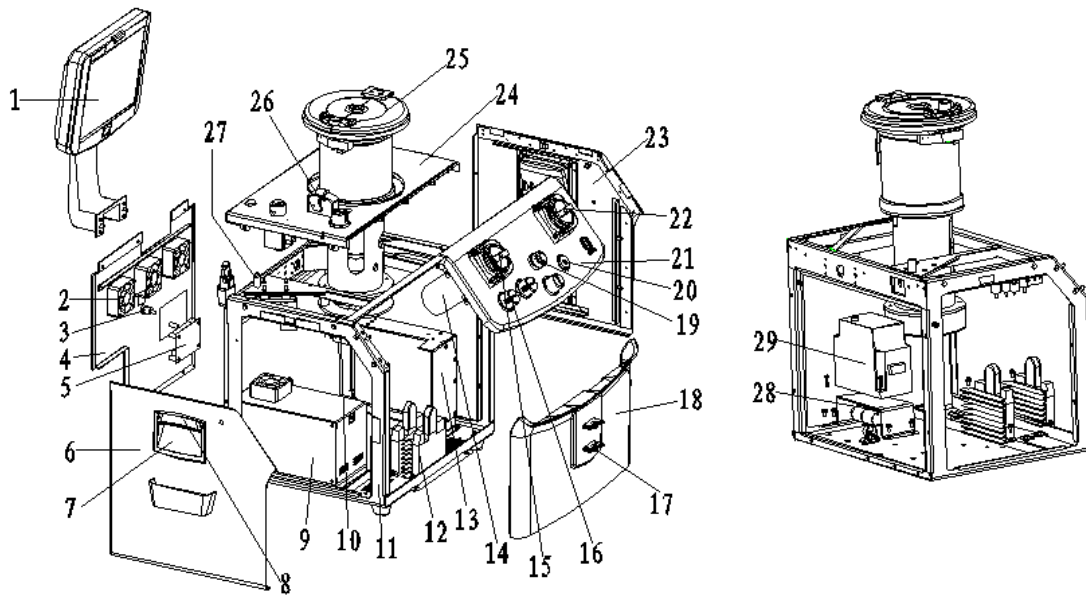

Figure 7-1 Exploded View of the Whole Set

No.	Material Code	Name	No.	Material Code	Name
1	1001-30-00002	Display modules	16	JC00.10.0	Ultrasonic wave air detector
2	1001-20-00127	Fan assembly	17	N10.18.10	Fixed seat
3	1001-10-00143	Connector PMCD1602	18	1001-30-00020	Front housing assembly of the host
4	1001-30-00021	Rear housing assembly of the host	19	1001-10-00135	Solenoid valve
5	1001-30-00142	Communication board PCBA	20	1001-30-00136	Pressure detector assembly

Error! Use the Home tab to apply 标题 1 to the text that you want to appear here.

6	1001-30-00022	Left housing assembly of the host	21	1001-30-00018	Bevel operation panel assembly
7	1001-20-00145	Handle	22	N13.04.01.04.0	Head of a blood pump
8	1001-20-00146	Handle cover	23	1001-30-00023	Right housing assembly of the host
9	1001-30-00117	Power pack assembly	24	1001-30-00017	Horizontal operation panel assembly
10	1001-20-00168	Prompt board PCB	25	1001-30-00019	Centrifuge components
11	1001-30-00016	Main frame assembly	26	1001-30-00133	Pipeline detector assembly
12	0101159	Digital AC serve driver ACS606	27	1001-30-00116	Electronic scale assembly
13	1001-30-00118	Plug box component	28	1001-20-00125	Air pump
14	0101158	AC brushless serve motor	29	0101104	Centrifuge driver
15	N13.04.01.03.0	Head of the Anticoagulation pump	30		

7.1.2 Exploded View of Components

7.1.2.1 Exploded View of Components for Display and Support Arm

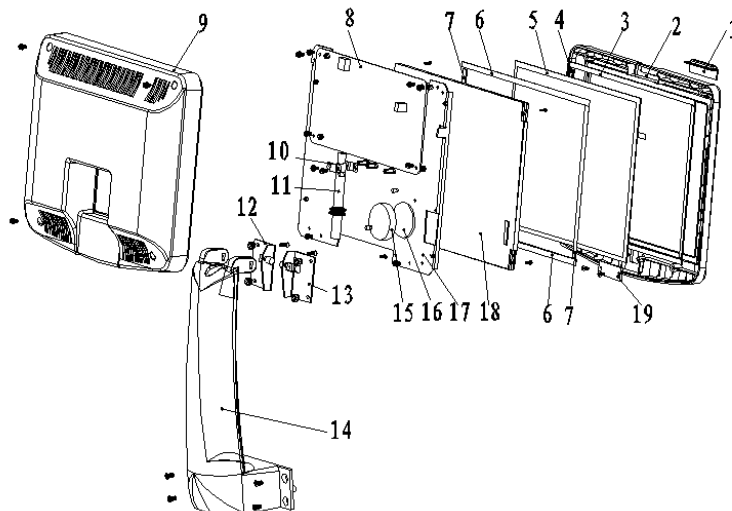
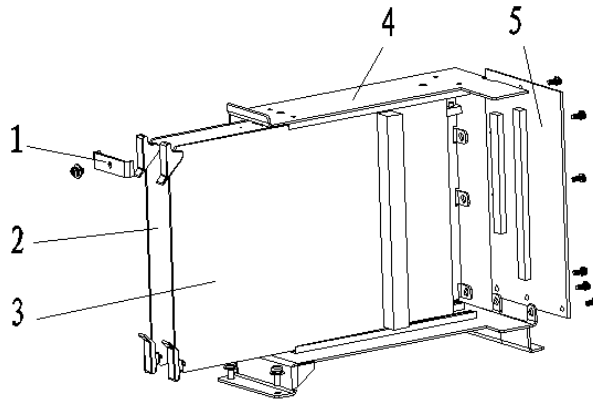

Figure 7-2 Exploded View of Components for Display and Support Arm

No.	Material Code	Name	No.	Material Code	Name
1	1001-20-00031	Display lamp cover	11	1001-20-00043	Communication cable
2	1001-20-00032	Front cover of display	12	1001-20-00029	Left damping spindle
3	1001-20-00036	Foam 1	13	1001-20-00030	Right damping spindle
4	1001-20-00037	Foam 2	14	1001-20-00035	Support arm
5	1001-20-00041	Touch screen	15	1001-20-00025	Horn assembly
6	1001-20-00038	Foam 3	16	1001-20-00042	Foam 5
7	1001-20-00039	Foam 4	17	1001-20-00034	Dead plate of display
8	1001-20-00026	System panel PCBA	18	1001-20-00040	LED Display
9	1001-20-00033	Rear cover of display	19	1001-20-00027	Button board PCBA
10	1001-20-00028	Pressing plate			

7.1.2.2 Plug Box Assembly



No.	Material Code	Name	No.	Material Code	Name
1	1001-20-00190	Pressing plate of the plug box	4	1001-20-00189	Metal plate assembly of the plug box
2	1001-30-00192	Control panel PCBA	5	1001-30-00191	Backplane PCBA
3	1001-30-00194	Driver board PCBA	6		

Error! Use the Home tab to apply 标题 1 to the text that you want to appear here.

7.1.2.3 Power Pack Assembly

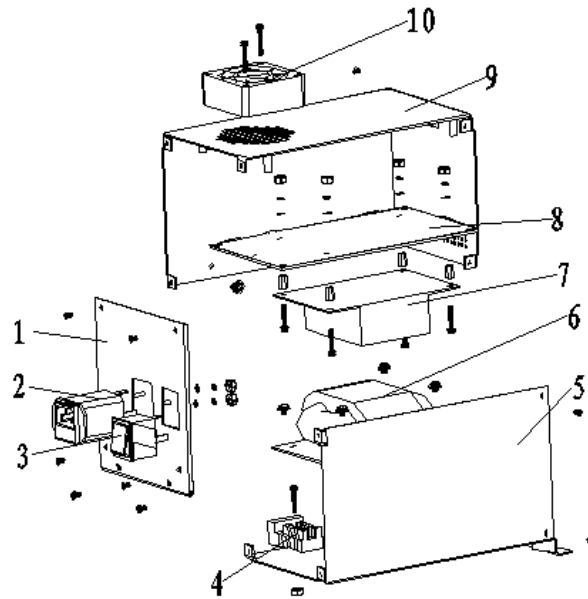

No.	Material Code	Name	No.	Material Code	Name
1	1001-20-00182	Front cover of a power pack	6	0101217	R80 transformer
2	0101088	Filter	7	0101034	Switching power supply
3	0101038	Power switch	8	1001-20-00184	Power panel PCBA
4	0101084	Wire holder	9	1001-20-00180	Upper cover of the power pack
5	1001-20-00181	Pedestal of the power pack	10	1001-20-00183	Fan assembly

7.2 Structure Dismounting



This part mainly focuses on the dismounting processes of main components and hardware board cards, and the assembly should be done according to the inverse process of disassembly if there is no special instruction.

7.2.1 Dismounting Tools

An internal hexagonal wrench (M4、M5) , a cross screwdriver (0#、2#) , a straight screwdriver (the tool bit is 3mm wide), a pair of antistatic gloves and a sleeve (M3、M4) :



7.2.2 Marking Instruction

-  —removed parts (screw for example)
-  —refers to the disassembled part (such as the cable plug, etc.)
-  —installed parts

7.2.3 Personnel requirements

The dismounting work must be done by maintenance engineers of Nigale who have professional knowledge or skills or engineers obtaining the skills by training.

7.2.4 Preparation for Dismounting

Please make following preparations before dismounting the plasma separator:

1. Stop the plasma separator, shutdown, disconnect the AC power supply, and unplug the AC power cord;
2. Remove the peripheral barcode scanner and other products;
3. Ready the disassembling tools and the anti-static gloves.

7.2.5 Dismounting of Host Assembly

7.2.5.1 Front Housing of Host

1. Take down 2 screws (M4×8) from the lower front end of the host;

Error! Use the Home tab to apply 标题 1 to the text that you want to appear here.



Figure 7-3 Diagram for Dismounting of Front Housing of Host

2. Apply a gentle force to the front direction of the device to pull out the front housing assembly of the host

7.2.5.2 Rear Housing of Host

Lift up a brine strut and an anticoagulant strut, and remove the combination screw fixed on the frame from the rear housing of the host. Pull outwardly from the bottom of the equipment to remove the rear housing of the host.



Figure 7-4 Diagram for Dismounting of Rear Housing of Host

7.2.5.3 Left and Right Side Plate Assemblies of Host

1. Remove the sunk screws (M4×8,two for each side) fixed on the left side plate and the right side plate;



Figure 7-5 Diagram for Dismounting of Left Side Plate and Right Side Plate of the Host

2. Pull the side plate rearward to remove the corresponding left and right side plate assemblies of the host

7.2.5.4 Display Modules

1. Remove the display modules from the host, see 3.3.3 for the process (use the inverse process);
2. Remove four screws (M3×8) fixed on the rear cover of the display;



Figure 7-6 Diagram for Dismounting of Rear Cover of Display

3. Remove 4 M4 screws between the upper end of the support arm and the fixed board of the display, and take down the support arm;;
4. Disconnect the cable connector on the system board, at the same time, and remove the four screws (M3×8) on the fixed plate of the display to take down the fixed plate of the display.

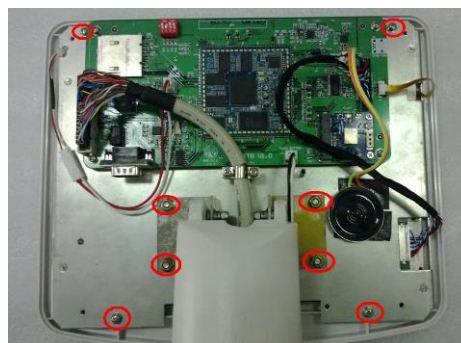

Error! Use the Home tab to apply 标题 1 to the text that you want to appear here.

Figure 7-7 diagram for Dismounting of Support Arm and Fixed Plate

7.2.6 Board Card Dismounting

The control panel, the driver board and the backplane of the plasma separator are mounted in the plug box of the host case:

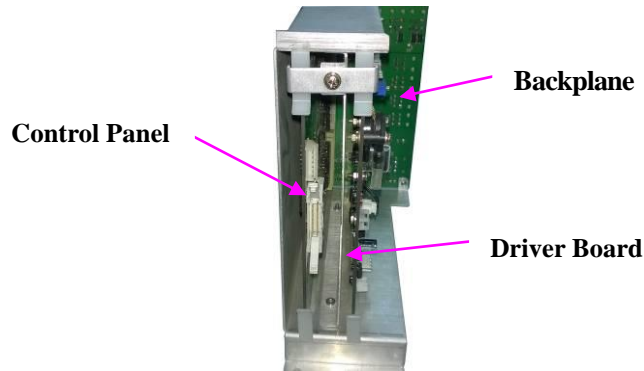

Figure 7- Structure Chart of Board Card Position of Plug Box

7.2.6.1 Control Panel

1. Dismounting the rear housing of the host;
2. Dismounting the screws(M4×8) on the plug box and take down the plug box pressing board;
3. Disconnect the communication cable on the control panel, flip the plug device on the board card to separate the socket of the control panel from the socket on the plug box, and pull vertically to the external side of the case to take down the control panel.

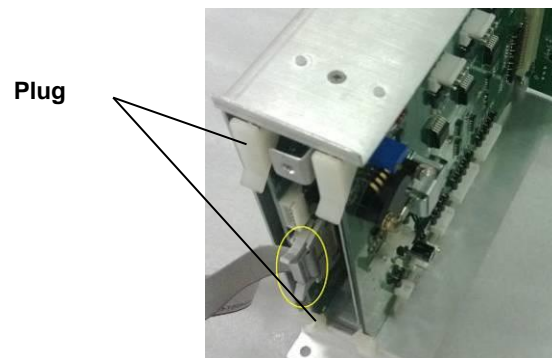

Figure 7-9 iagram for Dismounting of Control Panel

7.2.6.2 Driver Board

1. Dismounting the pressing boards on the rear housing of the host and the plug box (the same as 7.2.5.1);
2. Remove the connection cable on the driver board, flip the plug device on the driver board to

separate the socket of the driver board from the socket on the plug box, and pull vertically to the external side of the case to take down the driver board.

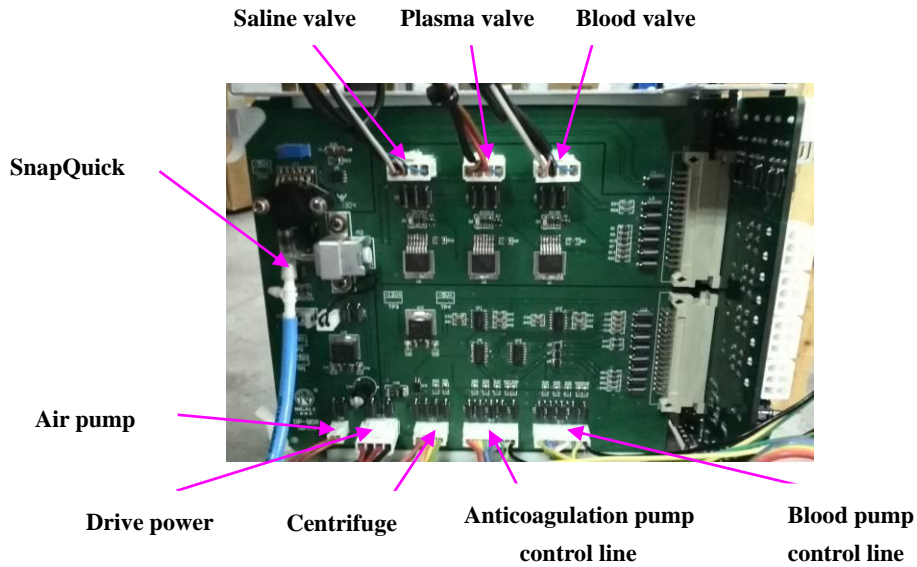
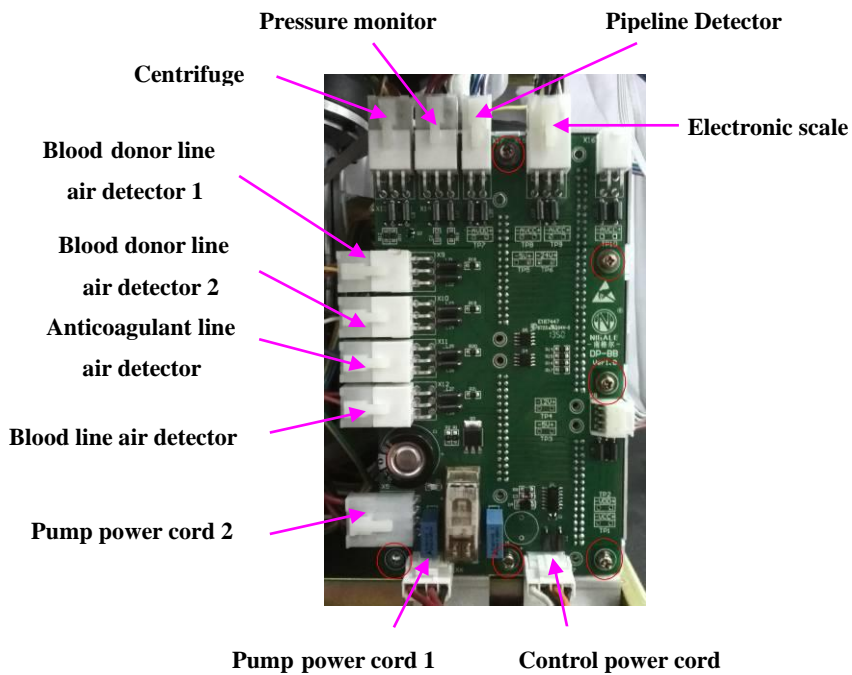

Figure 7-1 Diagram for Dismounting of Driver Board

7.2.6.3 Backplane

1. Dismounting the rear housing and right side plate assemblies of the host;
2. Pull up plugs connected on the backplane;
3. Remove 6 screws (M3×10) from the backplane to take down the backplane.



Error! Use the Home tab to apply 标题 1 to the text that you want to appear here.

Figure 7-11 Diagram for Dismounting of Backplane

7.2.6.4 System Board

1. Remove the rear cover of the display (the same as 7.2.4.4) ;
2. Disconnect cables connected on the system board and remove 4 combination screws (M3×8) from the system board to take down the system board.

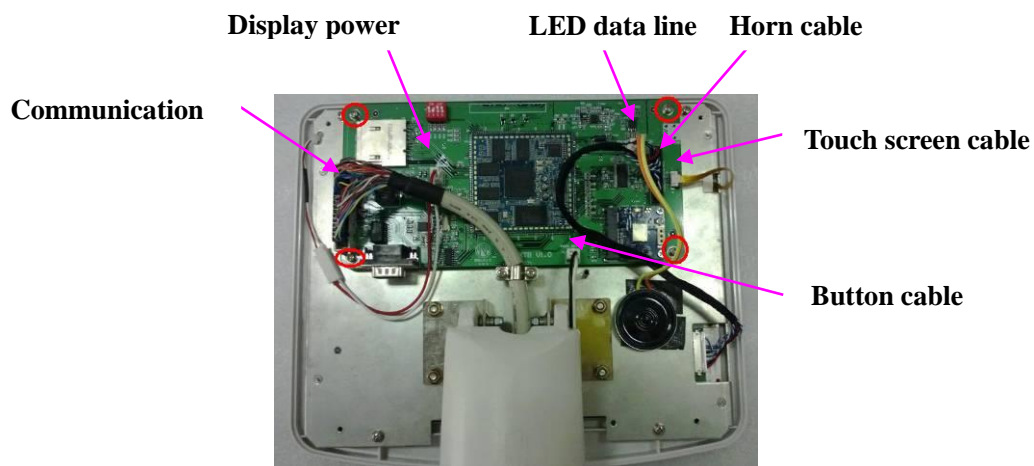

Figure 7-12 Diagram for Dismounting of System Board

7.2.6.5 Communication Board

1. Dismounting the pressing boards on the rear housing of the host;
2. Pull out plugs on the communication board;
3. Remove 4 screws (M3×10) from the communication board to take down the communication board.

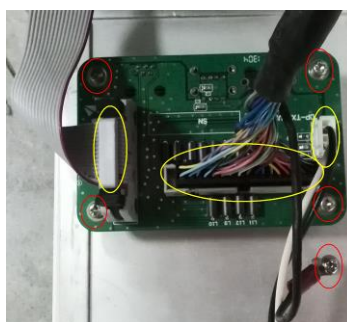

Figure 7-13 Diagram for Dismounting of Communication Board

7.2.7 Dismounting of Components

7.2.7.1 Air Detector Modules

1. The plasma separator contains 4 air detector modules with the same structures and performances: anticoagulant line air detector, Blood donor line air detector 1, Blood donor line air detector 2 and blood line air detector.
2. Dismounting the pressing boards on the rear housing and left side plate of the host
3. Pull up the corresponding cables from the backplane;
4. Remove the two screws (M3×8) at the bottom of the air detector on a horizontal operation panel (an anticoagulant air detector) or a bevel operation panel (blood member pipeline air detector 1, blood member pipeline air detector 2, and a blood pipeline air detector), and take down the corresponding air detector from the operation panel.



Figure 7-14 Diagram for Dismounting of Air Detector Modules

7.2.7.2 Solenoid Valve Assembly

1. The plasma separator comprises three solenoid valves (Plasma valve, Saline valve and Blood valve) having the same structures and performances;
2. Dismounting the front housing (blood valve) and rear housing (plasma valve and saline valve) assemblies of the host;
3. Remove the screws(M4×8) connecting the grounding wire of the solenoid valve and the host frame, unplug the connecting plug of the corresponding solenoid valve on the driver board;
4. Remove the nut at the bottom of the solenoid valve, pull it down and take down the corresponding solenoid valve from the operation panel.

Error! Use the Home tab to apply 标题 1 to the text that you want to appear here.



Figure 7-15 Diagram for Dismounting of Valve Assembly

7.2.7.3 Centrifuge Components

1. Dismounting the front housing and rear housing assemblies of the host;
2. Remove the three motor wires on the actuator of the centrifuge and the two screws(M4×20) on the opposite angle thereof, and remove them out from the host;



Figure 7-16 Diagram for Dismounting of Centrifuge Components(一)

3. Remove the centrifuge wires on the driver board and the backplane respectively, dismantle the screws connected with the grounding wire of the centrifuge and the four hexagon socket cap screws(M5×16) at the bottom of the centrifuge;

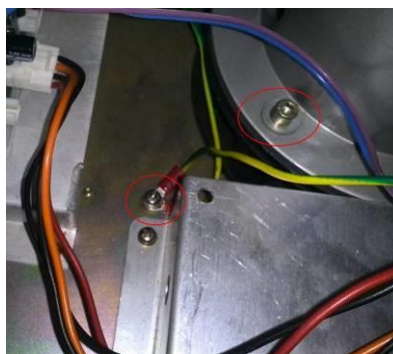

Figure 7-17 Diagram for Dismounting of Centrifuge Components(二)

4. Take out the centrifuge from the top of the horizontal operation panel.

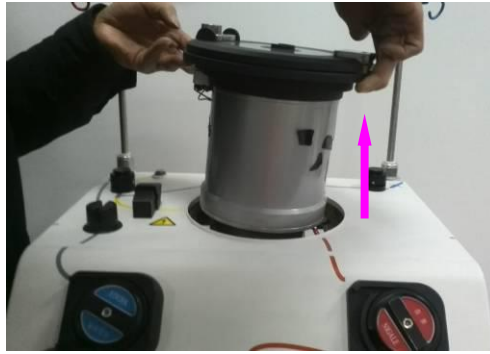

Figure 7-18 Diagram for Dismounting of Centrifuge Components(三)

7.2.7.4 Pressure Monitor Assembly

1. Dismounting the front housing assembly of the host;
2. Pull up the wire connected to the backplane, remove the fixed screws (two M3×8 screws) connecting the pressure monitor assembly with the bevel operation panel, drag out the assembly from the back side of the operation panel.

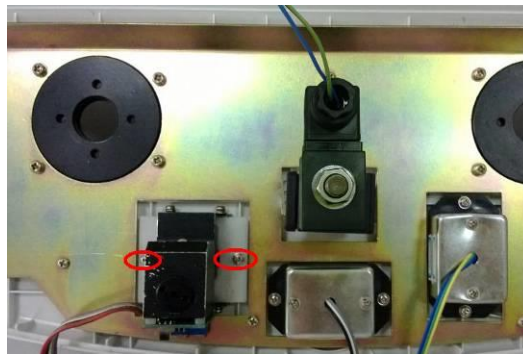

Figure 7-19 Diagram for Dismounting of Pressure Monitor Assembly

7.2.7.5 Pump Assembly

1. The plasma separator comprises two pump assemblies: Blood pump and Anticoagulant pump;
2. Dismounting the front housing assembly, left side plate (Anticoagulant pump) and right side plate (blood pump) of the host;
3. Remove the socket head cap screw(M5×16) on the pump head, pull outward to take out the pump head;

Error! Use the Home tab to apply 标题 1 to the text that you want to appear here.



Figure 7-20 Diagram for Dismounting of Pump Assembly(一)

4. Pulled out three plugs connected with the pump from the digital AC serve drivers in from of the host frame and the cable connected with the driver board;

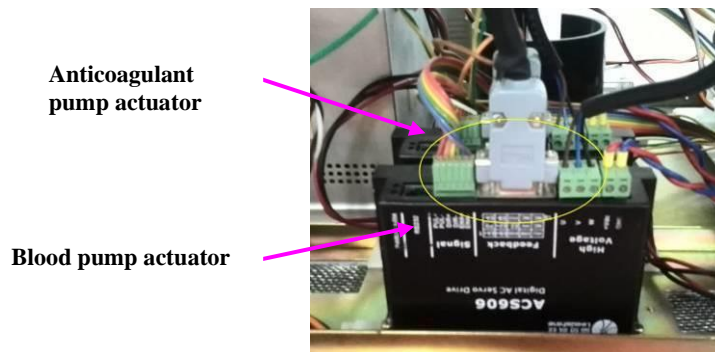

Figure 7-21 Diagram for Dismounting of Pump Assembly(二)

5. Pull hard and press the spindle of the serve motor at the back of the bevel operation panel to take down the motor of the pump.



Figure 7-22 Diagram for Dismounting of Pump Assembly(三)

7.2.7.6 Electronic scale assembly

1. Remove the weigher on the rear housing of the host, the left side board assembly and the horizontal operation panel;

2. Remove the screws(M4×16) connected with the nut stud of the host frame;
3. Drag out the electronic scale assembly outwardly in level.



Figure 7-23 Diagram for Dismounting of Electronic scale assembly

7.2.7.7 Power Pack Assembly

1. Dismounting the rear housing assembly and right side plate of the host;
2. Remove the cables connected with the power pack assembly

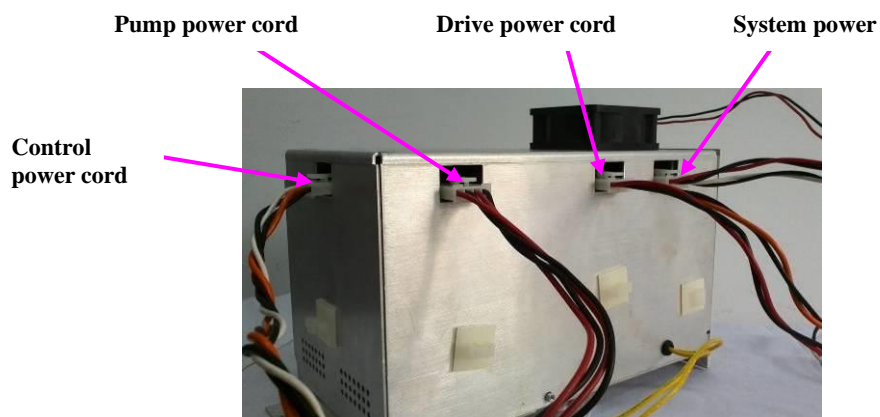

Figure 7-24 Diagram for Dismounting of Power Pack Assembly

3. Remove two screws on the power pack at the back of the host frame and the pins riveted in the host frame, then drag outwardly from the back of the host to take out the power pack.

Error! Use the Home tab to apply 标题 1 to the text that you want to appear here.

8 System Diagnosis and Support

8.1 Starting Up

Starting Up	Solutions and measures
The collection does not work after starting up	Check whether the power cord is connected correctly or not
The display does not bright after starting up	Open the rear housing of the host to check whether the communication cable is connected to the place
Start-up self-test failure	Inquire solutions from section 8.1.2 according to the screen tips

8.2 Components Fault and Test

8.2.1 Tools required for Maintenance

- Voltage Meter
- Pressure Meter (measurement of positive & negative pressure in mmHg)
- Calibrated Weights (200, 400, 600, 800, 1000g)
- Digital and Optical RPM measure meter
- Disposable for Testing

8.2.2 Power Pack

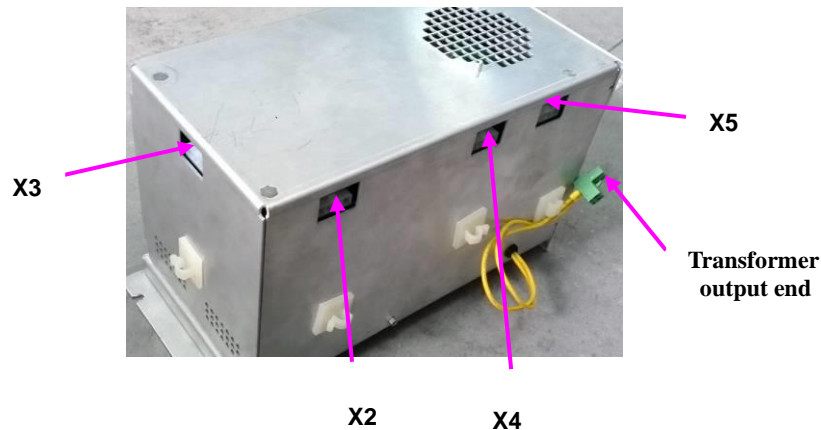

Figure 8-1 Power Pack Test Chart

1. Test for the output voltage of the transformer

Connect the power pack with the 230V/115V grid power supply by power cables, and measure the voltage is 230V at the output terminal of the transformer by 700V AC grade of a multimeter.

2. Test for the output voltage of the power pack

Connect the power pack with the 230V grid power supply by power cables, and measure the voltages of each pin (facing the socket and from left to right are pin 1, pin 2, pin 3, pin 4 and pin 5 respectively) of the connector socket X2, X3, X4 and X5 by 230V DC grade of a multimeter, wherein requirements of the following table should be accorded:

Plug	X2		X3		X4		X5	
Pin Number	1 (+), 2 (-)				3 (+), 4 (-)			
Voltage ($\pm 0.5V$)	24V	12V	24V	12V	24V	12V	24V	5V

3. Open the power pack, measure the input voltage (connector socket X1) of the power panel by 200V DC grade of a multimeter, if the voltage can meet $24V \pm 0.5V$, the power panel should be replaced, other wise, the switching power supply should be replaced.

8.2.3 Weigher (Electronic Scale)

1. Startup to enter the weigher calibration interface or debug interface:
2. Check the weighing result of the monitor by a 1000g weight, and check the function thereof;

Error! Use the Home tab to apply 标题 1 to the text that you want to appear here.

3. Set a target value 1000g firstly at the calibration interface of the weigher for calibration, regulate 7RP1 (a potentiometer used for the calibration) on a circuit board, and complete the calibration of 200g with the same method, wherein the error range is less than or equal to 5g;
4. Repeat steps until values are in range, then test 400 – 800g .

8.2.4 Cuff

1. Mount the pressure meter between the cuff connector and the cuff. ;
2. Click on the switch of the cuff at the interface of the venipuncture or the collection phase to test the pressure value, test the voltage test point TP5 on the driver board if the above test failure, and the voltage value should be $5V \pm 0.05V$, otherwise, regulate RP1 on the driver board for calibration;
3. If the test value is still incorrect, check whether the cuff is leak or not, if not, replace the air pump, and replace the driver board if the test failed again.

8.2.5 DPM

1. Connect the pressure meter with a syringe to the DPM.
2. Use the test material to run the plasma separator into the collection phase, extract air by an injector to drop the pressure to -80mmHg, the collection interface will show the low pressure alarm for blood collection; turn to the feedback phase, boost the pressure to 250mmHg by the injector and the collection interface will show the feedback high pressure alarm;
3. At the collection or feedback phase, remove the DPM connector, the interface shows DPM off alarm;
4. If the DPM performance fails – component exchange is required.

8.2.6 Pipeline Detector

1. Measure pin 2 and pin 4 of the pipeline detector connector by the 20V DC grade of a multimeter and the result should meet $3.5V \pm 0.1V$;
2. If failed, regulate the pipeline detector board RP1 to meet the above requirement;
3. If still cannot meet the requirements, replace the pipeline detector assembly.

8.2.7 Solenoid Valve

1. Insert manually the tubing with the connected pressure meter and the syringe and apply 200mmHg to the tubing.
2. If pressure remains constant (no reduction). If pressure decreases, check tubing position, if still failing – exchange clamp.
3. In the debugging interface, use the on/off of the valve to observe whether the action of the valve is correct, if not, replace the valve components.

8.2.8 Pump

1. Check mechanical condition of rollers. If rollers are hard to turn or making noise, clean rollers or exchange pump head.
2. Perform occlusion test – put tubing connected to a bag with fluid through the pump and check, if fluid is blocked by the pump rollers. Exchange head if failing.
3. In the debugging interface, set the pump speed as $20-150r/min \pm 2r / min$, measure the pump speed with a photoelectric tachometer, and observe the measured value and the displayed value which should be the same.
4. If failed, replace the pump actuator and the pump motor respectively and test again.

Caution:

Rollers can be accessed by removing the color sticker (don't forget to replace them after)

8.2.9 Centrifuge

1. Measure the speed (constant value, clockwise $7000 \pm 175rpm$) of the centrifuge by the photoelectric tachometer;
2. Centrifuge speed correction: set parameters directly on the centrifuge actuator by referring to appendix A;
3. Centrifuge switch test: in the collection phase (the centrifuge is running), switch on the centrifuge, the interface displays that the alarm of the centrifuge is not closed;
4. Leakage monitor test: press the stop button in the collection phase to suspend to run the program, use a cotton swab to apply water on the leakage monitor, re-operation, and the plasma separator interface will show the centrifuge cup leakage alarm.

Error! Use the Home tab to apply 标题 1 to the text that you want to appear here.

8.2.10 Air Detector

1. Insert an empty tubing into the air detector, the light on the detector remains on.
2. Insert a water filled tube and the light should go out.
3. In the collection phase, remove the pipeline with water contained form the air detector, the plasma separator interface displays the air alarm information (the blood air detector will make alarm after the collected whole blood is more than 30ml) of the corresponding air detector.

8.3 Alarm and Abnormal Information

Alarm Information	Fault Phenomenon	Solutions and Measures
High speed of centrifuge	The centrifuge speed is greater than or equal to 7175 r / min	Correct the speed of the centrifuge by referring to 8.2.9. If not work, replace the actuator or the centrifuge assembly.
Wrong direction of the pump	<ul style="list-style-type: none"> ● Draw phase: The blood pump runs anticlockwise, ● Return phase: The blood pump runs clockwise, ● The anticoagulation pump runs clockwise. 	Detect the pump by referring to 8.2.8.
The control system is abnormal in communication		Replace the communication board or the system board or the driver board one by one.

9 Care and Maintenance

9.1 Summary

9.1.1 Purpose

In order to ensure the performance and the security of the system, and extend the service life of the machine, regular care and maintenance should be applied to the plasma separator to guarantee the function and performance of the collection system in the using process as well as provide certain quality assurance for the product.

9.1.2 Tools, measuring equipment and Disposable

Table 9-1 List of Cleaning Supplies

Tools, measuring equipment and Disposable	QTY	Remarks
Cleaning solution		Specific to blood-borne pathogens is recommended
Clean warm water		
70% alcohol		
Hairless cleaning cloth	1	
Screwdriver	1	
Cotton swab		
Lubricant		
Voltage Meter	1	
Pressure Meter	1	measurement of positive & negative pressure in mmHg
Calibrated Weights	1 group	(200、400、600、800、1000g)
Disposable for Testing	1	
Digital and Optical RPM measure meter	1	
Leakage current meter	1	Model LCY-I

Caution :

1. Do not use deliquescent solvent (such as paint thinner or gasoline) or abrasive cleaner to clean the machine, or the system might be damaged.
2. It is forbid to use cleaner with hydrocarbon or for OA devices to clean the display screen.

9.1.3 Care and Maintenance Frequency

Table 9-2 List of Maintenance Frequency

Maintenance Contents	Frequency	Methods
Clean all external surfaces	After each time of use, 1 time per day	Refer to 9.2.2
Clean DPM	After each time of use, 1 time per day	Ditto
Clean air detector	1 time per week	Ditto
Clean pipeline detector	1 time per week	Ditto
Clean inner wall of centrifuge	1 time per week	Ditto
Clean leakage sensor	1 time per week	Ditto
Clean cuff	1 time per month	Ditto
Clean filter screen	1 time per half a year	Ditto
Weigher calibration	1 time per month	Refer to 8.2.3
Electrical safety maintenance	1 time per year	Refer to 9.4.1
Machinery safety maintenance	1 time per year	Refer to 9.4.2
Performance test	1 time per year	Refer to 4.5
Peripherals and components	1 time per year	Refer to 9.3.2

9.2 Cleaning System

9.2.1 Cleaning Procedures

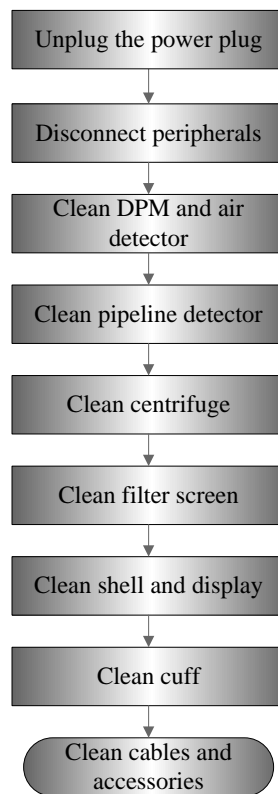

Figure 9-1 Flowchart of Cleaning and Maintenance

⚠Warning: Before cleaning the product, turn off the power switch of the product and unplug the power plug from the socket. Otherwise, it may result in electric shock.

9.2.2 Content

1. Display screen

Wipe the display screen with a soft cloth immersing with glass cleaner and then air dry.

2. Pressure monitor for blood tubes

Clean the pressure monitor with clean water, and dry the monitor with a dry hairless cleaning cloth.

3. Air detector

Error! Use the Home tab to apply 标题 1 to the text that you want to appear here.

Clean the pipe chase and surface of air detector with 70% medicinal alcohol and hairless cleaning cloth.

4. Tubes detector

Clean the tubes detector with clean water, and dry the detector with a dry hairless cleaning cloth.

5. Inner wall of the centrifuge

a. Routine cleaning

- Clean the inner wall and cup holder of the centrifuge with a cleaning cloth immersing with cleaning solution. For routine maintenance, no large quantity of cleaning solution is required;
- Clean the centrifuge cover with a cleaning cloth immersing with cleaning solution;
- Dry all surfaces with a dry cloth.
- Lubricate the O ring inside the cup holder of centrifuge with a little vacuum grease every month. It is not necessary to take out the O ring when lubricating. See the figure below:

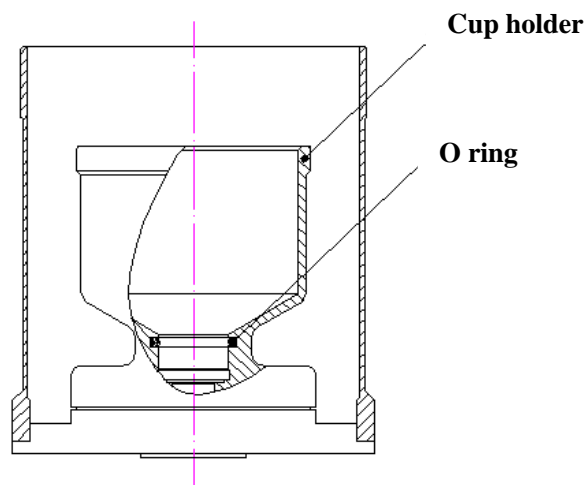

b. Cleaning when there is liquid leakage

- Turn off the power supply and pull the plug;
- Clean the centrifuge cover with a cleaning cloth immersing with cleaning solution, and then dry with a dry cloth;
- Clean the inner tank and cup holder with a cleaning cloth immersing with cleaning solution;
- Clean the leakage sensor with a cotton swab dipping with 70% alcohol.

c. Cleaning when there is oozing of blood

- Turn off the power supply and pull the plug, ensure the waste liquid bag is connected to the discharge pipe;
- Clean the centrifuge cover with a cleaning cloth immersing with cleaning solution, and then dry with a dry cloth;
- Clean the inner wall and cup holder with a cleaning cloth immersing with cleaning solution;
- Fill the injector of 50ml with cleaning solution;
- Squeeze out the cleaning solution from the discharge hole of centrifuge bowl holder, and rinse repeatedly until it is clean;
- Clamp the waste liquid bag, remove it for processing, and replace with a clean waste liquid bag;
- Each time after oozing of blood, lubricate the O ring with a little vacuum grease without taking out the O ring.

6. Leakage sensor

Clean the leakage sensor with a cotton swab dipping with 70% alcohol.

7. Filter screen

The filter screen is at the bottom of case.

- Unscrew the retainer in the filter screen with a cross screwdriver;
- Pull out the filter screen;
- Rinse the filter screen with warm water;
- Put the filter screen in a soft cloth that is clean and dry to completely dry it;
- Reinstall the filter screen and retainer at the bottom of case.

8. Cuff

Take out the outerwear of cuff, clean with a cleaning cloth immersing with cleaning solution or cleaning solution, and put in a cool and ventilated place for drying.

9. Cable/signal wires

- Visual test to make sure that the cable surface has no crack or broken mark;
- Use a soft dry cloth to wipe the dust or dirt adhered to the cable surface of the probe;
- If there is still a stubborn stain that is difficult to remove, use soft cloth dipped with neutral detergent to wipe the stain, and then dry in air.

10. Case surface

Error! Use the Home tab to apply 标题 1 to the text that you want to appear here.

Regularly clean the external surface of plasma separator including the operating panel with cleaning solution.

9.3 Maintenance Check

The maintenance check must be done by maintenance engineers of Nigale who have professional knowledge or skills or engineers obtaining the skills by training.

9.3.1 System Function

Table 9-3 List of System Function

Steps	Content	Description
1	Collection mode	Check the basic operations of the collection mode. Inspect some basic software or hardware controls that may affect related operations of the collection mode.
2	Configuration function	Check the basic operations of the function configuration
3	Maintenance function	Check the basic operations of the system maintenance. Inspect some basic software or hardware controls that may affect related operations of the collection mode.

Note: refer to **4.4** Functional examination for the specified methods

9.3.2 Inspection of Peripherals and Fittings

Table 9-4 List of Inspection of Peripherals and Fittings

Steps	Contents	Description
1	Barcode scanner	Inspect whether the scanner works normally or not, and clean the scanner window if necessary
2	UPS	Refer to 4.3.2.5 to inspect the performance of UPS
3	Software management	Inspect basic operations of the user, verify the realization of the functions of the software management and the network connection

9.4 System Maintenance

9.4.1 Electrical Safety Maintenance

The electrical safety maintenance is mainly aimed at the system leakage current detection.

■ Detection Tool

Only the specified measuring instrument according to Nigale can be used, for example, the tester used for the electrical safety detection should be LCY-1 leakage current gauge (hereinafter referred to as the gauge) and the fittings thereof.

⚠Warning:

1. Before the test, please read carefully the *Operation Manual of LCY-I Leakage Current Tester*; only the fittings of LCY-I can be used in the process of test.
2. Only maintenance engineers or staffs passed through the professional training of Nigale can carry out the safety maintenance to the equipment.

■ Line connection

1. Before power on, check carefully whether the various test lines and knobs are in good condition or not, whether the power cord of the *Specified Power for Tester* is connected, in good condition, reliable, and grounding protected.
2. Plug the power cord plugs of output 1 and output 2 behind the *Specified Power for Tester* into input 1 and output 2 at the rear panel of the host of the gauge.
3. Plug the power cord plug of the equipment under test into the socket of the *equipment under test* at the rear panel of the tester host.
4. Connect a black test line with the “functional ground” of the “tester host-terminal board” and the “functional grounding terminal” of the equipment under test respectively.
5. Connect a red test line with “application I” of the “terminal board” and the application section of the equipment under test respectively. Please follow the following steps to properly set the security analyzer, wherein the contents of the set include: standard option, types of equipment to be tested, lead number setting and DC settings.

■ Parameter preset

Error! Use the Home tab to apply 标题 1 to the text that you want to appear here.

1. After check and find the connection is correct, open the “special power for tester” and the “power” of the tester host.
2. Open the power switch of the equipment to be tested to make the equipment under test in working condition.
3. Now the display of the tester host bright, bar appears, a self-test result of **Normal (OK)** will be given immediately (at this moment, if the prompt not displays, check and repair till it displays), and then the it shows **preselection:I-LI-YI-D-T+**.

9.4.1.1 Test of ground leakage current

1. Test of ground leakage current (D – T+) in normal condition:
 - 1) Power on, the screen shows **preselection: I-LI-YI-D-T+**, and the indicator light of the corresponding keys of the “preselection area” bright.
 - 2) Press the key **GJ** and the indicator light bright.
 - 3) Check the selected key and if it is the same as that displayed on the screen, press the key of **Confirm** to lock the preselection state, and the indicator light bright.
 - 4) Press the key of **Test** again, the indicator light bright, the measurement procedure starts to run and the test mode begins.
 - 5) After the test, the screen will display **Test Finish Please Preselect I-LI-YI-D-T+**, and the final test result $\times\times\mu\text{A}$ will be presented at the lower right corner. At this point, can press **Print** to print or record test results.
2. Test of ground leakage current (D –T-) in single fault condition:
 - 1) After the last test, press the key of T- according to the prompt of **Please Preselect I-LI-YI-D-T+** displayed on the screen, the indicator light bright, and the screen displays **Please Preselect I-LI-YI-D-T-**.
 - 2) Make sure that the corresponding key of the “Preselection area” is the same as that displayed on the screen and the indicator light **GJ** bright, press the key of **Confirm** to lock the preselection state and the indicator light bright.
 - 3) Press the key of **Test** again, the indicator light bright, the measurement procedure starts to run and the test mode begins.
 - 4) After the test, the screen will display **Test Finish Please Preselect I-LI-YI-D-T-**, and the final test result $\times\times\mu\text{A}$ will be presented at the lower right corner. At this point, can press **Print** to print or record test results.

9.4.1.2 Patient Leakage Current Test

1. Test of patient leakage current in normal condition:
 - 1) After the last test, press the key of **H** and **T+** according to the prompt of **Please Preselect I-LI-YI-D-T-** displayed on the screen, the indicator light bright, and the screen displays **Please Preselect I-LI-YI-D-T+**.
 - 2) Make sure that the corresponding key of the “Preselection area” is the same as that displayed on the screen and the indicator light **GJ** bright, press the key of **Confirm** to lock the preselection state and the indicator light bright.
 - 3) Press the key of **Test** again, the indicator light bright, the measurement procedure starts to run and the test mode begins.
 - 4) After the test, the screen will display **Test Finish Please Preselect I-LI-YI-D-T+**, and the final test result $\times\times\times\mu\text{A}$ will be presented at the lower right corner. At this point, can press **Print** to print or record test results.
2. Test of patient leakage current in single fault condition:
 - 1) After the last test, press the key of **T-** according to the prompt of **Please Preselect I-LI-YI-D-T-** displayed on the screen, the indicator light bright, and the screen displays **Please Preselect I-LI-YI-D-T+**.
 - 2) Make sure that the corresponding key of the “Preselection area” is the same as that displayed on the screen and the indicator light **GJ** bright, press the key of **Confirm** to lock the preselection state and the indicator light bright.
 - 3) Press the key of **Test** again, the indicator light bright, the measurement procedure starts to run and the test mode begins.
 - 4) After the test, the screen will display **Test Finish Please Preselect I-LI-YI-D-T-**, and the final test result $\times\times\times\mu\text{A}$ will be presented at the lower right corner. At this point, can press **Print** to print or record test results.

9.4.1.3 Housing Leakage Current Test

1. Test of housing leakage current in normal condition:
 - 1) After the last test, press the key of **T+** and **K** according to the prompt of **Please Preselect I-LI-YI-D-T-** displayed on the screen, the indicator light bright, and the screen displays **Please Preselect I-LI-YI-D-T+-K**.

Error! Use the Home tab to apply 标题 1 to the text that you want to appear here.

- 2) Make sure that the corresponding key of the “Preselection area” is the same as that displayed on the screen and the indicator light **GJ** bright, press the key of **Confirm** to lock the preselection state and the indicator light bright.
 - 3) Press the key of **Test** again, the indicator light bright, the measurement procedure starts to run and the test mode begins.
 - 4) After the test, the screen will display **Test Finish Please Preselect LI-YI-D-T+-K**, and the final test result $\times\times\mu\text{A}$ will be presented at the lower right corner. At this point, can press **Print** to print or record test results.
2. Test of housing leakage current in single fault condition:
- 1) After the last test, press the key of **T** and **K** according to the prompt of **Please Preselect LI-YI-D-T+-K** displayed on the screen, the indicator light bright, and the screen displays **Please Preselect LI-YI-D-T--K**.
 - 2) Make sure that the corresponding key of the “Preselection area” is the same as that displayed on the screen and the indicator light **GJ** bright, press the key of **Confirm** to lock the preselection state and the indicator light bright.
 - 3) Press the key of **Test** again, the indicator light bright, the measurement procedure starts to run and the test mode begins.
 - 4) After the test, the screen will display **Test Finish Please Preselect LI-YI-D-T- -K**, and the final test result $\times\times\mu\text{A}$ will be presented at the lower right corner. At this point, can press **Print** to print or record test results.

After all the index testing, press reset button to reset and cut off the power switch, remove all kinds of test lines, return the instrument to seat after cleaning it.

9.4.2 Machinery Safety Maintenance

The machinery safety maintenance mainly refers to test the mechanical strength and functions of critical components of the plasma separator. The detection and evaluation methods mainly comprise: visual inspection and operational check, if the results cannot pass, the system is proved to be in abnormal state that it must be stopped and appropriate measures should be taken.

Table 9-5 List of Machinery Safety Test

Items	Standards	Tools
Display	<ol style="list-style-type: none"> 1. Visual test, make sure the display does not lean left or right 2. The connection between the display and the host does not loose 	Philip's head screw
Handle	<ol style="list-style-type: none"> 1. Visual test, make sure the left handle and the right handle of the equipment have no crack 2. Pull the handle manually to make sure the handle does not loose 	Philip's head screw
Weigher Strut/tray	<ol style="list-style-type: none"> 1. Visual test, make sure the structural integrity of the strut/tray 2. Pull by hands to make sure the connection of the strut/tray is firmly without shaking 	No
Cable connection	<ol style="list-style-type: none"> 1. Visual test, make sure the internal cable and external cable of the equipment have no damage or tooling mark. 2. Checking manually to make sure the internal cable connection of the equipment does not loose or drop 	Philip's head screw
Other mechanical structures	Make sure there is no other loose part, shell cracking and loose, and no exposed conductive parts	No

Error! Use the Home tab to apply 标题 1 to the text that you want to appear here.

Appendix A Programming of Centrifuge Driver

Group 1: Basic Parameters

Pr.	Functions	Settings	Pr.	Functions	Settings
1-00	Maximum operation Freq.	118.0	1-10	Decel time 1	40.0
1-01	Maximum setting Freq.	118.0	1-11	Accel time 2	10.0
1-02	Maximum output voltage	95.0	1-12	Decel time 2	10.0
1-03	Mid-point Freq.	1.0	1-13	JOG Accel time	10.0
1-04	Mid-point voltage	12.0	1-14	JOG Decel time	10.0
1-05	Minimum output Freq.	1.0	1-15	JOG frequency	6.0
1-06	Minumum output voltage	12.0	1-16	Auto-accel/decel	0
1-07	Upper bound of freq.	100	1-17	S-curve setting in acceleration	0
1-08	Lower bound of freq.	0	1-18	S-curve setting in deceleration	0
1-09	Accel time 1	30.0			

Group 2: Operation Method Parameters

Pr.	Functions	Settings	Pr.	Functions	Settings
2-00	Source of frequency	0	2-04	Reverse operation inhibit	0
2-01	Source of operation Command	2	2-05	ACI(4~20mA) input loss detection	0
2-02	Stop method	0	2-07	Lone Start Lockout	0
2-03	Carrier freq.	10			

Appendix B Verification Form

SERIAL NO:

TIMES BE USED:

PRESSURE	DPM	Alarm test ()		Open ()	Close ()		
	CUFF	40mmHg	50mmHg	60mmHg	70mmHg		
VALVES	Donor valve	Functional test ()					
	Plasma valve	Functional test ()					
	Saline valve	Functional test ()					
TRANSDUCERS	Line sensor clear ()			Line sensor test ()			
	Weigher	weight	200g	400g	600g	800g	1000g
		volume	195ml	389ml	584ml	779ml	974ml
		value					
AIR DETECTORS	ACAD	Functional test ()					
	BLAD	Functional test ()					
	DLAD-1	Functional test ()					
	DLAD-2	Functional test ()					
CENTRIFUGE	Speed						
	Fluid Sensor						
	Cover Lock						
PUMPS	Blood Pump	Clear ()	Seal test ()	Speed()			
	AC Pump	Clear ()	Seal test ()	Speed()			

Performed by:

Date:

Name: