

Medtronic

IN.PACT™ Admiral™

Paclitaxel-coated PTA Balloon Catheter

Instructions for Use

 **Caution:** Federal law (USA) restricts this device to sale by or on the order of a physician.

Symbols



























	Sterilized using ethylene oxide
	Catalogue number
	Lot number
	Manufacturer
	Manufactured in
	Use by
	Quantity
	Consult instructions for use at this website: www.medtronic.com/manuals
	Consult instructions for use
	Do not reuse
	Do not resterilize
	Keep away from sunlight
	Keep dry
	Do not use if package is damaged
	Outer diameter
	Temperature limit
	Nonpyrogenic
	Do not exceed rated burst pressure
	Over the wire
	Nominal pressure
	Rated burst pressure
	Pressure
	Balloon diameter
	Minimum sheath inner diameter
	Maximum guidewire diameter
	Balloon length
	Usable catheter length

Table of contents

1. Product Name	2
2. Product Description	3
2.1. Device Component Description	3
2.2. Drug Component Description	4
3. Indications for Use	5
4. Contraindications	5
5. Warnings	5
6. Precautions	6
6.1. General Precautions	6
6.2. Pre-procedure and Post-procedure Medication Regimen	6
6.3. Use of Multiple Balloons	7
6.4. Use in Conjunction with Other Procedures	7
6.5. Drug Interaction	7
6.6. Balloon Handling and Preparation Precautions	7
6.7. Balloon Placement Precautions	7
6.8. Balloon Catheter Removal Precautions	7
6.9. Post-procedure Precautions	8
7. Use in Special Populations	8
7.1. Pregnancy and Lactation	8
7.2. Gender	8
7.3. Ethnicity	8
7.4. Pediatric Use	8
7.5. Geriatric Use	8
8. Drug Information	8
8.1. Mechanism of Action	8
8.2. Pharmacokinetics	8
8.3. Metabolism	8
8.4. Carcinogenicity, Genotoxicity, and Reproductive Toxicity	8
9. Potential Adverse Effects	9
10. Patient Counseling Information	10
11. Summary of Clinical Studies	10
11.1. Late Mortality Signal for Paclitaxel-Coated Devices	10
11.2. IN.PACT SFA Trial	10
11.3. IN.PACT SFA Trial Post-Approval Study	21
11.4. Pharmacokinetic Sub-study	37
11.5. IN.PACT Global Study	38
11.6. Summary of Rare Adverse Events	38
11.7. IN.PACT Admiral DCB ISR Clinical Evaluation	38
11.8. IN.PACT Global DCB Long Lesion Sub-Cohort	46
12. How Supplied	63
13. Instructions for Use	64
13.1. Equipment	64
13.2. Balloon Catheter Size Selection	64
13.3. Recommendations for Optimal Treatment	64
13.4. PTA Preparation	65
13.5. IN.PACT Admiral DCB Preparation	65
13.6. Inflation Device Connection to the IN.PACT Admiral DCB	65
13.7. Delivery and Dilatation Procedure	66
13.8. Removal Procedure	66
13.9. Using Multiple IN.PACT Admiral DCBs	66
14. DISCLAIMER OF WARRANTY	68

1. Product Name

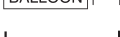
IN.PACT™ Admiral™ paclitaxel-coated percutaneous transluminal angioplasty (PTA) balloon catheter

2. Product Description

The IN.PACT Admiral paclitaxel-coated PTA balloon catheter is an over-the-wire (OTW) balloon catheter with a drug-coated balloon at the distal tip. The drug component, referred to as the FreePac™ drug coating, consists of the drug paclitaxel and the excipient urea. The device component physically dilates the vessel lumen by PTA, and the drug is intended to reduce the proliferative response that is associated with restenosis. Product Component Description (Table 1) summarizes the characteristics of the device, hereafter referred to as IN.PACT Admiral DCB.

Table 1. Product Component Description

Available Balloon Diameters (mm) and Lengths (mm)	Balloon Diameter (mm)	Balloon Length (mm)							
		20	40	60	80	120	150	200	250
	4.0	x	x	x	x	x	x	x	x
	5.0	x	x	x	x	x	x	x	x
	6.0	x	x	x	x	x	x	x	x
	7.0	x	x	x	x	---	---	---	---
Note: "—" indicates size not offered; "x" indicates sizes offered									
Balloon Coating (Drug Component)	Paclitaxel (Active Pharmaceutical Ingredient) and Urea (excipient)								
Catheter Design	Over-the-Wire (OTW)								
Usable Catheter Lengths	80 cm and 130 cm								
Balloon Inflation Pressure	Nominal Pressure (except 200 and 250 mm lengths): 8 atm (811 kPa) Rated Burst Pressure (except 200 and 250 mm lengths): 14 atm (1419 kPa)				Nominal Pressure (200 and 250 mm lengths): 5 atm (507 kPa) Rated Burst Pressure (200 and 250 mm lengths): 11 atm (1115 kPa)				
Minimum Introducer Sheath Compatibility	Balloon Diameter	Max Crossing Profile			Introducer Sheath				
	4.0 mm	5.6 Fr (1.88 mm)			5 Fr				
	5.0 mm	6.0 Fr (2.00 mm)			6 Fr				
	6.0 mm (except 120 mm)	6.3 Fr (2.10 mm)							
	6.0 mm (120 mm length)	6.3 Fr (2.10 mm) or 7.0 Fr (2.33 mm) Consult device label			6 Fr or 7 Fr Consult device label				
7.0 mm	7.0 Fr (2.33 mm)			7 Fr					
Guidewire Compatibility	The catheter is compatible with a guidewire diameter of 0.035 in (0.89 mm).								

2.1. Device Component Description

The OTW balloon catheter consists of a proximal hub, dual-lumen shaft, and a distal dilatation balloon. The central lumen extends to the distal tip and is used to pass the catheter over a guidewire with a diameter of 0.035 in (0.89 mm). The balloon-inflation lumen is used to inflate and deflate the balloon with a mixture of contrast medium and saline solution. Two radiopaque platinum-iridium markers indicate the working length of the balloon to position the balloon across the target lesion during fluoroscopy. See IN.PACT Admiral Paclitaxel-coated PTA Balloon Catheter (Figure 1).

Note: The 2 center marker bands shown in the diagram of the balloon are only available in the 200 and 250 mm balloon configurations.

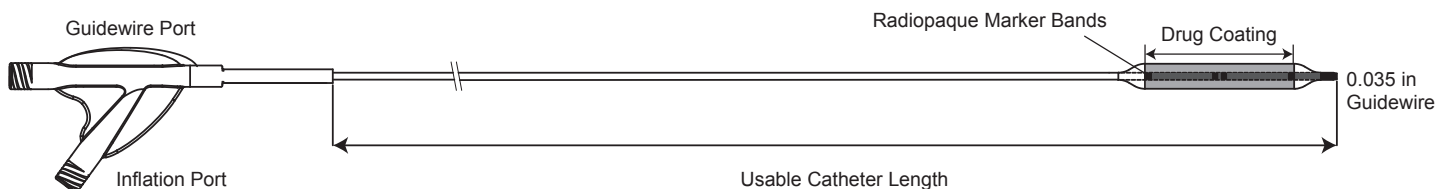

Figure 1. IN.PACT Admiral Paclitaxel-coated PTA Balloon Catheter

2.2. Drug Component Description

The FreePac™ drug coating on the balloon of the IN.PACT Admiral DCB consists of the drug paclitaxel and the excipient urea. The balloon surface has a nominal paclitaxel dose density of 3.5 µg/mm².

2.2.1. Paclitaxel

The active pharmaceutical ingredient in the IN.PACT Admiral DCB is paclitaxel. The principal mechanism by which paclitaxel inhibits neointimal growth is through the stabilization of microtubules by preventing their depolymerization during the final G2/M phase of cell division.

The CAS Registry number of paclitaxel is 33069-62-4. The chemical name of paclitaxel is:

Benzenepropanoic acid, β-(benzoylamino)-α-hydroxy-, 6,12b-bis(acetyloxy)-12-(benzoyloxy)-2a,3,4,4a,5,6,9,10,11,12,12a,12b-dodecahydro-4,11-dihydroxy-4a,8,13,13-tetramethyl-5-oxo-7,11-methano-1H-cyclodeca[3,4]benz[1,2-b]-oxet-9-ylester, [2aR-[2αα,4β,4aβ,6β,9α(αR, βS),11α,12α,12aα,12bα]]

See Chemical Structure of Paclitaxel (Figure 2) below.

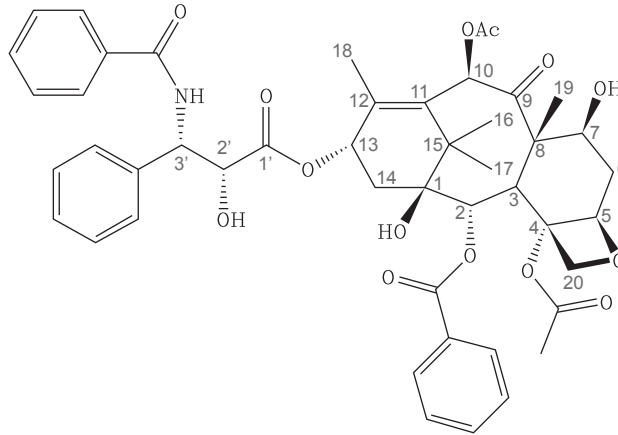

Figure 2. Chemical Structure of Paclitaxel

Paclitaxel is a diterpenoid with a characteristic taxane skeleton of 20 carbon atoms, a molecular weight of 853.91 g/mol, and a molecular formula of C₄₇H₅₁NO₁₄. It is a white powder, has extremely low water solubility, is highly lipophilic, and is freely soluble in methanol, ethanol, chloroform, ethyl acetate, and dimethyl sulfoxide.

2.2.2. Urea

The coating utilizes the inactive ingredient urea as an excipient to facilitate the release and transfer of paclitaxel into the arterial wall. See Chemical Structure of Urea (Figure 3) below.

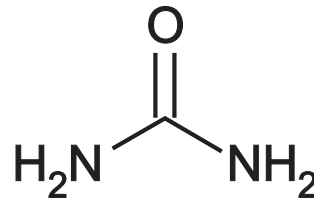

Figure 3. Chemical Structure of Urea

2.2.3. Product Matrix and Paclitaxel Content

Table 2. Product Matrix and Paclitaxel Content

Product Code (80 cm Usable Catheter Length)	Product Code (130 cm Usable Catheter Length)	Nominal Balloon Diameter (mm)	Nominal Balloon Length (mm)	Nominal Paclitaxel Content (µg)
ADM 040 020 08P	ADM 040 020 13P	4.0	20	1089
ADM 040 040 08P	ADM 040 040 13P	4.0	40	1969
ADM 040 060 08P	ADM 040 060 13P	4.0	60	2848
ADM 040 080 08P	ADM 040 080 13P	4.0	80	3728
ADM 040 120 08P	ADM 040 120 13P	4.0	120	5487
ADM 040 150 08P	ADM 040 150 13P	4.0	150	6807
ADM 040 200 08P	ADM 040 200 13P	4.0	200	9006
ADM 040 250 08P	ADM 040 250 13P	4.0	250	11205

Product Code (80 cm Usable Catheter Length)	Product Code (130 cm Usable Catheter Length)	Nominal Balloon Diameter (mm)	Nominal Balloon Length (mm)	Nominal Paclitaxel Content (µg)
ADM 050 020 08P	ADM 050 020 13P	5.0	20	1454
ADM 050 040 08P	ADM 050 040 13P	5.0	40	2553
ADM 050 060 08P	ADM 050 060 13P	5.0	60	3653
ADM 050 080 08P	ADM 050 080 13P	5.0	80	4752
ADM 050 120 08P	ADM 050 120 13P	5.0	120	6951
ADM 050 150 08P	ADM 050 150 13P	5.0	150	8601
ADM 050 200 08P	ADM 050 200 13P	5.0	200	11350
ADM 050 250 08P	ADM 050 250 13P	5.0	250	14098
ADM 060 020 08P	ADM 060 020 13P	6.0	20	1850
ADM 060 040 08P	ADM 060 040 13P	6.0	40	3170
ADM 060 060 08P	ADM 060 060 13P	6.0	60	4489
ADM 060 080 08P	ADM 060 080 13P	6.0	80	5809
ADM 060 120 08P	ADM 060 120 13P	6.0	120	8448
ADM 060 150 08P	ADM 060 150 13P	6.0	150	10427
ADM 060 200 08P	ADM 060 200 13P	6.0	200	13726
ADM 060 250 08P	ADM 060 250 13P	6.0	250	17024
ADM 070 020 08P	ADM 070 020 13P	7.0	20	2279
ADM 070 040 08P	ADM 070 040 13P	7.0	40	3819
ADM 070 060 08P	ADM 070 060 13P	7.0	60	5358
ADM 070 080 08P	ADM 070 080 13P	7.0	80	6897

3. Indications for Use

The IN.PACT Admiral paclitaxel-coated PTA balloon catheter is indicated for percutaneous transluminal angioplasty, after appropriate vessel preparation, of de novo, restenotic, or in-stent restenotic lesions with lengths up to 360 mm in superficial femoral or popliteal arteries with reference vessel diameters of 4-7 mm.

4. Contraindications

The IN.PACT Admiral DCB is contraindicated for use in:

- coronary arteries, renal arteries, and supra-aortic/cerebrovascular arteries
- patients who cannot receive recommended antiplatelet and/or anticoagulant therapy
- patients judged to have a lesion that prevents complete inflation of an angioplasty balloon or proper placement of the delivery system
- patients with known allergies or sensitivities to paclitaxel
- women who are breastfeeding, pregnant, or are intending to become pregnant, or men intending to father children. It is unknown whether paclitaxel will be excreted in human milk and whether there is a potential for adverse reaction in nursing infants from paclitaxel exposure.

5. Warnings

- **A signal for increased risk of late mortality has been identified following the use of paclitaxel-coated balloons and paclitaxel-eluting stents for femoropopliteal arterial disease beginning approximately 2-3 years post-treatment compared with the use of non-drug coated devices. There is uncertainty regarding the magnitude and mechanism for the increased late mortality risk, including the impact of repeat paclitaxel-coated device exposure. Physicians should discuss this late mortality signal and the benefits and risks of available treatment options with their patients. See Section 11 for further information.**
- Use the product prior to the Use-by Date specified on the package.
- Contents are supplied sterile. Do not use the product if the inner packaging is damaged or opened.
- Do not use air or any gaseous medium to inflate the balloon. Use only the recommended inflation medium (equal parts contrast medium and saline solution).
- Do not move the guidewire during inflation of the IN.PACT Admiral DCB.
- Do not exceed the rated burst pressure (RBP). The RBP is 14 atm (1419 kPa) for all balloons except the 200 and 250 mm balloons. For the 200 and 250 mm balloons the RBP is 11 atm (1115 kPa). The RBP is based on the results of in vitro testing. Use of pressures higher than RBP may result in a ruptured balloon with possible intimal damage and dissection.

- The safety and effectiveness of using multiple IN.PACT Admiral DCBs with a total drug dosage exceeding 34,854 µg of paclitaxel in a patient has not been clinically evaluated.

6. Precautions

6.1. General Precautions

- This product should only be used by physicians trained in percutaneous transluminal angioplasty (PTA).
- Assess risks and benefits before treating patients with a history of severe reaction to contrast agents.
- Administer appropriate drug therapy to the patient according to standard protocols for PTA before insertion of the dilatation catheter.
- Take precautions to prevent or reduce clotting when any catheter is used. Flush and rinse all products entering the vascular system with heparinized normal saline or a similar solution. For the IN.PACT Admiral DCB catheter, flush the guidewire lumen through the guidewire port with heparinized normal saline until the fluid exits the distal tip. **Do not rinse or wipe the IN.PACT Admiral DCB catheter.**
- Identify allergic reactions to contrast media and antiplatelet therapy before treatment and consider alternatives for appropriate management prior to the procedure.
- Prior to the procedure, inspect the product to verify that the product is intact.
- Handle the product with caution to avoid any damage to the balloon coating or folded balloon.
- This product is not intended for the expansion or delivery of a stent.
- Do not use the IN.PACT Admiral DCB for pre-dilatation or for post-dilatation.
- This product is designed for single patient use only. Do not reuse, reprocess, or resterilize this product. Reuse, reprocessing, or resterilization may compromise the structural integrity of the device and/or create a risk of contamination of the device, which could result in patient injury, illness, or death.
- Do not expose the product to organic solvents such as alcohol.
- To reduce the potential for vessel damage, the inflated diameter of the balloon should approximately match the diameter of the vessel just distal to the lesion.
- The use of this product carries the risks associated with percutaneous transluminal angioplasty, including thrombosis, vascular complications, and/or bleeding events.

6.2. Pre-procedure and Post-procedure Medication Regimen

It is recommended that dual antiplatelet therapy (aspirin with clopidogrel; use ticlopidine as an alternate to clopidogrel in case of allergy) is administered before the procedure and for a minimum of one month after the intervention, and that aspirin is continued for a minimum of six months after the procedure. Prolonged antiplatelet therapy can be given at the discretion of the physician. See Recommended Pre-procedure and Post-procedure Medication Regimen (Table 3).

Table 3. Recommended Pre-procedure and Post-procedure Medication Regimen

Medication		Pre-procedure	During Procedure	Post-procedure ^a
Antiplatelet	Aspirin (ASA)	300-325 mg loading dose within 24 hours prior to procedure ^b	NA	81-325 mg/day (6 months minimum)
Antiplatelet ^{c, d}	Clopidogrel	75-300 mg within 24 hours prior to procedure or 2 hours post-procedure ^e	NA	75 mg/day (1 month minimum)
	Ticlopidine ^f	500 mg/day for at least 3 consecutive days prior to procedure (last dose within 24 hours of procedure)	NA	500 mg/day (1 month minimum)
Anticoagulation	IV Heparin (or other thrombin inhibitor)	Dosing as per institutional standard ^g		

^a For cases of provisional stenting, refer to the published patient management guidelines for dosing instruction.

^b ASA loading dose not required for subjects already on a chronic regimen, defined as at least 81 mg daily for at least 5 consecutive days pre-procedure, with the last dose given/taken within 24 hours prior to procedure.

^c The safety and efficacy of this dose has not been prospectively studied. Please refer to current package inserts.

^d Subjects on a prasugrel or ticagrelor regimen for acute coronary syndrome (ACS) may continue that regimen as antiplatelet therapy. Please refer to the current package insert for information about risks and benefits of these medications, as well as for information on concomitant use of ASA and other medications.

^e Clopidogrel loading dose not required for subjects who have been taking 75 mg/day for at least 3 consecutive days before the intervention, with the last dose being taken within 24 hours prior to procedure.

^f Recommended in subjects with allergies to clopidogrel.

^g It is recommended that a bolus of 3000 to 5000 units of heparin be given prior to the angioplasty procedure, and that anticoagulation is given as needed to maintain an activated clotting time (ACT) of ≥250 seconds, or ≥200 seconds where GP IIb/IIIa inhibitors are concomitantly administered.

6.3. Use of Multiple Balloons

The extent of the patient's exposure to the drug coating is directly related to the number of balloons used. Refer to Using Multiple IN.PACT Admiral DCBs (Section 13.9) and Product Matrix and Paclitaxel Content (Table 2) for details regarding the use of multiple balloons and a product matrix containing the nominal paclitaxel content for each device size, respectively.

6.4. Use in Conjunction with Other Procedures

The safety and effectiveness of the IN.PACT Admiral DCB used in conjunction with other drug-eluting stents or drug-coated balloons in the same procedure or following treatment failure has not been evaluated.

6.5. Drug Interaction

Formal drug interaction studies have not been conducted with the IN.PACT Admiral DCB. In the clinical pharmacokinetic (PK) sub-study, systemic levels of paclitaxel following treatment with IN.PACT Admiral DCB(s) were low and cleared rapidly, reducing possible impact of drug-drug interactions due to concomitant medications. Consideration for both systemic and local drug interactions should be given when deciding to use IN.PACT Admiral DCB(s) in a patient who is taking a drug with known interactions to paclitaxel or when deciding to initiate therapy with such a drug in a patient who has recently been treated with IN.PACT Admiral DCB(s). Please refer to Drug Information (Section 8).

6.6. Balloon Handling and Preparation Precautions

- Do not remove the device from the pouch until it is needed for immediate use.
- Handle the device with caution to avoid any damage to the balloon coating or folded balloon.
- Keep the protective sheath in place when purging the balloon catheter of air bubbles.
- Carefully remove and discard the balloon's protective sheath and stylet.
- Do not use the protective sheath or stylet as an introduction aid or a rewinding tool.
- Do not apply positive pressure to the balloon during preparation.

6.7. Balloon Placement Precautions

- Manipulate the catheter under fluoroscopic observation when it is exposed to the vascular system. Do not advance or retract the catheter unless the balloon is fully deflated under vacuum.
- Do not move the guidewire during inflation of the balloon.
- Do not manipulate the IN.PACT Admiral DCB while inflated.
- Catheter applications vary. Select the technique on the basis of the patient's condition and the experience of the interventionalist.
- Introducer sheaths used must have lumen sizes that are suitable to accommodate the IN.PACT Admiral DCB. See Product Component Description (Table 1) for the introducer sheath compatibility and crossing profile of each device size.
- If resistance occurs during manipulation, ascertain the cause via fluoroscopy, road mapping, or digital subtraction angiography (DSA) before moving the IN.PACT Admiral DCB backward or forward.
- Do not manipulate the IN.PACT Admiral DCB without sufficient fluoroscopy.
- Use a pressure-monitoring device to prevent overpressurization. Refer to Product Component Description (Table 1).
- To ensure full coverage of the entire lesion, the balloon diameter must match the reference vessel diameter distal to the lesion and the balloon length must exceed the lesion length by approximately 1 cm on both ends. When using multiple balloons, do so only as described in Using Multiple IN.PACT Admiral DCBs (Section 13.9).
- Never advance the IN.PACT Admiral DCB without the guidewire extending from the tip.
- Maintaining balloon inflation is strongly recommended for 180 seconds. Adequate drug transfer occurs in the first 60 seconds of inflation.
- Appropriate vessel preparation is required prior to use of the IN.PACT Admiral DCB.

Note: Vessel preparation using only pre-dilatation was studied in the clinical study. Other methods of vessel preparation, such as atherectomy, have not been studied clinically with IN.PACT Admiral DCB.

6.8. Balloon Catheter Removal Precautions

- Prior to withdrawing the balloon catheter from the lesion, completely deflate the balloon under vacuum.
- Center the IN.PACT Admiral DCB relative to the introducer sheath when withdrawing, and use caution when removing the IN.PACT Admiral DCB.
- Should unusual resistance be felt at any time when withdrawing the balloon catheter back into the introducer sheath, remove the balloon catheter and the introducer sheath as a single unit to reduce the risk of vascular damage. This must be done under direct visualization with fluoroscopy.
- If removal of the IN.PACT Admiral DCB is required prior to deployment and a repeat attempt is desired, use a new IN.PACT Admiral DCB.

6.9. Post-procedure Precautions

- Administer post-procedure antiplatelet therapy as described in Pre-procedure and Post-procedure Medication Regimen (Section 6.2).

7. Use in Special Populations

7.1. Pregnancy and Lactation

The IN.PACT Admiral DCB is contraindicated in women who are pregnant or breast-feeding. It is unknown whether paclitaxel will be excreted in human milk or whether there is a potential for adverse reaction from paclitaxel exposure in nursing infants. Pregnancy Category C: See Carcinogenicity, Genotoxicity, and Reproductive Toxicity (Section 8.4).

7.2. Gender

Gender was a predefined subgroup that was analyzed in the pivotal clinical study. The outcomes are shown in Primary Safety Composite and Primary Effectiveness by Gender (Table 9). The results of an interaction analysis indicate that the treatment differences between IN.PACT Admiral DCB and PTA groups are consistent between male and female subjects.

7.3. Ethnicity

Clinical studies of the IN.PACT Admiral DCB did not include a sufficient number of patients to assess for differences in safety or effectiveness due to ethnicity, regardless of assessment by individual ethnicity categories or assessment by Caucasian or non-Caucasian categories.

7.4. Pediatric Use

The safety and effectiveness of the IN.PACT Admiral DCB in pediatric patients has not been established.

7.5. Geriatric Use

The pivotal clinical study for the IN.PACT Admiral DCB had an upper age limit of 85 years, and had a predefined study subgroup of subjects 75 years or older (85 subjects). Within this subgroup, the IN.PACT Admiral DCB group showed improvement on the primary safety and effectiveness endpoints.

8. Drug Information

8.1. Mechanism of Action

The mechanism(s) by which the IN.PACT Admiral DCB affects neointimal production has not been fully established. The principal mechanism by which paclitaxel inhibits neointimal growth is through the stabilization of microtubules by preventing their depolymerization during the final G2/M phase of cell division. Consequently, the microtubule network may not maintain the dynamic rearrangement required for a normal mitotic process.

8.2. Pharmacokinetics

The pharmacokinetic profile of paclitaxel following treatment with the IN.PACT Admiral DCB was evaluated in 25 patients receiving 2,850 µg to 16,900 µg of paclitaxel. This evaluation was conducted as a sub-study of the randomized clinical trial and is described in Summary of Clinical Studies (Section 11). Paclitaxel systemic exposure in the treated subjects was low and cleared rapidly with a bi-phasic decline. The C_{max} ranged from 1.0 to 35.9 ng/mL and the $AUC_{0-\infty}$ ranged from 11.4 to 128.8 hr*ng/mL. These data indicate that treatment with the IN.PACT Admiral DCB provides low systemic exposure of paclitaxel.

8.3. Metabolism

Metabolic transformation of paclitaxel occurs predominantly in the liver through cytochromes P450 2C8 (CYP2C8) and 3A4 (CYP3A4). Agents which could compete with or inhibit the activity of the CYP2C8 and CYP3A4 isoenzymes may increase paclitaxel plasma levels. For more information on potential drug interactions, see Drug Interaction (Section 6.5).

8.4. Carcinogenicity, Genotoxicity, and Reproductive Toxicity

No long-term studies in animals have been published in peer-reviewed literature to evaluate the carcinogenic potential of paclitaxel. Paclitaxel was not mutagenic in the Ames test or the CHO/HGPRT gene mutation assay. However, the mechanism by which paclitaxel interferes with cellular proliferation may give rise to loss of chromosomes during cell division as a result of microtubule stabilization during cell division. Paclitaxel is an established aneuploidic drug in vitro on human normal cells and will also produce a positive response in the mouse bone marrow micronucleus assay. It has not been established that paclitaxel exerts any direct action on DNA to induce strand fragmentation.

Reproductive toxicity has been previously evaluated in vivo in both rabbits and rats. When administered during rabbit fetal organogenesis, paclitaxel doses of 3.0 mg/kg/day caused embryo- and fetotoxicity; maternal toxicity was also observed. No teratogenic effects were observed at 1.0 mg/kg/day; effects at higher doses could not be assessed due to fetal mortality. In rats, fertility impairment was observed at doses \geq 1 mg/kg/day. For comparison, the average dose of paclitaxel in the IN.PACT SFA PK Sub-study was 7454 µg, with an average subject weight of 91 kg, for a theoretical normalized dose of 0.082 mg/kg (assuming all the paclitaxel from the coating enters the systemic circulation).

9. Potential Adverse Effects

Below is a list of the potential adverse effects (eg., complications) associated with the use of the device:

- abrupt vessel closure
- access site pain
- allergic reaction to contrast medium, antiplatelet therapy, or catheter system components (materials, drugs, and excipients)
- amputation/loss of limb
- arrhythmias
- arterial aneurysm
- arterial thrombosis
- arteriovenous (AV) fistula
- death
- dissection
- embolization
- fever
- hematoma
- hemorrhage
- hypotension/hypertension
- inflammation
- ischemia or infarction of tissue/organ
- local infection at access site
- local or distal embolic events
- perforation or rupture of the artery
- pseudoaneurysm
- renal insufficiency or failure
- restenosis of the dilated artery
- sepsis or systemic infection
- shock
- stroke
- systemic embolization
- vessel spasms or recoil
- vessel trauma which requires surgical repair

Potential complications of peripheral balloon catheterization include, but are not limited to:

- balloon rupture
- detachment of a component of the balloon and/or catheter system
- failure of the balloon to perform as intended
- failure to cross the lesion

These complications may result in adverse effects.

Although systemic effects are not anticipated, potential adverse effects not captured above that may be unique to the paclitaxel drug coating include, but are not limited to:

- allergic/immunologic reaction
- alopecia
- anemia
- gastrointestinal symptoms
- hematologic dyscrasia (including leucopenia, neutropenia, thrombocytopenia)
- hepatic enzyme changes
- histologic changes in vessel wall, including inflammation, cellular damage, or necrosis
- myalgia/arthritis
- myelosuppression
- peripheral neuropathy

Refer to the Physician's Desk Reference for more information on the potential adverse effects observed with paclitaxel. There may be other potential adverse effects that are unforeseen at this time.

10. Patient Counseling Information

Physicians should consider the following when counseling patients about this product:

- Discuss the risks associated with percutaneous transluminal angioplasty procedures.
- Discuss the risks associated with the IN.PACT Admiral DCB.
- Discuss the risks and benefits of the treatment specific to the patient.
- Discuss short- and long-term post-procedure changes to the patient's lifestyle.
- Discuss the risks of early discontinuation of the antiplatelet therapy.

11. Summary of Clinical Studies

11.1. Late Mortality Signal for Paclitaxel-Coated Devices

A meta-analysis of randomized controlled trials published in December 2018 by Katsanos et. al. identified an increased risk of late mortality at 2 years and beyond for paclitaxel-coated balloons and paclitaxel-eluting stents used to treat femoropopliteal arterial disease. In response to these data, FDA performed a patient-level meta-analysis of long-term follow-up data from the pivotal premarket randomized trials of paclitaxel-coated devices used to treat femoropopliteal disease using available clinical data through May 2019. The meta-analysis also showed a late mortality signal in study subjects treated with paclitaxel-coated devices compared to patients treated with uncoated devices. Specifically, in the 3 randomized trials with a total of 1090 patients and available 5-year data, the crude mortality rate was 19.8% (range 15.9% - 23.4%) in patients treated with paclitaxel-coated devices compared to 12.7% (range 11.2% - 14.0%) in subjects treated with uncoated devices. The relative risk for increased mortality at 5 years was 1.57 (95% confidence interval 1.16 - 2.13), which corresponds to a 57% relative increase in mortality in patients treated with paclitaxel-coated devices. As presented at the June 2019 FDA Advisory Committee Meeting, an independent meta-analysis of similar patient-level data provided by VIVA Physicians, a vascular medicine organization, reported similar findings with a hazard ratio of 1.38 (95% confidence interval 1.06 - 1.80). Additional analyses have been conducted and are underway that are specifically designed to assess the relationship of mortality to paclitaxel-coated devices. The presence and magnitude of the late mortality risk should be interpreted with caution because of multiple limitations in the available data, including wide confidence intervals due to a small sample size, pooling of studies of different paclitaxel-coated devices that were not intended to be combined, substantial amounts of missing study data, no clear evidence of a paclitaxel dose effect on mortality, and no identified pathophysiologic mechanism for the late deaths.

Paclitaxel-coated balloons and stents improve blood flow to the legs and decrease the likelihood of repeat procedures to reopen blocked blood vessels compared to uncoated devices. The benefits of paclitaxel-coated devices (e.g., reduced reinterventions) should be considered in individual patients along with potential risks (e.g., late mortality).

In the IN.PACT SFA IDE Trial, based on the analysis completed for the June 2019 FDA Advisory Committee Meeting using As-Treated cohort and vital status update, the Kaplan Meier cumulative mortality estimates at 2, 3 and 5 years are 7.3% [3.8%, 10.8%], 10.5% [6.4%, 14.6%], 15.7% [10.8%, 20.6%], respectively, for the IN.PACT Admiral DCB treatment device and 0.9% [0%, 2.7%], 2.8% [0%, 5.9%], 11.2% [5.3%, 17.1%], respectively, for the PTA control device. Additional information regarding long-term outcomes can be found in Section 11.

11.2. IN.PACT SFA Trial

11.2.1. Primary Objective

The objective of the IN.PACT SFA Trial was to evaluate the safety and effectiveness of the IN.PACT Admiral DCB as compared with PTA when used to treat atherosclerotic lesions of the superficial femoral artery (SFA) and/or proximal popliteal artery (PPA).

11.2.2. Study Design

The IN.PACT SFA Trial was designed as a two-phase, multicenter, single-blind, randomized trial. Subjects in the IN.PACT SFA I phase were enrolled in Austria, Belgium, Germany, Italy, and Switzerland under ISO 14155:2003, Declaration of Helsinki, and ICH GCP. The second phase, IN.PACT SFA II, was conducted in the United States under an investigational device exemption (IDE). Subjects were randomized 2:1 to treatment with the IN.PACT Admiral DCB as compared to PTA. Provisional stenting was used in cases of PTA failure. Follow-up was completed at 30 days, 6 months, 12 months, 24 months, 36 months, 48 months, and 60 months post-index procedure.

The data from the IN.PACT SFA Trial, with greater than 50% subjects coming from the U.S. population (150 subjects Europe and 181 subjects U.S.), have been pooled and comprise the pivotal trial data. This aggregate data provides statistical power for the 12-month primary safety and effectiveness endpoints.

The primary endpoints for the IN.PACT SFA Trial are listed below.

- Primary Safety Composite Endpoint:
 - Freedom from device- and procedure-related death through 30 days post-index procedure and freedom from target limb major amputation and clinically-driven target vessel revascularization (TVR)¹ within 12 months post-index procedure

For the primary safety endpoint, the treatment (π_T) and control (π_C) groups were compared in a non-inferiority format under the following hypothesis.

$$H_0: \pi_T \leq \pi_C - 0.1$$

$$H_A: \pi_T > \pi_C - 0.1$$

■ Primary Effectiveness Endpoint:

- Primary patency within 12 months post-index procedure, defined as freedom from clinically-driven target lesion revascularization (TLR)² and freedom from restenosis as determined by duplex ultrasound (DUS)³ peak systolic velocity ratio (PSVR) ≤ 2.4 ⁴

For the primary effectiveness endpoint, the treatment (p_T) and control (p_C) groups were compared in a superiority format under the following hypothesis.

$$H_0: p_T = p_C$$

$$H_A: p_T > p_C$$

The sample size was estimated using the two-group chi-square test for the primary effectiveness endpoint, and it was driven by the assumptions of a one-sided 0.024995 alpha and at least 80% desired power to show superiority of IN.PACT Admiral DCB to PTA.

The secondary endpoints for the IN.PACT SFA Trial are listed below.

- Major Adverse Events (MAE) through 60 months. MAE are defined as all-cause death, clinically-driven TVR, major target limb amputation, and thrombosis at the target lesion site
- Death of any cause within 30 days, 6, 12, 24, 36, 48 and 60 months
- TVR within 6, 12, 24, 36, 48 and 60 months
- TLR within 6, 12, 24, 36, 48 and 60 months
- Time to first clinically-driven target lesion revascularization (TLR) through 60 months post-index procedure
- Major target limb amputation within 6, 12, 24, 36, 48 and 60 months
- Thrombosis at the target lesion site within 6, 12, 24, 36, 48 and 60 months
- Primary sustained clinical improvement at 6, 12, 24, 36 months post-procedure
- Secondary sustained clinical improvement at 6, 12, 24, 36 months post-procedure
- Duplex-defined binary restenosis (PSVR > 2.4) of the target lesion at 6, 12, 24 and 36 months or at the time of the re-intervention prior to any pre-specified timepoint
- Duplex-defined binary restenosis (PSVR > 3.4) of the target lesion at 6, 12, 24 and 36 months or at the time of the re-intervention prior to any pre-specified timepoint
- Quality of life assessment by EQ-5D questionnaire at 6, 12, 24, and 36 months as change from baseline
- Walking distance as assessed by 6 Minute Walk Test at 30 days and at 6, 12, 24, and 36 months as change from baseline (IN.PACT SFA II phase only)
- Walking capacity assessment by walking impairment questionnaire (WIQ) at 30 days and at 6, 12, 24, and 36 months
- Device success defined as successful delivery, balloon inflation and deflation and retrieval of the intact study device without burst below the rated burst pressure (RBP)
- Procedural success defined as residual stenosis of $\leq 50\%$ (non-stented subjects) or $\leq 30\%$ (stented subjects) by core laboratory (if core laboratory was not available then the site-reported estimate was used)
- Clinical success defined as procedural success without procedural complications (death, major target limb amputation, thrombosis of the target lesion, or TVR) prior to discharge
- Days of hospitalization due to the index lesion from procedure through 6, 12, 24, and 36 months

As the four primary endpoint tests passed (and in a superiority manner), each at a critical level of 0.024995, several pre-defined secondary endpoints were compared on all ITT non-stented subjects between treatment groups sequentially. These secondary endpoints were analyzed in the following order: (1) CD-TLR at 12 months, (2) primary sustained clinical improvement at 12 months, (3) walking distance at 12 months as assessed by the 6-minute walk test, and (4) duplex-defined binary restenosis (PSVR >2.4) at 24 months or at the time of reintervention. This sequential approach keeps the family-wise error rate at the 0.024995 level across the set of four secondary endpoints.

The statistical analysis plan included planned primary analysis of all non-stented patients, as well as a secondary analysis of the intent to treat (ITT) population. The demographics and results provided are for the ITT population, which demonstrated similar results as the all non-stented patient population.

¹ Clinically-driven TVR is defined as any re-intervention within the target vessel due to symptoms or drop of ABI/TBI of $\geq 20\%$ or > 0.15 when compared to post-procedure baseline ABI/TBI

² Clinically-driven TLR is defined as any re-intervention at the target lesion due to symptoms or drop of ABI/TBI of $\geq 20\%$ or > 0.15 when compared to post-procedure baseline ABI/TBI

³ Post-index procedure DUS (intended to establish a post-treatment baseline) does not contribute to the primary endpoint determination

⁴ Restenosis determined by either PSVR > 2.4 as assessed by an independent DUS core laboratory or > 50% stenosis as assessed by an independent angiographic core laboratory

11.2.3. Patient Population

Subject demographics, medical history, and risk factors of the 331 subjects are summarized in Baseline Demographics and Medical History (Table 4), which shows similarity between subjects enrolled in both the IN.PACT Admiral DCB and PTA groups.

Table 4. Baseline Demographics and Medical History

	IN.PACT DCB (N=220 Subjects)	PTA (N=111 Subjects)	p-value
Age (yr)	67.5 ± 9.5	68.0 ± 9.2	0.612
Male	65.0% (143/220)	67.6% (75/111)	0.713
Race ^a			0.435
White	78.3% (94/120)	83.3% (50/60)	
Black	14.2% (17/120)	11.7% (7/60)	
Asian	5.8% (7/120)	3.3% (2/60)	
Native Hawaiian or Other Pacific Islander	1.7% (2/120)	0.0% (0/60)	
American Indian or Alaska Native	0.0% (0/120)	0.0% (0/60)	
Other	0.0% (0/120)	1.7% (1/60)	
Obesity (BMI ≥ 30 kg/m ²)	27.7% (61/220)	25.2% (28/111)	0.694
Diabetes Mellitus	40.5% (89/220)	48.6% (54/111)	0.161
Hypertension	91.4% (201/220)	88.3% (98/111)	0.431
Hyperlipidemia	84.5% (186/220)	82.0% (91/111)	0.637
Current Smoker	38.6% (85/220)	36.0% (40/111)	0.719
Coronary Heart Disease	57.0% (122/214)	55.0% (60/109)	0.813
Carotid Artery Disease	34.9% (73/209)	31.7% (32/101)	0.610
Renal Insufficiency (baseline serum creatinine ≥ 1.5 mg/dL)	8.3% (18/217)	6.4% (7/109)	0.662
Below-the-knee Vascular Disease of Target Leg (Stenotic/Occluded)	40.9% (90/220)	53.2% (59/111)	0.036
ABI / TBI ^b (mmHg ratio)	0.769 ± 0.228 (209)	0.744 ± 0.189 (106)	0.308
Rutherford Category			0.898
2	37.7% (83/220)	37.8% (42/111)	
3	57.3% (126/220)	55.9% (62/111)	
4	5.0% (11/220)	5.4% (6/111)	
5	0.0% (0/220)	0.9% (1/111)	
Numbers are % (counts/sample size) unless otherwise stated.			
Site reported data.			
^a Race and ethnicity data was not collected in IN.PACT SFA I phase (Europe).			
^b TBI was not measured in IN.PACT SFA I phase.			

The baseline lesion characteristics, as reported by the sites and angiographic core laboratories, have been provided in Lesion Characteristics (Table 5). The total target lesion length treated was similar between treatment groups (IN.PACT Admiral DCB 8.94 cm, PTA 8.81 cm; p=0.815). Occluded lesions comprised 25.8% of IN.PACT Admiral DCB subject lesions and 19.5% of PTA subject lesions (p=0.222). Pre-dilatation using a PTA catheter was performed as part of the clinical study to prepare the vessel and occurred in 96.4% (212/220) of IN.PACT Admiral DCB subjects.

Table 5. Lesion Characteristics

	IN.PACT DCB (N=220 Subjects)	PTA (N=111 Subjects)	p-value
Baseline Lesion Characteristics^a			
Lesion Type			0.875
De novo	95.0% (209/220)	94.6% (105/111)	
Restenotic (non-stented)	5.0% (11/220)	5.4% (6/111)	
Lesion Location^{b, c}	(N=221 Lesions)	(N=113 Lesions)	
Superficial Femoral Artery	97.7% (216/221)	94.7% (107/113)	0.193
Proximal Popliteal Artery	6.8% (15/221)	7.1% (8/113)	1.000
Angiographic Lesion Characteristics^b	(N=221 Lesions)	(N=113 Lesions)	
Lesion Length (cm)	8.94 ± 4.89	8.81 ± 5.12	0.815
Reference Vessel Diameter (RVD) (mm)	4.647 ± 0.841	4.681 ± 0.828	0.728

	IN.PACT DCB	PTA	p-value
Minimum Lumen Diameter (MLD) (Pre-procedure) (mm)	0.900 ± 0.776	0.933 ± 0.771	0.711
Diameter Stenosis (Pre-procedure)	81.1% ± 15.5%	81.3% ± 13.7%	0.946
Occluded Lesions (100% Stenosis)	25.8% (57/221)	19.5% (22/113)	0.222
TASC Lesion Type			
A	56.6% (125/221)	62.8% (71/113)	0.275
B	30.8% (68/221)	26.5% (30/113)	
C	12.2% (27/221)	10.6% (12/113)	
D	0.5% (1/221)	0.0% (0/113)	
Calcification	59.3% (131/221)	58.4% (66/113)	0.907
Severe Calcification	8.1% (18/221)	6.2% (7/113)	0.662
# Run-off Vessels Occluded			
0	41.5% (88/212)	35.7% (40/112)	0.042
1	41.5% (88/212)	33.0% (37/112)	
2	13.7% (29/212)	26.8% (30/112)	
3	3.3% (7/212)	4.5% (5/112)	
Dissections (Post-procedure)			
0 (No Dissection)	36.2% (80/221)	38.9% (44/113)	0.360
A–C	63.8% (141/221)	60.2% (68/113)	
D–F	0.0% (0/221)	0.9% (1/113)	
Minimum Lumen Diameter (Post-procedure) (mm)	3.903 ± 0.750	3.862 ± 0.732	0.632
Diameter Stenosis (Post-procedure)	19.9% ± 10.4%	19.1% ± 10.3%	0.535
Procedural Characteristics^d	(N=220 Subjects)	(N=111 Subjects)	
Pre-dilatation	96.4% (212/220)	85.6% (95/111)	<0.001
Post-dilatation	26.8% (59/220)	18.9% (21/111)	0.135
Provisional Stenting	7.3% (16/220)	12.6% (14/111)	0.110
Numbers are % (counts/sample size) or mean ± standard deviation.			
Note that four subjects in the trial were assessed by site as having tandem lesions treated during the index procedure and were assessed by the angiographic core laboratory as having two target lesions treated during the index procedure.			
<small>a Site reported data. b Core laboratory reported data. All lesions within artery segment are counted. c All lesions within artery segment are counted d Required for IN.PACT SFA II phase; not required for IN.PACT SFA I phase.</small>			

11.2.4. Primary Safety and Effectiveness Endpoints

The primary safety endpoint of the study, a composite of freedom from device- and procedure-related death through 30 days, freedom from target limb major amputation within 12 months and freedom from clinically-driven target vessel revascularization within 12 months, was 95.7% in the IN.PACT Admiral DCB group and 76.6% in the PTA group (p<0.001). The IN.PACT Admiral DCB group met the predefined 10% non-inferiority margin and showed superiority in safety against the PTA group using a sequential analysis approach. The primary effectiveness endpoint, primary patency at 12 months, was 82.2% in the IN.PACT Admiral DCB group and 52.4% for the PTA group (p<0.001). The IN.PACT Admiral DCB group showed statistical superiority against the PTA group.

See Primary Safety and Effectiveness Endpoints (Table 6). Also see Kaplan-Meier Plot - Event-Free from Primary Safety Endpoint through 360 Days (Figure 4) and Kaplan-Meier Plot - Primary Patency through 390 Days (Figure 5).

Table 6. Primary Safety and Effectiveness Endpoints

Outcome	IN.PACT DCB (N=220)	PTA (N=111)	Difference [95% CI]	p-value ^a
Primary Safety Endpoint	95.7% (198/207)	76.6% (82/107)	19.0% [10.5%, 27.5%]	<0.001
Primary Effectiveness Endpoint – Primary Patency at 12 Months	82.2% (157/191)	52.4% (54/103)	26.2% [15.1%, 37.3%]	<0.001
<ul style="list-style-type: none"> ■ Primary safety endpoint is defined as freedom from device- and procedure-related death through 30 days, target limb major amputation within 360 days, and clinically-driven TVR within 360 days. ■ Primary patency is defined as freedom from clinically-driven TLR¹ and freedom from restenosis as determined by duplex ultrasound² (DUS) peak systolic velocity ratio (PSVR) $\leq 2.4$³ within 12 months. Key primary patency endpoint definition components: <ol style="list-style-type: none"> 1. Clinically-driven TLR is defined as any reintervention at the target lesion due to symptoms or drop of ABI/TBI of $\geq 20\%$ or >0.15 when compared to postprocedure baseline ABI/TBI 2. Post-index procedure DUS is intended to establish a post-treatment baseline and does not contribute to the primary endpoint determination 3. Restenosis determined by either PSVR >2.4 as assessed by an independent DUS core laboratory or $>50\%$ stenosis as assessed by an independent angiographic core laboratory. ■ Post-index procedure DUS did not contribute to the primary effectiveness endpoint determination. Therefore, effectiveness results do not reflect four DCB patients who had post-procedure binary restenosis which was later not observed at 12 months. <p>Statistical references:</p> <ul style="list-style-type: none"> • Numbers are % (counts/sample size). CI - Confidence Interval • Analysis sets: Effectiveness - all randomized subjects with multiple imputation performed on missing data for primary patency are provided in the Difference [95% CI] and p-value columns; Safety - all randomized subjects experiencing at least one component for the safety endpoint or with follow-up of at least 330 days post-procedure (i.e. the denominator was adjusted for missing data). • Non-inferiority on the primary safety endpoint was tested using the Farrington-Manning approach. The non-inferiority margin of 10% was met, however, the results shown above are for superiority testing. <p>Data sources:</p> <p>All events were adjudicated by the independent Clinical Events Committee and all duplex ultrasound and angiographic measures were made by the independent core laboratories.</p>				
<p>^a all alpha are one-sided with significance of 0.024995 required.</p>				

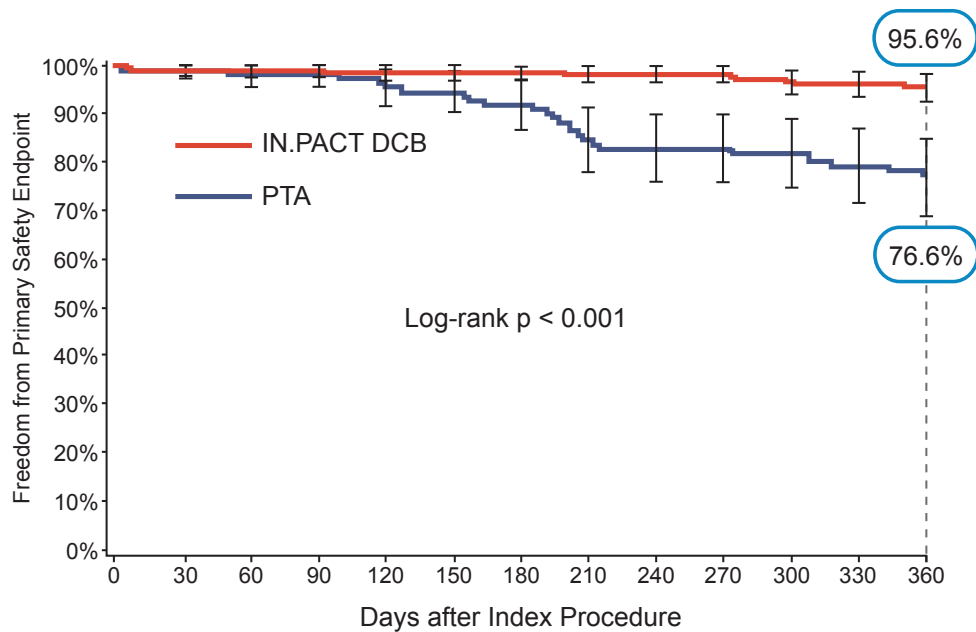

From day X To day Y	0	1	31	61	91	121	151	181	211	241	271	301	331	360
	0	30	60	90	120	150	180	210	240	270	300	330	360	
IN.PACT DCB (N=220 Subjects)														
# Entered	220	220	215	214	214	212	210	208	206	205	203	197	195	
# Censored	0	3	1	0	1	2	2	1	1	2	3	1	50	
# Events	0	2	0	0	1	0	0	1	0	0	3	1	1	
Event-free [%]	100.0%	99.1%	99.1%	99.1%	98.6%	98.6%	98.6%	98.1%	98.1%	98.1%	96.7%	96.2%	95.6%	
Greenwood SE [%]	0.0%	0.6%	0.6%	0.6%	0.8%	0.8%	0.8%	0.9%	0.9%	0.9%	1.2%	1.3%	1.4%	
PTA (N=111 Subjects)														
# Entered	111	111	109	108	108	105	104	101	91	89	89	88	84	
# Censored	0	1	0	0	0	0	0	2	0	0	0	1	24	
# Events	0	1	1	0	3	1	3	8	2	0	1	3	2	
Event-free [%]	100.0%	99.1%	98.2%	98.2%	95.5%	94.6%	91.8%	84.4%	82.6%	82.6%	81.7%	78.9%	76.6%	
Greenwood SE [%]	0.0%	0.9%	1.3%	1.3%	2.0%	2.2%	2.6%	3.5%	3.6%	3.6%	3.7%	3.9%	4.1%	
Survival Curves Comparison														
Analysis Method	Test		Chi Square		Degr. Freedom		p-value							
Kaplan-Meier Analysis	Log-Rank		27.3314		1		<math>< 0.001</math>							
All events were adjudicated by the independent Clinical Events Committee.														

Figure 4. Kaplan-Meier Plot - Event-Free from Primary Safety Endpoint through 360 Days

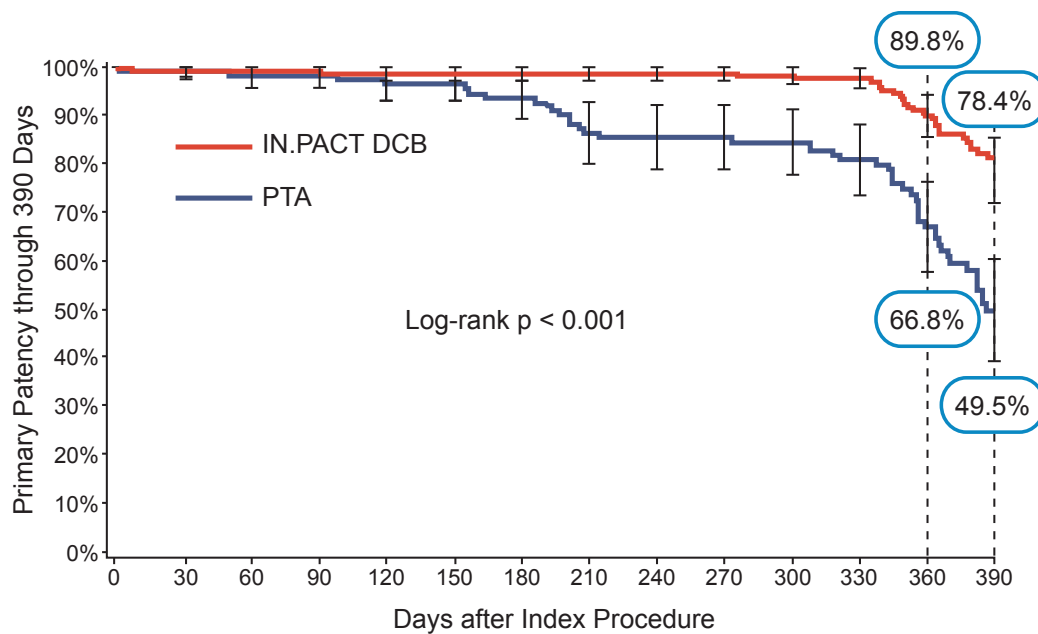

From day X To day Y	0	1	31	61	91	121	151	181	211	241	271	301	331	361
	0	30	60	90	120	150	180	210	240	270	300	330	360	390
IN.PACT DCB (N=220 Subjects)														
# Entered	220	220	215	214	214	212	210	208	207	206	204	200	198	141
# Censored	0	3	1	0	1	2	2	1	1	2	3	1	43	39
# Events	0	2	0	0	1	0	0	0	0	0	1	1	14	15
Event-free [%]	100.0%	99.1%	99.1%	99.1%	98.6%	98.6%	98.6%	98.6%	98.6%	98.6%	98.1%	97.6%	89.8%	78.4%
Greenwood SE [%]	0.0%	0.6%	0.6%	0.6%	0.8%	0.8%	0.8%	0.8%	0.8%	0.8%	0.9%	1.0%	2.2%	3.4%
PTA (N=111 Subjects)														
# Entered	111	111	109	108	108	106	106	103	93	92	92	91	86	55
# Censored	0	1	0	0	0	0	0	2	0	0	0	1	18	9
# Events	0	1	1	0	2	0	3	8	1	0	1	4	13	13
Event-free [%]	100.0%	99.1%	98.2%	98.2%	96.4%	96.4%	93.6%	86.3%	85.3%	85.3%	84.4%	80.7%	66.8%	49.5%
Greenwood SE [%]	0.0%	0.9%	1.3%	1.3%	1.8%	1.8%	2.3%	3.3%	3.4%	3.4%	3.5%	3.8%	4.7%	5.4%
Survival Curves Comparison														
Analysis Method	Test		Chi Square		Degr. Freedom		p-value							
Kaplan-Meier Analysis	Log-Rank		33.2068		1		<0.001							
All TLR events were adjudicated by the independent Clinical Events Committee. All DUSs were analyzed by an independent core laboratory.														

Figure 5. Kaplan-Meier Plot - Primary Patency through 390 Days

The primary safety and effectiveness outcomes of all non-stented patients and intent to treat (ITT) population are shown in Outcomes of All ITT and All Non-stented Populations (Table 7).

Table 7. Outcomes of All ITT and All Non-stented Populations

	All ITT		All Non-Stented	
	IN.PACT DCB	PTA	IN.PACT DCB	PTA
Primary Safety Endpoint	95.7% (198/207)	76.6% (82/107)	95.8% (183/191)	77.7% (73/94)
Primary Effectiveness Endpoint – Primary Patency at 12 Months	82.2% (157/191)	52.4% (54/103)	82.9% (145/175)	52.2% (47/90)
<ul style="list-style-type: none"> ■ Primary safety endpoint is defined as freedom from device- and procedure-related death through 30 days, target limb major amputation within 360 days, and clinically-driven TVR within 360 days. ■ Primary patency is defined as freedom from clinically-driven TLR¹ and freedom from restenosis as determined by duplex ultrasound² (DUS) peak systolic velocity ratio (PSVR) $\leq 2.4$³ within 12 months. Key primary patency endpoint definition components: <ol style="list-style-type: none"> 1. Clinically-driven TLR is defined as any reintervention at the target lesion due to symptoms or drop of ABI/TBI of $\geq 20\%$ or >0.15 when compared to postprocedure baseline ABI/TBI 2. Post-index procedure DUS is intended to establish a post-treatment baseline and does not contribute to the primary endpoint determination 3. Restenosis determined by either PSVR >2.4 as assessed by an independent DUS core laboratory or $>50\%$ stenosis as assessed by an independent angiographic core laboratory. ■ Post-index procedure DUS did not contribute to the primary effectiveness endpoint determination. Therefore, effectiveness results do not reflect four DCB patients who had post-procedure binary restenosis which was later not observed at 12 months. <p>Statistical references:</p> <ul style="list-style-type: none"> • Numbers are % (counts/sample size). • Analysis sets: Effectiveness - all randomized subjects with as-observed results for primary patency; Safety - all randomized subjects experiencing at least one component for the safety endpoint or with follow-up of at least 330 days post-procedure (ie, the denominator was adjusted for missing data). <p>Data sources:</p> <p>All events were adjudicated by the independent Clinical Events Committee and all duplex ultrasound and angiographic measures were made by the independent core laboratories.</p>				

11.2.5. Principal Safety and Effectiveness Results

A summary of the principal safety and effectiveness results through 12 months, including major secondary endpoints, have been shown below in Principal Safety and Effectiveness Results (Table 8). Secondary safety endpoints were more favorable in the IN.PACT Admiral DCB group. The 12-month major adverse event rate was 6.3% in the IN.PACT Admiral DCB group versus 24.3% in the PTA group ($p < 0.001$). This statistical significance was primarily driven by a dramatic reduction in clinically-driven target vessel revascularization (CD-TVR) rate. The IN.PACT Admiral DCB group also showed highly statistically significant results of secondary effectiveness, such as clinically-driven TLR (CD-TLR) and primary sustained clinical improvement both of which passed hierarchical testing.

Table 8. Principal Safety and Effectiveness Results

	IN.PACT DCB (N=220 Sub- jects)	PTA (N=111 Sub- jects)	Difference [95% CI]	p-value ^a
Safety Parameters				
Primary Safety Composite Endpoint – Freedom from:	95.7% (198/207)	76.6% (82/107)	19.0% [10.5%, 27.5%]	<0.001
Device- and Procedure-related Death through 30 Days	0.0% (0/218)	0.0% (0/111)	NA	>0.999
Target Limb Major Amputation within 360 Days	0.0% (0/207)	0.0% (0/107)	NA	>0.999
Clinically-driven TVR within 360 Days	4.3% (9/207)	23.4% (25/107)	-19.0% [-27.5%, -10.5%]	<0.001
Death (all-cause) within 30 days	0.0% (0/218)	0.0% (0/111)	NA	>0.999
Effectiveness Parameters				
Primary Effectiveness Endpoint – Primary Patency at 12 Months	82.2% (157/191)	52.4% (54/103)	26.2% [15.1%, 37.3%]	<0.001

	IN.PACT DCB (N=220 Sub- jects)	PTA (N=111 Sub- jects)	Difference [95% CI]	p-value ^a
Primary Sustained Clinical Improvement at 12 Months	85.2% (167/196)	68.9% (73/106)	16.3% [6.2%, 26.5%]	<0.001
Device Success	99.0% (308/311)	98.5% (128/130)	0.6% [-1.8%, 3.0%]	0.302
Procedural Success	99.5% (219/220)	98.2% (109/111)	1.3% [-1.3%, 4.0%]	0.111
Clinical Success	99.1% (218/220)	97.3% (108/111)	1.8% [-1.5%, 5.1%]	0.103
Binary Restenosis (PSVR >2.4) at 12 Months	16.5% (31/188)	33.7% (29/86)	-17.2% [-28.5%, -5.9%]	0.001
Binary Restenosis (PSVR >3.4) at 12 Months	7.3% (13/178)	21.4% (18/84)	-14.1% [-23.7%, -4.6%]	<0.001
Cumulative complications within 360 days				
MAE Composite (Death, Major Target Limb Amputation, Clinically-driven TVR, Thrombosis)	6.3% (13/207)	24.3% (26/107)	-18.0% [-26.8%, -9.2%]	<0.001
Death (all-cause)	1.9% (4/207)	0.0% (0/107)	1.9% [0.1%, 3.8%]	0.926
Clinically-driven TVR	4.3% (9/207)	23.4% (25/107)	-19.0% [-27.5%, -10.5%]	<0.001
Major Target Limb Amputation	0.0% (0/207)	0.0% (0/107)	NA	>0.999
Thrombosis	1.4% (3/207)	3.7% (4/107)	-2.3% [-6.2%, 1.7%]	0.096
Clinically-driven TLR	2.4% (5/207)	20.6% (22/107)	-18.1% [-26.1%, -10.2%]	<0.001
Any TVR	4.8% (10/207)	23.4% (25/107)	-18.5% [-27.1%, -10.0%]	<0.001
Any TLR	2.9% (6/207)	20.6% (22/107)	-17.7% [-25.7%, -9.7%]	<0.001

- Primary sustained clinical improvement was defined as freedom from target limb amputation, TVR, and increase in Rutherford class at 12 months post-procedure.
- Device success defined as successful delivery, inflation, deflation and retrieval of the intact study balloon device without burst below the RBP.
- Procedure success defined as residual stenosis of ≤50% (non-stented subjects) or ≤30% (stented subjects) by visual estimate.
- Clinical success defined as procedural success without procedural complications (death, major target limb amputation, thrombosis of the target lesion, or TVR) prior to discharge.
- Clinically-driven TLR/TVR is defined as any reintervention within the target vessel due to symptoms or drop of ABI/TBI of ≥20% or >0.15 when compared to post-procedure baseline ABI/TBI.
- Major Adverse Events (MAE) defined as all-cause death, clinically-driven TLR/TVR, major target limb amputation, thrombosis at the target lesion site at 360 days.
- Binary restenosis is defined as duplex restenosis (PSVR >2.4/3.4) or angiographic restenosis of the target lesion at 12 months postprocedure, or at the time of reintervention prior to any prespecified timepoint.

Statistical references:

- Numbers are % (counts/sample size). CI - Confidence Interval
- Analysis sets: Effectiveness - all randomized subjects with multiple imputation performed on missing data for primary patency are provided in the Difference [95% CI] and p-value columns; Safety - all randomized subjects experiencing at least one component for the safety endpoint or with follow-up of at least 330 days post-procedure (i.e. the denominator was adjusted for missing data).

Data sources:

All events were adjudicated by the independent Clinical Events Committee, all duplex ultrasound and angiographic measures were made by the independent core laboratories.

^a all alpha are one-sided with significance of 0.024995 required. All tests were for superiority using the chi-square test for binary variables and t-test for continuous variables.

11.2.6. Subgroup Analysis

Medtronic has analyzed trial results by different pre-defined subgroups to investigate the consistency of results through 12 months. Primary Safety Endpoint Event at 12 Months (Figure 6), Primary Patency at 12 Months (Figure 7), and Clinically-driven Target Lesion Revascularization at 12 Months (Figure 8) have been illustrated for each subgroup in the forest plots below. All data for the subgroup analyses trended in favor of IN.PACT Admiral DCB over PTA.

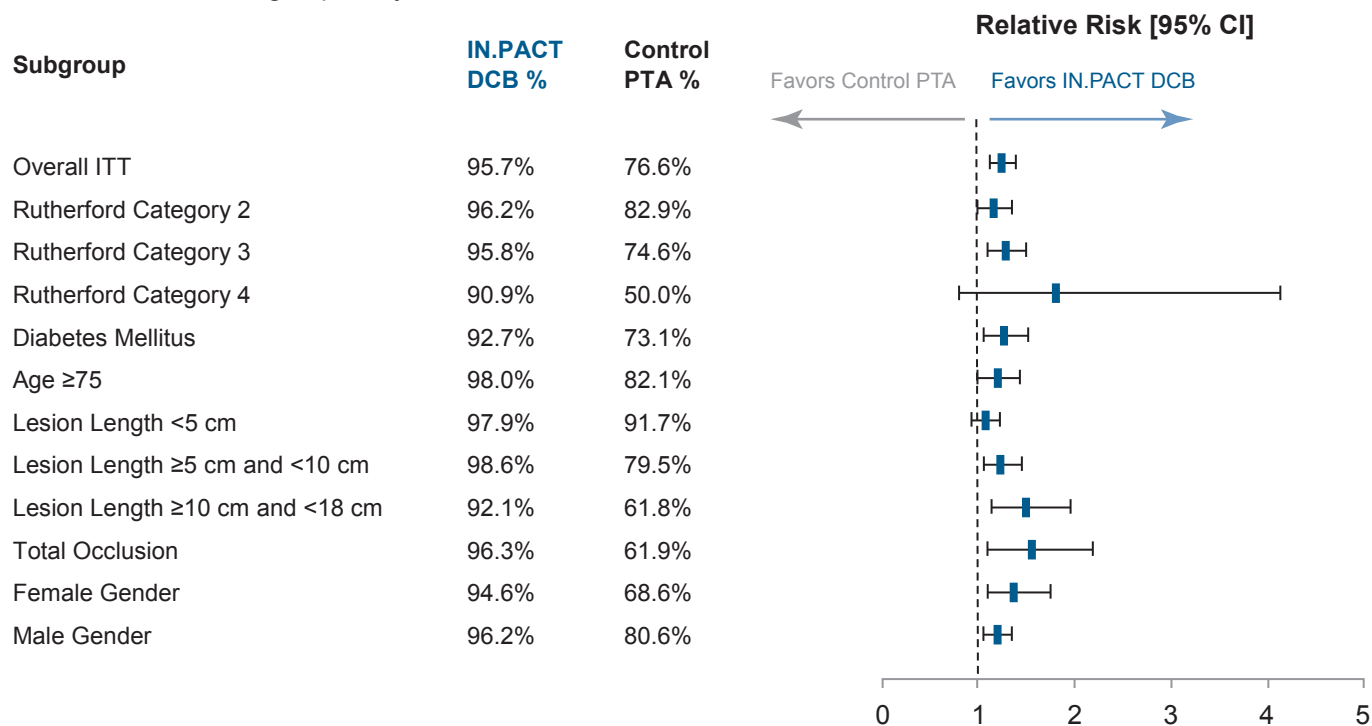

Figure 6. Primary Safety Endpoint Event at 12 Months

Note: There were no significant treatment-by-subgroup interactions ($p>0.15$). The 95% confidence intervals were unadjusted for multiplicity.

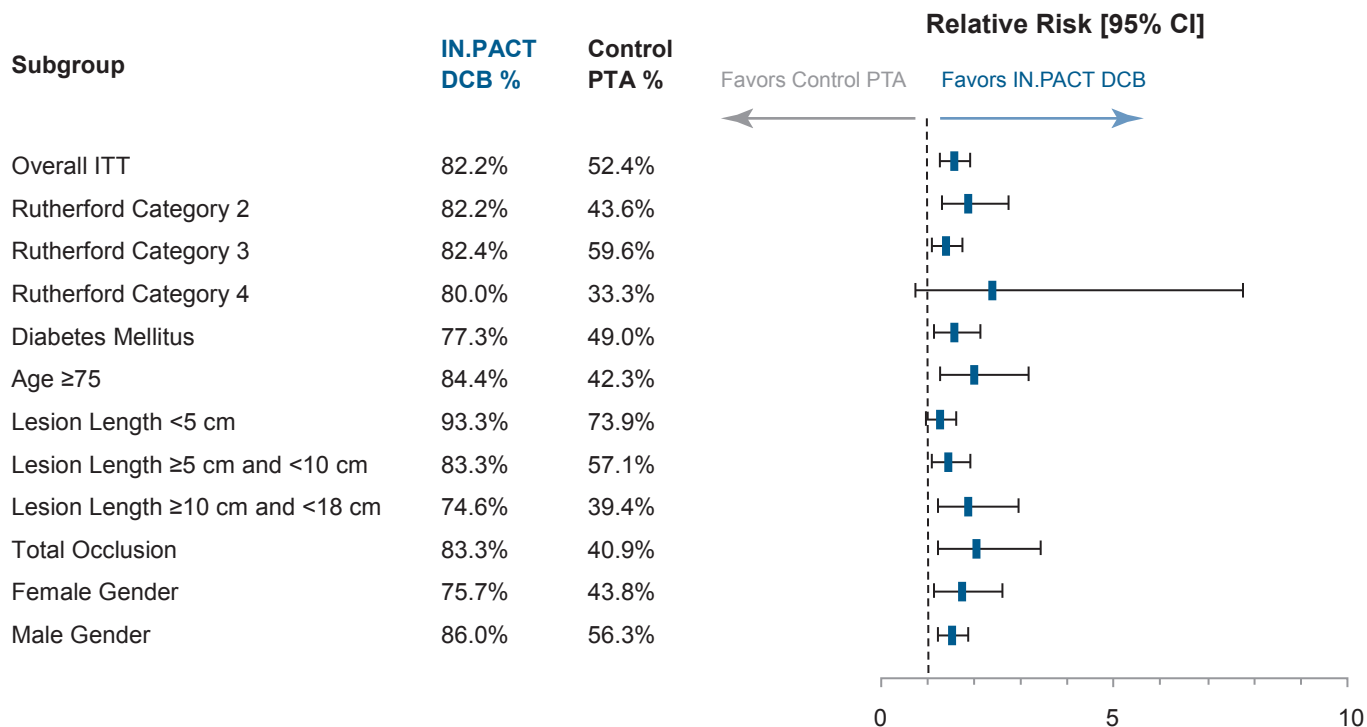

Figure 7. Primary Patency at 12 Months

Note: There were no significant treatment-by-subgroup interactions ($p>0.15$). The 95% confidence intervals were unadjusted for multiplicity.

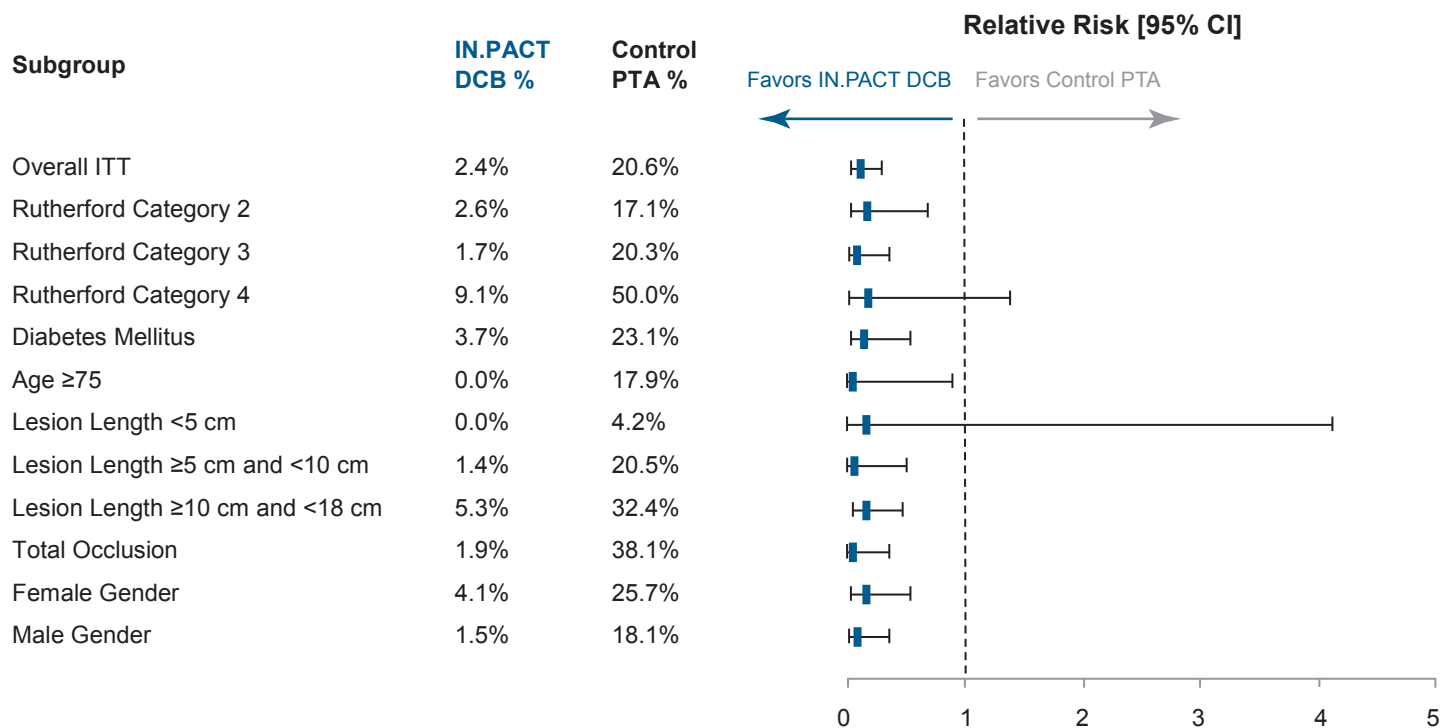

Figure 8. Clinically-driven Target Lesion Revascularization at 12 Months

Note: There were no significant treatment by subgroup interactions ($p>0.15$) except in diabetes mellitus ($p=0.027$). The 95% confidence intervals were unadjusted for multiplicity.

11.2.7. Gender Analysis

There were 218 males and 113 females enrolled in the pivotal study. Based on gender subgroup analyses, both female and male subgroups showed improvement on the primary safety and effectiveness endpoints through 12 months. The results of an interaction analysis indicate that the treatment differences between IN.PACT Admiral DCB and PTA groups are consistent between male and female subjects.

Table 9. Primary Safety Composite and Primary Effectiveness by Gender

Females			
Outcome	IN.PACT DCB (N=77 Subjects)	Standard PTA (N=36 Subjects)	Difference
Primary Safety Endpoint	94.6% (70/74)	68.6% (24/35)	26.0%
Primary Effectiveness Endpoint – Primary Patency at 12 Months	75.7% (53/70)	43.8% (14/32)	29.3%
Males			
Outcome	IN.PACT DCB (N=143 Subjects)	Standard PTA (N=75 Subjects)	Difference
Primary Safety Endpoint	96.2% (128/133)	80.6% (58/72)	15.7%

Primary Effectiveness Endpoint – Primary Patency at 12 Months	86.0% (104/121)	56.3% (40/71)	25.0%
---	-----------------	---------------	-------

■ Primary safety endpoint is defined as freedom from device- and procedure-related death through 30 days, target limb major amputation within 360 days, and clinically-driven TVR within 360 days.

■ Primary patency is defined as freedom from clinically-driven TLR¹ and freedom from restenosis as determined by duplex ultrasound² (DUS) peak systolic velocity ratio (PSVR) ≤ 2.4 ³ within 12 months. Key primary patency endpoint definition components:

1. Clinically-driven TLR is defined as any reintervention at the target lesion due to symptoms or drop of ABI/TBI of $\geq 20\%$ or >0.15 when compared to postprocedure baseline ABI/TBI
2. Post-index procedure DUS is intended to establish a post-treatment baseline and does not contribute to the primary endpoint determination
3. Restenosis determined by either PSVR >2.4 as assessed by an independent DUS core laboratory or $>50\%$ stenosis as assessed by an independent angiographic core laboratory.

■ Post-index procedure DUS did not contribute to the primary effectiveness endpoint determination. Therefore, effectiveness results do not reflect four DCB patients who had post-procedure binary restenosis which was later not observed at 12 months.

Statistical references:

- Numbers are % (counts/sample size).
- Analysis sets: Effectiveness - all randomized subjects with multiple imputation performed on missing data for primary patency are provided in the Difference column; Safety - all randomized subjects experiencing at least one component for the safety endpoint or with follow-up of at least 330 days post-procedure (ie, the denominator was adjusted for missing data).

Data sources:

All events were adjudicated by the independent Clinical Events Committee and all duplex ultrasound and angiographic measures were made by the independent core laboratories.

11.2.8. Serious Adverse Events

For additional details on serious adverse events, see Summary of Adverse Events (Section 11.3.7).

11.3. IN.PACT SFA Trial Post-Approval Study

11.3.1. Primary Objective

The IN.PACT SFA Trial Post-Approval Study was designed to evaluate the long-term safety and effectiveness of the IN.PACT Admiral DCB via a two-year primary patency endpoint and a composite two-year safety endpoint for the treatment of lesions in the SFA and/or PPA.

11.3.2. Study Design

As a condition of premarket approval, the IN.PACT SFA Trial subjects were followed through 60 months post-index procedure and assessed for the primary and secondary endpoints listed below. Additional de novo subjects were not enrolled. For additional details regarding study design, refer to Section 11.2.2, Study Design.

The primary endpoints for the IN.PACT SFA Trial Post-Approval Study are listed below:

- Primary Safety Endpoint:
 - Freedom from device- and procedure-related death at 30 days and freedom from target limb major amputation and clinically-driven target vessel revascularization (CD-TVR) at 24 months.
- Primary Effectiveness Endpoint
 - Primary patency at 24 months, defined as freedom from clinically-driven TLR (CD-TLR) and freedom from restenosis as determined by duplex ultrasound (DUS) peak systolic velocity ratio (PSVR) ≤ 2.4 .

The secondary endpoints for the IN.PACT SFA Trial Post-Approval Study are listed below:

Assessed through 60 months:

- Major adverse event (MAE) composite and its individual components (all-cause mortality, CD-TVR, major target limb amputation, and thrombosis at the target lesion site)
- CD-TLR
- All TVR
- All TLR
- Serious adverse events (SAEs)

Assessed at 24 and 36 months:

- Primary sustained clinical improvement
- Secondary sustained clinical improvement
- Duplex-defined binary restenosis (PSVR > 2.4) of the target lesion
- Duplex-defined binary restenosis (PSVR > 3.4) of the target lesion
- Quality of Life (QoL) assessment by EQ-5D Questionnaire
- Walking capacity assessment by Walking Impairment Questionnaire (WIQ)

11.3.3. Patient Population

The 331 subjects assessed for the IN.PACT SFA Trial Post-Approval Study were the same subjects as originally enrolled in the IN.PACT SFA Trial. For additional details on the study population, refer to Section 11.2.3, Patient Population.

Follow-up compliance through the 60-month follow-up visit is presented in Subject Follow-up Compliance through 60 Months (Table 10). The overall follow-up compliance rates in the IN.PACT Admiral DCB group and the PTA group were greater than 90% from 12 months through 60 months.

Table 10. Subject Follow-up Compliance through 60 Months

Subject Compliance Characteristics	IN.PACT DCB (N=220 Subjects)	Standard PTA (N=111 Subjects)
12-Month Follow-up		
Eligible Subjects ^a	202	108
Death ^b	5	0
Withdrawal ^b	13	3
Follow-up Not Done	5	4
Follow-up Visit Within Window ^c	188	98
Follow-up Visit Out of Window ^c	9	6
Within Window Follow-up Compliance (%) ^d	93.1%	90.7%
Overall Follow-up Compliance (%) ^e	97.5%	96.3%
24-Month Follow-up		
Eligible Subjects ^a	187	104
Death ^b	16	1
Withdrawal ^b	17	6
Follow-up Not Done	17	10
Follow-up Visit Within Window ^c	154	83
Follow-up Visit Out of Window ^c	16	11
Within Window Follow-up Compliance (%) ^d	82.4%	79.8%
Overall Follow-up Compliance (%) ^e	90.9%	90.4%
36-Month Follow-up		
Eligible Subjects ^a	173	99
Death ^b	22	2
Withdrawal ^b	25	10
Follow-up Not Done	12	7
Follow-up Visit Within Window ^c	133	82
Follow-up Visit Out of Window ^c	28	10
Within Window Follow-up Compliance (%) ^d	76.9%	82.8%
Overall Follow-up Compliance (%) ^e	93.1%	92.9%
48-Month Follow-up		
Eligible Subjects ^a	163	91
Death ^b	24	7
Withdrawal ^b	33	13
Follow-up Not Done	14	5
Follow-up Visit Within Window ^c	146	85
Follow-up Visit Out of Window ^c	3	1
Within Window Follow-up Compliance (%) ^d	89.6%	93.4%
Overall Follow-up Compliance (%) ^e	91.4%	94.5%
60-Month Follow-up		
Eligible Subjects ^a	155	88

Subject Compliance Characteristics	IN.PACT DCB (N=220 Subjects)	Standard PTA (N=111 Subjects)
Death ^b	29	10
Withdrawal ^b	36	13
Follow-up Not Done	8	3
Follow-up Visit Within Window ^c	142	83
Follow-up Visit Out of Window ^c	5	2
Within Window Follow-up Compliance (%) ^d	91.6%	94.3%
Overall Follow-up Compliance (%) ^e	94.8%	96.6%

Site reported data

- a Eligible subjects are all subjects who either have a follow-up visit form or are past due for their follow-up (beyond upper limit of window on study and did not exit the study before the upper limit of the window)
b Death and withdrawal are cumulative
c Within window visits are defined as: 30-days ± 7 days, 6-months ± 30 days, 12-months ± 30 days, 2-years ± 30 days, 3-years ± 30 days, 4-years ± 60 days, 5-years ± 60 days
d Percentage based on number of subjects who had follow-up visit within window divided by total number of eligible subjects
e Percentage based on number of subjects who had a follow-up visit within or out of window divided by total number of eligible subjects.

11.3.4. Primary Safety and Effectiveness Endpoints

The primary safety composite endpoint is defined as freedom from device- and procedure-related death through 30 days post-procedure and freedom from target limb major amputation and CD-TVTR within 24 months post-index procedure. The primary safety composite endpoint at 24 months in the IN.PACT Admiral DCB group was 87.4% (173/198) versus 69.8% (74/106) in the PTA group (p<0.001). The primary effectiveness endpoint is defined as primary patency within 24 months post-index procedure. Primary patency is defined as freedom from CD-TLR and freedom from restenosis as determined by DUS PSVR ≤ 2.4. Primary patency at 24 months in the IN.PACT Admiral DCB group was 69.2% (108/156) versus 50.5% (48/95) in the PTA group (p=0.005).

See Primary Safety and Effectiveness Endpoints at 24 Months (Table 11). Also see Kaplan-Meier Plot - Event-free from Primary Safety Endpoint through 720 Days (Figure 9) and Kaplan-Meier Plot - Cumulative Primary Patency through 750 Days (Figure 10).

Table 11. Primary Safety and Primary Effectiveness Endpoints at 24 Months

Primary Endpoints	IN.PACT DCB (N=220 Subjects)	Standard PTA (N=111 Subjects)	Difference [95% CI]	p-value
Primary Effectiveness Endpoint – Primary Patency at 24 Months	69.2% (108/156)	50.5% (48/95)	18.7% [6.3%, 31.1%]	0.005
Primary Safety Endpoint at 24 Months	87.4% (173/198)	69.8% (74/106)	17.6% [8.5%, ∞]	<0.001*

Endpoint definitions:

- Primary patency is defined as freedom from clinically-driven TLR^a and freedom from restenosis as determined by duplex ultrasound^b (DUS) Peak Systolic Velocity Ratio (PSVR) ≤ 2.4^c
- Primary safety endpoint consists of freedom from device- and procedure-related death through 30 days; freedom from target limb amputation within 24 months; and freedom from clinically-driven TVR^d within 24 months.

Statistical references:

- Numbers are % (counts/sample size) unless otherwise stated.
- CI – Confidence Interval
- Analysis sets: Effectiveness – all randomized subjects with multiple imputation performed on missing data for Primary Patency; Safety – all randomized subjects experiencing at least one component for the safety endpoint or with follow-up of at least 690 days post-procedure, i.e. the denominator was adjusted for missing data.
- For the primary effectiveness endpoint the Z test of two proportions was used to compare treatment groups for all randomized subjects.
- ∞ means Not Applicable for this one-sided test.
- *non-inferiority p-value.
- Non-inferiority on the primary safety endpoint was tested using the Farrington-Manning risk difference between treatments (calculated as treatment minus control) and its one-sided lower 97.5005% confidence interval. The non-inferiority margin was 10%.

Data sources:

All events were adjudicated by the independent Clinical Events Committee, all duplex ultrasound and angiographic measures were made by the independent core laboratories

Key endpoint definition components:

- a Clinically-driven TLR is defined as any re-intervention at the target lesion due to symptoms or drop of ABI/TBI of ≥20% or >0.15 when compared to post-procedure baseline ABI/TBI
b Post-index procedure DUS is intended to establish a post-treatment baseline and does not contribute to the Primary Endpoint determination
c Restenosis determined by either PSVR >2.4 (determined by Target Lesion Category of '50-99%' or 'Occluded') as assessed by an independent DUS core lab or >50% stenosis as assessed by an independent angiographic core lab
d Clinically-driven TVR is defined as any re-intervention within the target vessel due to symptoms or drop of ABI/TBI of ≥20% or >0.15 when compared to post-procedure baseline ABI/TBI

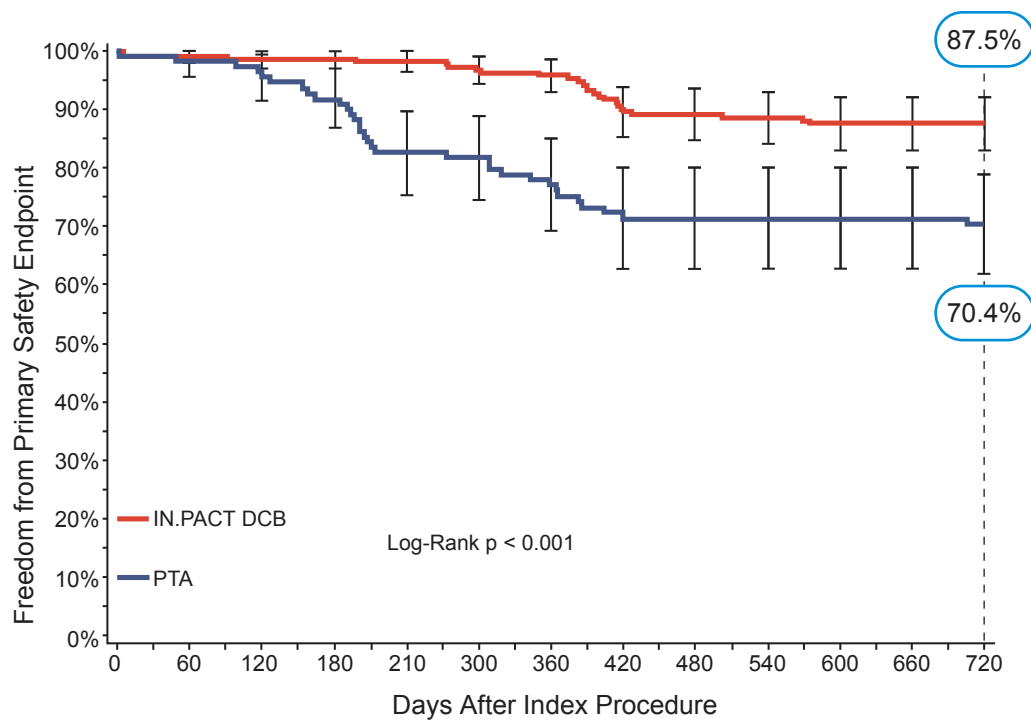

From day X To day Y	0	1	61	121	181	241	301	361	421	481	541	601	661	720
	0	60	120	180	240	300	360	420	480	540	600	660	720	
IN.PACT DCB (N=220 Subjects)														
# Entered	220	220	215	213	209	206	199	193	175	173	171	166	162	
# Censored	0	3	1	4	2	4	4	6	1	1	3	4	18	
# Events	0	2	1	0	1	3	2	12	1	1	2	0	0	
Event-free [%]	100.0%	99.1%	98.6%	98.6%	98.2%	96.7%	95.7%	89.6%	89.1%	88.6%	87.5%	87.5%	87.5%	
Greenwood SE [%]	0.0%	0.6%	0.8%	0.8%	0.9%	1.2%	1.4%	2.2%	2.2%	2.2%	2.3%	2.3%	2.3%	
Standard PTA (N=111 Subjects)														
# Entered	111	111	108	105	101	89	88	83	75	75	75	75	74	
# Censored	0	1	0	0	2	0	0	2	0	0	0	1	10	
# Events	0	2	3	4	10	1	5	6	0	0	0	0	1	
Event-free [%]	100.0%	98.2%	95.5%	91.8%	82.6%	81.7%	77.0%	71.4%	71.4%	71.4%	71.4%	71.4%	70.4%	
Greenwood SE [%]	0.0%	1.3%	2.0%	2.6%	3.6%	3.7%	4.0%	4.3%	4.3%	4.3%	4.3%	4.3%	4.4%	

Figure 9. Kaplan-Meier Plot – Event-free from Primary Safety Endpoint through 720 Days

Survival Curves Comparison				
Analysis Method	Test	Chi Square	Degr. Freedom	P-Value
Kaplan-Meier Analysis	Log-Rank	16.7894	1	<0.001

All events were adjudicated by the independent Clinical Events Committee.

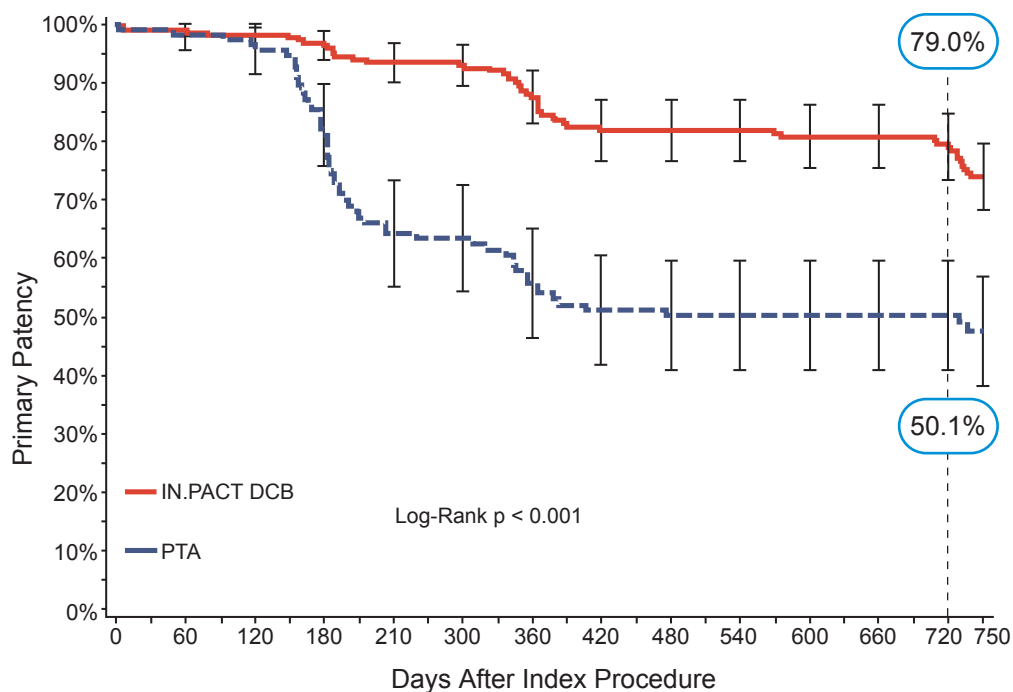

From day X To day Y	0	1	61	121	181	241	301	361	421	481	541	601	661	721	750
	0	60	120	180	240	300	360	420	480	540	600	660	720	750	
IN.PACT DCB (N=220 Subjects)															
# Entered	220	220	215	212	204	194	188	174	154	153	152	147	144	127	
# Censored	0	3	1	4	4	5	3	9	1	1	3	3	14	15	
# Events	0	2	2	4	6	1	11	11	0	0	2	0	3	8	
Event-free [%]	100.0%	99.1%	98.2%	96.3%	93.4%	92.9%	87.5%	81.8%	81.8%	81.8%	80.7%	80.7%	79.0%	73.8%	
Greenwood SE [%]	0.0%	0.6%	0.9%	1.3%	1.7%	1.8%	2.3%	2.7%	2.7%	2.7%	2.8%	2.8%	2.9%	3.2%	
Standard PTA (N=111 Subjects)															
# Entered	111	111	108	105	90	69	68	60	53	51	51	51	50	43	
# Censored	0	1	0	1	1	0	0	2	1	0	0	1	7	5	
# Events	0	2	3	14	20	1	8	5	1	0	0	0	0	2	
Event-free [%]	100.0%	98.2%	95.5%	82.6%	64.2%	63.2%	55.8%	51.1%	50.1%	50.1%	50.1%	50.1%	50.1%	47.7%	
Greenwood SE [%]	0.0%	1.3%	2.0%	3.6%	4.6%	4.6%	4.8%	4.8%	4.8%	4.8%	4.8%	4.8%	4.8%	4.9%	

Figure 10. Kaplan-Meier Plot – Cumulative Primary Patency through 750 Days

Survival Curves Comparison				
Analysis Method	Test	Chi Square	Degr. Freedom	P-Value
Kaplan-Meier Analysis	Log-Rank	32.0231	1	<0.001
All TLR events were adjudicated by the independent Clinical Events Committee.				
All DUSs were analyzed by an independent core laboratory.				

11.3.5. Secondary Safety and Effectiveness

A summary of the secondary safety and effectiveness endpoints through 60 months is shown in Secondary Safety and Effectiveness Endpoints through 60 Months (Table 12).

Within 720 days, the composite MAE rate was 18.6% (38/204) in the IN.PACT Admiral DCB group versus 30.6% (33/108) in the PTA group. CD-TVR rates were lower in the IN.PACT Admiral DCB group at 12.3% (25/204) versus 29.6% (32/108) in the PTA group. CD-TLR rates were lower in the IN.PACT Admiral DCB group at 8.8% (18/204) versus 27.8% (30/108) in the PTA group.

Within 1080 days, the composite MAE rate was 27.5% (55/200) in the IN.PACT Admiral DCB group versus 36.8% (39/106) in the PTA group. CD-TVR rates were lower in the IN.PACT Admiral DCB group at 18.5% (37/200) versus 34.9% (37/106) in the PTA group. CD-TLR rates were lower in the IN.PACT Admiral DCB group at 15.0% (30/200) versus 30.2% (32/106) in the PTA group.

Within 1440 days, the composite MAE rate was 37.4% (71/190) in the IN.PACT Admiral DCB group versus 40.4% (42/104) in the PTA group. CD-TVR rates were lower in the IN.PACT Admiral DCB group 26.3% (50/190) versus 35.6% (37/104) in the PTA group. CD-TLR rates were lower in the IN.PACT Admiral DCB group 23.2% (44/190) versus 30.8% (32/104) in the PTA group.

Within 1800 days, the composite MAE rate was 42.9% (79/184) in the IN.PACT Admiral DCB group versus 48.1% (50/104) in the PTA group. CD-TVR rates were lower in the IN.PACT Admiral DCB group 29.3% (54/184) versus 40.4% (42/104) in the PTA group. CD-TLR rates were lower in the IN.PACT Admiral DCB group 25.5% (47/184) versus 35.6% (37/104) in the PTA group.

All deaths were adjudicated by the blinded, Clinical Events Committee and none were found to be device- or procedure-related. The causes of death were varied and found to occur relatively late in the study. One major amputation in the IN.PACT DCB group occurred 1653 days post-index procedure.

Table 12. Secondary Safety and Effectiveness Endpoints through 60 Months

Description of Event	IN.PACT DCB (N=220 Subjects)	Standard PTA (N=111 Subjects)
Cumulative Complications Within 720 Days		
MAE (Death, Major Target Limb Amputation, Clinically-driven TVR, Thrombosis)	18.6% (38/204)	30.6% (33/108)
Death (all-cause)	7.8% (16/204)	0.9% (1/108)
Clinically-driven TVR	12.3% (25/204)	29.6% (32/108)
Major Target Limb Amputation	0.0% (0/204)	0.0% (0/108)
Thrombosis	1.5% (3/204)	3.7% (4/108)
Clinically-driven TLR	8.8% (18/204)	27.8% (30/108)
Any TVR	12.7% (26/204)	30.6% (33/108)
Any TLR	9.8% (20/204)	28.7% (31/108)
Cumulative Complications Within 1080 Days		
MAE (Death, Major Target Limb Amputation, Clinically-driven TVR, Thrombosis)	27.5% (55/200)	36.8% (39/106)
Death (all-cause)	10.5% (21/200)	1.9% (2/106)
Clinically-driven TVR	18.5% (37/200)	34.9% (37/106)
Major Target Limb Amputation	0.0% (0/200)	0.0% (0/106)
Thrombosis	2.0% (4/200)	4.7% (5/106)
Clinically-driven TLR	15.0% (30/200)	30.2% (32/106)
Any TVR	19.0% (38/200)	35.8% (38/106)
Any TLR	16.0% (32/200)	33.0% (35/106)
Cumulative Complications Within 1440 Days		
MAE (Death, Major Target Limb Amputation, Clinically-driven TVR, Thrombosis)	37.4% (71/190)	40.4% (42/104)
Death (all-cause)	12.6% (24/190)	6.7% (7/104)
Clinically-driven TVR	26.3% (50/190)	35.6% (37/104)
Major Target Limb Amputation	0.0% (0/190)	0.0% (0/104)
Thrombosis	2.1% (4/190)	4.8% (5/104)
Clinically-driven TLR	23.2% (44/190)	30.8% (32/104)
Any TVR	26.8% (51/190)	36.5% (38/104)
Any TLR	24.2% (46/190)	33.7% (35/104)
Cumulative Complications Within 1800 Days		
MAE (Death, Major Target Limb Amputation, Clinically-driven TVR, Thrombosis)	42.9% (79/184)	48.1% (50/104)
Death (all-cause)	15.8% (29/184)	9.6% (10/104)
Clinically-driven TVR	29.3% (54/184)	40.4% (42/104)
Major Target Limb Amputation	0.5% (1/184)	0.0% (0/104)
Thrombosis	2.2% (4/184)	4.8% (5/104)

Description of Event	IN.PACT DCB (N=220 Subjects)	Standard PTA (N=111 Subjects)
Clinically-driven TLR	25.5% (47/184)	35.6% (37/104)
Any TVR	29.9% (55/184)	40.4% (42/104)
Any TLR	26.6% (49/184)	37.5% (39/104)

Percentages are based on number of evaluable subjects at each time point, and all events are adjudicated by the CEC. Cumulative complications within 720 days, 1080 days, 1440 days and 1800 days include both IN.PACT SFA I and SFA II phase subjects.

All randomized subjects experiencing at least one component for the safety endpoint or with follow-up of at least 690 days for 24-month, 1050 days for 36-month, 1380 days for 48-month, and 1740 days for 60-month post-procedure, were considered as evaluable subjects for the event rate calculation for each corresponding time point, i.e. the denominator was adjusted for missing data.

Major Adverse Events (MAE) defined as all-cause death, clinically-driven TVR, major target limb amputation, thrombosis at the target lesion site.

Clinically-driven TLR/TVR is defined as any re-intervention within the target vessel due to symptoms or drop of ABI/TBI of $\geq 20\%$ or >0.15 when compared to post-procedure baseline ABI/TBI.

Numbers are % (counts/sample size) unless otherwise stated.

11.3.6. Functional Endpoints

A summary of functional outcomes through 24 months and 36 months are presented in Table 13. These functional tests are only assessed through the 36-month follow-up.

Primary sustained clinical improvement is defined as freedom from target limb amputation, TVR, and an increase in Rutherford classification. Outcomes for this endpoint at 24 months in the IN.PACT Admiral DCB subjects were 76.9% (133/173) versus 59.2% (61/103) in the PTA group. Secondary sustained clinical improvement is defined as freedom from target limb amputation and an increase in Rutherford classification. Outcomes for this endpoint at 24 months in the IN.PACT Admiral DCB subjects were 86.9% (146/168) versus 86.2% (81/94) in the PTA group.

The QoL assessment uses the EQ-5D Index four-digit scoring algorithm to calculate an overall score, that was generated by the five individual dimensions (mobility, self-care, activity, pain, and anxiety), where 0.109 represents the worst possible outcome and 1.000 represents the best possible outcome. At 24 months, the mean change from baseline in the IN.PACT Admiral DCB subjects was 0.0957 ± 0.2159 versus 0.0545 ± 0.2286 in the PTA group. The WIQ scoring (%) is expressed on a scale of 0% to 100%, with 0% meaning the patient was unable to perform the assessment due to claudication, and 100% meaning no impairment. The mean walking impairment score in the IN.PACT Admiral DCB group was $72.5\% \pm 34.1\%$ versus $67.2\% \pm 33.6\%$ in the PTA group.

At 36 months, primary sustained clinical improvement in the IN.PACT Admiral DCB subjects was 68.7% (114/166) versus 52.6% (51/97) in the PTA group and secondary sustained clinical improvement in the IN.PACT Admiral DCB subjects was 85.3% (133/156) versus 87.8% (79/90) in the PTA group.

At 36 months, the QoL mean change from baseline in the IN.PACT Admiral DCB subjects was 0.0832 ± 0.2293 versus 0.0662 ± 0.1977 in the PTA group. In the WIQ (%), the mean in the IN.PACT Admiral DCB group was $71.8\% \pm 34.2\%$ versus $74.7\% \pm 29.2\%$ in the PTA group.

Table 13. Secondary Safety and Effectiveness Endpoints through 36 Months

	IN.PACT DCB (N=220 Subjects)	Standard PTA (N=111 Subjects)
Outcomes At 24 Months		
Primary Sustained Clinical Improvement	76.9% (133/173)	59.2% (61/103)
Secondary Sustained Clinical Improvement	86.9% (146/168)	86.2% (81/94)
Change in Quality of Life from Baseline by EQ-5D Index		
N	167	92
Mean \pm SD	0.0957 ± 0.2159	0.0545 ± 0.2286
Median	0.1040	0.0370
Min, Max	-0.786, 0.672	-0.696, 0.554
Walking Impairment by WIQ (%)		
N	170	93
Mean \pm SD	72.5 ± 34.1	67.2 ± 33.6
Median	100.0	75.0
Min, Max	0, 100	0, 100

	IN.PACT DCB (N=220 Subjects)	Standard PTA (N=111 Subjects)
Outcomes At 36 Months		
Primary Sustained Clinical Improvement	68.7% (114/166)	52.6% (51/97)
Secondary Sustained Clinical Improvement	85.3% (133/156)	87.8% (79/90)
Change in Quality of Life from Baseline by EQ-5D Index		
N	156	90
Mean ± SD	0.0832 ± 0.2293	0.0662 ± 0.1977
Median	0.0905	0.0620
Min, Max	-0.759, 0.693	-0.689, 0.554
Walking Impairment by WIQ (%)		
N	158	91
Mean ± SD	71.8 ± 34.2	74.7 ± 29.2
Median	100.0	75.0
Min, Max	0, 100	0, 100
Endpoint definitions:		
<ul style="list-style-type: none"> Primary Sustained Clinical Improvement is defined as freedom from target limb amputation, TVR, and increase in Rutherford class of at least one class from baseline at 24 (36) months post-procedure. Secondary Sustained Clinical Improvement is defined freedom from target limb amputation and increase in Rutherford class of at least one class at 24 (36) months post-procedure. Quality of Life assessment by EQ-5D questionnaire index at 24 (36) months Walking impairment assessed by Walking Impairment Questionnaire (WIQ) at 24 (36) months. 		
Statistical references:		
<ul style="list-style-type: none"> Numbers are % (counts/sample size) unless otherwise stated. 		
Data Source:		
All events were adjudicated by the independent Clinical Events Committee, all duplex ultrasound and angiographic measures were made by the independent core laboratories, and all other data were site reported.		

11.3.7. Summary of Adverse Events

Serious Adverse Event Rates by SOC and Preferred Term through 1-year and through 5-year snapshot (Table 14) shows serious adverse event rates by subject and stratified by system-organ class (SOC) and preferred term. Serious adverse events were site-reported, and SOC was assigned via MedDRA version 13.0 coding.

A serious adverse event (SAE) was defined as an adverse event that led to a death or to a serious deterioration in the health of the subject. A serious deterioration in the health of the subject is defined as one or more of the following:

- a life-threatening illness or injury
- a permanent impairment of a body structure or a body function
- in-patient hospitalization or prolongation of an existing hospitalization
- a medical or surgical intervention to prevent life-threatening illness or injury or permanent impairment to a body structure or body function
- fetal distress, fetal death, or a congenital abnormality or birth defect.

Table 14. Serious Adverse Event Rates by SOC and Preferred Term through 1-year and through 5-year snapshot

Serious Adverse Events	Through 1-Year		Through 5-Year	
	IN.PACT DCB (N=220 Subjects)	Standard PTA (N=111 Subjects)	IN.PACT DCB (N=220 Subjects)	Standard PTA (N=111 Subjects)
SUBJECTS WITH ONE OR MORE SERIOUS ADVERSE EVENTS	46.4% (102/220)	55.9% (62/111)	79.1% (174/220)	84.7% (94/111)
BLOOD AND LYMPHATIC SYSTEM DISORDERS^a	2.3% (5/220)	1.8% (2/111)	8.2% (18/220)	2.7% (3/111)
ANAEMIA	1.8% (4/220)	0.9% (1/111)	5.9% (13/220)	2.7% (3/111)
ANAEMIA OF MALIGNANT DISEASE	0.0% (0/220)	0.0% (0/111)	0.5% (1/220)	0.0% (0/111)
HAEMORRHAGIC ANAEMIA	0.5% (1/220)	0.0% (0/111)	0.9% (2/220)	0.0% (0/111)
LEUKOCYTOSIS	0.0% (0/220)	0.0% (0/111)	0.5% (1/220)	0.0% (0/111)
PANCYTOPENIA	0.0% (0/220)	0.9% (1/111)	0.5% (1/220)	0.9% (1/111)

Serious Adverse Events	Through 1-Year		Through 5-Year	
	IN.PACT DCB (N=220 Subjects)	Standard PTA (N=111 Subjects)	IN.PACT DCB (N=220 Subjects)	Standard PTA (N=111 Subjects)
CARDIAC DISORDERS^a	9.5% (21/220)	6.3% (7/111)	30.5% (67/220)	21.6% (24/111)
ACUTE CORONARY SYNDROME	0.5% (1/220)	0.0% (0/111)	0.5% (1/220)	0.0% (0/111)
ACUTE MYOCARDIAL INFARCTION	1.4% (3/220)	0.0% (0/111)	5.9% (13/220)	1.8% (2/111)
ANGINA PECTORIS	0.9% (2/220)	0.9% (1/111)	2.7% (6/220)	0.9% (1/111)
ANGINA UNSTABLE	0.0% (0/220)	0.9% (1/111)	1.8% (4/220)	1.8% (2/111)
ARRHYTHMIA	0.5% (1/220)	0.0% (0/111)	0.5% (1/220)	0.0% (0/111)
ATRIAL FIBRILLATION	0.9% (2/220)	1.8% (2/111)	4.1% (9/220)	4.5% (5/111)
ATRIAL FLUTTER	0.0% (0/220)	0.0% (0/111)	0.9% (2/220)	0.0% (0/111)
ATRIOVENTRICULAR BLOCK COMPLETE	0.0% (0/220)	0.0% (0/111)	0.5% (1/220)	0.0% (0/111)
ATRIOVENTRICULAR BLOCK SECOND DEGREE	0.0% (0/220)	0.0% (0/111)	0.9% (2/220)	0.0% (0/111)
BRADYCARDIA	0.0% (0/220)	0.0% (0/111)	1.8% (4/220)	0.0% (0/111)
CARDIAC ARREST	0.5% (1/220)	0.0% (0/111)	2.3% (5/220)	0.9% (1/111)
CARDIAC FAILURE	0.0% (0/220)	0.0% (0/111)	3.2% (7/220)	0.9% (1/111)
CARDIAC FAILURE ACUTE	0.0% (0/220)	0.0% (0/111)	1.4% (3/220)	0.0% (0/111)
CARDIAC FAILURE CONGESTIVE	2.7% (6/220)	0.9% (1/111)	8.2% (18/220)	2.7% (3/111)
CARDIOMYOPATHY	0.0% (0/220)	0.0% (0/111)	0.5% (1/220)	0.0% (0/111)
CORONARY ARTERY DISEASE	3.2% (7/220)	0.9% (1/111)	9.1% (20/220)	7.2% (8/111)
CORONARY ARTERY DISSECTION	0.0% (0/220)	0.0% (0/111)	0.0% (0/220)	0.9% (1/111)
CORONARY ARTERY OCCLUSION	0.0% (0/220)	0.0% (0/111)	0.5% (1/220)	0.9% (1/111)
CORONARY ARTERY STENOSIS	0.0% (0/220)	0.0% (0/111)	2.3% (5/220)	0.0% (0/111)
CORONARY ARTERY THROMBOSIS	0.0% (0/220)	0.9% (1/111)	0.0% (0/220)	0.9% (1/111)
HEART VALVE STENOSIS	0.0% (0/220)	0.0% (0/111)	0.5% (1/220)	0.0% (0/111)
ISCHAEMIC CARDIOMYOPATHY	0.0% (0/220)	0.0% (0/111)	0.9% (2/220)	0.9% (1/111)
MITRAL VALVE DISEASE	0.0% (0/220)	0.0% (0/111)	0.5% (1/220)	0.0% (0/111)
MITRAL VALVE INCOMPETENCE	0.0% (0/220)	0.0% (0/111)	0.5% (1/220)	0.0% (0/111)
MYOCARDIAL INFARCTION	0.9% (2/220)	0.9% (1/111)	3.2% (7/220)	2.7% (3/111)
MYOCARDIAL ISCHAEMIA	0.5% (1/220)	0.0% (0/111)	0.5% (1/220)	0.0% (0/111)
PERICARDITIS	0.0% (0/220)	0.0% (0/111)	0.0% (0/220)	0.9% (1/111)
SINUS BRADYCARDIA	0.0% (0/220)	0.0% (0/111)	0.0% (0/220)	0.9% (1/111)
SINUS TACHYCARDIA	0.5% (1/220)	0.0% (0/111)	0.5% (1/220)	0.0% (0/111)
SUPRAVENTRICULAR TACHYCARDIA	0.0% (0/220)	0.9% (1/111)	0.0% (0/220)	0.9% (1/111)
TRICUSPID VALVE DISEASE	0.0% (0/220)	0.0% (0/111)	0.5% (1/220)	0.0% (0/111)
VENTRICULAR TACHYCARDIA	0.5% (1/220)	0.0% (0/111)	0.5% (1/220)	0.0% (0/111)
CONGENITAL, FAMILIAL AND GENETIC DISORDERS^a	0.0% (0/220)	0.0% (0/111)	0.5% (1/220)	0.9% (1/111)
ATRIAL SEPTAL DEFECT	0.0% (0/220)	0.0% (0/111)	0.5% (1/220)	0.0% (0/111)
HYDROCELE	0.0% (0/220)	0.0% (0/111)	0.0% (0/220)	0.9% (1/111)
EAR AND LABYRINTH DISORDERS^a	0.5% (1/220)	0.0% (0/111)	0.9% (2/220)	0.0% (0/111)
VERTIGO	0.5% (1/220)	0.0% (0/111)	0.5% (1/220)	0.0% (0/111)

Serious Adverse Events	Through 1-Year		Through 5-Year	
	IN.PACT DCB (N=220 Subjects)	Standard PTA (N=111 Subjects)	IN.PACT DCB (N=220 Subjects)	Standard PTA (N=111 Subjects)
VERTIGO POSITIONAL	0.0% (0/220)	0.0% (0/111)	0.5% (1/220)	0.0% (0/111)
EYE DISORDERS^a	0.5% (1/220)	0.0% (0/111)	2.3% (5/220)	1.8% (2/111)
CATARACT	0.0% (0/220)	0.0% (0/111)	1.8% (4/220)	0.0% (0/111)
DIABETIC RETINOPATHY	0.5% (1/220)	0.0% (0/111)	0.5% (1/220)	0.0% (0/111)
RETINAL DETACHMENT	0.0% (0/220)	0.0% (0/111)	0.0% (0/220)	0.9% (1/111)
VISUAL IMPAIRMENT	0.0% (0/220)	0.0% (0/111)	0.0% (0/220)	0.9% (1/111)
GASTROINTESTINAL DISORDERS^a	4.1% (9/220)	0.9% (1/111)	10.9% (24/220)	5.4% (6/111)
ABDOMINAL PAIN	0.5% (1/220)	0.0% (0/111)	0.5% (1/220)	0.9% (1/111)
ANAL FISTULA	0.5% (1/220)	0.0% (0/111)	0.5% (1/220)	0.0% (0/111)
ASCITES	0.0% (0/220)	0.0% (0/111)	0.5% (1/220)	0.0% (0/111)
COLONIC POLYP	0.0% (0/220)	0.0% (0/111)	0.5% (1/220)	0.0% (0/111)
DIABETIC GASTROPARESIS	0.0% (0/220)	0.0% (0/111)	0.5% (1/220)	0.0% (0/111)
DIARRHOEA	0.0% (0/220)	0.0% (0/111)	0.0% (0/220)	0.9% (1/111)
DYSPHAGIA	0.0% (0/220)	0.0% (0/111)	0.5% (1/220)	0.0% (0/111)
GASTRIC PERFORATION	0.0% (0/220)	0.0% (0/111)	0.5% (1/220)	0.0% (0/111)
GASTRIC ULCER	0.0% (0/220)	0.0% (0/111)	0.0% (0/220)	0.9% (1/111)
GASTRITIS EROSIVE	0.0% (0/220)	0.0% (0/111)	0.5% (1/220)	0.0% (0/111)
GASTROINTESTINAL HAEMORRHAGE	0.9% (2/220)	0.9% (1/111)	3.2% (7/220)	1.8% (2/111)
GASTROINTESTINAL ULCER HAEMORRHAGE	0.0% (0/220)	0.0% (0/111)	0.5% (1/220)	0.0% (0/111)
GASTROESOPHAGEAL REFLUX DISEASE	0.5% (1/220)	0.0% (0/111)	0.5% (1/220)	0.0% (0/111)
HAEMATOCHEZIA	0.0% (0/220)	0.0% (0/111)	0.5% (1/220)	0.0% (0/111)
ILEUS	0.0% (0/220)	0.0% (0/111)	0.9% (2/220)	0.0% (0/111)
IMPAIRED GASTRIC EMPTYING	0.5% (1/220)	0.0% (0/111)	0.5% (1/220)	0.0% (0/111)
INTESTINAL INFARCTION	0.0% (0/220)	0.0% (0/111)	0.0% (0/220)	0.9% (1/111)
INTESTINAL ISCHAEMIA	0.0% (0/220)	0.0% (0/111)	0.9% (2/220)	0.0% (0/111)
INTESTINAL OBSTRUCTION	0.5% (1/220)	0.0% (0/111)	0.5% (1/220)	0.0% (0/111)
LARGE INTESTINE PERFORATION	0.5% (1/220)	0.0% (0/111)	0.9% (2/220)	0.0% (0/111)
MELAENA	0.0% (0/220)	0.9% (1/111)	0.0% (0/220)	0.9% (1/111)
PANCREATITIS	0.5% (1/220)	0.0% (0/111)	0.5% (1/220)	0.0% (0/111)
PERITONITIS	0.5% (1/220)	0.0% (0/111)	0.9% (2/220)	0.0% (0/111)
PROCTITIS	0.0% (0/220)	0.0% (0/111)	0.5% (1/220)	0.9% (1/111)
RECTAL HAEMORRHAGE	0.0% (0/220)	0.0% (0/111)	0.5% (1/220)	0.0% (0/111)
SALIVARY GLAND FISTULA	0.0% (0/220)	0.0% (0/111)	0.5% (1/220)	0.0% (0/111)
SALIVARY GLAND MASS	0.0% (0/220)	0.0% (0/111)	0.0% (0/220)	0.9% (1/111)
SMALL INTESTINAL OBSTRUCTION	0.5% (1/220)	0.0% (0/111)	0.5% (1/220)	0.9% (1/111)
UMBILICAL HERNIA	0.0% (0/220)	0.0% (0/111)	0.5% (1/220)	0.0% (0/111)
UPPER GASTROINTESTINAL HAEMORRHAGE	0.0% (0/220)	0.0% (0/111)	0.5% (1/220)	0.0% (0/111)
VARICES OESOPHAGEAL	0.0% (0/220)	0.0% (0/111)	0.5% (1/220)	0.0% (0/111)
GENERAL DISORDERS AND ADMINISTRATION SITE CONDITIONS^a	5.5% (12/220)	4.5% (5/111)	11.4% (25/220)	9.9% (11/111)
ADVERSE DRUG REACTION	0.5% (1/220)	0.0% (0/111)	0.5% (1/220)	0.0% (0/111)
CHEST PAIN	0.9% (2/220)	0.9% (1/111)	5.0% (11/220)	4.5% (5/111)
DEATH	0.0% (0/220)	0.0% (0/111)	0.9% (2/220)	0.9% (1/111)

Serious Adverse Events	Through 1-Year		Through 5-Year	
	IN.PACT DCB (N=220 Subjects)	Standard PTA (N=111 Subjects)	IN.PACT DCB (N=220 Subjects)	Standard PTA (N=111 Subjects)
DEVICE DISLOCATION	0.0% (0/220)	0.0% (0/111)	0.5% (1/220)	0.0% (0/111)
DEVICE OCCLUSION	0.5% (1/220)	0.9% (1/111)	0.5% (1/220)	0.9% (1/111)
GENERALISED OEDEMA	0.0% (0/220)	0.0% (0/111)	0.5% (1/220)	0.0% (0/111)
IMPAIRED HEALING	0.5% (1/220)	0.9% (1/111)	1.4% (3/220)	0.9% (1/111)
IMPLANT SITE THROMBOSIS	0.5% (1/220)	0.0% (0/111)	0.0% (0/220)	0.0% (0/111)
MASS	0.0% (0/220)	0.9% (1/111)	0.0% (0/220)	0.0% (0/111)
MULTI-ORGAN FAILURE	0.5% (1/220)	0.0% (0/111)	0.5% (1/220)	0.0% (0/111)
NECROSIS	0.0% (0/220)	0.9% (1/111)	0.0% (0/220)	0.9% (1/111)
EDEMA PERIPHERAL	0.5% (1/220)	0.0% (0/111)	0.5% (1/220)	0.9% (1/111)
POLYP	0.5% (1/220)	0.0% (0/111)	0.5% (1/220)	0.0% (0/111)
PYREXIA	0.0% (0/220)	0.0% (0/111)	0.5% (1/220)	0.0% (0/111)
SUDDEN DEATH	0.5% (1/220)	0.0% (0/111)	0.5% (1/220)	0.0% (0/111)
THROMBOSIS IN DEVICE	0.0% (0/220)	0.0% (0/111)	0.5% (1/220)	0.9% (1/111)
VESSEL PUNCTURE SITE HAEMATOMA	0.9% (2/220)	0.0% (0/111)	0.5% (1/220)	0.0% (0/111)
HEPATOBIILIARY DISORDERS^a	0.9% (2/220)	0.9% (1/111)	1.8% (4/220)	0.9% (1/111)
BILE DUCT OBSTRUCTION	0.5% (1/220)	0.0% (0/111)	0.5% (1/220)	0.0% (0/111)
CHOLECYSTITIS	0.5% (1/220)	0.0% (0/111)	0.5% (1/220)	0.0% (0/111)
CHOLECYSTITIS ACUTE	0.0% (0/220)	0.0% (0/111)	0.5% (1/220)	0.0% (0/111)
HEPATIC CIRRHOSIS	0.0% (0/220)	0.9% (1/111)	0.0% (0/220)	0.9% (1/111)
HEPATIC MASS	0.0% (0/220)	0.0% (0/111)	0.5% (1/220)	0.0% (0/111)
LIVER DISORDER	0.5% (1/220)	0.0% (0/111)	0.5% (1/220)	0.0% (0/111)
PERFORATION BILE DUCT	0.0% (0/220)	0.0% (0/111)	0.5% (1/220)	0.0% (0/111)
PORCELAIN GALLBLADDER	0.0% (0/220)	0.0% (0/111)	0.5% (1/220)	0.0% (0/111)
IMMUNE SYSTEM DISORDERS^a	0.0% (0/220)	0.0% (0/111)	0.5% (1/220)	0.0% (0/111)
KIDNEY TRANSPLANT REJEC- TION	0.0% (0/220)	0.0% (0/111)	0.5% (1/220)	0.0% (0/111)
INFECTIONS AND INFESTA- TIONS^a	3.6% (8/220)	1.8% (2/111)	16.4% (36/220)	13.5% (15/111)
ABSCESS	0.0% (0/220)	0.0% (0/111)	0.5% (1/220)	0.0% (0/111)
APPENDICEAL ABSCESS	0.0% (0/220)	0.0% (0/111)	0.5% (1/220)	0.0% (0/111)
APPENDICITIS	0.0% (0/220)	0.0% (0/111)	0.5% (1/220)	0.0% (0/111)
ARTHRITIS BACTERIAL	0.5% (1/220)	0.0% (0/111)	0.5% (1/220)	0.0% (0/111)
ARTHRITIS INFECTIVE	0.0% (0/220)	0.0% (0/111)	0.5% (1/220)	0.0% (0/111)
BILIARY SEPSIS	0.5% (1/220)	0.0% (0/111)	0.5% (1/220)	0.0% (0/111)
BRONCHIECTASIS	0.0% (0/220)	0.9% (1/111)	0.0% (0/220)	0.9% (1/111)
BRONCHITIS	0.0% (0/220)	0.0% (0/111)	0.5% (1/220)	0.0% (0/111)
BRONCHOPNEUMONIA	0.0% (0/220)	0.0% (0/111)	0.5% (1/220)	0.9% (1/111)
CELLULITIS	0.0% (0/220)	0.0% (0/111)	0.9% (2/220)	2.7% (3/111)
CLOSTRIDIAL INFECTION	0.0% (0/220)	0.0% (0/111)	0.0% (0/220)	0.9% (1/111)
CLOSTRIDIUM DIFFICILE COL- ITIS	0.0% (0/220)	0.0% (0/111)	0.5% (1/220)	0.0% (0/111)
CYSTITIS	0.0% (0/220)	0.0% (0/111)	0.0% (0/220)	0.9% (1/111)
DEVICE RELATED INFECTION	0.0% (0/220)	0.0% (0/111)	0.5% (1/220)	0.0% (0/111)
DIVERTICULITIS	0.0% (0/220)	0.0% (0/111)	0.9% (2/220)	0.0% (0/111)
EAR INFECTION	0.0% (0/220)	0.0% (0/111)	0.5% (1/220)	0.0% (0/111)
GANGRENE	0.9% (2/220)	0.0% (0/111)	0.9% (2/220)	0.9% (1/111)
GASTROENTERITIS	0.5% (1/220)	0.0% (0/111)	0.9% (2/220)	0.0% (0/111)
HERPES ZOSTER	0.0% (0/220)	0.0% (0/111)	0.5% (1/220)	0.0% (0/111)
INFECTED LYMPHOCELE	0.5% (1/220)	0.0% (0/111)	0.5% (1/220)	0.0% (0/111)
INFECTION	0.0% (0/220)	0.0% (0/111)	0.5% (1/220)	0.0% (0/111)
LOBAR PNEUMONIA	0.0% (0/220)	0.0% (0/111)	0.5% (1/220)	0.0% (0/111)

Serious Adverse Events	Through 1-Year		Through 5-Year	
	IN.PACT DCB (N=220 Subjects)	Standard PTA (N=111 Subjects)	IN.PACT DCB (N=220 Subjects)	Standard PTA (N=111 Subjects)
LOCALISED INFECTION	0.5% (1/220)	0.0% (0/111)	0.5% (1/220)	0.0% (0/111)
MEDIASTINITIS	0.0% (0/220)	0.0% (0/111)	0.5% (1/220)	0.0% (0/111)
ORCHITIS	0.0% (0/220)	0.0% (0/111)	0.0% (0/220)	0.9% (1/111)
OSTEOMYELITIS	0.0% (0/220)	0.9% (1/111)	0.9% (2/220)	3.6% (4/111)
PNEUMONIA	0.5% (1/220)	0.0% (0/111)	5.5% (12/220)	2.7% (3/111)
PNEUMONIA PRIMARY ATYPICAL	0.0% (0/220)	0.0% (0/111)	0.5% (1/220)	0.0% (0/111)
POST PROCEDURAL INFECTION	0.0% (0/220)	0.0% (0/111)	0.5% (1/220)	0.0% (0/111)
SEPSIS	0.5% (1/220)	0.0% (0/111)	2.3% (5/220)	3.6% (4/111)
SEPTIC SHOCK	0.0% (0/220)	0.0% (0/111)	0.9% (2/220)	0.0% (0/111)
STAPHYLOCOCCAL OSTEO-MYELITIS	0.0% (0/220)	0.0% (0/111)	0.0% (0/220)	0.9% (1/111)
SUBCUTANEOUS ABSCESS	0.0% (0/220)	0.0% (0/111)	0.0% (0/220)	0.9% (1/111)
UPPER RESPIRATORY TRACT INFECTION	0.0% (0/220)	0.0% (0/111)	0.0% (0/220)	0.9% (1/111)
URINARY TRACT INFECTION	0.5% (1/220)	0.0% (0/111)	0.9% (2/220)	1.8% (2/111)
UROSEPSIS	0.0% (0/220)	0.0% (0/111)	0.9% (2/220)	1.8% (2/111)
WEST NILE VIRAL INFECTION	0.5% (1/220)	0.0% (0/111)	0.5% (1/220)	0.0% (0/111)
INJURY, POISONING AND PROCEDURAL COMPLICATIONS^a	5.9% (13/220)	12.6% (14/111)	21.8% (48/220)	24.3% (27/111)
ANAEMIA POSTOPERATIVE	0.0% (0/220)	0.0% (0/111)	0.5% (1/220)	0.0% (0/111)
ARTERIAL RESTENOSIS	0.5% (1/220)	3.6% (4/111)	5.5% (12/220)	13.5% (15/111)
BRAIN CONTUSION	0.0% (0/220)	0.0% (0/111)	0.0% (0/220)	0.9% (1/111)
BURNS SECOND DEGREE	0.0% (0/220)	0.0% (0/111)	0.0% (0/220)	0.9% (1/111)
CLAVICLE FRACTURE	0.0% (0/220)	0.0% (0/111)	0.0% (0/220)	0.9% (1/111)
CONTUSION	0.0% (0/220)	0.0% (0/111)	0.0% (0/220)	0.9% (1/111)
DELAYED RECOVERY FROM ANAESTHESIA	0.0% (0/220)	0.0% (0/111)	0.5% (1/220)	0.0% (0/111)
FACIAL BONES FRACTURE	0.5% (1/220)	0.0% (0/111)	0.5% (1/220)	0.0% (0/111)
FALL	0.0% (0/220)	0.9% (1/111)	0.0% (0/220)	0.9% (1/111)
FEMORAL NECK FRACTURE	0.5% (1/220)	0.9% (1/111)	1.4% (3/220)	0.9% (1/111)
FIBULA FRACTURE	0.5% (1/220)	0.0% (0/111)	0.5% (1/220)	0.0% (0/111)
FRACTURED COCCYX	0.5% (1/220)	0.0% (0/111)	0.5% (1/220)	0.0% (0/111)
HIP FRACTURE	0.0% (0/220)	0.0% (0/111)	0.9% (2/220)	0.9% (1/111)
IN-STENT ARTERIAL RESTENOSIS	1.4% (3/220)	0.9% (1/111)	7.3% (16/220)	0.9% (1/111)
IN-STENT CORONARY ARTERY RESTENOSIS	0.5% (1/220)	0.0% (0/111)	0.5% (1/220)	0.0% (0/111)
INCISIONAL HERNIA	0.0% (0/220)	0.0% (0/111)	0.5% (1/220)	0.0% (0/111)
LUMBAR VERTEBRAL FRACTURE	0.5% (1/220)	0.0% (0/111)	0.9% (2/220)	0.0% (0/111)
OVERDOSE	0.0% (0/220)	0.0% (0/111)	0.5% (1/220)	0.0% (0/111)
PATELLA FRACTURE	0.0% (0/220)	0.0% (0/111)	0.5% (1/220)	0.0% (0/111)
PERIPHERAL ARTERIAL REOCCLUSION	0.0% (0/220)	3.6% (4/111)	0.9% (2/220)	1.8% (2/111)
POST PROCEDURAL HAEMORRHAGE	0.0% (0/220)	0.0% (0/111)	0.5% (1/220)	0.0% (0/111)
RENAL INJURY	0.0% (0/220)	0.0% (0/111)	0.0% (0/220)	0.9% (1/111)
RIB FRACTURE	0.0% (0/220)	0.0% (0/111)	0.0% (0/220)	2.7% (3/111)
SHUNT MALFUNCTION	0.0% (0/220)	0.0% (0/111)	0.5% (1/220)	0.0% (0/111)
SHUNT STENOSIS	0.0% (0/220)	0.0% (0/111)	0.5% (1/220)	0.0% (0/111)

Serious Adverse Events	Through 1-Year		Through 5-Year	
	IN.PACT DCB (N=220 Subjects)	Standard PTA (N=111 Subjects)	IN.PACT DCB (N=220 Subjects)	Standard PTA (N=111 Subjects)
SPINAL COMPRESSION FRACTURE	0.0% (0/220)	0.0% (0/111)	0.5% (1/220)	0.9% (1/111)
SUBDURAL HAEMATOMA	0.0% (0/220)	0.0% (0/111)	0.0% (0/220)	0.9% (1/111)
TRACHEAL INJURY	0.0% (0/220)	0.0% (0/111)	0.5% (1/220)	0.0% (0/111)
UPPER LIMB FRACTURE	0.0% (0/220)	0.0% (0/111)	0.5% (1/220)	0.0% (0/111)
URETHRAL INJURY	0.0% (0/220)	0.0% (0/111)	0.5% (1/220)	0.0% (0/111)
VASCULAR GRAFT OCCLUSION	0.5% (1/220)	0.0% (0/111)	0.9% (2/220)	0.9% (1/111)
VASCULAR PSEUDOANEURYSM	1.4% (3/220)	2.7% (3/111)	2.7% (6/220)	2.7% (3/111)
INVESTIGATIONS^a	0.0% (0/220)	0.9% (1/111)	0.9% (2/220)	1.8% (2/111)
GENERAL PHYSICAL CONDITION ABNORMAL	0.0% (0/220)	0.0% (0/111)	0.5% (1/220)	0.0% (0/111)
INTERNATIONAL NORMALISED RATIO INCREASED	0.0% (0/220)	0.0% (0/111)	0.5% (1/220)	0.0% (0/111)
OXYGEN SATURATION DECREASED	0.0% (0/220)	0.0% (0/111)	0.0% (0/220)	0.9% (1/111)
PROSTATIC SPECIFIC ANTIGEN INCREASED	0.0% (0/220)	0.9% (1/111)	0.0% (0/220)	0.9% (1/111)
METABOLISM AND NUTRITION DISORDERS^a	1.4% (3/220)	0.0% (0/111)	1.4% (3/220)	0.0% (0/111)
DEHYDRATION	0.0% (0/220)	0.0% (0/111)	0.0% (0/220)	0.9% (1/111)
DIABETIC FOOT	0.0% (0/220)	0.0% (0/111)	0.0% (0/220)	0.9% (1/111)
FLUID RETENTION	0.0% (0/220)	0.0% (0/111)	0.5% (1/220)	0.0% (0/111)
HYPERCALCAEMIA	0.0% (0/220)	0.0% (0/111)	0.5% (1/220)	0.0% (0/111)
HYPERGLYCAEMIA	0.5% (1/220)	0.0% (0/111)	0.9% (2/220)	0.0% (0/111)
HYPERKALAEMIA	0.5% (1/220)	0.0% (0/111)	0.5% (1/220)	0.0% (0/111)
HYPONATRAEMIA	0.0% (0/220)	0.0% (0/111)	0.5% (1/220)	0.0% (0/111)
OBESITY	0.5% (1/220)	0.0% (0/111)	0.5% (1/220)	0.0% (0/111)
URAEMIC ACIDOSIS	0.0% (0/220)	0.0% (0/111)	0.5% (1/220)	0.0% (0/111)
MUSCULOSKELETAL AND CONNECTIVE TISSUE DISORDERS^a	4.5% (10/220)	4.5% (5/111)	8.2% (18/220)	9.9% (11/111)
ARTHRALGIA	0.0% (0/220)	0.0% (0/111)	0.9% (2/220)	0.0% (0/111)
BACK PAIN	0.5% (1/220)	0.9% (1/111)	0.5% (1/220)	2.7% (3/111)
BURSITIS	0.0% (0/220)	0.0% (0/111)	0.5% (1/220)	0.0% (0/111)
EXOSTOSIS	0.5% (1/220)	0.0% (0/111)	0.5% (1/220)	0.0% (0/111)
FISTULA	0.0% (0/220)	0.0% (0/111)	0.0% (0/220)	0.9% (1/111)
INTERVERTEBRAL DISC PROTRUSION	0.0% (0/220)	0.9% (1/111)	0.0% (0/220)	0.9% (1/111)
LUMBAR SPINAL STENOSIS	0.9% (2/220)	0.9% (1/111)	0.9% (2/220)	1.8% (2/111)
MUSCULOSKELETAL PAIN	0.5% (1/220)	0.0% (0/111)	0.5% (1/220)	0.9% (1/111)
OSTEOARTHRITIS	0.9% (2/220)	0.0% (0/111)	1.4% (3/220)	0.9% (1/111)
PAIN IN EXTREMITY	0.9% (2/220)	0.9% (1/111)	3.2% (7/220)	0.9% (1/111)
PATELLOFEMORAL PAIN SYNDROME	0.0% (0/220)	0.0% (0/111)	0.0% (0/220)	0.9% (1/111)
RHABDOMYOLYSIS	0.0% (0/220)	0.0% (0/111)	0.5% (1/220)	0.0% (0/111)
SPINAL COLUMN STENOSIS	0.0% (0/220)	0.9% (1/111)	0.0% (0/220)	1.8% (2/111)
SPINAL OSTEOARTHRITIS	0.5% (1/220)	0.0% (0/111)	0.5% (1/220)	0.0% (0/111)
SPONDYLOLISTHESIS	0.5% (1/220)	0.0% (0/111)	0.5% (1/220)	0.0% (0/111)
SYNOVIAL CYST	0.5% (1/220)	0.0% (0/111)	0.5% (1/220)	0.0% (0/111)
TENOSYNOVITIS	0.0% (0/220)	0.0% (0/111)	0.5% (1/220)	0.0% (0/111)

Serious Adverse Events	Through 1-Year		Through 5-Year	
	IN.PACT DCB (N=220 Subjects)	Standard PTA (N=111 Subjects)	IN.PACT DCB (N=220 Subjects)	Standard PTA (N=111 Subjects)
NEOPLASMS BENIGN, MALIGNANT AND UNSPECIFIED (INCL CYSTS AND POLYPS)^a	0.9% (2/220)	4.5% (5/111)	8.6% (19/220)	13.5% (15/111)
ADENOCARCINOMA	0.0% (0/220)	0.0% (0/111)	0.5% (1/220)	0.0% (0/111)
ADENOCARCINOMA PANCREAS	0.0% (0/220)	0.0% (0/111)	0.5% (1/220)	0.0% (0/111)
B-CELL LYMPHOMA	0.0% (0/220)	0.0% (0/111)	0.5% (1/220)	0.0% (0/111)
BASAL CELL CARCINOMA	0.0% (0/220)	0.9% (1/111)	0.0% (0/220)	0.9% (1/111)
BLADDER CANCER	0.0% (0/220)	0.9% (1/111)	0.5% (1/220)	0.9% (1/111)
BLADDER NEOPLASM	0.0% (0/220)	0.0% (0/111)	0.5% (1/220)	0.0% (0/111)
BLADDER TRANSITIONAL CELL CARCINOMA	0.0% (0/220)	0.0% (0/111)	0.5% (1/220)	0.0% (0/111)
BREAST CANCER	0.0% (0/220)	0.0% (0/111)	0.0% (0/220)	0.9% (1/111)
BRONCHIAL CARCINOMA	0.0% (0/220)	0.0% (0/111)	0.9% (2/220)	0.9% (1/111)
COLON CANCER	0.0% (0/220)	0.0% (0/111)	0.9% (2/220)	0.9% (1/111)
COLON CANCER METASTATIC	0.0% (0/220)	0.9% (1/111)	0.0% (0/220)	0.9% (1/111)
GASTROINTESTINAL CARCINOMA	0.0% (0/220)	0.0% (0/111)	0.5% (1/220)	0.0% (0/111)
KERATOACANTHOMA	0.0% (0/220)	0.0% (0/111)	0.5% (1/220)	0.0% (0/111)
LEUKAEMIA	0.0% (0/220)	0.0% (0/111)	0.5% (1/220)	0.0% (0/111)
LIPOMA	0.0% (0/220)	0.9% (1/111)	0.0% (0/220)	0.9% (1/111)
LUNG NEOPLASM	0.0% (0/220)	0.0% (0/111)	0.0% (0/220)	0.9% (1/111)
LUNG NEOPLASM MALIGNANT	0.0% (0/220)	0.0% (0/111)	0.9% (2/220)	1.8% (2/111)
LUNG SQUAMOUS CELL CARCINOMA STAGE UNSPECIFIED	0.0% (0/220)	0.0% (0/111)	0.5% (1/220)	1.8% (2/111)
MYELOID LEUKAEMIA	0.0% (0/220)	0.0% (0/111)	0.5% (1/220)	0.0% (0/111)
NEOPLASM MALIGNANT	0.0% (0/220)	0.0% (0/111)	0.0% (0/220)	0.9% (1/111)
NON-SMALL CELL LUNG CANCER	0.0% (0/220)	0.0% (0/111)	0.0% (0/220)	0.9% (1/111)
PROSTATE CANCER	0.5% (1/220)	0.0% (0/111)	0.5% (1/220)	0.0% (0/111)
RECTAL ADENOMA	0.0% (0/220)	0.0% (0/111)	0.5% (1/220)	0.0% (0/111)
RENAL CANCER	0.0% (0/220)	0.9% (1/111)	0.0% (0/220)	0.9% (1/111)
RENAL CELL CARCINOMA	0.0% (0/220)	0.0% (0/111)	0.9% (2/220)	0.0% (0/111)
SALIVARY GLAND NEOPLASM	0.0% (0/220)	0.0% (0/111)	0.5% (1/220)	0.0% (0/111)
SMALL CELL LUNG CANCER STAGE UNSPECIFIED	0.0% (0/220)	0.0% (0/111)	0.0% (0/220)	0.9% (1/111)
TONSIL CANCER	0.5% (1/220)	0.0% (0/111)	0.5% (1/220)	0.0% (0/111)
NERVOUS SYSTEM DISORDERS^a	5.0% (11/220)	6.3% (7/111)	19.1% (42/220)	14.4% (16/111)
AMNESIA	0.5% (1/220)	0.0% (0/111)	0.5% (1/220)	0.0% (0/111)
BALANCE DISORDER	0.0% (0/220)	0.0% (0/111)	0.5% (1/220)	0.0% (0/111)
BRAIN STEM STROKE	0.0% (0/220)	0.0% (0/111)	0.5% (1/220)	0.0% (0/111)
CAROTID ARTERY DISEASE	0.0% (0/220)	0.9% (1/111)	0.0% (0/220)	1.8% (2/111)
CAROTID ARTERY STENOSIS	0.5% (1/220)	1.8% (2/111)	3.6% (8/220)	4.5% (5/111)
CARPAL TUNNEL SYNDROME	0.0% (0/220)	0.0% (0/111)	0.0% (0/220)	0.9% (1/111)
CEREBRAL INFARCTION	0.5% (1/220)	0.9% (1/111)	0.5% (1/220)	0.9% (1/111)
CEREBROVASCULAR ACCIDENT	0.5% (1/220)	0.0% (0/111)	1.8% (4/220)	1.8% (2/111)
DEMENTIA	0.0% (0/220)	0.0% (0/111)	0.9% (2/220)	0.0% (0/111)
DIZZINESS	0.0% (0/220)	0.0% (0/111)	0.5% (1/220)	0.0% (0/111)
EMBOLIC CEREBRAL INFARCTION	0.5% (1/220)	0.0% (0/111)	0.5% (1/220)	0.0% (0/111)

Serious Adverse Events	Through 1-Year		Through 5-Year	
	IN.PACT DCB (N=220 Subjects)	Standard PTA (N=111 Subjects)	IN.PACT DCB (N=220 Subjects)	Standard PTA (N=111 Subjects)
ENCEPHALOPATHY	0.0% (0/220)	0.0% (0/111)	0.9% (2/220)	0.9% (1/111)
HAEMORRHAGE INTRACRANIAL	0.5% (1/220)	0.0% (0/111)	0.5% (1/220)	0.0% (0/111)
HAEMORRHAGIC STROKE	0.0% (0/220)	0.0% (0/111)	0.5% (1/220)	0.0% (0/111)
HEPATIC ENCEPHALOPATHY	0.0% (0/220)	0.0% (0/111)	0.5% (1/220)	0.9% (1/111)
HYPOAESTHESIA	0.5% (1/220)	0.0% (0/111)	0.9% (2/220)	0.0% (0/111)
INTRACRANIAL HAEMATOMA	0.0% (0/220)	0.0% (0/111)	0.5% (1/220)	0.0% (0/111)
LOSS OF CONSCIOUSNESS	0.0% (0/220)	0.0% (0/111)	0.5% (1/220)	0.0% (0/111)
LUMBAR RADICULOPATHY	0.5% (1/220)	0.0% (0/111)	0.9% (2/220)	0.0% (0/111)
ORTHOSTATIC INTOLERANCE	0.0% (0/220)	0.0% (0/111)	0.5% (1/220)	0.0% (0/111)
PARAESTHESIA	0.0% (0/220)	0.9% (1/111)	0.0% (0/220)	0.9% (1/111)
PARKINSON'S DISEASE	0.0% (0/220)	0.0% (0/111)	0.0% (0/220)	0.9% (1/111)
PARTIAL SEIZURES	0.0% (0/220)	0.0% (0/111)	0.5% (1/220)	0.0% (0/111)
PERIODIC LIMB MOVEMENT DISORDER	0.0% (0/220)	0.0% (0/111)	0.5% (1/220)	0.0% (0/111)
PRESYNCOPE	0.0% (0/220)	0.0% (0/111)	0.5% (1/220)	0.0% (0/111)
REVERSIBLE POSTERIOR LEUKOENCEPHALOPATHY SYNDROME	0.0% (0/220)	0.0% (0/111)	0.5% (1/220)	0.0% (0/111)
SYNCOPE	0.5% (1/220)	1.8% (2/111)	2.7% (6/220)	2.7% (3/111)
TRANSIENT ISCHAEMIC ATTACK	1.4% (3/220)	0.0% (0/111)	1.8% (4/220)	0.0% (0/111)
TREMOR	0.0% (0/220)	0.0% (0/111)	0.5% (1/220)	0.0% (0/111)
VISUAL PATHWAY DISORDER	0.0% (0/220)	0.0% (0/111)	0.0% (0/220)	0.9% (1/111)
PSYCHIATRIC DISORDERS^a	0.0% (0/220)	0.0% (0/111)	0.0% (0/220)	2.7% (3/111)
COMPLETED SUICIDE	0.0% (0/220)	0.0% (0/111)	0.0% (0/220)	0.9% (1/111)
DELIRIUM TREMENS	0.0% (0/220)	0.0% (0/111)	0.0% (0/220)	0.9% (1/111)
MENTAL STATUS CHANGES	0.0% (0/220)	0.0% (0/111)	0.0% (0/220)	0.9% (1/111)
RENAL AND URINARY DISORDERS^a	0.5% (1/220)	2.7% (3/111)	8.2% (18/220)	6.3% (7/111)
CALCULUS URETERIC	0.0% (0/220)	0.0% (0/111)	0.0% (0/220)	0.9% (1/111)
CALCULUS URINARY	0.0% (0/220)	0.0% (0/111)	0.5% (1/220)	0.0% (0/111)
CYSTITIS HAEMORRHAGIC	0.0% (0/220)	0.0% (0/111)	0.5% (1/220)	0.0% (0/111)
HAEMATURIA	0.0% (0/220)	0.9% (1/111)	0.9% (2/220)	1.8% (2/111)
HAEMORRHAGE URINARY TRACT	0.0% (0/220)	0.0% (0/111)	0.5% (1/220)	0.0% (0/111)
HYDRONEPHROSIS	0.0% (0/220)	0.0% (0/111)	0.0% (0/220)	0.9% (1/111)
NEPHROLITHIASIS	0.0% (0/220)	0.0% (0/111)	0.0% (0/220)	0.9% (1/111)
RENAL ARTERY STENOSIS	0.0% (0/220)	0.0% (0/111)	0.9% (2/220)	0.9% (1/111)
RENAL COLIC	0.0% (0/220)	0.9% (1/111)	0.0% (0/220)	0.0% (0/111)
RENAL CYST	0.0% (0/220)	0.0% (0/111)	0.0% (0/220)	0.9% (1/111)
RENAL FAILURE	0.0% (0/220)	0.9% (1/111)	1.8% (4/220)	2.7% (3/111)
RENAL FAILURE ACUTE	0.5% (1/220)	0.0% (0/111)	3.6% (8/220)	0.9% (1/111)
RENAL FAILURE CHRONIC	0.0% (0/220)	0.0% (0/111)	0.5% (1/220)	0.0% (0/111)
REPRODUCTIVE SYSTEM AND BREAST DISORDERS^a	0.5% (1/220)	0.0% (0/111)	0.5% (1/220)	0.9% (1/111)
BENIGN PROSTATIC HYPERPLASIA	0.0% (0/220)	0.0% (0/111)	0.0% (0/220)	0.9% (1/111)
POSTMENOPAUSAL HAEMORRHAGE	0.5% (1/220)	0.0% (0/111)	0.5% (1/220)	0.0% (0/111)
RESPIRATORY, THORACIC AND MEDIASTINAL DISORDERS^a	1.4% (3/220)	0.9% (1/111)	12.7% (28/220)	9.0% (10/111)

Serious Adverse Events	Through 1-Year		Through 5-Year	
	IN.PACT DCB (N=220 Subjects)	Standard PTA (N=111 Subjects)	IN.PACT DCB (N=220 Subjects)	Standard PTA (N=111 Subjects)
ACUTE PULMONARY EDEMA	0.5% (1/220)	0.0% (0/111)	0.5% (1/220)	0.0% (0/111)
ACUTE RESPIRATORY FAILURE	0.0% (0/220)	0.0% (0/111)	3.2% (7/220)	0.9% (1/111)
CHRONIC OBSTRUCTIVE PULMONARY DISEASE	0.5% (1/220)	0.0% (0/111)	2.3% (5/220)	2.7% (3/111)
DYSPNOEA	0.0% (0/220)	0.0% (0/111)	1.4% (3/220)	2.7% (3/111)
DYSPNOEA EXERTIONAL	0.5% (1/220)	0.0% (0/111)	1.4% (3/220)	0.0% (0/111)
HAEMOPTYSIS	0.0% (0/220)	0.0% (0/111)	0.0% (0/220)	0.9% (1/111)
HAEMOTHORAX	0.0% (0/220)	0.0% (0/111)	0.0% (0/220)	0.9% (1/111)
PLEURAL EFFUSION	0.0% (0/220)	0.0% (0/111)	1.4% (3/220)	0.0% (0/111)
PNEUMONIA ASPIRATION	0.0% (0/220)	0.0% (0/111)	0.9% (2/220)	0.0% (0/111)
PNEUMONITIS	0.0% (0/220)	0.0% (0/111)	0.9% (2/220)	0.0% (0/111)
PNEUMOTHORAX	0.0% (0/220)	0.0% (0/111)	0.5% (1/220)	0.0% (0/111)
PULMONARY CONGESTION	0.0% (0/220)	0.0% (0/111)	0.5% (1/220)	0.0% (0/111)
PULMONARY EMBOLISM	0.0% (0/220)	0.0% (0/111)	0.5% (1/220)	0.0% (0/111)
PULMONARY FIBROSIS	0.0% (0/220)	0.0% (0/111)	0.5% (1/220)	0.0% (0/111)
PULMONARY HYPERTENSION	0.0% (0/220)	0.0% (0/111)	0.5% (1/220)	0.0% (0/111)
PULMONARY OEDEMA	0.0% (0/220)	0.0% (0/111)	0.5% (1/220)	0.0% (0/111)
RESPIRATORY FAILURE	0.5% (1/220)	0.9% (1/111)	1.8% (4/220)	0.9% (1/111)
SLEEP APNOEA SYNDROME	0.0% (0/220)	0.0% (0/111)	0.9% (2/220)	0.0% (0/111)
SKIN AND SUBCUTANEOUS TISSUE DISORDERS^a	0.0% (0/220)	1.8% (2/111)	1.4% (3/220)	3.6% (4/111)
DECUBITUS ULCER	0.0% (0/220)	0.0% (0/111)	0.0% (0/220)	0.9% (1/111)
DRY GANGRENE	0.0% (0/220)	0.9% (1/111)	0.0% (0/220)	0.9% (1/111)
INGROWING NAIL	0.0% (0/220)	0.0% (0/111)	0.5% (1/220)	0.0% (0/111)
LICHENIFICATION	0.0% (0/220)	0.0% (0/111)	0.0% (0/220)	0.9% (1/111)
NEUROPATHIC ULCER	0.0% (0/220)	0.9% (1/111)	0.0% (0/220)	0.9% (1/111)
SKIN NECROSIS	0.0% (0/220)	0.0% (0/111)	0.5% (1/220)	0.0% (0/111)
SKIN ULCER	0.0% (0/220)	0.0% (0/111)	0.5% (1/220)	0.9% (1/111)
SUBCUTANEOUS EMPHYSEMA	0.0% (0/220)	0.0% (0/111)	0.5% (1/220)	0.0% (0/111)
SURGICAL AND MEDICAL PROCEDURES^a	0.9% (2/220)	0.9% (1/111)	1.4% (3/220)	5.4% (6/111)
ANGIOPLASTY	0.0% (0/220)	0.0% (0/111)	0.0% (0/220)	0.9% (1/111)
CAROTID ENDARTERECTOMY	0.0% (0/220)	0.0% (0/111)	0.0% (0/220)	0.9% (1/111)
CORONARY REVASCULARISATION	0.0% (0/220)	0.0% (0/111)	0.5% (1/220)	0.0% (0/111)
DEBRIDEMENT	0.0% (0/220)	0.0% (0/111)	0.0% (0/220)	0.9% (1/111)
IMPLANTABLE DEFIBRILLATOR REPLACEMENT	0.0% (0/220)	0.0% (0/111)	0.0% (0/220)	0.9% (1/111)
JOINT SURGERY	0.5% (1/220)	0.0% (0/111)	0.0% (0/220)	0.0% (0/111)
PERIPHERAL ARTERY ANGIOPLASTY	0.0% (0/220)	0.0% (0/111)	0.5% (1/220)	0.0% (0/111)
PERIPHERAL REVASCULARISATION	0.0% (0/220)	0.9% (1/111)	0.0% (0/220)	0.9% (1/111)
REMOVAL OF FOREIGN BODY FROM EYE	0.0% (0/220)	0.0% (0/111)	0.0% (0/220)	0.9% (1/111)
THERAPEUTIC EMBOLISATION	0.5% (1/220)	0.0% (0/111)	0.5% (1/220)	0.0% (0/111)
VASCULAR DISORDERS^a	22.7% (50/220)	35.1% (39/111)	46.8% (103/220)	57.7% (64/111)
AORTIC ANEURYSM	0.0% (0/220)	0.0% (0/111)	0.5% (1/220)	0.9% (1/111)
AORTIC DILATATION	0.0% (0/220)	0.0% (0/111)	0.5% (1/220)	0.0% (0/111)
AORTIC STENOSIS	0.0% (0/220)	0.0% (0/111)	0.9% (2/220)	2.7% (3/111)

Serious Adverse Events	Through 1-Year		Through 5-Year	
	IN.PACT DCB (N=220 Subjects)	Standard PTA (N=111 Subjects)	IN.PACT DCB (N=220 Subjects)	Standard PTA (N=111 Subjects)
ARTERIAL OCCLUSIVE DISEASE	0.5% (1/220)	0.0% (0/111)	0.9% (2/220)	0.0% (0/111)
ARTERIAL STENOSIS LIMB	0.5% (1/220)	2.7% (3/111)	3.2% (7/220)	5.4% (6/111)
ARTERIAL THROMBOSIS LIMB	0.0% (0/220)	0.0% (0/111)	0.5% (1/220)	1.8% (2/111)
ARTERIOVENOUS FISTULA	0.0% (0/220)	1.8% (2/111)	0.0% (0/220)	2.7% (3/111)
ARTERY DISSECTION	3.2% (7/220)	1.8% (2/111)	5.5% (12/220)	6.3% (7/111)
DEEP VEIN THROMBOSIS	0.0% (0/220)	0.0% (0/111)	0.0% (0/220)	0.9% (1/111)
EMBOLISM	0.0% (0/220)	0.0% (0/111)	0.5% (1/220)	0.0% (0/111)
FEMORAL ARTERIAL STENOSIS	6.8% (15/220)	9.0% (10/111)	18.6% (41/220)	20.7% (23/111)
FEMORAL ARTERY DISSECTION	1.8% (4/220)	4.5% (5/111)	1.4% (3/220)	1.8% (2/111)
FEMORAL ARTERY OCCLUSION	1.4% (3/220)	4.5% (5/111)	5.9% (13/220)	9.0% (10/111)
HAEMATOMA	0.0% (0/220)	0.9% (1/111)	0.9% (2/220)	0.9% (1/111)
HAEMORRHAGE	0.5% (1/220)	0.0% (0/111)	0.5% (1/220)	0.0% (0/111)
HYPERTENSION	0.0% (0/220)	0.0% (0/111)	1.4% (3/220)	0.0% (0/111)
HYPERTENSIVE CRISIS	0.0% (0/220)	0.0% (0/111)	2.3% (5/220)	2.7% (3/111)
HYPOTENSION	0.5% (1/220)	0.0% (0/111)	0.9% (2/220)	0.9% (1/111)
ILIAC ARTERY OCCLUSION	0.0% (0/220)	0.0% (0/111)	0.5% (1/220)	0.0% (0/111)
ILIAC ARTERY STENOSIS	0.9% (2/220)	0.9% (1/111)	5.0% (11/220)	3.6% (4/111)
INTERMITTENT CLAUDICATION	3.2% (7/220)	9.9% (11/111)	9.1% (20/220)	13.5% (15/111)
LABILE HYPERTENSION	0.0% (0/220)	0.0% (0/111)	0.5% (1/220)	0.0% (0/111)
LYMPHOCELE	0.0% (0/220)	0.0% (0/111)	0.0% (0/220)	0.9% (1/111)
ORTHOSTATIC HYPOTENSION	0.5% (1/220)	0.9% (1/111)	0.5% (1/220)	0.9% (1/111)
PERIPHERAL ARTERIAL OCCLUSIVE DISEASE	3.6% (8/220)	4.5% (5/111)	9.5% (21/220)	8.1% (9/111)
PERIPHERAL ARTERY DISSECTION	1.4% (3/220)	3.6% (4/111)	1.8% (4/220)	1.8% (2/111)
PERIPHERAL EMBOLISM	0.5% (1/220)	0.9% (1/111)	0.5% (1/220)	0.9% (1/111)
PERIPHERAL ISCHAEMIA	0.9% (2/220)	1.8% (2/111)	1.8% (4/220)	3.6% (4/111)
PERIPHERAL VASCULAR DISORDER	0.9% (2/220)	0.0% (0/111)	3.6% (8/220)	3.6% (4/111)
SHOCK HAEMORRHAGIC	0.5% (1/220)	0.0% (0/111)	0.5% (1/220)	0.0% (0/111)
SUBCLAVIAN ARTERY STENOSIS	0.0% (0/220)	0.9% (1/111)	0.0% (0/220)	0.9% (1/111)
VENOUS INSUFFICIENCY	0.0% (0/220)	0.0% (0/111)	0.5% (1/220)	0.0% (0/111)
VESSEL PERFORATION	0.0% (0/220)	0.0% (0/111)	0.5% (1/220)	0.0% (0/111)
TOTAL SERIOUS ADVERSE EVENTS	195	118	770	363

Numbers are % (counts/sample size).

^a Event verbatim terms are reported by sites. The events listed in this table are then coded using MedDRA version 13.0 and then stratified by System-Organ Class (SOC) and Preferred Term. Patients may be counted in this table more than once by Preferred Term, but are only counted once in the SOC summary line.

11.4. Pharmacokinetic Sub-study

Human pharmacokinetics was investigated as a sub-study of the IN.PACT SFA Trial. This sub-study was a prospective, multi-center, non-randomized study arm (IN.PACT Admiral DCB) conducted at multiple prespecified investigational sites, designed to evaluate the levels of paclitaxel in the systemic circulation of subjects at multiple time points. Pharmacokinetic parameters were determined for a total of 24 subjects (16 male and 8 female). A summary of the pharmacokinetic parameters is presented in Summary of Pharmacokinetic Parameters (Table 15). The pharmacokinetic sub-study demonstrated low systemic exposure with rapid clearance of paclitaxel.

Table 15. Summary of Pharmacokinetic Parameters

Parameter	Mean (N=24)	Standard Deviation	%CV	Range
T _{max} (hr)	0.17	0.067	38.8	0.07 – 0.32
C _{max} (ng/mL)	7.9	7.70	97.9	1.0 - 35.9
AUC _{0-last} (hr*ng/mL)	29.4	22.06	75.0	3.2 – 91.6
AUC _{0-inf} (hr*ng/mL)	47.8	28.98	60.6	11.4 – 128.8
T _{1/2} (hr)	72.5	39.70	54.7	8.2 – 153.5
CL/F (L/hr)	192.2	103.44	53.8	54.7 – 472.7
T _{max} (hr)	The timepoint where C _{max} is reached			
C _{max} (ng/mL)	Maximum plasma concentration			
AUC _{0-last} (hr*ng/mL)	Area under plasma concentration-time curve from time zero to time of last measurable concentration			
AUC _{0-inf} (hr*ng/mL)	Area under the plasma concentration-time curve from time zero extrapolated to infinity			
T _{1/2} (hr)	Terminal half-life			
CL/F (L/hr)	Apparent clearance			

11.5. IN.PACT Global Study

11.5.1. Study Overview

The IN.PACT Global Study is a prospective, multi-center, single-arm study designed to collect and assess global safety and effectiveness data on the IN.PACT Admiral DCB in treatment of atherosclerotic disease of the superficial femoral and/or popliteal arteries in a “real-world” population. The study is estimated to continue follow-up through 2019. The study will enroll approximately 1500 subjects at more than 60 sites in Europe, Australia, Asia, Northern Africa, Canada, the Middle East, and South America. Follow-up will be completed at 30 days, 6 months, and 12 months and 2, 3, 4, and 5 years. The interim data from the IN.PACT Global Study that were available at the time were provided to FDA for consideration as part of the PMA submission.

11.6. Summary of Rare Adverse Events

Medtronic has provided an evaluation of rare adverse events (RAE) in more than 800 subjects from the IN.PACT SFA Trial, the IN.PACT SFA PK Sub-study, and the IN.PACT Global Study.

The following RAEs were adjudicated by the independent Clinical Events Committees (CEC): paclitaxel-related vessel thrombosis within 30 days, paclitaxel-related distal embolic events within 360 days, paclitaxel-related neutropenia within 360 days, and paclitaxel-related drug hypersensitivity/reaction within 360 days. The rate of paclitaxel-related thrombosis within 30 days was 0.2% (2/890). There were no paclitaxel-related distal embolic events within 360 days (0/806), paclitaxel-related neutropenia within 360 days (0/806), or paclitaxel-related drug hypersensitivity/reaction within 360 days (0/806).

The current RAE outcomes demonstrate no increased risk of adverse events due to the paclitaxel coating.

11.7. IN.PACT Admiral DCB ISR Clinical Evaluation

11.7.1. Primary Objective

The objective of this clinical evaluation was to assess the safety and effectiveness of the IN.PACT Admiral DCB as compared with PTA when used to treat in-stent restenotic (ISR) lesions of the superficial femoral artery (SFA) or popliteal artery.

11.7.2. Design

This clinical evaluation was designed as an observational, propensity score-adjusted, comparative analysis of IN.PACT Admiral DCB subjects selected from the real-world IN.PACT Global Study (“DCB ISR Cohort”) and PTA subjects provided from the Society of Vascular Surgery (SVS) Vascular Quality Initiative (VQI) Registry database (“PTA ISR Comparator”).

A total of 164 DCB subjects from the IN.PACT Global Study comprised the DCB ISR Cohort, and a total of 153 PTA subjects from the SVS VQI Registry comprised the PTA ISR Comparator. Patients in the DCB ISR Cohort were treated at 31 sites in Austria, Belgium, Canada, Egypt, Germany, Hungary, Italy, The Netherlands, Poland, Singapore, Slovakia, South Korea, and Switzerland between June 6, 2012 and December 16, 2013, and patients in the PTA ISR Comparator were treated at 23 sites in the United States between 2011 and 2014.

The objective of this analysis was to demonstrate that the primary endpoint of 12-month target lesion revascularization (TLR) was significantly lower in the DCB ISR Cohort when compared to the PTA ISR Comparator group for the treatment of ISR.

For the primary effectiveness endpoint of 12-month TLR, the treatment (DCB ISR Cohort) and control (PTA ISR Comparator) groups were compared in a superiority format. Formally, the hypothesis tested was:

H_0 : 12-month TLR rate in subjects in DCB ISR Cohort (p_T) is equal to or higher than that for subjects in PTA ISR Comparator (p_C).

$$H_0: p_T \geq p_C$$

H_A : 12-month TLR rate in subjects in DCB ISR Cohort (p_T) is lower than that for subjects in PTA ISR Comparator (p_C).

$$H_A: p_T < p_C$$

Due to the nature of this non-randomized retrospective comparison, it was necessary to adjust for expected baseline differences between the subjects in the two groups to ensure objectivity of the clinical evaluation design and the validity of the results. As pre-specified in the statistical analysis plan, propensity score analysis was performed using clinically relevant baseline characteristics. The propensity score calculation was carried out by an independent statistician without access to the outcomes of either group. The calculation results were submitted to the FDA for review and approval prior to performing the primary endpoint analyses.

The primary endpoint of the powered statistical analysis comparing ISR outcomes in the DCB ISR Cohort and the PTA ISR Comparator was the incidence of TLR through 12 months.

The clinically relevant secondary endpoints assessed included:

1. All-cause mortality at 30 days, 6 months, and 12 months.
2. Any TVR at 30 days, 6 months, and 12 months.
3. Major target limb amputation at 30 days, 6 months, and 12 months.
4. Time to first TLR through 12 months post-index procedure.
5. Time to all-cause mortality through 12 months post-index procedure.

With regard to success criteria, the study was deemed successful if it demonstrated superiority of the DCB ISR Cohort on the 12-month primary endpoint of target lesion revascularization compared to the PTA ISR Comparator.

11.7.3. Patient Population

Table 16 below presents the baseline demographics and clinical characteristics for the 164 DCB ISR Cohort subjects and the 153 PTA ISR Comparator subjects. These 20 baseline variables were pre-specified as the covariates in the propensity score analysis, and all of the variables were included in the propensity score calculation except for the TASC lesion type due to a missing data rate in the DCB ISR Cohort that exceeded the pre-specified cutoff of 20%.

Table 16. Baseline Demographics and Clinical Characteristics

Baseline Characteristics	DCB ISR Cohort (N=164)	PTA ISR Comparator (N=153)	Propensity Score Adjusted p-value ^a
Baseline Demographics			
Age (yrs)			
Mean±SD (N)	66.95±9.84 (163)	66.79±11.23 (153)	0.795
Median (Q1, Q3)	67.00 (60.00,74.00)	66.00 (58.00,75.00)	
Range (Min, Max)	(39.00,86.00)	(44.00,89.00)	
Male	72.6% (119/164)	51.6% (79/153)	0.536
BMI (kg/m ²)			
Mean±SD (N)	26.34±4.39 (164)	28.21±6.06 (153)	0.835
Median (Q1, Q3)	25.94 (23.63,28.57)	28.00 (24.00,30.00)	
Range (Min, Max)	(16.46,43.26)	(13.00,50.00)	
Ankle-Brachial Index (ABI) (mmHg ratio)			
Mean±SD (N)	0.64±0.22 (147)	0.70±0.41 (140)	0.786
Median (Q1, Q3)	0.65 (0.51,0.77)	0.64 (0.48,0.81)	
Range (Min, Max)	(0.00,1.43)	(0.00,2.00)	
Baseline Clinical Characteristics			
Hypertension	83.4% (136/163)	87.6% (134/153)	0.972
Diabetes	36.6% (60/164)	49.0% (75/153)	0.920
Insulin-dependent Diabetes	16.5% (27/164)	22.9% (35/153)	0.946
On Dialysis	3.0% (5/164)	1.3% (2/153)	0.579
Coronary artery disease	20.5% (30/146)	24.2% (37/153)	0.964
Current smoker	36.0% (59/164)	32.7% (50/153)	0.915
Previous limb amputation (major or minor)	5.5% (9/164)	4.6% (7/153)	0.980

Baseline Characteristics	DCB ISR Cohort (N=164)	PTA ISR Comparator (N=153)	Propensity Score Adjusted p-value ^a
Renal insufficiency (per serum creatinine ≥1.5 mg/dl)	9.5% (14/147)	9.9% (15/151)	0.931
Baseline Lesion and Procedural Characteristics			
TASC lesion type			0.906
A	20.2% (21/104)	30.7% (47/153)	
B	30.8% (32/104)	27.5% (42/153)	
C	36.5% (38/104)	30.1% (46/153)	
D	12.5% (13/104)	11.8% (18/153)	
Lesion length (cm)			0.735
Mean±SD (N)	17.59±10.49 (164)	13.16±9.61 (151)	
Median (Q1, Q3)	16.00 (10.00,27.00)	10.00 (6.00,20.00)	
Range (Min, Max)	(1.00,47.00)	(2.00,47.00)	
Total occlusion	40.9% (67/164)	68.7% (103/150)	0.990
Occluded lesion length (cm)			0.709
Mean±SD (N)	7.47±11.65 (164)	7.87±9.40 (150)	
Median (Q1, Q3)	0.00 (0.00,10.50)	4.00 (0.00,14.00)	
Range (Min, Max)	(0.00,42.00)	(0.00,45.00)	
Pre-op aspirin	95.7% (157/164)	83.0% (127/153)	0.422
Indication of Claudication - Rutherford Classification or equivalent	87.8% (144/164)	74.5% (114/153)	0.633
Lesion Location: SFA	71.3% (117/164)	86.9% (133/153)	0.706
Provisional stent	15.9% (26/164)	33.3% (51/153)	0.814

Numbers are % (counts/sample size) unless otherwise stated.

Categorical variables between groups were compared using the chi-squared test or Fisher's exact test as appropriate, and continuous variables were compared using Student's t-test.

Site reported data.

All of the variables in this table were included in the propensity score calculation except TASC lesion type due to a missing data rate that exceeded the pre-specified cutoff of 20%.

p-values are not adjusted for multiplicity

^a The propensity score adjusted p-value was based on all subjects for each baseline variable. For each variable with missing values (<20%), a gender-specific imputation was performed by replacing the missing values of the variable with the gender-specific median observed value within each group.

Follow-up compliance for the 12-month follow-up visits is presented in Table 17 for the DCB ISR Cohort subjects. The rate of in-window follow-up visit completion at 12 months was 92.3%.

Table 17. Subject Follow-up Compliance – IN.PACT Global DCB ISR Cohort Subjects

Subject Compliance Characteristics ^a	DCB ISR Cohort (N=164 Subjects)
12-Month Follow-up	
Eligible Subjects ^b	155
Death ^c	1
Withdrawal ^c	8
Follow-up Not Done	7
Follow-up Visit Within Window ^d	143
Follow-up Visit Out of Window ^d	5
Follow-up Compliance (%) ^e	92.3%

^a Site reported data

^b Eligible subjects are all subjects who either have a follow-up visit form or are past due for their follow-up (beyond upper limit of window on study and did not exit the study before the upper limit of the window)

^c Death and withdrawal are cumulative

^d Within window visits are defined as: 12-month ± 60 days.

^e Percentage based on number of subjects who had follow-up visit within window divided by total number of eligible subjects

11.7.4. Safety and Effectiveness Results

Primary Endpoint Analysis

The results of the powered statistical analysis comparing the 12-month primary endpoint between the DCB ISR Cohort and the PTA ISR Comparator are shown in Table 18.

The primary endpoint of the clinical evaluation was met, demonstrating superiority of the DCB ISR Cohort over the PTA ISR Comparator on the primary effectiveness endpoint of target lesion revascularization (TLR) at 12 months (10.13% vs. 35.92%, $p < 0.001$).

Table 18. Primary Effectiveness Endpoint Results

	DCB ISR Cohort (N=164)	PTA ISR Comparator (N=153)	Hazard Ratio [95% CI]	p-value ^a
Effectiveness Parameters				
Target Lesion Revascularization at 12 Months	10.13% (16)	35.92% (51)	0.258 [0.128, 0.517]	<0.001

Statistical references:

- Numbers are cumulative incidence % (number of failures) based on Kaplan-Meier method. CI – Confidence Interval
- Analysis sets: The primary analysis set was based on the intent-to-treat (ITT) principle. All subjects enrolled through the selection process specified in SAP Section 3.1 were included as ITT subjects.
- ^a To analyze the treatment differences between the DCB ISR Cohort and PTA ISR Comparator groups in the clinical/safety endpoints such as TLR, a propensity-quintile-stratified Cox proportional hazards model was employed, with time to event as the dependent variable and treatment group as the independent variable.

The Kaplan-Meier analysis of this primary effectiveness endpoint, presented as freedom from target lesion revascularization, is shown in Figure 11.

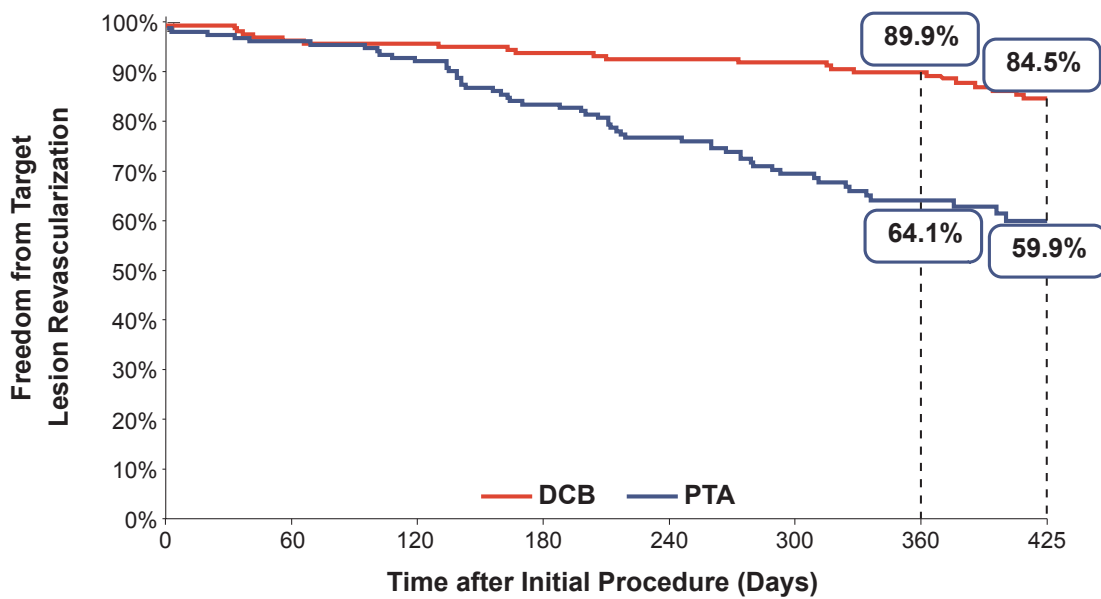

Target Lesion Revascularization	0	1-60	61-120	121-180	181-240	241-300	301-360	361-425
DCB								
# Entered	164	163	154	152	148	143	141	126
# Censored	0	4	1	1	3	0	12	15
# Events	1	5	1	3	2	1	3	7
Survived [%]	99.39%	96.27%	95.65%	93.75%	92.47%	91.82%	89.87%	84.53%
PTA								
# Entered	153	151	144	138	125	113	90	56
# Censored	0	3	0	0	2	13	28	17
# Events	2	4	6	13	10	10	6	3
Survived [%]	98.69%	96.07%	92.06%	83.39%	76.66%	69.40%	64.08%	59.94%

Figure 11. Kaplan-Meier Plot - Event-free from Target Lesion Revascularization through 360 and 425 Days

Secondary Safety and Effectiveness Endpoints

The results of the secondary endpoints for the IN.PACT Admiral DCB ISR Clinical Evaluation are shown in Table 19.

In both the DCB ISR Cohort and the PTA ISR Comparator, there were high rates of acute success. Since the acute success definitions differed, these were not able to be directly compared, but the DCB ISR Cohort had high rates of device success (99.5%), procedural success (99.4%), and clinical success (98.8%), while the PTA ISR Comparator had a high rate of technical success (97.4%). The definitions of each of these endpoints are provided in the footnotes of Table 19.

Clinical safety and effectiveness outcomes were reported at 30 days, 6 months, and 12 months. All event rates were low in both groups at 30 days, but lower event rates were observed at 6 months and at 12 months for both the TLR and the target vessel revascularization (TVR) endpoints in the DCB ISR Cohort. The 12-month TVR rate was 11.41% in the DCB ISR Cohort compared to 38.07% in the PTA ISR Comparator.

There were no major target limb amputations in the DCB ISR Cohort and three major target limb amputations in the PTA ISR Comparator within 12 months. Lastly, there was one death in the DCB ISR Cohort and no deaths in the PTA ISR Comparator within 12 months. One subject in the DCB ISR Cohort experienced a non-cardiac death at day 276 post-index procedure. The independent clinical events committee determined that the event was not device-related and not procedure-related.

Table 19. Secondary Safety and Effectiveness Endpoint Results

	DCB ISR Cohort (N=164)	PTA ISR Comparator (N=153)
Effectiveness Parameters		
Device Success ^a	99.5% (364/366)	NA
Procedural Success ^a	99.4% (163/164)	NA
Clinical Success ^a	98.8% (162/164)	NA
Technical Success ^a	NA	97.4% (149/153)
Safety Parameters		
Cumulative complications within 30 days		
Death (all-cause)	0.00% (0)	0.00% (0)
Target Vessel Revascularization	0.61% (1)	2.61% (4)
Major Target Limb Amputation	0.00% (0)	0.00% (0)
Target Lesion Revascularization	0.61% (1)	2.61% (4)
Cumulative complications within 180 days		
Death (all-cause)	0.00% (0)	0.00% (0)
Target Vessel Revascularization	6.88% (11)	17.28% (26)
Major Target Limb Amputation	0.00% (0)	1.33% (2)
Target Lesion Revascularization	6.25% (10)	16.61% (25)
Cumulative complications within 360 days		
Death (all-cause)	0.65% (1)	0.00% (0)
Target Vessel Revascularization	11.41% (18)	38.07% (54)
Major Target Limb Amputation	0.00% (0)	2.08% (3)

Other Major Secondary Endpoints at 12 Months	DCB ISR Cohort (N=164)	PTA ISR Comparator (N=153)
Time to all-cause mortality (days)		
Mean±SD (N)	276.00 (1)	--
Median	276.00	--
(Min, Max)	(276.00,276.00)	--
Time to first TLR (days)		
Mean±SD (N)	148.44±115.25 (16)	182.33±93.53 (51)
Median	146.50	187.00
(Min, Max)	(0.00,328.00)	(0.00,335.00)

Endpoint definitions:

- Device success (assessed for DCB ISR Cohort only) defined as successful delivery, balloon inflation and deflation and retrieval of the intact study device without burst below the rated burst pressure (RBP).
- Procedure success (assessed for DCB ISR Cohort only) defined as residual stenosis of ≤ 50% (non-stented subjects) or ≤ 30% (stented subjects) by visual estimate.
- Clinical success (assessed for DCB ISR Cohort only) defined as procedural success without procedural complications (mortality, major target limb amputation, thrombosis of the target lesion, or TVR) prior to discharge.
- Technical success (assessed for PTA ISR Comparator only) defined as the ability to cross the lesion without resulting in occlusion and having residual stenosis ≤ 30% and resting systolic pressure gradient < 10 mmHg (if measured).

Statistical references:

- Numbers are cumulative incidence % (number of failures) based on Kaplan-Meier method unless otherwise stated. CI – Confidence Interval
- ^a Numbers are % (counts/sample size)
- Analysis sets: The primary analysis set was based on the intent-to-treat (ITT) principle. All subjects enrolled through the selection process specified in SAP Section 3.1 were included as ITT subjects.

Subgroup Analyses

Medtronic has analyzed the clinical evaluation results by the male and female gender subgroups. Both the male and female gender subgroups showed favorable trends on the primary effectiveness endpoint of 12-month TLR (male subgroup: 8.72% DCB vs. 32.94% PTA, and female subgroup: 14.08% DCB vs. 39.11% PTA). Favorable clinical trends were also noted for the

secondary endpoint of 12-month TVR (male subgroup: 10.48% DCB vs. 34.67% PTA, and female subgroup: 14.08% DCB vs. 41.76% PTA).

Summary of Adverse Events

A serious adverse event was defined in the IN.PACT Global Study protocol as an adverse event that led to death; led to serious deterioration in the health of the subject that resulted in a life-threatening illness or injury, a permanent impairment of a body structure or a body function, in-patient or prolonged hospitalization, or medical or surgical intervention to prevent life-threatening illness or injury or permanent impairment to a body structure of a body function; or led to fetal distress, fetal death or a congenital abnormality or birth defect.

Table 20 provides a summary of serious adverse event rates by system-organ class (SOC) through 360 days occurring in the DCB ISR Cohort.

Table 20. Serious Adverse Event Rates by SOC and Preferred Term through 360 Days – IN.PACT Global DCB ISR Cohort Subjects

Serious Adverse Event	DCB ISR Cohort (N=164 Subjects)
Subjects with One or More Serious Adverse Events	41.5% (68/164)
CARDIAC DISORDERS^a	2.4% (4/164)
ACUTE MYOCARDIAL INFARCTION	0.6% (1/164)
ATRIAL FIBRILLATION	0.6% (1/164)
CONGESTIVE CARDIOMYOPATHY	0.6% (1/164)
CORONARY ARTERY DISEASE	0.6% (1/164)
MYOCARDIAL INFARCTION	0.6% (1/164)
CONGENITAL, FAMILIAL AND GENETIC DISORDERS^a	0.6% (1/164)
CONGENITAL CYSTIC KIDNEY DISEASE	0.6% (1/164)
EYE DISORDERS^a	1.2% (2/164)
CATARACT	0.6% (1/164)
RETINAL ARTERY OCCLUSION	0.6% (1/164)
GASTROINTESTINAL DISORDERS^a	1.2% (2/164)
GASTRITIS	0.6% (1/164)
OESOPHAGEAL HAEMORRHAGE	0.6% (1/164)
GENERAL DISORDERS AND ADMINISTRATION SITE CONDITIONS^a	1.2% (2/164)
DEATH	0.6% (1/164)
DEVICE BREAKAGE	0.6% (1/164)
HEPATOBIILIARY DISORDERS^a	1.2% (2/164)
ACUTE HEPATIC FAILURE	0.6% (1/164)
CHOLECYSTITIS	0.6% (1/164)
CHOLELITHIASIS	0.6% (1/164)
INFECTIONS AND INFESTATIONS^a	3.0% (5/164)
CLOSTRIDIUM DIFFICILE COLITIS	0.6% (1/164)
GANGRENE	0.6% (1/164)
GROIN INFECTION	0.6% (1/164)
PILONIDAL CYST	0.6% (1/164)
PNEUMONIA	0.6% (1/164)
PSEUDOMEMBRANOUS COLITIS	0.6% (1/164)
URINARY TRACT INFECTION	0.6% (1/164)
INJURY, POISONING AND PROCEDURAL COMPLICATIONS^a	7.3% (12/164)
ARTERIAL RESTENOSIS	2.4% (4/164)
IN-STENT ARTERIAL RESTENOSIS	4.3% (7/164)
IN-STENT CORONARY ARTERY RESTENOSIS	0.6% (1/164)
PERIPHERAL ARTERIAL REOCCLUSION	0.6% (1/164)
VASCULAR PSEUDOANEURYSM	1.2% (2/164)
INVESTIGATIONS^a	0.6% (1/164)
INTERNATIONAL NORMALISED RATIO INCREASED	0.6% (1/164)
METABOLISM AND NUTRITION DISORDERS^a	1.2% (2/164)
DIABETES MELLITUS	0.6% (1/164)

Serious Adverse Event	DCB ISR Cohort (N=164 Subjects)
DIABETIC FOOT	0.6% (1/164)
MUSCULOSKELETAL AND CONNECTIVE TISSUE DISORDERS^a	3.7% (6/164)
BACK PAIN	0.6% (1/164)
INTERVERTEBRAL DISC PROTRUSION	0.6% (1/164)
MUSCULOSKELETAL DISORDER	0.6% (1/164)
MYOFASCIAL PAIN SYNDROME	0.6% (1/164)
PAIN IN EXTREMITY	0.6% (1/164)
SPINAL COLUMN STENOSIS	0.6% (1/164)
NEOPLASMS BENIGN, MALIGNANT AND UNSPECIFIED (INCL CYSTS AND POLYPS)^a	3.7% (6/164)
LUNG NEOPLASM	0.6% (1/164)
LUNG NEOPLASM MALIGNANT	0.6% (1/164)
MALIGNANT NEOPLASM PROGRESSION	0.6% (1/164)
NEOPLASM SKIN	0.6% (1/164)
OESOPHAGEAL CARCINOMA	0.6% (1/164)
PROSTATE CANCER RECURRENT	0.6% (1/164)
NERVOUS SYSTEM DISORDERS^a	2.4% (4/164)
CAROTID ARTERY STENOSIS	0.6% (1/164)
CEREBROVASCULAR ACCIDENT	0.6% (1/164)
FACIAL PALSY	0.6% (1/164)
PARAESTHESIA	0.6% (1/164)
RENAL AND URINARY DISORDERS^a	1.2% (2/164)
BLADDER TAMPONADE	0.6% (1/164)
NEPHROLITHIASIS	0.6% (1/164)
RENAL COLIC	0.6% (1/164)
REPRODUCTIVE SYSTEM AND BREAST DISORDERS^a	0.6% (1/164)
UTERINE POLYP	0.6% (1/164)
RESPIRATORY, THORACIC AND MEDIASTINAL DISORDERS^a	1.2% (2/164)
DYSPNOEA	1.2% (2/164)
SURGICAL AND MEDICAL PROCEDURES^a	0.6% (1/164)
LEG AMPUTATION	0.6% (1/164)
VASCULAR DISORDERS^a	25.0% (41/164)
ARTERIAL OCCLUSIVE DISEASE	0.6% (1/164)
ARTERIAL STENOSIS LIMB	0.6% (1/164)
ARTERIAL THROMBOSIS	0.6% (1/164)
ARTERIAL THROMBOSIS LIMB	3.0% (5/164)
ARTERIOSCLEROSIS OBLITERANS	0.6% (1/164)
EMBOLISM	0.6% (1/164)
FEMORAL ARTERIAL STENOSIS	6.7% (11/164)
FEMORAL ARTERY OCCLUSION	4.3% (7/164)
HAEMORRHAGE	0.6% (1/164)
HYPERTENSION	0.6% (1/164)
HYPERTENSIVE CRISIS	0.6% (1/164)
INTERMITTENT CLAUDICATION	3.7% (6/164)
PERIPHERAL ARTERIAL OCCLUSIVE DISEASE	4.3% (7/164)
PERIPHERAL EMBOLISM	0.6% (1/164)
PERIPHERAL ISCHAEMIA	3.0% (5/164)
VESSEL PERFORATION	0.6% (1/164)

Total Serious Adverse Events**123**

Numbers are % (counts/sample size) unless otherwise stated.

^a Event verbatim terms are reported by sites. The events listed in this table are then coded using MedDRA version 13.0 and then stratified by System-Organ Class (SOC) and Preferred Term. Patients may be counted in this table more than once by Preferred Term, but are only counted once in the SOC summary line.

Site reported data.

11.8. IN.PACT Global DCB Long Lesion Sub-Cohort**11.8.1. Primary Objective**

The objective of this clinical evaluation was to assess the safety and effectiveness of the IN.PACT Admiral DCB in the treatment of long restenotic lesions (lesion length >180 mm) in the superficial femoral and popliteal arteries.

11.8.2. Design

This clinical evaluation was designed as an observational, non-randomized, multi-center, single-arm evaluation that is intended to assess the safety and effectiveness performance of the IN.PACT Admiral DCB for the treatment of de novo, restenotic, or in-stent restenotic long lesions (lesion length > 180 mm) in the superficial femoral and/or popliteal artery vessels.

A total of 227 DCB subjects from the IN.PACT Global Study Imaging Cohorts (Long Lesion, In-Stent Restenosis and Chronic Total Occlusions), and meeting specific post-hoc inclusion criteria (including lesion lengths > 180 mm, Rutherford clinical category 2-4, and single unilateral treated lesions), comprised the DCB Long Lesion Sub-Cohort. Patients in the DCB Long Lesion Sub-Cohort were treated at 28 sites from 13 countries, including Austria, Belgium, Canada, Colombia, Germany, Hungary, Italy, The Netherlands, Singapore, Slovakia, South Korea, Switzerland and the United Kingdom. The 227 DCB subjects were enrolled at these IN.PACT Global Study sites between 6 June 2012 and 16 December 2013.

The primary effectiveness endpoint is Primary Patency within 12 months post-index procedure, which is defined as:

- Freedom from clinically-driven TLR, and
- Freedom from restenosis as determined by DUS Peak Systolic Velocity Ratio (PSVR) ≤ 2.4 .

The Primary Safety Endpoint is a composite endpoint through 12 months. Composite Safety Endpoint is defined as freedom from device- and procedure-related death through 30 days post procedure and freedom from target limb major amputation and clinically-driven TVR within 12 months post index procedure.

The secondary endpoints include:

- Major Adverse Events (MAE) through 12 months.
MAE is defined as all-cause death, clinically-driven TVR, major target limb amputation, thrombosis at the target lesion site
- All-cause mortality at 30 days, 6 months, and 12 months.
- CD-TLR⁵ at 30 days, 6 months, and 12 months.
- Any TVR at 30 days, 6 months and 12 months.
- CD-TVR at 30 days, 6 months and 12 months.
- Thrombosis at the target lesion site at 30 days, 6 months and 12 months.
- Major target limb amputation at 30 days, 6 months and 12 months.
- Time to first TLR through 12 months post-index procedure.
- Time to all-cause mortality through 12 months post-index procedure.
- Primary sustained clinical improvement⁶ at 6 and 12 months.
- Secondary sustained clinical improvement⁷ at 6 and 12 months.
- Walking impairment evaluation by Walking Impairment Questionnaire (WIQ) at 6 and 12 months.
- Walking distance as measured by 6 Minute Walk Test at 6 and 12 months.
- Device success⁸
- Procedural success⁹
- Clinical success¹⁰
- Binary restenosis within 12 months post-index procedure, which is determined by DUS PSVR > 2.4.

⁵ Clinically-driven TLR is defined as any re-intervention within the target lesion due to symptoms or drop of ABI of $\geq 20\%$ or > 0.15 when compared to post-index procedure baseline ABI.

⁶ Primary sustained clinical improvement is defined as sustained upward shift of at least 1 category on Rutherford classification as compared to baseline without the need for repeated TLR or surgical revascularization in amputation-free surviving subjects.

⁷ Secondary sustained clinical improvement is defined as sustained upward shift of at least 1 category on Rutherford classification as compared to baseline including the need for repeated TLR or surgical revascularization in amputation-free surviving subjects.

⁸ Device success is defined as successful delivery, balloon inflation and deflation and retrieval of the intact study device without burst below the rated burst pressure (RBP).

⁹ Procedural success is defined as residual stenosis of $\leq 50\%$ (non-stented subjects) or $\leq 30\%$ (stented subjects) by visual estimate.

¹⁰ Clinical success is defined as procedural success without procedural complications (mortality, major target limb amputation, thrombosis of the target lesion, or TVR) prior to discharge.

11.8.3. Patient Population

Subject demographics, medical history, and risk factors of the 227 IN.PACT Global DCB Long Lesion Sub-Cohort subjects are summarized in Baseline Demographics and Clinical Characteristics (Table 21).

Table 21. Baseline Demographics and Clinical Characteristics- IN.PACT Global DCB Long Lesion Sub-Cohort Subjects

Subject Characteristics ^a	IN.PACT Admiral DCB (N=227 Subjects)
Age (yrs)	
N	226
Mean ± SD	68.8 ± 9.7
Median	69.0
Min, Max	37, 90
BMI (kg/m ²)	
N	222
Mean ± SD	26.7 ± 4.6
Median	26.4
Min, Max	16, 47
Obesity (BMI ≥ 30 kg/m ²)	20.7% (46/222)
Male	67.4% (153/227)
Hypertension	86.7% (195/225)
Hyperlipidemia	71.7% (157/219)
Diabetes Mellitus	38.7% (87/225)
Insulin Dependent Diabetes Mellitus	18.2% (41/225)
Carotid Artery Disease	24.0% (49/204)
Coronary Heart Disease	40.6% (89/219)
Current Smoker	42.7% (97/227)
Renal Insufficiency (baseline serum creatinine ≥ 1.5 mg/dl)	12.3% (25/203)
On Dialysis	1.8% (4/226)
Below-the-knee Vascular Disease of Target Leg (Stenotic/Occluded)	48.6% (101/208)
Previous Peripheral Revascularization	58.1% (132/227)
Iliac	21.1% (48/227)
Common Femoral	7.0% (16/227)
Femoral Profunda	1.3% (3/227)
Superficial Femoral	48.9% (111/227)
Popliteal	14.1% (32/227)
Below-the-knee	8.4% (19/227)
Other Location	1.3% (3/227)
Previous Limb Amputation	1.3% (3/227)
Toe	0.4% (1/227)
Transmetatarsal	0.0% (0/227)
Below-the-knee	0.0% (0/227)
Above-the-knee	0.9% (2/227)
Rutherford Category	
0	0.0% (0/227)
1	0.0% (0/227)
2	22.5% (51/227)
3	65.2% (148/227)
4	12.3% (28/227)
5	0.0% (0/227)
6	0.0% (0/227)
ABI ^b (mmHg ratio)	
N	198
Mean ± SD	0.625 ± 0.214
Median	0.630
Min, Max	0.00, 1.67

Numbers are % (counts/sample size) unless otherwise stated.

Rutherford clinical grades and categories:

Grade	Category	Clinical Description
0	0	Asymptomatic, no hemodynamically significant occlusive disease
I	1	Mild claudication
I	2	Moderate claudication
I	3	Severe claudication
II	4	Ischemic rest pain
III	5	Minor tissue loss; non-healing ulcer; focal gangrene with diffuse pedal ischemia
III	6	Major tissue loss extending above transmetatarsal level; functional foot no longer salvageable

^a Site reported data

^b ABI for all target limbs treated during the 1st index procedure are included (can be bilateral)

The baseline lesion characteristics, as reported by the sites and angiographic core laboratories, have been provided in Procedural Lesion Characteristics (Table 22). The mean total target lesion length treated was 28.74 ± 7.11 cm.

Table 22. Procedural Lesion Characteristics – IN.PACT Global DCB Long Lesion Sub-Cohort Subjects

Procedural Lesion Characteristics (per lesion)	IN.PACT Admiral DCB (N=227 Subjects) (N=227 Lesions)
Pre-procedure ^a	
RVD (mm)	
N	133
Mean \pm SD	4.611 ± 0.896
Median	4.500
Min, Max	2.25, 6.85
MLD (mm)	
N	134
Mean \pm SD	0.332 ± 0.568
Median	0.000
Min, Max	0.00, 2.65
Occluded Lesion (100% stenosis)	70.1% (157/224)
Diameter Stenosis (%)	
N	224
Mean \pm SD	94.1 ± 10.7
Median	100.0
Min, Max	54, 100
Lesion Length (cm)	
N	227
Mean \pm SD	28.74 ± 7.11
Median	27.50
Min, Max	18.5, 53.0
Occluded Lesion Length (cm)	
N	207
Mean \pm SD	11.67 ± 11.32
Median	10.00
Min, Max	0.0, 45.0
Post-Procedure ^b	
Diameter Stenosis (%)	
N	226
Mean \pm SD	11.2 ± 12.3
Median	10.0
Min, Max	0, 60
Total Target Lesion Length Treated with Study Device (cm)	

Procedural Lesion Characteristics (per lesion)	IN.PACT Admiral DCB (N=227 Subjects) (N=227 Lesions)
N	226
Mean ± SD	27.46 ± 6.68
Median	26.00
Min, Max	14.5, 47.0

Numbers are % (counts/sample size) unless otherwise stated.

Key Core Laboratory definitions:

Reference Vessel Diameter (RVD) – angiographic measurement of the normal artery proximal and/or distal to the lesion intended for treatment.

Minimum Lumen Diameter (MLD) – angiographic measurement of the tightest area of obstruction or stenosis located within the segment of interest or the intended area of treatment.

Lesion length – angiographic measurement from the proximal healthy vessel segment to the distal healthy vessel segment (e.g. length of obstruction).

^a Angio core lab reported data.

^b Site reported data.

As shown in Table 23 below, a total of 96 IN.PACT Global DCB Long Lesion Sub-Cohort subjects (42.5%) received provisional stenting. The mean total stent length per subject was 173.7 ± 104.7 mm.

Table 23. Provisional Stenting – IN.PACT Global DCB Long Lesion Sub-Cohort

Subject Characteristics	IN.PACT Admiral DCB (N=227 Subjects)
Provisional Stent Rate per Subject	42.5% (96/226)
Total Provisional Stent Length per Subject (mm)	
N	96
Mean ± SD	173.7 ± 104.7
Median	150.0
Min, Max	10, 450

Numbers are % (counts/sample size).

Site reported data.

Follow-up compliance through the 12-month follow-up visits is presented in Table 24 for the IN.PACT Global DCB Long Lesion Sub-Cohort subjects. The rate of in-window follow-up visit completion at 12 months was 84.5%.

Table 24. Subject Follow-up Compliance – IN.PACT Global DCB Long Lesion Sub-Cohort

Subject Compliance Characteristics ^a	IN.PACT Admiral DCB (N=227)
30-Day Follow-up	
Eligible Subjects ^b	225
Death ^c	0
Withdrawal ^c	2
Follow-up Not Done ^c	13
Follow-up Visit Within Window ^d	197
Follow-up Visit Out of Window ^d	15
Within Window Follow-up Compliance (%) ^e	87.6%
Overall Follow-up Compliance (%) ^f	94.2%
6-Month Follow-up	
Eligible Subjects ^b	218
Death ^c	1
Withdrawal ^c	8
Follow-up Not Done ^c	27
Follow-up Visit Within Window ^d	171
Follow-up Visit Out of Window ^d	20
Within Window Follow-up Compliance (%) ^e	78.4%
Overall Follow-up Compliance (%) ^f	87.6%
12-Month Follow-up	

Subject Compliance Characteristics^a	IN.PACT Admiral DCB (N=227)
Eligible Subjects ^b	207
Death ^c	5
Withdrawal ^c	15
Follow-up Not Done ^c	20
Follow-up Visit Within Window ^d	175
Follow-up Visit Out of Window ^d	12
Within Window Follow-up Compliance (%) ^e	84.5%
Overall Follow-up Compliance (%) ^f	90.3%

^a Site reported data

^b Eligible subjects are all subjects who either have a follow-up visit form or are past due for their follow-up (beyond upper limit of window on study and did not exit the study before the upper limit of the window)

^c Death, withdrawal and follow-up not done are cumulative

^d Within window visits are defined as: 30-day \pm 7 days, 6-month \pm 30 days, 12-month \pm 30 days.

^e Percentage based on number of subjects who had follow-up visit within window divided by total number of eligible subjects

^f Percentage based on number of subjects who had a follow-up visit within or out of window divided by total number of eligible subjects

11.8.4. Primary Effectiveness and Safety Results

The primary effectiveness and safety results are shown in Table 25 and Figure 12 below.

The primary effectiveness endpoint is defined as primary patency within 12 months post-index procedure. Primary patency is defined as freedom from CD-TLR and freedom from restenosis as determined by DUS PSVR \leq 2.4. Primary patency at 12 months was 64.9% for all subjects.

The primary safety composite endpoint is defined as freedom from device- and procedure-related death through 30 days post-procedure and freedom from target limb major amputation and CD-TVR within 12 months post-index procedure. The primary safety composite endpoint at 12 months was 92.9%.

Table 25. Primary Effectiveness and Safety Results through 12 Months – IN.PACT Global DCB Long Lesion Sub-Cohort Subjects

Parameters	IN.PACT Admiral DCB (N=227 Subjects)
Effectiveness Parameters	
Primary Effectiveness Endpoint – Primary Patency at 12 Months	64.9% (98/151)
Safety Parameters	
Primary Safety Composite Endpoint – Freedom from:	92.9% (195/210)
Device- and Procedure-related Death through 30 Days	0.0% (0/225)
Target Limb Major Amputation within 360 Days	0.0% (0/210)
Clinically-driven TVR within 360 Days	7.1% (15/210)
Death (all-cause) within 360 days	2.4% (5/210)

The Kaplan-Meier analysis of this primary effectiveness endpoint, presented as primary patency through 420 days, is shown in Figure 12.

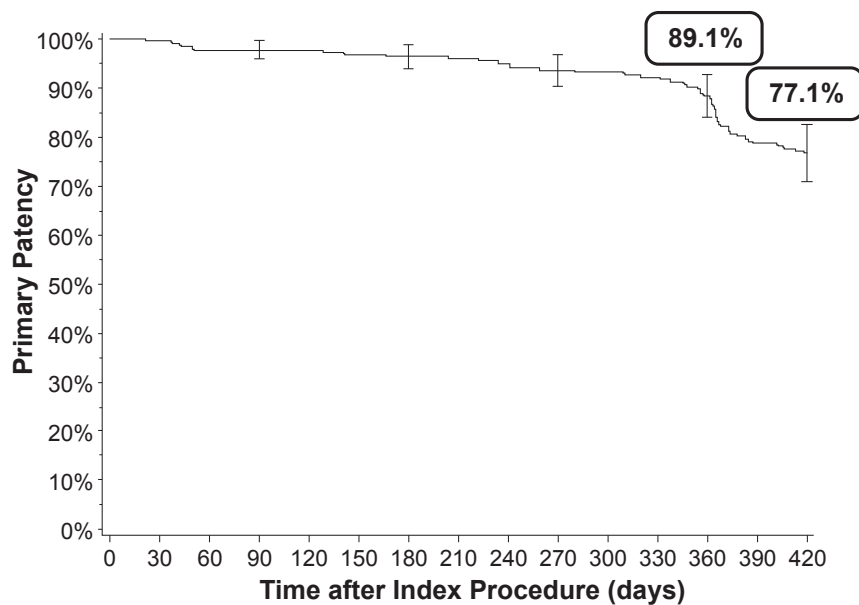

Figure 12. Kaplan-Meier Plot - Primary Patency through 420 Days

From day X To day Y IN.PACT DCB (N=227 Subjects)	0	1	31	61	91	121	151	181	211	241	271	301	331	361	391
	0	30	60	90	120	150	180	210	240	270	300	330	360	390	420
# Entered	227	227	224	215	214	214	213	210	205	203	200	195	190	181	157
# Censored	0	2	5	1	0	0	2	4	1	0	4	3	1	4	1
# Events	0	1	4	0	0	1	1	1	1	3	1	2	8	20	4
Event-free [%]	100.0%	99.6%	97.7%	97.7%	97.7%	97.3%	96.8%	96.4%	95.9%	94.5%	94.0%	93.0%	89.1%	79.1%	77.1%

11.8.5. Secondary Safety and Effectiveness Endpoints

The results of the secondary endpoints for the IN.PACT Global DCB Long Lesion Sub-Cohort Clinical Evaluation are shown in Table 26.

The primary sustained clinical improvement was 80.9% (152/188) at 12-months post-procedure. The device, procedural and clinical success was over 99% for the entire subject population in this sub-cohort (99.2%, 99.1% and 99.1% respectively).

The MAE composite for the long lesion sub-cohort at 360-days was 10.5% (22/210). Reported MAEs within 360-days included 2.4% death (5/210), 3.3% thrombosis (7/210) and no cases of major target limb amputation. Reintervention rates were reported as 7.1% (15/210) clinically-driven TVR and 7.1% (15/210) clinically-driven TLR. The average time to first clinically-driven TLR was 177.8 days. Other major secondary endpoints included binary restenosis (PSVR>2.4) in 34.2% (51/149) of subjects.

Table 26. Secondary Endpoints through 12 Months – IN.PACT Global DCB Long Lesion Sub-Cohort

Parameters	IN.PACT Admiral DCB (N=227 Subjects)
Effectiveness Parameters	
Primary Sustained Clinical Improvement at 12 Months	80.9% (152/188)
Secondary Sustained Clinical Improvement at 12 Months	86.5% (160/185)
Device Success	99.2% (653/658)
Procedural Success	99.1% (224/226)
Clinical Success	99.1% (224/226)
Cumulative complications within 360 days	
MAE Composite (Death, Major Target Limb Amputation, Clinically-driven TVR, Thrombosis)	10.5% (22/210)
Death (all-cause)	2.4% (5/210)
Clinically-driven TVR	7.1% (15/210)
Major Target Limb Amputation	0.0% (0/210)

Parameters	IN.PACT Admiral DCB (N=227 Subjects)
Thrombosis	3.3% (7/210)
Clinically-driven TLR	7.1% (15/210)
Any TVR	7.1% (15/210)
Any TLR	7.1% (15/210)
Other Major Secondary Endpoints at 12 Months	
Binary Restenosis (PSVR >2.4)	34.2% (51/149)
Time to First Clinically-driven TLR (days)	
N	15
Mean ± SD	177.8 ± 115.9
Median	204.0
Min, Max	21, 356
Walking Impairment by WIQ (%)	
N	178
Mean ± SD	73.7 ± 32.5
Median	100.0
Min, Max	0, 100

Endpoint definitions:

- Clinically-driven TLR is defined as any reintervention at the target lesion due to symptoms or drop of ABI/TBI of $\geq 20\%$ or >0.15 when compared to post-procedure baseline ABI/TBI
- Device success defined as successful delivery, inflation, deflation and retrieval of the intact study balloon device without burst below the RBP. Results reported as device based summary.
- Procedure success defined as residual stenosis of $\leq 50\%$ (non-stented subjects) or $\leq 30\%$ (stented subjects) by corelab (if corelab was not available then the site-reported estimate was used).
- Clinical success defined as procedural success without procedural complications (death, major target limb amputation, thrombosis of the target lesion, or TVR) prior to discharge.
- Primary sustained clinical improvement is defined as sustained upward shift of at least 1 category on Rutherford classification as compared to baseline without the need for repeated TLR or surgical revascularization in amputation-free surviving subjects.
- Secondary sustained clinical improvement is defined as sustained upward shift of at least 1 category on Rutherford classification as compared to baseline including the need for repeated TLR or surgical revascularization in amputation-free surviving subjects.
- Safety composite endpoint consists of: freedom from device- and procedure-related death within 30 days, freedom from major target limb amputation, and freedom from clinically-driven TVR within 360 days post-index procedure.
- Clinically-driven TLR/TVR is defined as any re-intervention within the target vessel due to symptoms or drop of ABI/TBI of $\geq 20\%$ or >0.15 when compared to post-procedure baseline ABI/TBI.
- Major Adverse Events (MAE) defined as all-cause death, clinically-driven TLR/TVR, major target limb amputation, thrombosis at the target lesion site at 360 days
- Walking impairment assessed by Walking Impairment Questionnaire (WIQ) at 12 months.

Data sources:

All events were adjudicated by the independent Clinical Events Committee, all duplex ultrasound and angiographic measures were made by the independent core laboratories, and all other data were site reported.

11.8.6. Subgroup Analysis

Medtronic has analyzed the clinical evaluation results by lesion length grouping, gender, and assigned imaging cohorts.

11.8.7. Lesion Length Grouping Analysis

The outcomes for subjects by respective lesion length grouping are presented below in Table 27. The primary patency by lesion length group were 75.5% (40/53) for lesions >180-240 mm, 65.1% (28/43) for lesions >240-300 mm, 63.3% (19/30) for lesions >300-360 mm, and 44.0% (11/25) for lesions > 360 mm.

The primary safety composite by lesion length group were 95.8% (68/71) for lesions >180-240 mm, 93.7% (59/63) for lesions >240-300 mm, 92.3% (36/39) for lesions >300-360 mm, and 86.5% (32/37) for lesions > 360 mm. There were no device- or procedure-related deaths through 30 days or major target limb amputations through 12 months.

Table 27. Principal Effectiveness and Safety Results through 12-months by Lesion Length Groups – IN.PACT Global DCB Long Lesion Sub- Cohort

Parameters	18-24cm (N=77 Subjects)	24-30cm (N=66 Subjects)	30-36cm (N=43 Subjects)	>36cm (N=41 Subjects)
Lesion Length (cm)				
N	77	66	43	41
Mean ± SD	21.65 ± 1.71	27.17 ± 1.88	32.74 ± 1.73	40.37 ± 3.83
Q1	20.0	25.5	31.0	37.5
Median	22.00	26.75	32.50	39.00
Q3	23.0	29.0	34.0	42.0
Min, Max	18.5, 24.0	24.5, 30.0	30.5, 36.0	36.5, 53.0
Effectiveness Parameters				
Primary Patency at 12 Months	75.5% (40/53)	65.1% (28/43)	63.3% (19/30)	44.0% (11/25)
Primary Sustained Clinical Improvement at 12 Months	83.3% (55/66)	83.6% (46/55)	82.9% (29/35)	68.8% (22/32)
Secondary Sustained Clinical Improvement at 12 Months	86.4% (57/66)	89.1% (49/55)	91.2% (31/34)	76.7% (23/30)
Device Success	100.0% (178/178)	99.5% (186/187)	99.3% (136/137)	98.1% (153/156)
Procedural Success	100.0% (76/76)	98.5% (65/66)	97.7% (42/43)	100.0% (41/41)
Clinical Success	100.0% (76/76)	98.5% (65/66)	97.7% (42/43)	100.0% (41/41)
Safety Parameters				
Primary Safety Composite Endpoint – Freedom from:	95.8% (68/71)	93.7% (59/63)	92.3% (36/39)	86.5% (32/37)
Device- and Procedure-related Death through 30 Days	0.0% (0/76)	0.0% (0/66)	0.0% (0/42)	0.0% (0/41)
Target Limb Major Amputation within 360 Days	0.0% (0/71)	0.0% (0/63)	0.0% (0/39)	0.0% (0/37)
Clinically-driven TLR within 360 Days	4.2% (3/71)	6.3% (4/63)	7.7% (3/39)	13.5% (5/37)
Death (all-cause) within 30 days	0.0% (0/76)	0.0% (0/66)	0.0% (0/42)	0.0% (0/41)
Cumulative complications within 360 days				
MAE Composite (Death, Major Target Limb Amputation, Clinically-driven TVR, Thrombosis)	5.6% (4/71)	12.7% (8/63)	7.7% (3/39)	18.9% (7/37)
Death (all-cause)	0.0% (0/71)	3.2% (2/63)	2.6% (1/39)	5.4% (2/37)
Clinically-driven TVR	4.2% (3/71)	6.3% (4/63)	7.7% (3/39)	13.5% (5/37)
Major Target Limb Amputation	0.0% (0/71)	0.0% (0/63)	0.0% (0/39)	0.0% (0/37)
Thrombosis at Target Lesion	1.4% (1/71)	3.2% (2/63)	5.1% (2/39)	5.4% (2/37)
Clinically-driven TLR	4.2% (3/71)	6.3% (4/63)	7.7% (3/39)	13.5% (5/37)
Any TVR	4.2% (3/71)	6.3% (4/63)	7.7% (3/39)	13.5% (5/37)
Any TLR	4.2% (3/71)	6.3% (4/63)	7.7% (3/39)	13.5% (5/37)
Other Major Secondary Endpoints at 12 Months				

Parameters	18-24cm (N=77 Subjects)	24-30cm (N=66 Subjects)	30-36cm (N=43 Subjects)	>36cm (N=41 Subjects)
Binary Restenosis (PSVR >2.4)	24.5% (13/53)	34.9% (15/43)	34.5% (10/29)	54.2% (13/24)
Time to First Clinically-driven TLR (days)				
N	3	4	3	5
Mean ± SD	221.0 ± 71.8	150.3 ± 149.2	91.7 ± 98.4	225.6 ± 110.9
Median	242.0	104.5	50.0	241.0
Min, Max	141, 280	37, 355	21, 204	50, 356
Walking Impairment by WIQ (%)				
N	63	54	32	29
Mean ± SD	73.0 ± 34.9	79.2 ± 28.2	75.0 ± 33.6	63.8 ± 32.4
Median	100.0	100.0	100.0	50.0
Min, Max	0, 100	0, 100	0, 100	0, 100

Endpoint definitions:

- Primary patency is defined as freedom from clinically-driven TLR¹ and freedom from restenosis as determined by duplex ultrasound² (DUS) Peak Systolic Velocity Ratio (PSVR) ≤ 2.4³ within 12 months. Key Primary Patency endpoint definition components:
 - ¹Clinically-driven TLR is defined as any reintervention at the target lesion due to symptoms or drop of ABI/TBI of ≥20% or >0.15 when compared to post-procedure baseline ABI/TBI
 - ²Post-index procedure DUS is intended to establish a post-treatment baseline and does not contribute to the Primary Endpoint determination
 - ³Restenosis determined by either PSVR >2.4 (determined by Target Lesion Category of '50-99%' or 'Occluded') as assessed by an independent DUS core lab or >50% stenosis as assessed by an independent angiographic core lab
- Device success defined as successful delivery, inflation, deflation and retrieval of the intact study balloon device without burst below the RBP.
- Results reported as a device-based summary.
- Procedure success defined as residual stenosis of ≤ 50% (non-stented subjects) or ≤ 30% (stented subjects) by corelab (if corelab was not available then the site-reported estimate was used).
- Clinical success defined as procedural success without procedural complications (death, major target limb amputation, thrombosis of the target lesion, or TVR) prior to discharge.
- Primary sustained clinical improvement is defined as sustained upward shift of at least 1 category on Rutherford classification as compared to baseline without the need for repeated TLR or surgical revascularization in amputation-free surviving subjects.
- Secondary sustained clinical improvement is defined as sustained upward shift of at least 1 category on Rutherford classification as compared to baseline including the need for repeated TLR or surgical revascularization in amputation-free surviving subjects.
- Safety composite endpoint consists of: freedom from device- and procedure-related death within 30 days; freedom from major target limb amputation; and freedom from clinically-driven TVR within 360 days post-index procedure.
- Clinically-driven TVR/TLR is defined as any re-intervention within the target vessel due to symptoms or drop of ABI/TBI of ≥20% or >0.15 when compared to post-procedure baseline ABI/TBI.
- Major Adverse Events (MAE) defined as all-cause death, clinically-driven TLR/TVR, major target limb amputation, thrombosis at the target lesion site at 360 days.
- Binary restenosis is defined as duplex restenosis (PSVR > 2.4) of the target lesion at 12 months post-procedure, or at the time of reintervention prior to any pre-specified timepoint.
- Walking impairment assessed by Walking Impairment Questionnaire (WIQ) at 12 months.

Data sources:

All events were adjudicated by the independent Clinical Events Committee, all duplex ultrasound and angiographic measures were made by the independent core laboratories, and all other data were site reported.

11.8.8. Gender Analysis

The results of sub-group analysis on gender are summarized in Table 28 below. The IN.PACT Global DCB Long Lesion Sub-Cohort included 153 males and 74 females at the time of the procedure. The comparison between genders showed the primary patency at 12 months to be 66.7% (70/105) in males and 60.9% (28/46) in females. The primary safety composite endpoint at

12 months was reported as 91.5% (129/141) and 95.7% (66/69) in males compared to females respectively. The MAE composite at 360 days were 10.6% (15/141) in males and 10.1% (7/69) in females.

Table 28. Principal Effectiveness and Safety Results through 12 Months by Gender – IN.PACT Global DCB Long Lesion Sub-Cohort

Parameters	Male Subjects (N=153 Subjects)	Female Subjects (N=74 Subjects)
Effectiveness Parameters		
Primary Effectiveness Endpoint – Primary Patency at 12 Months	66.7% (70/105)	60.9% (28/46)
Primary Sustained Clinical Improvement at 12 Months	79.7% (102/128)	83.3% (50/60)
Secondary Sustained Clinical Improvement at 12 Months	86.4% (108/125)	86.7% (52/60)
Device Success	98.9% (455/460)	100.0% (198/198)
Procedural Success	100.0% (153/153)	97.3% (71/73)
Clinical Success	100.0% (153/153)	97.3% (71/73)
Safety Parameters		
Primary Safety Composite Endpoint – Freedom from:	91.5% (129/141)	95.7% (66/69)
Device- and Procedure-related Death through 30 Days	0.0% (0/151)	0.0% (0/74)
Target Limb Major Amputation within 360 Days	0.0% (0/141)	0.0% (0/69)
Clinically-driven TVR within 360 Days	8.5% (12/141)	4.3% (3/69)
Death (all-cause) within 30 days	0.0% (0/151)	0.0% (0/74)
Cumulative complications within 360 days		
MAE Composite (Death, Major Target Limb Amputation, Clinically-driven TVR, Thrombosis)	10.6% (15/141)	10.1% (7/69)
Death (all-cause)	2.8% (4/141)	1.4% (1/69)
Clinically-driven TVR	8.5% (12/141)	4.3% (3/69)
Major Target Limb Amputation	0.0% (0/141)	0.0% (0/69)
Thrombosis	2.8% (4/141)	4.3% (3/69)
Clinically-driven TLR	8.5% (12/141)	4.3% (3/69)
Any TVR	8.5% (12/141)	4.3% (3/69)
Any TLR	8.5% (12/141)	4.3% (3/69)
Other Major Secondary Endpoints at 12 Months		
Binary Restenosis (PSVR >2.4)	32.0% (33/103)	39.1% (18/46)
Time to First Clinically-driven TLR (days)		
N	12	3
Mean ± SD	195.5 ± 113.5	107.0 ± 116.9
Median	213.0	42.0
Min, Max	21, 356	37, 242
Walking Impairment by WIQ (%)		
N	122	56
Mean ± SD	73.0 ± 32.1	75.4 ± 33.5
Median	100.0	100.0
Min, Max	0, 100	0, 100

11.8.9. Assigned Imaging Cohorts Analyses

The IN.PACT Global DCB Long Lesion Sub-Cohort was composed of subjects meeting the inclusion criteria specific to this analysis from the three imaging cohorts (Long Lesion, CTO, and ISR) in the IN.PACT Global study. As such, a breakdown of the subject outcomes for each of the imaging cohorts was conducted and the results of that analysis are presented in Table 29 below. Slight variability was seen in for the primary effectiveness outcome as the Long Lesion, CTO and ISR imaging groups reported patency at 12 months of 66.2% (47/71), 68.8% (33/48), and 56.3% (18/32) respectively. The primary safety composite

endpoint amongst the three imaging cohorts was 94.2% (98/104) for Long Lesion, 92.2% (59/64) for CTO, and 90.5% (38/42) for ISR. The cumulative MAE rate at 360 days was 10.6% (11/104), 10.9% (7/64), 9.5% (4/42) for the Long Lesion, CTO and ISR imaging cohorts respectively. It is noted that the reintervention rates (TVR or TLR) were highest in the ISR group compared to Long Lesions or CTO. Conversely, the ISR group had no reported cases of death or thrombosis compared to the Long Lesion (2.9% and 4.8% respectively) and the CTO (3.1% and 3.1% respectively) imaging cohorts. Overall, binary restenosis in the imaging cohorts was 33.8% (24/71) for Long Lesion, 28.3% (13/46) for CTO, and 43.8% (14/32) for ISR.

Table 29. Principal Effectiveness and Safety Results through 12 Months by Assigned Imaging Sub-Cohort – IN.PACT Global DCB Long Lesion Sub-Cohort

Parameters	Long Lesion (N=114 Subjects)	CTO (N=67 Subjects)	De novo ISR (N=46 Subjects)
Effectiveness Parameters			
Primary Effectiveness Endpoint – Primary Patency at 12 Months	66.2% (47/71)	68.8% (33/48)	56.3% (18/32)
Primary Sustained Clinical Improvement at 12 Months	82.6% (76/92)	83.9% (47/56)	72.5% (29/40)
Secondary Sustained Clinical Improvement at 12 Months	85.7% (78/91)	90.7% (49/54)	82.5% (33/40)
Device Success	99.4% (324/326)	99.0% (191/193)	99.3% (138/139)
Procedural Success	99.1% (112/113)	100.0% (67/67)	97.8% (45/46)
Clinical Success	99.1% (112/113)	100.0% (67/67)	97.8% (45/46)
Safety Parameters			
Primary Safety Composite End- point – Freedom from:	94.2% (98/104)	92.2% (59/64)	90.5% (38/42)
Device- and Procedure-related Death through 30 Days	0.0% (0/114)	0.0% (0/66)	0.0% (0/45)
Target Limb Major Amputation within 360 Days	0.0% (0/104)	0.0% (0/64)	0.0% (0/42)
Clinically-driven TVR within 360 Days	5.8% (6/104)	7.8% (5/64)	9.5% (4/42)
Death (all-cause) within 30 days	0.0% (0/114)	0.0% (0/66)	0.0% (0/45)
Cumulative complications within 360 days			
MAE Composite (Death, Major Target Limb Amputation, Clini- cally-driven TVR, Thrombosis)	10.6% (11/104)	10.9% (7/64)	9.5% (4/42)
Death (all-cause)	2.9% (3/104)	3.1% (2/64)	0.0% (0/42)
Clinically-driven TVR	5.8% (6/104)	7.8% (5/64)	9.5% (4/42)
Major Target Limb Amputation	0.0% (0/104)	0.0% (0/64)	0.0% (0/42)
Thrombosis	4.8% (5/104)	3.1% (2/64)	0.0% (0/42)
Clinically-driven TLR	5.8% (6/104)	7.8% (5/64)	9.5% (4/42)
Any TVR	5.8% (6/104)	7.8% (5/64)	9.5% (4/42)
Any TLR	5.8% (6/104)	7.8% (5/42)	9.5% (4/42)
Other Major Secondary End- points at 12 Months			
Binary Restenosis (PSVR >2.4)	33.8% (24/71)	28.3% (13/46)	43.8% (14/32)
Time to First Clinically-driven TLR (days)			
N	6	5	4
Mean ± SD	182.8 ± 123.3	224.0 ± 124.6	112.5 ± 85.7
Median	191.5	241.0	104.5
Min, Max	50, 355	21, 356	37, 204
Walking Impairment by WIQ (%)			
N	86	53	39

Parameters	Long Lesion (N=114 Subjects)	CTO (N=67 Subjects)	De novo ISR (N=46 Subjects)
Mean ± SD	70.3 ± 34.8	79.7 ± 28.2	73.1 ± 32.1
Median	75.0	100.0	100.0
Min, Max	0, 100	0, 100	0, 100

11.8.10. Summary of Serious Adverse Events

A serious adverse event was defined in the IN.PACT Global Study protocol as an adverse event that led to death; led to serious deterioration in the health of the subject that resulted in a life-threatening illness or injury, a permanent impairment of a body structure or a body function, in-patient or prolonged hospitalization, or medical or surgical intervention to prevent life-threatening illness or injury or permanent impairment to a body structure of a body function; or led to fetal distress, fetal death or a congenital abnormality or birth defect.

As shown in Table 30, there were a total of 246 serious adverse events reported in the IN.PACT Global DCB Long Lesion Sub-Cohort within 360 days. In total, 52.0% of subjects experienced one or more serious adverse events.

Table 30. Number of Subjects with One or More Serious Adverse Events through 360 days by MedDRA System-Organ Class and Preferred Term – IN.PACT Global DCB Long Lesion Sub-Cohort

Serious Adverse Event ^a	IN.PACT Admiral DCB (N=227 Subjects)
Subjects with One or More Serious Adverse Events	52.0% (118/227)
BLOOD AND LYMPHATIC SYSTEM DISORDERS^b	0.4% (1/227)
LEUKOCYTOSIS	0.4% (1/227)
CARDIAC DISORDERS^b	7.9% (18/227)
ACUTE MYOCARDIAL INFARCTION	0.9% (2/227)
ANGINA PECTORIS	0.4% (1/227)
ANGINA UNSTABLE	0.9% (2/227)
ARTERIOSCLEROSIS CORONARY ARTERY	0.4% (1/227)
ATRIAL FIBRILLATION	0.4% (1/227)
ATRIAL FLUTTER	0.4% (1/227)
ATRIAL THROMBOSIS	0.4% (1/227)
CARDIAC FAILURE	1.3% (3/227)
CARDIAC FAILURE ACUTE	0.4% (1/227)
CARDIAC FAILURE CONGESTIVE	0.4% (1/227)
CONGESTIVE CARDIOMYOPATHY	0.4% (1/227)
CORONARY ARTERY DISEASE	2.6% (6/227)
CORONARY ARTERY OCCLUSION	0.4% (1/227)
CORONARY ARTERY STENOSIS	1.3% (3/227)
HYPERTENSIVE HEART DISEASE	0.4% (1/227)
ISCHAEMIC CARDIOMYOPATHY	0.9% (2/227)
EAR AND LABYRINTH DISORDERS^b	0.4% (1/227)
VERTIGO	0.4% (1/227)
ENDOCRINE DISORDERS^b	0.4% (1/227)
GOITRE	0.4% (1/227)
EYE DISORDERS^b	0.9% (2/227)
CATARACT	0.4% (1/227)
RETINAL ARTERY OCCLUSION	0.4% (1/227)
GASTROINTESTINAL DISORDERS^b	3.1% (7/227)
COLITIS	0.4% (1/227)
GASTRITIS	0.4% (1/227)
GASTROINTESTINAL HAEMORRHAGE	1.3% (3/227)
OESOPHAGEAL HAEMORRHAGE	0.4% (1/227)
REFLUX OESOPHAGITIS	0.4% (1/227)
GENERAL DISORDERS AND ADMINISTRATION SITE CON- DITIONS^b	3.5% (8/227)
CHEST PAIN	0.9% (2/227)
DEATH	0.4% (1/227)
DEVICE OCCLUSION	1.3% (3/227)

Serious Adverse Event ^a	IN.PACT Admiral DCB (N=227 Subjects)
IMPAIRED HEALING	0.4% (1/227)
PUNCTURE SITE HAEMORRHAGE	0.4% (1/227)
HEPATOBIILIARY DISORDERS^b	0.4% (1/227)
CHOLECYSTITIS	0.4% (1/227)
CHOLELITHIASIS	0.4% (1/227)
INFECTIIONS AND INFESTATIONS^b	5.3% (12/227)
BRONCHITIS	0.4% (1/227)
ERYSIPELAS	0.4% (1/227)
GANGRENE	0.4% (1/227)
GASTROENTERITIS VIRAL	0.4% (1/227)
GRAFT INFECTION	0.4% (1/227)
GROIN INFECTION	0.4% (1/227)
INFECTION	0.4% (1/227)
NECROTISING FASCIITIS	0.4% (1/227)
PNEUMONIA	1.8% (4/227)
INJURY, POISONING AND PROCEDURAL COMPLICATIONS^b	11.9% (27/227)
ARTERIAL RESTENOSIS	5.3% (12/227)
IN-STENT ARTERIAL RESTENOSIS	3.1% (7/227)
IN-STENT CORONARY ARTERY RESTENOSIS	0.4% (1/227)
PERIPHERAL ARTERIAL REOCCLUSION	0.9% (2/227)
POSTOPERATIVE THROMBOSIS	0.4% (1/227)
THERMAL BURN	0.4% (1/227)
VASCULAR GRAFT OCCLUSION	0.4% (1/227)
VASCULAR PSEUDOANEURYSM	2.2% (5/227)
INVESTIGATIONS^b	1.3% (3/227)
BLOOD CREATININE INCREASED	0.4% (1/227)
HAEMOGLOBIN DECREASED	0.4% (1/227)
INTERNATIONAL NORMALISED RATIO INCREASED	0.4% (1/227)
METABOLISM AND NUTRITION DISORDERS^b	2.6% (6/227)
DIABETES MELLITUS	0.9% (2/227)
GOUT	0.9% (2/227)
HYPOKALAEMIA	0.4% (1/227)
HYPONATRAEMIA	0.4% (1/227)
MUSCULOSKELETAL AND CONNECTIVE TISSUE DISORDERS^b	4.4% (10/227)
ARTHRITIS	0.4% (1/227)
BACK PAIN	0.9% (2/227)
BURSITIS	0.4% (1/227)
INTERVERTEBRAL DISC PROTRUSION	0.4% (1/227)
NECK PAIN	0.4% (1/227)
OSTEOARTHRITIS	0.4% (1/227)
PAIN IN EXTREMITY	0.9% (2/227)
ROTATOR CUFF SYNDROME	0.9% (2/227)
NEOPLASMS BENIGN, MALIGNANT AND UNSPECIFIED (INCL CYSTS AND POLYPS)^b	4.0% (9/227)
BLADDER PAPILLOMA	0.4% (1/227)
COLON ADENOMA	0.4% (1/227)
LARYNGEAL CANCER	0.4% (1/227)
LUNG NEOPLASM MALIGNANT	0.4% (1/227)
OESOPHAGEAL CARCINOMA	0.4% (1/227)
PROSTATE CANCER RECURRENT	0.4% (1/227)
SMALL CELL LUNG CANCER STAGE UNSPECIFIED	0.4% (1/227)
SQUAMOUS CELL CARCINOMA	0.4% (1/227)
UNDIFFERENTIATED SARCOMA	0.4% (1/227)

Serious Adverse Event ^a	IN.PACT Admiral DCB (N=227 Subjects)
NERVOUS SYSTEM DISORDERS^b	3.5% (8/227)
BASAL GANGLIA INFARCTION	0.4% (1/227)
BRAIN EDEMA	0.4% (1/227)
CAROTID ARTERY STENOSIS	1.3% (3/227)
CEREBRAL INFARCTION	0.4% (1/227)
HEMIPARESIS	0.4% (1/227)
METABOLIC ENCEPHALOPATHY	0.4% (1/227)
SCIATICA	0.4% (1/227)
SUBARACHNOID HAEMORRHAGE	0.4% (1/227)
PSYCHIATRIC DISORDERS^b	0.4% (1/227)
ALCOHOL WITHDRAWAL SYNDROME	0.4% (1/227)
RENAL AND URINARY DISORDERS^b	0.9% (2/227)
BLADDER TAMPONADE	0.4% (1/227)
HAEMATURIA	0.4% (1/227)
REPRODUCTIVE SYSTEM AND BREAST DISORDERS^b	0.4% (1/227)
POSTMENOPAUSAL HAEMORRHAGE	0.4% (1/227)
RESPIRATORY, THORACIC AND MEDIASTINAL DISORDERS^b	1.3% (3/227)
DYSPNOEA EXERTIONAL	0.4% (1/227)
HYPERVENTILATION	0.4% (1/227)
PLEURAL EFFUSION	0.4% (1/227)
SURGICAL AND MEDICAL PROCEDURES^b	1.3% (3/227)
ILEOSTOMY CLOSURE	0.4% (1/227)
PERIPHERAL ARTERY ANGIOPLASTY	0.4% (1/227)
PERIPHERAL REVASCULARISATION	0.4% (1/227)
VASCULAR DISORDERS^b	31.3% (71/227)
AORTIC ANEURYSM	0.4% (1/227)
ARTERIAL STENOSIS LIMB	3.5% (8/227)
ARTERIAL THROMBOSIS LIMB	2.6% (6/227)
EMBOLISM	0.4% (1/227)
FEMORAL ARTERIAL STENOSIS	11.9% (27/227)
FEMORAL ARTERY DISSECTION	0.4% (1/227)
FEMORAL ARTERY OCCLUSION	5.3% (12/227)
HAEMATOMA	1.3% (3/227)
HYPERTENSION	0.4% (1/227)
HYPERTENSIVE CRISIS	0.4% (1/227)
ILIAC ARTERY STENOSIS	1.3% (3/227)
INTERMITTENT CLAUDICATION	1.3% (3/227)
PERIPHERAL ARTERIAL OCCLUSIVE DISEASE	6.6% (15/227)
PERIPHERAL EMBOLISM	1.8% (4/227)
PERIPHERAL ISCHAEMIA	1.3% (3/227)
PERIPHERAL VASCULAR DISORDER	0.4% (1/227)
VESSEL PERFORATION	1.3% (3/227)
Total Serious Adverse Events	246

Numbers are % (counts/sample size) unless otherwise stated.

^a Site reported data

^b Event verbatim terms are reported by sites. The events listed in this table are then coded using MedDRA version 16.1 and then stratified by System-Organ Class (SOC) and Preferred Term. Patients may be counted in this table more than once by Preferred Term, but are only counted once in the SOC summary line.

11.8.11. Rare Adverse Events

The Clinical Events Committee (CEC) was responsible for adjudicating rare adverse events, including potential distal embolic events in the target limb, thrombosis, paclitaxel-related neutropenia, and paclitaxel-related drug hypersensitivity reaction through 12 months. As reported in Table 31 below, there were no rare adverse events reported for the IN.PACT Global DCB Long Lesion Sub-Cohort.

Table 31. Rare Adverse Events - IN.PACT Global DCB Long Lesion Sub-Cohort

Description of Event	IN.PACT Admiral DCB/ (N=227 Subjects)
Rare Adverse Events to 180 Days	
Paclitaxel-related Thrombosis within 30 Days ^a	0.0% (0/225)
Paclitaxel-related Distal Embolic Events within 180 Days ^b	0.0% (0/219)
Paclitaxel-related Neutropenia within 180 Days ^c	0.0% (0/219)
Paclitaxel-related Drug Hypersensitivity/Reaction within 180 Days ^d	0.0% (0/219)
Rare Adverse Events to 360 Days	
Paclitaxel-related Thrombosis within 30 Days ^a	0.0% (0/225)
Paclitaxel-related Distal Embolic Events within 360 Days ^b	0.0% (0/210)
Paclitaxel-related Neutropenia within 360 Days ^c	0.0% (0/210)
Paclitaxel-related Drug Hypersensitivity/Reaction within 360 Days ^d	0.0% (0/210)

Numbers are % (counts/sample size).

^aThrombosis is defined as an occlusion due to thrombus formation which is rapidly evolving as confirmed by sudden onset of symptoms and documented by DUS and/or angiography at the index vessel within 14 days of symptom onset. Occlusions occurring within 30 days of the index procedure are assumed to be thrombotic, irrespective of symptoms, providing the sheath or guiding catheter has been removed and the patient has left the catheterization laboratory or angiography suite, and that they are documented by imaging with DUS and/or angiography of the index vessel. Thrombosis may be categorized as acute (occurring <1 day post- index), sub-acute (1-30 days) and late (>30 days). For rare adverse events reporting, CEC adjudication will occur through 30-days. Vessel thrombosis reported >30 days will be reported as MAE and CEC adjudicated through 60-months.

^bDistal Embolic Events are defined as embolism with concomitant suggestive clinical signs and symptoms, located separate from and distal to the target lesion. Classified by probability:

- Definite Angiographic evidence of distal embolization with a new intraluminal filling defect and/or abrupt occlusion of a run-off vessel distal to a lesion that is clearly not attributable to wire trauma or dissection, irrespective of the time from the index procedure.
- Probable: Suggestive clinical signs and symptoms of distal embolization occurring ≤ 30 days after the index procedure, in the absence of Angiographic evidence.
- Possible: Suggestive clinical signs and symptoms of distal embolization occurring >30 days after the index procedure in the absence of Angiographic evidence.

^cNeutropenia is defined as ANC <1500/mm³

- If no ANC is available, the white blood cell count will be used.
- If any WBC count is <3,000 cells/mm³ and is a decrease of >50% of the baseline, the event will be adjudicated as neutropenia.
- If no baseline WBC count is available and site-reported concurrent fever and infection, then any WBC count <3,000 cells/mm³ will be adjudicated as neutropenia.

^dDrug Hypersensitivity/Reactions is defined as events reported with signs and symptoms which include, but are not limited to the following: GI upset, Hair loss, Rash, Urticaria (Hives), Erythroderma, Itchy skin, Pruritus, Vasculitis, Edema, Anaphylaxis / shock, Asthma / Asthmatic Attack / Bronchospasm, Dyspnea, Chest tightness, Tachycardia, and Eosinophilia. All events were adjudicated by the independent Clinical Events Committee.

11.8.12. Long Term data (24 month)

The results of the secondary endpoints of the IN.PACT Global DCB Long Lesion Sub-Cohort Clinical Evaluation through 24 months are shown in Table 32 below. The primary sustained clinical improvement was 71.0% (125/176) at 24-months post-procedure. Freedom from CD-TLR by Kaplan Meier estimate was 80.3% through 24-months and can be found below in Figure 13.

The MAE composite for the long lesion sub-cohort at 720-days was 24.7% (49/198). Reported MAEs within 720-days included 4.5% death (9/198), 5.1% thrombosis (10/198) and one subject had a major target limb amputation (0.5%, 1/198).

Reintervention rates were reported as 20.2% (40/198) clinically-driven TVR and 20.2% (40/198) clinically-driven TLR. The average time to first clinically-driven TLR was 377.4 days.

Table 32. Secondary Endpoints through 24 months – IN.PACT Global DCB Long Lesion Sub-Cohort

Parameters	IN.PACT Admiral DCB (N=227 Subjects)
Effectiveness Parameters	
Primary Sustained Clinical Improvement at 24 Months	71.0% (125/176)
Secondary Sustained Clinical Improvement at 24 Months	89.2% (149/167)
Device Success	99.2% (653/658)
Procedural Success	99.1% (224/226)
Clinical Success	99.1% (224/226)
Safety Parameters	
Primary Safety Composite Endpoint – Freedom from: Device- and Procedure-related Death through 30 Days	79.3% (157/198)
Target Limb Major Amputation within 720 Days	0.0% (0/225)
Clinically-driven TVR within 720 Days	0.5% (1/198)
Death (all-cause) within 30 days	20.2% (40/198)
	0.0% (0/225)
Cumulative complications within 720 days	
MAE Composite (Death, Major Target Limb Amputation, Clinically-driven TVR, Thrombosis)	24.7% (49/198)
Death (all-cause)	4.5% (9/198)
Clinically-driven TVR	20.2% (40/198)
Major Target Limb Amputation	0.5% (1/198)
Thrombosis	5.1% (10/198)
Clinically-driven TLR	20.2% (40/198)
Any TVR	20.2% (40/198)
Any TLR	20.2% (40/198)
Other Major Secondary Endpoints at 24 Months	
Time to First Clinically-driven TLR (days)	
N	40
Mean ± SD	377.4 ± 190.2
Median	394.5
Min, Max	21, 712
Walking Impairment by WIQ (%)	
N	157
Mean ± SD	77.7 ± 29.6
Median	100.0

Min, Max

0, 100

Endpoint definitions:

Clinically-driven TLR is defined as any reintervention at the target lesion due to symptoms or drop of ABI/TBI of $\geq 20\%$ or >0.15 when compared to post-procedure baseline ABI/TBI

- Device success defined as successful delivery, inflation, deflation and retrieval of the intact study balloon device without burst below the RBP.
- Procedure success defined as residual stenosis of $\leq 50\%$ (non-stented subjects) or $\leq 30\%$ (stented subjects) by corelab (if corelab was not available then the site-reported estimate was used).
- Clinical success defined as procedural success without procedural complications (death, major target limb amputation, thrombosis of the target lesion, or TVR) prior to discharge.
- Primary sustained clinical improvement is defined as sustained upward shift of at least 1 category on Rutherford classification as compared to baseline without the need for repeated TLR or surgical revascularization in amputation-free surviving subjects.
- Secondary sustained clinical improvement is defined as sustained upward shift of at least 1 category on Rutherford classification as compared to baseline including the need for repeated TLR or surgical revascularization in amputation-free surviving subjects.
- Safety composite endpoint consists of: freedom from device- and procedure-related death within 30 days, freedom from major target limb amputation, and freedom from clinically-driven TVR within 720 days post-index procedure.
- Clinically-driven TLR/TVR is defined as any re-intervention within the target vessel due to symptoms or drop of ABI/TBI of $\geq 20\%$ or >0.15 when compared to post-procedure baseline ABI/TBI.
- Major Adverse Events (MAE) defined as all-cause death, clinically-driven TLR/TVR, major target limb amputation, thrombosis at the target lesion site at 720 days.
- Walking impairment assessed by Walking Impairment Questionnaire (WIQ) at 24 months.

Data sources:

All events were adjudicated by the independent Clinical Events Committee, all duplex ultrasound and angiographic measures were made by the independent core laboratories, and all other data were site reported.

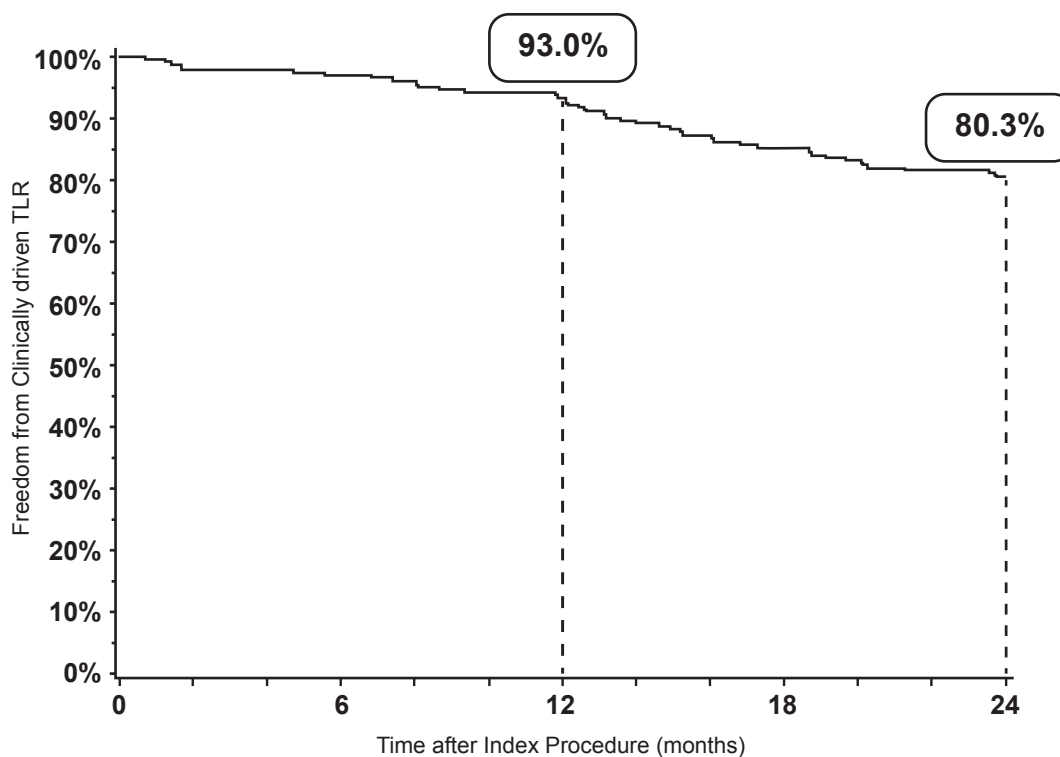

From day X To day Y IN.PACT DCB (N=227 Subjects)	0 0 0M	1 60 2M	61 120 4M	121 180 6M	181 240 8M	241 300 10M	301 360 12M	361 420 14M	421 480 16M	481 540 18M	541 600 20M	601 660 22M	661 720 24M
# Entered ¹	227	227	215	214	210	203	195	189	176	171	166	160	156
# Censored ²	0	7	1	2	5	4	4	5	1	1	2	1	5
# Events	0	5	0	2	2	4	2	8	4	4	4	3	2
Event-free [%] ³	100.0%	97.7%	97.7%	96.8%	95.9%	94.0%	93.0%	89.0%	87.0%	84.9%	82.9%	81.3%	80.3%

¹ Number of subjects at risk at the beginning of each interval.
² Subjects are censored because their last follow-up has not reached the end of the time interval or because they are lost to follow-up.
³ Estimate made at the end of the time interval.
 All events were adjudicated by the independent Clinical Events Committee.

Figure 13. Kaplan-Meier Plot – Event-free from Clinically-driven TLR through 24 months

12. How Supplied

STERILE: The IN.PACT Admiral DCB is sterilized by ethylene oxide (EtO) and is nonpyrogenic. It is intended for single use only. Do not resterilize. Do not use if package is opened or damaged.

CONTENTS: The package contains 1 IN.PACT Admiral DCB.

STORAGE: Store the device in the original container. Store between 15°C and 30°C (59°F and 86°F). Use product by the Use-by Date noted on the package. Do not store near radiation or ultraviolet light sources.

DISPOSAL INSTRUCTIONS: After use, this product may be a biohazard. Handle and dispose of all such devices in accordance with accepted medical practice and applicable hospital, administrative, and government regulations.

DEVICE RETURN INSTRUCTIONS: In the case of a product failure or malfunction related to the product, contact a Medtronic Vascular representative for return or replacement. Any ancillary devices involved in the incident should also be returned to Medtronic, if possible.

13. Instructions for Use

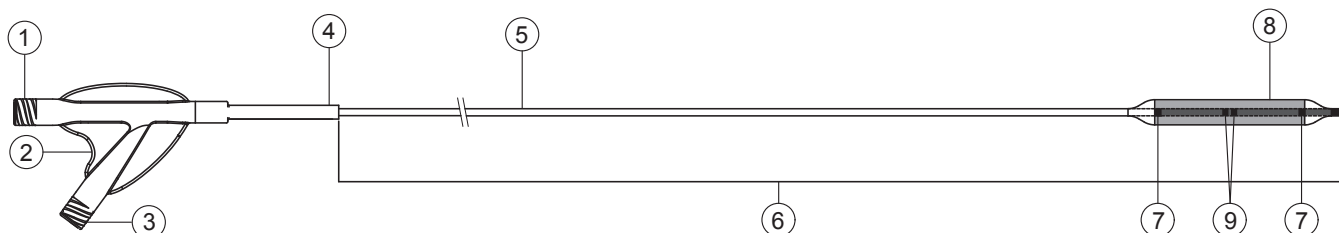

Figure 14. Schematic of the IN.PACT Admiral Paclitaxel-coated PTA Balloon Catheter

1. Guidewire Port
2. Hub
3. Inflation Port
4. Strain Relief
5. Shaft
6. Usable Catheter Length
7. Radiopaque Marker
8. Balloon
9. Central Balloon Markers (200 and 250 mm balloons only)

13.1. Equipment

- 0.035 in Guidewire
- Introducer sheath
- Vessel preparation device
- Contrast medium
- Sterile saline
- Inflation device with manometer
- Luer lock syringe for purging

13.2. Balloon Catheter Size Selection

- The nominal balloon diameter must match the diameter of the vessel distal to the lesion. The balloon length must exceed the lesion length by about 1 cm on the proximal and distal ends.
- If the lesion is longer than the longest available IN.PACT Admiral DCB, use multiple IN.PACT Admiral DCBs to treat the lesion, using the recommended overlap, as described in Using Multiple IN.PACT Admiral DCBs (Section 13.9), Recommended Overlap When Using Multiple IN.PACT Admiral DCBs (Figure 16), and Treatment of a Tandem Lesion with Multiple IN.PACT Admiral DCBs (Figure 18).

13.3. Recommendations for Optimal Treatment

- Appropriate vessel preparation is required prior to the use of the IN.PACT Admiral DCB.
Note: Vessel preparation using only pre-dilatation was studied in the clinical study. Other methods of vessel preparation, such as atherectomy, have not been studied clinically with IN.PACT Admiral DCB.
- When using a PTA balloon for vessel preparation, use a PTA balloon with a diameter 1 mm smaller than the reference vessel diameter to facilitate the passage of the appropriately sized IN.PACT Admiral DCB.
Note: Following vessel preparation, if the lesion cannot be crossed with the first inserted IN.PACT Admiral DCB, the second attempt must be made with a new IN.PACT Admiral DCB in order to ensure effective drug delivery.
- When using a device other than a PTA balloon for vessel preparation, use the device per its Instructions for Use.
- As noted in Delivery and Dilatation Procedure (Section 13.7), for optimal mechanical dilatation of the vessel, an inflation time of 180 seconds is strongly recommended for the IN.PACT Admiral DCB. Adequate drug transfer occurs in the first 60 seconds of inflation.
- Post-dilatation should be completed according to the physician's discretion. If adequate PTA results are not obtained after the IN.PACT Admiral DCB(s) balloon inflation, post-dilatation using a non-drug-coated PTA balloon of shorter length than the previously used IN.PACT Admiral DCB is recommended.
Note: In the randomized trial, provisional stenting with bare-metal stents was completed in cases where adequate results could not be obtained after using post-dilatation balloons, such as in the case of remaining residual stenosis [$\geq 50\%$] or major [\geq Grade D] flow-limiting dissection after post-dilatation.
- It is important to provide drug delivery to the entire length of the treated artery prior to post-dilatation or provisional stenting.

13.4. PTA Preparation

1. Prepare the inflation device, introducer sheath, and guidewire according to the manufacturer's instructions. See Minimum Introducer Sheath Compatibility (Table 33) for help selecting the appropriately sized introducer sheath.

Table 33. Minimum Introducer Sheath Compatibility

Balloon Diameter	Max Crossing Profile	Introducer Sheath
4.0 mm	5.6 Fr (1.82 mm)	5 Fr
5.0 mm	6.0 Fr (2.00 mm)	6 Fr
6.0 mm (except 120 mm)	6.3 Fr (2.10 mm)	
6.0 mm (120 mm length)	6.3 Fr (2.10 mm) or 7.0 Fr (2.33 mm) Consult device label	6 Fr or 7 Fr Consult device label
7.0 mm	7.0 Fr (2.33 mm)	7 Fr

Note: Use of a long introducer sheath extending beyond the iliac bifurcation is recommended if a contralateral approach is used.

2. Administer the appropriate medication to the patient prior to treatment as described in Pre-procedure and Post-procedure Medication Regimen (Section 6.2).
3. Prepare the vascular access site according to standard practice.
4. Insert a guidewire through the hemostatic valve following the manufacturer's instructions or standard practice. Advance the guidewire carefully into the introducer sheath.
5. Attach a torque device to the wire, if desired. Under fluoroscopy, advance the guidewire to the desired vessel, then across the stenosis. Remove the torque device once the guidewire is positioned.

Note: If treating an in-stent restenosis, ensure the guidewire has traversed the lesion intraluminally.

13.5. IN.PACT Admiral DCB Preparation

1. The catheter is packaged in a protective blister. Verify that the catheter and sterile packaging have not been damaged in shipment. After all preparation has been completed, carefully remove the catheter from the package. Do not remove the IN.PACT Admiral DCB from the packaging until it is ready for insertion.

Note: Avoid exposing the balloon drug coating to excessive handling or contact with liquids prior to preparation and delivery as the coating may be susceptible to damage or premature drug release.

2. The folded balloon catheter may contain air that should be purged prior to use. Connect a stopcock to the balloon port of the catheter hub. Connect a luer-lock syringe partially filled with saline solution to the stopcock. Open the stopcock. Keeping the syringe in a downward vertical position, draw back the plunger of the syringe and create a vacuum for 30 seconds in the balloon inflation line until air is completely evacuated.

Caution: If the air bubbles cannot be completely evacuated, there may be a leak in the catheter. Discard the device and select a new IN.PACT Admiral DCB.

Note: It is important to maintain the vacuum seal in order to keep the balloon profile tight before insertion into the introducer sheath.

Note: Keep the protective sheath in place during the purging procedure.

3. After air is completely evacuated, close the stopcock and remove the syringe.
4. Remove the stylet and the protective sheath from the balloon and discard. Do not use the protective sheath as an introduction aid or rewinding tool.
5. Connect the filled syringe to the guidewire port. Flush the guidewire lumen through the guidewire port with heparinized normal saline until the fluid exits the distal tip.

Note: Drops of saline must emerge from the device tip.

Note: To minimize the introduction of air, aspirate and flush the system and keep a tight catheter connection throughout the procedure.

13.6. Inflation Device Connection to the IN.PACT Admiral DCB

1. Fill the inflation device with 15 mL of saline-contrast mixture. Do not use air or any gaseous medium to inflate the balloon. Use only the recommended inflation medium (equal parts contrast medium and saline solution). Do not apply positive pressure to the balloon during preparation.
2. Evacuate all air present in the inflation device.

Note: The inflation device should have no air bubbles present, either in the tube or in the cylinder; to remove any air lodged, keeping the tip upward, purge approximately 1cc of saline-contrast mixture.

3. With the stopcock connected to the balloon port in the closed position, securely couple the inflation device to the stopcock. Verify that no air is evident in both the stopcock and the inflation device's connection.

13.7. Delivery and Dilatation Procedure

1. Load the distal tip of the balloon catheter over the prepositioned guidewire, which has been placed through the lesion.
2. Advance the catheter under direct fluoroscopic visualization. To avoid kinking, advance the catheter through the hemostatic valve slowly and in small increments while the stopcock is closed. Open the hemostatic valve to allow for easy passage of the balloon and to prevent damage to the balloon coating. Once the balloon has passed through, the hemostatic valve should be closed as much as is needed to prevent blood return while still permitting easy movements of the catheter.

Note: If significant resistance is encountered, do not advance the catheter through the introducer sheath.

3. Under fluoroscopy, use the balloon radiopaque markers to position the balloon within the lesion to be dilated. If the inflation device has not already been connected, connect the inflation device according to instructions in Inflation Device Connection to the IN.PACT Admiral DCB (Section 13.6).
4. Open the stopcock and inflate the balloon to the appropriate pressure as described in the Compliance Chart included in the device packaging, then close the stopcock to maintain pressure. For optimal mechanical dilatation of the vessel, balloon inflation time of 180 seconds is strongly recommended. Adequate drug transfer occurs in the first 60 seconds of inflation. If the IN.PACT Admiral DCB was inflated for at least 60 seconds but the vessel requires additional dilatation due to suboptimal PTA results, a plain PTA balloon of the operator's choice can be used (PTA balloon should be of shorter length compared to the IN.PACT Admiral DCB).

Warning: Do not exceed rated burst pressure as indicated on the device label. Use of pressures higher than those specified on the device label may result in a ruptured balloon with possible intimal damage and dissection.

Note: The IN.PACT Admiral DCB is intended for single inflation only.

13.8. Removal Procedure

1. Open the stopcock and deflate the balloon by applying negative pressure to the inflation device. For all balloon lengths except for 200 and 250 mm, allow approximately 60 seconds for full balloon deflation. For the 200 and 250 mm balloon lengths, allow approximately 120 seconds for full balloon deflation. Larger balloons may require more time for deflation. Deflation of the balloon should be confirmed by absence of contrast medium within the balloon.

Note: The balloon must be completely deflated before removal.

2. Upon confirmation of full deflation, disconnect the inflation device, then open the hemostatic valve and withdraw the deflated balloon catheter from the introducer sheath, through the hemostatic valve. Tighten the knurled knob on the hemostatic valve.
3. If necessary, the balloon catheter can be exchanged for different balloon types or sizes using the guidewire/ introducer that remains in the vessel.

Note: If further dilatation is required, post-dilatation should be performed with a non-drug-coated PTA balloon of shorter length than the IN.PACT Admiral DCB.

4. When complete, withdraw the guidewire/introducer, and close the hemostatic valve.

Note: After use, this device may be a biohazard. Handle and dispose of all such devices in accordance with accepted medical practice and applicable hospital, administrative, and government regulations.

13.9. Using Multiple IN.PACT Admiral DCBs

Warning: The safety and effectiveness of using multiple IN.PACT Admiral DCBs with a total drug dosage exceeding 34,854 μg paclitaxel in a patient has not been clinically evaluated.

Additional IN.PACT Admiral DCBs should be used to treat a lesion only under either of the following circumstances:

- The first IN.PACT Admiral DCB bursts prior to 60 seconds of inflation time.
- The lesion length requires more than 1 IN.PACT Admiral DCB to fully cover the lesion and extend about 1 cm at both the proximal and distal edges.

If multiple IN.PACT Admiral DCBs are required due to a lesion length greater than the longest available DCB, the balloons must overlap by at least 1 cm. The size of additional DCBs should not be longer than required to allow for this overlap and complete the lesion coverage with about 1 cm extended beyond the lesion both proximally and distally. Proper size selection is important to avoid excessive overlap. Refer to Figure 15 through Figure 18 for further guidance.

Note: In order to reduce procedure-related complications, use only the minimum number of devices needed to cover the lesion(s).

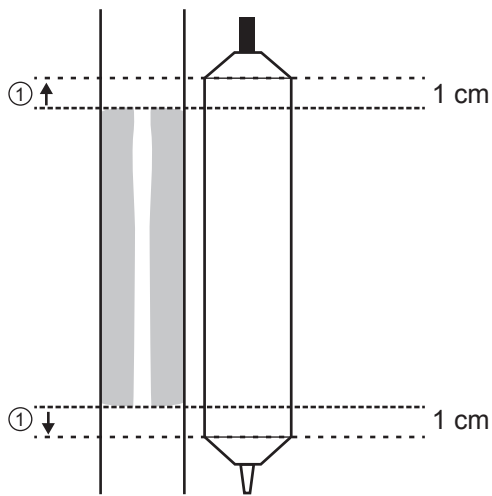

Figure 15. Treatment of a Single Lesion

1. approximately 1 cm

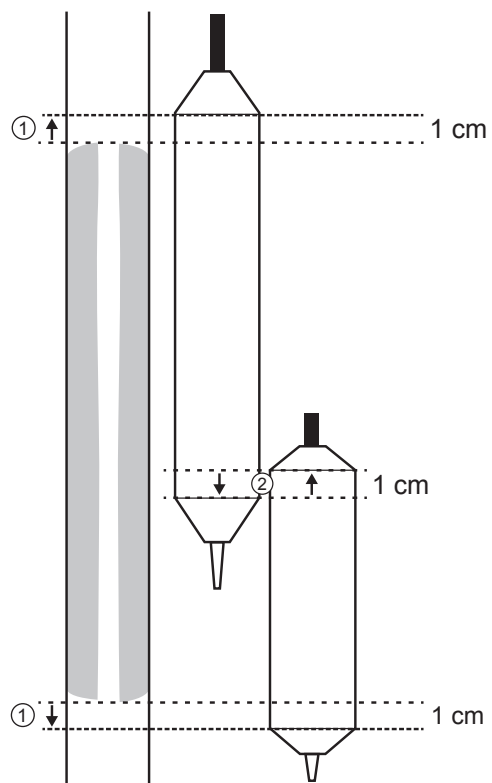

Figure 16. Recommended Overlap When Using Multiple IN.PACT Admiral DCBs

1. approximately 1 cm
2. at least 1 cm balloon overlap

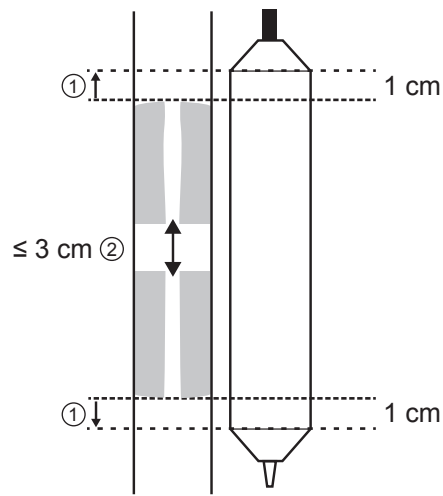

Figure 17. Treatment of a Tandem Lesion with a Single IN.PACT Admiral DCB

1. approximately 1 cm
2. lesion gap ≤ 3 cm

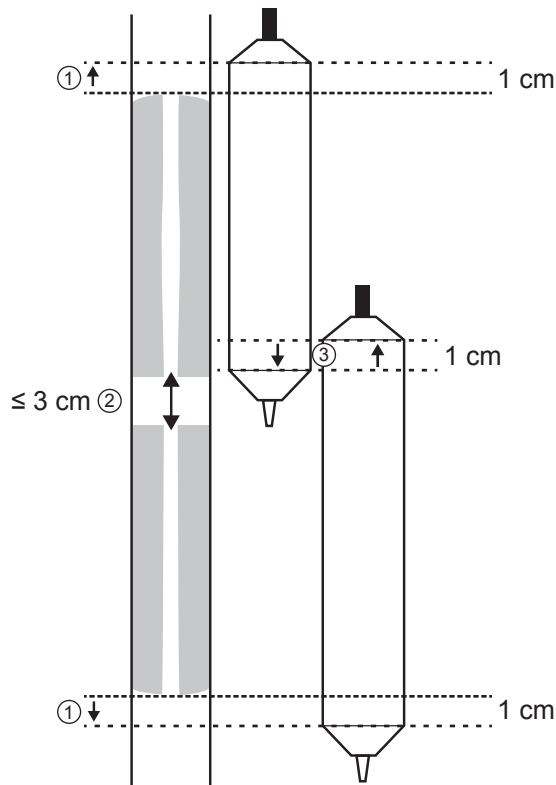

Figure 18. Treatment of a Tandem Lesion with Multiple IN.PACT Admiral DCBs

1. approximately 1 cm
2. lesion gap ≤ 3 cm
3. at least 1 cm balloon overlap

14. DISCLAIMER OF WARRANTY

ALTHOUGH THE IN.PACT ADMIRAL DRUG-COATED BALLOON CATHETER, HEREAFTER REFERRED TO AS “PRODUCT”, HAS BEEN MANUFACTURED UNDER CAREFULLY CONTROLLED CONDITIONS, MEDTRONIC, INC., AND AFFILIATES (COLLECTIVELY, “MEDTRONIC”) HAVE NO CONTROL OVER CONDITIONS UNDER WHICH THIS PRODUCT IS USED. THE WARNINGS CONTAINED IN THE PRODUCT LABELING PROVIDE MORE DETAILED INFORMATION AND ARE CONSIDERED AN INTEGRAL PART OF THIS DISCLAIMER OF WARRANTY. MEDTRONIC THEREFORE DISCLAIMS ALL WARRANTIES, BOTH EXPRESSED AND IMPLIED, WITH RESPECT TO THE PRODUCT, INCLUDING, BUT NOT LIMITED TO, ANY IMPLIED WARRANTY OF MERCHANTABILITY OR FITNESS FOR A PARTICULAR PURPOSE. MEDTRONIC SHALL NOT BE LIABLE TO ANY PERSON OR ENTITY FOR ANY MEDICAL EXPENSES OR ANY DIRECT, INCIDENTAL, OR CONSEQUENTIAL DAMAGES CAUSED BY ANY USE, DEFECT, FAILURE, OR MALFUNCTION OF THE

PRODUCT, WHETHER A CLAIM FOR SUCH DAMAGES IS BASED UPON WARRANTY, CONTRACT, TORT, OR OTHERWISE. NO PERSON HAS ANY AUTHORITY TO BIND MEDTRONIC TO ANY REPRESENTATION OR WARRANTY WITH RESPECT TO THE PRODUCT.

The exclusions and limitations set out above are not intended to and should not be construed so as to contravene mandatory provisions of applicable law. If any part or term of this Disclaimer of Warranty is held to be illegal, unenforceable, or in conflict with applicable law by a court of competent jurisdiction, the validity of the remaining portions of this Disclaimer of Warranty shall not be affected.

Medtronic



Medtronic, Inc.
710 Medtronic Parkway
Minneapolis, MN 55432 USA
www.medtronic.com



Medtronic Ireland
Parkmore Business Park West
Galway, Ireland

US CUSTOMER SERVICE/PRODUCT INQUIRIES:

Tel. (+1-888) 283-7868
Fax (+1-800) 838-3103



M052624T001

© 2019 Medtronic
M052624T001 Rev. K
2019-09-09