

# PERFORM-X

ADVANCED DIAGNOSTIC X-RAY SYSTEMS



# PERFORM-X, A MEDICAL DIAGNOSTIC SUITE THAT MEETS ALL YOUR NEEDS



Sophisticated yet cost-effective



Digital imaging for all practices



Full system integration



Ceiling- or floor-mounted



Dual (motorized and manual) movement

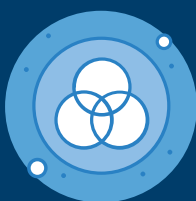

Multiple automation levels



Minimal patient dose

✓ MANUAL ✓ AUTO-TRACKING ✓ AUTO-STITCHING ✓ AUTO-POSITIONING



This brochure features both standard and optional system elements.

# FEATURES TO INCREASE PATIENT THROUGHPUT, CHOICE OF STUDIES AND OPERATOR COMFORT

## AUTO-TRACKING (PERFORM-X C200+ / F200+)

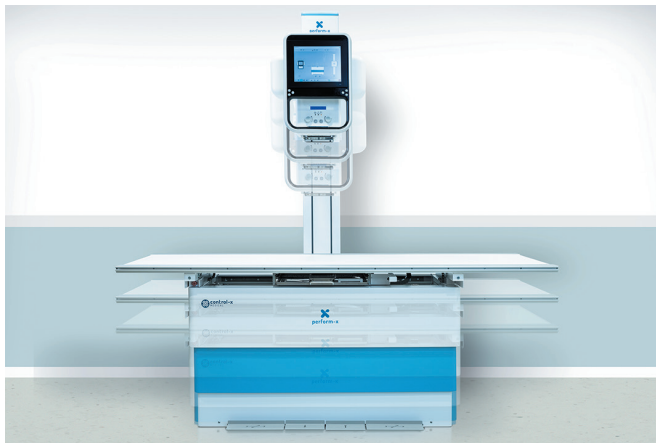

Motorized vertical syncing of x-ray tube and table top, keeping preset source-image distance (SID) constant

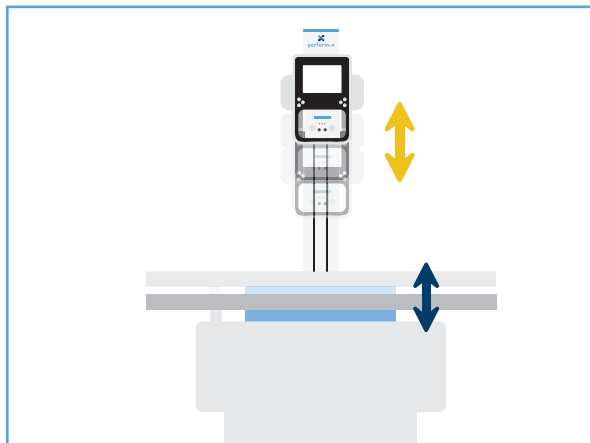

Motorized one- or two-way vertical syncing of x-ray tube and vertical detector

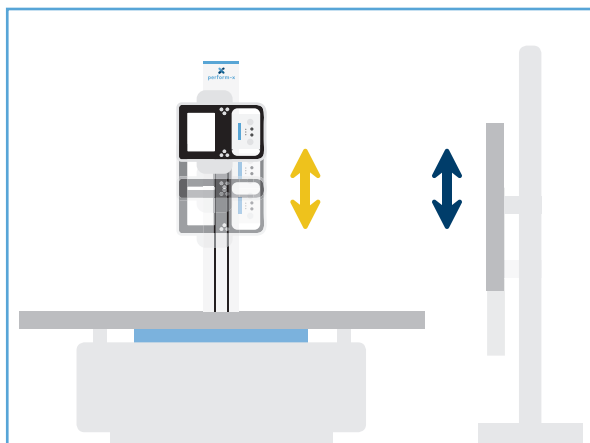

## TABLE IMAGE RECEPTOR AUTO-ALIGNMENT (PERFORM-X C200+ / F200+)



Motorized alignment of table image receptor with x-ray tube movement and rotation

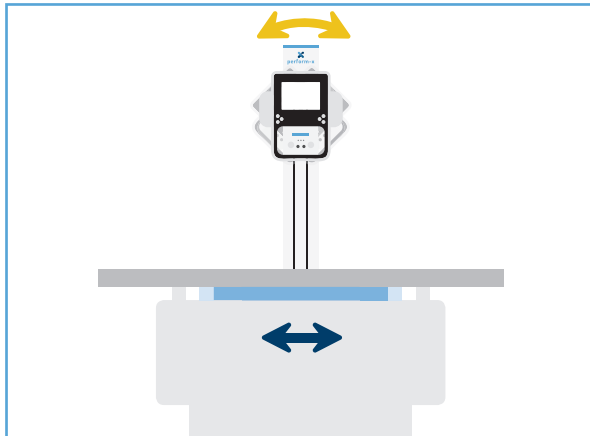

## DOSE-OPTIMIZED SMART STITCHING\* (PERFORM-X C300+ / F300+)

- PXIM System Software calculates dose-limiting lowest necessary number of exposures based on set Start and End positions
- Automatic system positioning executes programmed stitching procedure
- Procedure is performed with constant focus, rotating x-ray tube
- Overlapping images are combined into seamless study
- Vertical stitching for up to 5, Horizontal stitching\*\* for up to 3 images
- Stitching Stand is available to assist frail patients for vertical procedures



\* Smart Stitching Procedure requires Auto-Collimation

\*\* Horizontal stitching on the patient table requires Auto-Positioning features.



## AUTO-POSITIONING (PERFORM-X C400 / F400)

- APR-controlled automatic positioning moves system into place for procedure
- APR positioning from Workstation
- Favourite APRs can easily be selected
- Anti-collision sensors ensure safe operation

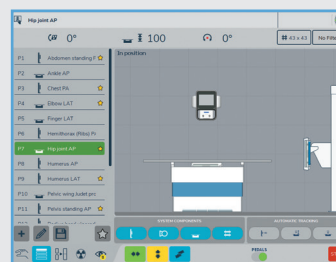

SCAN QR CODES FOR VIDEOS FEATURING  
THE PERFORM-X C400 AND F400 SYSTEMS



C400



F400

## CEILING-MOUNTED SYSTEM

- Customizable for any room height, including with low ceilings
- Variable longitudinal and cross-table travel ranges
- Maximum flexibility in system positioning
- Easy access to both sides of radiographic table
- Motorized movement with manual override



## VERTICAL STAND

- Receptor travels to the floor
- Fail-safe electromagnetic brakes
- LED system status light on stand (standby, tracked, error)
- Free-standing set-up
- Motorized or manual tilting receptor for full positioning flexibility
- Optional in-bucky charging of detector

## NEW 10" OR 12" SMART CONSOLE

- Enables full system integration with PXIM System Software
- Control of all movements in one place
- Access to favourite APR positions
- Quick Image Preview to evaluate exposure
- Integrated generator parameter control
- Live collimator Camera view
- Patient Positioning Guide to assist operator
- User Comfort Settings (e.g. table pedal lock)
- System status and error monitoring

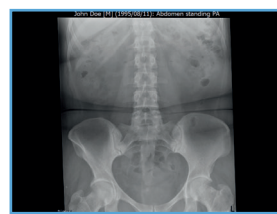
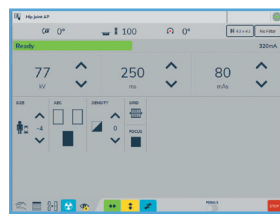
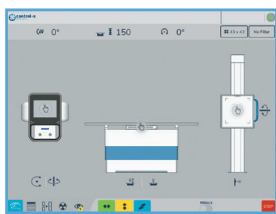

## FLOOR-MOUNTED SYSTEMS

- Column rotation for cross-table exams
- Transverse tube travel
- Extended vertical and horizontal travel options
- LED system status light on stands (standby, tracked, error)

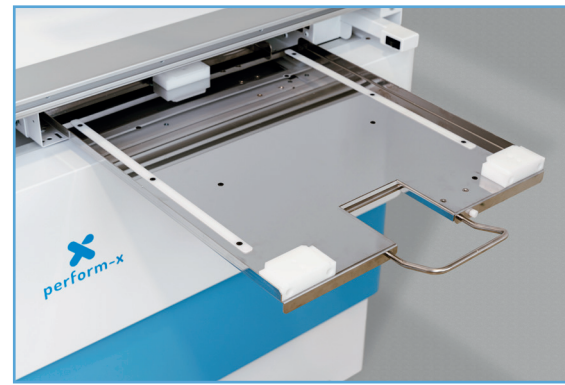

## PHOENIX ELEVATING TABLE

- Exceptionally wide vertical movement range
- Suitable for obese patients
- Six-way effortless patient positioning
- Advanced safety features to protect patient and operator
- Optional in-bucky charging of detector

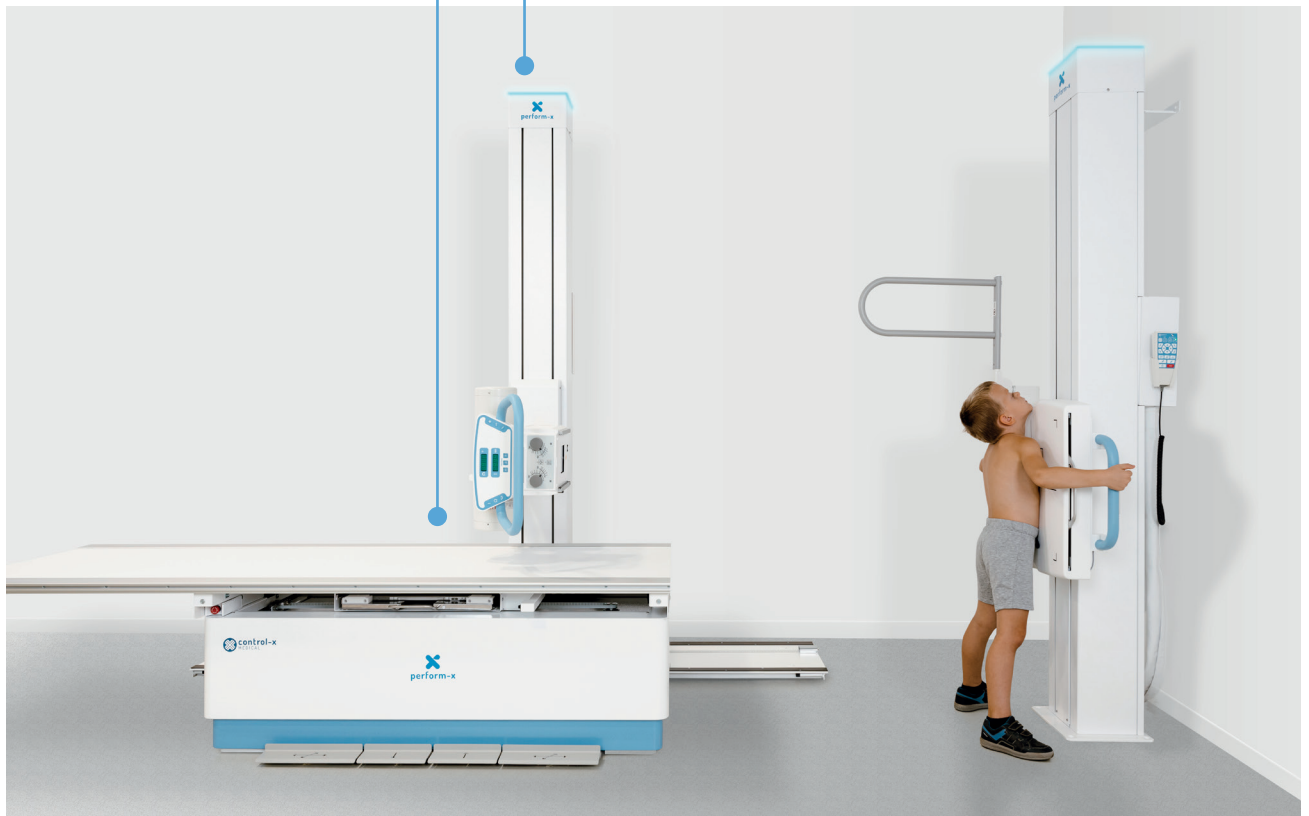

Wired or wireless remote control for motorized movements



Easy-to-use membrane console

## HIGH QUALITY COMPONENTS

- Receptor Tray with in-bucky charging or Receptor rotating mechanism (docking station)
- Wide selection of Industry-leading X-ray tubes
- High-density removable grids (non-oscillating)
- Manual or automatic Collimators, including with Camera

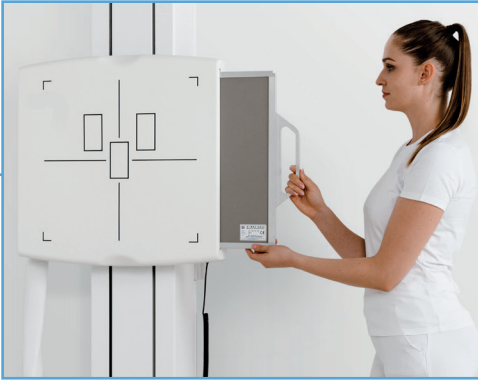

## DOSAGE LIMITATION AND GENERATOR CONTROL OPTIONS

- Automatic Exposure Control (AEC) and Dosage Area Product (DAP) meter to avoid unnecessary dose
- 50 kW to 80 kW generator output range
- Stored energy generators up to 50 kW (capacitor discharge)



## INTELLIGENT MODULAR SOFTWARE (PXIM):

- **PXIM Console** - LCD user interface for Movement selection, Generator settings, Image Preview and other advance features
- **PXIM Embedded Control** - Modular embedded software enabling Automated Tracking, Stitching, Positioning, Safety sensors and overall Communication
- **PXIM Service** - Remote Diagnostics and Calibration

## FULL DR SYSTEM INTEGRATION

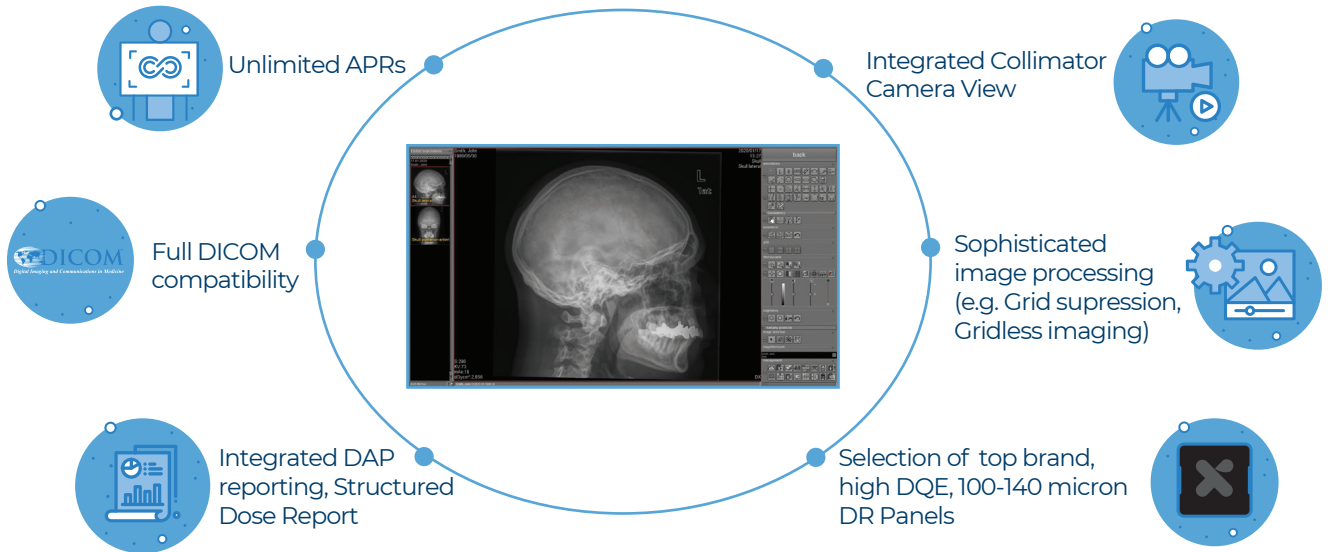

## REMOTE DIAGNOSTICS

Advanced diagnostic software to minimize downtime

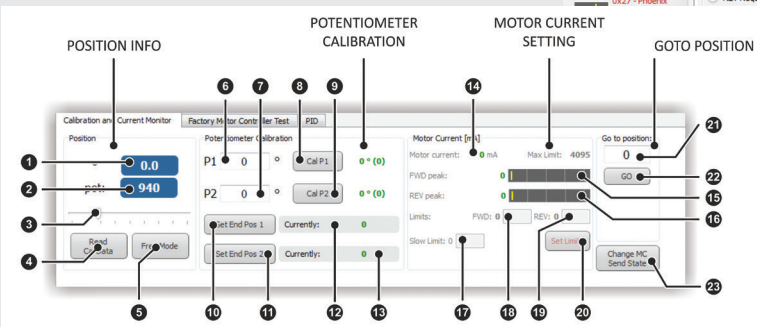
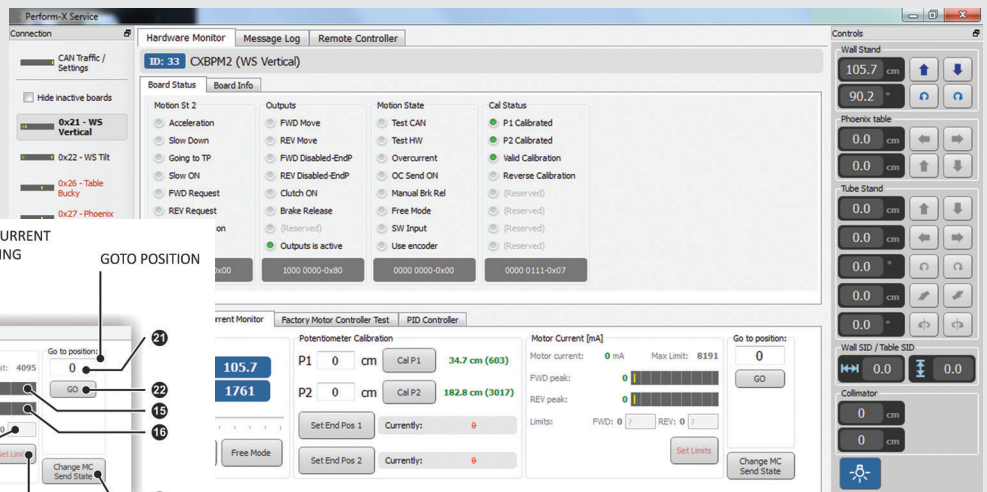

▼

## FOUR STANDARD CONFIGURATIONS IN BOTH CEILING- AND FLOOR-MOUNTED SYSTEMS



### PERFORM-X SYSTEM CONFIGURATIONS

	Model Code	Manual (Counterbalanced)	Auto-Tracking	Auto-Stitching	Auto-Positioning
Floor-Mounted	F100	✓			
	F200	✓	✓		
	F300	✓	✓	✓	
	F400	✓	✓	✓	✓
Ceiling-Mounted	C100	✓			
	C200	✓	✓		
	C300	✓	✓	✓	
	C400	✓	✓	✓	✓

#### Certifications

ISO 13485, CE marked and FDA approved



Authorized distributor:



Please contact us at [sales@cxmed.com](mailto:sales@cxmed.com)  
or at +36 1 381 0301

Follow us on

