



# OPERATING ROOM **ESSENTIALS**

THE COMPLETE  
SOLUTION  
**YOU CAN TRUST**



## Wound Closure **Catalogue**

September 2017

**Medtronic**  
Further, Together

# HOW TO READ A SUTURE LABEL

**COVIDIEN™**

**CL-812** — Re-Order Code

**Polysorb™** — Material

Braided Absorbable Suture

**0** — USP / EP

**3.5 Metric**

**30" 75 cm VIOLET** — Suture Length, Colour

**GS-21 TAPER** — Needle Description

**1/2 37 mm**

**36** — Quantity Per Box

**LOT XXXXXXXXX** — Lot Number

**Use by XXXX-XX** — Expiration Date

**Bar Code** — (XX)XXXXXXXXXXXX

**COVIDIEN™**

**CL-69-MG** — Re-Order Code

**Polysorb™** — Material

Braided Absorbable Suture

**2-0** — USP/EP

**3 Metric**

**5x18" 45 cm VIOLET** — Suture Length, Colour

**HOS-11 CUTTING** — Needle Description

**1/2 37 mm**

**12** — Quantity Per Box

**LOT XXXXXXXXXXXXX** — Lot Number

**Use by XXXX-XX** — Expiration Date

**Mfg XXXX-XX** — Manufacturing Date

**Bar Code** — (XX)XXXXXXXXXXXX (XX)XXXXXX (XX)XXXXXXXXXX

**PRODUCT INFORMATION ENCLOSED**

# WHY MEDTRONIC?

Medtronic have an extensive heritage in partnerships with Public Hospitals and Private Groups. Delivering value-based healthcare, clinical expertise and innovation through products and services that are focused on patient care and clinical outcomes.

## OR ESSENTIALS

We pride ourselves on being a brand you can trust. With our proven track record of **quality products and services**, you can feel reassured that Medtronic's OR Essentials will help you to continue providing **the very best patient care** from the first mark to the last stitch. Let's embrace the future together.



Operating Room Supplies Catalogue



Laparoscopic Access Catalogue



Cardiothoracic



Surgical Instruments Catalogue

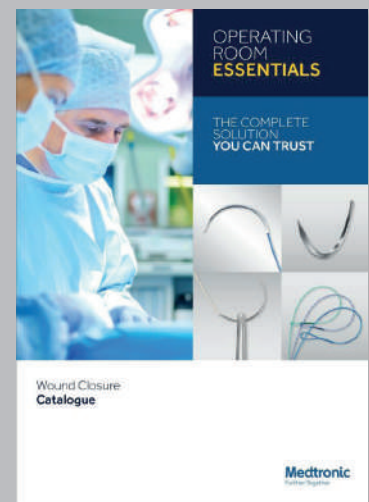

Wound Closure Catalogue

# INTRODUCTION

## A Comprehensive Portfolio of Wound Closure Materials and Accessories

We're all part of the same community. A community entrusted with enhancing and saving the lives of patients. At Medtronic, we actively partner with you to provide your patients with the most optimal care. Every day. Whatever role you play, we're here for you — leveraging over 100 years of expertise and insight to innovate wound closure solutions. We are committed to remaining by your side for the next 100 years, evolving with your changing needs so you can keep delivering the highest levels of patient care. Our comprehensive portfolio of effective wound closure solutions is for the full spectrum of general and specialty procedures.

### Absorbable Sutures

Absorbable sutures from Medtronic provide strength retention and absorption profiles to meet your surgical specialty and tissue healing requirements.

### Non-Absorbable Sutures

Non-absorbable sutures from Medtronic can be used in a range of procedures, including cardiovascular, ophthalmic and neurological surgery.



















### Barbed Wound Closure

The V-Loc™ wound closure device is a revolutionary technology that eliminates the need to tie knots, so you can close incisions up to 50% faster without compromising strength and security

### Wound Closure Accessories

Wound closure accessories from Medtronic include bone wax, bolsters, suture racks, cardiovascular pledgets and umbilical tape

# CONTENTS

	Velosorb™ Fast .....	06
	Polysorb™ .....	18
	Caprosyn™ .....	50
	Biosyn™ .....	60
	Maxon™ / Maxon™ CV .....	76
	Surgipro™ / Surgipro™ II .....	94
	Ti-Cron™ / Surgidac™ .....	120
	Vascufil™ .....	144
	Flexon™ .....	148
	Steel .....	152
	Dermalon™ / Monosof™ .....	158
	Novafil™ .....	176
	Surgilon™ .....	186
	Sofsilk™ .....	192
	V-Loc™ 90 Absorbable .....	212
	V-Loc™ 180 Absorbable .....	218
	V-Loc™ PBT .....	224
	Pledgets .....	232

# VELOSORB™ FAST

## Braided Fast Absorbable Suture

There when you need it. Gone when you don't.



**Braided absorbable sutures for use in soft tissue approximation when 7–10 days of wound support is required.**

- Velosorb™ Fast suture is stronger than the competition for the first 7 to 10 days.
- Velosorb™ Fast suture has no tensile strength after 14 days<sup>1</sup>
- No removal means enhanced patient comfort
- Fast absorption profile

### Absorption

By Hydrolysis. Essentially complete within 40 to 50 days.

### Tensile Strength

No less than 45% of its original tensile strength 5 days post-implantation. All of the original tensile strength is essentially gone by 14 days.

### Packaging

Are available in USP sizes 1 (4 Metric) through 6–0 (0.7 Metric). They are available undyed (natural). The sutures are supplied sterile, in pre-cut lengths affixed to various needle types.

### Indications

Indicated for use in soft tissue approximation of the skin, mucosa and conjunctiva, where only 7–10 days of wound support is required, but not for use in ligation, cardiovascular or neurological tissue.

## Description

Velosorb™ Fast absorbable braided sutures are composed of an absorbable synthetic polyester comprised of glycolide and lactide (derived from glycolic and lactic acids). Velosorb™ Fast absorbable sutures are prepared by coating the suture with a mixture of a glycolide and lactide copolymer and calcium stearate.

## Indications

Velosorb™ Fast absorbable sutures are indicated for use in soft tissue approximation of the skin, mucosa and conjunctiva, where only 7-10 days of wound support is required, but not for use in ligation, cardiovascular or neurological tissue.

## Actions

Velosorb™ Fast absorbable sutures elicit a minimal acute inflammatory reaction in tissue, which is followed by a gradual encapsulation of the suture by fibrous connective tissue. Progressive loss of tensile strength and eventual absorption of Velosorb™ Fast absorbable sutures occurs by means of hydrolysis, where the glycolide/lactide copolymer is broken down to glycolic and lactic acids which are subsequently absorbed and metabolized by the body.

## Tensile Strength

Studies indicate tensile strength averages for Velosorb™ Fast absorbable sutures are no less than 45% of its original tensile strength 5 days post implantation. All of the original tensile strength is essentially gone by 14 days.

## Sterilization

Gamma irradiation.

## Absorbtion

Absorption begins as a loss of tensile strength without appreciable loss of mass. Absorption of Velosorb™ Fast absorbable sutures is essentially complete between the 40<sup>th</sup> and 50<sup>th</sup> day.

## Packaging

Velosorb™ Fast absorbable sutures are available in USP sizes 1 (4 Metric) through 6-0 (0.7 Metric). They are available undyed (natural). The sutures are supplied sterile, in pre-cut lengths affixed to various needle types. Please refer to the individual package IFUs for complete instructions, indications, contraindications, warnings and precautions.

Please refer to the individual package IFUs for complete instructions, indications, contraindications, warnings and precautions.



1. IFU indicates tensile strength averages for Velosorb™ Fast sutures are approximately 50% of its original tensile strength 5 days post implantation. All of the original tensile strength is gone by 14 days. Absorption of Velosorb™ Fast sutures is essentially complete between the 40th and 50th day.

# Velosorb™ Fast absorbable suture

Fast braided absorbable suture for use in soft tissue approximation of the skin and mucosa, when only 7–10 days of wound support is required.





PRE-CUT								
Needles Specifications	Size		Length		Color	Units Per box	Comments	Reorder code
	USP	EP	cm	Inches				
	<b>4-0</b>	1.5	6×45	18	Undyed	36		CV-8977
	<b>4-0</b>	1.5	3×45	18	Undyed	36		CV-8643
	<b>3-0</b>	2	6×45	18	Undyed	36		CV-8978
	<b>3-0</b>	2	3×45	18	Undyed	36		CV-8644
	<b>2-0</b>	3	6×45	18	Undyed	36		CV-8979
	<b>2-0</b>	3	5×75	30	Undyed	36		CV-8653
	<b>0</b>	3.5	6×45	18	Undyed	36		CV-8980

STANDARD LENGTH								
Needles Specifications	Size		Length		Color	Units Per box	Comments	Reorder code
	USP	EP	cm	Inches				
<b>CV-9006G</b>	<b>3-0</b>	2	150	60	Undyed	12	Std Length	CV-9006G
<b>CV-9007G</b>	<b>2-0</b>	3	150	60	Undyed	12	Std Length	CV-9007G

REVERSE CUTTING								
Needles Specifications	Size		Length		Color	Units Per box	Comments	Reorder code
	USP	EP	cm	Inches				
<b>C-1</b> 3/8 Circle 12.0 mm 	<b>5-0</b>	1	75	30	Undyed	36		SV-2289
	<b>4-0</b>	1.5	45	18	Undyed	36		SV-1290
	<b>4-0</b>	1.5	75	30	Undyed	36		SV-2290
<b>C-12</b> 3/8 Circle 16.0 mm 	<b>5-0</b>	1	75	30	Undyed	36		SV-2296
	<b>4-0</b>	1.5	75	30	Undyed	36		SV-2294
	<b>3-0</b>	2	75	30	Undyed	36		SV-2295









REVERSE CUTTING									
Needles Specifications	Size		Length		Color	Units Per box	Comments	Reorder code	
	USP	EP	cm	Inches					
<b>C-13</b> 3/8 Circle 19.0 mm 	5-0	1	45	18	Undyed	36		SV-2910	
	4-0	1.5	45	18	Undyed	36		SV-2920	
	4-0	1.5	75	30	Undyed	36		SV-2297	
	3-0	2	45	18	Undyed	36		SV-2930	
	3-0	2	75	30	Undyed	36		SV-2298	
	2-0	3	75	30	Undyed	36		SV-2299	
<b>C-14</b> 3/8 Circle 24.0 mm 	4-0	1.5	75	30	Undyed	36		SV-2251	
	3-0	2	45	18	Undyed	36		SV-4431	
	3-0	2	75	30	Undyed	36		SV-2252	
	2-0	3	75	30	Undyed	36		SV-2253	
<b>C-15</b> 3/8 Circle 26.0 mm 	3-0	2	75	30	Undyed	12		SV-9940G	
	2-0	3	75	30	Undyed	12		SV-9941G	
<b>C-16</b> 3/8 Circle 30.0 mm 	3-0	2	90	36	Undyed	36		SV-2285	
	2-0	3	90	36	Undyed	36		SV-2286	
	0	3.5	90	36	Undyed	36		SV-2287	
<b>C-17</b> 3/8 Circle 39.0 mm 	2-0	3	75	30	Undyed	12		SV-9961G	











REVERSE CUTTING									
Needles Specifications	Size		Length		Color	Units Per box	Comments	Reorder code	
	USP	EP	cm	Inches					
<b>C-22</b> 1/2 Circle 20.0 mm 	4-0	1.5	45	18	Undyed	36		SV-4550	
<b>C-23</b> 1/2 Circle 24.0 mm 	4-0	1.5	45	18	Undyed	36		SV-9926	
	3-0	2	45	18	Undyed	36		SV-9927	
	2-0	3	45	18	Undyed	36		SV-9928	
<b>GS-10</b> 1/2 Circle 26.0 mm 	2-0	3	75	30	Undyed	12		CV-9936G	
<b>GS-11</b> 1/2 Circle 37.0 mm 	3-0	2	135	54	Undyed	12		CV-931G	
	2-0	3	90	36	Undyed	36		CV-4721	
	2-0	3	135	54	Undyed	12		CV-932G	
	0	3.5	90	36	Undyed	36		CV-4731	
<b>GS-12</b> 1/2 Circle 40.0 mm 	0	3.5	90	36	Undyed	36		CV-485	
	1	4	90	36	Undyed	36		CV-486	









PREMIUM REVERSE CUTTING										
Needles Specifications			Size		Length		Color	Units Per box	Comments	Reorder code
			USP	EP	cm	Inches				
<b>P-10</b> 3/8 Circle 11.0 mm 	6-0	0.7	45	18	Undyed	36			SV-9913	
	6-0	0.7	45	18	Violet	36			SV-32	
	6-0	0.7	75	30	Undyed	36			SV-4893	
	5-0	1	45	18	Undyed	36			SV-9915	
<b>P-13</b> 3/8 Circle 13.0 mm 	5-0	1	45	18	Undyed	36			SV-493	
	4-0	1.5	45	18	Undyed	36			SV-494	
	4-0	1.5	75	30	Undyed	36	Surgalloy™		SVP-494	
<b>P-11</b> 3/8 Circle 16.0 mm 	5-0	1	75	30	Undyed	36	Surgalloy™		SVP-2296	
	4-0	1.5	75	30	Undyed	36	Surgalloy™		SVP-2294	
	3-0	2	75	30	Undyed	36	Surgalloy™		SVP-2295	
<b>P-12</b> 3/8 Circle 19.0 mm 	4-0	1.5	45	18	Undyed	12			SV-496G	
	4-0	1.5	45	18	Undyed	36			SV-496	
	4-0	1.5	75	30	Undyed	36			SV-426	
	4-0	1.5	90	36	Undyed	36			SV-412	
	3-0	2	45	18	Undyed	12			SV-497G	
	3-0	2	75	30	Undyed	36			SV-425	
	2-0	3	75	30	Undyed	36			SV-424	
<b>P-14</b> 3/8 Circle 24.0 mm 	4-0	1.5	75	30	Undyed	36			SVP-2251	
	3-0	2	45	18	Undyed	36			SV-6830	
	3-0	2	75	30	Undyed	36			SV-935	
	2-0	3	45	18	Undyed	36			SV-6840	
	2-0	3	75	30	Undyed	36			SV-439	
<b>P-17</b> 3/8 Circle 30.0 mm 	3-0	2	90	36	Undyed	36			SVP-2285	
<b>P-18</b> 3/8 Circle 38.0 mm 	3-0	2	75	30	Undyed	12			SV-9937G	
	2-0	3	75	30	Undyed	12			SV-9938G	

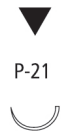





PREMIUM REVERSE CUTTING										
Needles Specifications	Size		Length		Color	Units Per box	Comments	Reorder code		
	USP	EP	cm	Inches						
<b>P-21</b> 1/2 Circle 9.0 mm 	4-0	1.5	45	18	Undyed	36		SV-1642		
<b>P-24</b> 1/2 Circle 16.0 mm 	5-0	1	45	18	Undyed	12		SV-9910G		
	4-0	1.5	45	18	Undyed	12		SV-9911G		

CONVENTIONAL CUTTING										
Needles Specifications	Size		Length		Color	Units Per box	Comments	Reorder code		
	USP	EP	cm	Inches						
<b>PC-10</b> 3/8 Circle 13.0 mm 	5-0	1	45	18	Undyed	12		SV-834G		
	4-0	1.5	45	18	Undyed	12		SV-835G		
<b>PC-11</b> 3/8 Circle 16.0 mm 	6-0	0.7	75	30	Undyed	12		SV-489G		
	5-0	1	45	18	Undyed	12		SV-844G		
	4-0	1.5	45	18	Undyed	12		SV-845G		
	4-0	1.5	75	30	Undyed	12		SV-488G		
	3-0	2	75	30	Undyed	12		SV-487G		
<b>SC-11</b> Straight 11.0 mm 	4-0	1.5	45	18	Undyed	12		SV-9909G		



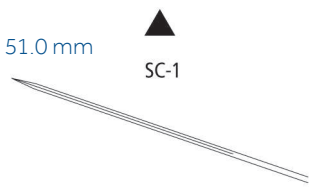
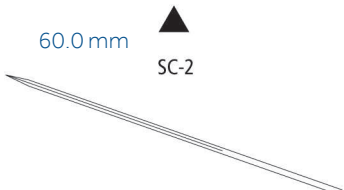

CONVENTIONAL CUTTING								
Needles Specifications	Size		Length		Color	Units Per box	Comments	Reorder code
	USP	EP	cm	Inches				
<b>SC-1</b> Straight 51.0 mm 	<b>4-0</b>	1.5	75	30	Undyed	36		SV-2238
	<b>3-0</b>	2	75	30	Undyed	36		SV-2239
	<b>2-0</b>	3	75	30	Undyed	36		SV-2240
<b>SC-2</b> Straight 60.0 mm 	<b>3-0</b>	2	75	30	Undyed	36		SV-9943
	<b>2-0</b>	3	75	30	Undyed	12		SV-9944G

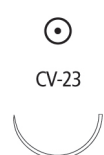
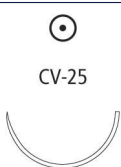
TAPER POINT								
Needles Specifications	Size		Length		Color	Units Per box	Comments	Reorder code
	USP	EP	cm	Inches				
<b>CV-1</b> 3/8 Circle 9.0 mm 	<b>8-0</b>	0.4	30	12	Violet	12		CV-9916G
<b>CV-23</b> 1/2 Circle 17.0 mm 	<b>5-0</b>	1	75	30	Undyed	36		CV-1213
	<b>4-0</b>	1.5	75	30	Undyed	36		CV-1214
	<b>3-0</b>	2	75	30	Undyed	36		CV-1215
<b>CV-25</b> 1/2 Circle 22.0 mm 	<b>4-0</b>	1.5	75	30	Undyed	36	Optivis™	CV-3100
	<b>3-0</b>	2	75	30	Undyed	36	Optivis™	CV-3110
	<b>2-0</b>	3	75	30	Undyed	36		CV-3120



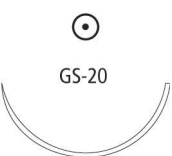

TAPER POINT									
Needles Specifications	Size		Length		Color	Units Per box	Comments	Reorder code	
	USP	EP	cm	Inches					
<b>V-20</b> 1/2 Circle 26.0 mm 	4-0	1.5	75	30	Undyed	36		CV-415	
	3-0	2	75	30	Undyed	12		CV-416G	
	2-0	3	75	30	Undyed	12		CV-417G	
	0	3.5	75	30	Undyed	36		CV-418	
<b>GS-22</b> 1/2 Circle 27.0 mm 	2-0	3	75	30	Undyed	36		CV-55	
	0	3.5	75	30	Undyed	36		CV-56	
	1	4	75	30	Undyed	36		CV-57	
<b>V-30</b> 1/2 Circle 30.0 mm 	0	3.5	75	30	Undyed	36		CV-318	
	1	4	75	30	Undyed	36		CV-319	
<b>GS-20</b> 1/2 Circle 34.0 mm 	2-0	3	75	30	Undyed	12		CV-9975G	
<b>GS-21</b> 1/2 Circle 37.0 mm 	3-0	2	75	30	Undyed	36		CV-322	
	3-0	2	90	36	Undyed	36		CV-944	
	2-0	3	75	30	Undyed	36		CV-323	
	2-0	3	90	36	Undyed	36		CV-945	
	0	3.5	75	30	Undyed	36		CV-1324	
	0	3.5	90	36	Undyed	36		CV-946	
	1	4	90	36	Undyed	36		CV-947	











TAPER POINT								
Needles Specifications	Size		Length		Color	Units Per box	Comments	Reorder code
	USP	EP	cm	Inches				
<b>GS-24</b> 1/2 Circle 40.0 mm 	<b>2-0</b>	3	90	36	Undyed	36		CV-9592
	<b>0</b>	3.5	90	36	Undyed	36		CV-9591
	<b>1</b>	4	90	36	Undyed	36		CV-9590
<b>GS-25</b> 1/2 Circle 48.0 mm 	<b>2-0</b>	3	90	36	Undyed	36		CV-606
	<b>0</b>	3.5	90	36	Undyed	36		CV-604
	<b>1</b>	4	90	36	Undyed	36		CV-605
<b>GU-45</b> 5/8 Circle 37.0 mm 	<b>2-0</b>	3	75	30	Undyed	36		UV-412
	<b>1</b>	4	90	36	Undyed	36		UV-401
<b>GU-44</b> 5/8 Circle 40.0 mm 	<b>0</b>	3.5	90	36	Undyed	36		UV-1381
	<b>1</b>	4	90	36	Undyed	36		UV-1382
<b>ST-4</b> Straight 19.0 mm 	<b>4-0</b>	1.5	75	30	Undyed	36		CV-1673

HEAVY TAPER POINT								
Needles Specifications	Size		Length		Color	Units Per box	Comments	Reorder code
	USP	EP	cm	Inches				
<b>HGS-20</b> 1/2 Circle 34.0 mm 	<b>1</b>	4	90	36	Undyed	36		CV-1696

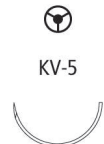

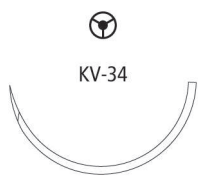

TAPERCUTTING									
Needles Specifications	Size		Length		Color	Units Per box	Comments	Reorder code	
	USP	EP	cm	Inches					
<b>KV-11</b> 3/8 Circle 13.0 mm 	5-0	1	75	30	Undyed	36		CV-2293	
<b>KV-15</b> 3/8 Circle 17.0 mm 	4-0	1.5	45	18	Undyed	12		CV-2275G	
	4-0	1.5	75	30	Undyed	36		CV-2279	
	3-0	2	75	30	Undyed	36		CV-2280	
<b>KV-5</b> 1/2 Circle 17.0 mm 	3-0	2	75	30	Undyed	12		CV-1674G	
<b>KV-7</b> 1/2 Circle 26.0 mm 	3-0	2	75	30	Undyed	12		CV-2003G	
	2-0	3	90	36	Undyed	36		CV-1002	
<b>KV-34</b> 1/2 Circle 37.0 mm 	3-0	2	90	36	Undyed	36		CV-916	
	2-0	3	90	36	Undyed	36		CV-917	
	2-0	3	120	48	Undyed	36		CV-927	
	0	3.5	90	36	Undyed	36		CV-919	
	1	4	90	36	Undyed	36		CV-918	
<b>KV17-C14</b> 1/2 Circle 40.0 mm Double-arm 	2-0	3.5/3	3×90	36t	Undyed	24	0 KV-34, 2-0 C-14	CV-0146	







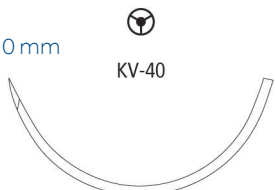

## TAPERCUTTING

Needles Specifications	Size		Length		Color	Units Per box	Comments	Reorder code
	USP	EP	cm	Inches				
<b>KV-37</b> 1/2 Circle 40.0 mm 	2-0	3	90	36	Undyed	36		CV-2218
	0	3.5	90	36	Undyed	36		CV-2217
	1	4	90	36	Undyed	36		CV-2216
<b>KV37-C-14</b> 1/2 Circle 40.0 mm Double-arm	2-0	3.5/3	3×75	30	Undyed	24	Set, 3 strands per pouch	CV-0046
<b>KV-40</b> 1/2 Circle 48.0 mm 	2-0	3	90	36	Undyed	36		CV-7192
	0	3.5	90	36	Undyed	36		CV-7191
	1	4	90	36	Undyed	36		CV-7190

## BLUNT POINT

Needles Specifications	Size		Length		Color	Units Per box	Comments	Reorder code
	USP	EP	cm	Inches				
<b>BGS-24</b> 1/2 Circle 40.0 mm 	0	3.5	90	36	Undyed	36		CV-9953

## SPATULA

Needles Specifications	Size		Length		Color	Units Per box	Comments	Reorder code
	USP	EP	cm	Inches				
<b>SE-140-8</b> 3/8 Circle 6.3 mm 	8-0	0.4	30	12	Violet	12		CV-501G
	7-0	0.5	30	12	Violet	12		CV-500G



# POLYSORB™

## Braided Absorbable Suture

Stronger<sup>1</sup> during the critical wound healing period



The strength of Polysorb™ suture, provided by the greater<sup>‡</sup> number of more tightly braided filaments, provides greater security during the Critical Wound Healing Period.<sup>1-3</sup>

### Absorption

By Hydrolysis. Essentially complete within 56–70 days

### Tensile Strength

Approximately 140% of USP and EP, 80% after 2 weeks and 30% @ 3 weeks post implantation.

### Packaging

Polysorb™ sutures are available in USP sizes 2 (5 Metric) through 8-0 (0.4 Metric).

They are available undyed or violet colored.

The sutures are supplied sterile, in pre-cut lengths and ligating reels, non-needed or affixed to various needle types using both permanent and removable needle attachment techniques; in one, two or three dozen boxes.

### Indications

Indicated for use in soft tissue approximation or ligation and ophthalmic surgery, but not in cardiovascular or neural tissue.

## Description

Polysorb™ braided sutures are composed of Lactomer™ glycolide/lactide copolymer which is a synthetic polyester composed of glycolide and lactide (derived from glycolic and lactic acids). Polysorb™ sutures are prepared by coating the suture with a mixture of a caprolactone/glycolide copolymer and calcium stearoyl lactylate.

## Indications

Polysorb™ sutures are indicated for use in soft tissue approximation or ligation and ophthalmic surgery, but not in cardiovascular or neural tissue.

## Actions

Polysorb™ sutures elicit a minimal acute inflammatory reaction in tissue, which is followed by a gradual encapsulation of the suture by fibrous connective tissue. Progressive loss of tensile strength and eventual absorption of Polysorb™ sutures occurs by means of hydrolysis, where the Lactomer™ glycolide/lactide copolymer is broken down to glycolic and lactic acids which are subsequently absorbed and metabolized by the body.

## Tensile Strength

Studies indicate tensile strength averages for Polysorb™ sutures are approximately 140% of USP and E.P. minimum knot strength initially, are approximately 80% after two weeks and in excess of 30% at three weeks post implant.

## Sterilization

Ethylene oxide.

## Absorbtion

Absorption begins as a loss of tensile strength without appreciable loss of mass. Absorption of Polysorb™ sutures is essentially complete between the 56<sup>th</sup> and 70<sup>th</sup> day.

## Packaging

Polysorb™ sutures are available in USP sizes 2 (5 Metric) through 8-0 (0.4 Metric). They are available undyed (natural) or violet colored. The sutures are supplied sterile, in pre-cut lengths and ligating reels, non-needed or affixed to various needle types using both permanent and removable needle attachment techniques. Please refer to the individual package IFUs for complete instructions, indications, contraindications, warnings and precautions.

1. van Ramshorst GH et al. World J Surg 2010;54:20-7

2. Covidien. Polysorb(tm)Instructions for use

3. Vicryl™\*. Instructions for use

‡ Compared to Vicryl™\* suture.

Please refer to the individual package IFUs for complete instructions, indications, contraindications, warnings and precautions.

# Polysorb™

Polysorb™ suture is a brand you have trusted for over 20 years with a history of improvements and performance.

PRE-CUT								
Needles Specifications	Size		Length		Color	Units Per box	Comments	Reorder code
	USP	EP	cm	Inches				
	4-0	1.5	3×45	18	Violet	36	Pre-cut	L-71
	4-0	1.5	6×45	18	Violet	24	Pre-cut	L-20
	4-0	1.5	12×45	18	Violet	24	Pre-cut	L-11
	4-0	1.5	12×45	18	Undyed	24	Pre-cut	L-1-
	3-0	2	3×45	18	Violet	36	Pre-cut	L-72
	3-0	2	6×45	18	Violet	24	Pre-cut	L-22
	3-0	2	12×45	18	Undyed	24	Pre-cut	L-2-
	3-0	2	12×45	18	Violet	24	Pre-cut	L-12
	3-0	2	12×60	24	Violet	24	Pre-cut	L-32
	3-0	2	3×75	30	Violet	24	Pre-cut	L-402
	3-0	2	6×75	30	Violet	24	Pre-cut	L-38
	2-0	3	3×45	18	Violet	36	Pre-cut	L-73
	2-0	3	12×45	18	Undyed	24	Pre-cut	L-3
	2-0	3	6×45	18	Violet	24	Pre-cut	L-23
	2-0	3	12×45	18	Violet	24	Pre-cut	L-13-
	2-0	3	12×60	24	Violet	24	Pre-cut	L-33
	2-0	3	12×75	30	Undyed	24	Pre-cut	L-43
	2-0	3	3×75	30	Violet	24	Pre-cut	L-403
	2-0	3	6×75	30	Violet	24	Pre-cut	L-39
	0	3.5	3×45	18	Violet	36	Pre-cut	L-74
	0	3.5	6×45	18	Undyed	24	Pre-cut	L-4
	0	3.5	12×45	18	Violet	24	Pre-cut	L-27
	0	3.5	12×45	18	Undyed	24	Pre-cut	L-24
	0	3.5	6×45	18	Violet	24	Pre-cut	L-14
	0	3.5	12×60	24	Violet	24	Pre-cut	L-34
	0	3.5	3×75	30	Violet	24	Pre-cut	L-404
	0	3.5	6×75	30	Violet	24	Pre-cut	L-40
	1	4	3×45	18	Violet	36	Pre-cut	L-75
	1	4	6×45	18	Undyed	24	Pre-cut	L-5
	1	4	12×45	18	Violet	24	Pre-cut	L-35
	1	4	12×45	18	Undyed	24	Pre-cut	L-25
	1	4	6×45	18	Violet	24	Pre-cut	L-15
	1	4	12×60	24	Violet	24	Pre-cut	L-36



## PRE-CUT

Needles Specifications	Size		Length		Color	Units Per box	Comments	Reorder code
	USP	EP	cm	Inches				
	1	4	6×75	30	Violet	24	Pre-cut	L-41
	1	4	3×75	30	Violet	24	Pre-cut	L-405
	2	5	3×45	18	Violet	36	Pre-cut	L-76
	2	5	12×45	18	Violet	24	Pre-cut	L-28
	2	5	12×45	18	Undyed	24	Pre-cut	L-26
	2	5	6×75	30	Violet	24	Pre-cut	L-42
	2	5	3×75	30	Violet	24	Pre-cut	L-406



## STANDARD LENGTH

Needles Specifications	Size		Length		Color	Units Per box	Comments	Reorder code
	USP	EP	cm	Inches				
	4-0	1.5	150	60	Violet	36	Standard length	L-111
	3-0	2	150	60	Undyed	36	Standard length	L-102
	3-0	2	150	60	Violet	36	Standard length	L-112
	2-0	3	150	60	Undyed	36	Standard length	L-103
	2-0	3	150	60	Violet	36	Standard length	L-113
	0	3.5	150	60	Violet	36	Standard length	L-114
	0	3.5	150	60	Undyed	36	Standard length	L-104
	2	5	150	60	Violet	36	Standard length	L-116
	1	4	150	60	Violet	36	Standard length	L-115





REEL								
Needles Specifications	Size		Length		Color	Units Per box	Comments	Reorder code
	USP	EP	cm	Inches				
	4-0	1.5	150	60	Violet	24	Reel	LL-111
	4-0	1.5	150	60	Undyed	24	Reel	LL-101
	4-0	1.5	250	98	Violet	24	Reel	LL-221
	3-0	2	150	60	Violet	24	Reel	LL-112
	3-0	2	150	60	Undyed	24	Reel	LL-102
	3-0	2	250	98	Undyed	24	Reel	LL-322
	3-0	2	250	98	Violet	24	Reel	LL-222
	2-0	3	150	60	Violet	24	Reel	LL-113
	2-0	3	150	60	Undyed	24	Reel	LL-103
	2-0	3	250	98	Undyed	24	Reel	LL-323
	2-0	3	250	98	Violet	24	Reel	LL-223
	2-0	3	366	144	Violet	24	Reel	LL-233
	0	3.5	150	60	Violet	24	Reel	LL-114
	0	3.5	150	60	Undyed	24	Reel	LL-104
	0	3.5	250	98	Violet	24	Reel	LL-224
	1	4	150	60	Violet	24	Reel	LL-115
	1	4	250	98	Violet	24	Reel	LL-225
	2	5	150	60	Violet	24	Reel	LL-116
	2	5	250	98	Violet	24	Reel	LL-226





REVERSE CUTTING								
Needles Specifications	Size		Length		Color	Units Per box	Comments	Reorder code
	USP	EP	cm	Inches				
<b>HE-6</b> 3/8 Circle 7.4 mm Double-arm 	6-0	0.7	45	18	Violet	12	Surgalloy™	L-1551-K
<b>C-1</b> 3/8 Circle 12.0 mm 	6-0	0.7	45	18	Undyed	36		SL-171
	5-0	1	45	18	Undyed	36		SL-172
<b>HE-3</b> 3/8 Circle 13.0 mm Double-arm 	5-0	1	30	12	Undyed	12	Surgalloy™	L-4323K











## REVERSE CUTTING

Needles Specifications	Size		Length		Color	Units Per box	Comments	Reorder code
	USP	EP	cm	Inches				
<b>C-12</b> 3/8 Circle    16.0 mm 	5-0	1	75	30	Violet	36		SL-630
	4-0	1.5	75	30	Violet	36		SL-607
	4-0	1.5	75	30	Undyed	36		SL-605
	3-0	2	75	30	Violet	36		SL-608
<b>C-13</b> 3/8 Circle    19.0 mm 	5-0	1	45	18	Undyed	36		SL-639
	5-0	1	75	30	Violet	36		SL-634
	5-0	1	75	30	Undyed	36		SL-690
	4-0	1.5	45	18	Undyed	12		SL-638
	4-0	1.5	75	30	Undyed	12		SL-691G
	4-0	1.5	75	30	Undyed	36		SL-691
	4-0	1.5	75	30	Violet	12		SL-635G
	4-0	1.5	75	30	Violet	36		SL-635
	3-0	2	45	18	Undyed	36		SL-637
	3-0	2	75	30	Undyed	36		SL-822
	3-0	2	75	30	Undyed	12		SL-822G
	3-0	2	75	30	Violet	36		SL-636
	<b>C-14</b> 3/8 Circle    24.0 mm 	4-0	1.5	75	30	Violet	36	
4-0		1.5	75	30	Undyed	36		SL-692
3-0		2	75	30	Undyed	36		SL-693
3-0		2	75	30	Violet	36		SL-694
2-0		3	75	30	Undyed	36		SL-823
2-0		3	75	30	Violet	36		CL-823
<b>C-15</b> 3/8 Circle    26.0 mm 	3-0	2	5x45	18	Undyed	12	D-Tach™	SL-73-MG
	2-0	3	75	30	Undyed	36		SL-586
	0	3.5	75	30	Undyed	36		SL-587



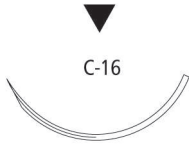
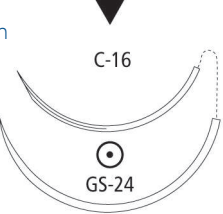



## REVERSE CUTTING

Needles Specifications	Size		Length		Color	Units Per box	Comments	Reorder code
	USP	EP	cm	Inches				
<b>C-16</b> 3/8 Circle 30.0 mm 	3-0	2	75	30	Undyed	36		SL-696
	2-0	3	75	30	Violet	36		SL-714
	2-0	3	75	30	Undyed	36		SL-611
	0	3.5	75	30	Violet	36		SL-713
	0	3.5	75	30	Undyed	36		SL-610
	0	3.5	90	36	Violet	36		SL-712
<b>C-16 - GS-24</b> 3/8 Circle 30.0 mm Double-arm (Not to scale) 	3-0	2	150	60	Undyed	36		CL-976
	2-0	3	150	60	Undyed	36		CL-977
<b>C-17</b> 3/8 Circle 39.0 mm 	2-0	3	75	30	Undyed	36		SL-674
	2	5	90	36	Undyed	36		SL-675
<b>C-23</b> 1/2 Circle 24.0 mm 	3-0	2	45	18	Undyed	36		CL-85
	3-0	2	5 × 45	18	Undyed	12	D-Tach™	SL-85-MG
	3-0	2	5 × 45	18	Violet	12	D-Tach™	SL-83-MG
	3-0	2	75	30	Violet	36		SL-632
	3-0	2	75	30	Undyed	36		SL-613
	2-0	3	75	30	Violet	36		SL-631
	2-0	3	75	30	Undyed	36		SL-612
<b>GS-10</b> 1/2 Circle 26.0 mm 	3-0	2	5 × 45	18	Undyed	12	D-Tach™	CL-53MG
	3-0	2	75	30	Undyed	36		CL-868
	2-0	3	5 × 45	18	Undyed	12	D-Tach™	CL-52-MG
	2-0	3	75	30	Undyed	36		CL-869
	2-0	3	75	30	Violet	36		CL-769
	0	3.5	75	30	Undyed	36		CL-870
	1	4	75	30	Undyed	36		CL-867



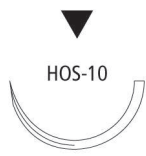
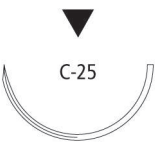

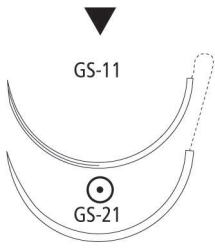
## REVERSE CUTTING

Needles Specifications	Size		Length		Color	Units Per box	Comments	Reorder code
	USP	EP	cm	Inches				
<b>HOS-10</b> 1/2 Circle    26.0 mm 	2-0	3	3 × 45	18	Violet	12	D-Tach™	CL-356-MG
	2-0	3	3 × 45	18	Undyed	12	D-Tach™	CL-354-MG
	0	3.5	5 × 45	18	Undyed	12	D-Tach™	CL-55-MG
	0	3.5	3 × 45	18	Undyed	12	D-Tach™	CL-355-MG
	1	4	3 × 45	18	Violet	12	D-Tach™	CL-358-MG
	1	4	75	30	Undyed	36		CL-581
	1	4	75	30	Violet	36		CL-547
	2	5	75	30	Violet	36		CL-552
<b>C-25</b> 1/2 Circle    30.0 mm 	2-0	3	75	30	Violet	36		SL-622
	0	3.5	90	36	Undyed	36		SL-721
	1	4	90	36	Violet	36		SL-722
<b>GS-11</b> 1/2 Circle    37.0 mm 	3-0	2	75	30	Violet	36		CL-815
	3-0	2	75	30	Undyed	36		CL-542
	2-0	3	75	30	Violet	36		CL-816
	2-0	3	75	30	Undyed	36		CL-543
	2-0	3	90	36	Violet	36		CL-916
	0	3.5	75	30	Violet	36		CL-817
	0	3.5	75	30	Undyed	36		CL-544
	0	3.5	90	36	Violet	36		CL-917
	0	3.5	90	36	Undyed	36		CL-534
	1	4	75	30	Violet	36		CL-818
	1	4	75	30	Undyed	36		CL-545
	1	4	90	36	Violet	36		CL-918
	1	4	90	36	Undyed	36		CL-535
	2	5	90	36	Violet	36		CL-919
	2	5	90	36	Undyed	36		CL-533
<b>GS-11 - GS-21</b> 1/2 Circle    37.0 mm <b>Double-arm</b> (Not to scale) 	3-0	2	150	60	Violet	36		CL-982
	2-0	3	150	54	Violet	36		CL-992



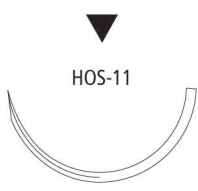

## REVERSE CUTTING

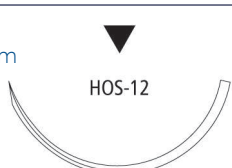
Needles Specifications	Size		Length		Color	Units Per box	Comments	Reorder code
	USP	EP	cm	Inches				
<b>HOS-11</b> 1/2 Circle 37.0 mm 	2-0	3	3 × 45	18	Undyed	12	D-Tach™	CL-374-MG
	2-0	3	3 × 45	18	Violet	12	D-Tach™	CL-369-MG
	2-0	3	75	30	Violet	36		CL-526
	2-0	3	75	30	Undyed	36		CL-536
	0	3.5	3 × 45	18	Undyed	12	D-Tach™	CL-375-MG
	0	3.5	3 × 45	18	Violet	12	D-Tach™	CL-370-MG
	0	3.5	75	30	Undyed	36		CL-537
	1	4	75	30	Undyed	36		CL-538
	1	4	75	30	Violet	36		CL-528
<b>GS-12</b> 1/2 Circle 40.0 mm 	2-0	3	75	30	Violet	36		CL-833
	2-0	3	75	30	Undyed	36		CL-595
	0	3.5	75	30	Violet	36		CL-804
	0	3.5	75	30	Undyed	36		CL-596
	0	3.5	90	36	Violet	36		CL-933
	1	4	75	30	Violet	36		CL-805
	1	4	75	30	Undyed	36		CL-597
	1	4	90	36	Violet	36		CL-936
	2	5	90	36	Violet	36		CL-937
<b>HOS-12</b> 1/2 Circle 40.0 mm 	2-0	3	3 × 45	18	Violet	12	D-Tach™	CL-382-MG
	0	3.5	3 × 45	18	Violet	12	D-Tach™	CL-380-MG
	0	3.5	3 × 45	18	Undyed	12	D-Tach™	CL-376-MG
	1	4	3 × 45	18	Violet	12	D-Tach™	CL-381-MG
	1	4	3 × 45	18	Undyed	12	D-Tach™	CL-377-MG
	1	4	5 × 75	30	Violet	12	D-Tach™	CL-97-MG
	2	5	3 × 45	18	Violet	12	D-Tach™	CL-383-MG



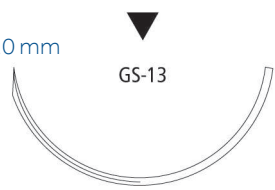
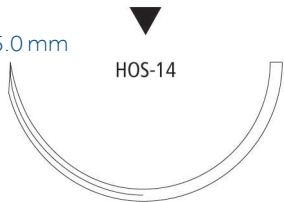

## REVERSE CUTTING

Needles Specifications	Size		Length		Color	Units Per box	Comments	Reorder code
	USP	EP	cm	Inches				
<b>GS-13</b> 1/2 Circle    48.0 mm 	0	3.5	75	30	Violet	36		CL-568
	0	3.5	75	30	Undyed	36		CL-554
	0	3.5	90	36	Violet	36		CL-927
	1	4	75	30	Violet	36		CL-569
	1	4	75	30	Undyed	36		CL-555
	1	4	90	36	Violet	36		CL-928
	2	5	75	30	Violet	36		CL-570
	2	5	90	36	Undyed	36		CL-939
	2	5	90	36	Violet	36		CL-929
<b>HOS-14</b> 1/2 Circle    55.0 mm 	2	5	75	30	Violet	36		CL-979



## PREMIUM REVERSE CUTTING

Needles Specifications	Size		Length		Color	Units Per box	Comments	Reorder code
	USP	EP	cm	Inches				
<b>P-10</b> 3/8 Circle    11.0 mm 	7-0	0.5	45	18	Undyed	12		SL-1624G
	6-0	0.7	45	18	Undyed	36	Surgalloy™	SL-1625
	6-0	0.7	45	18	Undyed	12	Surgalloy™	SL1625G
	5-0	1	45	18	Undyed	36	Surgalloy™	SL-1689
	5-0	1	45	18	Undyed	12	Surgalloy™	SL-1689G









## PREMIUM REVERSE CUTTING

Needles Specifications	Size		Length		Color	Units Per box	Comments	Reorder code
	USP	EP	cm	Inches				
<b>P-13</b> 3/8 Circle 13.0 mm 	6-0	0.7	45	18	Undyed	36	Surgalloy™	SL-5688
	6-0	0.7	45	18	Undyed	12	Surgalloy™	SL-5688-G
	5-0	1	45	18	Undyed	12	Surgalloy™	SL-5687G
	5-0	1	45	18	Undyed	36	Surgalloy™	SL-5687
	4-0	1.5	45	18	Undyed	12	Surgalloy™	SL-5691G
	4-0	1.5	45	18	Undyed	36	Surgalloy™	SL-5690
<b>P-11</b> 3/8 Circle 16.0 mm 	5-0	1	45	18	Undyed	36	Surgalloy™	SL-5626
	4-0	1.5	45	18	Undyed	36	Surgalloy™	SL-5686
	4-0	1.5	45	18	Undyed	12	Surgalloy™	SL-5686G
	4-0	1.5	75	30	Undyed	36	Surgalloy™	SL-5620
	3-0	2	75	30	Undyed	36	Surgalloy™	SL-5621
<b>P-12</b> 3/8 Circle 19.0 mm 	5-0	1	45	18	Undyed	12	Surgalloy™	SL-5636-G
	5-0	1	45	18	Undyed	36	Surgalloy™	SL-5636
	4-0	1.5	45	18	Violet	36	Surgalloy™	SL-5629
	4-0	1.5	45	18	Undyed	12	Surgalloy™	SL-5627-G
	4-0	1.5	45	18	Undyed	36	Surgalloy™	SL-5627
	4-0	1.5	75	30	Undyed	36	Surgalloy™	SL-5637
	3-0	2	45	18	Undyed	12	Surgalloy™	SL-5628G
	3-0	2	45	18	Undyed	36	Surgalloy™	SL-5628
	3-0	2	75	30	Undyed	36	Surgalloy™	SL-5638



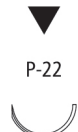



PREMIUM REVERSE CUTTING									
Needles Specifications	Size		Length		Color	Units Per box	Comments	Reorder code	
	USP	EP	cm	Inches					
<b>P-14</b> 3/8 Circle 24.0 mm 	4-0	1.5	45	18	Undyed	12	Surgalloy™	SL-5641G	
	4-0	1.5	45	18	Undyed	36	Surgalloy™	SL-5641	
	4-0	1.5	75	30	Undyed	36	Surgalloy™	SL-5678	
	3-0	2	45	18	Undyed	12	Surgalloy™	SL-5640G	
	3-0	2	45	18	Undyed	36	Surgalloy™	SL-5640	
	3-0	2	75	30	Undyed	12	Surgalloy™	SL-5679G	
	3-0	2	75	30	Undyed	36	Surgalloy™	SL-5679	
	2-0	3	75	30	Undyed	36		SL-5680	
<b>P-17</b> 3/8 Circle 30.0 mm 	2-0	3	75	30	Undyed	36		SL-1596	
<b>P-21</b> 1/2 Circle 9.0 mm 	6-0	0.7	45	18	Undyed	12		SL-1510G	
	5-0	1	45	18	Undyed	12		SL-1644G	
	4-0	1.5	45	18	Undyed	12		SL-1645G	
<b>P-22</b> 1/2 Circle 13.0 mm 	6-0	0.7	45	18	Undyed	36	Surgalloy™	SL-1613	
	5-0	1	45	18	Undyed	36	Surgalloy™	SL-1614	
	5-0	1	45	18	Undyed	12	Surgalloy™	SL-1614G	
	4-0	1.5	45	18	Undyed	36	Surgalloy™	SL-1615	
<b>P-24</b> 1/2 Circle 16.0 mm 	5-0	1	45	18	Undyed	12	Surgalloy™	SL-5632G	
	5-0	1	45	18	Undyed	36	Surgalloy™	SL-5632	
	4-0	1.5	45	18	Undyed	12	Surgalloy™	SL-5633G	
	4-0	1.5	45	18	Undyed	36	Surgalloy™	SL-5633	





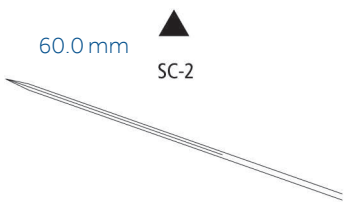

## CONVENTIONAL CUTTING

Needles Specifications	Size		Length		Color	Units Per box	Comments	Reorder code
	USP	EP	cm	Inches				
<b>PC-13</b> 3/8 Circle 11.0 mm 	6-0	0.7	45	18	Undyed	36		SL-1660
	5-0	1	45	18	Undyed	36		SL-1659
	4-0	1.5	45	18	Undyed	36		SL-1658
<b>PC-11</b> 3/8 Circle 16.0 mm 	6-0	0.7	45	18	Undyed	12	Surgalloy™	SL-1655G
	5-0	1	45	18	Undyed	36		SL-1656
	4-0	1.5	45	18	Undyed	36		SL-1657
<b>PC-12</b> 3/8 Circle 19.0 mm 	4-0	1.5	45	18	Undyed	36		SL-1653
	3-0	2	45	18	Undyed	36		SL-1654
<b>SC-2</b> Straight 60.0 mm 	4-0	1.5	75	30	Violet	36		SL-654
	4-0	1.5	75	30	Undyed	36		SL-644
	3-0	2	75	30	Violet	36		SL-653
	3-0	2	75	30	Undyed	36		SL-643
	2-0	3	75	30	Violet	36		SL-652
	2-0	3	75	30	Undyed	36		SL-642



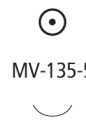

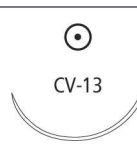
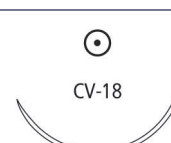
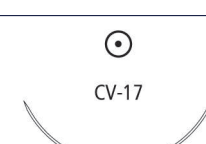



TAPER POINT										
Needles Specifications	Size	EP	Length		Color	Units	Comments	Reorder code		
			USP						cm	Inches
<b>MV-135-5</b> 3/8 Circle 6.0 mm 	<b>8-0</b>	0.4	13	5	Violet	12	Surgalloy™	L-2800		
<b>CV-11</b> 3/8 Circle 13.0 mm 	<b>6-0</b>	0.7	75	30	Violet	36		GL-889		
	<b>5-0</b>	1	75	30	Violet	36		GL-890		
<b>CV-15</b> 3/8 Circle 17.0 mm 	<b>4-0</b>	1.5	75	30	Violet	36		GL-881		
	<b>3-0</b>	2	75	30	Violet	36		GL-882		
<b>CV-13</b> 3/8 Circle 22.0 mm 	<b>4-0</b>	1.5	75	30	Violet	36		CL-304		
	<b>3-0</b>	2	75	30	Violet	36		GL-303		
	<b>2-0</b>	3	75	30	Violet	36		GL-302		
<b>CV-18</b> 3/8 Circle 26.0 mm 	<b>2-0</b>	3	75	30	Violet	36		CL-457		
<b>CV-17</b> 3/8 Circle 32.0 mm 	<b>3-0</b>	2	75	30	Violet	36		GL-522		
	<b>2-0</b>	3	75	30	Violet	36		GL-523		
	<b>0</b>	3.5	75	30	Violet	36		GL-524		





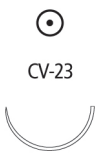

TAPER POINT									
Needles Specifications	Size USP	EP	Length		Color	Units Per box	Comments	Reorder code	
			cm	Inches					
<b>CVF-21</b> 1/2 Circle 12.0 mm 	6-0	0.7	45	18	Violet	36	Surgalloy™	UL-102	
	6-0	0.7	45	18	Undyed	36	Surgalloy™	UL-101	
	5-0	1	45	18	Undyed	36	Surgalloy™	SL-432	
	4-0	1.5	45	18	Undyed	36		SL-431	
<b>CV-22</b> 1/2 Circle 13.0 mm 	5-0	1	5 × 45	18	Violet	12	D-Tach™	GL-45-MG	
	5-0	1	75	30	Undyed	36		GL-885	
	4-0	1.5	5 × 45	18	Violet	12	D-Tach™	GL-44-MG	
	4-0	1.5	75	30	Undyed	36		GL-884	
	4-0	1.5	75	30	Violet	36		CL-782	
<b>CV-23</b> 1/2 Circle 17.0 mm 	6-0	0.7	75	30	Violet	36		UL-201	
	5-0	1	75	30	Violet	36		UL-202	
	5-0	1	75	30	Undyed	36		UL-213	
	4-0	1.5	5 × 45	18	Violet	12	D-Tach™	GL-46-MG	
	4-0	1.5	75	30	Violet	36	Surgalloy™	UL-303	
	4-0	1.5	75	30	Undyed	36		UL-212	
	3-0	2	5 × 45	18	Undyed	12	D-Tach™	UL-47-MG	
	3-0	2	5 × 45	18	Violet	12	D-Tach™	GL-47-MG	
	3-0	2	75	30	Violet	36		UL-204	
	3-0	2	75	30	Undyed	36		UL-215	
	2-0	3	75	30	Undyed	36		UL-216	
	2-0	3	75	30	Violet	36		UL-205	
<b>CVF-23</b> 1/2 Circle 17.0 mm 	4-0	1.5	75	30	Undyed	36	Surgalloy™	UL-214	
	4-0	1.5	75	30	Violet	36	Surgalloy™	UL-203	
<b>CVF-23</b> 1/2 Circle 17.0 mm Double-arm 	4-0	1.5	90	36	Violet	36	Surgalloy™	CL-219	





TAPER POINT									
Needles Specifications	Size		Length		Color	Units Per box	Comments	Reorder code	
	USP	EP	cm	Inches					
<b>CV-24</b> 1/2 Circle 20.0 mm 	<b>4-0</b>	1.5	75	30	Violet	36		CL-460	
	<b>3-0</b>	2	75	30	Violet	36		CL-461	
	<b>2-0</b>	3	75	30	Violet	36		CL-462	
<b>CV-25</b> 1/2 Circle 22.0 mm 	<b>4-0</b>	1.5	5 × 45	18	Violet	12	D-Tach™	GL-34-MG	
	<b>4-0</b>	1.5	75	30	Violet	36		GL-181	
	<b>4-0</b>	1.5	75	30	Undyed	36		GL-191	
	<b>3-0</b>	2	5 × 45	18	Violet	12	D-Tach™	GL-33-MG	
	<b>3-0</b>	2	75	30	Violet	36		GL-182	
	<b>3-0</b>	2	75	30	Undyed	36		GL-192	
	<b>3-0</b>	2	5 × 75	30	Violet	12	D-Tach™	GL-182-M	
	<b>3-0</b>	2	120	48	Violet	24	Surgalloy™ Endoscopy	EL-440	
	<b>2-0</b>	3	5 × 45	18	Violet	12	D-Tach™	GL-32-MG	
	<b>2-0</b>	3	75	30	Violet	36		GL-183	
<b>CV-25</b> 1/2 Circle 22.0 mm Double-arm 	<b>3-0</b>	2	90	36	Violet	36		GL-282	
<b>GS-23</b> 1/2 Circle 22.0 mm 	<b>3-0</b>	2	75	30	Violet	36		CL-892	
	<b>2-0</b>	3	5 × 45	18	Undyed	12	D-Tach™	CL-42-MG	
	<b>2-0</b>	3	75	30	Violet	36		CL-893	
	<b>0</b>	3.5	75	30	Violet	36		CL-894	

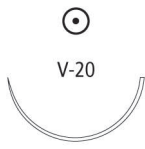
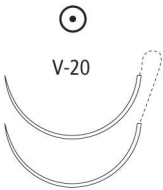

## TAPER POINT

Needles Specifications	Size		Length		Color	Units Per box	Comments	Reorder code	
	USP	EP	cm	Inches					
<b>V-20</b> 1/2 Circle 26.0 mm 	5-0	1	75	30	Violet	36		GL-120	
	4-0	1.5	5 × 45	18	Violet	12	D-Tach™	GL-64-MG	
	4-0	1.5	75	30	Undyed	36	Surgalloy™	GLS-321	
	4-0	1.5	75	30	Violet	36	Surgalloy™	GLS-121	
	4-0	1.5	5 × 75	30	Violet	12	D-Tach™	GL-68-M	
	4-0	1.5	75	30	Undyed	36		GL-321	
	4-0	1.5	75	30	Violet	36		GL-121	
	3-0	2	5 × 45	18	Undyed	12	D-Tach™	GL-69-MG	
	3-0	2	5 × 45	18	Violet	12	D-Tach™	GL-63-MG	
	3-0	2	75	30	Undyed	36	Surgalloy™	GLS-322	
	3-0	2	75	30	Violet	36	Surgalloy™	GLS-122	
	3-0	2	5 × 75	30	Violet	12	D-Tach™	GL-67-M	
	3-0	2	75	30	Undyed	36		GL-322	
	3-0	2	75	30	Violet	36		GL-122	
	3-0	2	90	36	Violet	36		GL-226	
	2-0	3	5 × 45	18	Violet	12	D-Tach™	GL-62-MG	
	2-0	3	5 × 45	18	Undyed	12	D-Tach™	GL-61-MG	
	2-0	3	75	30	Undyed	36	Surgalloy™	GLS-323	
	2-0	3	75	30	Violet	36	Surgalloy™	GLS-123	
	2-0	3	5 × 75	30	Violet	12	D-Tach™	GL-66-M	
	2-0	3	75	30	Undyed	36		GL-323	
	2-0	3	75	30	Violet	36		GL-123	
	2-0	3	90	36	Violet	36		GL-125	
	0	3.5	75	30	Undyed	36		GL-324	
	0	3.5	75	30	Violet	36		GL-124	
	<b>V-20</b> 1/2 Circle 26.0 mm Double-arm 	3-0	2	90	36	Violet	36		GL-332
		2-0	3	90	36	Violet	36		GL-333

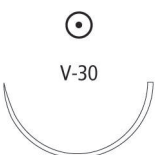

## TAPER POINT

Needles Specifications	Size		Length		Color	Units Per box	Comments	Reorder code
	USP	EP	cm	Inches				
<b>GS-22</b> 1/2 Circle 27.0 mm 	<b>3-0</b>	2	75	30	Violet	36		CL-882
	<b>3-0</b>	2	75	30	Undyed	36		CL-829
	<b>2-0</b>	3	5×45	18	Violet	12	D-Tach™	CL-16-MG
	<b>2-0</b>	3	75	30	Undyed	36		CL-830
	<b>2-0</b>	3	75	30	Violet	36		CL-883
	<b>0</b>	3.5	5×45	18	Violet	12	D-Tach™	CL-17-MG
	<b>0</b>	3.5	75	30	Violet	36	Surgalloy™	CLS-884
	<b>0</b>	3.5	5×75	30	Violet	12	D-Tach™	CL-886-M
	<b>0</b>	3.5	75	30	Violet	36		CL-884
	<b>0</b>	3.5	75	30	Undyed	36		CL-831
	<b>0</b>	3.5	90	36	Violet	36		CL-330
	<b>1</b>	4	75	30	Violet	36		CL-885
	<b>1</b>	4	5×75	30	Violet	12	D-Tach™	CL-885-M
	<b>1</b>	4	75	30	Undyed	36		CL-832
	<b>1</b>	4	90	36	Violet	36		CL-331
	<b>2</b>	5	75	30	Violet	36		CL-232
	<b>V-30</b> 1/2 Circle 30.0 mm 	<b>3-0</b>	2	75	30	Violet	36	
<b>2-0</b>		3	75	30	Violet	36		GL-223
<b>2-0</b>		3	75	30	Undyed	36		GL-228
<b>2-0</b>		3	5×75	30	Violet	12	D-Tach™	GL-223-M
<b>0</b>		3.5	75	30	Violet	36		GL-224
<b>1</b>		4	75	30	Violet	36		GL-225





## TAPER POINT

Needles Specifications	Size		Length		Color	Units Per box	Comments	Reorder code
	USP	EP	cm	Inches				
<b>GS-21</b> 1/2 Circle 37.0 mm 	4-0	1.5	75	30	Violet	36		CL-809
	3-0	2	5 × 45	18	Violet	12	D-Tach™	CL-8-MG
	3-0	2	75	30	Undyed	36		CL-842
	3-0	2	75	30	Violet	36		CL-810
	3-0	2	90	36	Violet	36		CL-922
	3-0	2	90	36	Undyed	36		CL-952
	2-0	3	5 × 45	18	Violet	12	D-Tach™	CL-9-MG
	2-0	3	5 × 45	18	Undyed	12	D-Tach™	CL-13-MG
	2-0	3	75	30	Undyed	36		CL-843
	2-0	3	75	30	Violet	36		CL-811
	2-0	3	5 × 75	30	Violet	12	D-Tach™	CL-4M
	2-0	3	90	36	Violet	36		CL-923
	2-0	3	90	36	Undyed	36		CL-953
	0	3.5	5 × 45	18	Undyed	12	D-Tach™	CL-14-MG
	0	3.5	5 × 45	18	Violet	12	D-Tach™	CL-10-MG
	0	3.5	75	30	Undyed	36		CL-844
	0	3.5	75	30	Violet	36		CL-812
	0	3.5	5 × 75	30	Violet	12	D-Tach™	CL-5-M
	0	3.5	5 × 75	30	Undyed	12	D-Tach™	CL-2M
	0	3.5	75	30	Violet	24		CL-812
	0	3.5	90	36	Undyed	36		CL-954
	0	3.5	90	36	Violet	36		CL-924
	1	4	5 × 45	18	Undyed	12	D-Tach™	CL-15-MG
	1	4	5 × 45	18	Violet	12	D-Tach™	CL-11-MG
	1	4	75	30	Undyed	36		CL-845
	1	4	75	30	Violet	36		CL-813
	1	4	5 × 75	30	Violet	12	D-Tach™	CL-6-M
	1	4	90	36	Violet	36		CL-925
	1	4	90	36	Undyed	36		CL-955
	2	5	75	30	Violet	36		CL-814
2	5	90	36	Violet	36		CL-926	





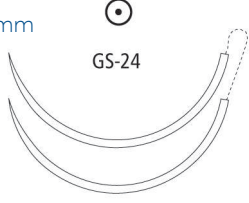







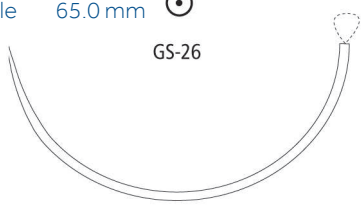

TAPER POINT								
Needles Specifications	Size		Length		Color	Units Per box	Comments	Reorder code
	USP	EP	cm	Inches				
<b>V-26</b> 1/2 Circle 37.0 mm 	3-0	2	75	30	Violet	36		GL-126
	2-0	3	75	30	Violet	36		GL-127
	0	3.5	75	30	Violet	36		GL-128
	1	4	75	30	Violet	36		GL-129
<b>GS-24</b> 1/2 Circle 40.0 mm 	3-0	2	75	30	Violet	36		CL-800
	3-0	2	90	36	Undyed	36		CL-962
	3-0	2	90	36	Violet	36		CL-912
	2-0	3	5×45	18	Violet	12	D-Tach™	CL-22-MG
	2-0	3	75	30	Undyed	36		CL-853
	2-0	3	75	30	Violet	36		CL-801
	2-0	3	90	36	Violet	36		CL-913
	2-0	3	90	36	Undyed	36		CL-963
	0	3.5	5×45	18	Violet	12	D-Tach™	CL-20-MG
	0	3.5	75	30	Violet	36		CL-802
	0	3.5	90	36	Violet	36		CL-914
	0	3.5	90	36	Undyed	36		CL-964
	1	4	5×45	18	Violet	12	D-Tach™	CL-21-MG
	1	4	75	30	Violet	36		CL-803
	1	4	75	30	Undyed	36		CL-855
	1	4	90	36	Violet	36		CL-915
	1	4	90	36	Undyed	36		CL-965
	2	5	5×45	18	Violet	6	D-Tach™	CL-623-M
	2	5	5×60	24	Violet	12	D-Tach™	CL-622-M
	2	5	75	30	Violet	36		CL-779
2	5	90	36	Violet	36		CL-911	
<b>GS-24</b> 1/2 Circle 40.0 mm Double-arm 	3-0	2	150	60	Violet	36		CL-990

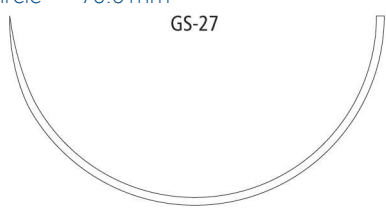

## TAPER POINT

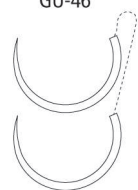
Needles Specifications	Size		Length		Color	Units Per box	Comments	Reorder code	
	USP	EP	cm	Inches					
<b>GS-25</b> 1/2 Circle 48.0 mm  GS-25	3-0	2	75	30	Violet	36		CL-862	
	3-0	2	90	36	Undyed	36		CL-972	
	2-0	3	5 × 45	18	Undyed	12	D-Tach™	CL-36-MG	
	2-0	3	75	30	Violet	36		CL-863	
	2-0	3	90	36	Undyed	36		CL-973	
	2-0	3	90	36	Violet	36		CL-903	
	0	3.5	5 × 45	18	Undyed	12	D-Tach™	CL-35-MG	
	0	3.5	5 × 45	18	Violet	12	D-Tach™	CL-30-MG	
	0	3.5	75	30	Violet	36		CL-864	
	0	3.5	90	36	Undyed	36		CL-974	
	0	3.5	90	36	Violet	36		CL-904	
	1	4	5 × 45	18	Violet	12	D-Tach™	CL-31-MG	
	1	4	75	30	Violet	36		CL-865	
	1	4	75	30	Violet	12	D-Tach™	CL-64-M	
	1	4	90	36	Undyed	36		CL-975	
	1	4	90	36	Violet	36		CL-905	
	2	5	5 × 45	18	Violet	6	D-Tach™	CL-633-M	
	2	5	5 × 60	24	Violet	12	D-Tach™	CL-644-M	
	2	5	75	30	Violet	36		CL-866	
	2	5	5 × 75	30	Violet	6	D-Tach™	CL-665-M	
	2	5	90	36	Violet	36		CL-906	
	<b>GS-26</b> 1/2 Circle 65.0 mm  GS-26	2-0	3	75	30	Undyed	24		CL-63
		1	4	5 × 75	30	Violet	12		CL-60-M
1		4	90	36	Violet	36		CL-968	
1		4	150	60	Violet	24		CL-824	
2		5	5 × 75	30	Violet	6		CL-659-M	
2		5	100	40	Undyed	36		CL-969	
2		5	150	60	Undyed	24		CL-880	
2		5	150	60	Violet	24		CL-825	



TAPER POINT									
Needles Specifications	Size		Length		Color	Units Per box	Comments	Reorder code	
	USP	EP	cm	Inches					
<b>GS-26 LOOP</b> 1/2 Circle 65.0 mm  GS-26 	1	4	120	48	Violet	24	Loop	CL824L	
	2	5	240	96	Violet	24	Loop	CL-835-L	
<b>GS-27</b> 1/2 Circle 76.0 mm  GS-27 	2-0	3	75	30	Undyed	24		CL-53	
	1	4	75	30	Violet	24	455	SL-603	
<b>GU-46</b> 5/8 Circle 27.0 mm  GU-46 	3-0	2	75	30	Violet	36		UL-879	
	2-0	3	75	30	Violet	36		UL-878	
	0	3.5	75	30	Violet	36		UL-877	
	1	4	75	30	Violet	36		UL-876	
<b>GU-46</b> 5/8 Circle 27.0 mm Double-arm  GU-46 	0	3.5	90	36	Violet	36		UL-240	
<b>GU-45</b> 5/8 Circle 37.0 mm  GU-45 	2-0	3	75	30	Violet	36		UL-245	
	0	3.5	75	30	Violet	36		UL-246	
<b>GU-44</b> 5/8 Circle 40.0 mm  GU-44 	0	3.5	75	30	Violet	36		UL-146	







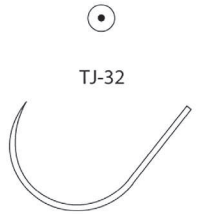



TAPER POINT										
Needles Specifications			Size		Length		Color	Units Per box	Comments	Reorder code
			USP	EP	cm	Inches				
<b>SK</b> SKI	23.0 mm		3-0	2	18	7	Violet	36	Endoscopy	EL415
			3-0	2	120	48	Violet	24	Endoscopy	EL450
<b>TJ-32</b> 1/2 Circle	32.0 mm		1	4	75	30	Violet	12		CL-673G
			1	4	75	30	Violet	36		CL-673

HEAVY TAPER POINT										
Needles Specifications			Size		Length		Color	Units Per box	Comments	Reorder code
			USP	EP	cm	Inches				
<b>HGS-22</b> 1/2 Circle	27.0 mm		2-0	3	5 × 45	18	Violet	12	D-Tach™	CL-86-MG
			0	3.5	5 × 45	18	Undyed	12	D-Tach™	CL-87-MG
			1	4	75	30	Violet	36		CL-871
<b>HGS-20</b> 1/2 Circle	34.0 mm		2-0	3	5 × 75	30	Violet	12	D-Tach™	CL-996-MG
			0	3.5	5 × 75	30	Violet	12	D-Tach™	CL-997-MG
			1	4	5 × 75	30	Violet	12	D-Tach™	CL-998-MG
<b>HGS-21</b> 1/2 Circle	37.0 mm		2-0	3	5 × 45	18	Violet	12	D-Tach™	CL-202-M
			2-0	3	75	30	Violet	36		CL-930
			2-0	3	90	36	Violet	36		CL-970
			0	3.5	5 × 45	18	Violet	12	D-Tach™	CL-200-M
			0	3.5	75	30	Violet	36		CL-931
			0	3.5	5 × 75	30	Violet	12	D-Tach™	CL-71-M
			0	3.5	90	36	Violet	36		CL-971
			1	4	5 × 45	18	Violet	12	D-Tach™	CL-201-M
			1	4	75	30	Violet	36		CL-932
			1	4	90	36	Violet	36		CL-239
			2	5	75	30	Violet	36		CL-934

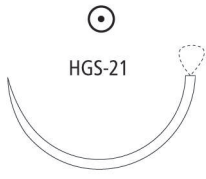





HEAVY TAPER POINT										
Needles Specifications	Size		Length		Color	Units Per box	Comments	Reorder code		
	USP	EP	cm	Inches						
<b>HGS-21 LOOP</b> 1/2 Circle 37.0 mm 	0	3.5	150	60	Violet	24	Loop	CL-871-L		
<b>HGU-46</b> 5/8 Circle 27.0 mm 	0	3.5	45	18	Violet	36		CL-576		
	0	3.5	75	30	Violet	36		CL-677		
	1	4	75	30	Violet	36		UL-676		

TAPERCUTTING										
Needles Specifications	Size		Length		Color	Units Per box	Comments	Reorder code		
	USP	EP	cm	Inches						
<b>KV-7</b> 1/2 Circle 26.0 mm 	3-0	2	75	30	Violet	36	Surgalloy™	CL-510		
	2-0	3	75	30	Violet	36	Surgalloy™	CL-511		
<b>KV-34</b> 1/2 Circle 37.0 mm 	3-0	2	90	36	Violet	36		CL-942		
	2-0	3	75	30	Violet	36		CL-837		
	2-0	3	90	36	Violet	36		CL-943		
	2-0	3	90	36	Undyed	36		CL-946		
	0	3.5	75	30	Violet	36		CL-838		
	0	3.5	90	36	Undyed	36		CL-515		
	0	3.5	90	36	Violet	36		CL-944		
	1	4	75	30	Violet	36		CL-839		
	1	4	90	36	Undyed	36		CL-516		
	1	4	90	36	Violet	36		CL-945		
	2	5	90	36	Violet	36		CL-517		



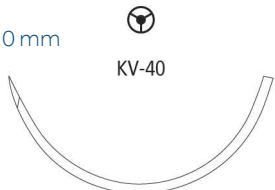
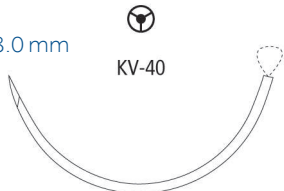



TAPERCUTTING										
Needles Specifications	Size		Length		Color	Units Per box	Comments	Reorder code		
	USP	EP	cm	Inches						
<b>KV-37</b> 1/2 Circle 40.0 mm 	2-0	3	75	30	Violet	36			CL-603	
	0	3.5	75	30	Violet	36			CL-602	
<b>KV-40</b> 1/2 Circle 48.0 mm 	0	3.5	90	36	Violet	36			CL-739	
	1	4	75	30	Violet	36			CL-840	
	1	4	90	36	Violet	36			CL-940	
	2	5	75	30	Violet	36			CL-841	
	2	5	90	36	Violet	36			CL-941	
<b>KV-40 LOOP</b> 1/2 Circle 48.0 mm 	1	4	150	60	Violet	24	Loop		CL-740-L	
	2	5	150	60	Violet	24	Loop		CL-741-L	





BLUNT POINT										
Needles Specifications	Size		Length		Color	Units Per box	Comments	Reorder code		
	USP	EP	cm	Inches						
<b>BTV-20</b> 1/2 Circle 26.0 mm 	3-0	2	5 × 45	18	Undyed	12	D-Tach™, ProtectPoint™		GLT-69-MG	
<b>BGS-21</b> 1/2 Circle 37.0 mm 	2-0	3	90	36	Violet	36	ProtectPoint™		CL-956	
	2-0	3	90	36	Undyed	36	ProtectPoint™		CL-259	
	0	3.5	5 × 45	18	Violet	12	D-Tach™, ProtectPoint™		CL-250-M	
	0	3.5	5 × 45	18	Undyed	12	D-Tach™, ProtectPoint™		CL-240-M	
	0	3.5	90	36	Violet	36	ProtectPoint™		CL-957	
	1	4	90	36	Violet	36	ProtectPoint™		CL-958	

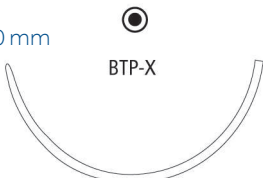

## BLUNT POINT



Needles Specifications	Size		Length		Color	Units Per box	Comments	Reorder code
	USP	EP	cm	Inches				
<b>BTP-1</b> 1/2 Circle 37.0 mm 	3-0	2	90	36	Undyed	36	ProtectPoint™	CLT-952
	2-0	3	5 × 45	18	Violet	12	D-Tach™, ProtectPoint™	CLT-9-MG
	2-0	3	5 × 45	18	Undyed	12	D-Tach™, ProtectPoint™	CLT-13-MG
	2-0	3	75	30	Undyed	36	ProtectPoint™	CLT-259
	2-0	3	90	36	Undyed	36	ProtectPoint™	CLT-953
	0	3.5	5 × 45	18	Violet	12	D-Tach™, ProtectPoint™	CLT-250-MG
	0	3.5	75	30	Violet	36		CLT-957
	0	3.5	90	36	Undyed	36	ProtectPoint™	CLT-954
	1	4	5 × 45	18	Undyed	12	D-Tach™, ProtectPoint™	CLT-15-MG
	1	4	5 × 45	18	Violet	12	D-Tach™, ProtectPoint™	CLT-11-MG
	1	4	75	30	Violet	36	ProtectPoint™	CLT-958
	1	4	90	36	Undyed	36	ProtectPoint™	CLT-955
	<b>BGS-24</b> 1/2 Circle 40.0 mm 	0	3.5	90	36	Violet	36	ProtectPoint™
1		4	90	36	Violet	36	ProtectPoint™	CL-951
<b>BTP-X</b> 1/2 Circle 48.0 mm 	0	3.5	5 × 45	18	Violet	12	D-Tach™, ProtectPoint™	CLT-850-MG
	0	3.5	5 × 45	18	Undyed	12	D-Tach™, ProtectPoint™	CLT-20-MG
	1	4	5 × 45	18	Violet	12	D-Tach™, ProtectPoint™	CLT-851-MG
	1	4	5 × 45	18	Undyed	12	D-Tach™, ProtectPoint™	CLT-21-MG
	1	4	90	36	Undyed	36	ProtectPoint™	CLT-855
	2	5	5 × 45	18	Violet	6	D-Tach™, ProtectPoint™	CLT-623-M





BLUNT POINT										
Needles Specifications	Size		Length		Color	Units Per box	Comments	Reorder code		
	USP	EP	cm	Inches						
<b>BGS-25</b> 1/2 Circle 48.0 mm  BGS-25	0	3.5	90	36	Violet	36	ProtectPoint™	CL-948		
	1	4	90	36	Violet	36	ProtectPoint™	CL-949		
<b>BGS-29</b> 1/2 Circle 63.0 mm  BGS-29	2	5	2 × 90	36	Violet	12	ProtectPoint™	2-CL-852		
<b>BP-27</b> 1/2 Circle 64.0 mm  BP-27	1	4	90	36	Violet	36	ProtectPoint™	CL-271		
	2	5	90	36	Violet	36	ProtectPoint™	CL-270		
<b>BGST-29</b> 1/2 Circle 65.0 mm  BGST-29	2	5	5 × 75	30	Violet	6	D-Tach™, ProtectPoint™	CLT-633-M		

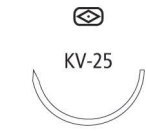









DIAMOND POINT									
Needles Specifications	Size		Length		Color	Units Per box	Comments	Reorder code	
	USP	EP	cm	Inches					
<b>KV-25</b> 1/2 Circle    22.0 mm 	1	4	75	30	Undyed	36		CL-513	
<b>KV-30</b> 1/2 Circle    27.0 mm 	0	3.5	90	36	Undyed	36		CL-730	





MULTIPURPOSE									
Needles Specifications	Size		Length		Color	Units Per box	Comments	Reorder code	
	USP	EP	cm	Inches					
<b>3.16</b> 3/8 Circle    16.0 mm 	4-0	1.5	45	18	Undyed	36		CL-005	
<b>4.21 (H)*</b> 1/2 Circle    20.0 mm 	2-0	3	75	30	Violet	36		CL-015	
<b>4.31 (H)*</b> 1/2 Circle    30.0 mm 	0	3.5	75	30	Violet	36		CL-030	

\*(H) = Heavy









MULTIPURPOSE										
Needles Specifications	Size		Length		Color	Units Per box	Comments	Reorder code		
	USP	EP	cm	Inches						
<b>4.41</b> 1/2 Circle 40.0 mm 	 4.41	2-0	3	75	30	Violet	36		CL-045	
		0	3.5	75	30	Violet	36		UL-046	
				75	30	Violet	36		CL-047	
<b>4.5</b> 1/2 Circle 50 mm (Not to scale) 	 4.50	2	5	90	36	Violet	36		CL-055	
<b>4.51 (H)</b> 1/2 Circle 50 mm 	 4.51	2-0	3	75	30	Violet	36		CL-060	

SPATULA										
Needles Specifications	Size		Length		Color	Units Per box	Comments	Reorder code		
	USP	EP	cm	Inches						
<b>SE-100-8</b> 1/4 Circle 6.3 mm Double-arm 	 SE-100-8	6-0	0.7	45	18	Violet	12	Surgalloy™	L-1750K	
<b>SS-29</b> 1/4 Circle 7.4 mm Double-arm 	 SS-29	6-0	0.7	30	12	Violet	12	Surgalloy™	L-1756K	
		6-0	0.7	45	18	Violet	12	Surgalloy™	L-1755K	







## SPATULA

Needles Specifications	Size		Length		Color	Units Per box	Comments	Reorder code
	USP	EP	cm	Inches				
<b>SS-14</b> 1/4 Circle 8.6 mm Double-arm 	6-0	0.7	45	18	Violet	12	Surgalloy™	L-1791K
	6-0	0.7	45	18	Undyed	12	Surgalloy™	L-1670-K
	5-0	1	45	18	Violet	12	Surgalloy™	L-1792K
	5-0	1	45	18	Undyed	12	Surgalloy™	L-1669-K
<b>SS-24</b> 1/4 Circle 8.6 mm Double-arm 	6-0	0.7	20	8	Violet	12		L-1740-K
	6-0	0.7	30	12	Violet	12	Surgalloy™	L-1742K
	6-0	0.7	30	12	Undyed	12	Surgalloy™	L-1745K
	6-0	0.7	45	18	Undyed	24	Surgalloy™	L-2752K
	5-0	1	20	8	Violet	12	Surgalloy™	L-1739-K
	5-0	1	30	12	Violet	12	Surgalloy™	L-1785K
	5-0	1	45	18	Undyed	24	Surgalloy™	L-2753K
<b>SE-140-8</b> 3/8 Circle 6.3 mm 	8-0	0.4	30	12	Violet	12	Surgalloy™	L-2750K
	7-0	0.5	30	12	Violet	12	Surgalloy™	L-2751K
<b>SE-140-8</b> 3/8 Circle 6.3 mm Double-arm 	8-0	0.4	20	8	Violet	12	Surgalloy™	L-2747K
	8-0	0.4	30	12	Violet	12	Surgalloy™	L-2748K
	8-0	0.4	45	18	Violet	12	Surgalloy™	L-5118K
	7-0	0.5	30	12	Violet	12	Surgalloy™	L-1796K
	7-0	0.5	45	18	Violet	12	Surgalloy™	L-1897K
<b>SS-28</b> 3/8 Circle 7.4 mm Double-arm 	6-0	0.7	45	18	Violet	12	Surgalloy™	L-1562-K





SPATULA									
Needles Specifications	Size		Length		Color	Units Per box	Comments	Reorder code	
	USP	EP	cm	Inches					
<b>SE-160-8</b> 1/2 Circle 5.5 mm Double-arm		<b>8-0</b>	0.4	20	8	Violet	12	Surgalloy™	L-2574K
	SE-160-8 	<b>8-0</b>	0.4	30	12	Violet	12	Surgalloy™	L-2749K
		<b>7-0</b>	0.5	45	18	Violet	12	Surgalloy™	L-1787K
<b>SS-2</b> 1/2 Circle 8.6 mm Double-arm		<b>5-0</b>	1	30	12	Undyed	12	Surgalloy™	L-0223K
	SS-2 								



# CAPROSYN™

## Monofilament Absorbable Suture

There when you need it. Gone when you don't.

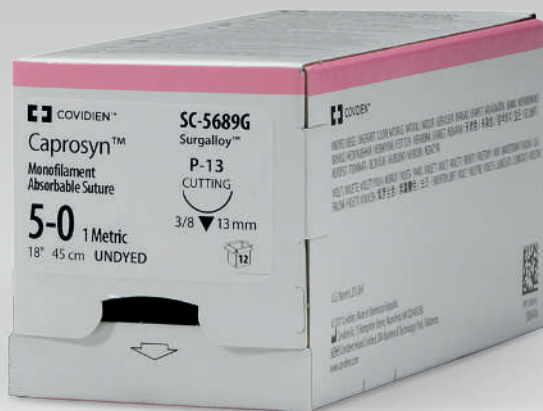

### Rapid absorption can lessen wound complications

- Fastest absorbing monofilament suture
- Short-term wound support
- Excellent pliability, handling and knot security
- Predictable strength retention

#### Absorption

Absorbable By Hydrolysis. Essentially complete by 56 days.

#### Tensile Strength

A minimum of 50 to 60% USP and EP knot strength at 5 days post implantation, and a minimum of 20–30% of USP and EP knot strength at 10 days. All original tensile strength is essentially lost by 21 days post implantation.

#### Packaging

Available undyed or dyed with D&C Violet No. 2 in USP sizes 1 (4 metric) through 6-0 (0.7 Metric).

The sutures are supplied sterile, in pre-cut lengths or ligating reels, nonneeded or affixed to various needle types. The sutures are available in box quantities of one, two and three dozen.

#### Indications

Caprosyn™ synthetic absorbable sutures are indicated for use in general soft tissue approximation and/or ligation, but not for use in cardiovascular or neurological surgery, microsurgery, or ophthalmic surgery

## Description

Caprosyn™ monofilament synthetic absorbable sutures are prepared from Polyglytone™ 6211 synthetic polyester which is composed of glycolide, caprolactone, trimethylene carbonate, and lactide.

## Indications

Caprosyn™ synthetic absorbable sutures are indicated for use in general soft tissue approximation and/or ligation, but not for use in cardiovascular or neurological surgery, microsurgery, or ophthalmic surgery.

## Actions

Caprosyn™ synthetic absorbable sutures elicit a minimal acute inflammatory reaction in tissues, which is followed by gradual encapsulation of the suture by fibrous connective tissue. Progressive loss of tensile strength and eventual absorption of Caprosyn™ synthetic absorbable sutures occurs by means of hydrolysis.

## Tensile Strength

Implantation studies in animals indicate that Caprosyn™ suture retains a minimum of 50 to 60% USP and EP knot strength at 5 days post implantation, and a minimum of 20 – 30% of USP and EP knot strength at 10 days post implantation. All of the original tensile strength is essentially lost by 21 days post implantation.

## Sterilization

Ethylene oxide.

## Absorbtion

Absorption begins as a loss of tensile strength followed by a loss of mass. Absorption of Caprosyn™ synthetic absorbable suture is essentially complete by 56 days.

## Packaging

Caprosyn™ synthetic absorbable sutures are available undyed (natural) or dyed with D&C Violet No. 2 in USP sizes 1 (4 metric) through 6–0 (0.7 Metric). The sutures are supplied sterile, in pre-cut lengths or ligating reels, non-needled or affixed to various needle types. The sutures are available in box quantities of one, two and three dozen.

Please refer to the individual package IFUs for complete instructions, indications, contraindications, warnings and precautions.

# Caprosyn™

Caprosyn™ suture is a brand you have trusted for over 10 years with a proven history of performance.

REEL								
Needles Specifications	Size		Length		Color	Units Per box	Comments	Reorder code
	USP	EP	cm	Inches				
	3-0	2	150	60	Undyed	24		C-212
	0	3.5	150	60	Undyed	36		C-214



REVERSE CUTTING								
Needles Specifications	Size		Length		Color	Units Per box	Comments	Reorder code
	USP	EP	cm	Inches				
<b>C-13</b> 3/8 Circle 19.0 mm 	5-0	1	45	18	Undyed	36		SC-3634
	4-0	1.5	45	18	Undyed	12		SC-690G
	4-0	1.5	75	30	Undyed	36		SC-691
	3-0	2	45	18	Undyed	12		SC-694G
	3-0	2	75	30	Undyed	36		SC-692
	2-0	3	75	30	Undyed	36		SC-693
<b>C-14</b> 3/8 Circle 24.0 mm 	3-0	2	75	30	Undyed	12	Surgalloy™	SC-693G
<b>C-15</b> 3/8 Circle 26.0 mm 	3-0	2	75	30	Undyed	36		SC-587
	2-0	3	75	30	Undyed	36		SC-586
<b>C-16</b> 3/8 Circle 30.0 mm 	0	3.5	75	30	Undyed	36	Surgalloy™	SC-585

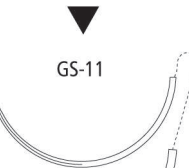
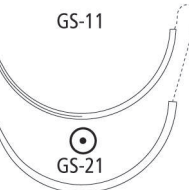

## REVERSE CUTTING

Needles Specifications	Size		Length		Color	Units Per box	Comments	Reorder code
	USP	EP	cm	Inches				
<b>GS-11</b> 1/2 Circle 37.0 mm 	2-0	3	75	30	Undyed	36		CC-543
<b>GS-11</b> 1/2 Circle 37.0 mm 	2-0	3	150	60	Undyed	36		CC-983
<b>GS-21</b> Taper Point 1/2 Circle 37.0 mm Double-arm 								





## PREMIUM REVERSE CUTTING

Needles Specifications	Size		Length		Color	Units Per box	Comments	Reorder code	
	USP	EP	cm	Inches					
<b>P-10</b> 3/8 Circle 11.0 mm 		6-0	0.7	45	18	Undyed	12	Surgalloy™	SC-3625G
		5-0	1	45	18			Undyed	12
<b>P-13</b> 3/8 Circle 13.0 mm 		6-0	0.7	45	18	Undyed	12	Surgalloy™	SC-5688G
		6-0	0.7	45	18	Violet	12	Surgalloy™	SC-5588G
		5-0	1	45	18	Undyed	12	Surgalloy™	SC-5689G
		5-0	1	45	18	Violet	12	Surgalloy™	SC-5587G
		4-0	1.5	45	18	Undyed	12	Surgalloy™	SC-5690G
		4-0	1.5	45	18	Violet	12	Surgalloy™	SC-5590G





## PREMIUM REVERSE CUTTING

Needles Specifications	Size		Length		Color	Units Per box	Comments	Reorder code
	USP	EP	cm	Inches				
<b>P-11</b> 3/8 Circle 16.0 mm 	6-0	0.7	45	18	Undyed	12	Surgalloy™	SC-5635G
	5-0	1	45	18	Undyed	12	Surgalloy™	SC-5626G
	5-0	1	45	18	Undyed	36	Surgalloy™	SC-5626
	4-0	1.5	45	18	Undyed	12	Surgalloy™	SC-5686G
<b>P-12</b> 3/8 Circle 19.0 mm 	5-0	1	45	18	Undyed	12	Surgalloy™	SC-5616G
	4-0	1.5	45	18	Undyed	12	Surgalloy™	SC-5617G
	4-0	1.5	45	18	Violet	12	Surgalloy™	SC-5627G
	4-0	1.5	75	30	Undyed	12	Surgalloy™	SC-5637G
	3-0	2	45	18	Undyed	12	Surgalloy™	SC-5618G
	3-0	2	75	30	Undyed	12	Surgalloy™	SC-5638G
<b>P-14</b> 3/8 Circle 24.0 mm 	4-0	1.5	45	18	Undyed	36	Surgalloy™	SC-5679
	4-0	1.5	75	30	Undyed	36	Surgalloy™	SC-5779
	3-0	2	45	18	Undyed	36	Surgalloy™	SC-5640
	3-0	2	75	30	Undyed	12	Surgalloy™	SC-5780G
<b>P-24</b> 1/2 Circle 16.0 mm 	4-0	1.5	45	18	Undyed	12	Surgalloy™	SC-5643G





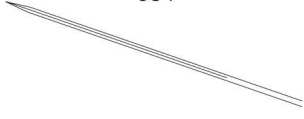
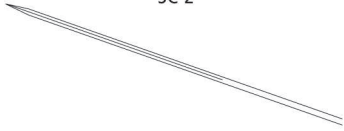

## CONVENTIONAL CUTTING

Needles Specifications	Size		Length		Color	Units Per box	Comments	Reorder code
	USP	EP	cm	Inches				
<b>SC-1</b> Straight    51.0 mm    ▲ SC-1 	3-0	2	75	30	Undyed	36	Surgalloy™	SC-543
	2-0	3	75	30	Undyed	36	Surgalloy™	SC-542
<b>SC-2</b> Straight    60.0 mm    ▲ SC-2 	4-0	1.5	75	30	Undyed	36	Surgalloy™	SC-644
	3-0	2	75	30	Undyed	36		SC-643

## DERMAX PREMIUM X CUTTINGT

Needles Specifications	Size		Length		Color	Units Per box	Comments	Reorder code
	USP	EP	cm	Inches				
<b>DX-13</b> 3/8 Circle    13.0 mm    ◊ DX-13 	5-0	1	45	18	Undyed	12	DermaX	XC-834
<b>DX-16</b> 3/8 Circle    16.0 mm    ◊ DX-16 	5-0	1	45	18	Undyed	12	DermaX	XC-844
	4-0	1.5	45	18	Undyed	12	DermaX	XC-845







## DERMAX PREMIUM X CUTTING

Needles Specifications	Size		Length		Color	Units Per box	Comments	Reorder code
	USP	EP	cm	Inches				
<b>DX-19</b> 3/8 Circle 19.0 mm  DX-19	4-0	1.5	45	18	Undyed	12	DermaX	XC-823

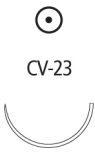
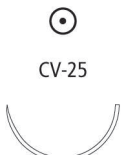
## TAPER POINT



Needles Specifications	Size		Length		Color	Units Per box	Comments	Reorder code
	USP	EP	cm	Inches				
<b>CV-23</b> 1/2 Circle 17.0 mm  CV-23	5-0	1	75	30	Undyed	36	Surgalloy™	UC-202
	4-0	1.5	75	30	Undyed	36	Surgalloy™	UC-203
	4-0	1.5	75	30	Violet	36	Surgalloy™	UC-214
	3-0	2	75	30	Violet	36		UC-213
	3-0	2	75	30	Undyed	36	Surgalloy™	UC-204
<b>CV-25</b> 1/2 Circle 22.0 mm  CV-25	4-0	1.5	75	30	Undyed	36	Surgalloy™	UC-403
	3-0	2	5 × 45	18	Undyed	12	D-Tach™	GC-33-M
	3-0	2	75	30	Undyed	36	Surgalloy™	UC-404
<b>GS-23</b> 1/2 Circle 22.0 mm  GS-23	2-0	3	75	30	Undyed	36		UC-863







## TAPER POINT

Needles Specifications	Size		Length		Color	Units Per box	Comments	Reorder code	
	USP	EP	cm	Inches					
<b>V-20</b> 1/2 Circle 26.0 mm 	4-0	1.5	75	30	Violet	36	Surgalloy™	GC-321	
	4-0	1.5	75	30	Undyed	36	Surgalloy™	GC-121	
	3-0	2	75	30	Undyed	36	Surgalloy™	GC-122	
	3-0	2	75	30	Violet	36	Surgalloy™	GC-322	
	2-0	3	75	30	Undyed	36	Surgalloy™	GC-123	
	2-0	3	75	30	Violet	36	Surgalloy™	GC-323	
	0	3.5	75	30	Undyed	36	Surgalloy™	GC-124	
<b>GS-22</b> 1/2 Circle 27.0 mm 	2-0	3	75	30	Undyed	36		CC-883	
	2-0	3	75	30	Violet	36		CC-830	
	0	3.5	75	30	Undyed	36		CC-884	
	0	3.5	75	30	Violet	36		CC-831	
	1	4	75	30	Undyed	36		CC-885	
<b>GS-21</b> 1/2 Circle 37.0 mm 	3-0	2	75	30	Undyed	36		CC-810	
	3-0	2	90	36	Undyed	36		CC-922	
	2-0	3	75	30	Violet	36		CC-843	
	2-0	3	75	30	Undyed	36		CC-811	
	2-0	3	90	36	Undyed	36		CC-923	
	0	3.5	75	30	Violet	36		CC-844	
	0	3.5	75	30	Undyed	36		CC-812	
	0	3.5	90	36	Undyed	36		CC-924	
	1	4	75	30	Violet	36		CC-845	
	1	4	75	30	Undyed	36		CC-813	
	1	4	90	36	Undyed	36		CC-925	





## TAPER POINT

Needles Specifications	Size		Length		Color	Units Per box	Comments	Reorder code
	USP	EP	cm	Inches				
<b>GS-24</b> 1/2 Circle    40.0 mm 	<b>2-0</b>	3	75	30	Undyed	36		CC-801
	<b>2-0</b>	3	90	36	Undyed	36		CC-915
	<b>0</b>	3.5	75	30	Undyed	36		CC-802
	<b>0</b>	3.5	90	36	Undyed	36		CC-913
	<b>1</b>	4	75	30	Undyed	36		CC-803
	<b>1</b>	4	90	36	Undyed	36		CC-914
<b>GS-25</b> 1/2 Circle    48.0 mm 	<b>2-0</b>	3	75	30	Undyed	36		CC-872
	<b>0</b>	3.5	90	36	Undyed	36		CC-904
	<b>1</b>	4	90	36	Violet	36		CC-975
	<b>1</b>	4	90	36	Undyed	36		CC-905
<b>GU-46</b> 5/8 Circle    27.0 mm 	<b>3-0</b>	2	75	30	Violet	36		UC-879
	<b>2-0</b>	3	75	30	Undyed	36		UC-978
<b>GU-46</b> 5/8 Circle    27.0 mm   <b>V-20</b> 1/2 Circle    26.0 mm Double-arm 	<b>2-0</b>	3	75	30	Violet	36	Surgalloy™	CC-658





## TAPERCUTTING

Needles Specifications	Size		Length		Color	Units Per box	Comments	Reorder code
	USP	EP	cm	Inches				
<b>KV-34</b> 1/2 Circle 37.0 mm 	2-0	3	90	36	Undyed	12		CC-1945G
	1	4	90	36	Undyed	36	Surgalloy™	CC-196



# BIOSYN™

## Monofilament Absorbable Sutures

Strength, suppleness and integrity.



### Strength, suppleness and integrity for unbraided security

- Handling & strength of a braided suture with the benefits of a monofilament
- Excellent first-throw hold
- Precise and secure wound approximation
- The only absorbable monofilament with three weeks of wound support

#### Absorption

Absorbable By Hydrolysis. Essentially complete between 90–110 days.

#### Tensile Strength

Approximately 75% of USP and EP knot strength at 2 weeks and approximately 40% at 3 weeks post implantation.

#### Packaging

Available clear (undyed) or dyed violet in U.S.P. and E.P. sizes 1 (4 Metric) through 6-0 (0.7 Metric). The sutures are supplied sterile, in pre-cut lengths or affixed to various needle types using both permanent and removal needle attachment techniques.

#### Indications

Indicated for use in general soft tissue approximation and/or ligation including use in ophthalmic surgery, but not for use in cardiovascular or neurological surgery.

## Description

Biosyn™ monofilament synthetic absorbable sutures are prepared from a synthetic polyester composed of glycolide, dioxanone, and trimethylene carbonate. Biosyn™ synthetic absorbable sutures are colored violet to increase visibility and are also available undyed.

## Indications

Biosyn™ synthetic absorbable sutures are indicated for use in general soft tissue approximation and/or ligation including use in ophthalmic surgery, but not for use in cardiovascular or neurological surgery.

## Actions

Biosyn™ synthetic absorbable sutures elicit a minimal acute inflammatory reaction in tissues, which is followed by gradual encapsulation of the suture by fibrous connective tissue. Progressive loss of tensile strength and eventual absorption of Biosyn™ synthetic absorbable sutures occurs by means of hydrolysis where the suture is broken down to glycolic acid, dioxanoic acid, propane diol and carbon dioxide which are subsequently absorbed and metabolized by the body.

## Tensile Strength

Studies in animals indicate tensile strength averages for Biosyn™ synthetic absorbable sutures are approximately 75% of U.S.P and E.P. minimum knot strength at two weeks and approximately 40% at three weeks post-implant.

## Sterilization

Ethylene oxide.

## Absorbtion

Absorption begins as a loss of tensile strength without appreciable loss of mass. Absorption of Biosyn™ synthetic absorbable sutures is essentially complete between 90 and 110 days.

## Packaging

Biosyn™ synthetic absorbable sutures are available undyed (natural) or dyed violet in U.S.P. and E.P. sizes 1 (4 Metric) through 6-0 (0.7 Metric). The sutures are supplied sterile, in pre-cut lengths or affixed to various needle types using both permanent and removal needle attachment techniques. Please refer to the individual package IFUs for complete instructions, indications, contraindications, warnings and precautions.

Please refer to the individual package IFUs for complete instructions, indications, contraindications, warnings and precautions.

# Biosyn™

Biosyn™ suture is a brand you have trusted for over 15 years with a proven history of performance.



PRE-CUT								
Needles Specifications	Size		Length		Color	Units Per box	Comments	Reorder code
	USP	EP	cm	Inches				
	<b>4-0</b>	1.5	6×45	18	Violet	24	Pre-cut	M-31-
	<b>3-0</b>	2	3×45	18	Violet	36	Pre-cut	M-72
	<b>3-0</b>	2	6×45	18	Violet	24	Pre-cut	M-32-
	<b>2-0</b>	3	6×45	18	Violet	24	Pre-cut	M-33-
	<b>2-0</b>	3	6×45	18	Undyed	24	Pre-cut	M-23-
	<b>0</b>	3.5	3×45	18	Violet	36	Pre-cut	M-74
	<b>1</b>	4	3×45	18	Violet	36	Pre-cut	M-75

STANDARD LENGHT								
Needles Specifications	Size		Length		Color	Units Per box	Comments	Reorder code
	USP	EP	cm	Inches				
	<b>0</b>	3.5	150	60	Violet	36	Standard length	M-114

REVERSE CUTTING								
Needles Specifications	Size		Length		Color	Units Per box	Comments	Reorder code
	USP	EP	cm	Inches				
<b>C-13</b> 3/8 Circle 19.0 mm 	<b>5-0</b>	1	75	30	Undyed	36		SM-690
	<b>4-0</b>	1.5	75	30	Violet	36		SM-791
	<b>4-0</b>	1.5	75	30	Undyed	12		SM-691G
	<b>4-0</b>	1.5	75	30	Undyed	36		SM-691
	<b>3-0</b>	2	75	30	Undyed	36		SM-822
	<b>3-0</b>	2	75	30	Violet	36		SM-922

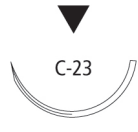

## REVERSE CUTTING

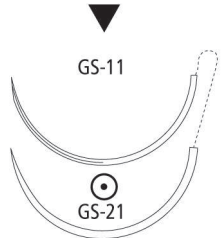
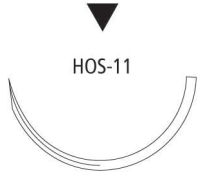
Needles Specifications			Size		Length		Color	Units Per box	Comments	Reorder code
			USP	EP	cm	Inches				
<b>C-14</b> 3/8 Circle    24.0 mm 	<b>3-0</b>	2	75	30	Undyed	36		SM-693		
	<b>2-0</b>	3	75	30	Violet	36		SM-923		
	<b>2-0</b>	3	75	30	Undyed	36		SM-823		
<b>C-23</b> 1/2 Circle    24.0 mm 	<b>4-0</b>	1.5	75	30	Violet	36		SM-633		
	<b>3-0</b>	2	5×45	18	Violet	12	D-Tach™	SM-83-M		
	<b>3-0</b>	2	75	30	Violet	36		SM-632		
<b>GS-10</b> 1/2 Circle    26.0 mm 	<b>2-0</b>	3	75	30	Violet	36		CM-879		
<b>GS-11</b> 1/2 Circle    37.0 mm 	<b>2-0</b>	3	75	30	Violet	36		CM-816		
	<b>2-0</b>	3	75	30	Undyed	36		CM-543		
	<b>0</b>	3.5	75	30	Violet	36		CM-817		
	<b>0</b>	3.5	75	30	Undyed	36		CM-544		
<b>GS-11 - GS-21</b> 1/2 Circle    37.0 mm *Double-arm 	<b>3-0</b>	2	135	54	Undyed	36		CM-991		
	<b>2-0</b>	3	150	60	Undyed	36		CM-932		
<b>HOS-11</b> 1/2 Circle    37.0 mm 	<b>1</b>	4	75	30	Violet	36		CM-528		





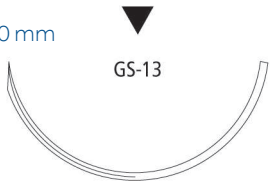

## REVERSE CUTTING

Needles Specifications	Size		Length		Color	Units Per box	Comments	Reorder code
	USP	EP	cm	Inches				
<b>GS-13</b> 1/2 Circle    48.0 mm 	<b>1</b>	4	90	36	Violet	36		CM-222

## PREMIUM REVERSE CUTTING

Needles Specifications	Size		Length		Color	Units Per box	Comments	Reorder code	
	USP	EP	cm	Inches					
<b>P-10</b> 3/8 Circle    11.0 mm 	<b>6-0</b>	0.7	45	18	Undyed	12	Surgalloy™	SM-3625	
		<b>5-0</b>	1	45	18	Undyed	12	Surgalloy™	SM-3626
<b>P-13</b> 3/8 Circle    13.0 mm 	<b>6-0</b>	0.7	45	18	Undyed	12	Surgalloy™	SM-5688	
		<b>5-0</b>	1	45	18	Undyed	12	Surgalloy™	SM-5687
		<b>4-0</b>	1.5	45	18	Undyed	12	Surgalloy™	SM-5690
<b>P-12</b> 3/8 Circle    19.0 mm 	<b>5-0</b>	1	45	18	Undyed	12	Surgalloy™	SM-5624	
		<b>4-0</b>	1.5	45	18	Undyed	12	Surgalloy™	SM-5627
			1.5	75	30	Undyed	12	Surgalloy™	SM-5637
			2	45	18	Undyed	12	Surgalloy™	SM-5628
		<b>3-0</b>	2	75	30	Undyed	12	Surgalloy™	SM-5638







## PREMIUM REVERSE CUTTING



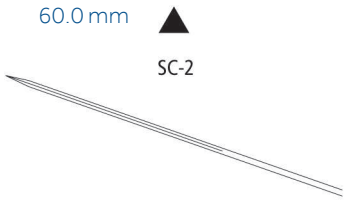

Needles Specifications	Size		Length		Color	Units Per box	Comments	Reorder code
	USP	EP	cm	Inches				
<b>P-14</b> 3/8 Circle    24.0 mm  P-14	<b>4-0</b>	1.5	45	18	Undyed	24	Surgalloy™	SM-5679
	<b>4-0</b>	1.5	75	30	Undyed	36	Surgalloy™	SM-5678
	<b>3-0</b>	2	75	30	Undyed	12	Surgalloy™	SM-5679G

## CONVENTIONAL CUTTING





Needles Specifications	Size		Length		Color	Units Per box	Comments	Reorder code
	USP	EP	cm	Inches				
<b>PC-13</b> 3/8 Circle    11.0 mm  PC-13	<b>5-0</b>	1	45	18	Undyed	24		CM-401
	<b>4-0</b>	1.5	45	18	Undyed	24		CM-400
<b>SC-2</b> Straight    60.0 mm  SC-2	<b>4-0</b>	1.5	75	30	Undyed	36		SM-644
	<b>3-0</b>	2	75	30	Undyed	36		SM-643



## X CUTTING



Needles Specifications	Size USP	EP	Length		Color	Units Per box	Comments	Reorder code
			cm	Inches				
<b>DX-13</b> 3/8 Circle 13.0 mm  DX-13 	<b>5-0</b>	1	45	18	Undyed	12	DermaX	XM-834
	<b>4-0</b>	1.5	45	18	Undyed	12	DermaX	XM-845
<b>DX-19</b> 3/8 Circle 19.0 mm  DX-19 	<b>5-0</b>	1	45	18	Undyed	12	DermaX	XM-822
	<b>4-0</b>	1.5	45	18	Undyed	12	DermaX	XM-823

## TAPER POINT

Needles Specifications	Size USP	EP	Length		Color	Units Per box	Comments	Reorder code
			cm	Inches				
<b>CVF-21</b> 1/2 Circle 12.0 mm  CVF-21 	<b>5-0</b>	1	45	18	Undyed	36	Surgalloy™	SM-432
	<b>4-0</b>	1.5	45	18	Undyed	36	Surgalloy™	SM-431
	<b>4-0</b>	1.5	75	30	Undyed	36	Surgalloy™	SM-434
<b>CV-11</b> 3/8 Circle 13.0 mm Double-arm  CV-11 	<b>5-0</b>	1	75	30	Violet	36	Surgalloy™	CM-126

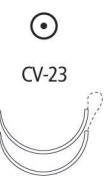

## TAPER POINT

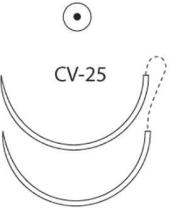
Needles Specifications	Size USP	EP	Length		Color	Units Per box	Comments	Reorder code
			cm	Inches				
<b>CV-22</b> 1/2 Circle 13.0 mm 	6-0	0.7	75	30	Violet	36	Surgalloy™	UM-986
	6-0	0.7	75	30	Undyed	36	Surgalloy™	UM-886
	5-0	1	75	30	Violet	36	Surgalloy™	GM-875
<b>CV-23</b> 1/2 Circle 17.0 mm 	6-0	0.7	75	30	Violet	36	Surgalloy™	UM-201
	5-0	1	75	30	Violet	36	Surgalloy™	UM-202
	5-0	1	75	30	Undyed	36	Surgalloy™	UM-213
	4-0	1.5	75	30	Undyed	36	Surgalloy™	UM-214
	4-0	1.5	75	30	Violet	36	Surgalloy™	UM-203
	3-0	2	75	30	Undyed	36	Surgalloy™	UM-215
	3-0	2	75	30	Violet	36	Surgalloy™	UM-204
<b>CV-23</b> 1/2 Circle 17.0 mm Double-arm 	3-0	2	75	30	Violet	36	Surgalloy™	CM-208
	4-0	1.5	75	30	Violet	36	Surgalloy™	UM-403
<b>CV-25</b> 1/2 Circle 22.0 mm 	4-0	1.5	5 × 45	18	Violet	12	D-Tach™	GM-34-M
	4-0	1.5	75	30	Violet	36	Surgalloy™	GM-181
	3-0	2	45	18	Violet	12	D-Tach™	GMJ33M
	3-0	2	75	30	Violet	36	Surgalloy™	GM-324
	2-0	3	75	30	Violet	36	Surgalloy™	GM-183
<b>CV-25</b> 1/2 Circle 22.0 mm Double-arm 	3-0	2	90	36	Violet	36	Surgalloy™	GM-282
	4-0	1.5	75	30	Violet	36	Surgalloy™	GM-281
	4-0	1.5	90	36	Violet	36	Surgalloy™	GM-291

## TAPER POINT

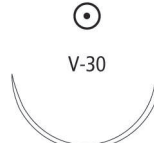
Needles Specifications	Size		Length		Color	Units Per box	Comments	Reorder code
	USP	EP	cm	Inches				
<b>V-20</b> 1/2 Circle 26.0 mm 	4-0	1.5	75	30	Violet	36	Surgalloy™	GM-121
	4-0	1.5	75	30	Undyed	36	Surgalloy™	GM-321
	3-0	2	5 × 45	18	Undyed	12		GM-69-M
	3-0	2	75	30	Violet	36	Surgalloy™	GM-122
	3-0	2	5 × 75	30	Violet	12	D-Tach™	GM-67-M
	3-0	2	75	30	Undyed	36	Surgalloy™	GM-322
	2-0	3	75	30	Violet	36		GM-123
	2-0	3	75	30	Undyed	36		GM-323
	2-0	3	90	36	Violet	36		GM-125
<b>V-20</b> 1/2 Circle 26.0 mm Double-arm 	4-0	1.5	75	30	Violet	36	Surgalloy™	GM-421
	4-0	1.5	90	36	Violet	36	Surgalloy™	GM-432
	3-0	2	90	36	Violet	36	Surgalloy™	GM-332
<b>GS-22</b> 1/2 Circle 27.0 mm 	3-0	2	75	30	Violet	36		CM-882
	2-0	3	75	30	Violet	36		CM-883
	2-0	3	75	30	Undyed	36		CM-830
	0	3.5	75	30	Violet	36		CM-884
	0	3.5	75	30	Undyed	36		CM-831
	1	4	75	30	Violet	36		CM-832
<b>V-30</b> 1/2 Circle 30.0 mm 	3-0	2	75	30	Violet	36		GM-222
	2-0	3	75	30	Violet	36		GM-223
	2-0	3	90	36	Violet	36		GM-326
	0	3.5	90	36	Violet	36		GM-327

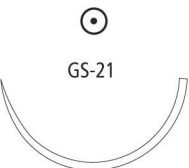

## TAPER POINT

Needles Specifications	Size		Length		Color	Units Per box	Comments	Reorder code
	USP	EP	cm	Inches				
<b>V-26</b> 1/2 Circle 37.0 mm 	<b>3-0</b>	2	75	30	Undyed	36		GM-226
	<b>2-0</b>	3	75	30	Undyed	36		GM-227
<b>GS-21</b> 1/2 Circle 37.0 mm 	<b>3-0</b>	2	5 × 45	18	Violet	12	D-Tach™	CM-738-M
	<b>3-0</b>	2	75	30	Undyed	36		CM-842
	<b>3-0</b>	2	75	30	Violet	36		CM-810
	<b>3-0</b>	2	90	36	Violet	36		CM-922
	<b>2-0</b>	3	5 × 45	18	Violet	12	D-Tach™	CM-9M
	<b>2-0</b>	3	75	30	Undyed	36		CM-843
	<b>2-0</b>	3	75	30	Violet	36		CM-811
	<b>2-0</b>	3	90	36	Undyed	36		CM-953
	<b>2-0</b>	3	90	36	Violet	36		CM-923
	<b>0</b>	3.5	5 × 45	18	Undyed	12		CM-14-M
	<b>0</b>	3.5	5 × 45	18	Violet	12	D-Tach™	CM-10-M
	<b>0</b>	3.5	75	30	Undyed	36		CM-844
	<b>0</b>	3.5	75	30	Violet	36		CM-812
	<b>0</b>	3.5	90	36	Violet	36		CM-924
	<b>0</b>	3.5	90	36	Undyed	36		CM-954
	<b>1</b>	4	5 × 45	18	Violet	12	D-Tach™	CM-11-M
	<b>1</b>	4	75	30	Undyed	36		CM-845
	<b>1</b>	4	75	30	Violet	36		CM-813
	<b>1</b>	4	90	36	Violet	36		CM-925



## TAPER POINT



Needles Specifications	Size		Length		Color	Units Per box	Comments	Reorder code
	USP	EP	cm	Inches				
<b>GS-24</b> 1/2 Circle 40.0 mm 	<b>3-0</b>	2	90	36	Undyed	36		CM-962
	<b>2-0</b>	3	75	30	Violet	36		CM-801
	<b>0</b>	3.5	90	36	Violet	36		CM-914
	<b>0</b>	3.5	90	36	Undyed	36		CM-964
	<b>1</b>	4	90	36	Violet	36		CM-966
<b>GS-24 LOOP</b> 1/2 Circle 40.0 mm 	<b>0</b>	3.5	150	60	Violet	12	Loop	CM-765-L
	<b>1</b>	4	150	60	Violet	12	Loop	CM-767-L
<b>GS-25</b> 1/2 Circle 48.0 mm 	<b>2-0</b>	3	90	36	Violet	36		CM-903
	<b>0</b>	3.5	90	36	Undyed	36		CM-974
	<b>0</b>	3.5	90	36	Violet	36		CM-904
	<b>1</b>	4	5×45	18	Violet	12	D-Tach™	CM-31-M
	<b>1</b>	4	90	36	Undyed	36		CM-975
	<b>1</b>	4	90	36	Violet	36		CM-905
<b>GS-25 LOOP</b> 1/2 Circle 48.0 mm 	<b>0</b>	3.5	150	60	Violet	12	Loop	CM-790L
	<b>1</b>	4	150	60	Violet	12	Loop	CM-776L
<b>GS-26 LOOP</b> 1/2 Circle 65.0 mm 	<b>0</b>	3.5	150	60	Violet	12	Loop	CM-779L
	<b>1</b>	4	240	96	Violet	12	Loop	CM-780L

**TAPER POINT**

Needles Specifications	Size	Length		Color	Units	Comments	Reorder code	
		USP	EP					cm
<b>GU-46</b> 5/8 Circle 27.0 mm 	<b>3-0</b>	2	75	30	Violet	36	UM-879	
	<b>2-0</b>	3	75	30	Undyed	36	UM-978	
	<b>2-0</b>	3	75	30	Violet	36	UM-878	
	<b>0</b>	3.5	75	30	Violet	36	UM-877	
	<b>0</b>	3.5	75	30	Undyed	36	UM-977	
<b>GU-46 - V - 20</b> 5/8 Circle 27.0 mm 	<b>2-0</b>	3	75	30	Violet	36	Loop	CM-558
<b>GU-45</b> 5/8 Circle 37.0 mm 	<b>2-0</b>	3	75	30	Undyed	36	UM-345	
	<b>2-0</b>	3	75	30	Violet	36	UM-245	
<b>GU-45 - GU-45</b> 5/8 Circle 37.0 mm Double-arm (Not to scale) 	<b>3-0</b>	2	75	30	Violet	36	UM-243	
<b>GU-44</b> 5/8 Circle 40.0 mm 	<b>0</b>	3.5	75	30	Violet	36	UM-383	



## HEAVY TAPER POINT

Needles Specifications	Size		Length		Color	Units Per box	Comments	Reorder code
	USP	EP	cm	Inches				
<b>HGS-20</b> 1/2 Circle    34.0 mm  HGS-20	<b>0</b>	3.5	5 × 45	18	Violet	12	D-Tach™	CM-90-M
<b>HGS-21</b> 1/2 Circle    37.0 mm  HGS-21	<b>0</b>	3.5	75	30	Violet	36		CM-436







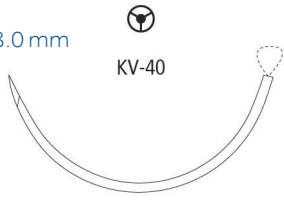

## TAPERCUTTING

Needles Specifications	Size		Length		Color	Units Per box	Comments	Reorder code
	USP	EP	cm	Inches				
<b>KV-34</b> 1/2 Circle    37.0 mm 	<b>2-0</b>	3	75	30	Undyed	36		CM-827
<b>KV-40 LOOP</b> 1/2 Circle    48.0 mm 	<b>1</b>	4	150	60	Violet	12	Loop	CM-740L



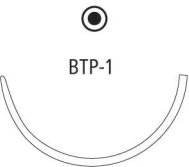

## BLUNT POINT

Needles Specifications	Size		Length		Color	Units Per box	Comments	Reorder code
	USP	EP	cm	Inches				
<b>BTV-20</b> 1/2 Circle 26.0 mm 	<b>3-0</b>	2	75	30	Undyed	36		GMT-226
<b>BTP-1</b> 1/2 Circle 37.0 mm 	<b>3-0</b>	2	90	36	Undyed	36		CMT-952
	<b>2-0</b>	3	75	30	Violet	36	ProtectPoint™	CMT-811
	<b>0</b>	3.5	5 × 45	18	Violet	12	D-Tach™, ProtectPoint™	CMT-740-M
	<b>0</b>	3.5	75	30	Violet	36		CMT-812
	<b>0</b>	3.5	90	36	Undyed	36	ProtectPoint™	CMT-967
	<b>1</b>	4	5 × 45	18	Violet	12	D-Tach™, ProtectPoint™	CMT-741-M
<b>BGS-24</b> 1/2 Circle 40.0 mm 	<b>1</b>	4	90	36	Violet	36	ProtectPoint™	CM-951
<b>BGS-25</b> 1/2 Circle 48.0 mm 	<b>1</b>	4	5 × 45	18	Violet	12	D-Tach™, ProtectPoint™	CM-949-M





BLUNT POINT										
Needles Specifications	Size		Length		Color	Units Per box	Comments	Reorder code		
	USP	EP	cm	Inches						
<b>BTP-X</b> 1/2 Circle 48.0 mm  (Not to scale)	0	3.5	5 × 45	18	Violet	12	D-Tach™, ProtectPoint™	CMT-950-M		
	0	3.5	90	36	Undyed	36	ProtectPoint™	CMT-974		
	1	4	5 × 45	18	Violet	12	D-Tach™, ProtectPoint™	CMT-949-M		
<b>BTP-X LOOP</b> 1/2 Circle 48.0 mm  (Not to scale)	0	3.5	150	60	Violet	12	LOOP, ProtectPoint™	CMT-789-L		



# MAXON™

## Monofilament Absorbable Suture

Highest knot holding capacity versus competition.



- Long-term monofilament absorbable suture
- Unequalled strength during critical stages of healing\*
- Six weeks of wound support
- Monofilament construction provides smooth passage through tissue, minimizing tissue drag and trauma
- Maxon™ looped sutures provide double strength of a single strand and can reduce closure time by 50%

### Absorption

By Hydrolysis. Essentially complete within 6 months.

### Tensile Strength

Approximately 80% of the original suture strength 1 week post implantation. Approximately 75% @ 2 weeks, 65% @ 3 weeks, 50% @ 4 weeks and 25% @ 6 weeks post-implant.

### Packaging

Available in USP and E.P sizes 1 (4 Metric) through 7-0 (0.5 Metric).

Maxon™ sutures are dyed with D&C Green No. 6.

Maxon™ sutures are also available in clear (Undyed).

The sutures are supplied sterile, affixed to various needle types, using permanent needle attachment techniques.

### Indications

Indicated for use as absorbable sutures in general soft tissue approximation and/or ligation, including use in pediatric cardiovascular tissue, where growth is expected to occur, and in peripheral vascular tissue. Maxon™ sutures are not indicated for use in adult cardiovascular tissue, ophthalmic surgery, microsurgery, and neural tissue.

**Description**

Maxon™ monofilament polyglyconate synthetic absorbable sutures are prepared from a copolymer of glycolic acid and trimethylene carbonate.

**Indications**

Maxon™ sutures are indicated for use as absorbable sutures in general soft tissue approximation and/or ligation, including use in pediatric cardiovascular tissue, where growth is expected to occur, and in peripheral vascular tissue. Maxon™ sutures are not indicated for use in adult cardiovascular tissue, ophthalmic surgery, microsurgery, and neural tissue.

**Actions**

Maxon™ synthetic absorbable sutures elicit a minimal acute inflammatory reaction in tissues, which is followed by gradual encapsulation of the suture by fibrous connective tissue. Progressive loss of tensile strength and eventual absorption of Maxon™ synthetic absorbable sutures occurs by means of hydrolysis where the suture is broken down and subsequently absorbed and metabolized by the body.

**Tensile Strength**

Studies indicate that tensile strength for Maxon™ sutures is approximately 80% of the original suture strength at one week post-implant. Approximately 75% of the original suture strength remains at two weeks, 65% at three weeks, 50% at four weeks and 25% at six weeks post-implant.

**Sterilization**

Ethylene oxide.

**Absorbtion**

Absorption of Maxon™ synthetic absorbable sutures is minimal until about the 60th day after implantation and is essentially complete within six months.

**Packaging**



Maxon™ sutures are available in USP and E.P sizes 1 (4 Metric) through 7–0 (0.5 Metric). Maxon™ sutures are dyed with D&C Green No. 6. Maxon™ sutures are also available in clear (Undyed). The sutures are supplied sterile, affixed to various needle types, using permanent needle attachment techniques. Please refer to the individual package IFUs for complete instructions, indications, contraindications, warnings and precautions.

Please refer to the individual package IFUs for complete instructions, indications, contraindications, warnings and precautions.





# Maxon™

Maxon™ suture is a brand you have trusted for over 25 years with a history of improvements and performance

PRE-CUT								
Needles Specifications	Size		Length		Color	Units Per box	Comments	Reorder code
	USP	EP	cm	Inches				
	3-0	2	3×45	18	Green	36	Pre-cut	8886600741
	2-0	3	3×45	18	Green	36	Pre-cut	8886600751
	0	3.5	5×45	18	Green	12	Pre-cut	8886601563

REVERSE CUTTING								
Needles Specifications	Size		Length		Color	Units Per box	Comments	Reorder code
	USP	EP	cm	Inches				
<b>C-1</b> 3/8 Circle 12.0 mm 	5-0	1	45	18	Green	36		8886660521
	4-0	1.5	45	18	Green	36		8886660531
<b>C-12</b> 3/8 Circle 16.0 mm 	4-0	1.5	75	30	Clear	36		8886611831
<b>C-13</b> 3/8 Circle 19.0 mm 	5-0	1	45	18	Clear	36		8886660821
	4-0	1.5	45	18	Clear	36		8886660831
	4-0	1.5	75	30	Green	36		8886663931
	4-0	1.5	75	30	Clear	36		8886661231
	3-0	2	45	18	Clear	36		8886660841
	3-0	2	75	30	Green	36		8886663941
	3-0	2	75	30	Clear	36		8886661241

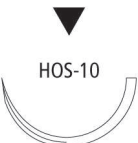

REVERSE CUTTING								
Needles Specifications	Size		Length		Color	Units Per box	Comments	Reorder code
	USP	EP	cm	Inches				
<b>C-14</b> 3/8 Circle 24.0 mm 	4-0	1.5	75	30	Clear	36		8886661831
	3-0	2	75	30	Clear	36		8886661841
	3-0	2	75	30	Green	36		8886664141
	2-0	3	75	30	Green	36		8886664151
	2-0	3	75	30	Clear	36		8886661851
<b>C-16</b> 3/8 Circle 30.0 mm 	2-0	3	75	30	Clear	36		8886662651
<b>C-27</b> 1/2 Circle 20.0 mm 	3-0	2	45	18	Green	36		8886605941
<b>GS-10</b> 1/2 Circle 26.0 mm 	3-0	2	75	30	Clear	36		8886674441
	2-0	3	5×45	18	Green	12	D-Tach™	CMM-435-MG
	2-0	3	75	30	Green	36		8886674551
	2-0	3	75	30	Clear	36		8886674451
<b>HOS-10</b> 1/2 Circle 26.0 mm 	1	4	75	30	Green	36		88866751-71





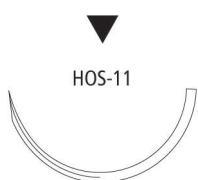
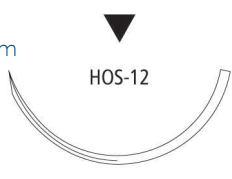
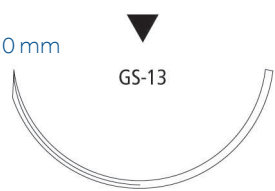



REVERSE CUTTING								
Needles Specifications	Size		Length		Color	Units Per box	Comments	Reorder code
	USP	EP	cm	Inches				
<b>GS-11</b> 1/2 Circle 37.0 mm 	2-0	3	75	30	Green	36		8886675551
	0	3.5	75	30	Green	36		8886675561
	1	4	75	30	Green	36		8886675571
<b>HOS-11</b> 1/2 Circle 37.0 mm 	1	4	75	30	Green	36		88866757-71
<b>HOS-12</b> 1/2 Circle 40.0 mm 	1	4	75	30	Green	36		8886678771
<b>GS-13</b> 1/2 Circle 48.0 mm 	1	4	90	36	Green	36		8886676971









PREMIUM REVERSE CUTTING									
Needles Specifications	Size		Length		Color	Units Per box	Comments	Reorder code	
	USP	EP	cm	Inches					
<b>P-10</b> 3/8 Circle 11.0 mm 	6-0	0.7	45	18	Green	36	Surgalloy™	8886653311	
	6-0	0.7	45	18	Clear	36	Surgalloy™	8886653211	
	5-0	1	45	18	Clear	36	Surgalloy™	8886653221	
<b>P-13</b> 3/8 Circle 13.0 mm 	6-0	0.7	45	18	Clear	36	Surgalloy™	SMM-5516	
	5-0	1	45	18	Clear	36	Surgalloy™	SMM-5526	
	4-0	1.5	45	18	Clear	36	Surgalloy™	SMM-5536	
<b>P-11</b> 3/8 Circle 16.0 mm 	5-0	1	45	18	Clear	36	Surgalloy™	SMM-5221	
	4-0	1.5	45	18	Clear	36	Surgalloy™	SMM-5431	
<b>P-12</b> 3/8 Circle 19.0 mm 	5-0	1	45	18	Clear	36	Surgalloy™	SMM-5042	
	4-0	1.5	45	18	Clear	36	Surgalloy™	SMM-5043	
	4-0	1.5	45	18	Green	36	Surgalloy™	SMM-5033	
	4-0	1.5	75	30	Clear	36	Surgalloy™	SMM-5323	
	3-0	2	45	18	Clear	36	Surgalloy™	SMM-5044	
	3-0	2	75	30	Clear	36	Surgalloy™	8886663241	
<b>P-14</b> 3/8 Circle 24.0 mm 	3-0	2	45	18	Clear	36	Surgalloy™	SMM-5241	
	2-0	3	45	18	Clear	36		8886662451	



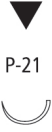



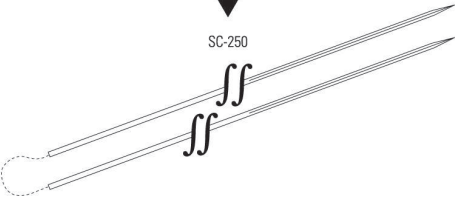









PREMIUM REVERSE CUTTING										
Needles Specifications	Size		Length		Color	Units Per box	Comments	Reorder code		
	USP	EP	cm	Inches						
<b>P-21</b> 1/2 Circle 9.0 mm 	5-0	1	45	18	Clear	12		88866704-23		
<b>P-24</b> 1/2 Circle 16.0 mm 	4-0	1.5	45	18	Clear	36	Surgalloy™	SMM-5831		

CONVENTIONAL CUTTING										
Needles Specifications	Size		Length		Color	Units Per box	Comments	Reorder code		
	USP	EP	cm	Inches						
<b>SC-2</b> Straight 60.0 mm 	4-0	1.5	75	30	Clear	36		8886690831		
	3-0	2	75	30	Clear	36		8886690841		
<b>SC-250</b> Straight 254.0 mm Double-arm (Not to scale) 	2-0	3	75	30	Green	12		8886639053		













TAPER POINT										
Needles Specifications	Size USP	EP	Length		Color	Units Per box	Comments	Reorder code		
			cm	Inches						
<b>CV-1</b> 3/8 Circle 9.0 mm Double-arm	 CV-1 	7-0	0.5	45	18	Green	36	Surgalloy™	8886614501	
		7-0	0.5	60	24	Green	36	Surgalloy™	8886613901	
		7-0	0.5	75	30	Green	36	Surgalloy™	8886612701	
		6-0	0.7	60	24	Green	36	Surgalloy™	8886613911	
		6-0	0.7	75	30	Green	36	Surgalloy™	8886612711	
<b>CV</b> 3/8 Circle 11.0 mm Double-arm	 CV 	6-0	0.7	45	18	Green	36	Surgalloy™	8886611511	
<b>CV-11</b> 3/8 Circle 13.0 mm	 CV-11 	6-0	0.7	75	30	Green	36	Surgalloy™	8886614811	
		5-0	1	75	30	Green	36	Surgalloy™	8886614821	
<b>CV-11</b> 3/8 Circle 13.0 mm Double-arm	 CV-11 	6-0	0.7	45	18	Green	36	Surgalloy™	8886612111	
		6-0	0.7	60	24	Green	36	Surgalloy™	8886614711	
		6-0	0.7	75	30	Green	36	Surgalloy™	8886612411	
		5-0	1	4×60	24	Green	12	Surgalloy™	8886616523	
		5-0	1	60	24	Green	36	Surgalloy™	8886614721	
		5-0	1	75	30	Green	36	Surgalloy™	8886612421	
		5-0	1	90	36	Green	36	Surgalloy™	8886612821	
<b>CV-15</b> 3/8 Circle 17.0 mm	 CV-15 	4-0	1.5	75	30	Green	36		8886605731	
<b>CV-15</b> 3/8 Circle 17.0 mm Double-arm	 CV-15 	5-0	1	75	30	Green	36	Surgalloy™	8886646221	
		4-0	1.5	75	30	Green	36	Surgalloy™	8886646231	

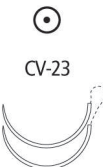

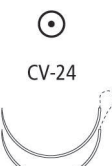
## TAPER POINT

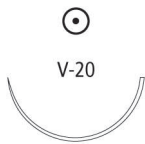
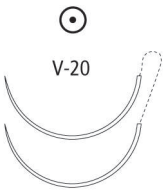

Needles Specifications	Size USP	EP	Length		Color	Units Per box	Comments	Reorder code
			cm	Inches				
<b>CV-20</b> 1/2 Circle 10.0 mm 	6-0	0.7	75	30	Green	36	Surgalloy™	8886600111
<b>CV-22</b> 1/2 Circle 13.0 mm 	6-0	0.7	75	30	Green	36	Surgalloy™	8886621311
	5-0	1	75	0	Green	36		8886621321
	4-0	1.5	5×45	18	Green	12	D-Tach™	8886620133
	4-0	1.5	75	30	Green	36	Surgalloy™	8886621331
<b>CV-22</b> 1/2 Circle 13.0 mm Double-arm 	6-0	0.7	75	30	Green	36	Surgalloy™	8886613211
	5-0	1	75	30	Green	36	Surgalloy™	8886612221
<b>CV-23</b> 1/2 Circle 17.0 mm 	5-0	1	75	30	Green	36	Surgalloy™	8886620721
	4-0	1.5	75	30	Green	36	Surgalloy™	8886620731
	3-0	2	75	30	Green	36	Surgalloy™	8886620741
<b>CV-23</b> 1/2 Circle 17.0 mm Double-arm 	5-0	1	75	30	Green	36	Surgalloy™	8886614921
	4-0	1.5	90	36	Green	36	Surgalloy™	8886613431
<b>CV-24</b> 1/2 Circle 20.0 mm 	5-0	1	75	30	Green	36		8886621721
	4-0	1.5	5×45	18	Green	12	D-Tach™	8886621933
	4-0	1.5	75	30	Green	36		8886621731
	3-0	2	5×45	18	Green	12	D-Tach™	8886621943
	3-0	2	75	30	Green	36		8886621741
<b>CV-24</b> 1/2 Circle 20.0 mm Double-arm 	4-0	1.5	90	36	Green	36		8886622131
	3-0	2	90	36	Green	36		8886603641

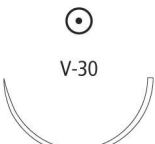

TAPER POINT									
Needles Specifications	Size		Length		Color	Units Per box	Comments	Reorder code	
	USP	EP	cm	Inches					
<b>V-20</b> 1/2 Circle 26.0 mm 	4-0	1.5	45	18	Green	12	D-Tach™	8886622933	
	4-0	1.5	5 × 75	30	Green	12	D-Tach™	8886603433	
	4-0	1.5	105	42	Green	36		8886614331	
	3-0	2	5 × 45	18	Green	12	D-Tach™	8886622943	
	3-0	2	75	30	Green	36	Surgalloy™	8886623341	
	3-0	2	75	30	Green	36		8886623341	
	3-0	2	75	30	Clear	36	Surgalloy™	8886623241	
	3-0	2	5 × 75	30	Green	12	D-Tach™	8886603443	
	2-0	3	5 × 45	18	Green	12	D-Tach™	8886622953	
	2-0	3	75	30	Green	36		8886623351	
	4-0	1.5	75	30	Green	36	Surgalloy™	8886623331	
	<b>V-20</b> 1/2 Circle 26.0 mm Double-arm 	4-0	1.5	75	30	Green	36	Surgalloy™	8886623131
4-0		1.5	90	36	Green	36		8886623531	
3-0		2	90	36	Green	36		8886623541	
<b>GS-22</b> 1/2 Circle 27.0 mm 	3-0	2	75	30	Green	36		8886624541	
	2-0	3	5 × 45	18	Green	12	D-Tach™	8886624753	
	2-0	3	75	30	Green	36		8886624551	
	0	3.5	75	30	Green	36		8886624561	
	1	4	75	30	Green	36		8886624571	
<b>V-30</b> 1/2 Circle 30.0 mm 	4-0	1.5	75	30	Green	36		8886626131	
	3-0	2	75	30	Green	36		8886626141	
	2-0	3	75	30	Green	36		8886626151	
	0	3.5	75	30	Green	36		8886626161	



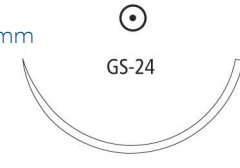



TAPER POINT								
Needles Specifications	Size		Length		Color	Units Per box	Comments	Reorder code
	USP	EP	cm	Inches				
<b>GS-21</b> 1/2 Circle 37.0 mm 	3-0	2	75	30	Green	36		8886626741
	2-0	3	5 × 45	18	Green	12	D-Tach™	8886627553
	2-0	3	75	30	Green	36		8886626751
	2-0	3	90	36	Green	36		8886626951
	2-0	3	150	60	Green	12		GMM-951
	0	3.5	5 × 45	18	Green	12	D-Tach™	8886627563
	0	3.5	75	30	Green	36		8886626761
	0	3.5	90	36	Green	36		8886626961
	1	4	5 × 45	18	Green	12	D-Tach™	8886627573
	1	4	75	30	Green	36		8886626771
	1	4	90	36	Green	36		8886626971
	<b>V-26</b> 1/2 Circle 37.0 mm 	3-0	2	75	30	Green	36	
2-0		3	75	30	Green	36		8886625751
0		3.5	75	30	Green	36		8886625761
<b>GS-24</b> 1/2 Circle 40.0 mm 	2-0	3	90	36	Green	36		8886628751
	0	3.5	75	30	Green	36		8886628561
	0	3.5	90	36	Green	36		8886628761
	1	4	75	30	Green	36		8886628571
	1	4	90	36	Green	36		8886628771
<b>GS-24 LOOP</b> 1/2 Circle 40.0 mm 	0	3.5	150	60	Green	12	Loop	GMM-563L
	1	4	150	60	Green	12	Loop	GMM573L







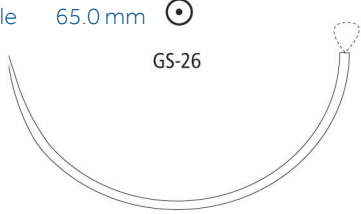
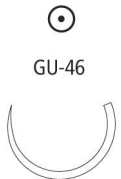
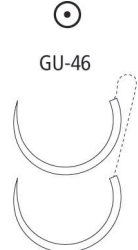

## TAPER POINT

Needles Specifications	Size		Length		Color	Units Per box	Comments	Reorder code
	USP	EP	cm	Inches				
<b>GS-25</b> 1/2 Circle 48.0 mm 	0	3.5	5 × 45	18	Green	12	D-Tach™	8886631163
	0	3.5	90	36	Green	36		8886630761
	1	4	5 × 45	18	Green	12	D-Tach™	8886631173
	1	4	90	36	Green	36		8886630771
	1	4	150	60	Green	24		8886630972
<b>GS-25 LOOP</b> 1/2 Circle 48.0 mm 	0	3.5	150	60	Green	12	Loop	GMM-634L
	1	4	150	60	Green	12	Loop	GMM-632L
<b>GS-26</b> 1/2 Circle 65.0 mm 	0	3.5	150	60	Green	24		8886631962
	1	4	100	40	Green	36		8886632271
	1	4	150	60	Green	24		8886631972
<b>GS-26 LOOP</b> 1/2 Circle 65.0 mm 	0	3.5	150	60	Green	12	Loop	GMM-341L
	0	3.5	240	96	Green	12	Loop	GMM-343L
	1	4	240	96	Green	12	Loop	GMM-344L
<b>GU-46</b> 5/8 Circle 27.0 mm 	2-0	3	75	30	Green	36		8886640351
<b>GU-46</b> 5/8 Circle 27.0 mm Double-arm 	2-0	3	75	30	Green	36		8886640451

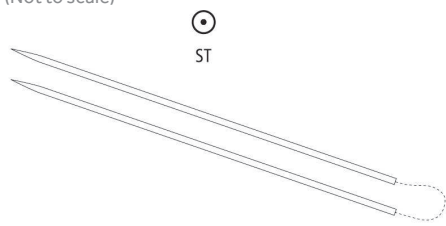













TAPER POINT								
Needles Specifications	Size		Length		Color	Units Per box	Comments	Reorder code
	USP	EP	cm	Inches				
<b>ST</b> Straight 60.0 mm Double-arm  (Not to scale) 	3-0	2	75	30	Green	36		8886623741
	0	3.5	75	30	Green	36		8886623761

HEAVY TAPER POINT								
Needles Specifications	Size		Length		Color	Units Per box	Comments	Reorder code
	USP	EP	cm	Inches				
<b>HGS-22</b> 1/2 Circle 27.0 mm  	0	3.5	75	30	Green	36		8886624961
<b>HGS-21</b> 1/2 Circle 37.0 mm  	0	3.5	90	36	Green	36		8886633961
	1	4	90	36	Green	36		88866339-71
<b>HGU-46</b> 5/8 Circle 27.0 mm  	0	3.5	45	18	Green	36		8886645561
	0	3.5	75	30	Green	36		8886645661
	1	4	75	30	Green	36		8886641971



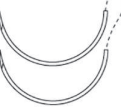



TAPERCUTTING										
Needles Specifications			Size		Length		Color	Units Per box	Comments	Reorder code
			USP	EP	cm	Inches				
<b>KV-1</b> 3/8 Circle 9.0 mm			6-0	0.7	75	30	Green	36	Surgalloy™	88866768-11
<b>KV-11</b> 3/8 Circle 13.0 mm			6-0	0.7	75	30	Green	36	Surgalloy™	88866297-11
			5-0	1	75	30	Green	36	Surgalloy™	88866297-21
<b>KV-11</b> 3/8 Circle 13.0 mm Double-arm			6-0	0.7	75	30	Green	36	Surgalloy™	88866288-11
			5-0	1	75	30	Green	36	Surgalloy™	88866288-21
<b>KV-5</b> 1/2 Circle 17.0 mm Double-arm			4-0	1.5	90	36	Green	36	Surgalloy™	VMM-137
<b>KV-7</b> 1/2 Circle 26.0 mm			2-0	3	75	30	Green	36		88866292-51
<b>KV-34</b> 1/2 Circle 37.0 mm			0	3.5	90	36	Green	36		8886627761





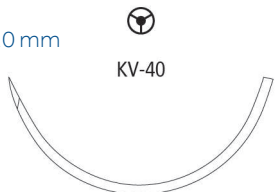
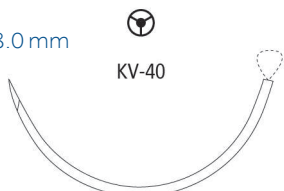

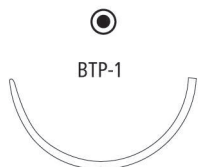

TAPERCUTTING										
Needles Specifications	Size		Length		Color	Units Per box	Comments	Reorder code		
	USP	EP	cm	Inches						
<b>KV-37 LOOP</b> 1/2 Circle 40.0 mm 	1	4	150	60	Green	12	Loop	GMM-873L		
<b>KV-40</b> 1/2 Circle 48.0 mm 	1	4	90	36	Green	36		8886629571		
<b>KV-40 LOOP</b> 1/2 Circle 48.0 mm 	0	3.5	150	60	Green	12	Loop	GMM-806L		
	1	4	150	60	Green	12	Loop	GMM-807L		

BLUNT POINT										
Needles Specifications	Size		Length		Color	Units Per box	Comments	Reorder code		
	USP	EP	cm	Inches						
<b>BTP-1</b> 1/2 Circle 37.0 mm 	2-0	3	90	36	Green	36	ProtectPoint™	GMMT-951		
	0	3.5	5 × 45	18	Green	12	D-Tach™, ProtectPoint™	GMMT-563-MG		
	0	3.5	90	36	Green	36	ProtectPoint™	GMMT-961		





BLUNT POINT										
Needles Specifications	Size		Length		Color	Units Per box	Comments	Reorder code		
	USP	EP	cm	Inches						
<b>BTP-X</b> 1/2 Circle 48.0 mm 	0	3.5	5 × 45	18	Green	12	D-Tach™, ProtectPoint™	GGMT-541-MG		
	1	4	5 × 45	18	Green	12	D-Tach™, ProtectPoint™	GGMT-540-MG		
<b>BTP-X LOOP</b> 1/2 Circle 48.0 mm 	0	3.5	150	60	Green	12	Loop, ProtectPoint™	GGMT-89L		
	1	4	150	60	Green	12	Loop, ProtectPoint™	GGMT-90L		
<b>BGS-25</b> 1/2 Circle 48.0 mm 	0	3.5	90	36	Green	12	ProtectPoint™	8886606163		
	1	4	90	36	Green	12	ProtectPoint™	8886606173		
<b>BGS-29</b> 1/2 Circle 63.0 mm 	1	4	150	60	Green	12	ProtectPoint™	8886606773		



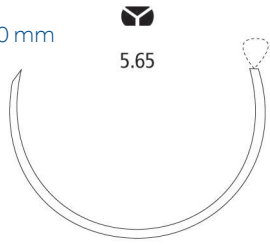

MULTIPURPOSE										
Needles Specifications	Size		Length		Color	Units Per box	Comments	Reorder code		
	USP	EP	cm	Inches						
<b>5.65 LOOP</b> 5/8 Circle 65.0 mm 	0	3.5	150	60	Green	12	Loop	GMM-496L		
	1	4	180	72	Green	12	Loop	GMM-497L		

SPATULA										
Needles Specifications	Size		Length		Color	Units Per box	Comments	Reorder code		
	USP	EP	cm	Inches						
<b>DGE-6</b> 3/8 Circle 8.0 mm 	7-0	0.5	45	18	Green	36		8886662801		





Maxon™ and Maxon™ CV



# SURGIPRO™ II

Monofilament Polypropylene

Meeting the demands in cardiovascular surgery.

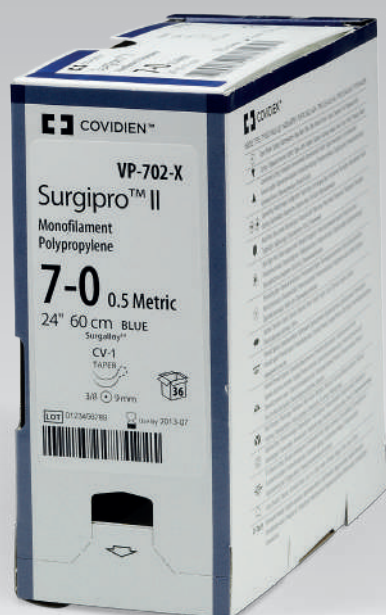

## Used for cardiovascular and peripheral vascular procedures

Surgipro™ II suture is a brand you have trusted for many years with several product innovations. Our history of innovation and experience provides you with consistent and reliable outcomes. With us, your patient's life can be safe and secure.

### Suture Performance

The continuous improvement in handling characteristics ensures ease of use.

### Tensile Strength

Surgipro™ and Surgipro™ II polypropylene sutures are not absorbed, nor is any significant change in strength retention known to occur in vivo.

### Packaging

Available in sizes 1 (4 Metric), through 6–0 (0.7 Metric).

Surgipro™ II sutures are available in sizes 3–0 (2 Metric) through 8–0 (0.4 Metric). The sutures are supplied sterile; affixed to various types of needles, using both permanent needle attachment techniques.

Surgipro™ and Surgipro™ II polypropylene sutures are also available with PTFE (polytetrafluorethylene) Pledgets for use as a pad between the suture area and the tissue surface to increase the load bearing area.

Surgipro™ polypropylene sutures are available in presentations containing Bead and Collar components to anchor the ends of the suture for subcuticular closure or for use as tendon sutures.

Indicated for use in general soft tissue approximation and/or ligation, including use in cardiovascular, ophthalmic, and neural tissue.

Indicated for use in soft tissue approximation of the skin, mucosa and conjunctiva, where only 7–10 days of wound support is required, but not for use in ligation, cardiovascular or neurological tissue.

### Indications

Surgipro™ and Surgipro™ II polypropylene sutures are indicated for use in general soft tissue approximation and/or ligation, including use in cardiovascular, ophthalmic, and neural tissue.

## Description

Surgipro™ and Surgipro™ II monofilament sutures (pigmented) are inert, nonabsorbable, sterile sutures composed of an isotactic crystalline stereoisomer of polypropylene (a synthetic linear polyolefin) and polyethylene.

## Indications

Surgipro™ and Surgipro™ II polypropylene sutures are indicated for use in general soft tissue approximation and/or ligation, including use in cardiovascular, ophthalmic, and neural tissue.

## Actions

Surgipro™ and Surgipro™ II polypropylene sutures elicit a minimal acute inflammatory reaction in tissues, which is followed by gradual encapsulation of the suture by fibrous connective tissue.

## Tensile Strength

Surgipro™ and Surgipro™ II polypropylene sutures are not absorbed, nor is any significant change in strength retention known to occur in vivo.

## Sterilization

Ethylene oxide.



## Packaging

Surgipro™ II polypropylene sutures are available either undyed (clear) or dyed with Copper Phthalocyanine Blue. Surgipro™ sutures are available in sizes 1 (4 Metric), through 6-0 (0.7 Metric). Surgipro™ II sutures are available in sizes 3-0 (2 Metric) through 8-0 (0.4 Metric). The sutures are supplied sterile; affixed to various types of needles, using both permanent needle attachment techniques. Surgipro™ and Surgipro™ II polypropylene sutures are also available with PTFE (polytetrafluorethylene) Pledgets for use as a pad between the suture area and the tissue surface to increase the load bearing area. Surgipro™ polypropylene sutures are available in presentations containing Bead and Collar components to anchor the ends of the suture for subcuticular closure or for use as tendon sutures.

Please refer to the individual package IFUs for complete instructions, indications, contraindications, warnings and precautions.



# Surgipro™ / Surgipro™ II

Surgipro™ / Surgipro™ II suture is a brand you have trusted for many years with several product innovations.

REVERSE CUTTING								
Needles Specifications	Size		Length		Color	Units Per box	Comments	Reorder code
	USP	EP	cm	Inches				
<b>C-12</b> 3/8 Circle    16.0 mm 	<b>6-0</b>	0.7	45	18	Blue	12		SP-660G
	<b>6-0</b>	0.7	45	18	Blue	36		SP-660
	<b>5-0</b>	1	45	18	Blue	12		SP-559G
	<b>4-0</b>	1.5	75	30	Blue	36		SP-631
<b>C-13</b> 3/8 Circle    19.0 mm 	<b>5-0</b>	1	45	18	Blue	36		SP-661
	<b>5-0</b>	1	45	18	Blue	12		SP-661G
	<b>4-0</b>	1.5	45	18	Blue	36		SP-683
	<b>4-0</b>	1.5	45	18	Blue	12		SP-683G
	<b>3-0</b>	2	45	18	Blue	12		SP-665G
	<b>3-0</b>	2	45	18	Blue	36		SP-665
	<b>3-0</b>	2	75	30	Blue	36		SP-655
<b>C-14</b> 3/8 Circle    24.0 mm 	<b>4-0</b>	1.5	45	18	Blue	36		SP-629
	<b>3-0</b>	2	45	18	Blue	36		SP-684
	<b>3-0</b>	2	45	18	Blue	12		SP-684G



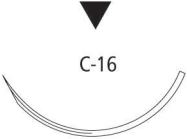



REVERSE CUTTING									
Needles Specifications	Size		Length		Color	Units Per box	Comments	Reorder code	
	USP	EP	cm	Inches					
<b>C-15</b> 3/8 Circle 26.0 mm 	<b>2-0</b>	3	45	18	Blue	12		SP-868G	
	<b>2-0</b>	3	45	18	Blue	36		SP-868	
	<b>2-0</b>	3	75	30	Blue	36		SP-685	
<b>C-16</b> 3/8 Circle 30.0 mm 	<b>4-0</b>	1.5	75	30	Blue	36	Nupack	SP-670	
	<b>3-0</b>	2	75	30	Blue	36		SP-675	
<b>C-18</b> 3/8 Circle 35.0 mm 	<b>3-0</b>	2	75	30	Blue	12	2 beads & 2 collars	SP-624-BC	
<b>C-17</b> 3/8 Circle 39.0 mm 	<b>3-0</b>	2	75	30	Blue	36		SP-649	
	<b>2-0</b>	3	75	30	Blue	36		SP-689	
	<b>0</b>	3.5	75	30	Blue	36		SP-690	



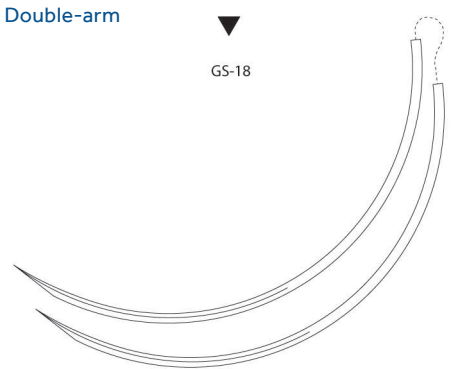





REVERSE CUTTING									
Needles Specifications	Size		Length		Color	Units Per box	Comments	Reorder code	
	USP	EP	cm	Inches					
<b>GS-18</b> 3/8 Circle 77.0 mm 	2	5	75	30	Blue	24		CP-460	
<b>GS-18</b> 3/8 Circle 77.0 mm Double-arm 	2	5	3 × 60	24	Blue	12	Long pack	3-CP-360	
<b>GS-10</b> 1/2 Circle 26.0 mm 	2-0	3	75	30	Blue	36		CP-443	
<b>GS-11</b> 1/2 Circle 37.0 mm 	2-0	3	75	30	Blue	36		CP-453	





PREMIUM REVERSE CUTTING									
Needles Specifications	Size		Length		Color	Units Per box	Comments	Reorder code	
	USP	EP	cm	Inches					
<b>P-10</b> 3/8 Circle 11.0 mm 	<b>7-0</b>	0.5	45	18	Blue	12	Surgalloy™	SP-1696G	
	<b>7-0</b>	0.5	45	18	Blue	36	Surgalloy™	SP-1696	
	<b>6-0</b>	0.7	45	18	Blue	36	Surgalloy™	SP-1697	
	<b>6-0</b>	0.7	45	18	Clear	36	Surgalloy™	SP-1606	
	<b>6-0</b>	0.7	45	18	Blue	12	Surgalloy™	SP-5697G	
	<b>5-0</b>	1	45	18	Blue	12	Surgalloy™	SP-2698G	
<b>P-13</b> 3/8 Circle 13.0 mm 	<b>6-0</b>	0.7	45	18	Blue	12	Surgalloy™	SP-5695-G	
	<b>6-0</b>	0.7	45	18	Blue	36	Surgalloy™	SP-5695	
	<b>5-0</b>	1	45	18	Blue	12	Surgalloy™	SP-5698-G	
	<b>5-0</b>	1	45	18	Blue	36	Surgalloy™	SP-5698	
	<b>4-0</b>	1.5	45	18	Blue	12	Surgalloy™	SP-5699G	
	<b>4-0</b>	1.5	45	18	Blue	36	Surgalloy™	SP-5699	
<b>P-11</b> 3/8 Circle 16.0 mm 	<b>6-0</b>	0.7	45	18	Blue	12	Surgalloy™	SP-5680G	
	<b>5-0</b>	1	45	18	Blue	12	Surgalloy™	SP-5681G	
	<b>5-0</b>	1	45	18	Blue	36	Surgalloy™	SP-5681	
	<b>4-0</b>	1.5	45	18	Blue	12	Surgalloy™	SP-5692G	
	<b>3-0</b>	2	45	18	Blue	12	Surgalloy™	SP-1693G	
<b>P-12</b> 3/8 Circle 19.0 mm 	<b>5-0</b>	1	45	18	Blue	12	Surgalloy™	SP-5686G	
	<b>5-0</b>	1	45	18	Blue	36	Surgalloy™	SP-5686	
	<b>4-0</b>	1.5	45	18	Blue	12	Surgalloy™	SP-5682G	
	<b>4-0</b>	1.5	45	18	Blue	36	Surgalloy™	SP-5682	
	<b>3-0</b>	2	45	18	Blue	36	Surgalloy™	SP-5687	
	<b>3-0</b>	2	45	18	Blue	12	Surgalloy™	SP-5687G	
	<b>3-0</b>	2	75	30	Blue	36		SP-5587	





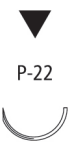

PREMIUM REVERSE CUTTING										
Needles Specifications	Size		Length		Color	Units Per box	Comments	Reorder code		
	USP	EP	cm	Inches						
<b>P-14</b> 3/8 Circle    24.0 mm 	<b>3-0</b>	2	45	18	Blue	12	Surgalloy™	SP-5663G		
	<b>3-0</b>	2	75	30	Blue	36		SP-5563		
<b>P-22</b> 1/2 Circle    13.0 mm 	<b>4-0</b>	1.5	45	18	Blue	12	Surgalloy™	SP-8656G		





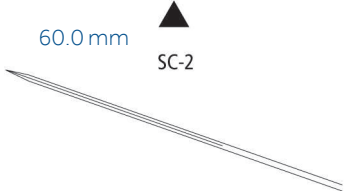

CONVENTIONAL CUTTING										
Needles Specifications	Size		Length		Color	Units Per box	Comments	Reorder code		
	USP	EP	cm	Inches						
<b>PC-13</b> 3/8 Circle    11.0 mm 	<b>6-0</b>	0.7	45	18	Blue	36			SP-1617	
	<b>5-0</b>	1	45	18	Blue	36			SP-1618	
<b>PC-11</b> 3/8 Circle    16.0 mm 	<b>6-0</b>	0.7	45	18	Blue	36			SP-1636	
	<b>5-0</b>	1	45	18	Blue	36	Surgalloy™		SP-1635	
	<b>4-0</b>	1.5	45	18	Blue	36			SP-1634	
<b>PC-12</b> 3/8 Circle    19.0 mm 	<b>4-0</b>	1.5	45	18	Blue	36			SP-1644	
	<b>3-0</b>	2	45	18	Blue	36			SP-1643	
<b>SC-2</b> Straight    60.0 mm 	<b>4-0</b>	1.5	75	30	Blue	36			SP-621	
	<b>3-0</b>	2	75	30	Blue	36			SP-622	
	<b>3-0</b>	2	75	30	Blue	24	2 beads and 2 collars		SP-622-BC	
	<b>2-0</b>	3	75	30	Blue	24	2 beads and 2 collars		SP-623-BC	
	<b>2-0</b>	3	75	30	Blue	36			SP-623	





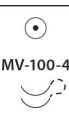
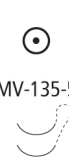





TAPER POINT									
Needles Specifications	Size		Length		Color	Units Per box	Comments	Reorder code	
	USP	EP	cm	Inches					
<b>MV-70-3</b> 3/8 Circle 4.0 mm 	10-0	0.2	13	5	Blue	12	Surgalloy™	P-2790G	
<b>MV-100-4</b> 3/8 Circle 5.0 mm 	10-0	0.2	13	5	Blue	12	Surgalloy™	P-2794G	
<b>MV-100-4</b> 3/8 Circle 5.0 mm <b>Double-arm</b> 	10-0	0.2	5	30	Blue	12	Surgalloy™	P-2795G	
<b>MV-135-5</b> 3/8 Circle 6.0 mm <b>Double-arm</b> 	8-0	0.4	45	18	Blue	36	Surgalloy™	VP-900-X	
	8-0	0.4	5 × 45	18	Blue	12	Surgalloy™, LONG PACK	VP-901-MX	
	8-0	0.4	2 × 45	18	Blue	12	Surgalloy™, LONG PACK	VP-900-MX	
	8-0	0.4	60	24	Blue	36	Surgalloy™	VP-902-X	
	8-0	0.4	5 × 60	24	Blue	12	Surgalloy™, LONG PACK	VP-903-MX	
	8-0	0.4	2 × 60	24	Blue	12	Surgalloy™, LONG PACK	VP-902-MX	
	8-0	0.4	75	30	Blue	12	Surgalloy™, LONG PACK	VP-973-X	
	7-0	0.5	60	24	Blue	36	Surgalloy™	VP-904-X	
	7-0	0.5	2 × 60	24	Blue	12	Surgalloy™, LONG PACK	VP-904-MX	







TAPER POINT									
Needles Specifications	Size	EP	Length		Color	Units	Comments	Reorder code	
			USP	cm					
<b>MVF-135-5</b> 3/8 Circle 6.0 mm Double-arm	 MV-135-5 	8-0	0.4	2 × 60	24	Blue	12	Surgalloy™, LONG PACK	VP-209MX
<b>MV-175-8</b> 3/8 Circle 8.0 mm Double-arm	 MV-175-8 	8-0	0.4	45	18	Blue	36	Surgalloy™	VP-744-X
		8-0	0.4	2 × 45	18	Blue	12	Surgalloy™, LONG PACK	VP-744-MX
		8-0	0.4	60	24	Blue	36	Surgalloy™	VP-745-X
		8-0	0.4	2 × 60	24	Blue	12	Surgalloy™, LONG PACK	VP-743-MX
		8-0	0.4	2 × 75	30	Blue	12	Surgalloy™, LONG PACK	VP-753-MX
		7-0	0.5	2 × 45	18	Blue	12	LONG PACK	VP-736-M
		7-0	0.5	45	18	Blue	36	Surgalloy™	VP-628
		7-0	0.5	5 × 45	18	Blue	12	Surgalloy™, LONG PACK	VP-734-MX
		7-0	0.5	60	24	Blue	36	Surgalloy™	VP-735-X
		7-0	0.5	2 × 60	24	Blue	12	Surgalloy™, LONG PACK	VP-737-MX
		7-0	0.5	5 × 60	24	Blue	12	Surgalloy™, LONG PACK	VP-735-MX
		7-0	0.5	75	30	Blue	36	Surgalloy™	VP-747-X
		7-0	0.5	2 × 75	30	Blue	12	Surgalloy™, LONG PACK	VP-747-MX
<b>MVF-175-8</b> 3/8 Circle 8.0 mm Double-arm	 MVF-175-8 	8-0	0.4	60	24	Blue	12		VPF-738-MX
		7-0	0.5	60	24	Blue	36	Surgalloy™	VPF-735-X





TAPER POINT									
Needles Specifications	Size	EP	Length		Color	Units	Comments	Reorder code	
			USP	cm					
<b>CV-351</b> 3/8 Circle 8.0 mm Double-arm	 CV-351	<b>8-0</b>	0.4	60	24	Blue	36	Cardiopoint™	VP-738-X
		<b>8-0</b>	0.4	2×60	24	Blue	12	Cardiopoint™, LONG PACK	VP-738-MX
		<b>7-0</b>	0.5	60	24	Blue	36	Cardiopoint™	VP-630-X
		<b>6-0</b>	0.7	60	24	Blue	36	Cardiopoint™	VP-631-X
<b>CVF-1</b> 3/8 Circle 9.0 mm Double-arm	 CVF-1	<b>7-0</b>	0.5	60	24	Blue	12	Surgalloy™, LONG PACK	VP-102-MX
		<b>7-0</b>	0.5	60	24	Blue	36	Surgalloy™, NUPACK™	VPF-702-X
		<b>7-0</b>	0.5	75	30	Blue	36	Surgalloy™, NUPACK™	VPF-713-X
		<b>6-0</b>	0.7	60	24	Blue	36	Surgalloy™, NUPACK™	VPF-703-X
		<b>6-0</b>	0.7	75	30	Blue	36	Surgalloy™, NUPACK™	VPF-709-X







## TAPER POINT

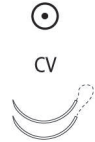

Needles Specifications	Size		Length		Color	Units Per box	Comments	Reorder code
	USP	EP	cm	Inches				
<b>CV-1</b> 3/8 Circle 9.0 mm 	<b>7-0</b>	0.5	5 × 45	18	Blue	36	Surgalloy™, NUPACK™	VP-701-X
	<b>7-0</b>	0.5	45	18	Blue	12	Surgalloy™, LONG PACK	VP-701-MX
	<b>7-0</b>	0.5	60	24	Blue	36	Surgalloy™, NUPACK™	VP-702-X
	<b>7-0</b>	0.5	5 × 60	24	Blue	12	Surgalloy™, LONG PACK	VP-702-MX
	<b>7-0</b>	0.5	75	30	Blue	36	Surgalloy™, NUPACK™	VP-713-X
	<b>7-0</b>	0.5	5 × 75	30	Blue	12	Surgalloy™, LONG PACK	VP-713-MX
	<b>6-0</b>	0.7	45	18	Blue	36	Surgalloy™, NUPACK™	VP-746-X
	<b>6-0</b>	0.7	2 × 45	18	Blue	12	Surgalloy™, LONG PACK	VP-746-MX
	<b>6-0</b>	0.7	60	24	Blue	36	Surgalloy™, NUPACK™	VP-703-X
	<b>6-0</b>	0.7	60	24	Blue	12	Surgalloy™, LONG PACK	VP-703-MX
	<b>6-0</b>	0.7	75	30	Blue	12	Surgalloy™, LONG PACK	VP-709-MX
	<b>6-0</b>	0.7	75	30	Blue	36	Surgalloy™, NUPACK™	VP-709-X
	<b>6-0</b>	0.7	90	36	Blue	36	Surgalloy™, NUPACK™	VP-365-X
	<b>CV-1 OPTIVIS</b> 3/8 Circle 9.0 mm Double-arm	<b>7-0</b>	0.5	60	24	Blue	36	Optivis™
<b>7-0</b>		0.5	5 × 60	24	Blue	12	Optivis™, LONG PACK	VP-72-MX
<b>7-0</b>		0.5	75	30	Blue	12	Optivis™, LONG PACK	VP-37-MX
<b>6-0</b>		0.7	60	24	Blue	36	Optivis™, NUPACK™	VP-73-X
<b>6-0</b>		0.7	5 × 60	24	Blue	12	Optivis™, LONG PACK	VP-73-MX







TAPER POINT									
Needles Specifications	Size	EP	Length		Color	Units	Comments	Reorder code	
			USP						
<b>MV-175-9</b> 3/8 Circle 10.0 mm Double-arm		<b>8-0</b>	0.4	60	24	Blue	36	Surgalloy™	VP-763-X
		<b>7-0</b>	0.5	5 × 75	30	Blue	12	Surgalloy™, LONG PACK	VP-875-MX
		<b>7-0</b>	0.5	75	30	Blue	36	Surgalloy™	VP-875-X
<b>CV</b> 3/8 Circle 11.0 mm Double-arm		<b>6-0</b>	0.7	60	24	Blue	36	Optivis™, NUPACK™	VP-74-X
		<b>6-0</b>	0.7	75	30	Blue	36	Surgalloy™, NUPACK	VP-776-X
<b>CVF</b> 3/8 Circle 11.0 mm Double-arm		<b>6-0</b>	0.7	75	30	Blue	36	Surgalloy™, NUPACK	VPF-776-X



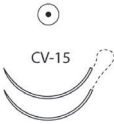
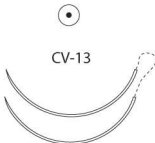

## TAPER POINT

Needles Specifications	Size		Length		Color	Units Per box	Comments	Reorder code
	USP	EP	cm	Inches				
<b>CV-11</b> 3/8 Circle 13.0 mm Double-arm 	<b>7-0</b>	0.5	45	18	Blue	36	Surgalloy™, NUPACK™	VP-800-X
	<b>7-0</b>	0.5	60	24	Blue	36	Surgalloy™, NUPACK™	VP-727-X
	<b>7-0</b>	0.5	75	30	Blue	36	Surgalloy™, NUPACK™	VP-812-X
	<b>6-0</b>	0.7	45	18	Blue	36	Optivis™, NUPACK™	VP-78-X
	<b>6-0</b>	0.7	45	18	Blue	36	Surgalloy™, NUPACK™	VP-718-X
	<b>6-0</b>	0.7	5 × 45	18	Blue	12	Surgalloy™, LONG PACK	VP-718-MX
	<b>6-0</b>	0.7	60	24	Blue	36	Surgalloy™, NUPACK™	VP-726-X
	<b>6-0</b>	0.7	5 × 60	24	Blue	12	Surgalloy™, LONG PACK	VP-726-MX
	<b>6-0</b>	0.7	75	30	Blue	36	Optivis™, NUPACK™	VP-76-X
	<b>6-0</b>	0.7	75	30	Blue	36	Surgalloy™, NUPACK™	VP-706-X
	<b>6-0</b>	0.7	5 × 75	30	Blue	12	Optivis™, LONG PACK	VP-76-MX
	<b>6-0</b>	0.7	5 × 75	30	Blue	12	Surgalloy™, LONG PACK	VP-706-MX
	<b>6-0</b>	0.7	90	36	Blue	36	Surgalloy™, NUPACK™	VP-363-X
	<b>5-0</b>	1	45	18	Blue	36	Surgalloy™, NUPACK™	VP-719-X
	<b>5-0</b>	1	45	18	Blue	12	Surgalloy™, LONG PACK	VP-719-MX
	<b>5-0</b>	1	60	24	Blue	36	Optivis™	VP-75-X
	<b>5-0</b>	1	60	24	Blue	36	Surgalloy™, NUPACK™	VP-725-X
	<b>5-0</b>	1	5 × 60	24	Blue	12	Surgalloy™, LONG PACK	VP-725-MX
<b>CV-11</b> 3/8 Circle 13.0 mm 	<b>4-0</b>	1.5	75	30	Blue	36	Surgalloy™	VP-891
	<b>6-0</b>	0.7	75	30	Blue	36	Surgalloy™	VP-889-X
	<b>5-0</b>	1	75	30	Blue	36	Surgalloy™	VP-890-X

## TAPER POINT



Needles Specifications	Size	Length	Color	Units	Comments	Reorder code		
							USP	EP
<b>CVF-11</b> 3/8 Circle 13.0 mm Double-arm 	6-0	0.7	60	24	Blue	36	NUPACK	VPF-726-X
	6-0	0.7	60	24	Blue	12	Surgalloy™, LONG PACK	VP-126-MX
	6-0	0.7	75	30	Blue	36	Surgalloy™, NUPACK	VPF-706-X
	5-0	1	90	36	Blue	36	Surgalloy™	VPF-720-X
	5-0	1	90	36	Blue	12	Surgalloy™, LONG PACK	VP-120-MX
<b>CV-15</b> 3/8 Circle 17.0 mm 	4-0	1.5	75	30	Blue	36	Surgalloy™	VP-881-X
<b>CV-15</b> 3/8 Circle 17.0 mm Double-arm 	5-0	1	75	30	Blue	36	Surgalloy™	VP-570X
	5-0	1	90	36	Blue	36	Surgalloy™, NUPACK	VP-580-X
	4-0	1.5	60	24	Blue	36	Surgalloy™	VP-584-X
	4-0	1.5	90	36	Blue	36	3 mm x 7 mm FIRM	VP-582-X
	4-0	1.5	90	36	Blue	36	Surgalloy™	VP-581-X
	4-0	1.5	120	48	Blue	36	Surgalloy™	VP-583-X
<b>CV-13</b> 3/8 Circle 22.0 mm Double-arm 	3-0	2	90	36	Blue	36	Surgalloy™	VP-585-X
	4-0	1.5	75	30	Blue	36	Surgalloy™	VP-841-X
	4-0	1.5	90	36	Blue	36	Surgalloy™	VP-851-X
	3-0	2	90	36	Blue	36	Surgalloy™	VP-532-X
<b>CV-20</b> 1/2 Circle 10.0 mm Double-arm 	2-0	3	90	36	Blue	36		VP-533
	7-0	0.5	60	24	Blue	36	Surgalloy™, NUPACK™	VP-772-X
	6-0	0.7	60	24	Blue	36	Surgalloy™, NUPACK™	VP-754-X
	5-0	1	60	24	Blue	36	Surgalloy™, NUPACK™	VP-755-X



TAPER POINT										
Needles Specifications	Size		Length		Color	Units Per box	Comments	Reorder code		
	USP	EP	cm	Inches						
<b>CV-22</b> 1/2 Circle 13.0 mm Double-arm		<b>6-0</b>	0.7	45	18	Blue	36	Surgalloy™, NUPACK™	VP-714-X	
		<b>6-0</b>	0.7	60	24	Blue	36	Surgalloy™, NUPACK™	VP-711-X	
		<b>6-0</b>	0.7	5 × 75	30	Blue	12	Surgalloy™, LONG PACK	VP-733-MX	
		<b>6-0</b>	0.7	75	30	Blue	36	Surgalloy™, NUPACK	VP-733-X	
		<b>5-0</b>	1	45	18	Blue	36	Surgalloy™, NUPACK™	VP-715-X	
		<b>5-0</b>	1	60	24	Blue	36	Surgalloy™, NUPACK™	VP-205-X	
		<b>5-0</b>	1	5 × 75	30	Blue	12	Surgalloy™, LONG PACK	VP-710-MX	
		<b>5-0</b>	1	75	30	Blue	36	Surgalloy™, NUPACK	VP-710-X	
		<b>4-0</b>	1.5	60	24	Blue	36	Surgalloy™	VP-204-X	
<b>CV-23</b> 1/2 Circle 17.0 mm		<b>5-0</b>	1	75	30	Blue	36	Surgalloy™, NUPACK	VP-870-X	
		<b>4-0</b>	1.5	75	30	Blue	36	Surgalloy™	VP-871-X	
		<b>3-0</b>	2	75	30	Blue	36	Surgalloy™	VP-872-X	
<b>CV-23</b> 1/2 Circle 17.0 mm Double-arm		<b>6-0</b>	0.7	90	36	Blue	36	Surgalloy™, NUPACK	VP-555X	
		<b>5-0</b>	1	90	36	Blue	36	Surgalloy™, NUPACK	VP-556X	
		<b>5-0</b>	1	90	36	Blue	36	Optivis™	VP-660-X	
		<b>5-0</b>	1	60	24	Blue	36	Surgalloy™, NUPACK™	VP-566X	
		<b>5-0</b>	1	5 × 90	36	Blue	12	Surgalloy™, LONG PACK	VP-556MX	
		<b>4-0</b>	1.5	45	18	Blue	36	Surgalloy™	VP-757-X	
		<b>4-0</b>	1.5	90	36	Blue	36	Pledgets 3 mm × 7 mm FIRM	VPP-557-X	
		<b>4-0</b>	1.5	90	36	Blue	36	Surgalloy™	VP-557X	







TAPER POINT										
Needles Specifications	Size	Length	Color	Units	Comments	Reorder code	Size		Length	
							USP	EP	cm	Inches
<b>CV-337</b> 1/2 Circle 10.0 mm Double-arm 	<b>6-0</b>	0.7	60	24	Blue	36	Cardiopoint™	VP-854-X		
<b>CVF-21</b> 1/2 Circle 12.0 mm Double-arm 	<b>4-0</b>	1.5	60	24	Blue	36	Surgalloy™	VPF-610-X		
<b>CVF-22</b> 1/2 Circle 13.0 mm Double-arm 	<b>6-0</b>	0.7	75	30	Blue	36	Surgalloy™, NUPACK	VPF-733-X		
	<b>5-0</b>	1	75	30	Blue	36	Surgalloy™, NUPACK	VPF-710-X		
	<b>5-0</b>	1	90	36	Blue	36	Surgalloy™, NUPACK	VPF-711-X		















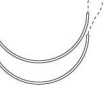

TAPER POINT									
Needles Specifications	Size USP	EP	Length		Color	Units Per box	Comments	Reorder code	
			cm	Inches					
<b>CVL</b> Cardio curve 11.0 mm Double-arm	7-0	0.5	2 × 60	24	Blue	12	Optivis™	VP-652-MX	 CVL 



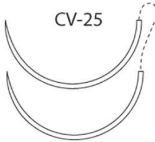

TAPER POINT										
Needles Specifications			Size		Length		Color	Units Per box	Comments	Reorder code
			USP	EP	cm	Inches				
<b>CV-23</b> 1/2 Circle 17.0 mm 	 CV-23	3-0	2	75	30	Blue	36	Surgalloy™	VP-872-X	
		4-0	1.5	120	48	Blue	36	Surgalloy™	X-1252	
		5-0	1	75	30	Blue	36	Surgalloy™	VP-870-X	
		4-0	1.5	75	30	Blue	36	Surgalloy™	VP-871-X	
<b>CV-23</b> 1/2 Circle 17.0 mm Double-arm 	 CV-23	4-0	1.5	5×90	36	Blue	12	Surgalloy™, LONG PACK	VP-557MX	
		3-0	2	90	36	Blue	36	Surgalloy™	VP-558X	
		2-0	3	90	36	Blue	36		VP-559-X	
<b>CVF-23</b> 1/2 Circle 17.0 mm Double-arm 	 CVF-23	4-0	1.5	90	36	Blue	36	Surgalloy™	VPF-557-X	
<b>CV-24</b> 1/2 Circle 20.0 mm Double-arm 	 CV-24	4-0	1.5	90	36	Blue	36		VP-331X	
<b>CV-25</b> 1/2 Circle 22.0 mm 	 CV-25	4-0	1.5	75	30	Blue	36	Surgalloy™	VP-771-X	
<b>CV-25</b> 1/2 Circle 22.0 mm Double-arm 	 CV-25	4-0	1.5	90	36	Blue	36	Surgalloy™	VP-761-X	
		4-0	1.5	5×90	36	Blue	12	Surgalloy™, LONG PACK	VP-761-MX	
		3-0	2	75	30	Blue	36	Surgalloy™	VP-760-X	
		3-0	2	90	36	Blue	36	Surgalloy™	VP-762-X	







TAPER POINT									
<b>V-20</b> 1/2 Circle 26.0 mm 	<b>4-0</b>	1.5	75	30	Blue	36	Surgalloy™	VP-831X	
	<b>3-0</b>	2	75	30	Blue	36	Surgalloy™	VP-832X	
	<b>2-0</b>	3	75	30	Blue	36	Surgalloy™	VP-833	
	<b>0</b>	3.5	75	30	Blue	36	Surgalloy™	VP-834	
<b>V-20</b> 1/2 Circle 26.0 mm <b>Double-arm</b> 	<b>5-0</b>	1	75	30	Blue	36	Surgalloy™, NUPACK	VP-510X	
	<b>5-0</b>	1	90	36	Blue	36	Surgalloy™	VP-520X	
	<b>4-0</b>	1.5	75	30	Blue	36	Surgalloy™	VP-511-X	
	<b>4-0</b>	1.5	90	36	Blue	36	4.8 mm × 9.5 mm SOFT	VP-621-X	
	<b>4-0</b>	1.5	90	36	Blue	36	Surgalloy™	VP-521-X	
	<b>4-0</b>	1.5	90	36	Blue	36	3 mm × 7 mm FIRM	VP-421X	
	<b>4-0</b>	1.5	120	48	Blue	36	Surgalloy™	VP-541X	
	<b>3-0</b>	2	90	36	Blue	36	Surgalloy™	VP-522-X	
	<b>3-0</b>	2	90	36	Blue	36	3 mm × 7 mm FIRM	VP-422X	
	<b>3-0</b>	2	120	48	Blue	36	Surgalloy™	VP-542-X	
	<b>2-0</b>	3	90	36	Blue	36	Surgalloy™	VP-523	
	<b>2-0</b>	3	120	48	Blue	36	Surgalloy™	VP-543	





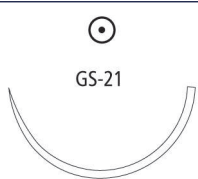

TAPER POINT									
Needles Specifications	Size		Length		Color	Units Per box	Comments	Reorder code	
	USP	EP	cm	Inches					
<b>VF-20</b> 1/2 Circle 26.0 mm 	<b>3-0</b>	2	45	18	Blue	36	Surgalloy™	VPF354X	
<b>VF-20</b> 1/2 Circle 26.0 mm Double-arm 	<b>4-0</b>	1.5	90	36	Blue	36	Surgalloy™	VPF-521-X	
	<b>3-0</b>	2	90	36	Blue	36	Surgalloy™	VPF-522-X	
	<b>3-0</b>	2	135	54	Blue	36	Surgalloy™	VPF-354-X	
	<b>2-0</b>	3	120	48	Blue	36	Surgalloy™	VPF-543	
<b>GS-22</b> 1/2 Circle 27.0 mm 	<b>2-0</b>	3	5 × 45	18	Blue	12	D-Tach™	CP-16-M	
	<b>2-0</b>	3	75	30	Blue	36		CP-411	
	<b>0</b>	3.5	5 × 45	18	Blue	12	D-Tach™	CP-17-M	
	<b>0</b>	3.5	75	30	Blue	36		CP-412	
<b>V-30</b> 1/2 Circle 30.0 mm 	<b>2-0</b>	3	75	30	Blue	36		VP-945	
<b>GS-21</b> 1/2 Circle 37.0 mm 	<b>3-0</b>	2	75	30	Blue	36		CP-422	
	<b>2-0</b>	3	75	30	Blue	36		CP-423	
	<b>0</b>	3.5	5 × 45	18	Blue	12	D-Tach™	CP-10-M	
	<b>0</b>	3.5	75	30	Blue	36		CP-424	
	<b>1</b>	4	75	30	Blue	36		CP-425	



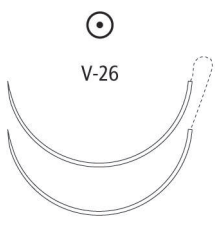







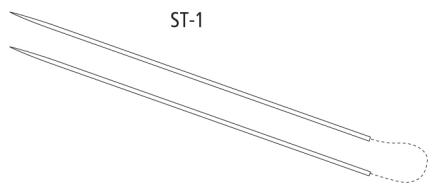

TAPER POINT										
Needles Specifications	Size		Length		Color	Units Per box	Comments	Reorder code		
	USP	EP	cm	Inches						
<b>V-26</b> 1/2 Circle 37.0 mm Double-arm 	<b>3-0</b>	2	90	36	Blue	36		VP-842-X		
	<b>2-0</b>	3	90	36	Blue	36		VP-843		
	<b>2-0</b>	3	120	48	Blue	36		VP-853		
<b>GS-24</b> 1/2 Circle 40.0 mm 	<b>2-0</b>	3	75	30	Blue	36		CP-433		
	<b>0</b>	3.5	75	30	Blue	36		CP-434		
	<b>1</b>	4	75	30	Blue	36		CP-435		
	<b>1</b>	4	100	40	Blue	36		CP-535		
<b>GS-25</b> 1/2 Circle 48.0 mm 	<b>0</b>	3.5	5 × 45	18	Blue	12	D-Tach™, LONG PACK	CP-30-M		
	<b>0</b>	3.5	75	30	Blue	36		CP-454		
	<b>1</b>	4	75	30	Blue	36		CP-455		
<b>GS-26</b> 1/2 Circle 65.0 mm 	<b>0</b>	3.5	3 × 60	24	Blue	12		3CP-444		
	<b>1</b>	4	150	60	Blue	24		CP-824		
	<b>2</b>	5	150	60	Blue	24		CP-825		





TAPER POINT								
Needles Specifications	Size		Length		Color	Units Per box	Comments	Reorder code
	USP	EP	cm	Inches				
<b>GS-26 LOOP</b> 1/2 Circle 65.0 mm  	<b>1</b>	4	120	48	Blue	24	Loop	CP-824-L
	<b>1</b>	4	240	96	Blue	24	Loop	CP-834-L
<b>ST-1</b> Straight 51.0 mm Double-arm  	<b>2-0</b>	3	90	36	Blue	36		GP-282

HEAVY TAPER POINT								
Needles Specifications	Size		Length		Color	Units Per box	Comments	Reorder code
	USP	EP	cm	Inches				
<b>HGS-23</b> 1/2 Circle 22.0 mm  	<b>0</b>	3.5	5 × 45	18	Blue	12	D-Tach™, LONG PACK	CP-92-M
<b>HGS-22</b> 1/2 Circle 27.0 mm  	<b>0</b>	3.5	75	30	Blue	36		CP-414
	<b>1</b>	4	90	36	Blue	36		CP-415

PENETRATING TAPER								
Needles Specifications	Size		Length		Color	Units Per box	Comments	Reorder code
	USP	EP	cm	Inches				
<b>YV-95</b> 3/8 Circle 9.5 mm Double-arm  	<b>7-0</b>	0.5	60	24	Blue	36	Cardiopoint™	VP-911-X











TAPERCUTTING									
Needles Specifications	Size	USP	EP	Length		Color	Units	Comments	Reorder code
				cm	Inches				
<b>KV-1</b> 3/8 Circle 9.0 mm Double-arm     	<b>7-0</b>		0.5	45	18	Blue	12	LONG PACK	VP-721-MX
	<b>7-0</b>		0.5	60	24	Blue	36	Surgalloy™	VP-704-X
	<b>7-0</b>		0.5	5×60	24	Blue	12	Surgalloy™, LONG PACK	VP-704-MX
	<b>6-0</b>		0.7	60	24	Blue	36	Surgalloy™, NUPACK	VP-712-X
	<b>6-0</b>		0.7	5×60	24	Blue	12	Surgalloy™, LONG PACK	VP-712-MX
<b>KVF-1</b> 3/8 Circle 9.0 mm Double-arm   	<b>7-0</b>		0.5	60	24	Blue	36	Surgalloy™, NUPACK	VPF-704-X
	<b>6-0</b>		0.7	75	30	Blue	36	Surgalloy™, NUPACK	VPF-807-X
<b>KV-11</b> 3/8 Circle 13.0 mm Double-arm     	<b>6-0</b>		0.7	60	24	Blue	36	Surgalloy™, NUPACK	VP-707-X
	<b>6-0</b>		0.7	75	30	Blue	36	Surgalloy™, NUPACK	VP-728-X
	<b>6-0</b>		0.7	5×75	30	Blue	12	Surgalloy™, LONG PACK	VP-728-MX
	<b>5-0</b>		1	75	30	Blue	36	Surgalloy™, NUPACK	VP-708-X
	<b>5-0</b>		1	90	36	Blue	36	Surgalloy™, NUPACK	VP-751-X
<b>KVF-11</b> 3/8 Circle 13.0 mm Double-arm   	<b>6-0</b>		0.7	75	30	Blue	36	Surgalloy™, NUPACK	VPF-728-X

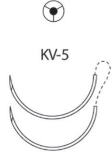
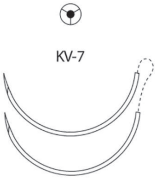



## TAPERCUTTING

Needles Specifications	Size		Length		Color	Units Per box	Comments	Reorder code	
	USP	EP	cm	Inches					
<b>KV-15</b> 3/8 Circle 17.0 mm 	5-0	1	75	30	Blue	36	Surgalloy™, NUPACK	VP-941-X	
<b>KV-15</b> 3/8 Circle 17.0 mm Double-arm 	5-0	1	75	30	Blue	36	Surgalloy™, NUPACK	VP-914-X	
		5-0	1	90	36	Blue	36	Surgalloy™	VP-924-X
		4-0	1.5	75	30	Blue	36	Surgalloy™	VP-942-X
		4-0	1.5	90	36	Blue	36	Surgalloy™	VP-925-X
		3-0	2	90	36	Blue	36	Surgalloy™	VP-926-X
<b>KV-26</b> 3/8 Circle 26.0 mm Double-arm 	4-0	1.5	120	48	Blue	36	Surgalloy™	VP-965	
		3-0	1.5	120	48	Blue	36		VP-956
<b>KV-5</b> 1/2 Circle 17.0 mm Double-arm 	5-0	1	90	36	Blue	36	Surgalloy™, NUPACK	VP-934-X	
		4-0	1.5	90	36	Blue	36	Surgalloy™	VP-935-X
		4-0	1.5	90	36	Blue	36	3 mm x 7 mm FIRM	VP-435-X
		3-0	2	90	36	Blue	36	Surgalloy™	VP-936-X
		2-0	3	90	36	Blue	36	Surgalloy™	VP-937
<b>KV-7</b> 1/2 Circle 26.0 mm Double-arm 	4-0	1.5	90	36	Blue	36	Surgalloy™	VP-975-X	
		3-0	2	90	36	Blue	36	Surgalloy™	VP-976-X
		3-0	2	90	36	Blue	36	3 mm x 7 mm FIRM	VP-986-X
		2-0	3	90	36	Blue	36	Surgalloy™	VP-977
		0	3.5	90	36	Blue	36	Surgalloy™	VP-978
<b>KV-34</b> 1/2 Circle 37.0 mm 	0	3.5	75	30	Blue	36		CP-844	
		1	4	75	30	Blue	36		CP-845

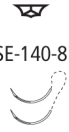

BLUNT POINT										
Needles Specifications	Size		Length		Color	Units Per box	Comments	Reorder code		
	USP	EP	cm	Inches						
<b>BGS-21</b> 1/2 Circle 37.0 mm  BGS-21	<b>0</b>	3.5	75	30	Blue	36	ProtectPoint™	CP-957		
<b>BGS-25</b> 1/2 Circle 48.0 mm  BGS-25	<b>1</b>	4	100	40	Blue	36	ProtectPoint™	CP-836		

SPATULA										
Needles Specifications	Size		Length		Color	Units Per box	Comments	Reorder code		
	USP	EP	cm	Inches						
<b>SE-140-8</b> 3/8 Circle 6.3 mm Double-arm  SE-140-8	<b>10-0</b>	0.2	30	12	Blue	12	Surgalloy™	P-2771K		
<b>SE-160-6</b> 1/2 Circle 5.5 mm Double-arm  SE-160-6	<b>10-0</b>	0.2	30	12	Blue	12	Surgalloy™	P-2756K		



# TI-CRON™ / SURGIDAC™

Coated and Uncoated Braided and Monofilament Polyester

A brand you have trusted for over 35 years.



- Ti-Cron™ suture polyester strand is soft and supple
- Silicone (impregnated) coating designed for excellent handling and pliability<sup>2</sup>
- Uniform braiding process designed to provide resistance to breaking<sup>1</sup>
- Excellent knot security<sup>2</sup>

## Absorption

Ti-Cron™ and Surgidac™ polyester sutures are not absorbed, nor is any significant change in tensile strength retention known to occur in vivo.

## Tensile Strength

Ti-Cron™ and Surgidac™ polyester sutures are not absorbed, nor is any significant change in tensile strength retention known to occur in vivo.

## Indications

Indicated for use in general soft tissue approximation and/or ligation, including use in cardiovascular, ophthalmic and neurological surgery.



## Description

Ti-Cron™ and Surgidac™ polyester sutures are non absorbable, sterile, surgical sutures composed of Polyethylene Terephthalate. They are prepared from fibers of high molecular weight, long-chain, linear polyesters having recurrent aromatic rings as an integral component. Ti-Cron™ braided sutures are available coated uniformly with silicone to increase surface lubricity, thereby enhancing handling characteristics, ease of passage through tissue, and knot run-down properties. Surgidac™ monofilament sutures are uncoated and the braided sutures are available uncoated or coated uniformly with polybutylene adipate to increase surface lubricity, thereby enhancing handling characteristics, ease of passage through tissue, and knot run-down properties.

## Indications

Ti-Cron™ and Surgidac™ polyester sutures are indicated for use in general soft tissue approximation and/or ligation, including use in cardiovascular, ophthalmic and neurological surgery.

## Actions

Ti-Cron™ and Surgidac™ polyester sutures elicit a minimal acute inflammatory reaction in tissues, followed by gradual encapsulation of the suture by fibrous connective tissue.

## Tensile Strength

Ti-Cron™ and Surgidac™ polyester sutures are not absorbed, nor is any significant change in tensile strength retention known to occur in vivo.

## Sterilization

Ti-Cron™ and Surgidac™ polyester sutures in sizes 6-0 or smaller or pledgeted sutures are sterilized by ethylene oxide. Sizes 5-0 or greater are sterilized by gamma irradiation.

## Packaging

Ti-Cron™ polyester sutures are available undyed (white) or dyed with D&C Blue No. 6 and braided, coated, in sizes 5 (7 Metric), size 2 (5 metric), size 1 (4 metric), 0 size (3.5 metric) through 5-0 (1 Metric). SURGIDAC™ polyester sutures are available undyed (white), braided and uncoated in USP and EP sizes 5-0 (1 metric). The sutures are supplied sterile, in pre-cut lengths, affixed to various needle types using both permanent and removable needle attachment techniques. Ti-Cron™ polyester sutures are also available with PTFE (polytetrafluorethylene) pledgets for use as a pad between the suture area and the tissue surface to increase the load bearing area. Please refer to the individual package IFUs for complete instructions, indications, contraindications, warnings and precautions.

1. Individual standard deviations were used to calculate the intervals. Based on internal test report, Suture analysis Ti-Cron™ suture large sizes. September 2013.
2. Medtronic R&D Testing Services Report, Ti-Cron™ suture 2-0 knot security benchmark data. August 2015

# Ti-Cron™ / Surgidac™





Ti-Cron™ / Surgidac™ is a suture brand you have trusted for over 35 years with a proven history for performance

PRE-CUT								
Needles Specifications	Size		Length		Color	Units Per box	Comments	Reorder code
	USP	EP	cm	Inches				
	5-0	1	12×45	18	Blue	36	Pre-cut	88863008-21
	4-0	1.5	12×45	18	Blue	36	Pre-cut	88863008-31
	4-0	1.5	12×75	30	Blue	24	Pre-cut	88863003-32
	3-0	2	12×45	18	Blue	36	Pre-cut	88863008-41
	3-0	2	6×45	18	Blue	36	Pre-cut	88863001-41
	3-0	2	12×75	30	Blue	24	Pre-cut	88863003-42
	2-0	3	5×45	18	White	12	Pre-cut	88863011-51
	2-0	3	12×45	18	Blue	36	Pre-cut	88863008-51
	2-0	3	12×75	30	Blue	24	Pre-cut	88863003-52
	0	3.5	6×45	18	Blue	24	Pre-cut	88863001-62
	0	3.5	6×75	30	Blue	24	Pre-cut	88863002-62
	1	4	6×45	18	Blue	24	Pre-cut	88863001-72

REEL								
Needles Specifications	Size		Length		Color	Units Per box	Comments	Reorder code
	USP	EP	cm	Inches				
	3-0	2	250	100	Blue	24	Reel	88863380-42
	2-0	3	250	100	Blue	24	Reel	88863380-52
	0	3.5	250	100	Blue	24	Reel	88863380-62
	1	4	250	100	Blue	24	Reel	88863380-72
	2	5	250	100	Blue	24	Reel	88863380-82
	4	6	150	60	Blue	24	Reel	88863381-09
	5	7	150	60	Blue	24	Reel	88863381-89









## REVERSE CUTTING

Needles Specifications	Size		Length		Color	Units Per box	Comments	Reorder code
	USP	EP	cm	Inches				
<b>C-12</b> 3/8 Circle 16.0 mm 	<b>5-0</b>	1	45	18	Blue	36		88863045-21
	<b>4-0</b>	1.5	75	30	Blue	36		88863046-31
<b>C-13</b> 3/8 Circle 19.0 mm 	<b>4-0</b>	1.5	45	18	Blue	36		88863047-31
	<b>3-0</b>	2	75	30	Blue	36		88863047-41
	<b>3-0</b>	2	45	18	Blue	36		88863055-41
	<b>2-0</b>	3	75	30	Blue	36		88863048-51
<b>C-14</b> 3/8 Circle 24.0 mm 	<b>3-0</b>	2	45	18	Blue	36		88863069-41
	<b>3-0</b>	2	75	30	Blue	36		88863050-41
	<b>2-0</b>	3	75	30	Blue	36		88863050-51
	<b>2-0</b>	3	90	36	Blue	36		88863065-51
	<b>0</b>	3.5	75	30	Blue	36		88863050-61
	<b>0</b>	3.5	90	36	Blue	36		88863065-61
<b>C-15</b> 3/8 Circle 26.0 mm 	<b>2-0</b>	3	75	30	Blue	36		88863070-51
<b>C-16</b> 3/8 Circle 30.0 mm 	<b>2-0</b>	3	75	30	Blue	36		88863023-51
	<b>0</b>	3.5	75	30	Blue	36		88863023-61
	<b>0</b>	3.5	90	36	Blue	36		88863012-61
	<b>1</b>	4	75	30	Blue	36		88863023-71

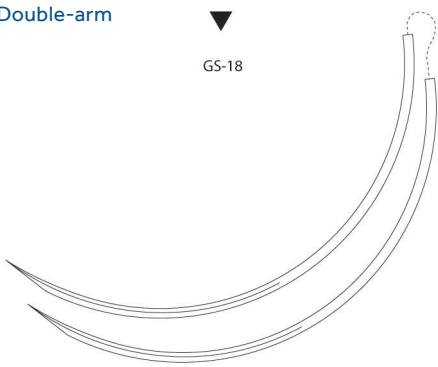

## REVERSE CUTTING



Needles Specifications	Size		Length		Color	Units Per box	Comments	Reorder code
	USP	EP	cm	Inches				
<b>C-17</b> 3/8 Circle 39.0 mm 	2-0	3	75	30	Blue	36		88863054-51
	0	3.5	75	30	Blue	36		88863054-61
	1	4	75	30	Blue	36		88863054-71
	2	5	75	30	Blue	36		88863054-81
<b>GS-18</b> 3/8 Circle 77.0 mm 	5	7	45	18	Blue	12		88863056-89
<b>GS-18</b> 3/8 Circle 77.0 mm Double-arm 	5	7	75	30	Blue	24		88863128-79
	2	5	75	30	Blue	24		88863128-82
	2	5	75	30	Green	24		CD-496
<b>HOS-10</b> 1/2 Circle 26.0 mm 	2-0	3	75	30	Blue	36		88863395-51
	0	3.5	75	30	Blue	36		88863395-61
	1	4	75	30	Blue	36		88863395-71
	2	5	75	30	Blue	36		88863395-81
<b>GS-11</b> 1/2 Circle 37.0 mm 	2-0	3	75	30	Blue	36		88863309-51
	0	3.5	75	30	Blue	36		88863309-61
	1	4	75	30	Blue	36		88863309-71
	4	6	75	30	Blue	36		88863154-09
<b>HOS-11</b> 1/2 Circle 37.0 mm 	1	4	75	30	Blue	36		88863028-71
	2	5	75	30	Blue	36		88863028-81

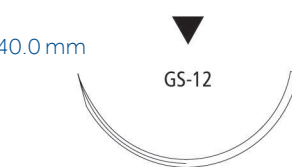
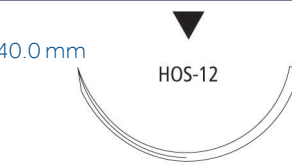
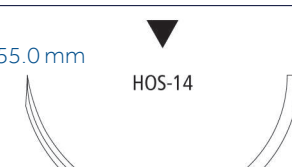

## REVERSE CUTTING



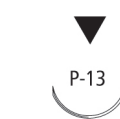



Needles Specifications	Size		Length		Color	Units Per box	Comments	Reorder code
	USP	EP	cm	Inches				
<b>GS-12</b> 1/2 Circle 40.0 mm 	2	5	75	30	Blue	36		88863155-81
<b>HOS-12</b> 1/2 Circle 40.0 mm 	1	4	75	30	Blue	36		88863026-71
	2	5	75	30	Blue	36		88863026-81
<b>HOS-14</b> 1/2 Circle 55.0 mm 	5	7	75	30	Blue	36		88863027-79







## PREMIUM REVERSE CUTTING

Needles Specifications	Size		Length		Color	Units Per box	Comments	Reorder code
	USP	EP	cm	Inches				
<b>P-13</b> 3/8 Circle 13.0 mm 	5-0	1	45	18	Blue	12	Surgalloy™	SCD-3058G
	5-0	1	45	18	White	12	Surgalloy™	SCD-2864G
	4-0	1.5	45	18	Blue	12	Surgalloy™	SCD-3059G
	4-0	1.5	45	18	White	12	Surgalloy™	88862862-34
<b>P-12</b> 3/8 Circle 19.0 mm 	4-0	1.5	45	18	Blue	12	Surgalloy™	SCD-3049G



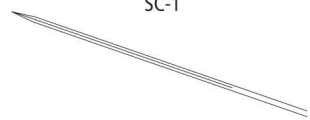

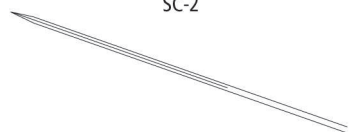
PREMIUM REVERSE CUTTING										
Needles Specifications			Size		Length		Color	Units Per box	Comments	Reorder code
			USP	EP	cm	Inches				
<b>P-21</b> 1/2 Circle 9.0 mm		P-21 	4-0	1.5	45	18	White	12		88862854-33
<b>P-22</b> 1/2 Circle 13.0 mm		P-22 	3-0	2	45	18	Blue	12	Surgalloy™	88863109-43
<b>P-24</b> 1/2 Circle 16.0 mm		P-24 	2-0	3	45	18	Blue	12	Surgalloy™	88863059-53

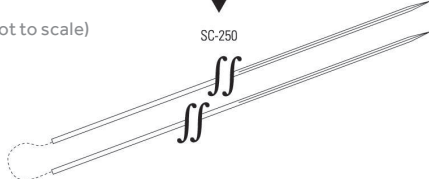
CONVENTIONAL CUTTING										
Needles Specifications			Size		Length		Color	Units Per box	Comments	Reorder code
			USP	EP	cm	Inches				
<b>SCC</b> 1/2 Circle 48.0 mm		SCC 	5	7	5x75	30	Blue	6		88863127-79
<b>SC-1</b> Straight 51.0 mm		SC-1 	2-0	3	75	30	Blue	36		88863163-51
			0	3.5	75	30	Blue	36		88863163-61
			1	4	75	30	Blue	36		88863163-71
<b>SC-2</b> Straight 60.0 mm		SC-2 	3-0	2	75	30	Blue	36		88863062-41
			2-0	3	75	30	Blue	36		88863062-51
			2-0	3	90	36	Blue	36		88863165-51
			0	3.5	75	30	Blue	36		88863062-61
<b>SC-250</b> Straight 254.0 mm		SC-250 	2-0	3	75	30	Blue	12		88862947-53
(Not to scale)										







TAPER POINT										
Needles Specifications	Size		Length		Color	Units Per box	Comments	Reorder code		
	USP	EP	cm	Inches						
<b>CV-310</b> 3/8 Circle 10.0 mm Double-arm		<b>7-0</b>	0.5	45	18	Blue	36	Cardiopoint™	88863288-01	
<b>CV-301</b> 3/8 Circle 13.0 mm		<b>4-0</b>	1.5	75	30	Blue	36	Cardiopoint™	88863106-31	
<b>CV-301</b> 3/8 Circle 13.0 mm Double-arm		<b>6-0</b>	0.7	75	30	Blue	36	Cardiopoint™	88863280-11	
		<b>5-0</b>	1	75	30	Blue	36	3mm x 3mm FIRM, Cardiopoint™	88863314-21	
		<b>5-0</b>	1	75	30	Blue	36	Cardiopoint™	88863280-21	
		<b>5-0</b>	1	75	30	White	36	Cardiopoint™	88862801-21	
		<b>4-0</b>	1.5	75	30	Blue	36	3 mm x 3 mm Firm, Cardiopoint™	88863314-31	
		<b>4-0</b>	1.5	75	30	Blue	36	Cardiopoint™	88863280-31	
		<b>3-0</b>	2	75	30	Blue	36	Cardiopoint™	88863280-41	

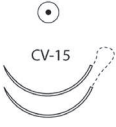

## TAPER POINT

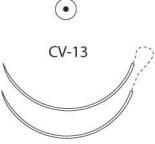
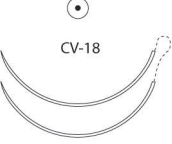
Needles Specifications	Size		Length		Color	Units Per box	Comments	Reorder code
	USP	EP	cm	Inches				
<b>CV-15</b> 3/8 Circle 17.0 mm Double-arm		2-0	3	90	36	White	6	Surgalloy™ 88862636-56
<b>CV-327</b> 3/8 Circle 18.0 mm Double-arm		5-0	1	75	30	Blue	36	Cardiopoint™ 88862775-21
		4-0	1.5	75	30	Blue	36	Cardiopoint™ 88862775-31
		3-0	2	75	30	Blue	36	Cardiopoint™ 88862775-41
<b>CV-13</b> 3/8 Circle 22.0 mm Double-arm		3-0	2	90	36	Blue	36	Surgalloy™ 88862627-41
<b>CV-18</b> 3/8 Circle 26.0 mm Double-arm		2-0	3	10×90	36	5 Blue and 5 White	6	88863230-56





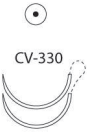

TAPER POINT									
Needles Specifications	Image	Size		Length		Color	Units Per box	Comments	Reorder code
		USP	EP	cm	Inches				
<b>CV-337</b> 1/2 Circle 10.0 mm Double-arm		5-0	1	75	30	Blue	36	Cardioint™	88863298-21
		5-0	1	90	36	Blue	36	Pledgets 3 mm × 3 mm FIRM, Cardioint™	88863297-21
		5-0	1	90	36	Blue	36	Cardioint™	88863139-21
<b>CV-330</b> 1/2 Circle 13.0 mm Double-arm		5-0	1	60	24	Blue	36	Cardioint™	88863226-21
		4-0	1.5	60	24	Blue	36	Cardioint™	88863226-31
		4-0	1.5	90	36	Blue	36	Cardioint™	88863249-31
		3-0	2	45	18	Blue	36	Pledgets 3 mm × 3 mm FIRM, Cardioint™	88863295-41
		3-0	2	60	24	Blue	36	Cardioint™	88863226-41





## TAPER POINT

Needles Specifications	Size		Length		Color	Units Per box	Comments	Reorder code
	USP	EP	cm	Inches				
<b>CV-331</b> 1/2 Circle 16.0 mm 	5-0	1	75	30	Blue	36	Cardiopoint™	88863186-21
	4-0	1.5	75	30	Blue	36	Cardiopoint™	88863186-31
	3-0	2	75	30	Blue	36	Cardiopoint™	88863186-41
	2-0	3	75	30	Blue	36	Cardiopoint™	88863186-51
<b>CV-331</b> 1/2 Circle 16.0 mm Double-arm 	5-0	1	90	36	Blue	36	Cardiopoint™	88863271-21
	4-0	1.5	75	30	Blue	36	Cardiopoint™	88863087-31
	4-0	1.5	90	36	Blue	36	Cardiopoint™	88863271-31
	3-0	2	10×75	30	Blue	6	Cardiopoint™	88863084-46
	3-0	2	75	30	Blue	36	Cardiopoint™	88863087-41
	3-0	2	90	36	Blue	36	Cardiopoint™	88863271-41
	2-0	3	8×75	30	4 Blue and 4 White	6	3 mm × 3 mm FIRM, Cardiopoint™	88863086-56
	2-0	3	8×75	30	4 Blue and 4 White	6	Cardiopoint™	88863083-56
	2-0	3	10×75	30	Blue	6	Cardiopoint™	88863084-56
	2-0	3	8×75	30	4 Blue and 4 White	6	Pledgets 3 mm × 7 mm FIRM, Cardiopoint™	88863091-56
	2-0	3	75	30	Blue	36	Cardiopoint™	88863087-51
	2-0	3	90	36	5 Blue and 5 White	6	Pledgets 3 mm × 3 mm FIRM, Cardiopoint™	88863273-56
	2-0	3	10×90	36	5 Blue and 5 White	6	Pledgets 3mm × 7 mm FIRM, Cardiopoint™	88863269-56
<b>CV-24</b> 1/2 Circle 20.0 mm 	3-0	2	5×45	18	Blue	24	D-Tach™	88863267-42



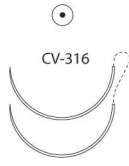

## TAPER POINT

Needles Specifications	Size		Length		Color	Units Per box	Comments	Reorder code
	USP	EP	cm	Inches				
<b>CV-316</b> 1/2 Circle 20.0 mm Double-arm 	4-0	1.5	75	30	Blue	36	Pledgets 3 mm × 7 mm FIRM, Cardiopoint™	88863348-31
	4-0	1.5	90	36	Blue	36	Cardiopoint™	88863369-31
	3-0	2	75	30	Blue	36	Cardiopoint™	88863227-41
	3-0	2	90	36	Blue	36	Cardiopoint™	88863369-41
	2-0	3	10×75	30	5 Blue and 5 White	6	Cardiopoint™	88863385-56
	2-0	3	75	30	Blue	36	Cardiopoint™	88863227-51
	2-0	3	75	30	Blue	36	3 mm × 7 mm FIRM, Cardiopoint™	88863348-51
	2-0	3	10×75	30	5 Blue and 5 White	6	3 mm × 7 mm FIRM, Cardiopoint™	88863323-56
	2-0	3	75	30	White	36	3 mm × 7 mm FIRM, Cardiopoint™	88862978-51
	2-0	3	10×75	30	5 Blue and 5 White	6	Pledgets 3 mm × 3 mm FIRM, Cardiopoint™	88863277-56
	2-0	3	8×75	30	4 Blue and 4 White	6	Pledgets 3 mm × 7 mm SOFT, Cardiopoint™	VCD-375
	2-0	3	10×75	30	Blue	6	Cardiopoint™	88863344-56
	2-0	3	90	36	White	36	Cardiopoint™	88862839-51
	2-0	3	90	36	Blue	36	Cardiopoint™	88863369-51



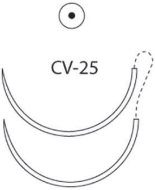

## TAPER POINT

Needles Specifications	Size	Length	Color	Units	Comments	Reorder code
<b>GS-23</b> 1/2 Circle 22.0 mm 	<b>0</b>	3.5	5×45 18	Blue	24	D-Tach™ 88863257-62
<b>CV-25</b> 1/2 Circle 22.0 mm Double-arm 	<b>3-0</b>	2	90 36	Blue	36	88863370-41
	<b>2-0</b>	3	90 36	Blue	36	Surgalloy™ 88863370-51



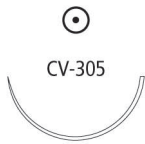
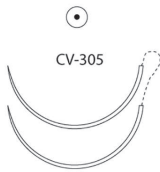

## TAPER POINT

Needles Specifications	Size		Length		Color	Units Per box	Comments	Reorder code
	USP	EP	cm	Inches				
<b>CV-305</b> 1/2 Circle 25.0 mm 	4-0	1.5	75	30	Blue	36	Cardioint™	88863185-31
	3-0	2	75	30	Blue	36	Cardioint™	88863185-41
	2-0	3	10×75	30	5 Blue and 5 White	6	Cardioint™	88863353-56
	2-0	3	5×75	30	Blue	24	Cardioint™	88863033-52
	0	3.5	75	30	Blue	36	Cardioint™	88863185-61
	1	4	75	30	Blue	36	Cardioint™	88863185-71
	<b>CV-305</b> 1/2 Circle 25.0 mm Double-arm 	4-0	1.5	90	36	Blue	36	Cardioint™
3-0	2	90	36	Blue	36	Pledgets 3 mm × 7 mm FIRM, Cardioint™	88863336-41	
3-0	2	90	36	Blue	36	Cardioint™	88863256-41	
3-0	2	105	42	Blue	36	Cardioint™	88863035-41	
2-0	3	10×75	30	5 Blue and 5 White	6	3 mm × 7 mm FIRM, Cardioint™	88863324-56	
2-0	3	8×75	30	4 Blue AND 4 White	6	Pledgets 3 mm × 7 mm SOFT, Cardioint™	VCD-346	
2-0	3	75	30	Blue and White	6		VCD- 2030556MSE	
2-0	3	75	30	Blue and White	6		VCD- 2030556MFE	
2-0	3	10×75	30	5 Blue and 5 White	6	Cardioint™	88863356-56	
2-0	3	75	30	Blue	36	Cardioint™	88863185-51	
2-0	3	5×75	30	Blue	6	Cardioint™	88863040-56	
2-0	3	10×75	30	5 Blue and 5 White	6	Pledgets 4 mm × 8 mm FIRM, Cardioint™	88863037-56	
2-0	3	90	36	Blue	36	3 mm × 7 mm FIRM, Cardioint™	88863336-51	
2-0	3	90	36	Blue	36	Cardioint™	88863256-51	
2-0	3	10×90	36	5 Blue and 5 White	6	Cardioint™	88862981-56	
2-0	3	90	36	White	36	Cardioint™	88862914-51	
2-0	3	90	36	White	36	3 mm × 7 mm FIRM, Cardioint™	88862953-51	





## TAPER POINT

Needles Specifications	Size		Length		Color	Units Per box	Comments	Reorder code
	USP	EP	cm	Inches				
<b>CV-305</b> 1/2 Circle 25.0 mm Double-arm 	2-0	3	8×90	36	4 Blue and 4 White	6	Pledgets 3 mm × 3 mm FIRM, Cardioint™	88863307-56
	2-0	3	6×90	36	3 Blue and 3 White	6	Pledgets 3 mm × 7 mm FIRM, Cardioint™	88863306-56
	2-0	3	10×90	36	Blue	6	Cardioint™	88863220-56
	2-0	3	105	42	Blue	36	Cardioint™	88863035-51
	0	3.5	90	36	Blue	36	Cardioint™	88863256-61
	0	3.5	90	36	White	36	Cardioint™	88862914-61
<b>V-20</b> 1/2 Circle 26.0 mm 	4-0	1.5	5×45	18	Blue	24	D-Tach™	88863258-32
	3-0	2	5×45	18	Blue	24	D-Tach™	88863258-42
	2-0	3	5×45	18	Blue	24	D-Tach™	88863258-52
	2-0	3	120	48	Blue	36	Endoscopy	88863129-51
	0	3.5	120	48	Blue	36	Endoscopy	88863015-61
<b>V-20</b> 1/2 Circle 26.0 mm Double-arm 	2-0	3	90	36	Blue	36	Surgalloy™	88863251-51
<b>GS-22</b> 1/2 Circle 27.0 mm 	2-0	3	75	30	Blue	36		88863093-51
	0	3.5	5×45	18	Blue	24	D-Tach™	88863259-62
	0	3.5	75	30	Blue	36		88863093-61



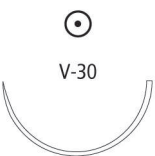
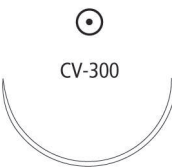
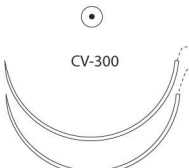

## TAPER POINT

Needles Specifications	Size		Length		Color	Units Per box	Comments	Reorder code
	USP	EP	cm	Inches				
<b>V-30</b> 1/2 Circle 30.0 mm 	<b>3-0</b>	2	75	30	Blue	36		88863205-41
	<b>2-0</b>	3	75	30	Blue	36		88863205-51
	<b>0</b>	3.5	75	30	Blue	36		88863205-61
<b>CV-300</b> 1/2 Circle 35.0 mm 	<b>0</b>	3.5	75	30	Blue	36	Cardioint™	88863082-61
	<b>2-0</b>	3	75	30	Blue	36	Cardioint™	88863082-51
<b>CV-300</b> 1/2 Circle 35.0 mm Double-arm 	<b>2-0</b>	3	75	30	Blue	36	Cardioint™	88863274-51
	<b>2-0</b>	3	90	36	Blue	36	Cardioint™	88863393-51
	<b>0</b>	3.5	75	30	Blue	36	Cardioint™	88863274-61
	<b>0</b>	3.5	90	36	Blue	36	Cardioint™	88863393-61
<b>GS-21</b> 1/2 Circle 37.0 mm 	<b>2-0</b>	3	5×45	18	Blue	24	D-Tach™	88863260-52
	<b>2-0</b>	3	75	30	Blue	36		88863090-51
	<b>0</b>	3.5	45	18	Blue	24	D-Tach™	88863260-62
	<b>0</b>	3.5	75	30	Blue	36		88863090-61
	<b>1</b>	4	5×45	18	Blue	24	D-Tach™	88863260-72
	<b>1</b>	4	75	30	Blue	36		88863090-71
	<b>2</b>	5	75	30	Blue	36		88863090-81
	<b>2</b>	5	90	36	Blue	36		88863146-81







## TAPER POINT

Needles Specifications	Size		Length		Color	Units Per box	Comments	Reorder code
	USP	EP	cm	Inches				
<b>GS-25</b> 1/2 Circle 48.0 mm  GS-25	0	3.5	5x45	18	Blue	24	D-Tach™	88863261-62
	0	3.5	75	30	Blue	36		88863097-61
	1	4	5x45	18	Blue	24	D-Tach™	88863261-72
	1	4	75	30	Blue	36		88863097-71
	2	5	5x45	18	Blue	24	D-Tach™	88863261-82
<b>GS-27</b> 1/2 Circle 76.0 mm Double-arm  GS-27	0	3.5	75	30	Blue	36		88863190-61
<b>GU-46</b> 5/8 Circle 27.0 mm  GU-46	2-0	3	75	30	Blue	36		88862768-51
<b>SK</b> SKI 23.0 mm  SK	2-0	3	120	48	Blue	36		88863017-51
	0	3.5	120	48	Blue	36		88863017-61
<b>TJ-32</b> 1/2 Circle 32.0 mm  TJ-32	1	4	75	30	Blue	36		88863103-71







HEAVY TAPER POINT										
Needles Specifications			Size		Length		Color	Units Per box	Comments	Reorder code
			USP	EP	cm	Inches				
<b>HGS-23</b> 1/2 Circle    22.0 mm 	<b>2-0</b>	3	5×45	18	Blue	24	D-Tach™	88863374-52		
	<b>0</b>	3.5	5×45	18	Blue	24	D-Tach™	88863374-62		
	<b>1</b>	4	75	30	Blue	36		88863375-71		
<b>HGU-46</b> 5/8 Circle    27.0 mm 	<b>0</b>	3.5	5×45	18	Blue	24	D-Tach™	88863386-62		
<b>HGS-22</b> 1/2 Circle    27.0 mm 	<b>2-0</b>	3	5×45	18	Blue	24	D-Tach™	88863379-52		
	<b>1</b>	4	5×45	18	Blue	24	D-Tach™	88863372-72		
	<b>2</b>	5	5×45	18	Blue	24		88863372-82		
<b>HGS-21</b> 1/2 Circle    37.0 mm 	<b>1</b>	4	75	30	Blue	36		88863113-71		
	<b>2</b>	5	75	30	Blue	36		88863113-81		
	<b>5</b>	7	75	30	Blue	36		88863111-79		





## HEAVY TAPER POINT

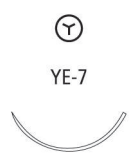
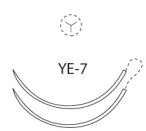

Needles Specifications	Size		Length		Color	Units Per box	Comments	Reorder code
	USP	EP	cm	Inches				
<b>HGS-24</b> 1/2 Circle 40.0 mm  HGS-24	<b>2</b>	5	75	30	Blue	36		88863376-81

## PENETRATING TAPER

Needles Specifications	Size		Length		Color	Units Per box	Comments	Reorder code
	USP	EP	cm	Inches				
<b>YE-7</b> 3/8 Circle 18.0 mm  YE-7	<b>4-0</b>	1.5	75	30	Blue	36	Cardiopoint™	88863107-31
<b>YE-7</b> 3/8 Circle 18.0 mm <b>Double-arm</b>  YE-7	<b>4-0</b>	1.5	75	30	Blue	36	Cardiopoint™	88863182-31
	<b>3-0</b>	2	10×75	30	Blue	6	Cardiopoint™	VCD-320
	<b>3-0</b>	2	75	30	Blue	36	Cardiopoint™	88863182-41
	<b>2-0</b>	3	10×75	30	5 Blue and 5 White	6	Pledgets 3 mm × 7 mm FIRM, Cardiopoint™	88863365-56
	<b>2-0</b>	3	75	30	Blue	36	Pledgets 3 mm × 7 mm FIRM, Cardiopoint™	88863233-51
	<b>2-0</b>	3	10×75	30	5 Blue and 5 White	6	Cardiopoint™	88863211-56
	<b>2-0</b>	3	75	30	Blue	36	Cardiopoint™	88863182-51
	<b>2-0</b>	3	5×90	36	5 Blue and 5 White	6	Cardiopoint™	88863052-56
	<b>2-0</b>	3	90	36	5 Blue and 5 White	6	Pledgets 3 mm × 7 mm FIRM, Cardiopoint™	88862658-56
	<b>2-0</b>	3	90	36	Blue	36	Cardiopoint™	88862631-51



## PENETRATING TAPER

Needles Specifications	Size		Length		Color	Units Per box	Comments	Reorder code
	USP	EP	cm	Inches				
<b>Y-31</b> 1/2 Circle 16.0 mm Double-arm 	4-0	1.5	8×75	30	4 Blue and 4 White	6	Pledgets 3 mm × 3 mm FIRM, Cardiopoint™	88863218-36
	4-0	1.5	90	36	Blue	36	Cardiopoint™	88863160-31
	3-0	2	75	30	White	36	Cardiopoint™	88862880-41
	3-0	2	90	36	Blue	36	Cardiopoint™	88863160-41
	2-0	3	10×75	30	5 Blue and 5 White	6	3 mm v 7 mm FIRM, Cardiopointv	88863221-56
	2-0	3	8×75	30	4 Blue and 4 White	6	3 mm × 7 mm FIRM, Cardiopointv	88863219-56
	2-0	3	8×75	30	4 Blue and 4 White	6	3 mm × 3 mm FIRM, Cardiopointv	88863218-56
	2-0	3	4×75	30	2 Blue and 2 White	6	Pledgets 3 mm v 5 mm FIRM, Cardiopointv	VCD-110
	2-0	3	75	30	Blue	36	Cardiopoint™	88863125-51
	2-0	3	75	30	White	36	Cardiopointv	88862880-51
	2-0	3	10×75	30	5 Blue and 5 White	6	Cardiopointv	88862877-56
	2-0	3	8×75	30	4 Blue and 4 White	6	Pledgets 3 mm × 7 mm SOFT, Cardiopoint™	VCD-656
	2-0	3	90	36	White	36	3 mm × 3 mm FIRM, Cardiopointv	88862811-51
	2-0	3	90	36	White	36	3 mm × 7 mm FIRM, Cardiopoint™	88862808-51
	2-0	3	90	36	Blue	36	3 mm × 3 mm FIRM, Cardiopoint™	88863191-51
	2-0	3	10×90	36	5 Blue and 5 White	6	Pledgets 3 mm × 3 mm FIRM, Cardiopoint™	88863255-56
	2-0	3	90	36	Blue	36	Pledgets 3 mm × 7 mm FIRM, Cardiopoint™	88863204-51
	2-0	3	90	36	Blue	36	Cardiopoint™	88863160-51
	2-0	3	10×90	36	5 Blue and 5 White	6	Cardiopoint™	88862851-56
	<b>Y-16</b> 1/2 Circle 20.0 mm Double-arm 	2-0	3	6×75	30	3 Blue and 3 White	6	Pledgets 3 mm × 7 mm FIRM, Cardiopoint™
2-0		3	10×75	30	5 Blue and 5 White	6	Cardiopoint™	88863241-56
2-0		3	90	36	Blue	36	Cardiopoint™	88863157-51

## PENETRATING TAPER

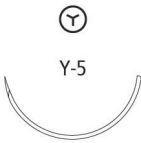
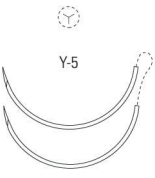
Needles Specifications	Size		Length		Color	Units Per box	Comments	Reorder code
	USP	EP	cm	Inches				
<b>Y-5</b> 1/2 Circle 26.0 mm 	<b>3-0</b>	2	75	30	Blue	36	Cardioint™	88863088-41
	<b>2-0</b>	3	75	30	Blue	36	Cardioint™	88863088-51
<b>Y-5</b> 1/2 Circle 26.0 mm Double-arm 	<b>4-0</b>	1.5	90	36	Blue	36	Cardioint™	88863167-31
	<b>3-0</b>	2	75	30	Blue	36	Cardioint™	88863088-41
	<b>3-0</b>	2	90	36	Blue	36	Cardioint™	88863167-41
	<b>2-0</b>	3	8×75	30	4 Blue and 4 White	6	3 mm × 7 mm SOFT, Cardioint™	VCD-256
	<b>2-0</b>	3	10×75	30	5 Blue and 5 White	6	Cardioint™	88863222-56
	<b>2-0</b>	3	8×75	30	4 Blue and 4 White	6	Pledgets 3 mm × 7 mm FIRM, Cardioint™	88863213-56
	<b>2-0</b>	3	8×75	30	4 Blue and 4 White	6	Pledgets 3 mm × 3 mm FIRM, Cardioint™	88863203-56
	<b>2-0</b>	3	75	30	Blue	36	Cardioint™	88863202-51
	<b>2-0</b>	3	75	30	Blue	36	Cardioint™	88863088-51
	<b>2-0</b>	3	75	30	White	36	Cardioint™	88862855-51
	<b>2-0</b>	3	10×90	36	5 Blue and 5 White	6	Pledgets 3 mm × 7 mm FIRM, Cardioint™	88863290-56
	<b>2-0</b>	3	90	36	Blue	36	Pledgets 3 mm × 7 mm FIRM, Cardioint™	88863212-51
	<b>2-0</b>	3	90	36	Blue	36	Cardioint™	88863167-51
	<b>2-0</b>	3	90	36	White	36	Cardioint™	88862815-51
	<b>2-0</b>	3	10×90	36	5 Blue and 5 White	6	Cardioint™	88862852-56
	<b>2-0</b>	3	90	36	White	36	Pledgets 3 mm × 7 mm FIRM, Cardioint™	88862840-51
	<b>0</b>	3.5	8×75	30	4 Blue and 4 White	6	Pledgets 3 mm × 7 mm FIRM, Cardioint™	88863213-66
<b>0</b>	3.5	75	30	Blue	36	Cardioint™	88863202-61	
<b>0</b>	3.5	90	36	Blue	36	Cardioint™	88863167-61	

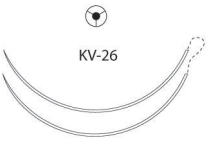
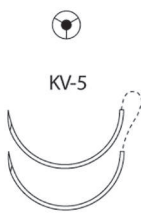
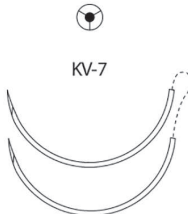
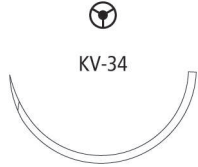

## TAPERCUTTING

Needles Specifications	Size		Length		Color	Units Per box	Comments	Reorder code
	USP	EP	cm	Inches				
<b>KV-15</b> 3/8 Circle 17.0 mm Double-arm 	2-0	3	4×75	30	Blue	6	Surgalloy™	88863131-56
<b>KV-26</b> 3/8 Circle 26.0 mm Double-arm 	2-0	3	10×90	36	5 Blue and 5 White	6	Pledgets 3 mm × 7 mm FIRM	88863275-56
<b>KV-5</b> 1/2 Circle 17.0 mm Double-arm 	4-0	1.5	90	36	Blue	36	Surgalloy™	88863159-31
	3-0	2	90	36	Blue	36	Surgalloy™	88863159-41
	2-0	3	8×75	30	4 Blue and 4 White	6	Pledgets 3 mm × 3 mm FIRM Pledgets	88863236-56
	2-0	3	8×75	30	4 Blue and 4 White	6	Pledgets 3 mm × 7 mm FIRM	88863235-56
	2-0	3	10×75	30	5 Blue and 5 White	6	Surgalloy™	88862879-56
	2-0	3	90	36	Blue	36	Surgalloy™	88863159-51
	2-0	3	90	36	Blue	36	Pledgets 3 mm × 3 mm FIRM	88863193-51
	<b>KV-7</b> 1/2 Circle 26.0 mm Double-arm 	2-0	3	75	30	Blue	36	Surgalloy™
2-0		3	8×75	30	4 Blue and 4 White	6	Pledgets 3 mm × 7 mm FIRM	88863240-56
2-0		3	10×75	30	5 Blue and 5 White	6	Pledgets 3 mm × 7 mm FIRM	88863228-56
2-0		3	90	36	Blue	36	Pledgets 3 mm × 7 mm FIRM	88863239-51
2-0		3	90	36	Blue	36	Surgalloy™	88863168-51
<b>KV-34</b> 1/2 Circle 37.0 mm 	0	3.5	75	30	Blue	36		88863119-61



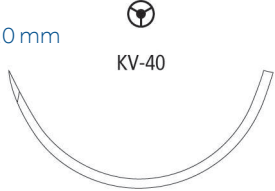

## TAPERCUTTING

Needles Specifications	Size		Length		Color	Units Per box	Comments	Reorder code
	USP	EP	cm	Inches				
<b>KV-37</b> 1/2 Circle 40.0 mm  KV-37	<b>0</b>	3.5	75	30	Blue	36		88863092-61
	<b>1</b>	4	75	30	Blue	36		88863092-71
	<b>2</b>	5	5×75	30	Blue	12		88863147-83
	<b>5</b>	7	5×75	30	Blue	12		88863147-89
<b>KV-40</b> 1/2 Circle 48.0 mm  KV-40	<b>5</b>	7	4×75	30	Blue	12		88862818-89





## STRAIGHT

Needles Specifications	Size		Length		Color	Units Per box	Comments	Reorder code
	USP	EP	cm	Inches				
<b>SS-24</b> 1/4 Circle 8.6 mm Double-arm 	6-0	0.7	45	18	White	12	Surgalloy™	CD-3113K
	5-0	1	45	18	White	12	Surgalloy™	CD-3123K
	5-0	1	45	18	White	12	Surgalloy™	D-1764K
	4-0	1.5	45	18	White	12	Surgalloy™	D-1763K
<b>SS-14</b> 1/4 Circle 8.6 mm Double-arm 	6-0	0.7	45	18	White	12	Surgalloy™	D-1722K
	5-0	1	45	18	White	12	Surgalloy™	D-1760K
<b>SS-28</b> 3/8 Circle 7.4 mm Double-arm 	6-0	0.7	45	18	White	12	Surgalloy™	D-1683K
<b>SS-2</b> 1/2 Circle 8.6 mm Double-arm 	5-0	1	45	18	White	12	Surgalloy™	CD-0423K
	5-0	1	45	18	White	12	Surgalloy™	D-1780K
	4-0	1.5	45	18	White	12	Surgalloy™	D-1779K



# VASCUFIL™

## Coated Monofilament Polybutester

### Innovation in Cardiovascular Surgery.



Vascufil™ suture provides a 20% greater luminal opening than polypropylene sutures.<sup>1</sup>

Important wherever restricted blood flow is a concern.



Vascufil™ suture is elastic, soft and supple, with less memory compared to polypropylene suture.<sup>2</sup>

Ideal when ease of use, excellent knot security and tighter, smaller knots are priorities.

#### Tensile Strength

Vascufil™ sutures are not absorbed, nor is any significant change in strength retention known to occur in vivo. Excretion of the absorbable coating is essentially complete within thirty days.

#### Packaging

Available dyed with Copper Phthalocyanine Blue in U.S.P. sizes 2–0 (3 Metric) through 7–0 (0.5 Metric). The sutures are supplied sterile, in pre-cut lengths affixed to various needle types, using permanent needle attachment techniques. Please refer to the individual package IFUs for complete instructions, indications, contraindications, warnings and precautions.

#### Indications

Indicated for use in general soft tissue approximation and/or ligation, including use in cardiovascular and ophthalmic surgery, but not in microsurgery and neural tissue.



## Description

Vascufil™ monofilament polybutester sutures are nonabsorbable, sterile, surgical sutures composed of a copolymer of butylene terephthalate and polytetramethylene ether glycol. The suture is coated with Polytribolate™, an absorbable polymer of ε-caprolactone / glycolide / poloxamer 188.

## Indications

Vascufil™ polybutester sutures are indicated for use in general soft tissue approximation and/or ligation, including use in cardiovascular and ophthalmic surgery, but not in microsurgery and neural tissue.

## Actions

Vascufil™ sutures elicit a minimal acute inflammatory reaction in tissues, which is followed by gradual encapsulation of the suture by fibrous connective tissue.

## Tensile Strength

Vascufil™ sutures are not absorbed, nor is any significant change in strength retention known to occur in vivo. Excretion of the absorbable coating is essentially complete within thirty days.

## Sterilization















Gamma irradiation.

## Packaging

Vascufil™ monofilament sutures are available dyed with Copper Phthalocyanine Blue in U.S.P. sizes 2–0 (3 Metric) through 7–0 (0.5 Metric). The sutures are supplied sterile, in pre-cut lengths affixed to various needle types, using permanent needle attachment techniques. Please refer to the individual package IFUs for complete instructions, indications, contraindications, warnings and precautions.



Please refer to the individual package IFUs for complete instructions, indications, contraindications, warnings and precautions.

1. Baumgartner, Norbert, et al. Influence of suture technique and suture material selection on the mechanics of end-to-end and end-to-side anastomoses. *J Thorac Cardiovasc Surg* 1996; 111: 1063-72.
2. Rodeheaver, G., Ph. D., et al. An Innovative Absorbable Coating for the Polybutester Suture. 2005. Pg 6-11.

TAPER POINT									
Needles Specifications	Size	EP	Length		Color	Units	Comments	Reorder code	
			USP						
<b>MV-175-8</b> 3/8 Circle 8.0 mm <b>Double-arm</b>	 MV-175-8 	5-0	1	75	30	Blue	36	Surgalloy™	88864741-21V
		7-0	0.5	4×60	24	Blue	12	Surgalloy™	88864788-05V
		7-0	0.7	2×60	24	Blue	12	Surgalloy™	88864795-06V
<b>CV-1</b> 3/8 Circle 9.0 mm <b>Double-arm</b>	 CV-1 	7-0	0.5	45	18	Blue	36	Surgalloy™	88864703-01V
		7-0	0.5	60	24	Blue	36	Surgalloy™	88864705-01V
		7-0	0.5	4×60	24	Blue	12	Surgalloy™	88864702-05V
		7-0	0.5	75	30	Blue	36	Surgalloy™	88864704-01V
		7-0	0.5	4×75	30	Blue	12	Surgalloy™	88864701-05V
		6-0	0.7	45	18	Blue	36	Surgalloy™	88864703-11V
		6-0	0.7	60	24	Blue	36	Surgalloy™	88864705-11V
		6-0	0.7	75	30	Blue	36	Surgalloy™	88864704-11V
<b>CV</b> 3/8 Circle 11.0 mm <b>Double-arm</b>	 CV 	6-0	0.7	75	30	Blue	36	Surgalloy™	88864756-11V
<b>CV-11</b> 3/8 Circle 13.0 mm	 CV-11 	5-0	1	75	30	Blue	36	Surgalloy™	88864722-21V
<b>CV-11</b> 3/8 Circle 13.0 mm <b>Double-arm</b>	 CV-11 	6-0	0.7	45	18	Blue	36	Surgalloy™	88864707-11V
		6-0	0.7	60	24	Blue	36	Surgalloy™	88864709-11V
		6-0	0.7	75	30	Blue	36	Surgalloy™	88864710-11V
		5-0	1	60	24	Blue	36	Surgalloy™	88864709-21V
		5-0	1	75	30	Blue	36	Surgalloy™	88864710-21V
		5-0	1	90	36	Blue	36	Surgalloy™	88864711-21V
<b>CV-15</b> 3/8 Circle 17.0 mm	 CV-15 	5-0	1	75	30	Blue	36	Surgalloy™	88864739-21V
		4-0	1.5	75	30	Blue	36	Surgalloy™	88864739-31V
<b>CV-15</b> 3/8 Circle 17.0 mm <b>Double-arm</b>	 CV-15 	5-0	1	90	36	Blue	36	Surgalloy™	88864716-21V
		4-0	1.5	90	36	Blue	36	Surgalloy™	88864716-31V

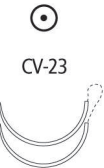
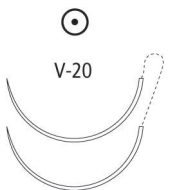

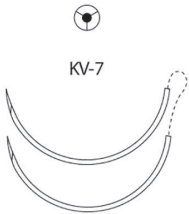
TAPER POINT										
Needles Specifications			Size		Length		Color	Units Per box	Comments	Reorder code
			USP	EP	cm	Inches				
<b>CV-22</b> 1/2 Circle 13.0 mm <b>Double-arm</b>		<b>6-0</b>	0.7	4×75	30	Blue	12	Surgalloy™	88864742-15V	
		<b>6-0</b>	0.7	75	30	Blue	36	Surgalloy™	88864741-11V	
		<b>7-0</b>	0.5	4×60	24	Blue	36	Surgalloy™	88864794-01V	
<b>CV-23</b> 1/2 Circle 17.0 mm <b>Double-arm</b>		<b>5-0</b>	1	90	36	Blue	36	Surgalloy™	88864719-21V	
		<b>4-0</b>	1.5	90	36	Blue	36	Surgalloy™	88864719-31V	
<b>V-20</b> 1/2 Circle 26.0 mm <b>Double-arm</b>		<b>2-0</b>	3	90	36	Blue	36	Surgalloy™	88864750-51V	
		<b>3-0</b>	2	90	36	Blue	36	Surgalloy™	88864750-41V	
		<b>4-0</b>	1.5	90	36	Blue	36	Surgalloy™	88864750-31V	

TAPERCUTTING										
Needles Specifications			Size		Length		Color	Units Per box	Comments	Reorder code
			USP	EP	cm	Inches				
<b>KV-7</b> 1/2 Circle 26.0 mm		<b>2-0</b>	3	90	36	Blue	36	Surgalloy™	88864730-51V	
<b>KV-7</b> 1/2 Circle 26.0 mm <b>Double-arm</b>		<b>4-0</b>	1.5	90	36	Blue	36	Surgalloy™	88864731-31V	
		<b>3-0</b>	2	90	36	Blue	36	Surgalloy™	88864731-41V	
		<b>2-0</b>	3	90	36	Blue	36	Surgalloy™	88864731-51V	
<b>KV-11</b> 3/8 Circle 13.0 mm <b>Double-arm</b>		<b>6-0</b>	0.7	75	30	Blue	36	Surgalloy™	88864734-11V	
		<b>5-0</b>	1	75	30	Blue	36	Surgalloy™	88864734-21V	
<b>KV-1</b> 3/8 Circle 9.0 mm <b>Double-arm</b>		<b>6-0</b>	0.7	60	24	Blue	36	Surgalloy™	88864714-11V	



# FLEXON™

## Multifilament Temporary Cardiac Pacing Lead

Excellent Stability with Great Flexibility.



- FLEXON™ temporary cardiac pacing leads are specifically designed to insulate the lead and be less traumatic during removal after pacing is complete.
- Breakaway cutting needle after chest wall penetration: eliminates requirement to cut needle and provides convenience to the clinician.
- Maximized area of coating in reference to the pacing lead end: less traumatic during removal of temporary pacing lead.

### Tensile Strength

Permanent

### Packaging

Available coated with orange or white PTFE or clear FEP in size 0 (3.5 metric), size 2-0 (3 metric) and 3-0 (2 metric). Flexon™ temporary cardiac pacing lead is supplied sterile affixed to various types of needles, including Breakaway™ needles.

### Indications

Indicated for use in temporary atrial and ventricular pacing and sensing during and after cardiac surgery.

**Description**

Flexon™ temporary cardiac pacing lead is a stainless steel twisted, multistrand wire coated with orange or white PTFE poly (tetrafluoroproethylene) or clear FEP poly (tetrafluoroethylene-co- hexafluoropropylene).

**Indications**

Flexon™ temporary cardiac pacing lead is indicated for use in temporary atrial and ventricular pacing and sensing during and after cardiac surgery.

**Actions**

Flexon™ temporary cardiac pacing lead elicits minimal acute inflammatory reaction in tissues and is not absorbed.

**Tensile Strength**

Permanent.

**Sterilization**

Ethylene oxide.

**Packaging**

Flexon™ temporary cardiac pacing lead are available coated with orange or white PTFE or clear FEP in size 0 (3.5 metric), size 2-0 (3 metric) and 3-0 (2 metric). Flexon™ temporary cardiac pacing lead is supplied sterile affixed to various types of needles, including Breakaway™ needles.

Please refer to the individual package IFUs for complete instructions, indications, contraindications, warnings and precautions.

1. IFU indicates tensile strength averages for Velosorb™ Fast sutures are approximately 50% of its original tensile strength 5 days post implantation. All of the original tensile strength is gone by 14 days. Absorption of Velosorb™ Fast sutures is essentially complete between the 40th and 50th day.

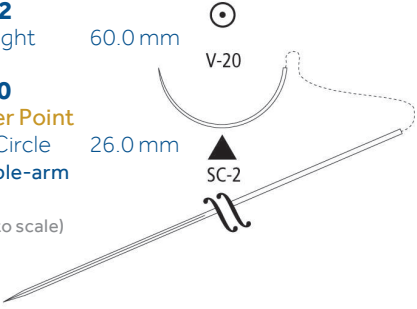
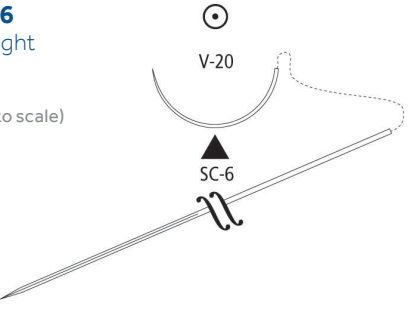
TAPER POINT								
Needles Specifications	Size		Length		Color	Units Per box	Comments	Reorder code
	USP	EP	cm	Inches				
<b>SC-2</b> Straight 60.0 mm  <b>V-20</b> Taper Point 1/2 Circle 26.0 mm Double-arm (Not to scale)	0	3.5	60	24	Undyed	12		88862597-63
<b>SC-6</b> Straight (Not to scale)  V-20 SC-6	2-0	3	2 × 60	24	1 Orange 1 White	12		88862623-53
	2-0	3	60	24	Orange	12		88862617-53
	2-0	3	60	24	White	12		88862615-53
	0	3.5	60	24	Undyed	12		88862589-63

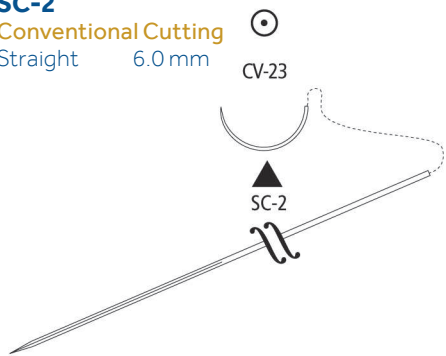
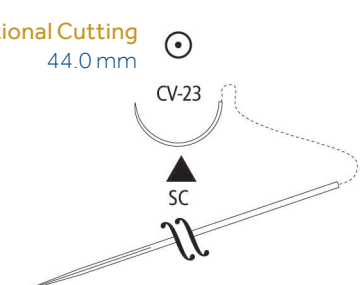
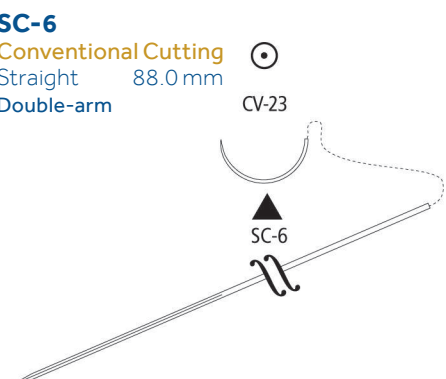
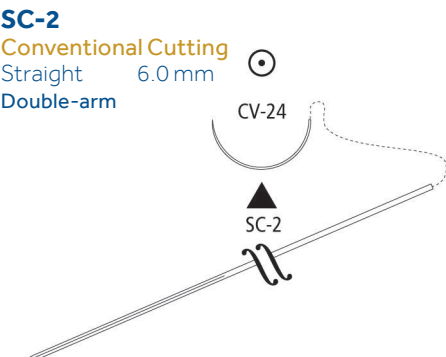

## TAPER POINT

Needles Specifications	Size		Length		Color	Units Per box	Comments	Reorder code
	USP	EP	cm	Inches				
<b>CV-23</b> 1/2 Circle 17.0 mm  <b>SC-2</b> Conventional Cutting Straight 6.0 mm 	3-0	2	60	24	Undyed	12	FEP Coating	88862592-43
<b>SC</b> Conventional Cutting Straight 44.0 mm 	3-0	2	60	24	Undyed	12	FEP Coating	88862591-43
<b>SC-6</b> Conventional Cutting Straight 88.0 mm Double-arm 	3-0	2	60	24	Undyed	12	Breakaway™ FEP Coating	88862586-43
<b>CV-24</b> 1/2 Circle 20.0 mm  <b>SC-2</b> Conventional Cutting Straight 6.0 mm Double-arm 	0	3.5	60	24	Undyed	12	FEP Coating	88862593-63



# STEEL

## Monofilament Stainless Steel

Providing Maximum Tensile Strength.



- Rotogrip™ needles (available on some monofilament steel) reduce kinking, making the suture easier to handle and helps prevent breakage at the needle suture junction.
- Mylar™/Tyvek™ outer envelope allows for easy suture removal and arming of needles.
- SCC needle, a very strong and sharp needle, excellent for sternotomy closure.

### Tensile Strength

Permanent

### Packaging

Available in monofilament strands in size 1 (4 Metric), size 2 (6 metric), size 4 (6 metric) through 7 (9 Metric). The sutures are supplied sterile, in pre-cut lengths affixed to various types of needles using permanent needle attachment technique.

### Indications

Indicated for use in abdominal wound closure, hernia repair and sternal closure.



**Description**

Stainless monofilament steel sutures are composed of 316L stainless steel conforming to ASTM Standard F138 Grade 2 "Stainless steel bar and wire for surgical implants."

**Indications**

Steel sutures are indicated for use in abdominal wound closure, hernia repair and sternal closure.

**Actions**

Steel sutures elicit a minimal acute inflammatory reaction in tissue, and are not absorbed.

**Tensile Strength**

Permanent.

**Sterilization**

Ethylene oxide or gamma irradiation.



**Packaging**

Steel sutures are available in monofilament strands in size 1 (4 Metric), size 2 (6 metric), size 4 (6 metric) through 7 (9 Metric). The sutures are supplied sterile, in pre-cut lengths affixed to various types of needles using permanent needle attachment technique.

Please refer to the individual package IFUs for complete instructions, indications, contraindications, warnings and precautions.

# Steel

PRE-CUT								
Needles Specifications	Size		Length		Color	Units Per box	Comments	Reorder code
	USP	EP	cm	Inches				
	<b>2-0</b>	3	12×45	18	Undyed	12	Pre-cut	88862407-53
	<b>0</b>	3.5	12×45	18	Undyed	12	Pre-cut	88862407-63
	<b>1</b>	4	6×45	18	Undyed	12	Pre-cut	88862408-73
	<b>2</b>	5	6×45	18	Undyed	12	Pre-cut	88862408-83
	<b>3-0</b>	2	12×45	18	Undyed	12	Pre-cut	88862407-43
	<b>7</b>	9	12×45	18	Undyed	12	Pre-cut	88862408-73

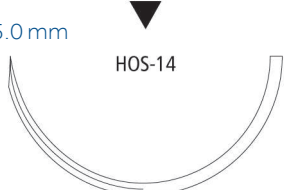
REVERSE CUTTING								
Needles Specifications	Size		Length		Color	Units Per box	Comments	Reorder code
	USP	EP	cm	Inches				
<b>GS-12</b> 1/2 Circle 40.0 mm  GS-12	<b>2</b>	5	5×45	18	Undyed	12		88862413-83
<b>GS-13 ROTO</b> 1/2 Circle 48.0 mm  GS-13 (Not to scale)	<b>2</b>	5	2×45	18	Undyed	12	ROTOGRIP™	88862420-83
	<b>4</b>	6	2×45	18	Undyed	12	ROTOGRIP™	88862420-09
<b>HOS-14</b> 1/2 Circle 55.0 mm  HOS-14 (Not to scale)	<b>5</b>	7	4×45	18	Undyed	12	ROTOGRIP™	88862410-89
	<b>5</b>	7	2×75	30	Undyed	12	ROTOGRIP™	88862424-89
	<b>5</b>	7	75	30	Undyed	12	ROTOGRIP™	88862412-89
	<b>6</b>	8	4×45	18	Undyed	12	ROTOGRIP™	88862410-69



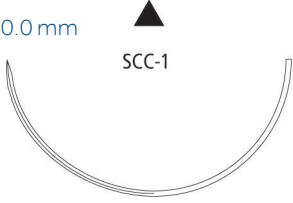

## CONVENTIONAL CUTTING

Needles Specifications	Size		Length		Color	Units Per box	Comments	Reorder code
	USP	EP	cm	Inches				
<b>SCC</b> 1/2 Circle 48.0 mm  SCC	5	7	4 × 45	18	Undyed	12		88862224-89
	5	7	2 × 45	18	Undyed	12		88862222-89
	5	7	6 × 45	18	Undyed	12		88862226-89
	6	8	4 × 45	18	Undyed	12		88862224-69
	6	8	6 × 45	18	Undyed	12		88862226-69
	6	8	2 × 45	18	Undyed	12		88862222-69
	7	9	4 × 45	18	Undyed	12		88862224-49
<b>SCC-1</b> 1/2 Circle 60.0 mm  SCC-1	5	7	2 × 75	30	Undyed	12		88862228-89



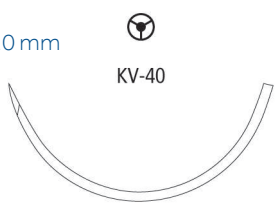

TAPER POINT										
Needles Specifications	Size		Length		Color	Units Per box	Comments	Reorder code		
	USP	EP	cm	Inches						
<b>GS-21</b> 1/2 Circle 37.0 mm  GS-21	2-0	3	5 × 45	18	Undyed	12		88862345-53		
<b>GS-25</b> 1/2 Circle 48.0 mm  GS-25	2-0	3	5 × 60	24	Undyed	12		88862348-53		

TAPERCUTTING										
Needles Specifications	Size		Length		Color	Units Per box	Comments	Reorder code		
	USP	EP	cm	Inches						
<b>KV-37</b> 1/2 Circle 40.0 mm  KV-37	2	5	5 × 45	18	Undyed	12		88862382-83		
<b>KV-40</b> 1/2 Circle 48.0 mm  KV-40 (Not to scale)	3	6	5 × 45	18	Undyed	12		88862466-25		
	5	7	4 × 45	18	Undyed	12		88862414-89		
	5	7	4 × 45	18	Undyed	12	ROTOGRIP	88862393-89		
	5	7	2 × 45	18	Undyed	12		88862376-89		
	6	8	2 × 45	18	Undyed	12		88862392-69		
	6	8	4 × 45	18	Undyed	12		88862393-69		
	7	9	2 × 45	18	Undyed	12		88862392-49		





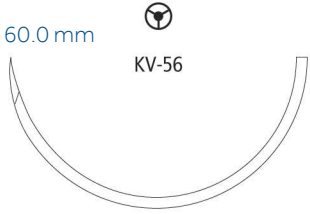

## TAPERCUTTING

Needles Specifications	Size		Length		Color	Units Per box	Comments	Reorder code
	USP	EP	cm	Inches				
<b>KV-56</b> 1/2 Circle 60.0 mm  KV-56	5	7	5 × 75	30	Undyed	12		88862396-89

## BLUNT TAPER POINT

Needles Specifications	Size		Length		Color	Units Per box	Comments	Reorder code
	USP	EP	cm	Inches				
<b>BGS-26</b> 1/2 Circle 44.0 mm  BGS-26 (Not to scale)	5	7	75	30	Undyed	12	ProtectPoint™	88862497-89
<b>BGS-29</b> 1/2 Circle 63.0 mm  BGS-29	5	7	5 × 45	18	Undyed	12	ProtectPoint™	88862495-89

## BLUNT POINT

Needles Specifications	Size		Length		Color	Units Per box	Comments	Reorder code
	USP	EP	cm	Inches				
<b>BP-27</b> 1/2 Circle 64.0 mm  BP-27	5	7	2 × 75	30	None	12	ProtectPoint™	88862494-89



# DERMALON™ / MONOSOF™

## Monofilament Nylon

High Tensile Strength. Low tissue Reactivity.



### The advanced extrusion process of the nylon molecule gives the suture:

- Uniform diameter
- Maximum flexibility of the strand
- Excellent security with snug and flattened knots
- Minimal memory
- Excellent and consistent knotting strength

#### Tensile Strength

As with any nylon suture, though not absorbed, progressive hydrolysis of the suture, in vivo, may result in gradual loss of its tensile strength over time.

#### Packaging

Available dyed blue with FD&C Blue No. 2 in sizes 2–0 (3 Metric) through 6–0 (0.7 metric). MONOSOF™ monofilament nylon sutures are available either clear (undyed) or dyed black with Logwood extract, in sizes 2 (5 Metric) through 11–0 (0.1 Metric). Both sutures are supplied sterile, in pre-cut lengths affixed to needles using permanent needle attachment techniques.

#### Indications

Indicated for use in general soft tissue approximation and/or ligation, including use in cardiovascular, ophthalmic, and neurological surgery.

**Description**

DERMALON™ and MONOSOF™ monofilament sutures are inert, nonabsorbable, sterile surgical sutures composed of the longchain aliphatic polymers Nylon 6 and Nylon 6.6.

**Indications**

DERMALON™ and MONOSOF™ monofilament nylon sutures are indicated for use in general soft tissue approximation and/or ligation, including use in cardiovascular, ophthalmic, and neurological surgery.

**Actions**

Both DERMALON™ and MONOSOF™ monofilament nylon sutures elicit a minimal acute inflammatory reaction in tissue, which is followed by gradual encapsulation of the suture by fibrous connective tissue.

**Tensile Strength**

As with any nylon suture, though not absorbed, progressive hydrolysis of the suture, in vivo, may result in gradual loss of its tensile strength over time.

**Sterilization**

DERMALON™ and MONOSOF™ monofilament nylon sutures are sterilized by ethylene oxide or gamma irradiation.

**Packaging**

DERMALON™ monofilament nylon sutures are available dyed blue with FD&C Blue No. 2 in sizes 2-0 (3 Metric) through 6-0 (0.7 metric). MONOSOF™ monofilament nylon sutures are available either clear (undyed) or dyed black with Logwood extract, in sizes 2 (5 Metric) through 11-0 (0.1 Metric). Both sutures are supplied sterile, in pre-cut lengths affixed to needles using permanent needle attachment techniques.

Please refer to the individual package IFUs for complete instructions, indications, contraindications, warnings and precautions.

## Dermalon™ / Monosof™

Dermalon™ / Monosof™ suture is a brand you have trusted for ~ 50 years with a proven history of performance.



PRE-CUT								
Needles Specifications	Size		Length		Color	Units Per box	Comments	Reorder code
	USP	EP	cm	Inches				
	<b>3-0</b>	2	12×45	18	Black	36	Pre-cut	N-63
	<b>2-0</b>	3	6×45	18	Black	36	Pre-cut	N-59
	<b>2</b>	5	6×45	18	Black	36	Pre-cut	N-64

REVERSE CUTTING								
Needles Specifications	Size		Length		Color	Units Per box	Comments	Reorder code
	USP	EP	cm	Inches				
<b>C-1</b> 3/8 Circle 12.0 mm 	<b>6-0</b>	0.7	25	10	Black	12		SN-770G
	<b>6-0</b>	0.7	45	18	Black	12		SN-667G
	<b>6-0</b>	0.7	45	18	Black	36		SN-667
	<b>6-0</b>	0.7	45	18	Blue	36		88861741-11
	<b>6-0</b>	0.7	75	30	Black	36		SN-367
	<b>5-0</b>	1	25	10	Black	12		SN-771G
	<b>5-0</b>	1	45	18	Black	36		SN-871
	<b>5-0</b>	1	45	18	Blue	36		88861741-21
	<b>5-0</b>	1	75	30	Black	36		SN-368
	<b>4-0</b>	1.5	25	10	Black	12		SN-772G
	<b>4-0</b>	1.5	45	18	Black	36		SN-872
	<b>4-0</b>	1.5	45	18	Blue	36		88861741-31







## REVERSE CUTTING

Needles Specifications	Size		Length		Color	Units Per box	Comments	Reorder code
	USP	EP	cm	Inches				
<b>C-12</b> 3/8 Circle    16.0 mm 	6-0	0.7	45	18	Blue	36		88861747-11
	6-0	0.7	45	18	Black	36		SN-660
	6-0	0.7	75	30	Black	36		SN-760
	5-0	1	45	18	Black	36		SN-659
	5-0	1	45	18	Black	12		SN-659G
	5-0	1	75	30	Black	36		SN-761
	4-0	1.5	75	30	Black	36		SN-762
	3-0	2	75	30	Black	36		SN-763
<b>C-13</b> 3/8 Circle    19.0 mm 	6-0	0.7	45	18	Blue	36		88861756-11
	5-0	1	45	18	Blue	36		88861756-21
	5-0	1	45	18	Black	12		SN-661G
	5-0	1	45	18	Black	36		SN-661
	5-0	1	75	30	Black	36		SN-643
	4-0	1.5	25	10	Black	12		SN-552G
	4-0	1.5	45	18	Black	12		SN-662G
	4-0	1.5	45	18	Black	36		SN-662
	4-0	1.5	45	18	Blue	36		88861756-31
	4-0	1.5	75	30	Blue	36		88861757-31
	4-0	1.5	90	36	Black	36		SN-644
	3-0	2	45	18	Black	36		SN-653
	3-0	2	45	18	Blue	36		88861756-41
	3-0	2	75	30	Black	36		SN-641
	3-0	2	75	30	Blue	36		88861757-41
	3-0	2	90	36	Black	36		SN-665
	2-0	3	45	18	Blue	36		88861756-51
	2-0	3	75	30	Black	36		SN-750
2-0	3	90	36	Black	36		SN-666	





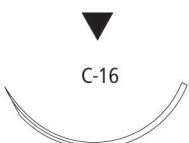

## REVERSE CUTTING

Needles Specifications	Size		Length		Color	Units Per box	Comments	Reorder code
	USP	EP	cm	Inches				
<b>C-14</b> 3/8 Circle    24.0 mm 	4-0	1.5	45	18	Black	36		SN-658
	4-0	1.5	45	18	Blue	36		88861744-31
	4-0	1.5	75	30	Blue	36		88861799-31
	4-0	1.5	90	36	Black	36		SN-649
	3-0	2	45	18	Black	12		SN-663G
	3-0	2	45	18	Black	36		SN-663
	3-0	2	45	18	Blue	36		88861744-41
	3-0	2	75	30	Blue	36		88861799-41
	3-0	2	75	30	Black	36		SN-669
	3-0	2	90	36	Black	36		SN-648
	2-0	3	45	18	Black	36		SN-758
	2-0	3	75	30	Undyed	36		88861799-51
	2-0	3	90	36	Black	36		SN-747
<b>C-15</b> 3/8 Circle    26.0 mm 	2-0	3	45	18	Black	12		SN-764G
	2-0	3	45	18	Black	36		SN-764
	2-0	3	45	18	Blue	36		88861744-51
	2-0	3	75	30	Black	12		SN-664G
	2-0	3	75	30	Black	36		SN-664
	2-0	3	90	36	Blue	36		88861720-51
	0	3.5	75	30	Black	36		SN-765
<b>C-16</b> 3/8 Circle    30.0 mm 	4-0	1.5	75	30	Black	36		SN-670
	3-0	2	75	30	Blue	36		88861750-41
	3-0	2	75	30	Black	12		SN-671G
	3-0	2	75	30	Black	36		SN-671
	3-0	2	90	36	Black	36		SN-771
	2-0	3	75	30	Black	36		SN-688
	2-0	3	90	36	Black	36		SN-788
	0	3.5	75	30	Black	36		SN-689
	1	4	90	36	Black	36		SN-790





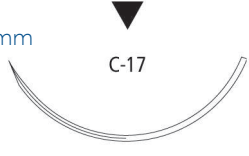

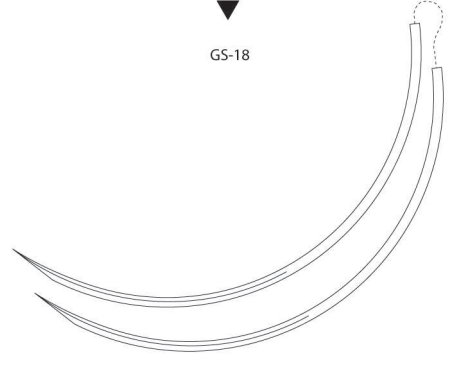
## REVERSE CUTTING

Needles Specifications	Size		Length		Color	Units Per box	Comments	Reorder code
	USP	EP	cm	Inches				
<b>C-18</b> 3/8 Circle 35.0 mm 	<b>3-0</b>	2	90	36	Black	36		SN-693
	<b>2-0</b>	3	90	36	Black	36		SN-694
<b>C-17</b> 3/8 Circle 39.0 mm 	<b>4-0</b>	1.5	75	30	Black	36		SN-672
	<b>3-0</b>	2	75	30	Black	12		SN-673G
	<b>3-0</b>	2	75	30	Black	36		SN-673
	<b>3-0</b>	2	75	30	Blue	36		88861727-41
	<b>2-0</b>	3	75	30	Blue	36		88861727-51
	<b>2-0</b>	3	75	30	Black	36		SN-674
	<b>0</b>	3.5	90	36	Black	36		SN-775
	<b>1</b>	4	90	36	Black	36		SN-776
	<b>2</b>	5	90	36	Black	36		SN-777
<b>GS-18</b> 3/8 Circle 77.0 mm 	<b>2</b>	5	45	18	Black	24	With bolster and weight	CN-290
<b>GS-18</b> 3/8 Circle 77.0 mm Double-arm 	<b>2</b>	5	75	30	Black	24		CN-490









REVERSE CUTTING									
Needles Specifications	Size		Length		Color	Units Per box	Comments	Reorder code	
	USP	EP	cm	Inches					
<b>C-22</b> 1/2 Circle 20.0 mm 	<b>5-0</b>	1	75	30	Black	36		SN-629	
	<b>4-0</b>	1.5	75	30	Black	36		SN-630	
	<b>3-0</b>	2	75	30	Black	36		SN-631	
<b>C-23</b> 1/2 Circle 24.0 mm 	<b>3-0</b>	2	90	36	Black	36		SN-247	
<b>C-25</b> 1/2 Circle 30.0 mm 	<b>3-0</b>	2	75	30	Black	36		SN-681	
	<b>3-0</b>	2	90	36	Black	36		SN-781	
	<b>2-0</b>	3	75	30	Black	36		SN-682	
	<b>2-0</b>	3	90	36	Black	36		SN-782	
<b>GS-11</b> 1/2 Circle 37.0 mm 	<b>3-0</b>	2	90	36	Black	36		SN-881	
	<b>2-0</b>	3	75	30	Black	36		CN-819	
	<b>1</b>	4	90	36	Black	36		CN-822	





## PREMIUM REVERSE CUTTING

Needles Specifications	Size		Length		Color	Units Per box	Comments	Reorder code
	USP	EP	cm	Inches				
<b>P-16</b> 3/8 Circle    7.0 mm 	7-0	0.5	45	18	Black	12		SN-1647G
	7-0	0.5	45	18	Black	36		SN-1647
<b>P-10</b> 3/8 Circle    11.0 mm 	7-0	0.5	45	18	Black	12	Surgalloy™	SN-3686
	6-0	0.7	45	18	Black	12	Surgalloy™	SN-3697
	6-0	0.7	45	18	Clear	12	Surgalloy™	SN-1689G
	6-0	0.7	45	18	Black	36	Surgalloy™	SN-5697
	6-0	0.7	45	18	Clear	36	Surgalloy™	SN-1689
	6-0	0.7	45	18	Blue	12		88861754-13
	5-0	1	45	18	Black	12	Surgalloy™	SN-3695
<b>P-13</b> 3/8 Circle    13.0 mm 	6-0	0.7	45	18	Black	36	Surgalloy™	SN-5696
	6-0	0.7	45	18	Black	12	Surgalloy™	SN-5696G
	6-0	0.7	45	18	Blue	12	Surgalloy™	SDN-5696G
	5-0	1	45	18	Black	12	Surgalloy™	SN-5698G
	5-0	1	45	18	Clear	12	Surgalloy™	SN-5690G
	5-0	1	45	18	Black	36	Surgalloy™	SN-5698
	5-0	1	45	18	Clear	36	Surgalloy™	SN-5690
	5-0	1	45	18	Blue	12	Surgalloy™	88861749-24
	4-0	1.5	45	18	Black	12	Surgalloy™	SN-5699G
	4-0	1.5	45	18	Black	36	Surgalloy™	SN-5699
	4-0	1.5	45	18	Clear	36	Surgalloy™	SN-5691
	4-0	1.5	45	18	Blue	12	Surgalloy™	SDN-5691G
	<b>P-11</b> 3/8 Circle    16.0 mm 	6-0	0.7	45	18	Black	12	Surgalloy™
5-0		1	45	18	Black	12	Surgalloy™	SN-5668G
5-0		1	45	18	Black	36	Surgalloy™	SN-5668
4-0		1.5	45	18	Black	12	Surgalloy™	SN-5694G
4-0		1.5	45	18	Black	36	Surgalloy™	SN-5694







## PREMIUM REVERSE CUTTING

Needles Specifications	Size		Length		Color	Units Per box	Comments	Reorder code
	USP	EP	cm	Inches				
<b>P-12</b> 3/8 Circle    19.0 mm 	<b>6-0</b>	0.7	45	18	Black	12	Surgalloy™	SN-5665G
	<b>5-0</b>	1	45	18	Black	12	Surgalloy™	SN-5666G
	<b>5-0</b>	1	45	18	Black	36	Surgalloy™	SN-5666
	<b>4-0</b>	1.5	45	18	Clear	12	Surgalloy™	SN-5677
	<b>4-0</b>	1.5	45	18	Black	12	Surgalloy™	SN-5667G
	<b>4-0</b>	1.5	45	18	Black	36	Surgalloy™	SN-5667
	<b>4-0</b>	1.5	45	18	Blue	12	Surgalloy™	SDN-5666G
	<b>3-0</b>	2	45	18	Black	12	Surgalloy™	SN-5669G
	<b>3-0</b>	2	45	18	Black	36	Surgalloy™	SN-5669
	<b>2-0</b>	3	45	18	Black	36	Surgalloy™	SN-5670





PREMIUM REVERSE CUTTING									
Needles Specifications	Size		Length		Color	Units Per box	Comments	Reorder code	
	USP	EP	cm	Inches					
<b>P-14</b> 3/8 Circle    24.0 mm 	<b>4-0</b>	1.5	45	18	Black	12	Surgalloy™	SN-5862G	
	<b>3-0</b>	2	45	18	Black	12	Surgalloy™	SN-5663G	
	<b>3-0</b>	2	45	18	Black	36	Surgalloy™	SN-5663	
	<b>3-0</b>	2	45	18	Blue	12	Surgalloy™	SDN-5943G	
<b>P-24</b> 1/2 Circle    16.0 mm 	<b>6-0</b>	0.7	45	18	Black	12	Surgalloy™	SN-5660G	
	<b>4-0</b>	1.5	45	18	Black	12	Surgalloy™	SN-5662G	
	<b>4-0</b>	1.5	45	18	Black	36	Surgalloy™	SN-5662	







CONVENTIONAL CUTTING										
Needles Specifications	Size		Length		Color	Units Per box	Comments	Reorder code		
	USP	EP	cm	Inches						
<b>PC-13</b> 3/8 Circle 11.0 mm 	<b>6-0</b>	0.7	45	18	Black	36		SN-1956		
	<b>5-0</b>	1	45	18	Black	36		SN-1955		
	<b>4-0</b>	1.5	45	18	Black	36		SN-1954		
<b>PC-11</b> 3/8 Circle 16.0 mm 	<b>6-0</b>	0.7	45	18	Black	36		SN-1966		
	<b>5-0</b>	1	45	18	Black	12	Surgalloy™	SN-3965		
	<b>4-0</b>	1.5	45	18	Black	36		SN-1964		
<b>PC-12</b> 3/8 Circle 19.0 mm 	<b>5-0</b>	1	45	18	Black	36		SN-1995		
	<b>4-0</b>	1.5	45	18	Black	36		SN-1994		
	<b>3-0</b>	2	45	18	Black	36		SN-1693		
<b>SCE-4</b> 3/8 Circle 19.0 mm 	<b>5-0</b>	1	45	18	Blue	36		88861742-21		
	<b>4-0</b>	1.5	45	18	Blue	36		88861742-31		
	<b>4-0</b>	1.5	45	18	Black	36		SN-568		
	<b>3-0</b>	2	45	18	Blue	36		88861742-41		
<b>GCC-90</b> 3/8 Circle 90.0 mm 	<b>2-0</b>	3	100	40	Black	36		CN-791		
	<b>0</b>	3.5	100	40	Black	36		CN-792		
	<b>1</b>	4	100	40	Black	36		CN-793		





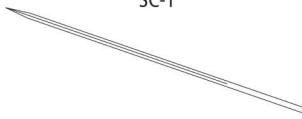















CONVENTIONAL CUTTING								
Needles Specifications	Size		Length		Color	Units Per box	Comments	Reorder code
	USP	EP	cm	Inches				
<b>SC-1</b> Straight    51.0 mm    ▲  SC-1	<b>4-0</b>	1.5	90	36	Black	36		SN-615
	<b>3-0</b>	2	90	36	Black	36		SN-616
	<b>2-0</b>	3	90	36	Black	36		SN-617
<b>SC-2</b> Straight    60.0 mm    ▲  SC-2	<b>3-0</b>	2	75	30	Black	36		SN-627
	<b>3-0</b>	2	75	30	Blue	36		88861764-41
	<b>2-0</b>	3	75	30	Black	36		SN-628
	<b>2-0</b>	3	75	30	Blue	36		88861764-51
	<b>2-0</b>	3	100	40	Black	36		SN-728







TAPER POINT										
Needles Specifications	Size		Length		Color	Units Per box	Comments	Reorder code		
	USP	EP	cm	Inches						
<b>MV-50-3</b> 3/8 Circle 4.0 mm  MV-50-3 	<b>11-0</b>	0.1	13	5	Black	12	Surgalloy™	N-2500		
<b>MV-70-3</b> 3/8 Circle 4.0 mm  MV-70-3 	<b>11-0</b>	0.1	13	5	Black	12	Surgalloy™	N-2510		
	<b>10-0</b>	0.2	13	5	Black	12	Surgalloy™	N-2512		
<b>MV-135-3</b> 3/8 Circle 4.0 mm  MV-135-3 	<b>10-0</b>	0.2	13	5	Black	12	Surgalloy™	N-2540		
	<b>9-0</b>	0.3	8	3	Black	12	Surgalloy™	N-1603G		
	<b>8-0</b>	0.4	13	5	Black	12	Surgalloy™	N-2541		
<b>MV-70-4</b> 3/8 Circle 5.0 mm  MV-70-4 	<b>10-0</b>	0.2	13	5	Black	12	Surgalloy™	N-2514		
<b>MV-100-4</b> 3/8 Circle 5.0 mm  MV-100-4 	<b>10-0</b>	0.2	13	5	Black	12	Surgalloy™	N-2530		
	<b>9-0</b>	0.3	13	5	Black	12	Surgalloy™	N-2532		
<b>MV-135-4</b> 3/8 Circle 5.0 mm  MV-135-4 	<b>10-0</b>	0.2	13	5	Black	12	Surgalloy™	N-2544		
	<b>9-0</b>	0.3	13	5	Black	12	Surgalloy™	N-2546		
	<b>8-0</b>	0.4	13	5	Black	12	Surgalloy™	N-2543		
<b>MV-135-5</b> 3/8 Circle 6.0 mm  MV-135-5 	<b>9-0</b>	0.3	13	5	Black	12	Surgalloy™	N-2548		
	<b>8-0</b>	0.4	13	5	Black	12	Surgalloy™	N-2547		







TAPER POINT									
Needles Specifications	Size		Length		Color	Units Per box	Comments	Reorder code	
	USP	EP	cm	Inches					
<b>GS-22</b> 1/2 Circle 27.0 mm 	0	3.5	100	40	Black	36		CN-225	
<b>GS-24</b> 1/2 Circle 40.0 mm 	0	3.5	100	40	Black	36		CN-723	
	1	4	100	40	Black	36		CN-722	
<b>GS-24 LOOP</b> 1/2 Circle 40.0 mm 	0	3.5	150	60	Black	24	Loop	CN-825-L	



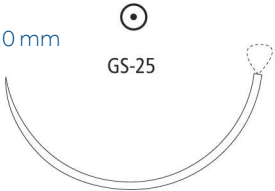

## TAPER POINT

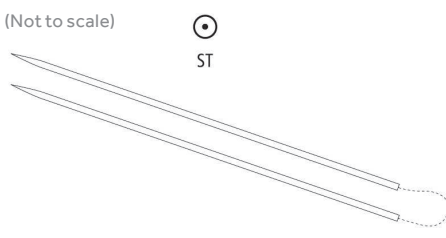
Needles Specifications	Size		Length		Color	Units Per box	Comments	Reorder code
	USP	EP	cm	Inches				
<b>GS-25</b> 1/2 Circle 48.0 mm  GS-25	1	4	100	40	Black	36		CN-724
<b>GS-25 LOOP</b> 1/2 Circle 48.0 mm  GS-25	1	4	150	60	Black	24	Loop	CN-830-L
<b>GS-26</b> 1/2 Circle 65.0 mm  GS-26	1	4	150	60	Black	24		CN-824
	2	5	150	60	Black	24		CN-825
<b>GS-26 LOOP</b> 1/2 Circle 65.0 mm  GS-26	0	3.5	240	96	Black	24	Loop	CN-823-L
<b>ST</b> Straight 60.0 mm Double-arm (Not to scale)  ST	2-0	3	90	36	Black	36		GN-283
	0	3.5	90	36	Black	36		GN-284







## HEAVY TAPER POINT

Needles Specifications	Size		Length		Color	Units Per box	Comments	Reorder code
	USP	EP	cm	Inches				
<b>HGS-22</b> 1/2 Circle 27.0 mm 	0	3.5	100	40	Black	36		CN-925
	1	4	100	40	Black	36		CN-926

## TAPERCUTTING



Needles Specifications	Size		Length		Color	Units Per box	Comments	Reorder code
	USP	EP	cm	Inches				
<b>MVK-70-3</b> 3/8 Circle 4.0 mm 	10-0	0.2	13	5	Black	12	Surgalloy™	N-2513
<b>MVK-100-4</b> 3/8 Circle 5.0 mm 	10-0	0.2	13	5	Black	12	Surgalloy™	N-2531
	9-0	0.3	13	5	Black	12	Surgalloy™	N-2533

## BLUNT POINT

Needles Specifications	Size		Length		Color	Units Per box	Comments	Reorder code
	USP	EP	cm	Inches				
<b>BGS-25</b> 1/2 Circle 48.0 mm 	1	4	100	40	Black	36	ProtectPoint™	CN-771



## PREMIUM SPATULA

Needles Specifications	Size	Length	Color	Units	Comments	Reorder code
<b>SE-100-8</b> 1/4 Circle 6.3 mm Double-arm 	<b>8-0</b>	30	Black	12	Surgalloy™	N-2714K
<b>SS-24</b> 1/4 Circle 8.6 mm Double-arm 	<b>5-0</b>	45	Black	12	Surgalloy™	N-2781K
<b>SE-140-6</b> 3/8 Circle 6.3 mm 	<b>10-0</b>	20	Black	12	Surgalloy™	N-2730-K
<b>SE-140-6</b> 3/8 Circle 6.3 mm Double-arm 	<b>10-0</b>	30	Black	12	Surgalloy™	N-2770-K
	<b>9-0</b>	30	Black	12	Surgalloy™	N-2771-K
<b>SE-140-8</b> 3/8 Circle 6.3 mm 	<b>10-0</b>	20	Black	12	Surgalloy™	N-2736K
<b>SE-140-8</b> 3/8 Circle 6.3 mm Double-arm 	<b>10-0</b>	30	Black	12	Surgalloy™	N-2718K
	<b>9-0</b>	30	Black	12	Surgalloy™	N-2717-K
<b>SE-CC-6</b> Compound curve 4.8 mm Double-arm 	<b>10-0</b>	30	Black	12	Surgalloy™	N-2799-K
<b>SE-160-4</b> 1/2 Circle 5.5 mm Double-arm 	<b>11-0</b>	30	Black	12	Surgalloy™	N-2705K
	<b>10-0</b>	30	Black	12	Surgalloy™	N-2704K



SPATULA										
Needles Specifications	Size		Length		Color	Units Per box	Comments	Reorder code		
	USP	EP	cm	Inches						
<b>SE-160-6</b> 1/2 Circle 5.5 mm 	10-0	0.2	20	8	Black	12	Surgalloy™	N-2734K		
<b>SE-160-6</b> 1/2 Circle 5.5 mm Double-arm 	10-0	0.2	15	6	Black	12	Surgalloy™	N-2757K		
	10-0	0.2	30	12	Black	12	Surgalloy™	N-2756K		
	9-0	0.3	30	12	Black	12	Surgalloy™	N-2760K		
<b>SE-160-8</b> 1/2 Circle 5.5 mm 	10-0	0.2	15	6	Black	12	Surgalloy™	N-2766K		
<b>SE-160-8</b> 1/2 Circle 5.5 mm Double-arm 	10-0	0.2	30	12	Black	12	Surgalloy™	N-2786K		
	9-0	0.3	30	12	Black	12	Surgalloy™	N-2787K		
<b>SE-175-8</b> 1/2 Circle 6.9 mm Double-arm 	10-0	0.2	30	12	Black	12	Surgalloy™	N-2719K		
	8-0	0.4	30	12	Black	12	Surgalloy™	N-2716K		
<b>SE-175-6</b> 1/2 Circle 7.0 mm Double-arm 	10-0	0.2	30	12	Black	12		N-2966K		
	9-0	0.3	30	12	Black	12	Surgalloy™	N-2967		
<b>SS-2</b> 1/2 Circle 8.6 mm Double-arm 	5-0	1	45	18	Black	12	Surgalloy™	N-2761K		



# NOVAFIL™

## Monofilament Polybutester

Supple and Flexible. Stretches with Healing.



### SUPPLE & FLEXIBLE

- With less memory and less resistant against creep structural fatigue<sup>3</sup>
- Easier to work with and handle for the user<sup>1,3</sup>

### HYDROPHOBIC

- Repels water, doesn't absorb body fluids<sup>1</sup>
- Easier removal

### ELASTICITY

- Stretches with edema and returns to its original shape when swelling subsides<sup>1</sup>
- Better cosmesis<sup>1</sup>, and reduced risk of hypertrophic scarring<sup>2\*</sup>

#### Tensile Strength

Novafil™ polybutester sutures are not absorbed, nor is any significant change in tensile strength retention known to occur in vivo.

#### Packaging

Available clear or pigmented with Copper Phthalocyanine Blue, in sizes 1 (4 Metric), size 2–0 (metric 3) through 7–0 (0.5 Metric). The sutures are supplied sterile, in pre-cut lengths affixed to reverse cutting needle type using permanent needle attachment techniques.

#### Indications

Indicated for use in general soft tissue approximation and/or ligation, including use in cardiovascular and ophthalmic surgery, but not in microsurgery and neural tissue.



**Description**

Novafil™ monofilament polybutester sutures are nonabsorbable, sterile, surgical sutures composed of a copolymer of butylene terephthalate and polytetramethylene ether glycol.

**Indications**

Novafil™ polybutester sutures are indicated for use in general soft tissue approximation and/or ligation, including use in cardiovascular and ophthalmic surgery, but not in microsurgery and neural tissue.

**Actions**

Novafil™ polybutester sutures elicit a minimal acute inflammatory reaction in tissues, followed by gradual encapsulation of the suture by fibrous connective tissue.

**Tensile Strength**

Novafil™ polybutester sutures are not absorbed, nor is any significant change in tensile strength retention known to occur in vivo.

**Sterilization**

Gamma irradiation.





**Packaging**

Novafil™ polybutester sutures are available clear or pigmented with Copper Phthalocyanine Blue, in sizes 1 (4 Metric), size 2-0 (metric 3) through 7-0 (0.5 Metric). The sutures are supplied sterile, in pre-cut lengths affixed to reverse cutting needle type using permanent needle attachment techniques. Please refer to the individual package IFUs for complete instructions, indications, contraindications, warnings and precautions.

Please refer to the individual package IFUs for complete instructions, indications, contraindications, warnings and precautions.



# Novafil™

Novafil™ suture is a brand you have trusted for ~ 30 years with a proven history of performance..

REVERSE CUTTING								
Needles Specifications	Size		Length		Color	Units Per box	Comments	Reorder code
	USP	EP	cm	Inches				
<b>C-1</b> 3/8 Circle 12.0 mm 	<b>6-0</b>	0.7	45	18	Blue	12		8886441913
	<b>5-0</b>	1	45	18	Blue	12		8886441923
	<b>4-0</b>	1.5	45	18	Blue	12		8886441933
<b>C-12</b> 3/8 Circle 16.0 mm 	<b>5-0</b>	1	45	18	Blue	12		88864555-23
<b>C-13</b> 3/8 Circle 19.0 mm 	<b>6-0</b>	0.7	45	18	Blue	12	455	8886442013
	<b>5-0</b>	1	45	18	Blue	12		8886442023
	<b>4-0</b>	1.5	45	18	Blue	12		8886442033
	<b>4-0</b>	1.5	75	30	Blue	36		8886403231
	<b>3-0</b>	2	45	18	Blue	12		8886442043
	<b>3-0</b>	2	75	30	Blue	36		88864554-41
<b>C-14</b> 3/8 Circle 24.0 mm 	<b>4-0</b>	1.5	45	18	Blue	12		8886442233
	<b>3-0</b>	2	45	18	Blue	12		8886442243
	<b>3-0</b>	2	90	36	Blue	36		8886400241
	<b>2-0</b>	3	45	18	Blue	12		8886442253
	<b>2-0</b>	3	75	30	Blue	12		8886442153



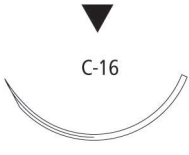
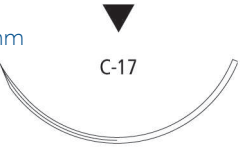

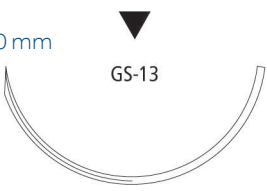

## REVERSE CUTTING

Needles Specifications	Size		Length		Color	Units Per box	Comments	Reorder code
	USP	EP	cm	Inches				
<b>C-16</b> 3/8 Circle 30.0 mm  C-16	<b>4-0</b>	1.5	75	30	Blue	36		8886442431
	<b>3-0</b>	2	75	30	Blue	36		8886442441
	<b>2-0</b>	3	75	30	Blue	36		8886442451
	<b>0</b>	3.5	75	30	Blue	36		8886442461
<b>C-17</b> 3/8 Circle 39.0 mm  C-17	<b>3-0</b>	2	75	30	Blue	36		8886442641
	<b>2-0</b>	3	75	30	Blue	36		8886442651
	<b>0</b>	3.5	75	30	Blue	36		8886442661
<b>GS-11</b> 1/2 Circle 37.0 mm  GS-11	<b>0</b>	3.5	100	40	Blue	12		8886400963
	<b>1</b>	4	75	30	Blue	36		8886443371
<b>GS-13</b> 1/2 Circle 48.0 mm (Not to scale)  GS-13	<b>1</b>	4	75	30	Blue	36		8886443671
	<b>1</b>	4	100	40	Blue	12		CPB-738G



## PREMIUM REVERSE CUTTING

Needles Specifications	Size	EP	Length		Color	Units	Comments	Reorder code
			USP					
<b>P-10</b> 3/8 Circle 11.0 mm 	<b>7-0</b>	0.5	45	18	Blue	12	Surgalloy™	8886441003
	<b>6-0</b>	0.7	45	18	Blue	12	Surgalloy™	8886441013
	<b>5-0</b>	1	45	18	Blue	12	Surgalloy™	8886441023
<b>P-13</b> 3/8 Circle 13.0 mm 	<b>6-0</b>	0.7	45	18	Blue	12	Surgalloy™	SPB-1213G
	<b>5-0</b>	1	45	18	Blue	12	Surgalloy™	SPB-5223G
	<b>5-0</b>	1	75	30	Blue	36	Surgalloy™	8886402721
	<b>4-0</b>	1.5	45	18	Blue	12	Surgalloy™	SPB-1233G
<b>SBE-2</b> 3/8 Circle 13.0 mm 	<b>6-0</b>	0.7	45	18	Blue	12		8886440013
	<b>5-0</b>	1	45	18	Blue	12		8886440023
<b>P-11</b> 3/8 Circle 16.0 mm 	<b>6-0</b>	0.7	45	18	Blue	12	Surgalloy™	SPB-5413G
	<b>5-0</b>	1	45	18	Blue	12	Surgalloy™	SPB-5142G
	<b>5-0</b>	1	75	30	Blue	36	Surgalloy™	8886402821
	<b>4-0</b>	1.5	45	18	Blue	12	Surgalloy™	SPB-5143G
	<b>4-0</b>	1.5	45	18	Blue	36	Surgalloy™	8886441431
	<b>4-0</b>	1.5	75	30	Blue	36	Surgalloy™	8886402831
<b>SBE-3</b> 3/8 Circle 16.0 mm 	<b>6-0</b>	0.7	45	18	Blue	12		8886440113
	<b>5-0</b>	1	45	18	Blue	12		8886440123
	<b>4-0</b>	1.5	45	18	Blue	12		8886440133





PREMIUM REVERSE CUTTING									
Needles Specifications	Size		Length		Color	Units Per box	Comments	Reorder code	
	USP	EP	cm	Inches					
<b>P-12</b> 3/8 Circle 19.0 mm 	<b>5-0</b>	1	45	18	Blue	12	Surgalloy™	SPB-1623G	
	<b>4-0</b>	1.5	45	18	Blue	12	Surgalloy™	SPB-5633G	
	<b>4-0</b>	1.5	75	30	Blue	36	Surgalloy™	8886442531	
	<b>3-0</b>	2	45	18	Blue	12	Surgalloy™	SPB-1643G	
	<b>3-0</b>	2	45	18	Blue	36	Surgalloy™	8886441543	
<b>SBE-4</b> 3/8 Circle 19.0 mm 	<b>5-0</b>	1	45	18	Blue	12		8886440223	
	<b>4-0</b>	1.5	45	18	Blue	12		8886440233	
	<b>3-0</b>	2	45	18	Blue	12		8886440243	
<b>P-14</b> 3/8 Circle 24.0 mm 	<b>4-0</b>	1.5	45	18	Blue	12	Surgalloy™	SPB-5833G	
	<b>3-0</b>	2	45	18	Blue	12	Surgalloy™	SPB-5843G	
	<b>3-0</b>	2	75	30	Blue	36	Surgalloy™	88864582-43	
	<b>2-0</b>	3	45	18	Blue	12	Surgalloy™	88864418-53	
	<b>2-0</b>	3	75	30	Blue	36	Surgalloy™	88864582-53	
<b>SBE-6</b> 3/8 Circle 24.0 mm 	<b>4-0</b>	1.5	45	18	Blue	12		8886440333	
	<b>3-0</b>	2	45	18	Blue	12		8886440343	
<b>P-24</b> 1/2 Circle 16.0 mm 	<b>4-0</b>	1.5	45	18	Clear	12	Surgalloy™	SPB-5433G	



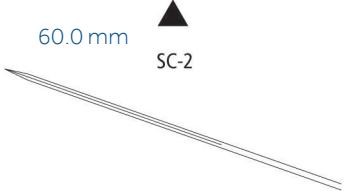

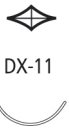



CONVENTIONAL CUTTING										
Needles Specifications	Size		Length		Color	Units Per box	Comments	Reorder code		
	USP	EP	cm	Inches						
<b>PC-12</b> 3/8 Circle 19.0 mm 	<b>5-0</b>	1	45	18	Blue	12			SPB-1945G	
<b>SC-2</b> Straight 60.0 mm 	<b>3-0</b>	2	75	30	Blue	36			88864490-41	
	<b>2-0</b>	3	75	30	Blue	36			88864490-51	



X CUTTING										
Needles Specifications	Size		Length		Color	Units Per box	Comments	Reorder code		
	USP	EP	cm	Inches						
<b>DX-11</b> 3/8 Circle 11.0 mm 	<b>6-0</b>	0.7	45	18	Blue	12	DermaX	XNF-697		
<b>DX-16</b> 3/8 Circle 16.0 mm 	<b>6-0</b>	0.7	45	18	Blue	12	DermaX	XNF-1966		
	<b>5-0</b>	1	45	18	Blue	12	DermaX	XNF-1965		
	<b>4-0</b>	1.5	45	18	Blue	12	DermaX	XNF-1964		
<b>DX-19</b> 3/8 Circle 19.0 mm 	<b>5-0</b>	1	45	18	Blue	12	DermaX	XNF-1995		
	<b>4-0</b>	1.5	45	18	Blue	12	DermaX	XNF-1994		
	<b>3-0</b>	2	45	18	Blue	12	DermaX	XNF-1993		

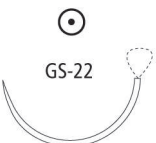
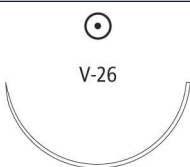

## TAPER POINT

Needles Specifications	Size		Length		Color	Units Per box	Comments	Reorder code
	USP	EP	cm	Inches				
<b>V-20</b> 1/2 Circle 26.0 mm 	<b>3-0</b>	2	75	30	Blue	36	Surgalloy™	8886445241
	<b>2-0</b>	3	75	30	Blue	36	Surgalloy™	8886445251
	<b>0</b>	3.5	75	30	Blue	36	Surgalloy™	8886445261
<b>GS-22</b> 1/2 Circle 27.0 mm 	<b>2-0</b>	3	75	30	Blue	36		8886445951
	<b>2-0</b>	3	5×45	18	Blue	12	D-Tach™	8886445853
	<b>0</b>	3.5	5×45	18	Blue	12	D-Tach™	8886445863
	<b>0</b>	3.5	75	30	Blue	36		8886445961
	<b>1</b>	4	75	30	Blue	36		8886445971
<b>GS-22 LOOP</b> 1/2 Circle 27.0 mm 	<b>2-0</b>	3	150	60	Blue	36	Loop	88864619-51
<b>V-26</b> 1/2 Circle 37.0 mm 	<b>3-0</b>	2	75	30	Blue	36		8886445041
<b>GS-21</b> 1/2 Circle 37.0 mm 	<b>0</b>	3.5	5×45	18	Blue	12	D-Tach™	8886445463
	<b>0</b>	3.5	75	30	Blue	36		8886445561
	<b>1</b>	4	5×45	18	Blue	12	D-Tach™	8886445473
	<b>1</b>	4	75	30	Blue	36		8886445571
<b>GS-24</b> 1/2 Circle 40.0 mm 	<b>1</b>	4	75	30	Blue	36		88864463-71

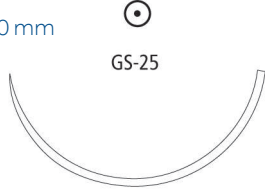

TAPER POINT								
Needles Specifications	Size		Length		Color	Units Per box	Comments	Reorder code
	USP	EP	cm	Inches				
<b>GS-25</b> 1/2 Circle 48.0 mm (Not to scale) 	<b>2</b>	5	75	30	Blue	36		88864465-81
	<b>1</b>	4	5x45	18	Blue	12	D-Tach™	88864464-73
	<b>1</b>	4	75	30	Blue	36		88864465-71
<b>GS-25 LOOP</b> 1/2 Circle 48.0 mm 	<b>0</b>	3.5	200	80	Blue	12	Loop	88864538-63
<b>GS-26</b> 1/2 Circle 65.0 mm 	<b>2</b>	5	150	60	Blue	36		88864470-81
<b>GS-26 LOOP</b> 1/2 Circle 65.0 mm 	<b>0</b>	3.5	150	60	Blue	36	Loop	8886440861







## HEAVY TAPER POINT

Needles Specifications	Size		Length		Color	Units Per box	Comments	Reorder code
	USP	EP	cm	Inches				
<b>HGS-22</b> 1/2 Circle 27.0 mm 	<b>0</b>	3.5	5×45	18	Blue	12	D-Tach™	8886446063

## SPATULA

Needles Specifications	Size		Length		Color	Units Per box	Comments	Reorder code
	USP	EP	cm	Inches				
<b>SS-1</b> 1/6 Circle 5.6 mm Double-arm 	<b>5-0</b>	1	30	12	Blue	12	Surgalloy™	PB-7740K
<b>SS-24</b> 1/4 Circle 8.6 mm Double-arm 	<b>6-0</b>	0.7	30	12	Blue	12	Surgalloy™	PB-6713K
	<b>5-0</b>	1	30	12	Blue	12	Surgalloy™	PB-6723K



# SURGILON™

## Braided Nylon

Coated with Silicone to Enhance Handling.



### The advanced extrusion process of the nylon molecule gives the suture:

- Uniform diameter
- Maximum flexibility of the strand
- Excellent security with snug and flattened knots
- Minimal memory
- Excellent and consistent knotting strength

#### Tensile Strength

As with any nylon suture, though not absorbed, progressive hydrolysis of the suture, in vivo, may result in gradual loss of its tensile strength over time.

#### Packaging

Available dyed black in sizes 1 (4 Metric) through 4-0 (1.5 Metric) and size 6-0 (0.7 metric). The sutures are supplied sterile, in pre-cut lengths or affixed to needles using both permanent and removable needle attachment techniques.

#### Indications

Indicated for use in general soft tissue approximation and/or ligation, including use in cardiovascular, ophthalmic, and neurological surgery.

**Description**

SURGILON™ braided sutures are inert, nonabsorbable, sterile sutures composed of the long-chain aliphatic polymers Nylon 6 and Nylon 6.6. The braided sutures are coated uniformly with silicone to enhance handling characteristics, ease of passage through tissue and reduction of capillarity.

**Indications**

SURGILON™ braided nylon sutures are indicated for use in general soft tissue approximation and/or ligation, including use in cardiovascular, ophthalmic, and neurological surgery.

**Actions**

SURGILON™ braided nylon sutures all elicit a minimal acute inflammatory reaction in tissue, which is followed by gradual encapsulation of the suture by fibrous connective tissue.

**Tensile Strength**

As with any nylon suture, though not absorbed, progressive hydrolysis of the suture, in vivo, may result in gradual loss of its tensile strength over time.

**Sterilization**

Surgilon™ braided nylon sutures are sterilized by ethylene oxide in sizes 6-0 (0.7 metric) and smaller and by gamma irradiation in sizes 2 (5 metric) through 5-0 (1 metric).

**Packaging**

SURGILON™ braided nylon sutures are available dyed black in sizes 1 (4 Metric) through 4-0 (1.5 Metric) and size 6-0 (0.7 metric). The sutures are supplied sterile, in pre-cut lengths or affixed to needles using both permanent and removable needle attachment techniques.

Please refer to the individual package IFUs for complete instructions, indications, contraindications, warnings and precautions.

# Surgilon™

## PRE-CUT



Needles Specifications	Size		Length		Color	Units Per box	Comments	Reorder code
	USP	EP	cm	Inches				
	4-0	1.5	12×45	18	Black	36	Pre-cut, RACETRAC	88861918-31
	4-0	1.5	7×75	30	Black	36	Pre-cut	88861919-31
	3-0	2	12×45	18	White	36	Pre-cut, RACETRAC	88861899-41
	3-0	2	12×45	18	Black	36	Pre-cut, RACETRAC	88861918-41
	3-0	2	7×75	30	Black	36	Pre-cut	88861919-41
	2-0	3	12×45	18	White	36	Pre-cut, RACETRAC	88861899-51
	2-0	3	12×45	18	Black	36	Pre-cut, RACETRAC	88861918-51
	2-0	3	7×75	30	Black	36	Pre-cut	88861919-51
	0	3.5	6×45	18	Black	36	Pre-cut, RACETRAC	88861917-61
	0	3.5	6×45	18	White	36	Pre-cut, RACETRAC	88861902-61
	0	3.5	7×75	30	Black	36	Pre-cut	88861919-61
	1	4	6×45	18	Black	36	Pre-cut, RACETRAC	88861917-71
	1	4	6×45	18	White	36	Pre-cut, RACETRAC	88861902-71
	1	4	7×75	30	Black	36	Pre-cut	88861919-71
	2	5	6×45	18	Black	24	Pre-cut, RACETRAC	88861917-82

## REEL

Needles Specifications	Size		Length		Color	Units Per box	Comments	Reorder code
	USP	EP	cm	Inches				
	3-0	2	366	144	Black	24	Reel	88861906-42
	2-0	3	366	144	Black	24	Reel	88861906-52
	0	3.5	250	98	Black	24	Reel	88861920-62
	1	4	250	98	Black	24	Reel	88861920-72
	2	5	300	120	Black	12	Reel	88861914-83
	3	6	238	95	Black	12	Reel	88861920-93

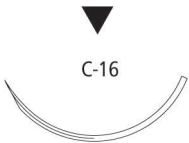

## REVERSE CUTTING

Needles Specifications	Size		Length		Color	Units Per box	Comments	Reorder code
	USP	EP	cm	Inches				
<b>C-13</b> 3/8 Circle    19.0 mm 	<b>3-0</b>	2	45	18	Black	12		88861931-43
	<b>2-0</b>	3	75	30	Black	36		88861982-51
<b>C-14</b> 3/8 Circle    24.0 mm 	<b>3-0</b>	2	75	30	Black	36		88861935-41
	<b>2-0</b>	3	45	18	Black	12		88861934-53
	<b>2-0</b>	3	75	30	Black	36		88861935-51
	<b>0</b>	3.5	75	30	Black	36		88861935-61
<b>C-16</b> 3/8 Circle    30.0 mm 	<b>3-0</b>	2	5 × 45	18	Black	24	D-Tach™	88861991-42
	<b>2-0</b>	3	75	30	Black	36		88861883-51
	<b>0</b>	3.5	75	30	Black	36		88861883-61
	<b>1</b>	4	75	30	Black	36		88861883-71
<b>C-18</b> 3/8 Circle    35.0 mm 	<b>1</b>	4	75	30	Black	36		88861922-71
<b>GS-10</b> 1/2 Circle    26.0 mm 	<b>2-0</b>	3	75	30	Black	36		88861932-51







## REVERSE CUTTING

Needles Specifications	Size		Length		Color	Units Per box	Comments	Reorder code
	USP	EP	cm	Inches				
<b>HOS-10</b> 1/2 Circle 26.0 mm 	1	4	75	30	Black	36		88861896-71
<b>GS-11</b> 1/2 Circle 37.0 mm 	0	3.5	75	30	Black	36		88861915-61
	1	4	75	30	Black	36		88861915-71
<b>HOS-12</b> 1/2 Circle 40.0 mm 	1	4	5 × 45	18	Black	24	D-Tach™	88861913-72
	1	4	75	30	Black	36		88861895-71

## PREMIUM REVERSE CUTTING

Needles Specifications	Size		Length		Color	Units Per box	Comments	Reorder code
	USP	EP	cm	Inches				
<b>P-13</b> 3/8 Circle 13.0 mm 	5-0	1	45	18	Black	12	Surgalloy™	SBS-1928G
	4-0	1.5	45	18	White	12	Surgalloy™	SBS-1880G
<b>P-11</b> 3/8 Circle 16.0 mm 	4-0	1.5	45	18	Black	12		88861981-33
<b>P-12</b> 3/8 Circle 19.0 mm 	4-0	1.5	45	18	White	12	Surgalloy™	SBS-1884G
	3-0	2	45	18	White	12	Surgalloy™	SBS-1883G





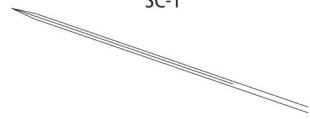
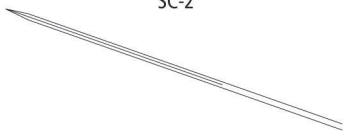

## CONVENTIONAL CUTTING

Needles Specifications	Size		Length		Color	Units Per box	Comments	Reorder code
	USP	EP	cm	Inches				
<b>SC-1</b> Straight    51.0 mm    ▲  SC-1	<b>2-0</b>	3	75	30	Black	36		88861985-51
	<b>0</b>	3.5	75	30	Black	36		88861985-61
	<b>1</b>	4	75	30	Black	36		88861985-71
<b>SC-2</b> Straight    60.0 mm    ▲  SC-2	<b>0</b>	3.5	75	30	Black	36		88861948-61
	<b>2</b>	5	75	30	Black	36		88861948-81

## TAPER POINT

Needles Specifications	Size		Length		Color	Units Per box	Comments	Reorder code
	USP	EP	cm	Inches				
<b>CV-20</b> 1/2 Circle    10.0 mm    ⊙  CV-20	<b>5-0</b>	1	5 × 45	18	Black	24	D-Tach™	88861910-22
	<b>4-0</b>	1.5	5 × 45	18	Black	24	D-Tach™	88861910-32
<b>CV-22</b> 1/2 Circle    13.0 mm    ⊙  CV-22	<b>4-0</b>	1.5	5 × 45	18	Black	24	D-Tach™	88861957-32
<b>CV-23</b> 1/2 Circle    17.0 mm    ⊙  CV-23	<b>4-0</b>	1.5	5 × 45	18	Black	24	D-Tach™	88861927-32
	<b>4-0</b>	1.5	75	30	Black	36		88861995-31
	<b>3-0</b>	2	5 × 45	18	Black	24	D-Tach™	88861927-42
	<b>3-0</b>	2	75	30	Black	36		88861995-41





TAPER POINT										
Needles Specifications			Size		Length		Color	Units Per box	Comments	Reorder code
			USP	EP	cm	Inches				
<b>CV-24</b> 1/2 Circle 20.0 mm			4-0	1.5	5 × 45	18	Black	24	D-Tach™	88861989-32
			3-0	2	5 × 45	18	Black	24	D-Tach™	88861989-42
<b>GS-23</b> 1/2 Circle 22.0 mm			0	3.5	5 × 45	18	Black	24	D-Tach™	88861993-62
<b>V-20</b> 1/2 Circle 26.0 mm			3-0	2	5 × 45	18	Black	24	D-Tach™	88861958-42
			3-0	2	75	30	Black	36		88861951-41
			3-0	2	75	30	Black	24	D-Tach™	88861926-42
			2-0	3	45	18	Black	24	D-Tach™	88861958-52
			2-0	3	5 × 75	30	Black	24	D-Tach™	88861967-52
			2-0	3	75	30	Black	36		88861951-51
			0	3.5	75	30	Black	36		88861951-61
<b>GS-22</b> 1/2 Circle 27.0 mm			2-0	3	5 × 45	18	Black	24	D-Tach™	88861969-52
			0	3.5	5 × 45	18	Black	24	D-Tach™	88861969-62
			0	3.5	75	30	Black	36		88861968-61
			1	4	5 × 45	18	Black	24	D-Tach™	88861969-72
<b>V-30</b> 1/2 Circle 30.0 mm			2-0	3	75	30	Black	36		88861964-51
			0	3.5	75	30	Black	36		88861964-61









## TAPER POINT

Needles Specifications	Size		Length		Color	Units Per box	Comments	Reorder code
	USP	EP	cm	Inches				
<b>GS-21</b> 1/2 Circle 37.0 mm 	2-0	3	5 × 45	18	Black	24	D-Tach™	88861962-52
	0	3.5	75	30	Black	36		88861971-61
	1	4	5 × 45	18	Black	24	D-Tach™	88861962-72
	1	4	75	30	Black	36		88861971-71
<b>GS-25</b> 1/2 Circle 48.0 mm 	0	3.5	5 × 45	18	Black	24	D-Tach™	88861998-62
<b>SK</b> SKI 23.0 mm 	2-0	3	250	98	Black	36		88862011-51

## HEAVY TAPER POINT

Needles Specifications	Size		Length		Color	Units Per box	Comments	Reorder code
	USP	EP	cm	Inches				
<b>HGS-22</b> 1/2 Circle 27.0 mm 	2-0	3	5 × 45	18	Black	24	D-Tach™	88861928-52
	0	3.5	5 × 45	18	Black	24	D-Tach™	88861928-62
	1	4	5 × 45	18	Black	24	D-Tach™	88861928-72

## DIAMOND POINT

Needles Specifications	Size		Length		Color	Units Per box	Comments	Reorder code
	USP	EP	cm	Inches				
<b>KV-25</b> 1/2 Circle 22.0 mm 	0	3.5	5 × 45	18	Black	24	D-Tach™	88861909-62



# SOFSILK™

## Wax Coated Braided Silk

### Maximum Surgical Handling.



Sof silk™ braided silk sutures are nonabsorbable, sterile, non-mutagenic surgical sutures composed of natural proteinaceous silk fibers called fibroin. The braided sutures are available coated uniformly with either silicone or a special wax mixture to reduce capillarity and to increase surface lubricity which enhances handling characteristics, ease of passage through tissue, and knot run-down properties.

#### Tensile Strength

While Sof silk™ sutures are not absorbed, progressive degradation of the proteinaceous silk fiber in vivo may result in gradual loss of the suture's tensile strength over time.

#### Packaging

Available in black with Logwood extract and uniformly coated with silicone or a special wax mixture, in sizes 2 (5 Metric) through 8-0 (0.4 Metric). The sutures are supplied sterile, in pre-cut lengths and ligating reels, nonneeded or affixed to needles using both permanent and removable needle attachment techniques.

#### Indications

Indicated for use in general soft tissue approximation and/or ligation, including use in cardiovascular, ophthalmic, microsurgery, and neurological surgery.

## Description

Sofsilk™ braided silk sutures are nonabsorbable, sterile, non-mutagenic surgical sutures composed of natural proteinaceous silk fibers called fibroin. This protein is derived from the domesticated silkworm species *Bombyx mori* of the family *bombycidae*. The silk fibers are treated to remove the naturally- occurring sericin gum and braided to produce Sofsilk™ surgical silk sutures. The braided sutures are available coated uniformly with either silicone or a special wax mixture to reduce capillarity and to increase surface lubricity which enhances handling characteristics, ease of passage through tissue, and knot run-down properties.

## Indications

Sofsilk™ sutures are indicated for use in general soft tissue approximation and/or ligation, including use in cardiovascular, ophthalmic, microsurgery, and neurological surgery.

## Actions

Sofsilk™ sutures elicit a minimal acute inflammatory reaction in tissue, which is followed by gradual encapsulation of the suture by fibrous connective tissue.

## Tensile Strength

While Sofsilk™ sutures are not absorbed, progressive degradation of the proteinaceous silk fiber in vivo may result in gradual loss of the suture's tensile strength over time.

## Sterilization

Gamma irradiation.

## Packaging

Sofsilk™ sutures are available in black with Logwood extract and uniformly coated with silicone or a special wax mixture, in sizes 2 (5 Metric) through 8-0 (0.4 Metric). The sutures are supplied sterile, in pre-cut lengths and ligating reels, nonneedled or affixed to needles using both permanent and removable needle attachment techniques. Please refer to the individual package IFUs for complete instructions, indications, contraindications, warnings and precautions.

Please refer to the individual package IFUs for complete instructions, indications, contraindications, warnings and precautions.

PRE-CUT								
Needles Specifications	Size		Length		Color	Units Per box	Comments	Reorder code
	USP	EP	cm	Inches				
	5-0	1	12×45	18	Black	36	Pre-cut	S-182
	4-0	1.5	12×45	18	Black	24	Pre-cut, racetrac	S-193
	4-0	1.5	12×45	18	Black	36	Pre-cut	S-183
	4-0	1.5	12×60	24	Black	36	Pre-cut	S-243
	4-0	1.5	12×75	30	Black	36	Pre-cut	S-303
	3-0	2	12×45	18	Black	24	Pre-cut, racetrac	S-194
	3-0	2	12×45	18	Black	36	Pre-cut	S-184
	3-0	2	12×60	24	Black	24	Pre-cut, racetrac	S-254
	3-0	2	12×60	24	Black	36	Pre-cut	S-244
	3-0	2	12×75	30	Black	24	Pre-cut, racetrac	S-404
	3-0	2	12×75	30	Black	36	Pre-cut	S-304
	2-0	3	12×45	18	Black	24	Pre-cut, racetrac	S-195
	2-0	3	12×45	18	Black	36	Pre-cut	S-185
	2-0	3	12×60	24	Black	36	Pre-cut	S-245
	2-0	3	12×75	30	Black	36	Pre-cut	S-305
	2-0	3	2×150	60	Black	36	Pre-cut	S-605
	0	3.5	6×45	18	Black	24	Pre-cut, racetrac	S-196
	0	3.5	12×45	18	Black	24	Pre-cut	S-176
	0	3.5	12×60	24	Black	24	Pre-cut	S-346
	0	3.5	6×60	24	Black	36	Pre-cut	S-246
	0	3.5	12×75	30	Black	24	Pre-cut	S-316
	0	3.5	2×150	60	Black	36	Pre-cut	S-606
	1	4	6×45	18	Black	24	Pre-cut, racetrac	S-197
	1	4	6×45	18	Black	36	Pre-cut	S-187
	1	4	12×75	30	Black	24	Pre-cut	S-317
	1	4	2×150	60	Black	36	Pre-cut	S-607
	2	5	12×75	30	Black	24	Pre-cut	S-318
	2	5	2×150	60	Black	36	Pre-cut	S-608



## PRE-CUT

Needles Specifications	Size		Length		Color	Units Per box	Comments	Reorder code
	USP	EP	cm	Inches				
	5	7	3×60	24	Black	36	Pre-cut	S-282
	5	7	2×150	60	Black	12	Pre-cut	S-610

## NON-NEELED-STANDARD LENGTH

Needles Specifications	Size		Length		Color	Units Per box	Comments	Reorder code
	USP	EP	cm	Inches				
	2	5	100	40	Black	36	Standard length	S-206
	4	6	180	72	Black	12	Standard length	S-199

## REEL





Needles Specifications	Size		Length		Color	Units Per box	Comments	Reorder code
	USP	EP	cm	Inches				
	4-0	1.5	250	98	Black	24	Reel	LS-640
	3-0	2	250	98	Black	24	Reel	LS-639
	2-0	3	250	98	Black	24	Reel	LS-638
	0	3.5	250	98	Black	24	Reel	LS-637
	1	4	250	98	Black	24	Reel	LS-636

## REVERSE CUTTING

Needles Specifications	Size		Length		Color	Units Per box	Comments	Reorder code
	USP	EP	cm	Inches				
<b>HE-6</b> 3/8 Circle 7.4 mm Double-arm	 HE-6	7-0	0.5	45	18	Black	12	S-1768K
		6-0	0.7	45	18	Black	12	Surgalloy™
<b>HE-5</b> 3/8 Circle 8.6 mm Double-arm	 HE-5	6-0	0.7	30	12	Black	12	Surgalloy™ S-1746K







REVERSE CUTTING									
Needles Specifications	Size		Length		Color	Units Per box	Comments	Reorder code	
	USP	EP	cm	Inches					
<b>HE-1</b> 3/8 Circle 11.0 mm Double-arm 	6-0	0.7	45	18	Black	12	Surgalloy™	S-1750K	
<b>C-1</b> 3/8 Circle 12.0 mm 	6-0	0.7	45	18	Black	36		S-1172	
	5-0	1	45	18	Black	36		S-1173	
	4-0	1.5	45	18	Black	36		S-1174	
	4-0	1.5	75	30	Black	36		S-1373	
<b>C-1</b> 3/8 Circle 12.0 mm Double-arm 	6-0	0.7	45	18	Black	12		S-1272	
	4-0	1.5	30	12	Black	12		S-1735	
	4-0	1.5	45	18	Black	12		S-1274	
<b>HE-3</b> 3/8 Circle 13.0 mm Double-arm 	4-0	1.5	45	18	Black	12	Surgalloy™	S-1789K	
	4-0	1.5	45	18	Black	12	Surgalloy™	S-1783K	







## REVERSE CUTTING

Needles Specifications	Size		Length		Color	Units Per box	Comments	Reorder code
	USP	EP	cm	Inches				
<b>C-12</b> 3/8 Circle    16.0 mm 	<b>6-0</b>	0.7	45	18	Black	36		SS-681
	<b>5-0</b>	1	75	30	Black	36		SS-673
	<b>4-0</b>	1.5	45	18	Black	12		SS-686
	<b>4-0</b>	1.5	75	30	Black	36		SS-645
	<b>3-0</b>	2	75	30	Black	36		SS-745
	<b>2-0</b>	3	75	30	Black	36		SS-746
<b>C-13</b> 3/8 Circle    19.0 mm 	<b>5-0</b>	1	45	18	Black	36		SS-682
	<b>5-0</b>	1	75	30	Black	36		SS-652
	<b>4-0</b>	1.5	45	18	Black	12		SS-683G
	<b>4-0</b>	1.5	45	18	Black	36		SS-683
	<b>4-0</b>	1.5	75	30	Black	36		SS-653
	<b>3-0</b>	2	45	18	Black	36		SS-694
	<b>3-0</b>	2	75	30	Black	36		SS-654
	<b>2-0</b>	3	75	30	Black	36		SS-655
	<b>0</b>	3.5	75	30	Black	36		SS-656



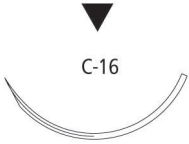

REVERSE CUTTING										
Needles Specifications	Size		Length		Color	Units Per box	Comments	Reorder code		
	USP	EP	cm	Inches						
<b>C-14</b> 3/8 Circle 24.0 mm 	<b>4-0</b>	1.5	45	18	Black	36		SS-629		
	<b>3-0</b>	2	45	18	Black	36		SS-684		
	<b>3-0</b>	2	45	18	Black	12		SS-684G		
	<b>3-0</b>	2	75	30	Black	36		SS-784		
	<b>2-0</b>	3	45	18	Black	36		SS-695		
	<b>2-0</b>	3	75	30	Black	36		SS-785		
	<b>0</b>	3.5	75	30	Black	36		SS-786		
	<b>1</b>	4	75	30	Black	36		SS-787		
<b>C-15</b> 3/8 Circle 26.0 mm 	<b>2-0</b>	3	45	18	Black	12		SS-685G		
	<b>2-0</b>	3	45	18	Black	36		SS-685		
<b>C-16</b> 3/8 Circle 30.0 mm 	<b>3-0</b>	2	75	30	Black	36		SS-675		
	<b>2-0</b>	3	45	18	Black	36		SS-677		
	<b>2-0</b>	3	75	30	Black	36		SS-679		
	<b>0</b>	3.5	45	18	Black	36		SS-678		
	<b>0</b>	3.5	5 × 75	30	Black	24	D-Tach™	SS-70-M		
	<b>0</b>	3.5	75	30	Black	36		SS-680		
	<b>1</b>	4	75	30	Black	36		SS-689		







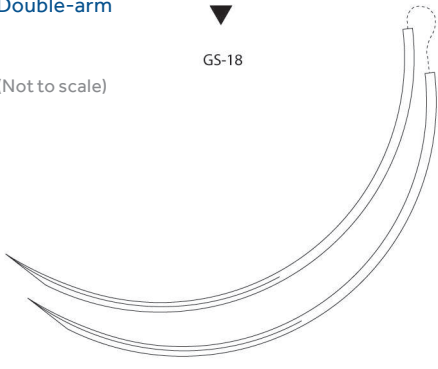



## REVERSE CUTTING

Needles Specifications	Size		Length		Color	Units Per box	Comments	Reorder code
	USP	EP	cm	Inches				
<b>C-17</b> 3/8 Circle    39.0 mm  C-17	<b>2-0</b>	3	75	30	Black	36		SS-648
	<b>0</b>	3.5	75	30	Black	36		SS-647
	<b>1</b>	4	75	30	Black	36		SS-646
	<b>2</b>	5	75	30	Black	36		SS-651
<b>GS-18</b> 3/8 Circle    77.0 mm Double-arm (Not to scale)  GS-18	<b>2</b>	5	75	30	Black	24		CS-482
	<b>5</b>	7	75	30	Black	24		CS-485
<b>HE-7</b> 1/2 Circle    7.4 mm Double-arm  HE-7	<b>7-0</b>	0.5	45	18	Black	12		S-1766K
	<b>6-0</b>	0.7	45	18	Black	12	Surgalloy™	S-1765K
<b>C-21</b> 1/2 Circle    13.0 mm  C-21	<b>4-0</b>	1.5	5 × 45	18	Black	24	D-Tach™	SS-82-M











REVERSE CUTTING										
Needles Specifications	Size		Length		Color	Units Per box	Comments	Reorder code		
	USP	EP	cm	Inches						
<b>C-22</b> 1/2 Circle 20.0 mm 	4-0	1.5	45	18	Black	36		SS-733		
<b>C-23</b> 1/2 Circle 24.0 mm 	3-0	2	45	18	Black	36		SS-732		
		2	75	30	Black	36		SS-632		
		2-0	3	45	18	Black	36		SS-734	
		2-0	3	75	30	Black	36		SS-633	
<b>GS-10</b> 1/2 Circle 26.0 mm 	2-0	3	45	18	Black	36		CS-390		
<b>GS-11</b> 1/2 Circle 37.0 mm 	2-0	3	75	30	Black	36		CS-490		







PREMIUM REVERSE CUTTING										
Needles Specifications			Size		Length		Color	Units Per box	Comments	Reorder code
			USP	EP	cm	Inches				
<b>P-10</b> 3/8 Circle 11.0 mm		6-0	0.7	45	18	Black	36	Surgalloy™	SS-5639	
		6-0	0.7	45	18	Black	12	Surgalloy™	SS-1639G	
<b>P-13</b> 3/8 Circle 13.0 mm		6-0	0.7	45	18	Black	12	Surgalloy™	SS-5649G	
		5-0	1	45	18	Black	36	Surgalloy™	SS-5640	
		4-0	1.5	45	18	Black	12	Surgalloy™	SS-5641G	
		4-0	1.5	45	18	Black	36	Surgalloy™	SS-5641	
<b>P-11</b> 3/8 Circle 16.0 mm		5-0	1	45	18	Black	36	Surgalloy™	SS-5678	
<b>P-12</b> 3/8 Circle 19.0 mm		5-0	1	45	18	Black	36	Surgalloy™	SS-5676	
		4-0	1.5	45	18	Black	36	Surgalloy™	SS-5677	
		3-0	2	45	18	Black	36	Surgalloy™	SS-5679	
<b>P-14</b> 3/8 Circle 24.0 mm		3-0	2	45	18	Black	36	Surgalloy™	SS-5684	
		2-0	3	45	18	Black	12		SS-5685G	
<b>P-24</b> 1/2 Circle 16.0 mm		4-0	1.5	45	18	Black	12	Surgalloy™	SS-1694G	



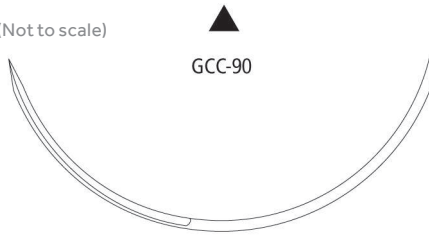

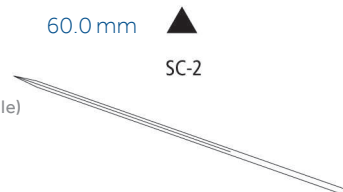

CONVENTIONAL CUTTING										
Needles Specifications	Size		Length		Color	Units Per box	Comments	Reorder code		
	USP	EP	cm	Inches						
<b>GCC-90</b> 3/8 Circle 90.0 mm (Not to scale) 	2-0	3	100	40	Black	36		CS-791		
	0	3.5	100	40	Black	36		CS-792		
	1	4	100	40	Black	36		CS-793		
	2	5	100	40	Black	36		CS-794		
<b>SC-1</b> Straight Double-arm 51.0 mm (Not to scale) 	2-0	3	75	30	Black	36		SS-523		
	1	4	75	30	Black	36		SS-525		
<b>SC-2</b> Straight 60.0 mm (Not to scale) 	4-0	1.5	75	30	Black	36		SS-621		
	3-0	2	75	30	Black	36		SS-622		
	3-0	2	100	40	Black	36		SS-722		
	2-0	3	75	30	Black	36		SS-623		
	2-0	3	100	40	Black	36		SS-723		
	0	3.5	75	30	Black	36		SS-624		

TAPER POINT										
Needles Specifications	Size		Length		Color	Units Per box	Comments	Reorder code		
	USP	EP	cm	Inches						
<b>CV-1</b> 3/8 Circle 9.0 mm 	6-0	0.7	45	18	Black	36	Surgalloy™	VS-802		
<b>CV-1</b> 3/8 Circle Double-arm 9.0 mm 	7-0	0.5	45	18	Black	36	Surgalloy™	VS-809		



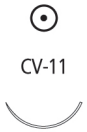

TAPER POINT										
Needles Specifications			Size		Length		Color	Units Per box	Comments	Reorder code
			USP	EP	cm	Inches				
<b>CV-11</b> 3/8 Circle 13.0 mm 	<b>6-0</b>	0.7	75	30	Black	36	Surgalloy™	VS-889		
	<b>5-0</b>	1	75	30	Black	36	Surgalloy™	VS-890		
	<b>4-0</b>	1.5	75	30	Black	36	Surgalloy™	VS-891		
<b>CV-11</b> 3/8 Circle 13.0 mm <b>Double-arm</b> 	<b>6-0</b>	0.7	45	18	Black	36	Surgalloy™	VS-806		
	<b>6-0</b>	0.7	5×60	24	Black	12	Surgalloy™	VS-706-M		
	<b>4-0</b>	1.5	45	18	Black	36	Surgalloy™	VS-709		
<b>CV-15</b> 3/8 Circle 17.0 mm 	<b>5-0</b>	1	75	30	Black	36	Surgalloy™	VS-880		
	<b>4-0</b>	1.5	75	30	Black	36	Surgalloy™	VS-881		
	<b>3-0</b>	2	75	30	Black	36	Surgalloy™	VS-882		
	<b>2-0</b>	3	75	30	Black	36	Surgalloy™	VS-823		
<b>CV-15</b> 3/8 Circle 17.0 mm <b>Double-arm</b> 	<b>4-0</b>	1.5	60	24	Black	36	Surgalloy™	VS-581		





TAPER POINT										
Needles Specifications			Size		Length		Color	Units Per box	Comments	Reorder code
			USP	EP	cm	Inches				
<b>CVF-21</b> 1/2 Circle    12.0 mm		CVF-21 	<b>5-0</b>	1	45	18	Black	36	Surgalloy™	CS-210
			<b>4-0</b>	1.5	45	18	Black	36	Surgalloy™	CS-211
<b>CV-22</b> 1/2 Circle    13.0 mm		CV-22 	<b>4-0</b>	1.5	5 × 45	18	Black	24	D-Tach™	GS-44-M





TAPER POINT									
Needles Specifications	Size		Length		Color	Units Per box	Comments	Reorder code	
	USP	EP	cm	Inches					
<b>CV-23</b> 1/2 Circle 17.0 mm 	5-0	1	75	30	Black	36	Surgalloy™	VS-870	
	4-0	1.5	75	30	Black	36	Surgalloy™	VS-871	
	3-0	2	5 × 45	18	Black	24	D-Tach™	GS-47-M	
	3-0	2	75	30	Black	36	Surgalloy™	VS-872	
	2-0	3	75	30	Black	36	Surgalloy™	VS-873	
<b>CV-24</b> 1/2 Circle 20.0 mm 	4-0	1.5	75	30	Black	36		GS-451	
	3-0	2	75	30	Black	36		GS-452	
	2-0	3	75	30	Black	36		GS-453	
<b>CV-25</b> 1/2 Circle 22.0 mm 	4-0	1.5	5 × 45	18	Black	24	D-Tach™	GS-34-M	
	3-0	2	5 × 45	18	Black	24	D-Tach™	GS-33-M	
	3-0	2	5 × 75	30	Black	24	D-Tach™	GS-30-M	
<b>CV-25</b> 1/2 Circle 22.0 mm Double-arm 	3-0	2	75	30	Black	36	Surgalloy™	VS-552	
<b>GS-23</b> 1/2 Circle 22.0 mm 	2-0	3	75	30	Black	36		CS-562	





## TAPER POINT

Needles Specifications	Size		Length		Color	Units Per box	Comments	Reorder code
	USP	EP	cm	Inches				
<b>V-20</b> 1/2 Circle 26.0 mm 	4-0	1.5	5 × 45	18	Black	24	D-Tach™	GS-64-M
	4-0	1.5	75	30	Black	36		GS-831
	3-0	2	5 × 45	18	Black	24	D-Tach™	GS-63-M
	3-0	2	5 × 75	30	Black	24	D-Tach™	GS-67-M
	3-0	2	75	30	Black	36		GS-832
	2-0	3	5 × 45	18	Black	24	D-Tach™	GS-62-M
	2-0	3	75	30	Black	36		GS-833
	2-0	3	5 × 75	30	Black	24	D-Tach™	GS-66-M
	0	3.5	75	30	Black	36		GS-834
	1	4	75	30	Black	36		GS-835
<b>V-20</b> 1/2 Circle 26.0 mm Double-arm 	2-0	3	90	36	Black	36	Surgalloy™	VS-533
<b>GS-22</b> 1/2 Circle 27.0 mm 	2-0	3	5 × 45	18	Black	24	D-Tach™	CS-16-M
	0	3.5	5 × 45	18	Black	24	D-Tach™	CS-17-M

















TAPER POINT									
Needles Specifications	Size		Length		Color	Units Per box	Comments	Reorder code	
	USP	EP	cm	Inches					
<b>V-30</b> 1/2 Circle 30.0 mm 	<b>3-0</b>	2	75	30	Black	36		GS-822	
	<b>2-0</b>	3	75	30	Black	36		GS-823	
	<b>0</b>	3.5	75	30	Black	36		GS-824	
<b>GS-21</b> 1/2 Circle 37.0 mm 	<b>2-0</b>	3	75	30	Black	36		CS-423	
	<b>0</b>	3.5	5 × 45	18	Black	24	D-Tach™	CS-10-M	
	<b>0</b>	3.5	75	30	Black	36		CS-424	
	<b>1</b>	4	75	30	Black	36		CS-425	
<b>V-26</b> 1/2 Circle 37.0 mm 	<b>3-0</b>	2	75	30	Black	36		VS-842	
	<b>2-0</b>	3	75	30	Black	36		VS-843	
	<b>0</b>	3.5	75	30	Black	36		VS-844	
	<b>1</b>	4	75	30	Black	36		VS-845	
	<b>1</b>	4	2 × 75	30	White	24	D-Tach™	CS-745	
	<b>1</b>	4	75	30	White	36		CS-744	
	<b>2</b>	5	75	30	Black	36		VS-846	
	<b>2</b>	5	2 × 75	30	White	24	D-Tach™	CS-746	





HEAVY TAPER POINT										
Needles Specifications			Size		Length		Color	Units Per box	Comments	Reorder code
			USP	EP	cm	Inches				
<b>HGS-23</b> 1/2 Circle 22.0 mm			2-0	3	5 × 45	18	Black	24	D-Tach™	CS-93-M
			0	3.5	5 × 45	18	Black	24	D-Tach™	CS-92-M
<b>HGS-22</b> 1/2 Circle 27.0 mm			0	3.5	5 × 45	18	Black	24	D-Tach™	CS-85-M
<b>HGS-20</b> 1/2 Circle 34mm			1	4	5 × 75	30	Black	12		X-1095

TAPERCUTTING										
Needles Specifications			Size		Length		Color	Units Per box	Comments	Reorder code
			USP	EP	cm	Inches				
<b>KV-5</b> 1/2 Circle 17.0 mm			3-0	2	75	30	Black	36	Surgalloy™	VS-863
<b>KV-7</b> 1/2 Circle 26.0 mm			2-0	3	75	30	Black	36	Surgalloy™	VS-964
<b>KV-34</b> 1/2 Circle 37.0 mm			1	4	2 × 75	30	White	12	D-Tach™	VS-766G





## SPATULA

Needles Specifications	Size		Length		Color	Units Per box	Comments	Reorder code
	USP	EP	cm	Inches				
<b>SE-100-8</b> 1/4 Circle 6.3 mm Double-arm 	<b>8-0</b>	0.4	45	18	Black	12	Surgalloy™	S-2176K
<b>SS-14</b> 1/4 Circle 8.6 mm Double-arm 	<b>6-0</b>	0.7	45	18	Black	12	Surgalloy™	S-1780K
<b>SS-24</b> 1/4 Circle 8.6 mm Double-arm 	<b>6-0</b>	0.7	45	18	Black	12	Surgalloy™	S-2780K
	<b>4-0</b>	1.5	45	18	White	12		S-2782K
<b>SE-140-8</b> 3/8 Circle 6.3 mm Double-arm 	<b>8-0</b>	0.4	30	12	Black	12	Surgalloy™	S-2752K
	<b>8-0</b>	0.4	45	18	Black	12	Surgalloy™	S-1734K
	<b>7-0</b>	0.5	45	18	Black	12	Surgalloy™	S-1733K
	<b>6-0</b>	0.7	45	18	Black	12	Surgalloy™	S-1732K



# V-LOC™ 90

## Absorbable Wound Closure Device

Secure. Fast. Effective.†



**THE VLOC™ DEVICE  
ADVANTAGE  
NOW WITH STRONGER,  
SHARPER NEEDLES\***

### Tensile Strength

Approximately 90% of initial tensile strength at 1 week, 75% at 2 weeks post implant.

### Packaging

Available in USP and EP sizes 2–0 (3 metric) through 4–0 (1.5 Metric). The V-LOC™ 90 absorbable wound closure devices are available dyed violet or undyed (clear).

The devices are supplied sterile, in pre-cut lengths affixed to various needle types.

The devices are available in box quantities of one dozen.

### Indications

Indicated for soft tissue approximation where use of an absorbable suture is appropriate. The safety and effectiveness of the V-LOC™ 90 absorbable wound closure device has not been established for use in fascial closures (abdominal wall, thoracic, extremity fascial closures), gastrointestinal anastomoses, cardiovascular anastomoses, neurological, ophthalmic, orthopedic or microsurgery.

## Description

The V-Loc™ 90 absorbable wound closure device consists of a barbed absorbable thread, armed with a surgical needle at one end and a loop end effector at the other. The barb and loop end effector design allow for tissue approximation without the need to tie surgical knots. The V-Loc™ 90 absorbable wound closure device is prepared from a synthetic polyester composed of glycolide, dioxanone, and trimethylene carbonate. The absorbable wound closure device is available undyed or violet. The device is sterile, inert, noncollagenous and nonantigenic.

## Indications

V-Loc™ 90 absorbable wound closure devices are indicated for soft tissue approximation where use of an absorbable suture is appropriate. The safety and effectiveness of the V-Loc™ 90 absorbable wound closure device has not been established for use in fascial closures (abdominal wall, thoracic, extremity fascial closures), gastrointestinal anastomoses, cardiovascular anastomoses, neurological, ophthalmic, orthopedic or microsurgery.

## Actions

V-Loc™ 90 absorbable wound closure devices elicit a minimal acute inflammatory reaction in tissues, which is followed by a gradual encapsulation of the device by fibrous connective tissue. Progressive loss of tensile strength and eventual absorption of V-Loc™ 90 absorbable wound closure device occurs by means of hydrolysis where the device is broken down to glycolic acid, dioxanoic acid, propane diol and carbon dioxide which are subsequently absorbed and metabolized by the body.

## Tensile Strength

Approximately 90% of initial tensile strength at 1 week, 75% at 2 weeks postimplant.

## Sterilization

Ethylene oxide.

## Absorbtion

Absorption begins as a loss of tensile strength without appreciable loss of mass. Animal data indicates that the absorption is essentially complete between 90 and 110 days.

## Packaging

The V-Loc™ 90 absorbable wound closure devices are available in USP and EP sizes 2-0 (3 metric) through 4-0 (1.5 Metric). The V-Loc™ 90 absorbable wound closure devices are available dyed violet or undyed (clear). The devices are supplied sterile, in pre-cut lengths affixed to various needle types. The devices are available in box quantities of one dozen. Please refer to the individual package IFUs for complete instructions, indications, contraindications, warnings and precautions.



Please refer to the individual package IFUs for complete instructions, indications, contraindications, warnings and precautions.

\* When compared with previous generation

† When compared with traditional suture

## V-Loc™ 90 Absorbable

V-Loc™ 90 wound closure device is a uni-directional short-term absorbable knotless barbed suture.

PREMIUM REVERSE CUTTING									
Needles Specifications	Size		Length		Color	Units Per box	Comments	Reorder code	
	USP	EP	cm	Inches					
<b>P-11</b> 3/8 Circle    16.0 mm 	<b>4-0</b>	1.5	30	12	Undyed	12	Surgalloy™	VLOCM1413	
	<b>4-0</b>	1.5	45	18	Undyed	12	Surgalloy™	VLOCM1423	
<b>P-12</b> 3/8 Circle    19.0 mm 	<b>4-0</b>	1.5	15	6	Undyed	12	Surgalloy™	VLOCM0003	
	<b>4-0</b>	1.5	30	12	Undyed	12	Surgalloy™	VLOCM0013	
	<b>4-0</b>	1.5	45	18	Undyed	12	Surgalloy™	VLOCM0023	
	<b>4-0</b>	1.5	58	23	Undyed	12	Surgalloy™	VLOCM0033	
	<b>3-0</b>	2	15	6	Undyed	12		VLOCM0004	
	<b>3-0</b>	2	30	12	Undyed	12		VLOCM0014	
	<b>3-0</b>	2	45	18	Undyed	12		VLOCM0024	
	<b>3-0</b>	2	58	23	Undyed	12	Surgalloy™	VLOCM0034	
	<b>2-0</b>	3	15	6	Undyed	12		VLOCM0005	
	<b>2-0</b>	3	30	12	Undyed	12		VLOCM0015	
	<b>2-0</b>	3	45	18	Undyed	12		VLOCM0025	
	<b>2-0</b>	3	58	23	Undyed	12		VLOCM0035	



## PREMIUM REVERSE CUTTING

Needles Specifications	Size		Length		Color	Units Per box	Comments	Reorder code
	USP	EP	cm	Inches				
<b>P-14</b> 3/8 Circle    24.0 mm 	4-0	1.5	30	12	Undyed	12	Surgalloy™	VLOCM0113
	4-0	1.5	45	18	Undyed	12	Surgalloy™	VLOCM0123
	4-0	1.5	58	23	Undyed	12	Surgalloy™	VLOCM0133
	3-0	2	30	12	Undyed	12	Surgalloy™	VLOCM0114
	3-0	2	45	18	Undyed	12	Surgalloy™	VLOCM0124
	3-0	2	58	23	Undyed	12	Surgalloy™	VLOCM0134
	2-0	3	30	12	Undyed	12		VLOCM0115
	2-0	3	45	18	Undyed	12		VLOCM0125
	2-0	3	58	23	Undyed	12		VLOCM0135
<b>P-17</b> 3/8 Circle    30.0 mm 	3-0	2	45	18	Undyed	12		VLOCM1824

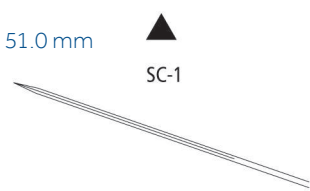
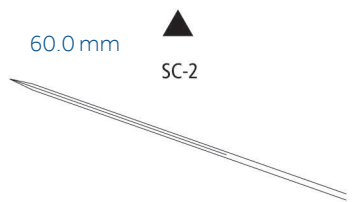

## CONVENTIONAL CUTTING

Needles Specifications	Size		Length		Color	Units Per box	Comments	Reorder code
	USP	EP	cm	Inches				
<b>SC-1</b> Straight    51.0 mm 	3-0	2	45	18	Undyed	12	Reliapoint™	VLOCM1624
<b>SC-2</b> Straight    60.0 mm 	4-0	1.5	45	18	Undyed	12	Reliapoint™	VLOCM0223
	3-0	2	45	18	Undyed	12		VLOCM0224



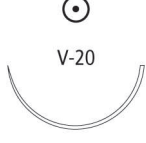

## TAPER POINT

Needles Specifications	Size USP	EP	Length		Color	Units Per box	Comments	Reorder code
			cm	Inches				
<b>CV-15</b> 3/8 Circle 17.0 mm 	4-0	1.5	15	6	Violet	12		VLOCM1203
	3-0	2	15	6	Violet	12	Surgalloy™	VLOCM1204
<b>CV-23</b> 1/2 Circle 17.0 mm 	4-0	1.5	23	9		12		VLOCM0843
	4-0	1.5	30	12	Violet	12		VLOCM0813
	3-0	2	15	6	Undyed	12	Surgalloy™	VLOCM1904
	3-0	2	15	6	Violet	12	Surgalloy™	VLOCM0804
	3-0	2	23	9	Undyed	12	Surgalloy™	VLOCM1944
	3-0	2	23	9	Violet	12	Surgalloy™	VLOCM0844
	3-0	2	30	12	Violet	12		VLOCM0814
	3-0	2	45	18	Violet	12		VLOCM0824
<b>V-20</b> 1/2 Circle 26.0 mm 	4-0	1.5	15	6	Violet	12	Surgalloy™	VLOCM0603
	4-0	1.5	45	18	Violet	12	Surgalloy™	VLOCM0623
	3-0	2	15	6	Violet	12		VLOCM0604
	3-0	2	15	6	Undyed	12	Surgalloy™	VLOCM2004
	3-0	2	23	9	Violet	12	Surgalloy™	VLOCM0644
	3-0	2	23	9	Undyed	12	Surgalloy™	VLOCM2044
	3-0	2	30	12	Violet	12		VLOCM0614
	3-0	2	45	18	Violet	12		VLOCM0624
	2-0	3	45	18	Violet	12		VLOCM0625





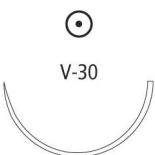

## TAPER POINT

Needles Specifications	Size		Length		Color	Units Per box	Comments	Reorder code
	USP	EP	cm	Inches				
<b>GS-22</b> 1/2 Circle    27.0 mm 	2-0	3	15	6	Violet	12		VLOCM2105
	2-0	3	15	6	Undyed	12		VLOCM2205
	2-0	3	23	9	Violet	12		VLOCM2145
	2-0	3	23	9	Undyed	12		VLOCM2245
	2-0	3	30	12	Violet	12		VLOCM2115
<b>V-30</b> 1/2 Circle    30.0 mm 	3-0	2	23	9	Violet	12		VLOCM1544
	2-0	3	23	9	Violet	12		VLOCM1545
<b>GS-21</b> 1/2 Circle    37.0 mm 	3-0	2	23	9	Violet	12		VLOCM0344
	3-0	2	45	18	Violet	12		VLOCM0324
	2-0	3	15	6	Violet	12		VLOCM0305
	2-0	3	23	9	Violet	12		VLOCM0345
	2-0	3	30	12	Violet	12		VLOCM0315
	2-0	3	45	18	Undyed	12		VLOCM3225
<b>GU-46</b> 5/8 Circle    27.0 mm 	3-0	2	15	6	Violet	12	Surgalloy™	VLOCM1704
	3-0	2	23	9	Violet	12		VLOCM1744



# V-LOC™ 180

Absorbable Wound Closure Device

Secure. Fast. Effective.†



**THE VLOC™ DEVICE  
ADVANTAGE  
NOW WITH STRONGER,  
SHARPER NEEDLES\***

## Tensile Strength

Approximately 80% of initial tensile strength at 1 week, 75% at 2 weeks, and 65% at 3 weeks post implant.

## Packaging

Available in USP and EP sizes 4–0 (1.5 Metric) through 0 (3.5 Metric). The V-LOC™ 180 absorbable wound closure devices are dyed with D&C No. 6 or available Clear (Undyed).

The devices are supplied sterile, in pre-cut lengths affixed to various needle types. The devices are available in box quantities of one dozen.

## Indications

Indicated for soft tissue approximation where use of an absorbable suture is appropriate. The safety and effectiveness of the V-LOC™ 180 absorbable wound closure device has not been established for use in fascial closures (abdominal wall, thoracic, extremity fascial closures), gastrointestinal anastomoses, cardiovascular anastomoses, neurological, ophthalmic, orthopedic or microsurgery.

## Description

The V-Loc™ 180 absorbable wound closure device consists of a barbed absorbable thread, armed with a surgical needle at one end and a loop end effector at the other. The barb and loop end effector design allow for tissue approximation without the need to tie surgical knots. The V-Loc™ 180 absorbable wound closure device is prepared from a copolymer of glycolic acid and trimethylene carbonate. The absorbable wound closure device is available clear or green. The device is sterile, inert, noncollagenous and nonantigenic.

## Indications

V-Loc™ 180 absorbable wound closure devices are indicated for soft tissue approximation where use of an absorbable suture is appropriate. The safety and effectiveness of the V-Loc™ 180 absorbable wound closure device has not been established for use in fascial closures (abdominal wall, thoracic, extremity fascial closures), gastrointestinal anastomoses, cardiovascular anastomoses, neurological, ophthalmic, orthopedic or microsurgery.

## Actions

When implanted in animal tissue, V-Loc™ 180 absorbable wound closure devices elicit a minimal tissue reaction characteristic of foreign body response to substance. The tissue reaction resolves as the device is absorbed. Experimental animal studies for this absorbable material produced no evidence of antigenicity, systemic toxicity, carcinogenicity, mutagenicity, teratogenicity or adverse effects on reproductive performance.

## Tensile Strength

Studies demonstrate the following approximate % of U.S.P. and E.P. knot pull minimum average specification for the labeled diameter size: Approximately 80% of initial tensile strength at 1 week, 75% at 2 weeks, and 65% at 3 weeks post implant.

## Sterilization

Ethylene oxide.

## Absorbtion

Animal data indicates that the absorption is minimal until about the 60th day after implantation. Absorption is substantially complete within six months.

## Packaging

The V-Loc™ 180 absorbable wound closure devices are available in USP and EP sizes 4–0 (1.5 Metric) through 0 (3.5 Metric). The V-Loc™ 180 absorbable wound closure devices are dyed with D&C No. 6 or available Clear (Undyed). The devices are supplied sterile, in pre-cut lengths affixed to various needle types. The devices are available in box quantities of one dozen.

Please refer to the individual package IFUs for complete instructions, indications, contraindications, warnings and precautions.



\* When compared with previous generation

† When compared with traditional suture

## V-Loc™ 180 Absorbable

V-Loc™ 180 wound closure device is a uni-directional long-term absorbable knotless barbed suture.

REVERSE CUTTING									
Needles Specifications	Size		Length		Color	Units Per box	Comments	Reorder code	
	USP	EP	cm	Inches					
<b>GS-11</b> 1/2 Circle 37.0 mm 	<b>2-0</b>	3	30	12	Clear	12	Reliapoint™	VLOCL2815	
	<b>0</b>	3.5	45	18	Clear	12	Reliapoint™	VLOCL2826	

PREMIUM REVERSE CUTTING									
Needles Specifications	Size		Length		Color	Units Per box	Comments	Reorder code	
	USP	EP	cm	Inches					
<b>P-11</b> 3/8 Circle 16.0 mm 	<b>4-0</b>	1.5	30	12	Green	12		VLOCL1413	
<b>P-12</b> 3/8 Circle 19.0 mm 	<b>4-0</b>	1.5	15	6	Clear	12	Surgalloy™	VLOCL0003	
	<b>4-0</b>	1.5	30	12	Clear	12	Surgalloy™	VLOCL0013	
	<b>4-0</b>	1.5	45	18	Clear	12	Surgalloy™	VLOCL0023	
	<b>4-0</b>	1.5	58	23	Clear	12	Surgalloy™	VLOCL0033	
	<b>3-0</b>	2	15	6	Clear	12		VLOCL0004	
	<b>3-0</b>	2	30	12	Clear	12		VLOCL0014	
	<b>3-0</b>	2	45	18	Clear	12		VLOCL0024	
	<b>3-0</b>	2	58	23	Clear	12		VLOCL0034	
	<b>2-0</b>	3	30	12	Clear	12		VLOCL0015	
	<b>2-0</b>	3	45	18	Clear	12		VLOCL0025	





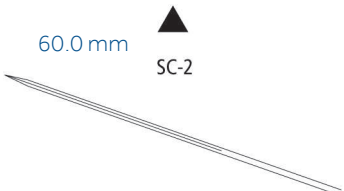

PREMIUM REVERSE CUTTING								
Needles Specifications	Size		Length		Color	Units Per box	Comments	Reorder code
	USP	EP	cm	Inches				
<b>P-14</b> 3/8 Circle 24.0 mm 	4-0	1.5	45	18	Clear	12	Surgalloy™	VLOCL0123
	4-0	1.5	58	23	Clear	12	Surgalloy™	VLOCL0133
	3-0	2	30	12	Clear	12		VLOCL0114
	3-0	2	45	18	Clear	12		VLOCL0124
	3-0	2	60	24	Clear	12		VLOCL0134
	2-0	3	30	12	Clear	12		VLOCL0115
	2-0	3	45	18	Clear	12		VLOCL0125
	2-0	3	60	24	Clear	12		VLOCL0135

CONVENTIONAL CUTTING								
Needles Specifications	Size		Length		Color	Units Per box	Comments	Reorder code
	USP	EP	cm	Inches				
<b>SC-2</b> Straight 60.0 mm 	4-0	1.5	45	18	Clear	12		VLOCL0223
	3-0	2	45	18	Clear	12		VLOCL0224

TAPER POINT								
Needles Specifications	Size		Length		Color	Units Per box	Comments	Reorder code
	USP	EP	cm	Inches				
<b>CV-23</b> 1/2 Circle 17.0 mm 	4-0	1.5	15	6	Green	12		VLOCL0803
	4-0	1.5	30	12	Green	12	Surgalloy™	VLOCL0813
	3-0	2	15	6	Green	12		VLOCL0804
	3-0	2	15	6	Steel	12		VLOCL1904
	3-0	2	23	9	Green	12	Surgalloy™	VLOCL0844
	3-0	2	30	12	Green	12		VLOCL0814
	3-0	2	45	18	Green	12		VLOCL0824



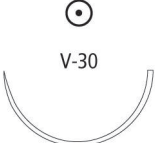

TAPER POINT									
Needles Specifications	Size		Length		Color	Units Per box	Comments	Reorder code	
	USP	EP	cm	Inches					
<b>V-20</b> 1/2 Circle 26.0 mm 	4-0	1.5	15	6	Green	12		VLOCL0603	
	4-0	1.5	30	12	Green	12		VLOCL0613	
	3-0	2	15	6	Green	12		VLOCL0604	
	3-0	2	23	9	Green	12	Surgalloy™	VLOCL0644	
	3-0	2	30	12	Green	12	Surgalloy™	VLOCL0614	
	3-0	2	45	18	Green	12	Surgalloy™	VLOCL0624	
	2-0	3	30	12	Green	12		VLOCL0615	
	2-0	3	45	18	Green	12		VLOCL0625	
<b>GS-22</b> 1/2 Circle 27.0 mm 	2-0	3	15	6	Green	12		VLOCL2105	
	2-0	3	23	9	Green	12		VLOCL2145	
<b>V-30</b> 1/2 Circle 30.0 mm 	3-0	2	23	9	Green	12		VLOCL1544	
	2-0	3	23	9	Green	12		VLOCL1545	
<b>GS-21</b> 1/2 Circle 37.0 mm 	3-0	2	23	9	Green	12		VLOCL0344	
	3-0	2	45	18	Green	12		VLOCL0324	
	2-0	3	15	6	Green	12		VLOCL0305	
	2-0	3	23	9	Green	12		VLOCL0345	
	2-0	3	30	12	Green	12		VLOCL0315	
	2-0	3	45	18	Green	12		VLOCL0325	
	2-0	3	60	24	Green	12		VLOCL0335	
	0	3.5	15	6	Green	12		VLOCL0306	
	0	3.5	23	9	Green	12		VLOCL0346	
	0	3.5	30	12	Green	12		VLOCL0316	
	0	3.5	45	18	Green	12		VLOCL0326	
	0	3.5	60	24	Green	12		VLOCL0336	
<b>GS-25</b> 1/2 Circle 48.0 mm (Not to scale) 	0	3.5	30	12	Green	12		VLOCL0416	
	0	3.5	45	18	Green	12		VLOCL0426	
	0	3.5	60	24	Green	12		VLOCL0436	



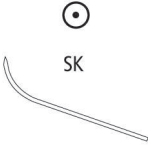

TAPER POINT								
Needles Specifications	Size		Length		Color	Units Per box	Comments	Reorder code
	USP	EP	cm	Inches				
<b>SK</b> SKI      23.0 mm 	<b>3-0</b>	2	23	9	Green	12		VLOCL2744



# V-LOC™ PBT

## PBT Non Absorbable Wound Closure Device

Secure. Fast. Effective.†



Dual-Angle Cut



### Dual-angle cut

Produces barbs with strong anchoring force while preserving the integrity of the strand's strength.

### Tensile Strength

No known significant change in tensile retention occurs in vivo for the V-Loc™ PBT non-absorbable wound closure device.

### Packaging

Available in USP and EP sizes 1 (4 Metric) through 3-0 (2 Metric). The V-Loc™ PBT nonabsorbable wound closure devices are pigmented with Copper Phthalocyanine Blue. The devices are supplied sterile, affixed to taperpoint needle types. The devices are available in box quantities of one dozen.

### Indications

Indicated for soft tissue approximation where use of an absorbable suture is appropriate. The safety and effectiveness of the V-Loc™ 90 absorbable wound closure device has not been established for use in fascial closures (abdominal wall, thoracic, extremity fascial closures), gastrointestinal anastomoses, cardiovascular anastomoses, neurological, ophthalmic, orthopedic or microsurgery.



## Description

The V-Loc™ Polybutester (PBT) non-absorbable wound closure device consists of a barbed non-absorbable thread, armed with a surgical needle at one end and a loop end effector at the other. The barb and loop end effector design allow for tissue approximation without the need to tie surgical knots. The V-Loc™ PBT nonabsorbable wound closure device is composed of a copolymer of butylene terephthalate and polytetramethylene ether glycol. The device is sterile, inert, noncollagenous and nonantigenic.

## Indications

V-Loc™ PBT non-absorbable wound closure devices are indicated for soft tissue approximation. The safety and effectiveness of the V-Loc™ PBT non-absorbable wound closure device has not been established for use in fascial closures (abdominal wall, thoracic, extremity fascial closures), gastrointestinal anastomoses, cardiovascular anastomoses, neurological, ophthalmic, orthopedic or microsurgery.

## Actions

Sofsil™ sutures elicit a minimal acute inflammatory reaction in tissue, which is followed by gradual encapsulation of the suture by fibrous connective tissue.

## Tensile Strength

No known significant change in tensile retention occurs in vivo for the V-Loc™ PBT non-absorbable wound closure device.

## Sterilization

Gamma irradiation.

## Absorbtion

Permanent.

## Packaging

The V-Loc™ PBT non-absorbable wound closure devices are available in USP and EP sizes 1 (4 Metric) through 3-0 (2 Metric). The V-Loc™ PBT non-absorbable wound closure devices are pigmented with Copper Phthalocyanine Blue. The devices are supplied sterile, affixed to taperpoint needle types. The devices are available in box quantities of one dozen.



Please refer to the individual package IFUs for complete instructions, indications, contraindications, warnings and precautions.

\* When compared with previous generation

† When compared with traditional suture

# V-Loc™ PBT

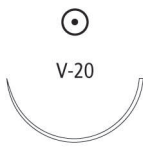
V-Loc™ PBT wound closure device is a uni-directional permanent knotless barbed suture.

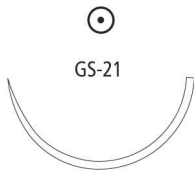
TAPER POINT															
Needles Specifications	Size		Length		Color	Units Per box	Comments	Reorder code							
	USP	EP	cm	Inches											
<b>CV-23</b> 1/2 Circle 17.0 mm 	<b>3-0</b>	2	30	12	Blue	12	Surgalloy™	VLOCN0814							
<b>V-20</b> 1/2 Circle 26.0 mm 	<b>3-0</b>	2	15	6	Blue	12			VLOCN0604						
		2	23	9							VLOCN0644				
		2	30	12					Blue	12	Surgalloy™	VLOCN0614			
		3	15	6											VLOCN0605
		3	30	12											VLOCN0615
<b>GS-22</b> 1/2 Circle 27.0 mm 	<b>0</b>	3.5	45	18	Blue	12		VLOCN1126							
<b>GS-21</b> 1/2 Circle 37.0 mm 	<b>2-0</b>	3	15	6	Blue	12		VLOCN0305							
		3	45	18						VLOCN0325					
		3.5	15	6						VLOCN0306					
		3.5	45	18						VLOCN0326					
		4	45	18						VLOCN0327					
<b>GS-25</b> 1/2 Circle 48.0 mm 	<b>1</b>	4	60	24	Blue	12		VLOCN0437							



# PLEDGETS

Non-Absorbable, undyed fabrics constructed of PTFE

**Simple strength. Secure placement.**



Oval pledgets provide you with the same performance you have come to expect from our existing product line, just in a different shape to better meet your cardiovascular procedural needs.

Like our rectangular pledgets, the oval pledgets act as a buttress under sutures when there is a possibility of sutures tearing through tissue.<sup>1</sup> They are inert<sup>2</sup> — plus they have adequate stiffness, yet do not fall apart.<sup>†</sup>

## Compared to rectangular pledgets:



Oval pledgets conform better to the shape of the anatomical structure and result in less foreign mass in the body<sup>2</sup>



The lack of corners prevents the oval pledget from catching the wrong orientation and the edges are less likely to overlap<sup>2</sup>



Soft oval pledgets are compliant, yet not fuzzy<sup>2</sup>

**Description**

PTFE Pledgets are non-absorbable, undyed fabrics composed of poly (tetrafluoroethylene).

**Indications**

PTFE Pledgets are indicated for use as non-absorbable suture buttresses when there is a possibility of sutures tearing through tissue. These pledgets are used in various surgical procedures such as vascular closure, septal repair, myocardial closure, valvular suturing and hepatic repair.

**Actions**

PTFE Pledgets elicit a minimal acute inflammatory reaction in tissues, followed by gradual encapsulation of the fabric by fibrous connective tissue.

**Absorption**

PTFE Pledgets are not absorbed, nor is any significant change in tensile strength retention known to occur in vivo.

**Packaging**

PTFE Pledgets are available sterile, prepunched, square, rectangular or oval in shape and in box quantities of 3 dozen.

1. Oval pledget [instructions for use]. Minneapolis, MN: Medtronic, 2015.
2. Based on survey of 6 CV surgeons in two cities - NYC and Chicago. HMV Report. Pledget Usability Lab Focus Group, conducted on June 10, 2015. — 06-10-15, 06-10-16, 06-10-17, 06-10-18, 06-10-20, 06-10-22, 06-10-25, 06-10-28.
3. Medtronic R&D Engineering Report. Report Number: RE00017984. Determination of Pledget Removal Force. Aug. 7, 2015.

# PLEDGETS

CATEGORY								
Needles Specifications	Size		Length		Color	Units Per box	Comments	Reorder code
	USP	EP	cm	Inches				
						36	Pledgets 4.5mm x 6mm SOFT	VPG56SE
						36	Pledgets 4.5mm x 6mm FIRM	VPG56FE
						36	Pledgets 3mm x 6mm SOFT	VPG36SE
						36	Pledgets 3mm x 6mm FIRM	VPG36FE
						36	3mm x 7mm FIRM	8886867701
						36	3mm x 3mm FIRM 10 pledgets per envelope	8886867501
						36	Pledgets 3mm x 7mm SOFT	8886868201
						36	Pledgets 4.8mm x 9.5mm SOFT 5 per pouch	8886867901
						36	Pledgets 4.8mm x 9.5mm FIRM 5 per pouch	8886867801





# Medtronic



Use scan app to read

For more information, please visit  
[medtronic.eu/product-catalog](https://www.medtronic.eu/product-catalog)

**IMPORTANT:** Please refer to the package insert for complete instructions, contraindications, warnings and precautions.

© 2017 Medtronic. All rights reserved. Medtronic, Medtronic logo and Further, Together are trademarks of Medtronic.  
™\* Third party brands are trademarks of their respective owners. All other brands are trademarks of a Medtronic company.  
17-rcegi-sutures-catalogue-em-1955361

