

HAEMOSTATIC FORCEPS

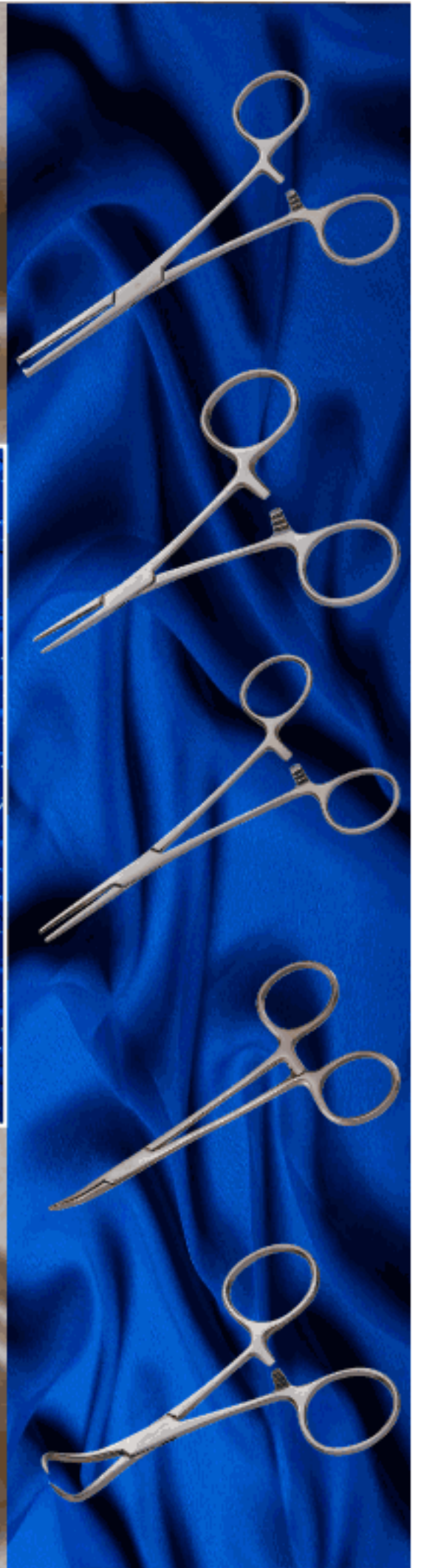
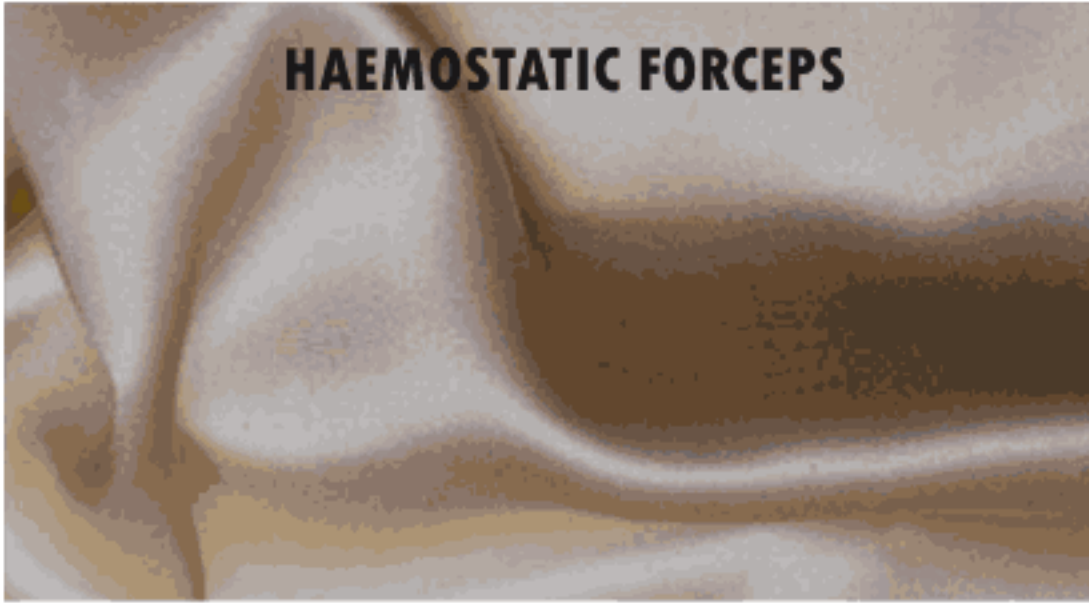

Arterienklemmen

Pinzas Hemostaticas

Pinces Hemostatiques

Pinze Emostatiche



Mosquito Haemostatic Forceps



F6-001
11.3 cm, 4 1/2"
straight, serrated



F6-002
11.3 cm, 4 1/2",
curved, serrated



F6-003
11.3 cm, 4 1/2" , straight
Haemostatic tissue
(rat tooth 1x2 teeth)



F6-004
11.3 cm, 4 1/2" , curved
Haemostatic tissue
(rat tooth 1x2 teeth)



Halsted-Mosquito
Haemostatic Forceps



F6-005 12.5 cm, 5"
F6-006 20 cm, 8"
straight



F6-007 12.5 cm, 5"
F6-008 20 cm, 8"
curved



F6-009 12.5 cm, 5"
F6-010 20 cm, 8"
straight Left Handed



F6-011 12.5 cm, 5"
F6-012 20 cm, 8"
curved Left Handed



Halsted-Mosquito
Haemostatic Forceps

Arterienklemmen
Pincas Hemostatiques

Pinzas Hemostaticas
Pinze Emostatiche



Kelly Haemostatic Forceps



F6-013
14.0 cm, 5 1/2"
straight



F6-014
14.0 cm, 5 1/2"
curved



F6-015
Kelly Haemostatic Fine
point Forceps 14.0 cm
5 1/2", straight



F6-016
Kelly Haemostatic Fine
point Forceps 14.0 cm
5 1/2", curved



Dandy Haemostatic Forceps
F6-017 14.0 cm, 5 1/2"
Curved sideways



**Dandy Haemostatic
Fine point Forceps**
F6-018 14.0 cm, 5 1/2"
Curved sideways



**Dandy Haemostatic
Tissue Forceps**
F6-019 14.0 cm, 5 1/2"
(rat tooth 1x2 teeth)
Curved sideways



**Dandy Haemostatic Fine
point Tissue Forceps**
F6-020 14.0 cm, 5 1/2"
(rat tooth 1x2 teeth)
Curved sideways

Arterienklemmen
Pinces Hemostatiques

Pinzas Hemostaticas
Pinze Emostatiche

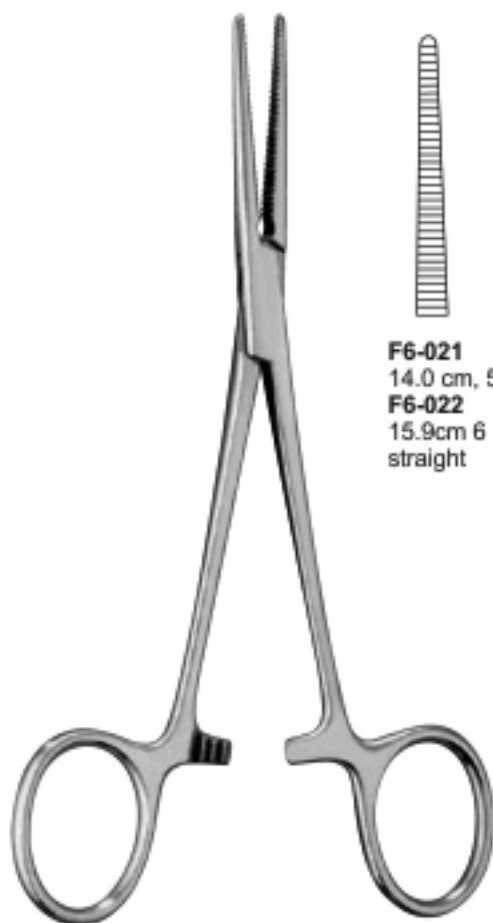

Crile Haemostatic Forceps

F6-021
14.0 cm, 5 1/2"
F6-022
15.9cm 6 1/4"
straight



F6-023
14.0 cm, 5 1/2"
F6-024
15.9cm 6 1/4"
curved



Crile Haemostatic Tissue Forceps

F6-025
14.0 cm, 5 1/2"
(rat tooth 1x2 teeth)
(KOCHER) straight



F6-026
14.0 cm, 5 1/2"
(rat tooth 1x2 teeth)
(KOCHER) curved

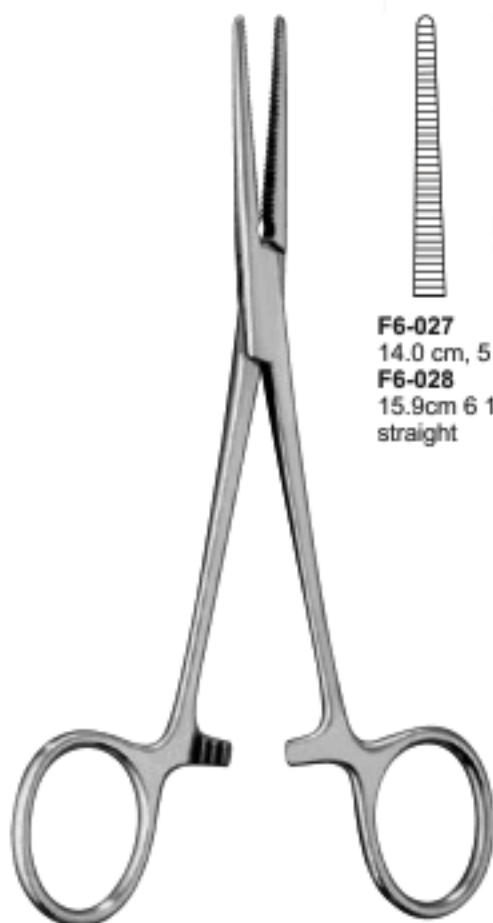

Crile Haemostatic Fine Point Forceps

F6-027
14.0 cm, 5 1/2"
F6-028
15.9cm 6 1/4"
straight



F6-029
14.0 cm, 5 1/2"
F6-030
15.9cm 6 1/4"
curved

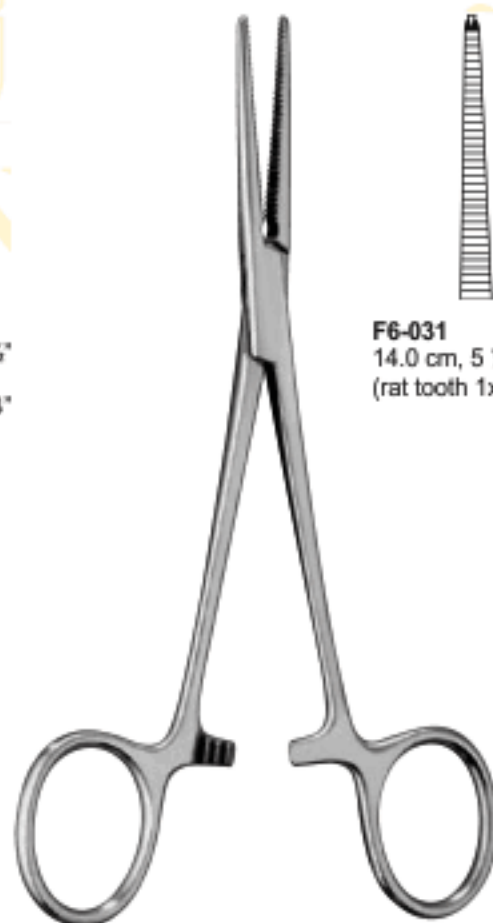

Crile Haemostatic Fine Point Tissue Forceps

F6-031
14.0 cm, 5 1/2" straight
(rat tooth 1x2 teeth)



F6-032
14.0 cm, 5 1/2" curved
(rat tooth 1x2 teeth)



Arterienklemmen
Pinces Hemostatiques

Pinzas Hemostaticas
Pinze Emostatiche



F6-033
18.5 cm , 7.25"
straight



F6-034
18.5 cm , 7.25"
curved

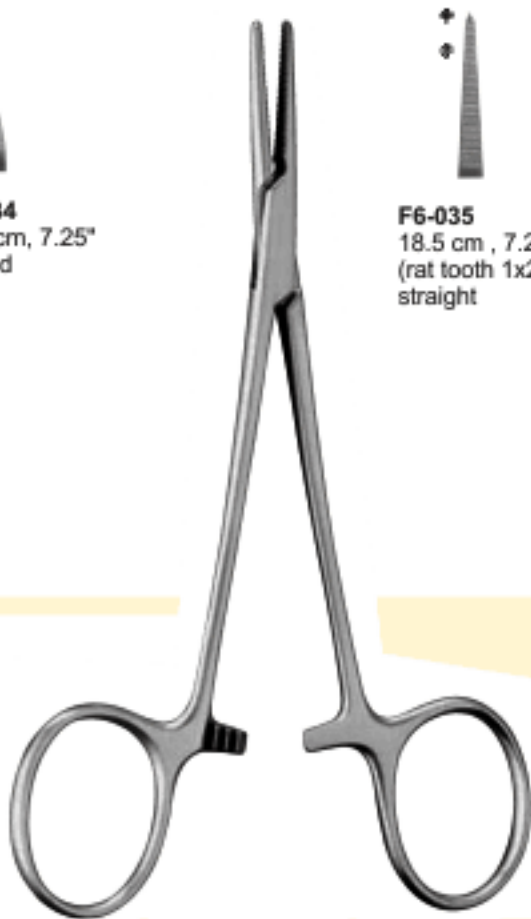

F6-035
18.5 cm , 7.25"
(rat tooth 1x2 teeth)
straight

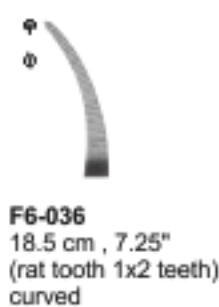

F6-036
18.5 cm , 7.25"
(rat tooth 1x2 teeth)
curved

Halsted Haemostatic Forceps

Halsted Haemostatic Tissue Forceps



F6-037
18.5 cm , 7.25"
straight



F6-038
18.5 cm , 7.25"
curved



F6-039
18.5 cm , 7.25"
(rat tooth 1x2 teeth)
straight

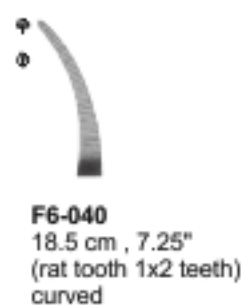

F6-040
18.5 cm , 7.25"
(rat tooth 1x2 teeth)
curved

Halsted Haemostatic Fine point Forceps

Halsted Haemostatic Fine Point Tissue Forceps

Arterienklemmen
Pincas Hemostatiques

Pinzas Hemostaticas
Pinze Emostatiche



Packer Mosquito Forceps
F6-041 5", 12.7cm
curved, flat jaws



Coller Haemostatic Forceps



F6-042 14 cm, 5 1/2"
F6-043 16 cm, 6 1/4"
Straight, serrated



F6-044 14 cm, 5 1/2"
F6-045 16 cm, 6 1/4"
Curved, serrated



Christophe Haemostatic Forceps



F6-046 13.0 cm, 5"
F6-047 15.0 cm, 6"
Curved, Serrated



Saroot Haemostatic Forceps



F6-048 24 cm, 9 1/2"
Straight, Serrated



F6-049 24 cm, 9 1/2"
Curved Serrated

Arterienklemmen
Pincas Hemostatiques

Pinzas Hemostaticas
Pinze Emostatiche



Adson Haemostatic Fine point Forceps

F6-050
18.5 cm, 7 1/4"
straight



F6-051
18.5 cm, 7 1/4"
curved



Adson Haemostatic Tissue Forceps

F6-052
18.5 cm, 7 1/4" straight
(rat tooth 1x2 teeth)

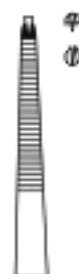

F6-053
18.5 cm, 7 1/4" Curved
(rat tooth 1x2 teeth)



O'Shaugnessy Haemostatic Forceps

F6-054 15 cm, 6"
F6-055 20 cm, 8"
Curved



F6-056 15 cm, 6"
F6-057 20 cm, 8"
Curved Fine Point



Cairns Haemostatic Forceps

F6-058
14.5 cm, 5 3/4" Straight,
box joint, as above but
curved on flat.



Arterienklemmen
Pincas Hemostatiques

Pinzas Hemostaticas
Pinze Emostatiche



**Pean Haemostatic Forceps
Slender Type**

F6-059 13.0 cm, 5"
F6-060 14.0 cm, 5 1/2"
straight



F6-061 13.0 cm, 5"
F6-062 14.0 cm, 5 1/2"
curved

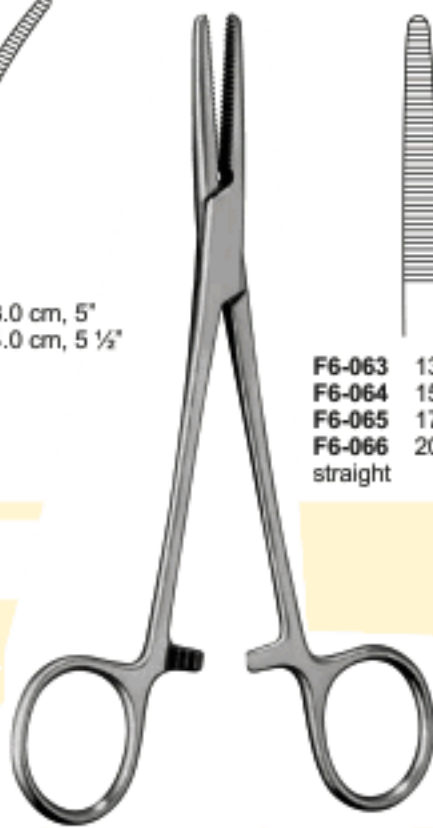

**Spencer-Wells Haemostatic Forceps
Slender Type**

F6-063 13.0 cm, 5"
F6-064 15.0 cm, 6"
F6-065 17.5 cm, 7"
F6-066 20 cm, 8"
straight



F6-067 13.0 cm, 5"
F6-068 15.0 cm, 6"
F6-069 17.5 cm, 7"
F6-070 20 cm, 8"
curved

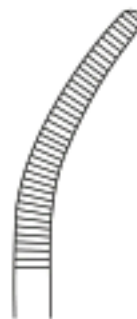

**Kocher Haemostatic
Forceps Strong Pattern**

F6-071
14.5cm, 5 3/4"
Straight



**Kocher Haemostatic Forceps
1x2 teeth**

F6-072 13cm, 5"
F6-073 14cm, 5 1/2"
straight



F6-074 13cm, 5"
F6-075 14cm, 5 1/2"
curved

















Arterienklemmen
Pincas Hemostatiques

Pinzas Hemostaticas
Pinze Emostatiche

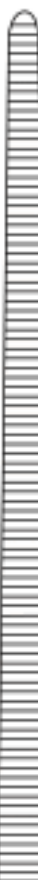

**Rochester-Pean
Haemostatic Forceps
Straight**

							
F6-076 14 cm, 5.5" straight	F6-077 16cm, 6 ¼" straight	F6-078 18.5cm, 7 ¼" straight	F6-079 20cm, 8" straight	F6-080 22.5cm, 9" straight	F6-081 24cm, 9 ½" straight	F6-082 25.4 cm, 10" straight	F6-083 27.9 cm, 11" straight
							
F6-084 30.5 cm, 12" straight	F6-085 35.6 cm, 14" straight	F6-086 40.64 cm, 16" straight	F6-087 45.72 cm, 18" straight	F6-088 50.8 cm, 20" straight	F6-089 55.88 cm, 22" straight	F6-090 60.96 cm, 24" straight	

Arterienklemmen
Pincas Hemostatiques

Pinzas Hemostaticas
Pinze Emostatiche



**Rochester-Pean
Haemostatic Forceps
Curved**

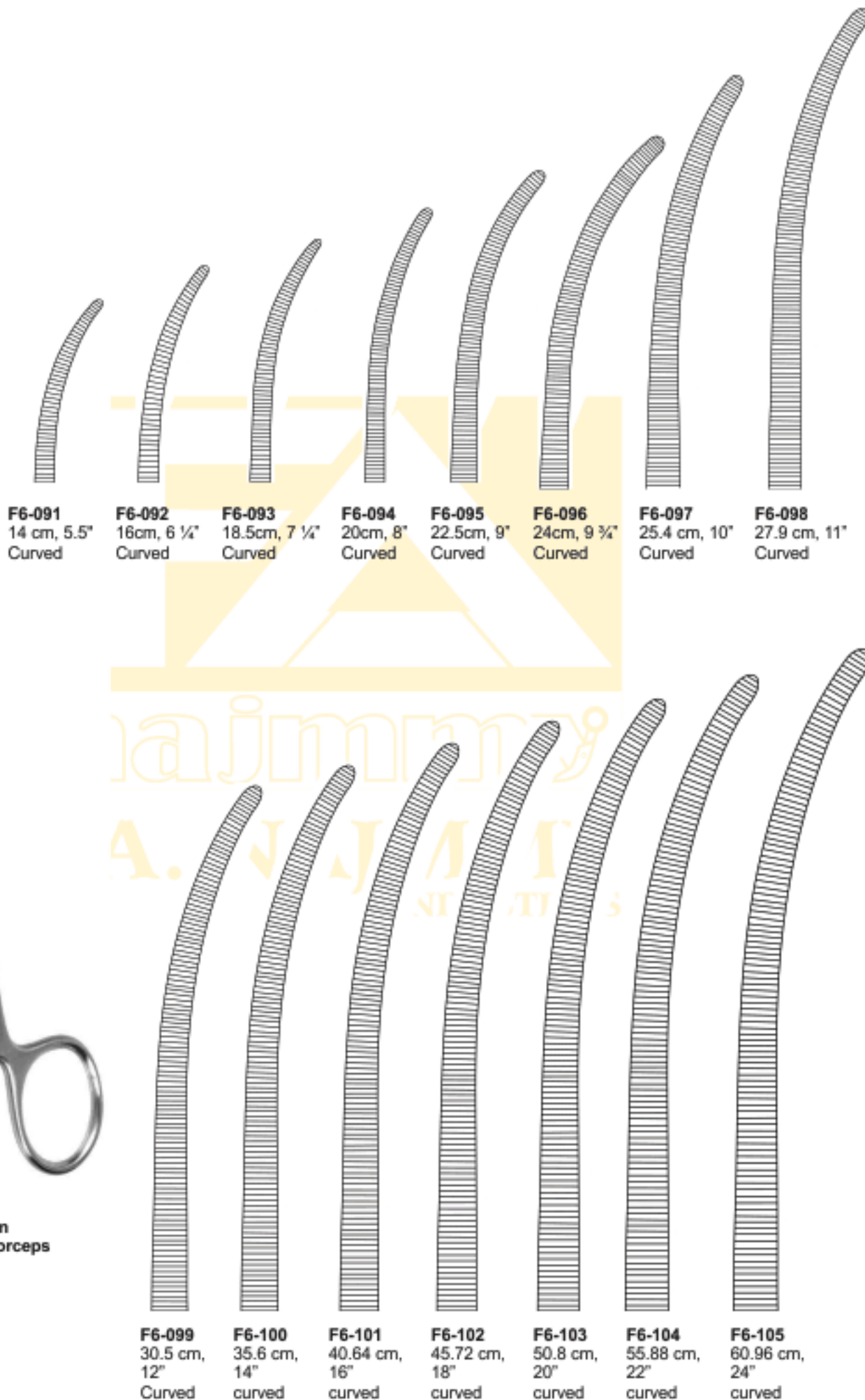

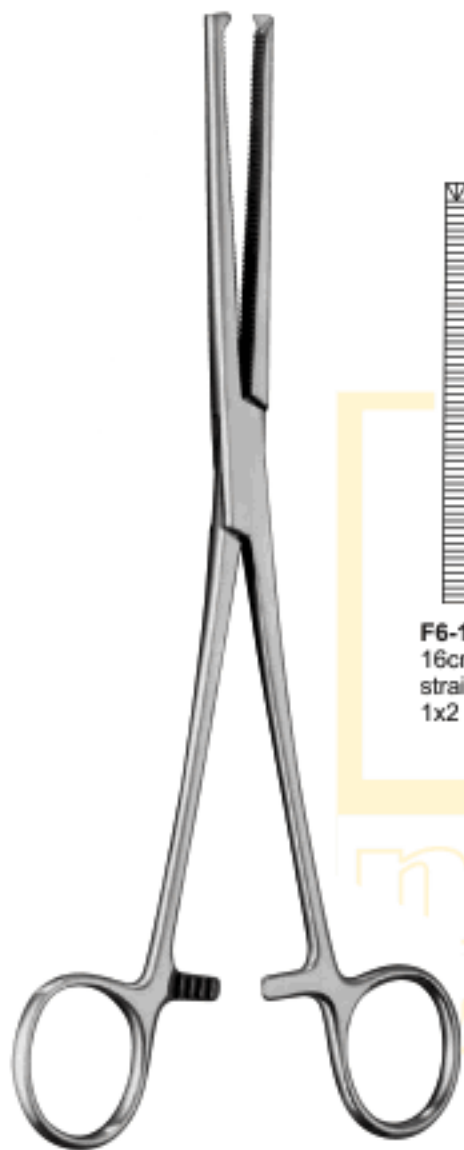

**Kocher-Ochsner
Haemostatic Forceps**
1x2 teeth



F6-106
16cm, 6 1/4"
straight
1x2 teeth



F6-107
18.5cm, 7 1/4"
straight
1x2 teeth



F6-108
20cm, 8"
straight
1x2 teeth



F6-109
22.5cm, 9"
straight
1x2 teeth



F6-110
24.0cm, 9 3/4"
straight
1x2 teeth



F6-111
26cm, 10 1/4"
straight
1x2 teeth

najmmy

A. NAJMMY

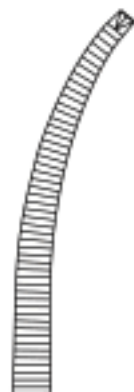

F6-112
16cm, 6 1/4"
Curved
1x2 teeth

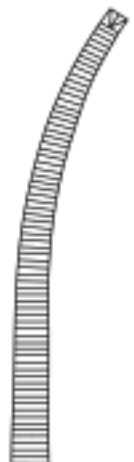

F6-113
18.5cm, 7 1/4"
Curved
1x2 teeth



F6-114
20cm, 8"
Curved
1x2 teeth

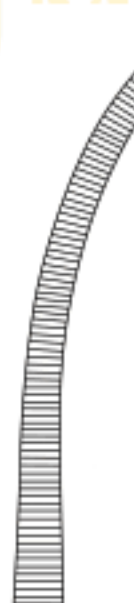

F6-115
22.5cm, 9"
Curved
1x2 teeth



F6-116
24.0cm, 9 3/4"
Curved
1x2 teeth

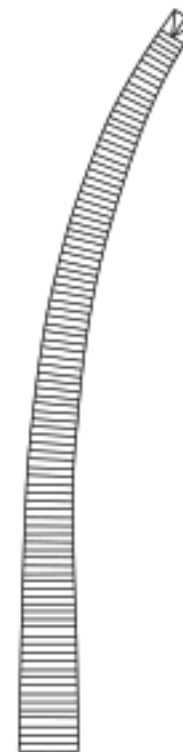

F6-117
26cm, 10 1/4"
Curved
1x2 teeth

Arterienklemmen

Pinzas Hemostaticas

Pinces Hemostatiques

Pinze Emostatiche



F6-118
15.9cm, 6 1/4"
F6-119
20.3cm 8"
Straight



**Rochester-Ochsner
Haemostatic Forceps**



F6-120
14cm, 5 1/2"
1x2 teeth
Straight



F6-121
14cm, 5 1/2"
1x2 teeth
Curved

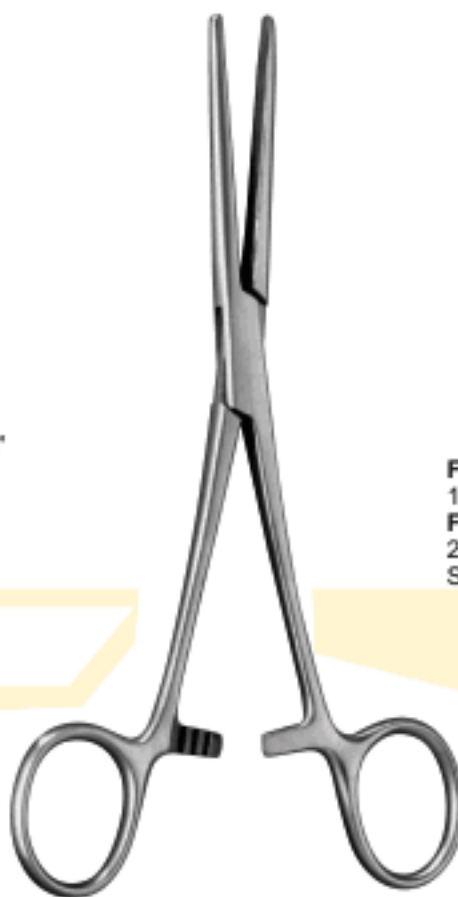

**Rochester-Carmalt
Haemostatic Forceps**



F6-122
16 cm, 6 1/4"
F6-123
20 cm, 8"
Straight



F6-124
16 cm, 6 1/4"
F6-125
20 cm, 8"
Curved

najr

F.A.

ny

M
STR

F6-126
23 cm, 9"



F6-127
24 cm, 9 3/4"

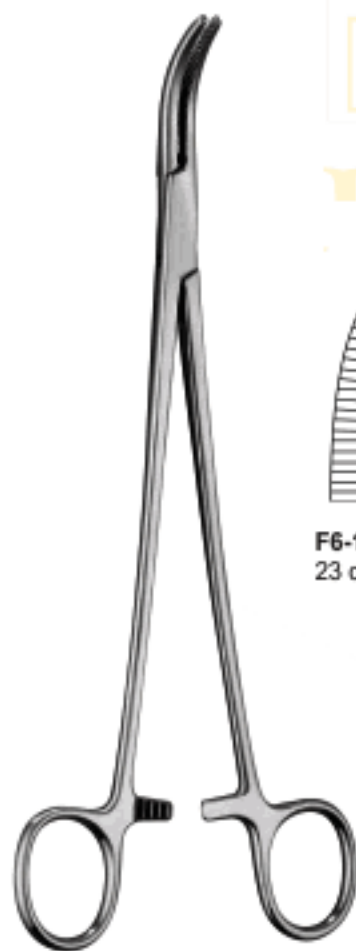
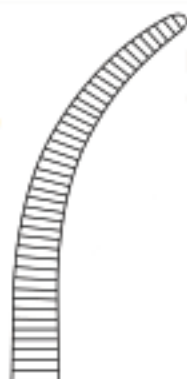

Moynihan Haemostatic Forceps

F6-128
19.5 cm, 7 3/4"



F6-129
19.5 cm, 7 3/4"

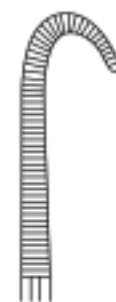

Negus Haemostatic Forceps

Arterienklemmen
Pinces Hemostatiques

Pinzas Hemostaticas
Pinze Emostatiche

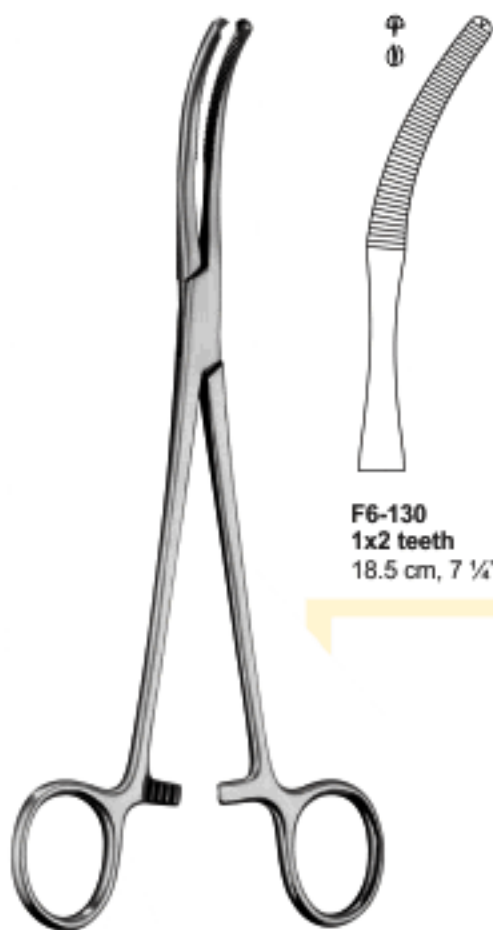

F6-130
1x2 teeth
18.5 cm, 7 1/4"



F6-131
Serrated
21.5 cm, 8 1/2"

F6-132
1x2 teeth
21.5 cm, 8 1/2"

Mikulicz Haemostatic Tissue Forceps

Halsted Haemostatic Forceps

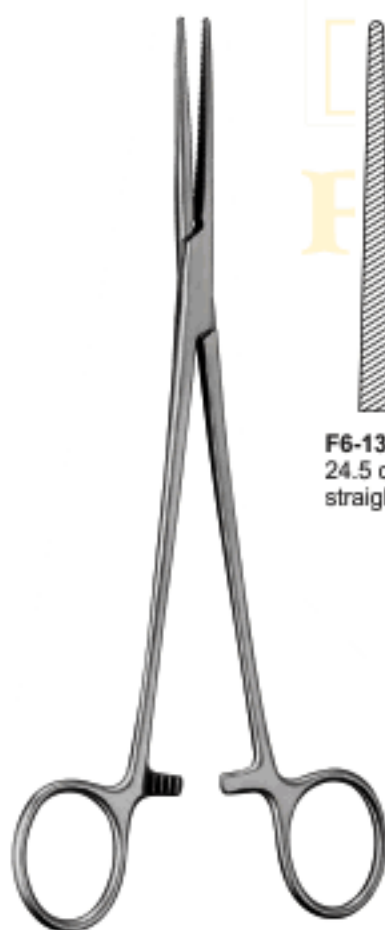

F6-133
24.5 cm, 9 3/4"
straight

Bengolea Haemostatic Forceps



F6-134
24.5 cm, 9 3/4"
Curved



F6-135
24.5 cm, 9 3/4"
straight

Bengolea Haemostatic Tissue Forceps
(rat tooth 1x2 teeth)

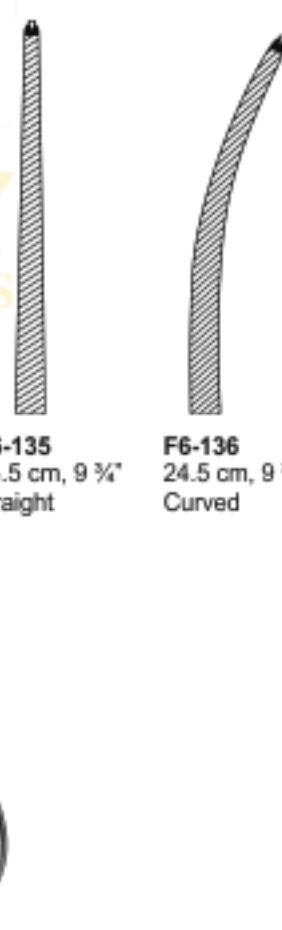

F6-136
24.5 cm, 9 3/4"
Curved

Arterienklemmen
Pincas Hemostatiques

Pinzas Hemostaticas
Pinze Emostatiche



Mixer-O'Shaugnessy
Haemostatic Forceps

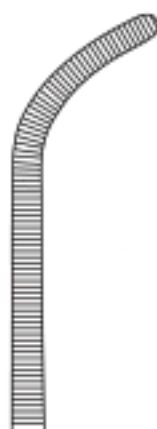

- F6-137 14 cm, 5 1/2"
- F6-138 16.5 cm, 6 1/2"
- F6-139 19 cm, 7 1/2"
- F6-140 21.5 cm, 8 1/2"
- F6-141 24 cm, 9 1/2"



Mixer-O'Shaugnessy
Haemostatic Forceps

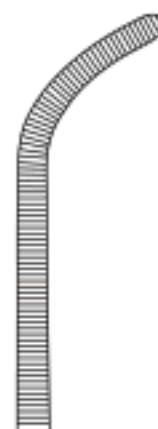

- F6-142 14 cm, 5 1/2"
 - F6-143 16.5 cm, 6 1/2"
 - F6-144 19 cm, 7 1/2"
 - F6-145 21.5 cm, 8 1/2"
 - F6-146 24 cm, 9 1/2"
- Fine Point



- Mixer-O'Shaugnessy
Haemostatic Forceps
- F6-147 14cm, 5 1/2"
 - F6-148 16.5cm, 6 1/2"
 - F6-149 19cm, 7 1/2"
 - F6-150 21.5cm, 8 1/2"
 - F6-151 24cm, 9 1/2"
- micro point



Craford Haemostatic Forceps

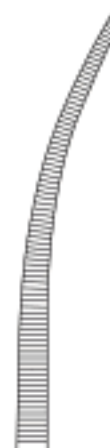

- F6-152 24.5 cm, 9 3/4"

Arterienklemmen
Pincas Hemostatiques

Pinzas Hemostaticas
Pinze Emostatiche



Herrick Haemostatic Forceps
F6-153 23.0 cm, 9"



Roberts Haemostatic Forceps

F6-154
22.0 cm, 8 3/4"
straight

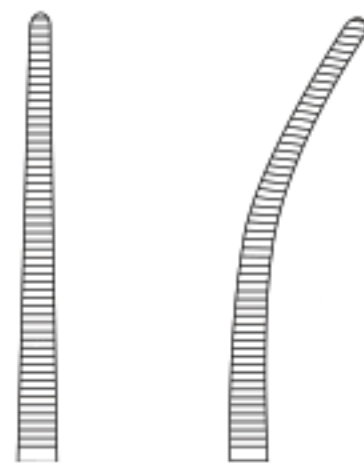

F6-155
22.0 cm, 8 3/4"
Curved



**Crafoord-Sellors
Haemostatic Forceps**

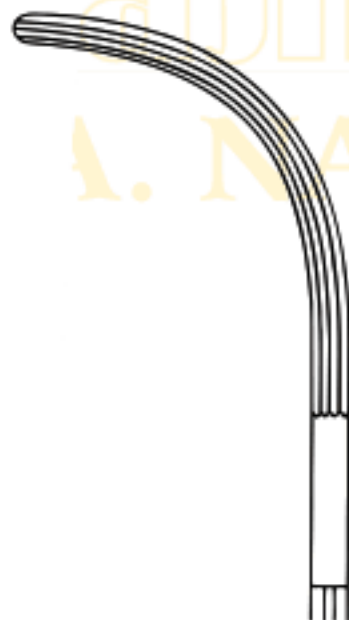

F6-156
22.0 cm, 8 3/4"



F6-157
23.0 cm, 9"



F6-158
24.0 cm, 9 1/2"

Arterienklemmen
Pincas Hemostatiques

Pinzas Hemostaticas
Pinze Emostatiche



F6-159
20 cm, 8"
Straight,
Serrated



F6-160
20 cm, 8"
Slight Curve,
Serrated



F6-161 21 cm, 8 1/2"
Straight, Cross Serrated
F6-162 21 cm, 8 1/2"
Slight curved, Cross
Serrated

**Heaney / Ballantine
Haemostatic Forceps**

**Heaney / Rezak
Haemostatic Forceps**

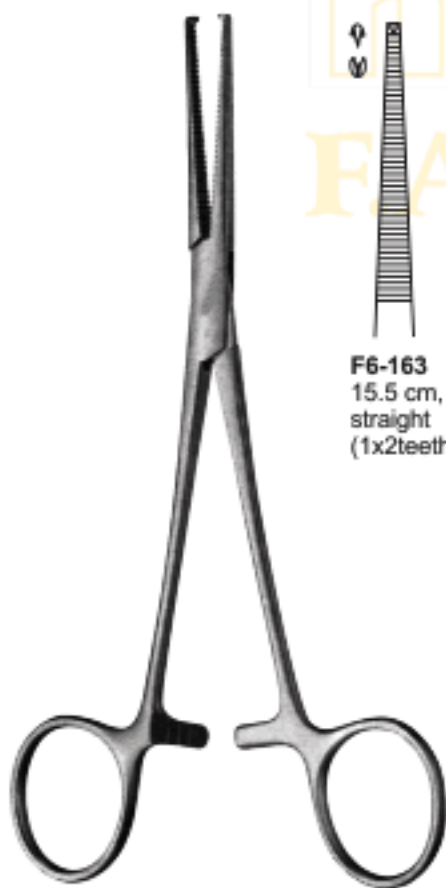

F6-163
15.5 cm, 6"
straight
(1x2teeth)



F6-164
15.5 cm, 6"
Curved
(1x2teeth)

**Dixon-Lovelace
Haemostatic Tissue Forceps**

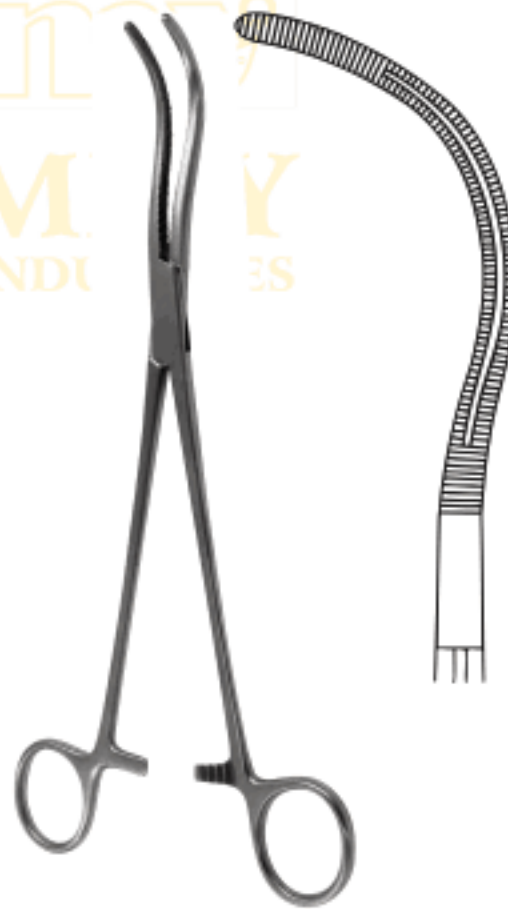

**Stille Haemostatic Forceps
F6-165** 23 cm, 9"

Arterienklemmen
Pincas Hemostatiques

Pinzas Hemostaticas
Pinze Emostatiche

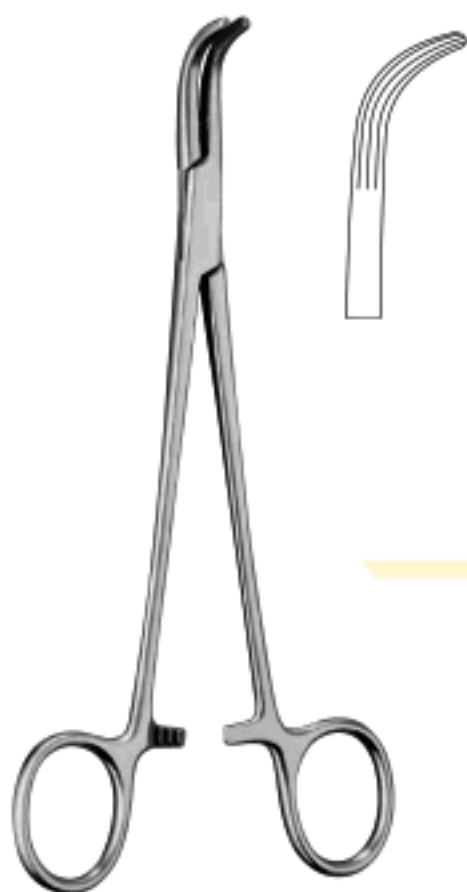

Lower Haemostatic Forceps
F6-166 18cm, 7"

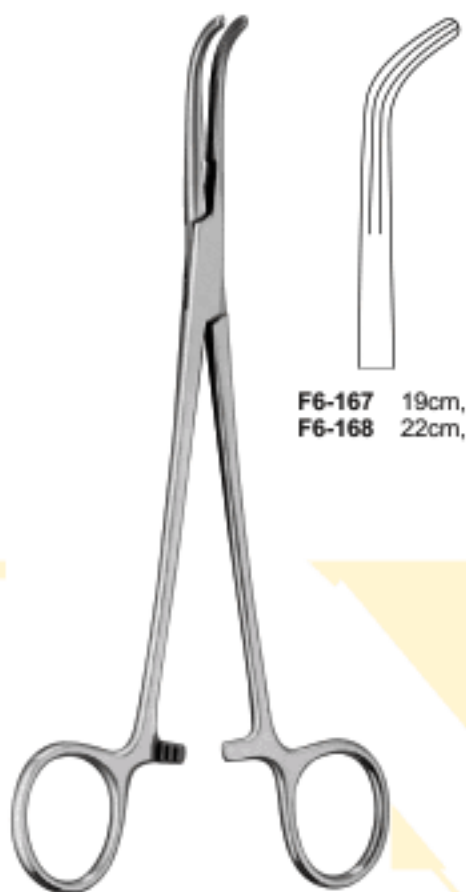

F6-167 19cm, 7 1/2"
F6-168 22cm, 8 1/4"

Lahey (Sweet) Haemostatic Forceps



Desjardins Haemostatic Forceps
F6-169 22cm, 8 1/2"



F6-170
22cm, 8 3/4"

Mixer Haemostatic Gall Duct Forceps



F6-171
25cm, 10"

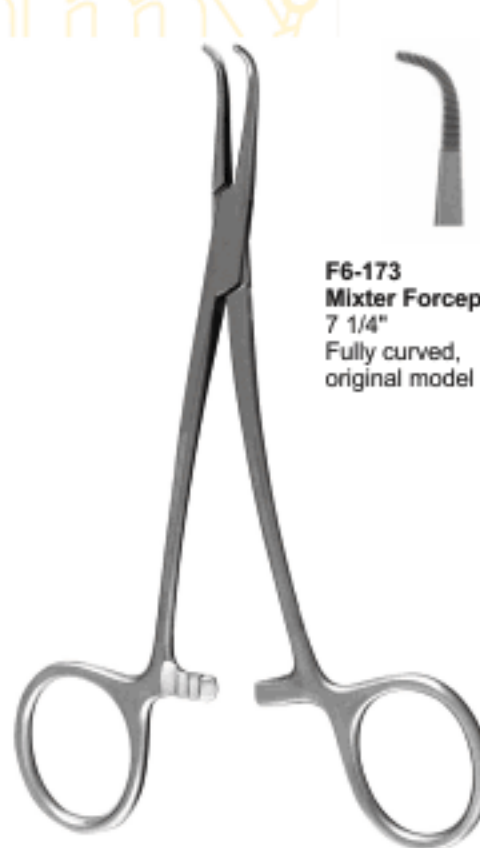

F6-173
Mixer Forceps, 18.4 cm
7 1/4"
Fully curved,
original model

Mixer Forceps, Lee Modif
F6-172 13.3 cm , 5.25"
Curved jaws and angled
shanks, delicate

Arterienklemmen
Pincas Hemostaticas

Pinzas Hemostaticas
Pinze Emostatiche



Heaney Haemostatic Forceps

F6-174

19.5 cm, 7 1/2"



F6-175

21.5 cm, 8 1/2"



F6-176

24 cm, 9 1/2"

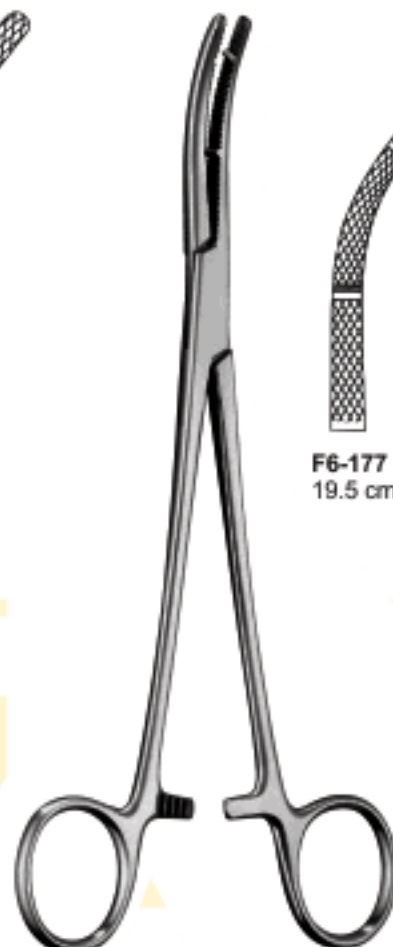

Heaney Modif. Haemostatic Forceps

F6-177

19.5 cm, 7 1/2"



F6-178

21.5 cm, 8 1/2"



F6-179

24 cm, 9 1/2"

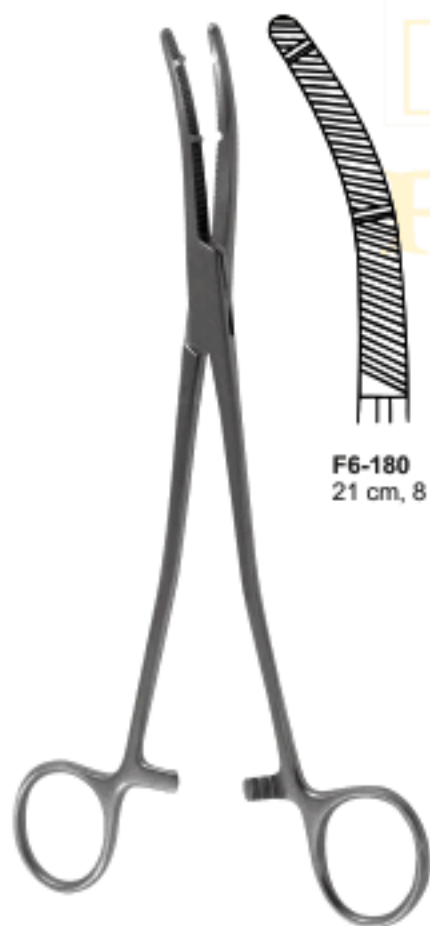

Heaney-Kanter Haemostatic Forceps

F6-180

21 cm, 8 1/4"

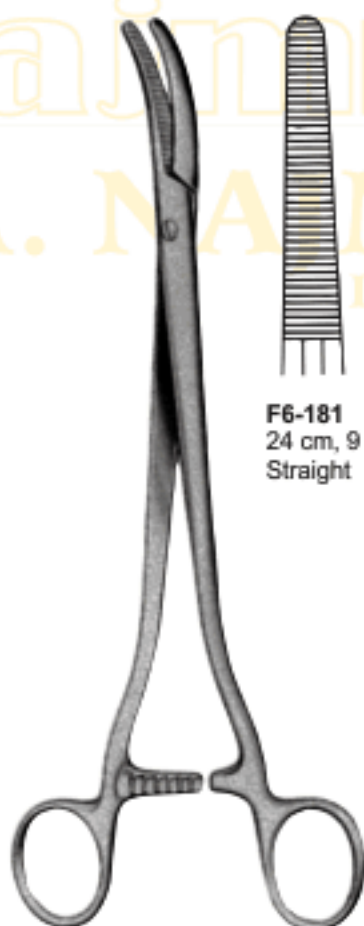

Segond-Landau Haemostatic Forceps

F6-181

24 cm, 9 1/2"

Straight



F6-182

24 cm, 9 1/2"

Curved



Schindler Haemostatic Tissue Forceps

F6-183

1x2 teeth

20 cm, 8"



Arterienklemmen
Pincas Hemostatiques

Pinzas Hemostaticas
Pinze Emostatiche



Parametrium Haemostatic Forceps

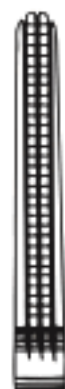

F6-184
21 cm, 8 1/4"
Straight



F6-185
21 cm, 8 1/4"
25° Angled



F6-186
21 cm, 8 1/4"
45° Angled

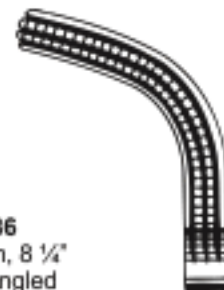

F6-187
21 cm, 8 1/4"
90° Angled



F6-188
24 cm, 9 1/2"
Straight



F6-189
24 cm, 9 1/2"
25° Angled



F6-190
24 cm, 9 1/2"
45° Angled



F6-191
24 cm, 9 1/2"
90° Angled



Bozemann Haemostatic Forceps



F6-192
26 cm, 10 1/4"
Curved, Serrated



Bozemann Haemostatic Forceps



F6-193
26 cm, 10 1/4"
Straight



Westermark Haemostatic Forceps

F6-194
23 cm, 9"
Straight

Arterienklemmen
Pinces Hemostatiques

Pinzas Hemostaticas
Pinze Emostatiche



F6-195
1x2 teeth
21.5 cm, 8 1/2"
Straight



F6-196
1x2 teeth
21.5 cm, 8 1/2"
Hard Curved



F6-197
1x2 teeth
19.0 cm, 7 1/2"
Curved



F6-198
1x2 teeth
19.0 cm, 7 1/2"
Straight

Phaneuf Haemostatic Tissue Forceps

Long Haemostatic Tissue Forceps



F6-199
1x2 teeth
14 cm, 5 1/2"



F6-200
1x2 teeth
18.5cm, 7 1/4"



Baby-Mikulicz Haemostatic Tissue Forceps

Mikulicz Haemostatic Tissue Forceps

Arterienklemmen
Pincas Hemostatiques

Pinzas Hemostaticas
Pinze Emostatiche



F6-201
1x2 teeth
20.5cm, 8"

Mikulicz Haemostatic Tissue Forceps



F6-202
1x2 teeth
20.5cm, 8"

Mikulicz Haemostatic Tissue Forceps



F6-203
1x2 teeth
20.5cm, 8"

Mikulicz Haemostatic Tissue Forceps



F6-204
1x2 teeth
20.5cm, 8"

Faure Haemostatic Tissue Forceps

Arterienklemmen
Pincas Hemostatiques

Pinzas Hemostaticas
Pinze Emostatiche



F6-205
1x2 teeth
23.5cm, 9 1/4"

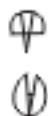

F6-206
1x2 teeth
24.5cm, 9 3/4"

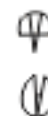

Wertheim Haemostatic
Tissue Forceps

Wertheim Haemostatic
Tissue Forceps



Heaney Atraumata
Hysterectomy Forceps



F6-207
22.5cm, 9"
Straight



F6-208
22.5cm, 9"
25° Angled



F6-209
21.5cm, 8 1/2"
45° Angled



F6-210
20.5cm, 8"
90° Angled

Arterienklemmen
Pincas Hemostatiques

Pinzas Hemostaticas
Pinze Emostatiche



Wertheim Parametrium Clamps



F6-211
25cm, 10"
Straight



F6-212
24.5cm, 9 3/4"
25° Angled



F6-213
24cm, 9 1/2"
45° Angled



F6-214
22cm, 8 3/4"
90° Angled



Wertheim Hysterectomy Forceps



F6-215
25.5cm, 10"



Wertheim Parametrium Clamp



F6-216
26cm, 10 1/4"



Gemini Mixer Hemostatic Forceps
F6-217 5 1/2"
F6-218 7"
full curve, delicate

Arterienklemmen
Pincas Hemostatiques

Pinzas Hemostaticas
Pinze Emostatiche



Dick Haemostatic Forceps



F6-219
25.5cm, 10"

F6-220
26.5cm, 10 1/2"

F6-221
27.5cm, 10 3/4"



F6-222
21.5cm, 8 1/2"



Wertheim-Cullen
Haemostatic Forceps

najimmy
F.A. NAJIMMY
INDUSTRIES



Wertheim-Cullen Haemostatic
Forceps
23cm, 9"

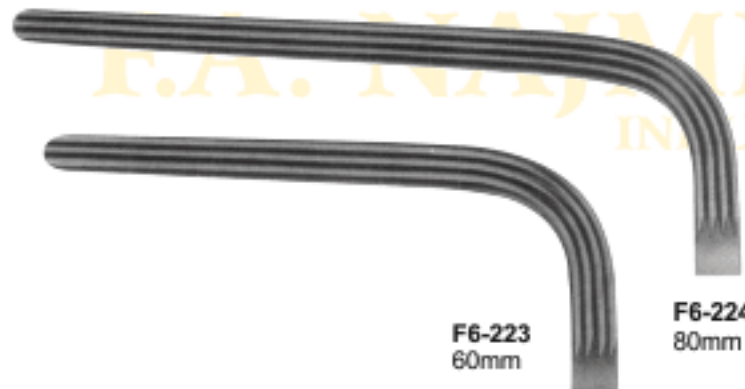

F6-223
60mm

F6-224
80mm



F6-225
25cm, 10"



Wertheim Haemostatic Forceps

Tuchklemmen	Pinces à champs
Pinzas de campo	Pinze fissatele



**Jones / Perforating
Towel Forceps**
F6-226 9 cm, 3 1/2"
Slight Curve



**Engl. Modell
Towel Forceps**
F6-227
9 cm, 3 1/2"



**Schaedel Towel
Forceps**
F6-228
9 cm, 3 1/2"

najmmy

A. NAJM
INDU

Y
ES



**Thomson-Walker's
Penile Clamps**
F6-229 9 cm, 3 1/2"
Cross-Action model.



Doyen Towel Forceps
F6-230 18 cm, 7"

Tuchklemmen	Pinces à champs
Pinzas de campo	Pinze fissatele

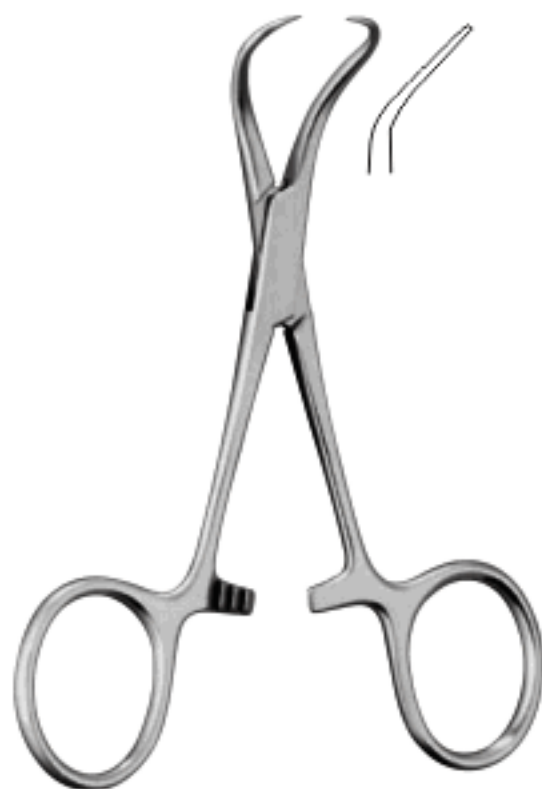

Backhaus Towel Forceps

F6-231 8 cm, 3"
F6-232 11 cm, 4 1/2"
F6-233 13 cm, 5"
F6-234 15 cm, 5 3/4"
Curved



Backhaus Clip Towel Forceps

F6-235 11 cm, 4 1/2"
with clip for tubing or cable



Roeder Towel Forceps

F6-236 13 cm, 5"
F6-237 15 cm, 6"
Curved, Serrated



Lorna Towel Forceps

F6-238 9.0 cm, 3 1/2"
F6-239 11.4 cm, 4 1/2"
F6-240 13.5 cm, 5 1/4"



Ball & Socket Towel Forceps

F6-241 13 cm, 5"
Non-perforating



Tohoku Towel Forceps

F6-242 10cm, 4"
F6-243 13cm, 5"
Non-Perforating

Arterienklemmen
Pincas Hemostatiques

Pinzas Hemostaticas
Pinze Emostatiche



Non-Perforating Towel Forceps
F6-244 11 cm, 4 1/2"
F6-245 13 cm, 5"



Peers-Bertman Towel Forceps
F6-246 14.5 cm, 5 3/4"
Serrated



Bernhard Towel Forceps
F6-247
16.5 cm, 6 1/2"



Presbyterian Tubing Clamp
F6-248 16.5 cm, 6 1/2"
F6-249 18 cm, 7"
Straight, Smooth



Tubing Clamp
F6-250 18 cm, 7"
F6-251 20 cm, 8"
Cross Serrated



Arterienklemmen
Pincas Hemostaticas

Pinzas Hemostaticas
Pinze Emostatiche

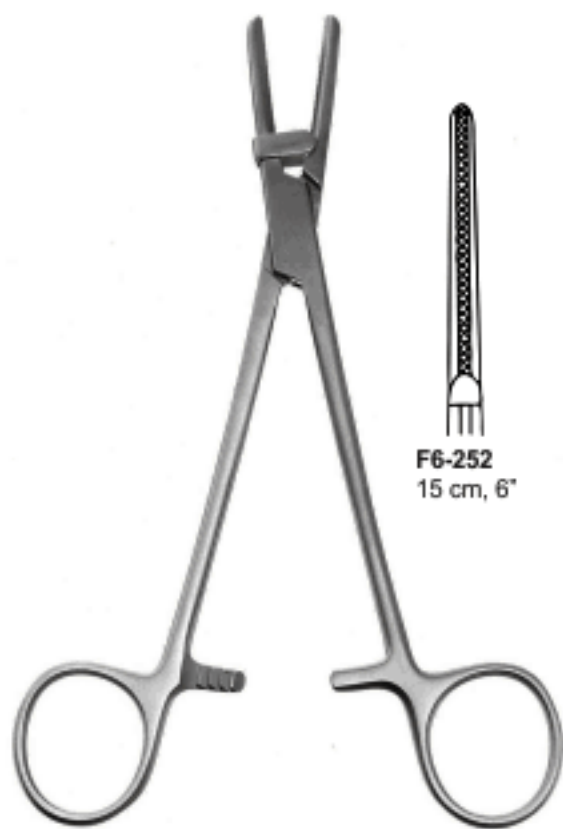

Tubing Clump with Protector,
Cross Serrated



F6-252
15 cm, 6"



F6-253
18 cm, 7"



F6-254
20 cm, 8"



Klinikum Berlin Tubing Clamp



F6-255 14.5 cm, 5 1/2"
with long ratchet



Fergusson Tubing Clamp



F6-256
16 cm, 6 1/4"

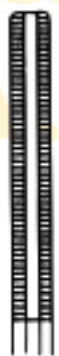

F6-257
20 cm, 8"



F6-258
16 cm, 6 1/4"



F6-259
20 cm, 8"



Fricke Artery Forceps
F6-260 13cm, 5 1/4"



Arterienklemmen
Pincas Hemostatiques

Pinzas Hemostaticas
Pinze Emostatiche



Tuffier Haemostatic Forceps
F6-261 13.0 cm, 5"



Chaput Haemostatic Forceps
F6-262 13.0 cm, 5"



Martel Haemostatic Forceps
F6-263 14.0 cm, 5 1/2"

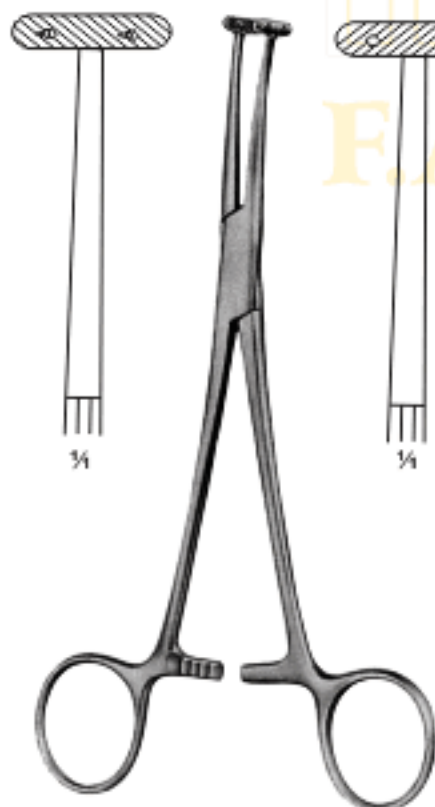

Willet-Martel Haemostatic Forceps
F6-264 19.0 cm, 7 1/2"



Pratt Haemostatic Forceps
F6-265 15 cm, 4 3/4"



Pennington / Sizing Haemostatic Forceps
F6-266 15.5 cm, 6"
F6-267 20 cm, 8"
Straight

Arterienklemmen
Pincas Hemostatiques

Pinzas Hemostaticas
Pinze Emostatiche

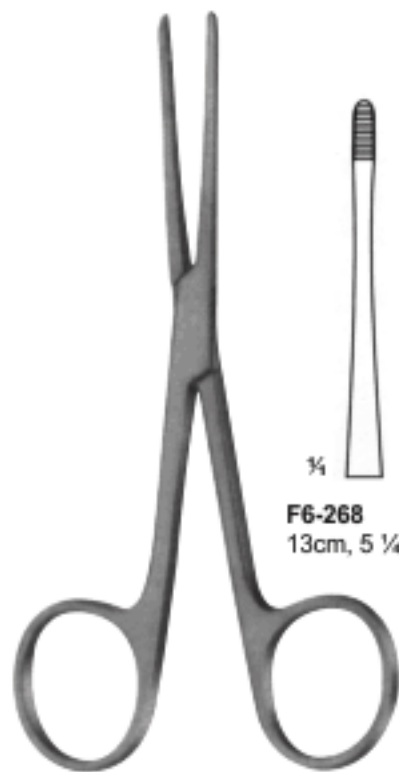

F6-268
13cm, 5 1/4"

Lister Sinus Forceps



F6-269 15.5cm, 6"
F6-270 17.5cm, 7"



F6-271
12.5cm,
4 3/4"

**Collin Dressing
Haemostatic Forceps**



F6-272
14cm, 5 1/2"

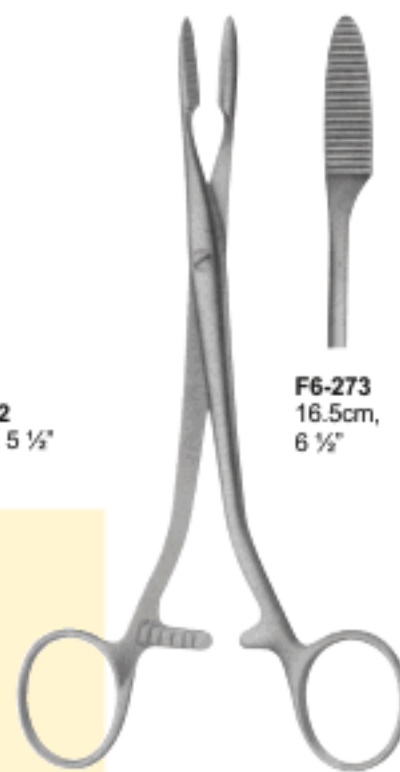

F6-273
16.5cm,
6 1/2"

**Colling Dressing
Haemostatic Forceps**



F6-274
18.5cm,
7 1/2"

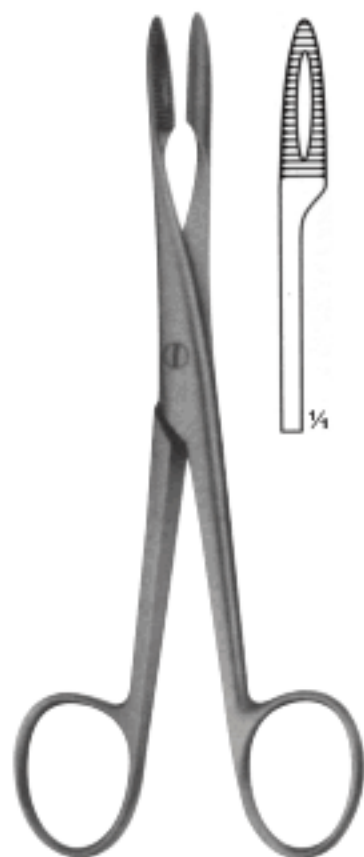

Gross Maier Dressing Forceps
F6-275 14.5cm, 5 3/4" straight
Without Ratchet



Gross Maier Dressing Forceps
F6-276 14.5cm, 5 3/4" straight
With Ratchet



Gross Maier Dressing Forceps
F6-277 14.5cm, 5 3/4" curved
With Ratchet

najimmy
F.A. NAJIMMY
INDUSTRIES

Arterienklemmen
Pincas Hemostatiques

Pinzas Hemostaticas
Pinze Emostatiche



Gross Maier Dressing Forceps
F6-278 14.5cm, 5 3/4" curved
With Ratchet

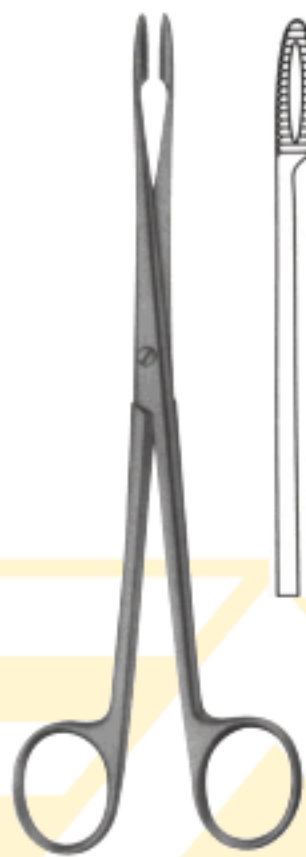

**Gross Maier Dressing
Sponge & Dressing Forceps**
F6-279 20.5 cm, 8" straight
Without Ratchet



**Gross Maier Dressing
Sponge & Dressing Forceps**
F6-280 17.8 cm, 7" straight
With Ratchet

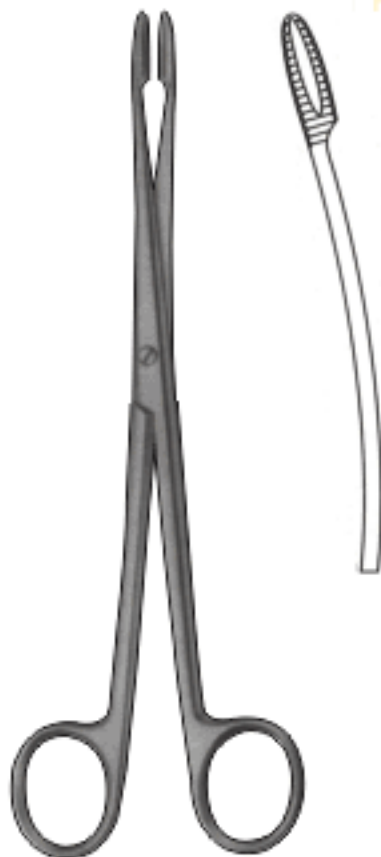

**Gross Maier Dressing
Sponge & Dressing Forceps**
F6-281 20.5 cm, 8" curved
Without Ratchet
(bullet holding forceps)



**Gross Maier Dressing
Sponge & Dressing Forceps**
F6-282 17.8 cm, 7" curved
With Ratchet



Gross Maier Dressing Forceps
F6-283 26.5cm, 10 1/2" straight
Without Ratchet
(bullet holding forceps)

najimmy
F.A. NAJIMMY
INDUSTRIES

Arterienklemmen
Pincas Hemostatiques

Pinzas Hemostaticas
Pinze Emostatiche



Gross Maier Dressing Forceps
F6-284 26.5cm, 10 1/2" straight
With Ratchet
(bullet holding forceps)

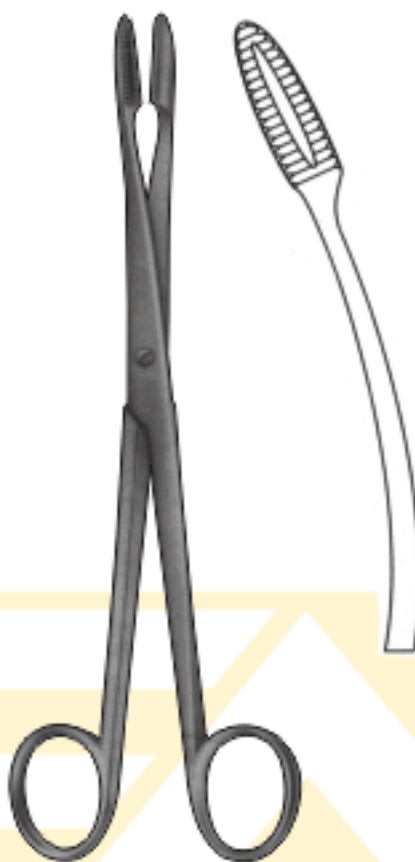

Gross Maier Dressing Forceps
F6-285 26.5cm, 10 1/2" curved
Without Ratchet
(bullet holding forceps)



Gross Maier Dressing Forceps
F6-286 26.5cm, 10 1/2" curved
With Ratchet
(bullet holding forceps)

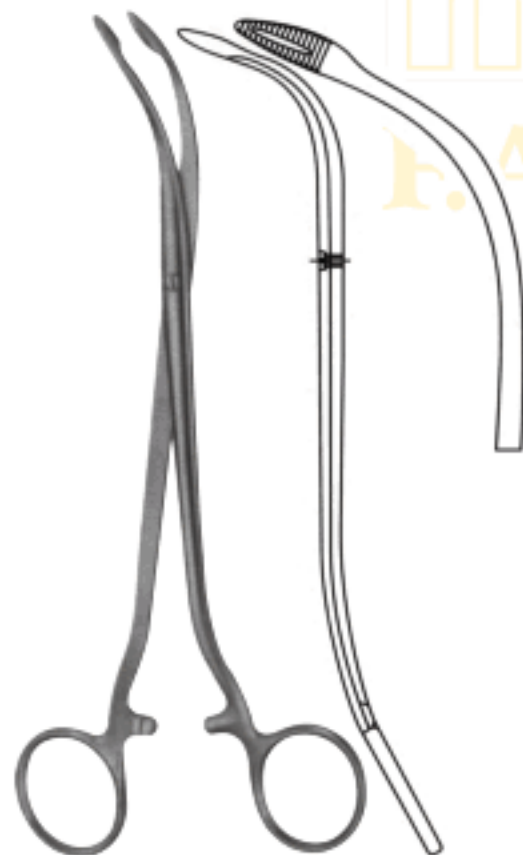

Duplay Sponge & Dressing Forceps
F6-287 19cm, 7 1/2"
Slight Curve

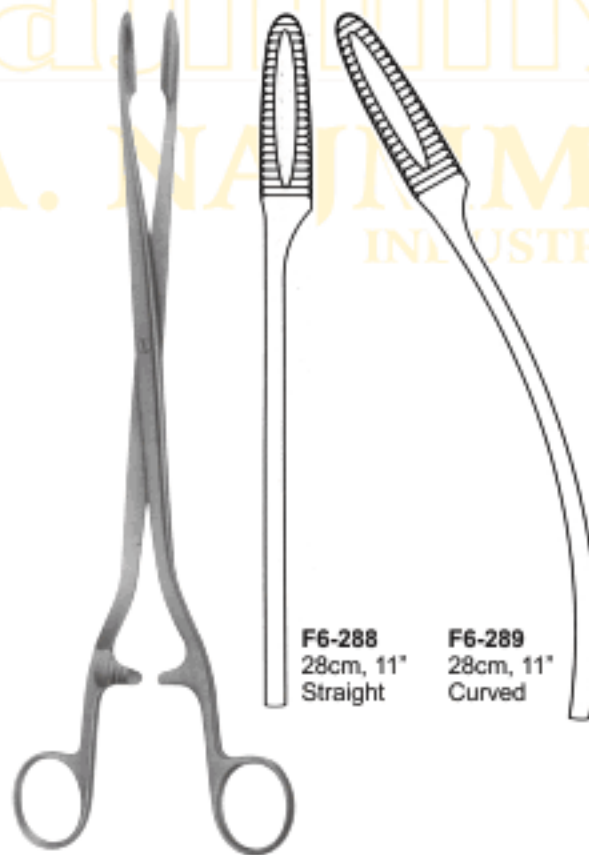

F6-288
28cm, 11"
Straight

F6-289
28cm, 11"
Curved

Sims-Maier Sponge & Dressing Forceps



F6-290
24cm, 9 1/2"

Collin Sponge & Dressing Forceps

Arterienklemmen
Pincas Hemostatiques

Pinzas Hemostaticas
Pinze Emostatiche

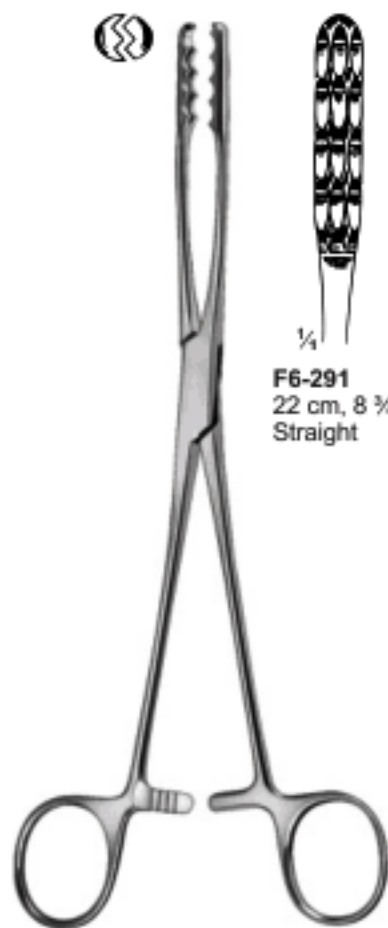

F6-291
22 cm, 8 3/4"
Straight

Ulrich Sponge Forceps

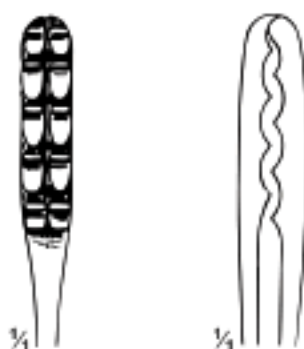

F6-292
25 cm, 10"
F6-293
27 cm, 11"
Straight



F6-294
22 cm, 8 3/4"
Curved

Ulrich Sponge Forceps



F6-295
25 cm, 10"
F6-296
27 cm, 11"
Curved



F6-297
22cm, 9 1/4"
Straight

Aesculap Sponge &
Dressing Forceps



F6-298
22cm, 9 1/4"
Curved



F6-299
24 cm, 9 1/2"
Straight

Fletcher Sponge Forceps



F6-300
24 cm, 9 1/2"
Slight Curve



Fletcher Sponge Forceps



Arterienklemmen
Pincas Hemostatiques

Pinzas Hemostaticas
Pinze Emostatiche



F6-301
25 cm, 10"
Straight

Pelkmann Sponge Forceps



F6-302
25 cm, 10"
Curved

Pelkmann Sponge Forceps

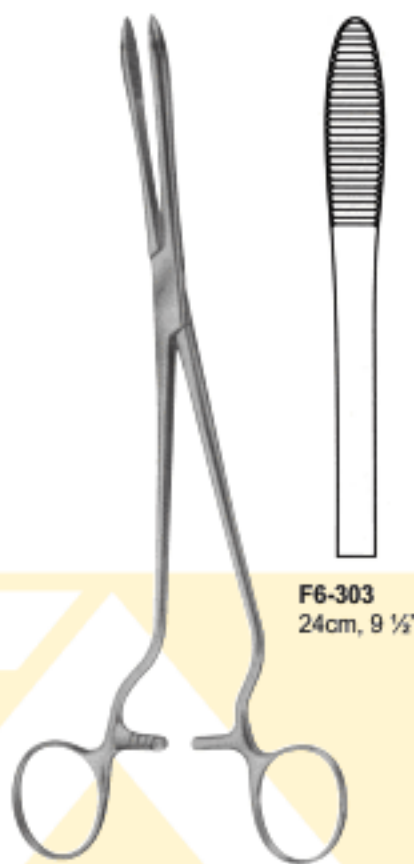

F6-303
24cm, 9 1/2"

Cheron Forceps
Handles Laterally
Angled



F6-304
20.5 cm, 8"
Straight

Duplay Sponge Forceps

najmmy
F.A. NAJMMY
INDUSTRIE

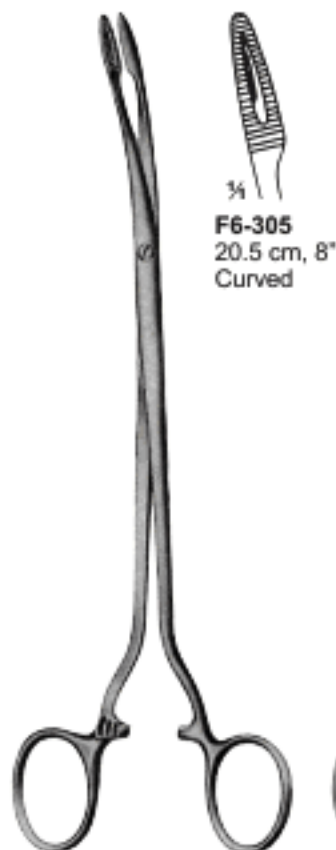

F6-305
20.5 cm, 8"
Curved

Duplay Sponge Forceps



**Heywood Smith
Sponge Forceps**
F6-306 25 cm, 10"



F6-307
21cm, 8 1/4"

**Emmet Sponge &
Dressing Forceps**



F6-308
15.5 cm, 6"

Tendon Seizing Forceps

Arterienklemmen
Pincas Hemostatiques

Pinzas Hemostaticas
Pinze Emostatiche



Herz Tendon Seizing Forceps



F6-309
15.5 cm, 6"
coarse serration



F6-310
15.5 cm, 6"
fine serrations



Noto Sponge & Dressing Forceps
F6-311 28cm, 11"



Kelly Sponge & Dressing Forceps



F6-312
32cm, 12 1/2"
Curved



F6-313
32cm, 12 1/2"
Straight

Arterienklemmen
Pincas Hemostatiques

Pinzas Hemostaticas
Pinze Emostatiche



**Foerster-Ballenger Sponge Forceps
& (bullet holding forceps)**

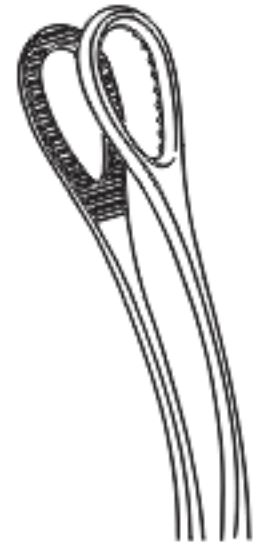

F6-314 18cm, 7"
F6-315 20.3cm, 8"
F6-316 24.1cm, 9.5"
Straight Smooth

F6-317 18cm, 7"
F6-318 20.3cm, 8"
F6-319 24.1cm, 9.5"
Straight Serrated

F6-320 18cm, 7"
F6-321 20.3cm, 8"
F6-322 24.4cm, 9.5"
Curved Smooth

F6-323 18cm, 7"
F6-324 20.3cm, 8"
F6-325 24.1cm, 9.5"
Curved Serrated

najimmy



F6-326
16cm, 6 1/4"



F6-327
16cm, 6 1/4"



F6-328
17cm, 6 3/4"



**Collin Sponge &
Dressing Forceps**



**Heywood-Smith Sponge &
Dressing Forceps**
F6-329 20cm, 8"