

VERTEBRAL COMPRESSION FRACTURES PRODUCT CATALOGUE

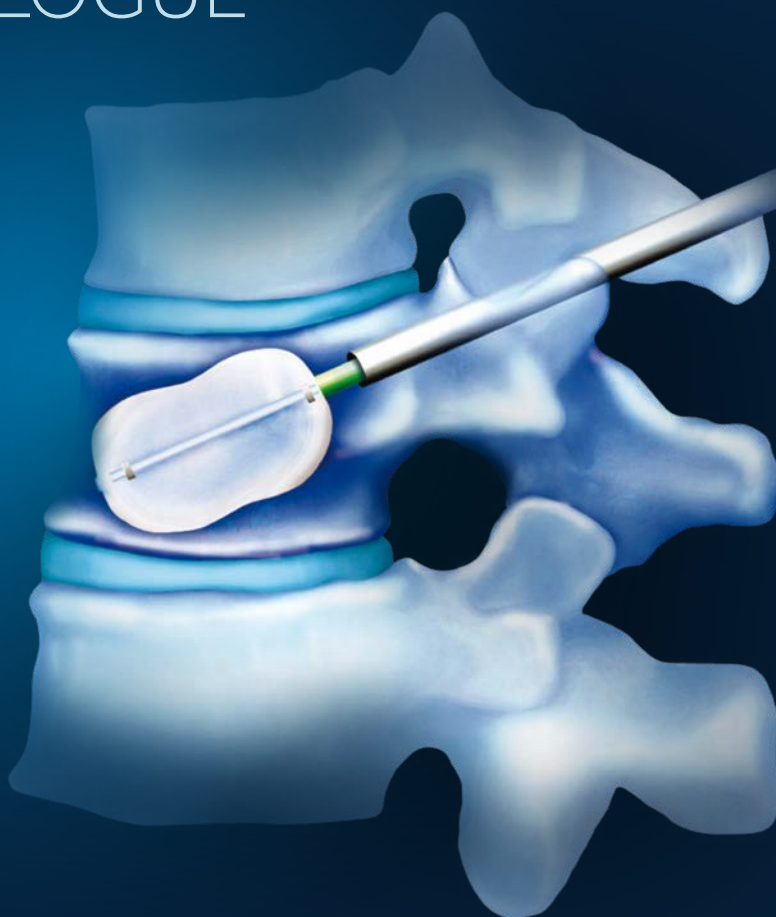

Kyphon® Balloon Kyphoplasty
Kyphon V™ Vertebroplasty

Medtronic
Further, Together



VERTEBRAL
COMPRESSION
FRACTURES
PRODUCT
CATALOGUE

COMPANY OVERVIEW

As a global leader in medical technology, services and solutions, Medtronic improves the health and lives of millions of people each year. We believe our deep clinical, therapeutic and economic expertise can help address the complex challenges — such as rising costs, aging populations and the burden of chronic disease — faced by families and healthcare systems today. But no one can do it alone. That’s why we’re committed to partnering in new ways and developing powerful solutions that deliver better patient outcomes.

Founded in 1949 as a medical repair company, we’re now among the world’s largest medical technology, services and solutions companies, employing more than 85,000 people worldwide, serving physicians, hospitals and patients in nearly 155+ countries.

Kyphon® Balloon Kyphoplasty	p4 - 21
Kyphon V™ Vertebroplasty	p22 - 23

BONE ACCESS

Kyphon® 11 Gauge Bone Access Needle

For correct tool positioning.

A02A

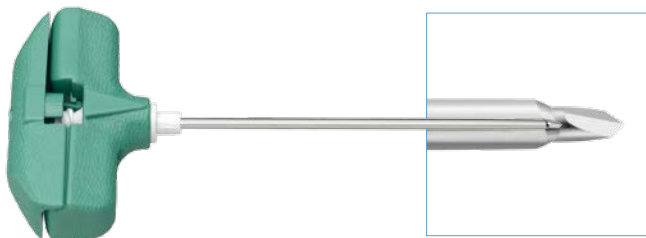

Kyphon® Osteo Introducer® System

For precise access to the vertebral body. Compatible with Xpander™ and Xpander™ II systems.

T15D



Osteo Introducer®

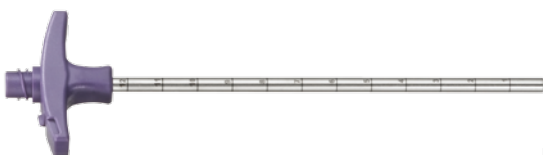

Extra Cannula



Drill

Guide Pins



BONE ACCESS

Kyphon® One-Step™ Osteo Introducer® System, Trocar and Diamond

For direct percutaneous access to the vertebral body. Compatible with Xpander™ and Xpander™ II systems.

T15J

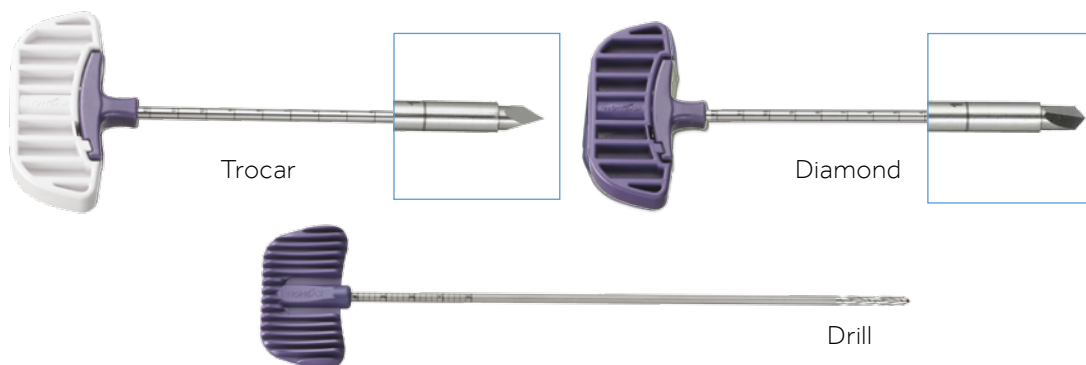

Kyphon® One-Step™ Osteo Introducer® Device, Bevel

T15K

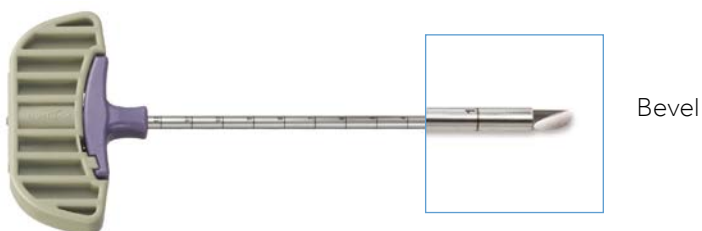

Kyphon® Advanced Osteo Introducer® System

T15E

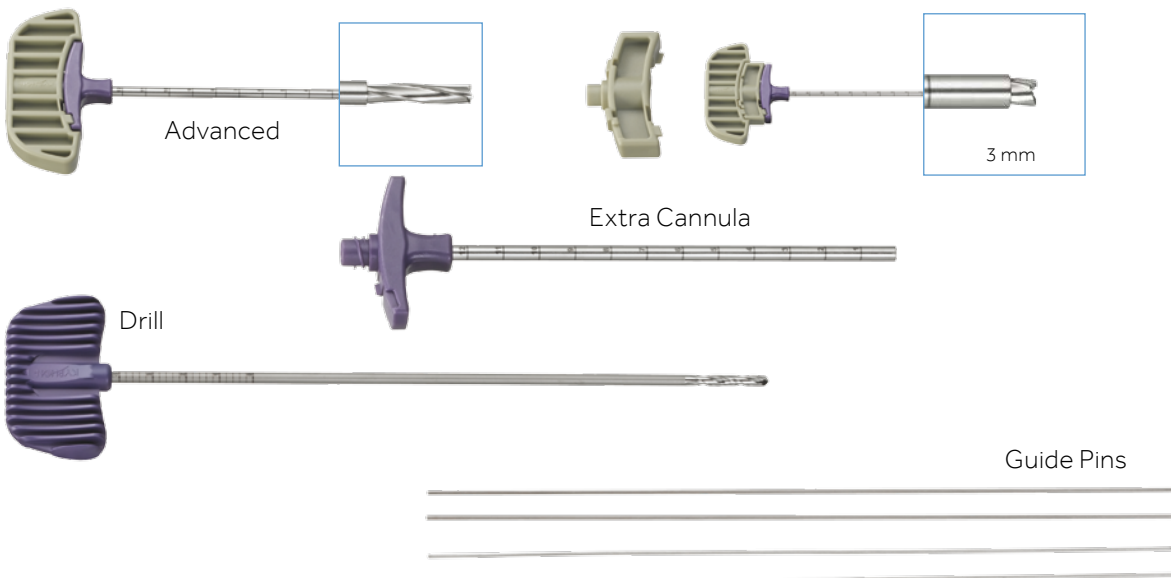

BONE ACCESS

Kyphon® Express™ Osteo Introducer® System, Diamond and Bevel

Lower profile access tools for accurate placement in small vertebral bodies.
Compatible with Express™ and Express™ II systems.

T34A



Diamond



Bevel



Drill



Plunger

BONE ACCESS

Kyphon® Express™ Osteo Introducer® Device

Additional tip configurations. Compatible with Express™ and Express™ II systems.

T34B



Trocar

T34C



Advanced

T34D



Diamond

T34E



Bevel

Kyphon® Express™ Bone Drill

T34F



FRACTURE REDUCTION

Kyphon® Xpander™ Inflatable Bone Tamps

Minimally invasive balloons for fracture reduction and correction of vertebral body anatomy.

K13A: 10/3

K09A: 15/3

K08A: 20/3

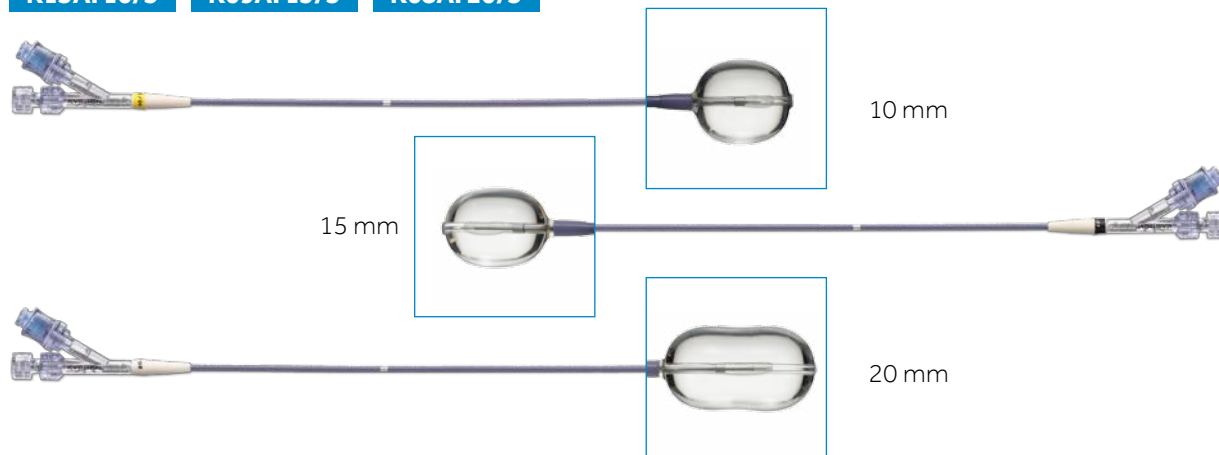

Kyphon® Xpander™ II Inflatable Bone Tamps

Stronger, more structured balloon material for greater predictability and better control.

KX103-C: 10/3

KX153-C: 15/3

KX203-C: 20/3

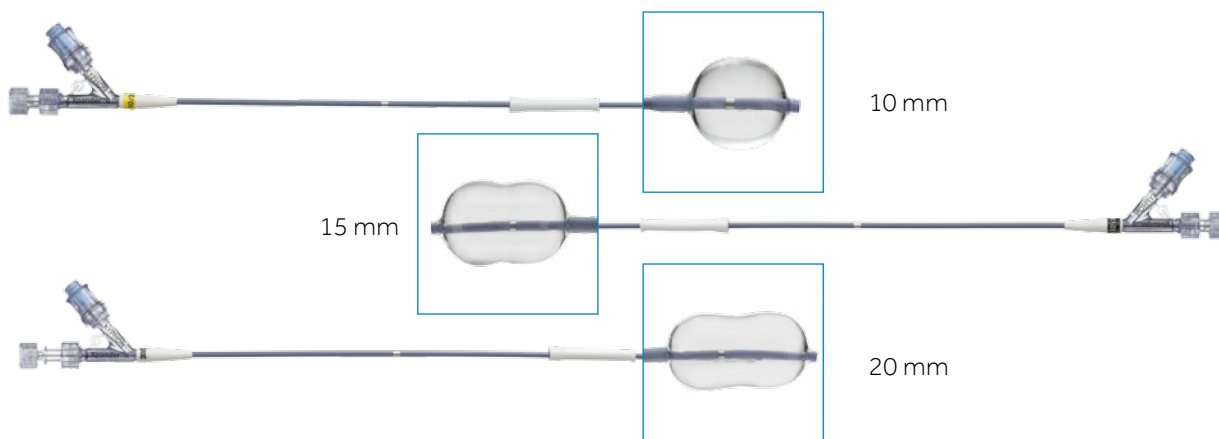

Kyphon® Exact® Inflatable Bone Tamps

Uni-directional balloon for focused fracture reduction and minimal lateral wall contact.

K17A: 10/3

K17B: 15/3

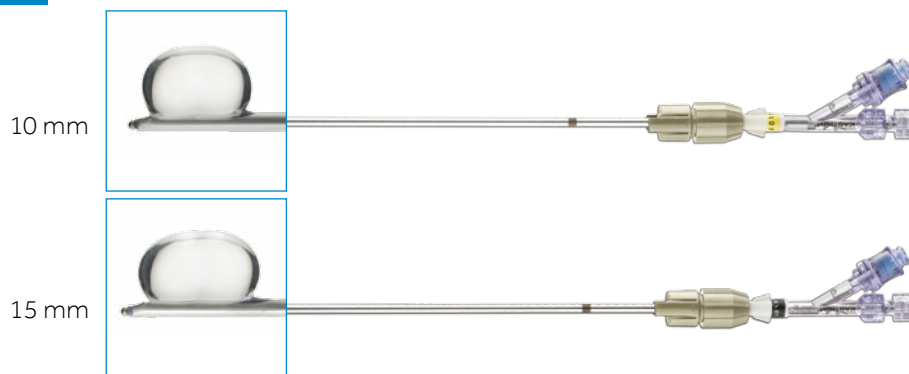

FRACTURE REDUCTION

Kyphon® Express™ Inflation Bone Tamps

Lower profile balloon for fracture reduction in small vertebral bodies.

K15A: 10/2

K15B: 15/2

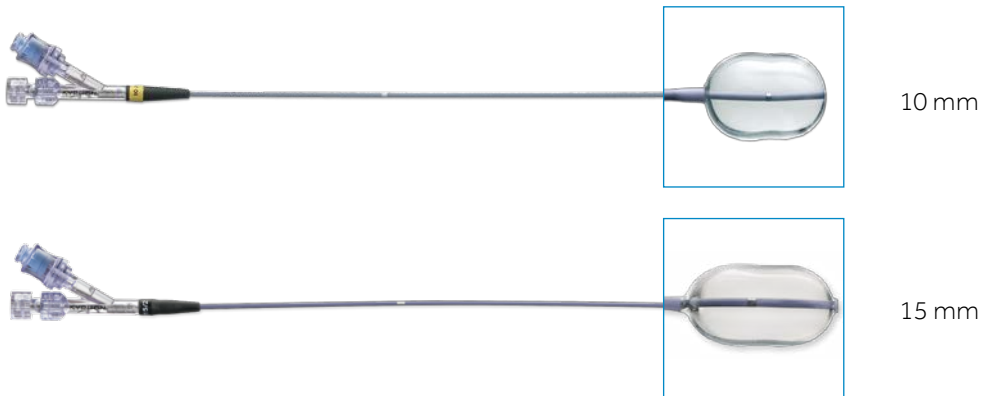

Kyphon® Express™ II Inflation Bone Tamps

Stronger, more structured balloon material for greater predictability and better control in small vertebral bodies.

KE102-INT:10/2

KE152-INT:15/2

KE202-INT:20/2

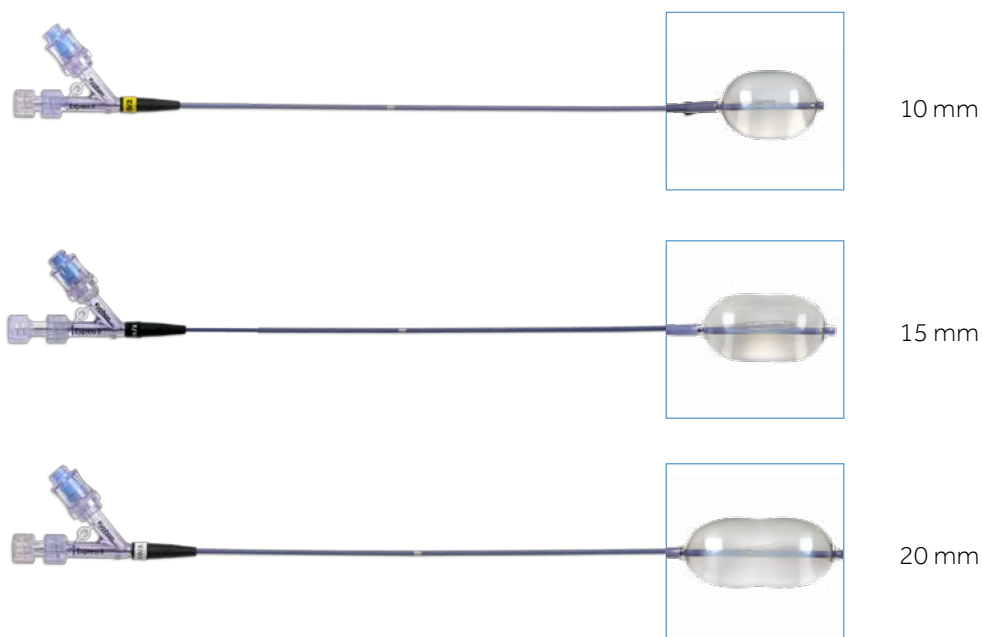

FRACTURE REDUCTION

Kyphon® Inflation Syringe with locking syringe

Proprietary syringe compatible with all systems.

A08E



Kyphon® Latitude® II Curette

For scraping bone in the vertebral body, increasing Inflatable Bone Tamp efficiency. Compatible with Xpander™ and Xpander™ II systems.

A11B



Kyphon® Express™ Curette

A system compatible with Express™ access tools designed for scraping bone in smaller vertebral body, increasing Inflatable Bone Tamp efficiency. Compatible with Express™ and Express II™ systems.

A13A

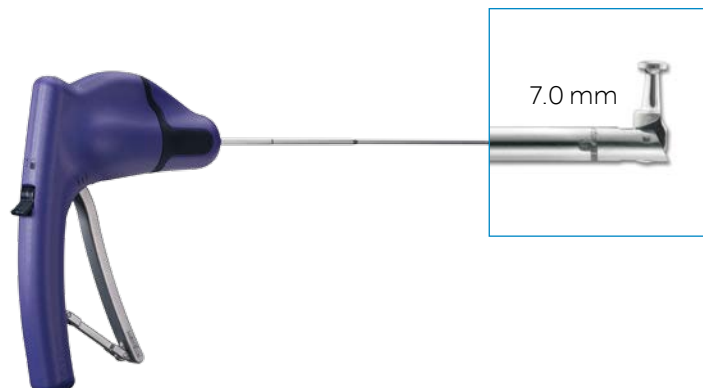

BIOPSY TOOLS

Kyphon® Bone Biopsy Device

For collecting biopsy sample after bone access.

F05A



Kyphon® Bone Biopsy Kit

Complete biopsy set. Compatible with Xpander™ and Xpander™ II systems.

F18A

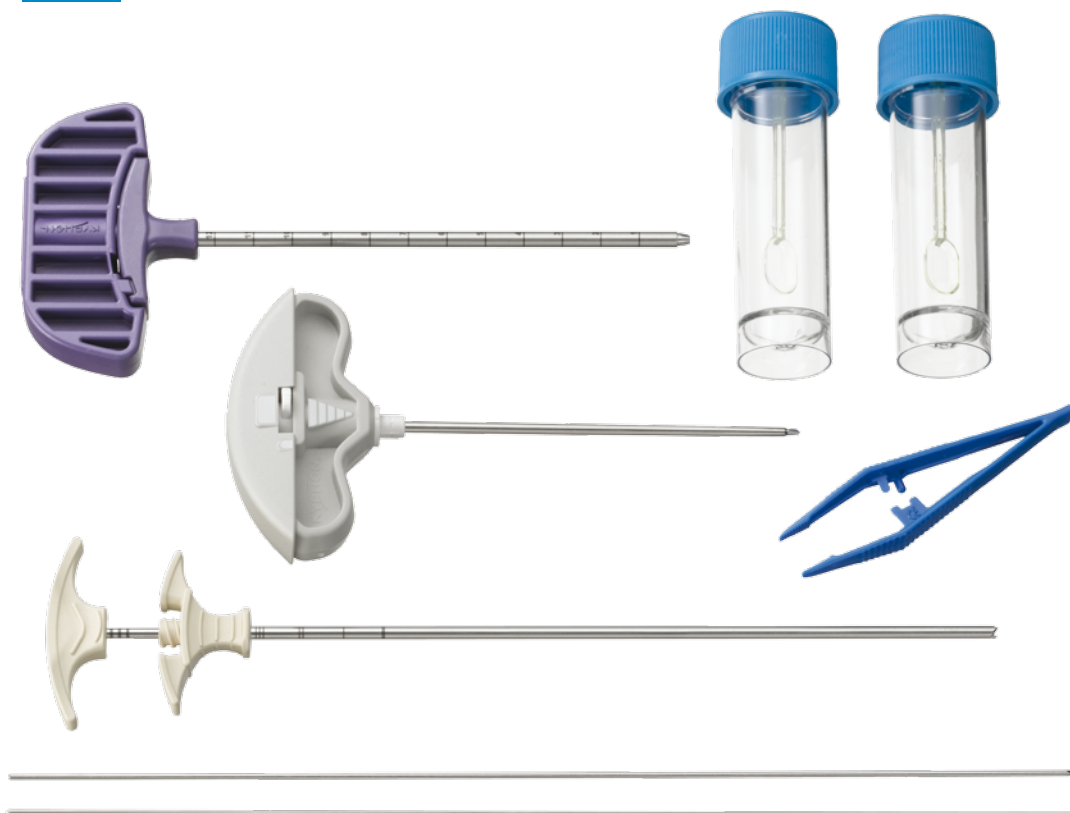

Kyphon® Express™ Bone Biopsy Device

For collecting biopsy sample after bone access in small vertebral bodies.

F07A

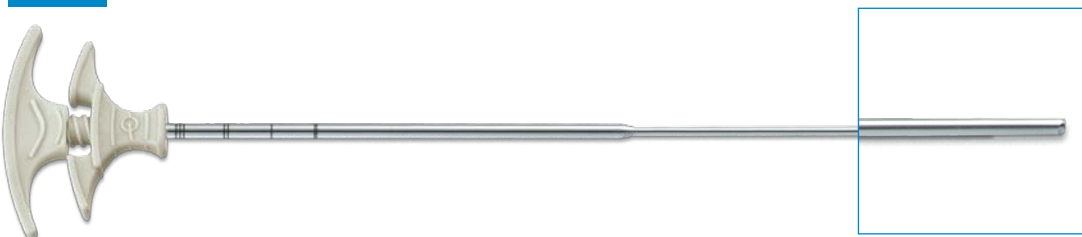

FRACTURE STABILISATION

Kyphon® Bone Filler Device

For safe, low pressure delivery of 1.5 cc of bone cement using manual control. Compatible with Xpander™ and Xpander™ II systems.

F04B



Kyphon® Directional Bone Filler Device

For a targeted delivery of 1.5 cc of bone cement. Compatible with Xpander™ and Xpander™ II systems.

F04C



Kyphon® Express™ Bone Filler Device

For safe, low pressure delivery of 1 cc of bone cement using manual control. Compatible with Express™ and Express™ II systems.

F06A



Kyphon® Express™ Directional Bone Filler Device

For targeted delivery of 1 cc of bone cement. Compatible with Express™ and Express™ II systems.

F06B

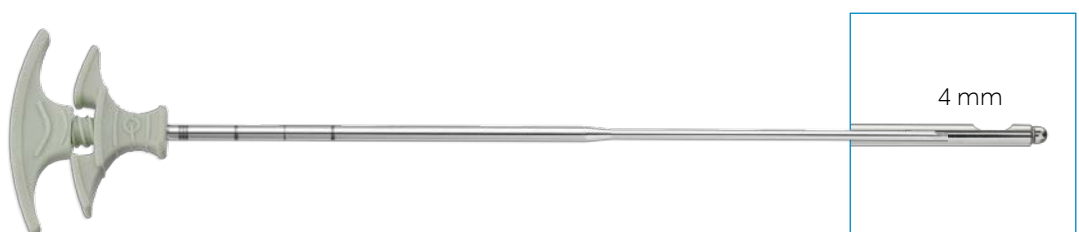

FRACTURE STABILISATION

Kyphon® Cement Delivery System Cement Delivery Gun and 2 Bone Filler Devices

To keep a safe distance from the radiation source with the ability to stop bone cement flow with the push of a button.

Compatible with Xpander™ and Xpander™ II systems.

CDS3A



Compatible with Express™ and Express™ II systems.

CDS2A



Kyphon® Cement Delivery System Cement Cartridges

2 Cement Cartridges with capacity of 8cc each.

CC02A



Kyphon® Inflatable Bone Tamps Geometry Chart

	Product Reference	Initial Length (mm)	Working Cannula Diameter (mm)	Gauge	Pressure Rate (PSI)	Maximum Diameter (mm)	Maximum Length (mm)	Maximum Volume (cc)
Xpander™ II	KX203-C	20	4.2	8	700	16.7	32.6	6
Xpander™ II	KX153-C	15	4.2	8	700	16.8	27.4	5
Xpander™ II	KX103-C	10	4.2	8	700	17.3	21.6	4
Xpander™	K08A	20	4.2	8	400	16	28	6
Xpander™	K09A	15	4.2	8	400	14	20	4
Xpander™	K13A	10	4.2	8	400	16	17	4
Exact™	K17B	15	4.2	8	300	16	22	4
Exact™	K17A	10	4.2	8	300	15	18	3
Express™ II	KE102-INT	10	3.3	10	700	15	18.7	5
Express™ II	KE152-INT	15	3.3	10	700	15.3	24.4	4
Express™ II	KE202-INT	20	3.3	10	700	16	28.5	3
Express™	K15B	15	3.3	10	400	15.1	24.8	5
Express™	K15A	10	3.3	10	400	15.5	21.1	4

Kyphon® Instruments Size Chart

	Product Code	Gauge	O.D. (mm)*	I.D. (mm)**
Bone Access				
Working Cannula		8	4,2	3,7
Osteo Introducer® Advanced and One-Step™, Stylet	T15D, E, J, K	10	3,5	
Express™ Working Cannula, Proximal End	T34A-E	7	4,6	4,1
Express™ Working Cannula, Distal End	T34A	10	3,4	2,8
Express™ Osteo Introducer®, Stylet, Proximal End	T34A-E	10	3,5	
Express™ Osteo Introducer®, Stylet, Distal End	T34A-E	12	2,7	
Fracture Reduction				
Xpander™ II Inflatable Bone Tamp, Shaft	KX203-C	12	2,6	
	KX153-C			
	KX103-C			
Xpander™ Inflatable Bone Tamp, Shaft	K08A	12	2,6	
	K09A			
	K13A			
Exact™ Inflatable Bone Tamp, Shaft	K17B	10	3,4	
	K17A			
Express™ Inflatable Bone Tamp, Shaft	K15B	14	2	
	K15A			
Express™ II Inflatable Bone Tamp, Shaft	KE102-INT	14	2	
	KE152-INT			
	KE202-INT			
Latitude™ Curette, Shaft	A11B	10	3,4	
Express™ Curette, Shaft, Proximal End	A13A	10	3,4	
Express™ Curette, Shaft, Distal End	A13A	12	2,7	
Fracture Stabilization				
Bone Filler Device / Bone Biopsy Device, Nozzle	F04C	10	3,4	2,9
	F04B			
	F05A			
	F18A			
Bone Filler Device / Bone Biopsy Device, Plunger	F04C	12	2,8	
	F04B			
	F05A			
Express™ Bone Filler Device / Bone Biopsy Device, Nozzle, Proximal End	F18A	9	3,8	3,3
	F06A			
	F06B			
Express™ Bone Filler Device / Bone Biopsy Device, Nozzle, Distal End	F07A	13	2,4	1,9
	F06A			
	F06B			
Express™ Bone Filler Device, Plunger, Proximal End	F07A	11	3,1	
	F06A			
	F06B			
Express™ Bone Filler Device, Plunger, Distal End	F07A	15	1,8	
	F06A			
	F06B			

* O.D. Outside Diameter

** I.D. Inside Diameter

FRACTURE STABILISATION

Kyphon® HV-R® Bone Cement

High viscosity radiopaque PMMA cement.

C01A-INT

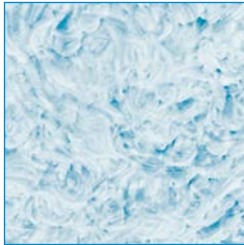

Kyphon® Xpede™ Bone Cement

Quick to dough, high viscosity radiopaque PMMA cement indicated for balloon kyphoplasty and vertebroplasty procedures. Packaged together with the mixer.

CX01B-C

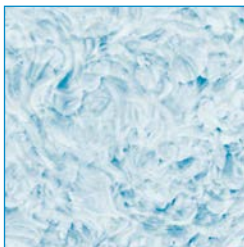

Kyphon® ActivOs® Bone Cement with Hydroxyapatite

Balanced mix of PMMA and Hydroxyapatite combining stability with osteoconductivity. Packaged together with the mixer.

C05B



FRACTURE STABILISATION

Kyphon® KyphOs™ FS Calcium Phosphate Bone Substitute

Cancellous bone substitute indicated for balloon kyphoplasty in stable traumatic vertebral body fractures.

C02B

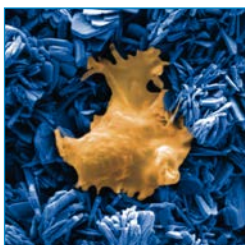

Kyphon® Mixer

A semi-closed mix and transfer system for preparation of PMMA-based cements.

A07A



Kyphon® Multi-tap Adapter™

For simultaneous fill of all Bone Filler Devices.

A22

With 8 bone filler attachments



A23

With 6 bone filler attachments



KIT CONFIGURATION

KyphoPak® Trays with Kyphon® Xpander™ II Inflatable Bone Tamps

		A02A	T15D	T15J	KX153-C	KX203-C	F04B	A08E
KPX153RB-C	KyphoPak® Tray, Xpander™ II 15/3, IBT Kyphon® Osteo Introducer® System	2	1		2		6	2
KPX203RB-C	KyphoPak® Tray, Xpander™ II 20/3, IBT Kyphon® Osteo Introducer® System	2	1			2	6	2
KPX153PB-C	KyphoPak® Tray, Xpander™ II 15/3, IBT Kyphon® One-Step™ Osteo Introducer® System			1	2		6	2
KPX203PB-C	KyphoPak® Tray, Xpander™ II 20/3, IBT Kyphon® One-Step™ Osteo Introducer® System			1		2	6	2

KyphoPak® Trays with Kyphon® Xpander™ Inflatable Bone Tamps

		A02A	T05D	T05J	K09A	K08A	F04B	A08A
KPT 1502	KyphoPak® Tray, Xpander™ 15/3, IBT Kyphon® Osteo Introducer® System	2	1		2		6	2
KPT 2002	KyphoPak® Tray, Xpander™ 20/3, IBT Kyphon® Osteo Introducer® System	2	1			2	6	2
KPT 1505	KyphoPak® Tray, Xpander™ 15/3, IBT Kyphon® One-Step™ Osteo Introducer® System			1	2		6	2
KPT 2005	KyphoPak® Tray, Xpander™ 20/3, IBT Kyphon® One-Step™ Osteo Introducer® System			1		2	6	2

KyphoPak® Trays with Kyphon® Xpander™ II Inflatable Bone Tamps and Kyphon® Cement Delivery System

		A02A	T15D	T15J	KX153-C	KX203-C	A08E	CC02A*	CDS3A**
KPX153RB-CDS-C	KyphoPak® Tray, Xpander™ II 15/3, IBT Kyphon® Osteo Introducer® System with CDS	2	1		2		2	1	1
KPX203RB-CDS-C	KyphoPak® Tray, Xpander™ II 20/3, IBT Kyphon® Osteo Introducer® System with CDS	2	1			2	2	1	1
KPX153PB-CDS-C	KyphoPak® Tray, Xpander™ II 15/3, IBT Kyphon® One-Step™ Osteo Introducer® System with CDS			1	2		2	1	1
KPX203PB-CDS-C	KyphoPak® Tray, Xpander™ II 20/3, IBT Kyphon® One-Step™ Osteo Introducer® System with CDS			1		2	2	1	1

*CC02A : 2 Cement Cartridges of 8cc each

**CDS3A : 1 Gun and 2 Bone Filler Devices

KyphoPak® Trays with Kyphon® Xpander™ Inflatable Bone Tamps and Kyphon® Cement Delivery System

		A02A	T05D	T05J	K09A	K08A	A08A	CC02A*	CDS3A**
KPT 1502-CDS	KyphoPak® Tray, Xpander™ 15/3, IBT Kyphon® Osteo Introducer® System with CDS	2	1		2		2	1	1
KPT 2002-CDS	KyphoPak® Tray, Xpander™ 20/3, IBT Kyphon® Osteo Introducer® System with CDS	2	1			2	2	1	1
KPT 1505-CDS	KyphoPak® Tray, Xpander™ 15/3, IBT Kyphon® One-Step™ Osteo Introducer® System with CDS			1	2		2	1	1
KPT 2005-CDS	KyphoPak® Tray, Xpander™ 20/3, IBT Kyphon® One-Step™ Osteo Introducer® System with CDS			1		2	2	1	1

*CC02A : 2 Cement Cartridges of 8cc each

**CDS3A : 1 Gun and 2 Bone Filler Devices



Bone Access Tools and Inflatable Bone Tamps



Bone Filler Devices



Kyphon® Inflation Syringe™



Bone Access Tools



Inflatable Bone Tamps



Bone Filler Devices

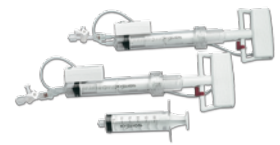

Inflation Syringes



Bone Access Tools and Inflatable Bone Tamps



Cement Delivery System



Cement Cartridges



Kyphon® Inflation Syringe™



Bone Access Tools and Inflatable Bone Tamps



Cement Delivery System



Cement Cartridges

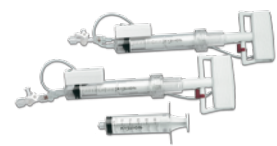

Inflation Syringes

KIT CONFIGURATION

KyphoPak® Trays with Kyphon® Express™ II Inflatable Bone Tamps		T34A	KE102-INT	KE152-INT	KE202-INT	F06A	A08E
KEX102EB-INT	KyphoPak® Express™ II Tray, 10/2 IBT, Kyphon® Express™ II Osteo Introducer® System	1	2			8	2
KEX152EB-INT	KyphoPak® Express™ II Tray, 15/2 IBT, Kyphon® Express™ II Osteo Introducer® System	1		2		8	2
KEX202EB-INT	KyphoPak® Express™ II Tray, 20/2 IBT, Kyphon® Express™ II Osteo Introducer® System	1			2	8	2

KyphoPak® Trays with Kyphon® Express™ Inflatable Bone Tamps		T24A	K15A	K15B	F06A	A08A
KPE 1001	KyphoPak® Express™ Tray 10/2, IBT Kyphon® Express™ Osteo Introducer® System	1	2		8	2
KPE 1003	KyphoPak® Express™ Tray 15/2, IBT Kyphon® Express™ Osteo Introducer® System	1		2	8	2

KyphoPak® Trays with Kyphon® Express™ II Inflatable Bone Tamps and Kyphon® Cement Delivery System		T34A	KE102-INT	KE152-INT	A08E	CC02A*	CDS2A**
KEX102EB-CDS-INT	KyphoPak® Express™ II Tray 10/2, IBT Kyphon® Express™ II Osteo Introducer® System with CDS	1	2		2	1	1
KEX152EB-CDS-INT	KyphoPak® Express™ II Tray 15/2, IBT Kyphon® Express™ II Osteo Introducer® System with CDS	1		2	2	1	1

* CC02A : 2 Cement Cartridges of 8cc each

**CDS2A : 1 Gun and 2 Express Bone Filler Devices

KyphoPak® Trays with Kyphon® Express™ Inflatable Bone Tamps and Kyphon® Cement Delivery System		T24A	K15A	K15B	A08A	CC02A*	CDS2A**
KPE 1001-CDS	KyphoPak® Express™ Tray 10/2, IBT Kyphon® Express™ Osteo Introducer® System with CDS	1	2		2	1	1
KPE1003-CDS	KyphoPak® Express™ Tray 15/2, IBT Kyphon® Express™ Osteo Introducer® System with CDS	1		2	2	1	1

* CC02A : 2 Cement Cartridges of 8cc each

**CDS2A : 1 Gun and 2 Express Bone Filler Devices



Bone Access Tools and Inflatable Bone Tamps



Bone Filler Devices



Kyphon® Inflation Syringe



Bone Access Tools



Inflatable Bone Tamps



Bone Filler Devices

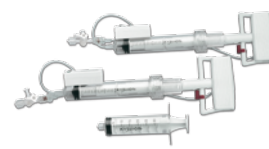

Inflation Syringes



Bone Access Tools and Inflatable Bone Tamps



Cement Delivery System



Cement Cartridges



Kyphon® Inflation Syringe



Bone Access Tools and Inflatable Bone Tamps



Cement Delivery System



Cement Cartridges

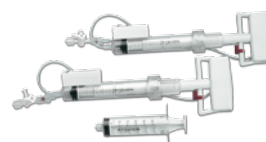

Inflation Syringes

KYPHON® V

Premium Vertebroplasty Kit



Available in Kits and A La Carte Packages

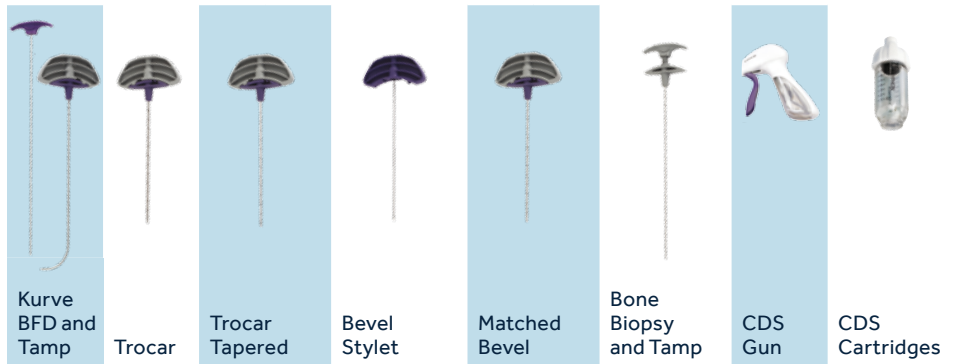

Catalog Number	Product Description	13ga	10ga	11ga	13ga	11ga	13ga	11ga	13ga	13ga	15ga		
Kits													
VPK011D	Kyphon V Osteo Introducer 11Ga Trocar/Bevel KIT			1		1						1	2
VPK011B	Kyphon V Osteo Introducer 11Ga Bevel KIT							1				1	2
VPK013D	Kyphon V Osteo Introducer 13Ga Trocar/Bevel KIT				1		1					1	2
VPK013B	Kyphon V Osteo Introducer 13Ga Bevel KIT								1			1	2
VPK1003	Kyphon Kurve KIT	1	1									1	2
A La Carte													
Curved Bone Filler													
VPT02A	Kyphon Kurve Curved Bone Filler Device	1											
11 Gauge													
VPT11D	Kyphon V Osteo Introducer 11Ga Trocar/Bevel			1		1							
VPT11B	Kyphon V Osteo Introducer 11Ga Bevel							1					
13 Gauge													
VPT13D	Kyphon V Osteo Introducer 13Ga Trocar/Bevel				1		1						
VPT13B	Kyphon V Osteo Introducer 13Ga Bevel								1				
Bone Biopsy													
VPB11	Kyphon V Bone Biopsy Device 13Ga									1			
VPB11D	Kyphon V Bone Biopsy Device 13Ga KIT			1		1				1			
VPB13	Kyphon V Bone Biopsy Device 15Ga										1		
VPB13D	Kyphon V Bone Biopsy Device 15Ga KIT				1		1				1		



Kyphon® Xpede® Bone Cement

- Quick-to-dough
- High-viscosity cement

VERTEBRAL COMPRESSION FRACTURES PRODUCT CATALOGUE

Medtronic

Europe
Medtronic International Trading Sàrl.
Route du Molliau 31
Case postale
CH-1131 Tolochenaz
Tel. +41 (0)21 802 70 00
Fax +41 (0)21 802 79 00

UC201402718bEE - EMO4832 © Medtronic Inc. 2015.
All rights reserved. Printed in Europe.

medtronic.eu