

# LANDANGER

---

1947



*«L'instrument des instruments  
c'est la main.»  
Aristote*

### MAYO-HEGAR

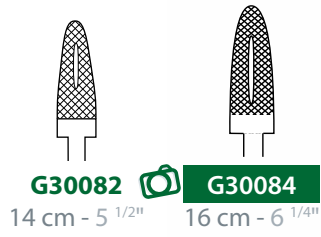

**G30084**  
16 cm - 6 1/4"

### CRILE WOOD

### CRILE MURRAY



**G300810**

### HEGAR BAUMGARTNER



### MAYO-HEGAR



TC Inserts

14 cm - 5 1/2 "	<b>G30210</b>		
16 cm - 6 1/4 "	<b>G30220</b>	<b>G30220L</b>	<b>L</b>
18 cm - 7 "	<b>G30230</b>	<b>G30230L</b>	<b>L</b>
20 cm - 8 "	<b>G30240</b>	<b>G30240L</b>	<b>L</b>
23 cm - 9 "	<b>G30250</b>		
26 cm - 10 1/4 "	<b>G30260</b>		
30 cm - 11 3/4 "	<b>G30270</b>		



Gaucher  
Left-handed  
Zurdo

Droit  
Straight  
Recta

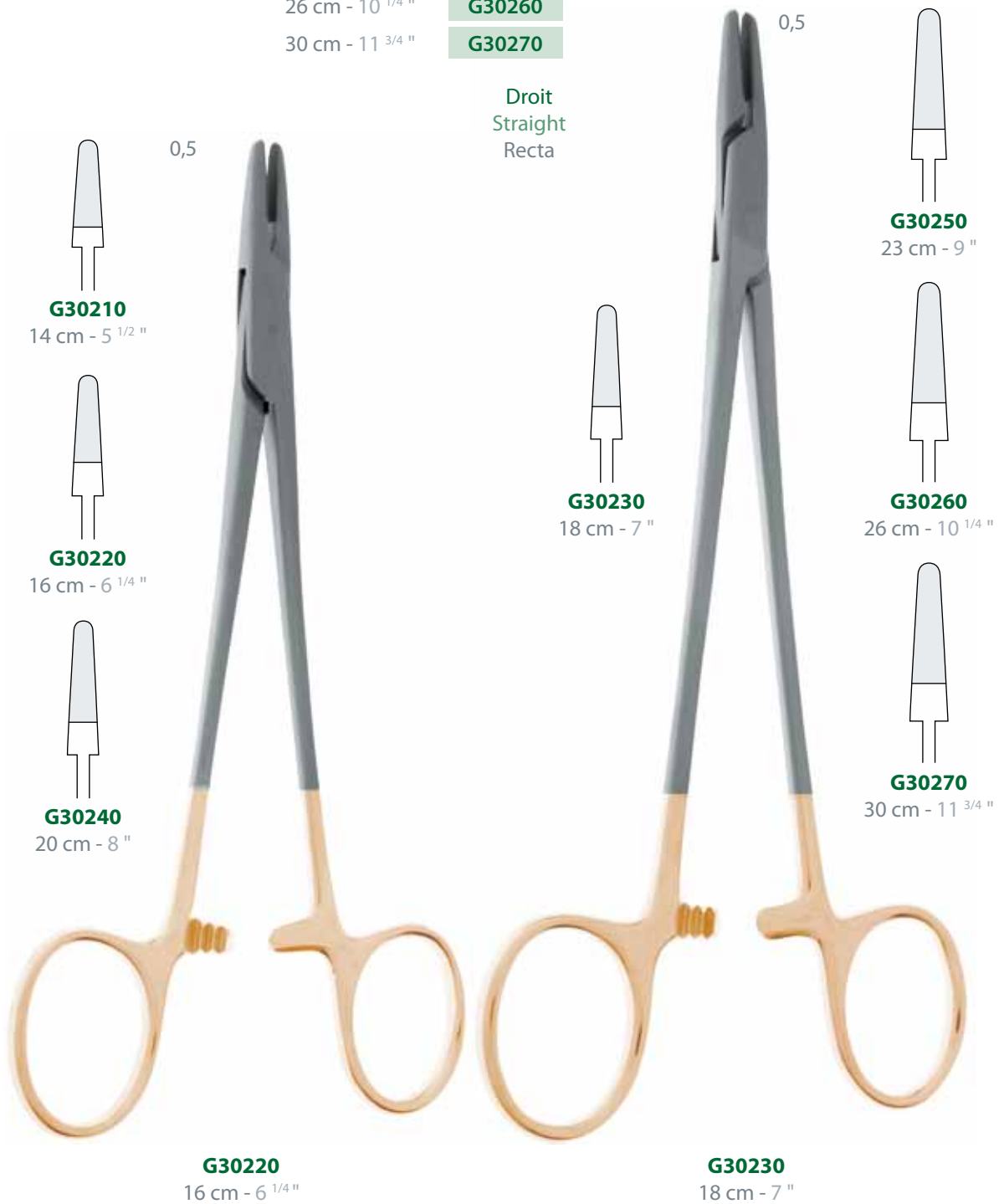

### DEBAKEY



L	<b>G30152L</b>	18 cm - 7 "
L	<b>G30153L</b>	20 cm - 8 "
L	<b>G30154L</b>	23 cm - 9 "
		26 cm - 10 1/4 "
		30 cm - 11 3/4 "

Standard	Fin
Standard	Fine
Standard	Fino
<b>G30152</b>	<b>G301521</b>
<b>G30153</b>	<b>G301531</b>
<b>G30154</b>	<b>G301541</b>
<b>G30155</b>	<b>G301551</b>
<b>G30156</b>	<b>G301561</b>

0,4

0,3



**G30152**  
18 cm - 7 "

**G301521**  
18 cm - 7 "



**G30153**  
20 cm - 8 "

**G301531**  
20 cm - 8 "



**G30154**  
23 cm - 9 "

**G301541**  
23 cm - 9 "



**G30155**  
26 cm - 10 1/4 "

**G301551**  
26 cm - 10 1/4 "



**G30156**  
30 cm - 11 3/4 "

**G301561**  
30 cm - 11 3/4 "



**G30152**  
18 cm - 7 "



TC Insert

### METZENBAUM-FINO

Courbe - Curved - Curva

Mousse / Mousse  
Blunt / Blunt  
Roma / Roma





Microcut



SupercutBlack

Pointu / Pointu  
Sharp / Sharp  
Aguda / Aguda

 <b>B35049</b>		<b>B35049SB</b>	15 cm - 6"	<b>B350492</b> 
<b>B35060</b>	<b>B35060M</b>	<b>B35060SB</b>	18 cm - 7"	<b>B350602</b>
<b>B35080</b>		<b>B35080SB</b>	20 cm - 8"	<b>B350802</b>
<b>B35100</b>		<b>B35100SB</b>	23 cm - 9"	<b>B351002</b>
<b>B351011</b>		<b>B351011SB</b>	25 cm - 10"	-
<b>B351021</b>		<b>B351021SB</b>	28 cm - 11"	-



**B35049**  
15 cm - 6"



**B350492**  
15 cm - 6"

### NABATOFF



Complet - Full set - Completo

**C095000**

135 x 100 x 25 mm



**C095020**

120 cm - 47 1/4 "



**C095010**



**C095030**



Ø 3 mm

**C095033**



Ø 6 mm

**C095036**



Ø 9 mm

**C095039**



Ø 12 mm

**C095042**



Ø 15 mm

**C095045**

### MYERS

Ø 6 mm **C095106**

Ø 9 mm **C095109**

Ø 12 mm **C095112**

Ø 15 mm **C095115**

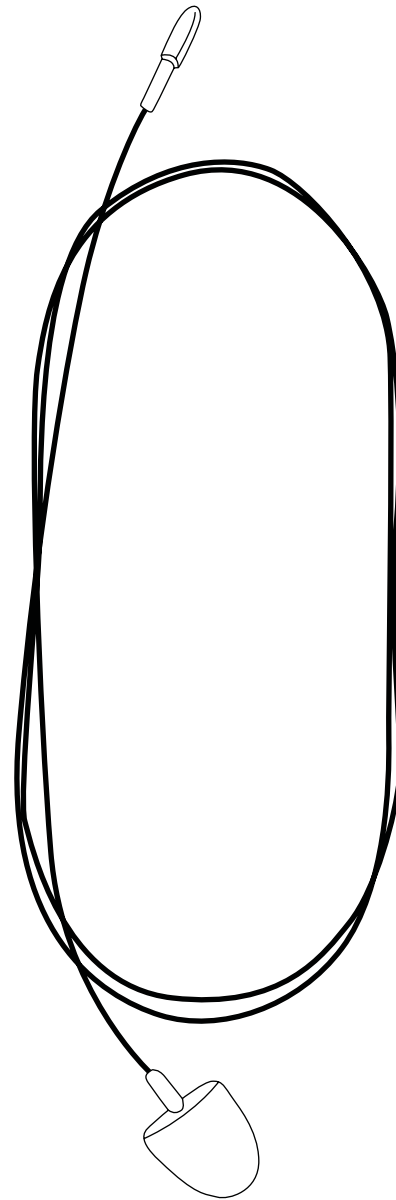

**C095112**



## Pinces clamps cardiovasculaires atrauma - Atrauma cardiovascular forceps - Pinzas clamps cardiovasculares atrauma



DeBakey

POUR ARTÈRE RÉNALE  
FOR RENAL ARTERY  
PARA ARTERIA RENAL

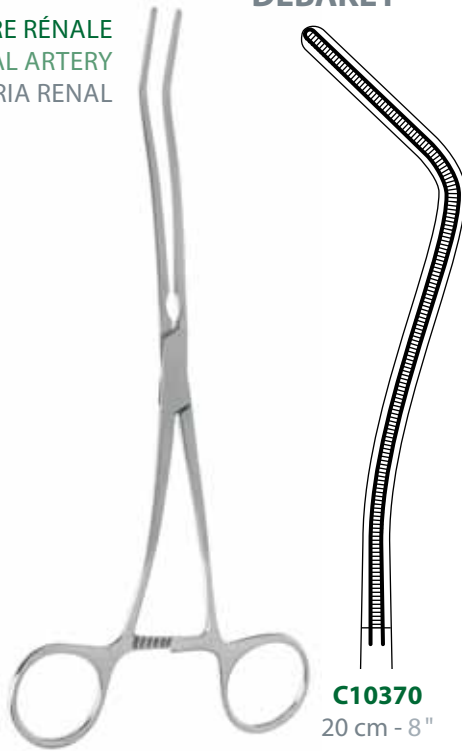

DEBAKEY

**C10370**  
20 cm - 8"

POUR ANÉVRISME DE L'AORTE  
FOR AORTIC ANEURYSM  
PARA ANEURISMA DE LA AORTA

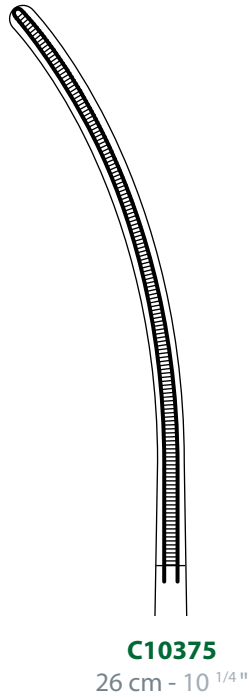

**C10375**  
26 cm - 10 1/4"

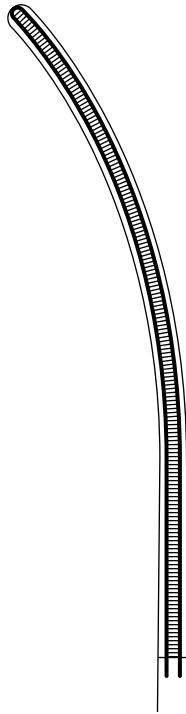

**C10380**   
27 cm - 10 1/2"

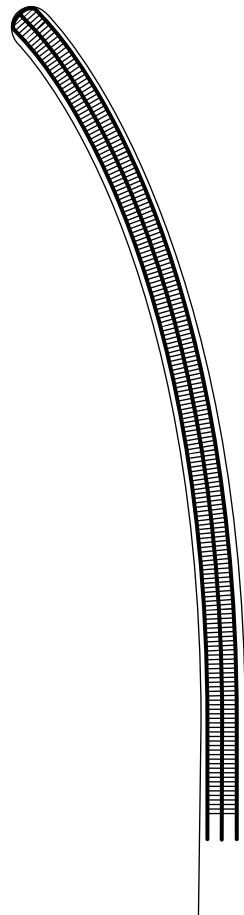

**C10385**  
31 cm - 12 1/4"

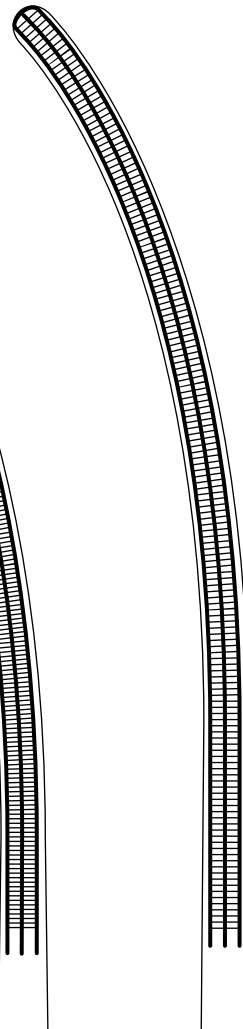

**C10390**  
33 cm - 13"

V - Clamps  
V - Clamps  
V - Clamps



Cooley

## COOLEY

POUR LA COARCTATION  
FOR COARCTATION  
PARA LA COARCTACIÓN

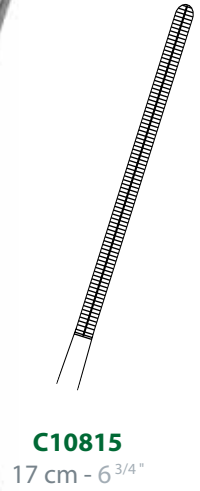
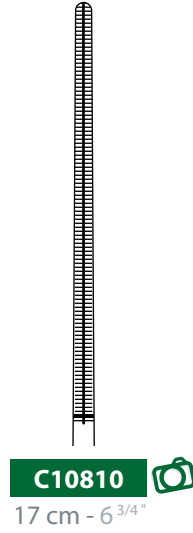
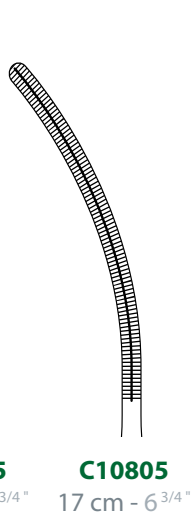
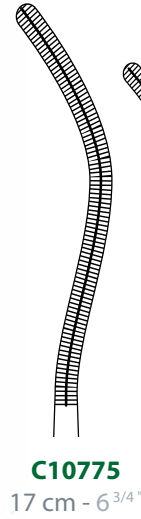

POUR LIGATURE  
FOR LIGATURE  
PARA LIGADURA

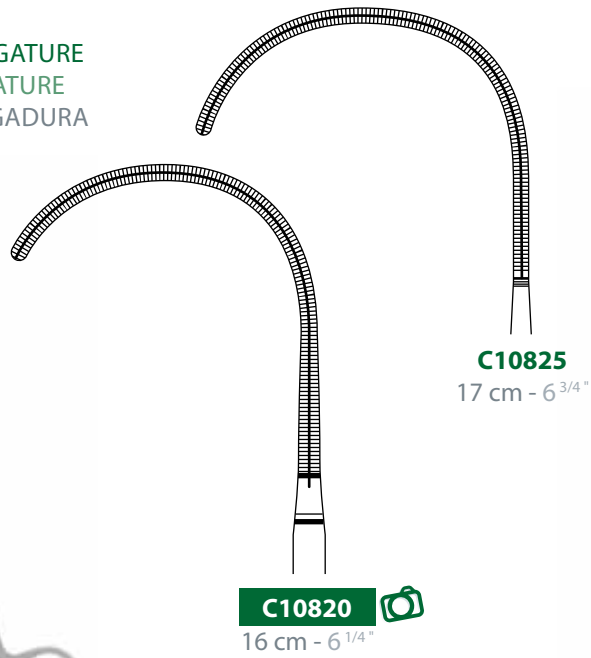

16 cm - 6<sup>1/4</sup>"

POUR ANASTOMOSE  
FOR ANASTOMOSIS  
PARA ANASTOMOSIS

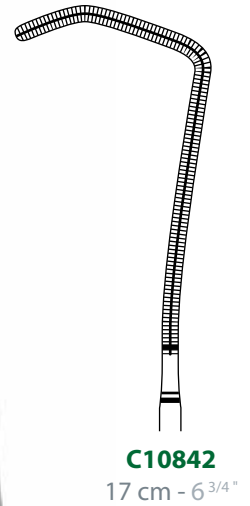



### MAYO-HEGAR



TC Inserts

14 cm - 5 1/2 "	<b>G30210</b>		
16 cm - 6 1/4 "	<b>G30220</b>	<b>G30220L</b>	<b>L</b>
18 cm - 7 "	<b>G30230</b>	<b>G30230L</b>	<b>L</b>
20 cm - 8 "	<b>G30240</b>	<b>G30240L</b>	<b>L</b>
23 cm - 9 "	<b>G30250</b>		
26 cm - 10 1/4 "	<b>G30260</b>		
30 cm - 11 3/4 "	<b>G30270</b>		



Gaucher  
Left-handed  
Zurdo

Droit  
Straight  
Recta

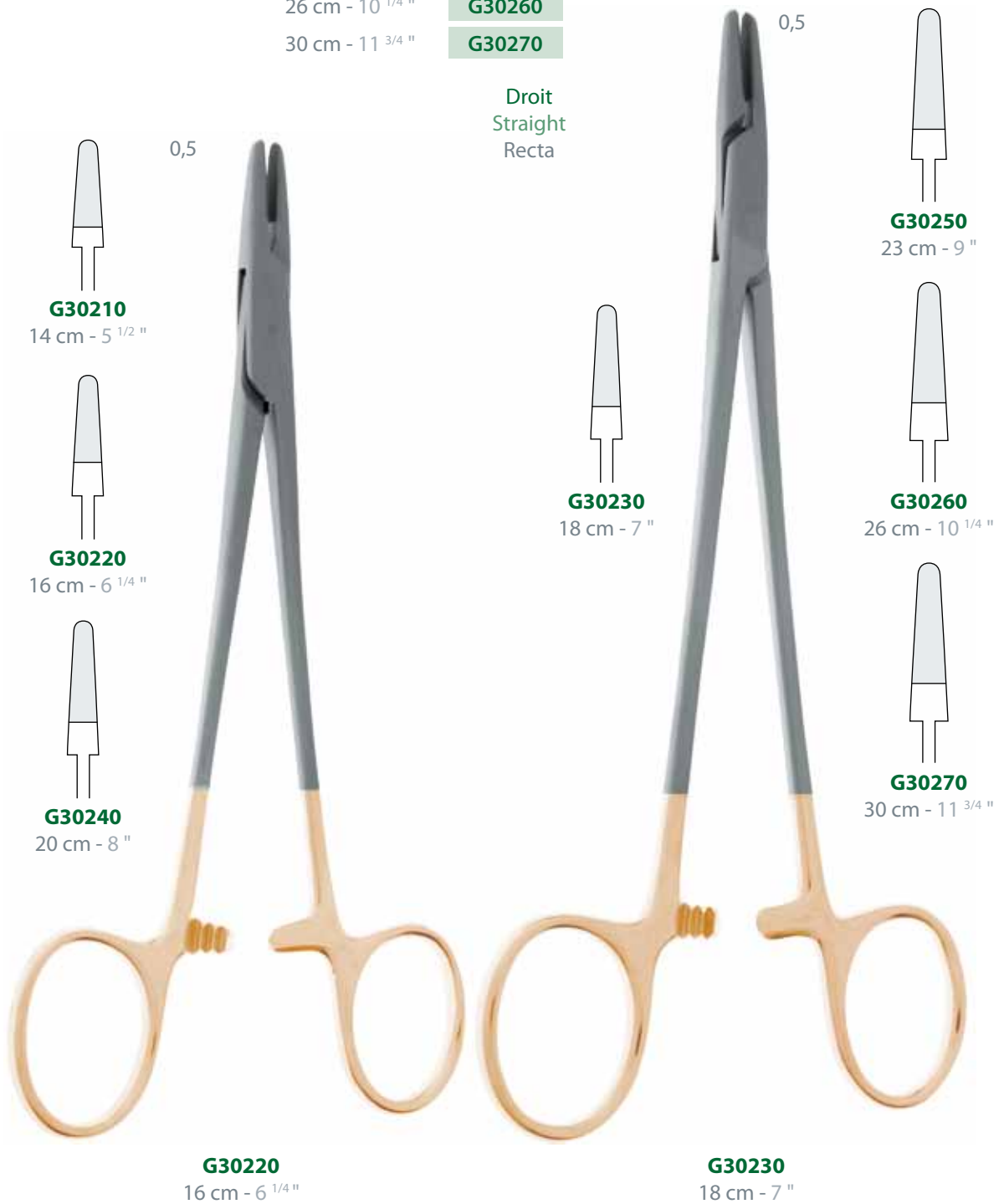

### PENFIELD



### SAUERBRUCH

130 x 38 mm



**B802940**  
26 cm - 10 1/4 "

**B802939**  
23 cm - 9 "

### CORYLLOS

115 x 67 mm



**B802938**

115 x 42 mm



**B802937**

82 x 22 mm

### TAKAHASHI

Droite  
Straight  
Recta

Coudée vers le haut  
Angled upward  
Angulada arriba

12 cm - 4 3/4"

**I160250**

3 x 10 mm

**I160260**



17 cm - 6 3/4"

**I160255**

3 x 10 mm

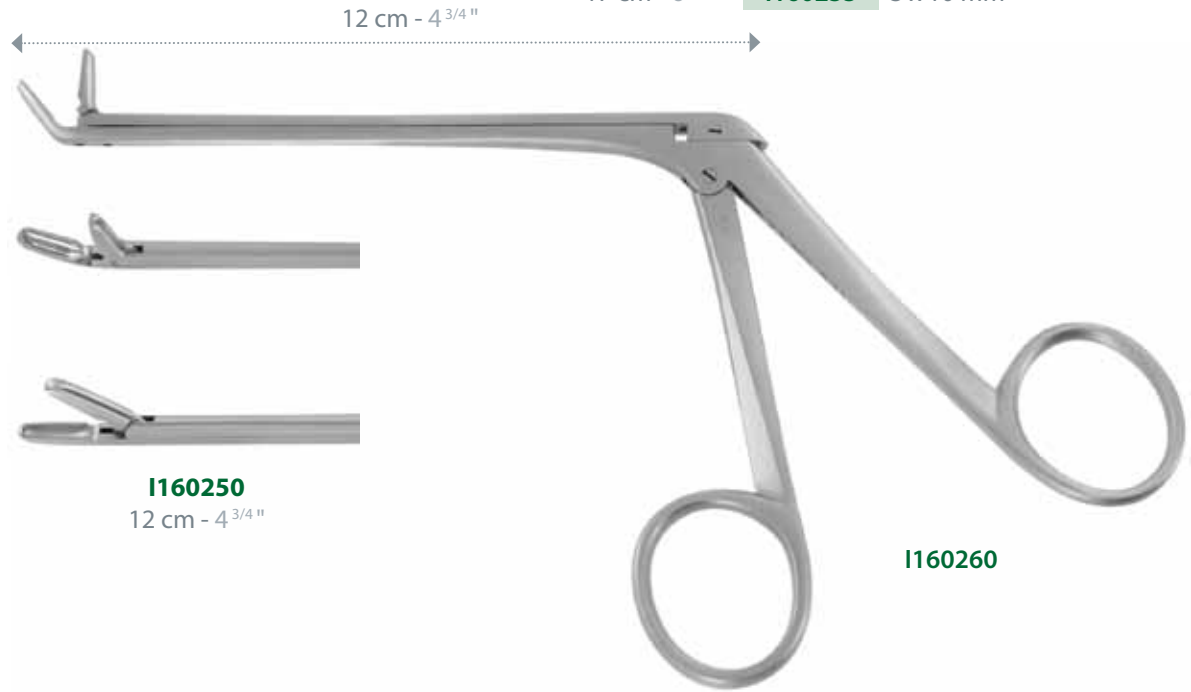

**I160250**

12 cm - 4 3/4"

**I160260**

### HARTMANN

12 cm - 4 3/4"

**I16055**

5 mm

12 cm - 4 3/4"

**I160570**

7 mm

12 cm - 4 3/4"

**I16060**

9 mm



ø 5 mm

ø 7 mm

ø 9 mm

### STRUYCKEN

12 cm - 4 3/4"

**I160610**

1,2 x 19 mm



1,2 x 19 mm

### GRUENWALD-HENKE

12 cm - 4 3/4"

**I160630**

3,0 x 11 mm

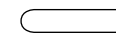

3,0 x 11 mm

### HAJEK

12 cm - 4 3/4"

**I160620**

3,5 x 14 mm

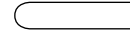

3,5 x 14 mm



# LANDANGER

Pinces passe-fils, dissecteurs - Ligature forceps, dissectors - Disecadores

## GEMINI

Très courbe  
Very curved  
Muy curva

13 cm - 5 "	<b>B605250</b> 
18 cm - 7 "	<b>B605251</b>
20 cm - 8 "	<b>B605252</b>
23 cm - 9 "	<b>B605253</b>
25 cm - 10 "	<b>B605254</b>
28 cm - 11 "	<b>B605255</b>

## MINI GEMINI

Très courbe  
Very curved  
Muy curva

18 cm - 7 "	<b>B605256</b> 
22 cm - 8 <sup>3</sup> / <sub>4</sub> "	<b>B605257</b>
25 cm - 10 "	<b>B605258</b>
28 cm - 11 "	<b>B605259</b>

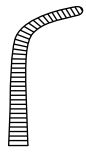

**B605250**

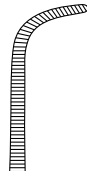

**B605251**

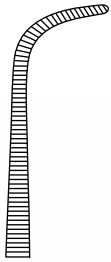

**B605252**

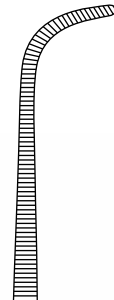

**B605253**



**B605254**

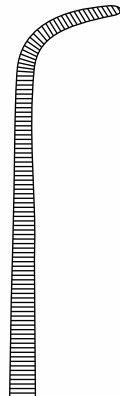

**B605255**

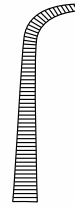

**B605256**

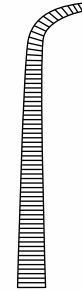

**B605257**

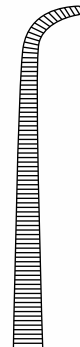

**B605258**

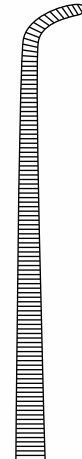

**B605259**

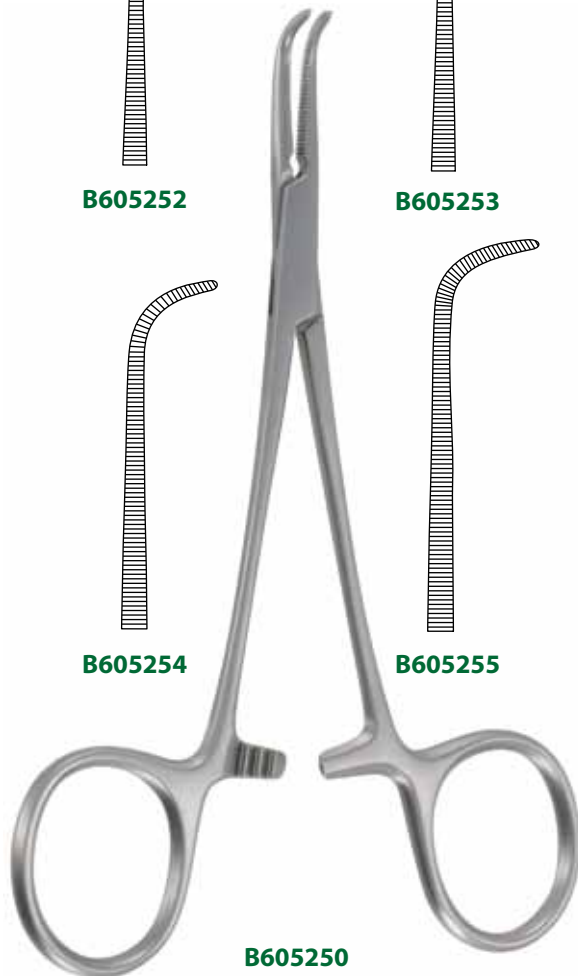

**B605250**  
13 cm - 5 "

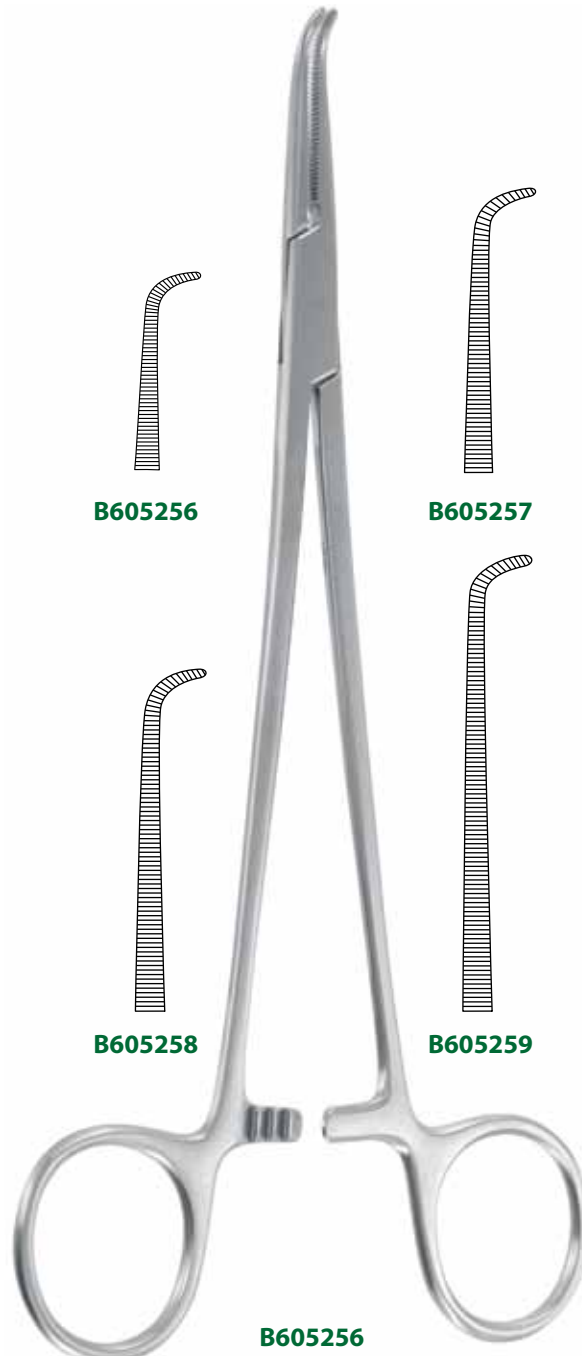

**B605256**  
18 cm - 7 "

IV - Pinces  
IV - Forceps  
IV - Pinzas

# LANDANGER

Porte-aiguilles - Needle holders - Porta agujas



TC Inserts

## CRILE-WOOD

13 cm - 5 "	<b>G30090</b>		
15 cm - 6 "	<b>G30100</b>	<b>G30100L</b>	<b>L</b>
18 cm - 7 "	<b>G30110</b>	<b>G30110L</b>	<b>L</b>
20 cm - 8 "	<b>G30120</b>	<b>G30120L</b>	<b>L</b>
23 cm - 9 "	<b>G30130</b>		
26 cm - 10 1/4 "	<b>G30140</b>		
30 cm - 11 3/4 "	<b>G30150</b>		



Gaucher  
Left-handed  
Zurdo

## BABY CRILE-WOOD



**G300950**  
15 cm - 6 "



**G30110**  
18 cm - 7 "

VI - Sutures  
VI - Sutures  
VI - Sutura

## Pinces à dissection vasculaires - Vascular dissecting forceps - Pinzas para disección vasculares



### DEBAKEY

1,5 mm		2,0 mm		2,0 mm	
	<b>C10005</b>	16 cm - 6 <sup>1</sup> / <sub>4</sub> "	<b>C10015</b>	16 cm - 6 <sup>1</sup> / <sub>4</sub> "	<b>C10030</b>
	<b>C10010</b>	20 cm - 8"	<b>C10020</b>	20 cm - 8"	<b>C10035</b>
	<b>C10012</b>	24 cm - 9 <sup>1</sup> / <sub>2</sub> "	<b>C10025</b>	24 cm - 9 <sup>1</sup> / <sub>2</sub> "	<b>C10040</b>
	<b>C10013</b>	30 cm - 11 <sup>3</sup> / <sub>4</sub> "	<b>C10027</b>	30 cm - 11 <sup>3</sup> / <sub>4</sub> "	<b>C10047</b>

Droite  
Straight  
Recta



**C10005**  
16 cm - 6<sup>1</sup>/<sub>4</sub>"

**C10010**  
20 cm - 8"

Droite  
Straight  
Recta



**C10015**  
16 cm - 6<sup>1</sup>/<sub>4</sub>"

**C10020**  
20 cm - 8"

Coudée  
Angled  
Angulada



**C10030**  
16 cm - 6<sup>1</sup>/<sub>4</sub>"

**C10035**  
20 cm - 8"

# LANDANGER

## Ciseaux tungstène - Tungsten scissors - Tijeras de tungsteno



### MAYO

Droit  
Straight  
Recta

Courbe  
Curved  
Curva

Standard  
Standard  
Estándar



Microcut

Standard  
Standard  
Estándar



Microcut



SupercutBlack

14 cm - 5 1/2"

**B35042**

14 cm - 5 1/2"

**B35043**

17 cm - 6 3/4"

**B35044**

**B35044M**

17 cm - 6 3/4"

**B35045**

**B35045M**

**B35045SB**

23 cm - 9"

**B35046**

23 cm - 9"

**B35047**



**B35042**  
14 cm - 5 1/2"

Lames plates  
Flat blades  
Hojas planas



**B35043**  
14 cm - 5 1/2"





III - Ciseaux  
III - Scissors  
III - Tijeras

\* **Microcut** : 1 lame TC standard + 1 lame TC microdentée - 1 TC standard blade + 1 TC serrated blade - 1 hoja TC estándar + 1 hoja TC micro-serrada

\* **SupercutBlack** : 1 lame TC microdentée + 1 lame TC rasoir + Nitrure de titane noir - 1 TC serrated blade + 1 TC razor blade + Black coating - 1 hoja TC micro-serrada + 1 hoja TC navaja + recubrimiento negro



## Pinces à dissection standards - Standard dissecting forceps - Pinzas para disección estándares

Sans griffes Without teeth Sin dientes			STANDARD - STANDARD - ESTÁNDAR			1 x 2 griffes 1 x 2 teeth 1 x 2 dientes		
B40005	-	10 cm - 4"	B40045	-				
B40010	B401140	12 cm - 4 <sup>3</sup> / <sub>4</sub> "	B40050	B401150				
B40015	B401141	14 cm - 5 <sup>1</sup> / <sub>2</sub> "	B40055	B401151				
 B40020	<b>B401142</b>	16 cm - 6 <sup>1</sup> / <sub>4</sub> "	<b>B40060</b>	<b>B401152</b>				
B40025	B401143	18 cm - 7"	B40065	B401153				
B40030	B401144	20 cm - 8"	B40070	B401154				
B40035	B401145	25 cm - 10"	B40075	B401155				
B40040	-	30 cm - 11 <sup>3</sup> / <sub>4</sub> "	B40080	-				



**B40020**  
16 cm - 6<sup>1</sup>/<sub>4</sub>"

**B401142**  
16 cm - 6<sup>1</sup>/<sub>4</sub>"



**B40060**  
16 cm - 6<sup>1</sup>/<sub>4</sub>"

**B401152**  
16 cm - 6<sup>1</sup>/<sub>4</sub>"

# LANDANGER

Pinces à couper les fils - Wire cutting pliers - Alicates para cortar alambre



TC Inserts



### LAMBOTTE (PAUWELLS)



2.5 mm

12,5 cm - 5"

Droit  
Straight  
Recto



3.2 mm

16 cm - 6 1/4"

Droit  
Straight  
Recto



3.2 mm

24 cm - 9 1/2"

Droit  
Straight  
Recto



3.2 mm

24 cm - 9 1/2"

Courbe  
Curved  
Curvo



**J32470**

16 cm - 6 1/4"

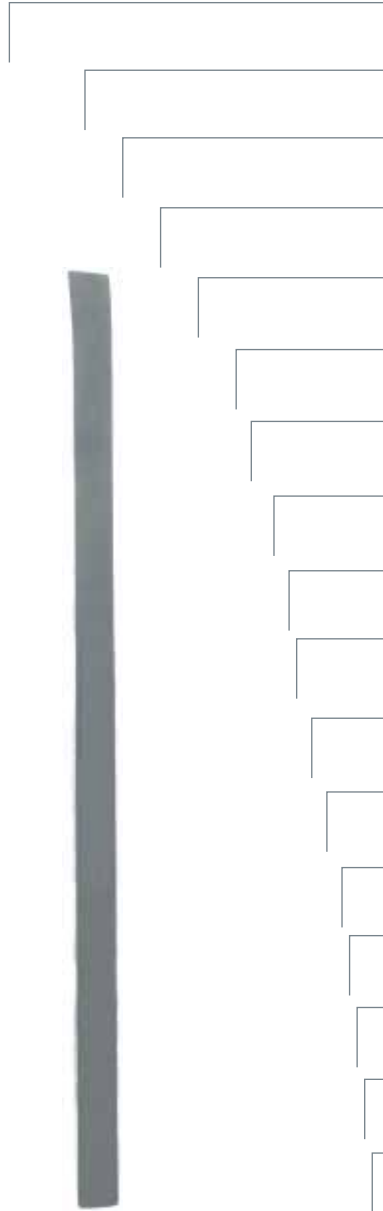

**J324623**

12,5 cm - 5"

Width (mm)	2.5 mm	3.2 mm	3.2 mm	3.2 mm
50 mm	-	J32540	J32620	J325430
40 mm	-	J32530	J32610	J325429
35 mm	-	J32520	J32600	J325428
30 mm	-	J32510	J32590	J325427
25 mm	-	J32500	J32580	J325426
20 mm	-	J32490	J32570	J325425
18 mm	-	J324850	J32565	J325424
15 mm	J324627	J32480	J32560	J325423
13 mm	-	J324750	J32555	J325422
12 mm	J324626	-	-	-
10 mm	J324625	<b>J32470</b>	J32550	J325421
8 mm	J324624	J324658	J325455	J325418
6 mm	<b>J324623</b>	-	-	-
5 mm	-	J32465	J325450	J325420
4 mm	J324622	-	-	-
3 mm	J324621	-	-	-
2 mm	J324620	-	-	-

# LANDANGER

---

1947



*«L'instrument des instruments  
c'est la main.»  
Aristote*

# LANDANGER

Pinces punch - Punch forceps - Pinzas punch

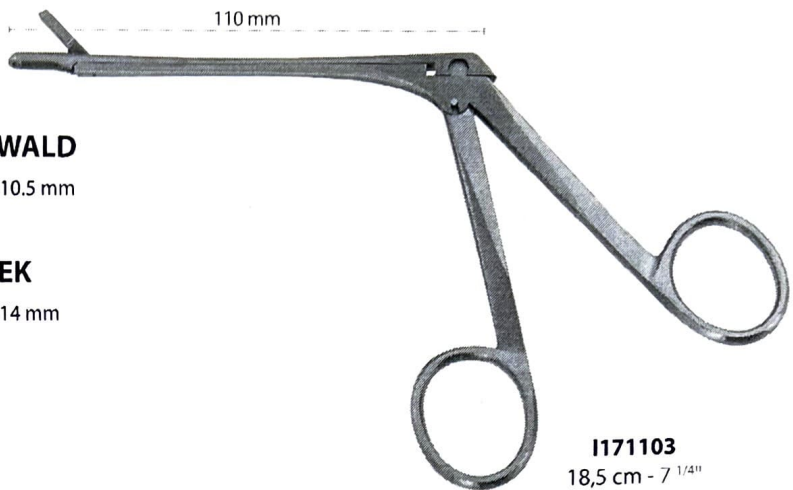

**GRUENWALD**

 **I171103** 3.5 x 10.5 mm

**HAJEK**

**I160620** 3.5 x 14 mm

**I171103**  
18,5 cm - 7 <sup>1/4</sup>"



**GRUENWALD**

 **I171100** 3.0 x 10.0 mm

**I171101** 3.5 x 11.3 mm

**I171102** 4.0 x 12.0 mm

**I171100**  
18,5 cm - 7 <sup>1/4</sup>"



**GRUENWALD**

 **I171130** 0° **I171132** 45° 2.0 mm  
**I171131** 2.5 mm **I171133** 2.5 mm

22,5 cm - 8 <sup>3/4</sup>"



## TERRIER

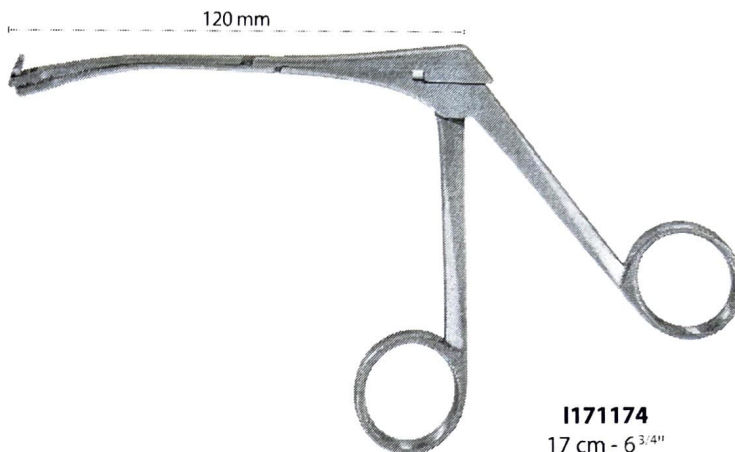

- I171173** 2x3 mm
- I171174** 4x6 mm

**I171174**  
17 cm - 6<sup>3/4</sup>"

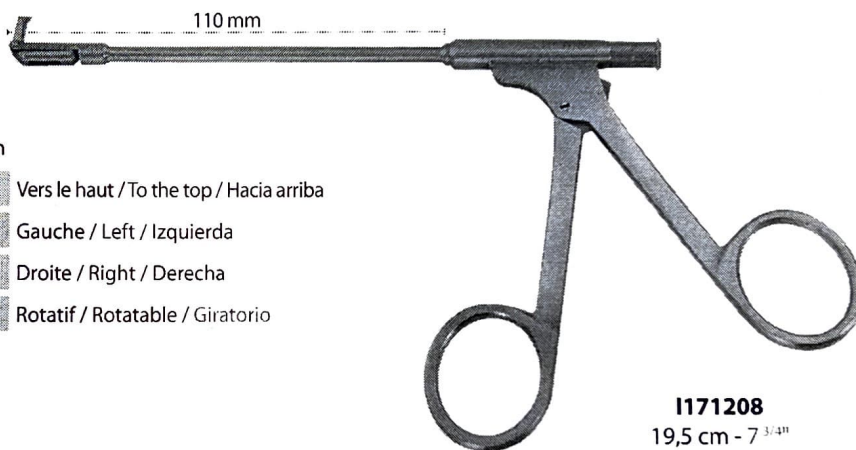

1.5 x 5.2 mm 2.5 x 7.0 mm

- I171207** **I171204** Vers le haut / To the top / Hacia arriba
- I171208** **I171205** Gauche / Left / Izquierda
- I171209** **I171206** Droite / Right / Derecha
- I171190** **I171191** Rotatif / Rotatable / Giratorio

**I171208**  
19,5 cm - 7<sup>3/4</sup>"

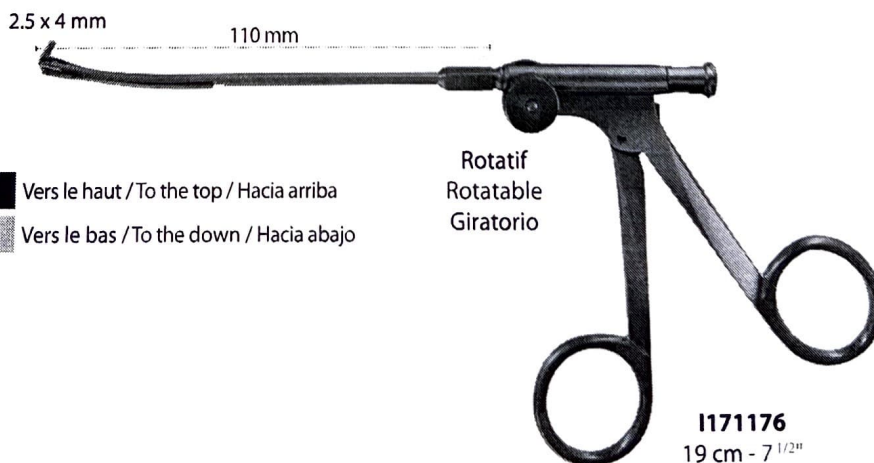

- I171176** 360° Vers le haut / To the top / Hacia arriba
- I171175** Vers le bas / To the down / Hacia abajo

Rotatif  
Rotatable  
Giratorio

**I171176**  
19 cm - 7<sup>1/2</sup>"

# LANDANGER

Micro ciseaux - Micro scissors - Micro tijeras



Gauche Left Izquierda	Droit Straight Recta	Droite Right Derecha
-----------------------------	----------------------------	----------------------------

 <b>I171401</b>	<b>I171400</b>	<b>I171402</b>
--	----------------	----------------

**I171401**  
15,5 cm - 6"

## HOUSE-BELLUCCI

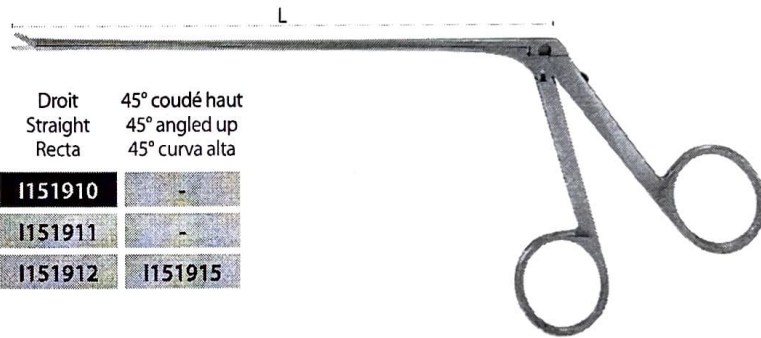

Gauche Left Izquierda	Droit Straight Recta	45° coudé haut 45° angled up 45° curva alta
-----------------------------	----------------------------	---

L: 120 mm	-	<b>I151910</b>	-
L: 150 mm	<b>I151913</b>	<b>I151911</b>	-
L: 180 mm	<b>I151914</b>	<b>I151912</b>	<b>I151915</b>

**I151910**  
18 cm - 7"

1 lame crantée  
1 serrated blade  
1 hoja serrada



Gauche Left Izquierda	Droit Straight Recta	Droite Right Derecha
-----------------------------	----------------------------	----------------------------

<b>I152201</b>	<b>I152200</b>	<b>I152202</b>
----------------	----------------	----------------

**I152200**  
18 cm - 7 1/4"

# LANDANGER

Micro ciseaux - Micro scissors - Micro tijeras

170 mm  
Ø 1 mm

Droit Straight Recta	Coudé 45° Angled 45° Curva 45°	Courbe droite Right curve Curva derecha	Courbe gauche Left curve Curva izquierda
<b>I010170</b>	<b>I010176</b>	<b>I010172</b>	<b>I010174</b>

Ouverture horizontale  
Horizontal opening  
Apertura horizontal

**I010144**   **I010145**



**I010170**  
27 cm - 10<sup>1/2</sup>"

220 mm

Droit Straight Recta	Coudé 45° Angled 45° Curva 45°	Courbe droite Right curve Curva derecha	Courbe gauche Left curve Curva izquierda
Ø 1 mm <b>I010171</b>	<b>I010177</b>	<b>I010173</b>	<b>I010175</b>
Ø 2 mm <b>I010140</b>	<b>I010143</b>	<b>I010141</b>	<b>I010142</b>

Ouverture horizontale  
Horizontal opening  
Apertura horizontal

Ø 2 mm **I010178**   **I010179**



**I010143**  
32 cm - 12<sup>3/4</sup>"

250 mm  
Ø 2 mm

Droit Straight Recta	Coudé 45° Angled 45° Curva 45°	Courbe droite Right curve Curva derecha	Courbe gauche Left curve Curva izquierda
<b>I010090</b>	<b>I010093</b>	<b>I010091</b>	<b>I010092</b>

Ouverture horizontale  
Horizontal opening  
Apertura horizontal

**I010094**   **I010095**

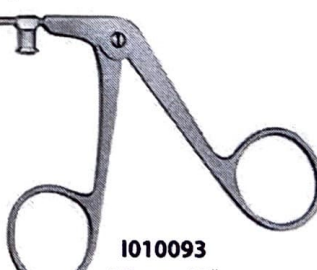

**I010093**  
35 cm - 10"



Poignées composite HF - pouce mobile

HF polymer handle - mobile thumb



**E0616016** Sans crémaillère / *Without ratchet*



**E0616017** Avec crémaillère française / *With flat ratchet*



**E0616018** Avec crémaillère centrale / *With central ratchet*

**E0616019** Avec crémaillère centrale débrayable  
*With switchable central ratchet*

## Tubes isolés pour instruments de laparoscopie - ø 10 mm

### Laparoscopy instruments insulated shaft - ø 10mm



Longueur / Length

E0634001	220 mm
E0634002	330 mm
E0634003	450 mm

## Tubes non isolés pour instruments de laparoscopie - ø 10 mm

### Laparoscopy instruments uninsulated shaft - ø 10mm



\* Ne pas utiliser la fonction HF avec des tubes non isolés

\* *Not use the HF function with uninsulated shafts*

E0634005	220 mm
E0634006	330 mm
E0634007	450 mm

## Écrous de personnalisation pour instruments de laparoscopie - ø 10 mm

### Laparoscopy instruments customization nuts - ø10mm



Couleur / Color

E9634001	Noir / Black
E9634002	Rouge / Red
E9634003	Jaune / Yellow
E9634004	Bleu / Blue
E9634005	Vert / Green

## Raccord de nettoyage pour tube / Flushing part for shaft



E0631000



Inserts pour instruments de laparoscopie - ø 10 mm

Laparoscopy instruments inserts - ø 10mm

Dissecteur courbe - 2 mors mobiles L : 23 mm / *Curved dissector - double action - L:23mm*



Longueur utile  
*Working length*

E0634051	220 mm
E0634052	330 mm
E0634053	450 mm

Mixer 90° - 2 mors mobiles - L : 25 mm / *Mixer 90° - double action - L:22mm*

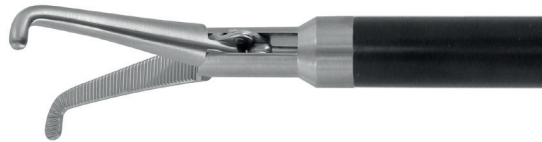

E0634061	220 mm
E0634062	330 mm
E0634063	450 mm

Duval - 2 mors mobiles - L : 40 mm / *Duval - double action - L:40mm*

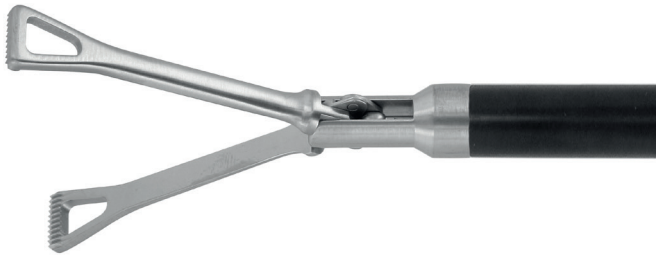

E0634071	220 mm
E0634072	330 mm
E0634073	450 mm

Babcock atraumatique - 2 mors mobiles - L : 35 mm / *Atraumatic Babcock - double action - L:35mm*



E0634081	220 mm
E0634082	330 mm
E0634083	450 mm

## Électrodes HF HF electrodes

### ● Électrode crochet / Hook electrode



	∅	Longueur / Length
E0622010	2,8 mm	250 mm
E0622019	2,8 mm	330 mm
E0622011	5 mm	330 mm
E0622012	5 mm	450 mm

### ● Électrode crochet 90° / 90° hook electrode



E0622020	2,8 mm	250 mm
E0622029	2,8 mm	330 mm
E0622021	5 mm	330 mm
E0622022	5 mm	450 mm

### ● Électrode spatule / Spatula electrode



E0622030	2,8 mm	250 mm
E0622039	2,8 mm	330 mm
E0622031	5 mm	330 mm
E0622032	5 mm	450 mm

### ● Électrode boule / Ball electrode



E0622040	2,8 mm	250 mm
E0622049	2,8 mm	330 mm
E0622041	5 mm	330 mm
E0622042	5 mm	450 mm

## Inserts pour instruments de laparoscopie - ø 5 mm

### Laparoscopy instruments inserts - ø 5mm

Dissecteur droit - 2 mors mobiles - L : 20 mm / *Straight dissector - double action - L:20mm*

Longueur utile  
Working length



E0633131 250 mm

E0633132 330 mm

E0633133 450 mm

Micro Maryland - 2 mors mobiles - L : 8 mm / *Micro Maryland - double action - L:8mm*



E0633141 250 mm

E0633142 330 mm

E0633143 450 mm

Maryland - 2 mors mobiles - L : 18 mm / *Maryland - double action - L:18mm*

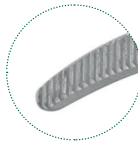

E0633151 250 mm

E0633152 330 mm

E0633153 450 mm

Kelly - 2 mors mobiles - L : 20 mm / *Kelly - double action - L:20mm*

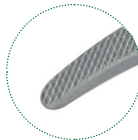

E0633161 250 mm

E0633162 330 mm

E0633163 450 mm

Dissecteur courbe Gee Gee 1 mors mobile L : 35 mm / *Gee Gee curved dissector - single action - L:35mm*



E0633171 250 mm

E0633172 330 mm

E0633173 450 mm

Mixer 60° - 2 mors mobiles - L : 25 mm / *Mixer 60° - double action - L:25mm*



E0633181 250 mm

E0633182 330 mm

E0633183 450 mm

## Tubes isolés pour instruments de laparoscopie - ø 5 mm

### Laparoscopy instruments insulated shafts - ø 5mm



Longueur / Length

E0633001	250 mm
E0633002	330 mm
E0633003	450 mm

## Tubes non isolés pour instruments de laparoscopie - ø 5 mm

### Laparoscopy instruments uninsulated shafts - ø 5mm



\* Ne pas utiliser la fonction HF avec des tubes non isolés  
 \* *Not use the HF function with uninsulated shafts*

Longueur / Length

E0633005	250 mm
E0633006	330 mm
E0633007	450 mm

## Écrous de personnalisation pour instruments de laparoscopie - ø 5 mm

### Laparoscopy instruments customization nuts - ø 5mm



Couleur / Color

E9633001	Noir / Black
E9633002	Rouge / Red
E9633003	Jaune / Yellow
E9633004	Bleu / Blue
E9633005	Vert / Green

Raccord de nettoyage pour tube / *Flushing part for shaft*



E0631000



Poignées composite HF - pouce mobile

HF polymer handle - mobile thumb



**E0616016** Sans crémaillère / *Without ratchet*



**E0616017** Avec crémaillère française / *With flat ratchet*



**E0616018** Avec crémaillère centrale / *With central ratchet*

**E0616019** Avec crémaillère centrale débrayable / *With switchable central ratchet*

## Électrodes HF HF electrodes

### ● Électrode crochet / Hook electrode



	∅	Longueur / Length
E0622010	2,8 mm	250 mm
E0622019	2,8 mm	330 mm
 E0622011	5 mm	330 mm
E0622012	5 mm	450 mm

### ● Électrode crochet 90° / 90° hook electrode



E0622020	2,8 mm	250 mm
E0622029	2,8 mm	330 mm
 E0622021	5 mm	330 mm
E0622022	5 mm	450 mm

### ● Électrode spatule / Spatula electrode



E0622030	2,8 mm	250 mm
E0622039	2,8 mm	330 mm
 E0622031	5 mm	330 mm
E0622032	5 mm	450 mm

### ● Électrode boule / Ball electrode



E0622040	2,8 mm	250 mm
E0622049	2,8 mm	330 mm
 E0622041	5 mm	330 mm
E0622042	5 mm	450 mm



## Inserts pour instruments de laparoscopie - ø 5 mm

### Laparoscopy instruments inserts - ø 5mm

Ciseaux Metzenbaum droits - 2 lames mobiles - L : 15 mm / *Straight Metzenbaum scissors - double action - L:15mm*  
 Longueur utile  
*Working length*



E0633551	250 mm
E0633552	330 mm
E0633553	450 mm

Ciseaux Metzenbaum courbes - 2 lames mobiles - L : 15 mm / *Curved Metzenbaum scissors - double action - L:15mm*



E0633561	250 mm
E0633562	330 mm
E0633563	450 mm

Ciseaux Metzenbaum courbes micro-dentés - 2 lames mobiles - L : 15 mm  
*Curved Metzenbaum scissors with micro serrated blades - double action - L:15mm*

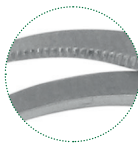

E0633571	250 mm
E0633572	330 mm
E0633573	450 mm

Porte-Aiguille/Pousse noeud/Ciseaux - 2 mors mobiles - L : 18 mm / *Needle-Holder/Knot pusher/Scissors - double action - L:18mm*



E0633581	250 mm
E0633582	330 mm
E0633583	450 mm

Porte-aiguille 1 mors mobile - L : 10 mm / *Needle holder - single action - L:10mm*



E0633591	250 mm
E0633592	330 mm
E0633593	450 mm

## Tubes isolés pour instruments de laparoscopie - ø 5 mm

### Laparoscopy instruments insulated shafts - ø 5mm



Longueur / Length

E0633001	250 mm
E0633002	330 mm
E0633003	450 mm

## Tubes non isolés pour instruments de laparoscopie - ø 5 mm

### Laparoscopy instruments uninsulated shafts - ø 5mm



\* Ne pas utiliser la fonction HF avec des tubes non isolés  
 \* *Not use the HF function with uninsulated shafts*

Longueur / Length

E0633005	250 mm
E0633006	330 mm
E0633007	450 mm

## Écrous de personnalisation pour instruments de laparoscopie - ø 5 mm

### Laparoscopy instruments customization nuts - ø 5mm



Couleur / Color

E9633001	Noir / Black
E9633002	Rouge / Red
E9633003	Jaune / Yellow
E9633004	Bleu / Blue
E9633005	Vert / Green

Raccord de nettoyage pour tube / *Flushing part for shaft*



E0631000



Poignées composite HF - pouce mobile

HF polymer handle - mobile thumb



**E0616016** Sans crémaillère / *Without ratchet*



**E0616017** Avec crémaillère française / *With flat ratchet*



**E0616018** Avec crémaillère centrale / *With central ratchet*

**E0616019** Avec crémaillère centrale débrayable / *With switchable central ratchet*

Trocarts Magnétique COLIBRI - Pointes - ø 11 mm

Magnetic COLIBRI trocars - Tips - ø 11mm

Pour / For  
instruments ø 10 mm

● Pointes pyramidales inox / *Stainless steel pyramidal trocar tips*

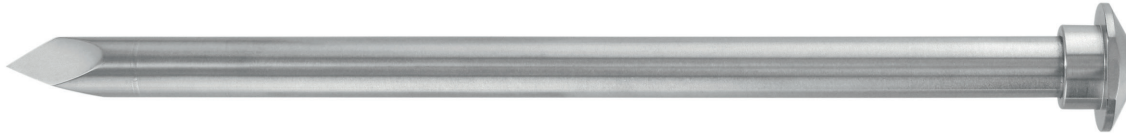

Standard / *Standard*

 **E0639650**

Trocarts / *Trocars*

L : 100 mm

Bariatrique / *Bariatric*

**E0639651**

L : 140 mm

● Pointe de Hasson / *Hasson trocar tip*



Standard / *Standard*

 **E0639610**

Trocarts / *Trocars*

L : 100 mm

Bariatrique / *Bariatric*

**E0639611**

L : 140 mm

● Pointes coniques / *Conical trocar tips*



Standard / *Standard*

 **E0639630**

Trocarts / *Trocars*

L : 100 mm

Bariatrique / *Bariatric*

**E0639631**

L : 140 mm

Trocarts Magnétique COLIBRI - Ø 11 mm

Magnetic COLIBRI trocars - Ø 11mm

Pour / For  
instruments Ø 10 mm

Tube PEEK strié / Grooved PEEK tube

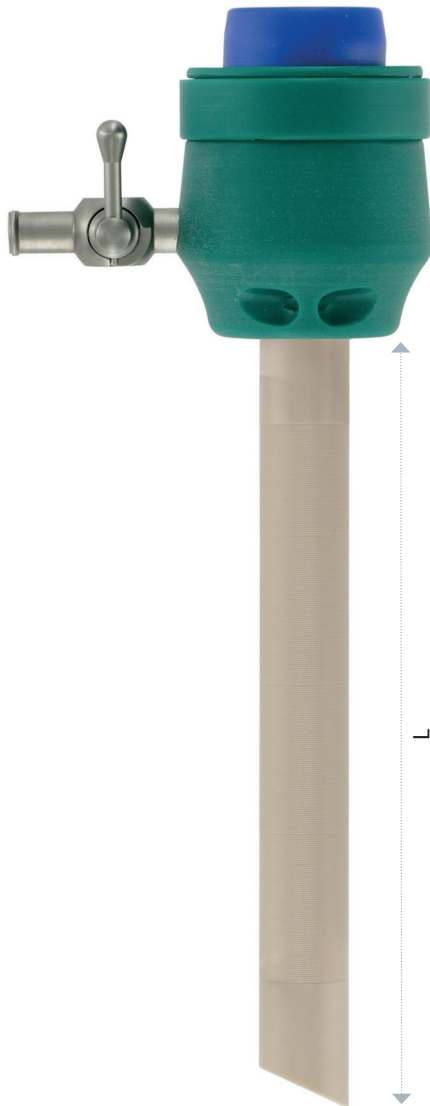

Tube PEEK filaté / Threaded PEEK tube



**Avec robinet / With stopcock**

Standard / <i>Standard</i>	<b>E0639010</b>	L : 100 mm
Bariatrique / <i>Bariatric</i>	<b>E0639011</b>	L : 140 mm

**Avec Luer / With Luer**

Standard / <i>Standard</i>	<b>E0639110</b>	L : 100 mm
Bariatrique / <i>Bariatric</i>	<b>E0639111</b>	L : 140 mm

**Sans robinet / Without stopcock**

Standard / <i>Standard</i>	<b>E0639210</b>	L : 100 mm
Bariatrique / <i>Bariatric</i>	<b>E0639211</b>	L : 140 mm

**Avec robinet / With stopcock**

Standard / <i>Standard</i>	<b>E0639310</b>	L : 100 mm
----------------------------	-----------------	------------

**Avec Luer / With Luer**

Standard / <i>Standard</i>	<b>E0639410</b>	L : 100 mm
----------------------------	-----------------	------------

**Sans robinet / Without stopcock**

Standard / <i>Standard</i>	<b>E0639510</b>	L : 100 mm
----------------------------	-----------------	------------

Systèmes de lavage et aspiration - poignée droite à robinet basculant  
 Suction-irrigation systems - sliding valve straight handle



E0615500

Poignée / Handle

● Tubes 4 trous / 4 holes tubes



E0615502

∅

5 mm

Longueur / Length

330 mm

E0615503

10 mm

330 mm

● Pièces détachées / Spare parts



E9615610

Bouchon ressort / Cap spring



E9615500

Robinet basculant / Valve



## Porte aiguilles avec canal de nettoyage

### Needle holders with flushing port



TC Inserts

#### ● Droit / Straight



	ø	Longueur / Length
E0619541	5 mm	250 mm
E0619551	5 mm	330 mm
E0619552	5 mm	450 mm

#### ● Courbe gauche / Left curved



E0619542	5 mm	250 mm
 E0619553	5 mm	330 mm
E0619554	5 mm	450 mm

#### ● Courbe droite / Right curved



E0619543	5 mm	250 mm
E0619555	5 mm	330 mm
E0619556	5 mm	450 mm



Diamonite

#### ● Mors Roméo / Romeo jaws



E0619544	5 mm	250 mm
E0619557	5 mm	330 mm
E0619558	5 mm	450 mm



LANDANGER

1947



**ÉLECTROCHIRURGIE**

***ELECTROSURGERY***

***ELECTRO-CIRUGÍA***



2 kVp max

Droit  
Straight  
Recta

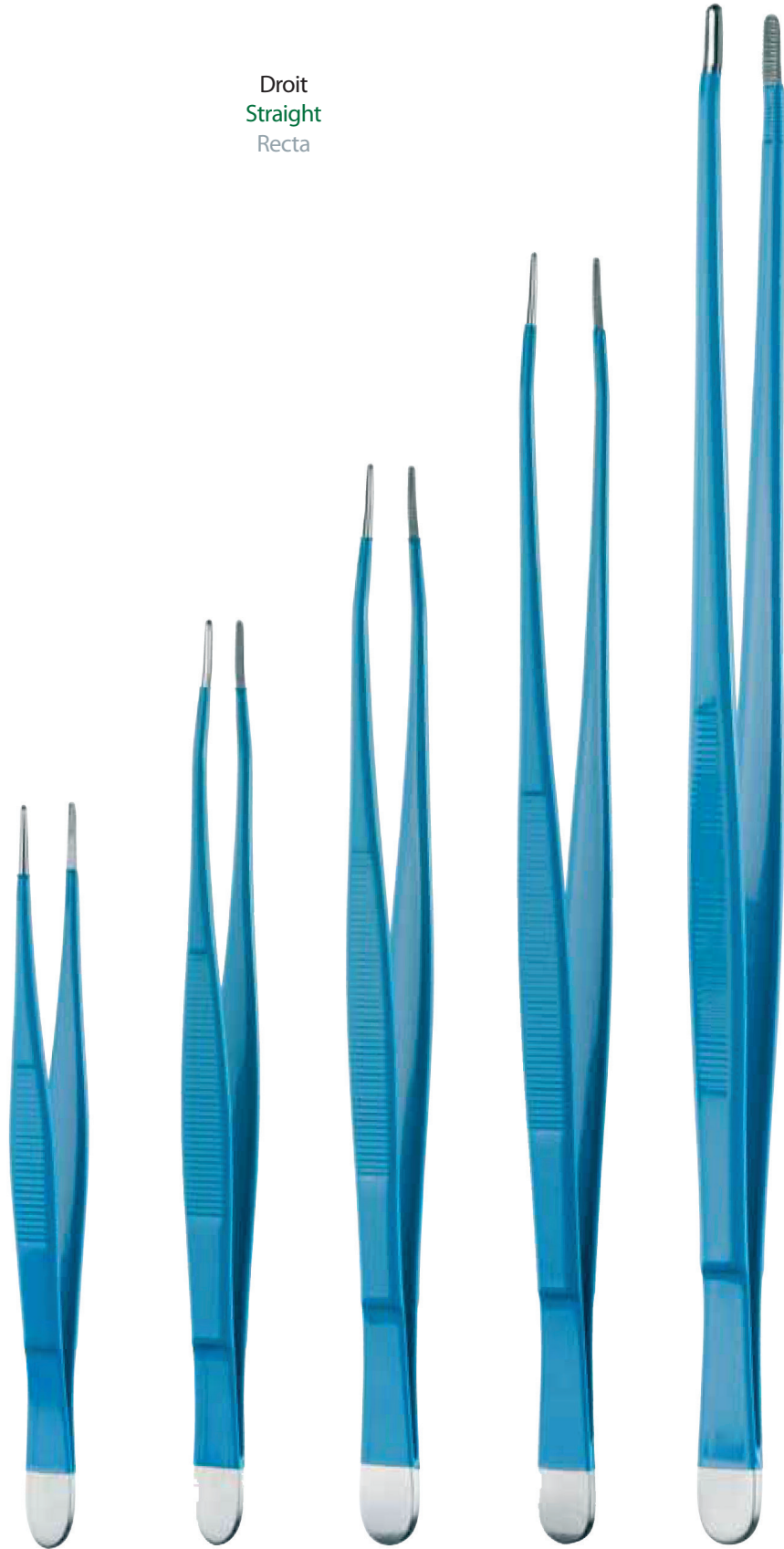
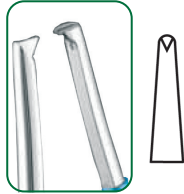
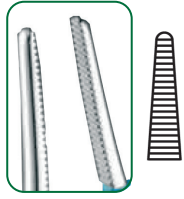

145 mm

180 mm

210 mm

250 mm

300 mm

Sans griffe  
Without teeth  
Sin dientes



HF9714110

HF9618110

HF9621110

HF9625110

HF9630110



Avec griffe  
With teeth  
Con dientes



HF9714120

HF9618120

HF9621120

HF9625120

HF9630120



**STÉRILISATION**

***STERILIZATION***

**L A N D A N G E R**

## Boîte perforée avec couvercle articulé pour aiguilles

Perforated needles case with hinged lid



Perforation  
Perforation  
Ø 1 mm

Dimensions / Dimensions



**O602540**

150 × 90 × 15 mm / 5.90 × 3.54 × 0.59"

1

## Boîte perforée avec couvercle amovible pour aiguilles

Perforated needles case with removable lid



Perforation  
Perforation  
Ø 2 mm

Dimensions / Dimensions



**O602550**

Ø 65 mm × 15 mm / Ø 2.56 × 0.59"

1

## Boîtes perforées avec couvercle coulissant pour aiguilles

Perforated needles cases with sliding lid

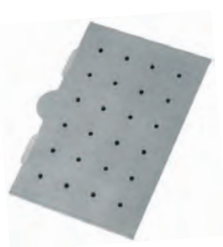
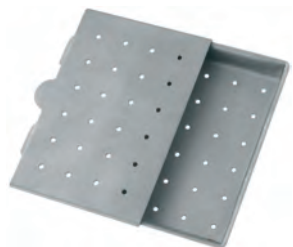

Perforation  
Perforation  
Ø 1,5 mm

Dimensions / Dimensions



**O602560**

65 × 45 × 8 mm / 2.56 × 1.77 × 0.31"

**O602570**

80 × 30 × 8 mm / 3.15 × 1.18 × 0.31"

**O602580**

50 × 30 × 8 mm / 1.97 × 1.18 × 0.31"

1

LANDANGER