

# LANDANGER

1947



«L'entretien des instruments  
s'est fait mieux.»  
1947

# LANDANGER

Pour tout renseignement, devis et commandes :  
For all information, quotes and orders:  
Para más información, presupuestos y pedidos:



Tél. France : 03 25 02 10 10 - Monde - World - Mundo : +33 3 25 02 10 35

Du lundi au vendredi - Monday to Friday - De lunes a viernes  
De 8 heures à 18 heures - From 8:00 am to 6:00 pm - Desde las 8 hrs hasta las 18 hrs



Fax France : 03 25 02 10 20 - Monde - World - Mundo : +33 3 25 02 10 20



contact@landanger.com



Siège - Corporate office - Sede  
**Landanger**  
13 avenue de la République  
75011 Paris  
FRANCE

Service clients - Customer service - Servicio al cliente  
**Landanger**  
Rue Renée et Louis Landanger  
52906 Chaumont  
FRANCE

www.landanger.com

*Le plus complet des catalogues LANDANGER  
depuis sa création, soit plus de 1000 pages à  
votre service !*

*Instrumentalement votre,  
Benoit LANDANGER*

*- Dédié à Louis LANDANGER -  
Fondateur*

*The largest LANDANGER catalogue since the creation of the company, with over  
1000 pages at your service!  
Thank you for your confidence,*

*Benoit LANDANGER  
- Dedicated to Louis LANDANGER -  
The founder*

*El catálogo más completo de LANDANGER desde su creación, con más de 1000  
páginas a su servicio.  
Gracias por su confianza,*

*Benoit LANDANGER  
- Dedicado a Louis LANDANGER -  
Fundador*

L A N D A N G E R



CHIRURGIE  
SURGERY  
CIRUGÍA

*« Vous avez le geste, nous vous apportons la précision »*  
*« You have the gesture, we bring you the precision »*  
*« Usted tiene el gesto, nosotros le aportamos la precisión »*

## Bistouris fixes - One-piece scalpels - Bisturís fijos

FARABEUF NELATON SIMS TENOTOME

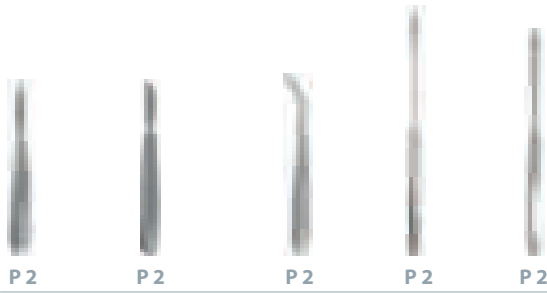

P 2 P 2 P 2 P 2 P 2

## Manches de bistouris, lames U.U. - Scalpel handles, disposable blades - Mangos de bisturís, hojas desechables

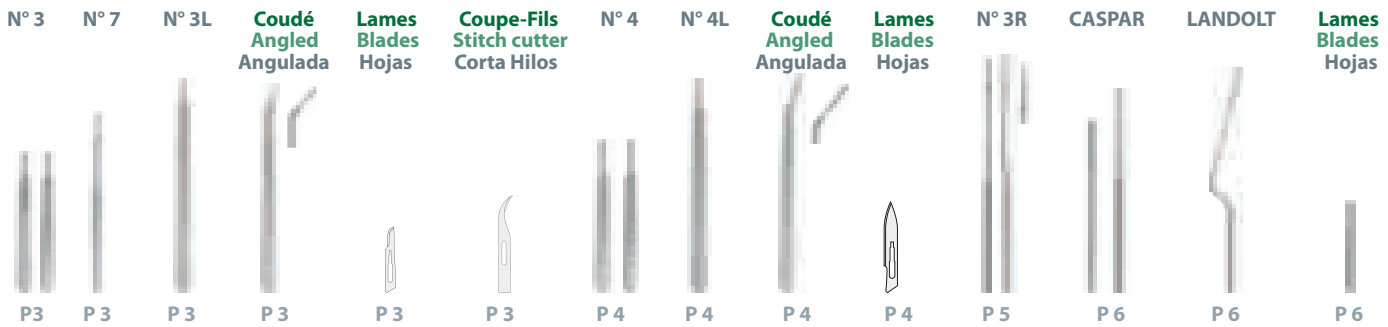

P 3 P 3 P 3 P 3 P 3 P 3 P 4 P 4 P 4 P 4 P 5 P 6 P 6 P 6

## Bistouris à usage unique stériles - Disposable sterile scalpels - Bisturís desechables estériles

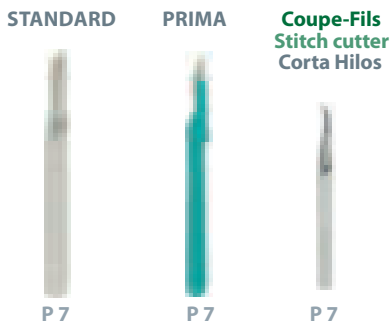

P 7 P 7 P 7

## Dermatome à main - Hand dermatome - Dermátomo de mano

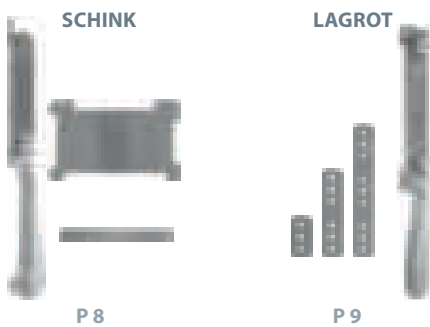

P 8 P 9

## Amplificateur pour greffe de peau - Graft skin amplifier - Amplificador para injerto de piel

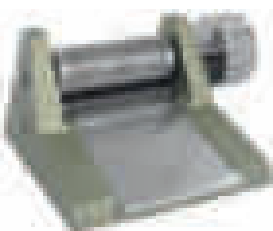

P 10



## Bistouris fixes - One-piece scalpels - Bisturís fijos

I - Incision  
I - Incision  
I - Incision

### FARABEUF

### NELATON

### SIMS

### TENOTOME

Lame 45 mm  
Blade 1<sup>3/4</sup>"  
Hoja 45 mm

Lame 35 mm  
Blade 1<sup>1/2</sup>"  
Hoja 35 mm

Lame 45 mm  
Blade 1<sup>3/4</sup>"  
Hoja 45 mm

Lame 20 mm  
Blade 0<sup>3/4</sup>"  
Hoja 20 mm

16 cm - 6<sup>1/4</sup>"

**B05103**

20 cm - 8"

**B05104**

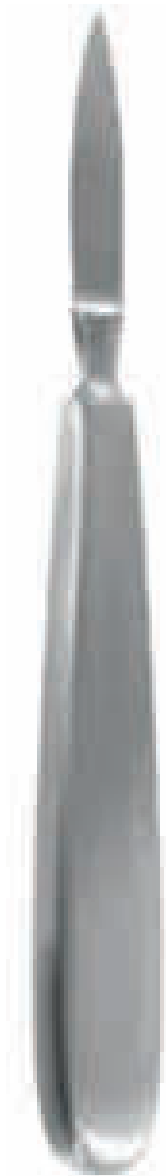

**B05033**  
15,5 cm - 6"

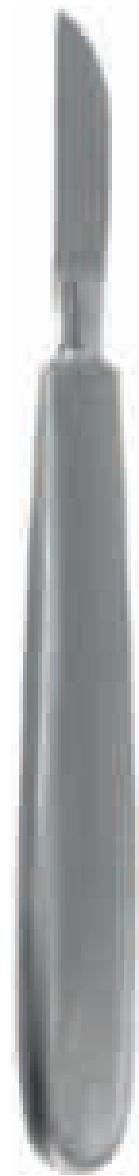

**B05060**  
15,5 cm - 6"



**B05070**  
16 cm - 6<sup>1/4</sup>"



**B05090**  
22 cm - 8<sup>3/4</sup>"

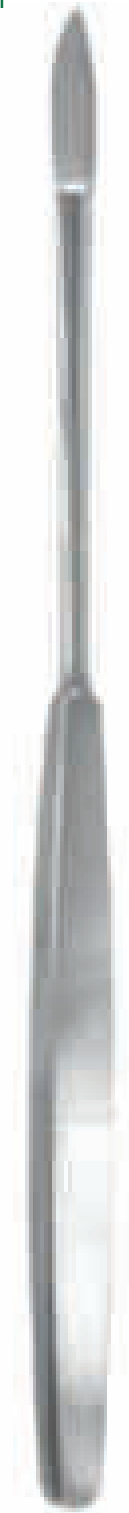

**B05104**  
20 cm - 8"

Manches acier inoxydable  
Stainless steel handles  
Mangos acero inoxidable

N° 3L

N° 3L  
Coudé  
Angled  
Angulada

N° 7 (ex 5)

Lame carbone  
Carbon blade  
Hoja carbono



Stérile  
Sterile  
Estérile

N° 3

10

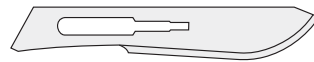

B130100

11P



B13011P

12



B130120

15S



B13015S

Coupe fils standard  
Standard stitch cutter  
Corta hilos estándar



B130710

**B12000**  
12,5 cm - 5"

**B12000G**  
12,5 cm - 5"

**B110050**  
16 cm - 6<sup>1</sup>/<sub>4</sub>"

**B11013**  
21 cm - 8<sup>1</sup>/<sub>4</sub>"

**B12008**  
20,5 cm - 8"



## Manches de bistouris, lames U.U. - Scalpel handles, disposable blades - Mangos de bisturís, hojas disponibles

Manches acier inoxydable  
Stainless steel handles  
Mangos acero inoxidable

N° 4L

N° 4L

Coudé  
Angled  
Angulada

N° 4

Lame carbone  
Carbon blade  
Hoja carbono



Stérile  
Sterile  
Estérile

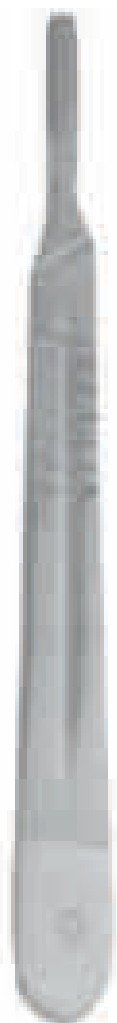

**B12001**

13,5 cm - 5<sup>1</sup>/<sub>4</sub>"



**B12001G**

13,5 cm - 5<sup>1</sup>/<sub>4</sub>"

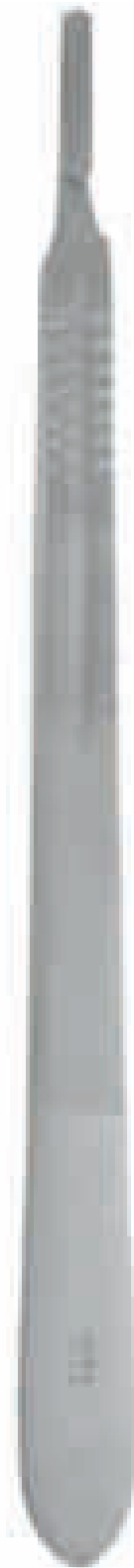

**B11014**

21 cm - 8<sup>1</sup>/<sub>4</sub>"

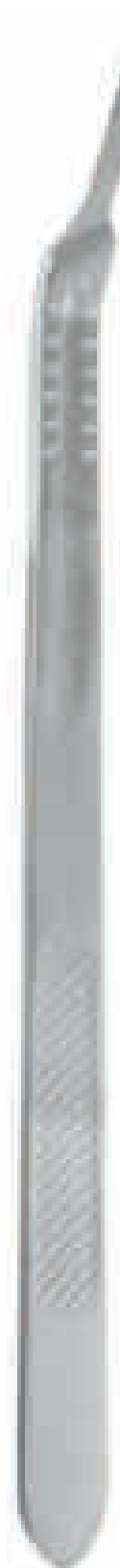

**B12009**

21,5 cm - 8<sup>1</sup>/<sub>2</sub>"

<b>18</b>		<b>B130180</b>
<b>19</b>		<b>B130190</b>
<b>20</b>		<b>B130200</b>
<b>21</b>		<b>B130210</b>
<b>22</b>		<b>B130220</b>
<b>23</b>		<b>B130230</b>
<b>24</b>		<b>B130240</b>
<b>36</b>		<b>B130360</b>

Manches acier inoxydable pour lames de bistouris 10, 11P, 12, 15S  
 Stainless steel handles for 10, 11P, 12, 15S scalpel blades  
 Mangos acero inoxidable para hojas de bisturís 10, 11P, 12, 15S



## LANDOLT



### CASPAR

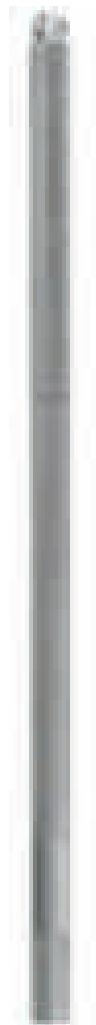

**B160013**  
13,5 cm - 5<sup>1</sup>/<sub>4</sub>"

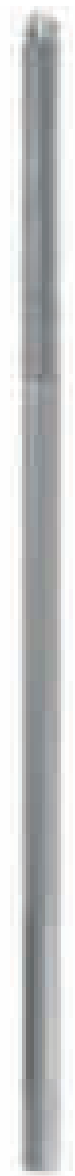

**B160015**  
15,5 cm - 6"

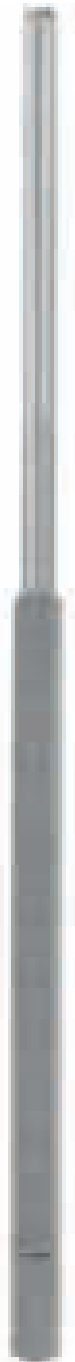

**B160080**  
18 cm - 7"



**B160020**  
20 cm - 8"



**B160021**  
21 cm - 8<sup>1</sup>/<sub>4</sub>"



**B160025**  
25 cm - 10"



N° 64

**B161064**



N° 65

**B161065**



N° 67

**B161067**



N° 69

**B161069**



Bistouris standard  
Standard scalpels  
Bisturís estándar

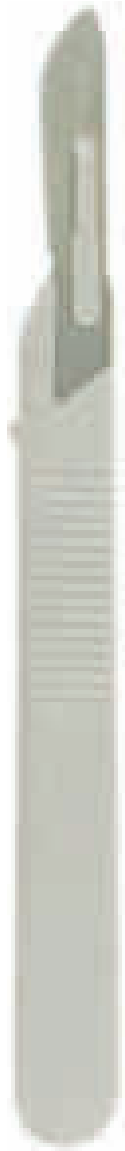

N° 21

Bistouris PRIMA  
PRIMA scalpels  
Bisturís PRIMA

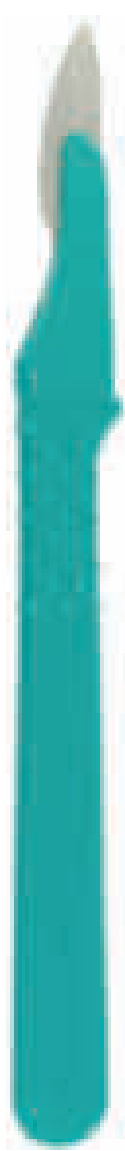

N° 23

- B132100**
- B13211P**
- B132120**
- B13215S**
- B132180**
- B132190**
- B132200**
-  **B132210**
- B132220**
- B132230**
- B132240**

- B134100**
- B13411P**
- B134120**
- B13415S**
- B134180**
- B134190**
- B134200**
- B134210**
- B134220**
-  **B134230**
- B134240**

- 10**
- 11P**
- 12**
- 15S**
- 18**
- 19**
- 20**
- 21**
- 22**
- 23**
- 24**



Stérile  
Sterile  
Estérile

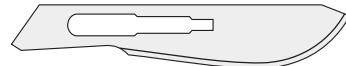
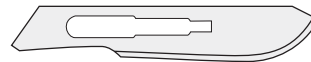
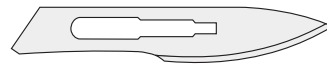
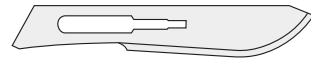

Stérile  
Sterile  
Estérile



Bistouri coupe fils  
Stitch cutter scalpel  
Bisturís corta hilos

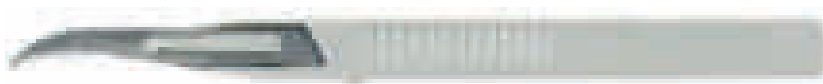

**B132700**

### SCHINK

Livré avec 2 plaques, 1 lame  
Supplied with 2 plates, 1 blade  
Entregado con 2 placas, 1 hoja

Réglable, 0,1 - 2 mm  
Adjustable, 0,1 - 2 mm  
Ajustable, 0,1 - 2 mm



**B20010**  
30 cm - 11<sup>3</sup>/<sub>4</sub>"

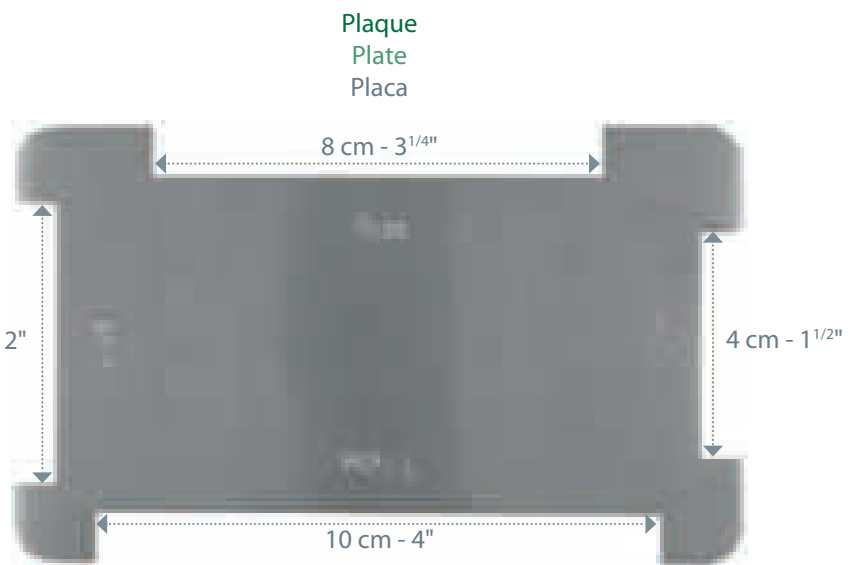

Plaque  
Plate  
Placa

**B20030**

Lame de rechange  
Spare blade  
Hoja de cambio

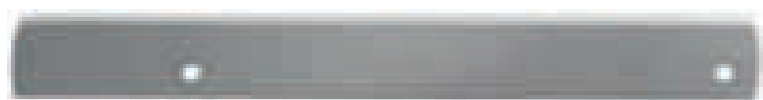

**B20040**

10 cm - 4"



### LAGROT

Livré avec une boîte de 6 lames  
 Supplied with 1 box of 6 blades  
 Entregado con 1 caja de 6 hojas

Réglable, 0,1 - 3 mm  
 Adjustable, 0,1 - 3 mm  
 Ajustable, 0,1 - 3 mm

- 40 mm - 1<sup>1/2</sup>" **B20045**
- 90 mm - 3<sup>1/2</sup>" **B20050**
- 140 mm - 5<sup>1/2</sup>" **B20060** 

Lames / Blades / Hojas

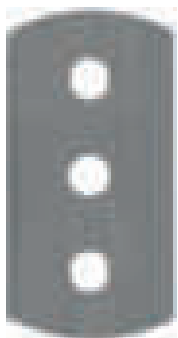

**B20015**  
40 mm - 1<sup>1/2</sup>"



**B20020**  
90 mm - 3<sup>1/2</sup>"

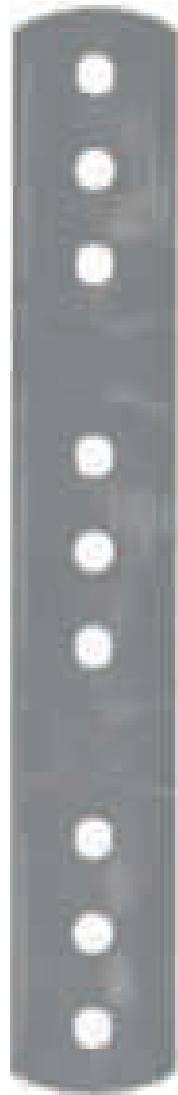

**B20025**  
140 mm - 5<sup>1/2</sup>"



**B20060**  
30 cm - 11<sup>3/4</sup>"

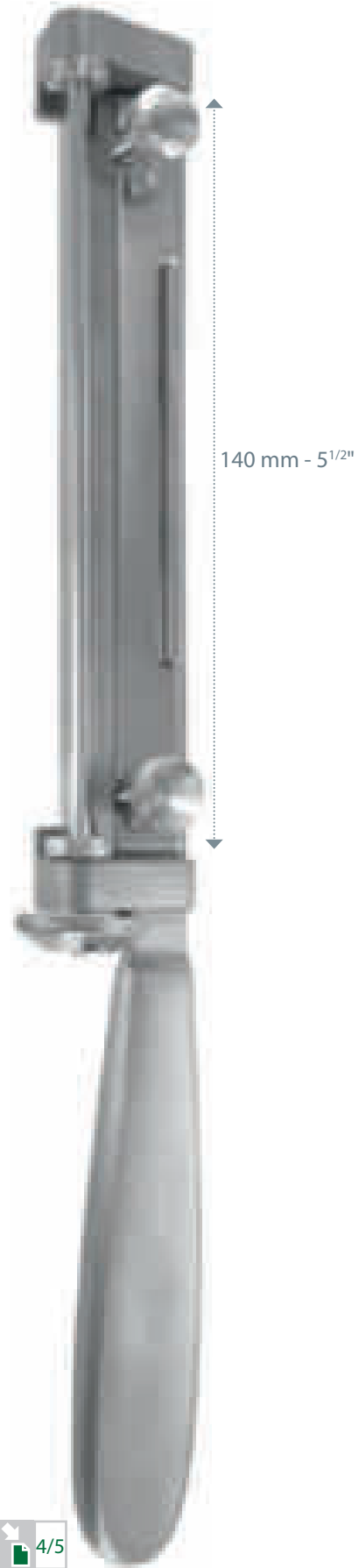



 Aluminium  
Aluminum  
Aluminio



Chirurgie plastique  
Plastic surgery  
Cirugía plástica

x 2

Brûlés, ulcères, escarres  
Burnt, ulcers, bedsores  
Quemados, úlceras, escaras

x 4

Grands brûlés  
Deep burnt  
Grandes quemados

x 6

Expansion maximum - Maximum expansion - Expansión máxima

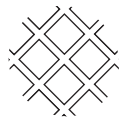

3,75 x 3,75 mm  
**B201020**

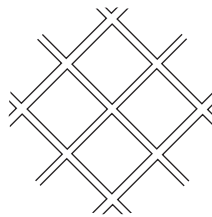

7,5 x 7,5 mm  
**B201040**

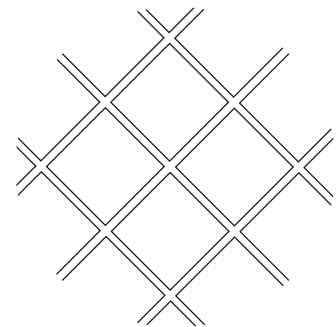

11 x 11 mm  
**B201060**

## Pinces à dissection - Dissecting forceps - Pinzas para disección

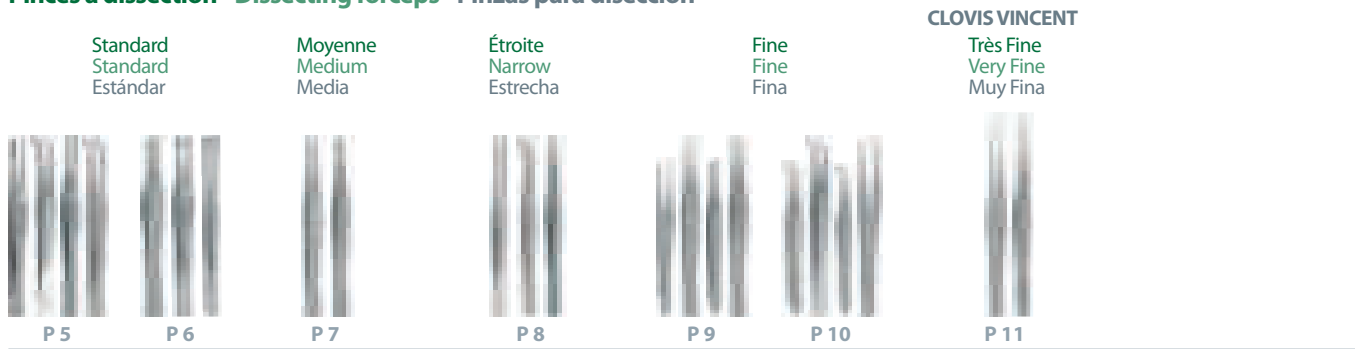

## Pinces à dissection spéciales - Special dissecting forceps - Pinzas para disección especiales

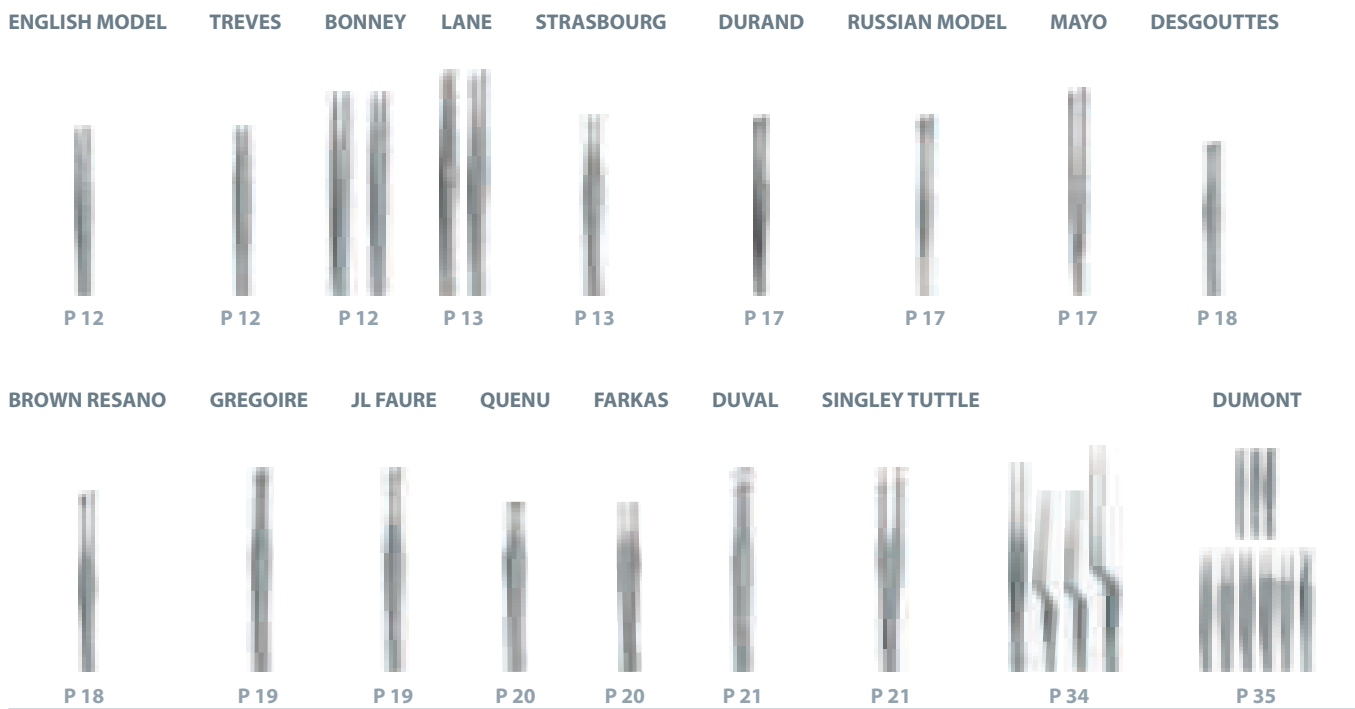

## Pinces à dissection délicates - Delicate dissecting forceps - Pinzas para disección delicadas

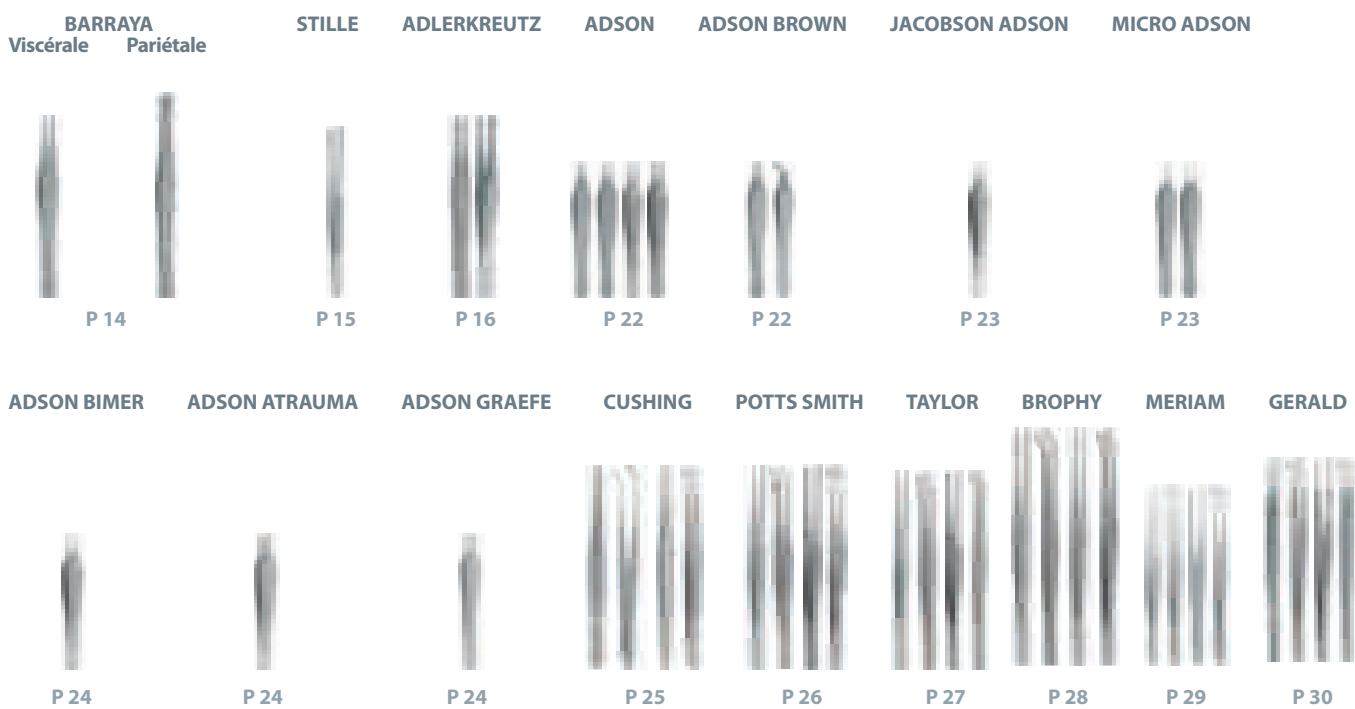

**Pincès à dissection délicates - Delicate dissecting forceps - Pinzas para disección delicadas**

MC INDOE   GILLIES   GILLIES WAUGH   WAUGH   SEMKEN   DUFOURMENTEL   VISE   OSCHNER   AUSTIN   PERRY



**PRECELLE**



**Pincès à dissection ophtalmologiques - Ophtalmologic dissecting forceps - Pinzas para disección oftalmológicas**



**Pincès à dissection ORL - ENT dissecting forceps - Pinzas para disección ORL**

TROELTSCH   POLITZER   LUCAE   JANSEN LUCAE



**Pincès à dissection vasculaires - Vascular dissecting forceps - Pinzas para disección vasculares**

DEBAKEY   COOLEY   DEBAKEY GERALD   DEBAKEY DIETRICH   DEBAKEY



**Pinces à dissection mors tungstène - Dissecting forceps with tungsten jaws - Pinzas para disección boca de tungsteno**

DEBAKEY Standard Standard Estándar OEHLER WANGENSTEEN EVANS POTTS-SMITH CUSHING GRUENWALD ADSON MICRO-ADSON

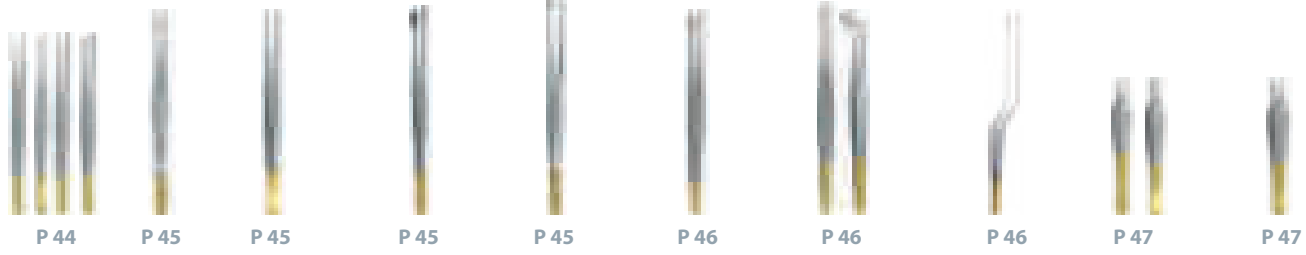

SEMKEN MC INDOE

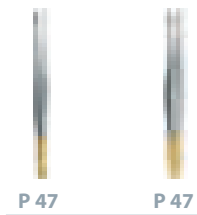

**Pinces à dissection Prestige - Prestige dissecting forceps - Pinzas para disección Prestige**

Fine Fine Fina VINCENT BARRAYA ADLERKREUTZ DURAND

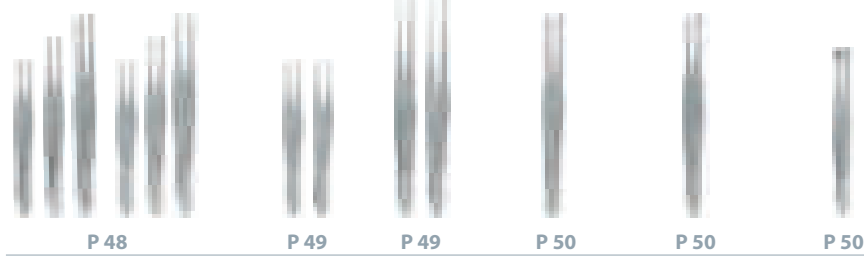

**Pinces à échardes - Splinters forceps - Pinzas para astillas**

FELCHENFELD HUNTER WALTER-CARMALT PEET STIEGLITZ



**Microchirurgie pinces fines - Microsurgery fine forceps - Microcirugía pinzas finas**

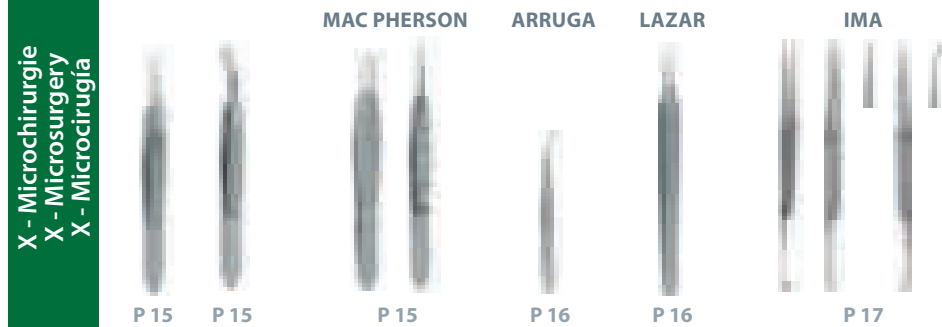

X - Microchirurgie  
X - Microsurgery  
X - Microcirugía

Instrumentation de service - Instrumentation for services - Instrumentación de servicio



XV - Divers  
XV - Miscellaneous  
XV - Diversos

ADSON



P 17

## Pinces à dissection standards - Standard dissecting forceps - Pinzas para disección estándares

Sans griffes Without teeth Sin dientes		STANDARD - STANDARD - ESTÁNDAR	1 x 2 griffes 1 x 2 teeth 1 x 2 dientes	
B40005	-	10 cm - 4"	B40045	-
B40010	B401140	12 cm - 4 <sup>3</sup> / <sub>4</sub> "	B40050	B401150
B40015	B401141	14 cm - 5 <sup>1</sup> / <sub>2</sub> "	B40055	B401151
 B40020	<b>B401142</b>	16 cm - 6 <sup>1</sup> / <sub>4</sub> "	<b>B40060</b>	<b>B401152</b> 
B40025	B401143	18 cm - 7"	B40065	B401153
B40030	B401144	20 cm - 8"	B40070	B401154
B40035	B401145	25 cm - 10"	B40075	B401155
B40040	-	30 cm - 11 <sup>3</sup> / <sub>4</sub> "	B40080	-



**B40020**  
16 cm - 6<sup>1</sup>/<sub>4</sub>"



**B401142**  
16 cm - 6<sup>1</sup>/<sub>4</sub>"



**B40060**  
16 cm - 6<sup>1</sup>/<sub>4</sub>"

**B401152**  
16 cm - 6<sup>1</sup>/<sub>4</sub>"

### STANDARD - STANDARD - ESTÁNDAR

 <b>B40090</b>	14 cm - 5 1/2"	<b>B400901</b>	14 cm - 5 1/2"	<b>B400902</b>
<b>B40095</b>	16 cm - 6 1/4"	<b>B400951</b>	16 cm - 6 1/4"	<b>B400952</b> 
<b>B40100</b>	18 cm - 7"	-	18 cm - 7"	-
<b>B40105</b>	20 cm - 8"	-	20 cm - 8"	-
<b>B40092</b>	25 cm - 10"	-	25 cm - 10"	-

2 x 3 griffes  
2 x 3 teeth  
2 x 3 dientes

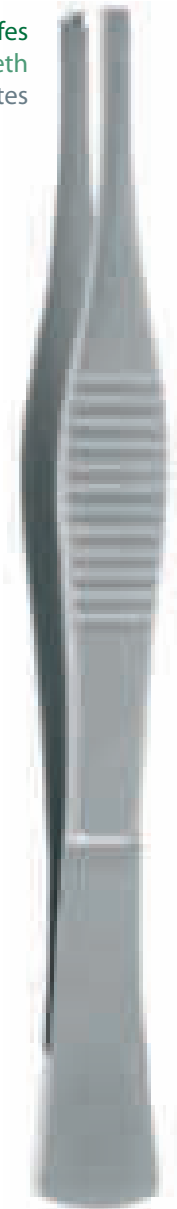

**B40095**  
16 cm - 6 1/4"

3 x 4 griffes  
3 x 4 teeth  
3 x 4 dientes





**B400951**  
16 cm - 6 1/4"

4 x 5 griffes  
4 x 5 teeth  
4 x 5 dientes



**B400952**  
16 cm - 6 1/4"

## Pinces à dissection moyennes - Medium dissecting forceps - Pinzas para disección medias finas

	Sans griffes Without teeth Sin dientes	MOYENNE - MEDIUM - MEDIA - 2,5 mm	1 x 2 griffes 1 x 2 teeth 1 x 2 dientes
	<b>B40021</b>	16 cm - 6 <sup>1/4</sup> "	<b>B40061</b> 
	<b>B40026</b>	18 cm - 7"	<b>B40066</b>
	<b>B40031</b>	20 cm - 8"	<b>B40071</b>

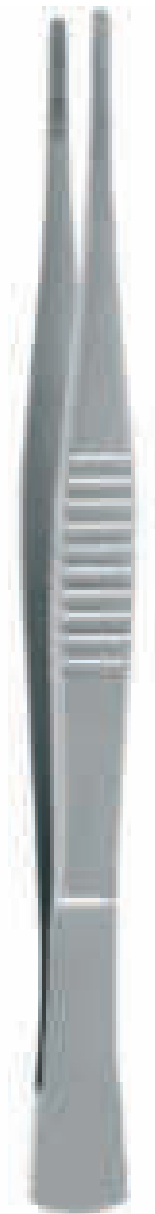

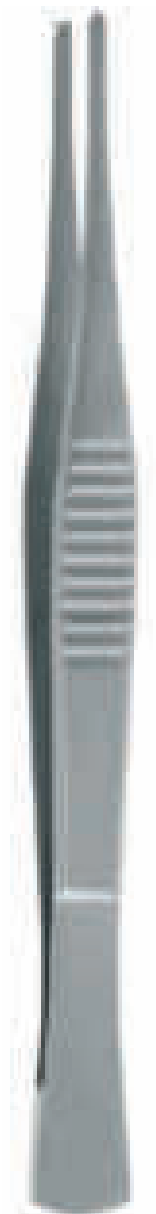

**B40021**  
16 cm - 6<sup>1/4</sup>"



**B40061**  
16 cm - 6<sup>1/4</sup>"



## Pinces à dissection moyennes - Medium dissecting forceps - Pinzas para disección medias finas

Sans griffes Without teeth Sin dientes		ETROITE - NARROW - ESTRECHA	1 x 2 griffes 1 x 2 teeth 1 x 2 dientes
B401110	B401120	11,5 cm - 4 1/2"	B401130
B401111	B401121	14,5 cm - 5 3/4"	B401131
 B401112	<b>B401122</b>	16 cm - 6 1/4"	<b>B401132</b> 
B401113	B401123	18 cm - 7"	B401133
B401114	B401124	20 cm - 8"	B401134
B401115	B401125	25 cm - 10"	B401135



**B401112**  
16 cm - 6 1/4"





**B401122**  
16 cm - 6 1/4"



**B401132**  
16 cm - 6 1/4"

## Pinces droites à dissection fines - Fine straight dissecting forceps - Pinzas para disección finas rectas

Sans griffes Without teeth Sin dientes	FINE - FINE - FINA	1 x 2 griffes 1 x 2 teeth 1 x 2 dientes
B40120	10 cm - 4"	B40145
B40125	12 cm - 4 <sup>3</sup> / <sub>4</sub> "	B40150
 B40130	14 cm - 5 <sup>1</sup> / <sub>2</sub> "	B40155 
 B40135	16 cm - 6 <sup>1</sup> / <sub>4</sub> "	B40160 
B40140	18 cm - 7"	B40165
B401430	20 cm - 8"	B401680
B401432	25 cm - 10"	B401682
B401434	30 cm - 11 <sup>3</sup> / <sub>4</sub> "	B401684

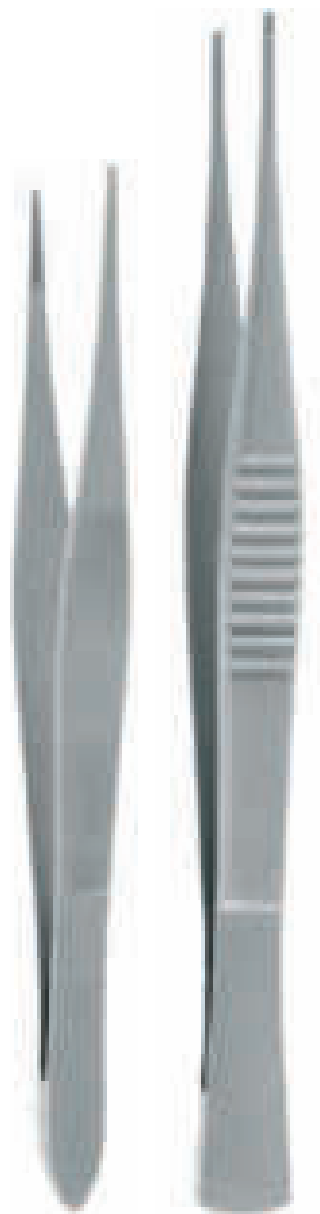



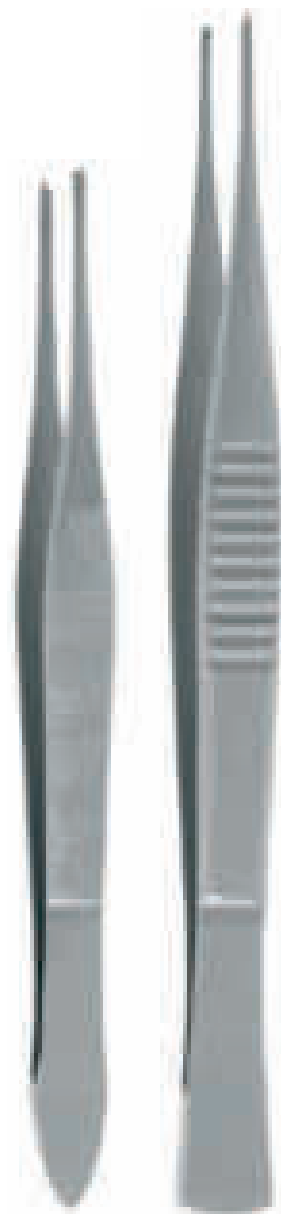

**B40130** 14 cm - 5<sup>1</sup>/<sub>2</sub>"  
**B40135** 16 cm - 6<sup>1</sup>/<sub>4</sub>"



**B40155** 14 cm - 5<sup>1</sup>/<sub>2</sub>"  
**B40160** 16 cm - 6<sup>1</sup>/<sub>4</sub>"

## Pinces courbes à dissection fines - Fine curved dissecting forceps - Pinzas para disección finas curvas

Sans griffes Without teeth Sin dientes	FINE - FINE - FINA COURBE - CURVED - CURVA	1 x 2 griffes 1 x 2 teeth 1 x 2 dientes
B401220	10 cm - 4"	B401470
B401270	12 cm - 4 <sup>3</sup> / <sub>4</sub> "	B401520
 B40132	14 cm - 5 <sup>1</sup> / <sub>2</sub> "	B40157 
 B401370	16 cm - 6 <sup>1</sup> / <sub>4</sub> "	B401620 
B401420	18 cm - 7"	B401670
B401431	20 cm - 8"	B401681
B401433	25 cm - 10"	B401683
B401435	30 cm - 11 <sup>3</sup> / <sub>4</sub> "	B401685



**B40132**  
14 cm - 5 <sup>1</sup>/<sub>2</sub>"

**B401370**  
16 cm - 6 <sup>1</sup>/<sub>4</sub>"

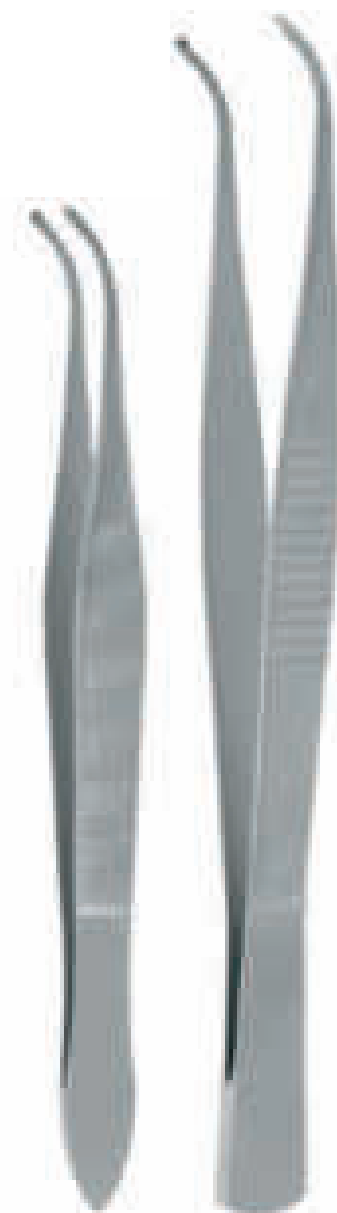



**B40157**  
14 cm - 5 <sup>1</sup>/<sub>2</sub>"

**B401620**  
16 cm - 6 <sup>1</sup>/<sub>4</sub>"

## CLOVIS VINCENT

TRÈS FINE - VERY FINE - MUY FINA

B401698	15 cm - 6"	B401748
B401699	18 cm - 7"	B401749
 B40170	20 cm - 8"	<b>B40175</b> 
B401710	25 cm - 10"	B401760
B401711	30 cm - 11 <sup>3/4</sup> "	B401761

Sans griffes  
Without teeth  
Sin dientes

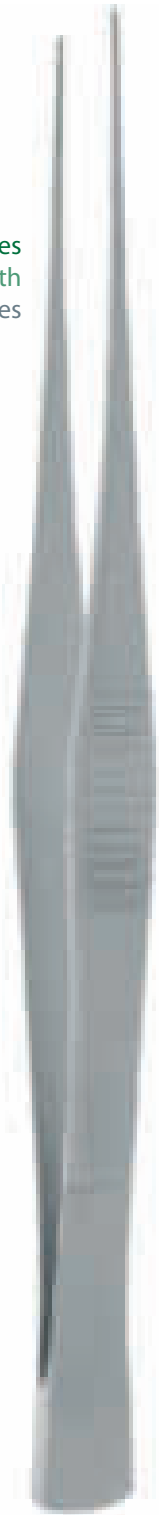

**B40170**  
20 cm - 8"

1 x 2 griffes  
1 x 2 teeth  
1 x 2 dientes



**B40175**  
20 cm - 8"

### ENGLISH MODEL

### TREVES

### BONNEY

B401820

13 cm - 5"

B401830

Sans griffes  
Without teeth  
Sin dientes

1 x 2 griffes  
1 x 2 teeth  
1 x 2 dientes



B401821

15 cm - 6"

B401831



Sans griffes  
Without teeth  
Sin dientes

1 x 2 griffes  
1 x 2 teeth  
1 x 2 dientes



**B401821**  
15 cm - 6"



**B401831**  
15 cm - 6"

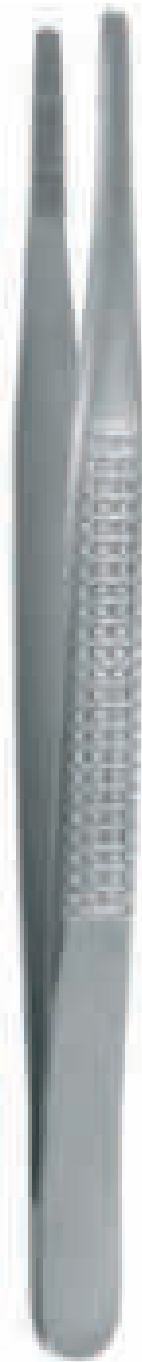

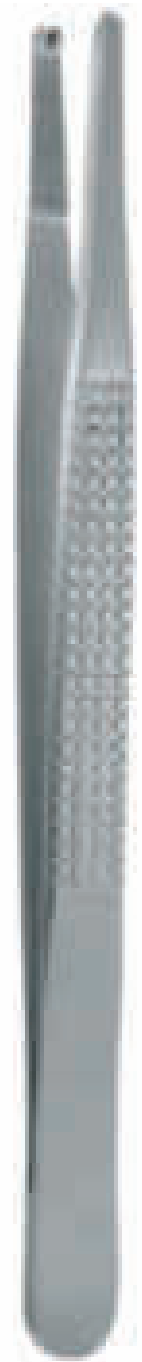

**B401840**  
18 cm - 7"



**B401841**  
18 cm - 7"

## LANE

## STRASBOURG

	<b>B401800</b>	15 cm - 6"	<b>B401810</b>
	<b>B401801</b>	20 cm - 8"	<b>B401811</b>

14 cm - 5 1/2"	<b>B40200</b>
16 cm - 6 1/4"	<b>B40205</b>
18 cm - 7"	<b>B40210</b>
20 cm - 8"	<b>B40215</b>
25 cm - 10"	<b>B402151</b>
30 cm - 11 3/4"	<b>B402152</b>

1 x 2 griffes  
1 x 2 teeth  
1 x 2 dientes

2 x 3 griffes  
2 x 3 teeth  
2 x 3 dientes

Mors quadrillés  
Squared jaws  
Bocas cuadriculadas

1 x 2 griffes  
À talon  
1 x 2 teeth  
With heel  
1 x 2 dientes  
Con talón



**B401801**  
20 cm - 8"

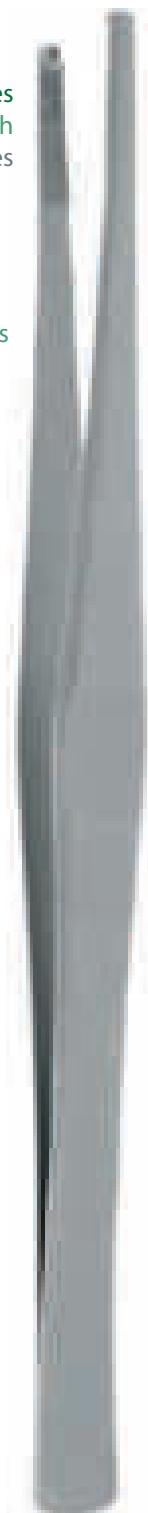

**B401811**  
20 cm - 8"



**B40205**  
16 cm - 6 1/4"

## BARRAYA (VISCÉRALE)

14 cm - 5 1/2"	B40225	
16 cm - 6 1/4"	B40230	
18 cm - 7"	B40235	
20 cm - 8"	B40240	
25 cm - 10"	B40245	
30 cm - 11 3/4"	B402451	

## BARRAYA (PARIETALE)

16 cm - 6 1/4"	B402455	
18 cm - 7"	B40246	
20 cm - 8"	B40248	
25 cm - 10"	B40249	
30 cm - 11 3/4"	B402491	

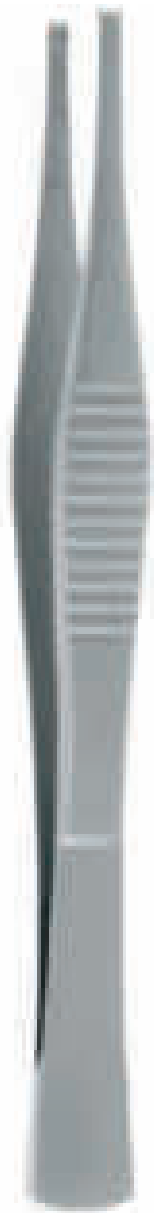

2 x 3 griffes  
Mors étroits quadrillés  
2 x 3 teeth  
Narrow jaws squared  
2 x 3 dientes  
Bocas estrechas cuadriculadas

**B40230**  
16 cm - 6 1/4"

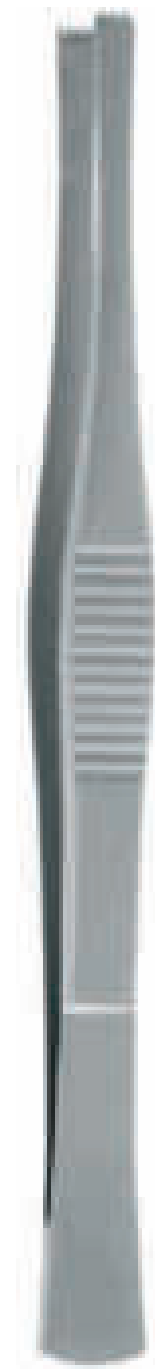

4 x 5 griffes  
Mors larges quadrillés  
4 x 5 teeth  
Wide jaws squared  
4 x 5 dientes  
Bocas anchas cuadriculadas

**B40246**  
18 cm - 7"

## STILLE

13 cm - 5"	B402200	
15 cm - 6"	B402201	
17 cm - 6 <sup>3</sup> / <sub>4</sub> "	B402202	
20 cm - 8"	B402203	

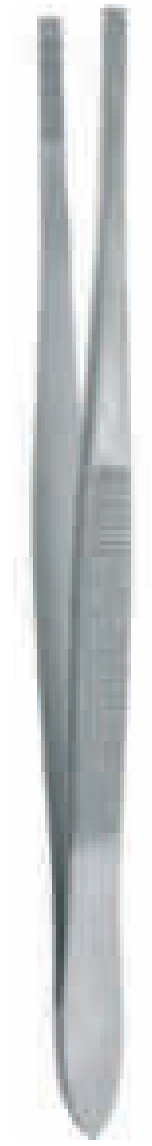

Mors striés  
Serrated jaws  
Bocas estriadas

**B402201**  
15 cm - 6"



	ADLERKREUTZ	
3 x 4 griffes 3 x 4 teeth 3 x 4 dientes		5 x 6 griffes 5 x 6 teeth 5 x 6 dientes
<b>B40374</b>	14 cm - 5 1/2"	-
 <b>B40375</b>	16 cm - 6 1/4"	<b>B403959</b> 
<b>B40380</b>	18 cm - 7"	<b>B403960</b>
<b>B40385</b>	20 cm - 8"	<b>B403961</b>
<b>B40390</b>	25 cm - 10"	<b>B403962</b>
<b>B403950</b>	30 cm - 11 3/4"	<b>B403963</b>

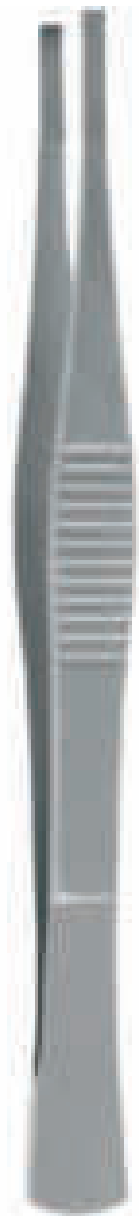

**B40375**  
16 cm - 6 1/4"

À talon  
With heel  
Con talón



**B403959**  
16 cm - 6 1/4"

**DURAND  
(PATTE DE VELOURS)**

**RUSSIAN MODEL**

**MAYO**

 <b>B40255</b>	20 cm - 8"	<b>B402656</b>	
<b>B40250</b>	15 cm - 6"	<b>B402655</b>	
<b>B40260</b>	25 cm - 10"	<b>B402657</b>	
<b>B40265</b>	30 cm - 11 <sup>3/4</sup> "	-	

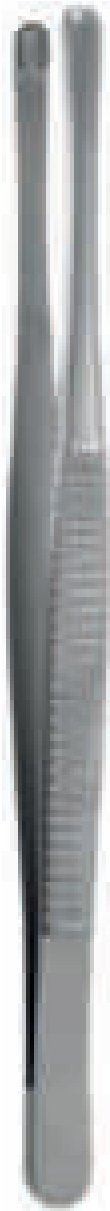

**B40255**  
20 cm - 8"



**B402656**  
20 cm - 8"



**B402660**  
23 cm - 9"

### DESGOUTTES

17 cm - 6 <sup>3</sup> / <sub>4</sub> "	<b>B40280</b> 
20 cm - 8"	<b>B40285</b>
22 cm - 8 <sup>5</sup> / <sub>8</sub> "	<b>B40290</b>
25 cm - 10"	<b>B40295</b>
30 cm - 11 <sup>3</sup> / <sub>4</sub> "	<b>B40300</b>

### BROWN RESANO

16 cm - 6 <sup>1</sup> / <sub>4</sub> "	<b>B403040</b>
20 cm - 8"	<b>B40305</b> 
25 cm - 10"	<b>B40310</b>
30 cm - 11 <sup>3</sup> / <sub>4</sub> "	<b>B40315</b>

4 x 5 griffes  
4 x 5 teeth  
4 x 5 dientes

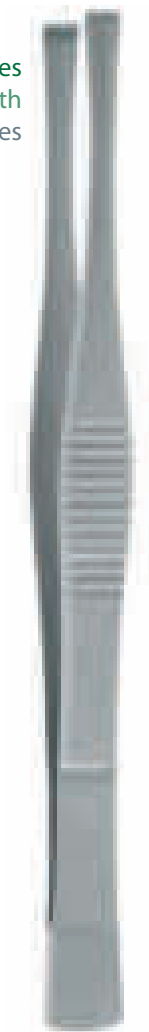

**B40280**  
17 cm - 6 <sup>3</sup>/<sub>4</sub>"



**B40305**  
20 cm - 8"

### GREGOIRE

18 cm - 7"

**B40270**



20 cm - 8"

**B40275**

### J.L. FAURE

18 cm - 7"

**B40415**



20 cm - 8"

**B40420**

25 cm - 10"

**B40425**

30 cm - 11<sup>3/4</sup>"

**B404251**



**B40270**  
18 cm - 7"

3 x 4 griffes  
3 x 4 teeth  
3 x 4 dientes



**B40415**  
18 cm - 7"

### QUENU

12 cm - 4 <sup>3</sup> / <sub>4</sub> "	B40325	
15 cm - 6"	B40330	
18 cm - 7"	B40335	
20 cm - 8"	B40340	
25 cm - 10"	B40345	
30 cm - 11 <sup>3</sup> / <sub>4</sub> "	B40350	

### FARKAS

12 cm - 4 <sup>3</sup> / <sub>4</sub> "	B404349	
15 cm - 6"	B40435	
18 cm - 7"	B404360	

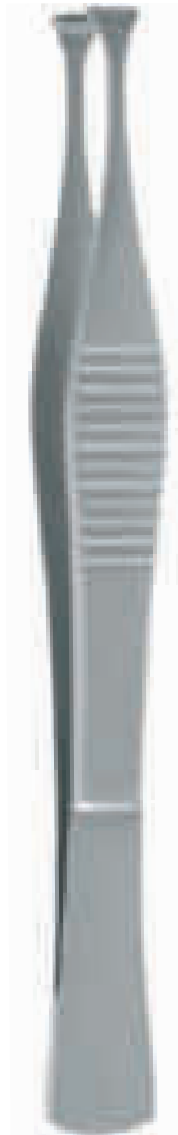

**B40330**  
15 cm - 6"



**B40435**  
15 cm - 6"

## DUVAL

15 cm - 6"	<b>B40355</b>	
18 cm - 7"	<b>B40360</b>	
20 cm - 8"	<b>B40365</b>	
25 cm - 10"	<b>B403655</b>	
30 cm - 11 <sup>3/4</sup> "	<b>B403660</b>	

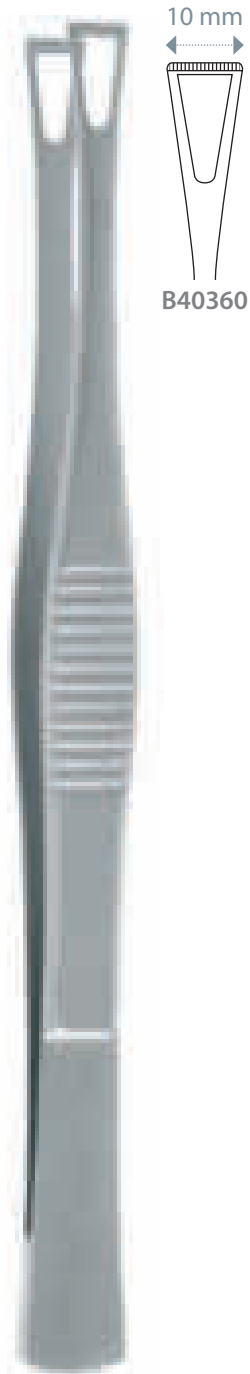

**B40360**  
18 cm - 7"

## SINGLEY TUTTLE

18 cm - 7"	<b>B403670</b>	
23 cm - 9"	<b>B403680</b>	
30 cm - 11 <sup>3/4</sup> "	<b>B403690</b>	

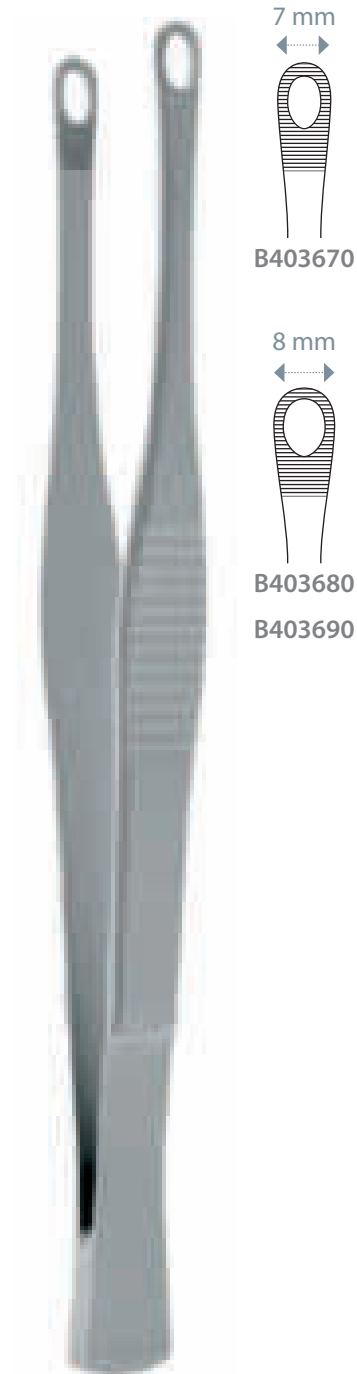

**B403670**  
18 cm - 7"

### ADSON

### ADSON BROWN

12 cm - 4<sup>3/4</sup>"

**B40440**

**B40445**



**B404430**

**B404440**



**B40448**

**B404490**

15 cm - 6"

**B404450**

**B404451**

-

**B404441**

18 cm - 7"

**B404453**

**B404454**

Sans griffes  
Without teeth  
Sin dientes

1 x 2 griffes  
1 x 2 teeth  
1 x 2 dientes

1 x 2 griffes  
1 x 2 teeth  
1 x 2 dientes

2 x 3 griffes  
2 x 3 teeth  
2 x 3 dientes

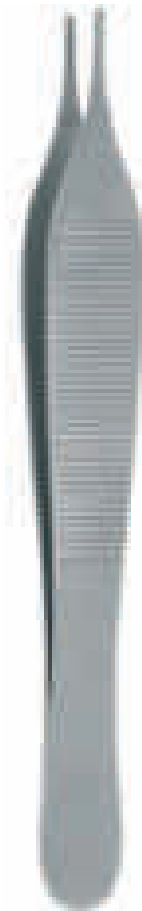
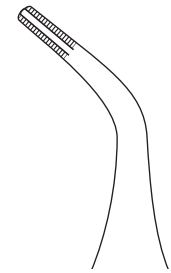
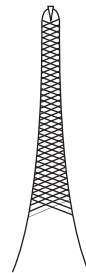
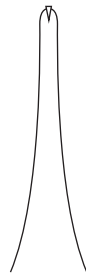
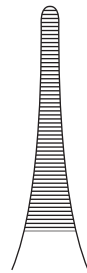

**B40440**

12 cm - 4<sup>3/4</sup>"



**B40445**

12 cm - 4<sup>3/4</sup>"



**B404430**

12 cm - 4<sup>3/4</sup>"



**B404440**

12 cm - 4<sup>3/4</sup>"



**B40448**

12 cm - 4<sup>3/4</sup>"



**B404490**

12 cm - 4<sup>3/4</sup>"

## JACOBSON ADSON

12 cm - 4<sup>3/4</sup>" **B404458** 

15 cm - 6" **B404459**

Sans griffes  
Without teeth  
Sin dientes

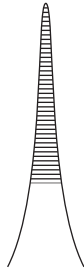

**B404458**  
12 cm - 4<sup>3/4</sup>"

## MICRO ADSON

12 cm - 4<sup>3/4</sup>" **B40447** **B40446** 

15 cm - 6" **B404470** **B404471**

Sans griffes  
Without teeth  
Sin dientes

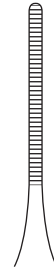

**B40447**  
12 cm - 4<sup>3/4</sup>"

1 x 2 griffes  
1 x 2 teeth  
1 x 2 dientes

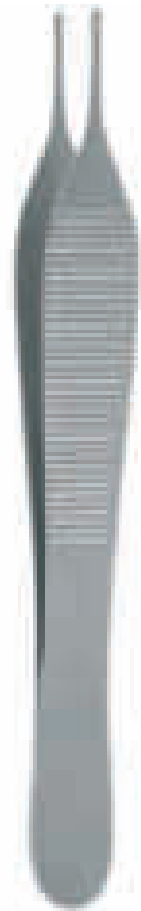

**B40446**  
12 cm - 4<sup>3/4</sup>"



## ADSON BIMER

## ADSON ATRAUMA

## ADSON GRAEFE

 <b>B404475</b>	12 cm - 4 3/4"	 <b>B404495</b>	12 cm - 4 3/4"	<b>B404456</b> 
-	15 cm - 6"	<b>B404496</b>	15 cm - 6"	<b>B404457</b>

1 x 2 griffes  
1 x 2 teeth  
1 x 2 dientes



Sans griffes  
Without teeth  
Sin dientes

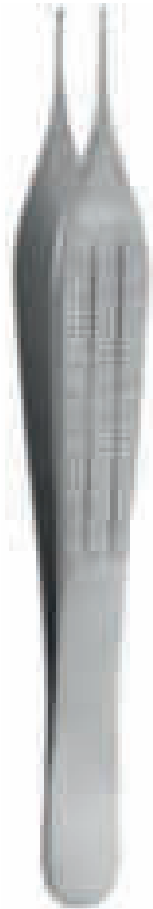
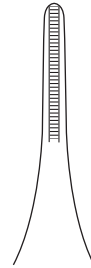

**B404475**  
12 cm - 4 3/4"



**B404495**  
12 cm - 4 3/4"

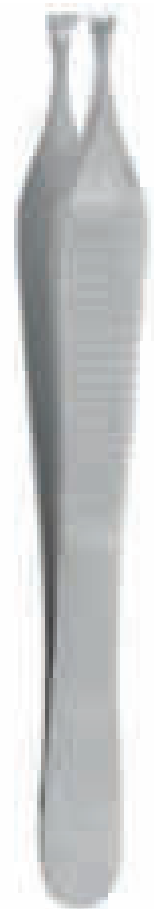

**B404456**  
12 cm - 4 3/4"

## CUSHING

Sans griffes  
Without teeth  
Sin dientes

1 x 2 griffes  
1 x 2 teeth  
1 x 2 dientes

18 cm - 7" 

**B40400**

**B404021**

18 cm - 7"

**B404020**

**B404022**

20 cm - 8"

**B404005**

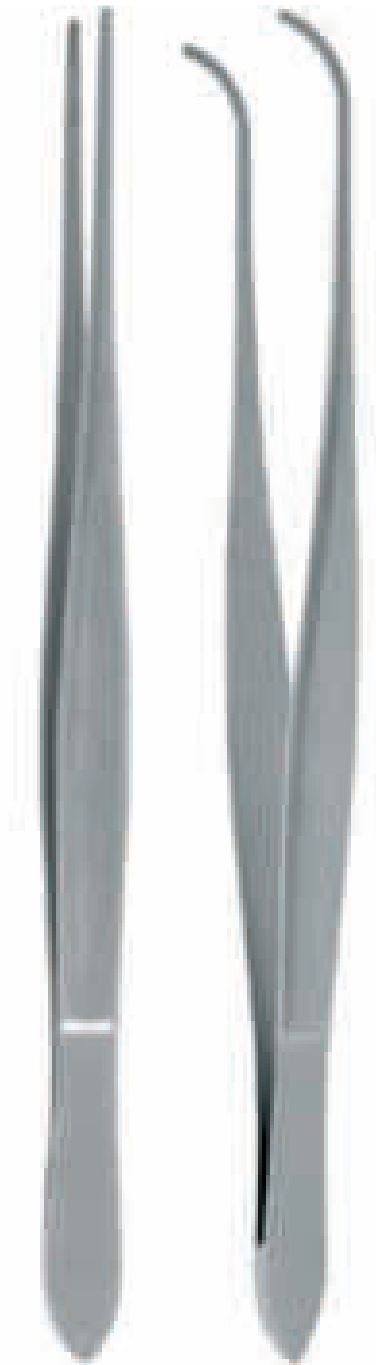

**B40400**  
18 cm - 7"

**B404021**  
18 cm - 7"





**B404020**  
18 cm - 7"

**B404022**  
18 cm - 7"

Sans griffes  
Without teeth  
Sin dientes

### POTTS SMITH

1 x 2 griffes  
1 x 2 teeth  
1 x 2 dientes

	<b>B407810</b>	<b>B407811</b>	18 cm - 7"	<b>B407840</b>	<b>B407841</b>	
	<b>B407820</b>	<b>B407821</b>	21 cm - 8 1/4"	<b>B407850</b>	<b>B407851</b>	
	<b>B407830</b>	<b>B407831</b>	25 cm - 10"	<b>B407860</b>	<b>B407861</b>	



**B407810**  
18 cm - 7"

**B407811**  
18 cm - 7"

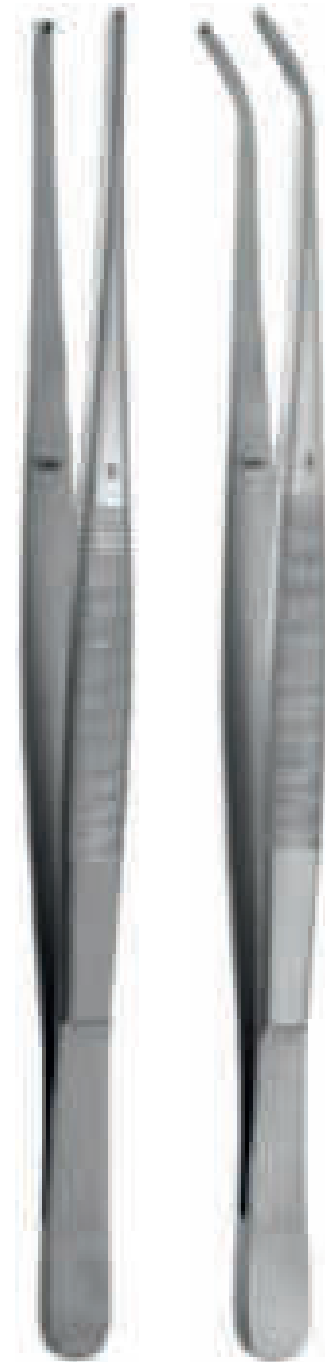

**B407840**  
18 cm - 7"

**B407841**  
18 cm - 7"

TAYLOR

Sans griffes  
Without teeth  
Sin dientes



**B404090**  
17,5 cm - 7"

**B404091**  
17,5 cm - 7"

1 x 2 griffes  
1 x 2 teeth  
1 x 2 dientes



**B404100**  
17,5 cm - 7"

**B404101**  
17,5 cm - 7"

Sans griffes  
Without teeth  
Sin dientes

**BROPHY**

1 x 2 griffes  
1 x 2 teeth  
1 x 2 dientes

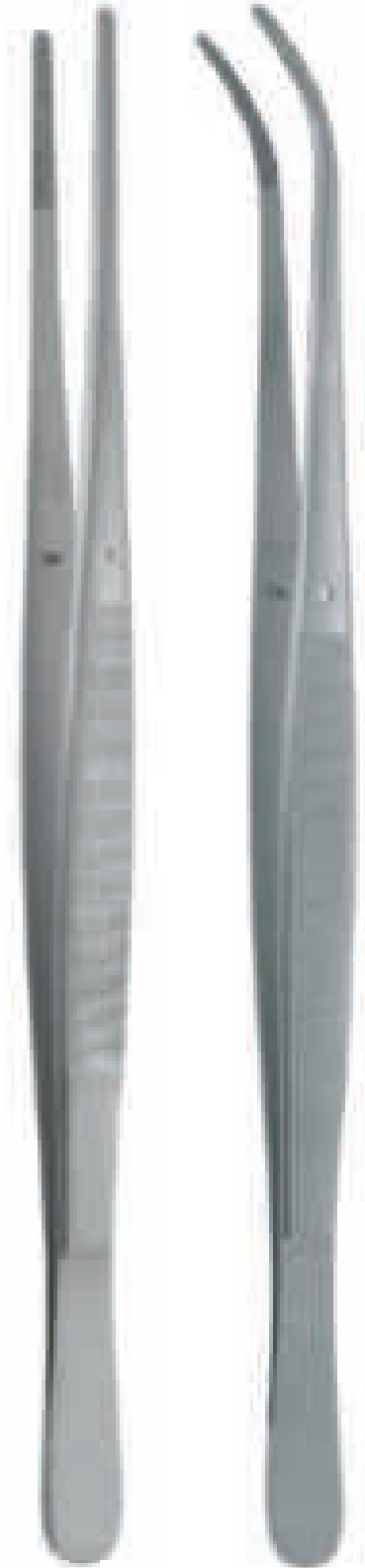

**B404110**  
21 cm - 8<sup>1</sup>/<sub>4</sub>"

**B404111**  
21 cm - 8<sup>1</sup>/<sub>4</sub>"



**B404120**  
21 cm - 8<sup>1</sup>/<sub>4</sub>"

**B404121**  
21 cm - 8<sup>1</sup>/<sub>4</sub>"

## MERIAM

Sans griffes  
Without teeth  
Sin dientes

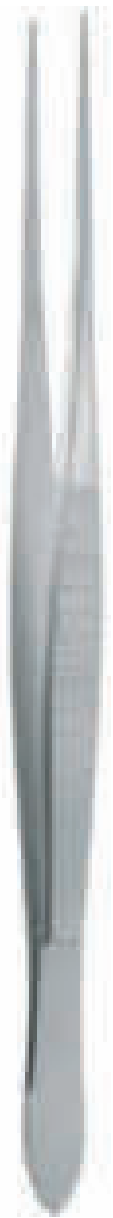

**B403954**  
16 cm - 6<sup>1</sup>/<sub>4</sub>"

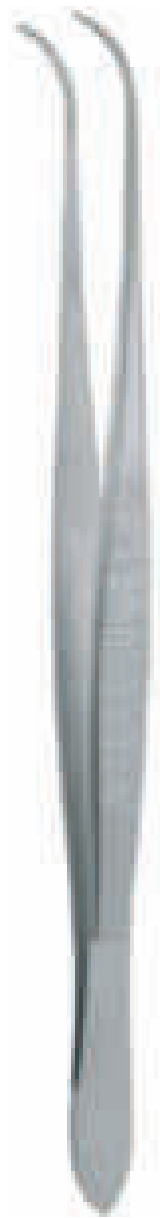

**B403952**  
16 cm - 6<sup>1</sup>/<sub>4</sub>"

1 x 2 griffes  
1 x 2 teeth  
1 x 2 dientes

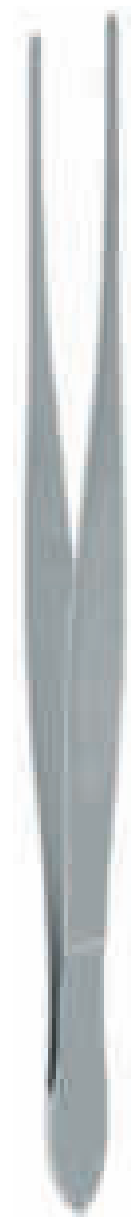

**B403955**  
16 cm - 6<sup>1</sup>/<sub>4</sub>"

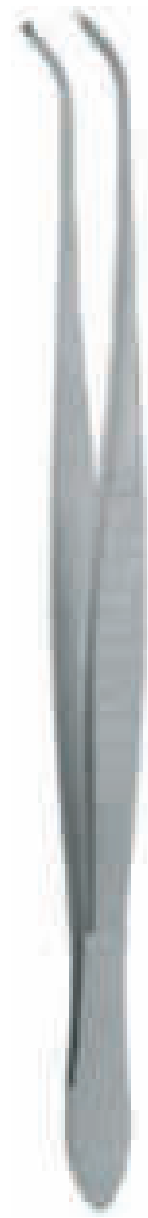

**B403953**  
16 cm - 6<sup>1</sup>/<sub>4</sub>"

GERALD

II - Dissection  
II - Dissecting  
II - Disección

Sans griffes  
Without teeth  
Sin dientes

1 x 2 griffes  
1 x 2 teeth  
1 x 2 dientes



**B40406**  
18 cm - 7"





**B404061**  
18 cm - 7"



**B40404**  
18 cm - 7"

**B404041**  
18 cm - 7"

## Pinces à dissection délicates - Delicate dissecting forceps - Pinzas para disección delicadas

	MC INDOE	GILLIES	GILLIES (WAUGH)	WAUGH	
15 cm - 6"	<b>B404010</b> 	<b>B408601</b> 	<b>B408602</b> 	<b>B408610</b>	<b>B408620</b> 
20 cm - 8"	-	-	<b>B408603</b>	<b>B408611</b>	<b>B408621</b>

Sans griffes  
Without teeth  
Sin dientes

1 x 2 griffes  
1 x 2 teeth  
1 x 2 dientes

1 x 2 griffes  
1 x 2 teeth  
1 x 2 dientes

Sans griffes  
Without teeth  
Sin dientes

1 x 2 griffes  
1 x 2 teeth  
1 x 2 dientes

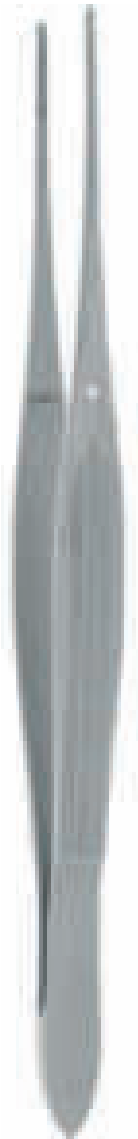

**B404010**  
15 cm - 6"



**B408601**  
15 cm - 6"



**B408602**  
15 cm - 6"

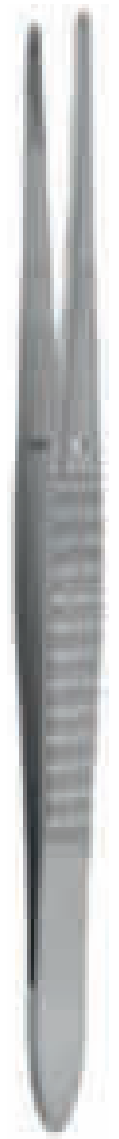

**B408610**  
15 cm - 6"

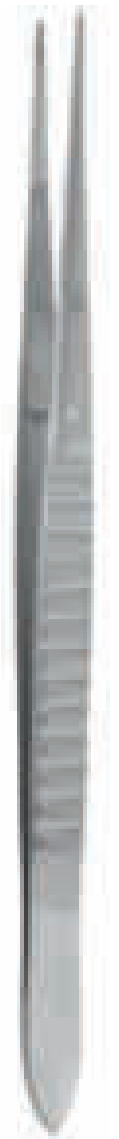

**B408620**  
15 cm - 6"



### SEMKEN

### DUFOURMENTEL

12 cm - 4<sup>3/4</sup>"

B408500

B408502

B408501

B408515 

12 cm - 4<sup>3/4</sup>"

B408522

15 cm - 6"



B408510

B408512

B408511

B408516

16 cm - 6<sup>1/4</sup>"

B408526 

Sans griffes  
Without teeth  
Sin dientes

Sans griffes  
Without teeth  
Sin dientes

1 x 2 griffes  
1 x 2 teeth  
1 x 2 dientes

3 x 4 griffes  
3 x 4 teeth  
3 x 4 dientes

2 x 3 griffes  
2 x 3 teeth  
2 x 3 dientes

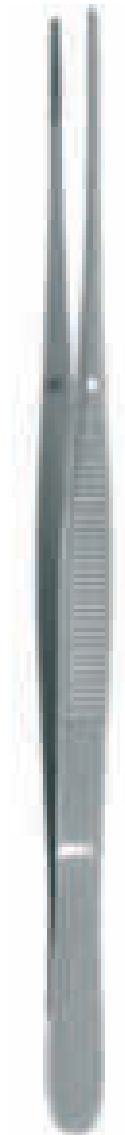

**B408510**  
15 cm - 6"



**B408512**  
15 cm - 6"

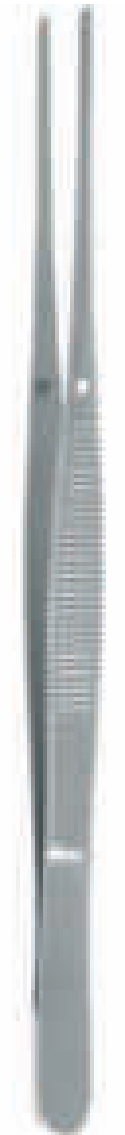

**B408511**  
15 cm - 6"



**B408515**  
12 cm - 4<sup>3/4</sup>"



**B408526**  
16 cm - 6<sup>1/4</sup>"

## Pinces à dissection délicates - Delicate dissecting forceps - Pinzas para disección delicadas

### WISE

Droite	Courbe
Straight	Curved
Recta	Curva

12 cm - 4<sup>3</sup>/<sub>4</sub>"

**B408801**

-

13,5 cm - 5<sup>1</sup>/<sub>4</sub>"

**B408802**

**B408804**



### OSCHNER

PINCE À LIGATURE  
LIGATURE FORCEPS  
PINZA PARA HILO

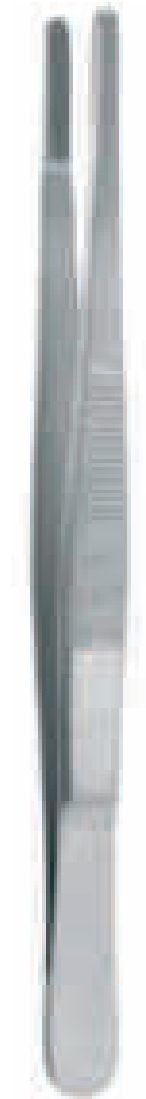

**B408810**

14,5 cm - 5<sup>3</sup>/<sub>4</sub>"

### AUSTIN

14 cm - 5<sup>1</sup>/<sub>2</sub>"

**B408820**

18 cm - 7"

**B408821**



PINCE MICRO-TUBAIRE  
MICRO-TUBAL FORCEPS  
PINZA MICROTUBARICA



**B408821**

18 cm - 7"

MICRO-PINCE À SUTURE 0,3 MM  
SUTURE MICRO FORCEPS 0.3 MM  
MICRO PINZA PARA SUTURA 0,3 MM

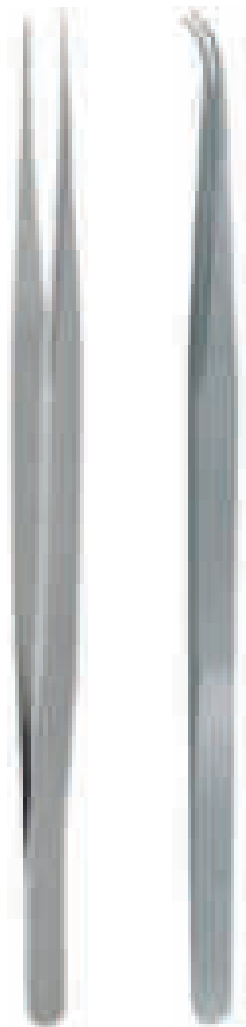

**B408802**

13,5 cm - 5<sup>1</sup>/<sub>4</sub>"

**B408804**

13,5 cm - 5<sup>1</sup>/<sub>4</sub>"

TRÈS FINE - VERY FINE - MUY FINA

18,5 cm - 7 1/4"

**B408830**



20 cm - 8"

**B408831**

Sans griffes  
Without teeth  
Sin dientes



Sans griffes  
Lisses  
Without teeth  
Smooth  
Sin dientes  
Lissa

Sans griffes  
Without teeth  
Sin dientes

1 x 2 griffes  
1 x 2 teeth  
1 x 2 dientes



Lisses  
Smooth  
Lissa



Lisses  
Smooth  
Lissa

Baïonnette  
Bayonet  
Bayoneta

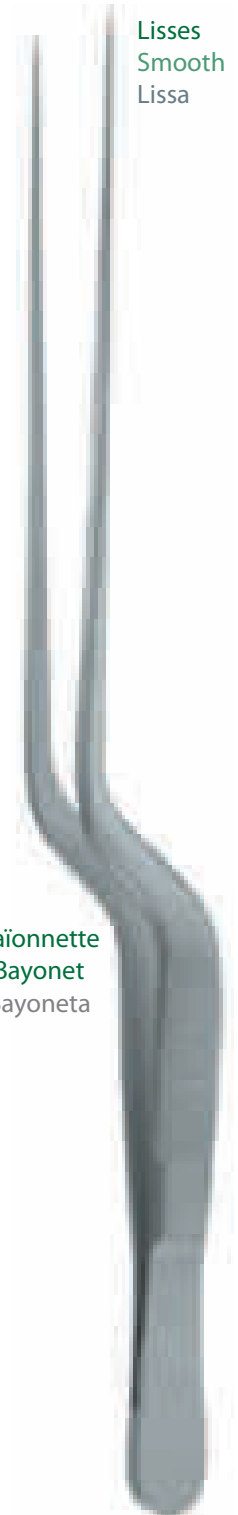

**B408830**

18,5 cm - 7 1/4"

**B408835**

16 cm - 6 1/4"

**B408836**

16 cm - 6 1/4"

**B408838**

20 cm - 8"



## DUMONT

### PINCE D'HORLOGER - WATCH MAKER'S FORCEPS - PINZA DE RELOJERO

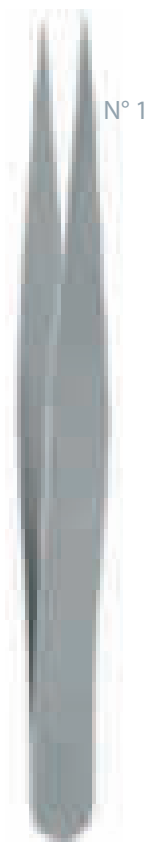

N° 1

**B408701**  
11 cm - 4<sup>1</sup>/<sub>4</sub>"

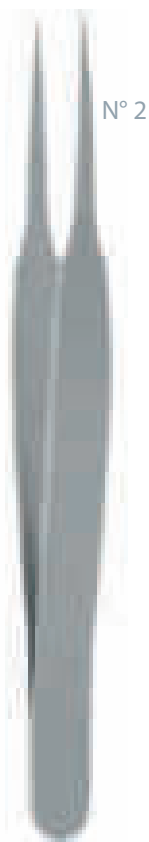

N° 2

**B408702**  
11 cm - 4<sup>1</sup>/<sub>4</sub>"

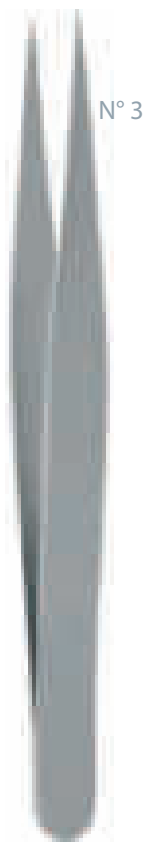

N° 3

**B408703**  
11 cm - 4<sup>1</sup>/<sub>4</sub>"

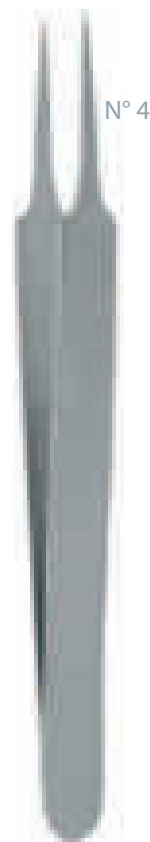

N° 4

**B408704**  
11 cm - 4<sup>1</sup>/<sub>4</sub>"

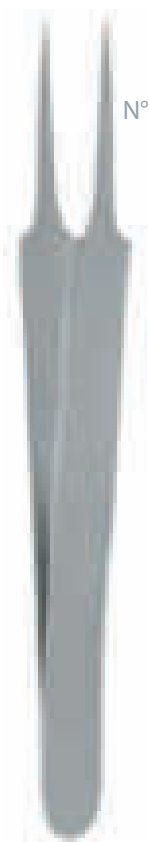

N° 5

**B408705**  
11 cm - 4<sup>1</sup>/<sub>4</sub>"

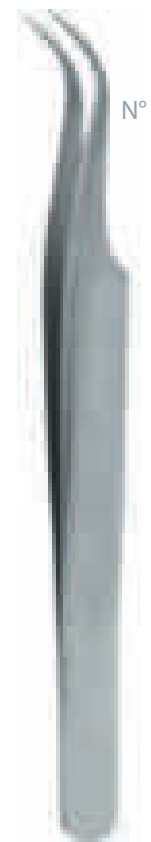

N° 7

**B408707**  
11 cm - 4<sup>1</sup>/<sub>4</sub>"

### À ÉPILER - FOR EPILATION - PARA DEPILACIÓN

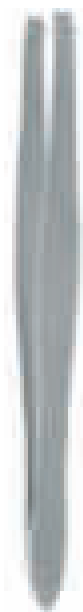

**B408010**  
8 cm - 3"

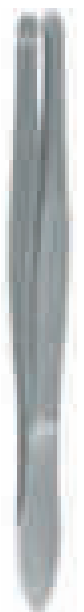

**B408020**  
8 cm - 3"

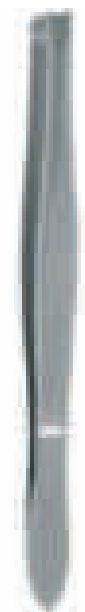

**B408030**  
8 cm - 3"

Pinces à dissection ophtalmologiques - Ophthalmologic dissecting forceps - Pinzas para disección oftalmológicas

II - Dissection  
II - Dissecting  
II - Disección



Sans  
griffes  
Without  
teeth  
Sin  
dientes

**I150880**  
10,5 cm - 4 1/4"



Sans  
griffes  
Without  
teeth  
Sin  
dientes

**I150881**  
10,5 cm - 4 1/4"



**I150882**  
10,5 cm - 4 1/4"



1 x 2  
griffes  
1 x 2  
teeth  
1 x 2  
dientes

**I150885**  
10,5 cm - 4 1/4"



1 x 2  
griffes  
1 x 2  
teeth  
1 x 2  
dientes

**I150886**  
10,5 cm - 4 1/4"

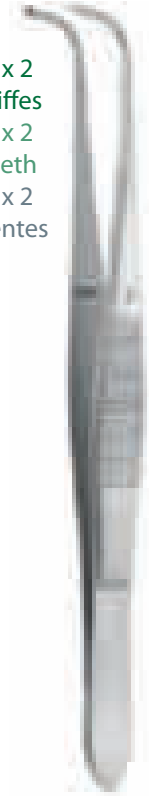

**I150887**  
10,5 cm - 4 1/4"



Sans griffes  
Mors 8/10  
Without teeth  
8/10 jaws  
Sin dientes  
Bocas 8/10

**I150890**  
10 cm - 4"



**I150895**  
10 cm - 4"

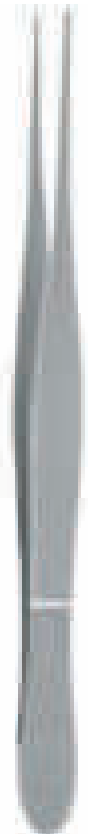

Sans  
griffes  
Without  
teeth  
Sin  
dientes

**B40840**  
11 cm - 4 1/4"



**I15120**  
11 cm - 4 1/4"



**B40830**  
11 cm - 4 1/4"

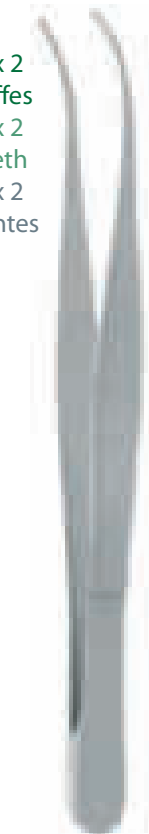

1 x 2  
griffes  
1 x 2  
teeth  
1 x 2  
dientes

**I15110**  
11 cm - 4 1/4"

## PRECELLE

### PERRY

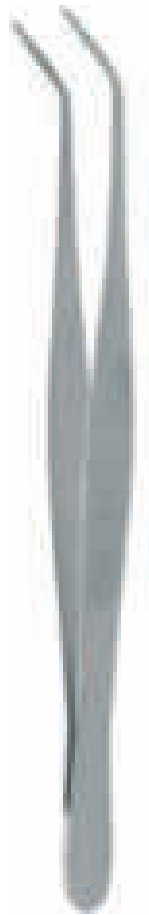

**B408250**  
12 cm - 4<sup>3/4</sup>"

Sans griffes  
Without teeth  
Sin dientes



**B408110**  
16 cm - 6<sup>1/4</sup>"

1 x 2 griffes  
1 x 2 teeth  
1 x 2 dientes

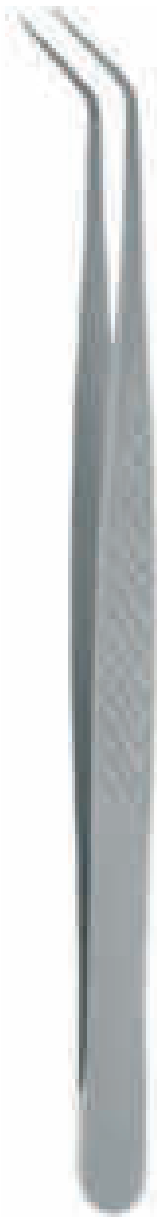

**B40810**  
16 cm - 6<sup>1/4</sup>"

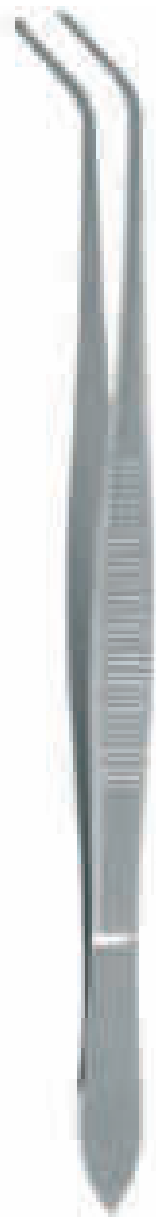

**B40820**  
16 cm - 6<sup>1/4</sup>"

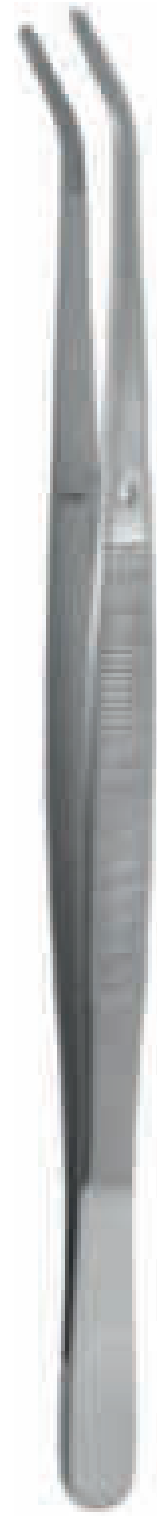

**B408210**  
20 cm - 8"

## Pinces à dissection O.R.L - ENT dissecting forceps - Pinzas para disección O.R.L.

### TROELTSCH

12 cm - 4 <sup>3</sup>/<sub>4</sub>" **I150490**

14 cm - 5 <sup>1</sup>/<sub>2</sub>" **I15050** 

17 cm - 6 <sup>3</sup>/<sub>4</sub>" **I150501**



Sans griffes  
Mors striés  
Without teeth  
Serrated jaws  
Sin dientes  
Bocas estriadas

**I15050**  
14 cm - 5 <sup>1</sup>/<sub>2</sub>"

14 cm - 5 <sup>1</sup>/<sub>2</sub>" **I150504** 

17 cm - 6 <sup>3</sup>/<sub>4</sub>" **I150505**



Sans griffes  
Mors fins striés  
Without teeth  
Fine jaws serrated  
Sin dientes  
Bocas fines estriadas

**I150504**  
14 cm - 5 <sup>1</sup>/<sub>2</sub>"

14 cm - 5 <sup>1</sup>/<sub>2</sub>" **I150502** 

17 cm - 6 <sup>3</sup>/<sub>4</sub>" **I150503**



Sans griffes  
Mors lisses  
Without teeth  
Smooth jaws  
Sin dientes  
Bocas lisas

**I150502**  
14 cm - 5 <sup>1</sup>/<sub>2</sub>"

12 cm - 4 <sup>3</sup>/<sub>4</sub>" **I150590**

14 cm - 5 <sup>1</sup>/<sub>2</sub>" **I15060** 

17 cm - 6 <sup>3</sup>/<sub>4</sub>" **I150601**



1 x 2 griffes  
1 x 2 teeth  
1 x 2 dientes

**I15060**  
14 cm - 5 <sup>1</sup>/<sub>2</sub>"

14 cm - 5 <sup>1</sup>/<sub>2</sub>" **I150602** 

17 cm - 6 <sup>3</sup>/<sub>4</sub>" **I150603**



1 x 2 griffes  
Mors fins  
1 x 2 teeth  
Fine jaws  
1 x 2 dientes  
Bocas finas

**I150602**  
14 cm - 5 <sup>1</sup>/<sub>2</sub>"

14 cm - 5 <sup>1</sup>/<sub>2</sub>" **I150604** 

17 cm - 6 <sup>3</sup>/<sub>4</sub>" **I150605**



Mors cuillères  
Spoon jaws  
Bocas cucharas

**I150604**  
14 cm - 5 <sup>1</sup>/<sub>2</sub>"

## POLITZER



Sans griffes  
Mors striés  
Without teeth  
Serrated jaws  
Sin dientes  
Bocas estriadas

**I150610**  
12 cm - 4<sup>3</sup>/<sub>4</sub>"



1 x 2 griffes  
1 x 2 teeth  
1 x 2 dientes

**I150611**  
12 cm - 4<sup>3</sup>/<sub>4</sub>"



Mors cuillères  
Spoon jaws  
Bocas cucharas

**I150612**  
12 cm - 4<sup>3</sup>/<sub>4</sub>"



## Pinces à dissection O.R.L - ENT dissecting forceps - Pinzas para disección O.R.L.

II - Dissection  
II - Dissecting  
II - Disección

### JANSEN (LUCAE)

Sans griffes  
Without teeth  
Sin dientes

1 x 2 griffes  
1 x 2 teeth  
1 x 2 dientes

	<b>I150444</b>	16 cm - 6 1/4"	<b>I150441</b>	
	<b>I150445</b>	18 cm - 7"	<b>I150442</b>	
	<b>I150446</b>	20 cm - 8"	<b>I150443</b>	

### LUCAE

Sans griffes  
Mors striés  
Without teeth  
Serrated jaws  
Sin dientes  
Bocas estriadas

1 x 2 griffes  
1 x 2 teeth  
1 x 2 dientes

Mors cuillères  
Spoon jaws  
Bocas cucharas

Mors striés  
Serrated jaws  
Bocas estriadas



 **I150620**  
14 cm - 5 1/2"  
**I150640**  
17 cm - 6 1/2"



**I150621**  
14 cm - 5 1/2"



**I150630**  
14 cm - 5 1/2"

Baionnette  
Bayonet  
Bayoneta



**I150444**  
16 cm - 6 1/4"







**I150441**  
16 cm - 6 1/4"

Baionnette  
Bayonet  
Bayoneta

## Pinces à dissection vasculaires - Vascular dissecting forceps - Pinzas para disección vasculares



### DEBAKEY

1,5 mm		2,0 mm		2,0 mm	
	<b>C10005</b>	16 cm - 6 <sup>1</sup> / <sub>4</sub> "	<b>C10015</b>	16 cm - 6 <sup>1</sup> / <sub>4</sub> "	<b>C10030</b> 
	<b>C10010</b>	20 cm - 8"	<b>C10020</b>	20 cm - 8"	<b>C10035</b> 
	<b>C10012</b>	24 cm - 9 <sup>1</sup> / <sub>2</sub> "	<b>C10025</b>	24 cm - 9 <sup>1</sup> / <sub>2</sub> "	<b>C10040</b>
	<b>C10013</b>	30 cm - 11 <sup>3</sup> / <sub>4</sub> "	<b>C10027</b>	30 cm - 11 <sup>3</sup> / <sub>4</sub> "	<b>C10047</b>

Droite  
Straight  
Recta

Droite  
Straight  
Recta

Coudée  
Angled  
Angulada

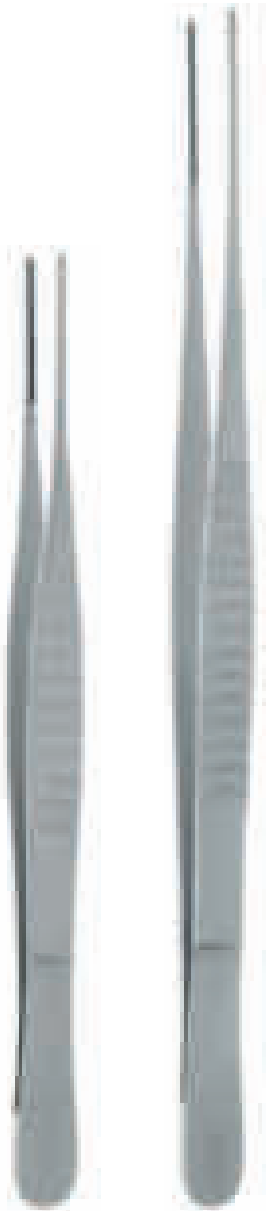

**C10005**  
16 cm - 6<sup>1</sup>/<sub>4</sub>"

**C10010**  
20 cm - 8"

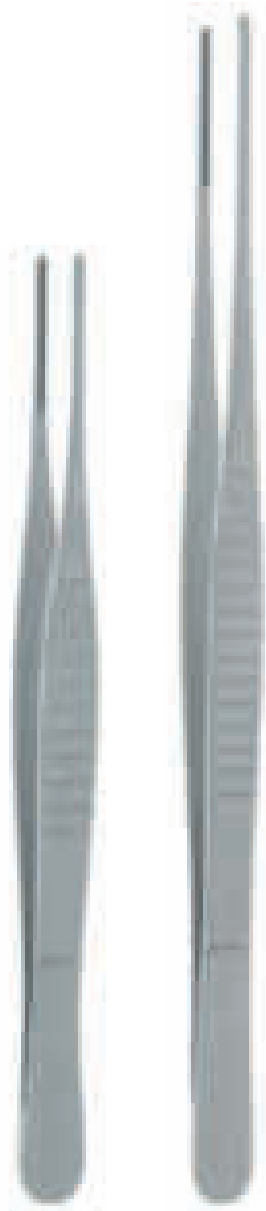

**C10015**  
16 cm - 6<sup>1</sup>/<sub>4</sub>"

**C10020**  
20 cm - 8"

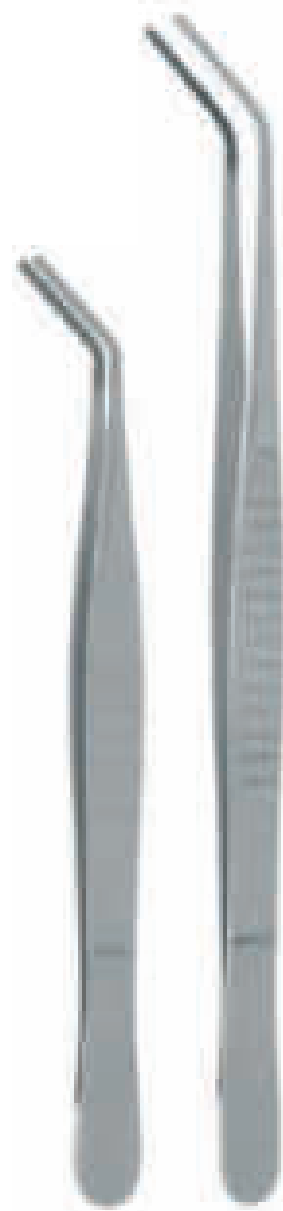

**C10030**  
16 cm - 6<sup>1</sup>/<sub>4</sub>"

**C10035**  
20 cm - 8"

## Pinces à dissection vasculaires - Vascular dissecting forceps - Pinzas para disección vasculares



### DEBAKEY

2,7 mm		3,5 mm	
	<b>C10041</b>	16 cm - 6 1/4"	<b>C10045</b> 
	<b>C10042</b>	20 cm - 8"	<b>C10050</b> 
	<b>C10043</b>	24 cm - 9 1/2"	<b>C10055</b>
	<b>C10044</b>	30 cm - 11 3/4"	<b>C10057</b>



### COOLEY

2,0 mm	
16 cm - 6 1/4"	<b>C10765</b>
20 cm - 8"	<b>C10770</b> 



**C10041**  
16 cm - 6 1/4"

**C10042**  
20 cm - 8"

**C10045**  
16 cm - 6 1/4"

**C10050**  
20 cm - 8"

**C10770**  
20 cm - 8"

## Pinces à dissection vasculaires - Vascular dissecting forceps - Pinzas para disección vasculares



### DEBAKEY GERALD

	1,2 mm	
15 cm - 6"	<b>C100580</b>	
18 cm - 7"	C100581	

### DEBAKEY DIETRICH

	1,5 mm	
16 cm - 6 <sup>1/4</sup> "	<b>C100582</b>	
20 cm - 8"	C100583	
24 cm - 9 <sup>1/2</sup> "	C100584	

### DEBAKEY

	1,2 mm	
15 cm - 6"	<b>C100590</b>	
	1,5 mm	
20 cm - 8"	<b>C100595</b>	
24 cm - 9 <sup>1/2</sup> "	C100596	
30 cm - 11 <sup>3/4</sup> "	C100597	

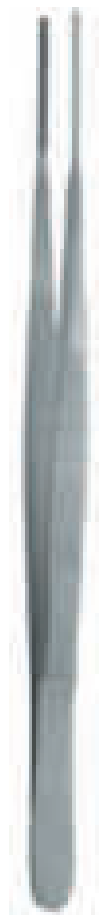

**C100580**  
15 cm - 6"



**C100582**  
16 cm - 6<sup>1/4</sup>"



**C100590**  
15 cm - 6"



**C100595**  
20 cm - 8"

Pinces à dissection mors tungstène - Dissecting forceps with tungsten jaws - Pinzas para disección boca de tungsteno



DEBAKEY



1,5 mm

2,0 mm

2,7 mm

3,5 mm

C100010 16 cm - 6<sup>1</sup>/<sub>4</sub>"

C100020

C100030 16 cm - 6<sup>1</sup>/<sub>4</sub>"

C100040



C100011 20 cm - 8"

C100021



C100031 20 cm - 8"

C100041



C100012 24 cm - 9<sup>1</sup>/<sub>2</sub>"

C100022

C100032 24 cm - 9<sup>1</sup>/<sub>2</sub>"

C100042



**C100011**  
20 cm - 8"



**C100021**  
20 cm - 8"

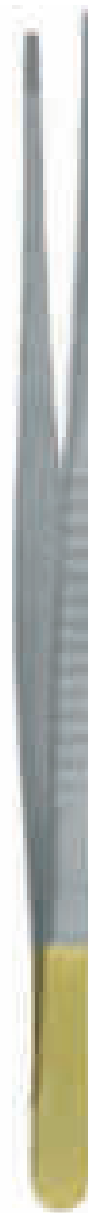

**C100031**  
20 cm - 8"



**C100041**  
20 cm - 8"

## Pinces à dissection mors tungstène - Dissecting forceps with tungsten jaws - Pinzas para disección boca de tungsteno



STANDARD  
STANDARD  
ESTÁNDAR

OEHLER

WANGENSTEEN

EVANS

**B40610** 14 cm - 5<sup>1</sup>/<sub>2</sub>"

**B406810**

15 cm - 6"

**B406910**

**B40620** 16 cm - 6<sup>1</sup>/<sub>4</sub>"

**B406811**

23 cm - 9"

**B406911** 



**B40640** 18 cm - 7"

**B406812** 

25 cm - 10"

**B406912**

**B40650** 20 cm - 8"

**B406813**

**B40660** 25 cm - 10"

**B406814**

**B40670** 30 cm - 11<sup>3</sup>/<sub>4</sub>"

**B406815**

1 x 2 griffes  
1 x 2 teeth  
1 x 2 dientes



**B40640**  
18 cm - 7"



**B406812**  
18 cm - 7"



4/5

**B406911**  
23 cm - 9"



4/5

**B407900**  
25 cm - 9<sup>3</sup>/<sub>4</sub>"



1/1

II - Dissection  
II - Dissecting  
II - Disección



## POTTS-SMITH

- 15 cm - 6" B407550
- 18 cm - 7" B40760
- 21 cm - 8<sup>1/4</sup>" B40770
- 23 cm - 9" B407750
- 25 cm - 10" B40780

## CUSHING

## GRUENWALD



**B40760**  
18 cm - 7"

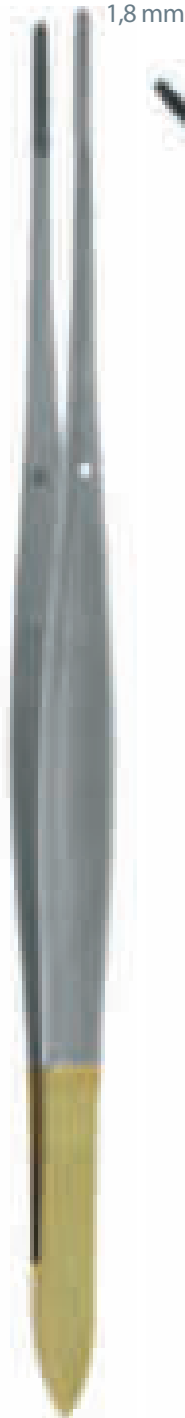

**B40750**  
18 cm - 7"

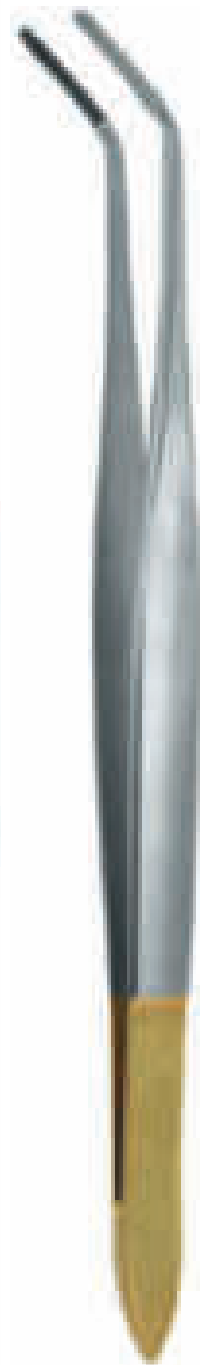

**B407510**  
18 cm - 7"



Baïonnette  
Bayonet  
Bayoneta



**B407520**  
18 cm - 7"

## Pinces à dissection mors tungstène - Dissecting forceps with tungsten jaws - Pinzas para disección boca de tungsteno



### ADSON

### MICRO ADSON

 **B40600** 12 cm - 4<sup>3/4</sup>" **B406001** 

**B406010** 15 cm - 6" **B406011**

12 cm - 4<sup>3/4</sup>" **B406020** 

15 cm - 6" **B406021**

Sans griffes  
Without teeth  
Sin dientes

1 x 2 griffes  
1 x 2 teeth  
1 x 2 dientes

1 x 2 griffes  
1 x 2 teeth  
1 x 2 dientes

### SEMKEN

### MC INDOE

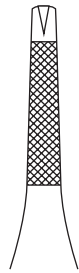
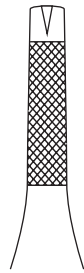

**B40600**  
12 cm - 4<sup>3/4</sup>"



**B406001**  
12 cm - 4<sup>3/4</sup>"

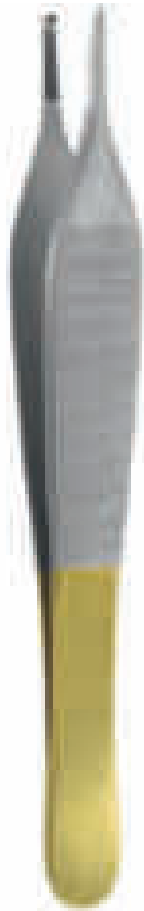

**B406020**  
12 cm - 4<sup>3/4</sup>"

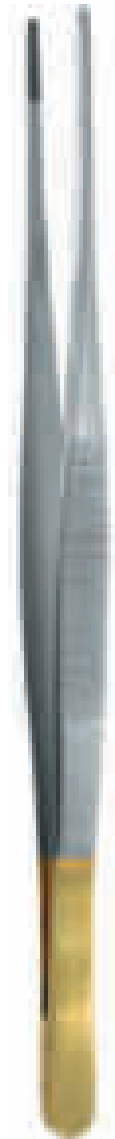

**B406950**  
15 cm - 6"

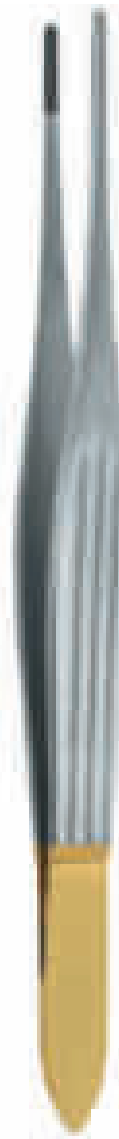

**B406960**  
15 cm - 6"





*Prestige*

II - Dissection  
II - Dissecting  
II - Disección

Sans griffes  
Without teeth  
Sin dientes

1 x 2 griffes  
1 x 2 teeth  
1 x 2 dientes



**B86715**  
14 cm - 5 1/2"



**B86720**  
16 cm - 6 1/4"



**B86725**  
18 cm - 7"



**B86700**  
14 cm - 5 1/2"



**B86705**  
16 cm - 6 1/4"

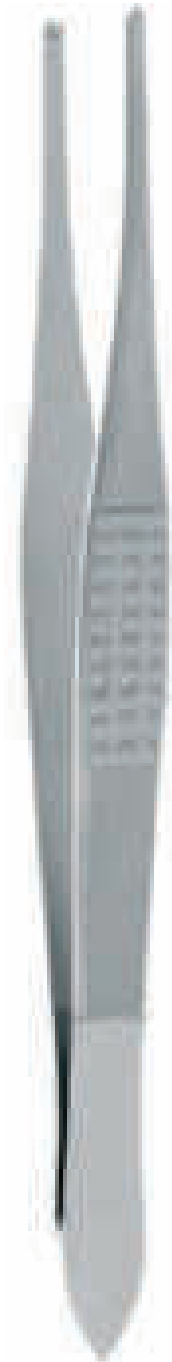

**B86710**  
18 cm - 7"

## *Prestige*

### VINCENT

Sans griffes  
Without teeth  
Sin dientes

1 x 2 griffes  
1 x 2 teeth  
1 x 2 dientes

MODÈLE FIN  
FINE MODEL  
MODELO FINO

Sans griffes  
Without teeth  
Sin dientes

1 x 2 griffes  
1 x 2 teeth  
1 x 2 dientes



**B86735**  
14 cm - 5 1/2"



**B86730**  
14 cm - 5 1/2"



**B86745**  
20 cm - 8"

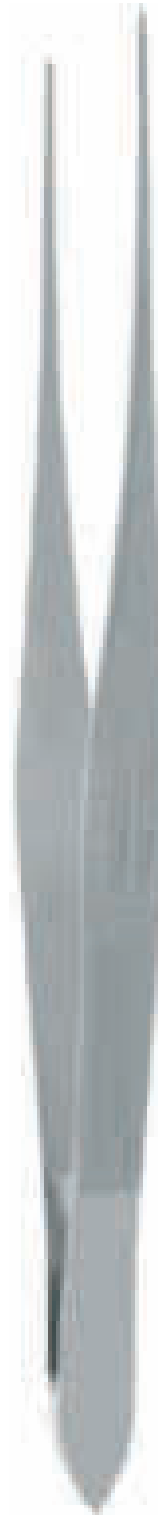

**B86740**  
20 cm - 8"

### *Prestige*

#### BARRAYA

- 16 cm - 6<sup>1</sup>/<sub>4</sub>" **B86750**
- 18 cm - 7" **B86755** 
- 20 cm - 8" **B86760**



**B86755**  
18 cm - 7"

2 x 3 griffes  
Mors étroits quadrillés  
2 x 3 teeth  
Narrow jaws squared  
2 x 3 dientes  
Boca estrecha cuadriculada

#### ADLERKREUTZ

- 16 cm - 6<sup>1</sup>/<sub>4</sub>" **B86765**
- 18 cm - 7" **B86770** 
- 20 cm - 8" **B86775**



**B86770**  
18 cm - 7"

3 x 4 griffes  
à talon  
3 x 4 teeth  
With heel  
3 x 4 dientes  
Con talón

#### DURAND (PATTE DE VELOURS)

- 15 cm - 5<sup>3</sup>/<sub>4</sub>" **B86780** 
- 20 cm - 8" **B86785**

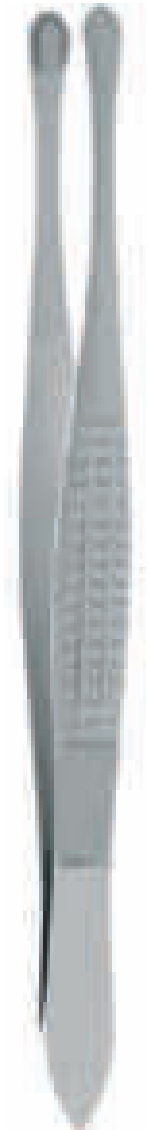

**B86780**  
15 cm - 5<sup>3</sup>/<sub>4</sub>"

## Pinces à échardes - Splinters forceps - Pinzas para astillas

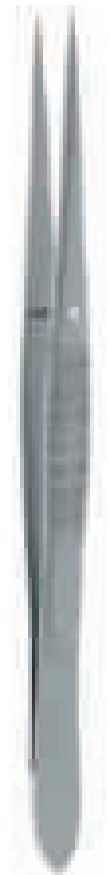

Lisse  
Smooth  
Liso

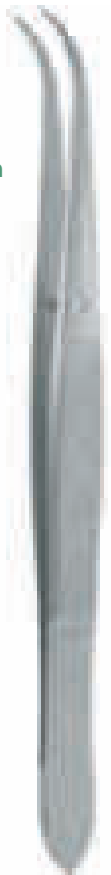

**B410021**  
11,5 cm - 4<sup>1</sup>/<sub>2</sub>"

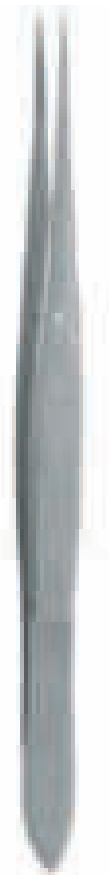

**B410031**  
11,5 cm - 4<sup>1</sup>/<sub>2</sub>"

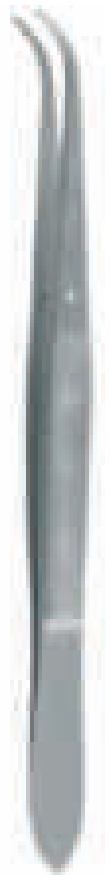

Strié  
Serrated  
Estriado

**B410041**  
11,5 cm - 4<sup>1</sup>/<sub>2</sub>"



**B40800**  
10 cm - 4"



**B408040**  
10 cm - 4"

### FEILCHENFELD

### HUNTER

### WALTER-CARMALT

7,5 cm - 3"

**B410100**

9 cm - 3<sup>1</sup>/<sub>2</sub>"

**B410101** 

11,5 cm - 4<sup>1</sup>/<sub>2</sub>"

**B410102**

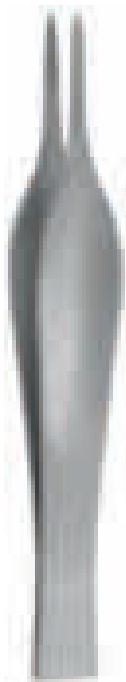

**B410101**  
9 cm - 3<sup>1</sup>/<sub>2</sub>"

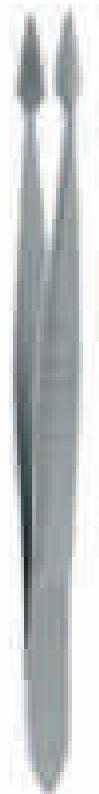

**B410110**  
10,5 cm - 4"



**B410111**  
10,5 cm - 4"

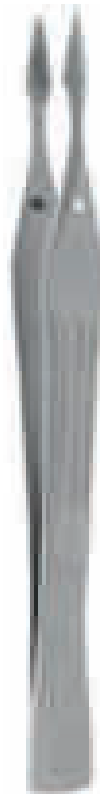

**B410120**  
10,5 cm - 4"



**B410121**  
10,5 cm - 4"

PEET



STIEGLITZ

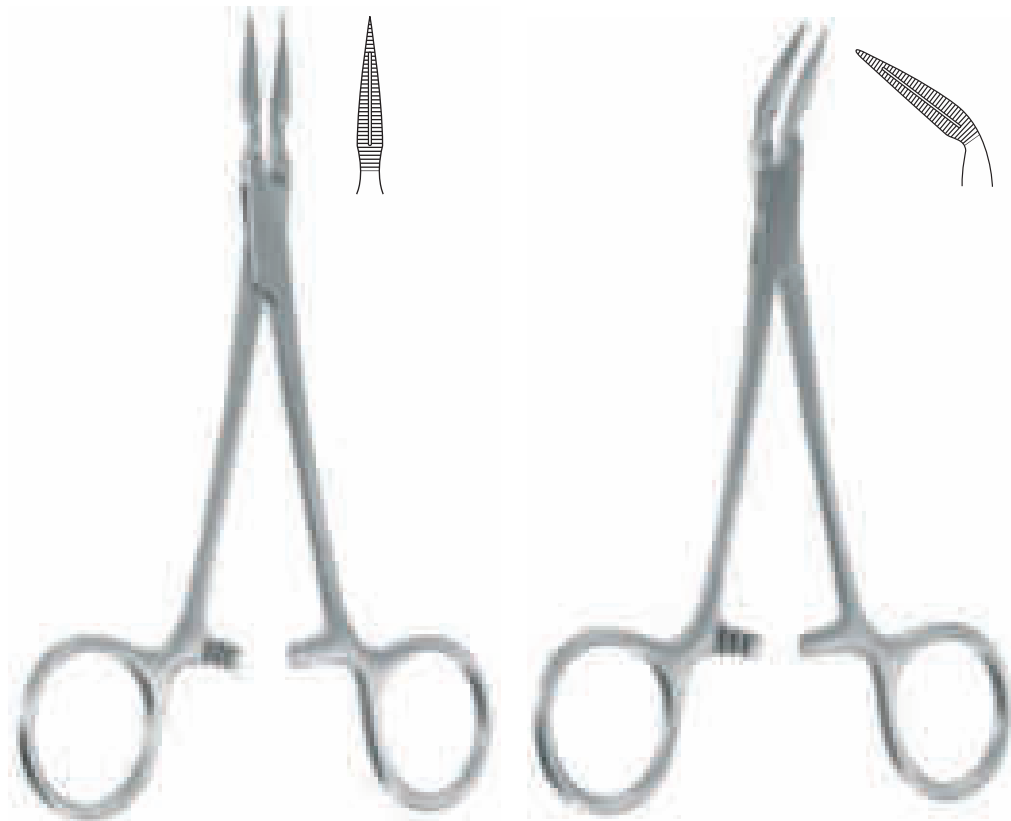

## Ciseaux chirurgicaux - Surgical scissors - Tijeras quirúrgicas

Mousse-Mousse  
Blunt-Blunt  
Roma-Roma

Pointu-Pointu  
Sharp-Sharp  
Aguda-Aguda

DAUPHIN

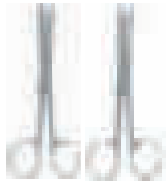

P 9



P 10

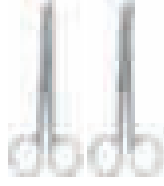

P 11

## Ciseaux délicats - Delicate scissors - Tijeras delicadas

Strabisme  
Strabismus  
Estrabismo

DAUPHIN

Cataracte  
Cataract  
Catarata

Enucléation  
Enucleation  
Enucleación

GRAZIL

ALLAIRE

KILNER  
(RAGNELL)

## Ciseaux fins - Fine scissors - Tijeras finas

WAGNER DEEVER MIXTER



P 12



P 12



P 12

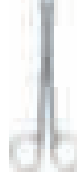

P 13



P 13



P 13



P 15



P 15

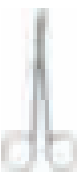

P 14



P 14

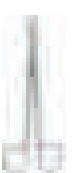

P 14

## Ciseaux à dissection - Dissecting scissors - Tijeras para disección

MAYO

MAYO-STILLE

MAYO-ALSACE

MAYO-LEGER

MAYO-LYON

MAYO-NOBLE

MAYO-SANTY

MAYO-HARRINGTON

DUBOST



P 16



P 17



P 18



P 18



P 18



P 19



P 19



P 19

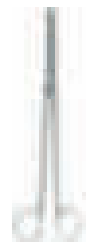

P 20



BABY-LEXER LEXER LEXER-FINO

METZENBAUM

METZENBAUM-FINO

ALLAINE

ALLAINE (BOYD)



P 21



P 21



P 21



P 22



P 23



P 24



P 24



P 25



P 26



## Ciseaux divers - Miscellaneous scissors - Tijeras diversas

NANCY DOYEN



P 27



P 27

## Ciseaux à incision - Incision scissors - Tijeras para incisión

RICHTER

HI-LEVEL  
KNOWLES

KNOWLES

FERGUSON



P 28



P 28



P 28



P 28

## Ciseaux à pansements - Bandage scissors - Tijeras para vendajes

LISTER LISTER-EXCENTRIC ESMARCH BERGMANN

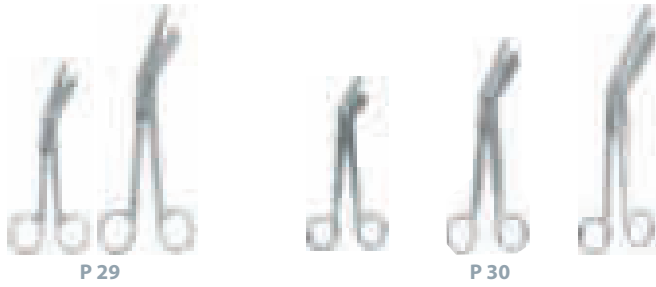

## Ciseaux pour couper les fils - Wire cutting scissors - Tijeras para cortar hilos

HARVEY UNIVERSEL BEEBE EISELSBERG SCHOEMAKER-LOTH



## Ciseaux pour chirurgie vasculaire - Scissors for vascular surgery - Tijeras para cirugía vascular

POTTS-SMITH DEBAKEY HEGEMANN (DIETRICH) POTTS DE MARTEL MILLS VINCENT (SCHMIEDEN) POTTS-SMITH DEBAKEY FAVALORO

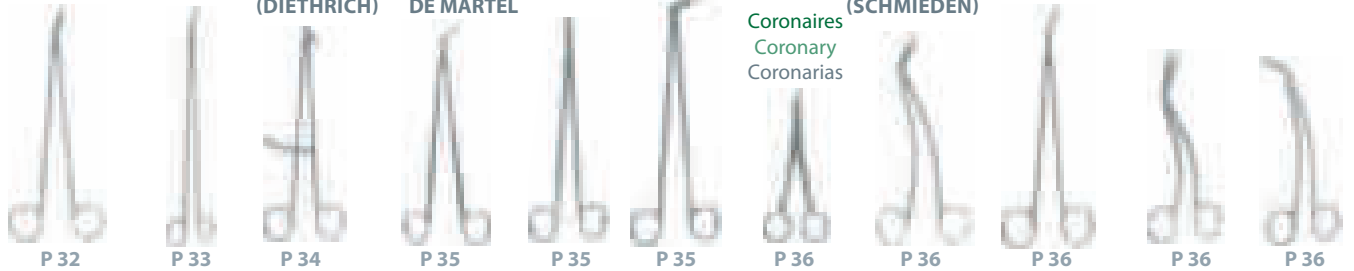

## Ciseaux divers - Various scissors - Tijeras diversas

## Ciseaux fins - Fine scissors - Tijeras finas

BOETTCHER PRINCE GOOD MARTIN-CARTILAGE MC INDOE POTTS-SMITH LA GRANGE KNAPP MICRO

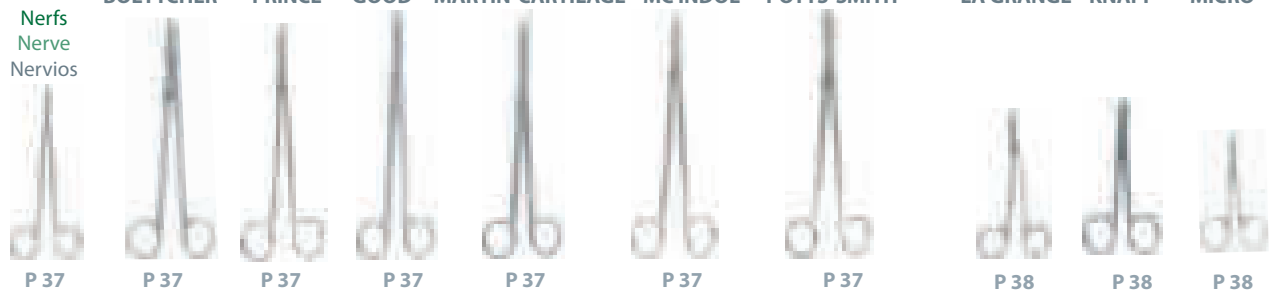

## Ciseaux fins - Fine scissors - Tijeras finas

GRAEFE WILMER Strabisme Strabismus Estrabismo CHADWICK BONN WALTON



## Ciseaux coupe ligatures - Ligature cutting scissors - Tijeras para cortar ligaduras

SPENCER    LITTLER    LITTAUER    SPENCER-FINO



## Ciseaux fins - Fine scissors - Tijeras finas

STEVENS    RIBBON TYPE    GOLDMANN-FOX    LOCKLIN

Gencives  
Gingiva  
Encía



## Ciseaux divers - Miscellaneous scissors - Tijeras diversas

DEAN    QUINBY    LANDOLT

Enucléation  
Enucleation  
Enucleación

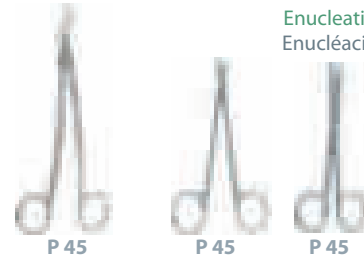

## Ciseaux longs et fins - Long and fine scissors - Tijeras largas y finas

JAMESON    REYNOLDS    TOENNIS    TOENNIS-ADSON    TOENNIS-ADSON -FINO    KELLY    STRULLY    SANVENERO    BROPHY (SULLIVAN)

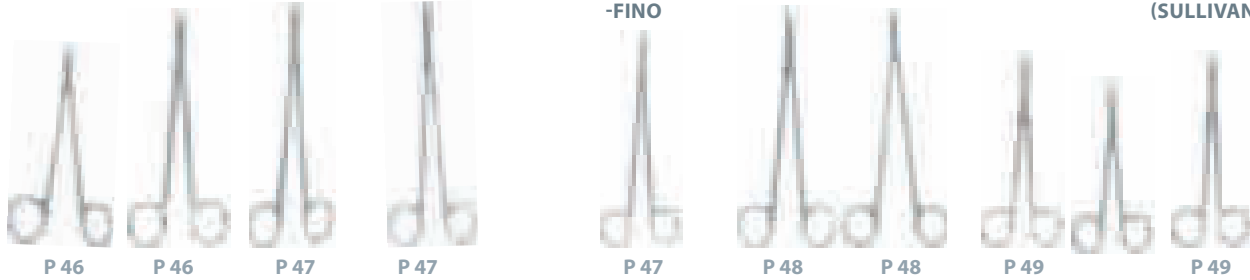

## Ciseaux divers - Miscellaneous scissors - Tijeras diversas

KLIKENBERG    SATINSKY    SIEBOLD



## Ciseaux pour intervention en profondeur -

Scissors for deep operations - Tijeras para intervención a fondo

CRAFOORD    DUBOIS    SIMS    WERTHEIM

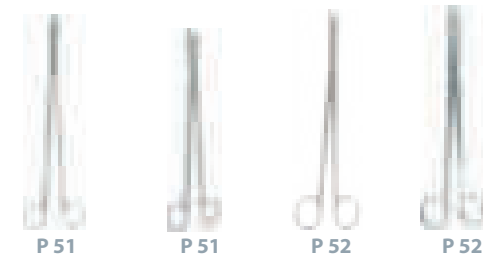

## Ciseaux divers - Miscellaneous scissors - Tijeras diversas

Coiffeur  
Hairdresser  
Peluquero

Colleuse  
Gluer  
Encolador

Lingère  
Lingere  
Lencera

Couturière  
Dressmaker  
Modista

Ciseaux pour coton  
Cottons scissors  
Tijeras para algodón

ROUENNAIS

JESCO

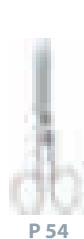



Ciseaux en tungstène - Tungsten scissors - Tijeras de tungsteno

KILNER KELLY (RAGNELL) MAYO MAYO-LEXER LEXER-FINO MAYO-STILLE MAYO-LEXER LEXER-FINO MAYO-STILLE

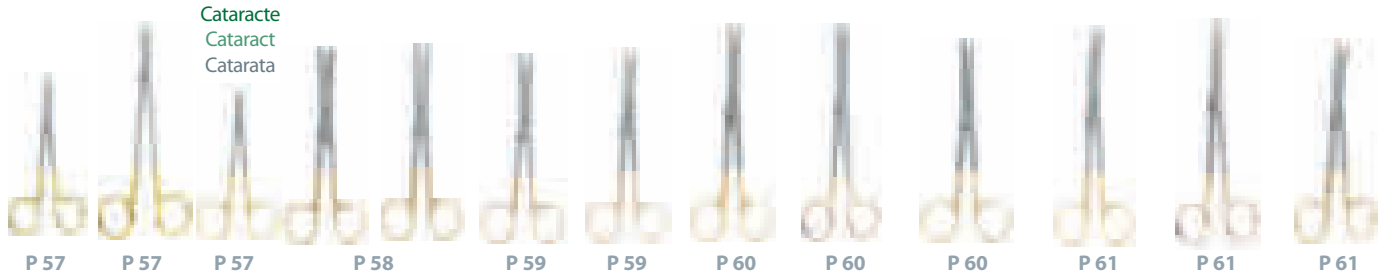

METZENBAUM METZENBAUM-FINO TOENNIS-ADSON GOLDMANN FOX UNIVERSSEL LISTER DUBOST KLIKENBERG SIMS POTTS-SMITH DEBAKEY

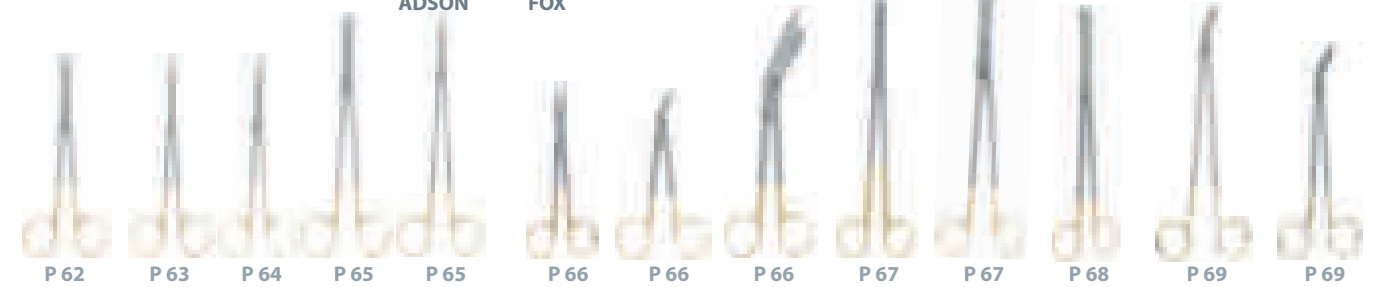

Ciseaux Prestige - Prestige scissors - Tijeras Prestige

MAYO MAYO-STILLE MAYO-LEXER BABY-METZENBAUM METZENBAUM METZENBAUM -FINO WAGNER STEVENS REYNOLDS JAMESON



POTTS-SMITH MERVEILLEUX SIMS JOSEPH KAYE GORNEY FOMON COTTLE HEYMANN



Ciseaux pour le cordon ombilical - Scissors for umbilical cord - Tijeras para el cordón umbilical

BUSCH SCHUMACHER



## Ciseaux à épisiotomie - Episiotomy scissors - Tijeras para episiotomía

DELESTRE      BRAUN-STADLER      WALDMANN

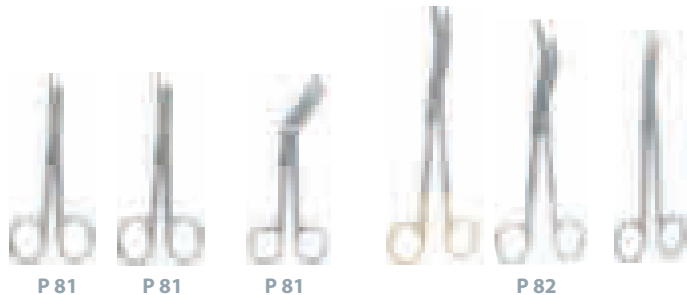

P 81      P 81      P 81      P 82      P 82      P 82

## Ciseaux ORL - ENT scissors - Tijeras ORL

JOSEPH      FOMON      HALLE      FOMON      COTTLE      HEYMANN



P 83      P 83      P 83      P 84      P 84      P 84

## Instruments pour plâtres - Plaster instruments - Instrumentos para escayolas

BRUNS      LANGE

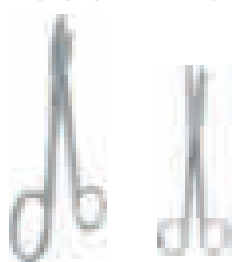

P 85      P 85

## Ciseaux pour chirurgie osseuse - Bone surgery scissors - Tijeras para cirugía ósea

Ciseaux à décapsuler  
Scissors to uncap  
Tijeras para decapsular

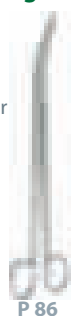

P 86

Ciseaux à ménisque  
Meniscus scissors  
Tijeras para menisco



P 86

## Ciseaux divers - Miscellaneous scissors - Tijeras diversas

SMITH

Ciseaux enterotome  
Enterotome scissors  
Tijeras enterotomo

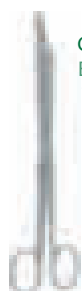

P 87



P 87

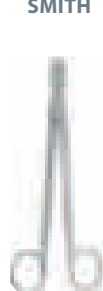

P 87

## Ciseaux à ongles - Nails scissors - Tijeras para uñas

Ciseaux à fendre les ongles  
Nail splitting scissors  
Tijeras para hender las uñas



P 88

P 88

P 88

Instruments pour prostate - Instruments for prostate - Instrumentos para prostate

VIII - Voies basses  
VIII - Gyne/Uro/Procto  
VIII - Gyne/Uro/Procto

METZENBAUM



P 95

X - Microchirurgie  
X - Microsurgery  
X - Microcirugía

Microchirurgie ciseaux - Microsurgery scissors - Microcirugía tijeras

WESTCOTT



P 3

VANNAS



P 4

VANNAS modifié TÜBINGEN

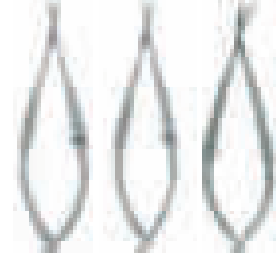

P 4

CASTROVIEJO

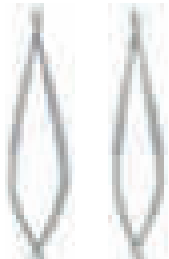

P 5

CASTROVIEJO



P 5

TROUTMAN-BARRAQUER

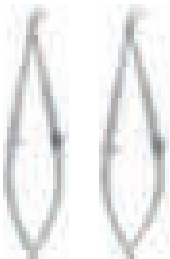

P 5

NOYES



P 6

WECKER



P 6

TROUTMAN

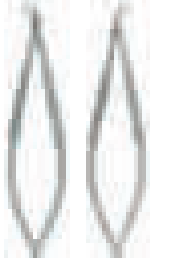

P 7

KATZIN BARRAQUER



P 7

KATZIN



P 7

WESTCOTT



P 7

CASTROVIEJO

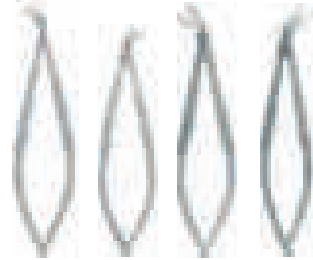

P 8

VANNAS MILLESI



P 9

VANNAS

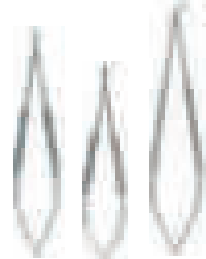

P 10

YASARGIL



P 11

Instrumentation de service - Instrumentation for services - Instrumentación de servicio

XV - Divers  
XV - Miscellaneous  
XV - Diversos

LISTER

MAYO



P 15

P 15

P 15

P 15

P 16

P 16

P 16

P 16

P 17

Ciseaux pour plâtre - Plaster scissors - Tijeras para escayolas

XV - Divers  
XV - Miscellaneous  
XV - Diversos

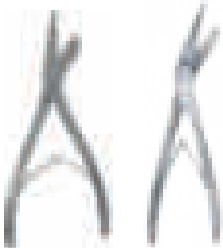

P 21

P 21

Matériels divers - Miscellaneous materials - Materiales varios

XV - Divers  
XV - Miscellaneous  
XV - Diversos

LORTAT-JACOB

MAYO



P32

P 32

III - Ciseaux  
III - Scissors  
III - Tijeras



# LANDANGER

## Ciseaux chirurgicaux - Surgical scissors - Tijeras quirúrgicas

	Droit Straight Recta			Courbe Curved Curva
	<b>B25255</b>	11 cm - 4 1/4"		<b>B25260</b>
	<b>B25261</b>	13 cm - 5"		<b>B25262</b> 
	<b>B25275</b>	14 cm - 5 1/2"		<b>B25280</b>
	<b>B25285</b>	16 cm - 6 1/4"		<b>B25290</b>
	<b>B25295</b>	18 cm - 7"		<b>B25300</b>
	<b>B25302</b>	20 cm - 8"		<b>B25303</b>

Mousse / Mousse  
Blunt / Blunt  
Roma / Roma

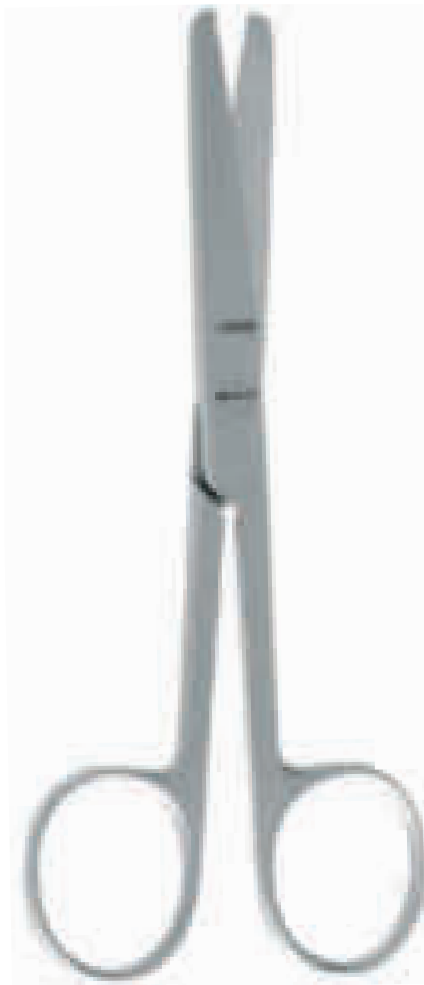

**B25261**  
13 cm - 5"

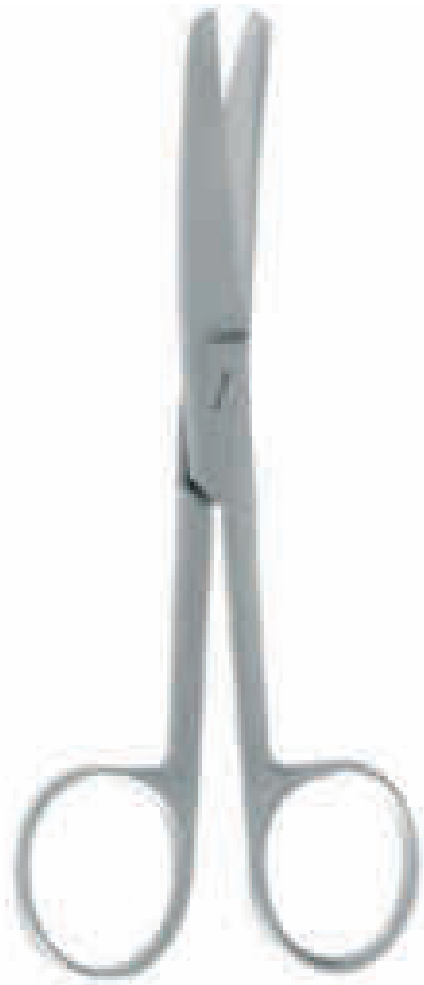

**B25262**  
13 cm - 5"

III - Ciseaux  
III - Scissors  
III - Tijeras

## Ciseaux chirurgicaux - Surgical scissors - Tijeras quirúrgicas

Droit Straight Recta		Courbe Curved Curva
	B25305 11 cm - 4 1/4"	B25310
	<b>B25311</b> 13 cm - 5"	<b>B25312</b> 
	B25325 14 cm - 5 1/2"	B25330
	B25335 16 cm - 6 1/4"	B25340
	B25345 18 cm - 7"	B25350
	B253470 20 cm - 8"	B253520

Pointu / Pointu  
Sharp / Sharp  
Aguda / Aguda



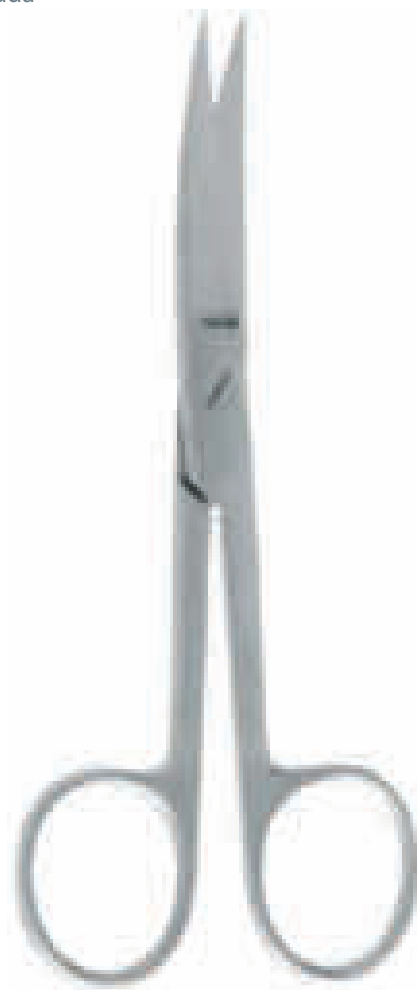

**B25311**  
13 cm - 5"



**B25312**  
13 cm - 5"

### DAUPHIN

	Droit Straight Recta			Courbe Curved Curva
	<b>B25355</b>	11 cm - 4 1/4"		<b>B25360</b>
	<b>B25365</b>	13 cm - 5"		<b>B25370</b> 
	<b>B25375</b>	14 cm - 5 1/2"		<b>B25380</b>
	<b>B25385</b>	16 cm - 6 1/4"		<b>B25390</b>
	<b>B25395</b>	18 cm - 7"		<b>B25400</b>
	<b>B253970</b>	20 cm - 8"		<b>B254010</b>

Pointu / Mousse  
Sharp / Blunt  
Aguda / Roma



**B25365**  
13 cm - 5"



**B25370**  
13 cm - 5"



## Ciseaux délicats - Delicate scissors - Tijeras delicadas

STRABISME  
STRABISMUS  
ESTRABISMO

Droit	Courbe
Straight	Curved
Recta	Curva

12 cm - 4<sup>3/4</sup>"  **B25265** **B25270**

CATARACTE  
CATARACT  
CATARATA

Droit	Courbe
Straight	Curved
Recta	Curva

 **B25315** **B25320**

Droit	Courbe
Straight	Curved
Recta	Curva

 **B253680** **B253730**

### DAUPHIN

Mousse / Mousse  
Blunt / Blunt  
Roma / Roma

Pointu / Mousse  
Sharp / Blunt  
Aguda / Roma

Pointu / Pointu  
Sharp / Sharp  
Aguda / Aguda



**B25265**  
12 cm - 4<sup>3/4</sup>"



**B253680**  
12 cm - 4<sup>3/4</sup>"





**B25315**  
12 cm - 4<sup>3/4</sup>"

## Ciseaux délicats - Delicate scissors - Tijeras delicadas

### ÉNUCLÉATION ENUCLEATION ENUCLEACIÓN

### GRAZIL

	Droit Straight Recta	Courbe Curved Curva		Droit Straight Recta	Courbe Curved Curva		Droit Straight Recta	Courbe Curved Curva
13 cm - 5" 	<b>B25402</b>	<b>B25403</b>		<b>B254021</b>	<b>B254031</b>		<b>B254022</b>	<b>B254032</b>
14,5 cm - 5 <sup>3/4</sup> "	<b>B25405</b>	<b>B25410</b>		<b>B254051</b>	<b>B254101</b>		<b>B254052</b>	<b>B254102</b>

Mousse / Mousse  
Blunt / Blunt  
Roma / Roma

Pointu / Mousse  
Sharp / Blunt  
Aguda / Roma

Pointu / Pointu  
Sharp / Sharp  
Aguda / Aguda



**B25403**



**B254031**



**B254032**

**B25402**  
13 cm - 5"

**B254021**  
13 cm - 5"

**B254022**  
13 cm - 5"



### WAGNER



### DEAVER



### MIXTER



# LANDANGER

Ciseaux délicats - Delicate scissors - Tijeras delicadas

## ALLAIRE

Droit  
Straight  
Recta

Courbe  
Curved  
Curva

13 cm - 5"

**B25415**



**B25418**

## KILNER (RAGNELL)

Courbe  
Curved  
Curva

12 cm - 4 3/4"

**B25421**



13 cm - 5"

**B254220**

15 cm - 6"

**B25426**

Spatulé  
Spatula  
Espatula



**B25418**

**B25415**  
13 cm - 5"



**B25421**  
12 cm - 4 3/4"

III - Ciseaux  
III - Scissors  
III - Tijeras

### MAYO

	Droit Straight Recta			Courbe Curved Curva
	<b>B25483</b>	15 cm - 6"		<b>B25485</b> 
	B25486	17 cm - 6 <sup>3</sup> / <sub>4</sub> "		B25489
	B254891	19 cm - 7 <sup>1</sup> / <sub>2</sub> "		B254892
	B254893	23 cm - 9"		B254894
	B255100	28 cm - 11"		B255101

Lames plates  
Flat blades  
Hojas planas



**B25483**  
15 cm - 6"

**B25485**  
15 cm - 6"

### MAYO - STILLE

Droit Straight Recta		Courbe Curved Curva
	B25490 15 cm - 6"	B25495
	<b>B25497</b> 17 cm - 6 <sup>3</sup> / <sub>4</sub> "	<b>B25498</b> 
	B254981 19 cm - 7 <sup>1</sup> / <sub>2</sub> "	B254982
	- 21 cm - 8 <sup>1</sup> / <sub>4</sub> "	B254983



**B25497**  
17 cm - 6 <sup>3</sup>/<sub>4</sub>"

**B25498**  
17 cm - 6 <sup>3</sup>/<sub>4</sub>"

## Ciseaux à dissection - Dissecting scissors - Tijeras para disección

### MAYO-ALSACE

Droit  
Straight  
Recta

Courbe  
Curved  
Curva

16 cm - 6<sup>1</sup>/<sub>4</sub>"

**B25460**

**B25465**



Lames évidées  
Hollowed blades  
Hojas vaciadas

### MAYO-LEGER

Droit  
Straight  
Recta

Courbe  
Curved  
Curva

17 cm - 6<sup>3</sup>/<sub>4</sub>"

**B25470**

**B25475**



### MAYO-LYON

Coudé  
Angled  
Angulada

14 cm - 5<sup>1</sup>/<sub>2</sub>"

**B25480**



**B25460**

16 cm - 6<sup>1</sup>/<sub>4</sub>"

**B25465**

**B25475**

**B25470**

17 cm - 6<sup>3</sup>/<sub>4</sub>"

**B25480**

14 cm - 5<sup>1</sup>/<sub>2</sub>"

### MAYO-NOBLE

Droit  
Straight  
Recta

Courbe  
Curved  
Curva

17 cm - 6<sup>3</sup>/<sub>4</sub>"

**B255800**

**B255801**



### MAYO-SANTY

Droit  
Straight  
Recta

Courbe  
Curved  
Curva

24 cm - 9<sup>1</sup>/<sub>2</sub>"

**B25600**

**B25605**



Lames rondes  
Round blades  
Hojas redondas

### MAYO-HARRINGTON

Droit  
Straight  
Recta

Courbe  
Curved  
Curva

20 cm - 8"

**B25572**

**B25574**

23 cm - 9"

**B25576**

**B25578**

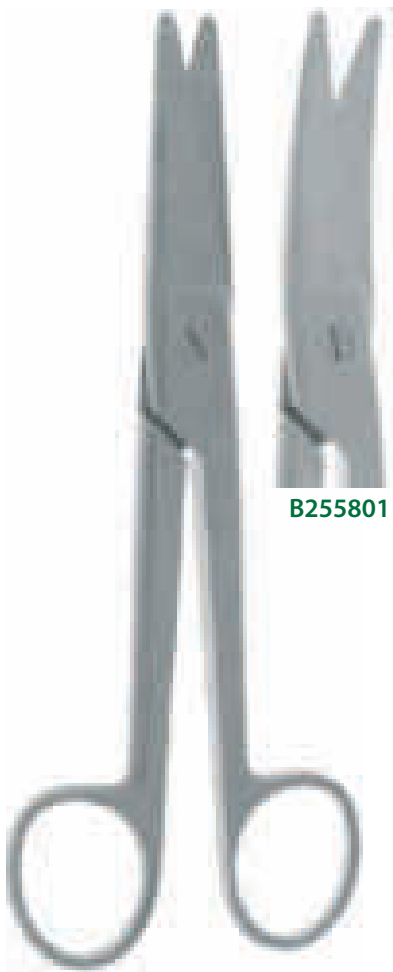

**B255801**

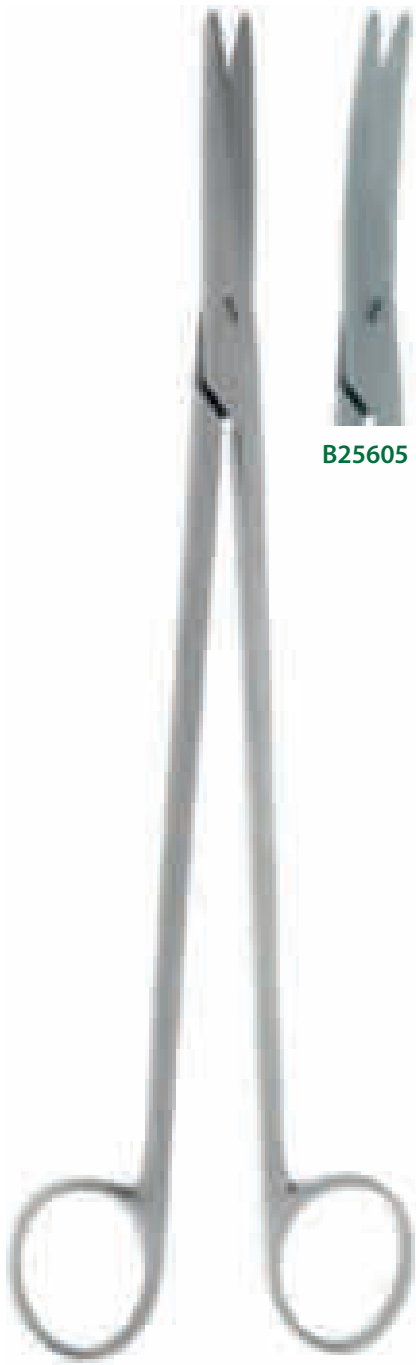

**B25605**



**B25578**

**B255800**  
17 cm - 6<sup>3</sup>/<sub>4</sub>"

**B25600**  
24 cm - 9<sup>1</sup>/<sub>2</sub>"

**B25576**  
23 cm - 9"





### DUBOST

	Droit Straight Recta		Courbe Curved Curva	
	<b>B25686</b>	23 cm - 9"	<b>B25688</b>	
	<b>B25692</b>	26 cm - 10 <sup>1</sup> / <sub>4</sub> "	<b>B25694</b>	
	<b>B25696</b>	30 cm - 11 <sup>3</sup> / <sub>4</sub> "	<b>B25700</b>	



**B25686**  
23 cm - 9"

**B25688**  
23 cm - 9"

# LANDANGER

Ciseaux à dissection - Dissecting scissors - Tijeras para disección

## BABY-LEXER

Droit  
Straight  
Recta

Courbe  
Curved  
Curva

10 cm - 4"

**B256070**

**B256071**



## LEXER

Droit  
Straight  
Recta

Courbe  
Curved  
Curva

16 cm - 6<sup>1</sup>/<sub>4</sub>"

**B256080**

**B256081**



## LEXER-FINO

Droit  
Straight  
Recta

Courbe  
Curved  
Curva

16 cm - 6<sup>1</sup>/<sub>4</sub>"

**B256090**

**B256091**





**B256070**  
10 cm - 4"

**B256080**  
16 cm - 6<sup>1</sup>/<sub>4</sub>"

**B256090**  
16 cm - 6<sup>1</sup>/<sub>4</sub>"

III - Ciseaux  
III - Scissors  
III - Tijeras

### METZENBAUM

	Droit Straight Recta		Courbe Curved Curva
	<b>B25610</b>	12 cm - 4 <sup>3</sup> / <sub>4</sub> "	<b>B25615</b>
	<b>B25620</b>	15 cm - 6"	<b>B25625</b> 
	<b>B25630</b>	18 cm - 7"	<b>B25635</b>
	<b>B25640</b>	20 cm - 8"	<b>B25645</b>
	<b>B25650</b>	23 cm - 9"	<b>B25655</b>
	<b>B25660</b>	25 cm - 10"	<b>B25665</b>
	<b>B25670</b>	28 cm - 11"	<b>B25675</b>
	<b>B25680</b>	30 cm - 11 <sup>3</sup> / <sub>4</sub> "	<b>B25685</b>





Mousse / Mousse  
Blunt / Blunt  
Roma / Roma

**B25620**  
15 cm - 6"

**B25625**  
15 cm - 6"

### METZENBAUM

	Droit Straight Recta	Courbe Curved Curva		Droit Straight Recta	Courbe Curved Curva	
	<b>B256201</b>	<b>B256251</b>	15 cm - 6"		<b>B256202</b>	<b>B256252</b>
	<b>B256301</b>	<b>B256351</b>	18 cm - 7"		<b>B256302</b>	<b>B256352</b>
	<b>B256401</b>	<b>B256451</b>	20 cm - 8"		<b>B256402</b>	<b>B256452</b>
	<b>B256501</b>	<b>B256551</b>	23 cm - 9"		<b>B256502</b>	<b>B256552</b>
	<b>B256601</b>	<b>B256651</b>	26 cm - 10 <sup>1/4</sup> "		<b>B256602</b>	<b>B256652</b>
	<b>B256701</b>	<b>B256751</b>	28 cm - 11"		<b>B256702</b>	<b>B256752</b>
	<b>B256801</b>	<b>B256851</b>	30 cm - 11 <sup>3/4</sup> "		<b>B256802</b>	<b>B256852</b>

Pointu / Mousse  
Sharp / Blunt  
Aguda / Roma





**B256201**  
15 cm - 6"

Pointu / Pointu  
Sharp / Sharp  
Aguda / Aguda



**B256202**  
15 cm - 6"

### METZENBAUM-FINO

	Droit Straight Recta	Courbe Curved Curva		Droit Straight Recta	Courbe Curved Curva
15 cm - 6" 	<b>B256205</b>	<b>B256255</b>		15 cm - 6" 	<b>B256215</b> <b>B256265</b>
18 cm - 7"	<b>B256305</b>	<b>B256355</b>			
20 cm - 8"	<b>B256405</b>	<b>B256455</b>			
23 cm - 9"	<b>B256505</b>	<b>B256555</b>			
25 cm - 10"	<b>B256605</b>	<b>B256655</b>			
28 cm - 11"	-	<b>B256760</b>			
28 cm - 11"	-	<b>B256770</b>	WELLER (Lames courtes - Short blades - Lamas cortas)		

Mousse / Mousse  
Blunt / Blunt  
Roma / Roma



**B256205**  
15 cm - 6"

Pointu / Pointu  
Sharp / Sharp  
Aguda / Aguda



**B256215**  
15 cm - 6"

**B256255**  
15 cm - 6"

**B256265**

### ALLAINE

	Droit Straight Recta		Courbe Curved Curva	
	<b>B25705</b>	18 cm - 7"	<b>B25706</b>	
	<b>B25715</b>	20 cm - 8"	<b>B25716</b>	
	<b>B25725</b>	23 cm - 9"	<b>B25726</b>	



**B25705**  
18 cm - 7"

**B25706**  
18 cm - 7"

**ALLAINE  
(BOYD)**

18 cm - 7"

**B25707**



20 cm - 8"

**B25717**



23 cm - 9"

**B25727**

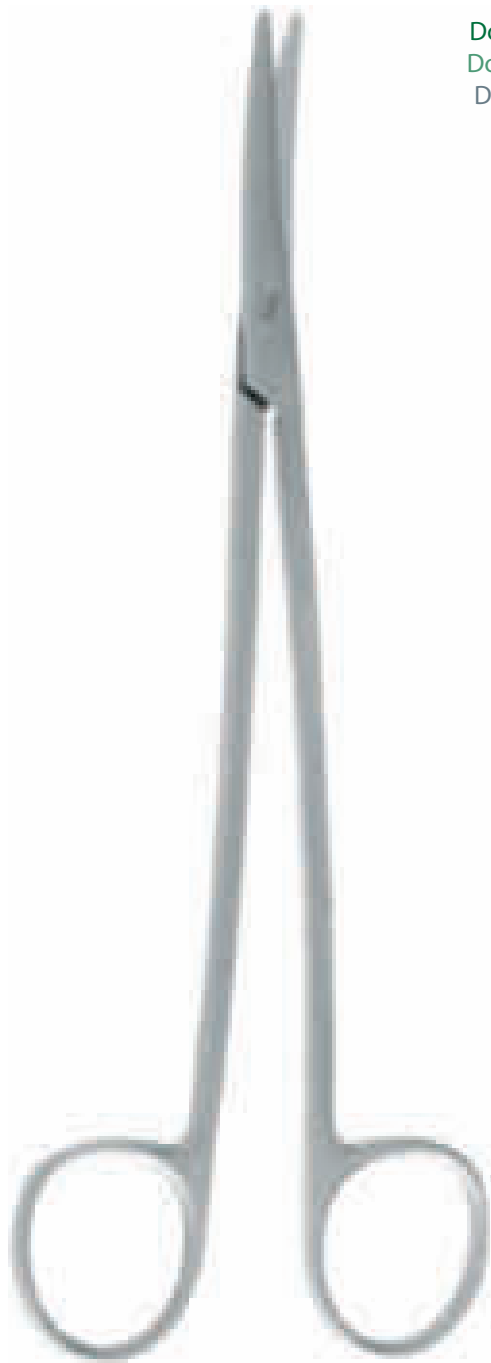

Double courbure  
Double curvature  
Doble curvatura

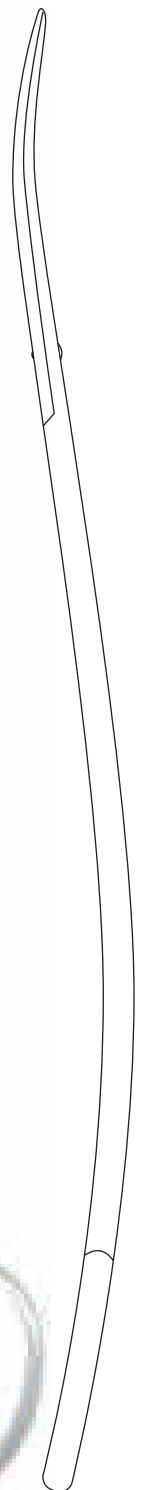

**B25707**  
18 cm - 7"

**B25717**  
20 cm - 8"

### NANCY

### DOYEN

Droit  
Straight  
Recta

Droit  
Straight  
Recta

Courbe  
Curved  
Curva

16 cm - 6 1/4"

**B257609**

**B257614**

18 cm - 7" 

**B257610**

**B257615**

Courbe  
Curved  
Curva

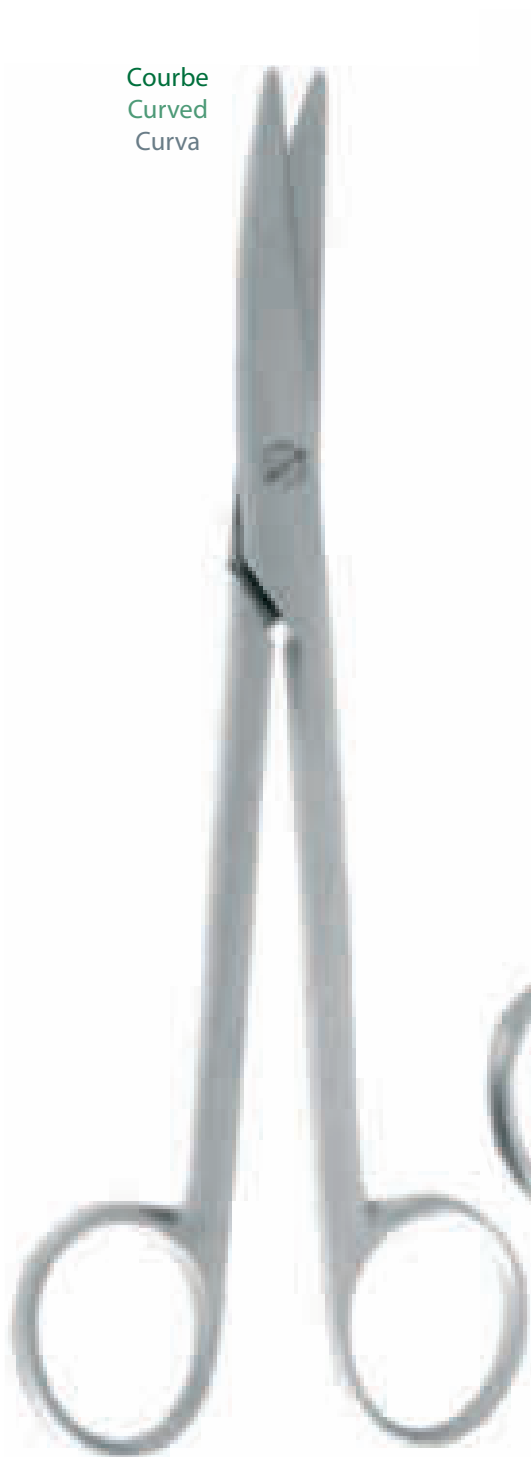

**B25775**  
18,5 cm - 7 1/4"



**B257605**  
16 cm - 6 1/4"



**B257610**  
18 cm - 7"

**B257615**

III - Ciseaux  
III - Scissors  
III - Tijeras



### RICHTER

**B257640**

13 cm - 5"

**B257641** 

14,5 cm - 5 <sup>3</sup>/<sub>4</sub>"

**B257642**

16,5 cm - 6 <sup>1</sup>/<sub>2</sub>"



**B257641**  
14,5 cm - 5 <sup>3</sup>/<sub>4</sub>"



**B257645**  
16,5 cm - 6 <sup>1</sup>/<sub>2</sub>"

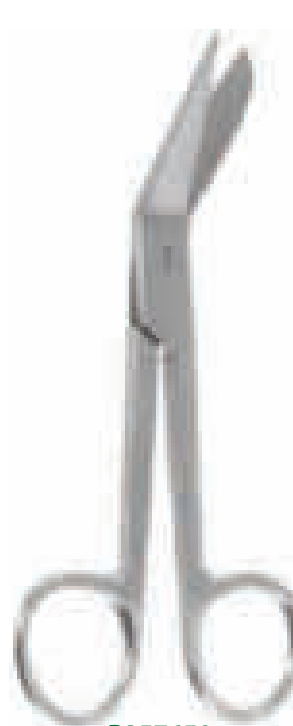

**B257650**  
14 cm - 5 <sup>1</sup>/<sub>2</sub>"

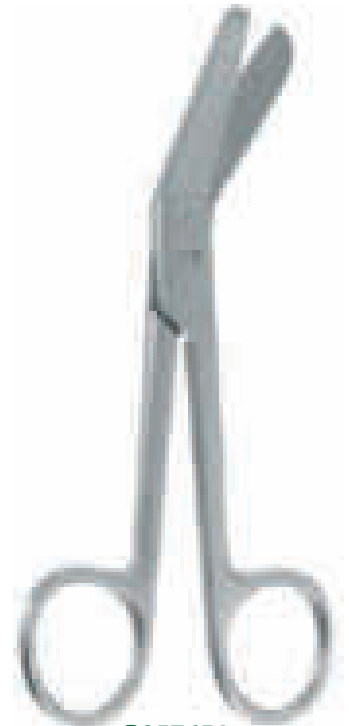

**B257651**  
14,5 cm - 5 <sup>3</sup>/<sub>4</sub>"

### HI-LEVEL KNOWLES

Coudé  
Angular  
Angulada

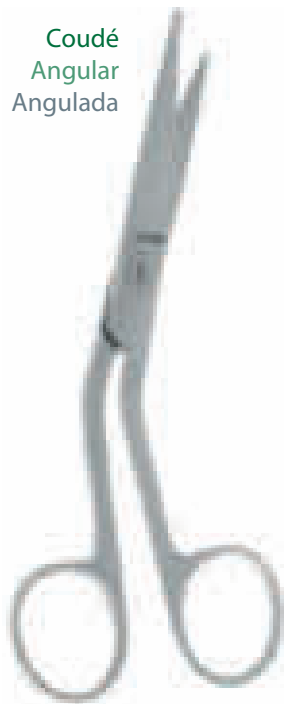

**B25770**  
14 cm - 5 <sup>1</sup>/<sub>2</sub>"

### KNOWLES

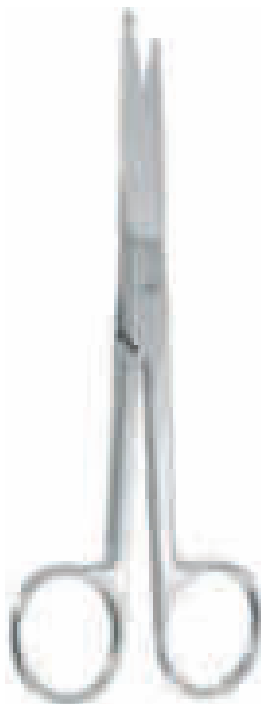

**B257695**  
14 cm - 5 <sup>1</sup>/<sub>2</sub>"

### FERGUSSON





**B257661**  
18 cm - 7"



**B257660**  
14,5 cm - 5 <sup>3</sup>/<sub>4</sub>"

## LISTER

11 cm - 4 1/2"	<b>B257350</b>	
14 cm - 5 1/2"	<b>B25745</b>	
15,5 cm - 6"	<b>B257360</b>	
18 cm - 7"	<b>B25737</b>	
20 cm - 8"	<b>B25740</b>	

Croix rouge  
Red cross  
Cruz roja



**B25745**  
14 cm - 5 1/2"

**B25737**  
18 cm - 7"

## ESMARCH

20 cm - 8"

**B257460**



23,5 cm - 9<sup>1</sup>/<sub>4</sub>"

**B257462**

## LISTER-EXCENTRIC

## BERGMANN

Dentelées  
Serrated  
Serradas



**B257340**

16 cm - 6<sup>1</sup>/<sub>4</sub>"

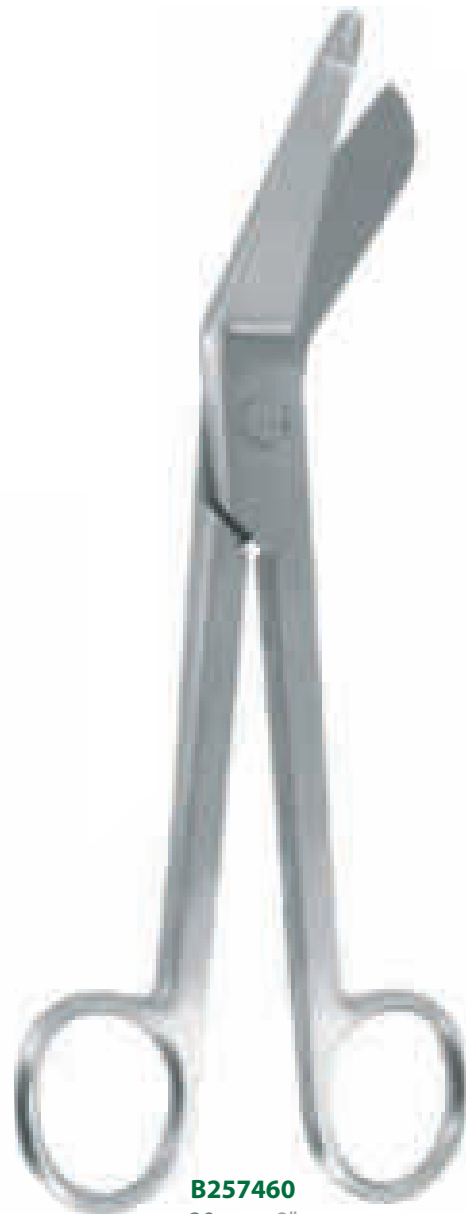

**B257460**

20 cm - 8"



**B257465**

23,5 cm - 9<sup>1</sup>/<sub>4</sub>"

## Ciseaux pour couper les fils - Wire cutting scissors - Tijeras para cortar hilos

### HARVEY

### UNIVERSEL

### BEEBE

Droit      Courbe  
Straight      Curved  
Recta      Curva

Pointu - Sharp - Aguda

10 cm - 4" **B258445** **B25845** 

Mousse - Blunt - Roma

10 cm - 4" **-** **B258451**



Lames dentelées  
Serrated blades  
Hojas serradas

**B25780**  
12 cm - 4 3/4"

**B25786**  
12 cm - 4 3/4"



Lames dentelées  
Serrated blades  
Hojas serradas

**B25845**  
10 cm - 4"

### EISELSBERG

### SCHOEMAKER-LOTH

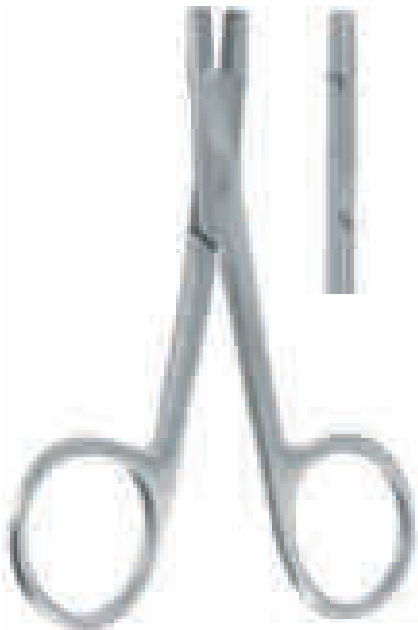

**B258460**  
11 cm - 4 1/2"



**B258465**  
12,5 cm - 5"

III - Ciseaux  
III - Scissors  
III - Tijeras

## POTTS-SMITH

	25°	45°	60°	125°
19 cm - 7 1/2"	<b>B25802</b>	B25804	B25806	B25812

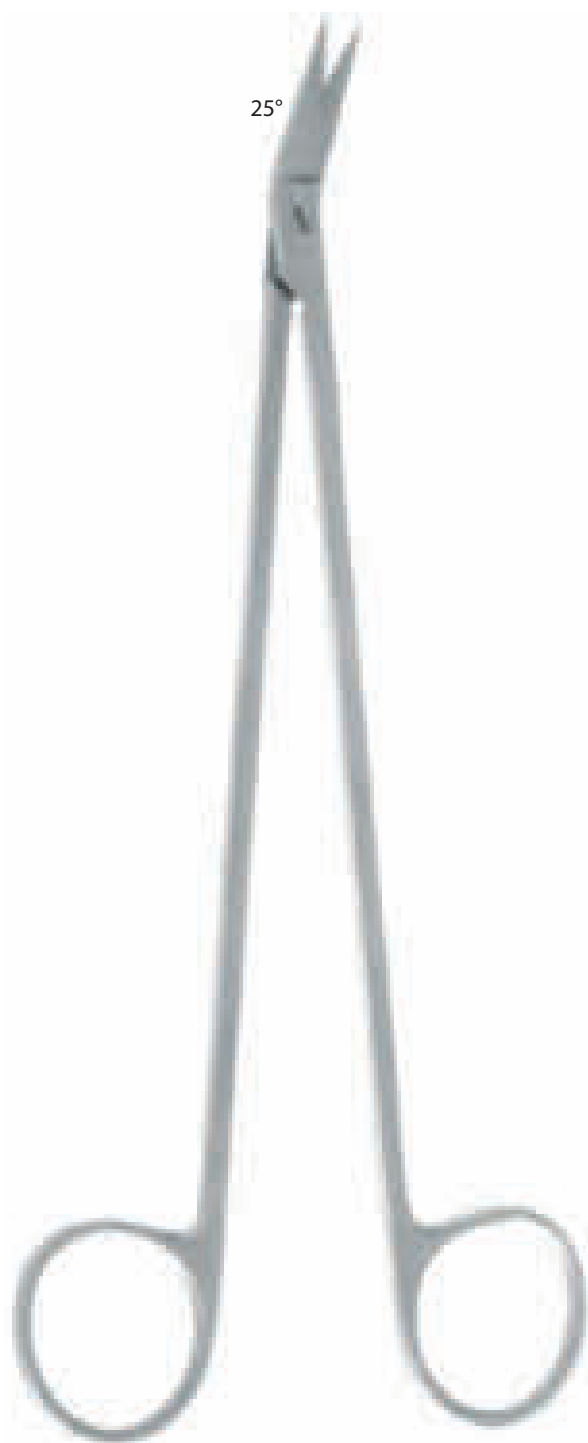

25°

45°

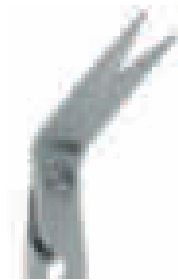

60°



125°



**B25802**  
19 cm - 7 1/2"

## DEBAKEY

	25°	45°	60°
16 cm - 7 1/2"	B258023	B258043	B258063
23 cm - 9"	B258024	B258044	B258064
28 cm - 11"	<b>B258025</b>	B258045	B258065



**B258025**  
28 cm - 11"



25°



45°

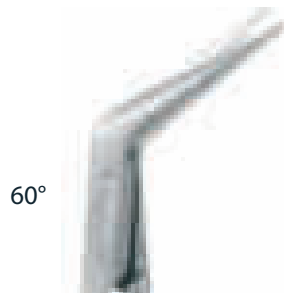

60°

## HEGEMANN (DIETRICH)

	25°	45°	60°	90°	125°	125°
13,5 cm - 5 1/4"	B258027	B258047	B258067	B258107	-	-
16 cm - 6 1/4"	B258028	B258048	B258068	B258108	B258128	-
19 cm - 7 1/2"	B258029	B258049	B258069	B258109	B258129	B258125

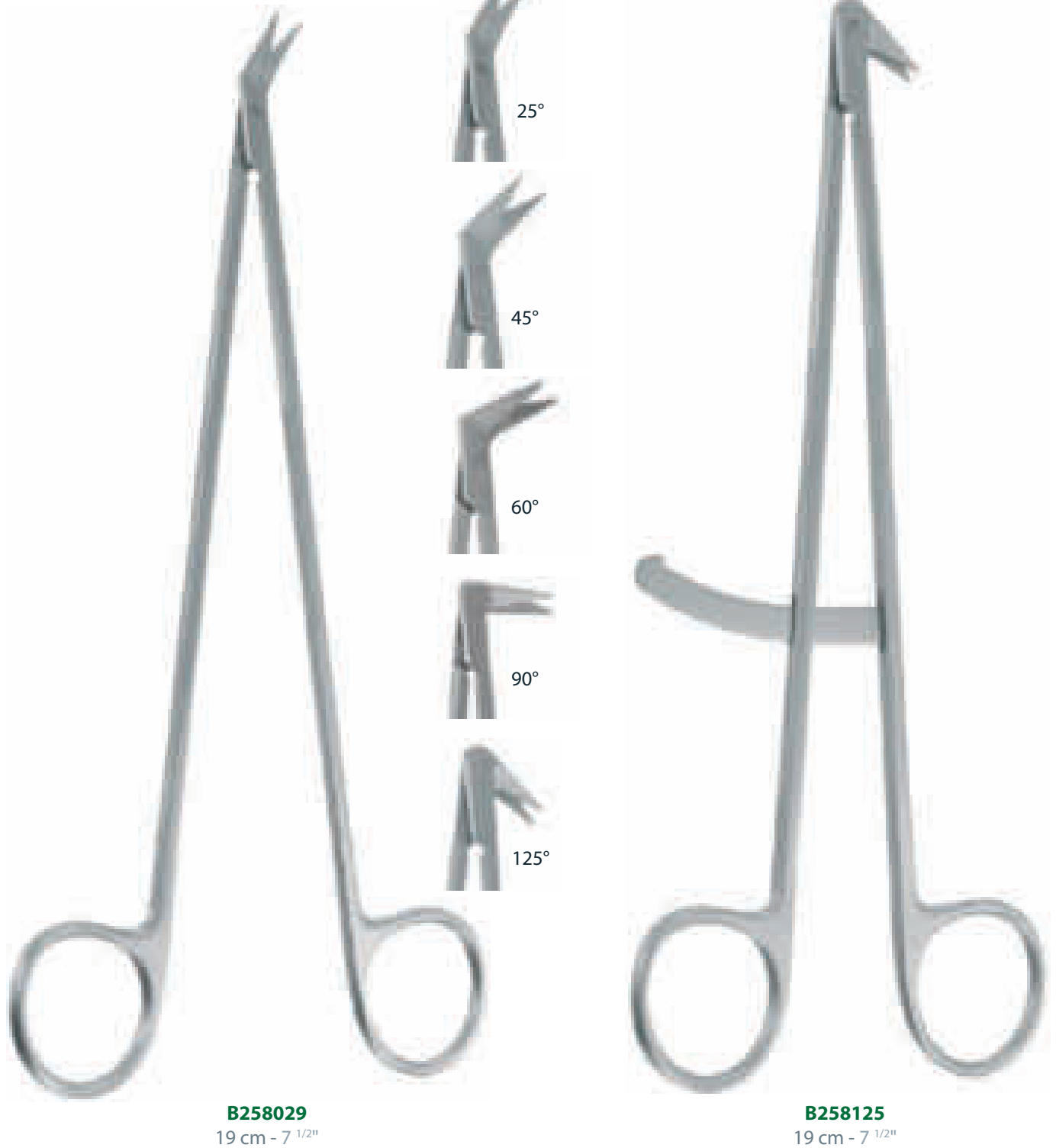

**B258029**  
19 cm - 7 1/2"

**B258125**  
19 cm - 7 1/2"

## DE MARTEL

Droit	Courbe
Straight	Curved
Recta	Curva

18 cm - 7"

**B25813**

**B25814**



## POTTS DE MARTEL

## MILLS

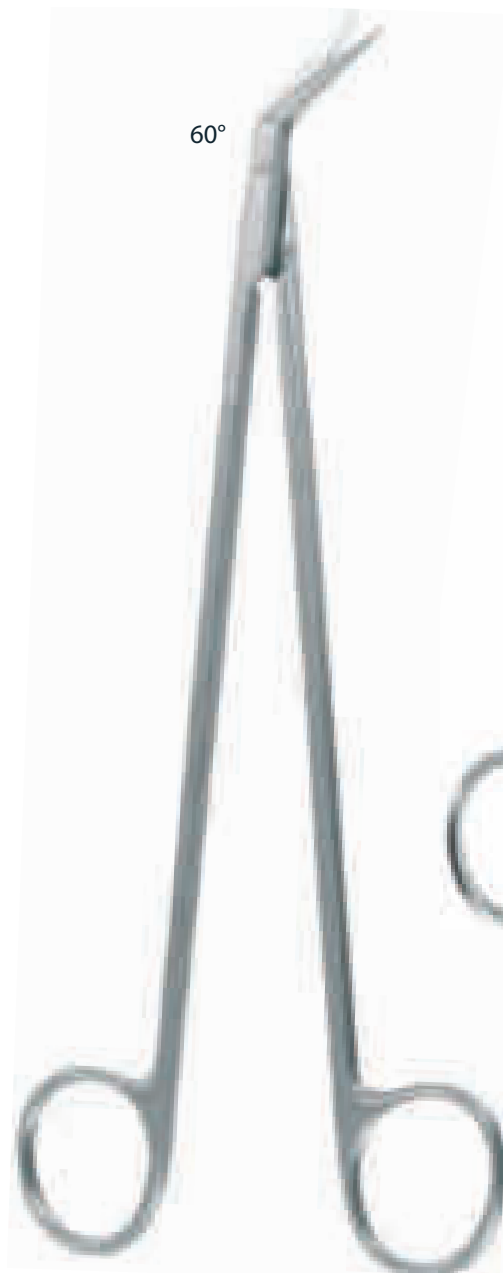

**B258121**  
21 cm - 8 1/4"



**B25813**  
18 cm - 7"

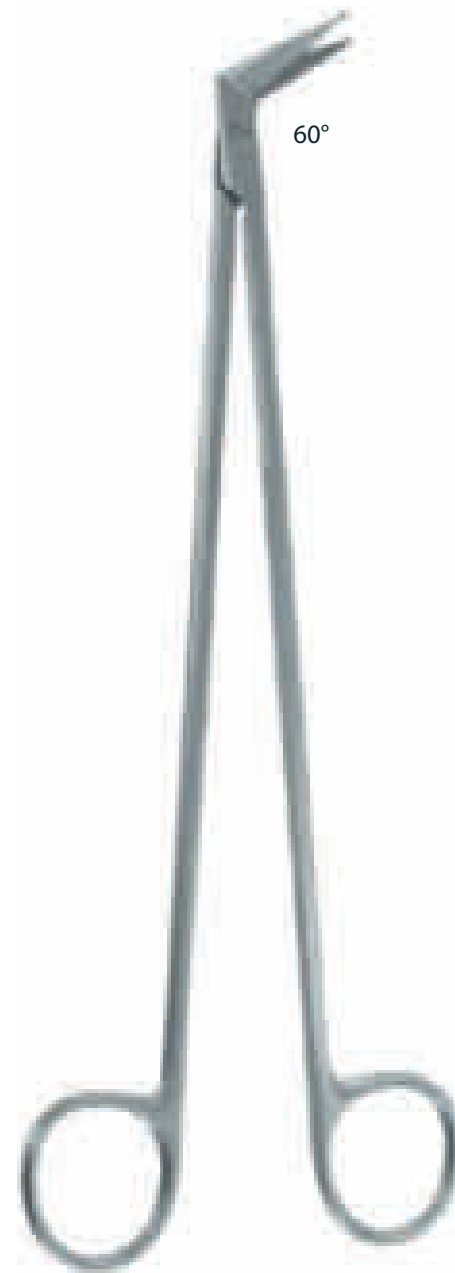

**B258123**  
21 cm - 8 1/4"

III - Ciseaux  
III - Scissors  
III - Tijeras



CISEAUX CORONAIRES  
CORONARY SCISSORS  
TIJERAS CORONARIAS

VINCENT  
(SCHMIEDEN)

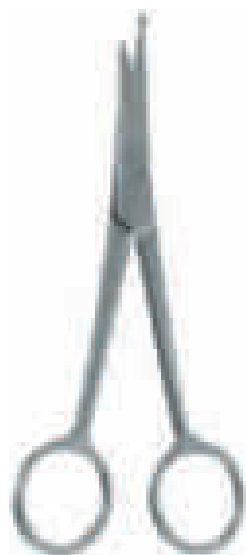

**B258155**  
14,5 cm - 5 <sup>3</sup>/<sub>4</sub>"

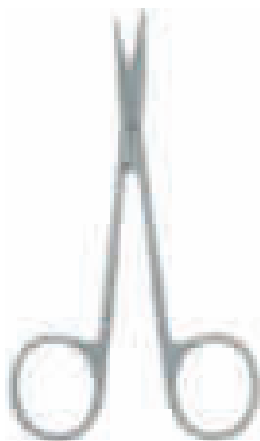

**B258150**  
11,5 cm - 4 <sup>1</sup>/<sub>2</sub>"

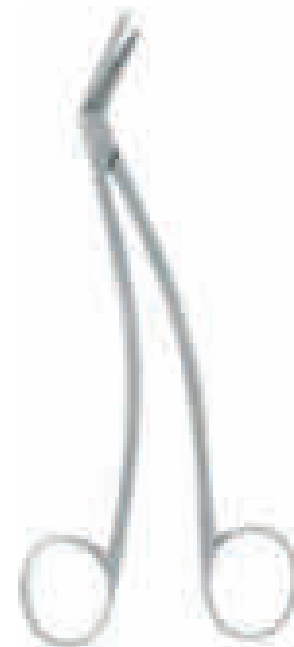

**B25820**  
17 cm - 6 <sup>3</sup>/<sub>4</sub>"

POTTS-SMITH

DEBAKEY

FAVALORO



**B258010**  
19,5 cm - 7 <sup>3</sup>/<sub>4</sub>"



**B258014**  
15,5 cm - 6"



**B258015**  
15,5 cm - 6"

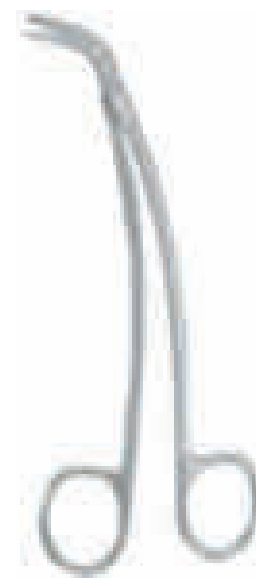

**B258016**  
15 cm - 6"

## Ciseaux divers - Various scissors - Tijeras diversas

POUR LES AMYGDALES  
TONSIL SCISSORS  
PARA AMÍGDALAS

**GOOD**

CISEAUX POUR LES NERFS  
NERVE DISSECTING SCISSORS  
TIJERAS PARA NERVIOS

**BOETTCHER**

**PRINCE**

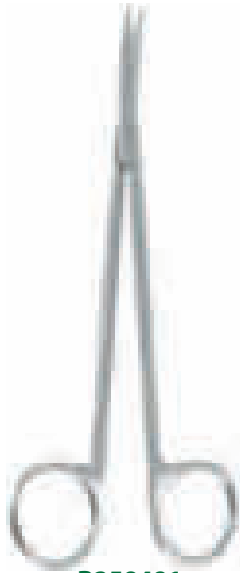

**B258481**  
15 cm - 6"



**B258491**  
18 cm - 7"



**B258489**  
17,5 cm - 7"

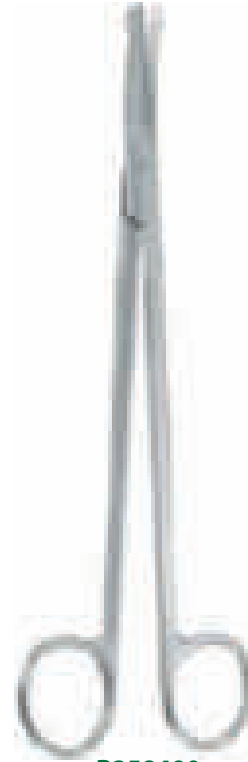

**B258490**  
20 cm - 8"

**MARTIN-CARTILAGE**

**MC-INDOE**

**POTTS-SMITH**

CISEAUX POUR CARTILAGE  
CARTILAGE SCISSORS  
TIJERAS PARA CARTILAGO

Dentelées  
Saw edge  
Dentadas



**B258483**  
20 cm - 8"

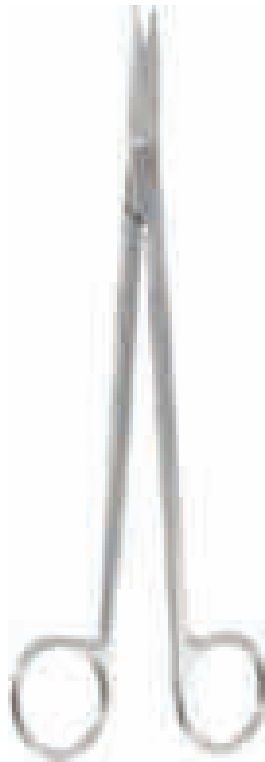

**B258485**  
20 cm - 8"

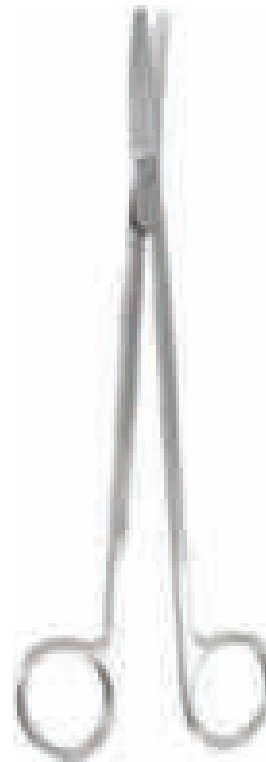

**B258487**  
20 cm - 8"

III - Ciseaux  
III - Scissors  
III - Tijeras

### LA GRANGE

Lames standards  
Standard blades  
Hojas normales



**B258175**  
11,5 cm - 4 1/2"

Lames dentelées  
Serrated blades  
Hojas serradas



**B258176**  
11,5 cm - 4 1/2"

### KNAPP

Droit	Courbe
Straight	Curved
Recta	Curva

Mousse-Mousse / Blunt-Blunt / Roma-Roma  
10,5 cm - 4" **B258180** **B258181**

Pointu-Mousse / Sharp-Blunt / Aguda-Roma  
10,5 cm - 4"  **B258182** **B258183**

Pointu-Pointu / Sharp-Sharp / Aguda-Aguda  
10,5 cm - 4" **B258184** **B258185**



**B258183**

### MICRO

Droit	Courbe
Straight	Curved
Recta	Curva

9 cm - 3 1/2"  **B25816** **B25817**

10,5 cm - 4" **B258161** **B258171**

11,5 cm - 4 1/2" **B258162** **B258172**

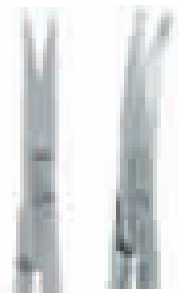

**B25817**

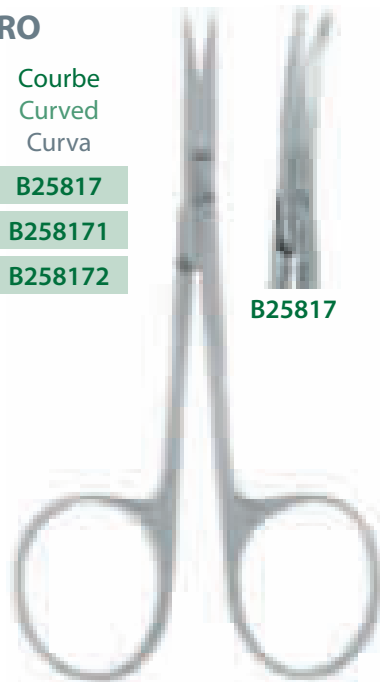

**B25816**  
9 cm - 3 1/2"

**B258182**  
10,5 cm - 4"

## GRAEFE

## WILMER

## CHADWICK

CISEAUX À STRABISME  
STRABISMUS SCISSORS  
TIJERAS PARA ESTRABISMO



**B259800**

10,5 cm - 4 1/4"

**B259801**

10,5 cm - 4 1/4"

**B259810**

11,5 cm - 4 1/2"

**B259820**

11 cm - 4 1/2"

## BONN

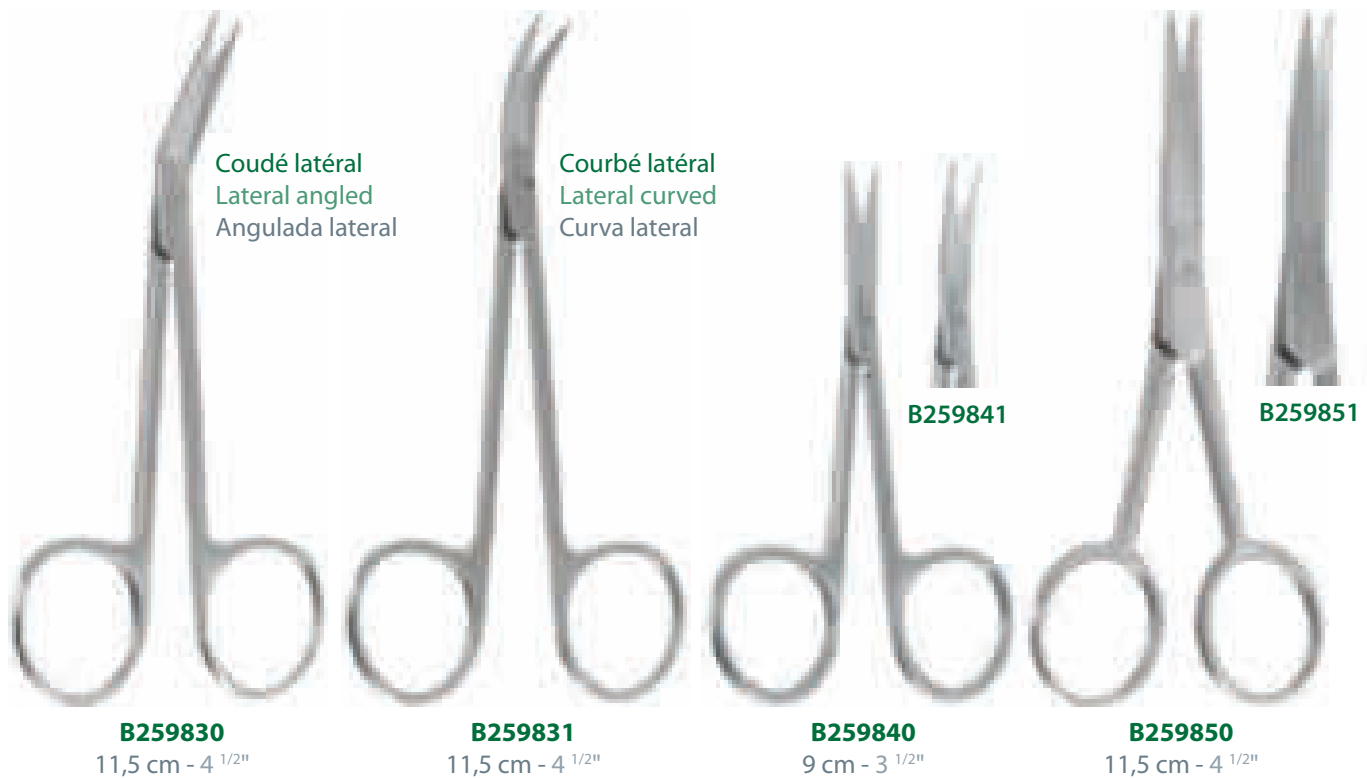

Coudé latéral  
Lateral angled  
Angulada lateral

Courbé latéral  
Lateral curved  
Curva lateral

**B259830**

11,5 cm - 4 1/2"

**B259831**

11,5 cm - 4 1/2"

**B259840**

9 cm - 3 1/2"

**B259850**

11,5 cm - 4 1/2"

**B259841**

**B259851**





**B259910**  
11,5 cm - 4 1/2"

	Droit Straight Recta	Courbe Curved Curva	Coudé Angled Angulada
10,5 cm - 4 1/4"	<b>B259900</b>	<b>B259901</b>	-
11,5 cm - 4 1/2" 	<b>B259910</b>	<b>B259911</b>	<b>B259915</b>



**B259910**



**B259911**



**B259915**



**B259860**  
10,5 cm - 4 1/4"

Extra plats  
Extra flat  
Extremadamente planas

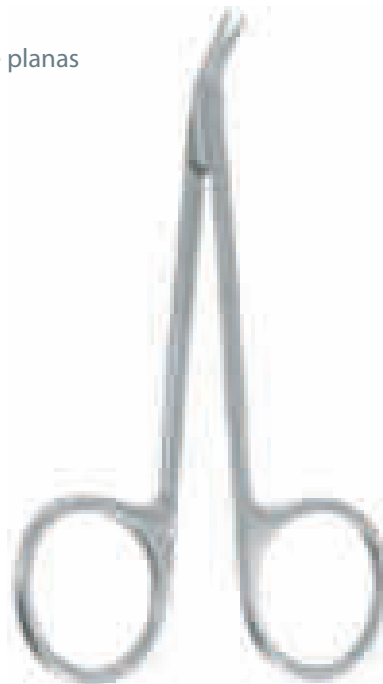

**B259865**  
9 cm - 3 1/2"





**B259870**  
10,5 cm - 4 1/4"

**WALTON**

Courbe  
Curved  
Curva

### SPENCER

Droit Straight Recta		Courbe Curved Curva
B25825	9 cm - 3 1/2"	B25830
 B25835	12 cm - 4 3/4"	B25840 



**B25835**  
12 cm - 4 3/4"



**B25840**  
12 cm - 4 3/4"

LITTLER



**B258405**  
11,5 cm - 4 1/2"

LITTAUER



**B258410**  
14 cm - 5 1/2"

SPENCER-FINO



**B258415**  
16 cm - 6 1/4"

### STEVENS

Droit  
Straight  
Recta

Courbe  
Curved  
Curva

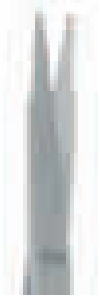

**B25856**

**B25857**



**B25858**

**B25859**

Mousse  
Blunt  
Roma

### STEVENS (RIBBON TYPE)

Droit  
Straight  
Recta

Courbe  
Curved  
Curva

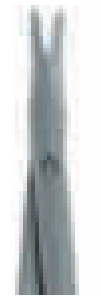

**B258561**

**B258571**



**B258562**

**B258572**

Pointu  
Sharp  
Aguda



**B25856**  
11 cm - 4 1/4"

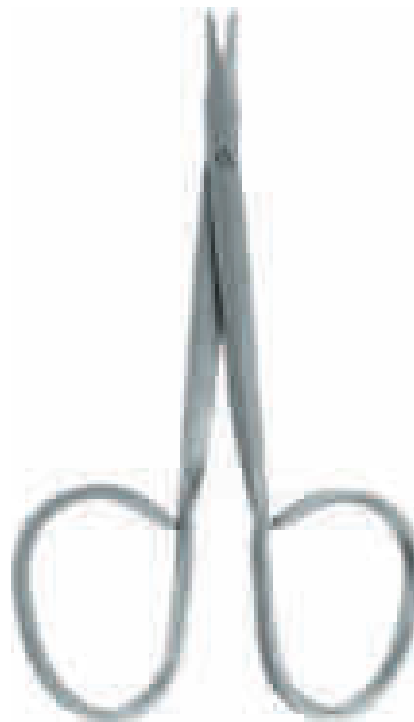

**B258561**  
9,5 cm - 3 1/4"



### GOLDMANN-FOX

### LOCKLIN

CISEAUX À GENCIVES  
GINGIVA SCISSORS  
TIJERAS PARA ENCÍA

Droit	Courbe
Straight	Curved
Recta	Curva

13 cm - 5"

**B258590**

**B258591**



Lames dentelées  
Serrated blades  
Hojas serradas

Coudé dentelé  
Angled serrated  
Angulada serrada



**B258591**

**B258590**  
13 cm - 5"



**B258595**  
16 cm - 6 1/4"

**B258596**  
16 cm - 6 1/4"

## Ciseaux divers - Miscellaneous scissors - Tijeras diversas

### DEAN



Dentelées  
Saw edge  
Dentadas

**B258597**

17 cm - 6 <sup>3</sup>/<sub>4</sub>"

### QUINBY



Droit  
Straight  
Recta

Courbe  
Curved  
Curva

13 cm - 5"

**B258598**

**B258599**

**B258599**

**B258598**

13 cm - 5"

### LANDOLT

#### CISEAUX À ÉNUCLÉATION - ENUCLEATION SCISSORS - TIJERAS PARA ENUCLÉACIÓN



Droit  
Straight  
Recta

**B254012**

12,5 cm - 5"

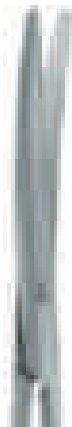

Demi-courbe  
Half curved  
Media curva

**B254013**

12,5 cm - 5"



Courbe  
Curved  
Curva

**B254014**

12,5 cm - 5"



Très courbe  
Very curved  
Muy curva

**B254015**

12,5 cm - 5"



### JAMESON

### REYNOLDS

	Droit Straight Recta	Courbe Curved Curva
15 cm - 6" 	<b>B258499</b>	<b>B25850</b>
18 cm - 7"	<b>B258509</b>	<b>B25851</b>

Courbe  
Curved  
Curva



**B258495**  
15 cm - 6"



**B25850**

**B258499**  
15 cm - 6"

## TOENNIS

Droit  
Straight  
Recta

Courbe  
Curved  
Curva

18 cm - 7" 

**B25852**

**B25853**

Lames plates  
Flat blades  
Hojas planas

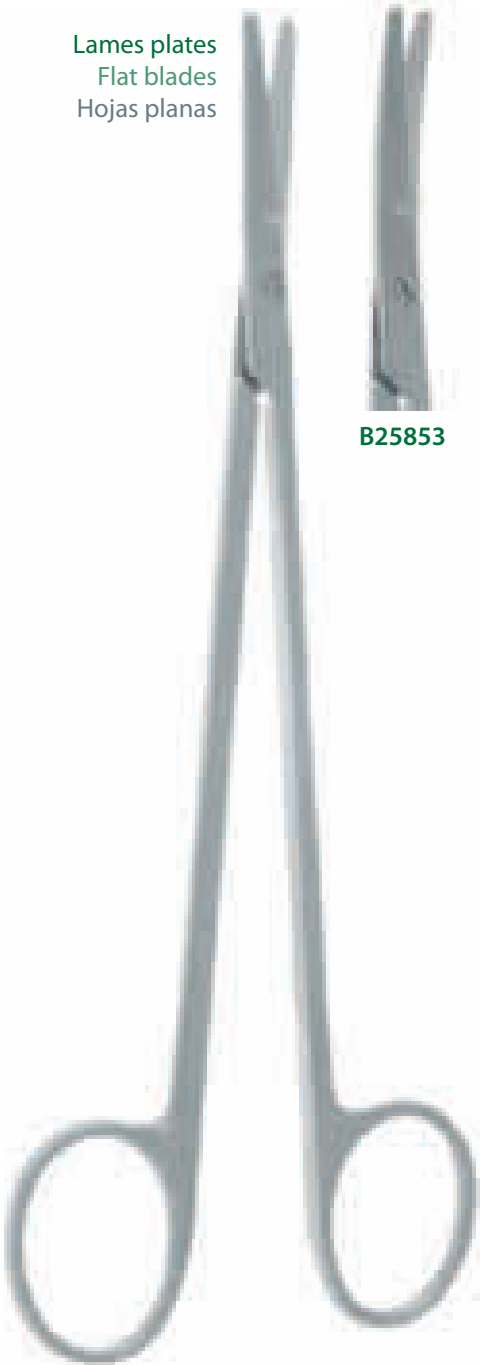

**B25852**  
18 cm - 7"

**B25853**

## TOENNIS-ADSON

## TOENNIS-ADSON-FINO (DEBAKEY)

Lames rondes  
Round blades  
Hojas redondas



**B258531**  
17,5 cm - 7"

**B258532**  
17,5 cm - 7"

III - Ciseaux  
III - Scissors  
III - Tijeras



## Ciseaux longs et fins - Long and fine scissors - Tijeras largas y finas

### KELLY

Droit	Courbe
Straight	Curved
Recta	Curva

16 cm - 6 1/4"	<b>B258468</b>	<b>B258478</b>
----------------	----------------	----------------

18 cm - 7" 	<b>B25847</b>	<b>B25848</b>
--	---------------	---------------

Dentelées - Serrated - Serradas

16 cm - 6 1/4"	<b>B258469</b>	<b>B258479</b>
----------------	----------------	----------------

### STRULLY

Courbe
Curved
Curva

Pour fistule  
For fistula  
Para fistula



**B25848**

**B25847**  
18 cm - 7"



**B258538**  
22,5 cm - 9"

**B258537**  
22,5 cm - 9"

## Ciseaux longs et fins - Long and fine scissors - Tijeras largas y finas

### SANVENERO

Droit  
Straight  
Recta

Courbe  
Curved  
Curva

14,5 cm - 5<sup>3</sup>/<sub>4</sub>"

**B259730**

**B259731**



### BROPHY (SULLIVAN)

Droit  
Straight  
Recta

Courbe  
Curved  
Curva

13 cm - 5"

**B259740**

**B259741**



Droit  
Straight  
Recta

Courbe  
Curved  
Curva

14,5 cm - 5<sup>3</sup>/<sub>4</sub>"

**B259750**

**B259751**



**B259731**



**B259741**



**B259751**

**B259730**  
14,5 cm - 5<sup>3</sup>/<sub>4</sub>"

**B259740**  
13 cm - 5"

**B259750**  
14,5 cm - 5<sup>3</sup>/<sub>4</sub>"



KLINKENBERG

SATINSKY

SIEBOLD

Double courbure - Double curvature - Doble curvatura



**B25920**  
23 cm - 9"

**B25925**  
24 cm - 9 1/2"

**B25930**  
24 cm - 9 1/2"

## CRAFOORD

Courbe  
Curved  
Curva

23 cm - 9" **B259330**

25 cm - 10" **B259340**

30 cm - 11 <sup>3/4</sup>" **B25935** 

POUR LOBECTOMIE  
FOR LOBECTOMY  
PARA LOBECTOMÍA

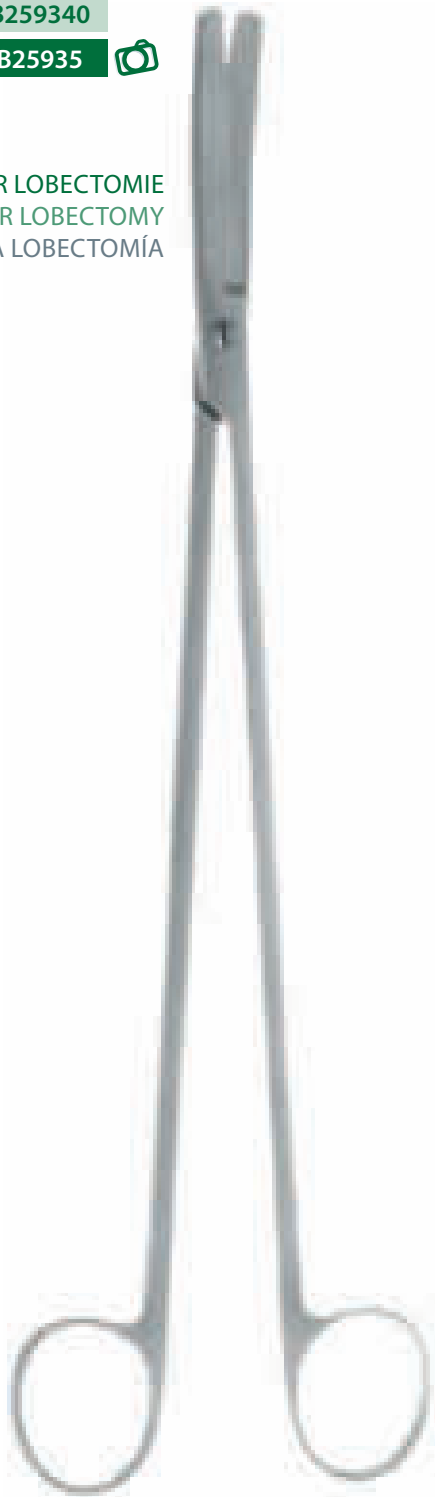

**B25935**  
30 cm - 11 <sup>3/4</sup>"

## DUBOIS

Droit  
Straight  
Recta

Courbe  
Curved  
Curva

27 cm - 10 <sup>1/2</sup>" **B25854**

**B25855**

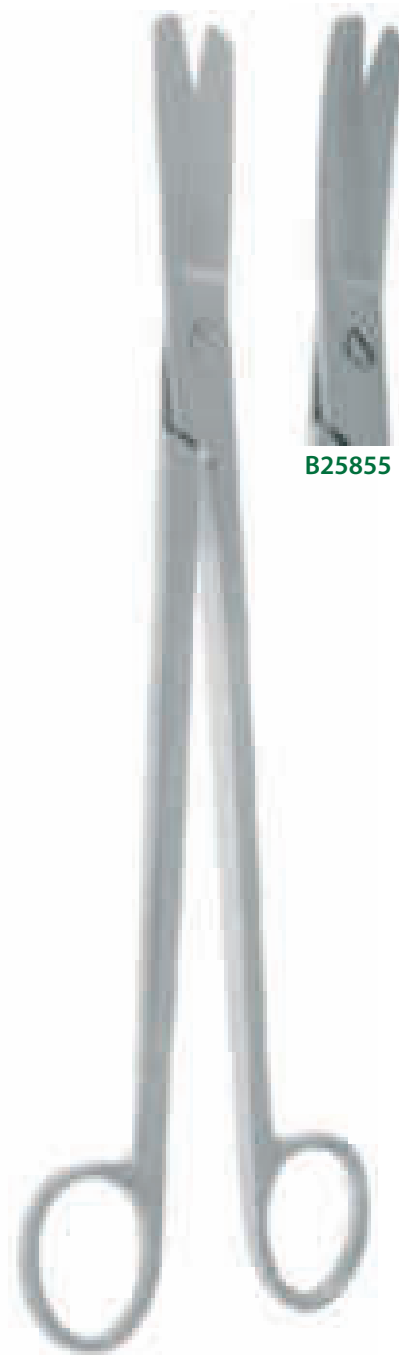

**B25854**  
27 cm - 10 <sup>1/2</sup>"



### SIMS

### WERTHEIM

	Droit Straight Recta	Courbe Curved Curva
20 cm - 8"	<b>F05100</b>	<b>F05110</b>
23 cm - 9" 	<b>F05160</b>	<b>F05120</b>

	Droit Straight Recta	Courbe Curved Curva
20 cm - 8"	<b>F051001</b>	<b>F051101</b>
23 cm - 9"	<b>F051601</b>	<b>F051201</b>

	Courbe Curved Curva
14,5 cm - 5 3/4"	<b>F053014</b>
20,5 cm - 8" 	<b>F053019</b>
23 cm - 9"	<b>F053022</b>

Mousse / Mousse  
Blunt / Blunt  
Roma / Roma



**F05160**  
23 cm - 9"

Pointu / Mousse  
Sharp / Blunt  
Aguda / Roma

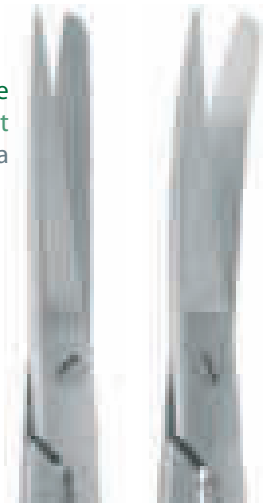

**F051001**   **F051101**

Droit  
Straight  
Recta

Courbe  
Curved  
Curva

20 cm - 8"	<b>F051002</b>	<b>F051102</b>
23 cm - 9"	<b>F051602</b>	<b>F051202</b>

Pointu / Pointu  
Sharp / Sharp  
Aguda / Aguda



**F051002**   **F051102**



**F053019**  
20,5 cm - 8"



Acier chromé  
Chrome steel  
Acero cromado

PRÉPARATION COLLEUR  
GLUER PREPARATION  
PREPARACIÓN ENCOLADOR

COIFFEUR  
HAIRDRESSER  
PELUQUERO



**B25860**  
15 cm - 6"



**B25865**  
25 cm - 10"



 Acier chromé  
Chrome steel  
Acero cromado

COUTURIÈRE  
DRESSMAKER  
MODISTA

COUTURIÈRE BANCAL  
WOBBLY DRESSMAKER  
MODISTA COJO

LINGÈRE  
LINGERE  
LENCERA



**B25870**  
13 cm - 5"

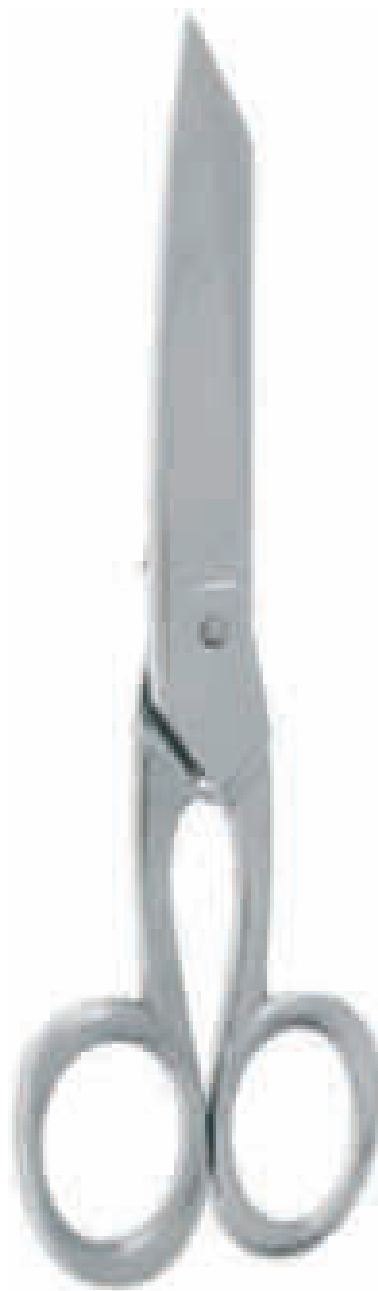

**B25875**  
17 cm - 6 <sup>3</sup>/<sub>4</sub>"

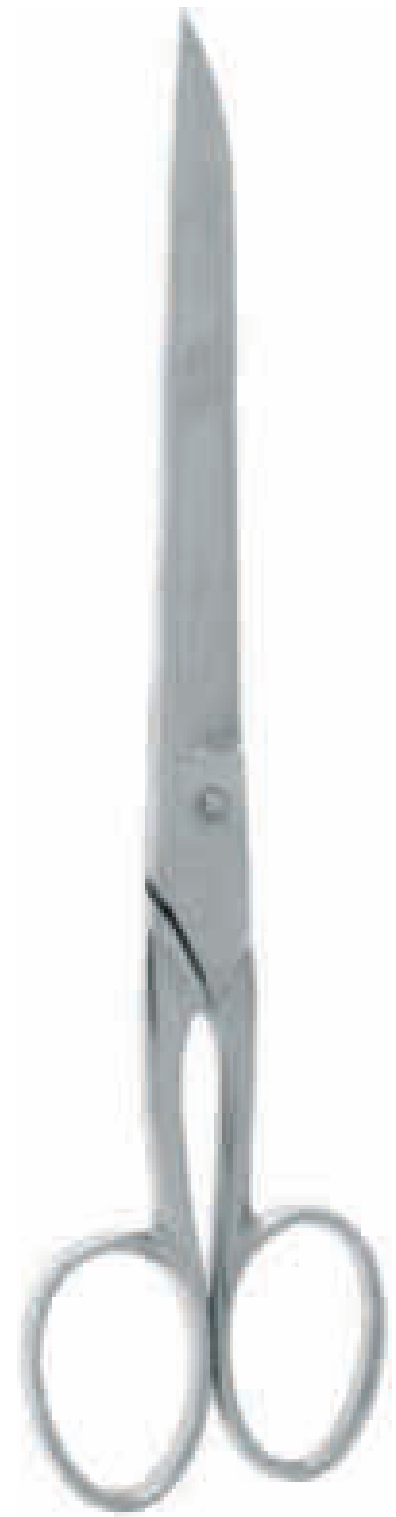

**B25880**  
20 cm - 8"

### ROUENNAIS

Droit  
Straight  
Recta

12 cm - 4 <sup>3</sup>/<sub>4</sub>"

**B25890**

17 cm - 6 <sup>3</sup>/<sub>4</sub>"

**B25900**



Acier chromé  
Chrome steel  
Acero cromado

CISEAUX POUR COTON  
COTTON SCISSORS  
TIJERAS PARA ALGODÓN



**B25885**

28 cm - 11"



**B25900**

17 cm - 6 <sup>3</sup>/<sub>4</sub>"



III - Ciseaux  
III - Scissors  
III - Tijeras

### JESCO

	Noir Black Negra	Vert Green Verde	Bleu Blue Azúl	Rouge Red Roja	Jaune Yellow Amarillo
14,5 cm - 5 3/4"	B259040	<b>B259041</b>	B259042	B259043	B259044
18 cm - 7"	B25905	<b>B259051</b>	B259052	B259053	B259054



**B259041**  
14,5 cm - 5 3/4"

**B259051**  
18 cm - 7"





CATARACTE - CATARACT - CATARATA

### KILNER (RAGNELL)

Courbe  
Curved  
Curva



**B353015**  
12 cm - 4 <sup>3</sup>/<sub>4</sub>"

### KELLY

CISEAUX POUR FISTULES  
FISTULA SCISSORS  
TIJERAS PARA FISTULAS

Droit  
Straight  
Recta



**B353000**  
16 cm - 6 <sup>1</sup>/<sub>4</sub>"

Courbe  
Curved  
Curva



**B353005**

Fin - Pointu  
Fine - Sharp  
Fina - Aguda



**B35001**  
11,5 cm - 4 <sup>1</sup>/<sub>2</sub>"

Droit  
Straight  
Recta

Courbe  
Curved  
Curva

Standard  
Standard  
Estándar

Standard  
Standard  
Estándar



**B35001**

**B35002**



**B35001M**



**B35002M**



**B35002SB**



**B35002**

III - Ciseaux  
III - Scissors  
III - Tijeras



\* Microcut : 1 lame TC standard + 1 lame TC microdentée - 1 TC standard blade + 1 TC serrated blade - 1 hoja TC estandar + 1 hoja TC micro-serrada

\* SupercutBlack : 1 lame TC microdentée + 1 lame TC rasoir + Nitrure de titane noir - 1 TC serrated blade + 1 TC rasor blade + Black coating - 1 hoja TC micro-serrada + 1 hoja TC navaja + recubrimiento negro

## Ciseaux tungstène - Tungsten scissors - Tijeras de tungsteno



TC Inert

Droit  
Straight  
Recta

Courbe  
Curved  
Curva

Mousse / Mousse  
Blunt / Blunt  
Roma / Roma

Pointu / Mousse  
Sharp / Blunt  
Aguda / Roma

Pointu / Pointu  
Sharp / Sharp  
Aguda / Aguda

Mousse / Mousse  
Blunt / Blunt  
Roma / Roma

Pointu / Mousse  
Sharp / Blunt  
Aguda / Roma

Pointu / Pointu  
Sharp / Sharp  
Aguda / Aguda



**B35003**

**B350031**

**B35005**



**B35004**

**B350041**

**B35006**



**B35003**

14,5 cm - 5 <sup>3</sup>/<sub>4</sub>"

**B350031**

**B35005**



**B35004**

14,5 cm - 5 <sup>3</sup>/<sub>4</sub>"

**B350041**

**B35006**

# LANDANGER

## Ciseaux tungstène - Tungsten scissors - Tijeras de tungsteno



### MAYO

Droit  
Straight  
Recta

Courbe  
Curved  
Curva

Standard  
Standard  
Estándar



Standard  
Standard  
Estándar



14 cm - 5 1/2"		<b>B35042</b>	
17 cm - 6 3/4"		<b>B35044</b>	<b>B35044M</b>
23 cm - 9"		<b>B35046</b>	

14 cm - 5 1/2"		<b>B35043</b>	
17 cm - 6 3/4"		<b>B35045</b>	<b>B35045M</b> <b>B35045SB</b>
23 cm - 9"		<b>B35047</b>	



**B35042**  
14 cm - 5 1/2"

Lames plates  
Flat blades  
Hojas planas



**B35043**  
14 cm - 5 1/2"



III - Ciseaux  
III - Scissors  
III - Tijeras

\* **Microcut** : 1 lame TC standard + 1 lame TC microdentée - 1 TC standard blade + 1 TC serrated blade - 1 hoja TC estandar + 1 hoja TC micro-serrada

\* **SupercutBlack** : 1 lame TC microdentée + 1 lame TC rasoir + Nitrure de titane noir - 1 TC serrated blade + 1 TC rasor blade + Black coating - 1 hoja TC micro-serrada + 1 hoja TC navaja + recubrimiento negro





### MAYO-LEXER

### LEXER-FINO

### MAYO-STILLE

Droit - Straight - Recta

Standard  
Standard  
Estándar



15 cm - 6"

**B35010**

17 cm - 6<sup>3/4</sup>"

**B35030**

**B35030M**

III - Ciseaux  
III - Scissors  
III - Tijeras



Lames rondes  
Round blades  
Hojas redondas

**B35007**

16 cm - 6<sup>1/4</sup>"

**B35090**

16 cm - 6<sup>1/4</sup>"

**B35010**

15 cm - 6"

### III - 60

\* **Microcut** : 1 lame TC standard + 1 lame TC microdentée - 1 TC standard blade + 1 TC serrated blade - 1 hoja TC estándar + 1 hoja TC micro-serrada

\* **SupercutBlack** : 1 lame TC microdentée + 1 lame TC rasoir + Nitrure de titane noir - 1 TC serrated blade + 1 TC razor blade + Black coating - 1 hoja TC micro-serrada + 1 hoja TC navaja + recubrimiento negro

## Ciseaux tungstène - Tungsten scissors - Tijeras de tungsteno



### MAYO-LEXER

### LEXER-FINO

### MAYO-STILLE

Courbe - Curved - Curva

Standard  
Standard  
Estándar



Standard  
Standard  
Estándar



Standard  
Standard  
Estándar



**B35008**

**B35008M**

**B35008SB**



**B350095**

**B350095SB**

15 cm - 6"

**B35020**

17 cm - 6<sup>3/4</sup>"

**B35040**

**B35040M**



Lames rondes  
Round blades  
Hojas redondas

**B35008**

16 cm - 6<sup>1/4</sup>"

**B350095**

16 cm - 6<sup>1/4</sup>"

**B35020**

15 cm - 6"



\* **Microcut** : 1 lame TC standard + 1 lame TC microdentée - 1 TC standard blade + 1 TC serrated blade - 1 hoja TC estandar + 1 hoja TC micro-serrada

\* **SuperCutBlack** : 1 lame TC microdentée + 1 lame TC rasoir + Nitruure de titane noir - 1 TC serrated blade + 1 TC rasor blade + Black coating - 1 hoja TC micro-serrada + 1 hoja TC navaja + recubrimiento negro



### METZENBAUM

Droit - Straight - Recta

Courbe - Curved - Curva

Standard  
Standard  
Estándar



Standard  
Standard  
Estándar



Baby	<b>B35104</b>	<b>B35104M</b>	11,5 cm - 4 1/2"	<b>B35106</b>	<b>B35106M</b>	<b>B35106SB</b>	
	<b>B35110</b>		15 cm - 6"		<b>B35120</b>	<b>B35120M</b>	<b>B35120SB</b>
	<b>B35130</b>		18 cm - 7"	<b>B35140</b>	<b>B35140M</b>	<b>B35140SB</b>	
	<b>B35150</b>		20 cm - 8"	<b>B35160</b>	<b>B35160M</b>	<b>B35160SB</b>	
	<b>B35172</b>		23 cm - 9"	<b>B35174</b>	<b>B35174M</b>	<b>B35174SB</b>	
	<b>B351750</b>		25 cm - 10"	<b>B351751</b>			
	<b>B351780</b>		28 cm - 11"	<b>B351781</b>			
	<b>B35250</b>		30 cm - 11 3/4"	<b>B35240</b>			



**B35110**  
15 cm - 6"



**B35120**  
15 cm - 6"

### III - 62

\* **Microcut** : 1 lame TC standard + 1 lame TC microdentée - 1 TC standard blade + 1 TC serrated blade - 1 hoja TC estándar + 1 hoja TC micro-serrada

\* **SupercutBlack** : 1 lame TC microdentée + 1 lame TC rasoir + Nitrure de titane noir - 1 TC serrated blade + 1 TC rasor blade + Black coating - 1 hoja TC micro-serrada + 1 hoja TC navaja + recubrimiento negro



### METZENBAUM-FINO

Droit - Straight - Recta

Mousse / Mousse  
Blunt / Blunt  
Roma / Roma

Pointu / Pointu  
Sharp / Sharp  
Aguda / Aguda

 <b>B35048</b>	15 cm - 6"	<b>B350482</b> 
<b>B35050</b>	18 cm - 7"	<b>B350502</b>
<b>B35070</b>	20 cm - 8"	<b>B350702</b>
<b>B35090</b>	23 cm - 9"	<b>B350902</b>
<b>B351010</b>	25 cm - 10"	-
<b>B351020</b>	28 cm - 11"	-



**B35048**  
15 cm - 6"



**B350482**  
15 cm - 6"



### METZENBAUM-FINO

Courbe - Curved - Curva

Mousse / Mousse  
Blunt / Blunt  
Roma / Roma



Pointu / Pointu  
Sharp / Sharp  
Aguda / Aguda

	<b>B35049</b>		<b>B35049SB</b>	15 cm - 6"	<b>B350492</b>
	<b>B35060</b>	<b>B35060M</b>	<b>B35060SB</b>	18 cm - 7"	<b>B350602</b>
	<b>B35080</b>		<b>B35080SB</b>	20 cm - 8"	<b>B350802</b>
	<b>B35100</b>		<b>B35100SB</b>	23 cm - 9"	<b>B351002</b>
	<b>B351011</b>		<b>B351011SB</b>	25 cm - 10"	-
	<b>B351021</b>		<b>B351021SB</b>	28 cm - 11"	-



**B35049**  
15 cm - 6"

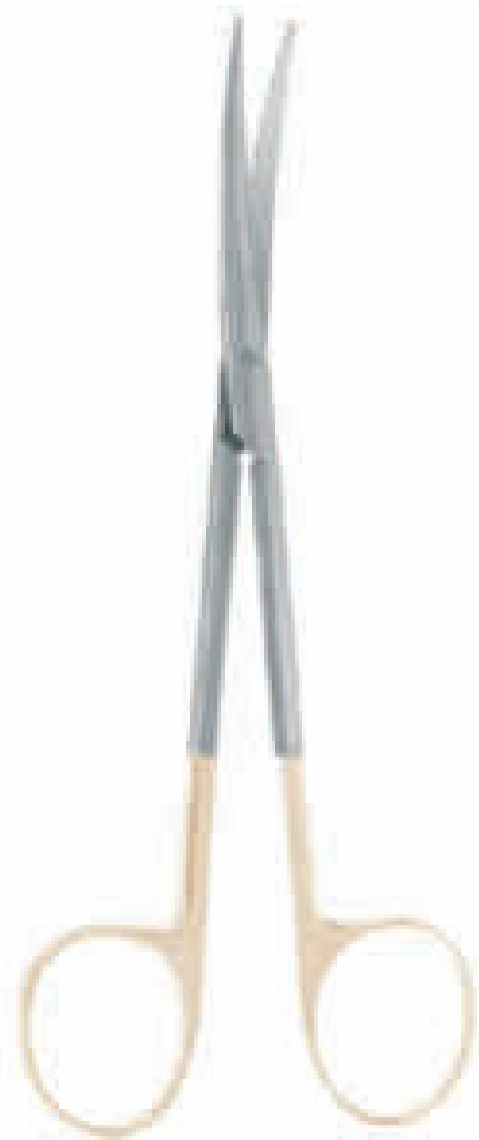

**B350492**  
15 cm - 6"

### III - 64

\* **Microcut** : 1 lame TC standard + 1 lame TC microdentée - 1 TC standard blade + 1 TC serrated blade - 1 hoja TC estándar + 1 hoja TC micro-serrada

\* **SupercutBlack** : 1 lame TC microdentée + 1 lame TC rasoir + Nitrure de titane noir - 1 TC serrated blade + 1 TC rasor blade + Black coating - 1 hoja TC micro-serrada + 1 hoja TC navaja + recubrimiento negro

## Ciseaux tungstène - Tungsten scissors - Tijeras de tungsteno



### METZENBAUM-FINO

Double courbure  
Double curvature  
Doble curvatura

- 15 cm - 6" **B35228**
- 18 cm - 7" **B35230**
- 20 cm - 8" **B35232**
- 23 cm - 9" **B35234**

### TOENNIS-ADSON

Standard  
Standard  
Estándar



- 18 cm - 7" **B35260** **B35260SB**

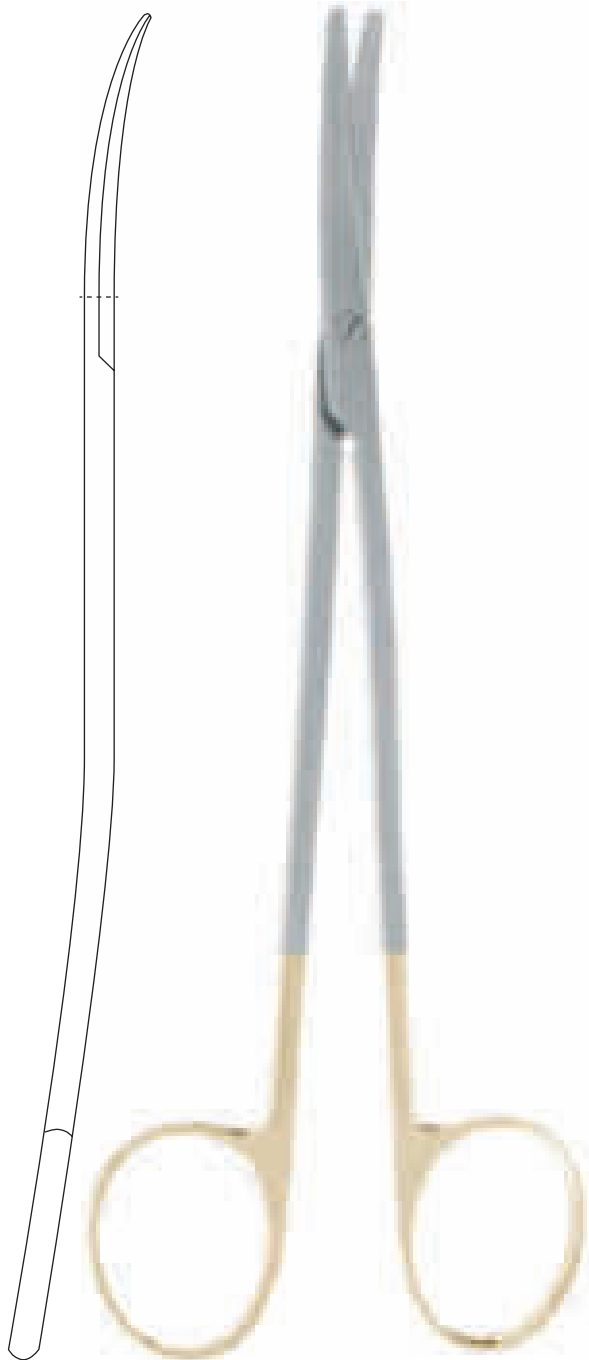

**B35230**  
18 cm - 7"

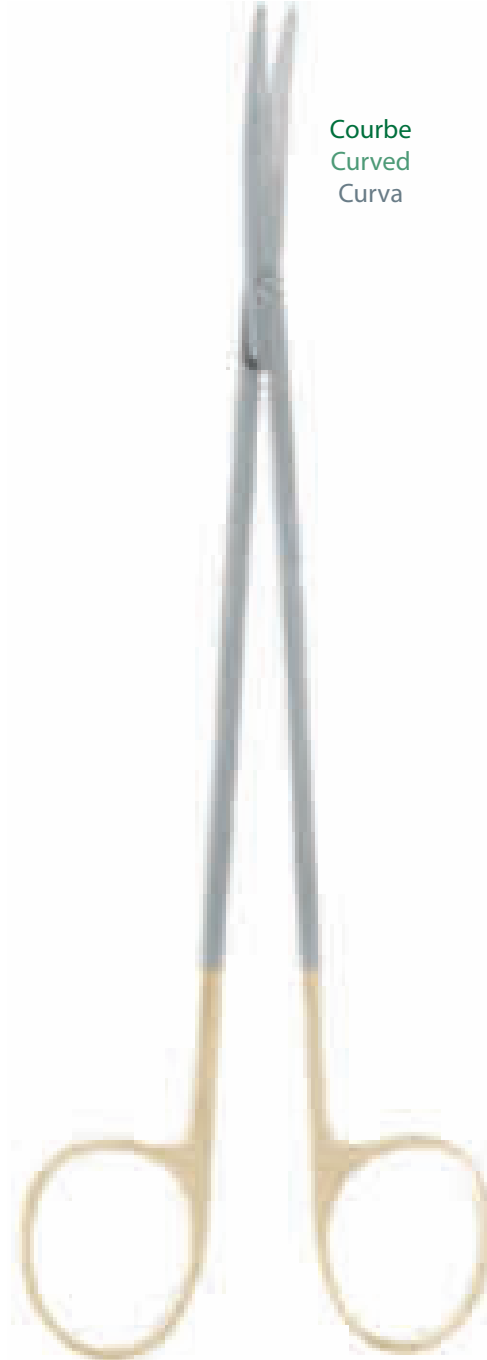

Courbe  
Curved  
Curva

**B35260**  
18 cm - 7"



III - Ciseaux  
III - Scissors  
III - Tijeras

\* **Microcut** : 1 lame TC standard + 1 lame TC microdentée - 1 TC standard blade + 1 TC serrated blade - 1 hoja TC estándar + 1 hoja TC micro-serrada

\* **SupercutBlack** : 1 lame TC microdentée + 1 lame TC rasoir + Nitrure de titane noir - 1 TC serrated blade + 1 TC rasor blade + Black coating - 1 hoja TC micro-serrada + 1 hoja TC navaja + recubrimiento negro



**GOLDMANN-FOX**

**UNIVERSEL**

**LISTER**

Droit  
Straight  
Recta

Courbe  
Curved  
Curva

**CROIX ROUGE**  
RED CROSS  
CRUZ ROJA

13 cm - 5"



**B352580**

**B352581**

Lames dentelées  
Serrated blades  
Hojas serradas

Lames dentelées  
Serrated blades  
Hojas serradas



**B352580**  
13 cm - 5"

**B352581**



**B35270**  
12 cm - 4<sup>3/4</sup>"



**B35280**  
18 cm - 7"

## Ciseaux tungstène - Tungsten scissors - Tijeras de tungsteno



### DUBOST

Droit  
Straight  
Recta

Courbe  
Curved  
Curva

23 cm - 9"	<b>B35180</b>	<b>B35190</b>
26 cm - 10"	<b>B35200</b>	<b>B35210</b>

### KLINKENBERG

Double courbure  
Double curvature  
Doble curvatura



**B35180**  
23 cm - 9"

**B35190**

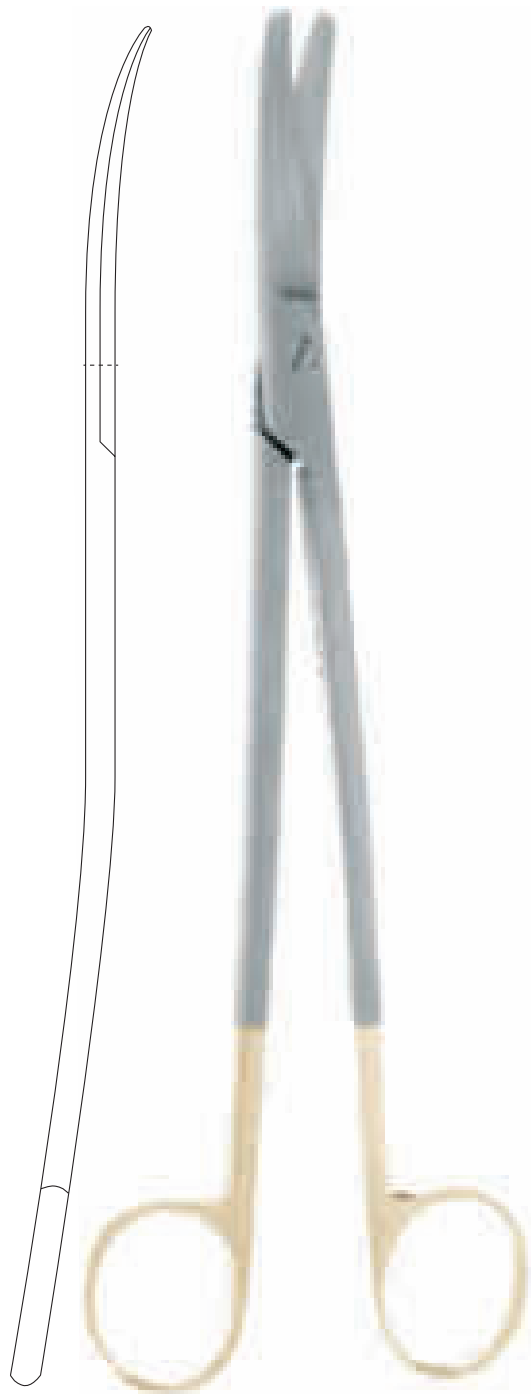

**B35220**  
23 cm - 9"

III - Ciseaux  
III - Scissors  
III - Tijeras



## Ciseaux tungstène - Tungsten scissors - Tijeras de tungsteno



### SIMS

Droit Straight Recta	Courbe Curved Curva
----------------------------	---------------------------

CISEAUX À PARAMÈTRES  
PARAMETRIUM SCISSORS  
TIJERAS DE PARAMETRIO

20 cm - 8"	-	F051650
23 cm - 9"	<b>F05170</b>	F05175



Courbe Curved Curva	Très courbe Very curved Muy curva
---------------------------	---



**F05170**  
23 cm - 9"

**F05175**



**F052000**  
23 cm - 9"

**F052010**



## POTTS-SMITH

## DEBAKEY

19 cm - 7 1/2" **B354025** **B354045** **B354060**

16 cm - 6 1/4" **B354125** **B354145** **B354160**

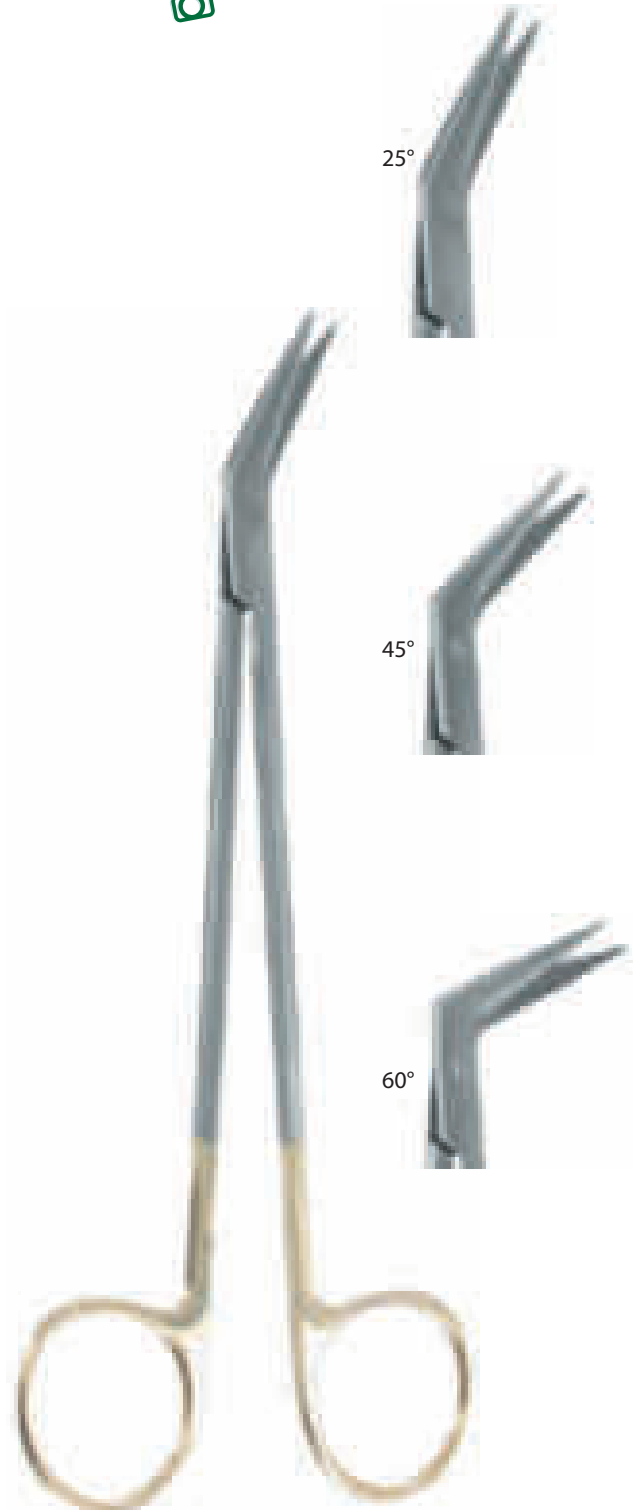
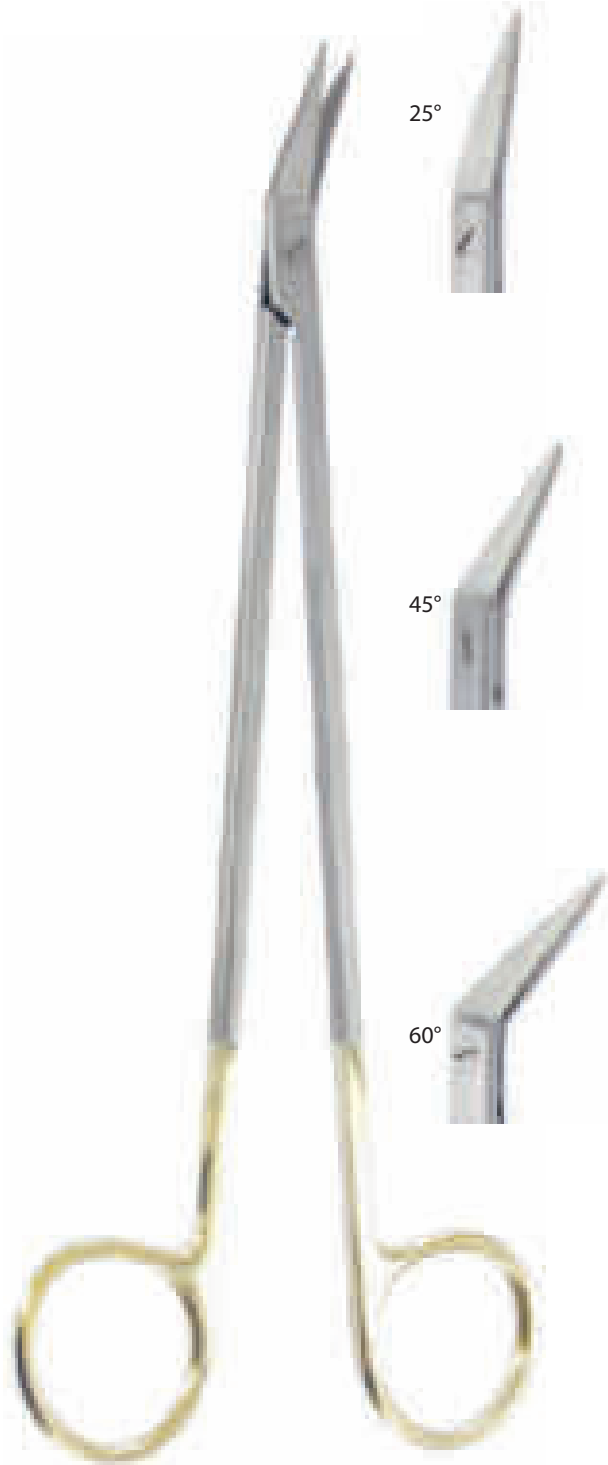

**B354025**  
19 cm - 7 1/2"

**B354125**  
16 cm - 6 1/4"



## Ciseaux Prestige - Prestige scissors - Tijeras Prestige



*Prestige*

### MAYO

### MAYO-STILLE

### MAYO-LEXER

	Droit Straight Recta	Courbe Curved Curva		Droit Straight Recta	Courbe Curved Curva
	<b>B86215</b>	<b>B86230</b>	15 cm - 6"		<b>B86245</b> <b>B86255</b>
	<b>B86220</b>	<b>B86235</b>	17 cm - 6 3/4"	<b>B86250</b>	<b>B86260</b>
	<b>B86225</b>	<b>B86240</b>	23 cm - 9"		

Lames plates  
Flat blades  
Hojas planas

Lames rondes  
Round blades  
Hojas redondas

Droit  
Straight  
Recta

Courbe  
Curved  
Curva



**B86215**  
15 cm - 6"

**B86245**  
15 cm - 6"

**B86205**  
16 cm - 6 1/4"



# LANDANGER

## Ciseaux Prestige - Prestige scissors - Tijeras Prestige



*Prestige*

### BABY METZENBAUM

### METZENBAUM

### METZENBAUM-FINO

	Droit Straight Recta	Courbe Curved Curva		Droit Straight Recta	Courbe Curved Curva		Droit Straight Recta	Courbe Curved Curva
11,5 cm - 4 1/2"	<b>B86265</b>	<b>B86270</b>		<b>B86275</b>	<b>B86285</b>	14,5 cm - 5 3/4"	<b>B86305</b>	<b>B86310</b>
				<b>B86280</b>	<b>B86290</b>	18 cm - 7"	-	<b>B86315</b>
				-	<b>B86295</b>	20 cm - 8"	-	-
				-	<b>B86300</b>	23 cm - 9"	-	<b>B86320</b>



**B86270**

**B86265**

11,5 cm - 4 1/2"



**B86285**

**B86275**

14,5 cm - 5 3/4"



**B86310**

**B86305**

14,5 cm - 5 3/4"

III - Ciseaux  
III - Scissors  
III - Tijeras

## Ciseaux Prestige - Prestige scissors - Tijeras Prestige



*Prestige*

**WAGNER**

	Droit Straight Recta	Courbe Curved Curva		Droit Straight Recta	Courbe Curved Curva		Courbe Curved Curva
11,5 cm - 4 1/2"	<b>B86325</b>	<b>B86330</b>	12 cm - 4 3/4"	<b>B86335</b>	<b>B86340</b>	11 cm - 4 1/4"	<b>B86345</b>
						14 cm - 5 1/2"	<b>B86350</b>

CATARACTE  
CATARACT  
CATARATA

Pointu  
Sharp  
Aguda



**B86330**

**B86325**

11,5 cm - 4 1/2"

Pointu  
Sharp  
Aguda



**B86340**

**B86335**

12 cm - 4 3/4"

Mousse  
Blunt  
Roma



**B86345**

11 cm - 4 1/4"

# LANDANGER

## Ciseaux Prestige - Prestige scissors - Tijeras Prestige



*Prestige*

### STEVENS

### REYNOLDS

### JAMESON

	Droit Straight Recta	Courbe Curved Curva		Droit Straight Recta	Courbe Curved Curva		Courbe Curved Curva
11,5 cm - 4 1/2"	<b>B86355</b>	<b>B86360</b>	13 cm - 5"	-	<b>B86365</b>	15 cm - 6"	<b>B86380</b>
			15 cm - 6"	<b>B86370</b>	<b>B86375</b>	18 cm - 7"	<b>B86385</b>

Lames mousses étroites - Narrow blunt blades - Hojas romas estrechas



**B86360**

**B86355**  
11,5 cm - 4 1/2"



**B86375**

**B86370**  
15 cm - 6"

**B86380**  
15 cm - 6"

III - Ciseaux  
III - Scissors  
III - Tijeras



*Prestige*

POTTS-SMITH

	25°	45°	60°
19 cm - 7 1/2"	<b>B86390</b>	B86395	B86400



Pointu  
Sharp  
Aguda

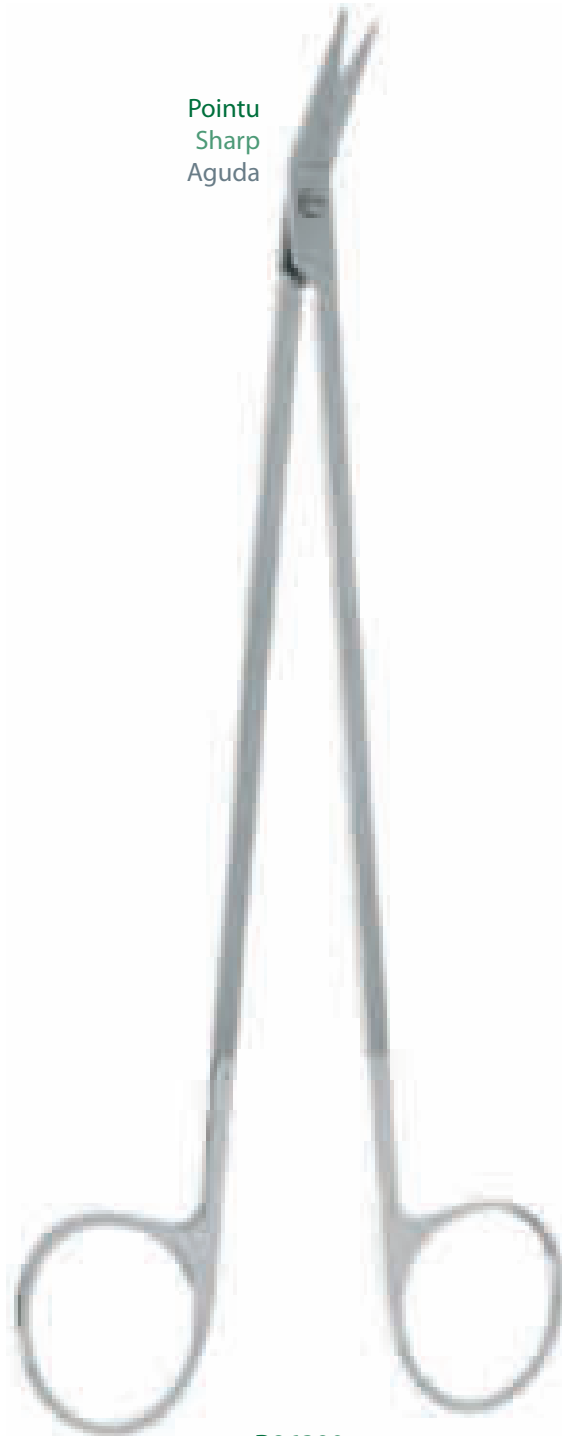

**B86390**  
19 cm - 7 1/2"

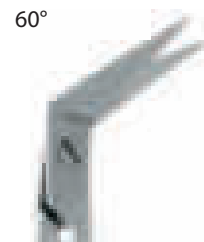
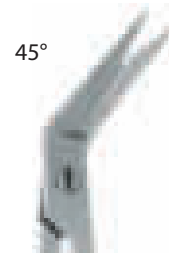

## Ciseaux Prestige - Prestige scissors - Tijeras Prestige



*Prestige*

**MERVEILLEUX**

Lames rasoir - Courbe  
Razor blades - Curved  
Hojas navajas - Curva

Mousse  
Blunt  
Roma

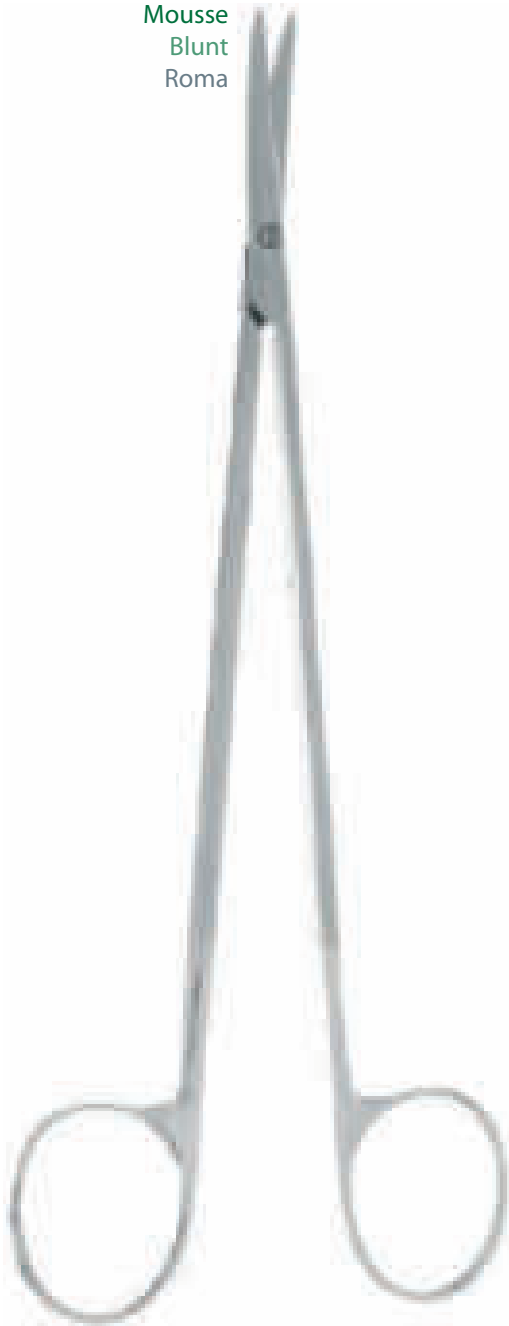

**B864020**  
17,5 cm - 6 <sup>3</sup>/<sub>4</sub>"

Pointu  
Sharp  
Aguda

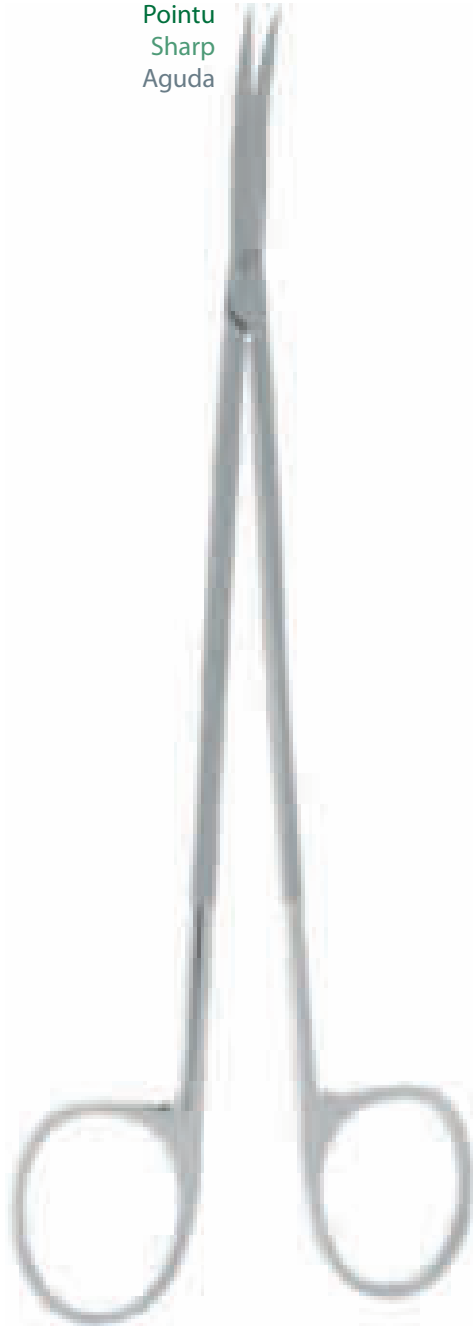

**B864025**  
17,5 cm - 6 <sup>3</sup>/<sub>4</sub>"

III - Ciseaux  
III - Scissors  
III - Tijeras



## Ciseaux Prestige - Prestige scissors - Tijeras Prestige



*Prestige*

**SIMS**

**JOSEPH**

Droit  
Straight  
Recta

Courbe  
Curved  
Curva

20 cm - 8" 	<b>B86410</b>	<b>B86415</b>
23 cm - 9"	-	<b>B86420</b>



**B86415**



**B86410**  
20 cm - 8"



**B86425**  
15 cm - 5 <sup>3</sup>/<sub>4</sub>"



# LANDANGER

Ciseaux Prestige - Prestige scissors - Tijeras Prestige



*Prestige*

**KAYE**

**GORNEY**

Droit  
Straight  
Recta

Courbe  
Curved  
Curva

20,5 cm - 8"



**B864400**

**B864405**

Courbe  
Curved  
Curva

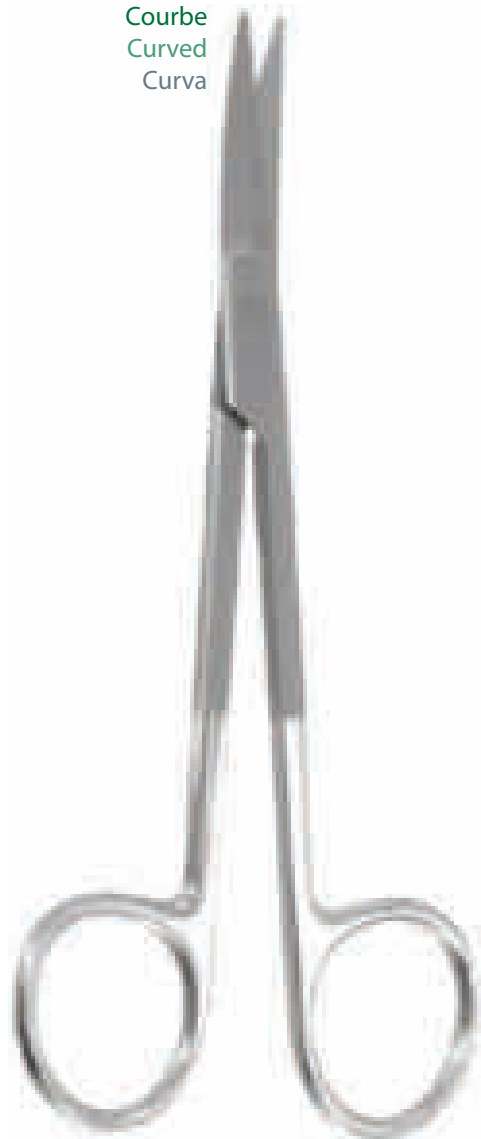

**B864300**  
15 cm - 6 1/2"



**B864405**

**B864400**  
20,5 cm - 8"



III - Ciseaux  
III - Scissors  
III - Tijeras



*Prestige*

FOMON

CISEAUX NASAUX  
NASAL SCISSORS  
TIJERAS NASALES



**B864500**  
13,5 cm - 5"



**B864505**  
13,5 cm - 5"

Ciseaux Prestige - Prestige scissors - Tijeras Prestige



*Prestige*

COTTLE

HEYMANN

CISEAUX NASAUX  
NASAL SCISSORS  
TIJERAS NASALES



**B864510**  
16,5 cm - 6 1/4"



**B864515**  
18 cm - 7"



Ciseaux pour le cordon ombilical - Scissors for umbilical cord - Tijeras para el cordón umbilical

## BUSCH (VEZIEN)

- 13 cm - 5" B257470
- 16 cm - 6 1/4" B257471
- 18 cm - 7" B257500 

## SCHUMACHER



**B257500**  
18 cm - 7"

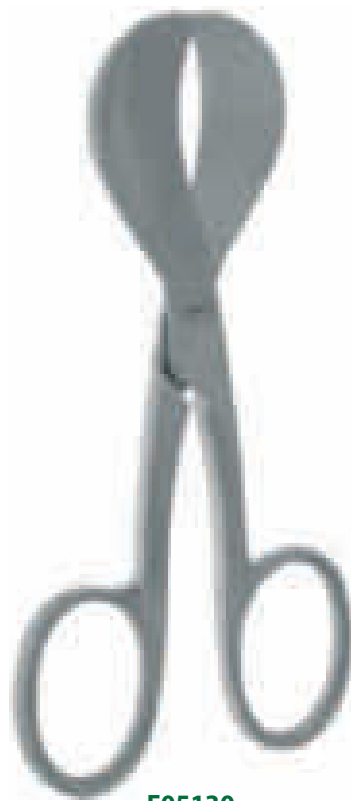

**F05130**  
10,5 cm - 4"



**F051310**  
16 cm - 6 1/4"

## DELESTRE

14 cm - 5 1/2" **B257540** 

18 cm - 7" **B257550**

## BRAUN-STADLER

14 cm - 5 1/2" **B25760** 

22 cm - 8 3/4" **B257602**

A doigt  
Collin's lock  
Desmontable



**B25755**  
14 cm - 5 1/2"



**B257540**  
14 cm - 5 1/2"



**B25760**  
14 cm - 5 1/2"



Ciseaux à épisiotomie - Episiotomy scissors - Tijeras episiotomía

WALDMANN



Inox  
Stainless steel  
Acero inoxidable

19 cm - 7 1/2"

F05180

F051850



*Prestige*

III - Ciseaux  
III - Scissors  
III - Tijeras

Lame dentelée  
Serrated blade  
Hoja serrada



**F05180**  
19 cm - 7 1/2"



**B86405**  
18 cm - 7"

VAGINAUX (TYPE MAYO)  
VAGINAL (STYLE MAYO)  
VAGINAL (TIPO MAYO)



**F051900**  
17 cm - 6 3/4"

### JOSEPH

### FOMON

### HALLE

Droit  
Straight  
Recta

Courbe  
Curved  
Curva

14 cm - 5 1/2" 

**I19010**

**I19020**

CISEAUX NASAUX  
NASAL SCISSORS  
TIJERAS NASALES



**I19010**  
14 cm - 5 1/2"



**I19020**



**I190070**  
13,5 cm - 5 1/4"

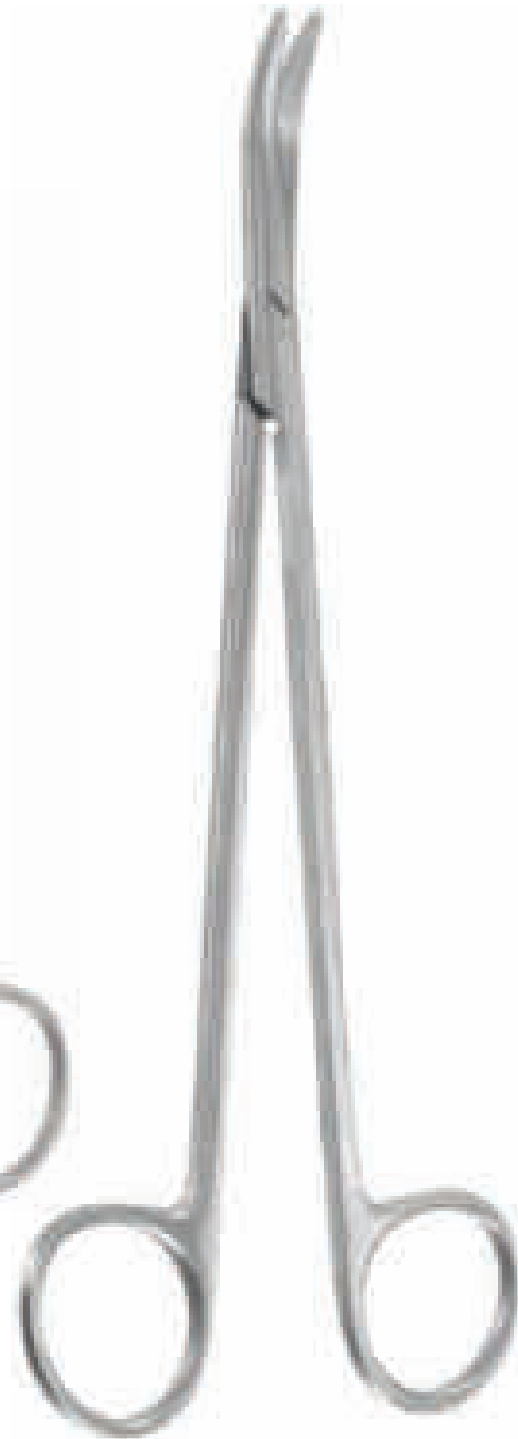

**I190075**  
19 cm - 7 1/2"

III - Ciseaux  
III - Scissors  
III - Tijeras



### FOMON

Standard  
Standard  
Estándar

 **I190080**



**B355000**

Lame ronde  
Round blade  
Lamas redondas



**I190080**  
13 cm - 5"

Lame plate  
Flat blade  
Lamas planas



**I190085**  
13,5 cm - 5 1/4"

### COTTLE

Standard  
Standard  
Estándar

 **I190090**



**B355010**

Lame ronde  
Round blade  
Lamas redondas



**I190090**  
16 cm - 6 1/4"

### HEYMANN

Lame ronde  
Round blade  
Lamas redondas



**I190050**  
18 cm - 7"

CISEAUX NASAUX  
NASAL SCISSORS  
TIJERAS NAsALES

Lame plate  
Flat blade  
Lamas planas

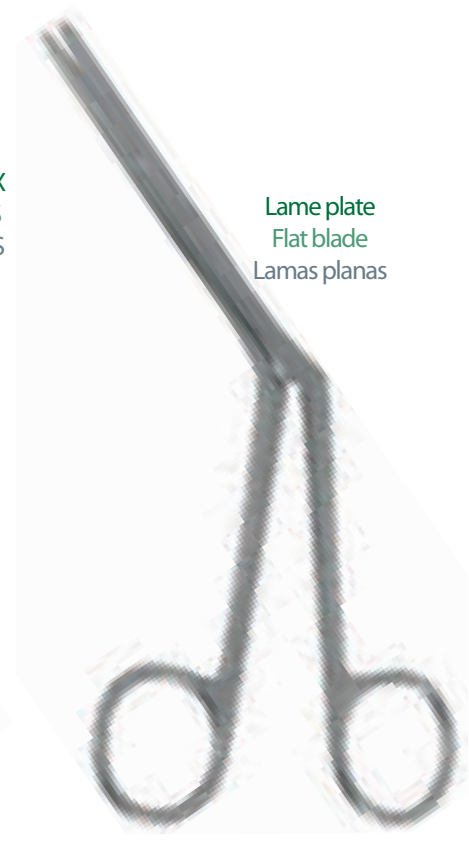

**I190060**  
18 cm - 7"

### BRUNS

CISEAUX BRUNS À PANSEMENTS ET BANDAGES PLÂTRÉS  
BRUNS CLOTHING SCISSORS, PLASTER SCISSORS  
BRUNS TIJERAS PARA CURAS Y VENDAJES ESCAYOLADOS

Lame dentelée  
Serrated blade  
Hoja serrada

Lame lisse  
Smooth blade  
Hoja lisa

23,5 cm - 9 1/4"

**J76140**

**J761410**

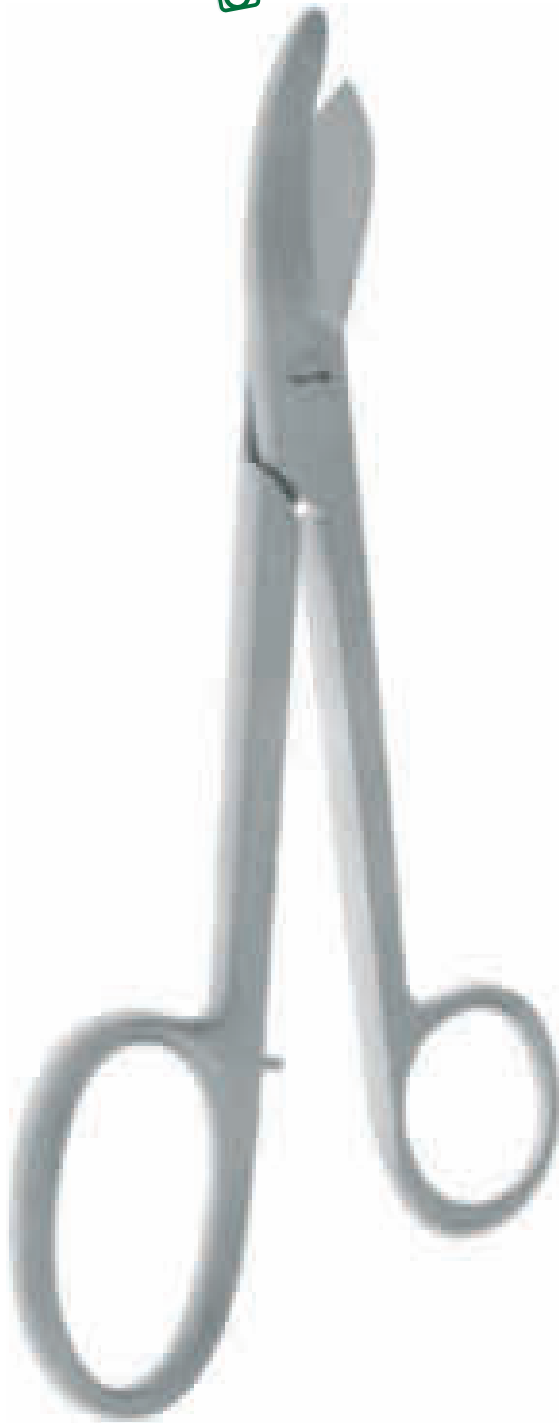

**J76140**

23,5 cm - 9 1/4"

### LANGE



**B257618**

18 cm - 7"

CISEAUX À DÉCAPSULER  
SCISSORS TO UNCAP  
TIJERAS PARA DECAPSULAR

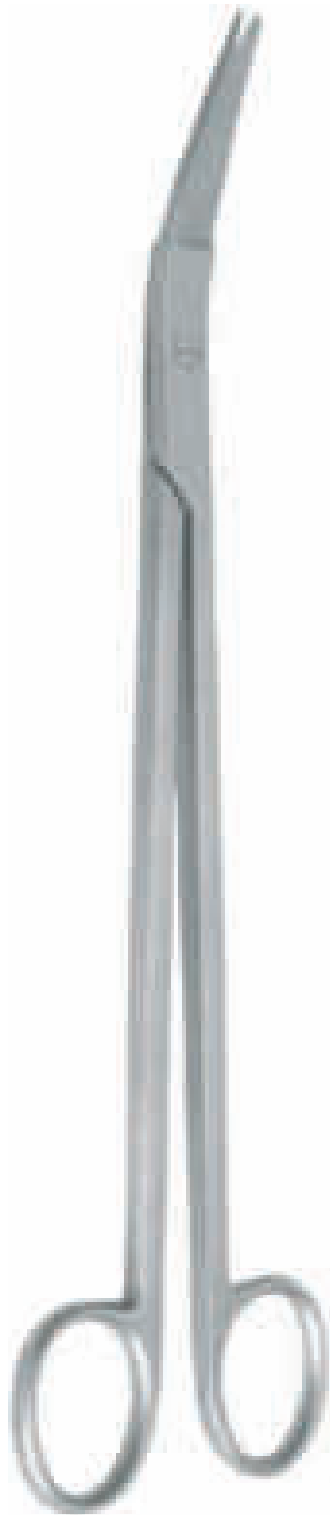

**J72700**  
25 cm - 10"

CISEAUX À MÉNISQUE  
MENISCUS SCISSORS  
TIJERAS PARA MENISCO

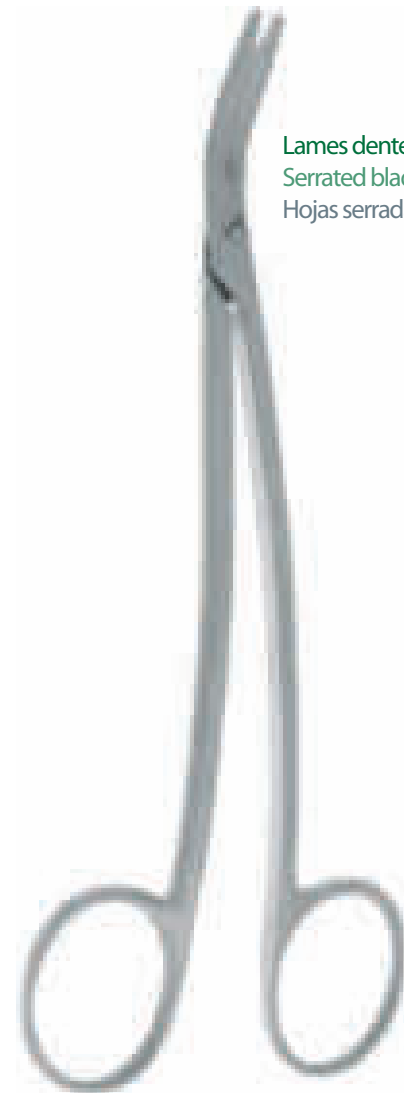

Lames dentelées  
Serrated blades  
Hojas serradas

**J80170**  
18 cm - 7"

SMITH

CISEAUX ENTEROTOME  
ENTEROTOME SCISSORS  
TIJERAS ENTEROTOMO



**J14145**  
21 cm - 8 1/4"

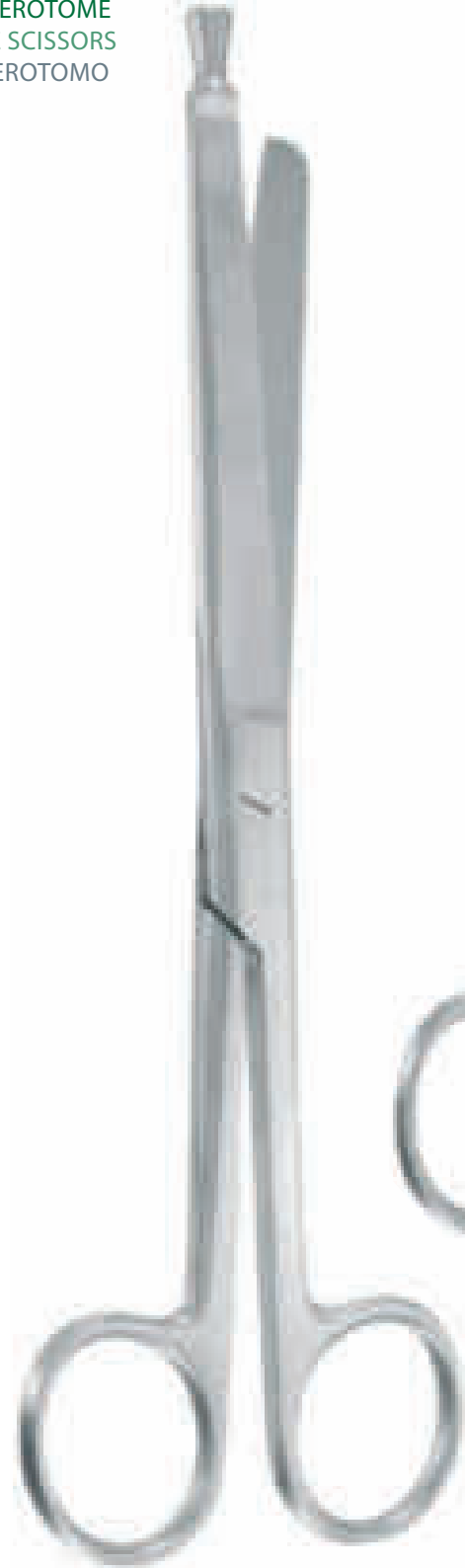

**J14146**  
21 cm - 8 1/4"

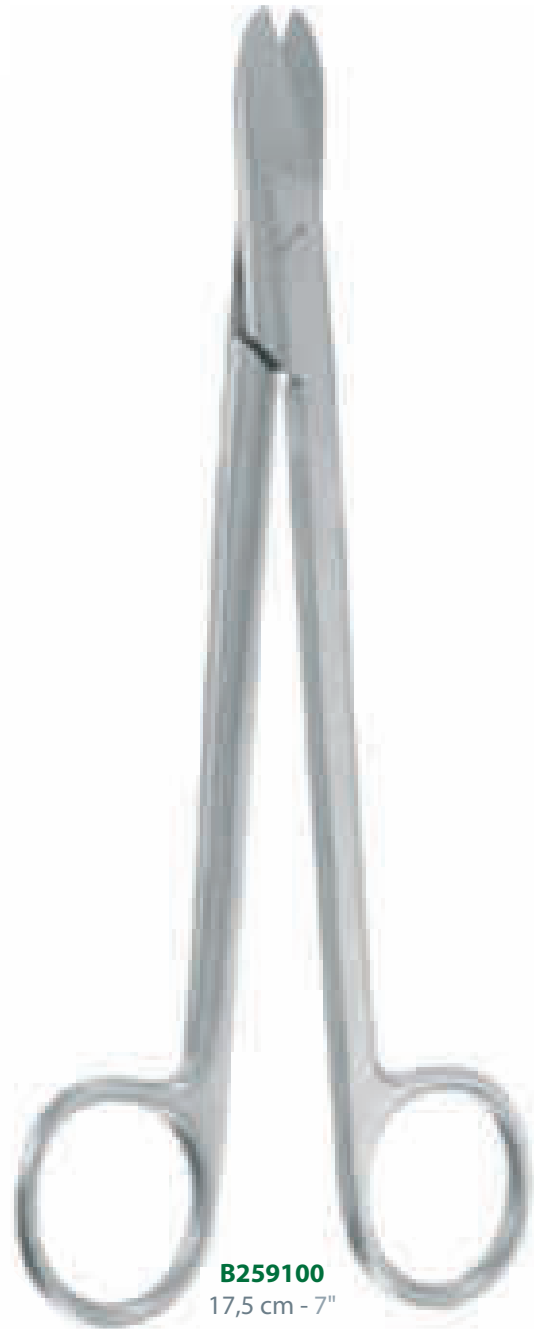

**B259100**  
17,5 cm - 7"

III - Ciseaux  
III - Scissors  
III - Tijeras

## Ciseaux à ongles - Nails scissors - Tijeras para uñas

Droit  
Straight  
Recta



**A85090**

11 cm - 4 1/4"

Courbe  
Curved  
Curva

**A85100**



CISEAUX À FENDRE LES ONGLES  
NAIL SPLITTING SCISSORS  
TIJERAS PARA HENDER LAS UÑAS

13 cm - 5"

**A851113**



15 cm - 6"

**A851115**

Droit  
Straight  
Recta



**A851010**

10,5 cm - 4 1/4"

Courbe  
Curved  
Curva

**A851015**

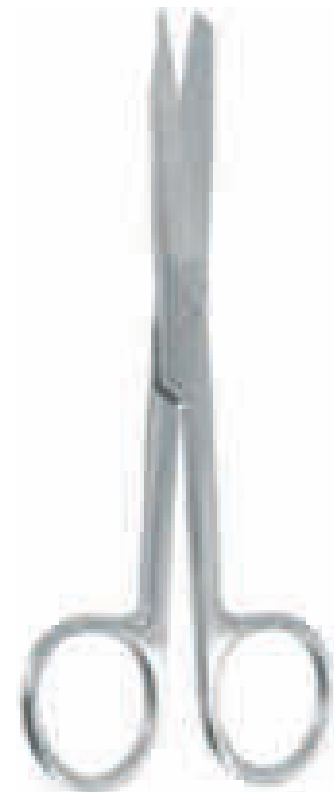

**A851113**  
13 cm - 5"

## Pinces hémostatiques - Haemostatic forceps - Pinzas hemostáticas

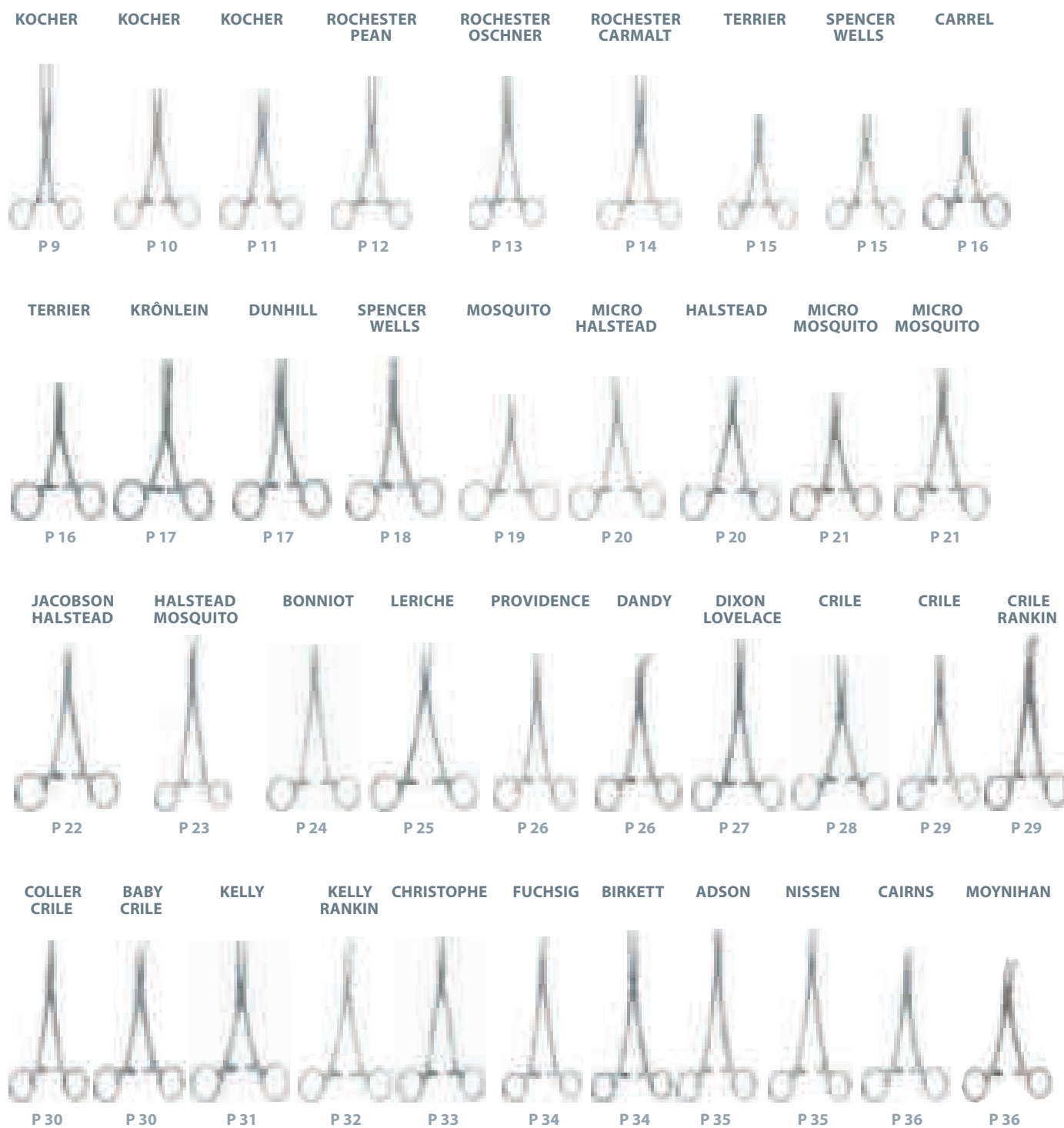

## Pinces hémostatiques longues - Long haemostatic forceps - Pinzas hemostáticas largas

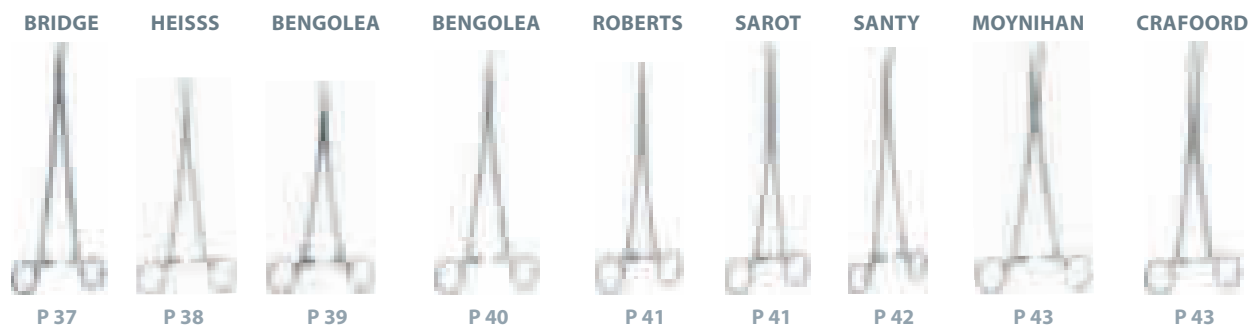

## Pinces hémostatiques spéciales - Special haemostatic forceps - Pinzas hemostáticas especiales

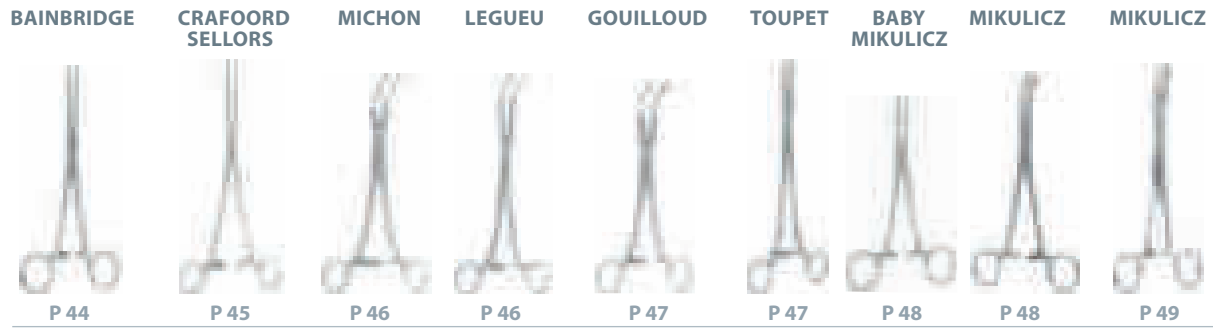

## Pinces passe-fils, dissecteurs - Ligature forceps, dissectors - Disecadores

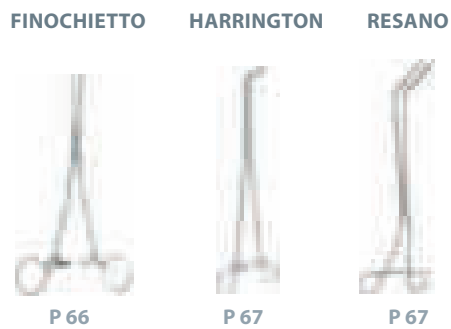
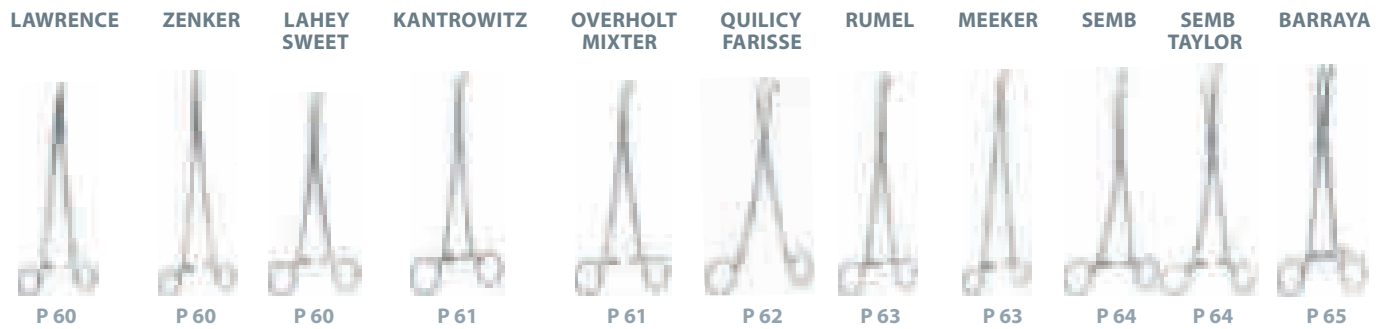
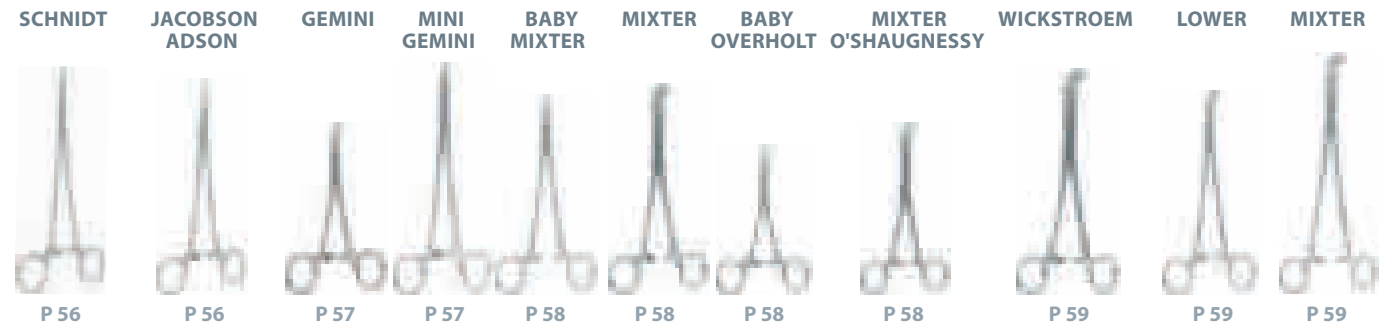

## Pinces clamps intestinales et stomacales - Intestinal and stomach clamp forceps - Pinzas clamps intestinales y estomacales

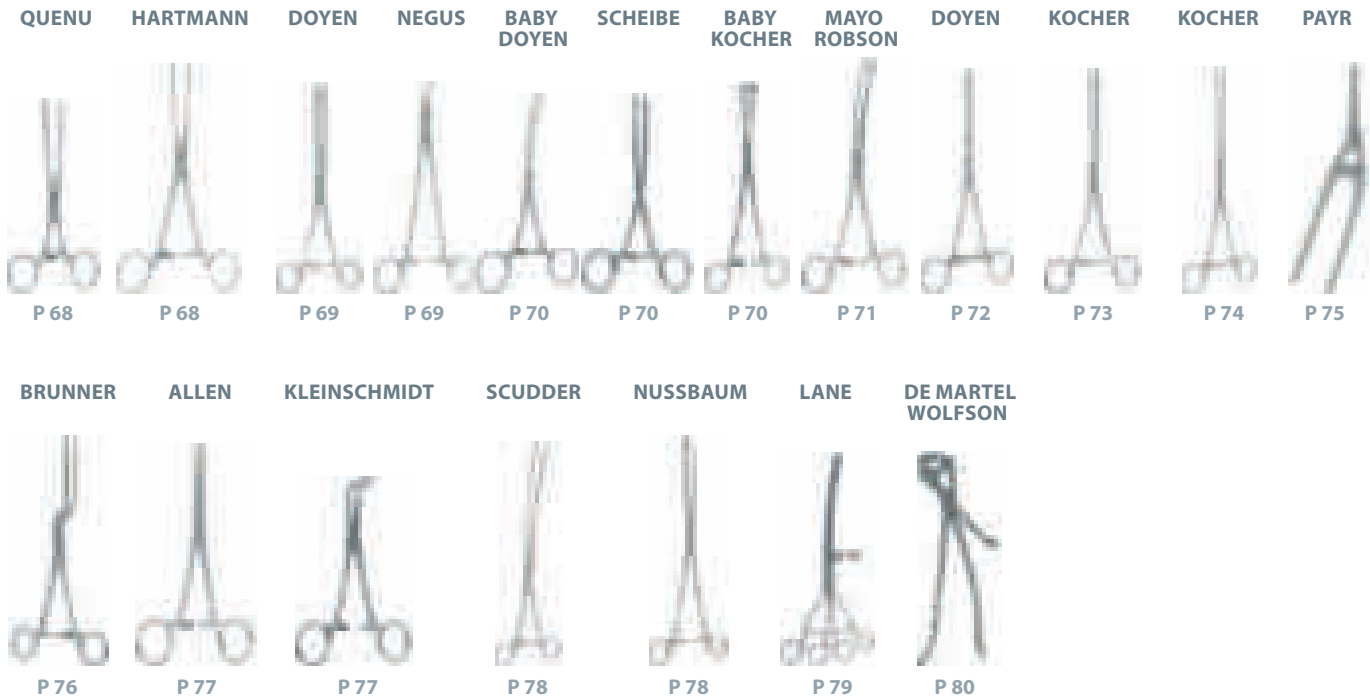

## Pinces à préhension - Grasping forceps - Pinzas a prensión

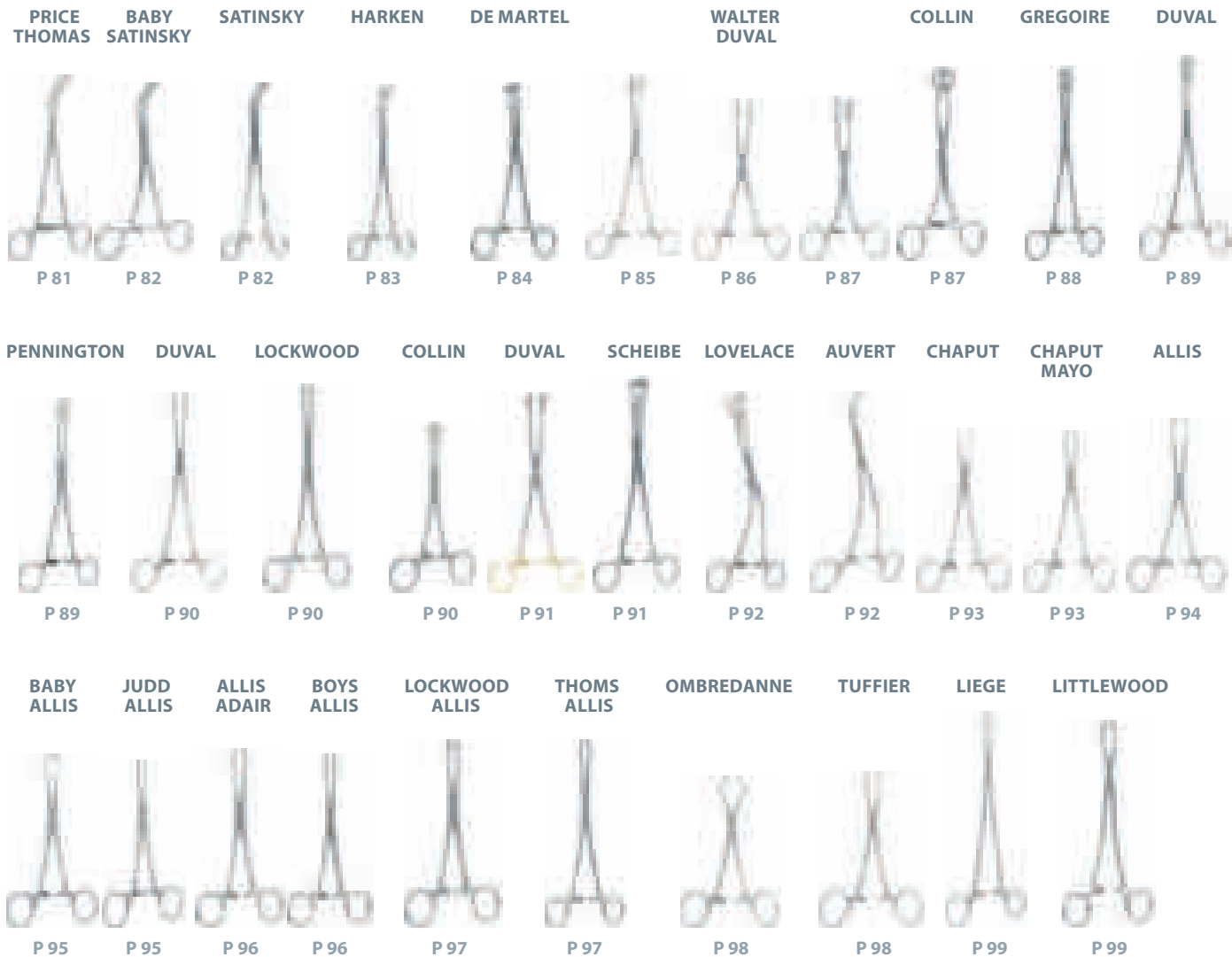



BABCOCK BABCOCK PRATT BENSON

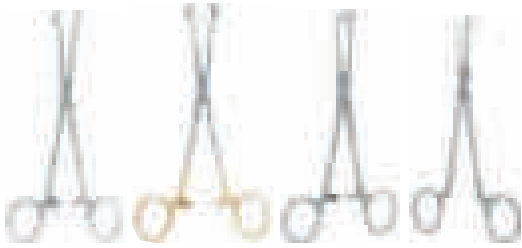

P 100 P 101 P 102 P 102

**Pinces à champs - Towel forceps - Pinzas de compo**

DOYEN **Crabe** SCHADEL JONES **Modèle britannique** BACKHAUS BACKHAUS PEERS TOHOKU LORNA  
 Crabe British model  
 Cangrojo Modelo británico



P 103 P 103 P 103 P 103 P 103 P 104 P 105 P 105 P 106 P 106

ROEDER

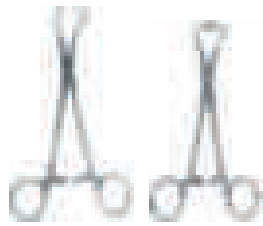

P 107 P 107

**Pinces diverses - Miscellaneous forceps - Pinzas diversas**

**A traire les drains** GUNNAR HEY LANE PAUCHET LOCHARD MOHR HOFFMAN WEISS MURPHY  
 Drainage tube  
 Ordenar las canulas

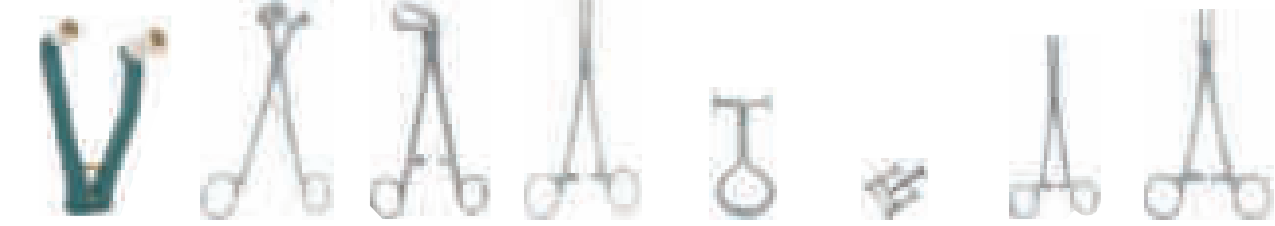

P 108 P 108 P 109 P 110 P 110 P 110 P 111 P 112

**Pinces hémostatiques Prestige - Prestige Haemostatic forceps - Pinzas hemostáticas Prestige**

HALSTEAD LERICHE BENGOLEA KELLY KOCHER CRILE CHRISTOPHE

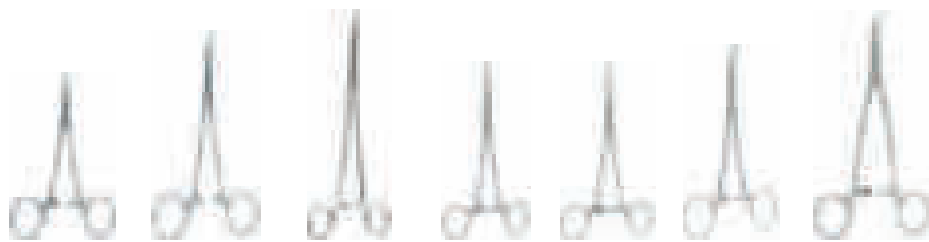

P 113 P 114 P 115 P 116 P 116 P 117 P 117

## Pinces à pansements - Bandage forceps - Pinzas para vendajes

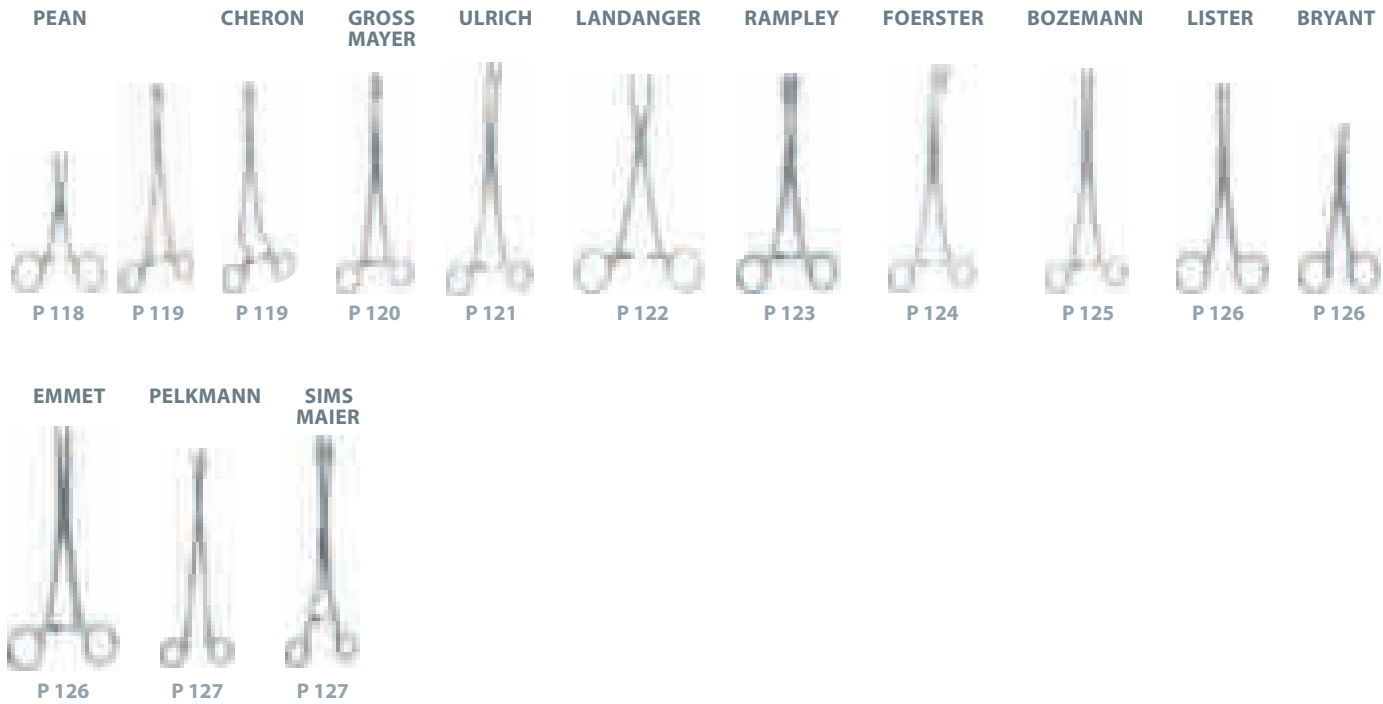

## Pinces à échardes - Splinters forceps - Pinzas para astillas

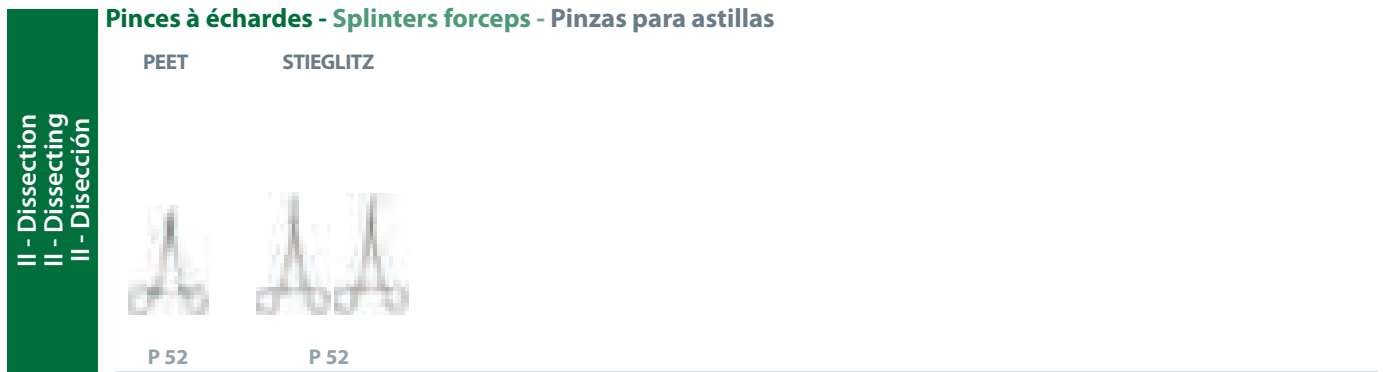

## Pinces utérines - Uterines forceps - Pinzas uterinas

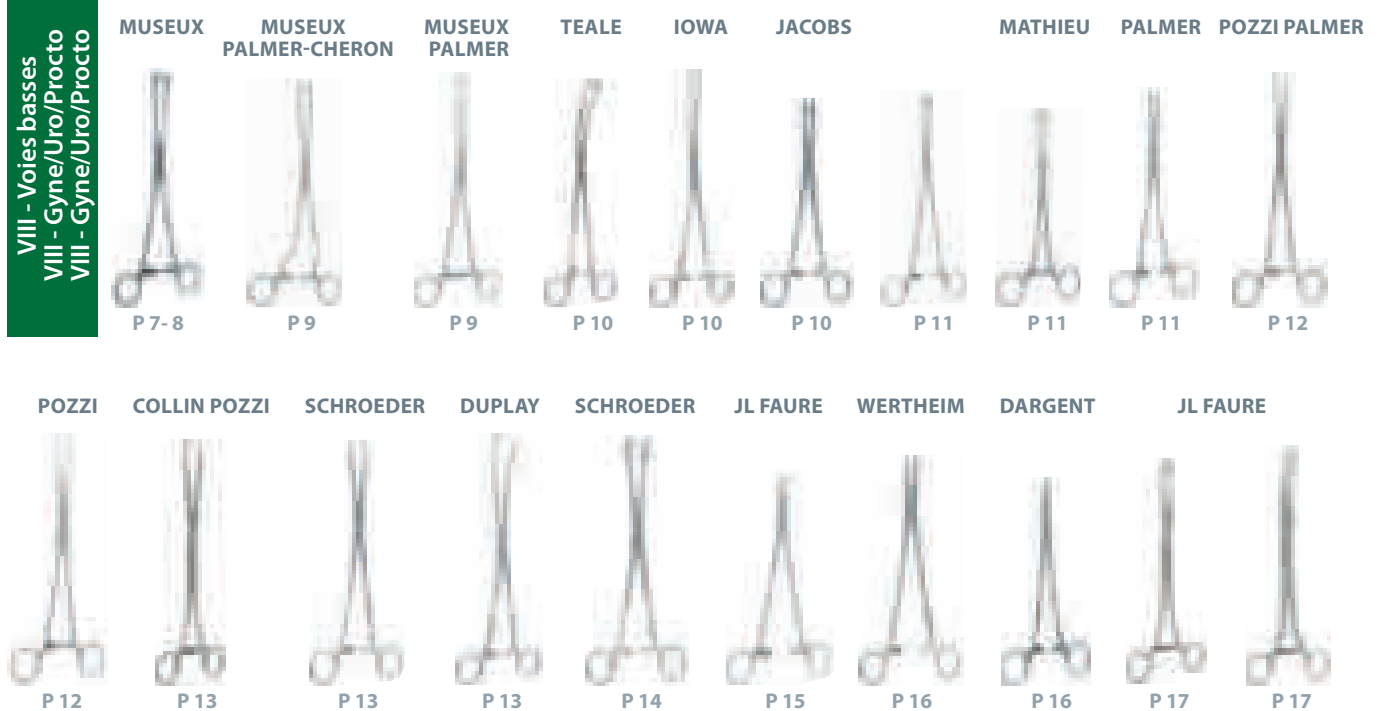

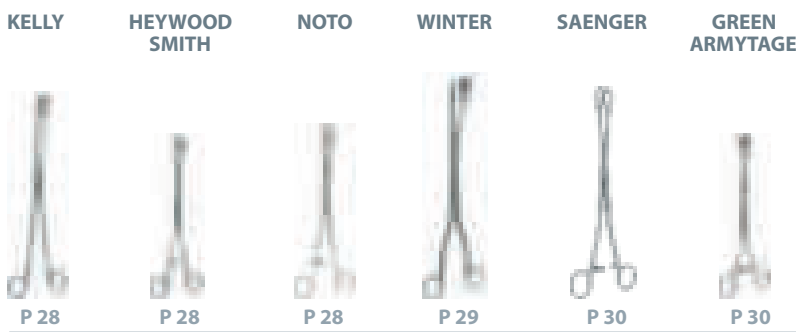
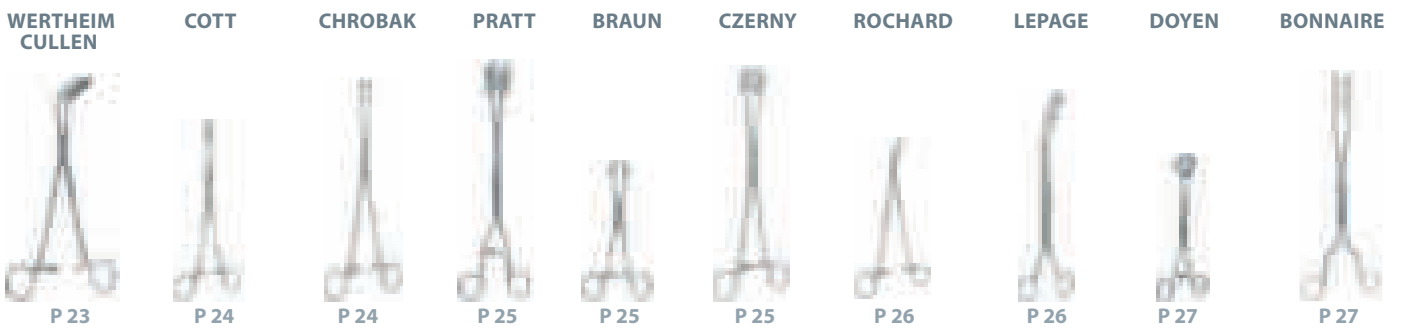
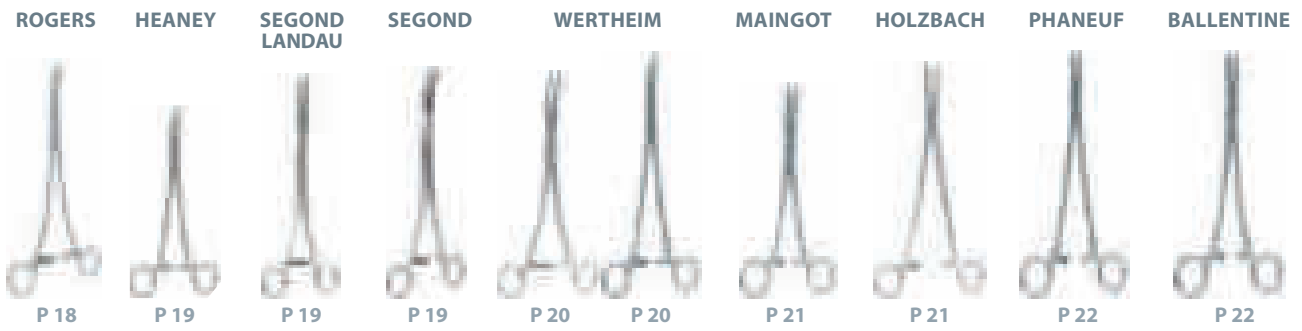

**Pince hystérolable - Uterine elevating forceps - Pinzas para coger el útero**



**Instruments pour prostate - Instruments for prostate - Instrumentos para prostate**



**Pinces pour calculs rénaux - Forceps for kidney stones - Pinzas para cálculos renales**

IX - Voies billiaires  
IX- Bile ducts  
IX - Vías biliares

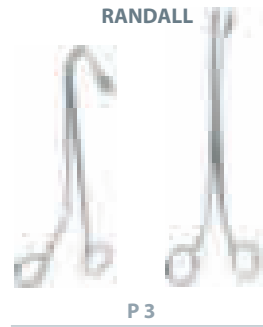

**Pinces pour calculs biliaries - Forceps gales stones - Pinzas para cálculos biliaries**

IX - Voies billiaires  
IX- Bile ducts  
IX - Vías biliares



**Instruments pour pédicules rénaux - Instruments for kidney pedicle - Pinzas para pedunculos renales**

IX - Voies billiaires  
IX- Bile ducts  
IX - Vías biliares



**Instruments pour voies biliaries - Instruments for bile ducts - Instrumentos para vías biliaries**

IX - Voies billiaires  
IX- Bile ducts  
IX - Vías biliares

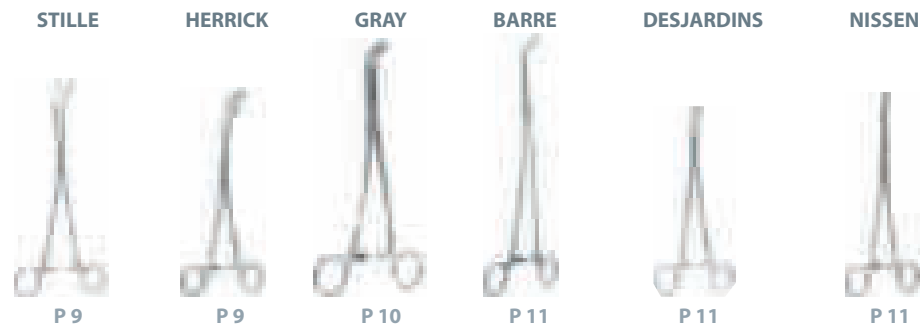

**O.R.L. pinces à préhension - E.N.T. grasping forceps - O.R.L. pinzas a prensión**

XII - O.R.L.  
XII - E.N.T.  
XII - O.R.L.

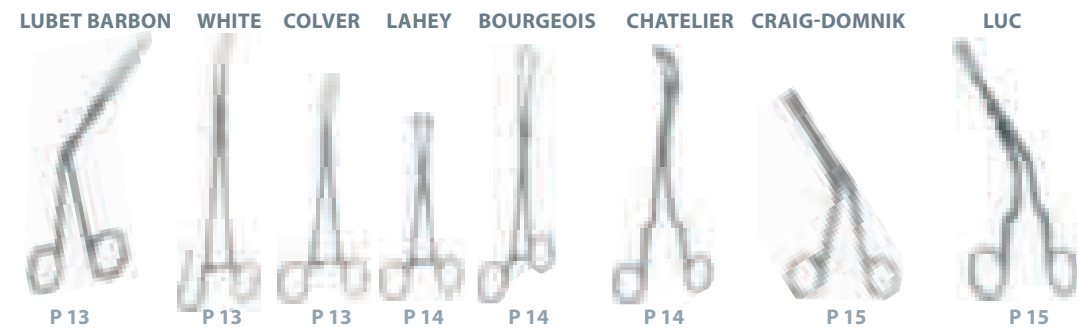

IV - Pinces  
IV - Forceps  
IV - Pinzas

**Chirurgie des tendons - Surgery for tendons - Cirugía para tendones**

XIII - Osseux  
XIII - Bone surgery  
Cirugía osea

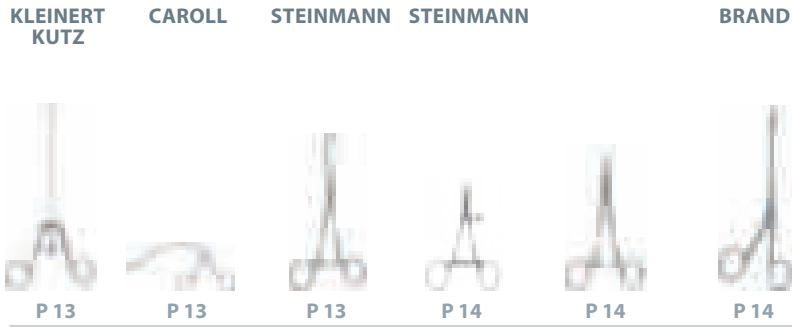

**Daviers - Bone holding forceps - Pinzas para huesos**

XIII - Osseux  
XIII - Bone surgery  
Cirugía osea



**Pour épaule - For shoulder - Para hombro**



**Pour ménisque - For meniscus - Para menisco**

NICOLLET  
KOCHER

BIRCHER  
GANSKE



**Instrumentation de service - Instrumentation for services - Instrumentación de servicio**

XV - Divers  
XV - Miscellaneous  
XV - Diversos

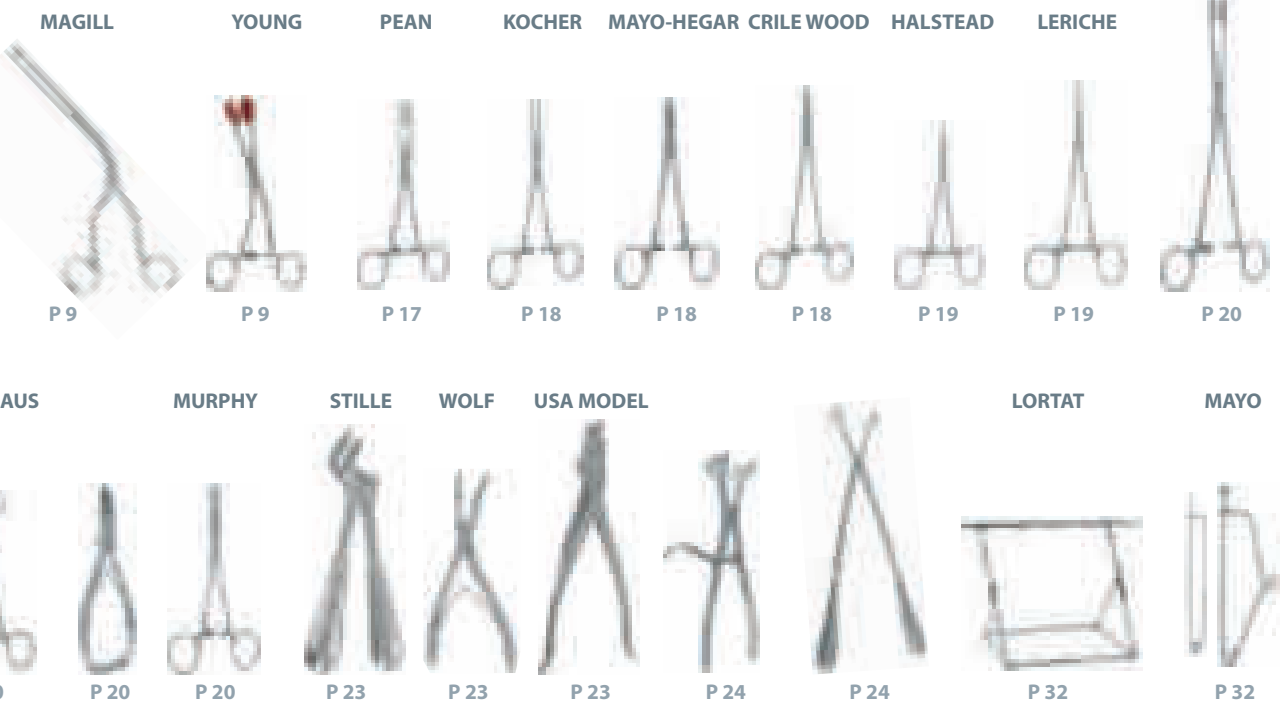

## KOCHER

A griffes  
With teeth  
Con dientes

13 cm - 5 "

**B50070**

15 cm - 6 "

**B50075**



18 cm - 7 "

**B50085**



A doigt  
Collin's lock  
Desmontable



**B50070**  
13 cm - 5 "

**B50075**  
15 cm - 6 "

**B50085**  
18 cm - 7 "

### KOCHER

Droite  
Straight  
Recta

Sans griffes  
Without teeth  
Sin dientes

A griffes  
With teeth  
Con dientes

 <b>B50202</b>	14 cm - 5 1/2"	<b>B50200</b>
<b>B50207</b>	15 cm - 6 "	<b>B50205</b>
<b>B50212</b>	16 cm - 6 1/4 "	<b>B50210</b>
<b>B50217</b>	18 cm - 7 "	<b>B50215</b>
<b>B50225</b>	21 cm - 8 1/4 "	<b>B50220</b>
<b>B50231</b>	24 cm - 9 1/2 "	<b>B50230</b>

Mors courts - Short jaws - Boca corta

<b>B50274</b>	15 cm - 6 "	<b>B50272</b>
---------------	-------------	---------------

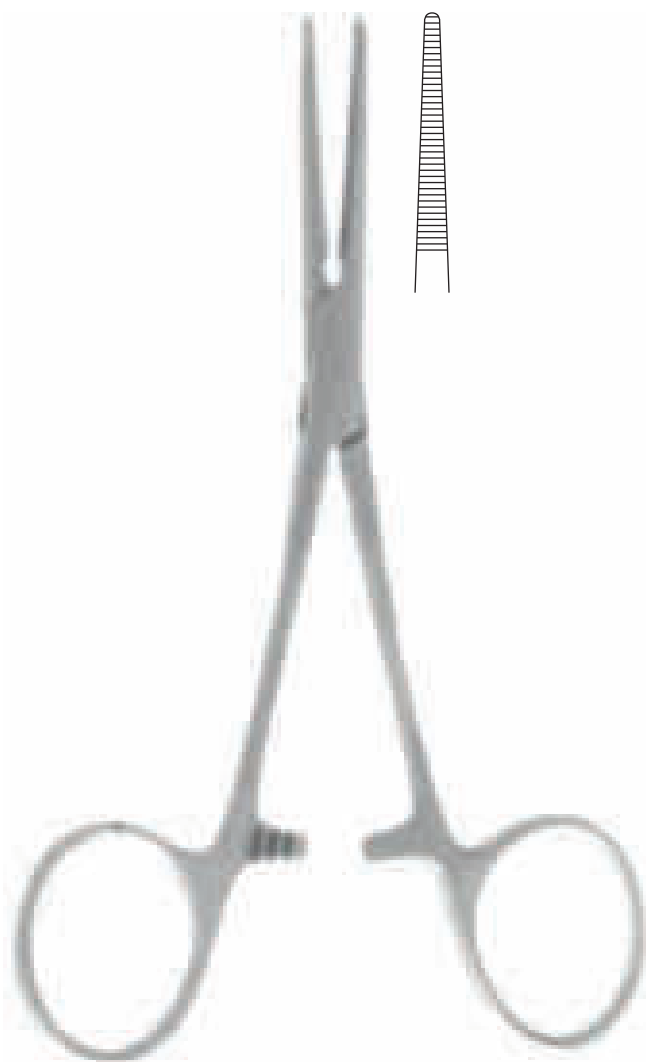

**B50202**  
14 cm - 5 1/2 "



**B50274**  
15 cm - 6 "

Mors courts - Short jaws - Boca corta



**B50207**  
15 cm - 6 "



**B50212**  
16 cm - 6 1/4 "



**B50217**  
18 cm - 7 "



**B50225**  
21 cm - 8 1/4 "



**B50231**  
24 cm - 9 1/2 "

### KOCHER

Courbe  
Curved  
Curva

Sans griffes  
Without teeth  
Sin dientes

A griffes  
With teeth  
Con dientes

 <b>B50236</b>	14 cm - 5 1/2"	<b>B50235</b>
<b>B50242</b>	15 cm - 6"	<b>B50240</b>
<b>B50247</b>	16 cm - 6 1/4"	<b>B50245</b>
<b>B50252</b>	18 cm - 7"	<b>B50250</b>
<b>B50257</b>	21 cm - 8 1/4"	<b>B50255</b>
<b>B50267</b>	24 cm - 9 1/2"	<b>B50265</b>

Mors courts - Short jaws - Boca corta

<b>B50278</b>	15 cm - 6"	<b>B50276</b>
---------------	------------	---------------



**B50236**  
14 cm - 5 1/2"

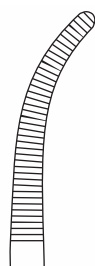

**B50278**  
15 cm - 6"

Mors courts - Short jaws - Boca corta

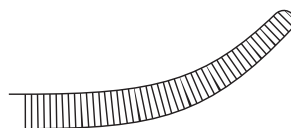

**B50242**  
15 cm - 6"



**B50247**  
16 cm - 6 1/4"



**B50252**  
18 cm - 7"

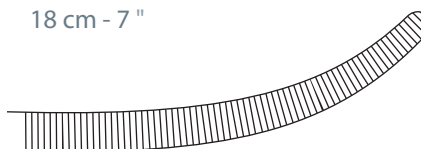

**B50257**  
21 cm - 8 1/4"

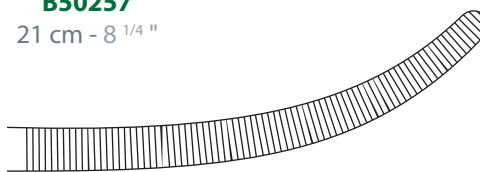

**B50267**  
24 cm - 9 1/2"



### ROCHESTER-PEAN

Droite Straight Recta	Sans griffes Without teeth Sin dientes	Courbe Curved Curva
B506990	14 cm - 5 1/2"	B507090
 B50700	16 cm - 6 1/4"	B50710
B50705	18 cm - 7"	B50715
B50706	20 cm - 8"	B50720
B507065	22 cm - 8 3/4"	B507210
B50707	24 cm - 9 1/2"	B50725
B507080	26 cm - 10 1/4"	B507261
B507081	30 cm - 11 3/4"	B507262

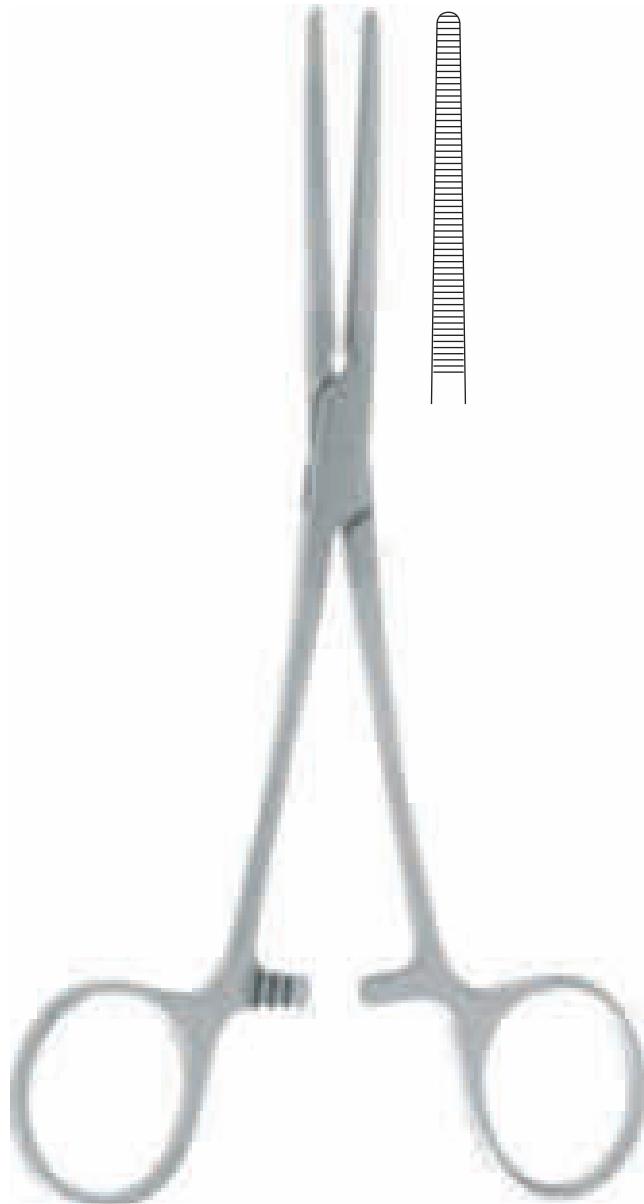

**B50700**  
16 cm - 6 1/4"



**B50705**  
18 cm - 7"



**B50706**  
20 cm - 8"

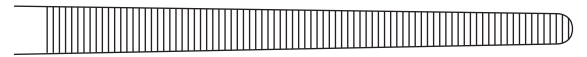

**B50707**  
24 cm - 9 1/2"

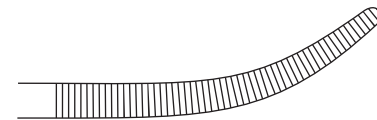

**B50710**  
16 cm - 6 1/4"



**B50715**  
18 cm - 7"

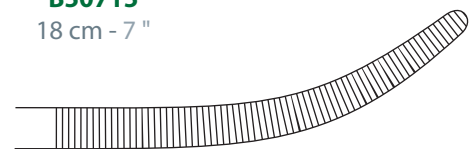

**B50720**  
20 cm - 8"

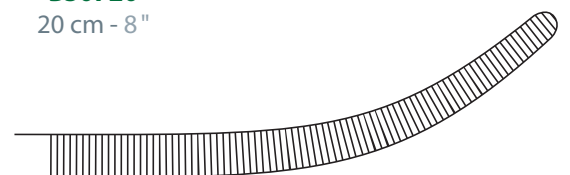

**B50725**  
24 cm - 9 1/2"

## ROCHESTER-OSCHNER

	A griffes With teeth Con dientes		Courbe Curved Curva
Droite Straight Recta			
<b>B507295</b>	14 cm - 5 1/2"		<b>B507395</b>
 <b>B50730</b>	16 cm - 6 1/4"		<b>B50740</b>
<b>B50735</b>	18 cm - 7"		<b>B50745</b>
<b>B507351</b>	20 cm - 8"		<b>B507451</b>
<b>B507352</b>	22 cm - 8 3/4"		<b>B507452</b>
<b>B507353</b>	24 cm - 9 1/2"		<b>B507453</b>
<b>B507354</b>	26 cm - 10 1/4"		<b>B507454</b>
<b>B507355</b>	30 cm - 11 3/4"		<b>B507455</b>



**B50730**  
16 cm - 6 1/4 "



**B50730**  
16 cm - 6 1/4 "



**B50735**  
18 cm - 7 "



**B507351**  
22cm - 8 3/4 "



**B507353**  
24cm - 9 1/2 "

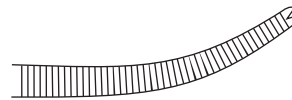

**B50740**  
16 cm - 6 1/4 "



**B50745**  
18 cm - 7 "

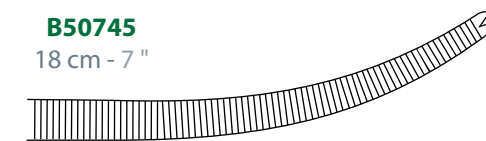

**B507451**  
20 cm - 8 "

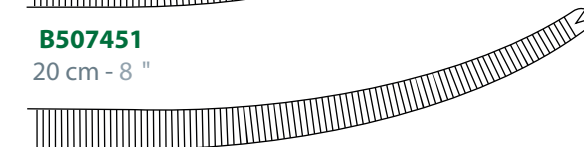

**B507453**  
22 cm - 8 3/4 "



## ROCHESTER-CARMALT

Droite  
Straight  
Recta

Courbe  
Curved  
Curva



**B50746**

16 cm - 6 1/4 "

**B50747**



**B50748**

20 cm - 8 "

**B50749**



**B50748**  
20 cm - 8 "

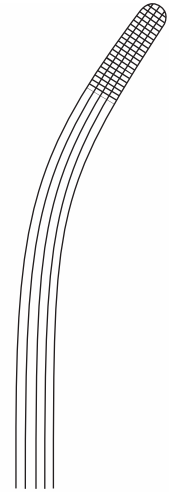
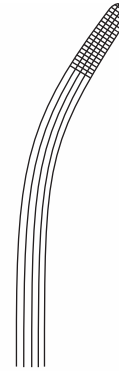

**B50749**  
20 cm - 8 "

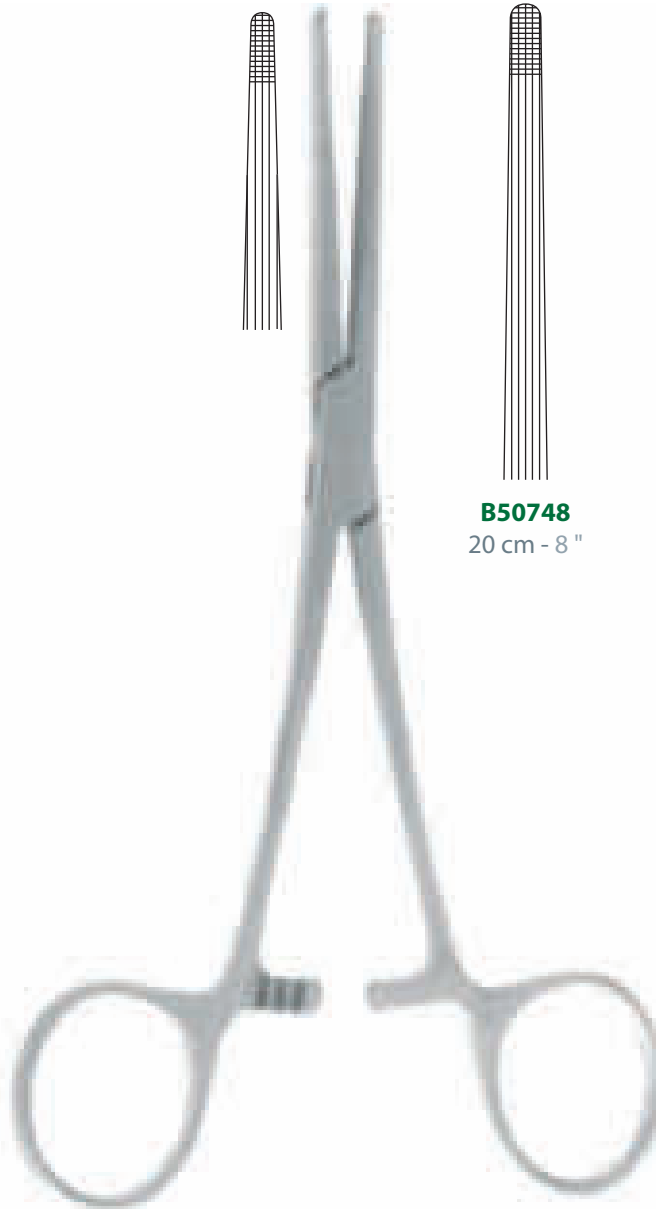

**B50746**  
16 cm - 6 1/4 "

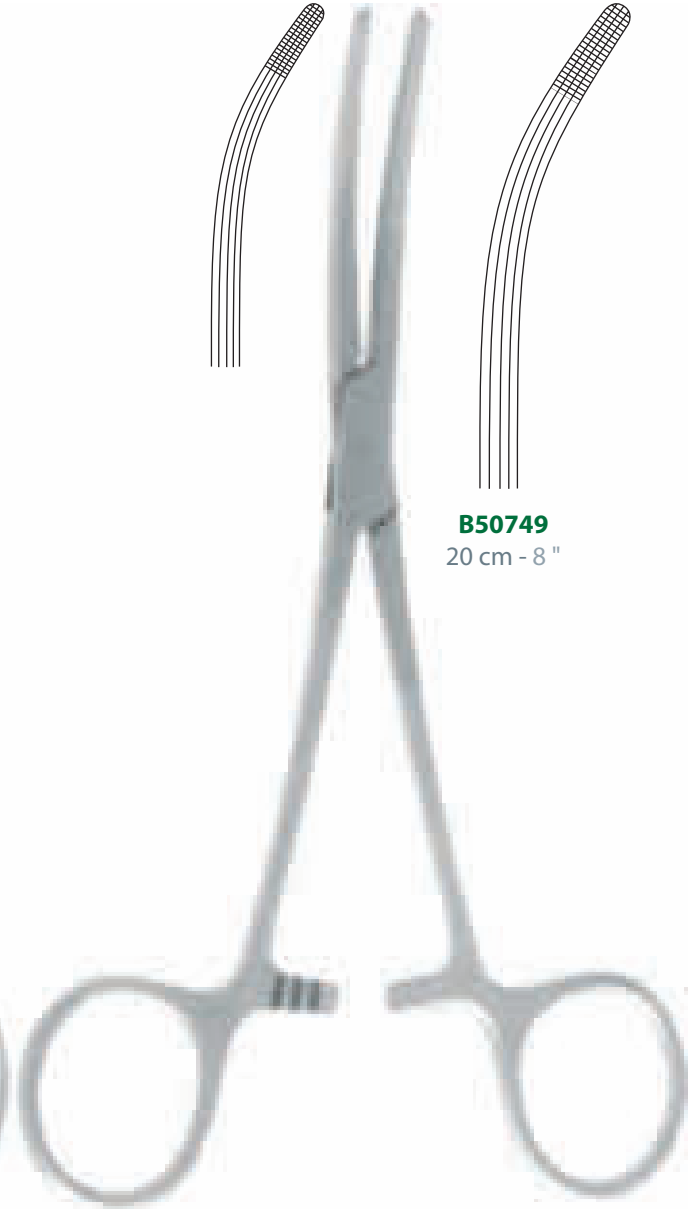

**B50747**  
16 cm - 6 1/4 "

### TERRIER

### SPENCER WELLS



**B50455**  
12 cm - 4 <sup>3</sup>/<sub>4</sub> "



**B50465**  
12 cm - 4 <sup>3</sup>/<sub>4</sub> "

CARREL

TERRIER

Sans griffes  
Without teeth  
Sin dientes

A griffes  
With teeth  
Con dientes

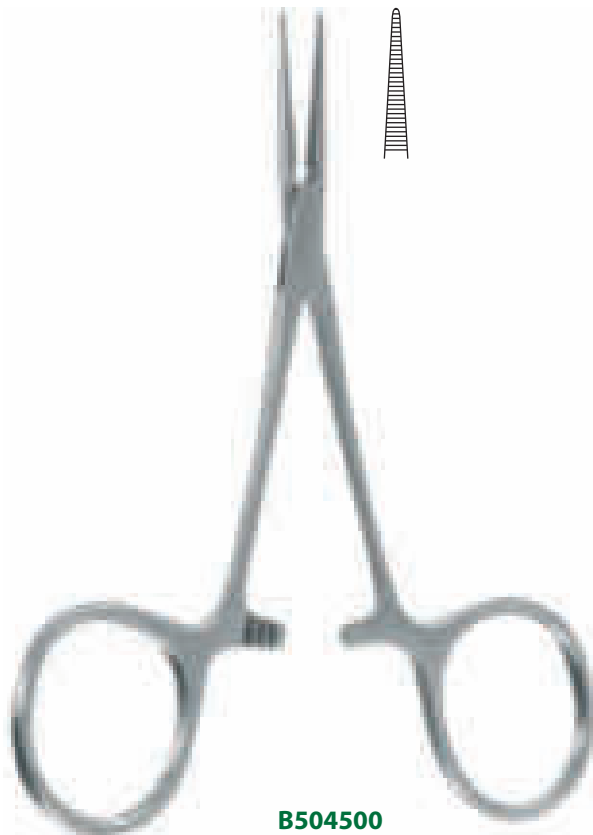

**B504500**  
11 cm - 4 1/4"



**B504510**  
10 cm - 4"

KRÔNLEIN

DUNHILL



**B504520**  
13 cm - 5"



**B504530**  
13 cm - 5"



### SPENCER WELLS

Sans griffes  
Without teeth  
Sin dientes

Droite Straight Recta		Courbe Curved Curva
 <b>B504651</b>	13 cm - 5 "	<b>B504661</b> 
<b>B504652</b>	15 cm - 6 "	<b>B504662</b>
<b>B504653</b>	18 cm - 7 "	<b>B504663</b>
<b>B504654</b>	20 cm - 8 "	<b>B504664</b>

Modèle allemand  
German model  
Modelo alemán



**B504651**  
13 cm - 5 "

**B504661**  
13 cm - 5 "

## Pinces hémostatiques - Haemostatic forceps - Pinzas hemostáticas

Droite  
Straight  
Recta

### MOSQUITO

Courbe  
Curved  
Curva

Sans griffes - Without teeth - Sin dientes



**B50435**  
10 cm - 4 "



**B50445**  
10 cm - 4 "

A griffes - With teeth - Con dientes



**B50430**  
10 cm - 4 "



**B50440**  
10 cm - 4 "

IV - Pinces  
IV - Forceps  
IV - Pinzas



### MICRO-HALSTEAD

Sans griffes - Without teeth - Sin dientes

A griffes - With teeth - Con dientes

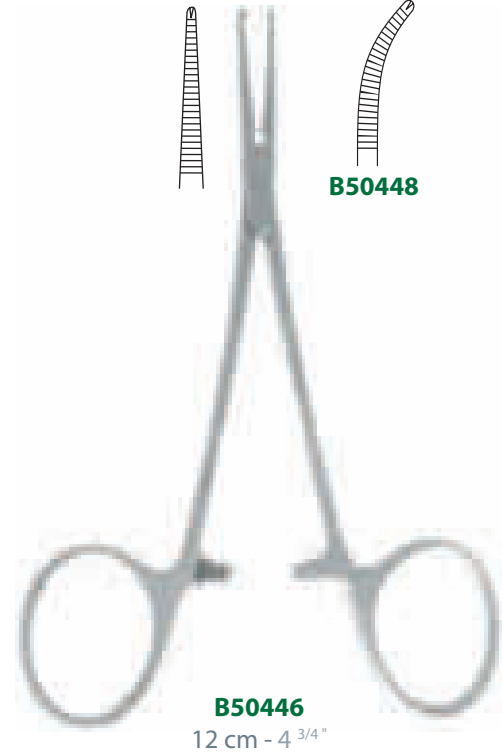
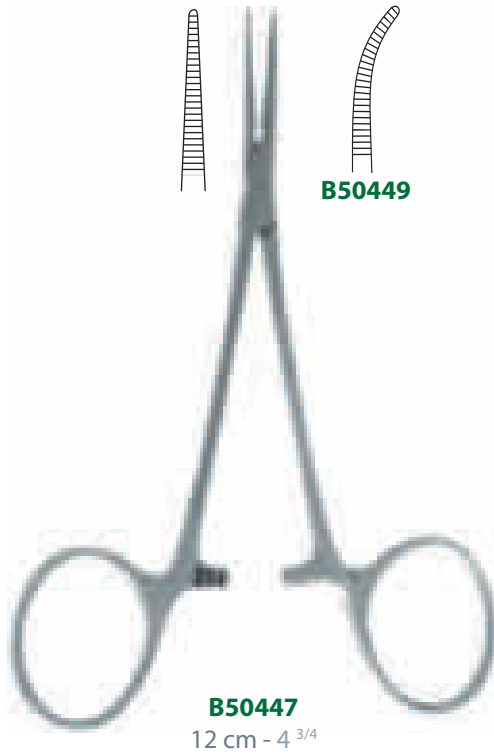

### HALSTEAD

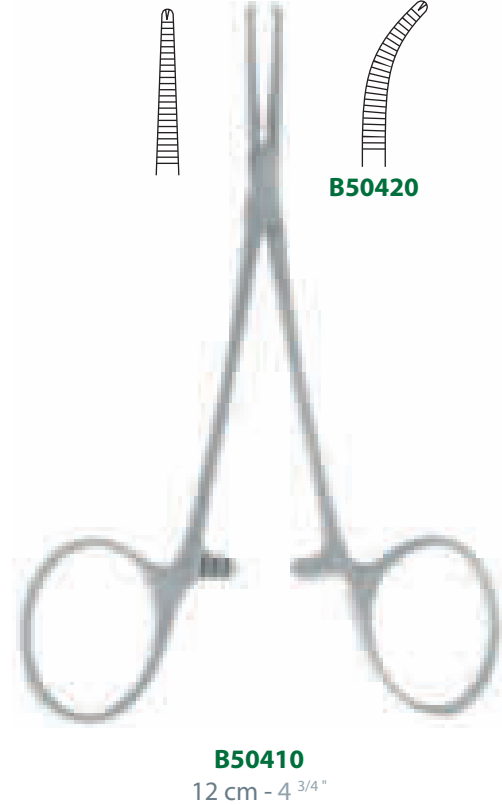

## MICRO-MOSQUITO

Sans griffes - Without teeth - Sin dientes

A griffes - With teeth - Con dientes

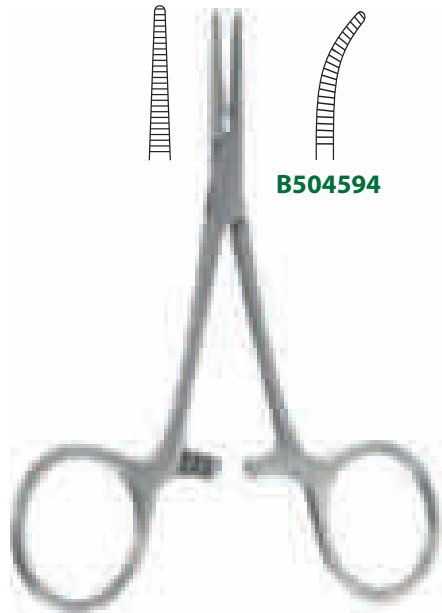

**B504594**

**B504590**  
10 cm - 4 "

Modèles allemands  
German models  
Modelos alemanes

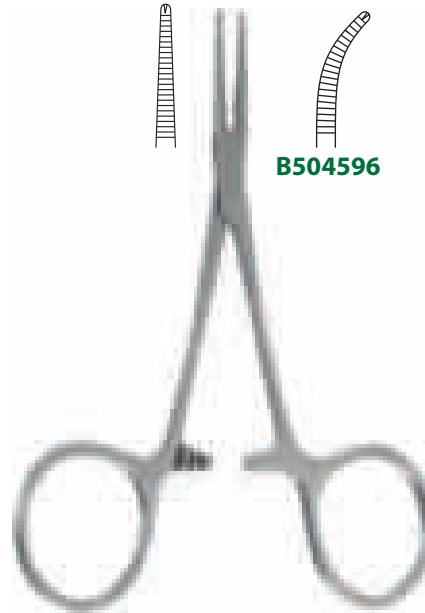

**B504596**

**B504592**  
10 cm - 4 "



**B504595**

**B504591**  
12 cm - 4 <sup>3</sup>/<sub>4</sub> "

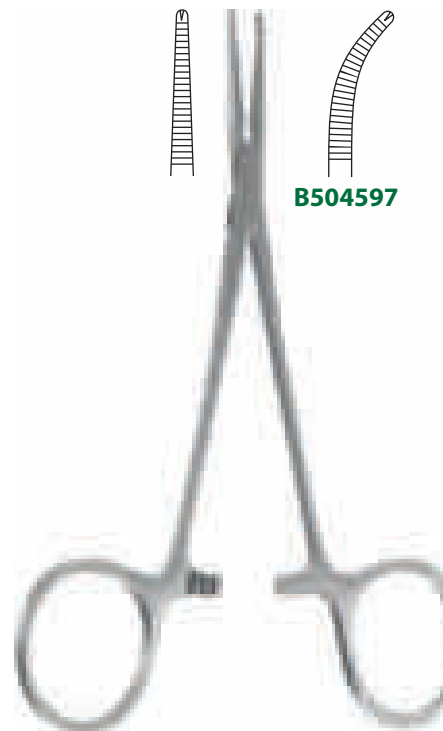

**B504597**

**B504593**  
12 cm - 4 <sup>3</sup>/<sub>4</sub> "

JACOBSON HALSTEAD

Modèles allemands  
 German models  
 Modelos alemanés

Sans griffes - Très fine  
 Without teeth - Very fine  
 Sin dientes - Muy fino



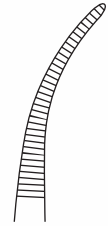

**B504598**  
 13 cm - 5 "



**B504599**  
 13 cm - 5 "

## Pinces hémostatiques - Haemostatic forceps - Pinzas hemostáticas

		<b>HALSTEAD-MOSQUITO</b>					
		Droite Straight Recta		Courbe Curved Curva			
		Sans griffes Without teeth Sin dientes	A griffes With teeth Con dientes	Sans griffes Without teeth Sin dientes	A griffes With teeth Con dientes		
		<b>B504580</b>	<b>B504582</b>	12 cm - 4 <sup>3</sup> / <sub>4</sub> "	<b>B504584</b>	<b>B504586</b>	
		<b>B504581</b>	<b>B504583</b>	14 cm - 5 <sup>1</sup> / <sub>2</sub> "	<b>B504585</b>	<b>B504587</b>	
		<b>B504560</b>	<b>B504564</b>	18 cm - 7 "	<b>B504562</b>	<b>B504566</b>	
		<b>B504561</b>	<b>B504565</b>	21 cm - 8 <sup>1</sup> / <sub>4</sub> "	<b>B504563</b>	<b>B504567</b>	

Modèles allemands  
German models  
Modelos alemanes

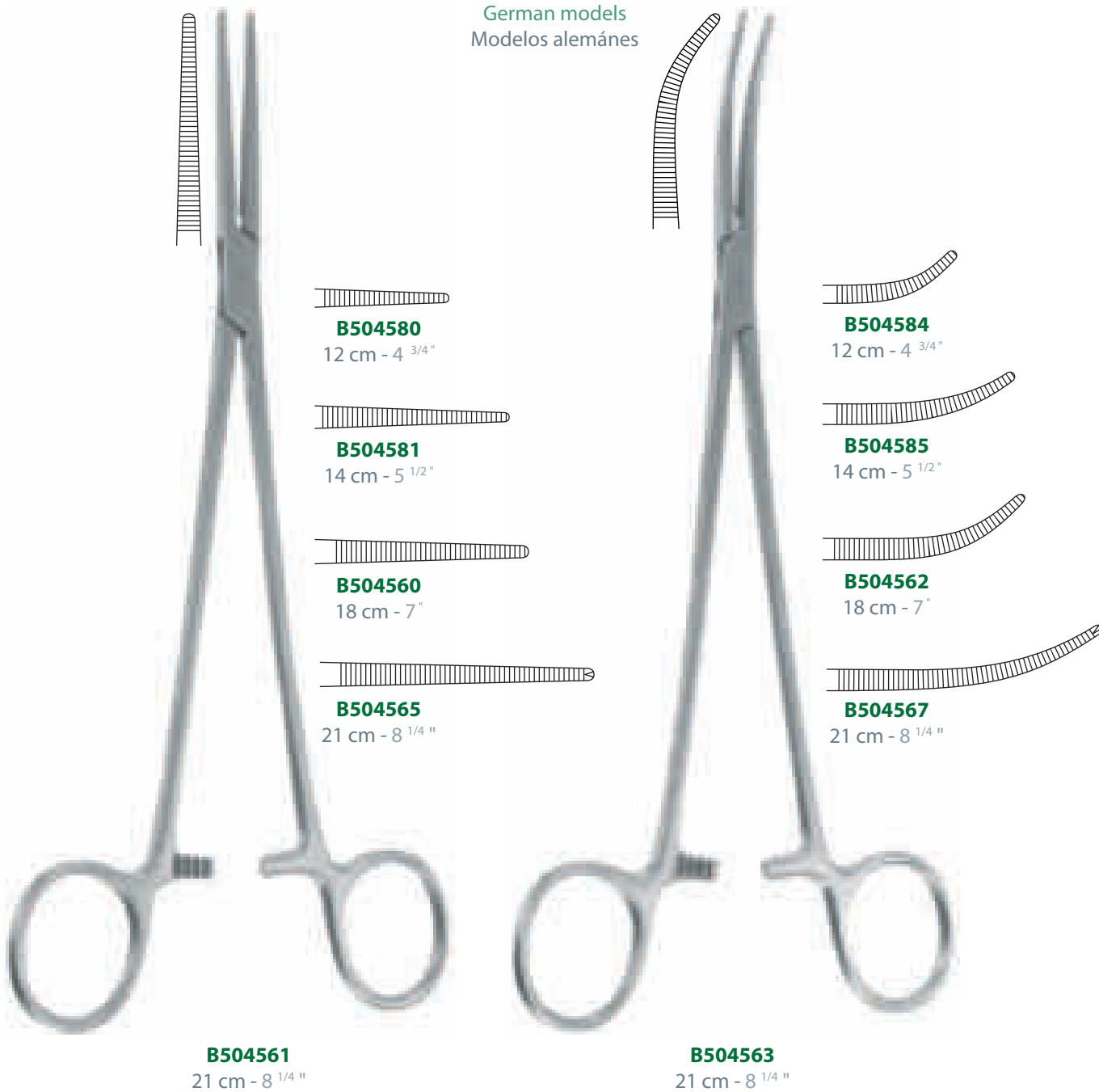

IV - Pinces  
IV - Forceps  
IV - Pinzas

### BONNIOT

Droite  
Straight  
Recta

Courbe  
Curved  
Curva

Sans griffes  
Without teeth  
Sin dientes

A griffes  
With teeth  
Con dientes

Sans griffes  
Without teeth  
Sin dientes

A griffes  
With teeth  
Con dientes



**B503000**

**B503001**

15 cm - 6"



**B503010**

**B503011**



**B503001**



**B503000**  
15 cm - 6"



**B503011**

**B503010**  
15 cm - 6"

### LERICHE

Droite Straight Recta		Courbe Curved Curva	
Sans griffes Without teeth Sin dientes	A griffes With teeth Con dientes	Sans griffes Without teeth Sin dientes	A griffes With teeth Con dientes
 <b>B50345</b>	<b>B50330</b>	 <b>B50375</b>	<b>B50360</b>
<b>B50350</b>	<b>B50335</b>	<b>B50380</b>	<b>B50365</b>
	15 cm - 6 "		15 cm - 6 "
	18 cm - 7 "		18 cm - 7 "

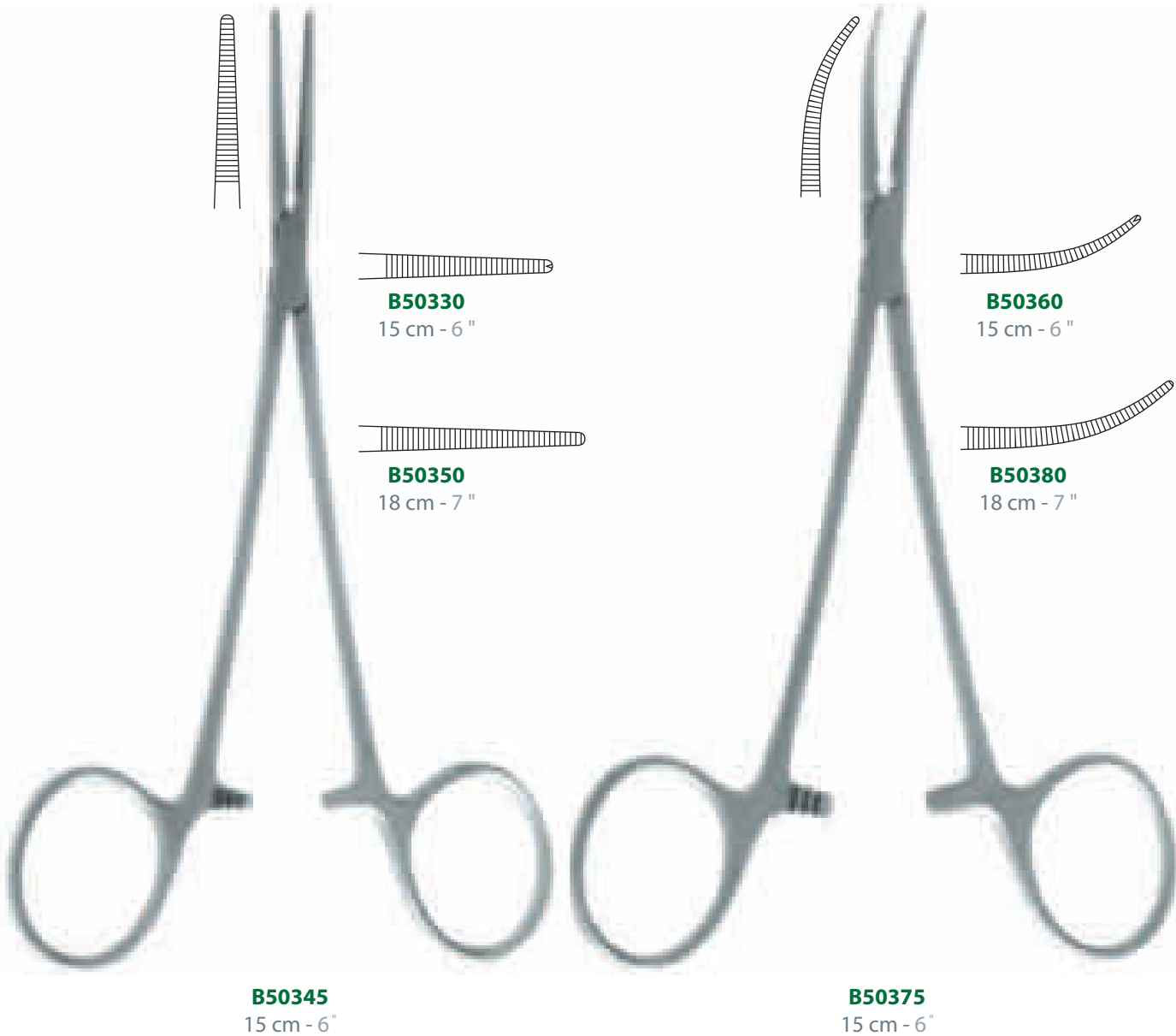

IV - Pinces  
IV - Forceps  
IV - Pinzas

## Pinces hémostatiques - Haemostatic forceps - Pinzas hemostáticas

### PROVIDENCE

Droite	Courbe
Straight	Curved
Recta	Curva

14 cm - 5 1/2"

**B508400**

**B508401**



### DANDY

Sans griffes	A griffes
Without teeth	With teeth
Sin dientes	Con dientes

14 cm - 5 1/2"

**B508450**

**B508451**



### MOSQUITO-DANDY

12 cm - 4 3/4"

**B508455**

-

Courbe latérale  
Lateral curved  
Curva lateral



**B508400**  
14 cm - 5 1/2"



**B508451**  
14 cm - 5 1/2"

## DIXON-LOVELACE

Droite  
Straight  
Recta

Courbe  
Curved  
Curva

Sans griffes  
Without teeth  
Sin dientes

A griffes  
With teeth  
Con dientes

Sans griffes  
Without teeth  
Sin dientes

A griffes  
With teeth  
Con dientes



**B50284**

**B50282**

16 cm - 6 1/4 "



**B50288**

**B50286**



**B50284**  
16 cm - 6 1/4 "

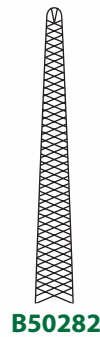

**B50282**



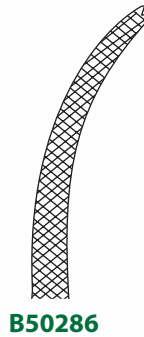

**B50288**  
16 cm - 6 1/4 "



**B50286**



### CRILE

Droite Straight Recta		Courbe Curved Curva	
Sans griffes Without teeth Sin dientes	A griffes With teeth Con dientes	Sans griffes Without teeth Sin dientes	A griffes With teeth Con dientes
 <b>B50680</b>	<b>B50660</b>	 <b>B50690</b>	<b>B50670</b>
<b>B50685</b>	<b>B50665</b>	<b>B50695</b>	<b>B50675</b>
		14 cm - 5 1/2"	
		16 cm - 6 1/4"	



**B50685**

**B50660**

**B50695**

**B50670**

**B50680**  
14 cm - 5 1/2 "

**B50690**  
14 cm - 5 1/2 "

## Pinces hémostatiques - Haemostatic forceps - Pinzas hemostáticas

### CRILE

Droite  
Straight  
Recta

**B506953**

Courbe  
Curved  
Curva

**B506954**



**B506951**

**B506952**

14 cm - 5 1/2"

A griffes  
With teeth  
Con dientes

Sans griffes  
Without teeth  
Sin dientes

### CRILE-RANKIN

Droite  
Straight  
Recta

**B506957**

Courbe  
Curved  
Curva

**B506958**

**B506955**

**B506956**



16 cm - 6 1/4"

Modèle allemand  
German model  
Modelo alemán



**B506955**

**B506953**

**B506951**  
14 cm - 5 1/2"



**B506952**

**B506958**

**B506956**  
16 cm - 6 1/4"

IV - Pinces  
IV - Forceps  
IV - Pinzas

## Pinces hémostatiques - Haemostatic forceps - Pinzas hemostáticas

### COLLER-CRILE

Droite Straight Recta	Sans griffes Without teeth Sin dientes	Courbe Curved Curva
<b>B506966</b>	14 cm - 5 1/2"	 <b>B506968</b>
<b>B506967</b>	16 cm - 6 1/4"	<b>B506969</b>

### BABY-CRILE

Droite Straight Recta	Sans griffes Without teeth Sin dientes	Courbe Curved Curva
 <b>B506960</b>	<b>B506961</b>	
<b>B506962</b>	A griffes With teeth Con dientes	<b>B506963</b>

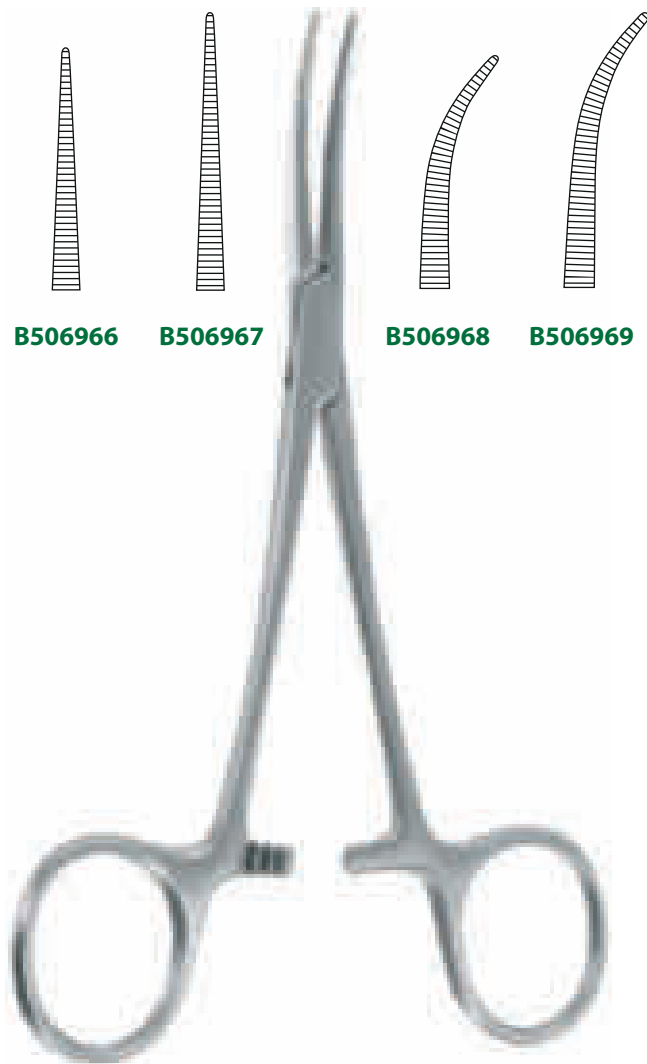



**B506968**  
14 cm - 5 1/2 "



**B506960**  
14 cm - 5 1/2 "

### KELLY

Droite Straight Recta		Courbe Curved Curva	
A griffes With teeth Con dientes	Sans griffes Without teeth Sin dientes	A griffes With teeth Con dientes	Sans griffes Without teeth Sin dientes
B50555	<b>B50575</b> 	B50595	<b>B50615</b> 
B50560	B50580	B50600	B50620
B50565	B50585	B50605	B50625
B50570	B50590	B50610	B50630

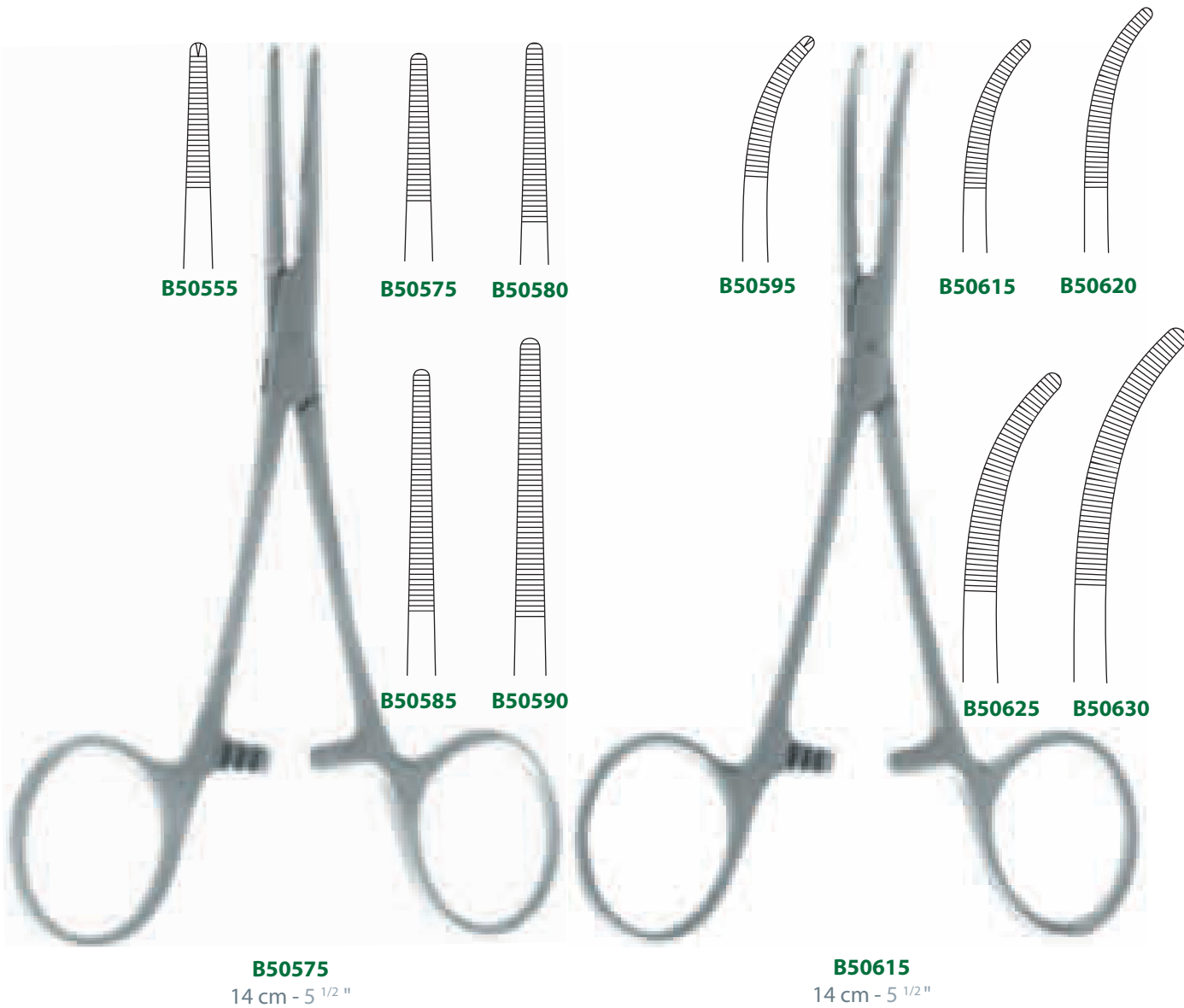

IV - Pinces  
IV - Forceps  
IV - Pinzas

KELLY-RANKIN



**B50632**  
16 cm - 6 1/4"

**B50634**  
16 cm - 6 1/4"

IV - Pinces  
IV - Forceps  
IV - Pinzas

### CHRISTOPHE

Droite  
Straight  
Recta

Courbe  
Curved  
Curva

Sans griffes  
Without teeth  
Sin dientes

A griffes  
With teeth  
Con dientes

Sans griffes  
Without teeth  
Sin dientes

A griffes  
With teeth  
Con dientes



**B50755**

**B50750**

16 cm - 6 1/4"



**B50765**

**B50760**



**B50750**



**B50760**

**B50755**  
16 cm - 6 1/4"

**B50765**  
16 cm - 6 1/4"



## Pinces hémostatiques - Haemostatic forceps - Pinzas hemostáticas

### FUCHSIG

Sans griffes  
Without teeth  
Sin dientes



**B609095**  
19 cm - 7 1/2 "

### BIRKETT

Droite  
Straight  
Recta

 **B609096** 19 cm - 7 1/2 "

Courbe  
Curved  
Curva

**B609097**



**B609096**

**B609097**

**B609096**  
19 cm - 7 1/2 "

## Pinces hémostatiques - Haemostatic forceps - Pinzas hemostáticas

### ADSON

Droite  
Straight  
Recta

Courbe  
Curved  
Curva

À griffes - With teeth - Con dientes

**B609100** 18,5 cm - 7 1/4" **B609101**

Sans griffes - Without teeth - Sin dientes

 **B609102** 18,5 cm - 7 1/4" **B609103**

### NISSEN

Sans griffes  
Without teeth  
Sin dientes

18,5 cm - 7 1/4" **B609112** 

22,5 cm - 9" **B609113**



**B609102**

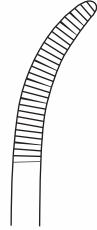

**B609103**

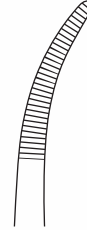

**B609112**

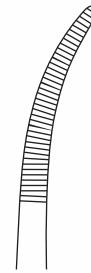

**B609113**



**B609102**  
18,5 cm - 7 1/4"



**B609112**  
18,5 cm - 7 1/4"



MOYNIHAN

Courbe latérale  
Lateral curved  
Curva lateral

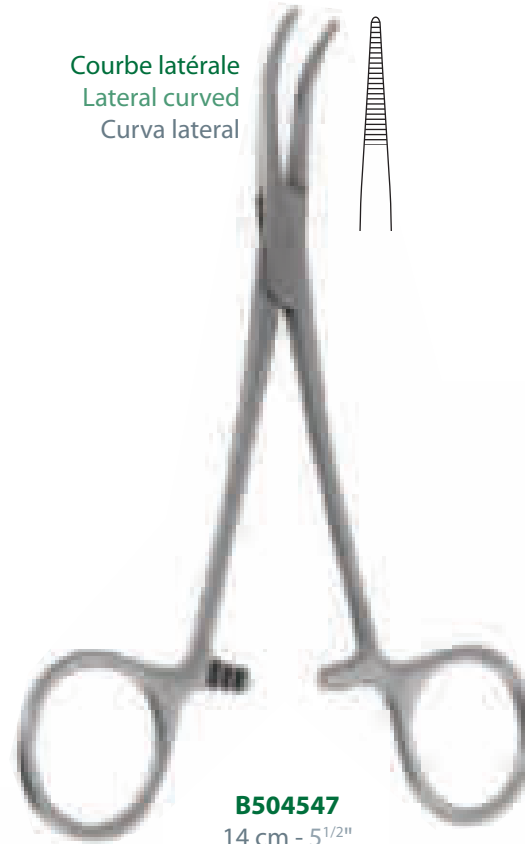

**B50457**  
14 cm - 5<sup>1/2</sup>"

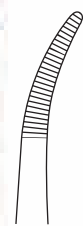

**B50458**  
15 cm - 6"

CAIRNS

Droite  
Straight  
Recta



**B504540**

Courbe  
Curved  
Curva



**B504545** 

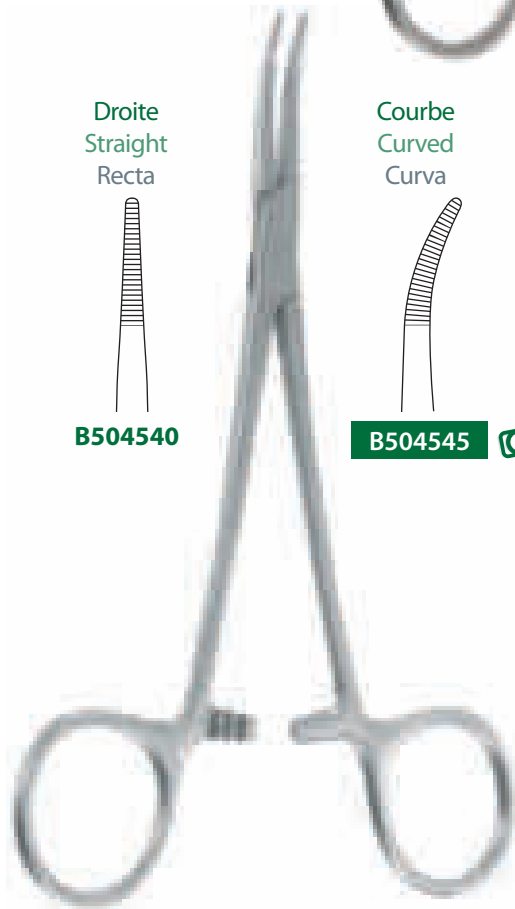

**B504545**  
15 cm - 6"

BRIDGE



**B609108**  
28 cm - 11 "

**B609109**  
28 cm - 11 "



## Pinces hémostatiques longues - Long haemostatic forceps - Pinzas hemostáticas largas

### HEISS

Droite  
Straight  
Recta

Courbe  
Curved  
Curva

Sans griffes  
Without teeth  
Sin dientes

A griffes  
With teeth  
Con dientes

Sans griffes  
Without teeth  
Sin dientes

A griffes  
With teeth  
Con dientes



**B60460**

**B60450**

20 cm - 8 "



**B60480**

**B60470**

**B604810**



**B60460**

**B60450**

**B60460**  
20 cm - 8 "





**B60480** **B604810**

**B60470**

**B60480**  
20 cm - 8 "

### BENGOLEA

Droite Straight Recta		Courbe Curved Curva	
Sans griffes Without teeth Sin dientes	A griffes With teeth Con dientes	Sans griffes Without teeth Sin dientes	A griffes With teeth Con dientes
 <b>B60180</b>	<b>B60140</b>	 <b>B60260</b>	<b>B60220</b>
<b>B60190</b>	<b>B60150</b>	<b>B60270</b>	<b>B60230</b>
<b>B60200</b>	<b>B60160</b>	<b>B60280</b>	<b>B60240</b>
	21 cm - 8 1/4 "		
	24 cm - 9 1/2 "		
	30 cm - 11 3/4 "		

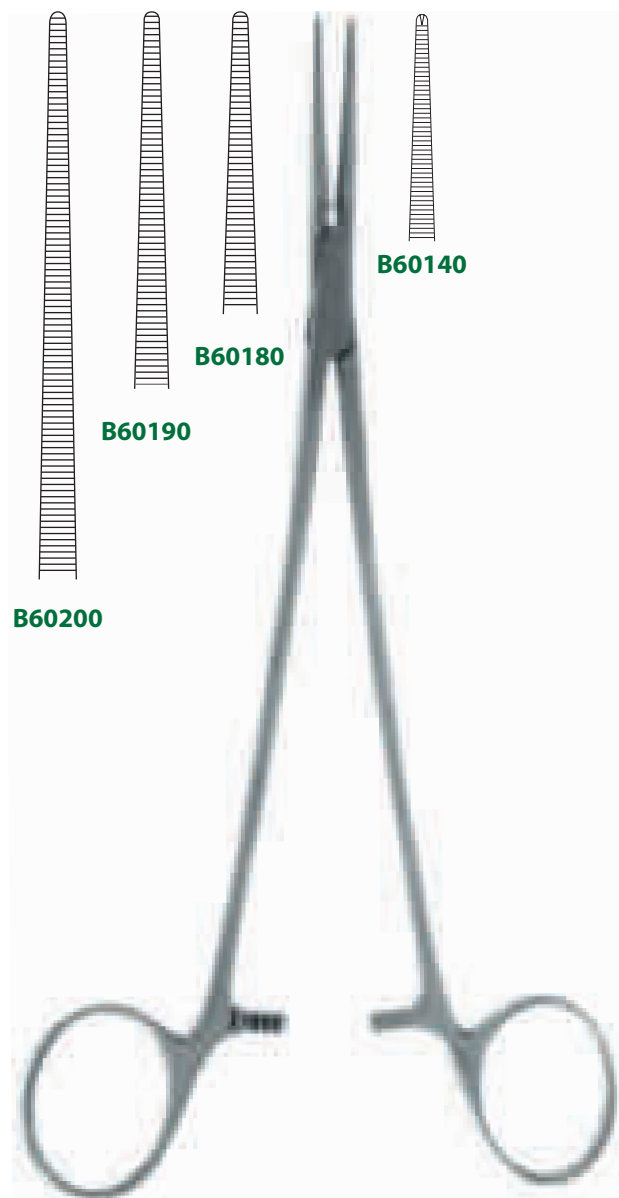

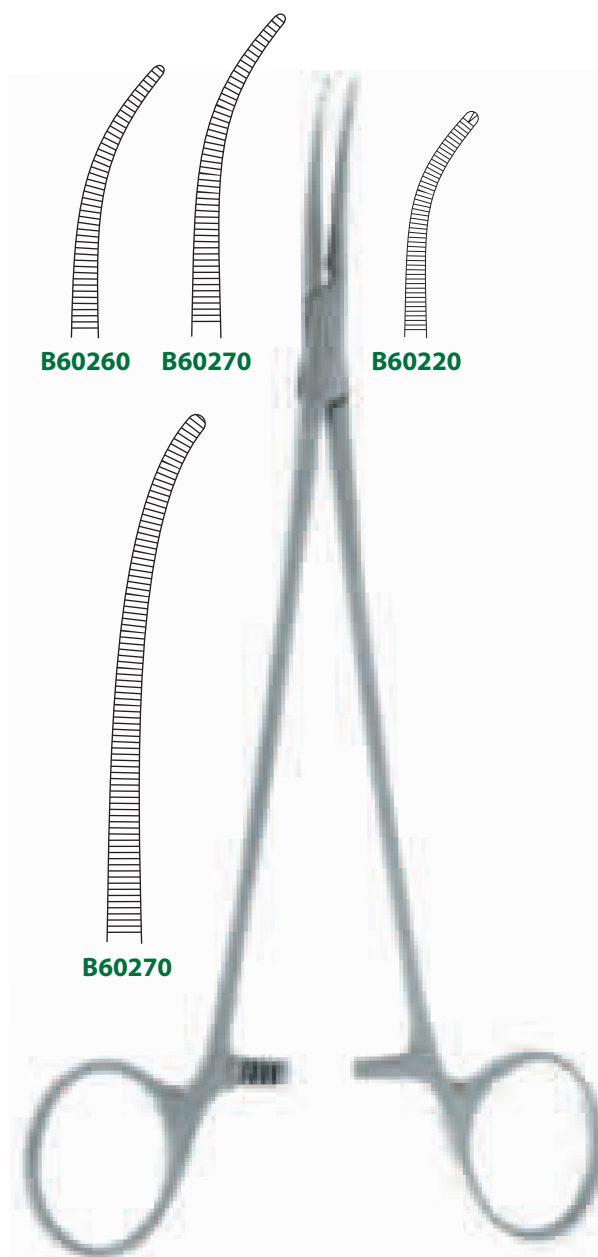

**B60180**  
21 cm - 8 1/4 "



**B60260**  
21 cm - 8 1/4 "

### BENGOLEA

Droite Straight Recta		Courbe Curved Curva	
Sans griffes Without teeth Sin dientes	A griffes With teeth Con dientes	Sans griffes Without teeth Sin dientes	A griffes With teeth Con dientes
<b>B602900</b>	<b>B602908</b>	<b>B602904</b>	<b>B602912</b>
 <b>B602902</b>	<b>B602910</b>	 <b>B602906</b>	<b>B602914</b>
		20 cm - 8"	
		24 cm - 9 1/2"	

Modèle allemand  
German model  
Modelo alemán

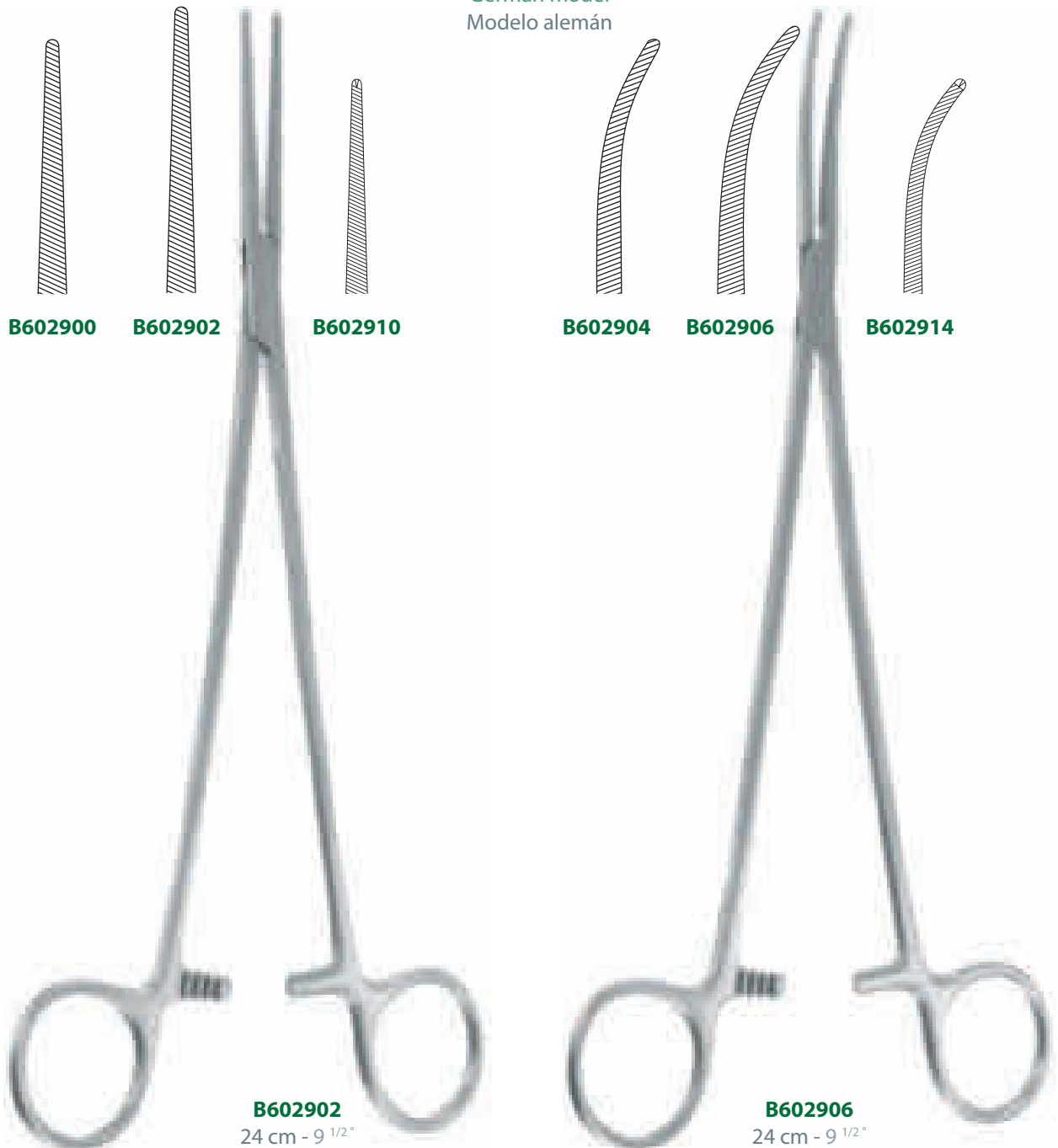

## Pinces hémostatiques longues - Long haemostatic forceps - Pinzas hemostáticas largas

### ROBERTS

Droite  
Straight  
Recta

Courbe  
Curved  
Curva



**B609110**

22 cm - 8 <sup>3</sup>/<sub>4</sub> "

**B609111**

Sans griffes  
Without teeth  
Sin dientes

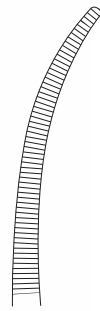

**B609111**



**B609110**  
22 cm - 8 <sup>3</sup>/<sub>4</sub> "

### SAROT

Droite  
Straight  
Recta

Courbe  
Curved  
Curva



**B609115**

24 cm - 9 <sup>1</sup>/<sub>2</sub> "

**B609116**

Sans griffes  
Without teeth  
Sin dientes

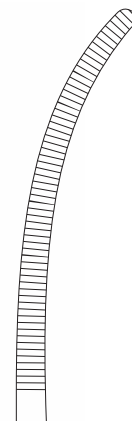

**B609116**



**B609115**  
24 cm - 9 <sup>1</sup>/<sub>2</sub> "

### SANTY

Sans griffes  
Without teeth  
Sin dientes

**B60340**

24 cm - 9 1/2"

A griffes  
With teeth  
Con dientes

**B60330**



**B60360**

30 cm - 11 3/4"



**B60350**

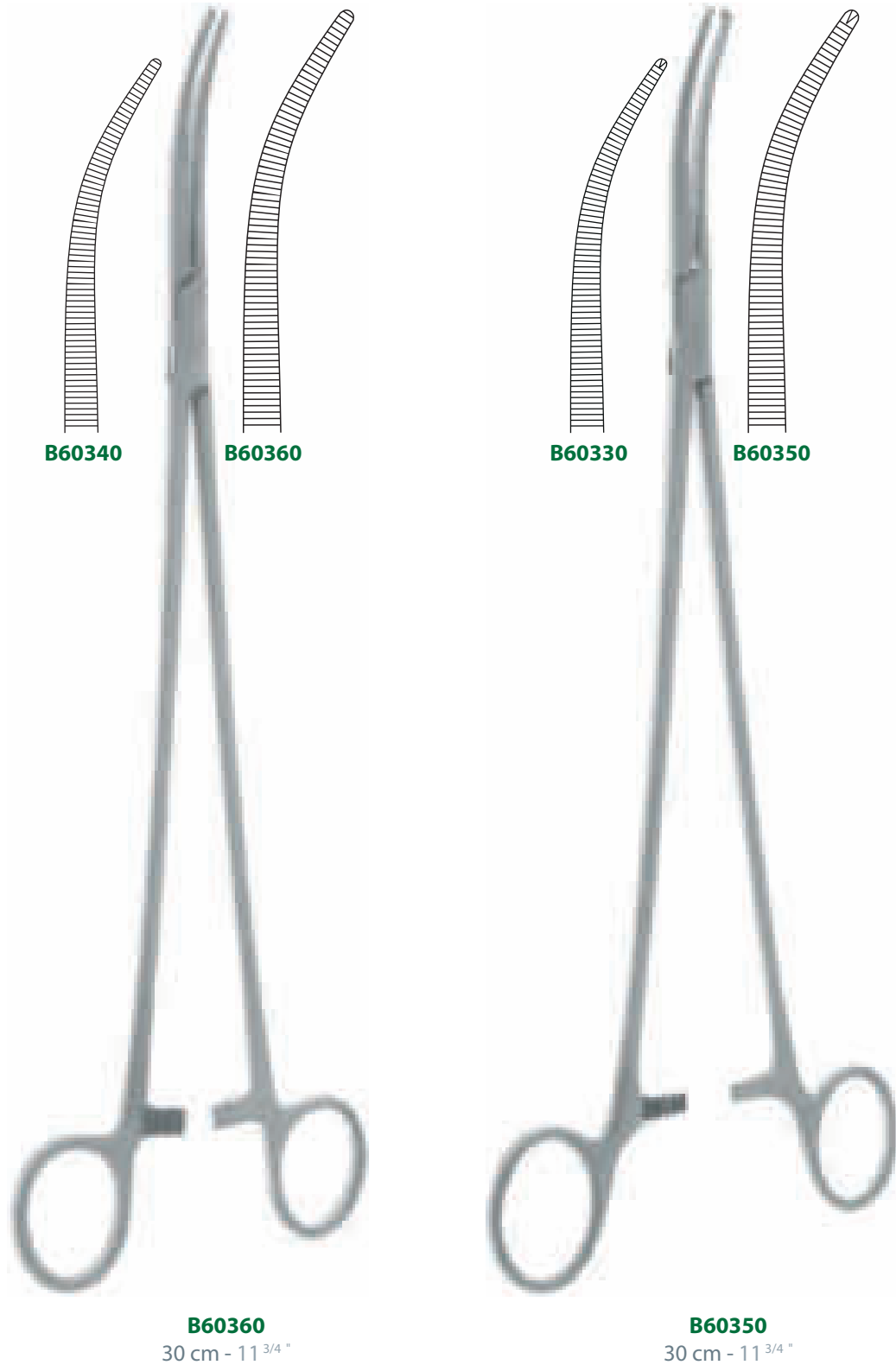

**B60340**

**B60360**

**B60330**

**B60350**

**B60360**

30 cm - 11 3/4"

**B60350**

30 cm - 11 3/4"

## Pinces hémostatiques longues - Long haemostatic forceps - Pinzas hemostáticas largas

### MOYNIHAN

23 cm - 9"

**B604390**

24 cm - 9 1/2"

**B60440**



### CRAFOORD

18 cm - 7"

**B609122**

24 cm - 9 1/2"

**B609123**



**B604390**

**B60440**

**B60440**

24 cm - 9 1/2"



**B609122**

**B609123**

**B609123**

24 cm - 9 1/2"



## BAINBRIDGE

Droite  
Straight  
Recta

Courbe  
Curved  
Curva

**B508000**

15 cm - 6"

**B508002**



**B508001**

18 cm - 7"

**B508003**



## CRAFOORD (SELLORS)

Droite  
Straight  
Recta

1/2 Courbe  
1/2 Curved  
1/2 Curva

Courbe  
Curved  
Curva

Très courbe  
Very curved  
Muy curva



**B60770**

24 cm - 9 1/2 "

**B60790**

24 cm - 9 1/2 "

**B607901**

23 cm - 9 "

**B607902**

22 cm - 8 3/4 "



**B60770**

24 cm - 9 1/2 "



**B60770**

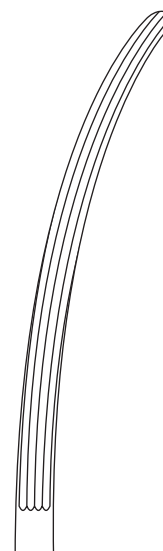

**B60790**

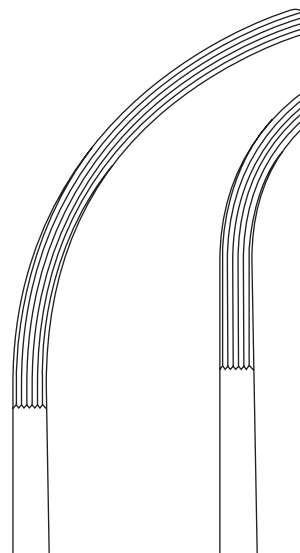

**B607901**

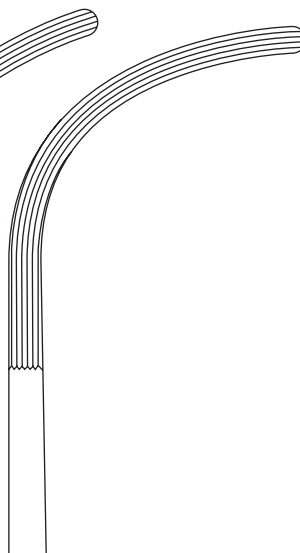

**B607902**



### MICHON

### LEGUEU

A doigt  
Collin's lock  
Desmontable



**B55260**  
24 cm - 9 1/2 "



**B55280**  
24 cm - 9 1/2 "

### GOUILLOUD

A doigt  
Collin's lock  
Desmontable

### TOUPET



**B55300**  
22 cm - 8 <sup>3</sup>/<sub>4</sub> "

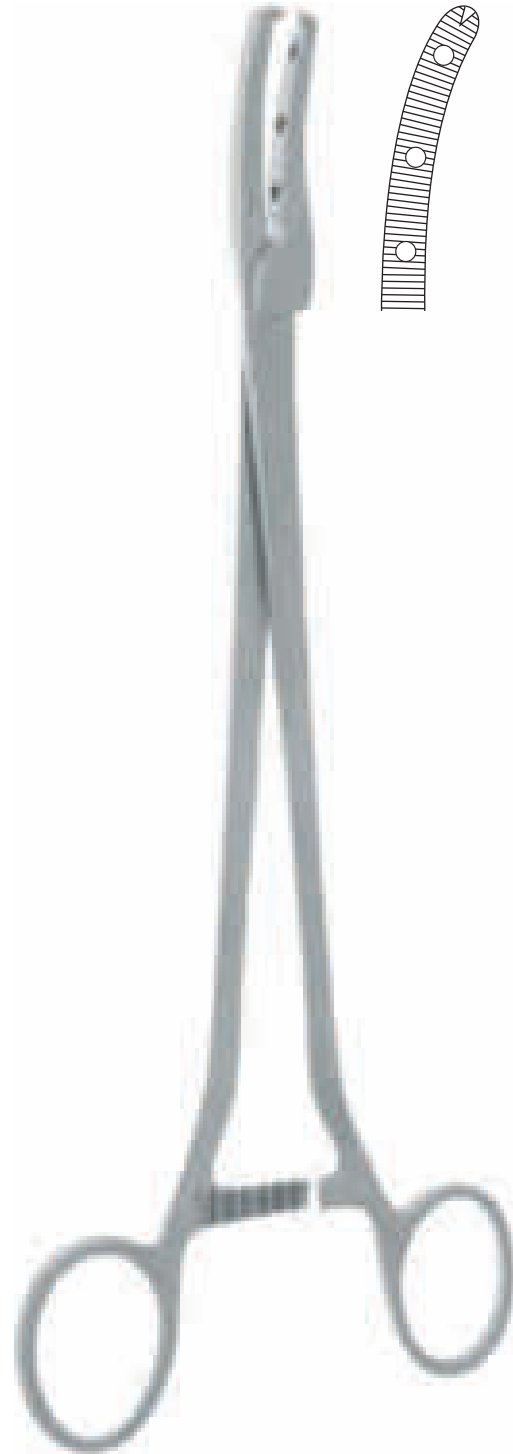

**B55310**  
24 cm - 9 <sup>1</sup>/<sub>2</sub> "

IV - Pinces  
IV - Forceps  
IV - Pinzas

## MIKULICZ

Pinces pour le péritoine  
Peritoneal forceps  
Pinzas para peritoneo

Fine - Fine - Fina

18 cm - 7"

**B507662**

**B507661**

20 cm - 8"

-

**B50767**

## BABY-MIKULICZ

Courbe latérale  
Lateral curved  
Curva lateral

Courbe  
Curved  
Curva

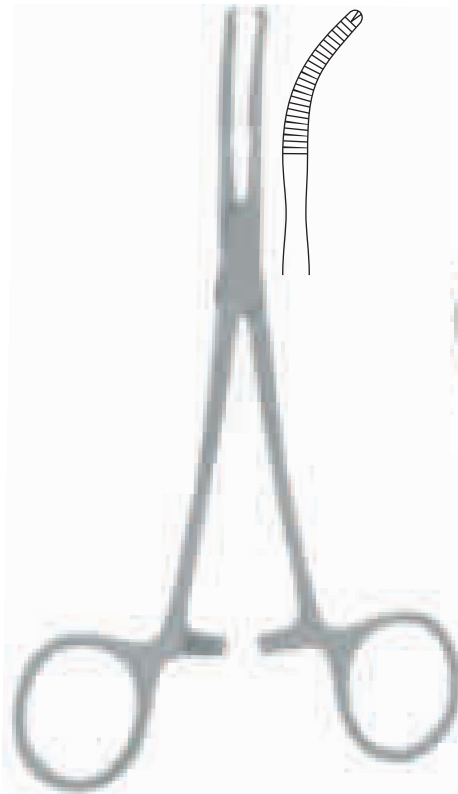

**B507660**  
14 cm - 5 1/2"

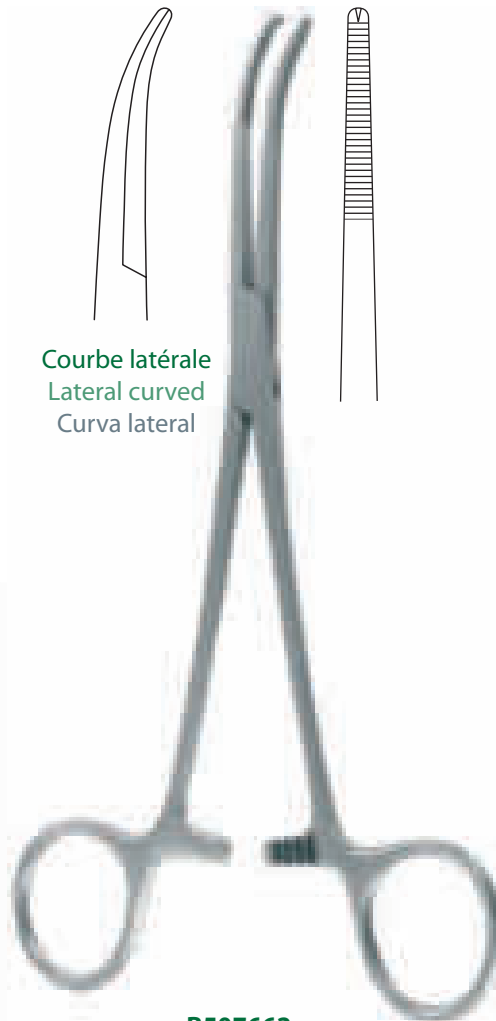

**B507662**  
18 cm - 7"

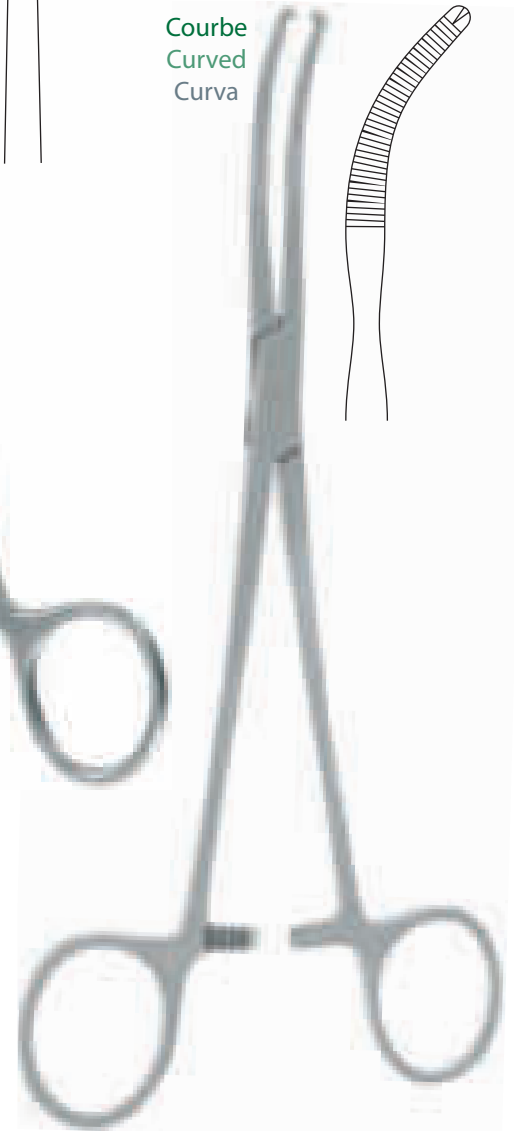

**B50767**  
20 cm - 8"

## MIKULICZ

Pinces pour le péritoine  
Peritoneal forceps  
Pinzas para peritoneo

A griffes  
With teeth  
Con dientes

Courbe  
Curved  
Curva

Très courbe  
Very curved  
Muy curva

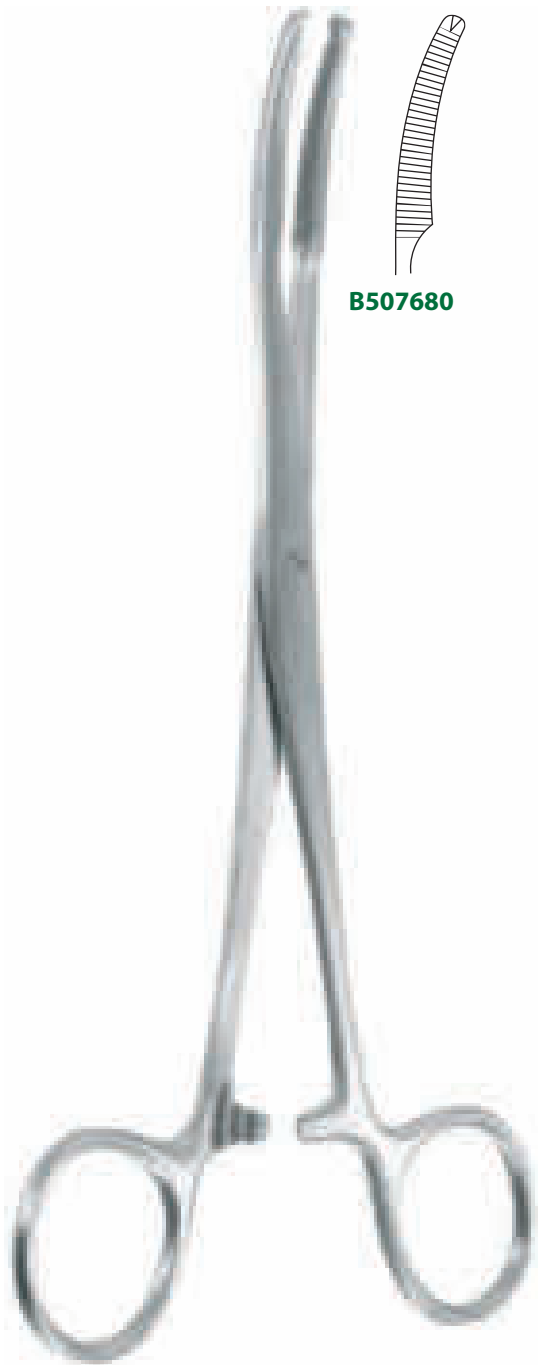

**B507680**

**B507680**  
18 cm - 7"



**B507690**

**B507695**

**B507690**  
20 cm - 8"

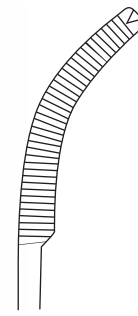
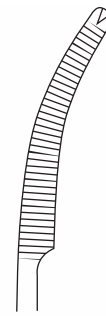

BABY-ADSON

14 cm - 5 1/2"

**B605300** 

18 cm - 7"

**B605301**

REDON

Courbe  
Curved  
Curva

Très courbe  
Very curved  
Muy curva



**B60535**  
14 cm - 5 1/2 "



**B605300**

**B605301**

**B605300**  
14 cm - 5 1/2 "

## O 'SHAUGNESSY

	45° Fin 45° Fine 45° Fino	90° Fin 90° Fine 90° Fino
14 cm - 5 1/2 "	B60540	B60601
16 cm - 6 1/4 "	B60545	B60602 
18 cm - 7 "	B60550	B60603
20 cm - 8 "	B60560	B60604
22 cm - 8 3/4 "	B60570	B60605
24 cm - 9 1/2 "	B60580	B60606
28 cm - 11 "	B60590	B60607
30 cm - 11 3/4 "	B60600	B60608



**B60545**  
16 cm - 6 1/4 "

**B60602**  
16 cm - 6 1/4 "





### O'SHAUGNESSY

	45° Fort 45° Strong 45° Fuerte	90° Fort 90° Strong 90° Fuerte
14 cm - 5 1/2 "	B60610	B60710
16 cm - 6 1/4 "	<b>B60615</b>	<b>B60715</b> 
18 cm - 7 "	B60620	B60720
20 cm - 8 "	B60630	B60730
22 cm - 8 3/4 "	B60640	B60740
24 cm - 9 1/2 "	B60650	B60750
28 cm - 11 "	B60660	B60752
30 cm - 11 3/4 "	B60670	B60753

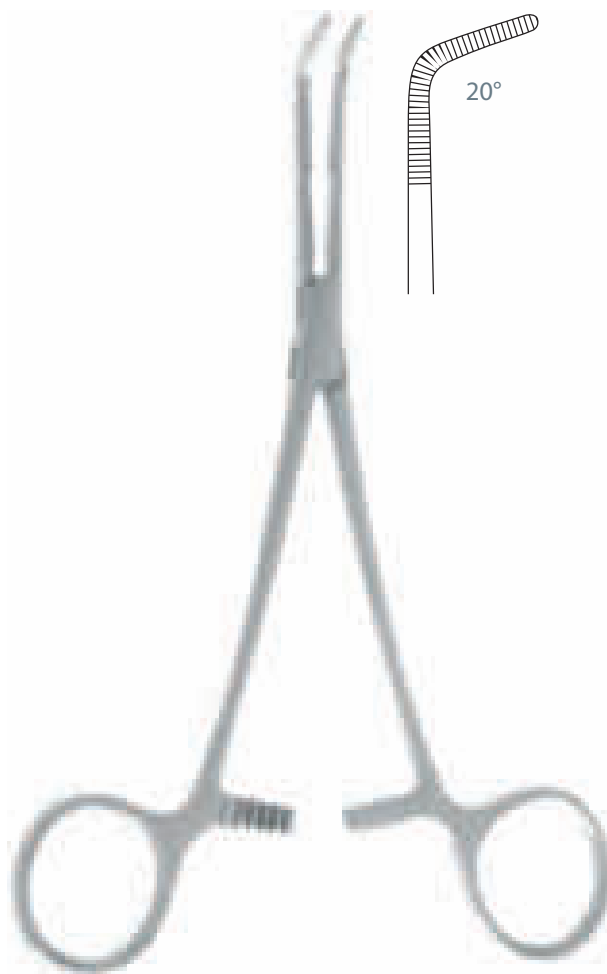

**B60615**  
16 cm - 6 1/4 "

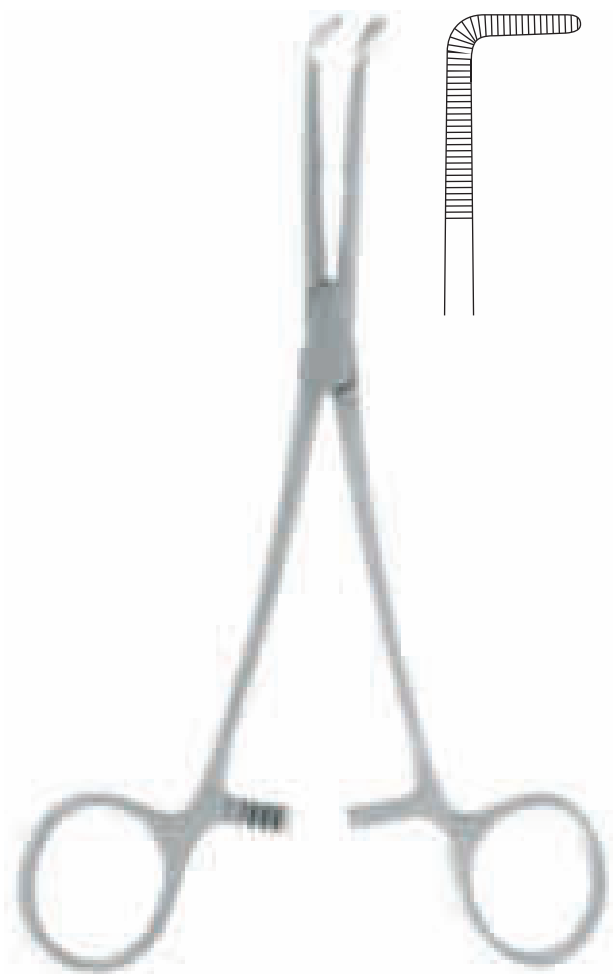

**B60715**  
16 cm - 6 1/4 "

## O'SHAUGNESSY

## ALLAINE

21,5 cm - 8 1/2" **B60894** 

26,5 cm - 10 1/2" **B60895**

Très courbe  
Very curved  
Muy curva

Double courbure  
Double bend  
Dobla curvatura

Double courbure  
Double bend  
Dobla curvatura



**B60700**  
24 cm - 9 1/2"

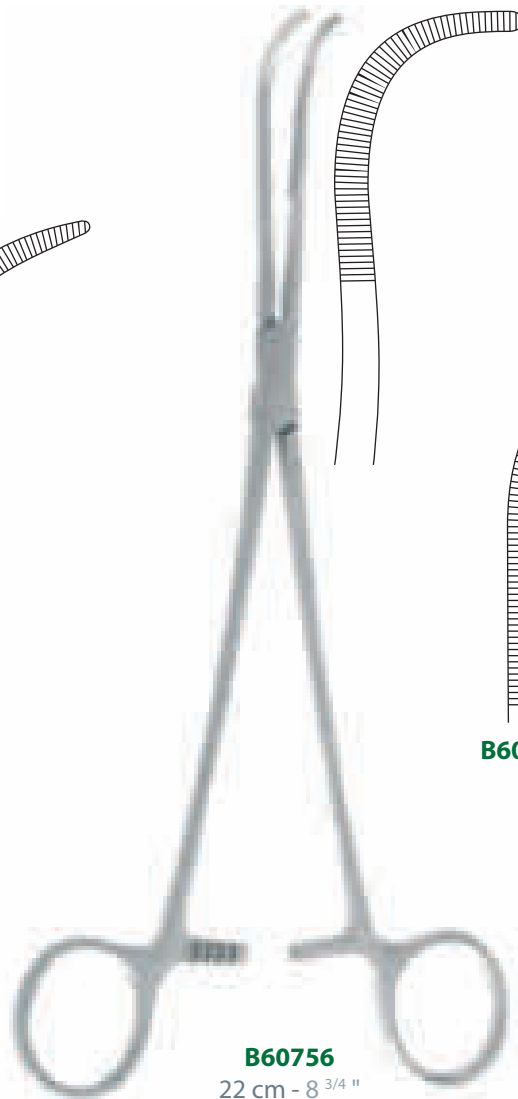

**B60756**  
22 cm - 8 3/4"

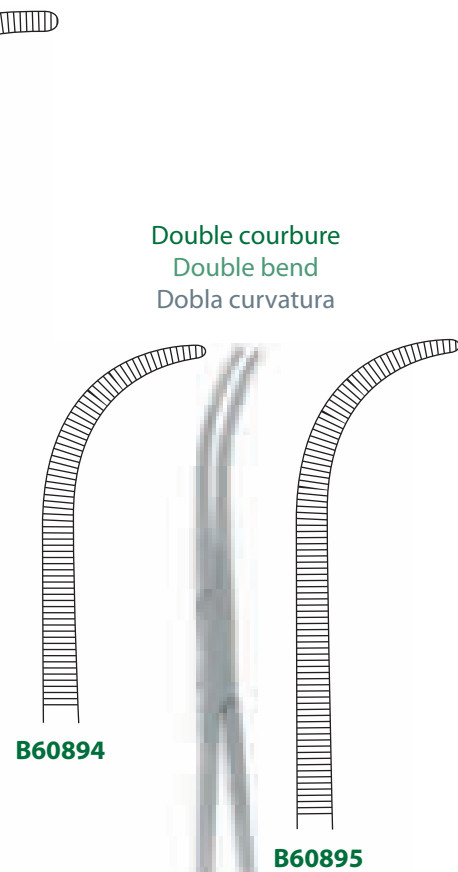

**B60894**

**B60895**

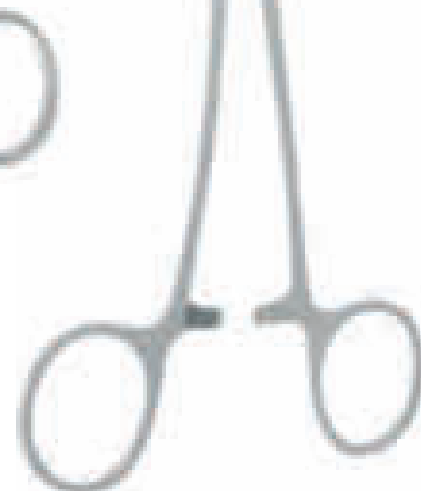

**B60894**  
21,5 cm - 8 1/2"

## OVERHOLT-GEISSENDORFER

21 cm - 8 1/4 "	<b>B612100</b>	B612110	B612120	B612130	B612140	B612150	B612160
27 cm - 10 1/2 "	B612700	B612710	B612720	B612730	B612740	B612750	B612760



**B612100**  
21 cm - 8 1/4 "

IV - Pinces  
IV - Forceps  
IV - Pinzas

## OVERHOLT-SLIM

B605000	18,5 cm - 7 1/4 "
B605001	20,5 cm - 8 "
B605002	21 cm - 8 1/4 "
B605003	21,5 cm - 8 1/2 "
	24 cm - 9 1/2 "

Double courbure  
Double bend  
Doble curvatura

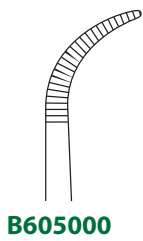

B605000

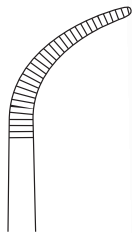

B605001

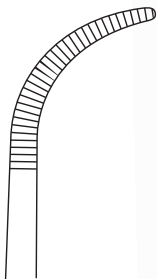

B605002

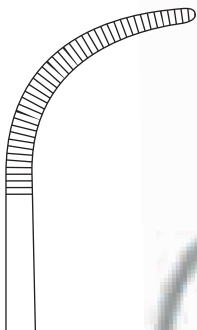

B605003

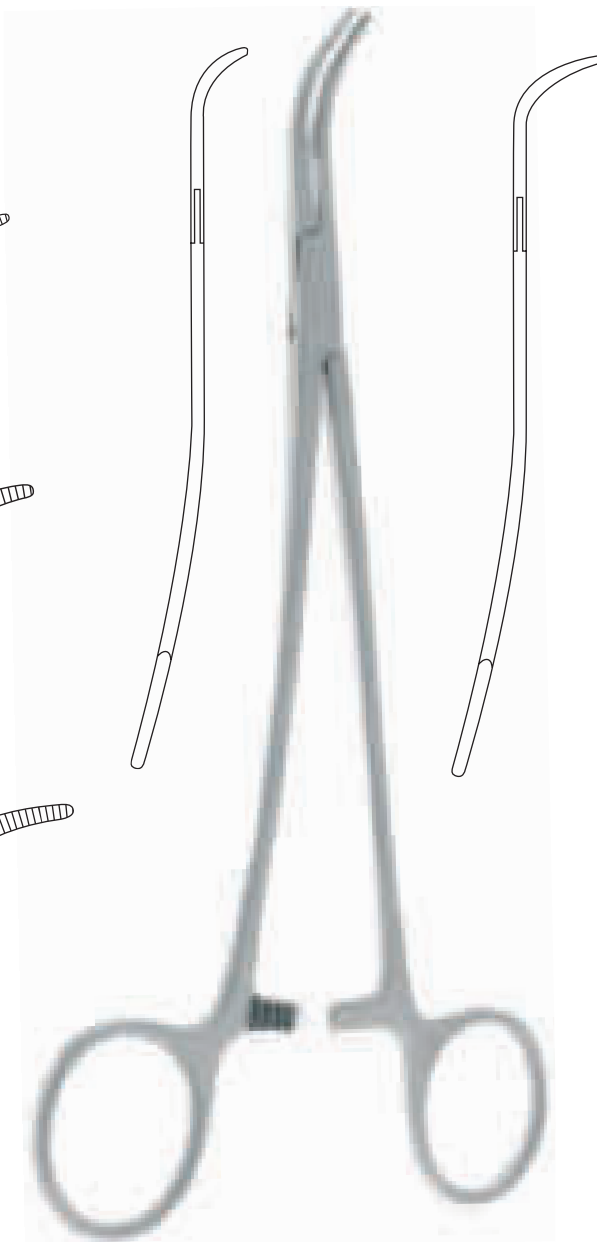

B605005  
20,5 cm - 8 "

## OVERHOLT-S

B605004	
B605005	
B605006	
B605007	
B605008	

Courbe "S"  
"S" curved  
Curva "S"

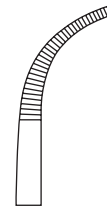

B605004

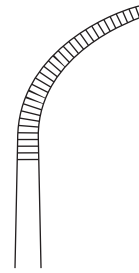

B605005

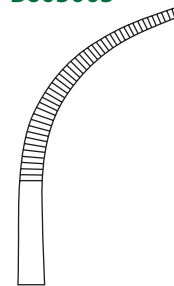

B605006

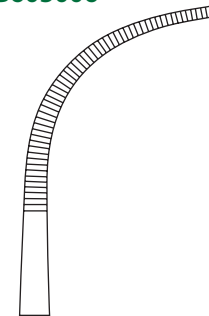

B605007

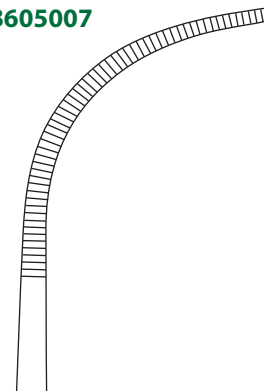

B605008

## SCHNIDT

## JACOBSON-ADSON

19 cm - 7 1/2"

**B609000**

**B609001**

18 cm - 7"

**B609104**

**B609105**

**B609106**

Très fine  
Very fine  
Muy finas

Courbe  
Curved  
Curva

Très courbe  
Very curved  
Muy curva

Droite  
Straight  
Recta

1/2 Courbe  
1/2 Curved  
1/2 Curva

Courbe  
Curved  
Curva



**B609000**

**B609001**

**B609000**  
19 cm - 7 1/2"

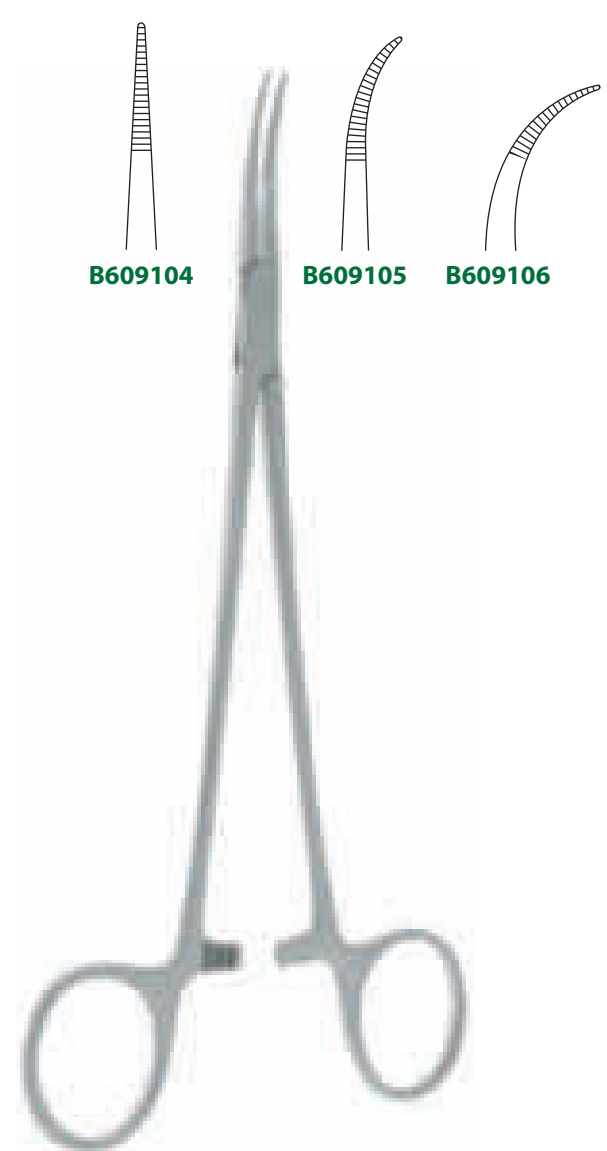

**B609104**

**B609105**

**B609106**

**B609105**  
18 cm - 7"

# LANDANGER

Pinces passe-fils, dissecteurs - Ligature forceps, dissectors - Disecadores

## GEMINI

Très courbe  
Very curved  
Muy curva

13 cm - 5 "	<b>B605250</b> 
18 cm - 7 "	<b>B605251</b>
20 cm - 8 "	<b>B605252</b>
23 cm - 9 "	<b>B605253</b>
25 cm - 10 "	<b>B605254</b>
28 cm - 11 "	<b>B605255</b>

## MINI GEMINI

Très courbe  
Very curved  
Muy curva

18 cm - 7 "	<b>B605256</b> 
22 cm - 8 <sup>3</sup> / <sub>4</sub> "	<b>B605257</b>
25 cm - 10 "	<b>B605258</b>
28 cm - 11 "	<b>B605259</b>

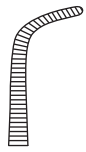

**B605250**

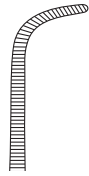

**B605251**

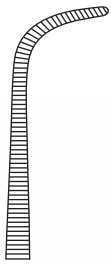

**B605252**

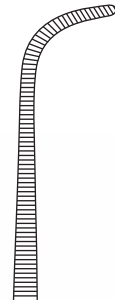

**B605253**

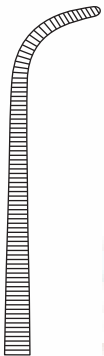

**B605254**

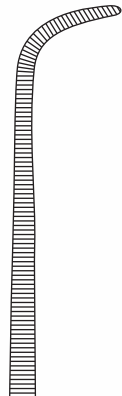

**B605255**

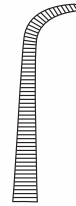

**B605256**

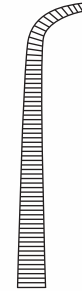

**B605257**

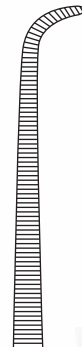

**B605258**

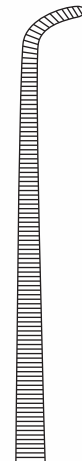

**B605259**

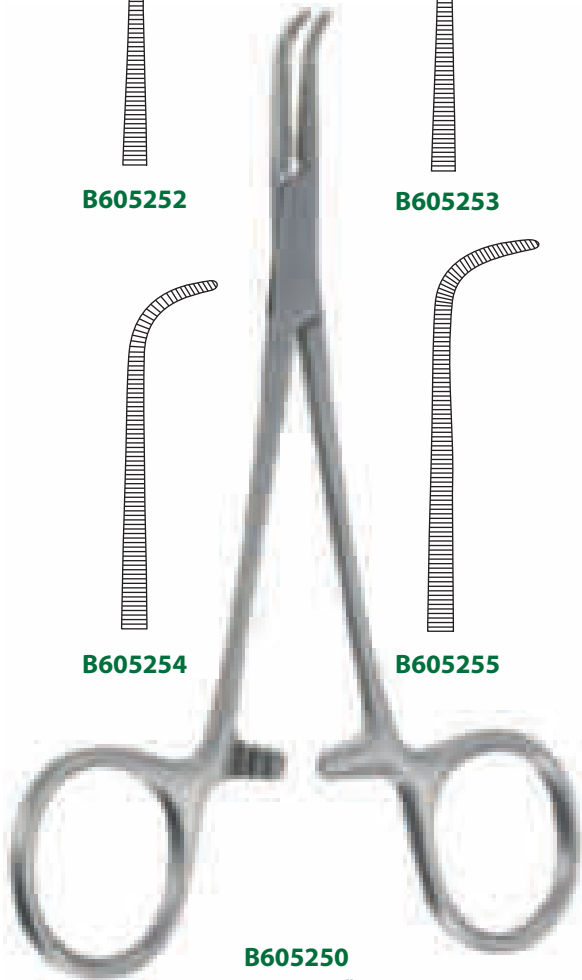

**B605250**  
13 cm - 5 "

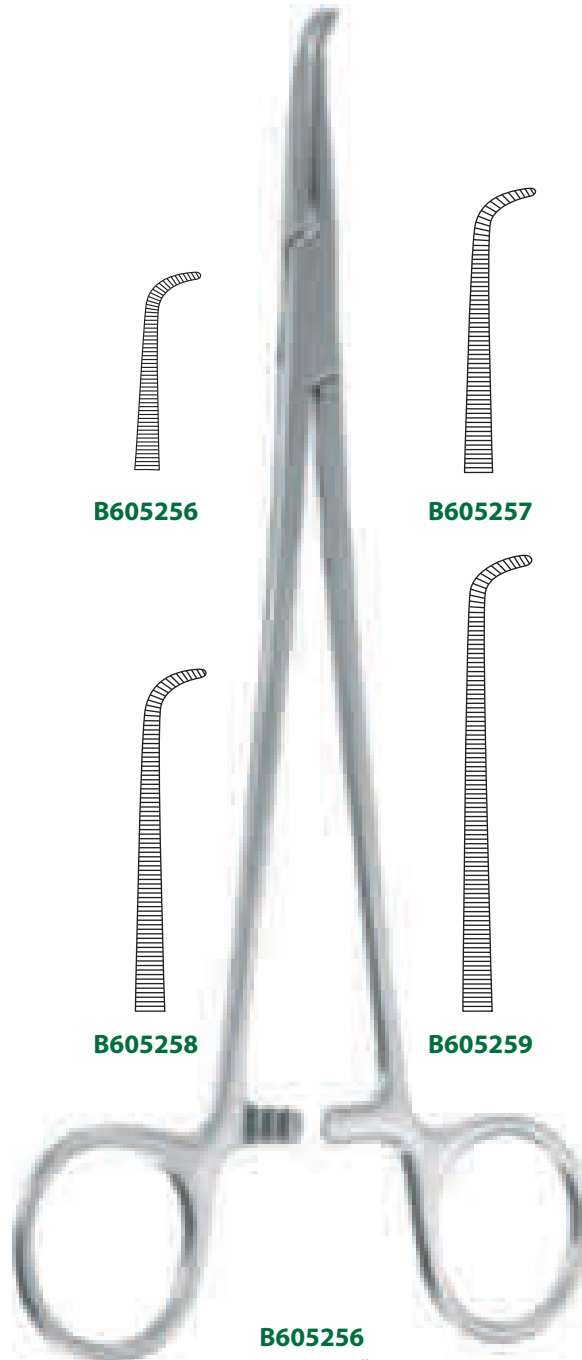

**B605256**  
18 cm - 7 "

IV - Pinces  
IV - Forceps  
IV - Pinzas

### BABY-MIXTER

Courbe Très courbe  
Curved Very curved  
Curva Muy curva

14 cm - 5 1/2" **B609125** **B609126**  
18 cm - 7" **B609127** 

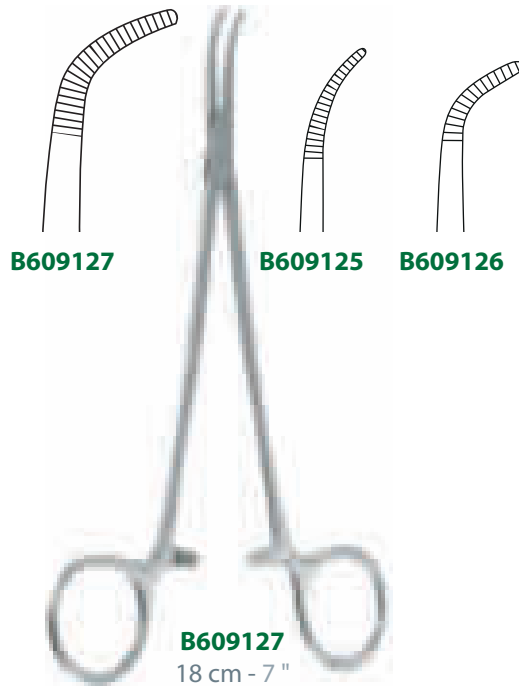

### MIXTER

15 cm - 6" **B609129**  
19 cm - 7 1/2" **B609130** 

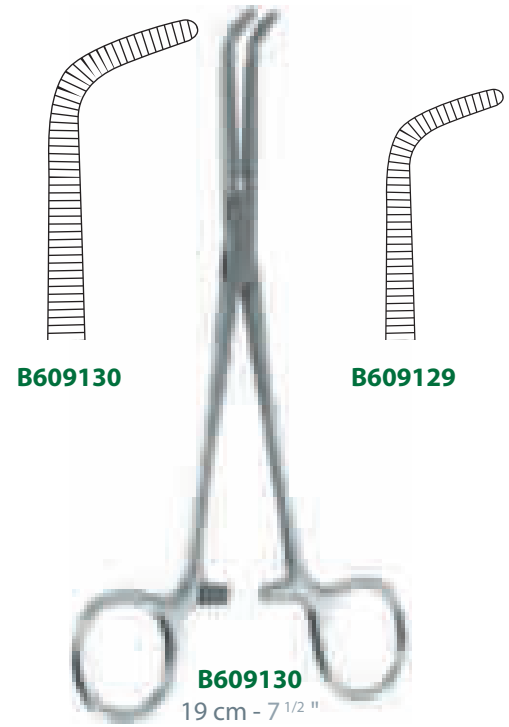

### BABY-OVERHOLT

Très courbe  
Very curved  
Muy curva

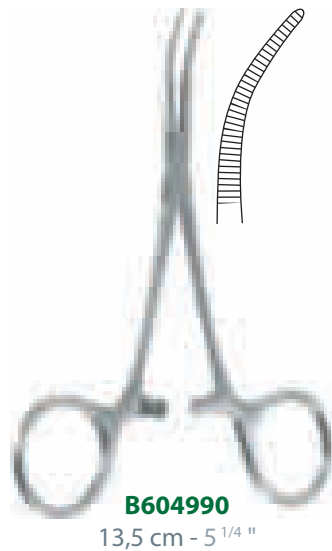

### MIXTER-O'SHAUGNESSY

15,5 cm - 6 1/2" **B609135**  
19 cm - 7 1/2" **B609140**

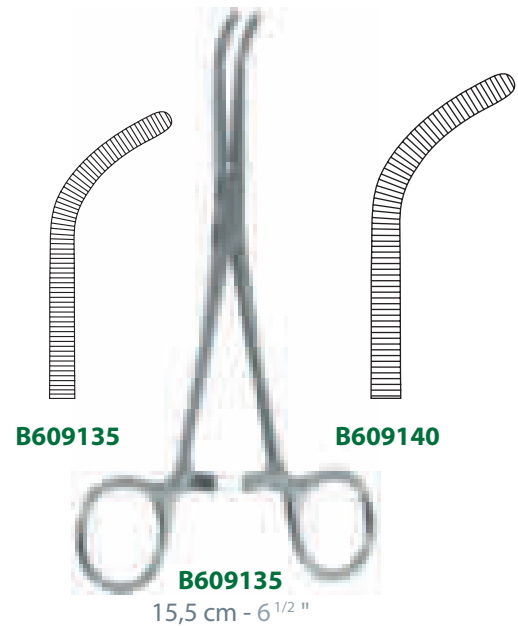

## WICKSTROEM

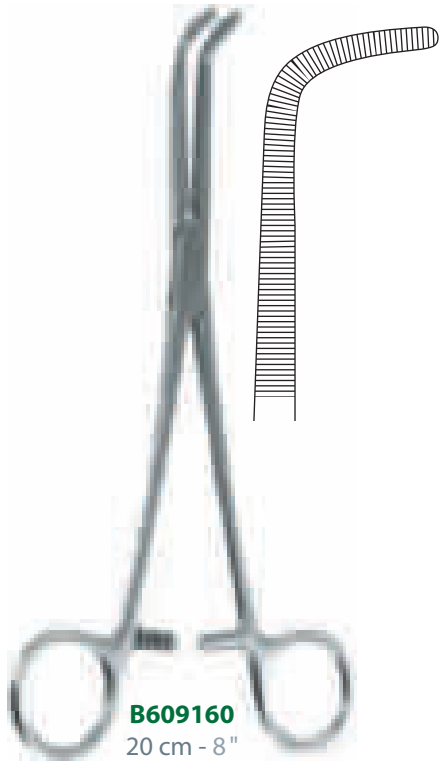

## LOWER

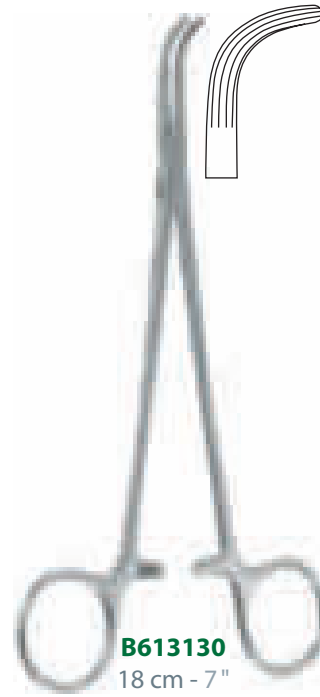

## MIXTER

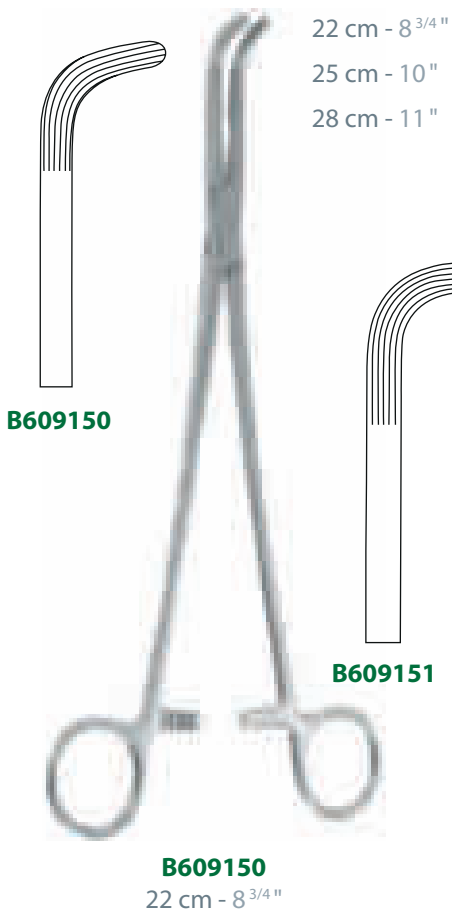

- 22 cm - 8<sup>3/4</sup>"
- 25 cm - 10"
- 28 cm - 11"

- B609150**
- B609151**
- B609152**

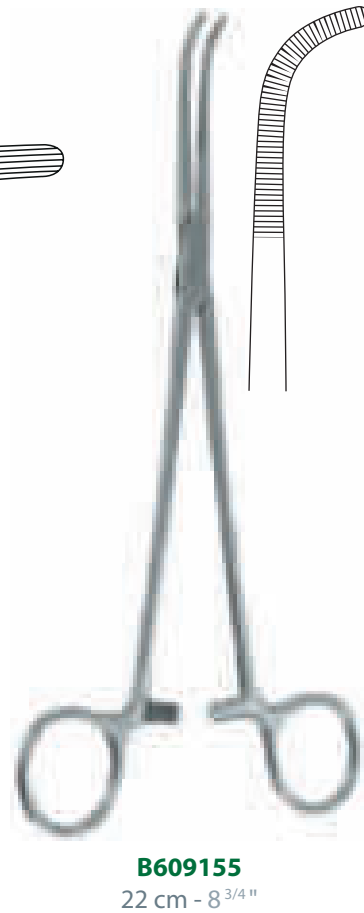
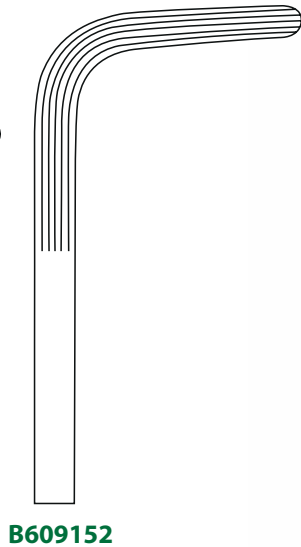
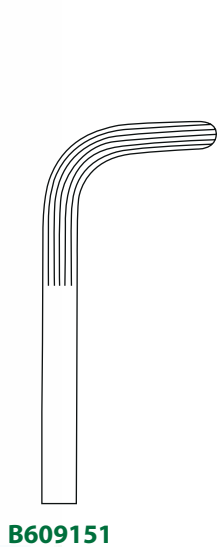

IV - Pincas  
IV - Forceps  
IV - Pinzas



## LAWRENCE

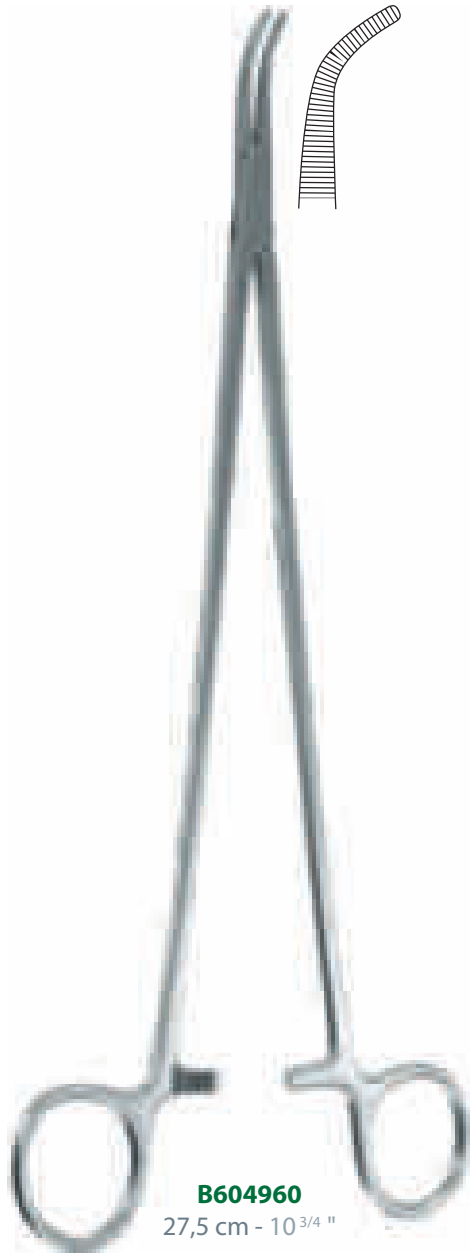

## ZENKER



## LAHEY (SWEET)

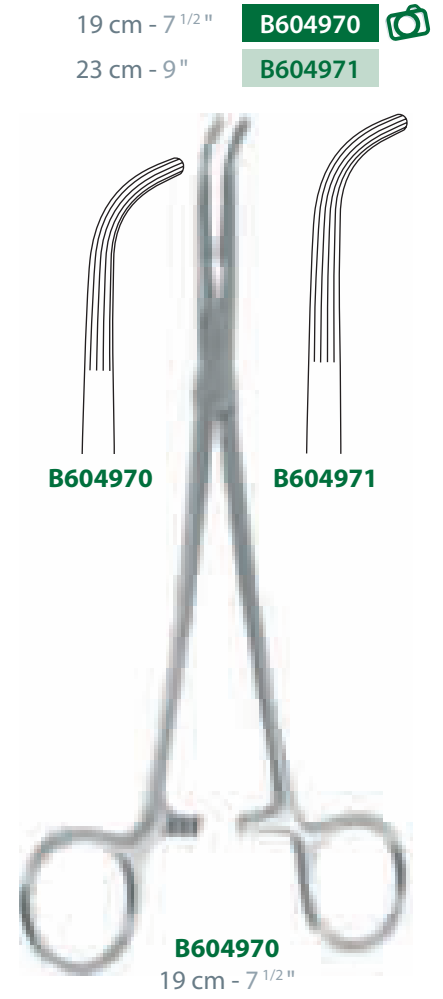

## KANTROWITZ

19 cm - 7 1/2"

**B607570** 

24 cm - 9 1/2"

**B607571**

26,5 cm - 10 1/2"

**B607569**

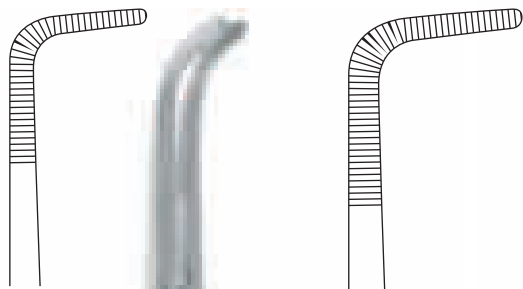

**B607571**

24 cm - 9 1/2"

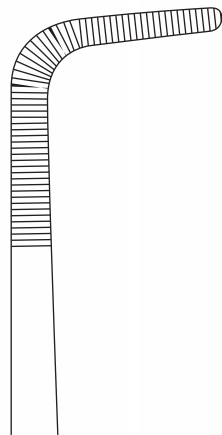

**B607569**

26.5 cm - 10 1/2"



**B607570**  
19 cm - 7 1/2"

## OVERHOLT-MIXTER

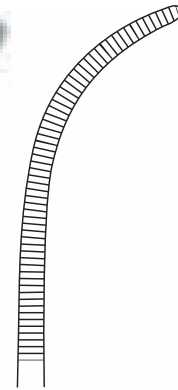

**B605009**  
22 cm - 8 3/4"

### QUILICY FARISSE

Sans crémaillère - Without ratchet - Sin cramallera

20 cm - 8"	<b>B613000</b> 
22 cm - 8 1/2"	<b>B613020</b>
24 cm - 9 1/2"	<b>B613040</b>
28 cm - 11"	<b>B613080</b>
30 cm - 11 3/4"	<b>B613100</b>

Avec crémaillère - With ratchet - Con cramallera

24 cm - 9 1/2"	<b>B613041</b>
----------------	----------------



Sans crémaillère  
Without ratchet  
Sin cramallera

**B613000**  
20 cm - 8"

**B613000**

**B613020**

**B613040**  
**B613041**

**B613080**

**B613100**

## RUMEL

## MEEKER

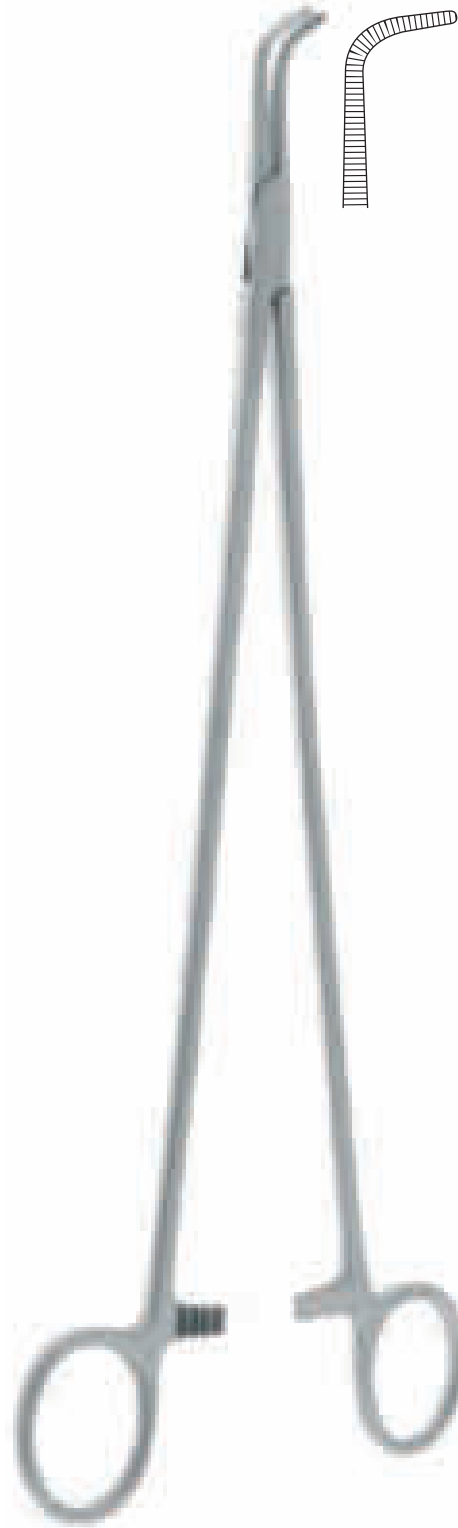
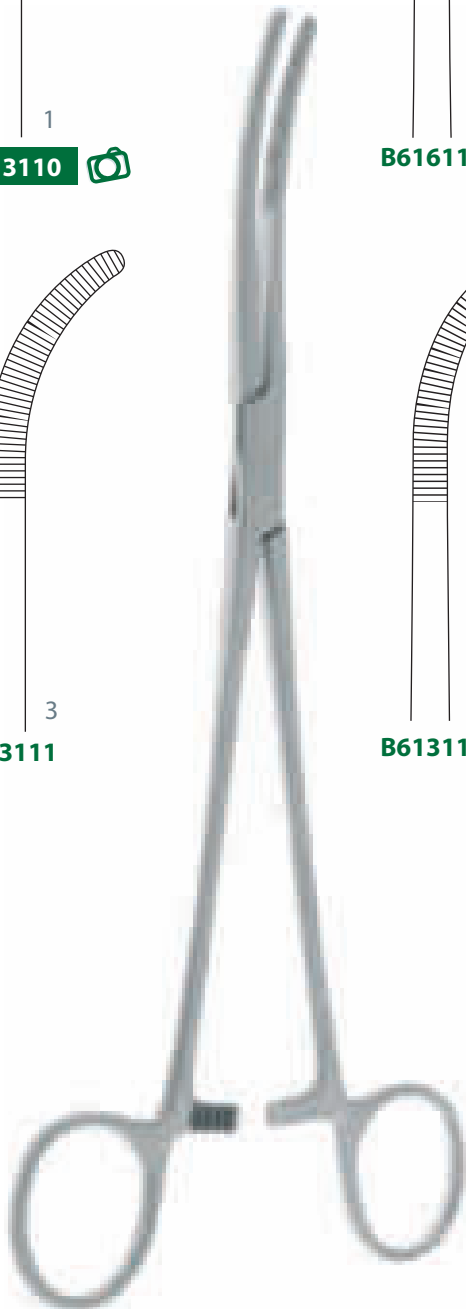
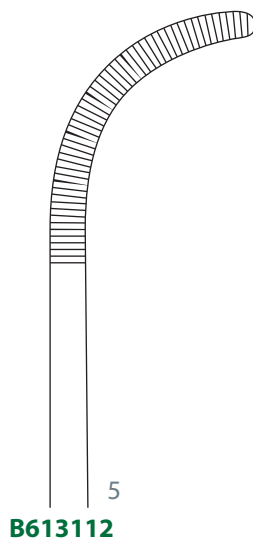
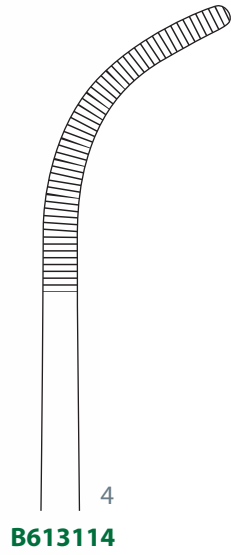
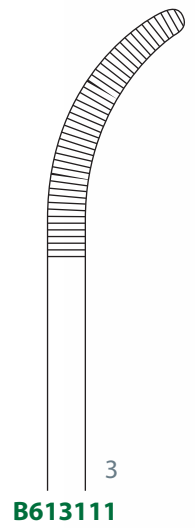
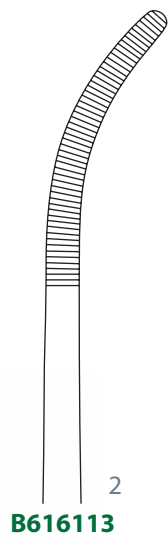
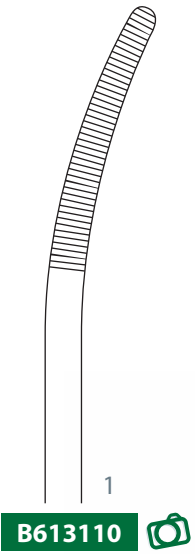

IV - Pinces  
IV - Forceps  
IV - Pinzas

SEMB

SEMB-SAYLOR

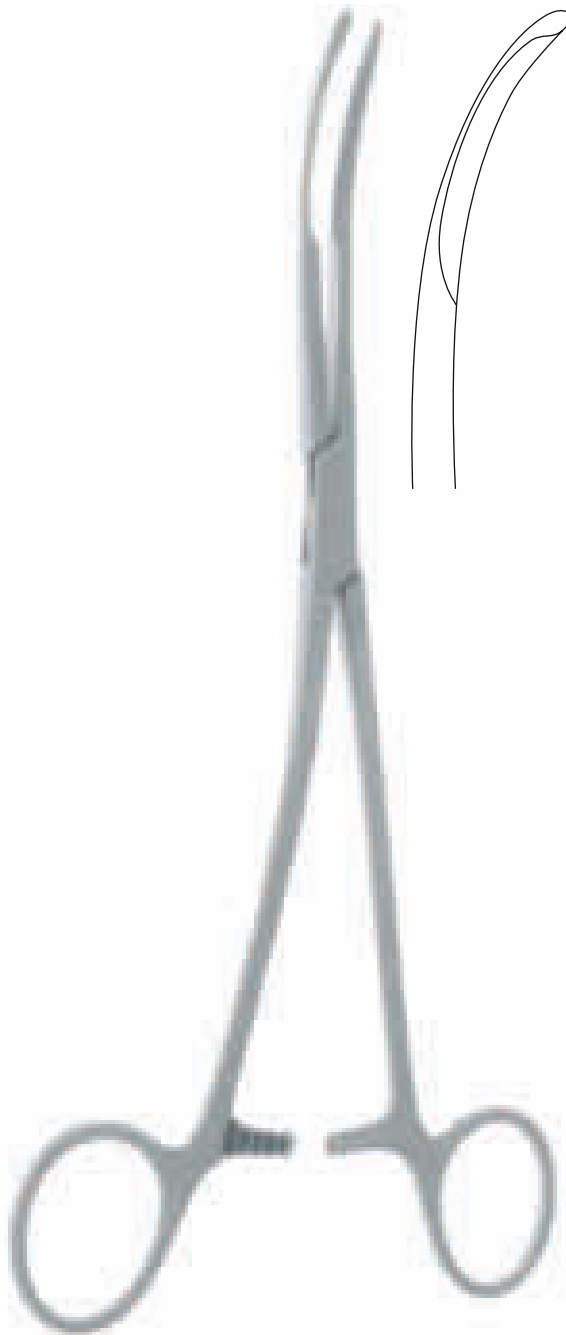

**B60810**  
22 cm - 8 <sup>3</sup>/<sub>4</sub> "



**B60820**  
25 cm - 10 "

IV - Pinces  
IV - Forceps  
IV - Pinzas

BARRAYA



**B60860**  
21 cm - 8 1/4 "



**B60870**  
21 cm - 8 1/4 "



FINOCHIETTO

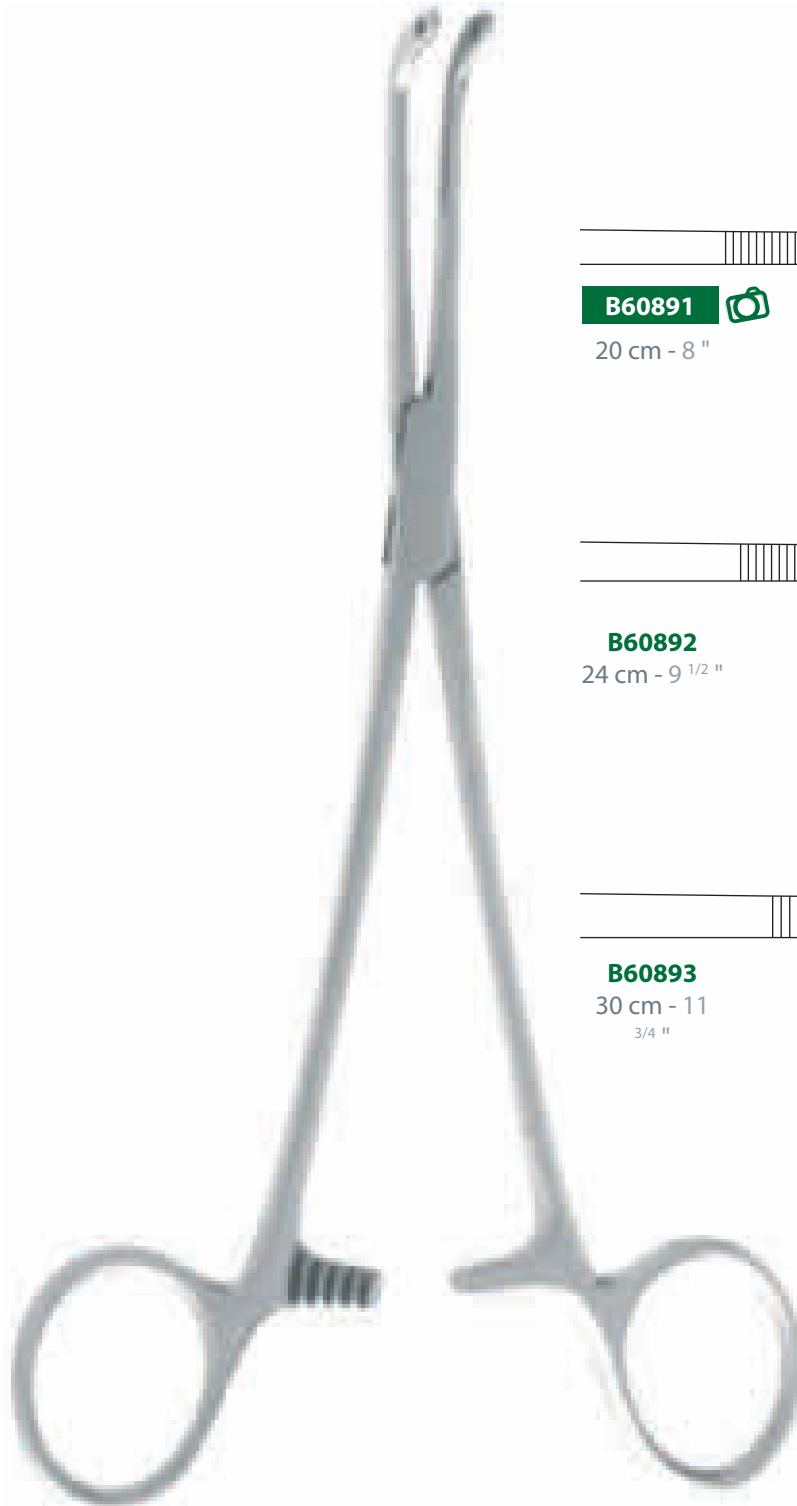

**B60891**   
20 cm - 8 "

**B60892**  
24 cm - 9 1/2 "

**B60893**  
30 cm - 11 3/4 "

**B60891**  
20 cm - 8 "

IV - Pinces  
IV - Forceps  
IV - Pinzas

## HARRINGTON

31 cm - 12 1/4" **B607572**

30,5 cm - 12" **B607574** 

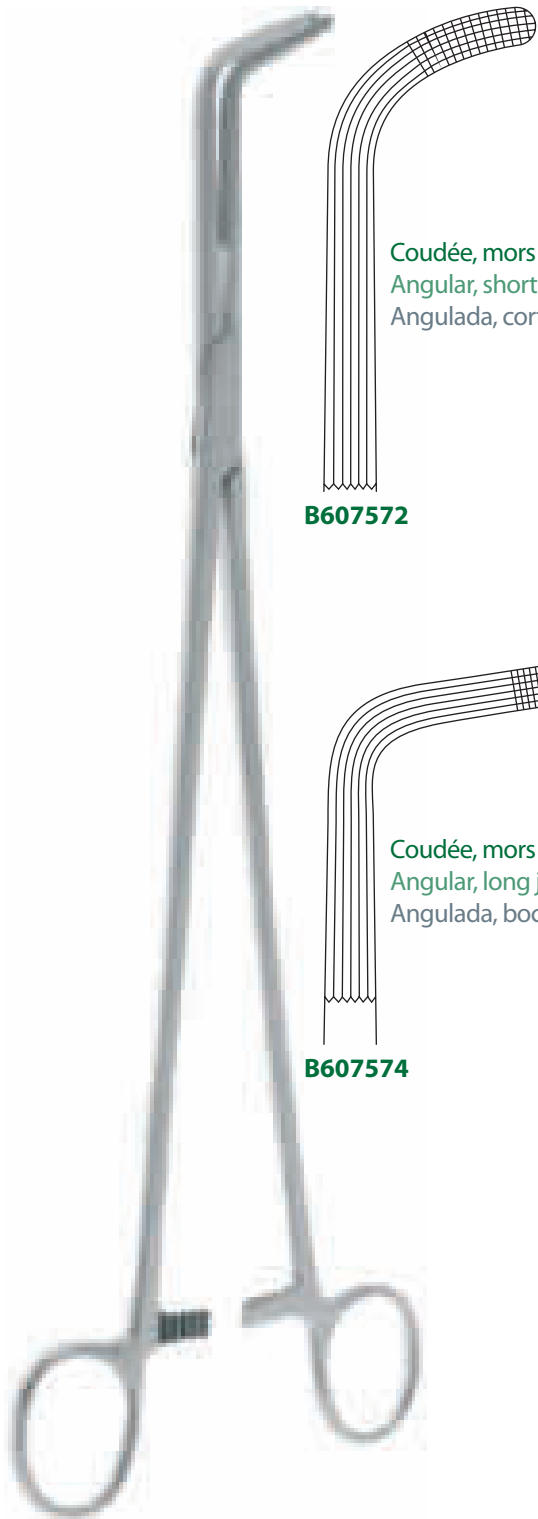

**B607572**

Coudée, mors courts forts  
Angular, short heavy jaws  
Angulada, corto fuerte bocas

**B607574**

Coudée, mors long  
Angular, long jaws  
Angulada, bocas largas

**B607574**  
30,5 cm - 12"

## RESANO

Coudée  
Angular  
Angulada



Double courbure  
Double bend  
Doble curvatura

**B640000**  
30 cm - 11 3/4"



## QUENU

## HARTMANN

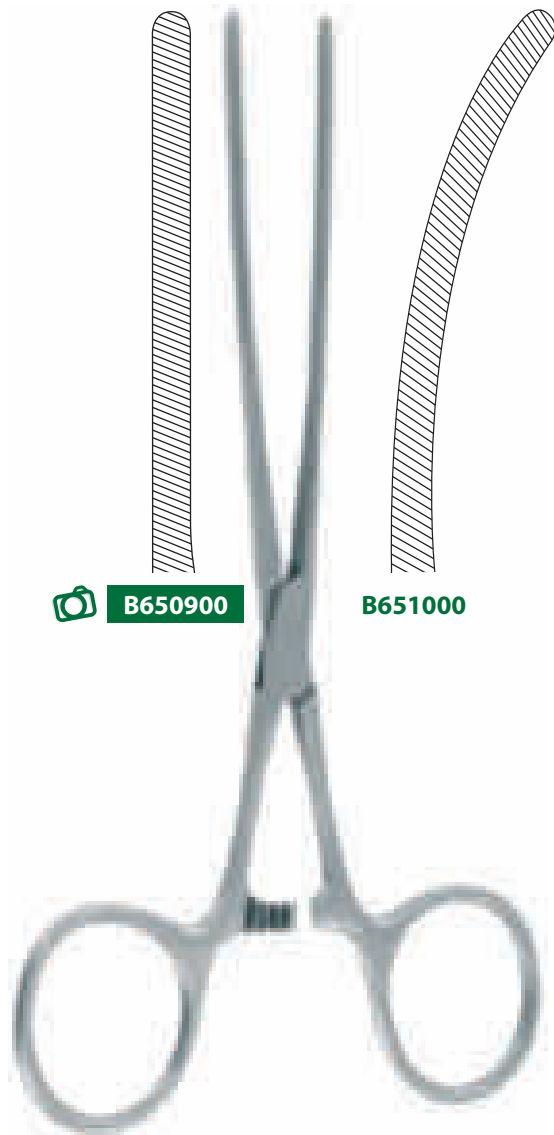

 **B650900**

**B651000**

**B650900**  
15 cm - 6 "

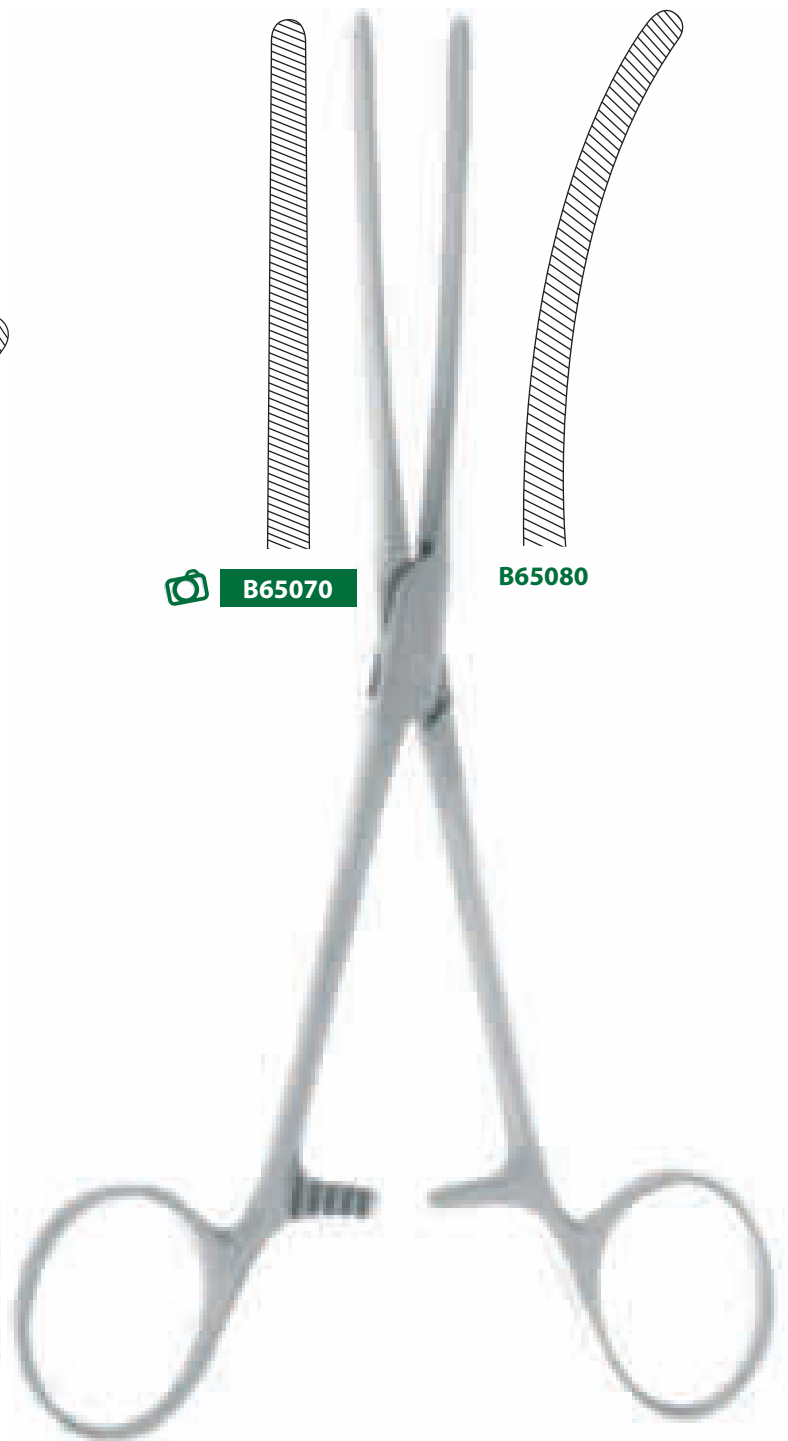

 **B65070**

**B65080**

**B65070**  
19 cm - 7 1/2 "

## DOYEN

## NEGUS

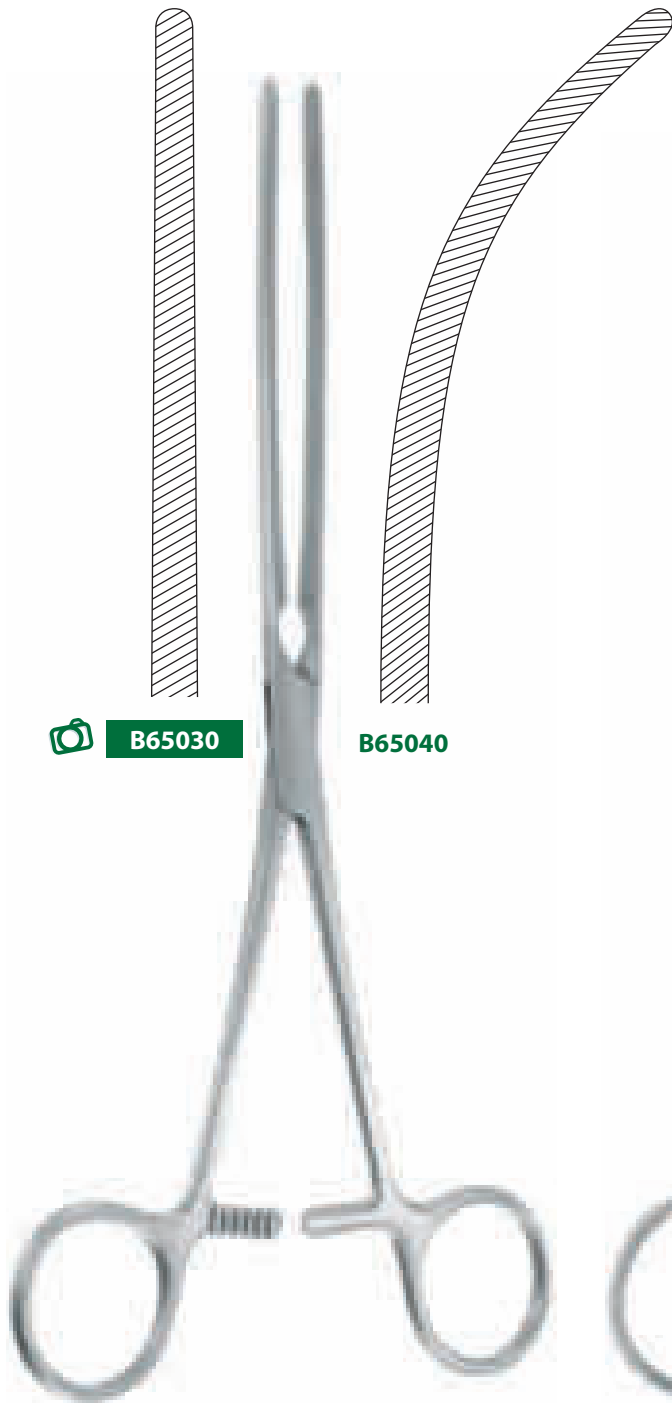

 **B65030**

**B65040**

**B65030**  
23 cm - 9 "

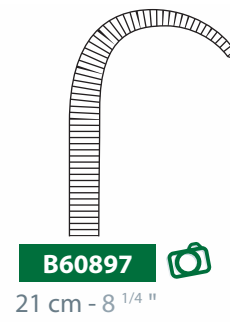

**B60897**  
21 cm - 8 1/4 "

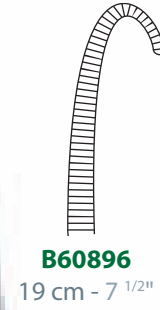

**B60896**  
19 cm - 7 1/2 "

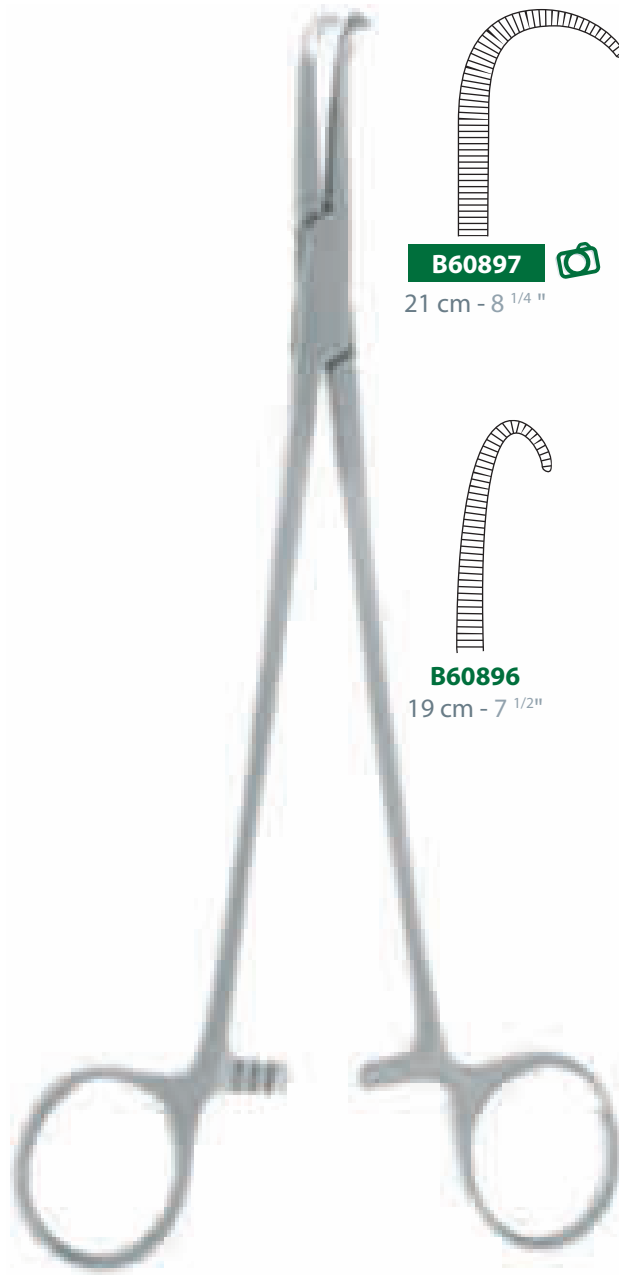

**B60897**  
21 cm - 8 1/4 "

IV - Pinces  
IV - Forceps  
IV - Pinzas

BABY-DOYEN

Droite  
Straight  
Recta



**C10855**  
13 cm - 5"

Courbe  
Curved  
Curva

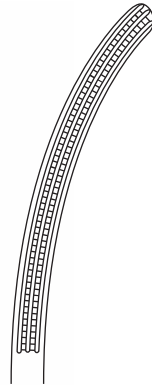

**C10860**

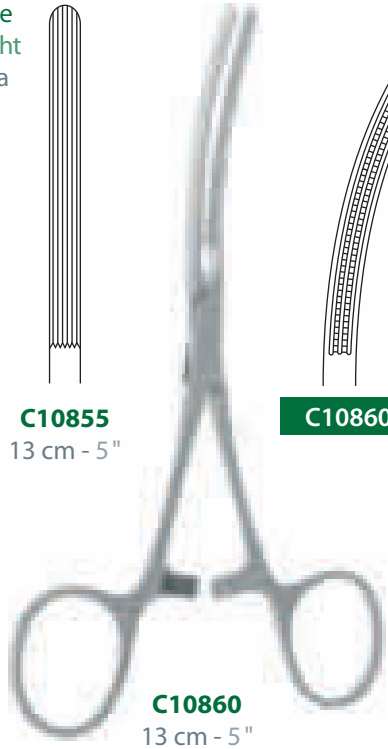

**C10860**  
13 cm - 5"

Mors non traumatisants  
Non-traumatic jaws  
Boca no traumática

SCHEIBE

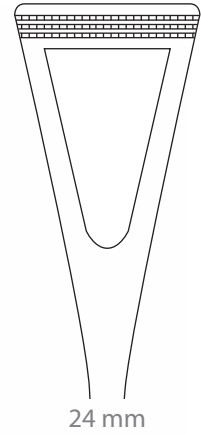

24 mm



**C10850**  
23 cm - 9"

BABY KOCHER

Droite  
Straight  
Recta



**C108540**

Courbe  
Curved  
Curva

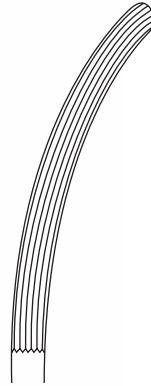

**C108545**  
13 cm - 5"

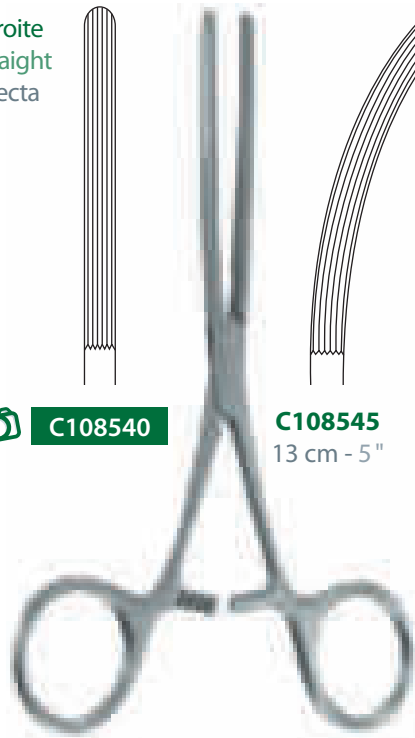

**C108540**  
13 cm - 5"

## MAYO ROBSON

	Droite Straight Recta		Courbe Curved Curva
	<b>C108990</b>	21 cm - 8 1/4 "	<b>C108995</b>
	<b>C108991</b>	23 cm - 9 "	<b>C108996</b>
	<b>C108992</b>	25 cm - 10 "	<b>C108997</b>
Mors non traumatisants - Non-traumatic jaws - Boca no traumática			
	<b>C10900</b>	25 cm - 10 "	<b>C10905</b>

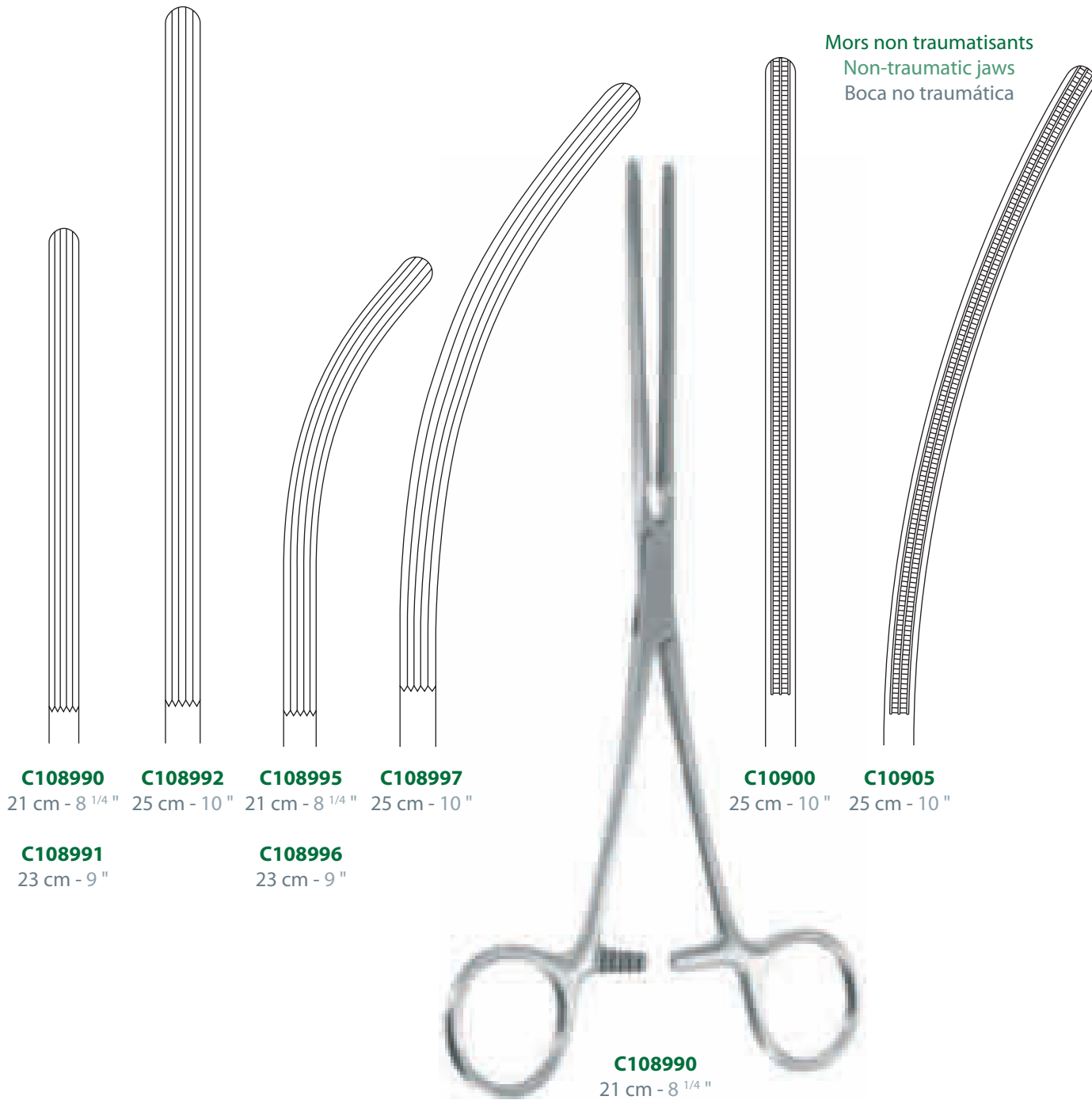

IV - Pinces  
IV - Forceps  
IV - Pinzas

## DOYEN

Droite  
Straight  
Recta

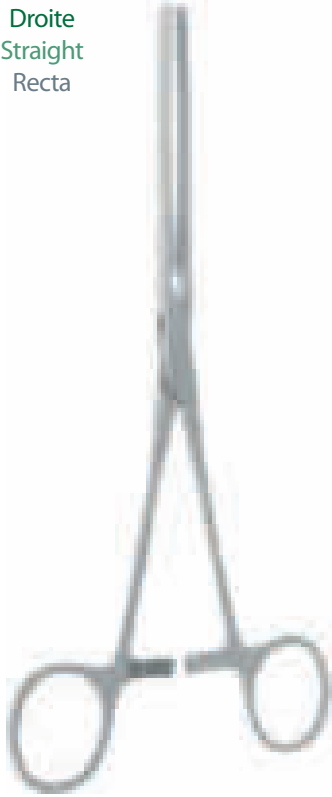

Mors non traumatisants  
Non-traumatic jaws  
Boca no traumática

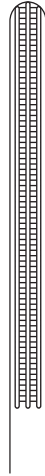

**C10865**  
18 cm - 7 "

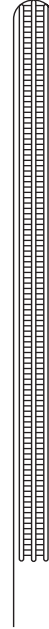

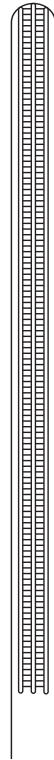

 **C10870**  
21 cm - 8 1/4 "

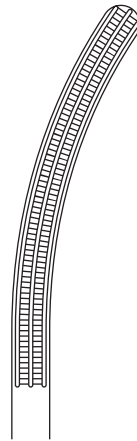
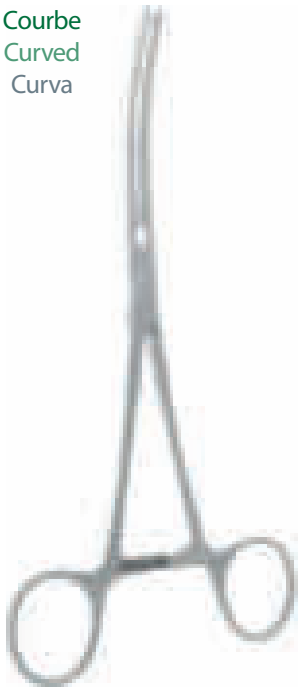

**C10875**  
23 cm - 9 "

Courbe  
Curved  
Curva



 **C10880**  
18 cm - 7 "

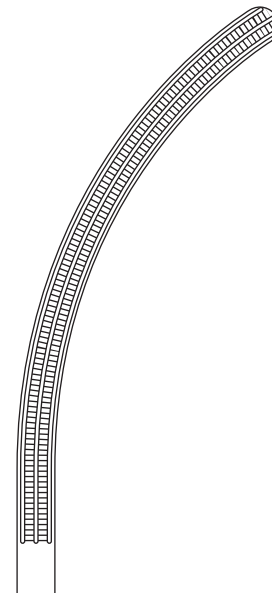

**C10890**  
21 cm - 8 1/4 "

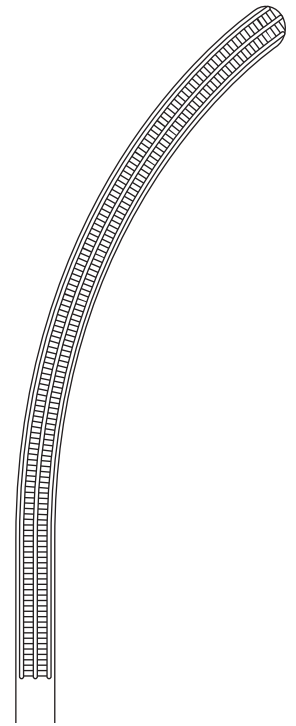



**C10895**  
23 cm - 9 "

## KOCHER

Droite  
Straight  
Recta

Courbe  
Curved  
Curva

 <b>C109090</b>	22 cm - 8 <sup>3</sup> / <sub>4</sub> "	<b>C109095</b> 
<b>C109091</b>	25 cm - 10 "	<b>C109096</b>
<b>C109092</b>	28 cm - 11 "	<b>C109097</b>



KOCHER

Mors non traumatisants - Non-traumatic jaws - Boca no traumática



IV - Pinces  
IV - Forceps  
IV - Pinzas

**C10910**  
22 cm - 8 3/4 "

 **C10915**  
25 cm - 10 "

**C10920**  
28 cm - 11 "

**C10925**  
22 cm - 8 3/4 "

**C10930**  
25 cm - 10 "

**C10935**  
28 cm - 11 "

**C10915**  
25 cm - 10 "

## PAYR

Pour enfant  
For children  
Para niños

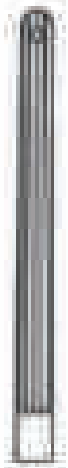

**BABY**

**C109500**  
15 cm - 5 3/4 "



**C109501**

21 cm - 8 1/4 "

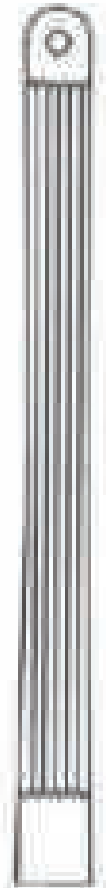

**C109502**

29 cm - 11 1/2 "



**C109503**

35 cm - 13 3/4 "

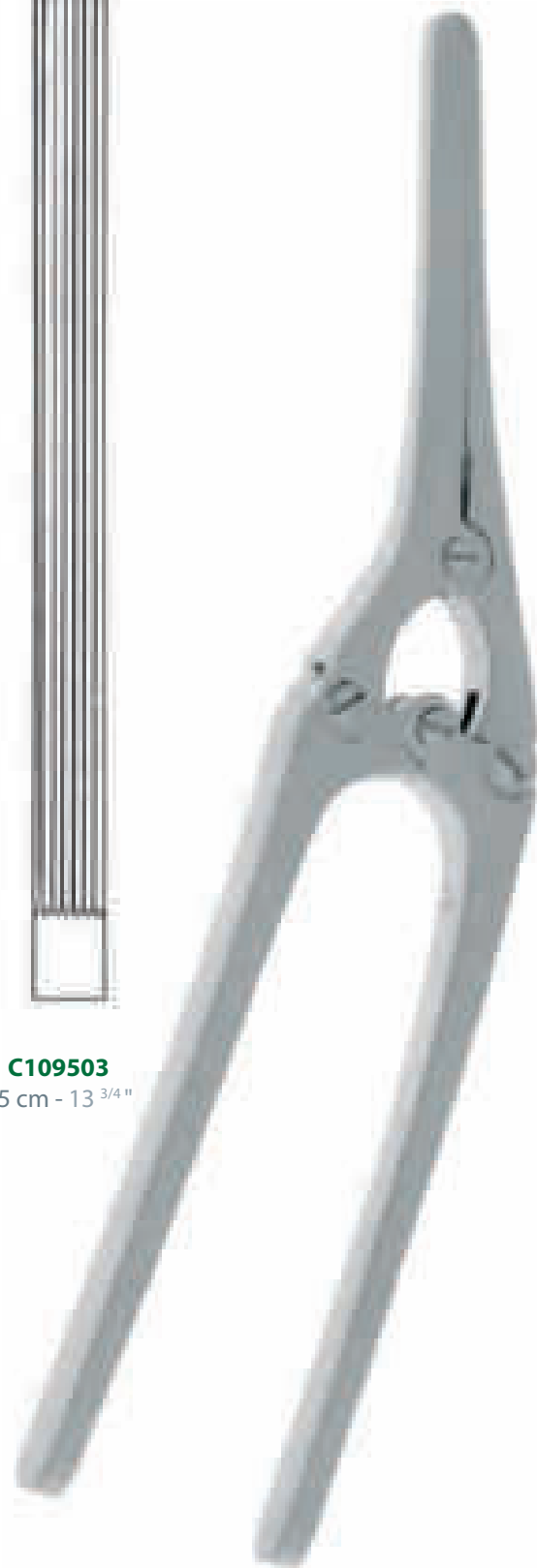

**C109501**  
21 cm - 8 1/4 "

IV - Pinces  
IV - Forceps  
IV - Pinzas



## BRUNNER

23 cm - 9 1/4"

**C109461**



24 cm - 9 1/2"

**C109460**

Mors non traumatisants  
Non-traumatic jaws  
Boca no traumática

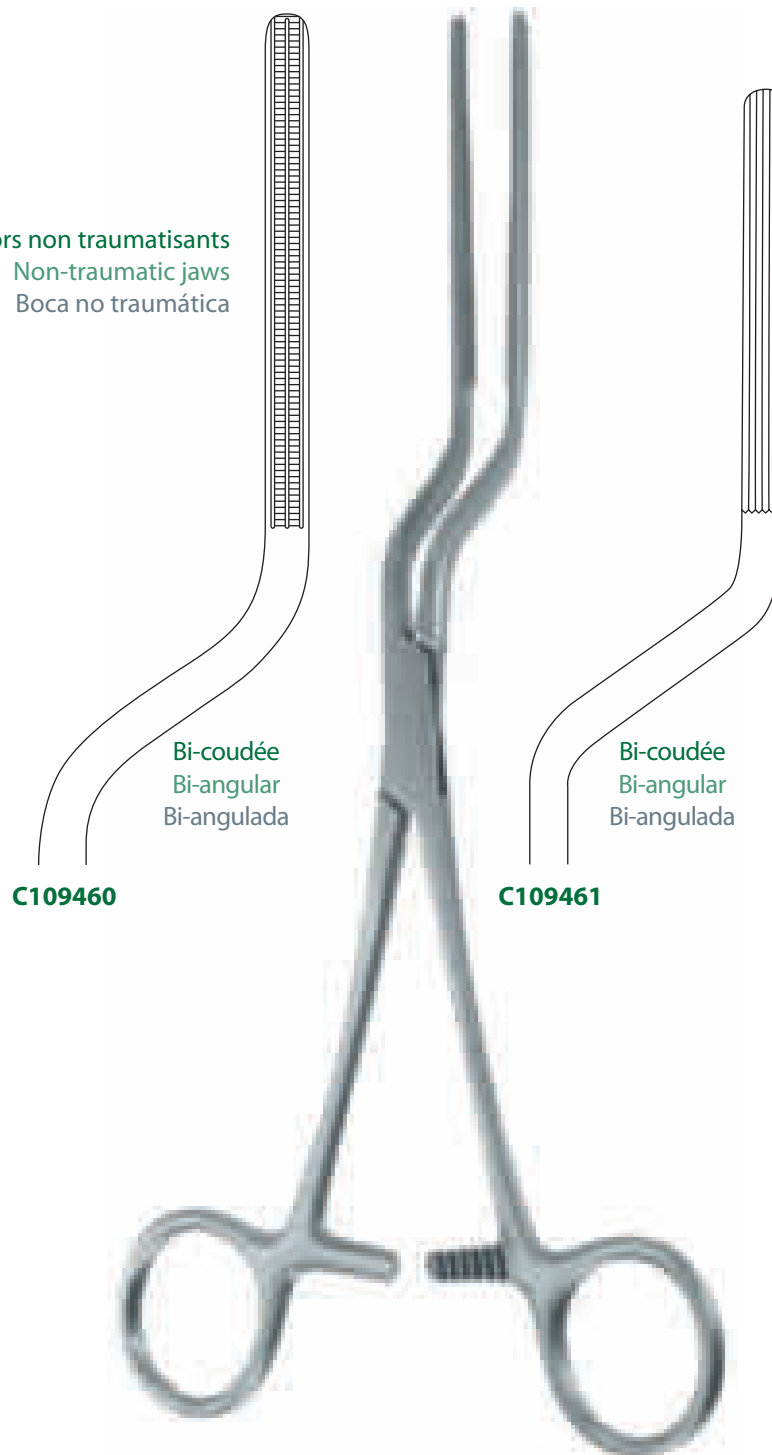

**C109460**

Bi-coudée  
Bi-angular  
Bi-angulada

**C109461**

Bi-coudée  
Bi-angular  
Bi-angulada

**C109461**

23 cm - 9 1/4"

## ALLEN

15,5 cm - 6"

**C108530**



20,5 cm - 8"

**C108531**

A griffes  
With teeth  
Con dientes



**C108530**



**C108531**

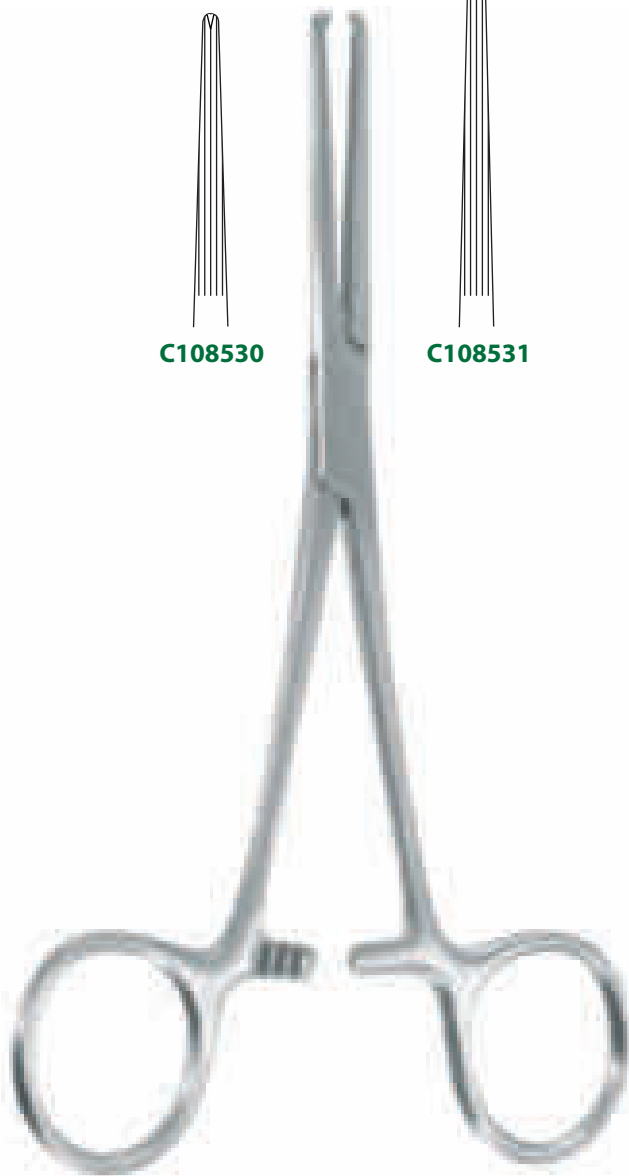

**C108530**  
15,5 cm - 6"

## KLEINSCHMIDT

Pince pour l'appendice  
Blind gut forceps  
Pinza para apendice

Coudée à griffes  
Angular with teeth  
Angulada con dientes

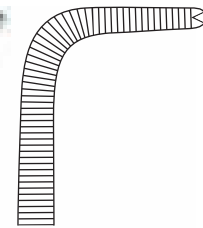

**B641000**  
12 cm - 4<sup>3/4</sup>"

SCUDDER

NUSSBAUM

Mors non traumatisants - Non-traumatic jaws - Boca no traumática

Droite  
Straight  
Recta

Courbe  
Curved  
Curva

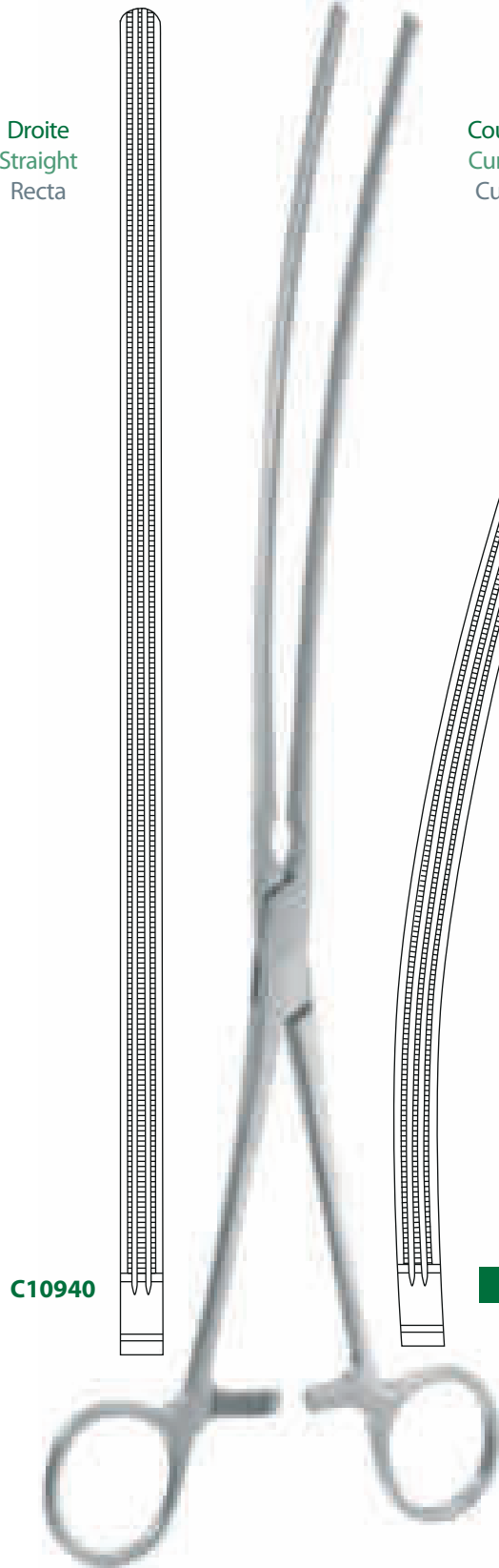

C10940

C10945

C10945  
33 cm - 13"

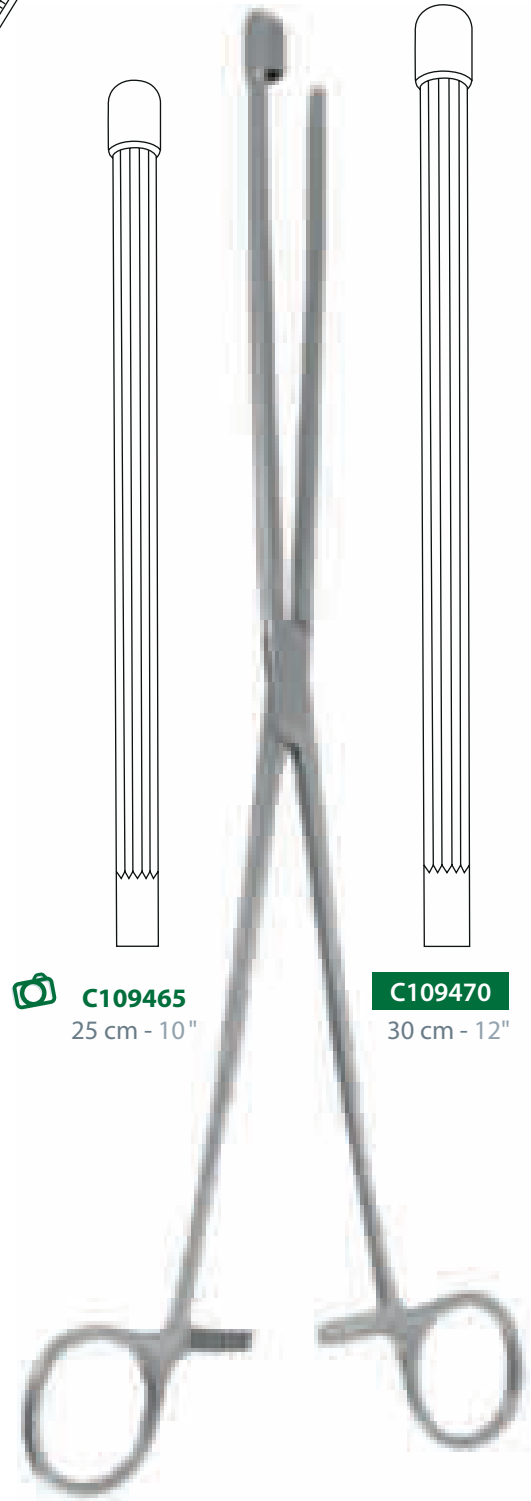

C109465

25 cm - 10"

C109470

30 cm - 12"

C109470  
30 cm - 12"

LANE

Pinces clamps jumelées - Twin clamp forceps - Pinzas clamps gemelas

Droite  
Straight  
Recta

Courbe  
Curved  
Curva

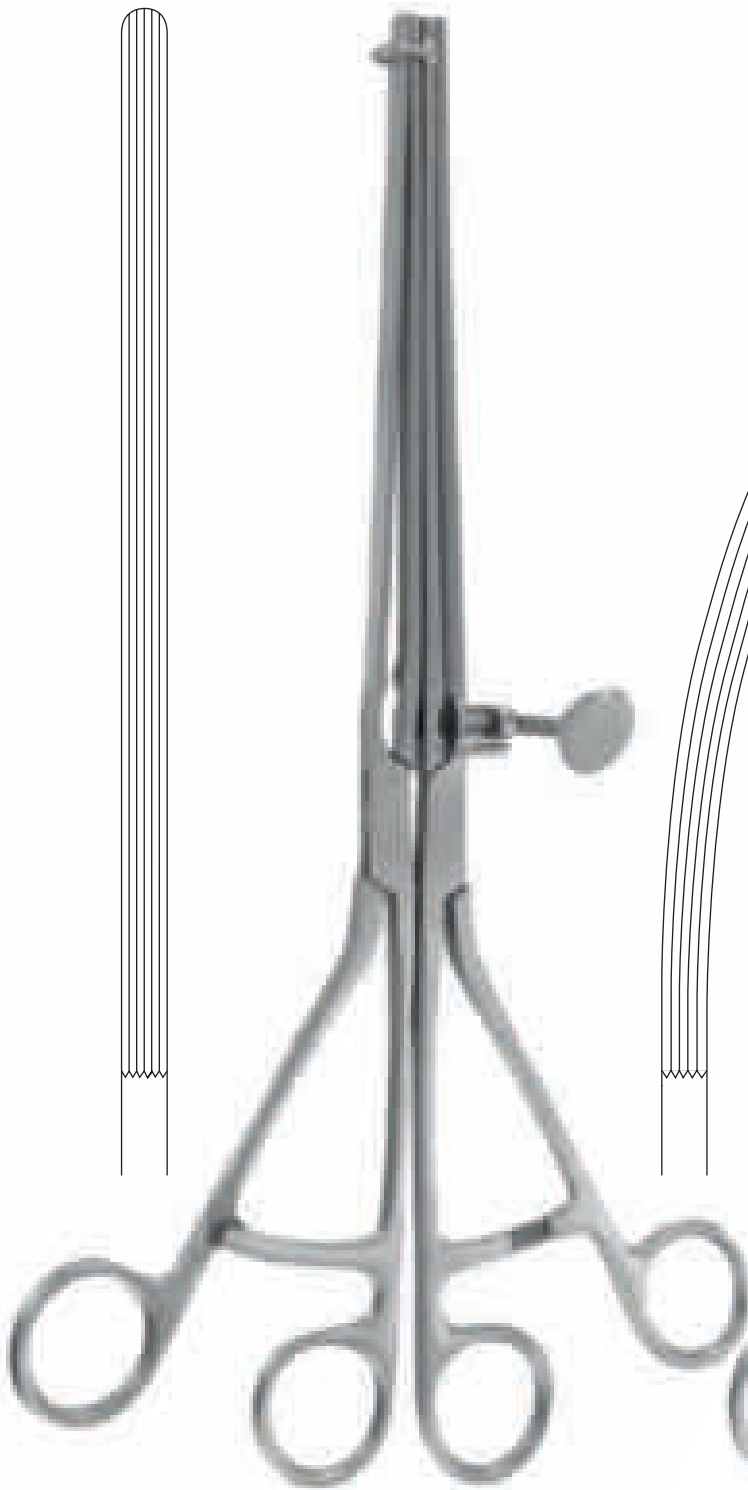

**C109480**  
30 cm - 12"

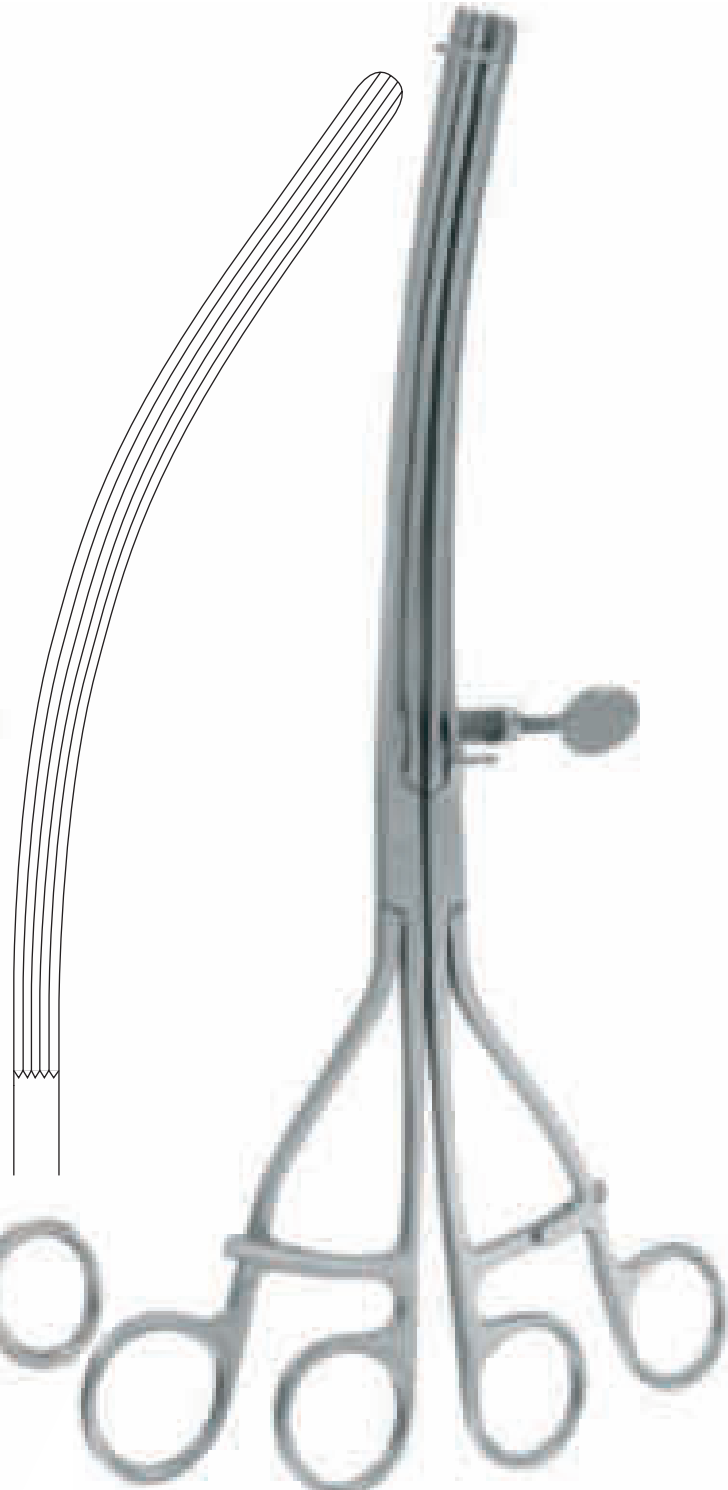

**C109485**  
30 cm - 12"

DE MARTEL - WOLFSON

Pince pour fermer les clamps  
Clamp closing forceps  
Pinzas para cerrar clamps

Porte clamps  
Clamp holder  
Porta clamps

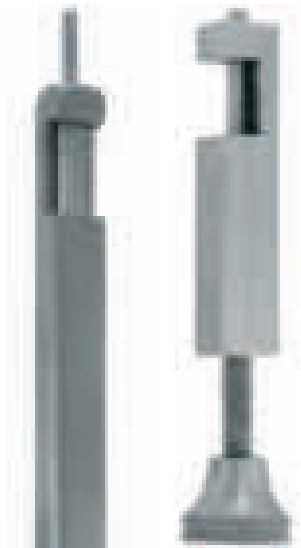

**B641110**  
8,5 cm - 3 1/2"

Jeu de 3 clamps  
Set of 3 clamps  
Juego de 3 clamps

7 cm - 2 3/4"  
10 cm - 4"

**B641100**   
**B641105**



**B641120**  
26,5 cm - 10 1/2"

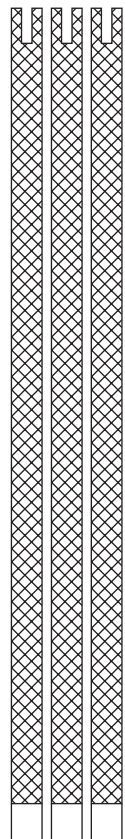
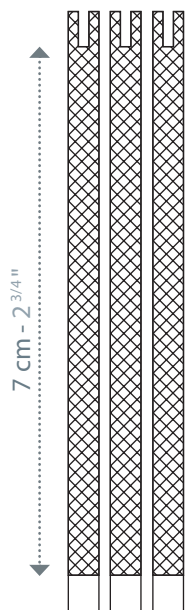

**B641115**  
23 cm - 9"

**B641100**

**B641105**

IV - Pinces  
IV - Forceps  
IV - Pinzas

## PRICE THOMAS

Pinces clamps à bronches  
Bronchus clamps  
Pinzas clamps para bronquios



**B60885**  
22 cm - 8 <sup>3</sup>/<sub>4</sub> "



Sans griffes  
Without teeth  
Sin dientes

**B60880**



Griffes à droite  
Teeth on the right  
Dientes a la derecha

**B60885**



Griffes à gauche  
Teeth on the left  
Dientes a la izquierda

**B60890**

## BABY SATINSKY



**B640020**  
15 cm - 6 "

## SATINSKY

Branches droites  
Straight branches  
Ramas rectas

- N° 1  **B640009**
- N° 2 **B640010**

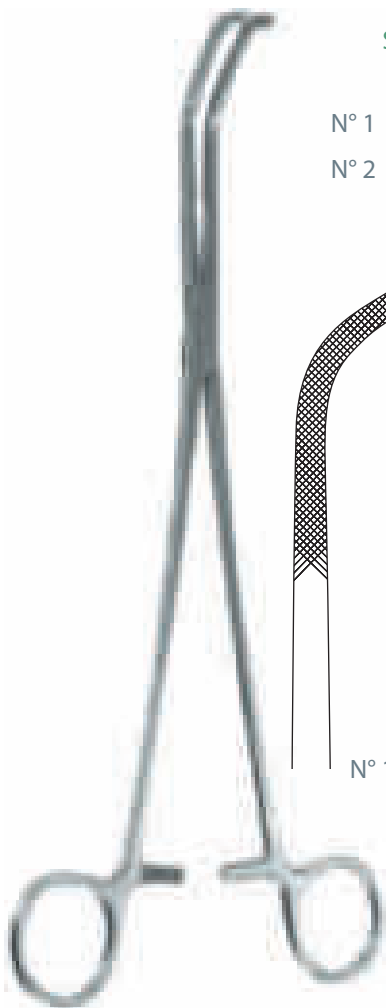

**B640009**  
26,5 cm - 10 1/2 "

Branches courbes  
Curved branches  
Ramas curvas

- N° 1 **B640015**
- N° 2 **B640016** 

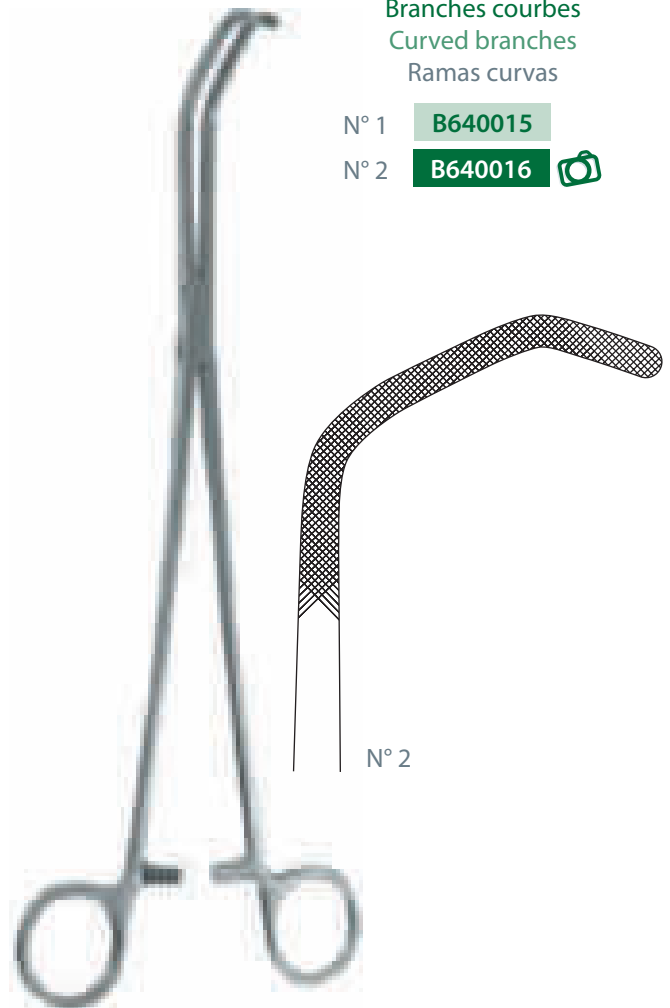

**B640016**  
26,5 cm - 10 1/2 "

## HARKEN

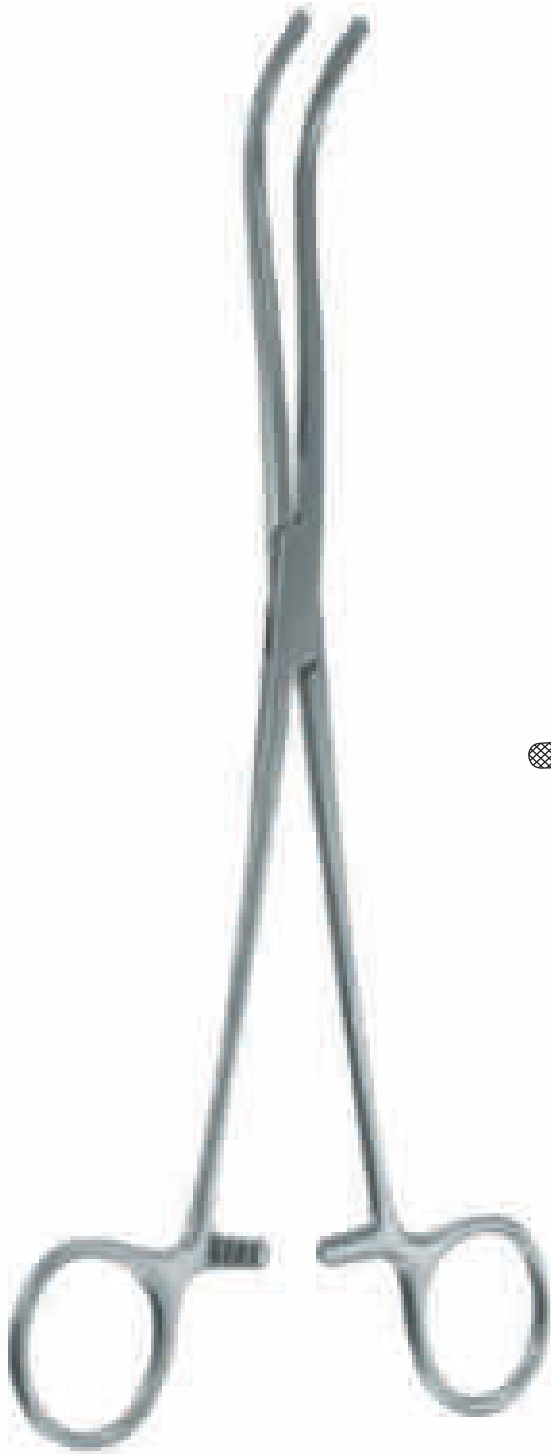

**B640032**  
24 cm - 9 1/2 "

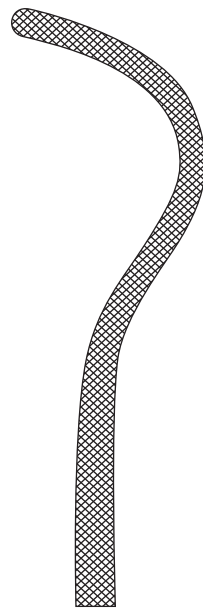

**B640031**

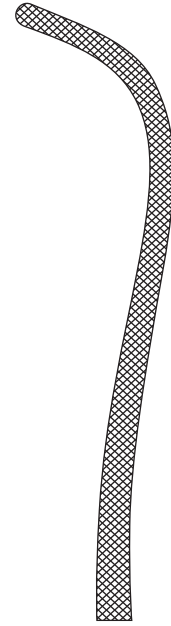

 **B640032**

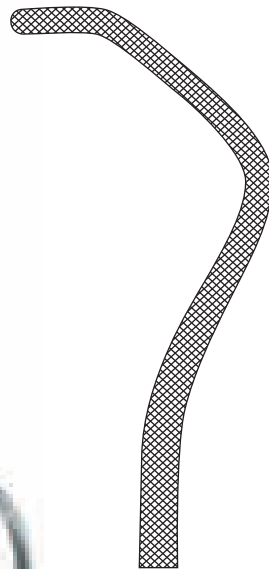

**B640033**

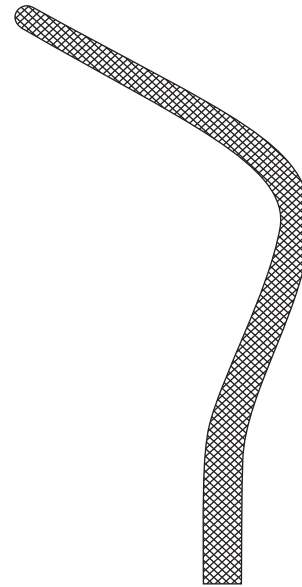

**B640034**



### DE MARTEL

Pince pour le cuir chevelu - Scalp flap forceps - Pinza para pericraneo

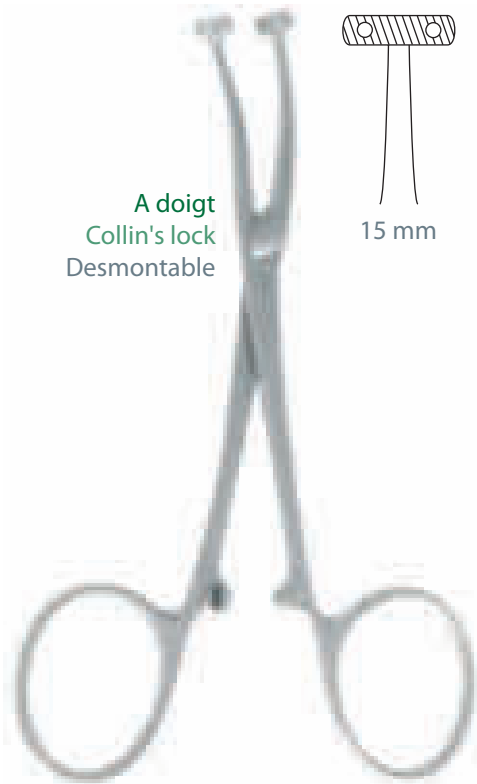

A doigt  
Collin's lock  
Desmontable

15 mm

**B65135**  
13 cm - 5 "

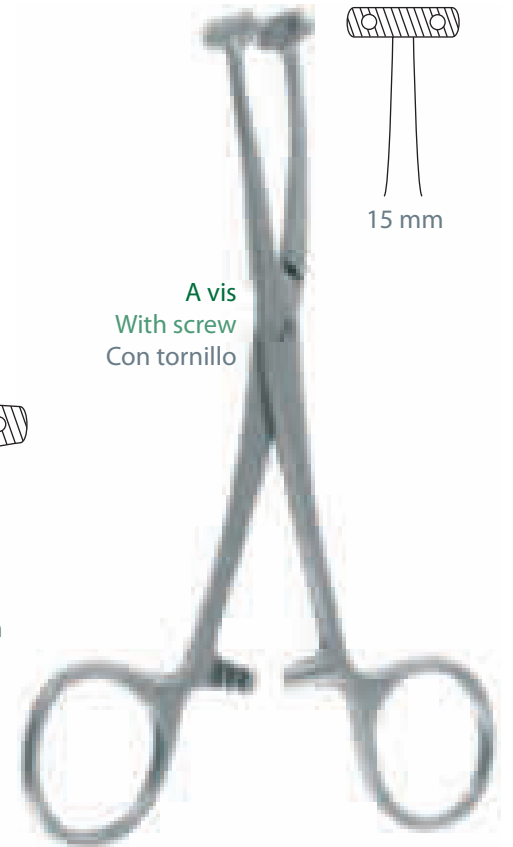

A vis  
With screw  
Con tornillo

15 mm

**B651350**  
14 cm - 5 1/2 "



18 mm

**B651360**  
19 cm - 7 1/2 "

En coeur - Heart-shaped - Figura de corazon

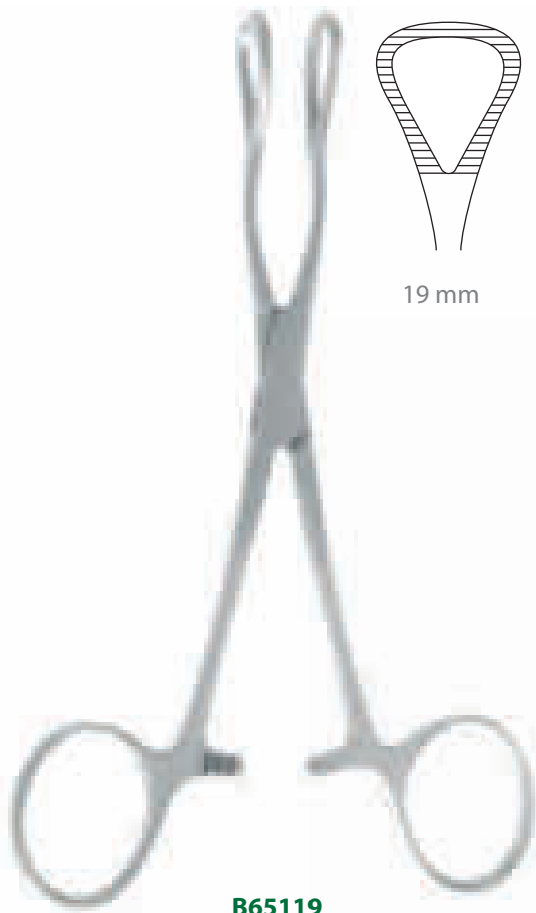

**B65119**  
16 cm - 6 1/4 "

A doigt  
Collin's lock  
Desmontable  
**B65113**  
16 cm - 6 1/4 "

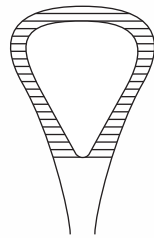

19 mm

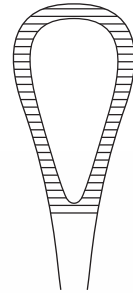

16 mm

**B65123**

22 cm - 8 3/4 "

Légère - Light - Ligera

**B65125**

22 cm - 8 3/4 "

Forte - Strong - Fuerte



**B65123**  
22 cm - 8 3/4 "

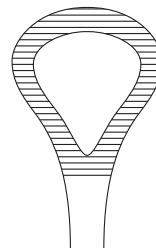

21 mm

**B651200**

20 cm - 8 "

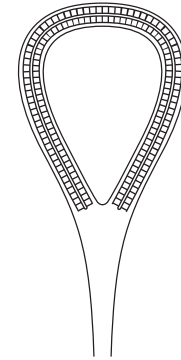

22 mm

**B65126**

25 cm - 10 "

Atraumatique  
Non-traumatic  
No traumática

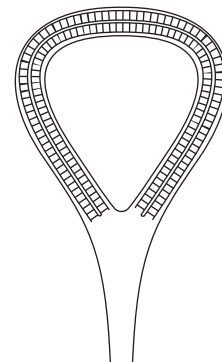

28 mm

**B651265**

27 cm - 10 3/5 "

WALTER-DUVAL



**B65230**  
16 cm - 6 1/4 "

**B65240**  
22 cm - 8 3/4 "

**B65250**  
22 cm - 8 3/4 "

IV - Pinces  
IV - Forceps  
IV - Pinzas

## COLLIN

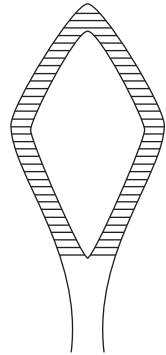

Losange  
Diamond  
Rombo



**B65127**

16 cm - 6 1/4 "

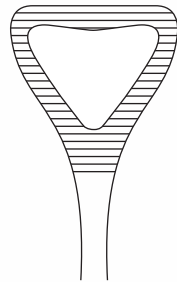

Triangle  
Triangular  
Triángulo

**B65129**

16 cm - 6 1/4 "

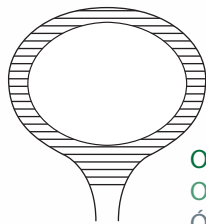

Ovale  
Oval  
Óvalo

**B65131**

16 cm - 6 1/4 "

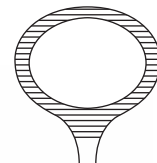

**B651315**

16 cm - 6 1/4 "

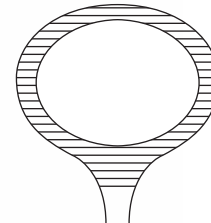

**B651320**

16,5 cm - 6 1/2 "

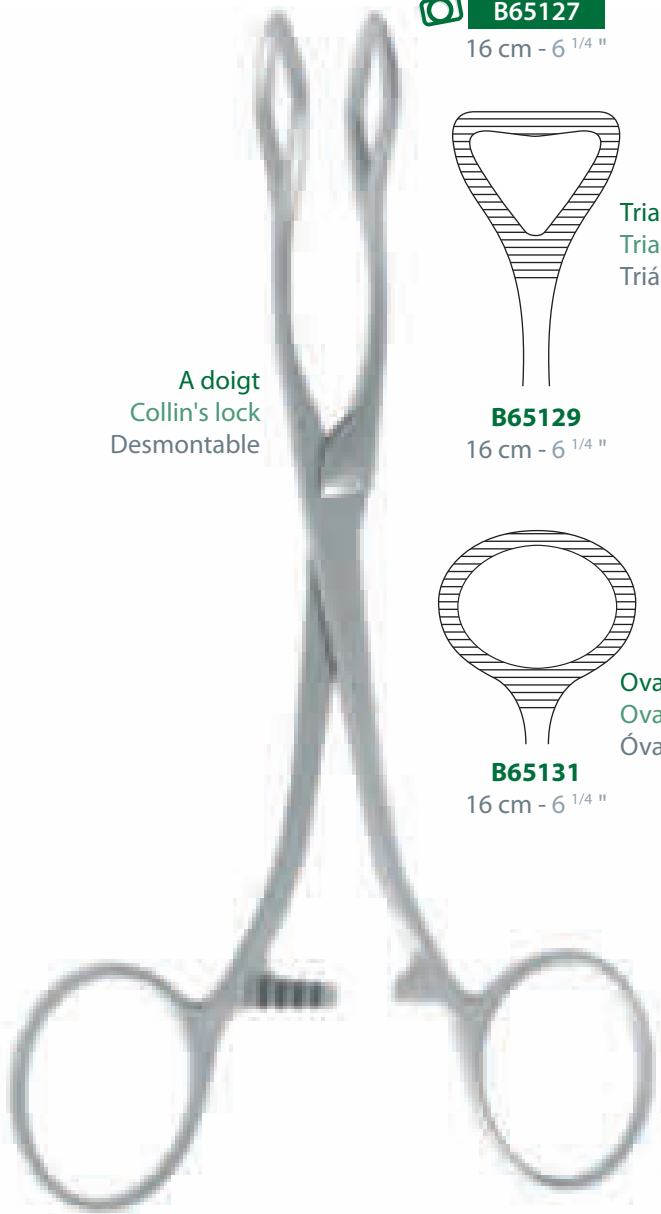

A doigt  
Collin's lock  
Desmontable

**B65127**

16 cm - 6 1/4 "



**B651315**

16 cm - 6 1/4 "



GREGOIRE



IV - Pinces  
IV - Forceps  
IV - Pinzas

# LANDANGER

Pinces à préhension - Grasping forceps - Pinzas a presión

## DUVAL

Striures horizontales  
Horizontal streaking  
Estrizados horizontales

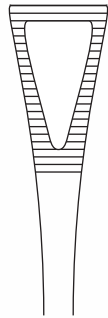

13 mm  
**B65190**  
22 cm - 8 <sup>3</sup>/<sub>4</sub> "

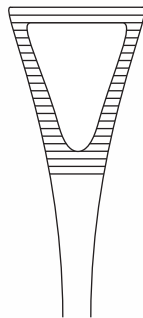

18 mm  
**B65191**   
22 cm - 8 <sup>3</sup>/<sub>4</sub> "

## PENNINGTON

15 cm - 6 "

**B651500**

20 cm - 8 "

**B651550** 

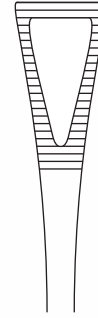

12 mm



**B65191**  
22 cm - 8 <sup>3</sup>/<sub>4</sub> "



**B651550**  
20 cm - 8 "

IV - Pinces  
IV - Forceps  
IV - Pinzas

### DUVAL

Dents pénétrantes - Penetrating teeth - Dientes penetrantes

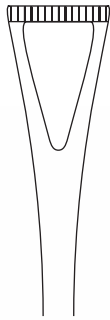

**B65192**  
13 mm  
22 cm - 8 3/4"

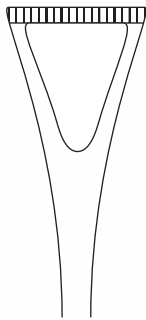

**B65193**   
18 mm  
22 cm - 8 3/4"

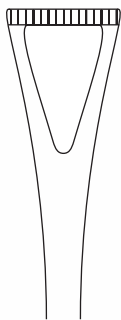

**B651565**  
14 mm  
18 cm - 7"

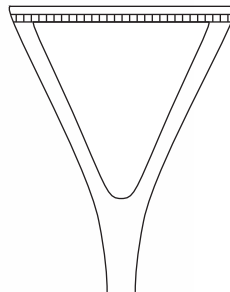

A doigt  
Collin's lock  
Desmontable

**B65170**  
30 mm  
20 cm - 8"

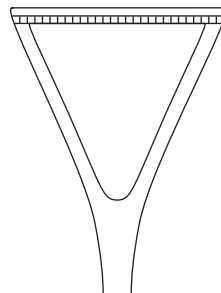

**B651580**  
28 mm  
21 cm - 8 1/3"

### LOCKWOOD



**B651555**  
8 mm  
20 cm - 8"

### COLLIN

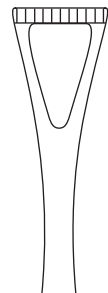

**B651560**  
13 mm  
14 cm - 5 1/2"

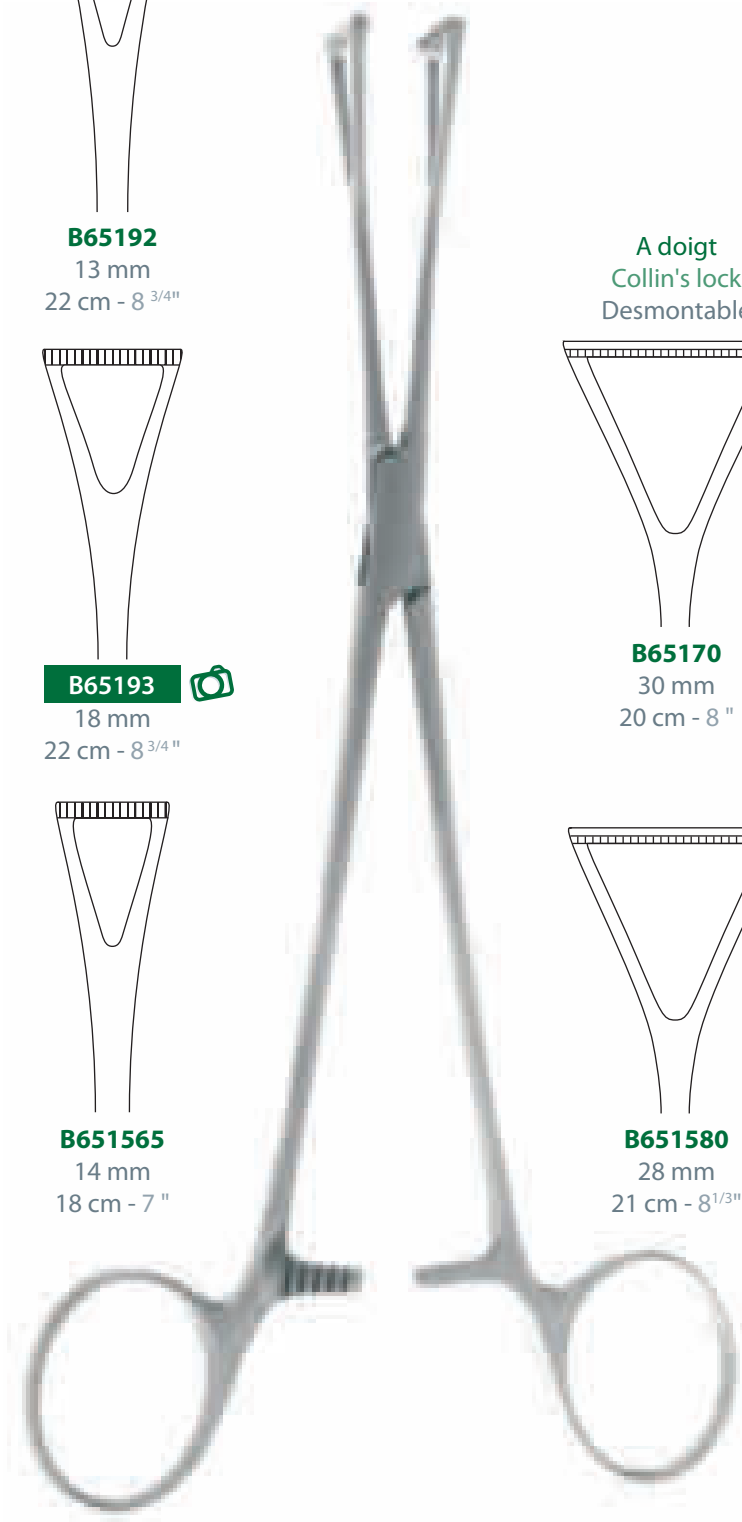

**B65193**  
22 cm - 8 3/4"

# LANDANGER

Pinces à préhension - Grasping forceps - Pinzas a presión

## DUVAL



Non-traumatic



**B65210**  
20 cm - 8 "

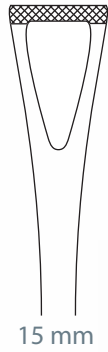

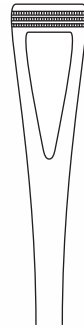

15 mm

Mors non traumatisants  
Non-traumatic jaws  
Bocas no traumáticas

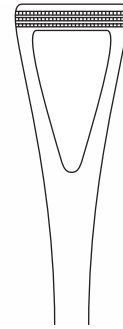

10 mm  
**B652110**  
18 cm - 7"



15 mm  
**B65215**   
20 cm - 8 "

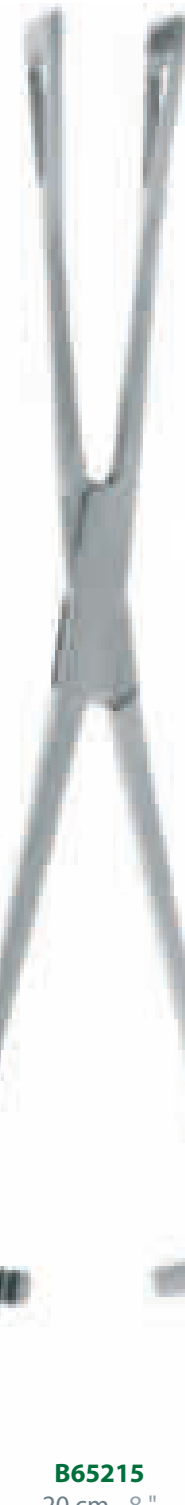

**B65215**  
20 cm - 8 "

## SCHEIBE

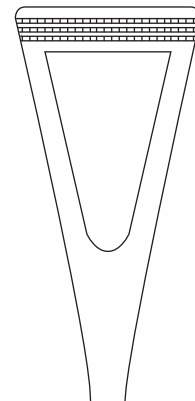

24 mm  
**C10850**  
23 cm - 9 "



IV - Pinces  
IV - Forceps  
IV - Pinzas



### LOVELACE

### AUVERT

Pince à poumons  
Lung forceps  
Pinza pulmonar

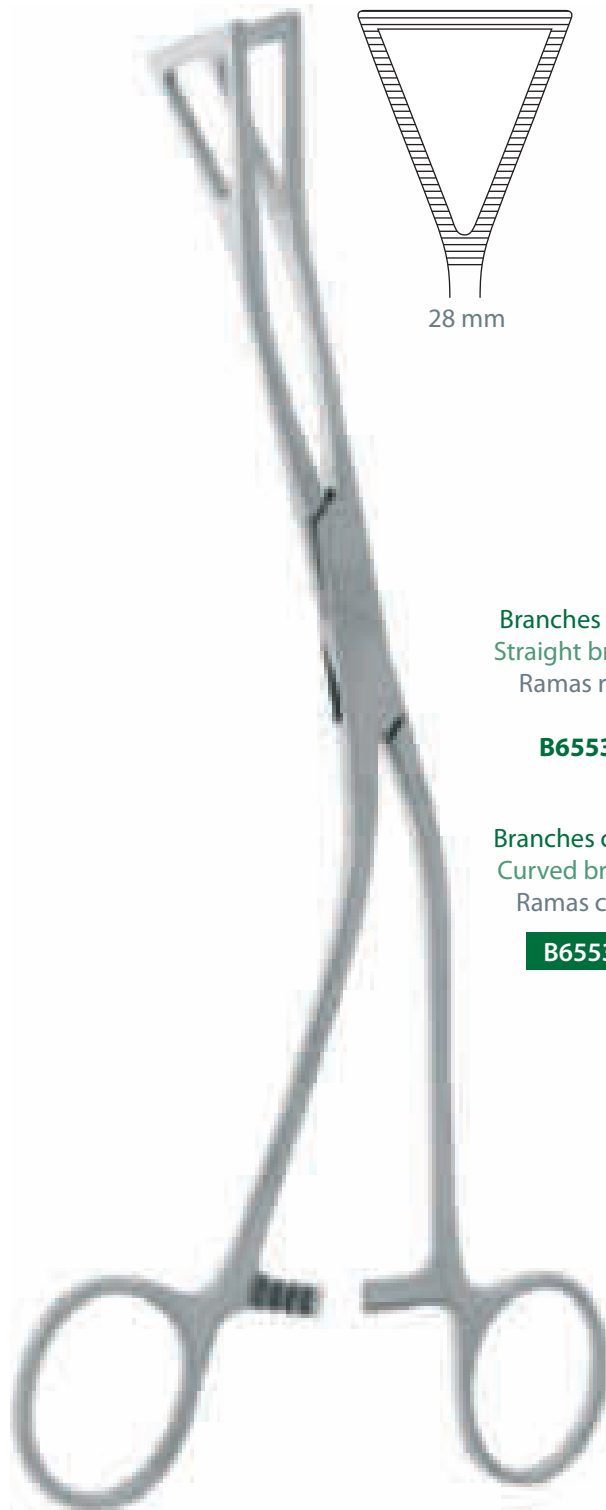

Branches droites  
Straight branches  
Ramas rectas

**B655365**

Branches courbes  
Curved branches  
Ramas curvas

**B655370** 



**B655370**  
20 cm - 8 "

**B656025**  
20 cm - 8 "

### CHAPUT

2 x 3 griffes  
2 x 3 teeth  
2 x 3 dientes

13 cm - 5 1/8 "	<b>B65330</b>	
16 cm - 6 1/4 "	<b>B65335</b>	
20 cm - 8 "	<b>B65370</b>	

### CHAPUT-MAYO

5 x 6 griffes  
5 x 6 teeth  
5 x 6 dientes

16 cm - 6 1/4 "	<b>B65420</b>	
20 cm - 8 "	<b>B65430</b>	
22 cm - 8 3/4 "	<b>B65440</b>	



**B65335**  
16 cm - 6 1/4 "



**B65420**  
16 cm - 6 1/4 "



### ALLIS

Atraumatique  
Non-traumatic  
No traumática

4 x 5 griffes  
4 x 5 teeth  
4 x 5 dientes

5 x 6 griffes  
5 x 6 teeth  
5 x 6 dientes

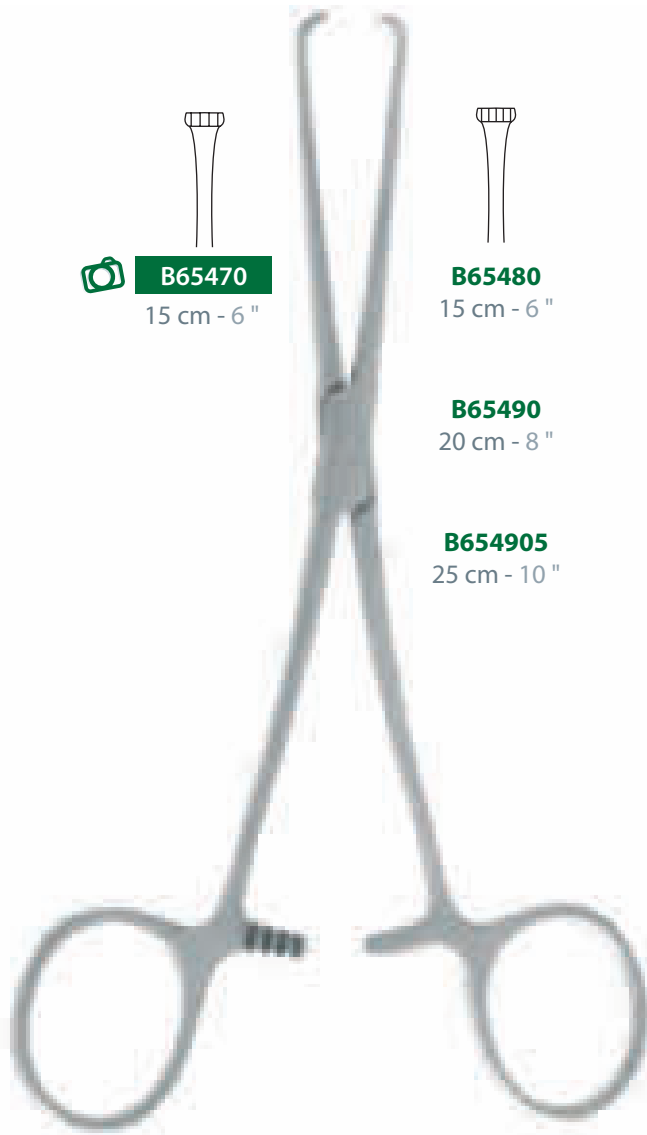
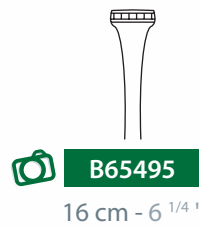
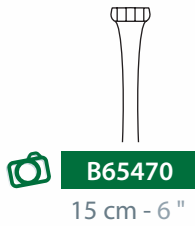

**B65470**  
15 cm - 6 "

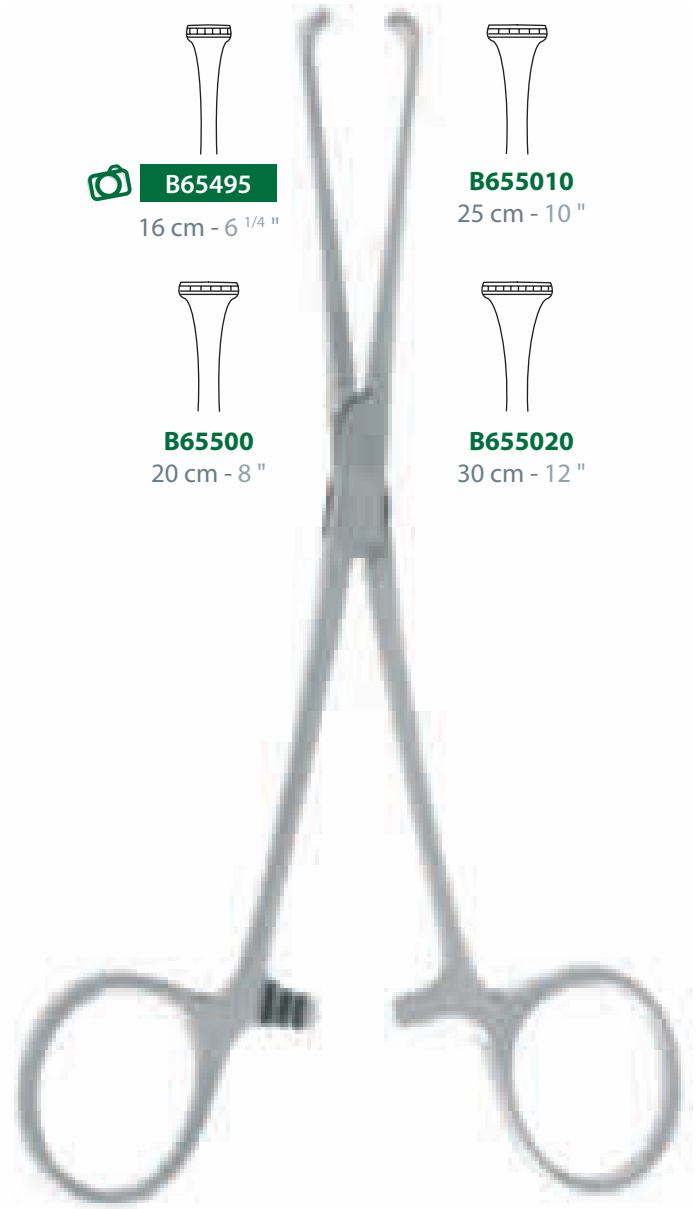

**B65495**  
16 cm - 6 1/4 "

## BABY-ALLIS

4 x 5 griffes  
4 x 5 teeth  
4 x 5 dientes



**B654600**  
14 cm - 5 1/2 "

## JUDD-ALLIS

3 x 4 griffes  
3 x 4 teeth  
3 x 4 dientes



 **B654610**

**B654620**  
19 cm - 7 1/2 "

**B654610**  
15 cm - 6 "

## ALLIS-ADAIR

9 x 10 griffes  
9 x 10 teeth  
9 x 10 dientes



**B654630**  
16 cm - 6 1/4"

## BOYS-ALLIS

5 x 6 griffes  
5 x 6 teeth  
5 x 6 dientes



**B654640**  
15 cm - 6"

THOMS-ALLIS

LOCKWOOD-ALLIS

6 x 7 griffes  
6 x 7 teeth  
6 x 7 dientes

4 x 5 griffes  
4 x 5 teeth  
4 x 5 dientes



**B654650**  
15 cm - 6 "

**B654660**  
20 cm - 8 "

IV - Pinces  
IV - Forceps  
IV - Pinzas

OMBREDANNE

TUFFIER

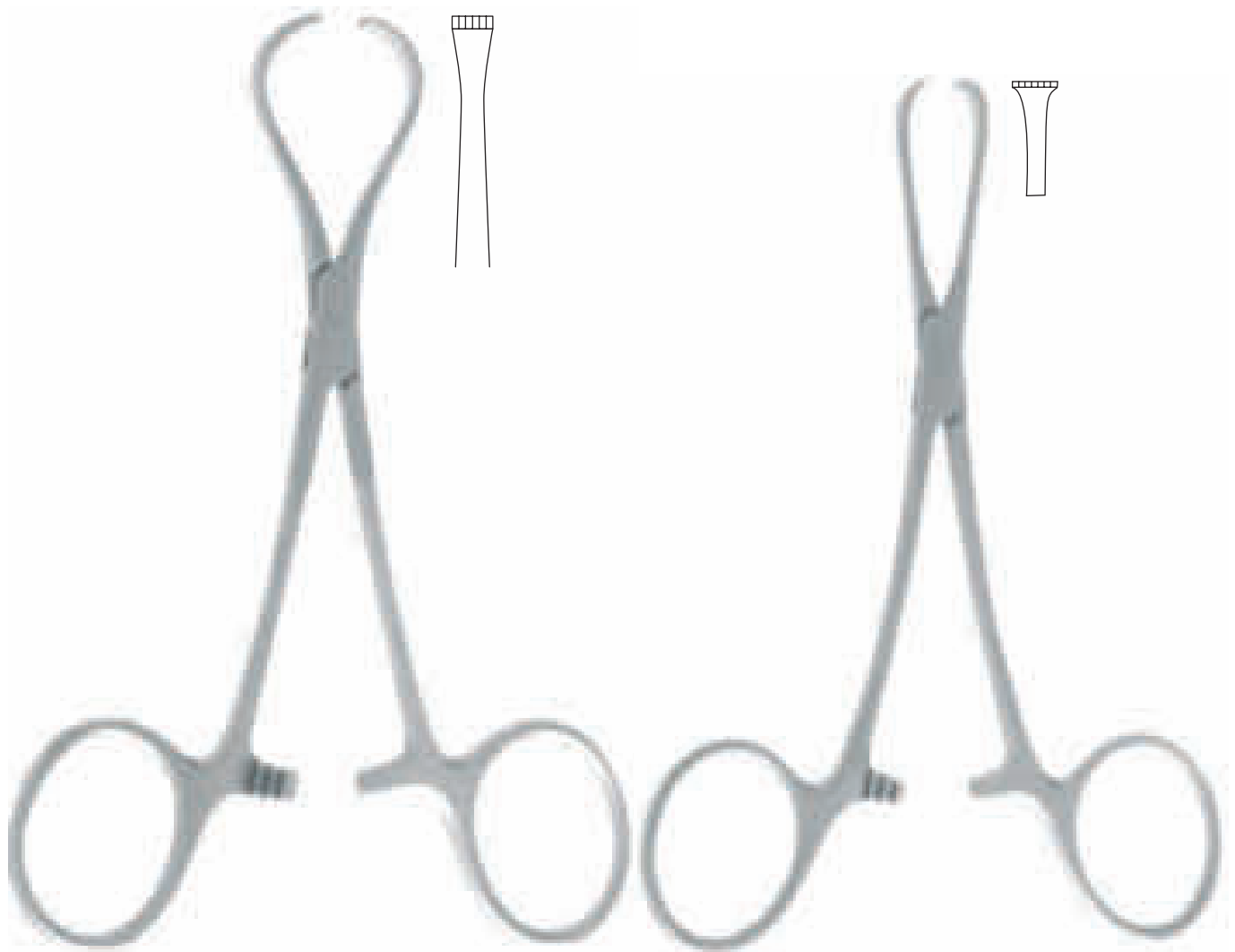

**B50805**  
14 cm - 5 1/2 "

**B65515**  
13 cm - 5 "

IV - Pinces  
IV - Forceps  
IV - Pinzas

### LIEGE

3 x 4 griffes  
3 x 4 teeth  
3 x 4 dientes



**B65530**  
26 cm - 10<sup>1</sup>/<sub>4</sub>"

### LITTLEWOOD

2 x 3 griffes  
2 x 3 teeth  
2 x 3 dientes



**B655200**  
18,5 cm - 7<sup>1</sup>/<sub>4</sub>"



### BABCOCK

Mors non traumatisant  
Non-traumatic jaws  
Bocas no traumáticas



8 mm

**B60370**

16 cm - 6 1/4 "



### BABY



8 mm

**B603650**

16 cm - 6 1/4 "



8 mm

**B60422**

16 cm - 6 1/4 "

9 mm  
**B603800**  
17 cm - 6 3/4 "

10 mm  
**B60390**  
20 cm - 8 "

11 mm  
**B603950**  
24 cm - 9 1/2 "

12 mm  
**B60424**  
20 cm - 8 "

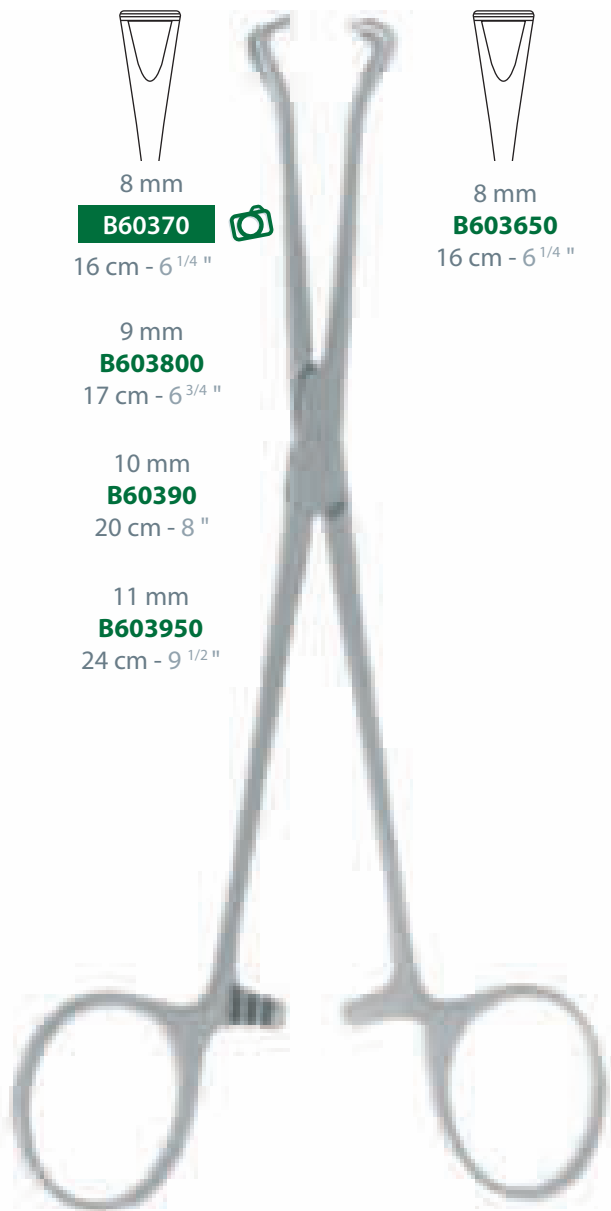

**B60370**  
16 cm - 6 1/4 "



**B60422**  
16 cm - 6 1/4 "

## BABCOCK



16 cm - 6 1/4 "

**B60400**



20 cm - 8 "

**B60420**

Mors non traumatisant  
Non-traumatic jaws  
Bocas no traumáticas



9 mm  
**B60400**  
16 cm - 6 1/4 "

10 mm  
**B60420**  
20 cm - 8 "

**B60400**  
16 cm - 6 1/4 "

PRATT

Pince hémorroïdale  
Haemorrhoidal clamps  
Pinzas hemorroidales



**B655340**  
15 cm - 6 "

BENSON

Écarteur du pylore  
Pylorus spreader  
Separador para piloro



**B655360**  
15,5 cm - 6 1/8 "

### DOYEN

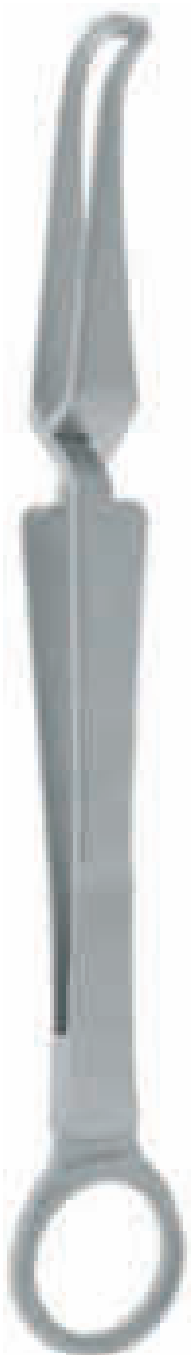

**B70070**  
18 cm - 7 "

Crabe  
Crabe  
Cangrejo

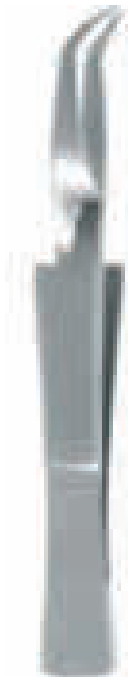

**B70100**  
9 cm - 3 1/2 "

### SCHADEL



**B702300**  
9 cm - 3 1/2 "

### JONES



**B702350**  
5 cm - 2 "

Modèle britannique  
British model  
Modelo británico



**B702355**  
9 cm - 3 1/2 "

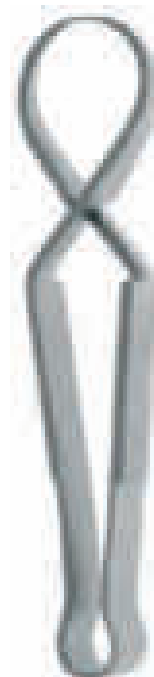

**B702400**  
9 cm - 3 1/2 "

IV - Pinces  
IV - Forceps  
IV - Pinzas

BACKHAUS



**B70140**  
11 cm - 4 1/4 "



**B70130**  
9 cm - 3 1/2 "



**B70150**  
13 cm - 5 "



**B70160**  
14 cm - 5 1/2 "

### BACKHAUS

Porte-tube  
Tube holder  
Soporte para tubo



**B70190**  
14 cm - 5 1/2 "

### PEERS

Non perforante  
Non-perforating  
No perforante

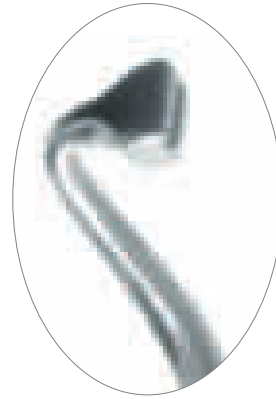

**B70200**  
14,5 cm - 5 3/4"

IV - Pinces  
IV - Forceps  
IV - Pinzas

### TOHOKU

10 cm - 4 " **B702450**   
 13 cm - 5 " **B702451**

### LORNA

10 cm - 4 " **B702500**   
 13 cm - 5 " **B702505**

Non perforante  
 Non-perforating  
 No perforante

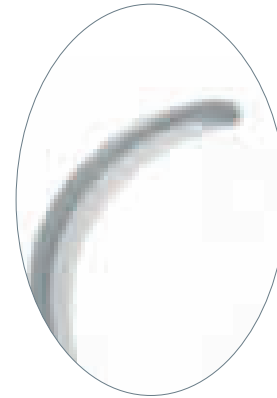
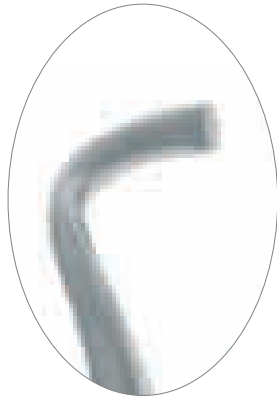

**B702450**  
 10 cm - 4 "



**B702500**  
 10 cm - 4 "

### ROEDER

13 cm - 5 "

**B70210**

15 cm - 6 "

**B70220**



Non perforante  
No-perforating  
No perforante



**B70220**  
15 cm - 6 "



**B702250**  
14 cm - 5 1/2 "





### GUNNAR-HEY

Pince à traire les drains - Drainage-tube drawing forceps - Pinza para ordenar las canulas

0 - 12 mm

**B95100**



0 - 20 mm

**B951020**



## LANE (PAUCHET)

Droite  
Straight  
Recta

13 cm - 5"

**B508090**

15,5 cm - 6"

**B508095**

20 cm - 8"

**B50810**



Coudée  
Angular  
Angulada



**B50810**  
20 cm - 8"



**B50815**  
20 cm - 8"

### LOCHARD

Pince ouvre capsule  
Capsule-opening forceps  
Pinza para abrir las capsulas



**B95060**  
17 cm - 6 3/4"

### MOHR

Presse-tube  
Pinchoc clamps  
Cierra tubos

- 5 cm - 2" **B950450** 
- 6 cm - 2 1/4" **B950460**
- 7 cm - 2 3/4" **B950470**
- 8 cm - 3 1/4" **B950480**

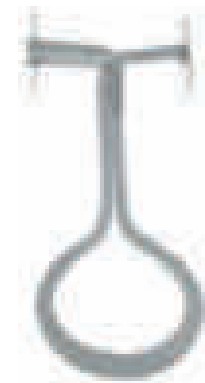

**B950450**

### HOFFMAN

Presse-tube  
Pinchoc clamps  
Cierra tubos

- 17 mm - 0 2/3" **B95017** 
- 20 mm - 0 3/4" **B95020**
- 25 mm - 1" **B95025**
- 30 mm - 1 1/4" **B950300**
- 40 mm - 1 1/2" **B950400**



**B95017**

### WEISS

Mors lisses  
Smooth jaws  
Bocas lisas

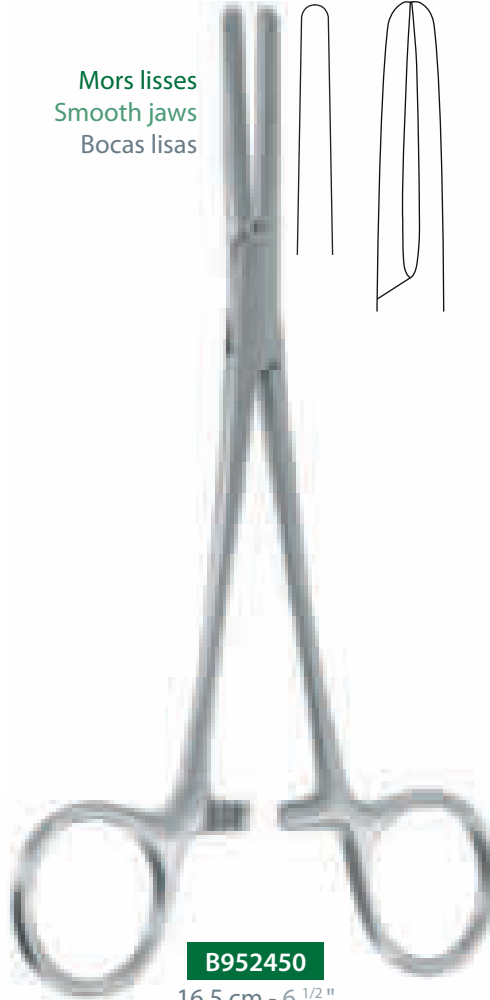
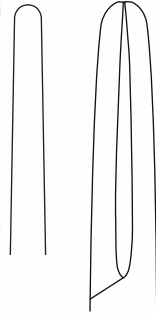

**B952450**

16,5 cm - 6 1/2 "

**B952460**

18 cm - 7 "

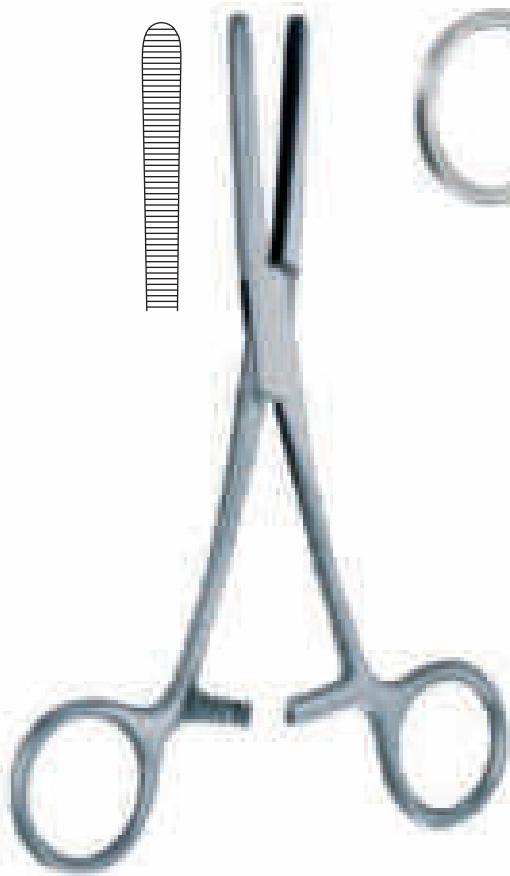

**B952400**

14,5 cm - 5 3/4 "



**B95250**

18 cm - 7 "

IV - Pinces  
IV - Forceps  
IV - Pinzas

### MURPHY

- 15 cm - 6 " **B952014** 
- 18 cm - 7 " **B952018**
- 20 cm - 8 " **B952020**

Avec barre de protection  
With safety rod  
Con estribo de protección



**B95150**  
16 cm - 6 1/4"

**B952014**  
15 cm - 6 "

*Prestige*

HALSTEAD

Droite  
Straight  
Recta

Courbe  
Curved  
Curva

Sans griffes  
Without teeth  
Sin dientes

A griffes  
With teeth  
Con dientes

Sans griffes  
Without teeth  
Sin dientes

A griffes  
With teeth  
Con dientes

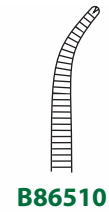
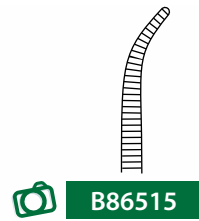
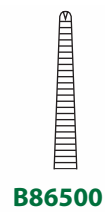
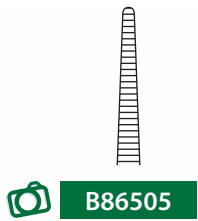

**B86505**  
12 cm - 4 <sup>3</sup>/<sub>4</sub>"

**B86515**  
12 cm - 4 <sup>3</sup>/<sub>4</sub>"

IV - Pinces  
IV - Forceps  
IV - Pinzas

## *Prestige*



### LERICHE

Droite  
Straight  
Recta

Courbe  
Curved  
Curva

Sans griffes    A griffes  
Without teeth    With teeth  
Sin dientes    Con dientes

Sans griffes    A griffes  
Without teeth    With teeth  
Sin dientes    Con dientes

	<b>B86525</b>	<b>B86520</b>	15 cm - 6 "		<b>B86535</b>	<b>B86530</b>
	<b>B86545</b>	<b>B86540</b>	18 cm - 7 "		<b>B86555</b>	<b>B86550</b>

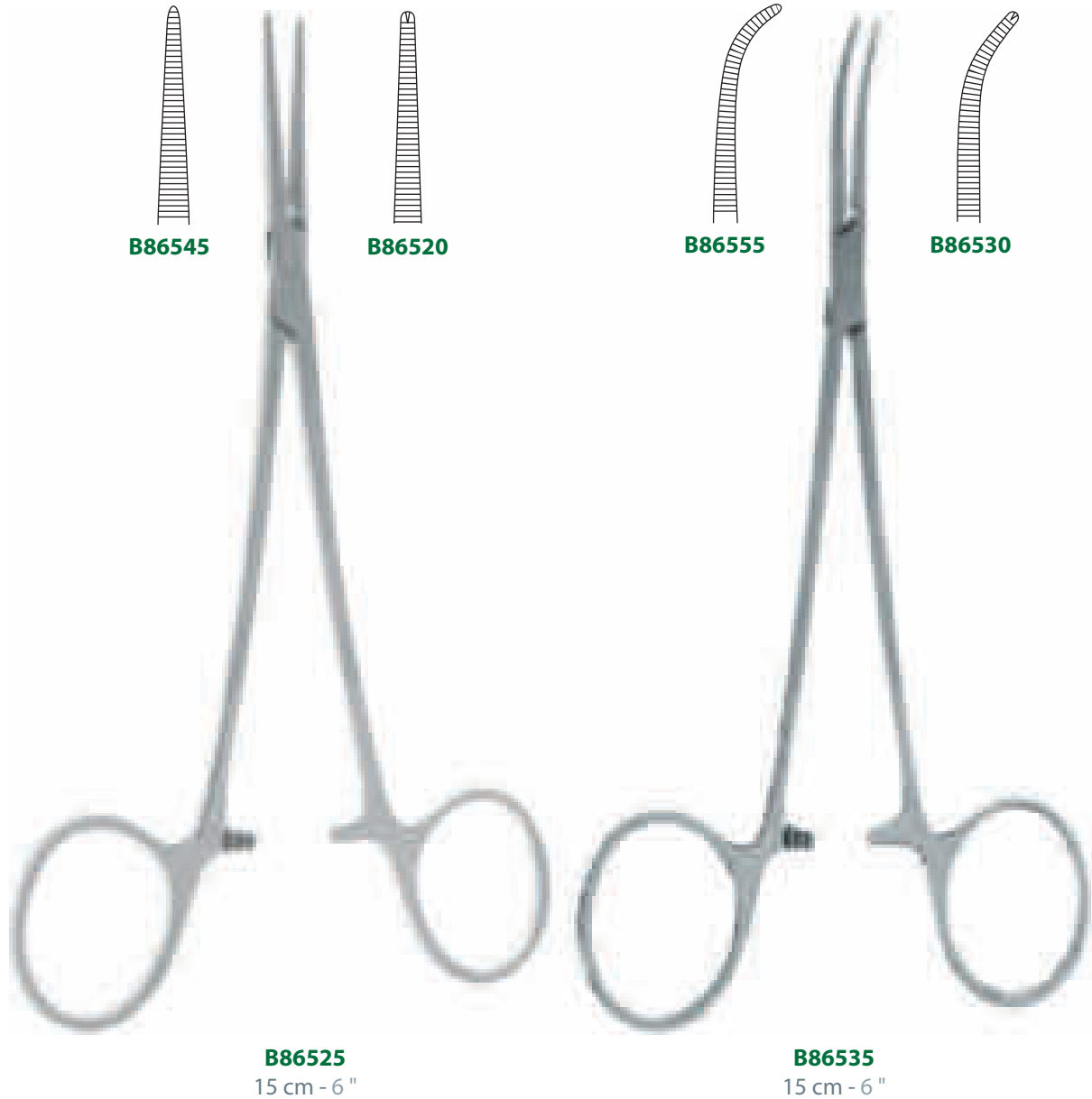

**B86525**  
15 cm - 6 "

**B86535**  
15 cm - 6 "

*Prestige*

**BENGOLEA**

Sans griffes  
Without teeth  
Sin dientes



**B86560**  
21 cm - 8 1/4"



**B86570**  
24 cm - 9 1/2"

IV - Pinces  
IV - Forceps  
IV - Pinzas



## *Prestige*

### KOCHER

A griffes  
With teeth  
Con dientes

### KELLY

Sans griffes  
Without teeth  
Sin dientes

Droite  
Straight  
Recta

Courbe  
Curved  
Curva



**B86580**  
16 cm - 6 1/4"



**B86595**  
16 cm - 6 1/4"



**B86595**

**B86590**

*Prestige*

**CRILE**

**CHRISTOPHE**

Sans griffes  
Without teeth  
Sin dientes



**B86600**  
14 cm - 5 1/2 "



**B86610**  
16 cm - 6 1/4 "

IV - Pinces  
IV - Forceps  
IV - Pinzas

### PEAN

12 cm - 4 3/4 " **B50010**   
 14 cm - 5 1/2 " **B50020**  
 16 cm - 6 1/4 " **B50025**

14 cm - 5 1/2 " **B50050**   
 16 cm - 6 1/4 " **B50055**

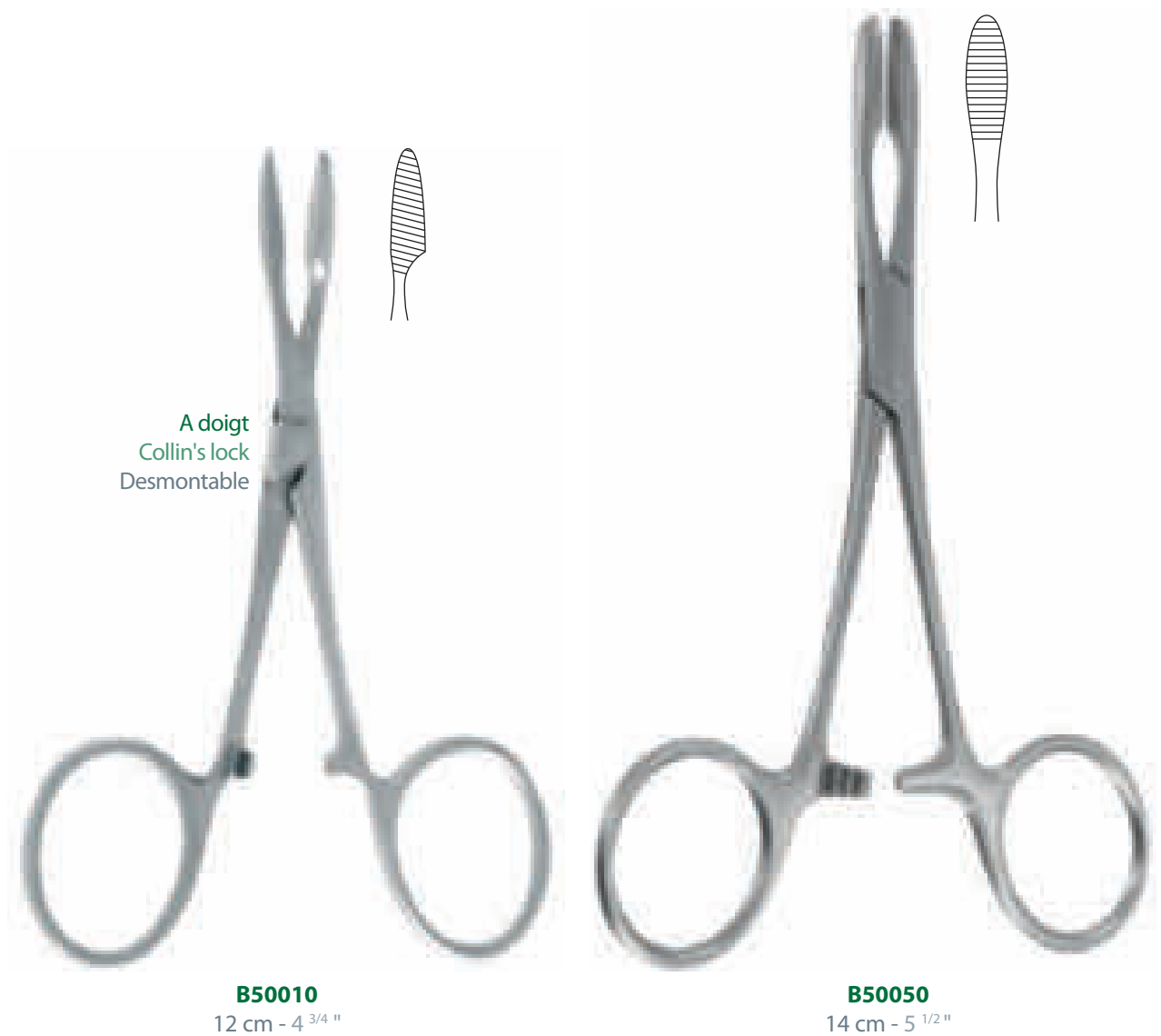

## Pince à pansements - Dressing forceps - Pinza para vendajes

Droite  
Straight  
Recta

Courbe  
Curved  
Curva



**F10030** 24 cm - 9 1/2 "

**F10040**

**F10050** 30 cm - 11 3/4 "

**F10060**

À doigt - Collin's lock - Desmontable

**F10010** 24 cm - 9 1/2 "

**F10020**

### CHERON

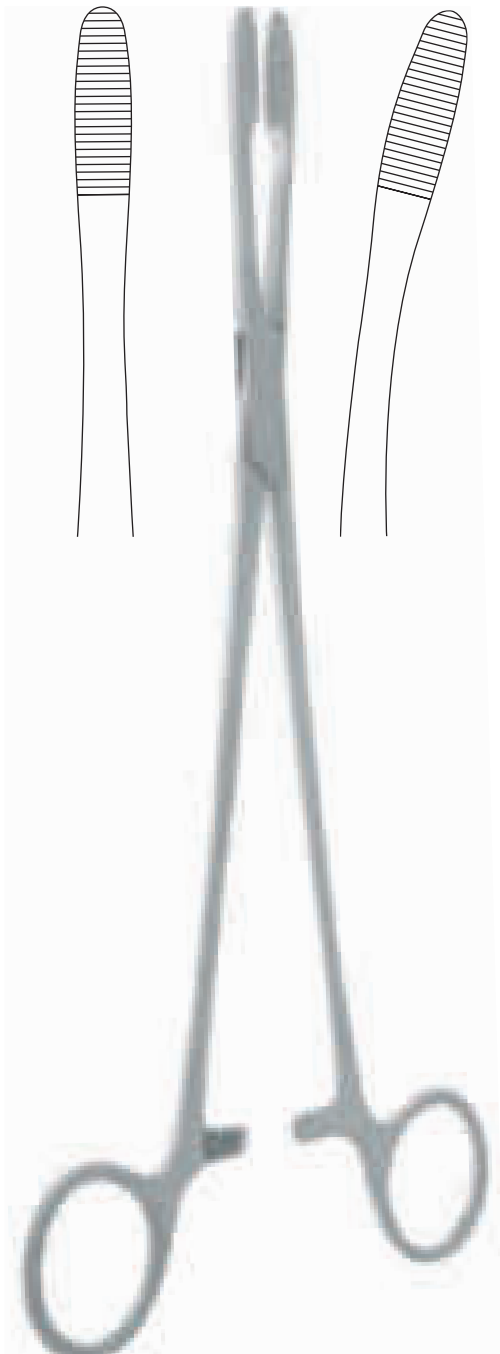

**F10030**  
24 cm - 9 1/2 "

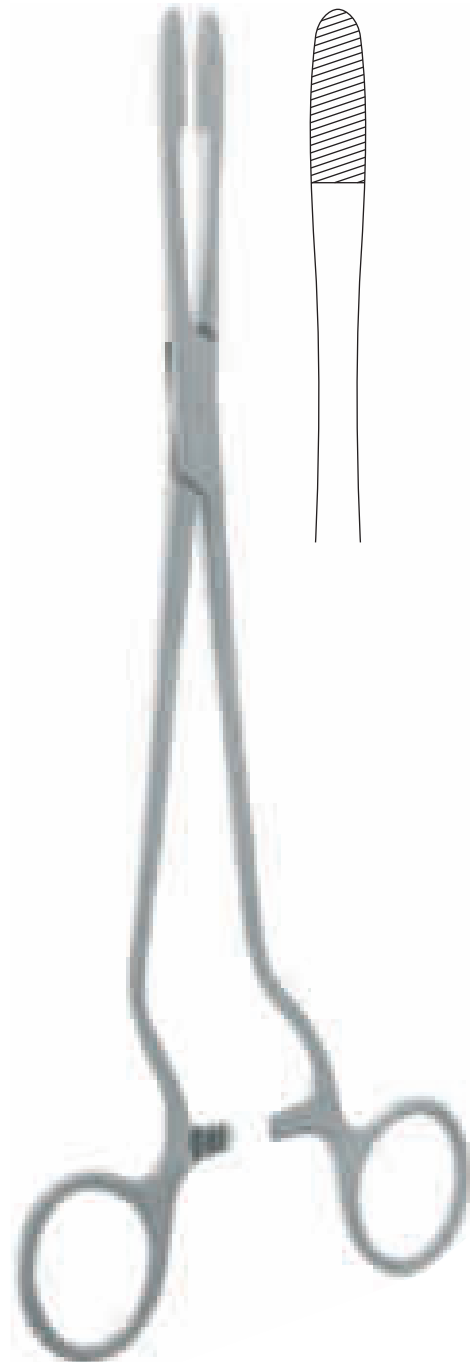

**F10100**  
24 cm - 9 1/2 "

IV - Pinces  
IV - Forceps  
IV - Pinzas

## GROSS MAYER

Droite Straight Recta		Courbe Curved Curva
	B507701	20 cm - 8"
	<b>B50780</b>	25 cm - 10"
		B507702
		<b>B50785</b> 

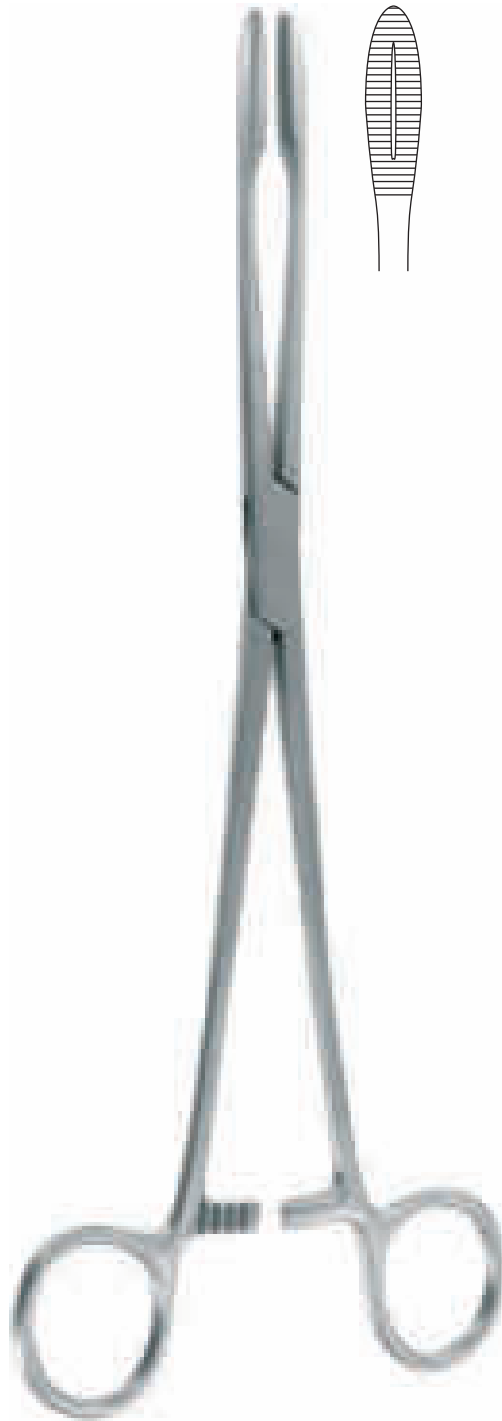

**B50780**  
25 cm - 10 "



**B50785**  
25 cm - 10 "

## ULRICH

Droite  
Straight  
Recta

Courbe  
Curved  
Curva

**B507900**

22 cm - 8<sup>3/4</sup>"

**B507901**



**B507910**

27 cm - 10<sup>1/2</sup>"

**B507911**



**B507910**  
27 cm - 10<sup>1/2</sup>"



**B507911**  
27 cm - 10<sup>1/2</sup>"

## LANDANGER



**B50793**  
16 cm - 6 <sup>1</sup>/<sub>4</sub> "

**B50794**  
22 cm - 8 <sup>3</sup>/<sub>4</sub> "

### RAMPLEY



18 cm - 7"	<b>F101900</b> 
25 cm - 10"	<b>F101910</b>



**F101900**  
18 cm - 7"



## Pince à pansements - Dressing forceps - Pinza para vendajes

Droite Straight Recta		<b>FOERSTER</b>		Courbe Curved Curva	
Mors lisses Smooth jaws Boca liso	Mors striés Serrated jaws Boca estriada			Mors lisses Smooth jaws Boca liso	Mors striés Serrated jaws Boca estriada
<b>F102000</b>	<b>F102080</b>	18 cm - 7 "		<b>F102001</b>	<b>F102090</b>
<b>F102005</b>	<b>F10210</b>	20 cm - 8 "		<b>F102006</b>	<b>F10220</b>
 <b>F102010</b>	<b>F10230</b>	25 cm - 10 "		 <b>F102011</b>	<b>F10240</b>

Mors lisses  
Smooth jaws  
Boca liso



Mors striés  
Serrated jaws  
Boca estriada

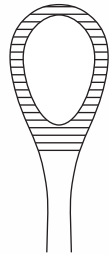

Mors lisses  
Smooth jaws  
Boca liso



Mors striés  
Serrated jaws  
Boca estriada



**F102010**  
25 cm - 10 "



**F102011**  
25 cm - 10 "

### BOZEMANN

Droite  
Straight  
Recta

Courbe  
Curved  
Curva

Double courbure  
Double curvature  
Doble curvatura



**F102050**

26 cm - 10<sup>1</sup>/<sub>4</sub>"

**F102049**



**F102052**

26 cm - 10<sup>1</sup>/<sub>4</sub>"

**F102051**

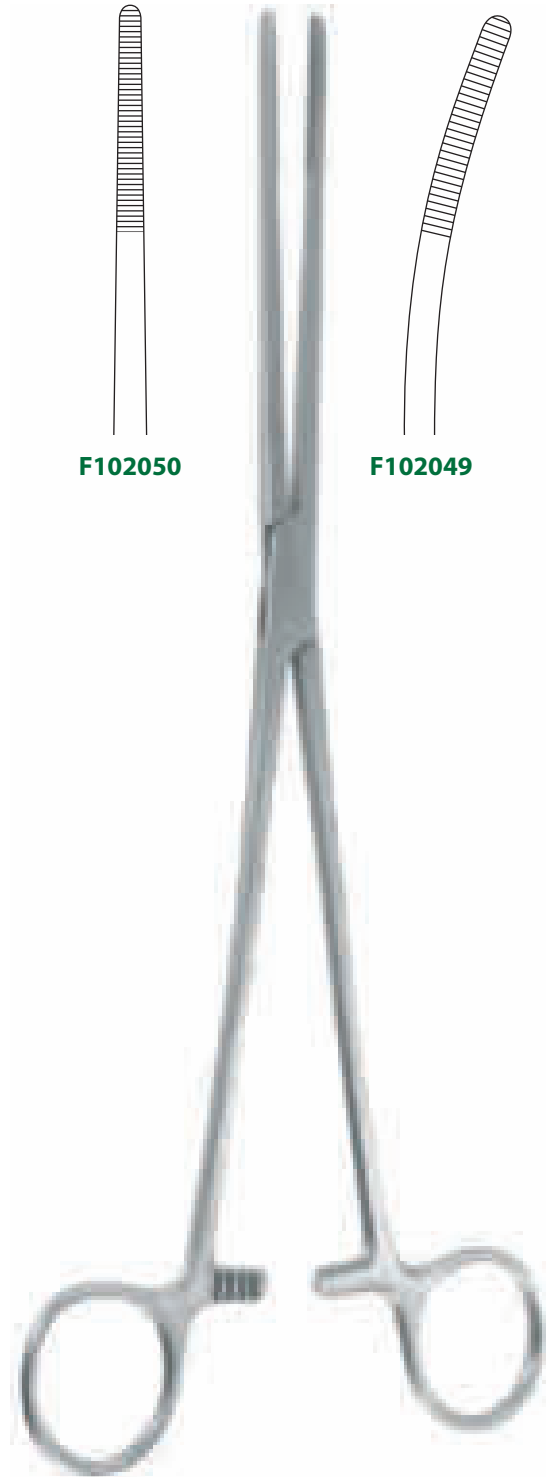

**F102050**

**F102049**



**F102052**

**F102051**

Mors lisses  
Smooth jaws  
Boca liso

Mors striés  
Serrated jaws  
Boca estriada

**F102050**  
26 cm - 10<sup>1</sup>/<sub>4</sub>"

**F102052**  
26 cm - 10<sup>1</sup>/<sub>4</sub>"

## LISTER

12,5 cm - 5"

**B507950**

16 cm - 6 1/4"

**B507955**



18 cm - 7"

**B507960**

## BRYANT

## EMMET



**B507955**  
16 cm - 6 1/4"

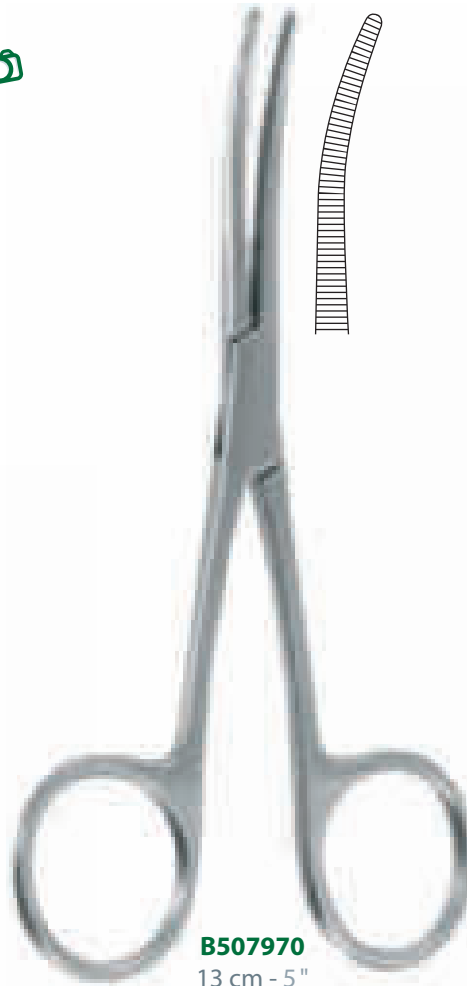

**B507970**  
13 cm - 5"



**B507975**  
20 cm - 7 4/5"

### PELKMANN

Droite  
Straight  
Recta

Courbe  
Curved  
Curva

 **B507980** 26 cm - 10 <sup>1</sup>/<sub>4</sub> " **B507981**



**B507980**



**B507981**



**B507980**  
26 cm - 10 <sup>1</sup>/<sub>4</sub> "

### SIMS-MAIER

Droite  
Straight  
Recta

Courbe  
Curved  
Curva

 **B507990** 28 cm - 11 " **B507991**



**B507990**

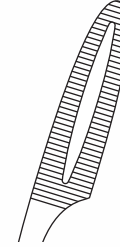

**B507991**

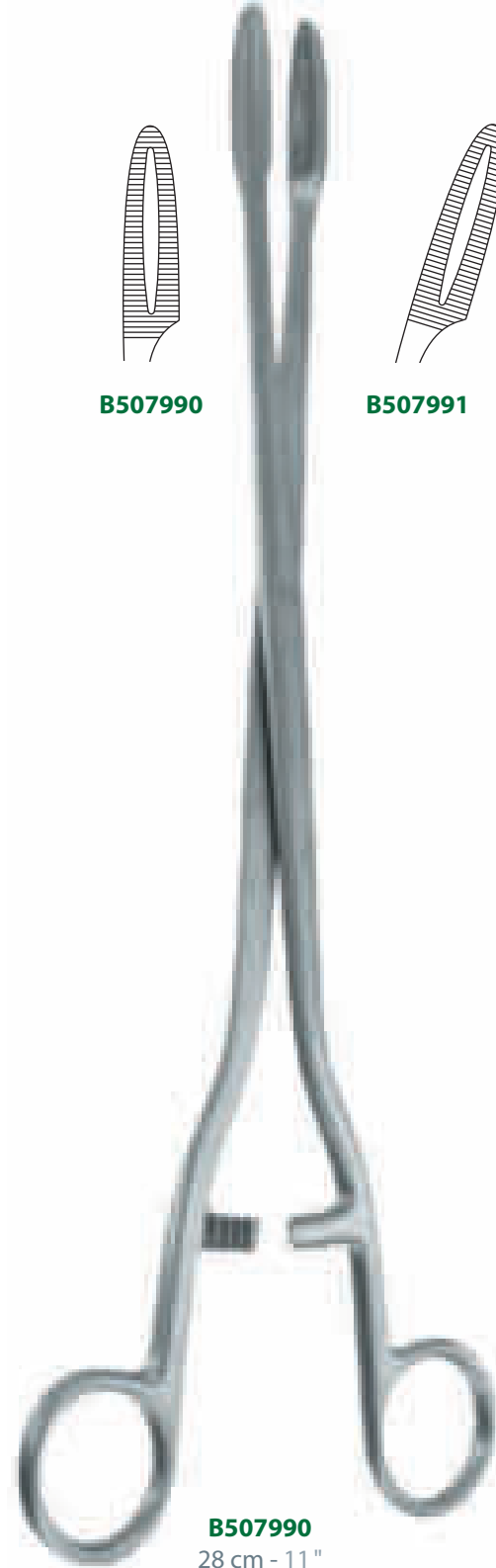

**B507990**  
28 cm - 11 "



## Strippers - Strippers - Sondas para varices

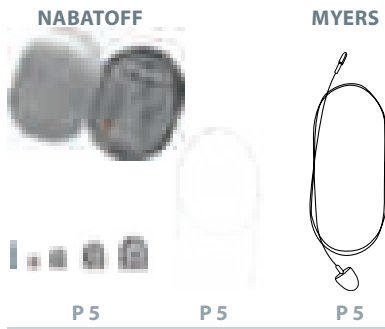

## Endartériectomie - Endarterectomy - Endarterectomia

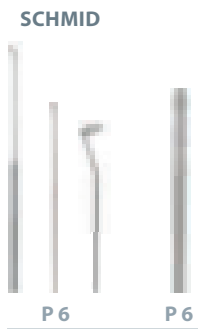

## Phlébectomie - Phlebotomy - Flebectomía

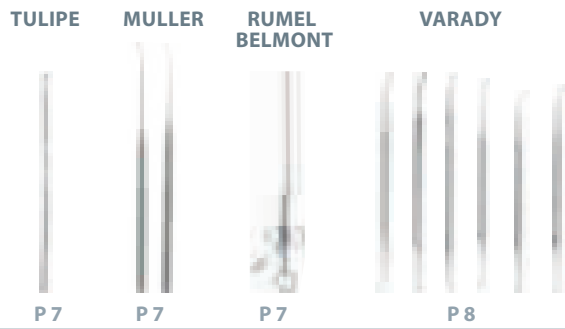

## Clamps bulldog - Bulldog clamps - Clamp bulldog

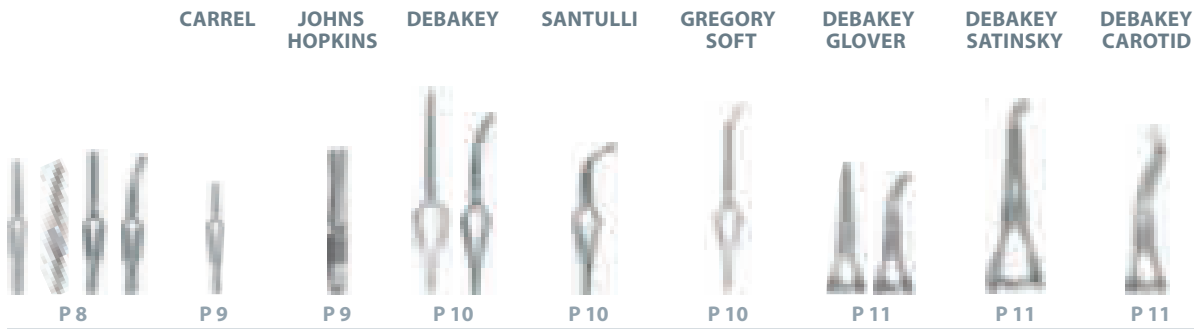

## Pincas clamps cardiovasculaires atrauma - Atrauma cardiovascular forceps - Pinzas clamps cardiovasculares atrauma

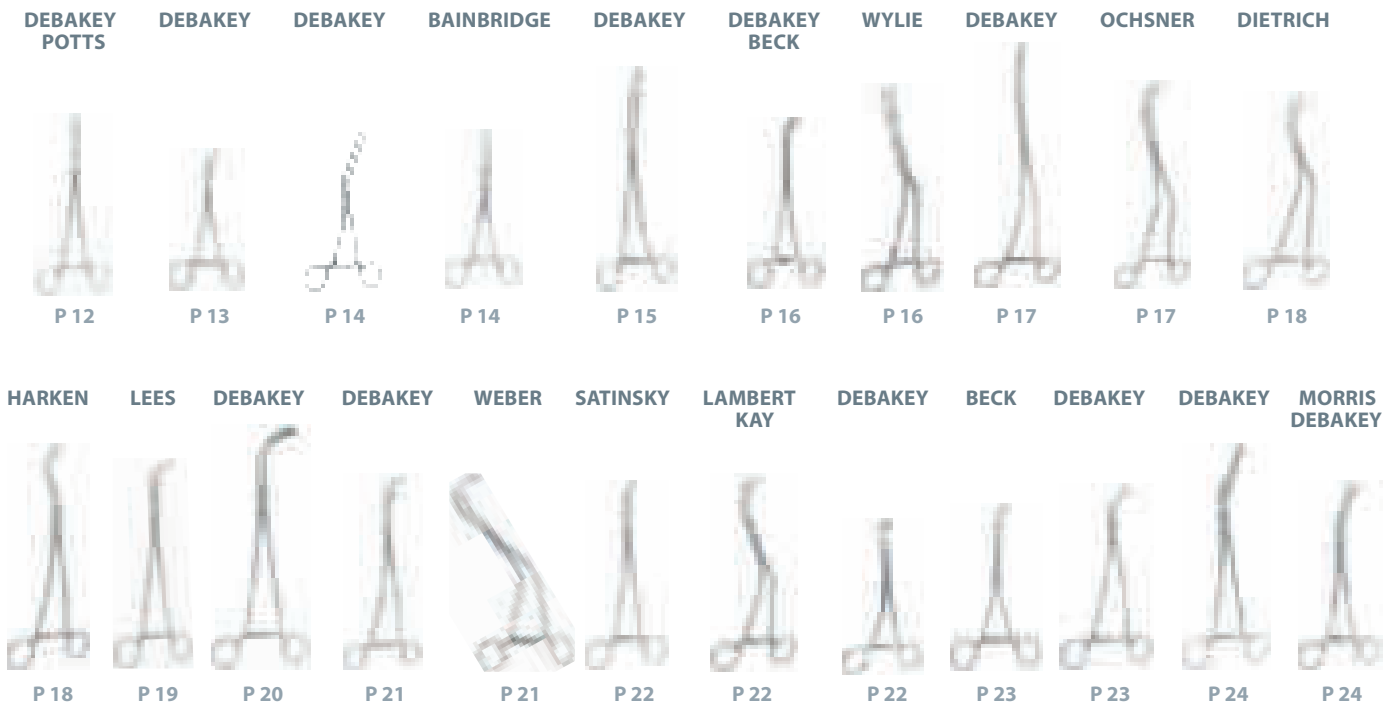

V - Clamps  
V - Clamps  
V - Clamps

DEBAKEY BAHNSON DEBAKEY PEAN DEBAKEY RANKIN DEBAKEY MOSQUITO DEBAKEY

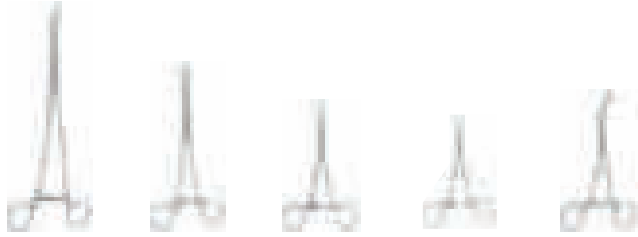

P 25 P 26 P 27 P 27 P 27

DEBAKEY GLOVER GLOVER DERRA DALE GREGORY SUBRAMANIAN DEBAKEY JAVID COOLEY BECK

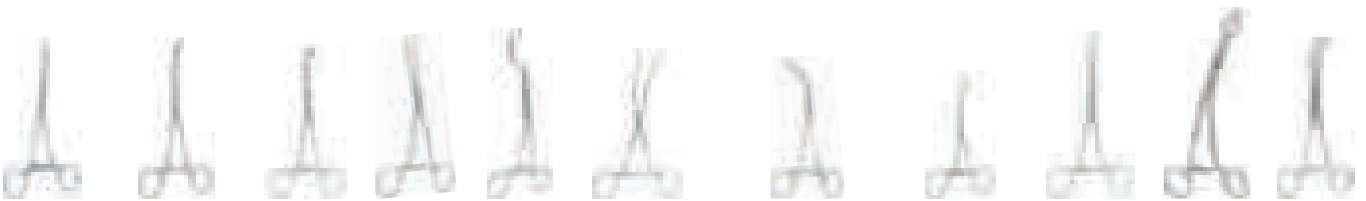

P 28 P 28 P 29 P 29 P 30 P 31 P 31 P 32 P 33 P 33 P 34

COOLEY DERRA COOLEY COOLEY COOLEY



P 34 P 34 P 35 P 36 P 37

**Pinces clamps nouveau né et pédiatrique - Neonatal and pediatric clamps - Pinzas clamps para recién nacidos y pediátrico**

COOLEY COOLEY CASTANEDA



P 37 P 38 P 39

**Dilatateurs vasculaires et aortiques - Aortic and vascular dilators - Dilatadores vasculares y de aorta**

DEBAKEY COOLEY TUBBS

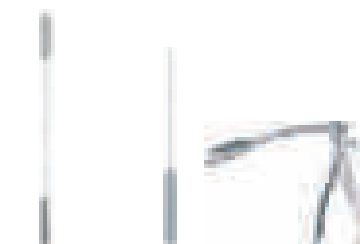

P 40 P 40 P 40

**Pinces à dissection vasculaires - Vascular dissecting forceps - Pinzas para disección vasculares**

II - Dissection  
II - Dissecting  
II - Disección

DEBAKEY COOLEY DEBAKEY GERALD DEBAKEY DIETRICH DEBAKEY



P 41 P 42 P 42 P 43 P 43 P 43

**Ciseaux pour chirurgie vasculaire - Scissors for vascular surgery - Tijeras para cirugía vascular**

III - Ciseaux  
III - Scissors  
III - Tijeras

POTTS-SMITH DEBAKEY HEGEMANN (DIETRICH) POTTS DE MARTEL MILLS VINCENT (SCHMIEDEN) POTTS-SMITH DEBAKEY FAVALORO

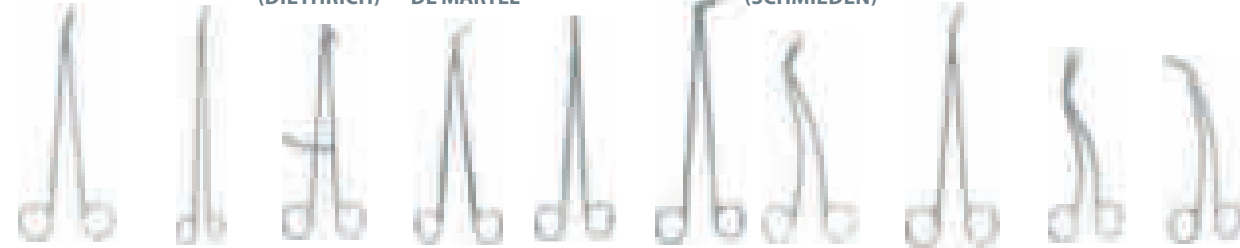

P 32 P 33 P 34 P 35 P 35 P 35 P 36 P 36 P 36 P 36

POTTS-SMITH DEBAKEY POTTS-SMITH

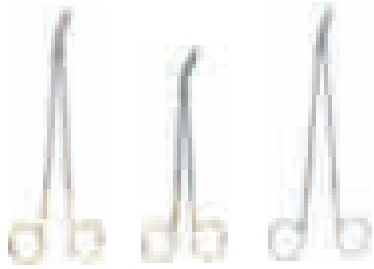

P 69 P 69 P 74

**Canules - Cannulas - Cánulas**

XV - Divers  
XV - Miscellaneous  
XV - Diversos

HÉPARINE



P 27

V - Clamps  
V - Clamps  
V - Clamps



V - Clamps  
V - Clamps  
V - Clamps

### NABATOFF



Complet - Full set - Completo

**C095000**

135 x 100 x 25 mm



**C095020**

120 cm - 47 1/4 "



**C095010**



**C095030**



Ø 3 mm

**C095033**



Ø 6 mm

**C095036**



Ø 9 mm

**C095039**



Ø 12 mm

**C095042**



Ø 15 mm

**C095045**

### MYERS

Ø 6 mm **C095106**

Ø 9 mm **C095109**

Ø 12 mm **C095112** 

Ø 15 mm **C095115**

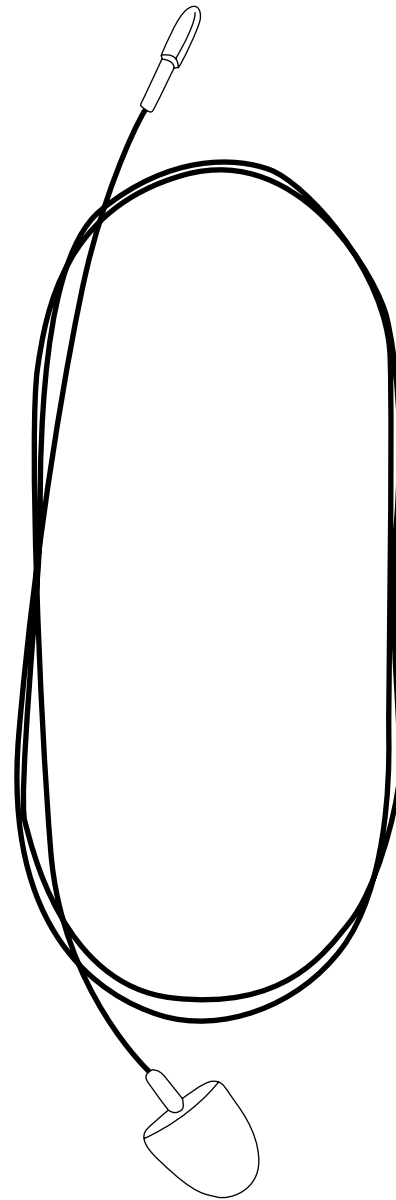

**C095112**



### SCHMID

Ø intérieur - inside - interior

18,5 cm - 7 1/4" **J082020** 

21,5 cm - 8 1/2" **J082030**

Ø 2 mm **C095202**

Ø 3 mm **C095203**

Ø 4 mm **C095204**

Ø 6 mm **C095206**

Ø 7 mm **C095207**

Ø 8,5 mm **C095208**

Ø 10 mm **C095210** 

Ø 12 mm **C095212**

Ø 14 mm **C095214**



Mousse  
Blunt  
Roma

3 mm



Mousse  
Blunt  
Roma

5 mm



Sonde  
Probe  
Sonda

Poignée  
Handle  
Mango

**J082020**  
18,5 cm - 7 1/4"

**J082010**  
14 cm - 5 1/2"







**C095210**  
55 cm - 21 1/2"

**C095200**  
12 cm - 4 3/4"

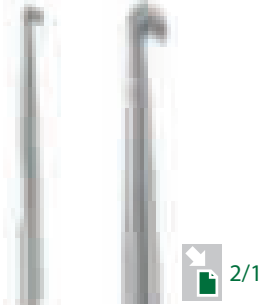
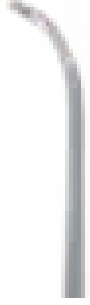
### TULIPE

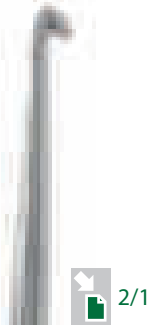
### MULLER

#### Crochets à phlébectomie - Phlebectomy hooks - Ganchos para flebectomía

 <p>1,75 mm <b>C012003</b> 12 cm - 4 3/4 "</p>	<p>N° 1 <b>C010106</b> 15 cm - 6 "</p>	<p><b>C010001</b> N° 1</p>	
	<p>N° 2 <b>C010206</b> 15 cm - 6 "</p>	<p><b>C010002</b> N° 2</p>	
	<p>N° 3 <b>C010306</b> 15 cm - 6 "</p>	<p><b>C010003</b> N° 3</p>	
	<p>N° 4 <b>C010406</b> 15 cm - 6 "</p>	<p></p>	
 <p>2 mm <b>C012004</b> 13 cm - 5 "</p>	<p>N° 1 N° 2 N° 3 N° 4</p>	<p>N° 1 N° 2 N° 3</p>	
<p><b>C012003</b> 12 cm - 4 3/4 "</p>	<p> 2/1</p>	<p> 2/1</p>	

Modèle Lepine  
Lepine model  
Modelo Lepine

### RUMEL BELMONT

TOURNIQUET VASCULAIRE  
VASCULAR TOURNIQUET  
TOURNIQUETE VASCULAR

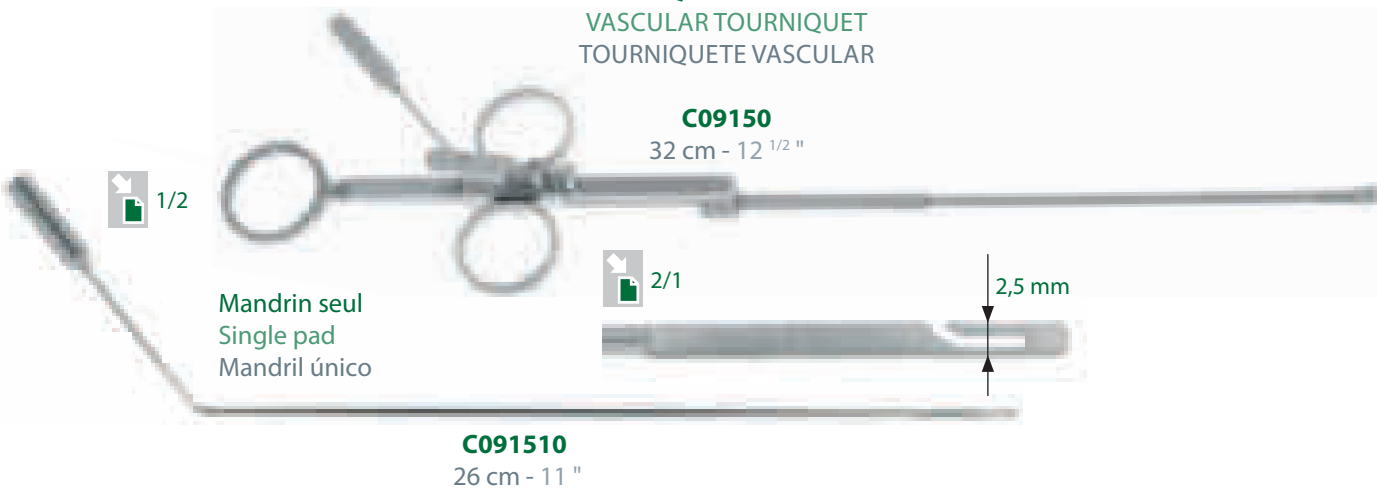

**C09150**  
32 cm - 12 1/2 "

**C091510**  
26 cm - 11 "

Mandrin seul  
Single pad  
Mandril único

2,5 mm

V - Clamps  
V - Clamps  
V - Clamps

### VARADY

Dissecteur  
Dissector  
Disector

Extracteur  
Extractor  
Extractor

Extracteur  
Extractor  
Extractor

Micro-spatule  
Micro-spatula  
Micro-espatula

Micro-spatule  
Micro-spatula  
Micro-espatula

Micro-extracteur  
Micro-extractor  
Micro-extractor

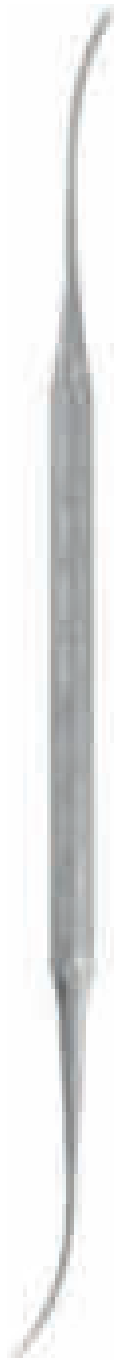

**C011010**  
18 cm - 7 "



**C011020**  
18 cm - 7 "

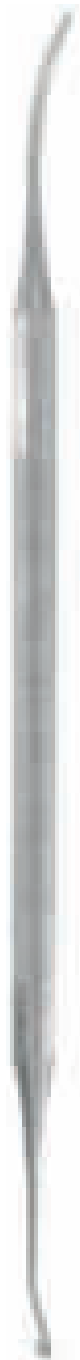

**C011030**  
18 cm - 7 "



**C011040**  
17 cm - 6 <sup>3</sup>/<sub>4</sub> "

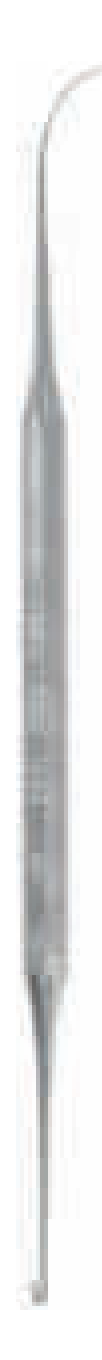

**C011050**  
17 cm - 6 <sup>3</sup>/<sub>4</sub> "

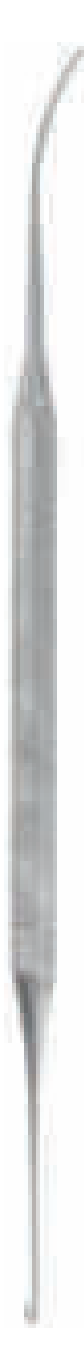

**C011060**  
17 cm - 6 <sup>3</sup>/<sub>4</sub> "

# LANDANGER

## Clamps bulldog - Bulldog clamps - Clamp bulldog

Droit Straight Recto	STANDARD STANDARD STANDARD	Courbe Curve Curvo	Droit Straight Recto	FIN FINE FINO	Courbe Curve Curvo
<b>C10170</b>	3,5 cm - 1 1/3 "	<b>C10195</b>	<b>C101701</b>	3,5 cm - 1 1/3 "	<b>C101951</b>
<b>C10175</b>	4 cm - 1 1/2 "	<b>C10200</b>	<b>C101751</b>	4 cm - 1 1/2 "	<b>C102001</b>
<b>C10180</b>	5 cm - 2 "	<b>C10205</b>	<b>C101801</b>	5 cm - 2 "	<b>C102051</b>
<b>C10185</b>	6 cm - 2 1/4 "	<b>C10210</b>	<b>C101851</b>	6,5 cm - 2 1/2 "	<b>C102101</b>
<b>C10190</b>	7 cm - 2 3/4 "	<b>C10215</b>	<b>C101901</b>	7 cm - 2 3/4 "	<b>C102151</b>



**C10185**  
6 cm - 2 1/4 "



**C10210**  
6 cm - 2 1/4 "



**C101851**  
6,5 cm - 2 1/2 "



**C102101**  
6,5 cm - 2 1/2 "

### CARREL

### JOHNS HOPKINS

CLAMP POUR LYMPHOGRAPHIE  
LYMPHOGRAPHIA CLAMP  
CLAMP PARA LINFOGRAFÍA



**C10220**  
5 cm - 2 "



**C102304**  
6,3 cm - 2 1/2 "



**C102304**



Droit Straight Recto		Courbe Curve Curvo
<b>C102301</b>	3,8 cm - 1 1/3 "	<b>C102401</b>
<b>C102302</b>	5,1 cm - 2 "	<b>C102402</b>
<b>C102303</b>	5,7 cm - 2 1/4 "	<b>C102403</b>
<b>C102304</b>	6,3 cm - 2 1/2 "	<b>C102404</b>
<b>C102305</b>	7,0 cm - 2 3/4 "	<b>C102405</b>
<b>C102306</b>	7,5 cm - 3 "	<b>C102406</b>
<b>C102307</b>	9,0 cm - 3 1/2 "	<b>C102407</b>



**C102404**

V - Clamps  
V - Clamps  
V - Clamps

## Clamps bulldog - Bulldog clamps - Clamp bulldog



Bulldog

### DEBAKEY

Droit  
Straight  
Recto

Courbe  
Curve  
Curvo

-	7,0 cm - 2 3/4 "	C10080
C10060	7,5 cm - 3 "	-
-	8,0 cm - 3 1/8 "	C10085
C10065	8,5 cm - 3 1/4 "	-
-	10,0 cm - 4 "	C10090
C10070	10,5 cm - 4 1/4 "	-
-	11,5 cm - 4 1/2 "	C10095
C10075	12,0 cm - 4 3/4 "	-

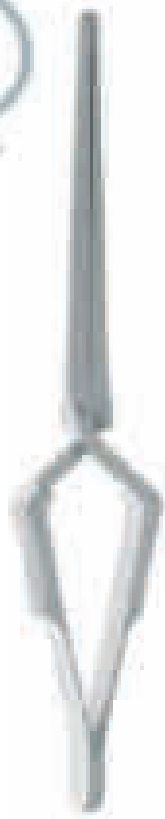

**C10070**  
10,5 cm - 4 1/4 "



**C10090**  
10 cm - 4 "

PINCE À POSER LES CLAMPS  
CLAMP SETTING FORCEPS  
PINZA PARA COLOCAR CLAMPS

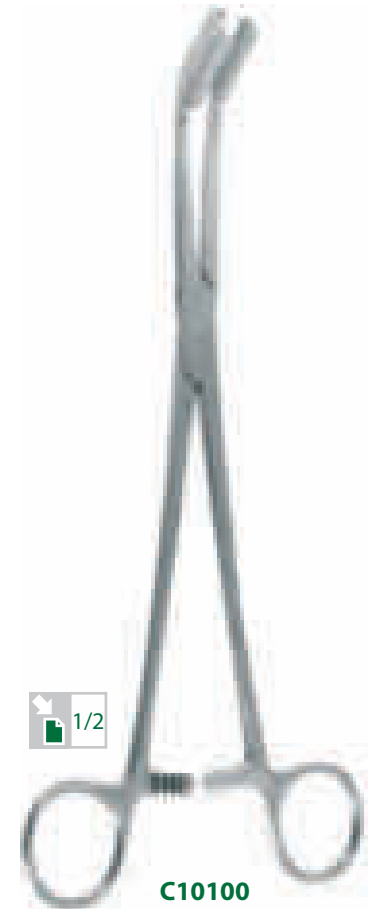

**C10100**  
24 cm - 9 1/2 "

### SANTULLI

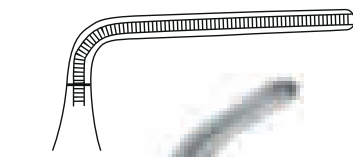

**C10096**  
7 cm - 2 3/4 "



### GREGORY SOFT

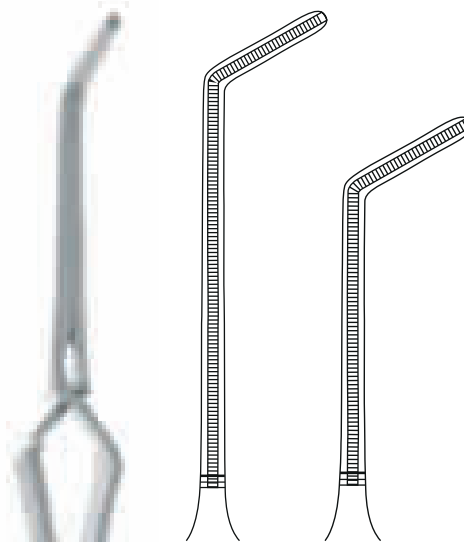

**C10099** 11 cm - 4 1/4 "  
**C10098** 9 cm - 3 1/2 "



## Clamps bulldog - Bulldog clamps - Clamp bulldog



Delivery

### DEBAKEY GLOVER

Droit  
Straight  
Recto

Courbe  
Curve  
Curvo

-	4,0 cm - 1 1/2"	C101231
-	4,5 cm - 1 3/4"	C101251
C101051	5,0 cm - 2"	C101421
-	6,5 cm - 2 1/2"	C101301
C101101	7,0 cm - 2 3/4"	-
-	8,0 cm - 3 1/4"	C101351
C101151	8,5 cm - 3 1/2"	-
-	11,5 cm - 4 1/2"	C101401
C101201	12,5 cm - 5"	-

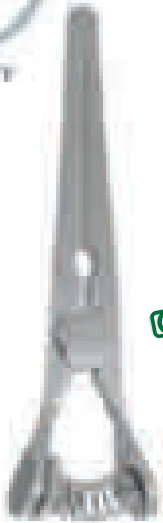

**C101101**  
7 cm - 2 3/4"



**C101301**  
6,5 cm - 2 1/2"



**C101421**  
5 cm - 2"

### DEBAKEY SATINSKY

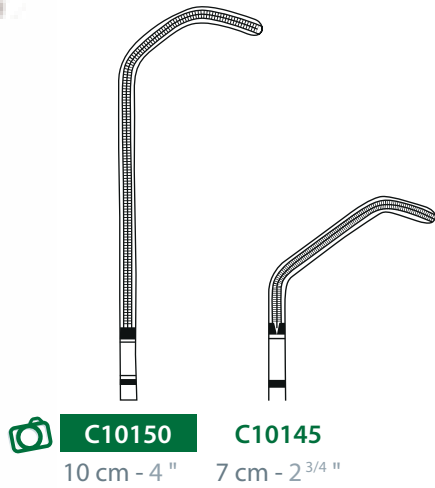
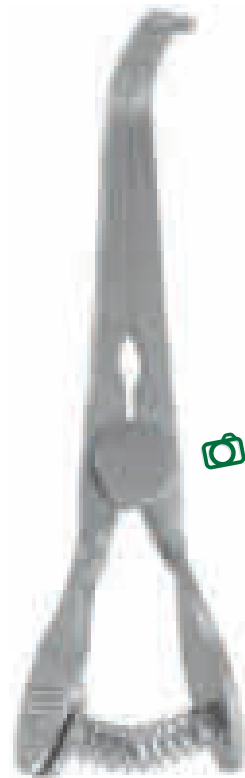

**C10150**  
10 cm - 4"

**C10145**  
7 cm - 2 3/4"

### DEBAKEY CAROTID

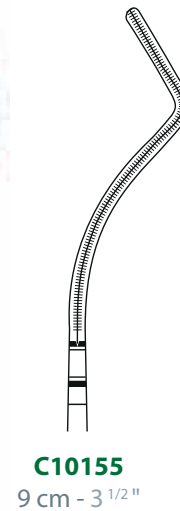

**C10155**  
9 cm - 3 1/2"

V - Clamps  
V - Clamps  
V - Clamps





Delivery

## DEBAKEY POTTS

POUR COARCTATION  
FOR COARCTATION  
PARA COARCTACIÓN

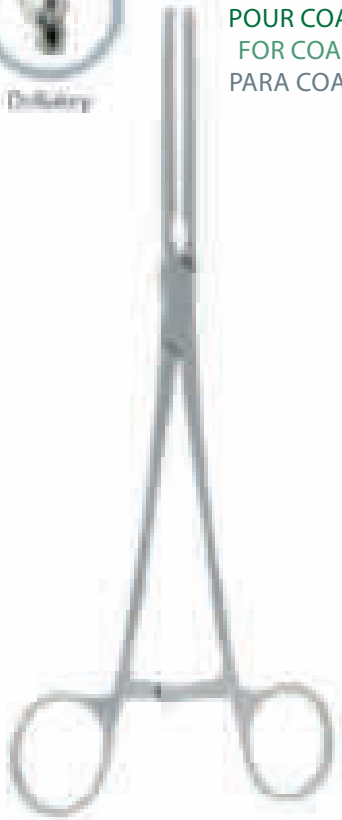

**C10265**  
21 cm - 8 1/4"



 **C10270**  
22 cm - 8 3/4"

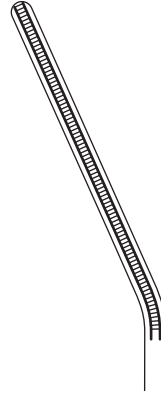

**C10275**  
21 cm - 8 1/4"

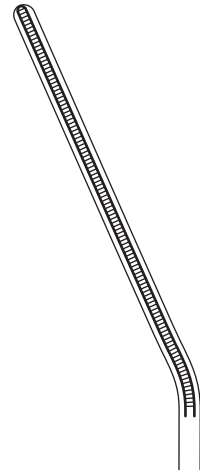

**C10280**  
22 cm - 8 3/4"

POUR COARCTATION  
FOR COARCTATION  
PARA COARCTACION

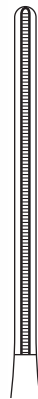

**C10285**  
21 cm - 8 1/4"

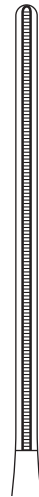

**C10290** 

POUR ANASTOMOSE  
FOR ANASTOMOSIS  
PARA ANASTOMOSIS

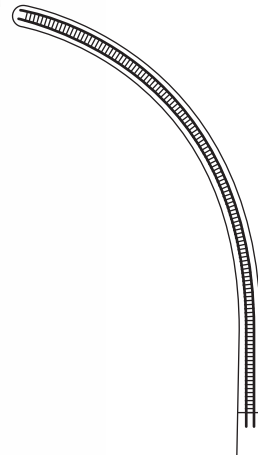
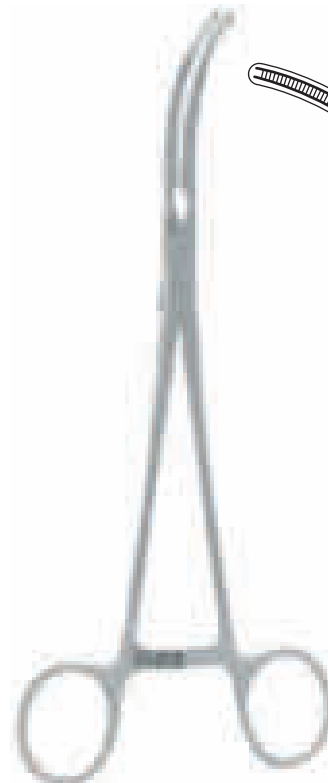

 **C10295**  
22 cm - 8 3/4"

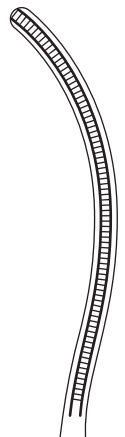

**C10300**  
22 cm - 8 3/4"

V - Clamps  
V - Clamps  
V - Clamps



Dissection

## DEBAKEY

POUR DISSECTION ET LIGATURE  
FOR DISSECTING AND LIGATURE  
PARA DISECCIÓN Y LIGADURAS

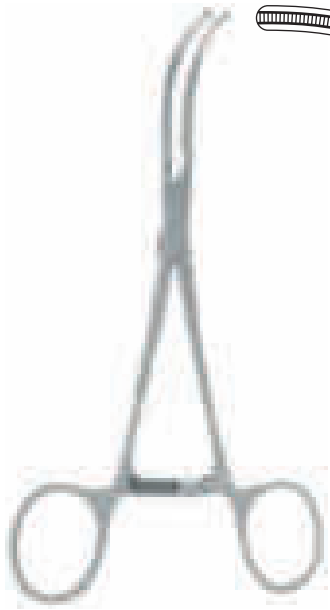

**C10320**  
16 cm - 6 3/4"

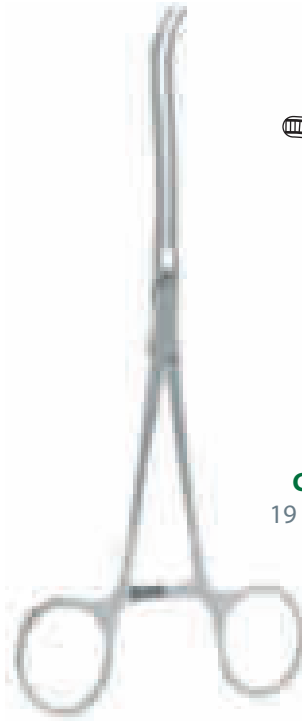

**C10310**  
19 cm - 7 1/2"

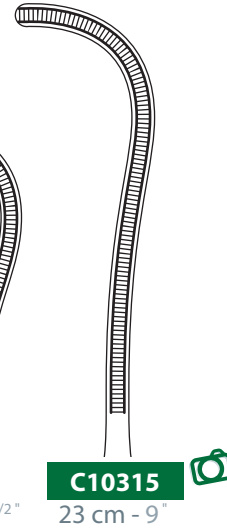

**C10315**



**C10325**

19 cm - 7 1/2"

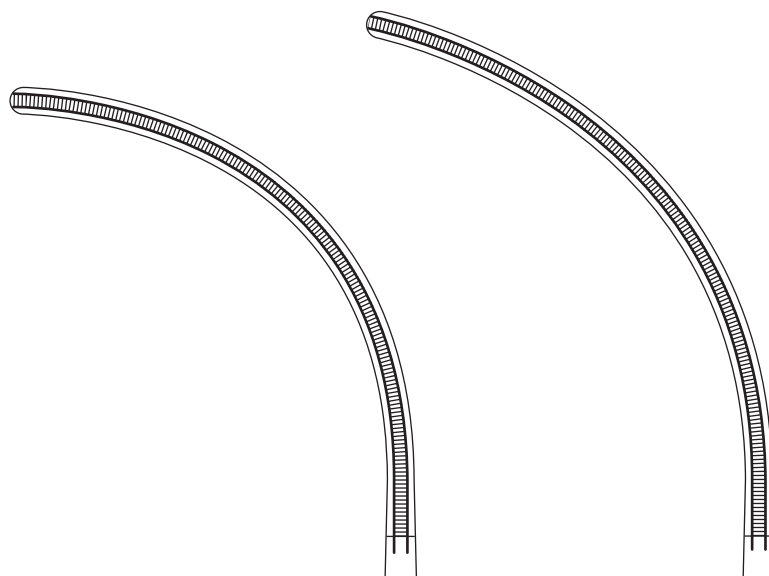

**C10330**

20 cm - 8"

V - Clamps  
V - Clamps  
V - Clamps



**DEBAKEY  
(LELAND JONES)**



**C10335**  
18 cm - 7 "

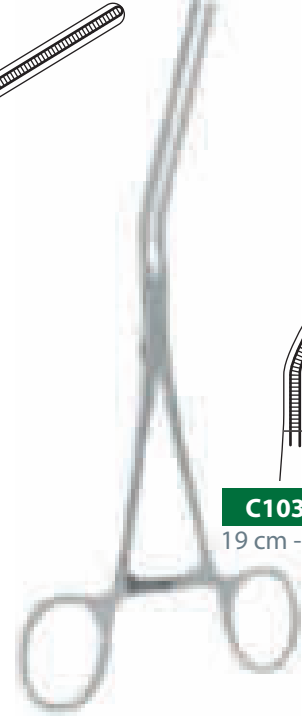

**C10340**  
19 cm - 7 1/2 "

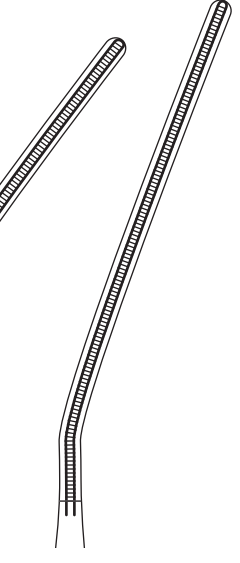

**C10345**  
20 cm - 8 "

**BAINBRIDGE**

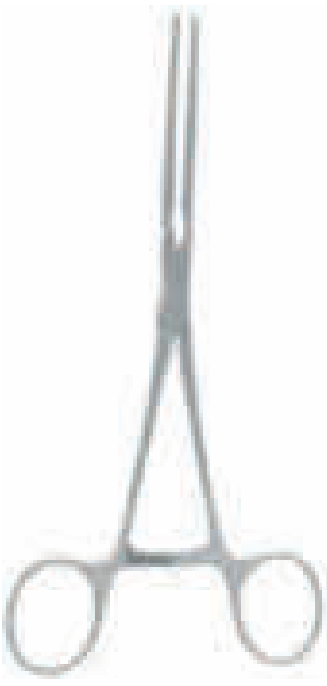

**C10350**  
15 cm - 6 "



**C10355**  
18 cm - 7 "

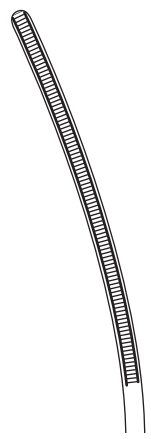

**C10360**  
15 cm - 6 "

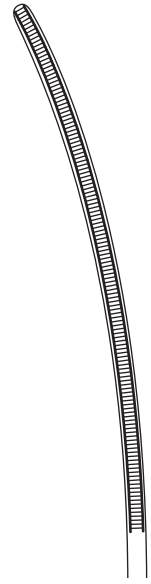

**C10365**  
18 cm - 7 "

V - Clamps  
V - Clamps  
V - Clamps



POUR ARTÈRE RÉNALE  
FOR RENAL ARTERY  
PARA ARTERIA RENAL

DEBAKEY

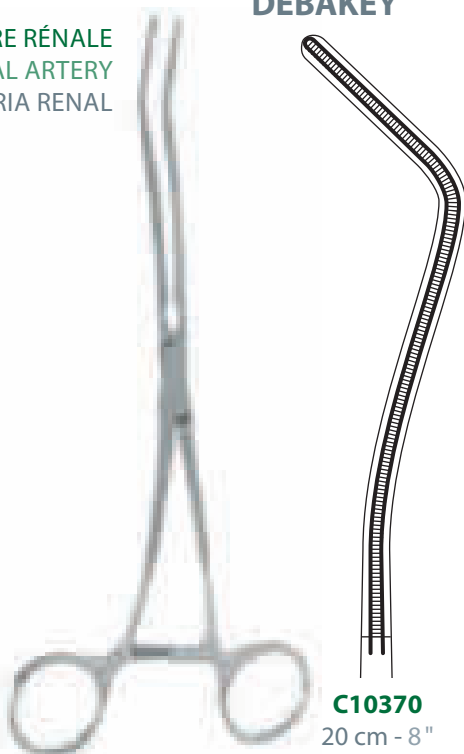

**C10370**  
20 cm - 8"

POUR ANÉVRISME DE L'AORTE  
FOR AORTIC ANEURYSM  
PARA ANEURISMA DE LA AORTA

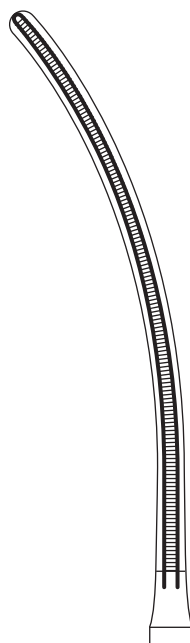
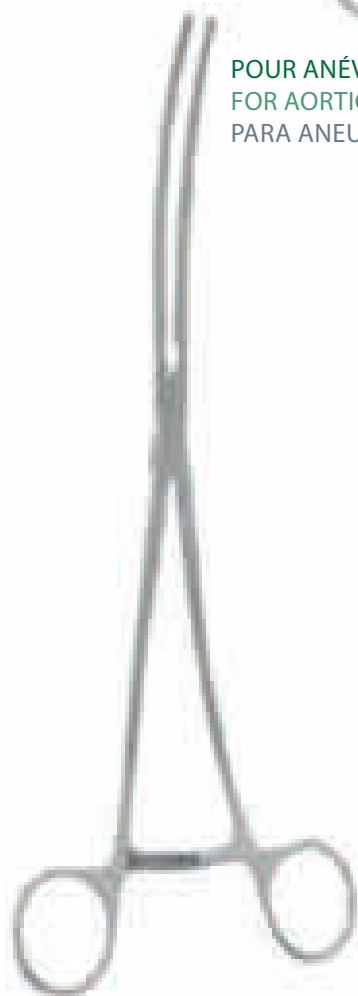

**C10375**  
26 cm - 10 1/4"

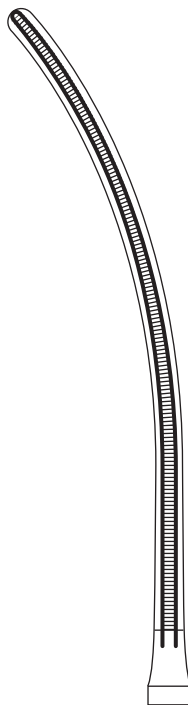

**C10380**   
27 cm - 10 1/2"

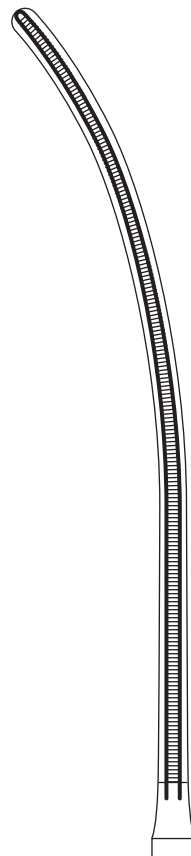

**C10385**  
31 cm - 12 1/4"

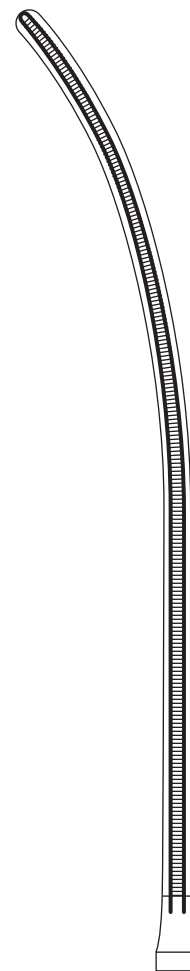

**C10390**  
33 cm - 13"

V - Clamps  
V - Clamps  
V - Clamps



Atraumatic

DEBAKEY-BECK

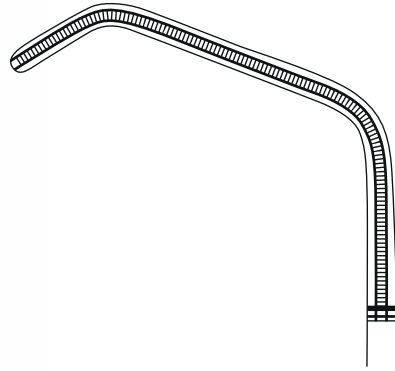
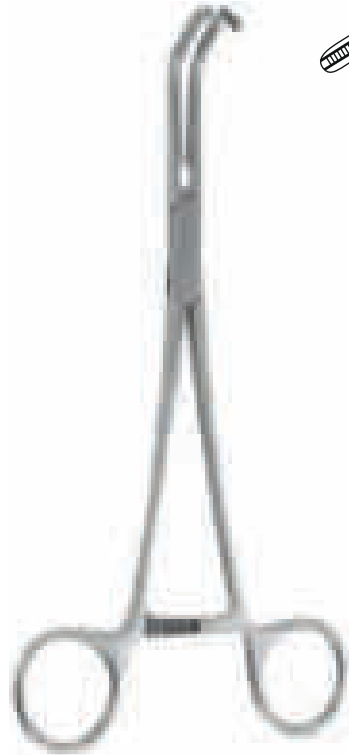

**C103905**  
21 cm - 8 1/4"

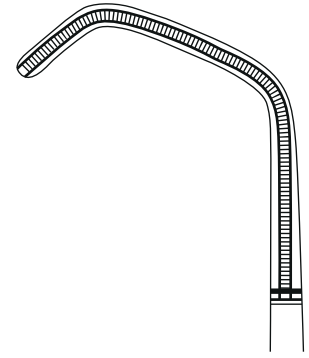

**C103910**  
20,5 cm - 8"

WYLIE

POUR ANÉVRISME DE L'AORTE  
FOR AORTIC ANEURYSM  
PARA ANEURISMA DE LA AORTA

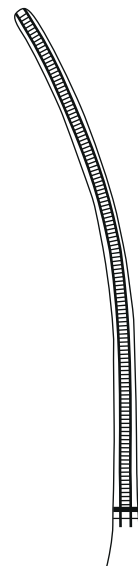

**C103920**  
24 cm - 9 1/2"

V - Clamps  
V - Clamps  
V - Clamps



## DEBAKEY

POUR ANÉVRISME DE L'AORTE  
FOR AORTIC ANEURYSM  
PARA ANEURISMA DE LA AORTA

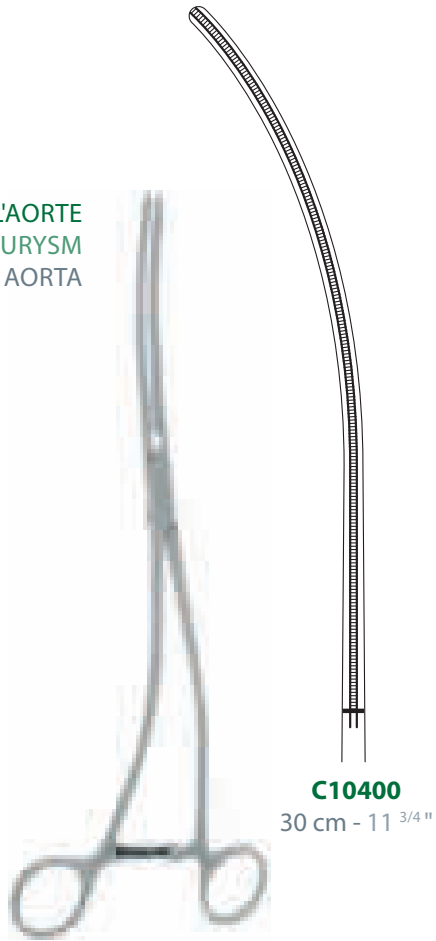

**C10400**  
30 cm - 11 <sup>3</sup>/<sub>4</sub>''

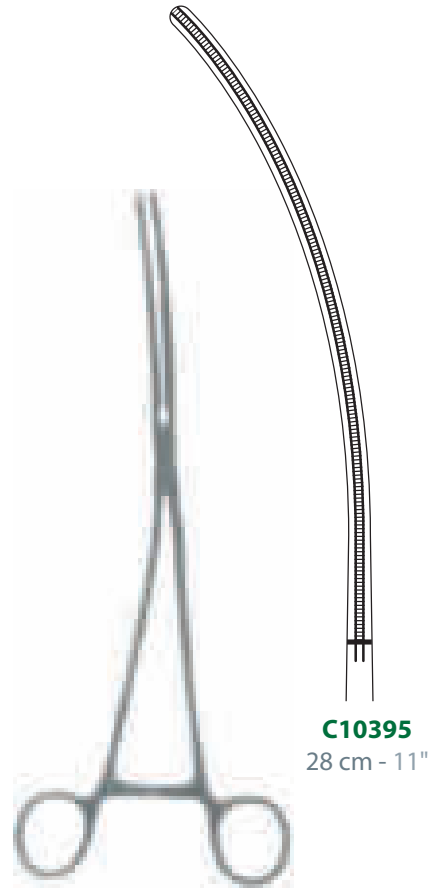

**C10395**  
28 cm - 11''

## OCHSNER

POUR L'AORTE  
FOR AORTIC  
PARA LA AORTA

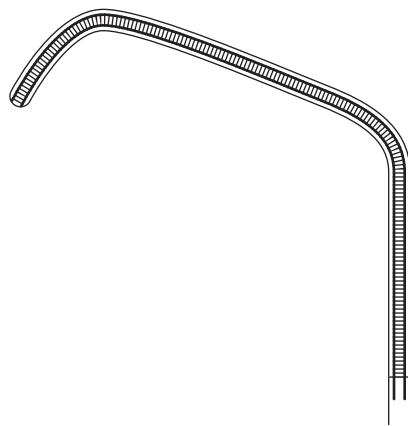
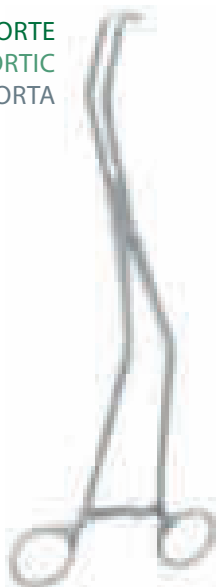

**C10742**  
23,5 cm - 9 <sup>1</sup>/<sub>4</sub>''

V - Clamps  
V - Clamps  
V - Clamps



Illustration



POUR L'AORTE  
FOR AORTIC  
PARA LA AORTA

## DIETRICH

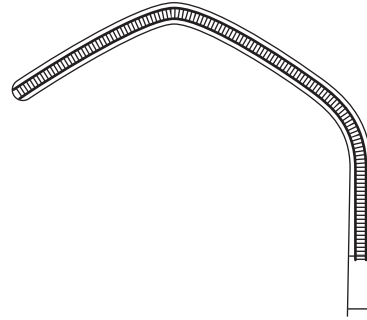

**C10744**  
20 cm - 8"

## HARKEN

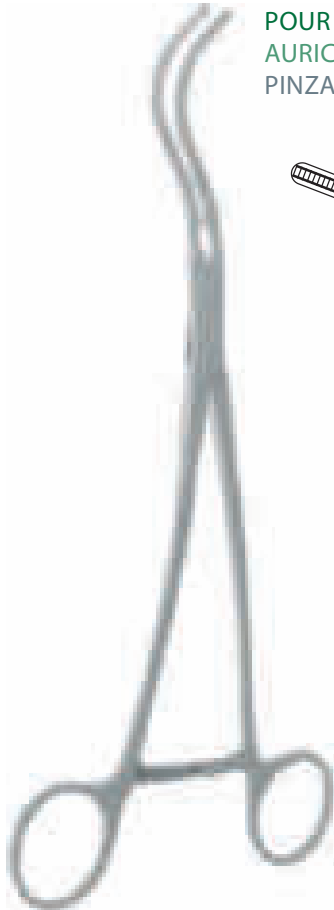

POUR OREILLETTE  
AURICLE CLAMPS  
PINZAS-CLAMPS AURICULARES

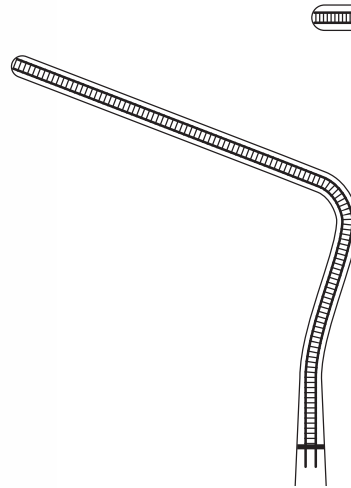

**C10500**  
24 cm - 9 1/2"

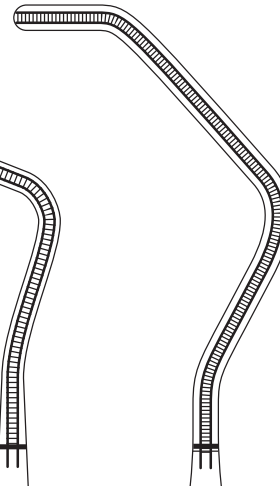

**C10495**  
24 cm - 9 1/2"

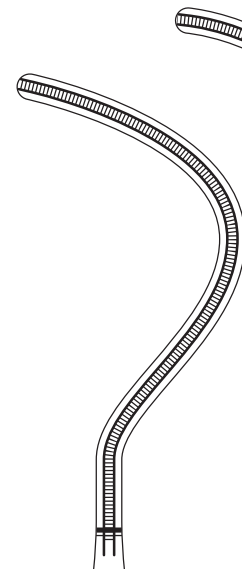

**C10490**  24 cm - 9 1/2"

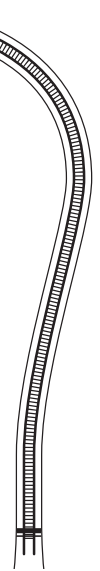

**C10485**  
24 cm - 9 1/2"



### LEES

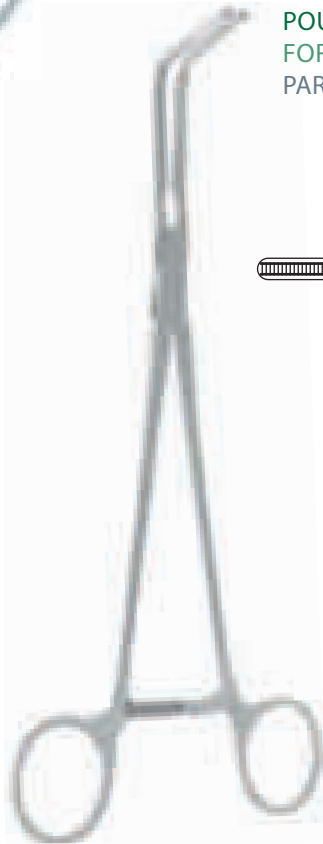

POUR LES BRONCHES  
FOR BRONCHUS  
PARA LOS BRONQUIOS

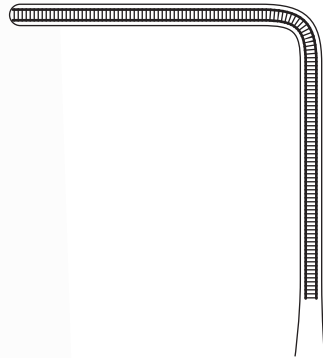

**C10505**   
23 cm - 9"

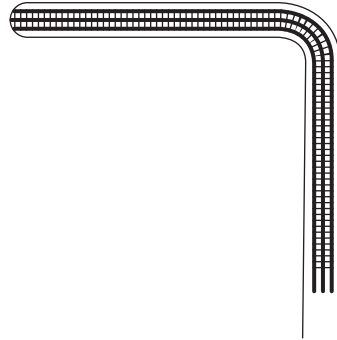

**C10510**  
25 cm - 10"

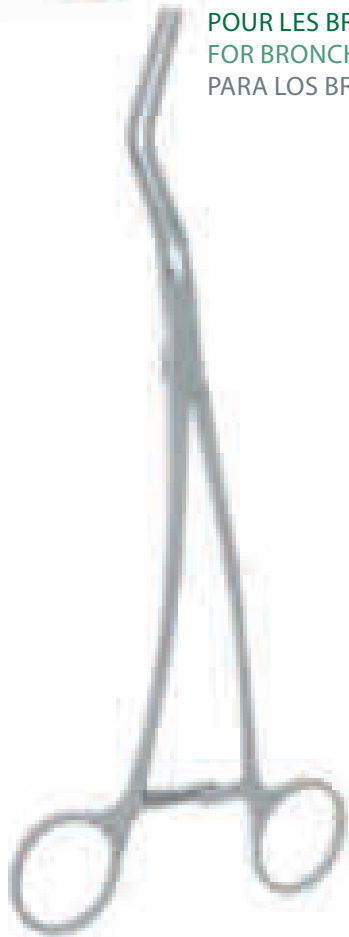

POUR LES BRONCHES  
FOR BRONCHUS  
PARA LOS BRONQUIOS

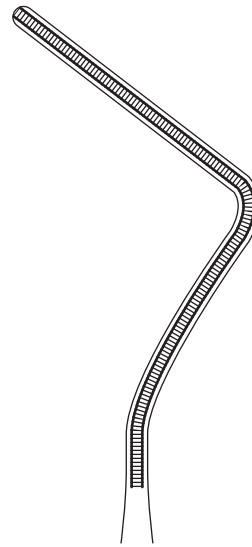

**C10515**  
25 cm - 10"

V - Clamps  
V - Clamps  
V - Clamps





DEBAKEY



POUR L'AORTE  
FOR AORTIC  
PARA LA AORTA

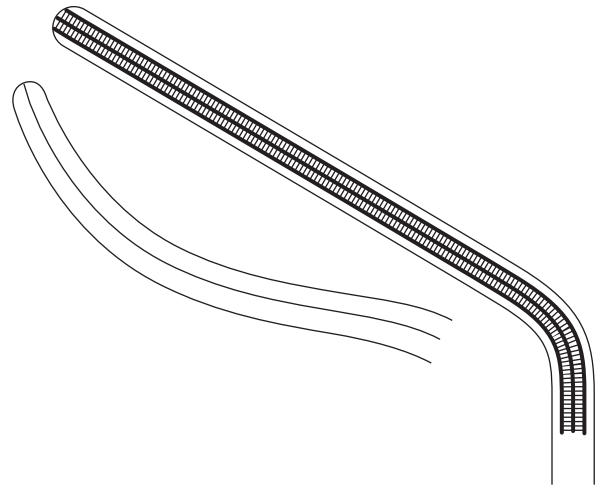

**C10405**  
27 cm - 10 1/2"

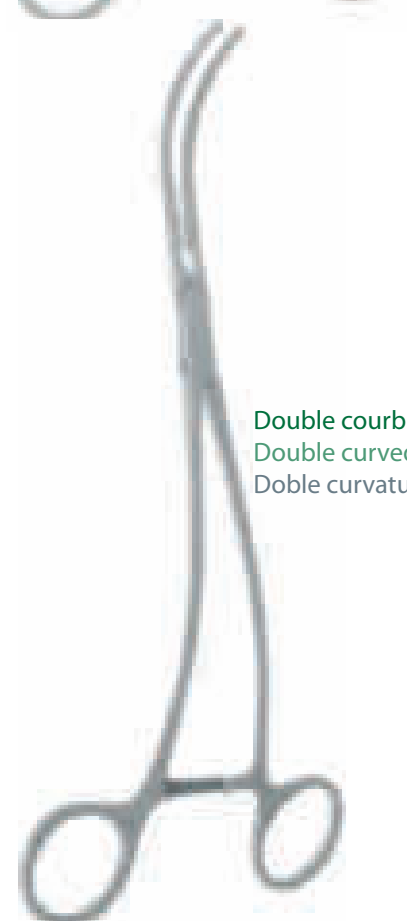

Double courbure  
Double curved  
Doble curvatura



POUR LIGATURE  
FOR LIGATURE  
PARA LIGADURA



POUR L'AORTE  
FOR AORTIC  
PARA LA AORTA

**C10410**  
24 cm - 9 1/2"

**C10415**   
24 cm - 9 1/2"

V - Clamps  
V - Clamps  
V - Clamps



## DEBAKEY

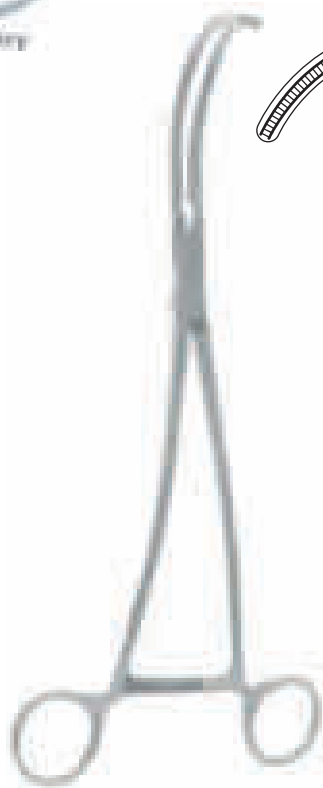

POUR LIGATURE  
FOR LIGATURE  
PARA LIGADURA

**C10420**  
25 cm - 10"

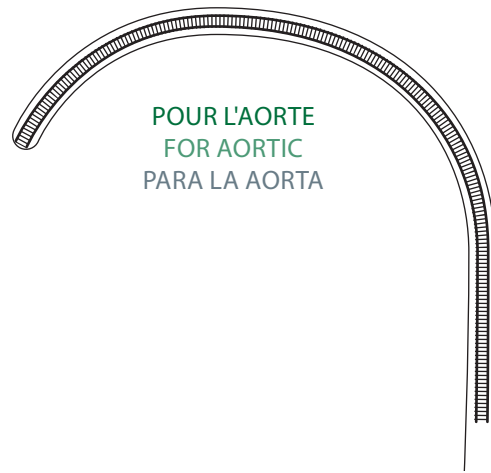

POUR L'AORTE  
FOR AORTIC  
PARA LA AORTA

**C10425**   
26 cm - 10 1/4"

## WEBER



A droite  
On the Right  
A la derecha

**C10430**  
26 cm - 10 1/4"

POUR L'AORTE  
FOR AORTIC  
PARA LA AORTA

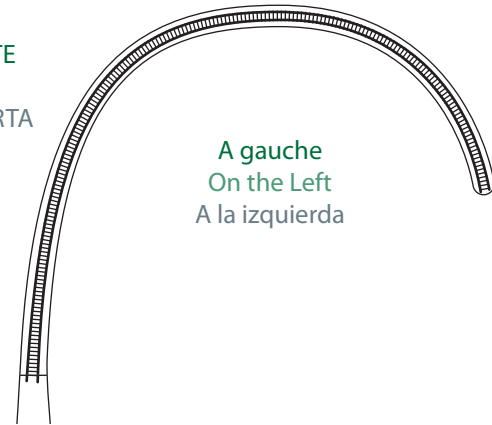

A gauche  
On the Left  
A la izquierda

**C10435**   
26 cm - 10 1/4"

V - Clamps  
V - Clamps  
V - Clamps



Delivering

## SATINSKY

POUR OCCLUSION TANGENTIELLE  
FOR TANGENTIAL OCCLUSION  
PARA OCLUSIÓN TANGENCIAL

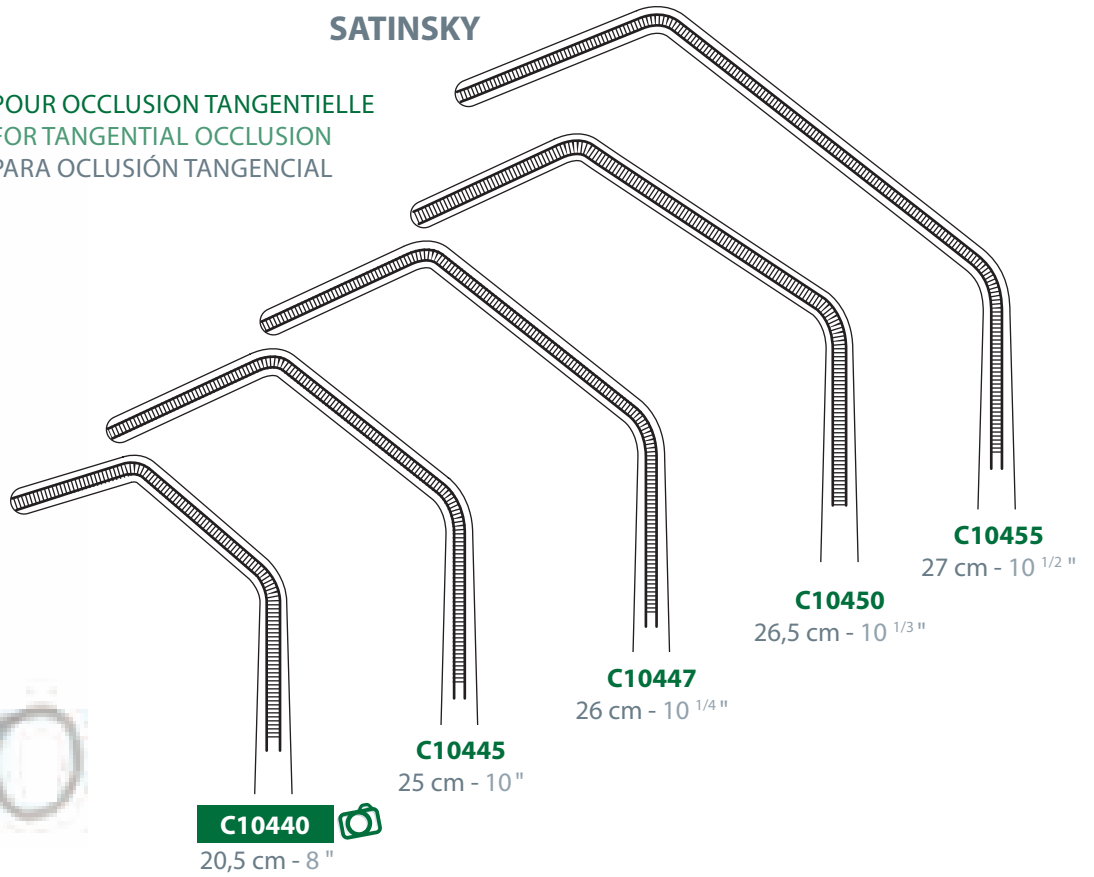
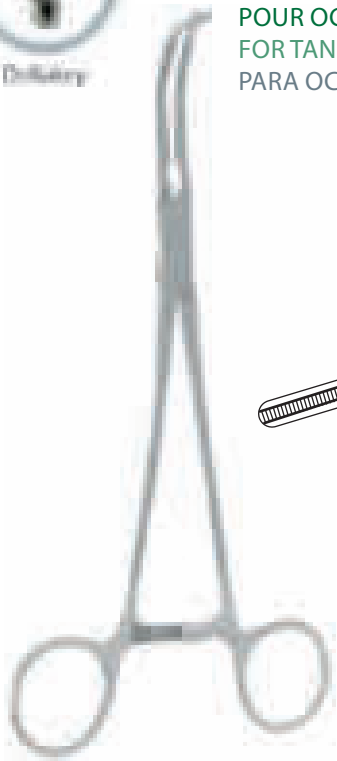

## LAMBERT KAY

POUR ANASTOMOSE DE L'AORTE  
FOR AORTIC ANASTOMOSIS  
PARA ANASTOMOSIS DE LA AORTA

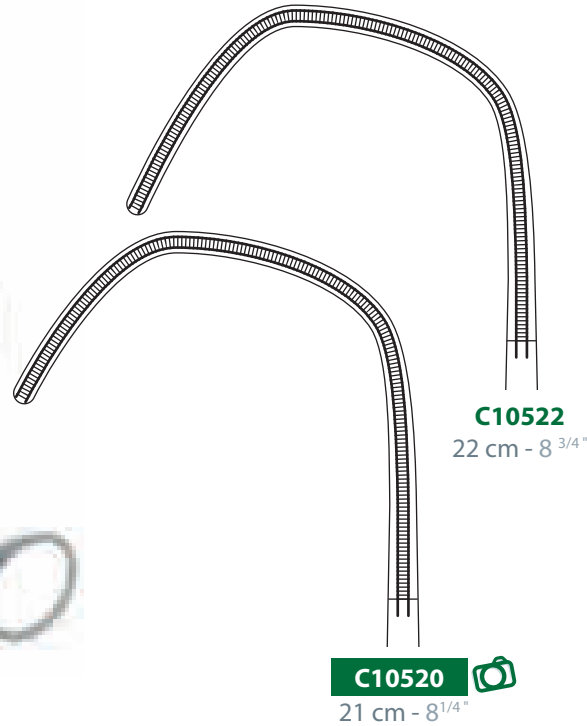
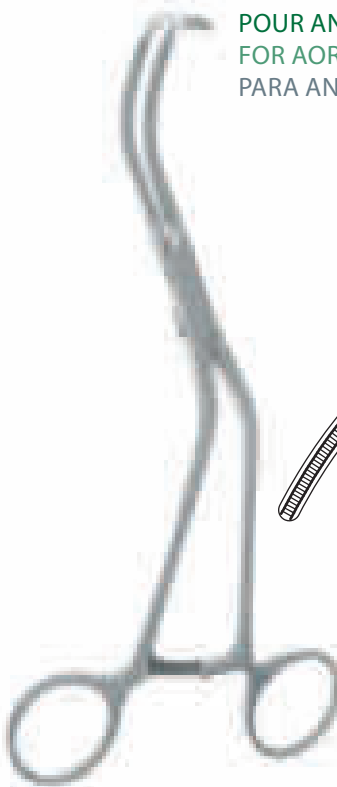

## DEBAKEY



**C10525**  
17 cm - 6 3/4"



## BECK

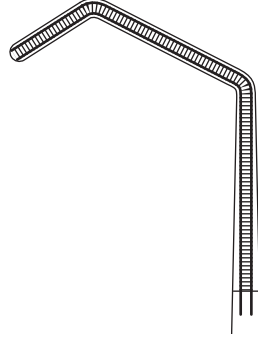

**C10715**  
17 cm - 6<sup>3/4</sup>"

## DEBAKEY

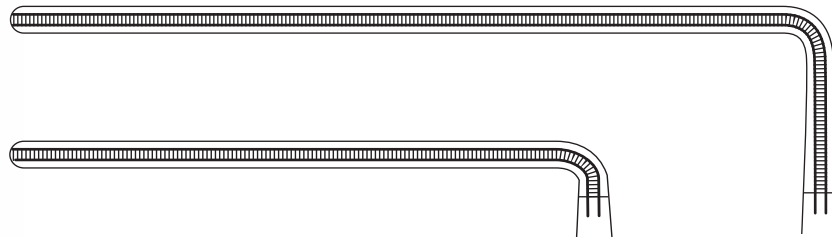

**C10605**  
23 cm - 9"

**C10610**  
27 cm - 10<sup>1/2</sup>"

**C10600**   
19 cm - 7<sup>1/2</sup>"

**C10595**  
18 cm - 7"

V - Clamps  
V - Clamps  
V - Clamps



Delivering

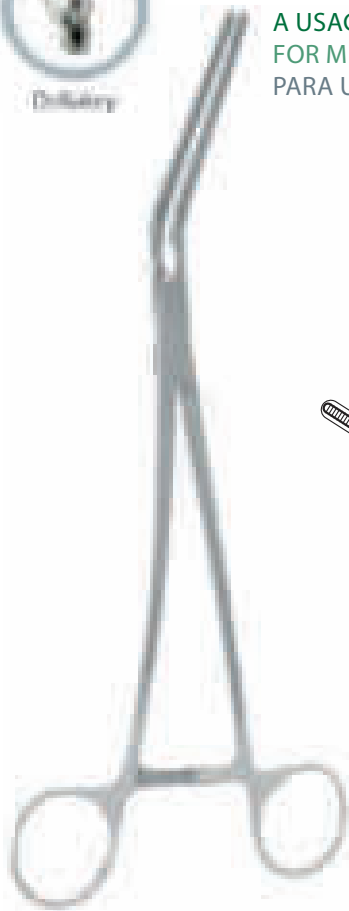

A USAGES MULTIPLES  
FOR MULTI PURPOSE  
PARA USOS VARIOS

## DEBAKEY

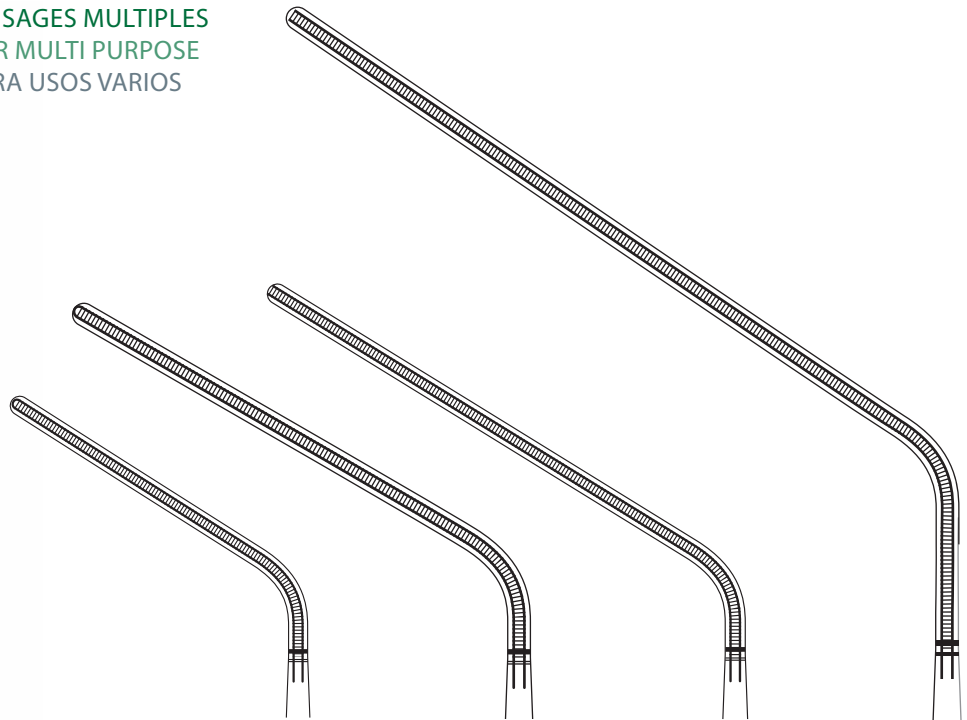

**C10615**  
21 cm - 8 1/4"

**C10620**   
22 cm - 8 3/4"

**C10625**  
26 cm - 10 1/4"

**C10630**  
31 cm - 12"

## MORRIS DEBAKEY



POUR L'AORTE  
FOR AORTIC  
PARA LA AORTA

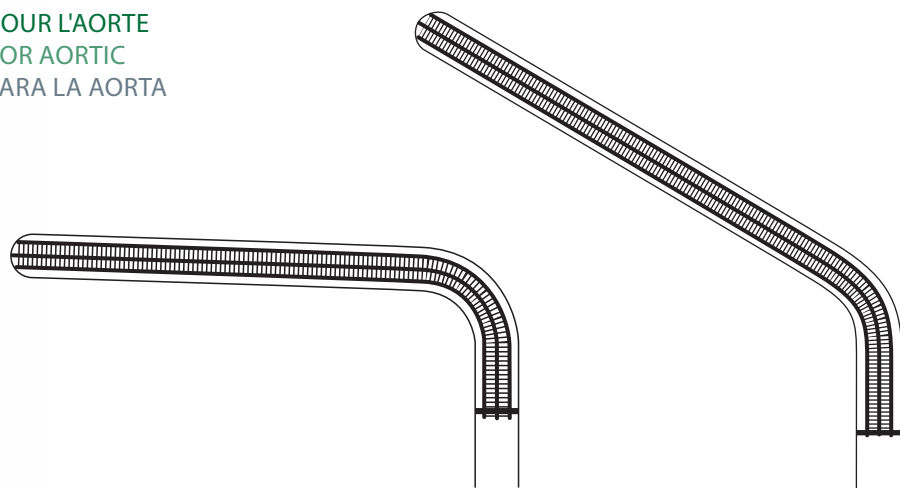

18 cm - 7"  
23 cm - 9"

**C10528**

**C10532**

20 cm - 8"

25 cm - 10"

**C10530** 

**C10535**

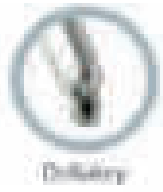

## DEBAKEY BAHNSON

POUR ANÉVRISME DE L'ARTÈRE ILIAQUE  
FOR ILIAC ARTERY ANEURYSM  
PARA ANEURISMA DE LA ARTERIA ILIACA

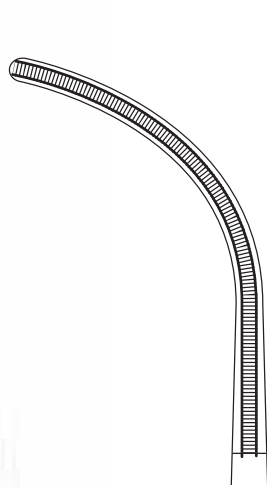
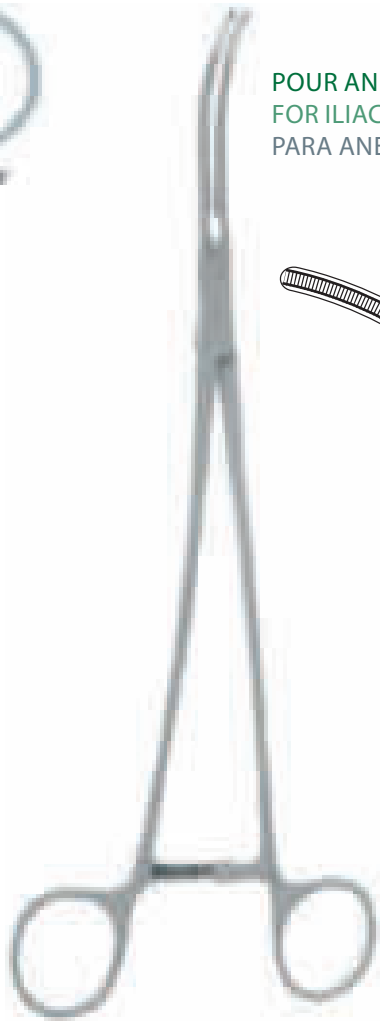

**C10540**   
26 cm - 10 1/4"

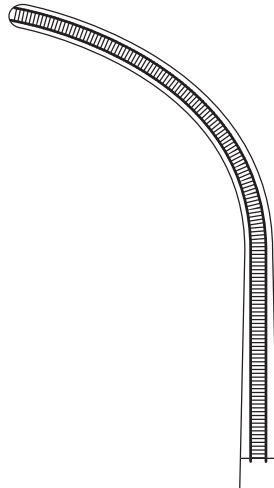

**C10545**  
26,5 cm - 10 1/3"

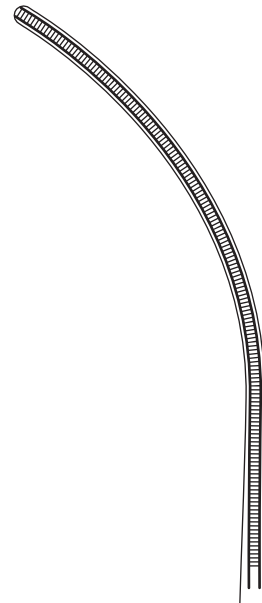

**C10550**  
28,5 cm - 11 1/4"

POUR COARCTATION  
FOR COARCTATION  
PARA COARCTACIÓN

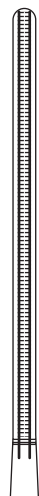

**C10555**   
21,5 cm - 8 1/2"

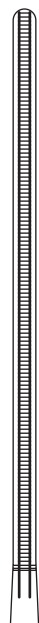

**C10560**  
23 cm - 9"

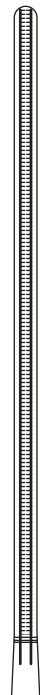

**C10565**  
27 cm - 10 1/2"

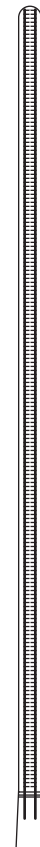

**C10570**  
31,5 cm - 12 1/2"

V - Clamps  
V - Clamps  
V - Clamps

## Pinces clamps cardiovasculaires atrauma - Atrauma cardiovascular forceps - Pinzas clamps cardiovasculares atrauma

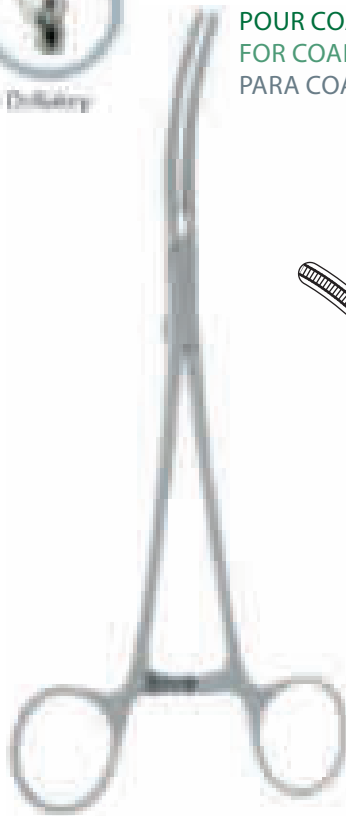

POUR COARCTATION  
FOR COARCTATION  
PARA COARCTACIÓN

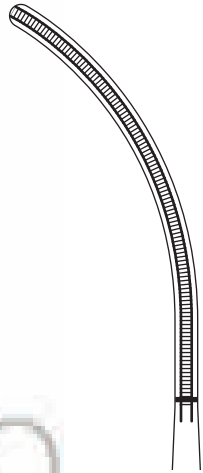

**C10575**   
21 cm - 8 1/4"

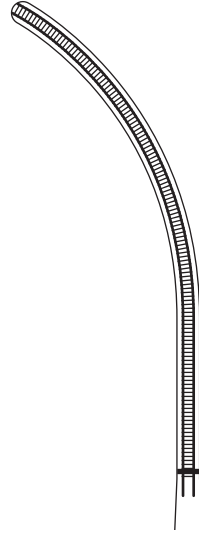

**C10580**  
23 cm - 9"

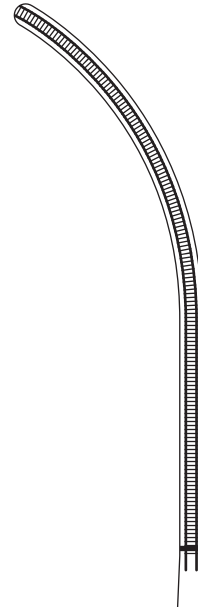

**C10585**  
26 cm - 10 1/4"

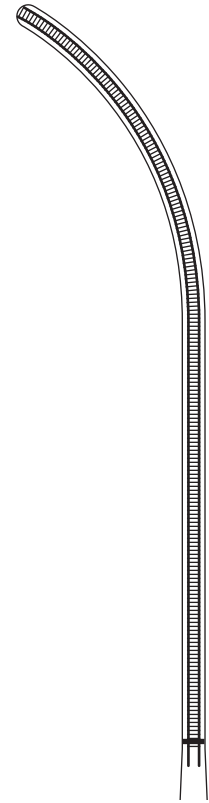

**C10590**  
31 cm - 12 1/4"

### DEBAKEY PEAN

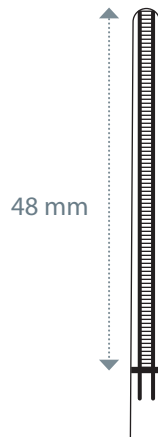
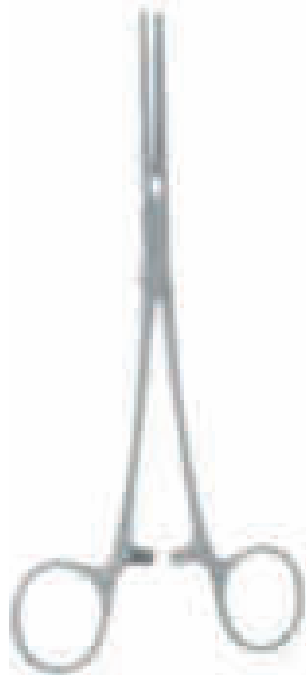

14 cm - 5 1/2"	<b>C10640</b>	38 mm
16 cm - 6 1/4"	<b>C10641</b>	44 mm
18 cm - 7"	<b>C10642</b> 	48 mm
20 cm - 8"	<b>C10643</b>	50 mm

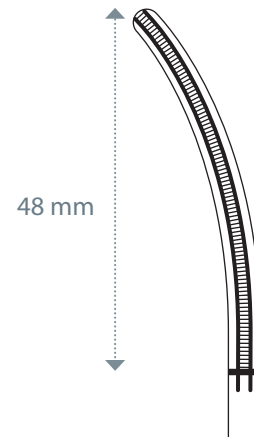

14 cm - 5 1/2"	<b>C10650</b>	38 mm
16 cm - 6 1/4"	<b>C10651</b>	44 mm
18 cm - 7"	<b>C10652</b>	48 mm
20 cm - 8"	<b>C10653</b>	50 mm

V - Clamps  
V - Clamps  
V - Clamps



## DEBAKEY RANKIN



## DEBAKEY MOSQUITO

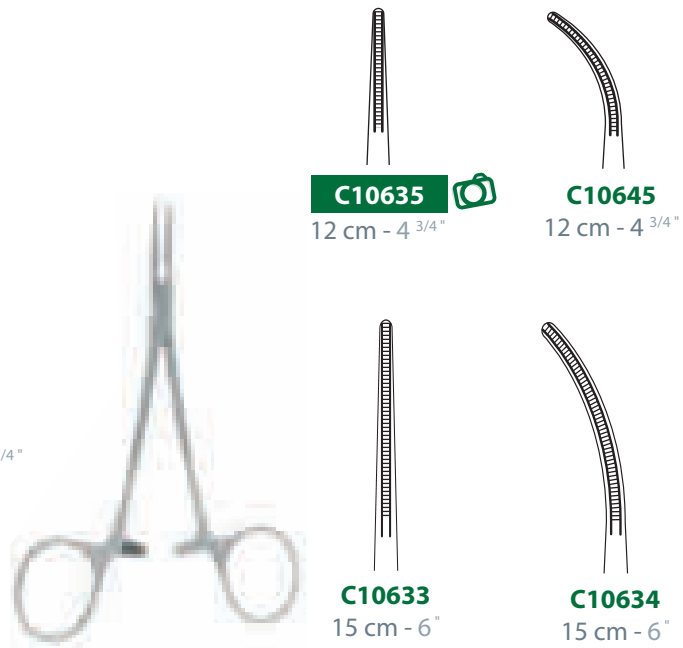

## DEBAKEY

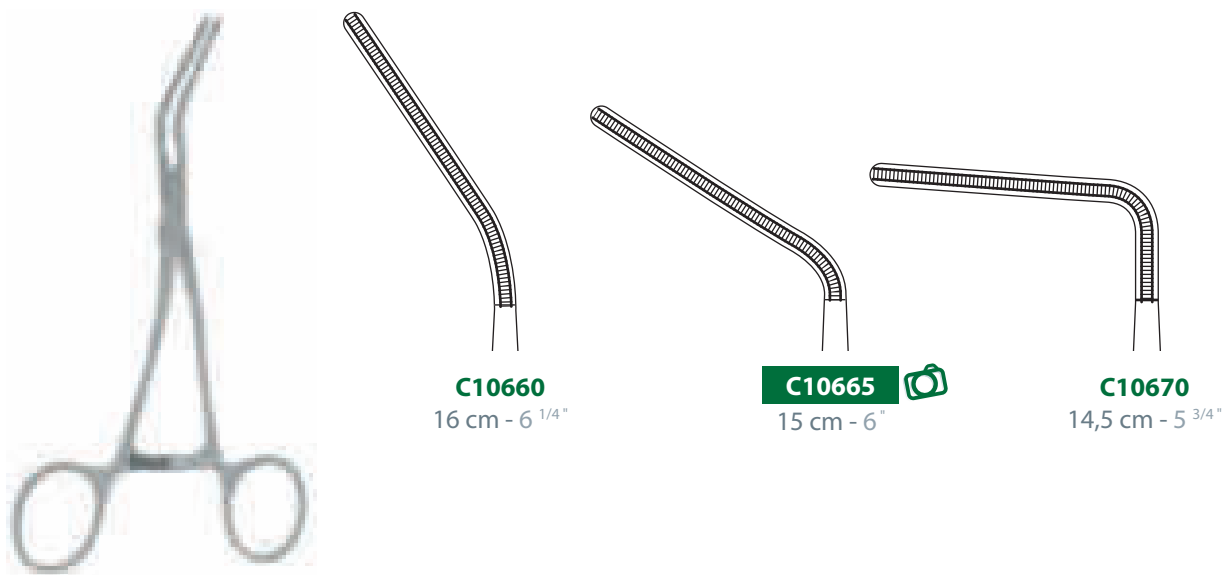

V - Clamps  
V - Clamps  
V - Clamps





Debakey

DEBAKEY



**C10655**  
17 cm - 6 3/4"

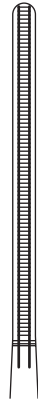

**C10675**  
17 cm - 6 3/4"

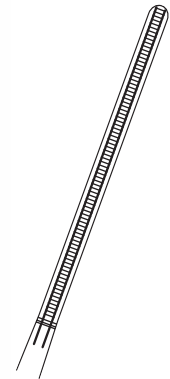

GLOVER

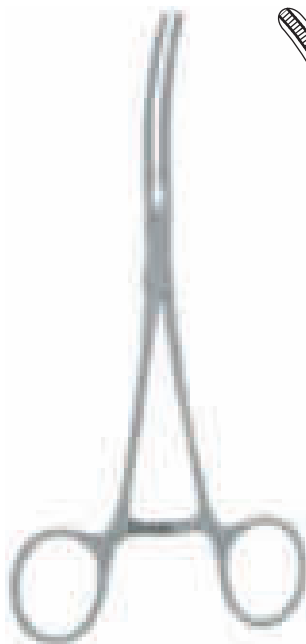

**C10680**  
17 cm - 6 3/4"

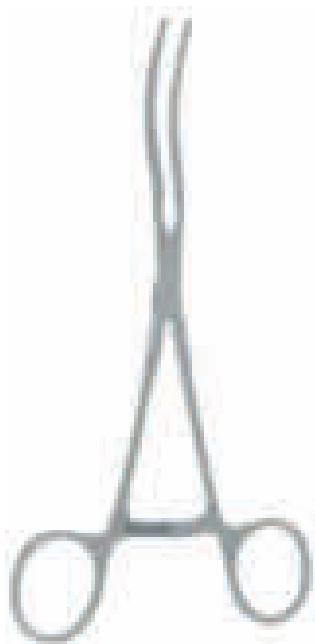
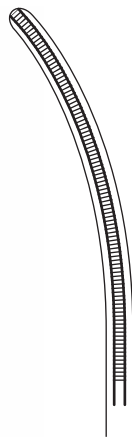

**C10685**  
17 cm - 6 3/4"

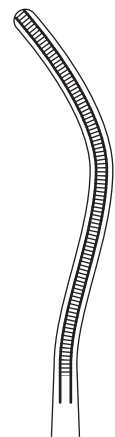

V - Clamps  
V - Clamps  
V - Clamps



Delicate

## GLOVER

POUR LIGATURE  
FOR LIGATURE  
PARA LIGADURA

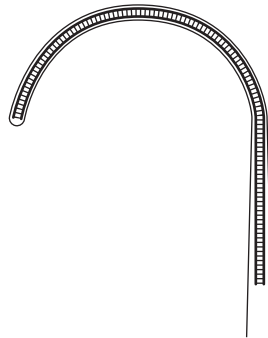
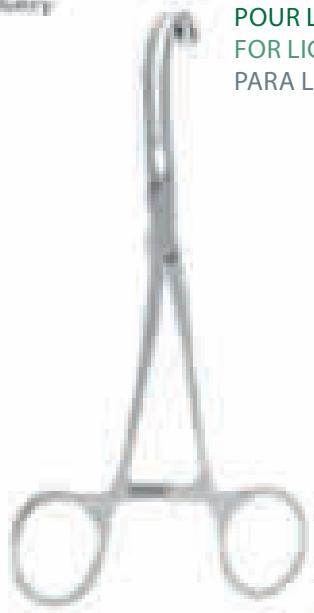

**C10690**  
16 cm - 6 1/2"

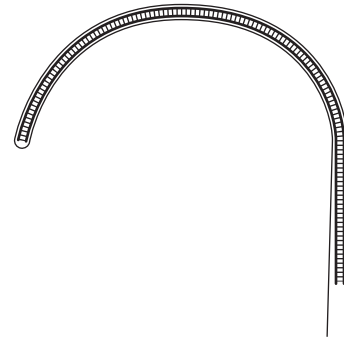

**C10695**   
16 cm - 6 1/2"

## DERRA

POUR L'ANASTOMOSE  
FOR ANASTOMOSIS  
PARA ANASTOMOSIS

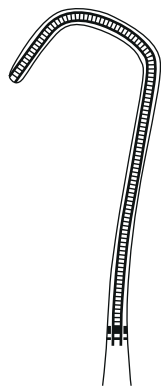

**C10700**  
16 cm - 6 1/4"

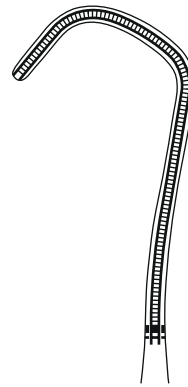

**C10705**   
17 cm - 6 3/4"

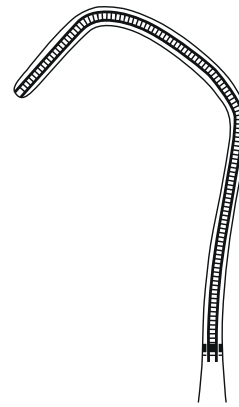

**C10710**  
18 cm - 7"



DALE

DALE

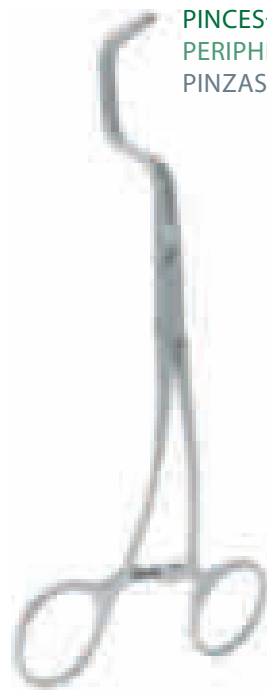

PINCES-CLAMPS PÉRIPHÉRIQUES  
PERIPHERAL VESSEL CLAMPS  
PINZAS CLAMPS PERIFERICAS

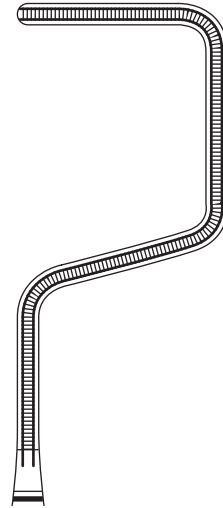

**C10746**  
18,5 cm - 7 1/4"

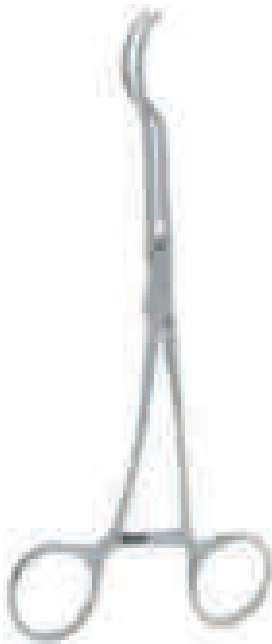

**C10748**  
17 cm - 6 3/4"

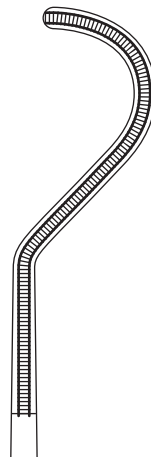

**C10749**   
17,5 cm - 6 4/5"

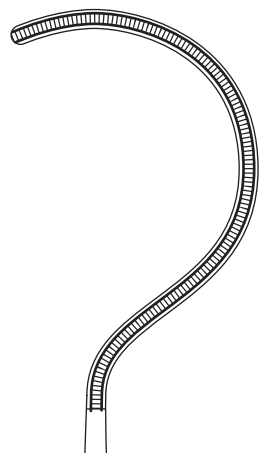
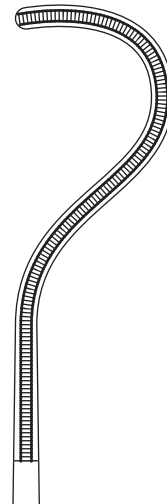

**C10751**  
18,5 cm - 7 1/4"

V - Clamps  
V - Clamps  
V - Clamps



## GREGORY

POUR LA PROFONDEUR  
PROFUNDA CLAMPS  
PARA LA PROFUNDIDAD

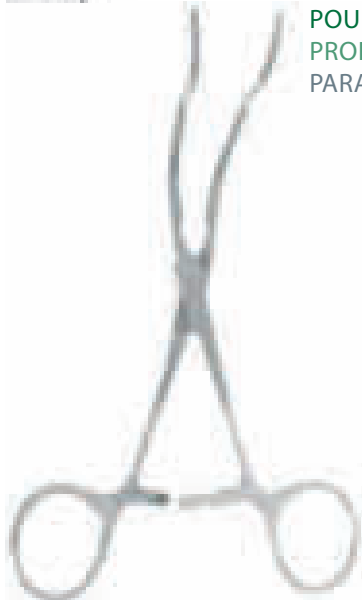

**C10753**

14,5 cm - 5<sup>3/4</sup>"

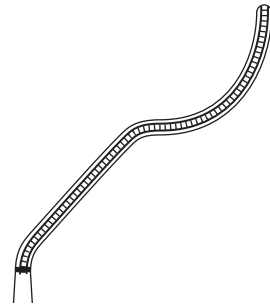

**C10754**

18,5 cm - 7<sup>1/4</sup>"

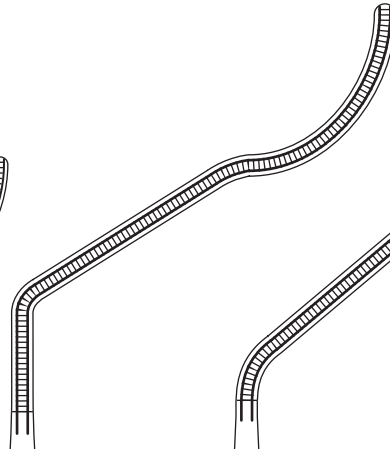

**C10756**

19,5 cm - 7<sup>3/4</sup>"

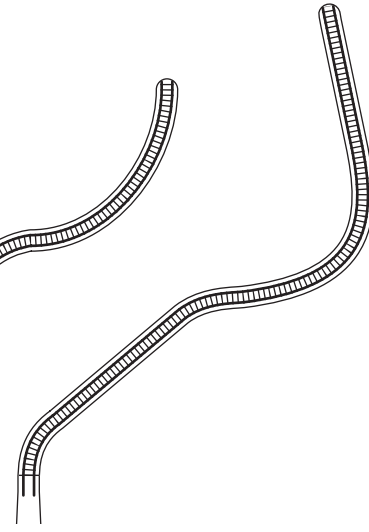

## SUBRAMANIAN

POUR L'AORTE  
FOR AORTIC  
PARA LA AORTA

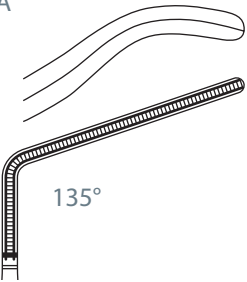

**C11005**

15,5 cm - 6"

135°

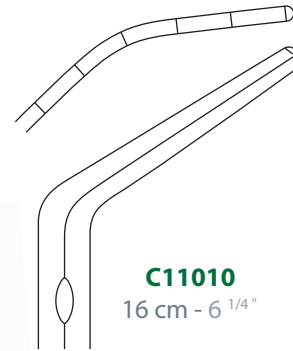
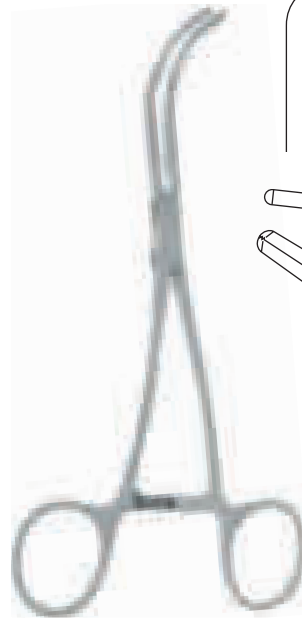

**C11010**

16 cm - 6<sup>1/4</sup>"

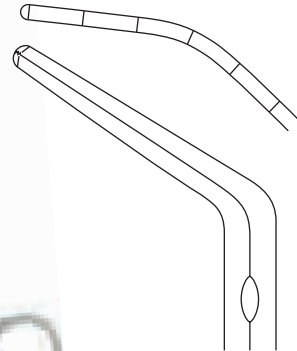

**C11015**

16 cm - 6<sup>1/4</sup>"

V - Clamps  
V - Clamps  
V - Clamps



Dilatation

DEBAKEY

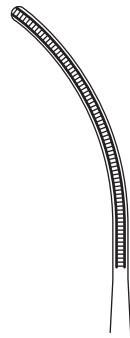
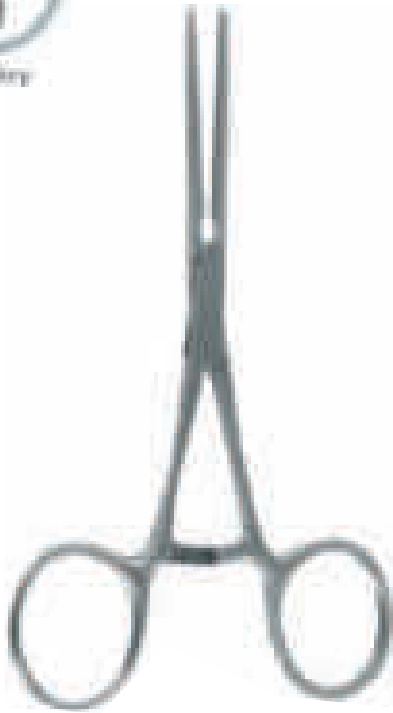

**C10720**  
11 cm - 4 1/4"



**C10725**  
10 cm - 4"

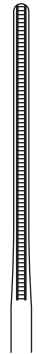

**C10730**   
12 cm - 4 3/4"

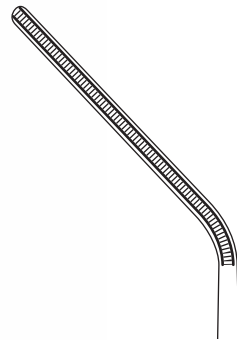
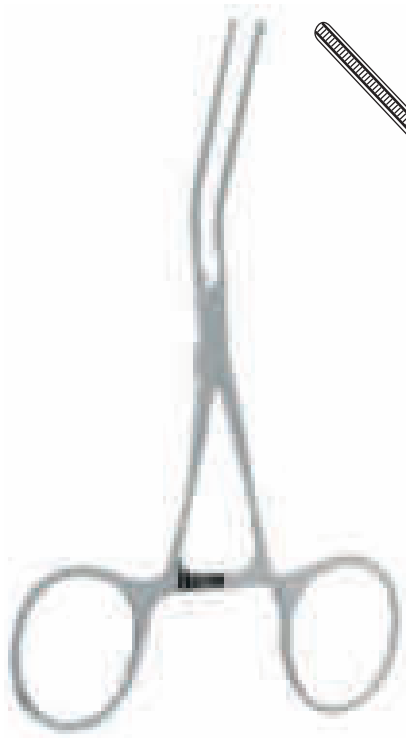

**C10740**  
13 cm - 5"

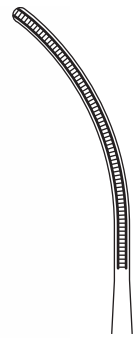
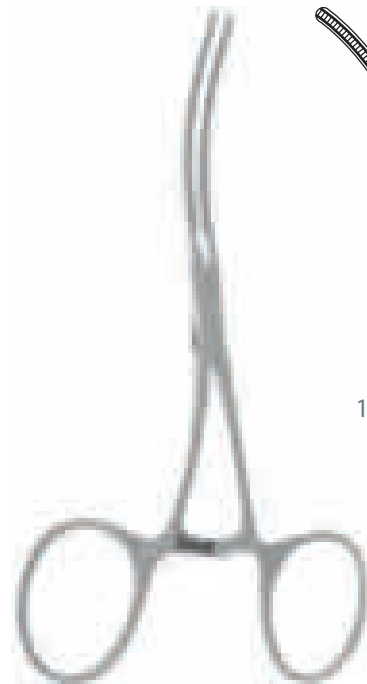

**C10735**  
12 cm - 4 3/4"

V - Clamps  
V - Clamps  
V - Clamps

## JAVID



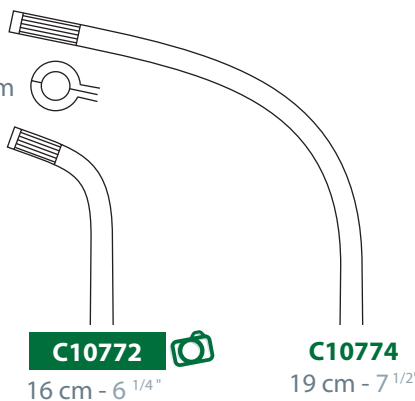

POUR LA CAROTIDE  
FOR CAROTID  
PARA LA CAROTIDA

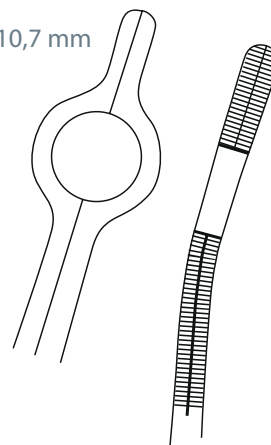

## COOLEY

Ø 10,7 mm



24 CH	16 cm - 6 1/4"	<b>C10758</b>
26 CH	16 cm - 6 1/4"	<b>C10759</b>
28 CH	19 cm - 7 1/2"	<b>C10761</b>
30 CH	19 cm - 7 1/2"	<b>C10762</b>
32 CH	19 cm - 7 1/2"	<b>C10763</b> 
36 CH	19 cm - 7 1/2"	<b>C10764</b>

V - Clamps  
V - Clamps  
V - Clamps



## BECK



**C10785**  
17 cm - 6<sup>3/4</sup>"

## COOLEY-DERRA

POUR L'ANASTOMOSE  
FOR ANASTOMOSIS  
PARA ANASTOMOSIS

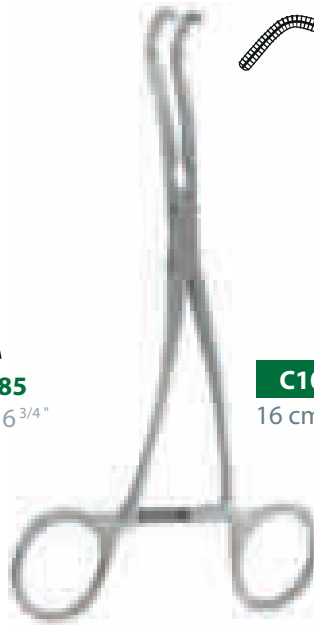

**C10830**   
16 cm - 6<sup>1/4</sup>"

**C10835**  
17 cm - 6<sup>3/4</sup>"

**C10840**  
18 cm - 7"

## COOLEY

A USAGES MULTIPLES  
FOR MULTI-PURPOSE  
PARA USOS VARIOS



**C10800**  
17 cm - 6<sup>3/4</sup>"

POUR LA COARCTATION  
FOR COARCTATION  
PARA LA COARCTACIÓN

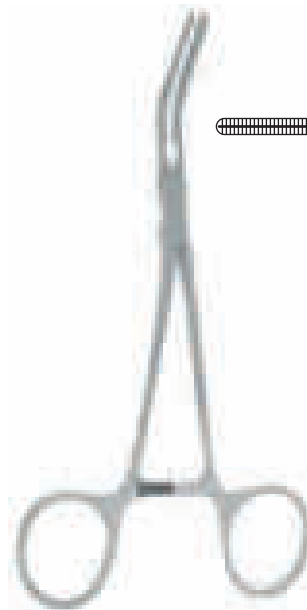

**C10790**   
13,5 cm - 5<sup>1/4</sup>"

**C10795**   
15,5 cm - 6<sup>1/8</sup>"



## COOLEY

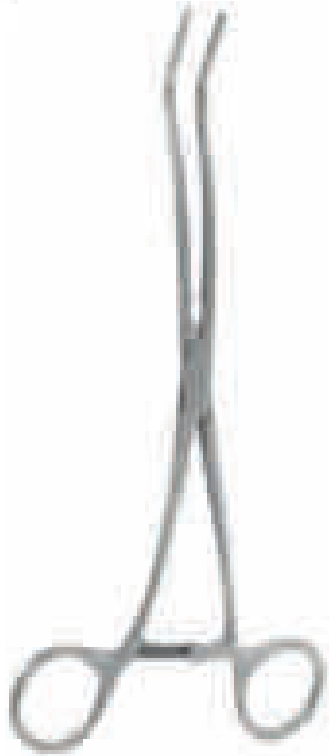

**C107790**  
18 cm - 7"

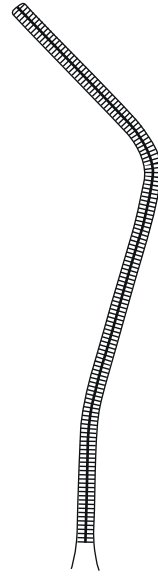
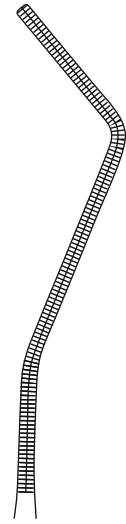

**C10780**   
20 cm - 8"

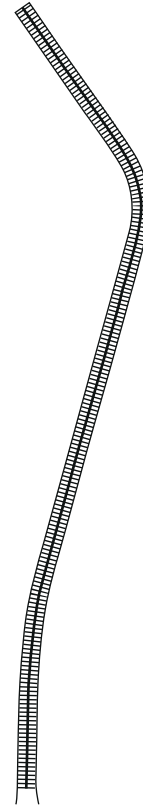

**C107810**  
29 cm - 11 1/2"



**C108410**  
21,5 cm - 8 1/2"

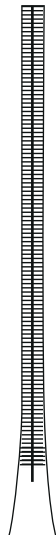





## COOLEY

POUR LA COARCTATION  
FOR COARCTATION  
PARA LA COARCTACIÓN

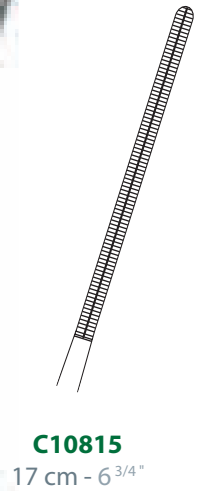
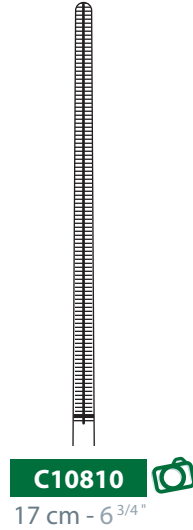
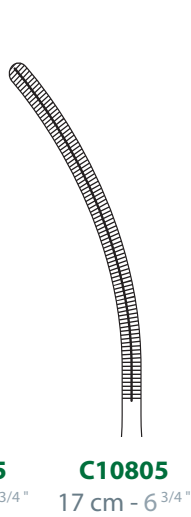
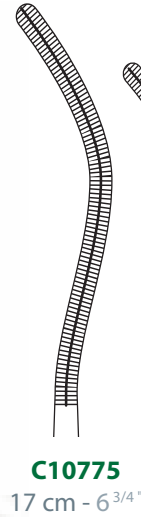
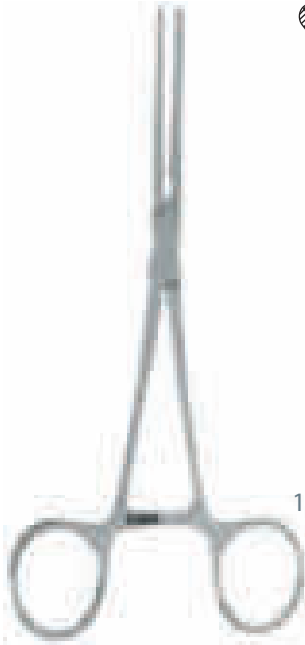

POUR LIGATURE  
FOR LIGATURE  
PARA LIGADURA

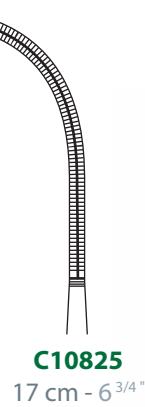

POUR ANASTOMOSE  
FOR ANASTOMOSIS  
PARA ANASTOMOSIS

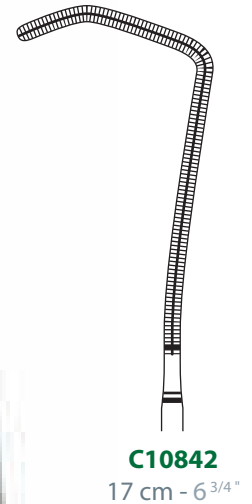
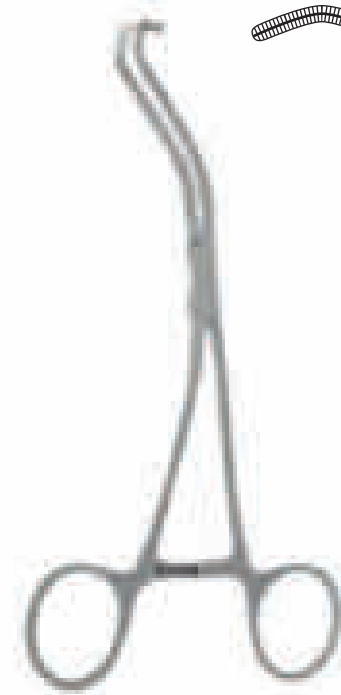

## Pinces clamps cardiovasculaires atrauma - Atrauma cardiovascular forceps - Pinzas clamps cardiovasculares atrauma



### COOLEY

POUR ANASTOMOSE  
FOR ANASTOMOSIS  
PARA ANASTOMOSIS

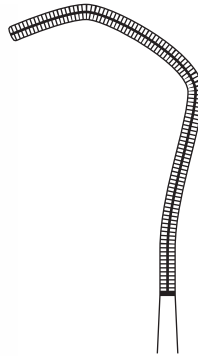

**C10845**  
16 cm - 6 1/4"

## Pinces clamps nouveau né et pédiatrique - Neonatal and pediatric clamps - Pinzas clamps para recién nacidos y pediátrico

### COOLEY

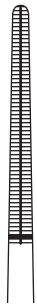

**C11020**   
14 cm - 5 1/2"

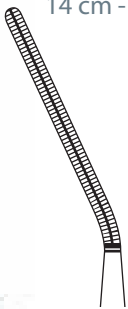

**C11025**  
14 cm - 5 1/2"



**C11030**  
14 cm - 5 1/2"

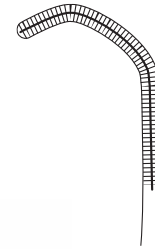

**C11035**   
14 cm - 5 1/2"



**C11040**  
14 cm - 5 1/2"

V - Clamps  
V - Clamps  
V - Clamps



## COOLEY

15 cm - 6"

A	C11045	C11050	<b>C11055</b>	C11060
B	C11200	C11205	C11210	C11215

A	C11065	C11070	C11075	C11080	C11085
B	C11220	C11225	C11230	C11235	C11240

16,5 cm - 6 1/2"

**C11090**

16 cm - 6 1/4"

**C11095**

15 cm - 6"

**C11100**

15 cm - 6"

**C11105**

15,5 cm - 6 1/8"

**C11110**

V - Clamps  
V - Clamps  
V - Clamps

## CASTANEDA

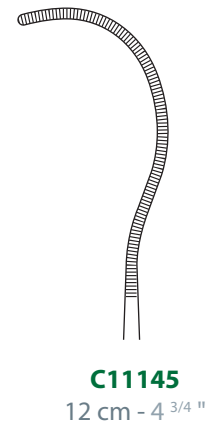
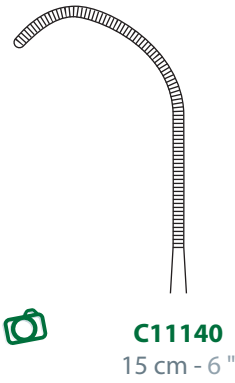
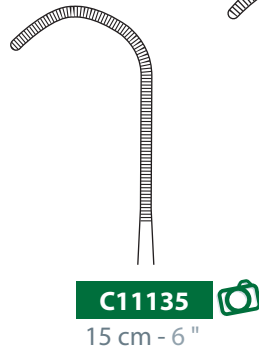
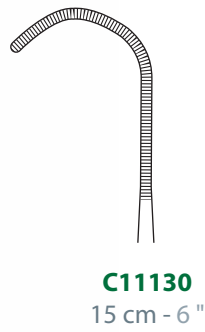
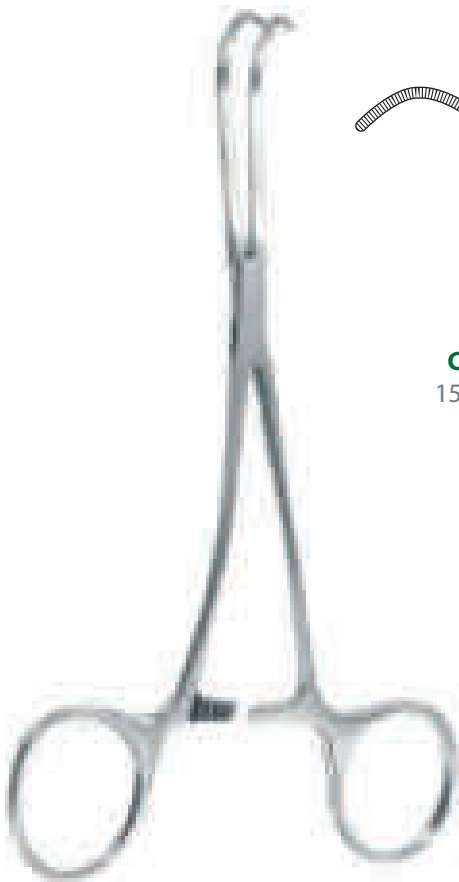
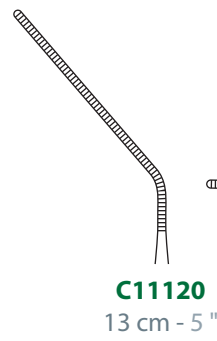
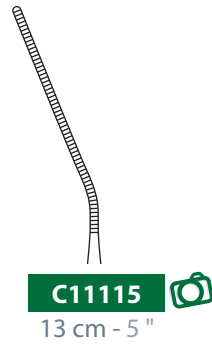

V - Clamps  
V - Clamps  
V - Clamps

### DEBAKEY

19 cm - 7 1/2"	35 cm - 14"
<b>C120005</b> Ø 0,5 mm	-
<b>C120010</b> Ø 1,0 mm	<b>C120110</b>
<b>C120015</b> Ø 1,5 mm	<b>C120115</b>
<b>C120020</b> Ø 2,0 mm	<b>C120120</b>
<b>C120025</b> Ø 2,5 mm	<b>C120125</b>
<b>C120030</b> Ø 3,0 mm	<b>C120130</b>
<b>C120035</b> Ø 3,5 mm	<b>C120135</b>
<b>C120040</b> Ø 4,0 mm	<b>C120140</b>
<b>C120045</b> Ø 4,5 mm	<b>C120145</b>
<b>C120050</b> Ø 5,0 mm	<b>C120150</b>
<b>C120070</b> Ø 7,0 mm	<b>C120170</b>
<b>C120090</b> Ø 9,0 mm	<b>C120190</b>

### COOLEY

Ø	13 cm - 5"
Ø 0,5 mm	<b>C120205</b>
Ø 1,0 mm	<b>C120210</b>
Ø 1,5 mm	<b>C120215</b>
Ø 2,0 mm	<b>C120220</b>
Ø 2,5 mm	<b>C120225</b> 
Ø 3,0 mm	<b>C120230</b>
Ø 4,0 mm	<b>C120240</b>
Ø 5,0 mm	<b>C120250</b>

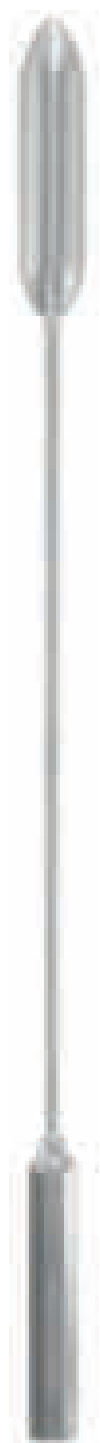

**C120090**  
19 cm - 7 1/2"

### TUBBS



**C120300**  
16 cm - 6 1/4"

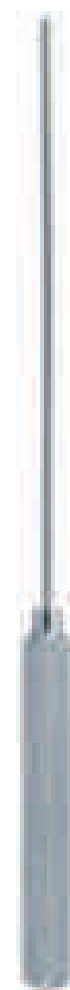

**C120225**  
13 cm - 5 1/2"

V - Clamps  
V - Clamps  
V - Clamps

## Instruments à sutures - Suture instruments - Instrumentos de sutura

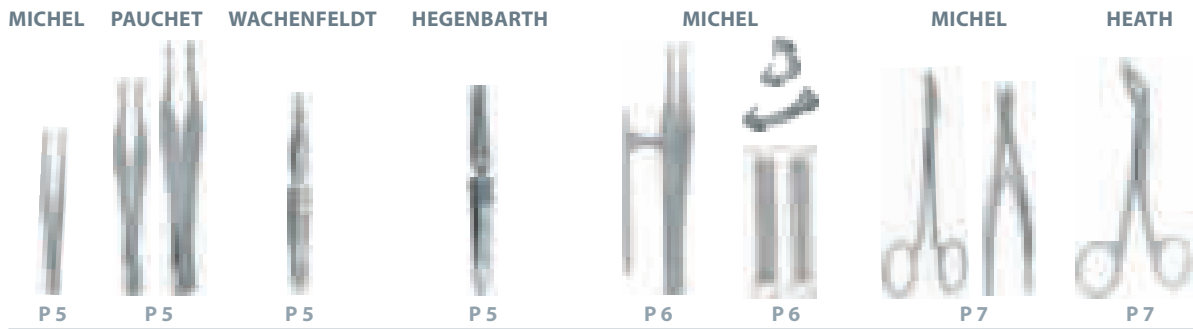

## Porte-aiguilles - Needle holders - Porta agujas

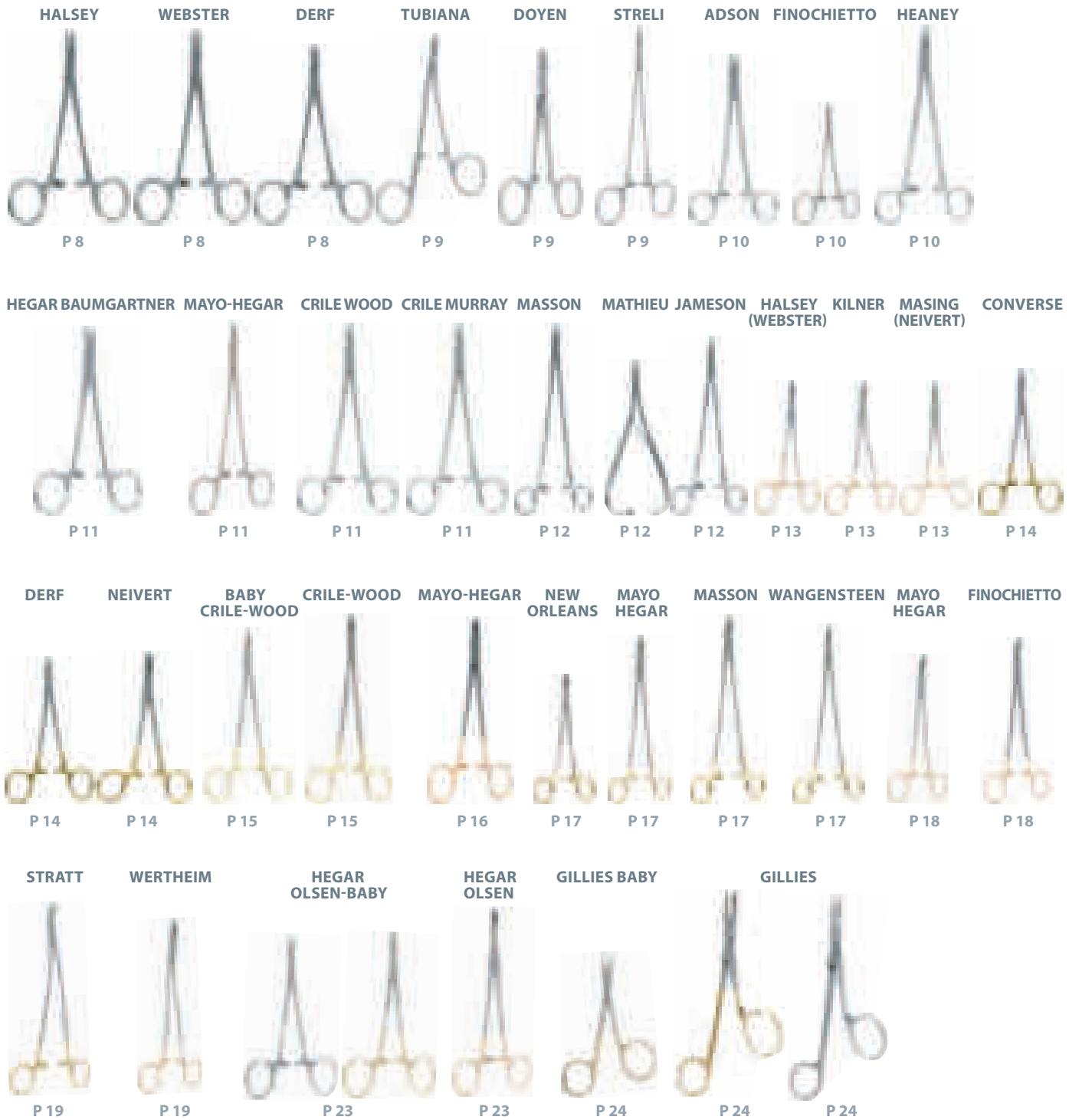

**Porte-aiguilles - Needle holders - Porta agujas**

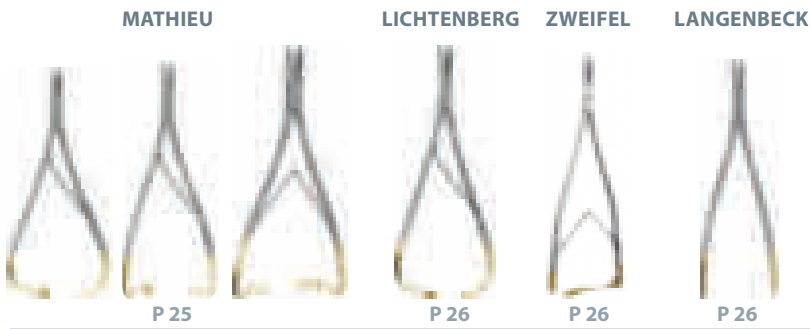

**Porte-aiguilles vasculaires - Vascular needle holders - Porta agujas vasculares**

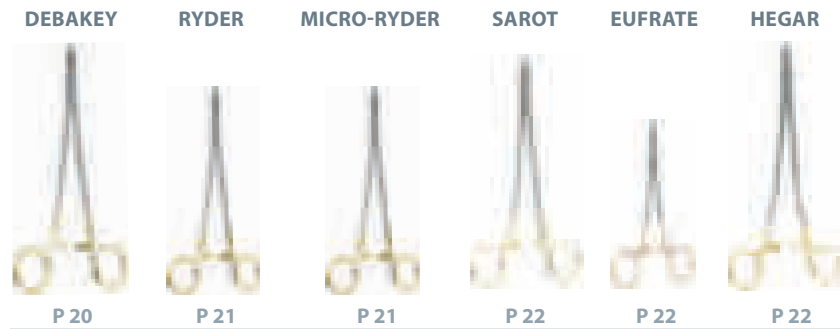

**Aiguilles à sutures - Suture needles - Agujas de sutura**



**Aiguilles à ligatures - Ligature needles - Agujas para ligaduras**



**Instruments à ligatures - Ligature instruments - Instrumentos para ligaduras**

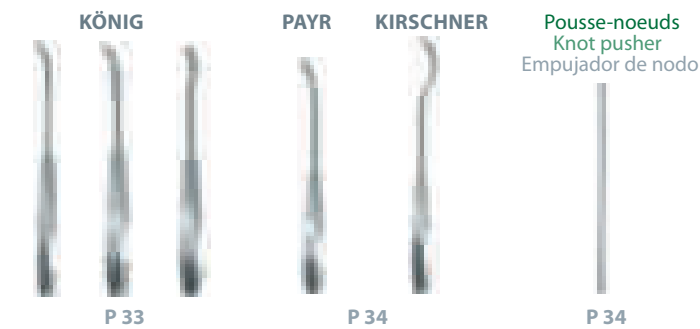

Microchirurgie porte-aiguilles - Microsurgery needle-holders - Microcirugía porta-agujas

X - Microchirurgie  
X - Microsurgery  
X - Microcirugía

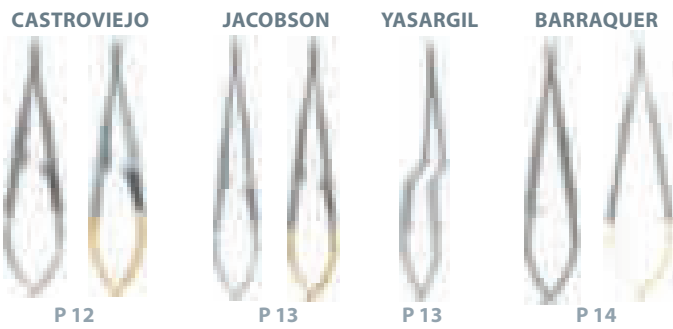

Instrumentation de service - Instrumentation for services - Instrumentación de servicio

XV - Divers  
XV - Miscellaneous  
XV - Diversos

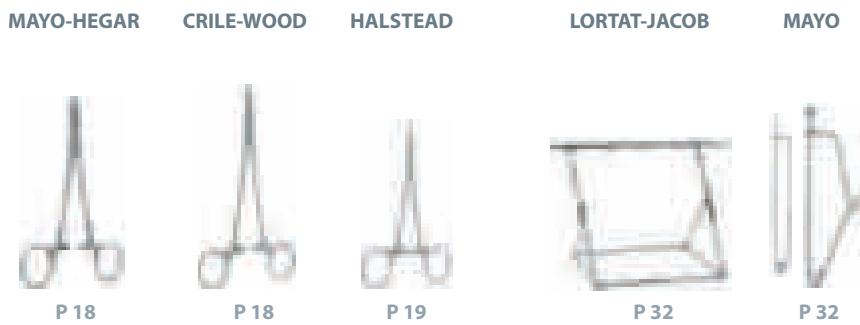





MICHEL

PAUCHET

WACHENFELDT

HEGENBARTH

Pinces à poser les agrafes  
Clip applying forceps  
Pinzas para poner las grapas

Pour agrafes 7,5 mm  
For clips 7,5 mm  
Para grapas 7,5 mm



**G25010**  
10 cm - 4"

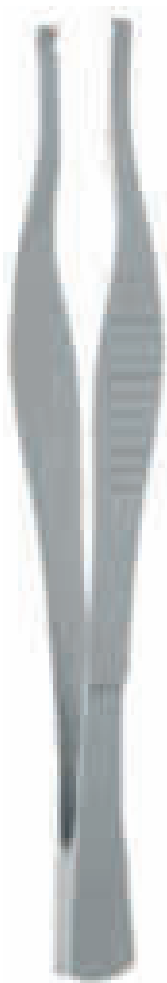

**G25020**  
13 cm - 5"



**G25030**  
16 cm - 6 1/4"



**G25040**  
12 cm - 4 3/4"



**G250410**  
12,5 cm - 5"



### MICHEL

Pour agrafes  
For clips  
Para grapas

7,5 mm - 9/32 "	<b>G25135</b> 
12 mm - 15/32 "	<b>G25140</b>
14 mm - 9/16 "	<b>G25150</b>
16 mm - 5/8 "	<b>G25160</b>

Boite de 100  
Box of 100  
Caja de 100

7,5 mm x 1.75mm	<b>G254607</b>
12 mm x 2.5 mm	<b>G254612</b> 
14 mm x 3.0 mm	<b>G254614</b>
16 mm x 3.0 mm	<b>G254616</b>
18 mm x 3.0 mm	<b>G254618</b>
20 mm x 3.0 mm	<b>G254620</b>

Agrafes  
Clips  
Grapas

Pincés à affronter avec magasin fixe  
Clip applying forceps with fixed magazine  
Pinzas para tener con deposito fijo

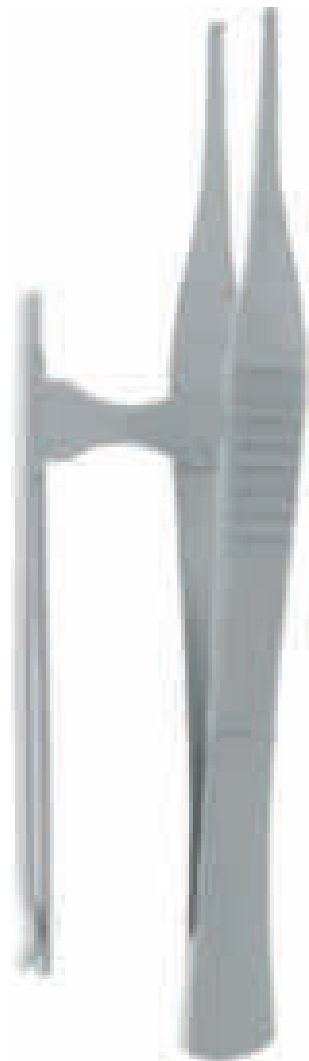

**G25135**  
14 cm - 5 1/2 "



Agrafes de Michel  
Michel suture clips  
Grapas de Michel

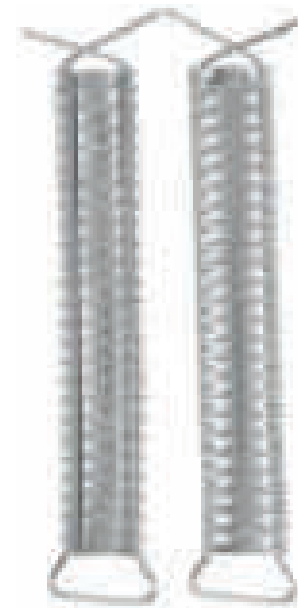

**G254612**  
12 mm

### MICHEL

### HEATH

Pinces à retirer les agrafes  
 Clip removing forceps  
 Pinzas para retirar las grapas

Double usage  
 Applying and removing  
 Uso doble

Fine  
 Fine  
 Fina

A doigts  
 Collin's lock  
 Desmontables

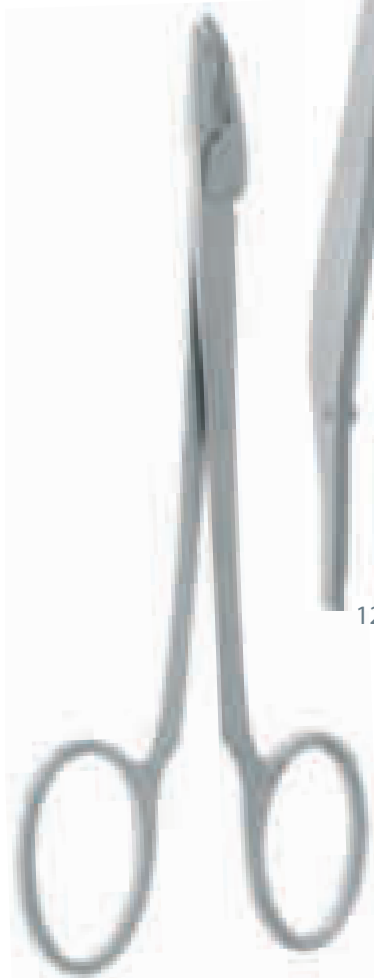

**G25050**  
 13 cm - 5 "

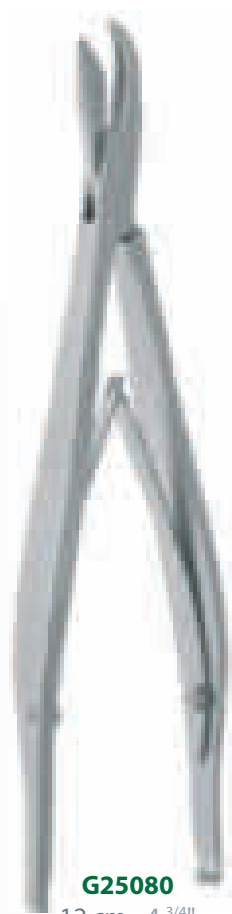

**G25080**  
 12 cm - 4 3/4"



**G25060**  
 14 cm - 5 1/2"



**G25061**  
**(Affinée)**  
 14 cm - 5 1/2 "

### HALSEY

Mors lisses  
Smooth jaws  
Boccas lisas

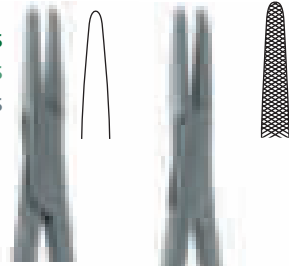

**G300200**  
13 cm - 5"



**G300205**  
13 cm - 5"

### WEBSTER

Mors lisses  
Smooth jaws  
Boccas lisas



**G300220**  
13 cm - 5"

### DERF

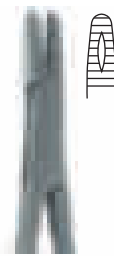

**G300210**  
12 cm - 4 <sup>3</sup>/<sub>4</sub>"



**G300215**  
12,5 cm - 5"

### TUBIANA



**G300050**  
14 cm - 5 1/2 "

### DOYEN

A doigt  
Collin's lock  
Desmontable

**G30010**   
13 cm - 5 "

Branches passées  
Box lock  
Indesmontable

**G300150**  
13 cm - 5 "

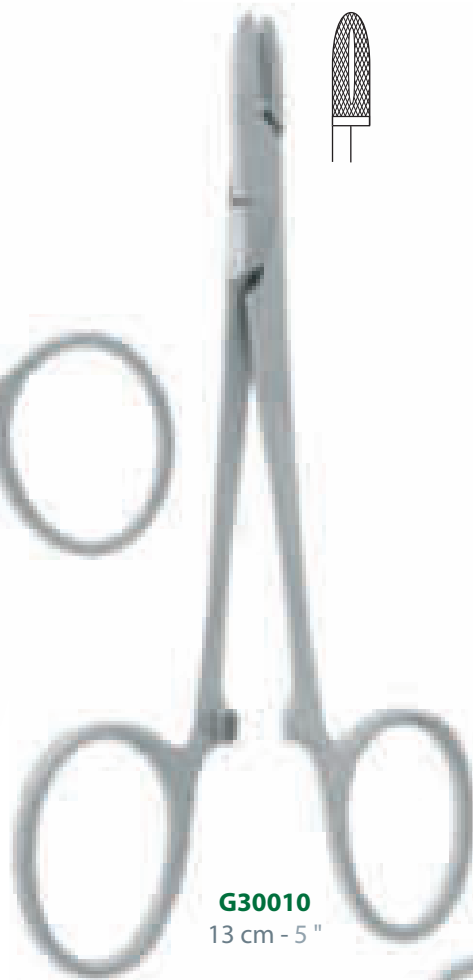

**G30010**  
13 cm - 5 "

### STRELI

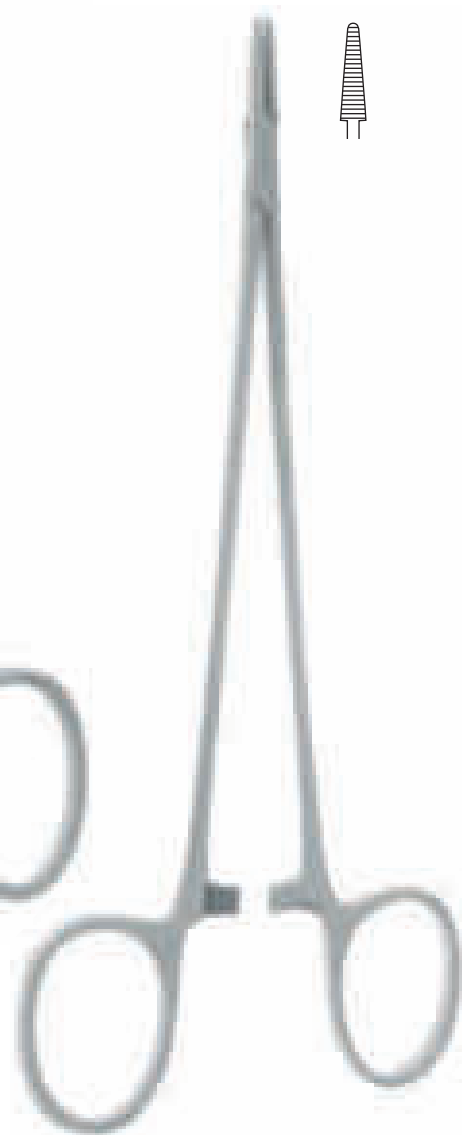

**G30080**  
15 cm - 6 "

## Porte-aiguilles - Needle holders - Porta agujas

**ADSON**

**FINOCHIETTO**

**HEANEY**



**G30060**

17 cm - 6 <sup>3</sup>/<sub>4</sub>"



**G30070**

20 cm - 8 "



**G30050**

13 cm - 5 <sup>1</sup>/<sub>8</sub>"



**G300230**  
18 cm - 7 "

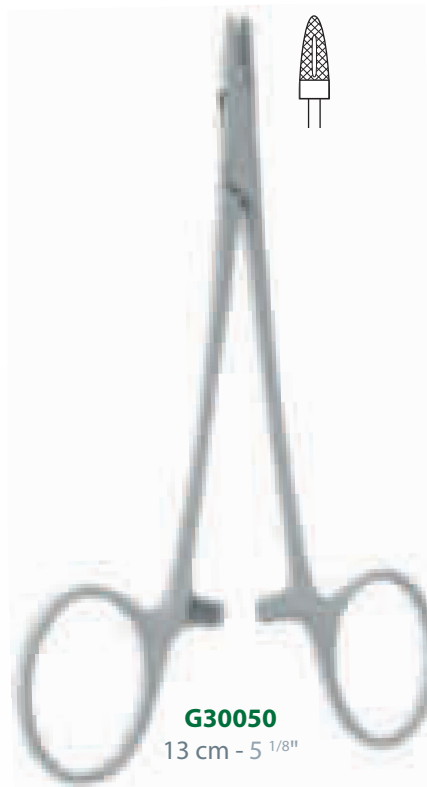

**G300240**  
20,5 cm - 8 "

## MAYO-HEGAR

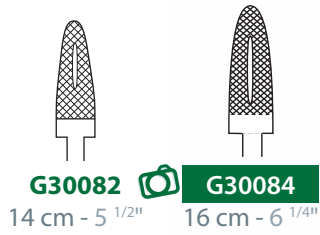

**G30084**

16 cm - 6 1/4"

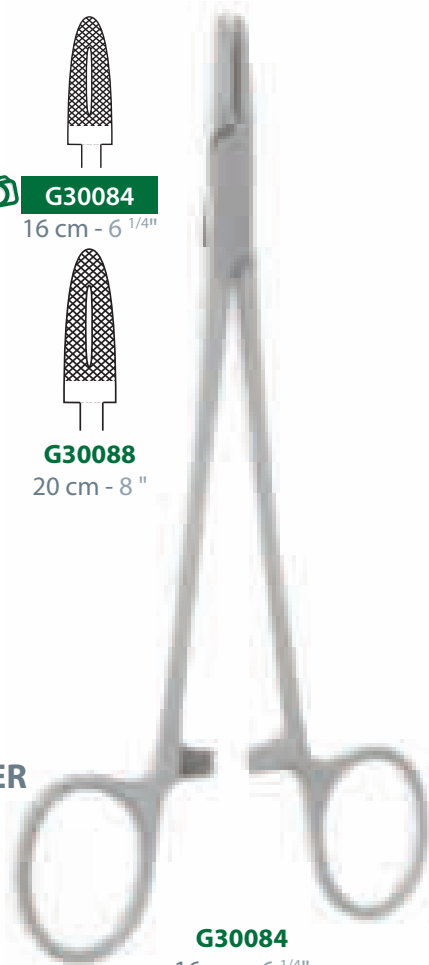
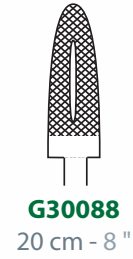
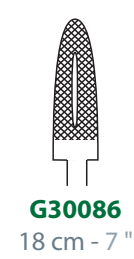

**CRILE  
WOOD**

**CRILE  
MURRAY**

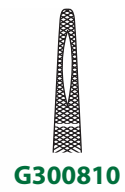

## HEGAR BAUMGARTNER

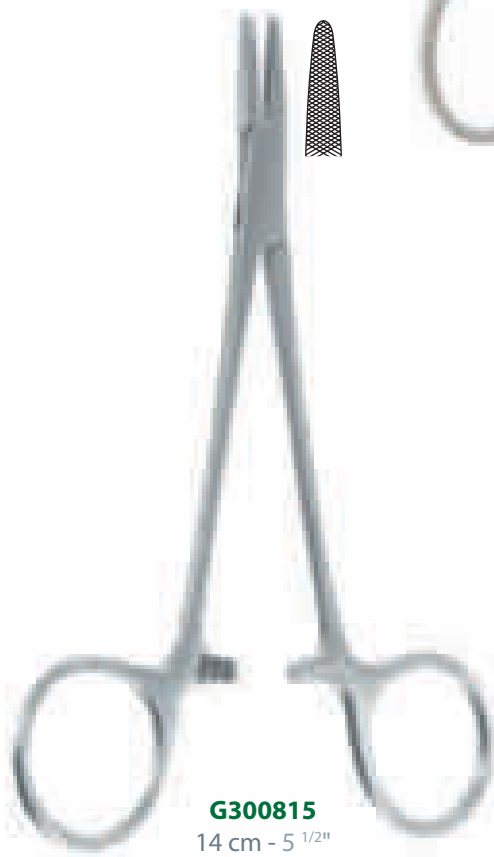



### MASSON

### MATHIEU

### JAMESON



**G300260**  
26,5 cm - 10<sup>1/2</sup> "

**G300310**  
20 cm - 8 "

14 cm - 5 <sup>1/2</sup>"

**G300300**

17 cm - 6 <sup>3/4</sup>"

**G300305**

20 cm - 8 "

**G300310**



**G300250**  
23 cm - 9"



### KILNER



### HALSEY (WEBSTER)

Mors lisses  
Smooth jaws  
Bocas lisas



**G30158**  
13 cm - 5 "

### MASING (NEIVERT)

0,3

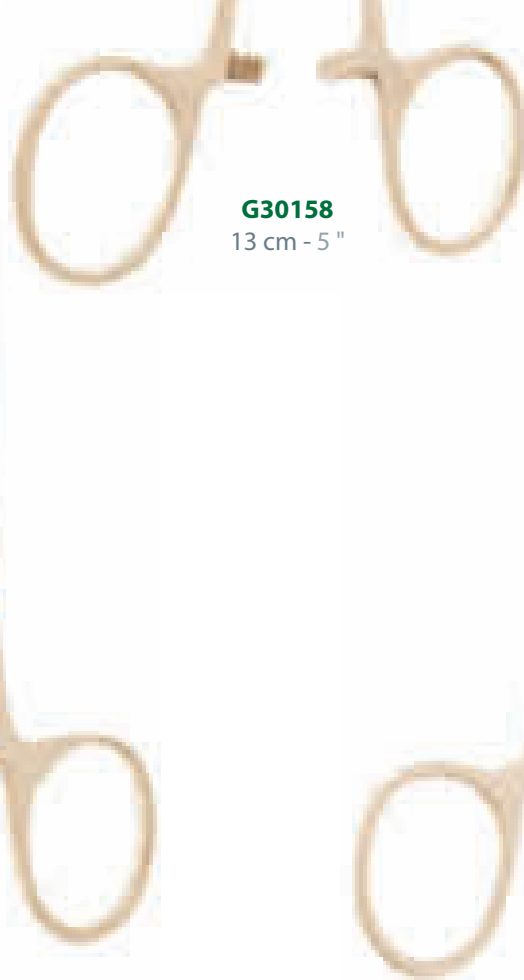

Anneau décalé  
Juted ring  
Anillo decalado

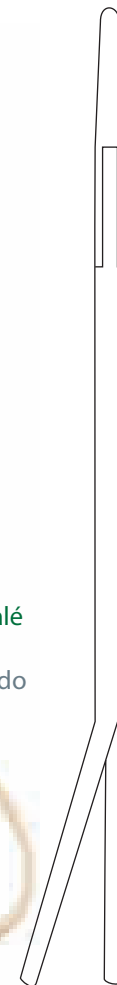

**G30151**  
13 cm - 5 "

**G30159**  
13 cm - 5 "





DERF



CONVERSE

NEIVERT

2 anneaux décalés  
2 rings juted  
2 anillos decalados

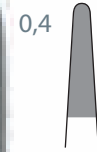

**G300892**  
12,5 cm - 5 "

**G300891**  
12,5 cm - 5 "

**G300893**  
13 cm - 5 "

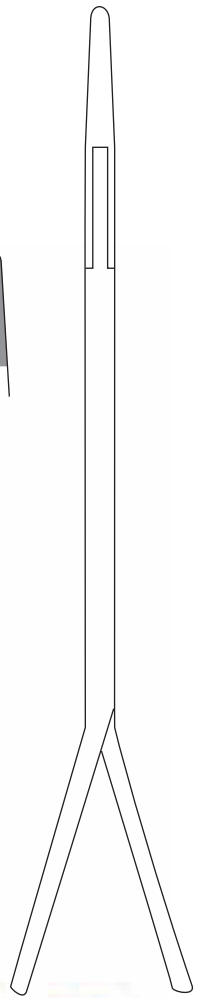



# LANDANGER

Porte-aiguilles - Needle holders - Porta agujas



## CRILE-WOOD

13 cm - 5 "	<b>G30090</b>		
15 cm - 6 "	<b>G30100</b>	<b>G30100L</b>	<b>L</b> 
18 cm - 7 "	<b>G30110</b>	<b>G30110L</b>	<b>L</b> 
20 cm - 8 "	<b>G30120</b>	<b>G30120L</b>	<b>L</b> 
23 cm - 9 "	<b>G30130</b>		
26 cm - 10 1/4 "	<b>G30140</b>		
30 cm - 11 3/4 "	<b>G30150</b>		

Gaucher  
Left-handed  
Zurdo

## BABY CRILE-WOOD



**G300950**  
15 cm - 6 "



**G30100**  
15 cm - 6 "

**G30110**  
18 cm - 7 "

**G30120**  
20 cm - 8 "

**G30130**  
23 cm - 9 "

**G30140**  
26 cm - 10 1/4 "

**G30150**  
30 cm - 11 3/4 "

**G30110**  
18 cm - 7 "

0,4

0,4

VI - Sutures  
VI - Sutures  
VI - Sutura

### MAYO-HEGAR



14 cm - 5 1/2 "	<b>G30210</b>		
16 cm - 6 1/4 "	<b>G30220</b>	G30220L	<b>L</b>
18 cm - 7 "	<b>G30230</b>	G30230L	<b>L</b>
20 cm - 8 "	<b>G30240</b>	G30240L	<b>L</b>
23 cm - 9 "	<b>G30250</b>		
26 cm - 10 1/4 "	<b>G30260</b>		
30 cm - 11 3/4 "	<b>G30270</b>		



Gaucher  
Left-handed  
Zurdo

Droit  
Straight  
Recta

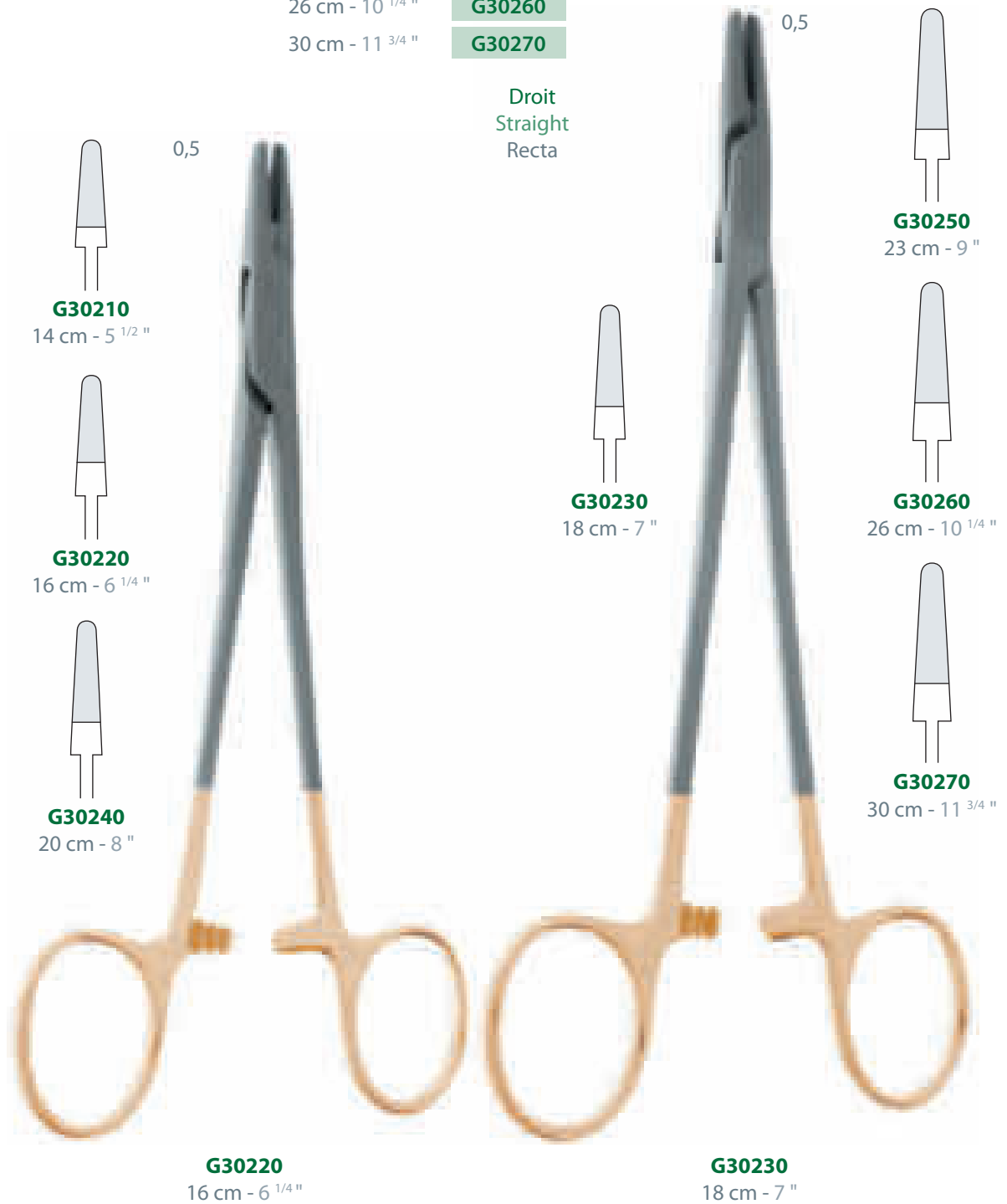

### NEW ORLEANS



0,4



### MAYO-HEGAR

**G303300**

**G303301**

Modèle robuste  
Heavy pattern  
Modelo robusto



**G303290**  
18 cm - 7 "

0,5



**G303300**  
20 cm - 8 "

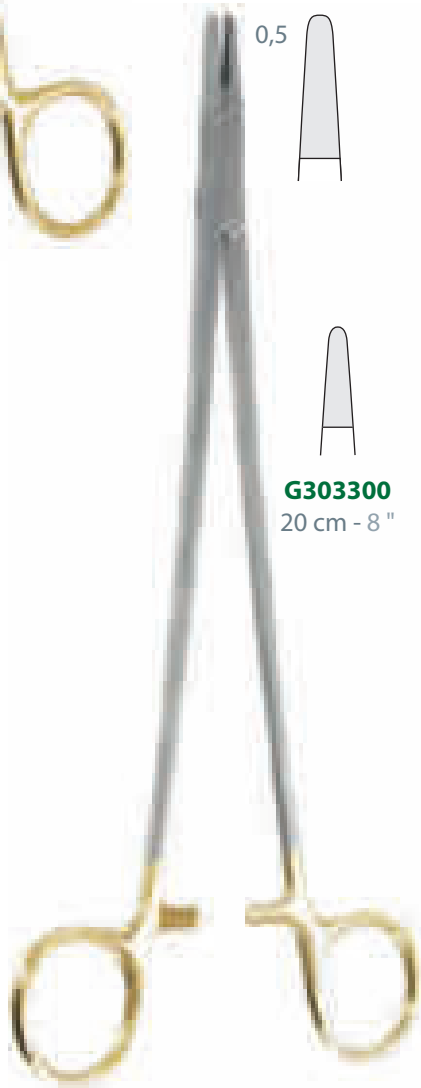

**G303301**  
24 cm - 9 1/2 "

### MASSON

0,5



**G303310**  
27 cm - 10 1/2 "

### WANGENSTEEN

0,5



**G303320**  
27 cm - 10 1/2 "

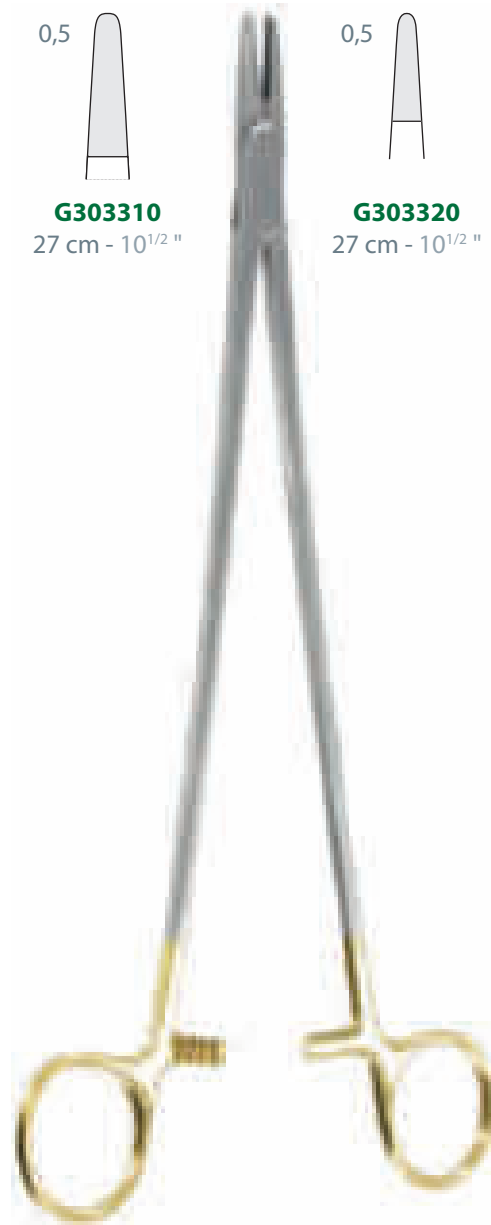

**G303320**  
27 cm - 10 1/2 "



### MAYO-HEGAR

Courbe  
Curved  
Curva

- 18 cm - 7 "
- 20 cm - 8 "
- 23 cm - 9 "
- 26 cm - 10 1/4 "

- G30280**
- G30290**
- G30300**
- G30310**

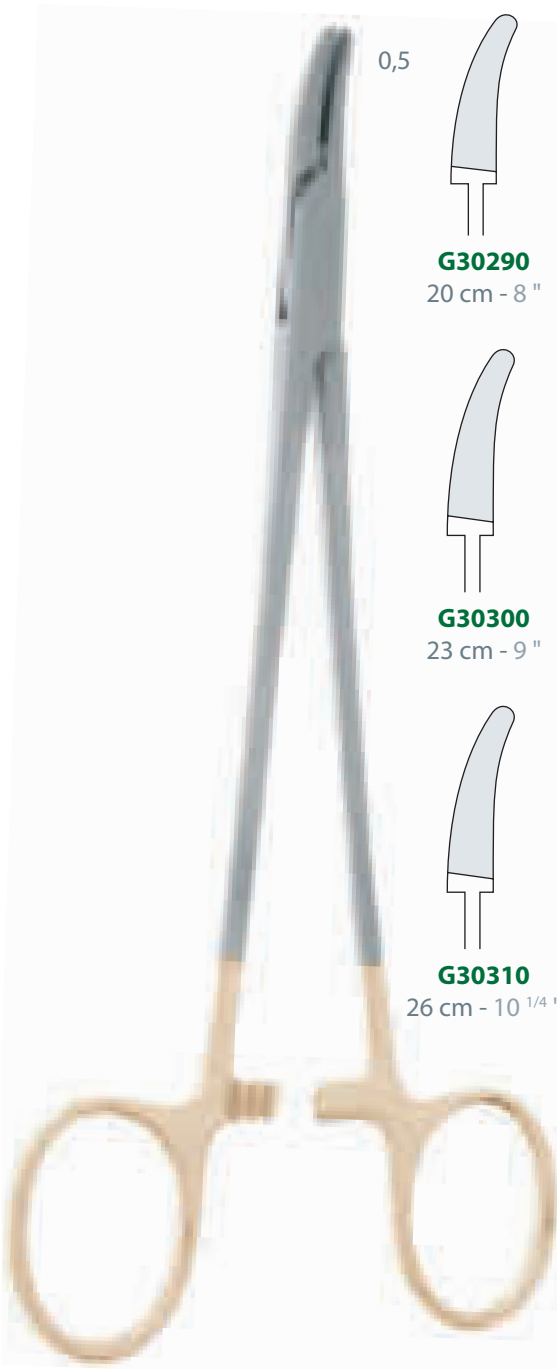
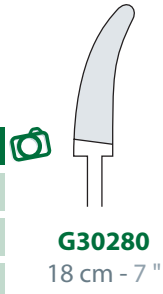

**G30280**  
18 cm - 7 "

### FINOCHIETTO

Courbe  
Curved  
Curva

- 20 cm - 8 "
- 27 cm - 10 1/2 "

- G303110**
- G303120**

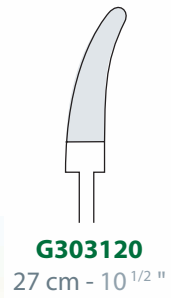
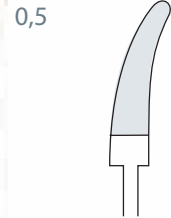

**G303110**  
20 cm - 8 "



**STRATT**



**G30370**  
23 cm - 9 "

**WERTHEIM  
(BOZEMANN)**

20 cm - 8 "

**G30380**



26 cm - 10<sup>1/4</sup> "

**G30390**

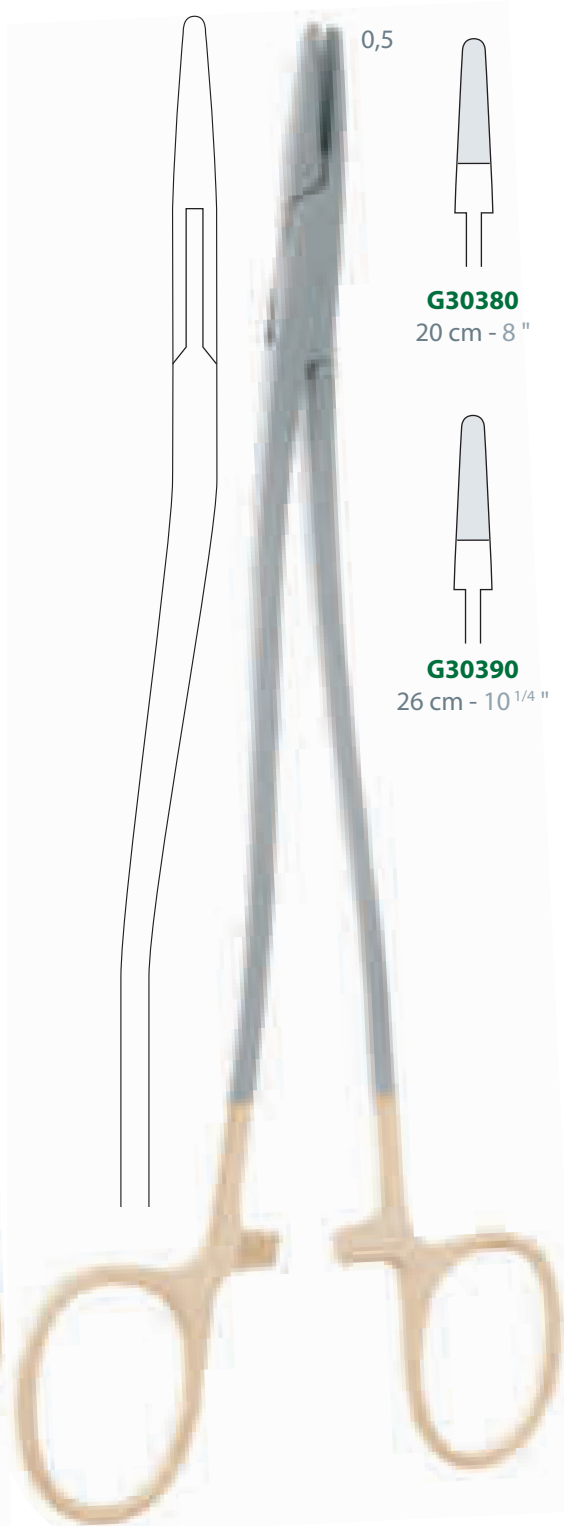

0,5



**G30380**

20 cm - 8 "



**G30390**

26 cm - 10<sup>1/4</sup> "

**G30380**

20 cm - 8 "





### DEBAKEY



Gaucher  
Left-handed  
Zurdo

L	<b>G30152L</b>	18 cm - 7 "
L	<b>G30153L</b>	20 cm - 8 "
L	<b>G30154L</b>	23 cm - 9 "
		26 cm - 10 1/4 "
		30 cm - 11 3/4 "

Standard  
Standard  
Standard

<b>G30152</b>
<b>G30153</b>
<b>G30154</b>
<b>G30155</b>
<b>G30156</b>



Fin  
Fine  
Fino

<b>G301521</b>
<b>G301531</b>
<b>G301541</b>
<b>G301551</b>
<b>G301561</b>

0,4



**G30152**  
18 cm - 7 "



**G30153**  
20 cm - 8 "



**G30154**  
23 cm - 9 "



**G30155**  
26 cm - 10 1/4 "



**G30156**  
30 cm - 11 3/4 "

0,3



**G301521**  
18 cm - 7 "



**G301531**  
20 cm - 8 "



**G301541**  
23 cm - 9 "



**G301551**  
26 cm - 10 1/4 "



**G301561**  
30 cm - 11 3/4 "



**G30152**  
18 cm - 7 "



Gaucher  
Left-handed  
Zurdo

**L** **G30164L**

**L** **G30170L**

### RYDER

Mors  
Jaws  
Bocas

16 mm

18 mm

21 mm

22 mm

22 mm

23 mm

**G30160**

13 cm - 5 "

**G30164**

15 cm - 6 "

**G30170**

18 cm - 7 "

**G30180**

20 cm - 8 "

**G30182**

23 cm - 9 "

**G30190**

26 cm - 10 <sup>1</sup>/<sub>4</sub> "

### MICRO-RYDER

Mors  
Jaws  
Bocas

16 mm

18 mm

21 mm

22 mm

22 mm

23 mm

**G301601**

**G301641**

**G301701**

**G301801**

**G301821**

**G301901**



**G30170**  
18 cm - 7 "

## Porte-aiguilles vasculaires - Vascular needle holders - Porta agujas vasculares

### SAROT

18 cm - 7" **G303210**   
 26 cm - 10 1/4" **G303215**



### EUFRATE

13 cm - 5" **G30440**   
 15 cm - 6" **G30450**  
 20 cm - 8" **G30460**

### HEGAR VASCULAR

14 cm - 5 1/2" **G303200**  
 18 cm - 7" **G303201**  
 20 cm - 8" **G303202**   
 23 cm - 9" **G303203**

Cardiovasculaire  
 Cardiovascular  
 Cardiovascular

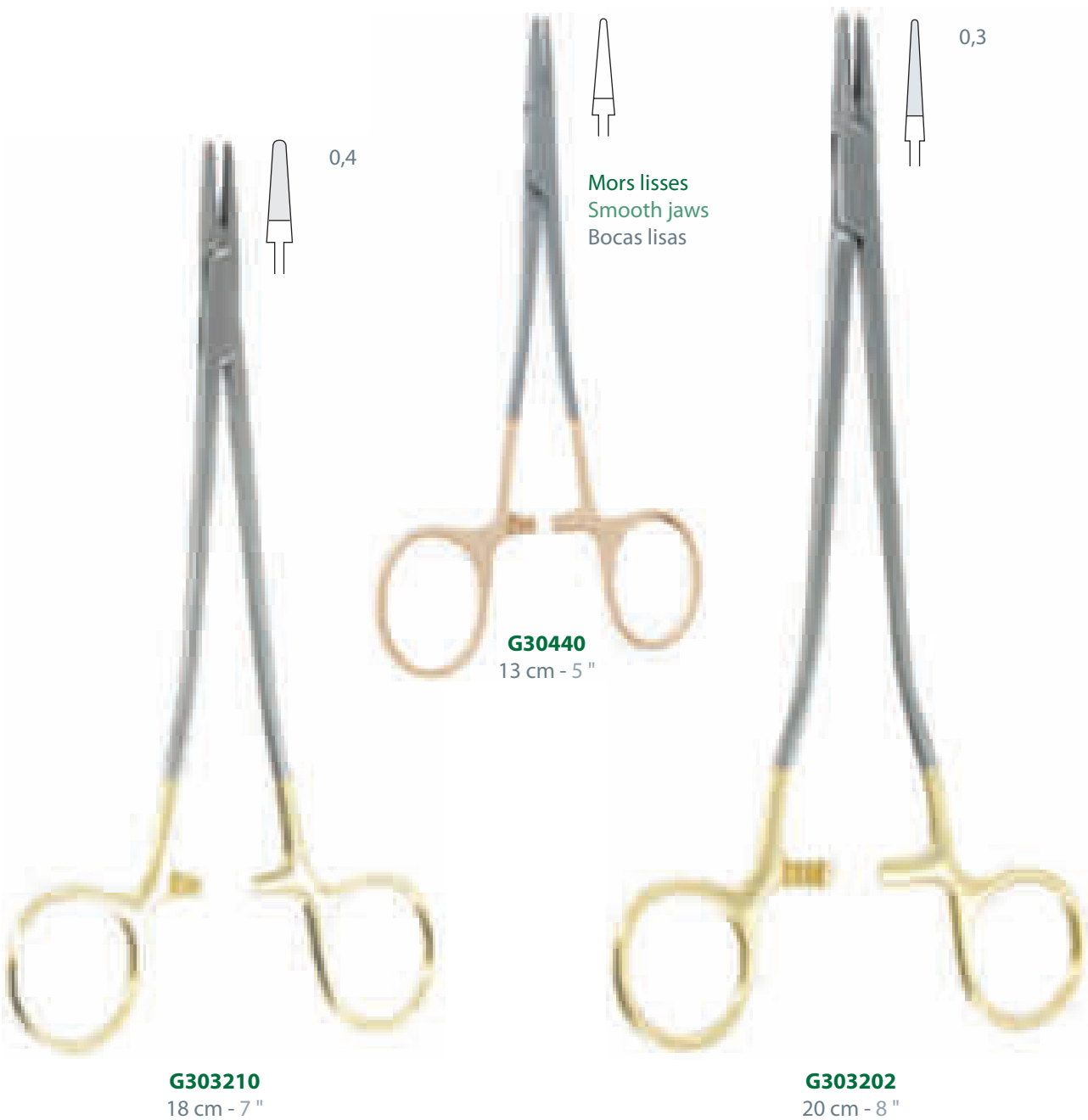

### HEGAR-OLSEN-BABY

### HEGAR-OLSEN

14 cm - 5 1/2 "	G301990	G301950
16 cm - 6 1/4 "	G30200 	-
18 cm - 7 "	-	G301960

Inox  
Stainless steel  
Aceno inoxidable

Inox  
Stainless steel  
Aceno inoxidable



**D01120**  
12 cm - 4 3/4 "



**D01130**  
12 cm - 4 3/4 "

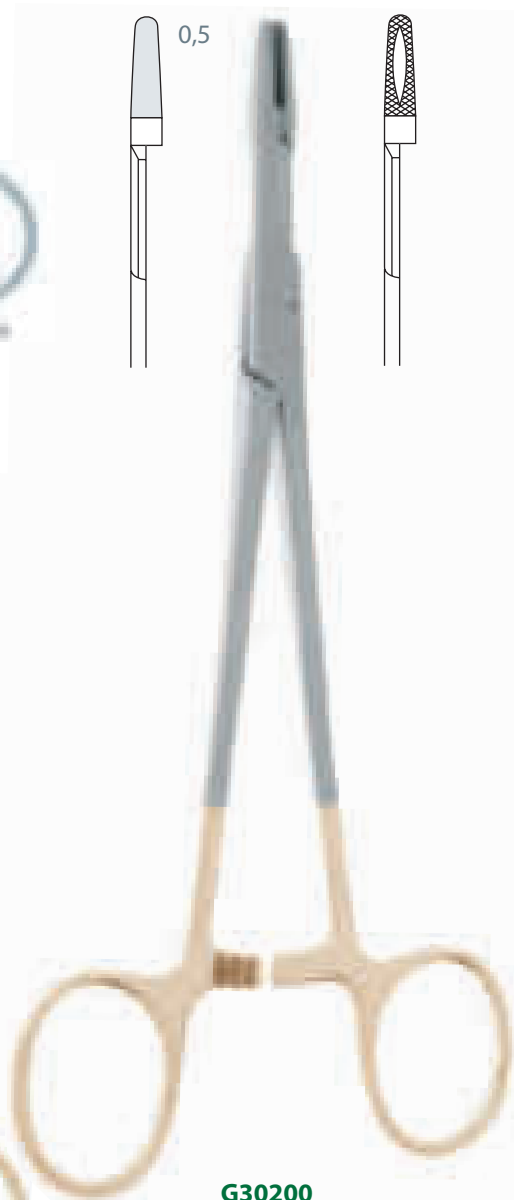

**G30200**  
16 cm - 6 1/4 "

VI - Sutures  
VI - Sutures  
VI - Sutura

GILLIES-BABY



**D01110**  
11 cm - 4 1/4 "

GILLIES



**Inox**  
Stainless steel  
Acero inoxidable

**B25795**  
16 cm - 6 1/4 "

**B25800**  
16 cm - 6 1/4 "

# LANDANGER

Porte-aiguilles - Needle holders - Porta agujas



## MATHIEU

14 cm - 5 1/2"

**G305000**

14 cm - 5 1/2"

**G305100**

17 cm - 6 3/4"

**G305010**



17 cm - 6 3/4"

**G305110**



20 cm - 8"

**G305015**

20 cm - 8"

**G305115**

20 cm - 8"

**G305215**



24 cm - 9 1/2"

**G305020**

24 cm - 9 1/2"

**G305120**

24 cm - 9 1/2"

**G305220**



**G305010**

17 cm - 6 3/4"

**G305110**

17 cm - 6 3/4"

**G305215**

20 cm - 8"

### LICHTENBERG



### ZWEIFEL

### LANGENBECK

20 cm - 8 "

**G305630**

23 cm - 9 "

**G305640**

16 cm - 6<sup>1/4</sup> "

**G305660**

18 cm - 7 "

**G305670**

20 cm - 8 "

**G305680**



**G305600**  
20 cm - 8 "



**G305630**  
20 cm - 8 "



**G305670**  
18 cm - 7 "

### REVERDIN



Inox  
Stainless steel  
Acero inoxidable



Droite  
Straight  
Recta

1/2 courbe  
Half curved  
Media curva

Courbe  
Curved  
Curva

Très courbe  
Very curved  
Muy curva

19 cm - 7 1/2 "

**G35004**

**G35008**

**G35012**

**G35016**

21 cm - 8 1/4 " 

**G35132**

**G35136**

**G35140**

**G35144**

(paroi)

**G35132**

21 cm - 8 1/4 "





### DOYEN

En hameçon  
Strongly curved  
Forma de anzuelo

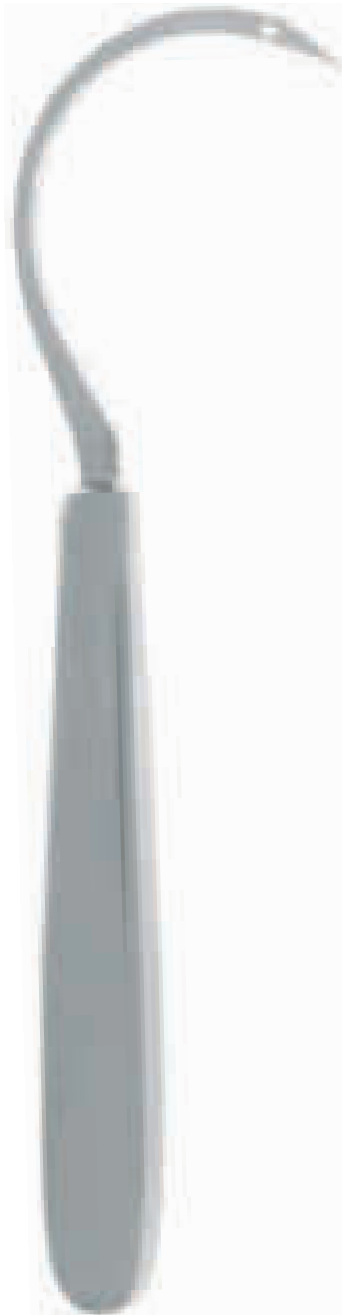

**G40050**  
18 cm - 7"

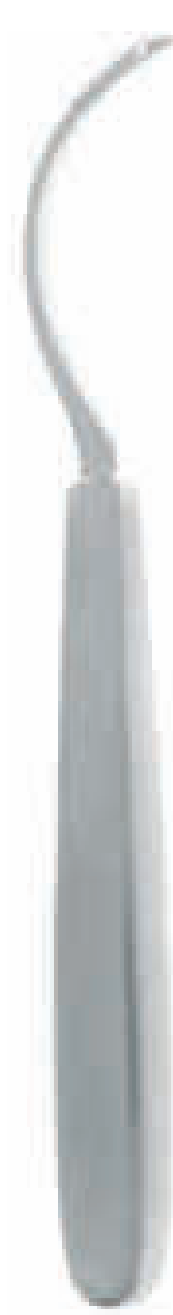

**G40060**  
17 cm - 6 <sup>3</sup>/<sub>4</sub>"

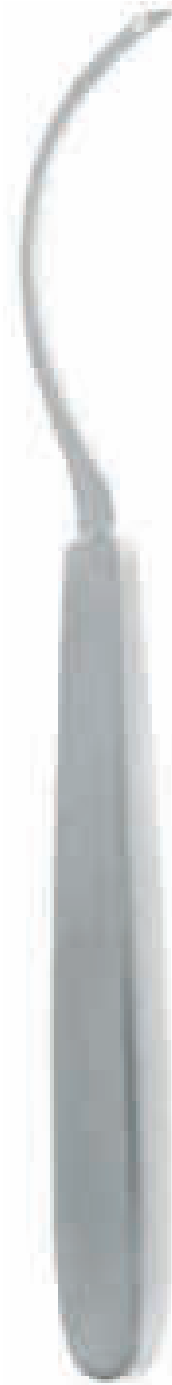

**G40070**  
18,5 cm - 7 <sup>1</sup>/<sub>4</sub>"

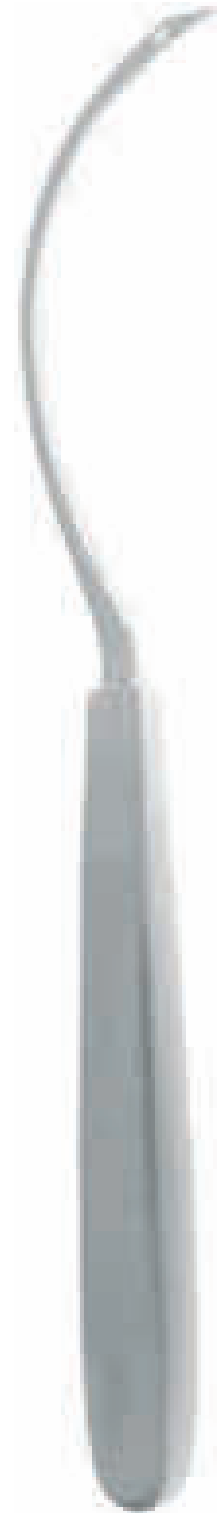

**G40080**  
20 cm - 8"

# LANDANGER

Aiguilles à ligatures - Ligature needles - Aguja para ligaduras

EMMET

PAUCHET  
(SABRE)

STAMEY

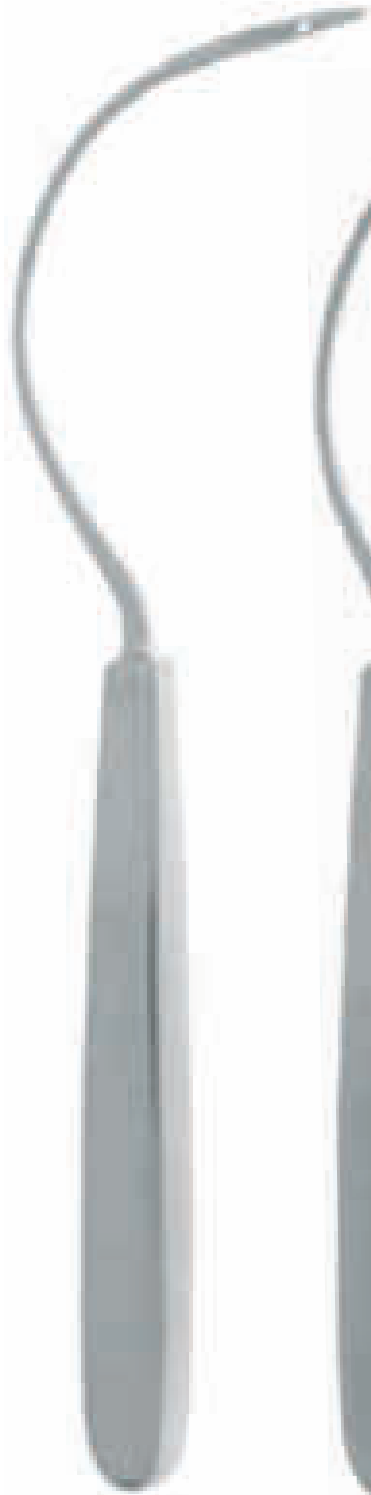

**G40120**  
20 cm - 8"



**G40110**  
19 cm - 7 1/2"

**G40100**  
18 cm - 7"



 3/4  
**G40135**  
27 cm - 10 1/2"



 3/4  
**G401360**  
25 cm - 9 3/4"



VI - Sutures  
VI - Sutures  
VI - Sutura

### REDON

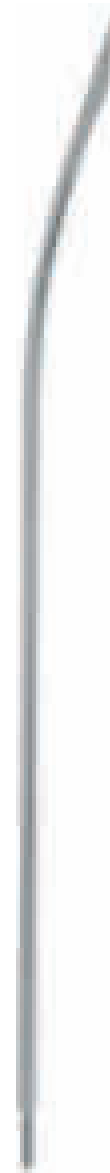

Courbe 20 cm  
Curved 8 "  
Curva 20 cm



Droite 16 cm  
Straight 6 1/4 "  
Recta 16 cm

<b>G40270</b>	2,3 mm / CH 07	<b>G40210</b>
<b>G402350</b>	2,5 mm / CH 08	<b>G401750</b>
<b>G40240</b>	3,0 mm / CH 09	<b>G40180</b>
<b>G40275</b>	3,3 mm / CH 10	<b>G40215</b>
<b>G40250</b>	4,0 mm / CH 12	<b>G40190</b>
<b>G402550</b>	4,6 mm / CH 14	<b>G401950</b>
<b>G40260</b>	5,0 mm / CH 15	<b>G40200</b>
<b>G402650</b>	5,3 mm / CH 16	<b>G402050</b>
<b>G402670</b>	6,0 mm / CH 18	<b>G402070</b>

### DESCHAMPS SCHAUTA

### BRUNNER

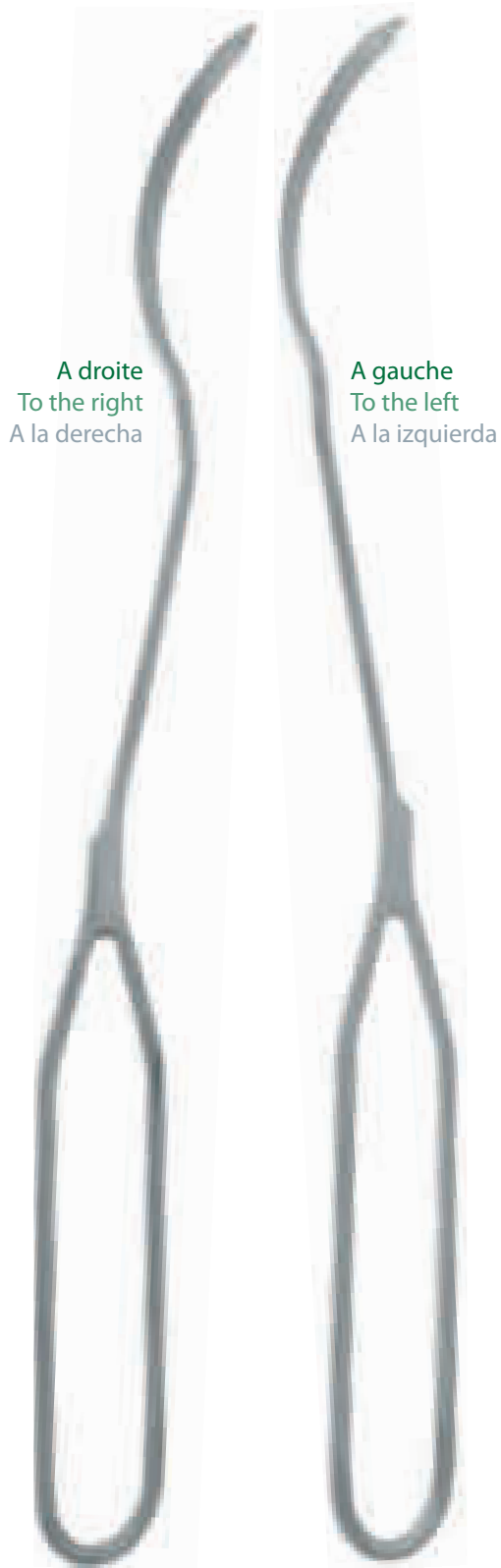

**G403510**  
28 cm - 11 "

**G403520**  
28 cm - 11 "

**G403540**  
30 cm - 12 "

**G403550**  
30 cm - 12 "



VI - Sutures  
VI - Sutures  
VI - Sutura

### DESCHAMPS

20 cm - 8 " **G40350**

24 cm - 9 1/2 " **G403501** 

28 cm - 11 " **G403502**

20 cm - 8 " **G40340**

24 cm - 9 1/2 " **G403401** 

28 cm - 11 " **G403402**

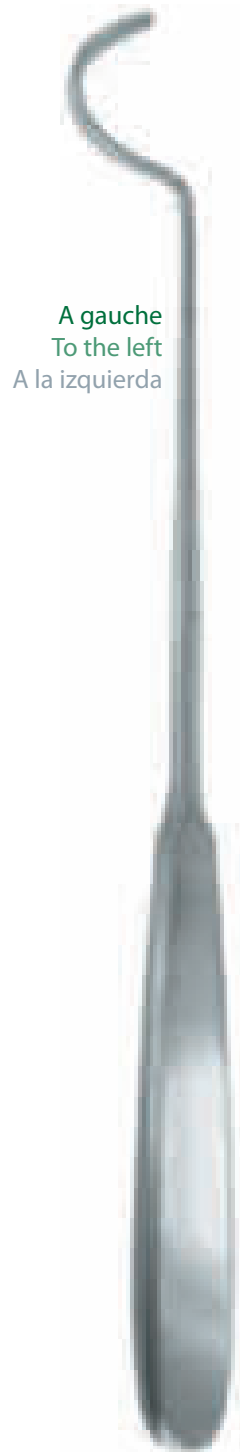

A gauche  
To the left  
A la izquierda

**G403501**  
24 cm - 9 1/2 "



**G40350** **G40340**

20 cm - 8 "



**G403501** **G403401**

24 cm - 9 1/2 "

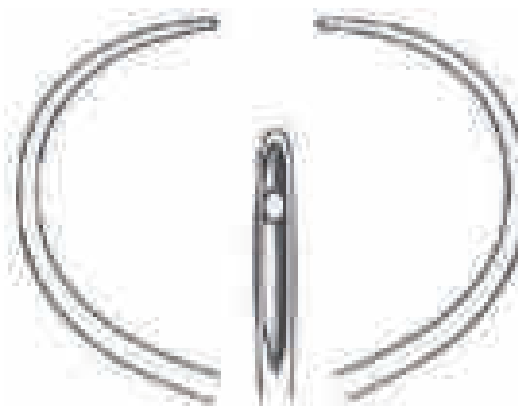

**G403502** **G403402**

28 cm - 11 "

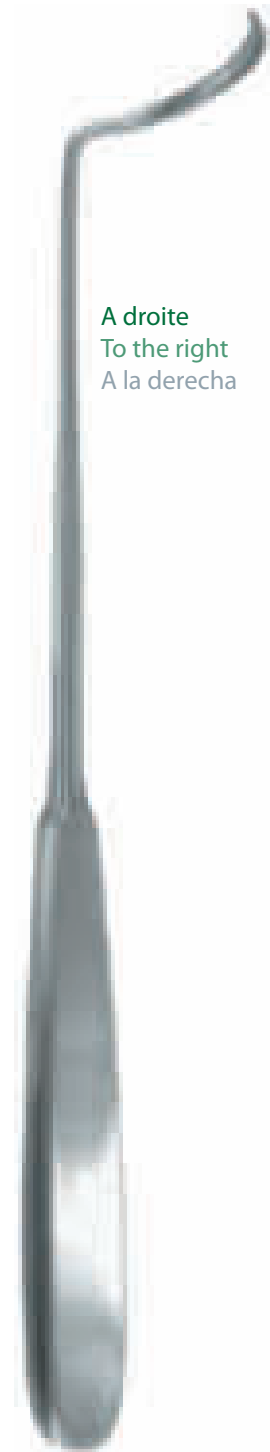

A droite  
To the right  
A la derecha

**G403401**  
24 cm - 9 1/2 "

### KÖNIG (KOENIG)

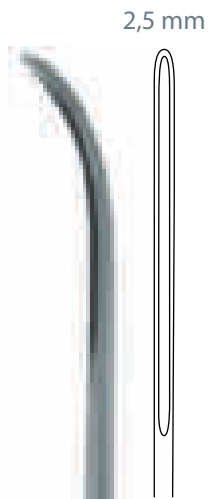

**G403600**  
19,5 cm - 7<sup>3</sup>/<sub>4</sub> "

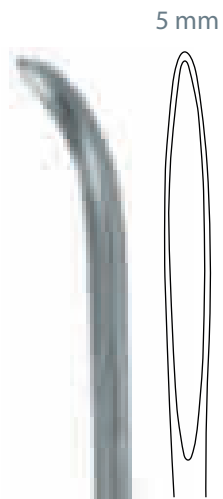

**G403610**  
19,5 cm - 7<sup>3</sup>/<sub>4</sub> "

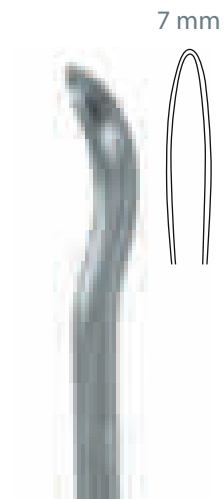

**G403620**  
20 cm - 8 "

PAYR

KIRSCHNER

Pousse-noeuds  
Knot pusher  
Empujador de nodos

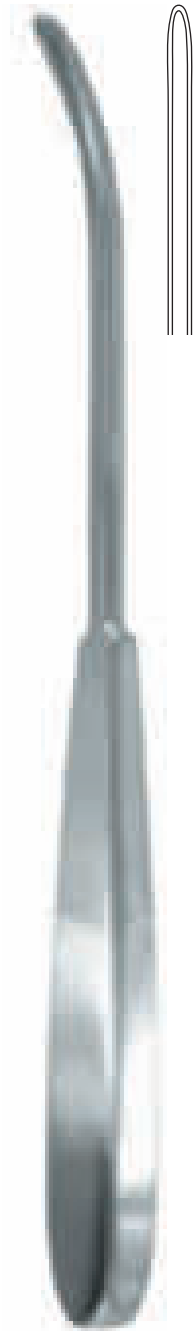

**G403630**  
22 cm - 8<sup>3/4</sup> "

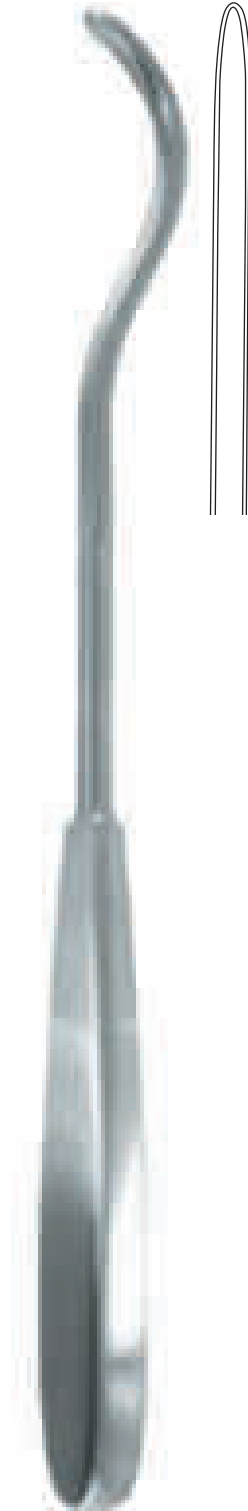

**G403640**  
25,5 cm - 10 "

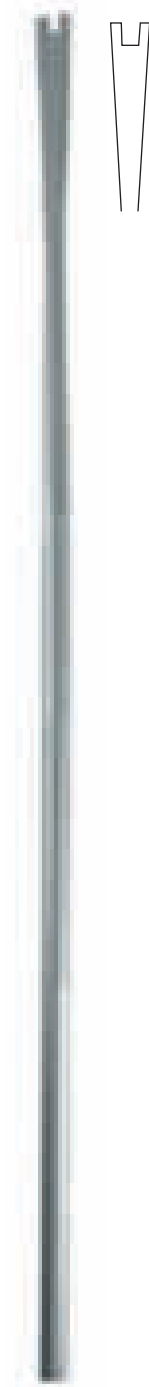

**G403650**  
23 cm - 9 "

## Écarteurs, crochets - Retractors, hooks - Separadores, ganchos

GILLIES    KLEINERT  
KUTZ    BARSKY    HUMBY    COTTLE    KILNER    BERGMANN    LERICHE

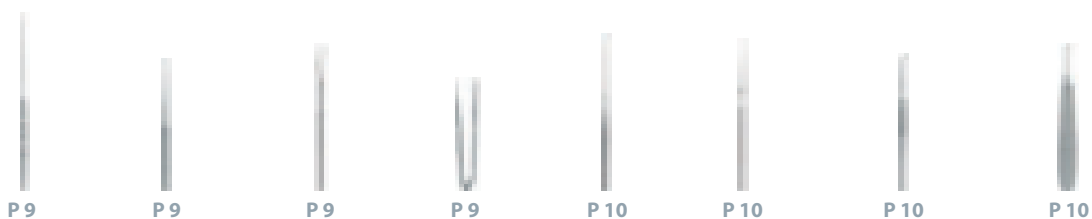

## Écarteurs - Retractors - Separadores

Ajouré  
Open work  
Con ventana

DESMARRES    ABOULKER    GIL-VERNET  
PAPIN    GIL-VERNET    CUSHING    KÔNIG    LOVE  
MORSE    LOWE    LUKENS



JACKSON    ROSE    MINI  
LANGENBECK    SEEN GREEN  
CHIGOT    LANGENBECK  
GREEN    CUSHING  
KOCHER    STRANDELL  
STILLE    MEYERDING    SENN  
MILLER



SEEN-MILLER  
BABY    RAGNEL  
DAVIS    KIENNY    LANGENBECK  
GREEN    KLAPP    VOLKMANN    MURPHY



VOLKMANN    KOCHER    LAHEY    KÔRTE    KÔRTE  
WAGNER    ISRAEL    KÔRTE    OLLIER    FARABEUF    FARABEUF  
CORTI





## Écarteurs - Retractors - Separadores

CRILE LUER OPEN COELIO ROUX BABY ROUX COLLIN GOELET PARKER LANGENBECK US Army PARKER MATHIEU CANNY RYALL HARTMANN



PARKER MOTT CRAWFORD HIBBS HEANEY CHARRIER LARDENOIS TUFFIER HABERER LARDENOIS REVERDIN



ALLISON Valve à poumon Blade for lung Valva para pulmón CHEVRET KOCHER LANGENBECK FARABEU KOCHER LANGENBECK BRUNNER KOCHER WAGNER HÔSEL

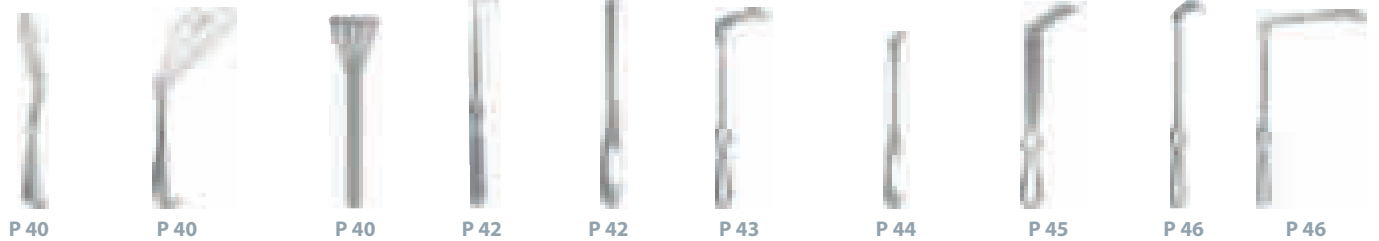

CASPAR KOCHER ZENKER KÜMMEL KÔRTE KOCHER TUFFIER MEYERDING RICHARDSON EASTMAN RICHARDSON



KELLY SIMON MARTIN SAUERBRUCH MORRIS SAUERBRUCH CORYLLOS MIKULICZ KELLY KADER SEGOND



## VII - 2

## Écarteurs - Retractors - Separadores

POLOSSON	LERICHE BUGATTI	HARRINGTON	HARRINGTON PEMBERTON	DEAVER	DEAVER	LEGUEU	Pour prostate For prostate Para prostate	FRITSCH			
P 56	P 57	P 58	P 58	P 59	P 60	P 60	P 60	P 61			
MIDDELDORF	DOYEN	MIDDELDORF	GREEN	CUSCHING	OBWEGESER	KIRSCH	DOCKHORN	SPINA NASALIS			
P 61	P 61	P 62	P 62	P 62	P 63	P 64	P 64	P 65			
RAMUS	OBWEGESER	DINGMAN	TESSIER	ROCHARD	ROCHARD	DOYEN ROCHARD	DESMARET	FOUCAULT	HAUTEFEUILLE		
P 65	P 65	P 66	P 66	P 67	P 68	P 69	P 70	P 71	P 72		
TOUPET	BERGERET TOUPET	RICARD	TOUPET	RICARD BEGOIN	RICARD	TOUPET	TOUPET ENTEROSTAT	COTT	PALMER	COLLIN	COLLIN
P 72	P 72	P 73	P 73	P 74	P 75	P 76	P 76	P 77	P 78	P 79	P 80
BABY COLLIN	MAYO ADAMS	OLIVIER	KIRSCHNER	DENIS BROWN	SEMM	O'SULIVAN O'CONNOR	AUVERT	GOSSET	MONTESTRUC	GOSSET	
P 81	P 81	P 82	P 83	P 84	P 85	P 85	P 86	P 87	P 87	P 88	

## Écarteurs - Retractors - Separadores

BALFOUR    BALFOUR    BALFOUR    BALFOUR    ABADIE    HRYNTSCHAK    MILLIN    JUDD    LEGUEU    DARTIGUES  
 BABY    USA MODEL



FINOCHIETTO    FINOCHIETTO    FINOCHIETTO    FINOCHIETTO    DUBOST    DUBOST    COOLEY    HAIGHT    DEBAKEY  
 NOGENT

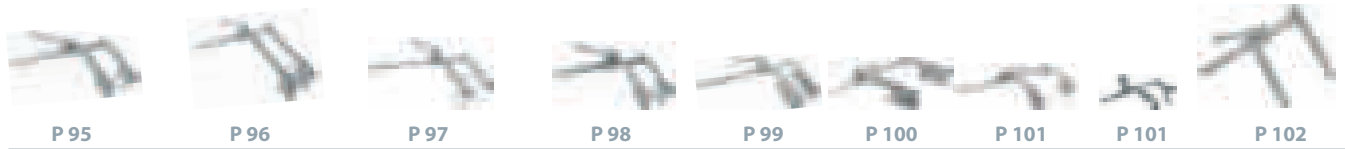

MERCEDES    MORSE    RACHIS    CHANDLER    DRYSSSEN    FINOCHIETTO    HERTZLER    TUFFIER    BAILEY    BAILEY  
 FAVALORO    NOGENT    BURFORD    BABY



SELLORS    MAURER    MATHEY    FINSEN    ALM    HEISS    JANSEN    JANSEN    PLESTER    WEITLANER    WEITLANER  
 HOLZEIMER    DEEP

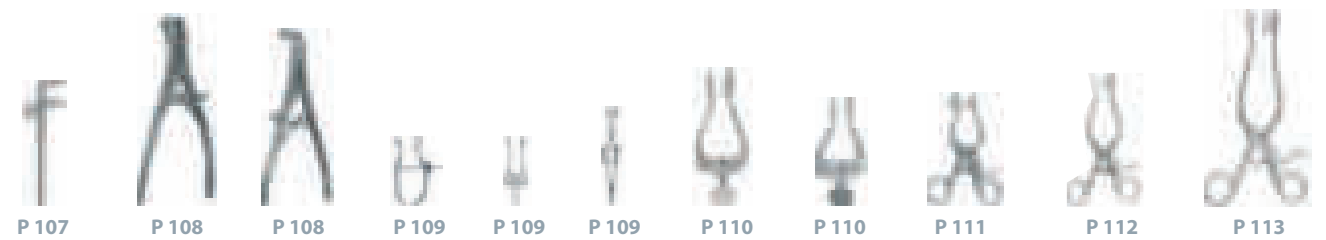

HENLY    TRAVERS    MAC FEE    NORFOLK    WEITLANER    WEITLANER    WEITLANER    ANDERSON    BECKMANN  
 NORWICH    WULLSTEIN    NEURO    ADSON    CONE



## Écarteurs - Retractors - Separadores

BECKMANN    BECKMANN    BECKMANN    DECOULX    BECKMANN EATON    ADSON    BECKMANN ADSON    ADSON    WALTON    MARKHAM MEYERDING

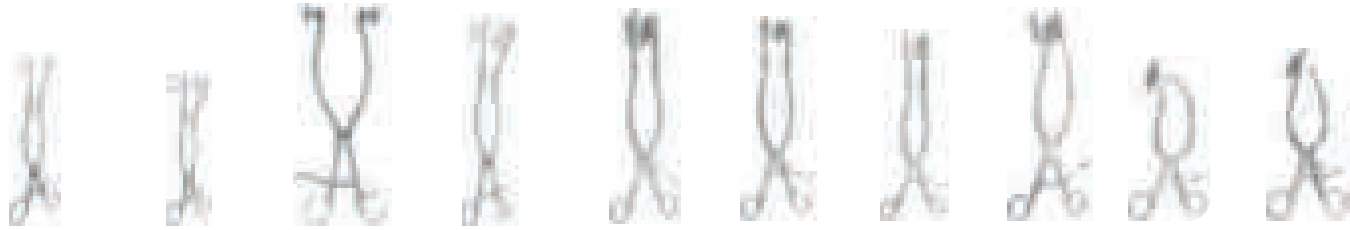

P 118    P 119    P 120    P 121    P 122    P 122    P 123    P 124    P 125    P 126

WILLIAMS    GELPI    DEBAKEY    JOLL    COURTY    BUCK GRAMCKO    LANGE HOHMANN    WAGNER    LANGE HOHMANN    LANGE HOHMANN    VERBRUGGE MULLER



P 127    P 128    P 128    P 129    P 129    P 130    P 131    P 131    P 132    P 133    P 134

LANGE HOHMANN    HOHMANN ALDINGER    SCHUMACHER WAGNER    SCHUMACHER    MERLE D'AUBIGNE    MERLE D'AUBIGNE    JUDET    CHANDLER    LANE    LANE

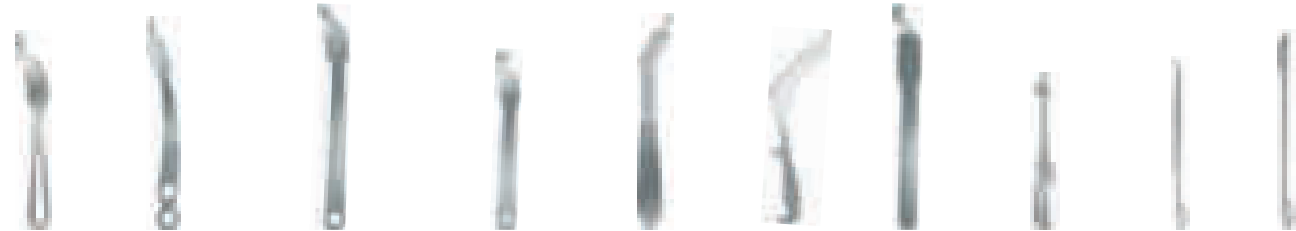

P 135    P 135    P 136    P 136    P 137    P 138    P 138    P 139    P 139    P 139

BRISTOW    BLOUNT    FUKUDA    BENNET    TRILLAT    CAUCHOIX    SKID MURPHY    LAMBOTTE    MOORE LAMBOTTE    POSTEL    MAURER



P 139    P 140    P 140    P 141    P 141    P 142    P 143    P 143    P 143    P 144    P 144

## Valves vaginales - Vaginal blades - Valvas vaginales

DOYEN    MANGIAGALLI    DOUGLAS    DARGENT    LANDAU    BRIESKY



P 37    P 38    P 38    P 39    P 39    P 40    P 41    P 41    P 42    P 43    P 43

VIII - Voies basses  
VIII - Gyne/Uro/Procto  
VIII - Gyne/Uro/Procto

VII - Écarteurs  
VII - Retractors  
VII - Separadores

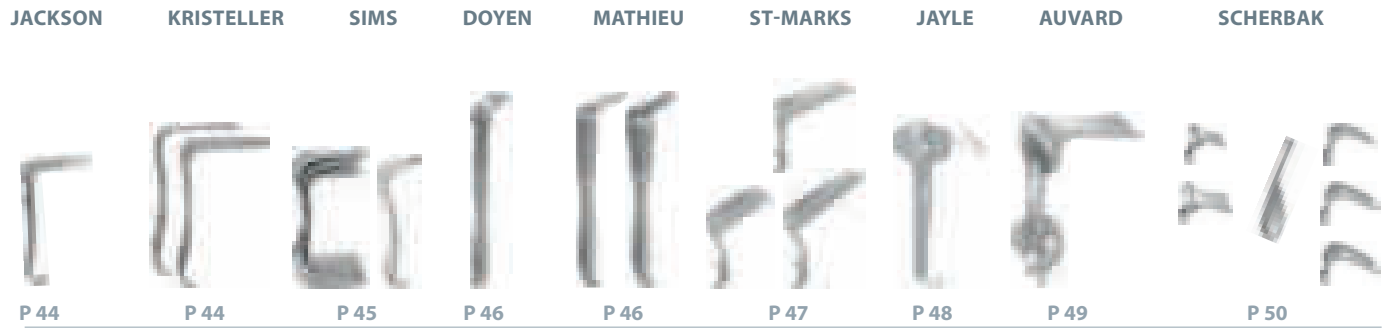

**Neurochirurgie : spatules - Neurosurgery : spatulas - Neurocirugía : espátulas**

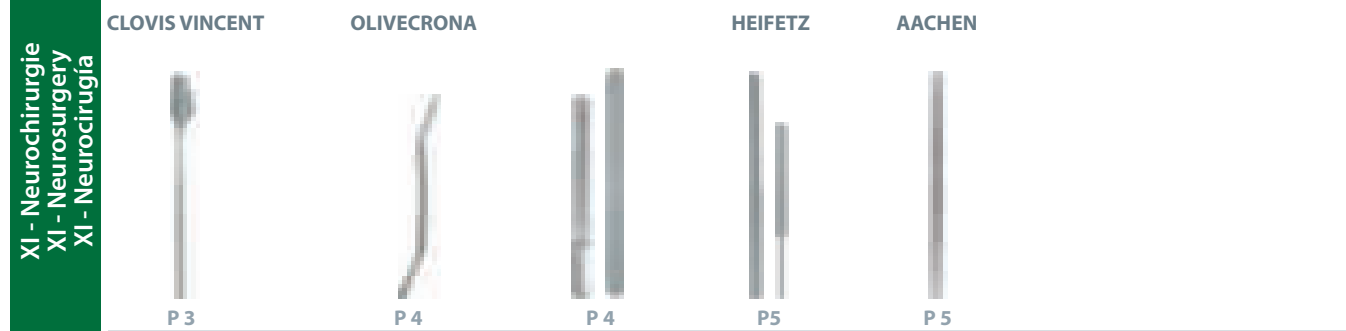

**Neurochirurgie : écarteurs - Neurosurgery : retractors - Neurocirugía : separadores**

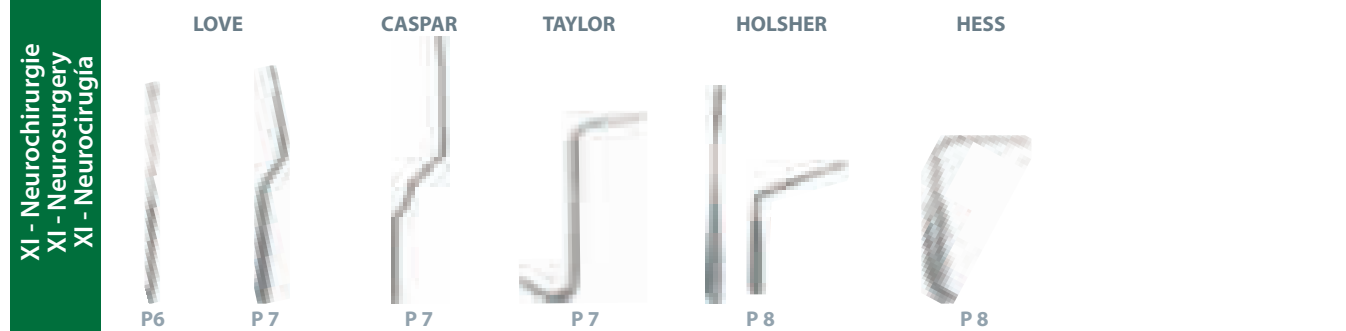

**O.R.L. écarteurs - E.N.T. retractors - O.R.L. separadores**

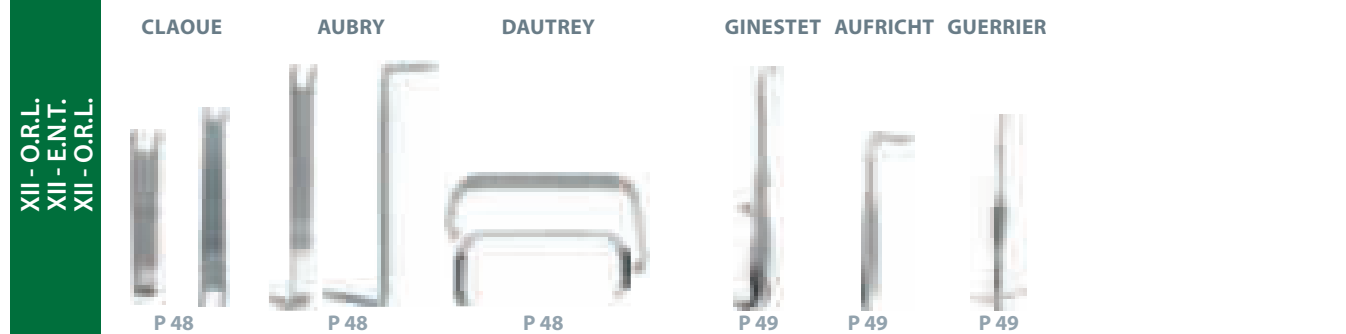

**Écarteur - Retractor - Separador**



**Instrumentation pour épaule - Shoulder instrumentation - Instrumentación para hombro**

XIII - Osseux  
XIII - Bone surgery  
XIII - Cirugía osea

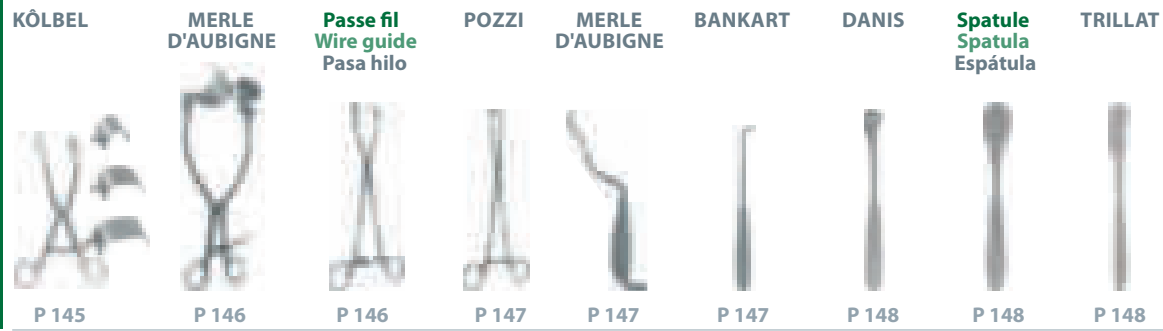

**Pour ménisque - For meniscus - Para menisco**

XIII - Osseux  
XIII - Bone surgery  
XIII - Cirugía osea

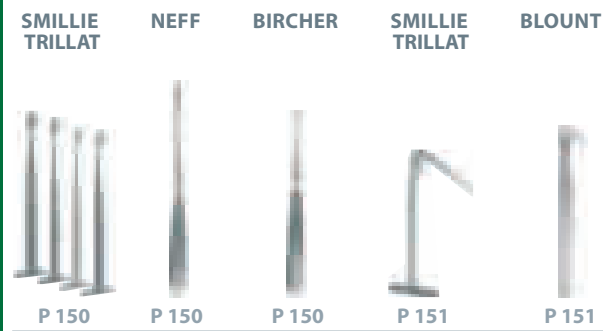

**Mains de plomb - Lead hands - Manos de plomo**

XIII - Osseux  
XIII - Bone surgery  
XIII - Cirugía osea

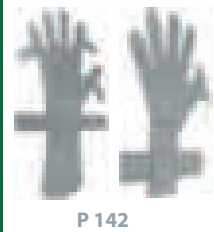



### GILLIES

### KLEINERT-KUTZ

### BARSKY

### HUMBY



**B80348**   
n° 1 - 2,5 mm

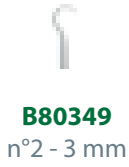

**B80349**  
n°2 - 3 mm

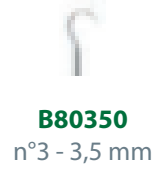

**B80350**  
n°3 - 3,5 mm

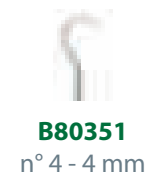

**B80351**  
n° 4 - 4 mm

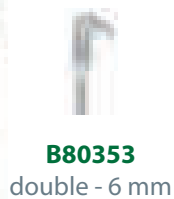

**B80353**  
double - 6 mm

**B80348**  
18 cm - 7 "



**B803533**   
3 mm

**B803535**  
5 mm

**B803537**  
7 mm

**B803533**  
13 cm - 5 "

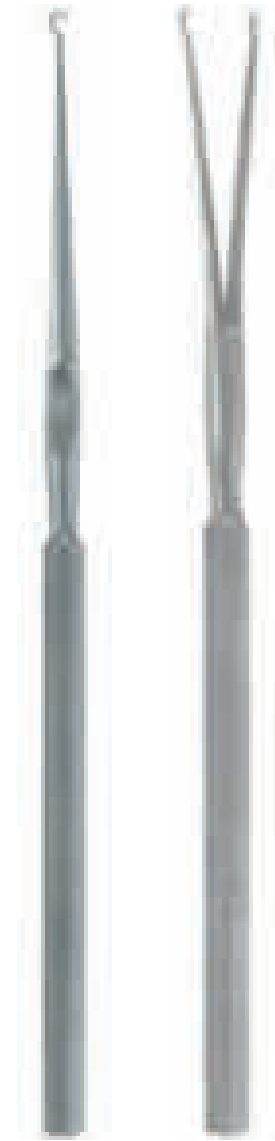

**B803540**  
15 cm - 6 "

**B803541**  
15 cm - 6 "

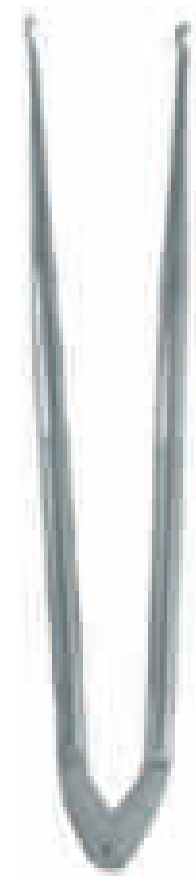

**B803545**  
11,5 cm - 4 1/2 "





### COTTLE

### KILNER

### BERGMANN

### LERICHE

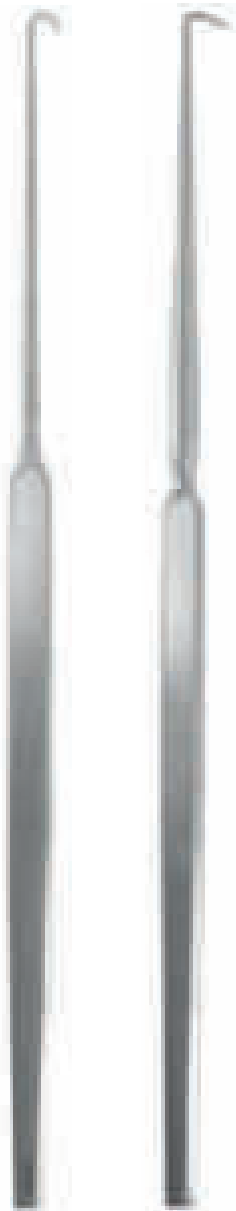

**B803550** 16 cm - 6 1/4 "  
**B803551** 16 cm - 6 1/4 "

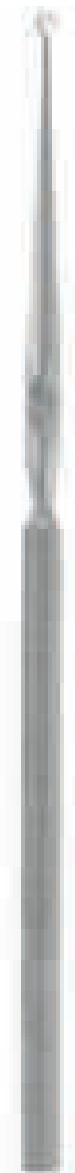

**B803543** 15,5 cm - 6"

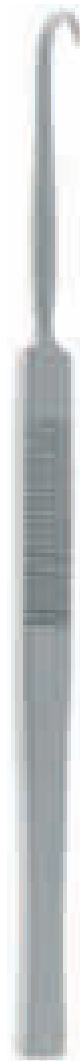

**B803320** 14 cm - 5 1/2 "

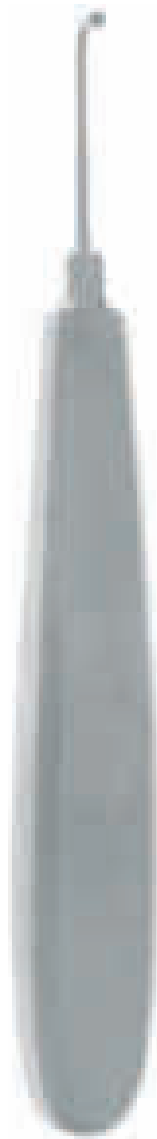

**B80337** 15 cm - 6 "

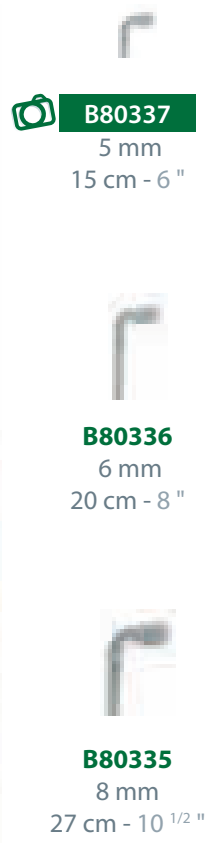

**B80337**  
 5 mm  
 15 cm - 6 "

**B80336**  
 6 mm  
 20 cm - 8 "

**B80335**  
 8 mm  
 27 cm - 10 1/2 "

### DESMARRES

### ABOULKER

Ajouré  
Open work  
Con ventana

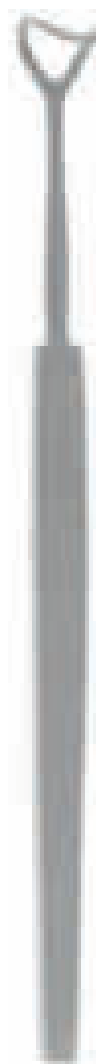

**B803070**   
12 mm



**B803071**  
14 mm



**B803072**  
16 mm



**B803073**  
18 mm

**B803070**  
14 cm - 5 1/2 "



**B80301**  
15 cm - 6 "



**B80301**   
6 mm



**B80302**  
8 mm



**B80303**  
10 mm



**B80304**  
12 mm



**B80306**  
15 mm



**B803062**  
16 mm



**B803064**  
18 mm

Malléable  
Malleable  
Maleable



**B80312**  
19 cm - 7 1/2 "



10 mm

**B80312**   
19 cm - 7 1/2 "

**B80316**  
25 cm - 10 "



14 mm

**B80314**  
19 cm - 7 1/2 "

**B80318**  
25 cm - 10 "

### GIL-VERNET (PAPIN)

	Rigide Rigid Rigida	Malleable Malleable Maleable
10 mm 	<b>H20085</b>	H20087
15 mm	H20089	H20091
20 mm	H20093	H20095

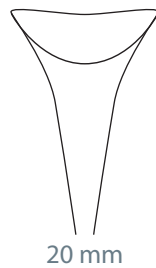

**H20085**  
28 cm - 11 "

### GIL-VERNET

	Malleable Malleable Maleable
8 mm	<b>H200961</b>
11 mm	<b>H200962</b>
15 mm	<b>H200963</b> 
17 mm	<b>H200964</b>
20 mm	<b>H200965</b>
23 mm	<b>H200966</b>

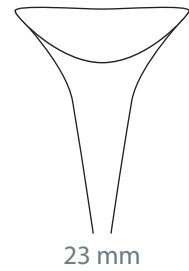
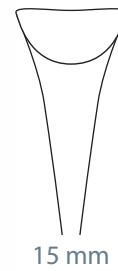
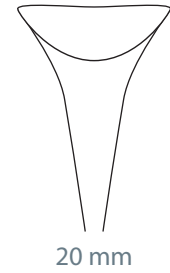
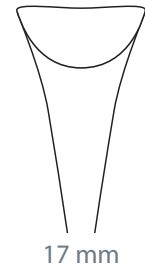
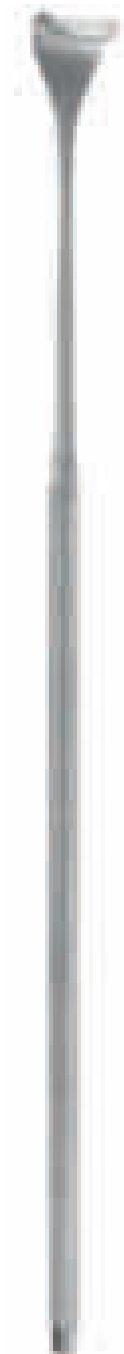



**H200963**  
24 cm - 9 1/2 "

### CUSHING

### KÖNIG

### LOVE (MORSE)

Largeur Width Anchura	Longueur / Length / longitud	
	20 cm - 8 "	24 cm - 9 1/2 "
8 mm	 <b>B803080</b>	<b>B803090</b>
10 mm	<b>B803081</b>	<b>B803091</b>
12 mm	<b>B803082</b>	<b>B803092</b>
14 mm	<b>B803083</b>	<b>B803093</b>
16 mm	<b>B803084</b>	<b>B803094</b>
18 mm	<b>B803085</b>	<b>B803095</b>

Largeur Width Anchura	
10 mm	<b>B803074</b>
15 mm	<b>B803075</b>
20 mm	<b>B803076</b>
30 mm	<b>B803077</b> 
40 mm	<b>B803078</b>
50 mm	<b>B803079</b>

Largeur Width Anchura	
13 mm	<b>B803086</b>
16 mm	<b>B803087</b> 

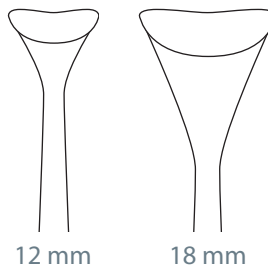
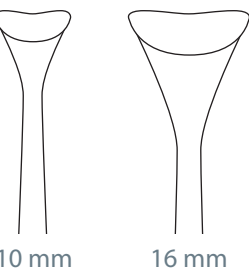
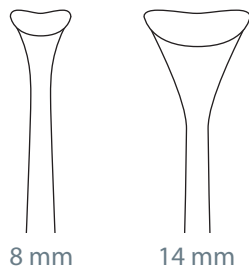
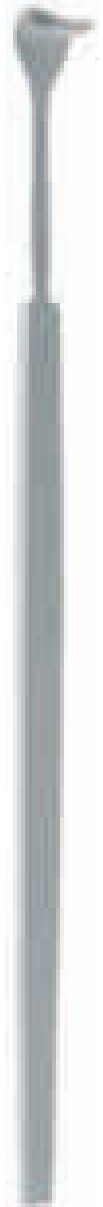

**B803080**  
20 cm - 8 "

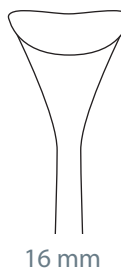
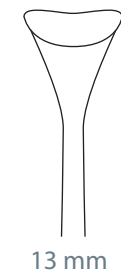

**B803087**  
17 cm - 6 3/4 "

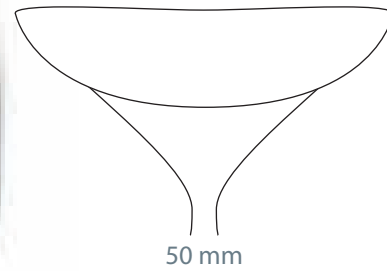
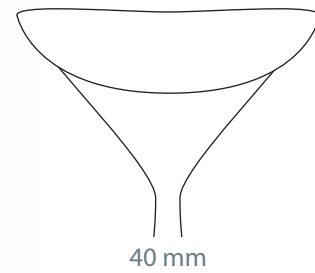
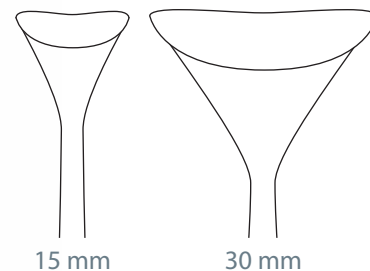
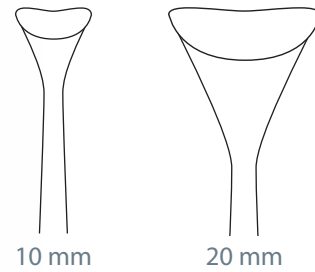
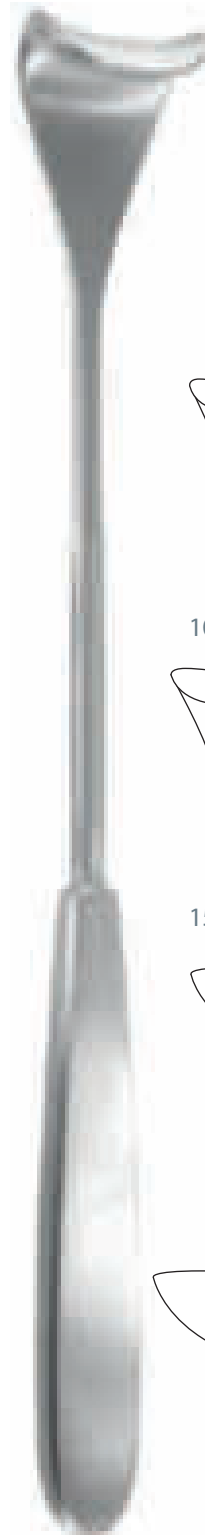

**B803077**  
25 cm - 10 "

LOWE



B80342

B80341

B80340

B80338

19 cm - 7 1/2"



# LANDANGER

## Écarteurs - Retractors - Separadores

### LUKENS

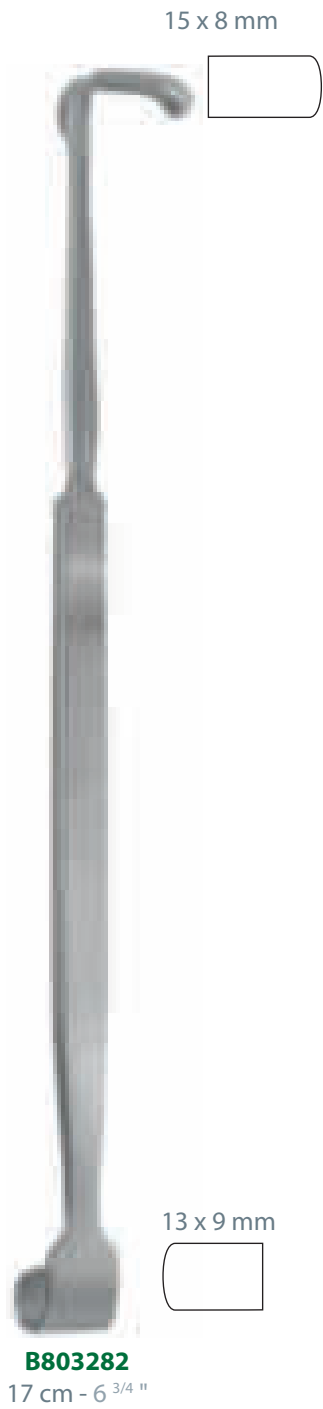

### JACKSON



### ROSE

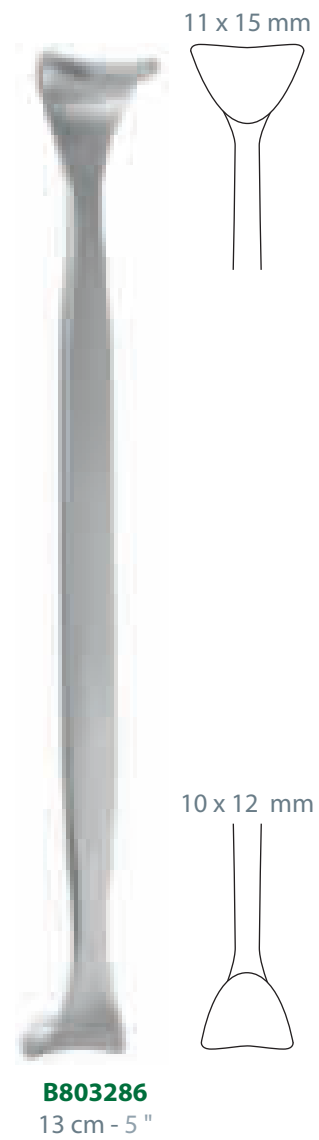

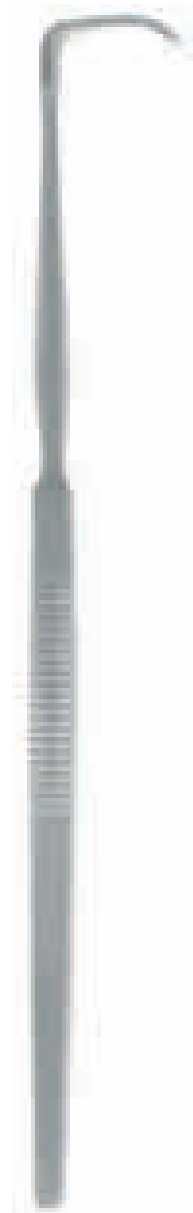

### MINI-LANGENBECK

### SENN GREEN (CHIGOT)

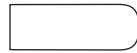

**B802862**  
6 x 10 mm



**B802863**   
6 x 17 mm



**B802864**  
6 x 20 mm



**B802865**  
8 x 22 mm

**B802863**  
16 cm - 6 1/4"



**B80081**   
6 x 10 mm



**B80083**  
6 x 20 mm

**B80081**  
15 cm - 6"

### LANGENBECK-GREEN

### CUSCHING-KOCHER

### STRANDELL-STILLE

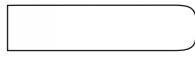

**B803108**   
6 x 25 mm



**B803109**  
8 x 25 mm

**B803108**  
17 cm - 6 <sup>3</sup>/<sub>4</sub> "

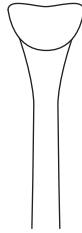
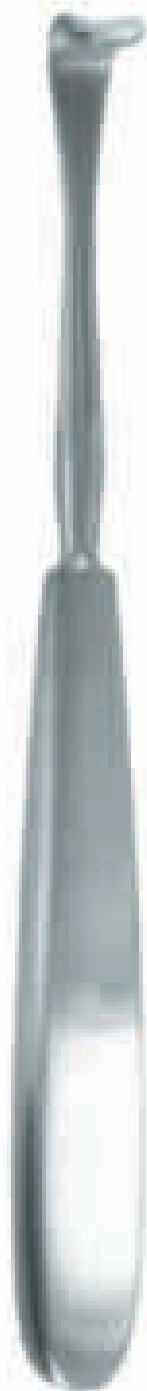

10 mm

**B803110**  
18 cm - 7 "

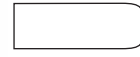

**B803112**   
6 x 17 mm

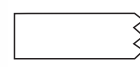

**B803113**  
6 x 17 mm

**B803112**  
19 cm - 7 <sup>1</sup>/<sub>2</sub> "



### MEYERDING

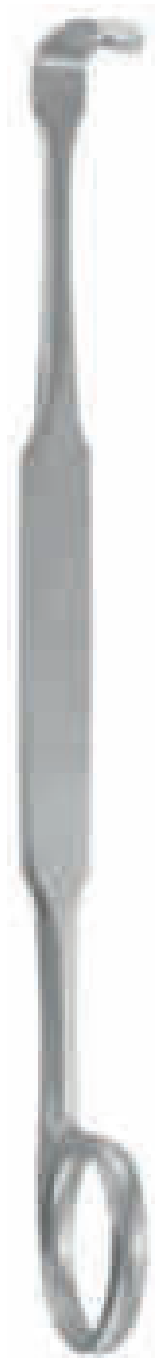

**B803101**  
18 cm - 7 "

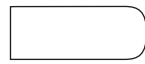

**B803101**   
7 x 18 mm



**B803104**  
3 x 10 mm



**B803103**  
4 x 7 mm



**B803105**  
4 x 7 mm



**B803102**  
5 x 16 mm

3 griffes pointues  
3 sharp teeth  
3 dientes agudas

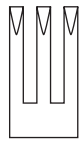

10 x 7 mm

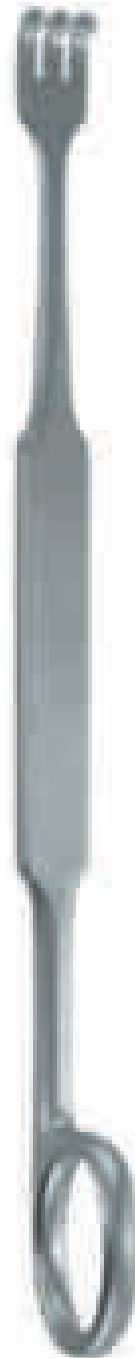

**B803106**  
18 cm - 7 "

### SENN-MILLER

### SENN-MILLER BABY

### RAGNEL (DAVIS)

### KIENNY

Pointu  
Sharp  
Agudo

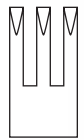

**B80325**  
9 x 7 mm

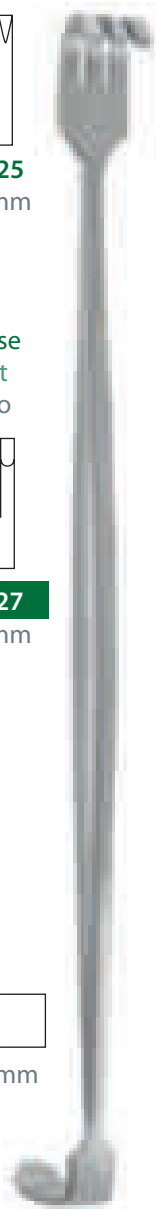

Pointu  
Sharp  
Agudo

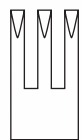

**B803255**  
9 x 7 mm



Chausse veine  
Vein holder  
Porta veina



4 mm

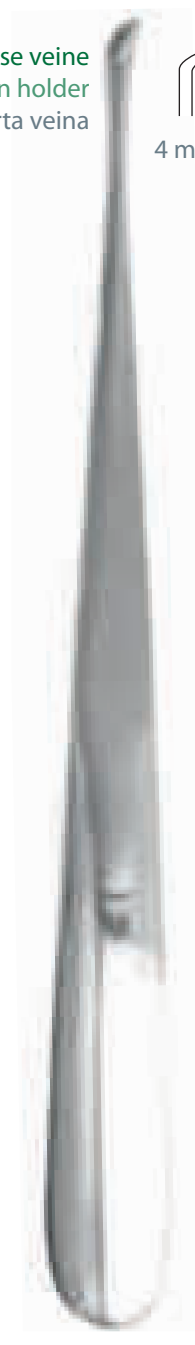

Mousse  
Blunt  
Romo

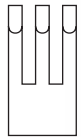

 **B80327**  
9 x 7 mm

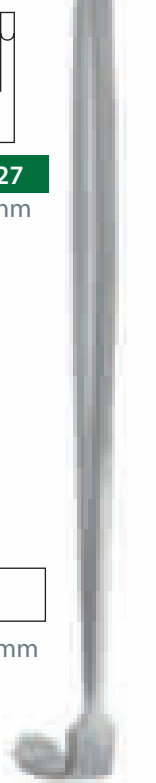

Mousse  
Blunt  
Romo

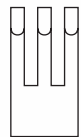

 **B803275**  
9 x 7 mm

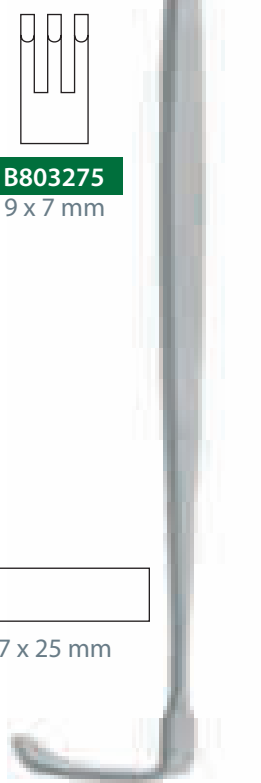

6 x 15 mm

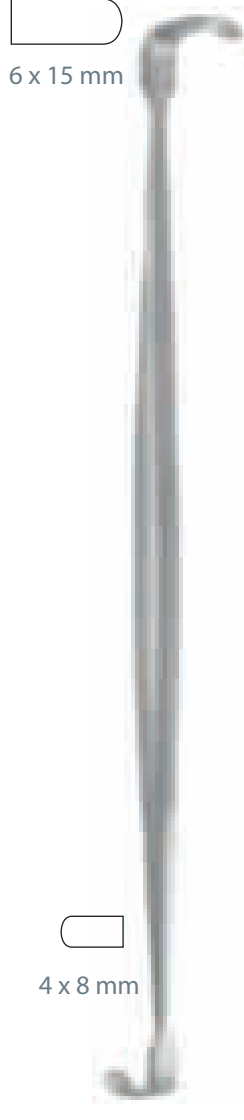

7 x 20 mm

**B80327**  
16 cm - 6 1/4 "



7 x 25 mm

**B803275**  
16 cm - 6 1/4 "



4 x 8 mm

**B80328**  
14 cm - 5 1/2 "

**B80330**  
17 cm - 6 3/4 "



### LANGENBECK-GREEN

### KLAPP



**B803302**  
16 cm - 6 1/4 "

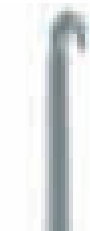

**B803301**  
7 mm



**B803305**  
13 x 11 mm



 **B803302**  
5 x 5 mm



**B803306**  
6 x 16 mm



**B803303**  
5 x 12 mm



**B803307**  
6 x 25 mm



**B803310**  
17,5 cm - 7 "



**B803310**   
6 x 12 mm



**B803311**  
11 x 12 mm



**B803312**  
11 x 15 mm

Flexible  
Flexible  
Flexible

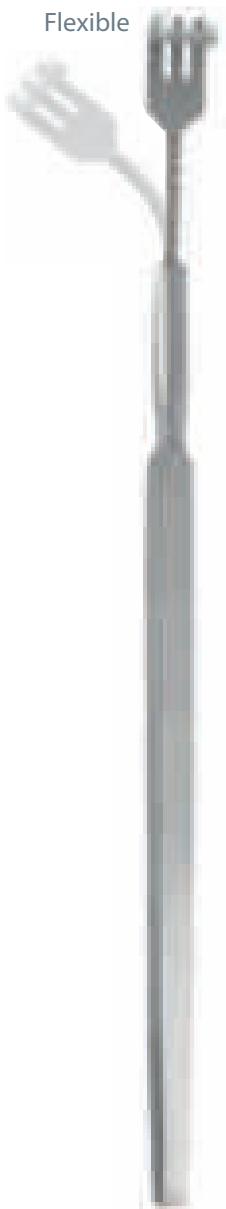

**B812106**  
16 cm - 6 1/4 "

Pointu  
Sharp  
Agudo

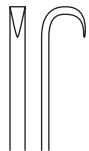

**B812101**  
4 mm



**B812103**  
5 x 5 mm



**B812105**  
5 x 7 mm

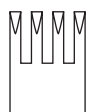

**B812107**  
5 x 10 mm

Mousse  
Blunt  
Romo

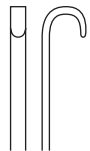

**B812102**  
4 mm



**B812104**  
5 x 5 mm

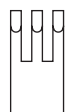

**B812106**   
5 x 7 mm

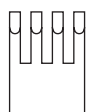

**B812108**  
5 x 10 mm

Pointu  
Sharp  
Agudo



**B812025**   
5 x 10 mm

Mousse  
Blunt  
Romo

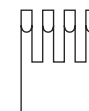

**B812026**  
5 x 10 mm



**B812025**  
16 cm - 6 1/4 "

### VOLKMANN

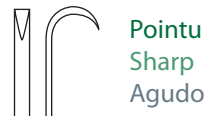

Pointu  
Sharp  
Agudo

**B812011** 7 mm



**B812013** 7 x 7 mm



 **B812015** 7 x 9 mm

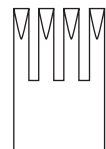

**B812017** 7 x 12 mm

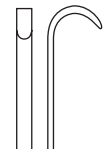

Mousse  
Blunt  
Romo

**B812012** 7 mm



**B812014** 7 x 7 mm



**B812016** 7 x 9 mm

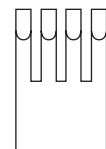

**B812018** 7 x 12 mm

**B812015**  
16 cm - 6 1/4 "

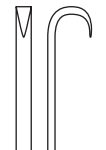

Pointu  
Sharp  
Agudo

**B812001** 6 mm



**B812003** 5 x 5 mm



 **B812005** 5 x 8 mm

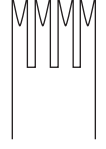

**B812007** 5 x 11 mm

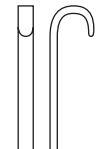

Mousse  
Blunt  
Romo

**B812002** 6 mm



**B812004** 5 x 5 mm



**B812006** 5 x 8 mm

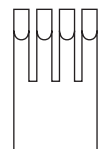

**B812008** 5 x 11 mm

**B812005**  
16 cm - 6 1/4 "

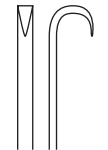

Pointu  
Sharp  
Agudo

**B80218** 6 mm



**B80220** 6 x 6 mm



**B80240** 6 x 9 mm



**B80266** 6 x 12 mm

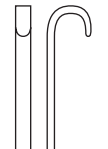

Mousse  
Blunt  
Romo

**B80219** 6 mm



**B80225** 6 x 6 mm



 **B80245** 6 x 9 mm



**B80267** 6 x 12 mm

**B80245**  
15 cm - 6 "

### VOLKMANN

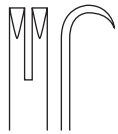

**B812203**

Pointu  
Sharp  
Agudo

7 x 5 mm

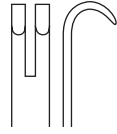

**B812204**

Mousse  
Blunt  
Romo

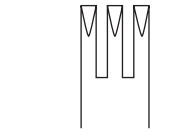

**B812205**

7 x 9 mm

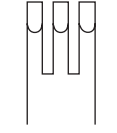

**B812206**

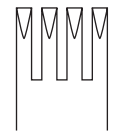

**B812207**

7 x 12 mm

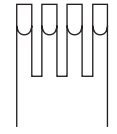

**B812208**

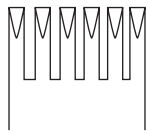

**B812209**

7 x 18 mm

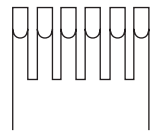

**B812210**

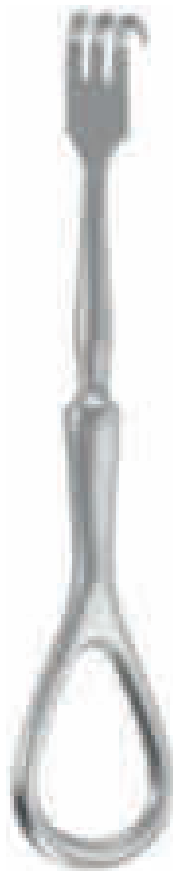

**B812205**

11,5 cm - 4 1/2 "

### MURPHY

Pointu  
Sharp  
Agudo

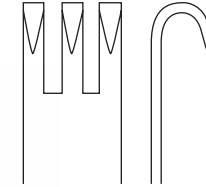

**B812305**

8 x 13 mm

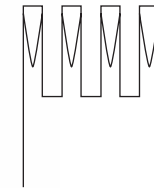

**B812307**

8 x 18 mm

Mousse  
Blunt  
Romo

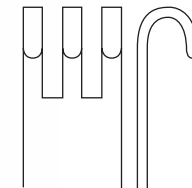

**B812306**

8 x 13 mm

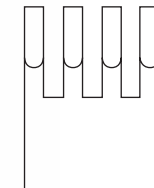

**B812308**

8 x 18 mm

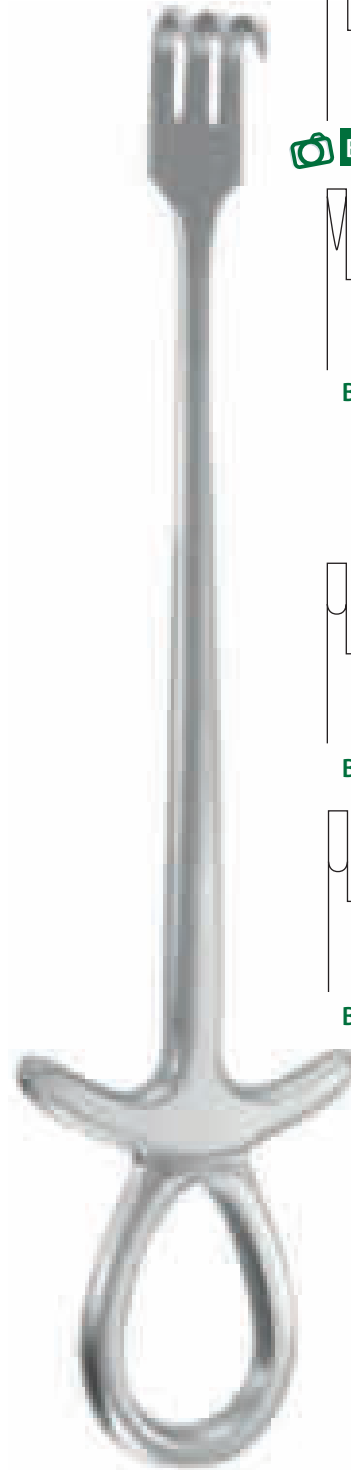

**B812305**

19,5 cm - 7 3/4 "

### VOLKMANN

Pointu  
Sharp  
Agudo

Semi-Pointu  
Semi-Sharp  
Semi-Agudo

Mousse  
Blunt  
Romo



**B80150**  
22 cm - 8 5/8"

19 mm

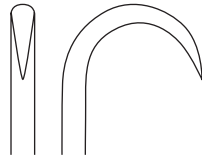

**B801492**

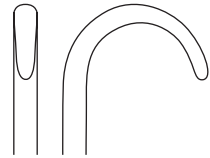

**B801493**

9 x 8 mm



 **B80150**

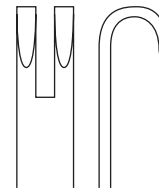

**B801570**

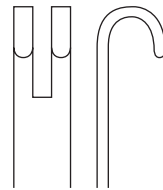

**B80155**

9 x 13 mm

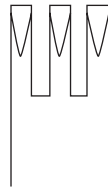

**B80160**

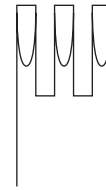

**B801670**

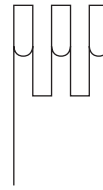

**B80165**

9 x 19 mm

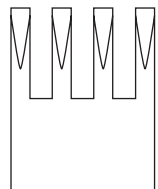

**B80170**

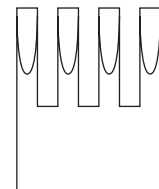

**B801770**

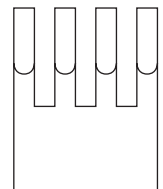

**B80175**

9 x 28 mm

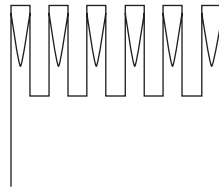

**B80190**

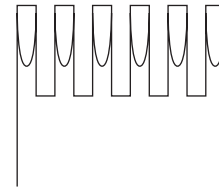

**B801970**

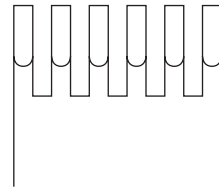

**B80195**

9 x 36 mm

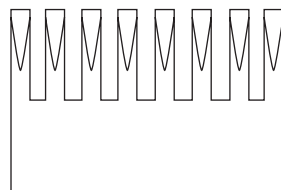

**B80210**

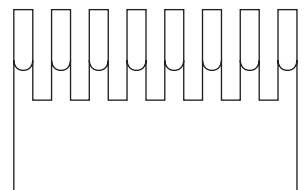

**B80215**

### VOLKMANN

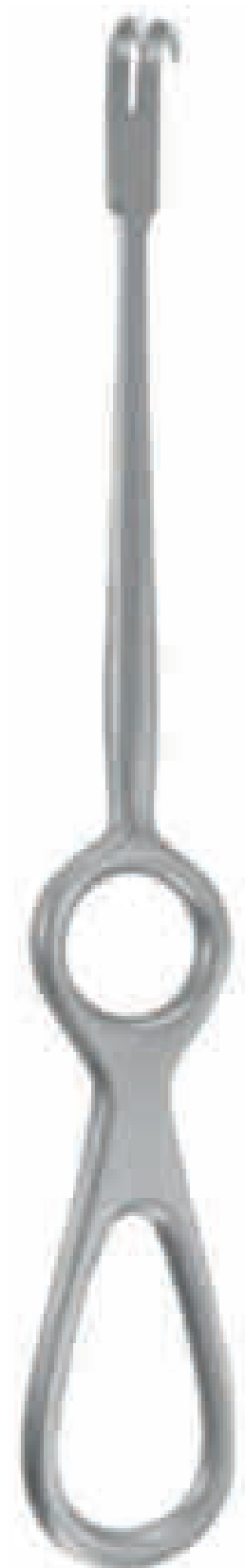

**B80151**

22 cm - 8 5/8"

Pointu  
Sharp  
Agudo

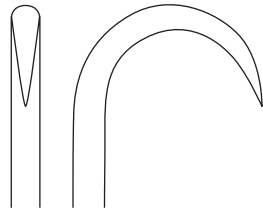

25 mm

**B801490**

Semi-Pointu  
Semi-Sharp  
Semi-Agudo



Mousse  
Blunt  
Romo

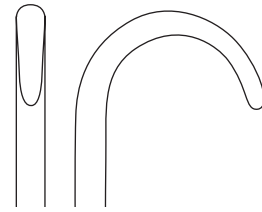

**B801491**



9 x 8 mm

**B80151**

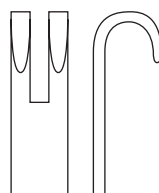

**B801575**

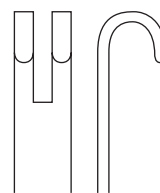

**B80156**

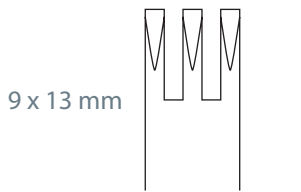

9 x 13 mm

**B80161**

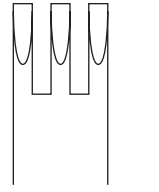

**B801675**

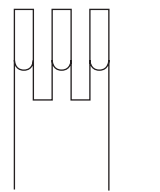

**B80166**

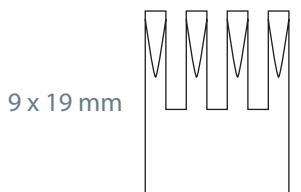

9 x 19 mm

**B80171**

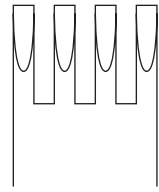

**B801775**

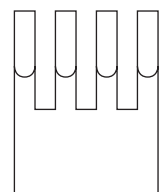

**B80176**

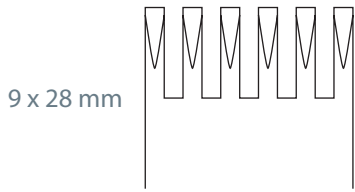

9 x 28 mm

**B80191**

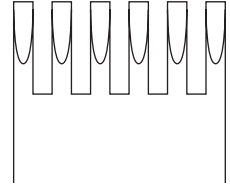

**B801975**

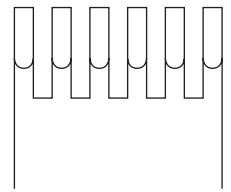

**B80196**



9 x 36 mm

**B80211**

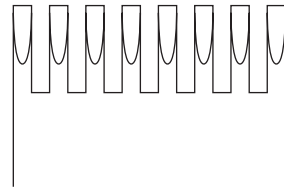

**B802175**

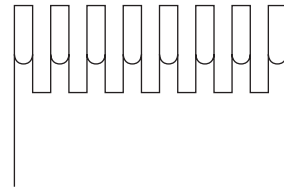

**B80216**





KOCHER

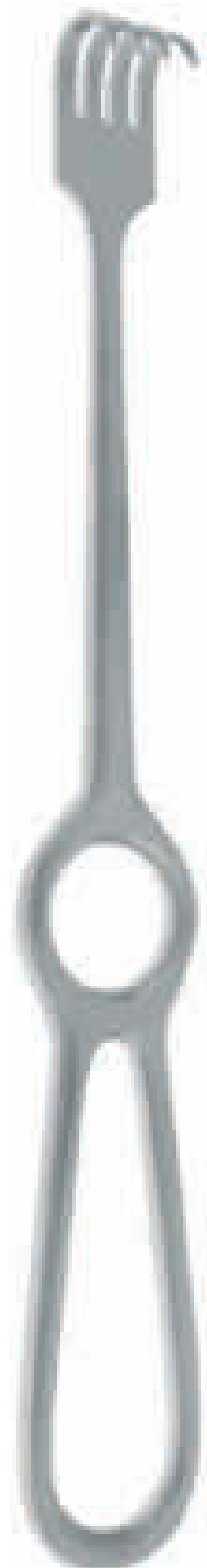

**B802869**  
22 cm - 8<sup>3/4</sup> "

Pointu  
Sharp  
Agudo

Semi-Pointu  
Semi-Sharp  
Semi-Agudo

Mousse  
Blunt  
Romo

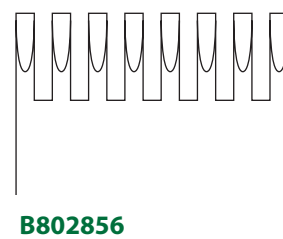
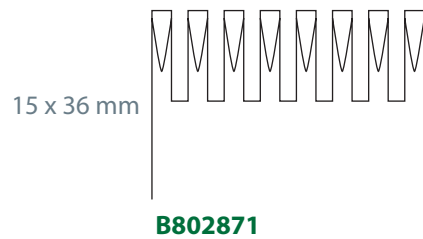
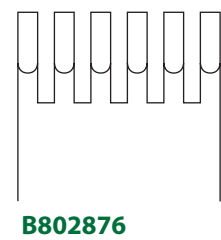
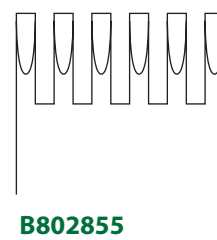
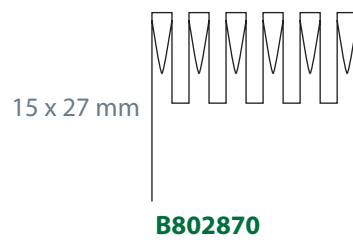
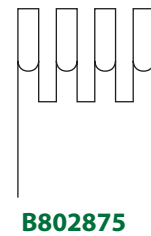
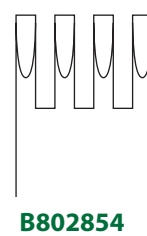
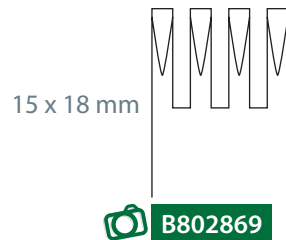
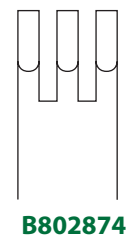
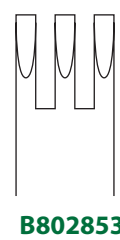
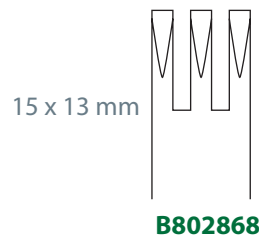
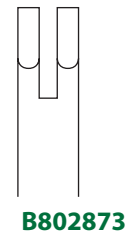
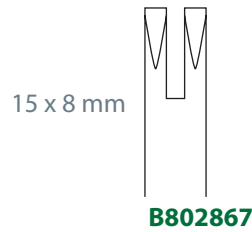
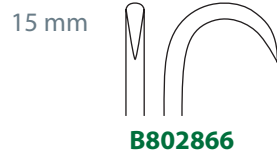

### KOCHER

### LAHEY

Modèle fort  
Strong model  
Modelo fuerte



**B802880**  
20 cm - 8"



28 mm  
Pointu  
Sharp  
Agudo

**B802880**

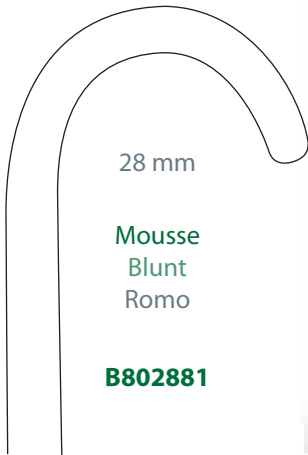

28 mm  
Mousse  
Blunt  
Romo

**B802881**



**B802878**  
24,5 cm - 9 3/4"



23 mm  
Pointu  
Sharp  
Agudo

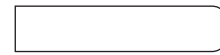

6 x 28 mm

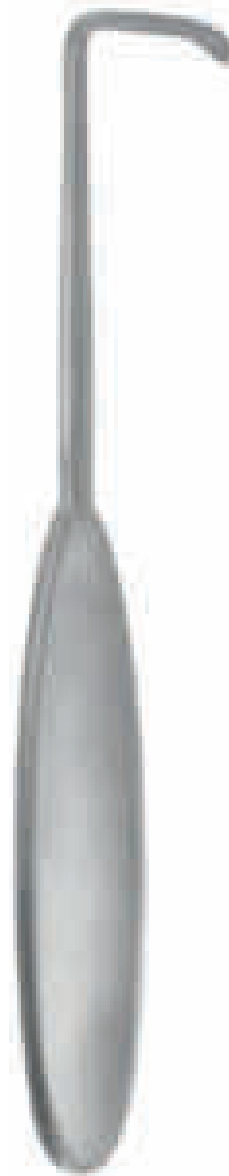

**B802883**  
19 cm - 7 1/2"

KÖRTE

KÖRTE-WAGNER

26 x 40 mm



### ISRAEL

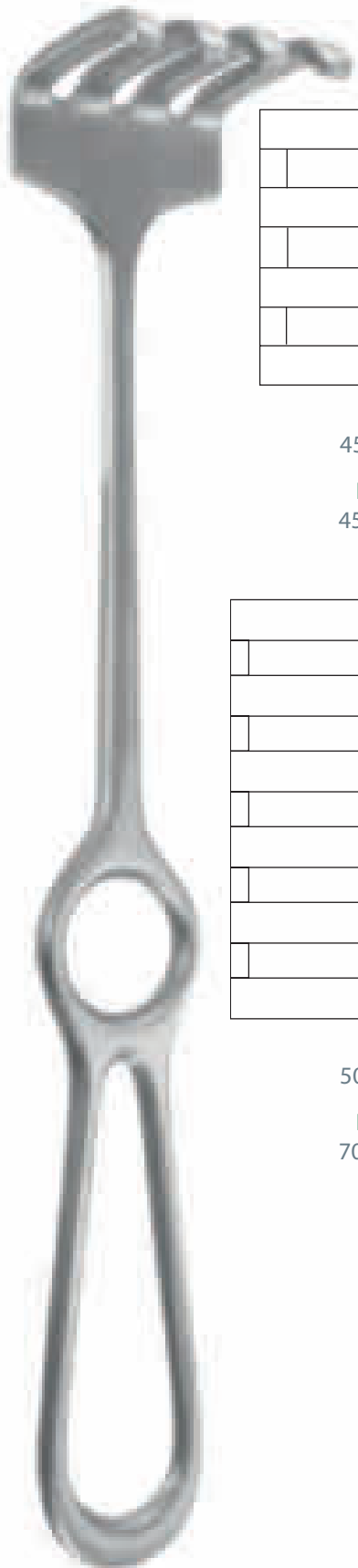

**B80268**  
23 cm - 9 "

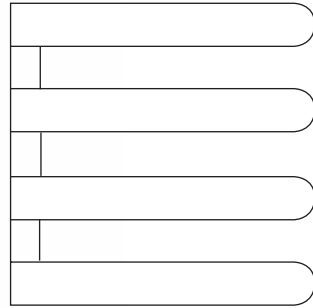

**B80268**  
45 x 40 mm

**B80269**  
45 x 50 mm

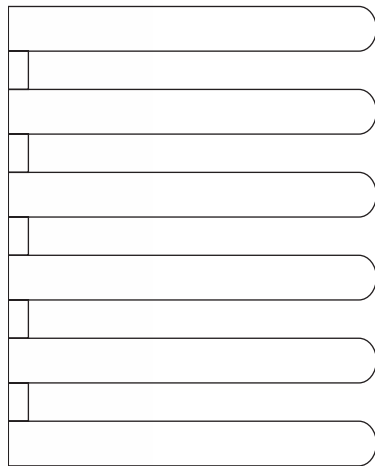

**B80270**  
50 x 60 mm

**B80271**  
70 x 70 mm

### KÖRTE



**B802679**  
23 cm - 9 "

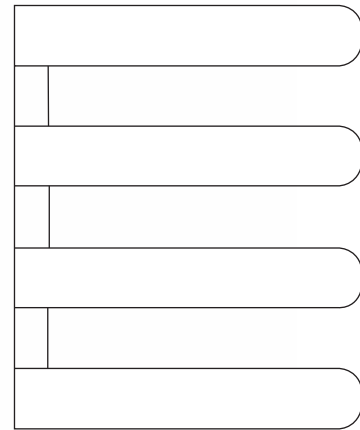

**B802679**  
46 x 55 mm

Manche vertical  
Vertical handle  
Mango vertical

OLLIER

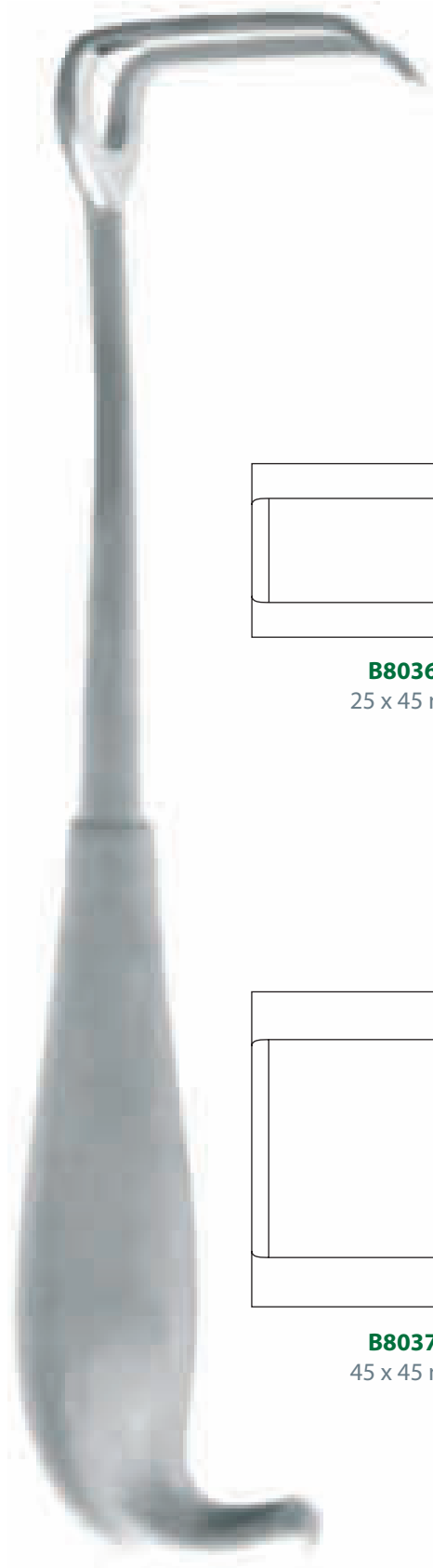

**B80360**  
22 cm - 8 <sup>3</sup>/<sub>4</sub> "

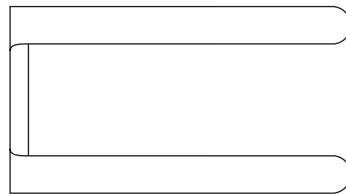

**B80360**  
25 x 45 mm

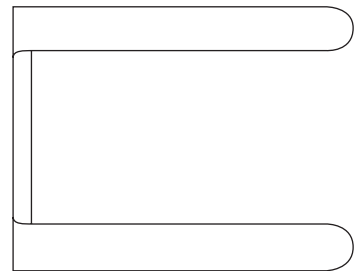

**B80365**  
35 x 45 mm

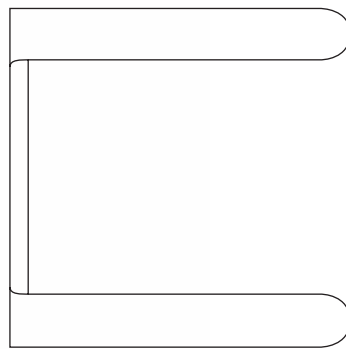

**B80370**  
45 x 45 mm

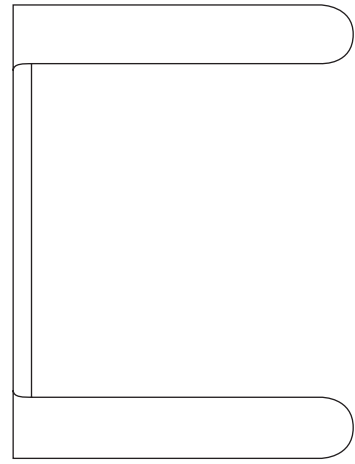

**B80375**  
60 x 45 mm

### FARABEUF

Jeu de 2 - Set of 2 - Juego de 2

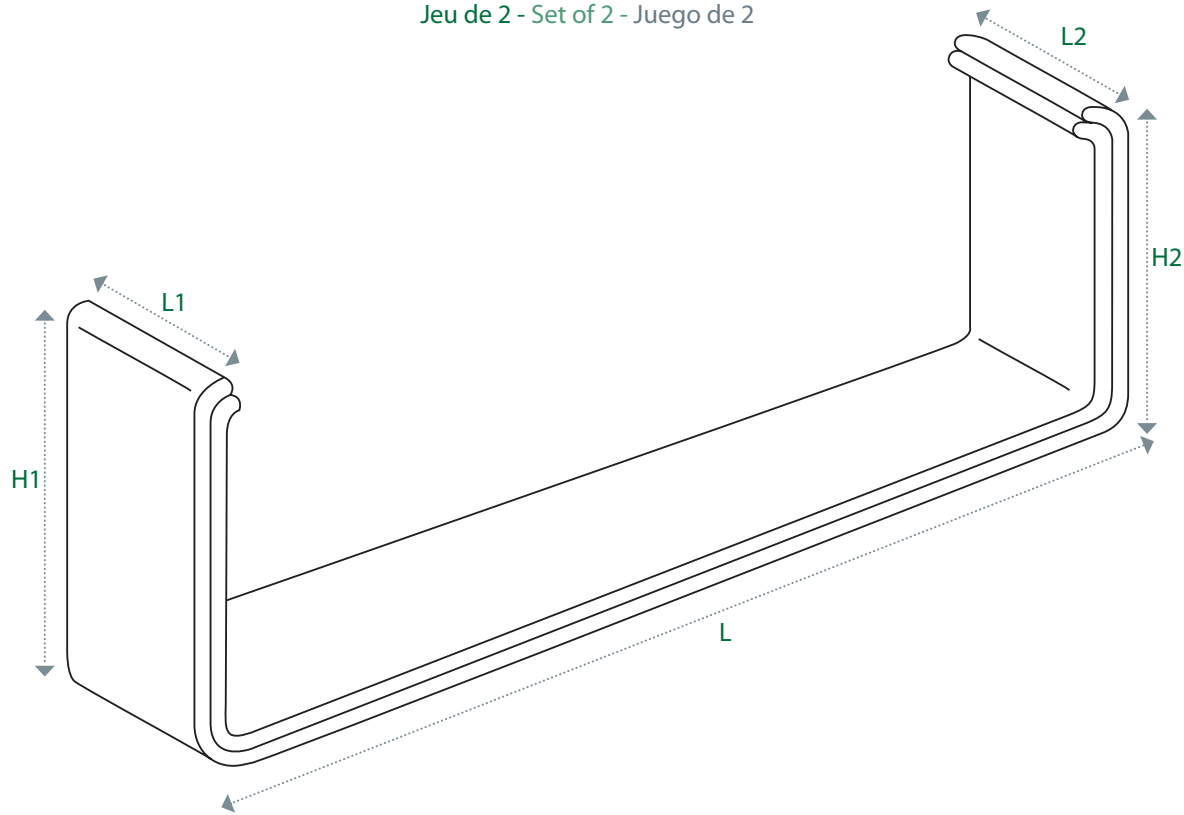

	L1 x H1 (mm)	L (mm)	L2 x H2 (mm)
<b>B80117</b>	8 x 18	100	10 x 20
<b>B80120</b>	7 x 20	120	9 x 25
<b>B80125</b>	10 x 20		14 x 25
<b>B801255</b>	15 x 30	130	15 x 40
 <b>B80130</b>	13 x 25	150	16 x 35
<b>B80135</b>	15 x 25		21 x 35
<b>B801351</b>	15 x 30		15 x 40
<b>B801352</b>	15 x 30		15 x 50
<b>B801353</b>	15 x 30		15 x 60
<b>B801354</b>	15 x 40		15 x 60
<b>B801356</b>	20 x 40		175
<b>B801358</b>		200	20 x 50
<b>B801359</b>			20 x 60

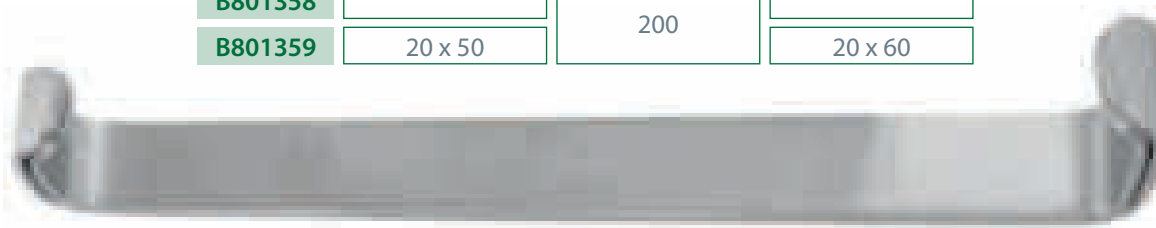

**B80130**  
15 cm - 6"

### FARABEUF

**Fabrication spéciale - Écarteur de FARABEUF (paire)**  
**Special manufacture - FARABEUF retractor (pair)**  
**Fabricación especial - Separador de FARABEUF (par)**

**Établissement :**  
**Establishment**  
**Establecimiento**

**Rédigé par :**  
**Written by**  
**Escrito por**

**Date :**  
**Date**  
**Fecha**

**Visa :**  
**Visa**  
**Visa**

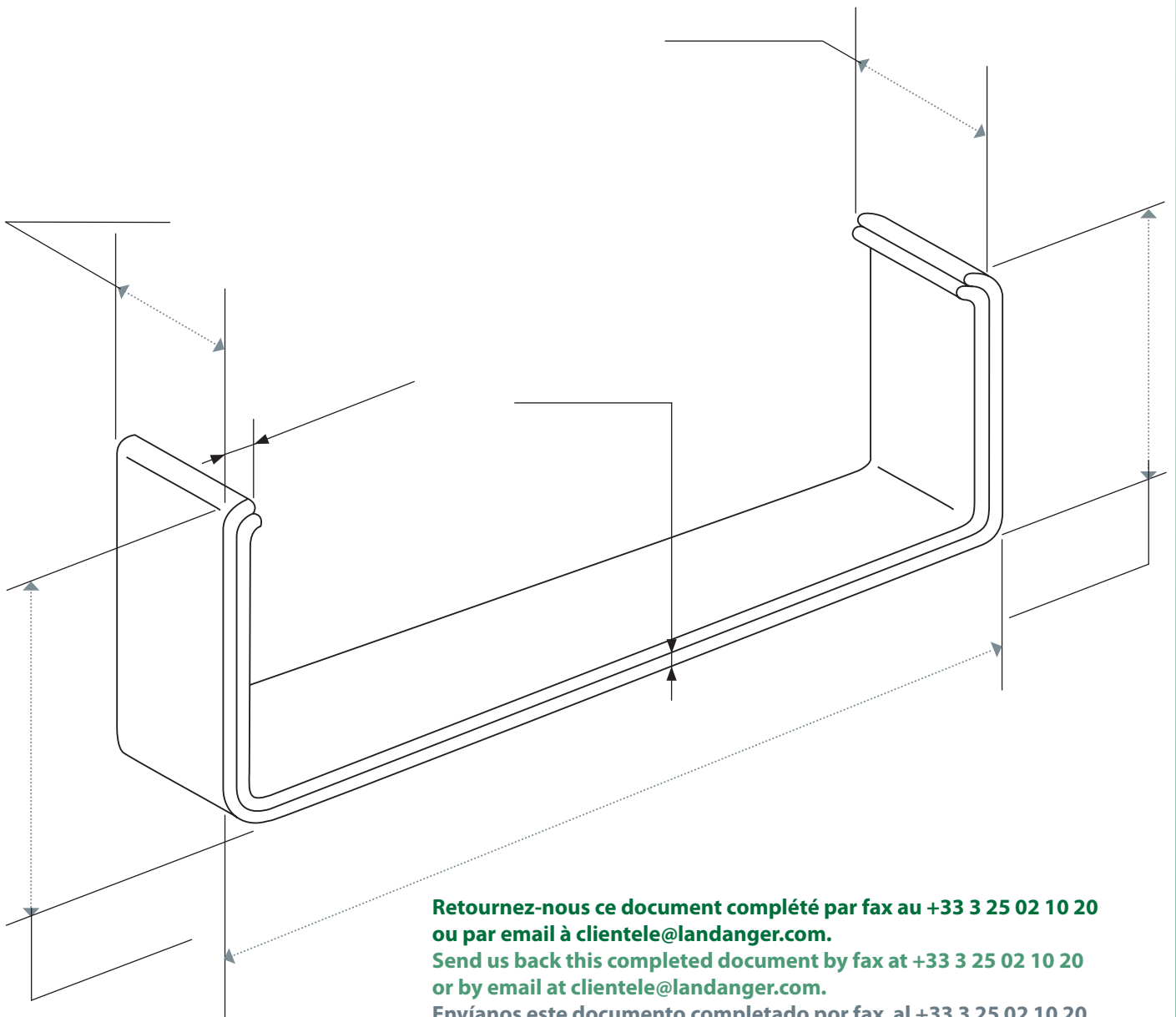

**Retournez-nous ce document complété par fax au +33 3 25 02 10 20  
 ou par email à [clientele@landanger.com](mailto:clientele@landanger.com).**

**Send us back this completed document by fax at +33 3 25 02 10 20  
 or by email at [clientele@landanger.com](mailto:clientele@landanger.com).**

**Envíanos este documento completado por fax al +33 3 25 02 10 20  
 o por correo a [clientele@landanger.com](mailto:clientele@landanger.com)**

### FARABEU-FORTI

Jeu de 2  
Set of 2  
Juego de 2

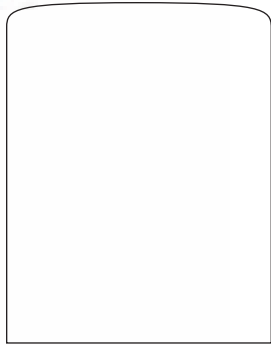
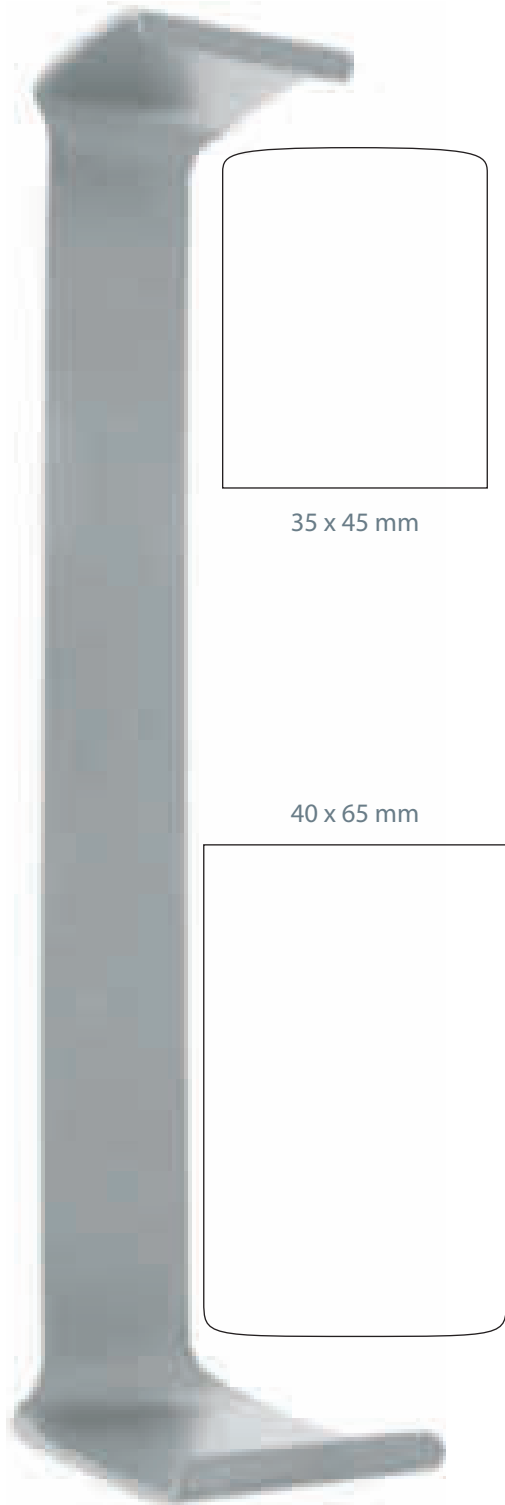

35 x 45 mm

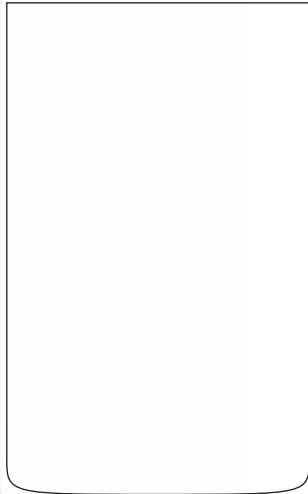

40 x 65 mm

**B80136**  
20 cm - 8 "

### CRILE



6 x 20 mm



4 x 12 mm

**B801363**  
11 cm - 4 1/4 "

### LUER

7 x 15 mm



7 x 11 mm

**B80137**  
11 cm - 4 1/4 "

### OPEN COELIO



12 mm

12 mm

**B801422**  
20 cm - 8 "



### ROUX

### BABY-ROUX

### COLLIN

### GOELET

À l'unité  
Per unit  
La unidad

14 cm - 5 1/2 "

**B801451 n°1**



15 cm - 6 "

**B801452 n°2**

17 cm - 6 3/4 "

**B801453 n°3**

Jeu de 3  
Set of 3  
Juego de 3

17 x 15 mm

Jeu de 2  
Set of 2  
Juego de 2  
15 x 35 mm

37 x 40 mm

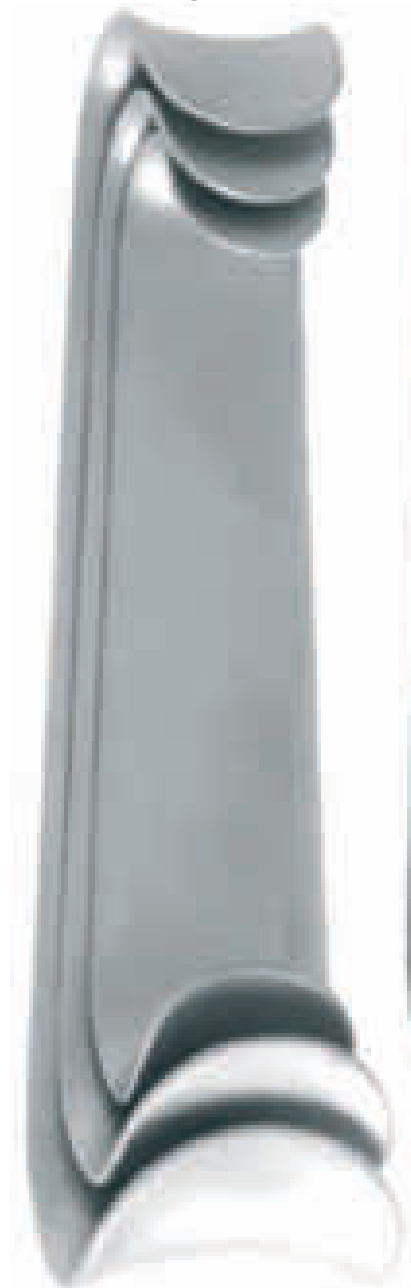

**B80145**  
170 mm - 6 3/4"

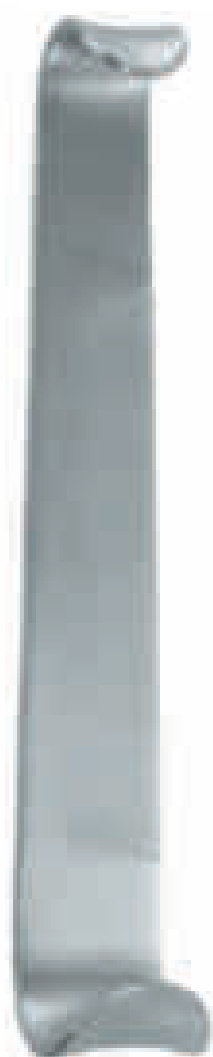

20 x 22 mm  
**B801455**  
13,5 cm - 5 1/4 "



17 x 35 mm  
**B801456**  
16,5 cm - 6 1/2 "

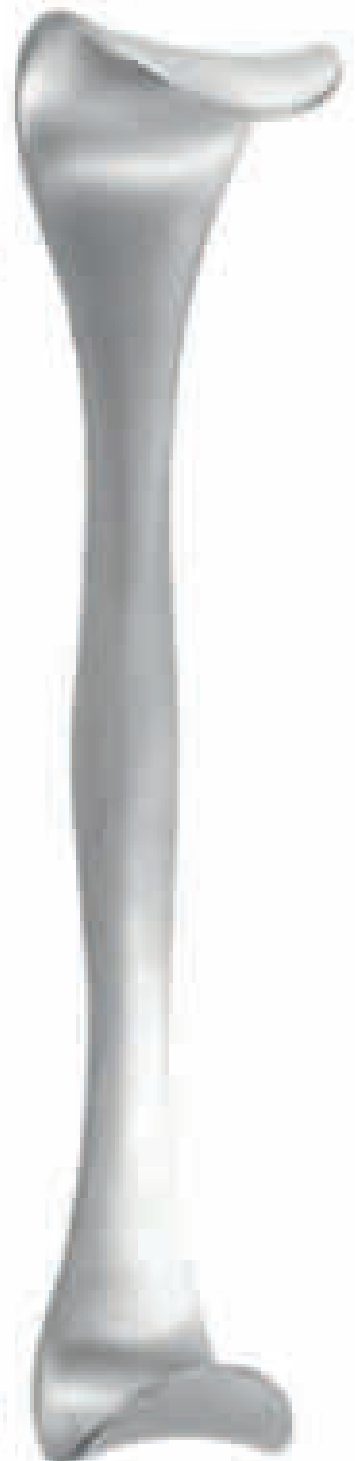

30 x 31 mm  
**B801457**  
19 cm - 7 1/2 "

### PARKER LANGENBECK (US ARMY)

Jeu de 2  
Set of 2  
Juego de 2

30 x 16 mm



45 x 16 mm  
**B801480**  
21 cm - 8 1/4 "



### PARKER

Jeu de 2  
Set of 2  
Juego de 2

15 x 27 mm

27 x 15 mm

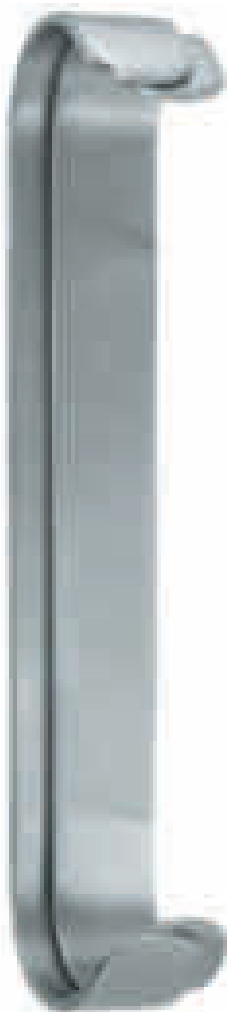

27 x 15 mm  
**B801458**  
13,5 cm - 5 1/2 "

### MATHIEU

50 x 13 mm

Jeu de 2  
Set of 2  
Juego de 2



50 x 26 mm  
**B801460**  
20 cm - 8 "

15 x 27 mm  
**B801459**  
18 cm - 7 "



### CANNY-RYALL

**B801483**

16 mm  
19 cm - 7 1/2 "

 **B801484**

20 mm  
19 cm - 7 1/2 "

**B801485**

25 mm  
20 cm - 8 "

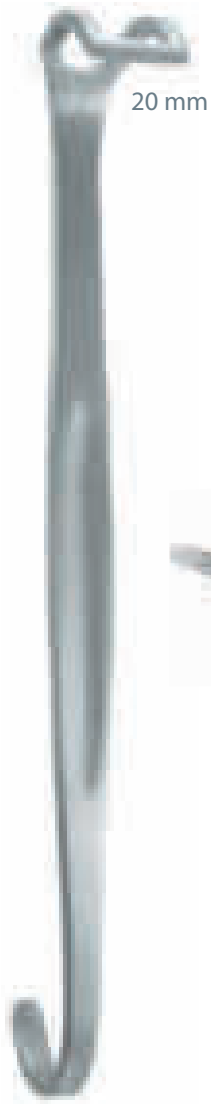

**B801484**  
19 cm - 7 1/2 "

### HARTMANN

Jeu de 2  
Set of 2  
Juego de 2

37 x 32 mm



48 x 35 mm  
**B80140**  
16 cm - 6 1/4 "

### PARKER-MOTT

Jeu de 2  
Set of 2  
Juego de 2

65 x 24 mm

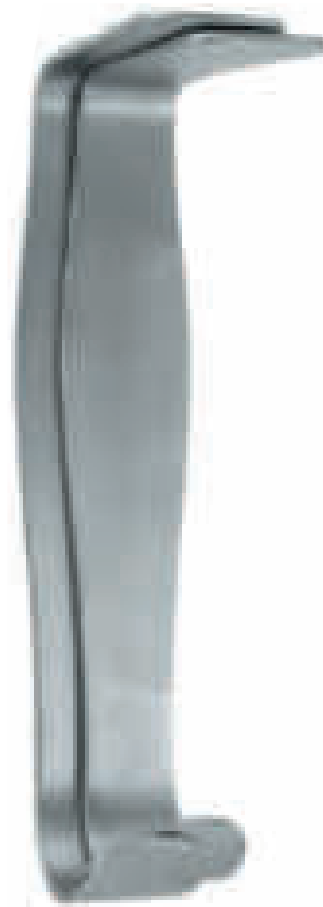

30 x 24 mm  
**B801486**  
14,5 cm - 5 3/4 "

### CRAWFORD

**B801488** 

15 x 23 mm

**B801487**

15 x 15 mm

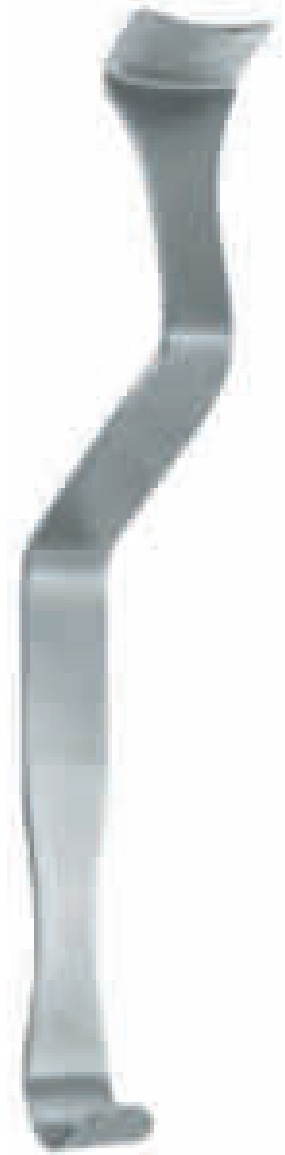
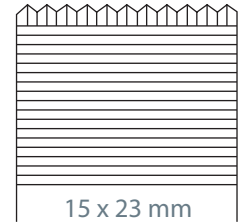

15 x 23 mm  
**B801488**  
19 cm - 7 1/2 "

### HIBBS



**B801364** 

75 x 25 mm

**B801365**

80 x 25 mm

**B801364**  
24 cm - 9 1/2"

### HEANEY



**B801366**

45 x 25 mm

**B801367** 

73 x 28 mm

**B801368**

82 x 28 mm

**B801367**  
27 cm - 10 3/4"

### CHARRIER

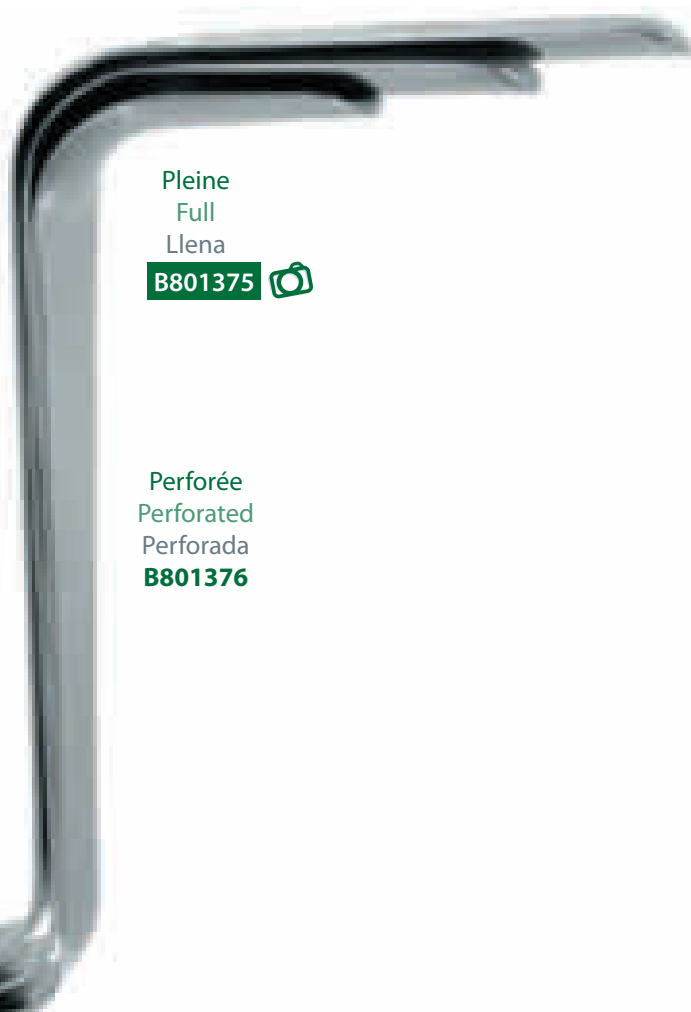

Jeu de 3  
Set of 3  
Juego de 3

60 - 90 - 100 mm

Pleine  
Full  
Llena

**B801375** 

Perforée  
Perforated  
Perforada  
**B801376**

**B801375**  
20 cm - 8"

### LARDENOIS

- 27 cm - 10 1/2" **B80380** 25 x 45 mm
- 27 cm - 10 1/2"  **B80382** 25 x 65 mm
- 36 cm - 10 1/2" **B80385** 25 x 40 mm



65 mm  
**B80382**  
27 cm - 10 1/2"

### TUFFIER

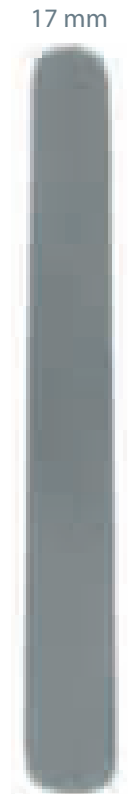

25 mm  
**B803790**  
20 cm - 8"



50 x 150 mm  
**B803890**  
40 cm - 15 3/4"

### HABERER

- 28 cm - 11" **B803830** 25 x 30 mm
- 30 cm - 11 3/4"  **B803831** 37 x 45 mm
- 30 cm - 11 3/4" **B803832** 40 x 50 mm

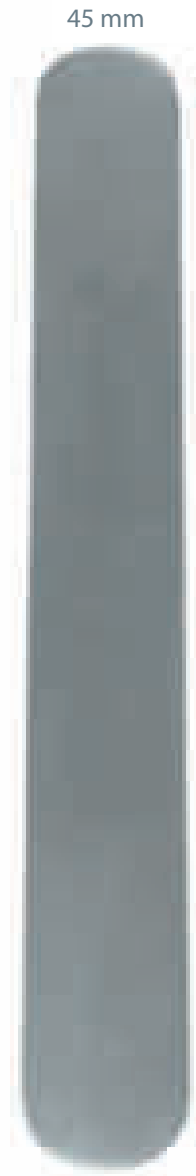

37 mm  
**B803831**  
30 cm - 11 3/4"

### LARDENOIS

### REVERDIN

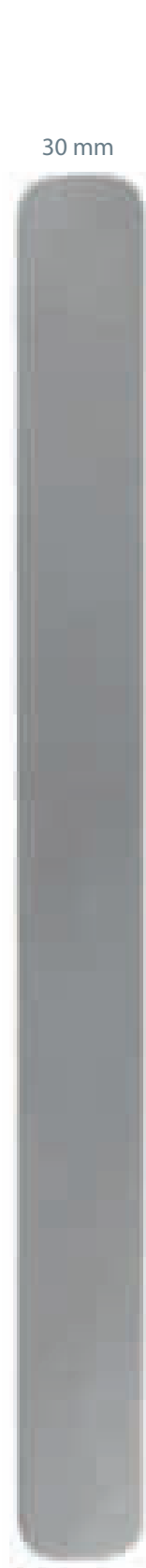

**B803932**  
33 cm - 13 "

- |              |  |
|--------------|--|
| 20 cm - 8 "  |  |
| 6 mm         | <b>B803910</b>   |
| 8 mm         | <b>B803911</b>   |
| 10 mm        | <b>B803912</b>   |
| 12 mm        | <b>B803913</b>   |
| 17 mm        | <b>B803914</b>   |
| 20 mm        | <b>B80386</b>  |
| 25 mm        | <b>B803915</b>   |
| 25 cm - 10 " |  |
| 25 mm        | <b>B803920</b>   |
| 30 mm        | <b>B80388</b>  |
| 33 cm - 13 " |  |
| 20 mm        | <b>B803930</b>   |
| 25 mm        | <b>B803931</b>   |
| 30 mm        | <b>B803932</b>  |
| 35 mm        | <b>B803933</b>   |
| 40 mm        | <b>B803934</b>   |
| 45 mm        | <b>B803935</b>   |
| 50 mm        | <b>B803936</b>   |
| 64 mm        | <b>B803937</b>   |
| 76 mm        | <b>B803938</b>   |
| 102 mm       | <b>B803939</b>   |

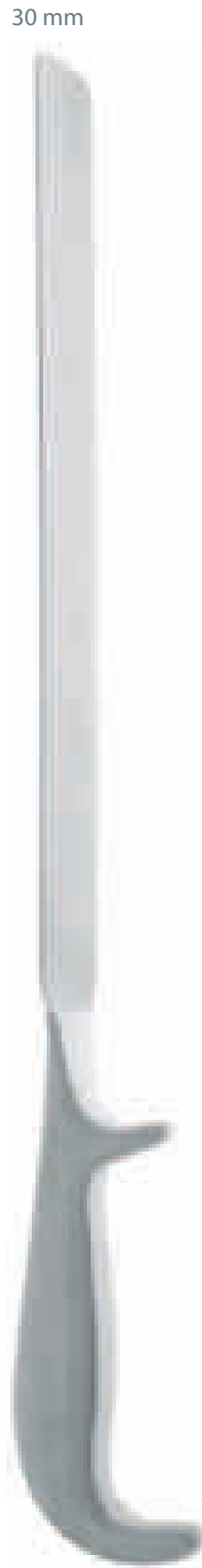

**B80390**  
36 cm - 14 1/4 "



**B803905**  
28 cm - 11 "

### ALLISON

25,5 cm - 10 "

**B804105**

30 cm - 12 "

**B804110**



**B804110**  
30 cm - 12 "

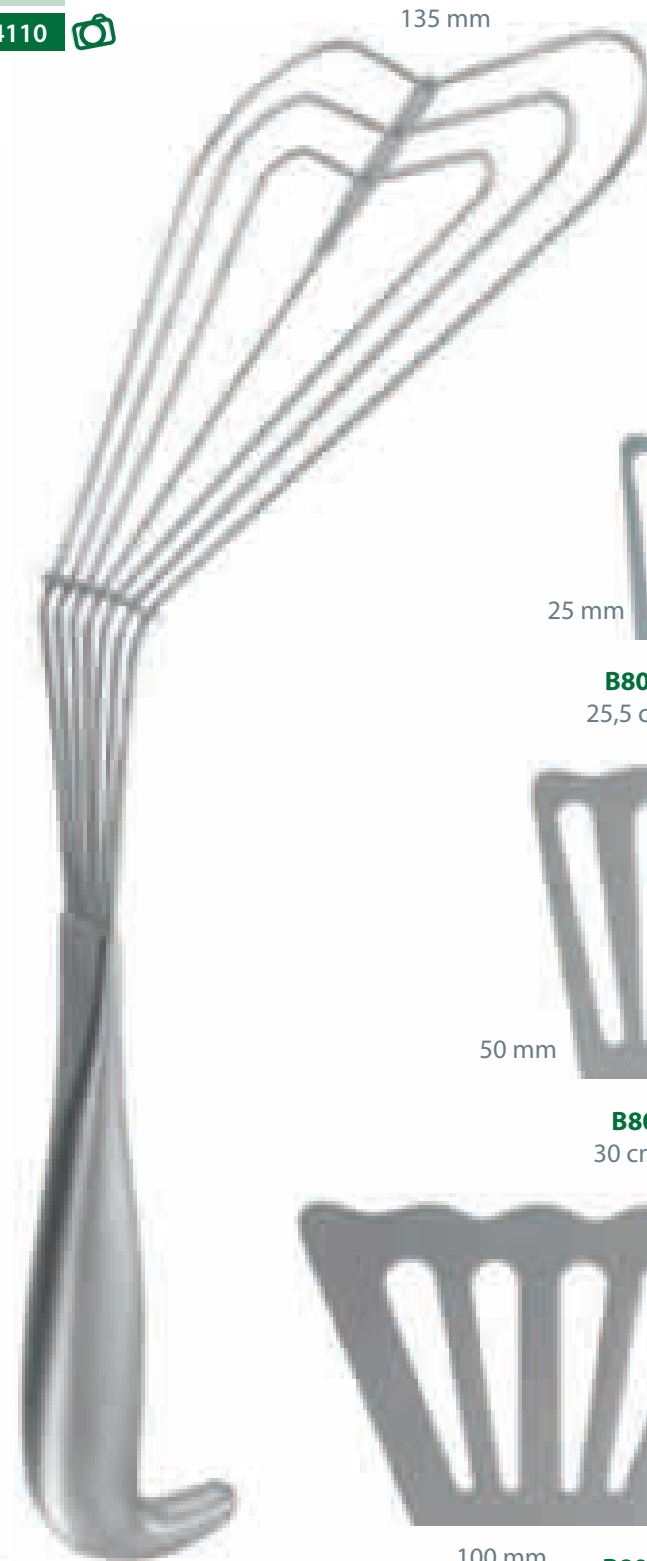

**B804120**  
30 cm - 12 "

### VALVE À POUMON BLADE FOR LUNG VALVA PARA PULMÓN

135 mm

25 mm

**B803990**

25,5 cm - 10 "

50 mm

**B80400**

30 cm - 12 "

100 mm

**B80410**

30 cm - 12 "

### CHEVRET

80 mm



**B80405**  
30 cm - 12 "

### SILICONE SURMOULÉE SILICON COATED SILICONE MOLDEADAS

Valves souples  
Flexible blades  
Válvulas ligeras

Avec 2 points d'accrochage - With 2 anchors - Con 2 puntos de enganche

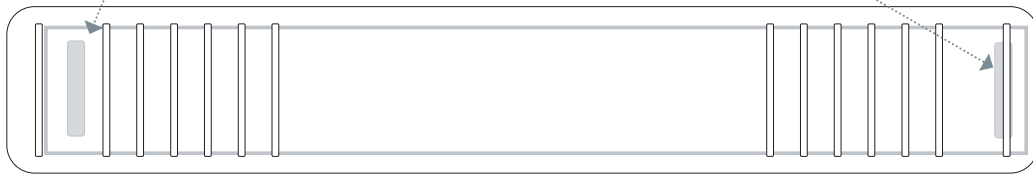

**B803940** 

50 mm  
30 cm - 11 <sup>3</sup>/<sub>4</sub> "

Avec 4 points d'accrochage - With 4 anchors - Con 4 puntos de enganche

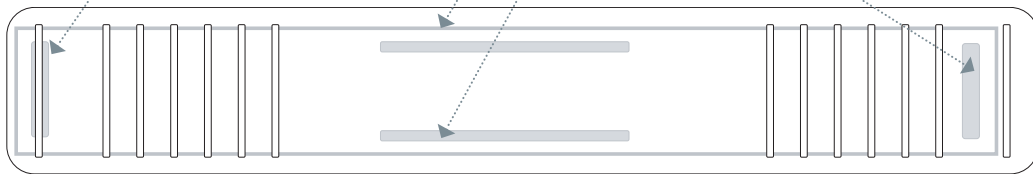

**B803941**

50 mm  
30 cm - 11 <sup>3</sup>/<sub>4</sub> "

Valve ferme  
Firm blade  
Válvula rigida

Sans point d'accrochage - Without any anchor - Sin puntos de enganche



**B803942**

50 mm  
30 cm - 11 <sup>3</sup>/<sub>4</sub> "





### KOCHER-LANGENBECK

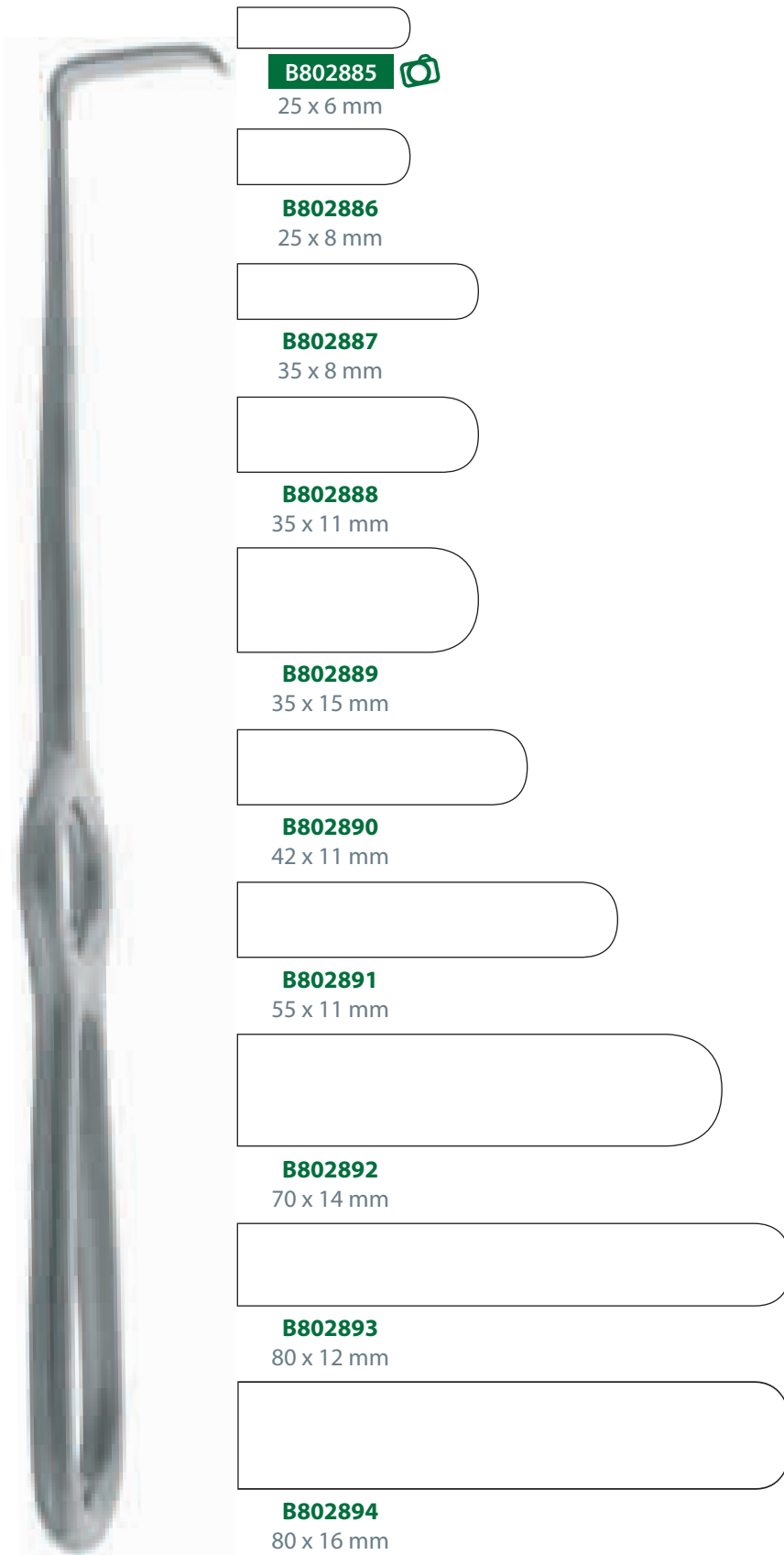

**B802885**  
21,5 cm - 8 1/2 "

### FARABEUF



**B80085**  
22 cm - 8 3/4 "

### KOCHER



**B80275** 

40 x 18 mm

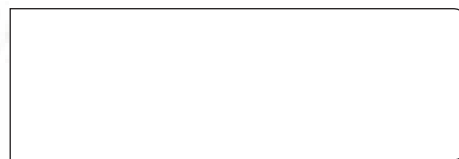

**B802755**

60 x 20 mm

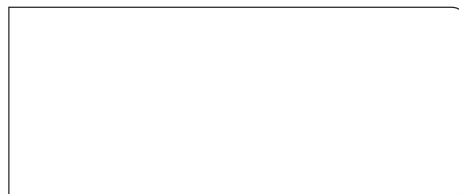

**B80276**

60 x 25 mm



**B802765**

75 x 30 mm



**B80277**

80 x 40 mm



**B802770**  
70 x 25 mm

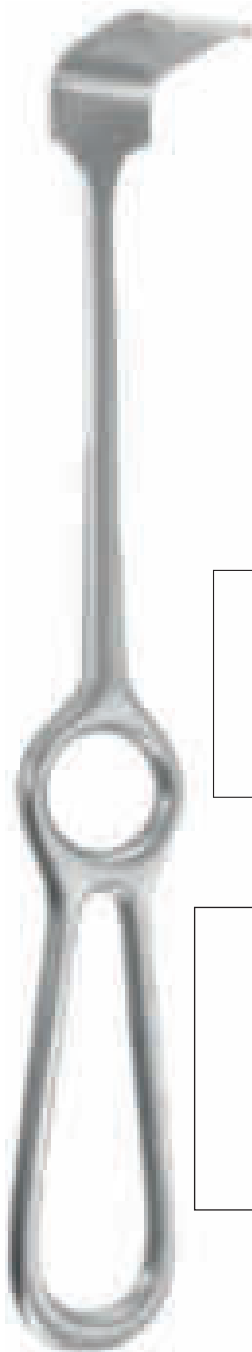

**B80275**  
22 cm - 8 <sup>3</sup>/<sub>4</sub> "

**B802770**  
22,5 cm - 8 <sup>4</sup>/<sub>5</sub> "

### LANGENBECK



85 x 15 mm



Manche vertical  
Vertical handle  
Mango vertical

**B80286**

21,5 cm - 8 1/2"

**B80285**

21 cm - 8 1/4"



**B80278**

30 x 10 mm

**B802785** 

30 x 10 mm



**B80279**

30 x 14 mm

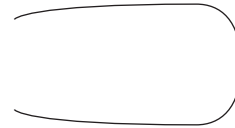

**B80280**

30 x 16 mm

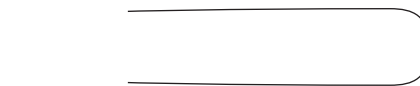

**B80281**

40 x 10 mm

**B802815**

40 x 10 mm



**B80282**

43 x 13 mm

**B802825**

43 x 13 mm



**B802826**

50 x 11 mm

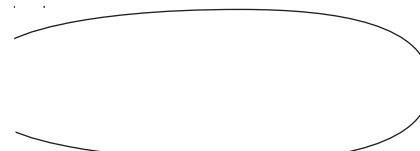

**B80283**

55 x 20 mm



**B80285** 

63 x 20 mm



**B802785**

22 cm - 8 3/4"

### BRUNNER



**B802777**

80 x 20 mm

**B802771**

100 x 25 mm

**B802778**

120 x 25 mm

**B802779**

130 x 30 mm

**B802772**

140 x 30 mm

**B802774** 

160 x 30 mm

**B802776**

180 x 30 mm

**B802774**

25 cm - 10 "



**B812770**

80 x 20 mm

**B812771**

100 x 20 mm

**B812772** 

120 x 25 mm

**B812773**

140 x 25 mm

**B812774**

160 x 30 mm

**B812775**

180 x 30 mm

**B812772**

25 cm - 10 "

### KOCHER - WAGNER

### HÖSEL

### CASPAR



**B802743**  
67 x 25 mm

**B802744**  
100 x 35 mm

**B802741**  
22 x 15 mm

**B802740**  
38 x 20 mm

**B802747**  
80 x 30 mm

**B802749**  
100 x 30 mm

**B802745**  
120 x 30 mm

**B802746**   
140 x 30 mm

**B802748**  
140 x 40 mm

67 x 17 mm

**B802743**  
28 cm - 11 "

**B802740**  
28 cm - 11 "

**B802746**  
25 cm - 10 "

**B812800**  
21,5 cm - 8 1/2 "

### KOCHER

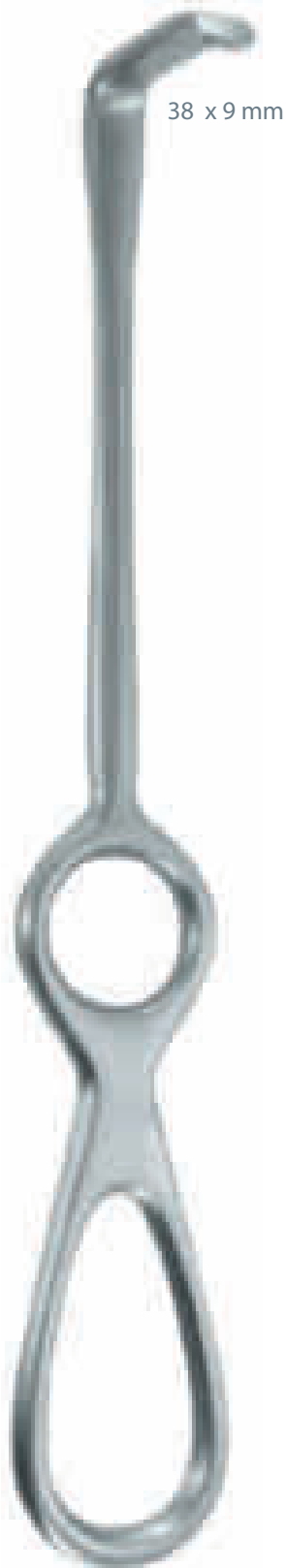

**B802861**  
21 cm - 8 1/4"



**B812810**  
19 cm - 7 1/2"



**B812820**  
22 cm - 8 3/4"



### ZENKER

### KÜMMEL

### KÖRTE



**B812830**  
35 x 8 mm  
25 cm - 10"

**B812831**  
60 x 12 mm  
26 cm - 10 1/4"

**B812832**   
75 x 12 mm  
27,5 cm - 10 3/4"

**B812833**  
120 x 12 mm  
29 cm - 12 1/2"

46 mm

120 x 46 mm

Rigide  
Rigid  
Rigido

**B812832**  
27,5 cm - 10 3/4"

**B812840**  
33 cm - 13"

**B812845**  
28 cm - 11"

### KOCHER

80 x 45 mm

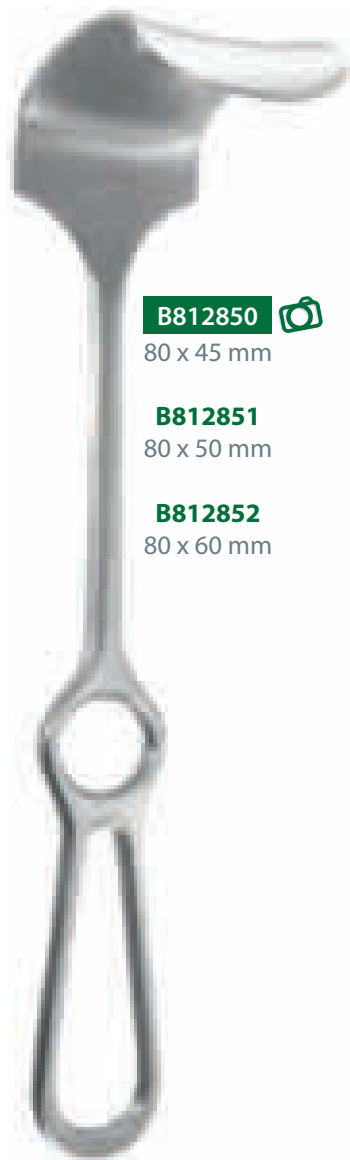

**B812850** 

80 x 45 mm

**B812851**

80 x 50 mm

**B812852**

80 x 60 mm

**B812850**  
25 cm - 10"

### TUFFIER

64 x 60 mm



**B812860**  
23 cm - 9"

### MEYERDING

52 x 16 mm

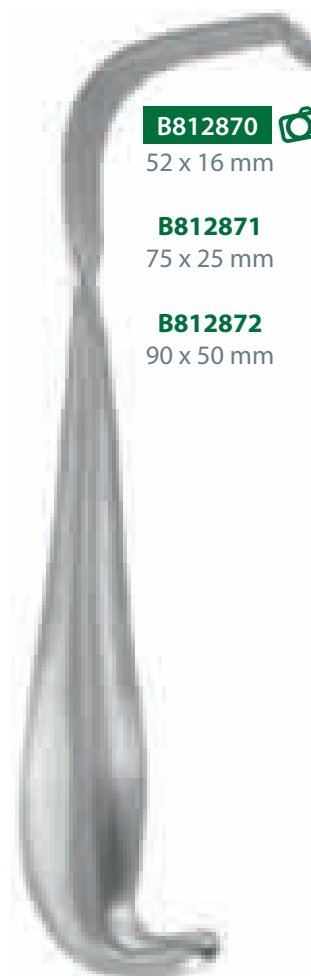

**B812870** 

52 x 16 mm

**B812871**

75 x 25 mm

**B812872**

90 x 50 mm

**B812870**  
23 cm - 9"



### RICHARDSON-EASTMAN

### RICHARDSON

### KELLY



Valves seules  
Blades only  
Valvas so las

**B801474**  
26 cm - 10 "

**B801476**  
28 cm - 11 "

Jeu de 2  
Set of 2  
Juego de 2

**B801478**   
28 cm - 11 "



**B801478**  
28 cm - 11 "



**B801462**  
28 x 20 mm

**B801464**   
30 x 28 mm

**B801466**  
38 x 37 mm

**B801468**  
52 x 22 mm

**B801464**  
24 cm - 9 1/2 "



**B801470**   
40 x 50 mm

**B801471**  
50 x 65 mm

**B801472**  
65 x 75 mm

**B801473**  
75 x 90 mm

**B801470**  
26 cm - 10 1/4 "

### SIMON

### MARTIN

### SAUERBRUCH

**B802715** 

115 x 22 mm

**B802716**

115 x 27 mm

**Model Tübingen**

**B802714**

95 x 20 mm

**B802717**

105 x 27 m

**B802896**

45 x 15 mm

**B802897** 

60 x 23 mm

**B802898**

72 x 20 mm

**B802715**

28 cm - 11 "

**B802717**

26 cm - 10 <sup>1</sup>/<sub>4</sub> "

**B802897**

22,5 cm - 8 <sup>3</sup>/<sub>4</sub> "



MORRIS



**B802919**

70 x 40 mm

**B802920**

70 x 50 mm

**B802921** 

70 x 65 mm

**B802921**

21 cm - 8 1/4"



**B802934** 

38 x 50 mm

32 x 50 mm

**B802935**

50 x 50 mm

45 x 50 mm

**B802936**

65 x 50 mm

38 x 50 mm

**B802934**

24 cm - 9 1/2"

SAUERBRUCH

CORYLLOS

130 x 38 mm



**B802940**  
26 cm - 10 1/4 "

**B802939**  
23 cm - 9 "

115 x 67 mm



**B802938**

115 x 42 mm



**B802937**

82 x 22 mm



MIKULICZ

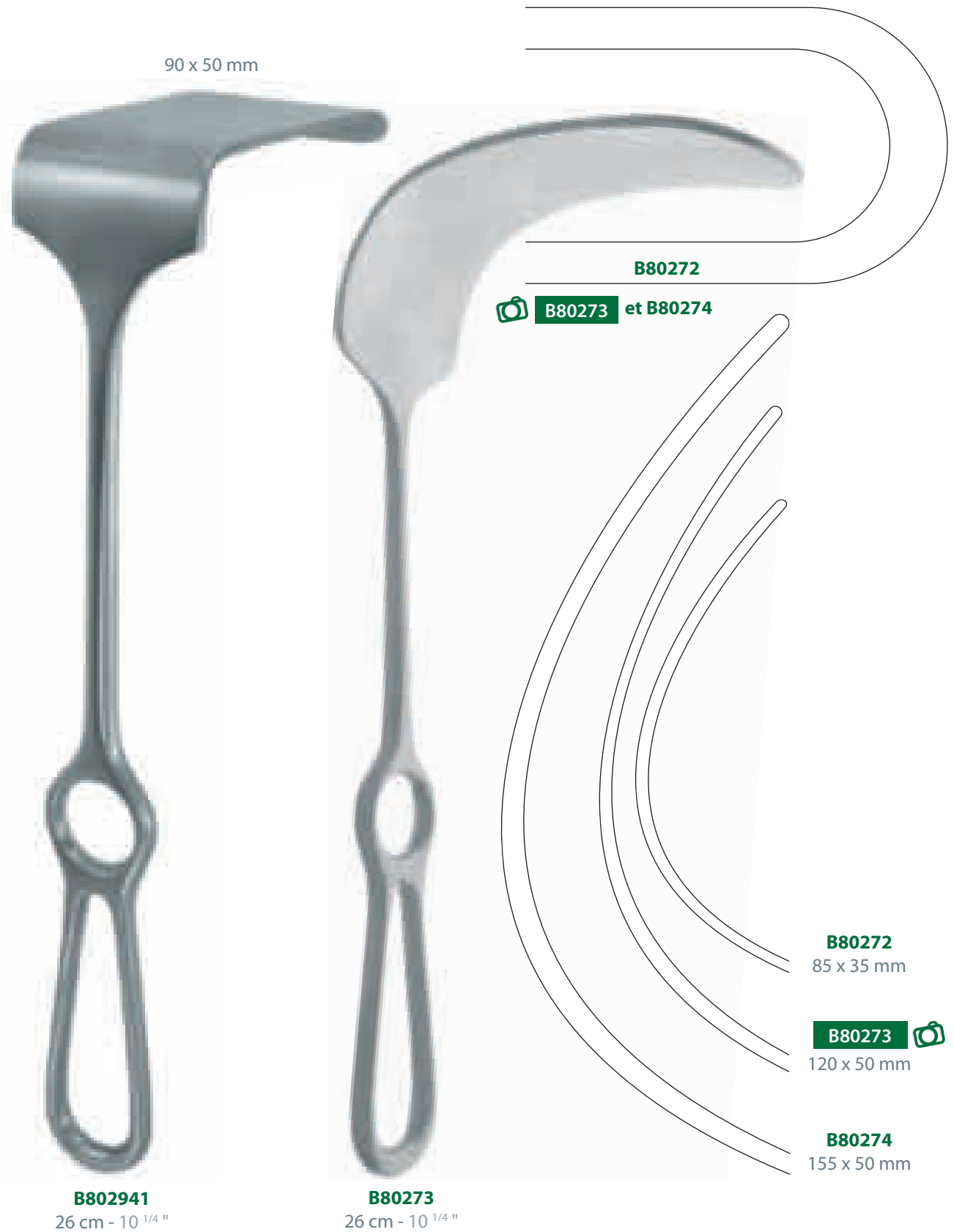

### KELLY

### SEGOND

140 x 35 mm



### KADER

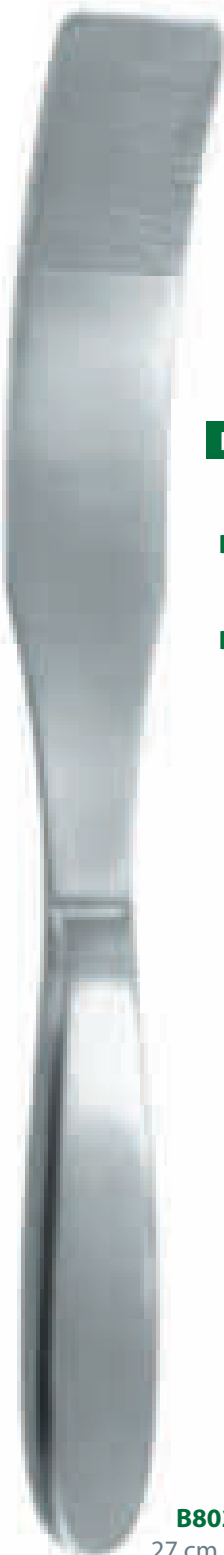

**B802711**

160 x 38 mm

**B802712**

160 x 57 mm

**B802719** 

190 x 38 mm

**B802742**

190 x 57 mm

**B802942** 

20 mm

**B802943**

30 mm

**B802944**

40 mm



**B802719**

27 cm - 10 1/2 "

**B802942**

27 cm - 10 1/2 "

**B802945**

31 cm - 12 1/4 "



### POLOSSON



Ajourée  
Open work  
Con ventana

Pleine  
Full  
Llana

**B804150**  
25 mm

 **B80422**  
45 mm

**B80420**  
45 mm

**B80427**  
60 mm

Ajourée  
Open work  
Con ventana

 **B80425**  
60 mm

Pleine  
Full  
Llana

**B80425**  
29 cm - 11 1/2"

**B80422**  
26,5 cm - 10 1/2"

# LANDANGER

## Valves - Blades - Valvas

### LERICHE - BUGATTI

Largeur Très grande courbure  
Width Very long curvature  
Anchura Curva muy grande

39 cm - 15<sup>1/3</sup> "

48 mm **B804285**

### OBESE

21 cm - 8<sup>1/4</sup> "

90 mm **B804280**

### LERICHE

Largeur Petite courbure Moyenne Grande courbure  
Width Short curvature Medium Long curvature  
Anchura Curva pequeña Medio Curva grande

21 cm - 8<sup>1/4</sup> "

26 cm - 10<sup>1/4</sup> "

30 cm - 12 "

35 mm  **B80435** **B804422** **B80443**

45 mm **B80440** **B804424** **B80444**

60 mm **B80442** **B804426** **B80445**

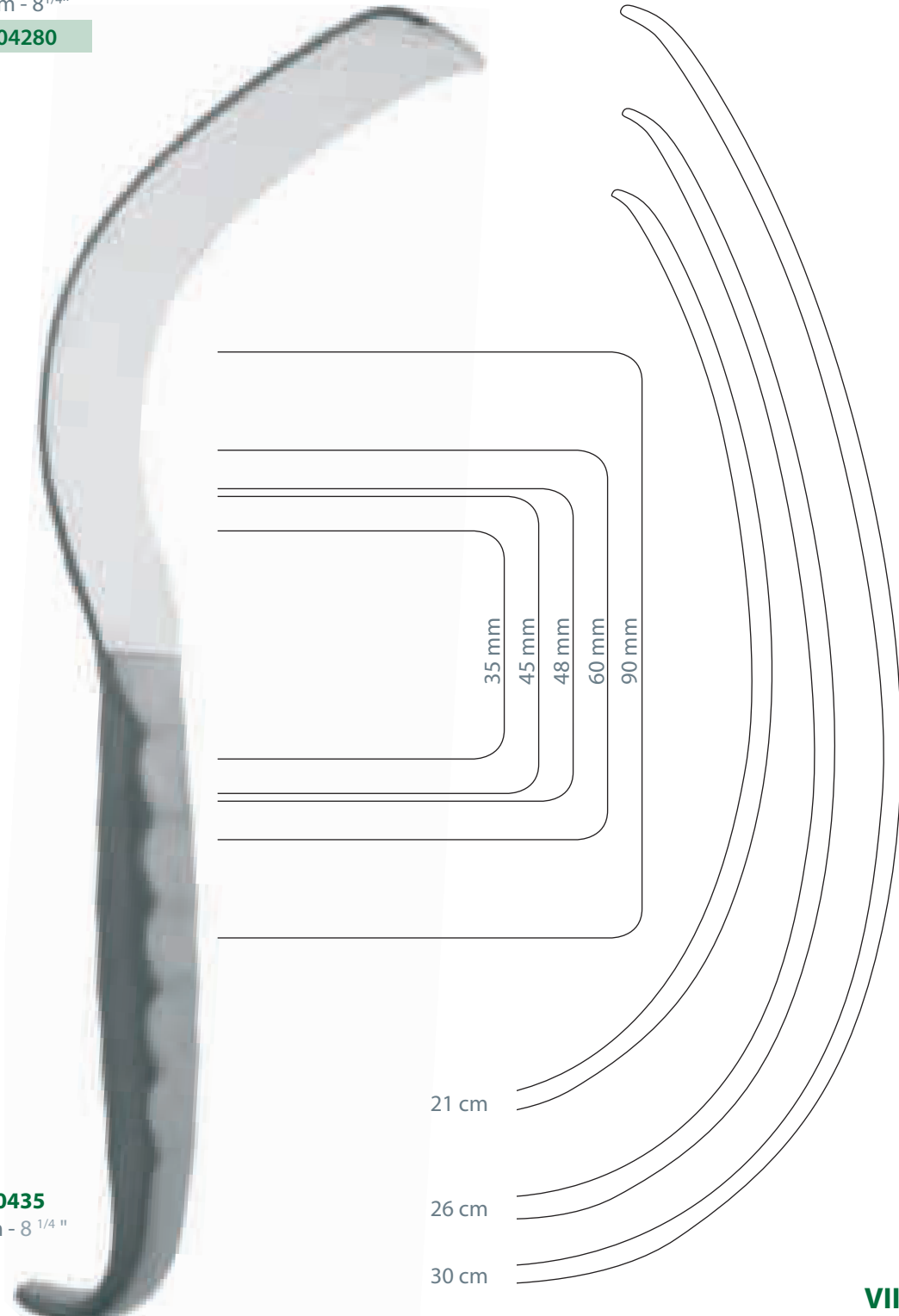

**B80435**  
21 cm - 8<sup>1/4</sup> "





### HARRINGTON



**B804310**

40 x 127 mm

**B804312**

62 x 127 mm

**BABY**

**B804308**

24 x 70 mm

27 cm - 10 1/2"

**B804310**

32 cm - 12 1/2"

### HARRINGTON-PEMBERTON



64 x 175 mm

**B804320**

32 cm - 12 1/2"

### DEAVER

	Largeur Width Anchura	Longueur Lenght Longitud
 <b>B804460</b>	19 mm	18 cm - 7 "
<b>B804461</b>	22 mm	22 cm - 8 <sup>3</sup> / <sub>4</sub> "
<b>B804462</b>	25 mm	23 cm - 9 "
<b>B804463</b>	25 mm	30 cm - 11 <sup>3</sup> / <sub>4</sub> "
<b>B804464</b>	25 mm	33 cm - 13 "
<b>B804465</b>	25 mm	36 cm - 14 <sup>1</sup> / <sub>4</sub> "
<b>B804466</b>	38 mm	30 cm - 11 <sup>3</sup> / <sub>4</sub> "
<b>B804467</b>	50 mm	30 cm - 11 <sup>3</sup> / <sub>4</sub> "
<b>B804468</b>	75 mm	30 cm - 11 <sup>3</sup> / <sub>4</sub> "



**B804460**  
18 cm - 7 "

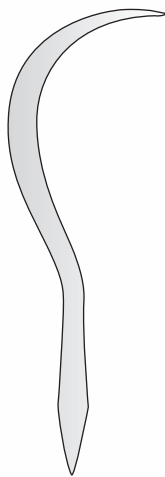

**B804460**  
18 cm - 7 "

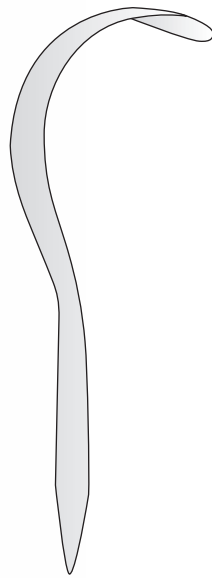

**B804461**  
22 cm - 8 <sup>3</sup>/<sub>4</sub> "

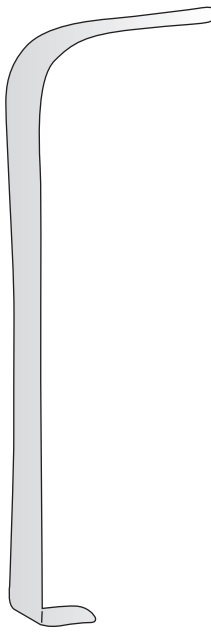

**B804462**  
23 cm - 9 "



**B804463**  
30 cm - 11 <sup>3</sup>/<sub>4</sub> "



**B804466**  
30 cm - 11 <sup>3</sup>/<sub>4</sub> "



### DEAVER

### LEGUEU



**B804470**

25 mm



**B804471**

38 mm

**B804472**

50 mm

**B804473**

75 mm

Manche grip  
Grip handle  
Mango grip

**B804471**

30 cm - 11 <sup>3</sup>/<sub>4</sub> "



35 mm

28 mm

Pour prostate  
For prostate  
Para prostate

**B804590**

27 cm - 10 <sup>1</sup>/<sub>2</sub> "

**B804600**

36 cm - 14 <sup>1</sup>/<sub>4</sub> "

### FRITSCH

### MIDDELDORPF

### DOYEN

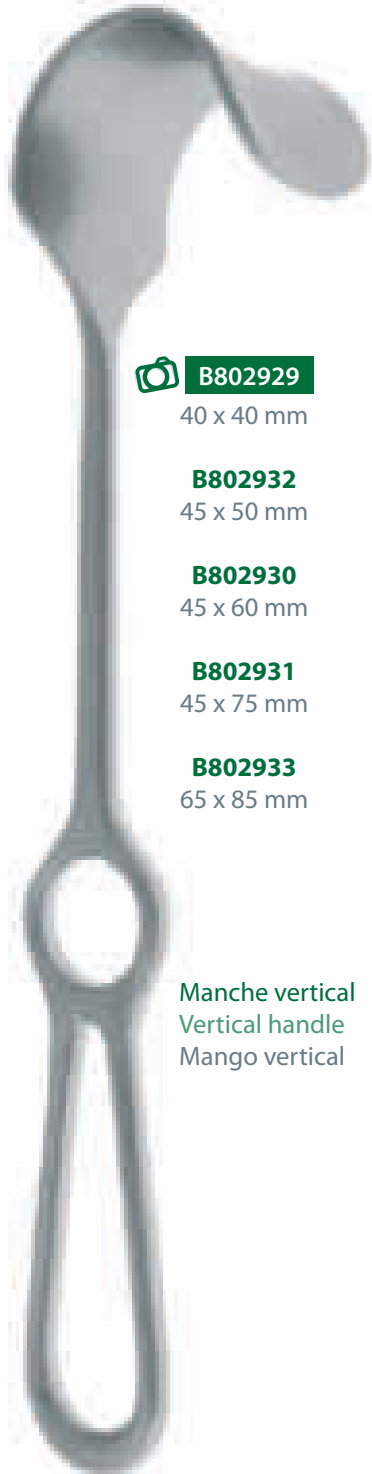

 **B802929**

40 x 40 mm

**B802932**

45 x 50 mm

**B802930**

45 x 60 mm

**B802931**

45 x 75 mm

**B802933**

65 x 85 mm

Manche vertical  
Vertical handle  
Mango vertical

**B802929**

24 cm - 9 1/2"



 **B802926**

45 x 45 mm

**B802927**

45 x 50 mm

**B802928**

55 x 70 mm

**B802926**

25,5 cm - 10"



50 x 85 mm

**B802949**

25 cm - 10"

### MIDDELDORPF

### GREEN

### CUSHING

22 x 22 mm

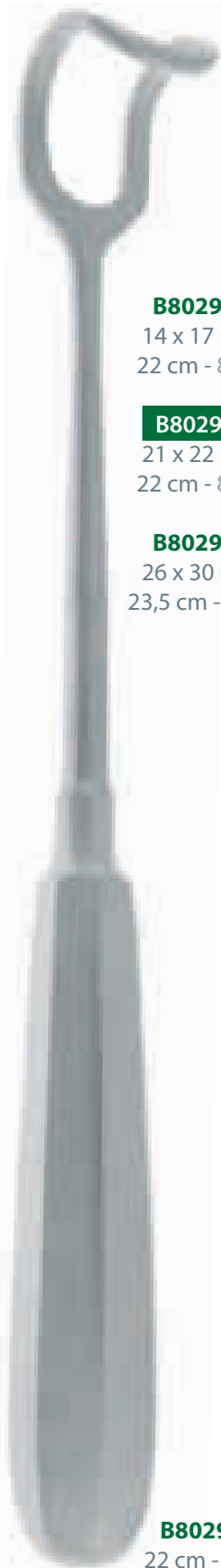

**B802917**

14 x 17 mm  
22 cm - 8 3/4"

**B802922**

21 x 22 mm  
22 cm - 8 3/4"

**B802923**

26 x 30 mm  
23,5 cm - 9 1/4"

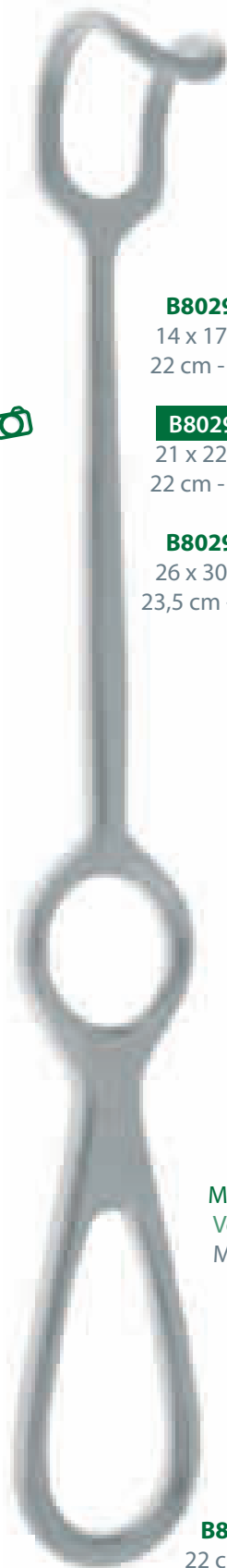

**B802918**

14 x 17 mm  
22 cm - 8 3/4"

**B802924**

21 x 22 mm  
22 cm - 8 3/4"

**B802925**

26 x 30 mm  
23,5 cm - 9 1/4"

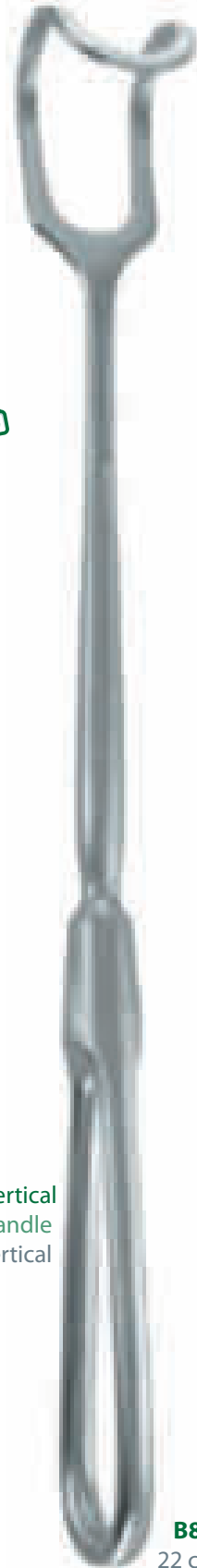

**B802946**

22 cm - 8 3/4"

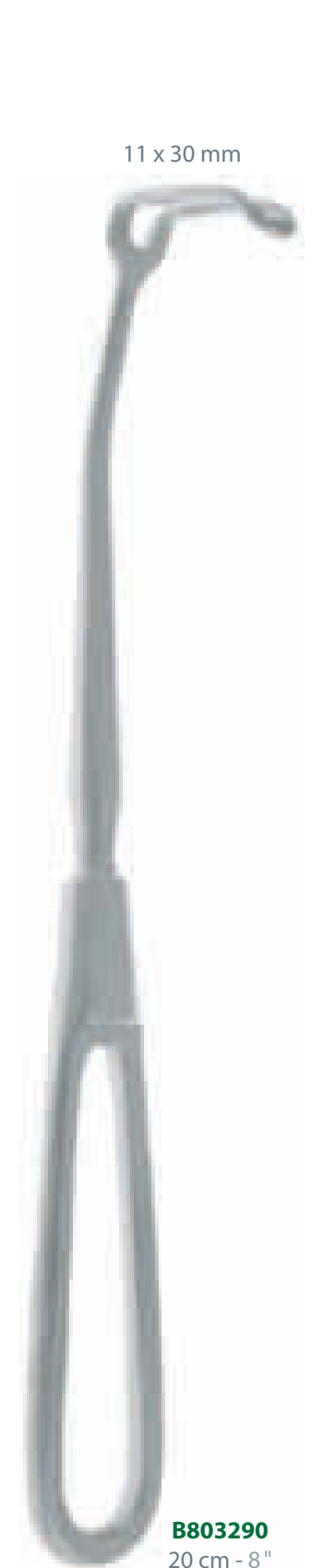

**B803290**

20 cm - 8"

11 x 30 mm

Manche vertical  
Vertical handle  
Mango vertical

### OBWEGESER

CHIRURGIE MAXILLO-FACIALE  
MAXILLOFACIAL SURGERY  
CIRUGIA MAXILO-FACIAL

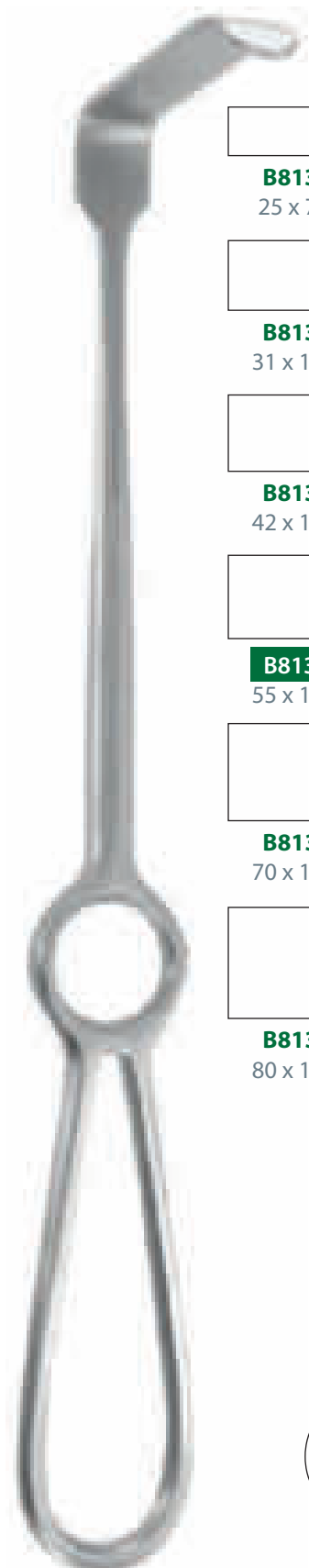

**B813000**  
25 x 7 mm



**B813001**  
31 x 10 mm

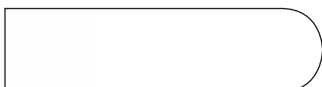

**B813002**  
42 x 11 mm



**B813003**   
55 x 12 mm



**B813004**  
70 x 14 mm



**B813005**  
80 x 16 mm



**B813012**  
42 x 13 mm



 **B813013**  
60 x 12 mm



**B813015**  
80 x 16 mm



**B813013**  
22 cm - 8 3/4 "

**B813003**  
22 cm - 8 3/4 "



### KIRSCH

### DOCKHORN

CHIRURGIE MAXILLO-FACIALE  
MAXILLOFACIAL SURGERY  
CIRUGIA MAXILO-FACIAL



 **B813020 + B813021**  
60 x 10 mm

 **B813020**  
Gauche  
Left  
Izquierda

**B813021**  
Droit  
Right  
Derecha

**B813020**  
20 cm - 8"



 **B813030**  
40 x 12 mm



**B813031**  
55 x 14 mm

**B813030**  
20 cm - 8"

### SPINA-NASALIS



44 x 9,5 mm



**B813040**

22 cm - 8 3/4 "

### RAMUS

CHIRURGIE MAXILLO-FACIALE

MAXILLOFACIAL SURGERY

CIRUGIA MAXILO-FACIAL



70 x 11,5 mm



**B813041**

22 cm - 8 3/4 "

### OBWEGESER

8 mm



**B813050**

15,5 cm - 6 "

**B813055**

17,5 cm - 7 "



TESSIER

CHIRURGIE MAXILLO-FACIALE  
MAXILLOFACIAL SURGERY  
CIRUGIA MAXILO-FACIAL

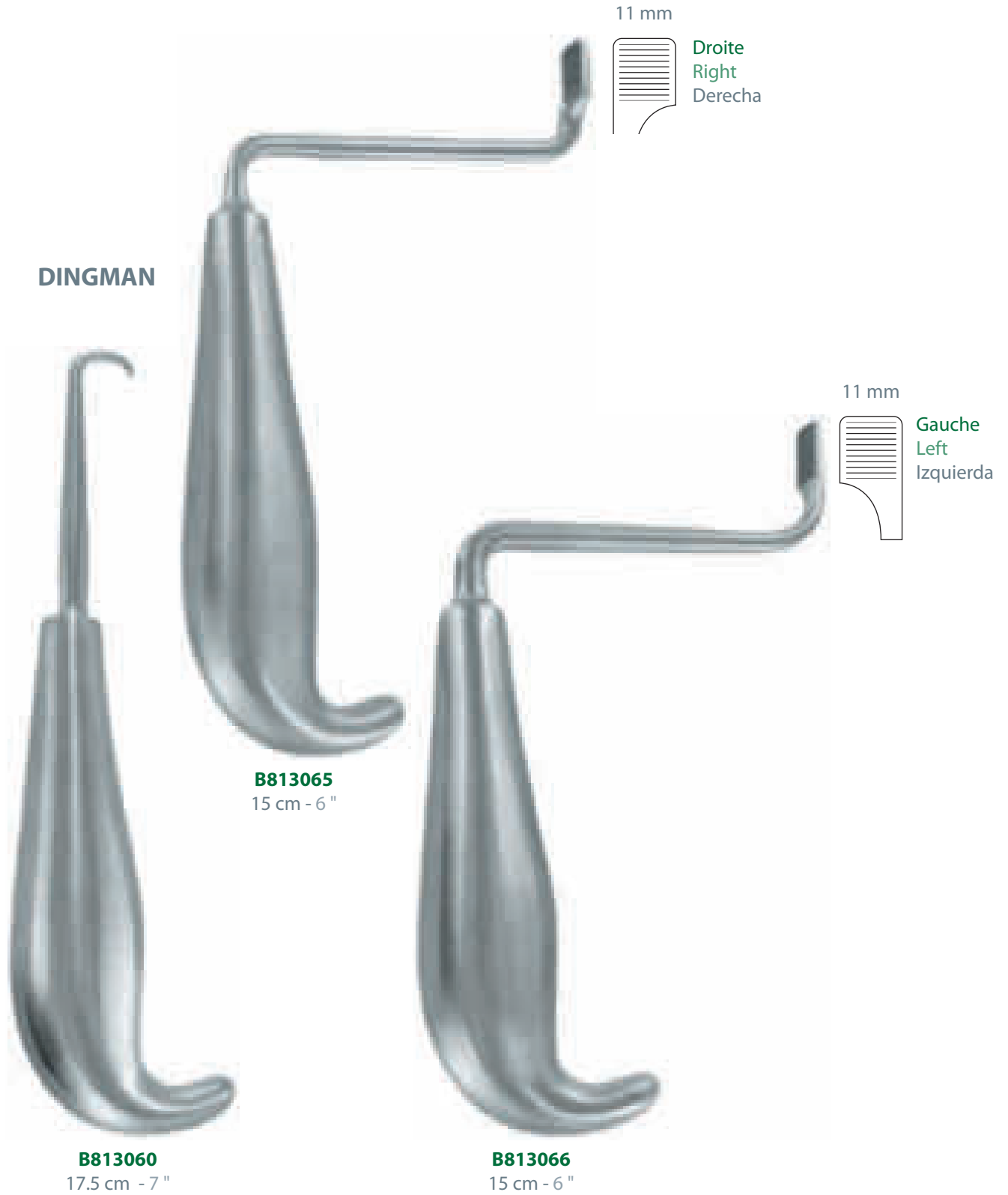

### ROCHARD

20 cm - 8 "  **B805910**

26 cm - 10 1/4 " **B805920**

Compas seul  
Compass only  
Compas sólo



**B80590**  
19 cm - 7 1/2 "

Rallonge  
Extension  
Extension



**B805910**  
20 cm - 8 "



### ROCHARD

Valve sus-pubienne  
Top pubic blade  
Valva para abajo del pubis

	P	L
 <b>B80605</b>	40 mm	80 mm
<b>B80610</b>	50 mm	100 mm
<b>B80615</b>	55 mm	120 mm
<b>B806152</b>	55 mm	135 mm
<b>B806154</b>	50 mm	155 mm

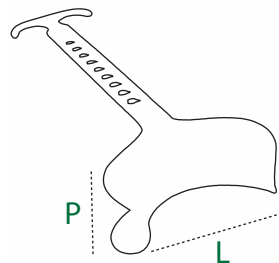

**B80605**

	P	L
 <b>B80601</b>	50 mm	100 mm

Valve radio transparente  
Radioluscent blade  
Valva radio transparente

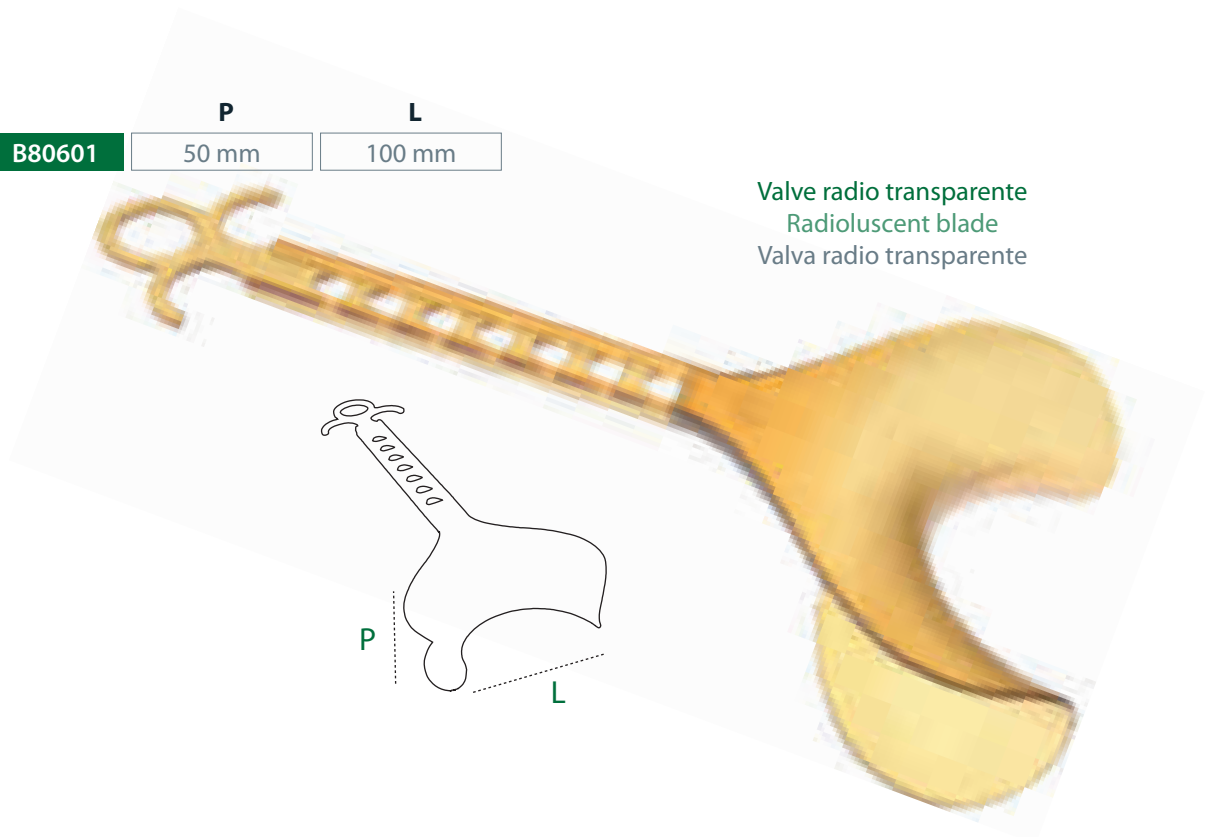
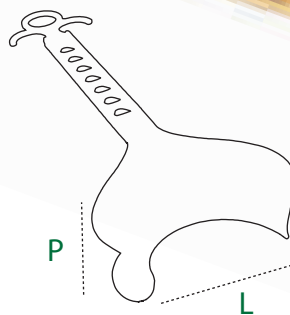

O : Ouverture - Blades opening - Abertura de las hojas  
P : Profondeur - Depth - Profundidad  
L : Largeur - Width - Anchura

### DOYEN-ROCHARD

Valve sus-pubienne  
Top pubic blade  
Valva para abajo del pubis

	P	L
 <b>B80607</b>	45 mm	80 mm
<b>B80612</b>	50 mm	100 mm
<b>B80617</b>	65 mm	120 mm

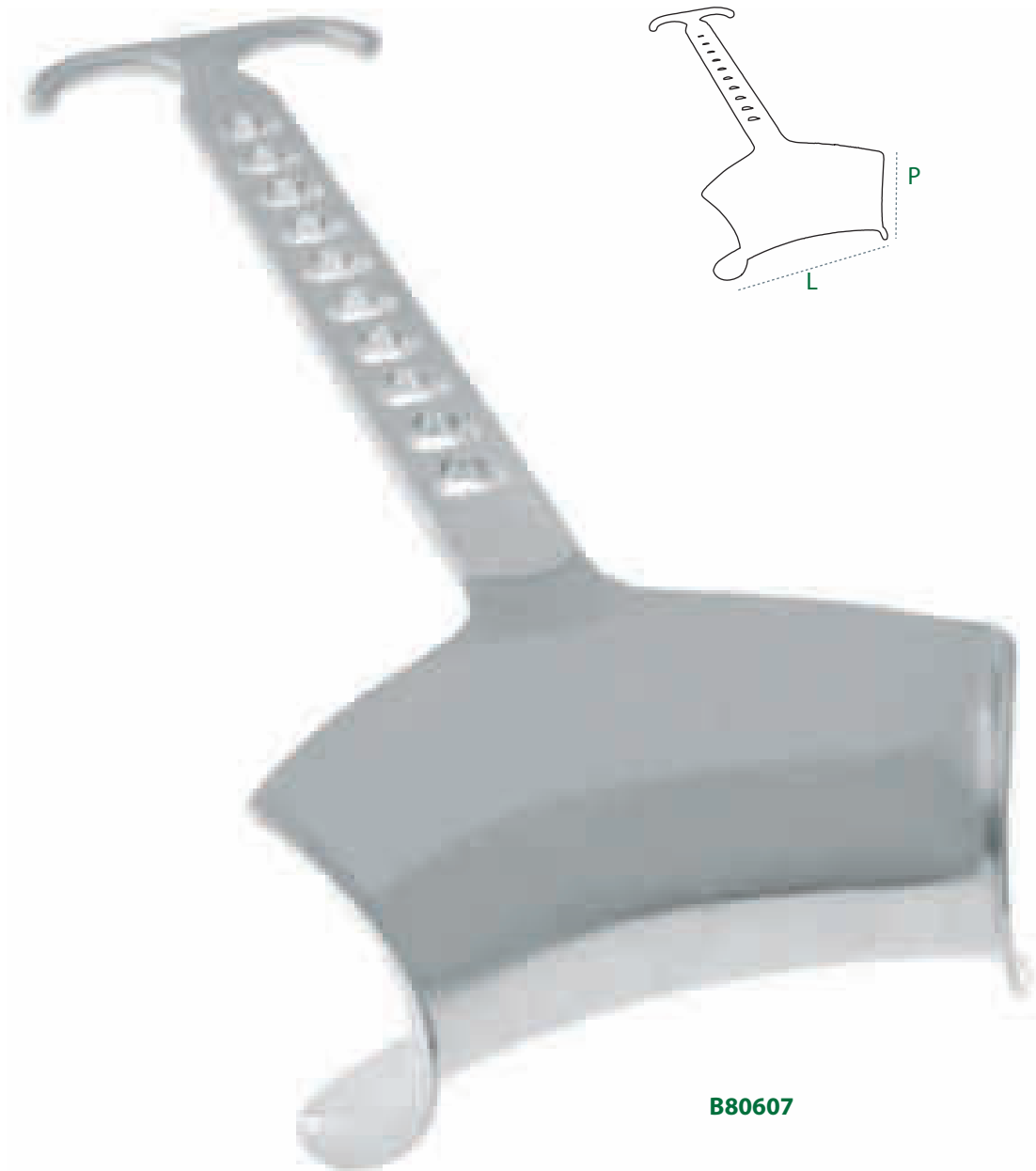

**B80607**

O : Ouverture - Blades opening - Abertura de las hojas  
P : Profondeur - Depth - Profundidad  
L : Largeur - Width - Anchura

### DESMARET



	P	L
 <b>B80603</b>	65 mm	50-170 mm
<b>B80604</b>	45 mm	50-170 mm

**B80603**  
43 cm - 17 "

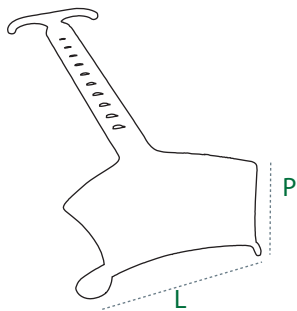

O : Ouverture - Blades opening - Abertura de las hojas  
P : Profondeur - Depth - Profundidad  
L : Largeur - Width - Anchura

# LANDANGER

## Écarteurs VK - VK Retractors - Separadores VK

### FOUCAULT

	P	L
<b>B806187</b>	50 mm	100 mm



**B806187**  
30 cm - 12"

50 mm



**B806185**  
34,5 cm - 13 1/2"

30 mm

Valve Malléable avec curseur  
Malleable balde with cursor  
Valva maleable con cursor

	P	L
<b>B806178</b>	35 mm	85-110 mm



**B806178**  
26 cm - 10 1/4"

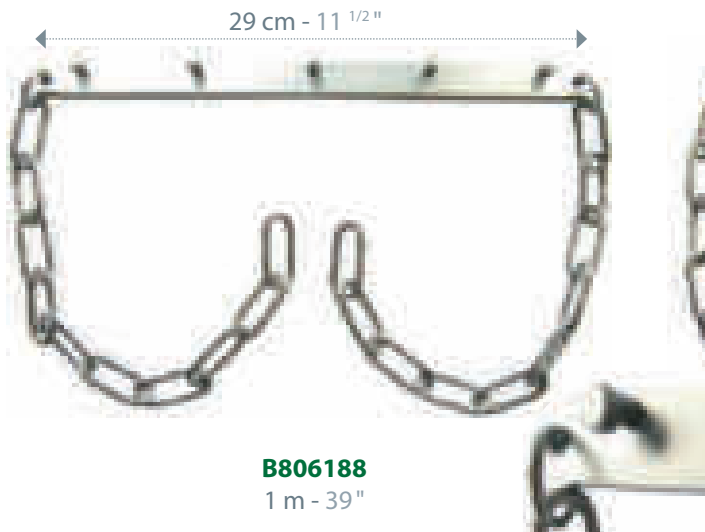

**B806188**  
1 m - 39"

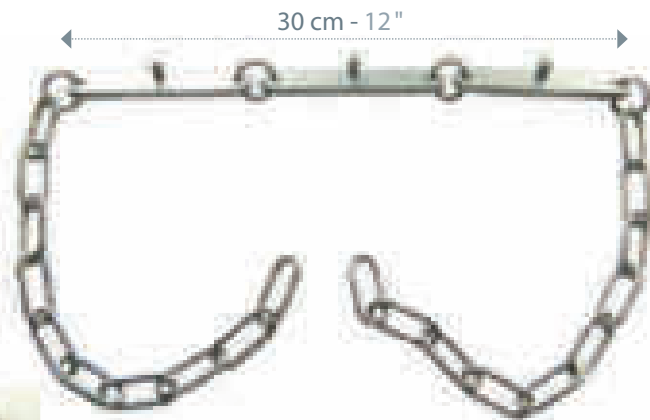

**B806189**  
1 m - 39"



O : Ouverture - Blades opening - Abertura de las hojas  
P : Profondeur - Depth - Profundidad  
L : Largeur - Width - Anchura

### HAUTEFEUILLE

### TOUPET

### BERGERET TOUPET

Piquet (Paire)  
Peg (Par)  
Estraca (Pair)

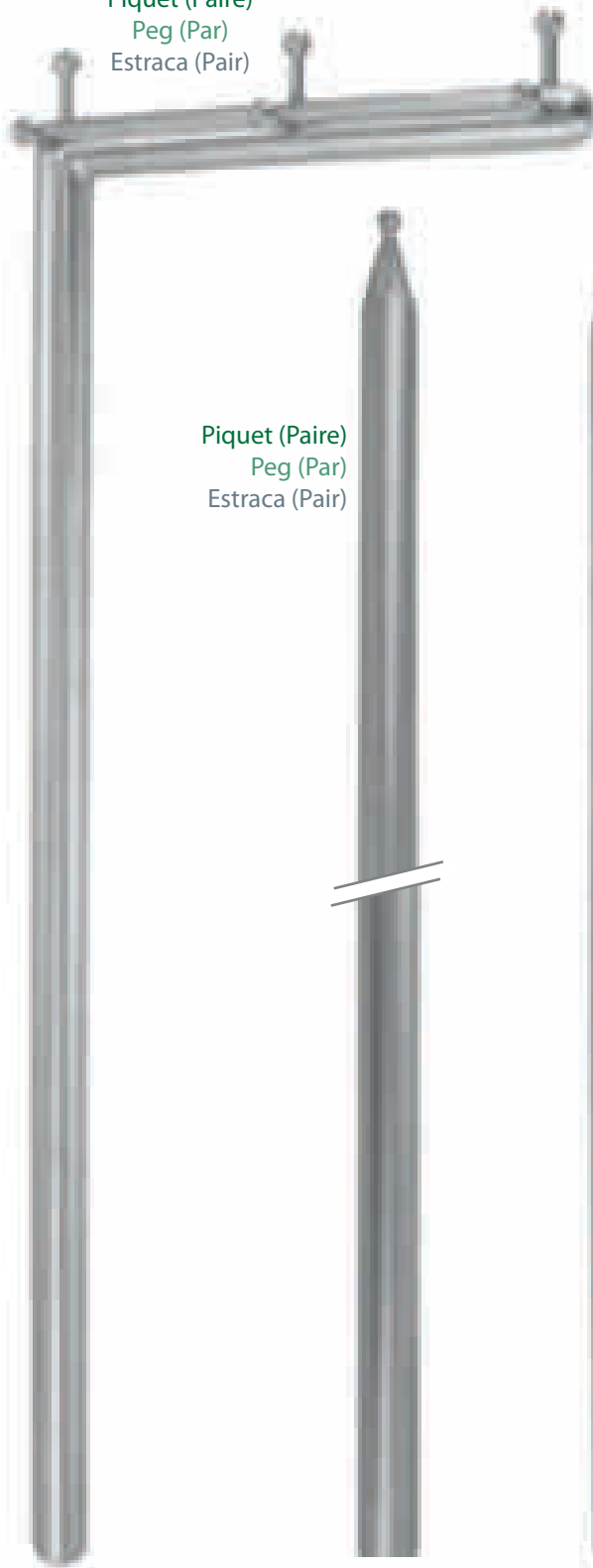

**B808410**  
ø 16 mm  
40 cm - 15 3/4 "

Piquet (Paire)  
Peg (Par)  
Estraca (Pair)

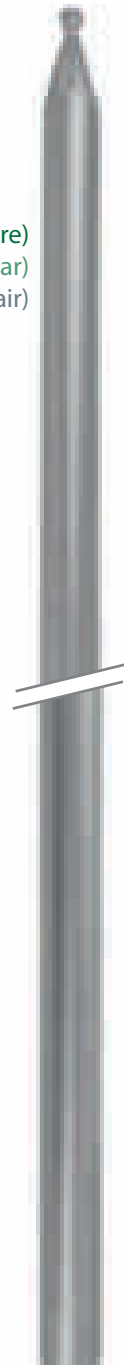

**B80840**  
ø 16 mm  
60 cm - 23 1/2 "

Porte-piquet (Paire)  
Peg holder (Par)  
Porta estraca (Pair)

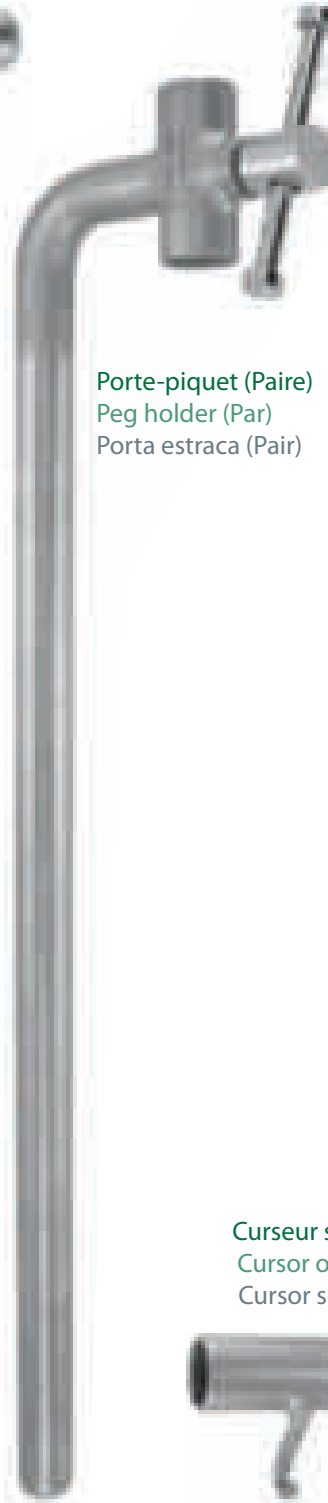

**B808085**  
ø 16 mm  
38 cm - 15 "

Chaine avec curseur  
Chain with cursor  
Cadena con cursor

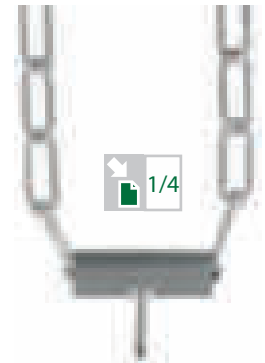

**B80618**  
100 cm - 39 1/2 "

Chaine sans curseur (Paire)  
Chain without cursor (Par)  
Cadena sin cursor (Pair)

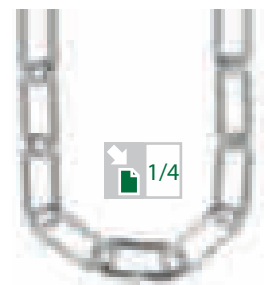

**B80835**  
100 cm - 39 1/2 "

Curseur seul  
Cursor only  
Cursor sólo



**B808340**  
60 mm - 2 1/4 "

Maillon rapide  
Quick ring  
Anillo rápido



**B808360**  
40 mm - 1 1/2 "



### RICARD

Valves latérales (à l'unité)  
Lateral blades (per unit)  
Valvas laterales (la unidad)



**P**                      **L**

 <b>B80645</b>	50 mm	60 mm
<b>B80650</b>	65 mm	80 mm
<b>B80655</b>	80 mm	100 mm
<b>B80660</b>	100 mm	120 mm



Valve médiane  
Center blade  
Valva mediana

**P**                      **L**

 <b>B80665</b>	50 mm	60 mm
<b>B80670</b>	65 mm	80 mm
<b>B80675</b>	80 mm	100 mm
<b>B80680</b>	100 mm	120 mm

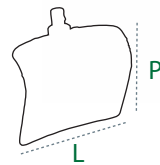

Compas seul  
Compass only  
Compas sólo



Ouverture maxi 300mm  
Blade opening 11 3/4"  
Abertura total 300 mm

**B80645**  
18 cm - 7"

### TOUPET

Valves latérales (à l'unité)  
Lateral blades (per unit)  
Valvas laterales (la unidad)



**P**                      **L**

 <b>B80806</b>	70 mm	40 mm
<b>B80807</b>	50 mm	40 mm

O : Ouverture - Blades opening - Abertura de las hojas  
P : Profondeur - Depth - Profundidad  
L : Largeur - Width - Anchura



### RICARD-BEGOIN

Compas seul  
Compass only  
Compas sólo



Ouverture maxi 300 mm  
Blade opening 11 <sup>3/4</sup> ''  
Abertura total 300 mm

**B80640**  
18 cm - 7 ''

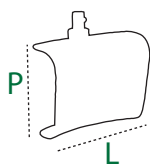

Valves latérales (à l'unité)  
Lateral blades (per unit)  
Valvas laterales (la unidad)



	P	L
 <b>B80705</b>	50 mm	60 mm
<b>B80710</b>	70 mm	80 mm
<b>B80715</b>	75 mm	100 mm
<b>B80720</b>	95 mm	120 mm

Valve médiane  
Center blade  
Valva mediana



	P	L
<b>B80725</b>	55 mm	60 mm
 <b>B80730</b>	75 mm	80 mm
<b>B80735</b>	110 mm	100 mm
<b>B80740</b>	120 mm	120 mm

O : Ouverture - Blades opening - Abertura de las hojas  
P : Profondeur - Depth - Profundidad  
L : Largeur - Width - Anchura

### RICARD

Complet avec 3 valves  
Complete with 3 blades  
Completo con 3 valvas

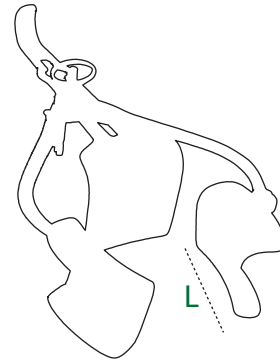

**B80620**  
60 mm

L

60 mm	<b>B80620</b>	= B80640 + 2 x B80645 + B80665
80 mm	<b>B80625</b>	= B80640 + 2 x B80650 + B80670
100 mm	<b>B80630</b>	= B80640 + 2 x B80655 + B80675
120mm	<b>B80635</b>	= B80640 + 2 x B80660 + B80680

### RICARD-BEGOIN

**B80685**  
60 mm

L

60 mm	<b>B80685</b>	= B80640 + 2 x B80705 + B80725
80 mm	<b>B80690</b>	= B80640 + 2 x B80710 + B80730
100 mm	<b>B80695</b>	= B80640 + 2 x B80715 + B80735
120 mm	<b>B80700</b>	= B80640 + 2 x B80720 + B80740

O : Ouverture - Blades opening - Abertura de las hojas  
P : Profondeur - Depth - Profundidad  
L : Largeur - Width - Anchura

### TOUPET

Adaptable sur compas de Ricard  
Use with Ricard compass  
Se utiliza con compas de Ricard

Dépresseur double  
Double depressor  
Valva doble

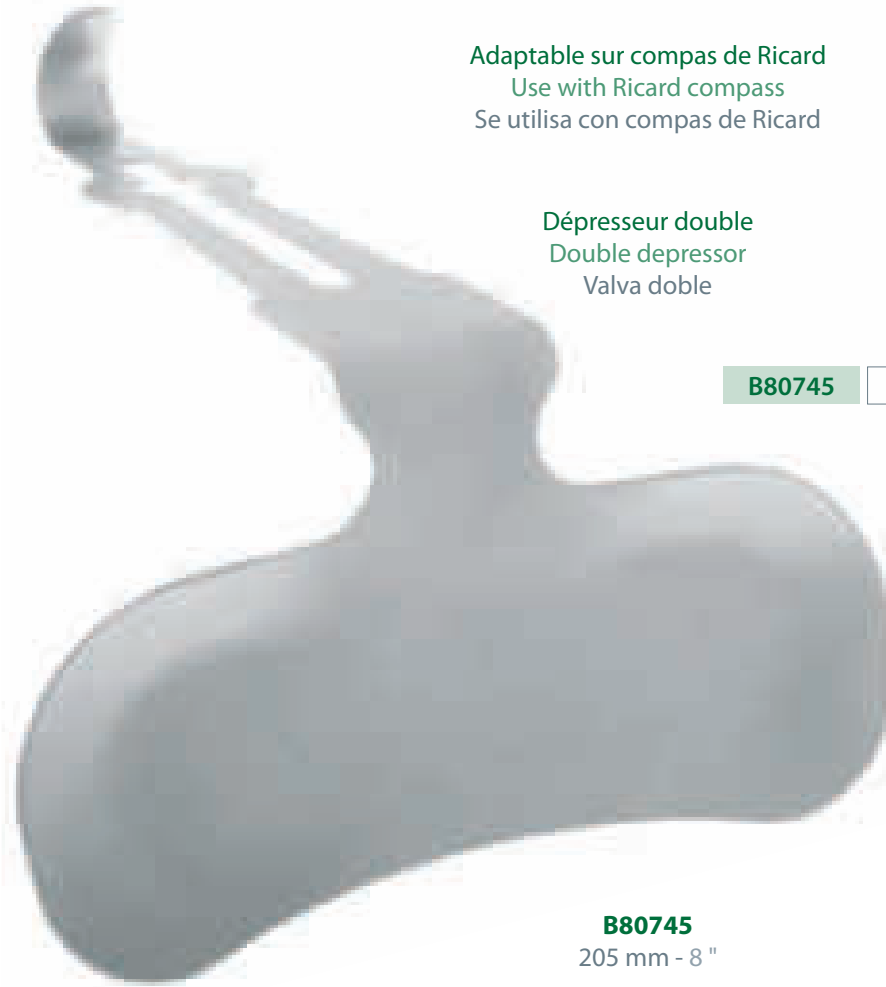

	P	L
<b>B80745</b>	90 mm	155 mm

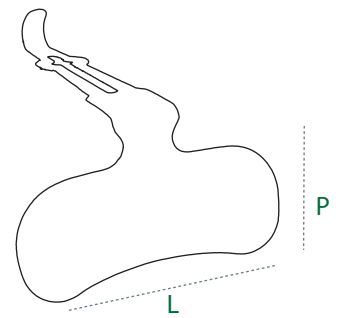

**B80745**  
205 mm - 8 "

### TOUPET (ENTEROSTAT)

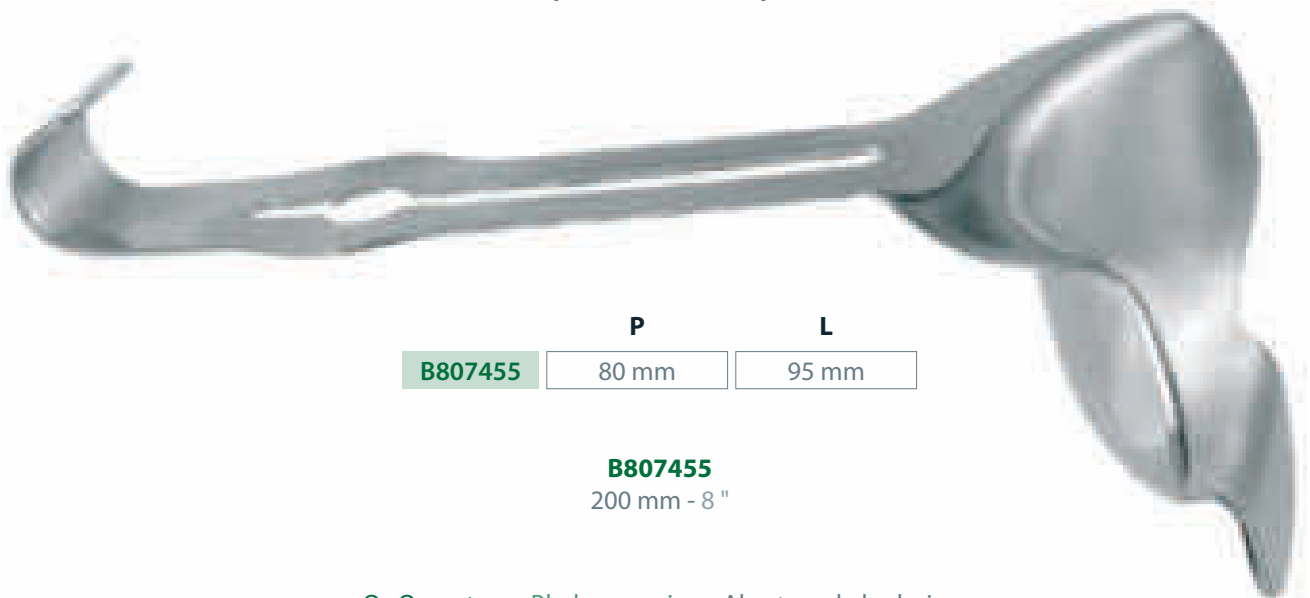

	P	L
<b>B807455</b>	80 mm	95 mm

**B807455**  
200 mm - 8 "

O : Ouverture - Blades opening - Abertura de las hojas  
P : Profondeur - Depth - Profundidad  
L : Largeur - Width - Anchura



### COTT

Valves latérales (à l'unité)  
Lateral blades (per unit)  
Valvas laterales (la unidad)



P

L

<b>B807580</b>	40 mm	50 mm
<b>B80759</b>	45 mm	75 mm
<b>B80760</b>	55 mm	75 mm

Compas seul  
Compass only  
Compas sólo



**B807610**  
20 cm - 8 "

**B807620**  
25 cm - 10 "

**B80763**  
30 cm - 11 <sup>3</sup>/<sub>4</sub> "

Valve médiane  
Center blade  
Valva mediana

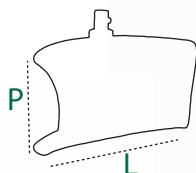

P

L

<b>B80765</b>	65 mm	75 mm
---------------	-------	-------

Complet avec 2 valves latérales et 1 valve médiane  
Complete with 2 lateral blades and 1 center blade  
Completo con 2 valvas laterales y 1 valva mediana

**B80755** = B80763 + 2 x B80759 + B80765

**B80756** = B80763 + 2 x B80760 + B80765

Complet avec 4 valves latérales et 1 valve médiane  
Complete with 4 lateral blades and 1 center blade  
Completo con 4 valvas laterales y 1 valva mediana

**B80750** = B80763 + 2 x B80759 + 2 x B80760 + B80765

O : Ouverture - Blades opening - Abertura de las hojas  
P : Profondeur - Depth - Profundidad  
L : Largeur - Width - Anchura

### PALMER

Complet avec 3 paires de valves latérales de Ricard  
 Complete with 3 pairs of Ricard lateral blades  
 Completo con 3 pares de valvas laterales de Ricard

**B80767** = B80763 + 2 x B80645 + 2 x B80650 + 2 x B80655

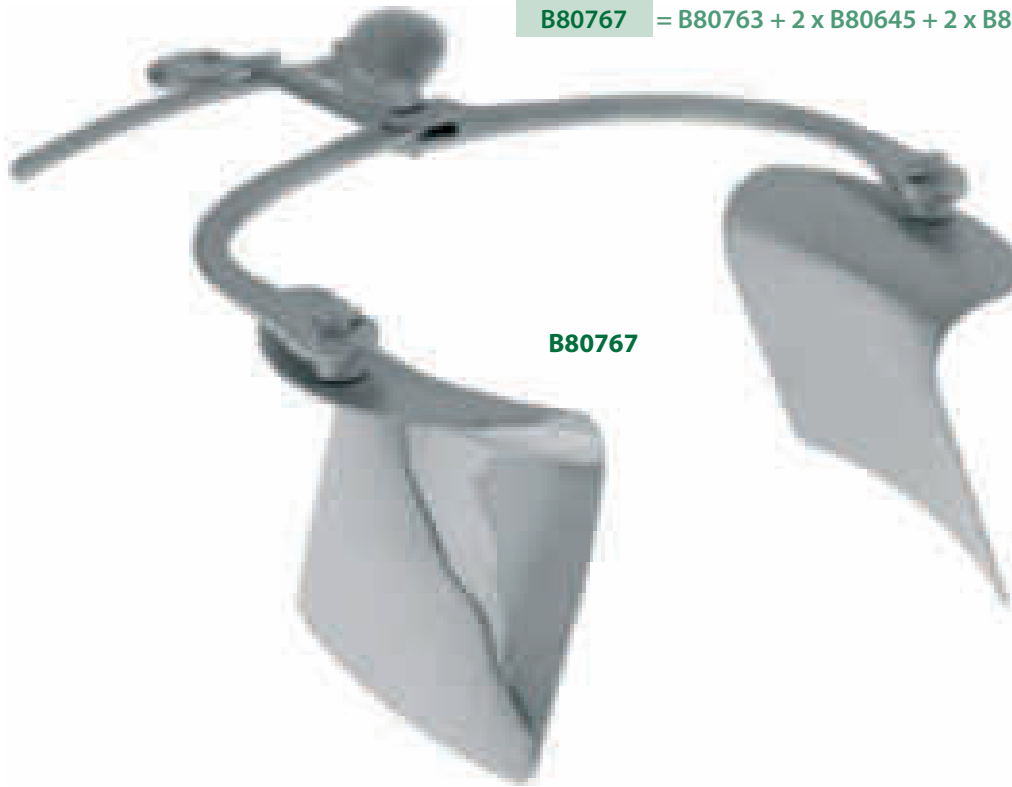

Compas seul  
 Compass only  
 Compas sólo

**B80763**  
 30 cm - 11 <sup>3/4</sup> "

Valves latérales (à l'unité)  
 Lateral blades (per unit)  
 Valvas laterales (la unidad)

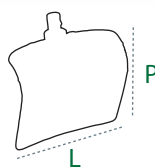
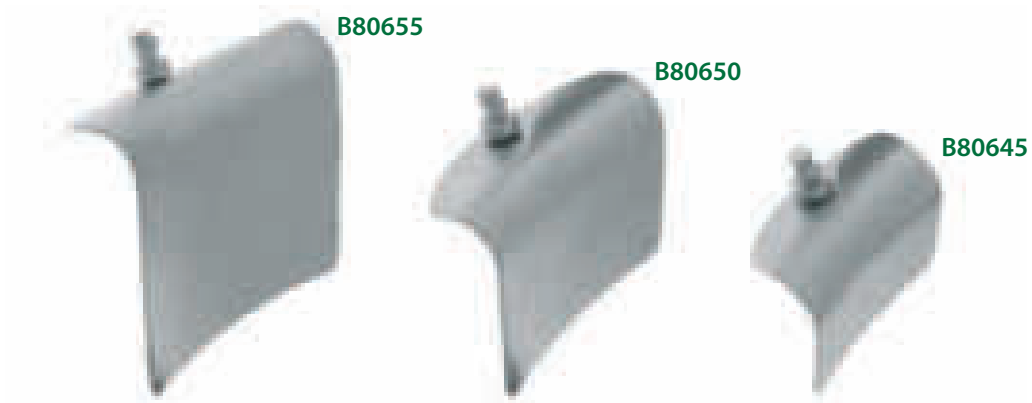

	P	L
 <b>B80645</b>	50 mm	60 mm
 <b>B80650</b>	65 mm	80 mm
 <b>B80655</b>	80 mm	100 mm

O : Ouverture - Blades opening - Abertura de las hojas  
 P : Profondeur - Depth - Profundidad  
 L : Largeur - Width - Anchura

### COLLIN

Valves latérales (à l'unité)  
Lateral blades (per unit)  
Valvas laterales (la unidad)

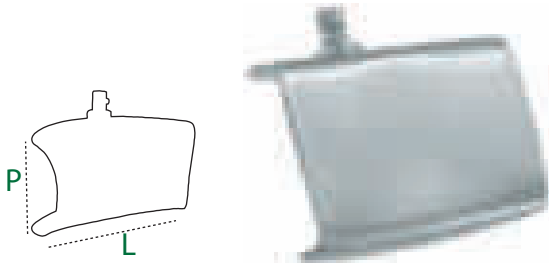

**P**                      **L**

 <b>B817020</b>	38 mm	60 mm
<b>B817021</b>	38 mm	80 mm
<b>B817022</b>	38 mm	100 mm

Compas seul  
Compass only  
Compas sólo



**B817010**  
21 cm - 8 1/2"

Valve médiane  
Center blade  
Valva mediana



**P**                      **L**

 <b>B817030</b>	55 mm	55 mm
<b>B817031</b>	55 mm	75 mm

Complet avec 2 valves latérales et 1 valve médiane  
Complete with 2 lateral blades and 1 center blade  
Completo con 2 valvas laterales y 1 valva mediana

 <b>B817000</b>	= B817010 + 2 x B817020 + B817030
<b>B817001</b>	= B817010 + 2 x B817021
<b>B817002</b>	= B817010 + 2 x B817022 + B817031

O : Ouverture - Blades opening - Abertura de las hojas  
P : Profondeur - Depth - Profundidad  
L : Largeur - Width - Anchura



### COLLIN

Valves latérales (à l'unité)  
Lateral blades (per unit)  
Valvas laterales (la unidad)

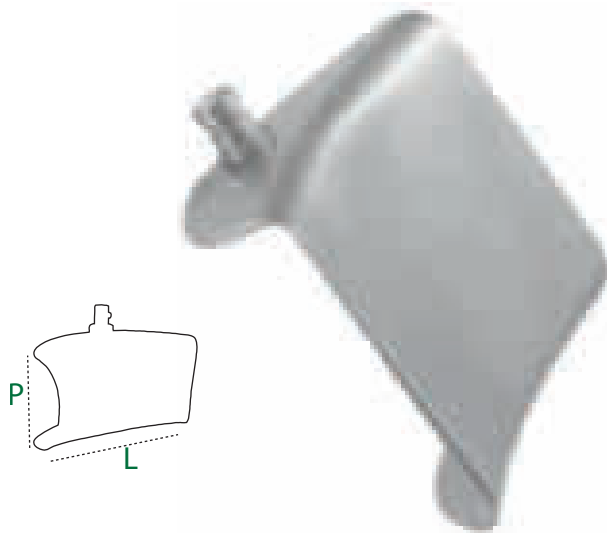

<b>B817120</b>	<b>P</b>	<b>L</b>
	60 mm	80 mm

Compas seul  
Compass only  
Compas sólo



**B817110**  
25 cm - 10"

Valve médiane  
Center blade  
Valva mediana

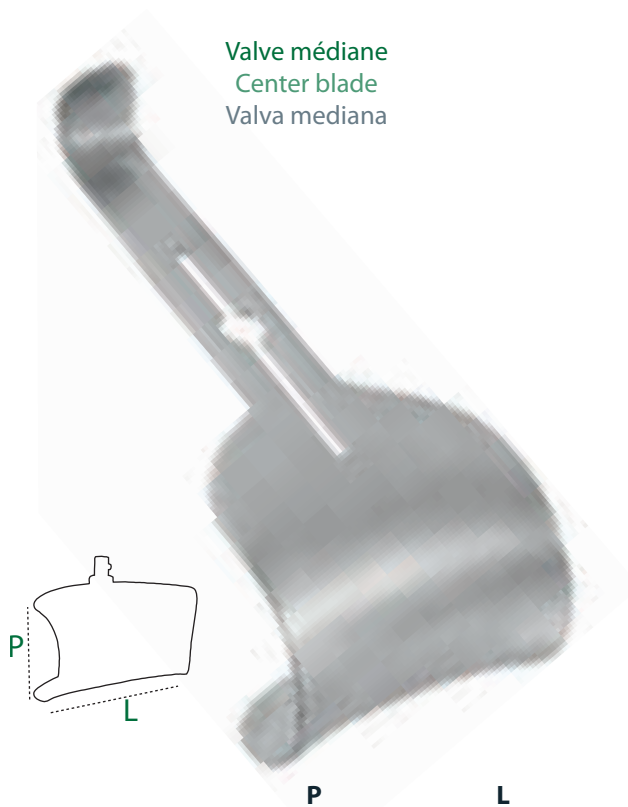

<b>B817130</b>	<b>P</b>	<b>L</b>
	60 mm	75 mm

Complet avec 2 valves latérales et 1 valve médiane  
Complete with 2 lateral blades and 1 center blade  
Completo con 2 valvas laterales y 1 valva mediana



**B817100** = B817110 + 2 x B817120 + B817130

O : Ouverture - Blades opening - Abertura de las hojas  
P : Profondeur - Depth - Profundidad  
L : Largeur - Width - Anchura

### BABY-COLLIN

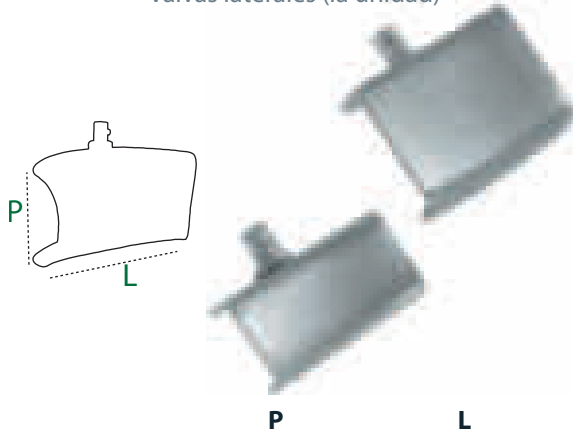
Valves latérales (à l'unité)  
Lateral blades (per unit)  
Valvas laterales (la unidad)



	<b>B817220</b>	20 mm	40 mm
	<b>B817221</b>	30 mm	42 mm

Complet avec 4 valves latérales  
Complete with 4 lateral blades  
Completo con 4 valvas laterales

**B817200** = B817210 + 2 x B817220 + 2 x B817221

Compas seul  
Compass only  
Compas sólo

**B817210**  
18 cm - 7"

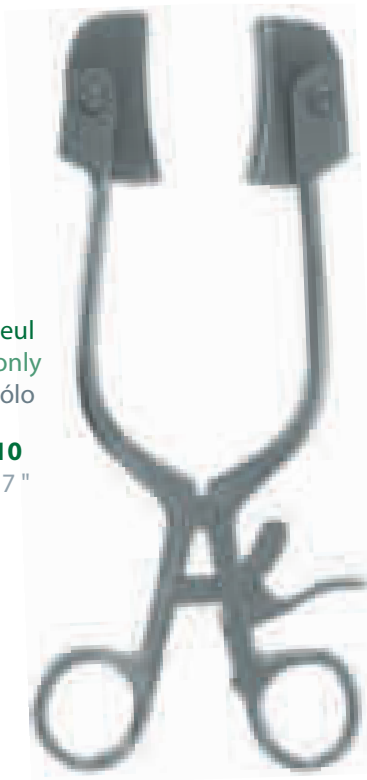

### MAYO-ADAMS

35 x 18 mm



Avec valve médiane  
With central blade  
Con valva mediana

**B817300**

35 x 14 mm

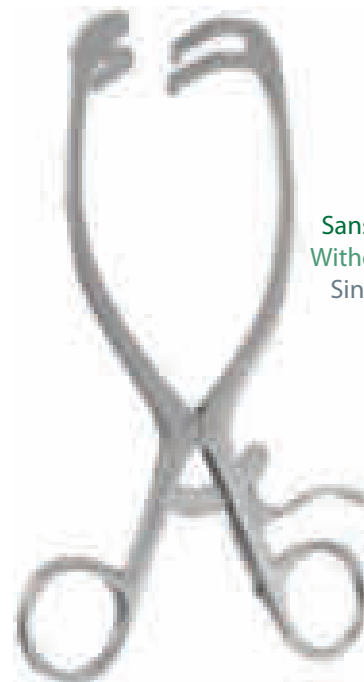

Sans valve médiane  
Without central blade  
Sin valva mediana

**B817301**

O : Ouverture - Blades opening - Abertura de las hojas  
P : Profondeur - Depth - Profundidad  
L : Largeur - Width - Anchura



### OLIVIER

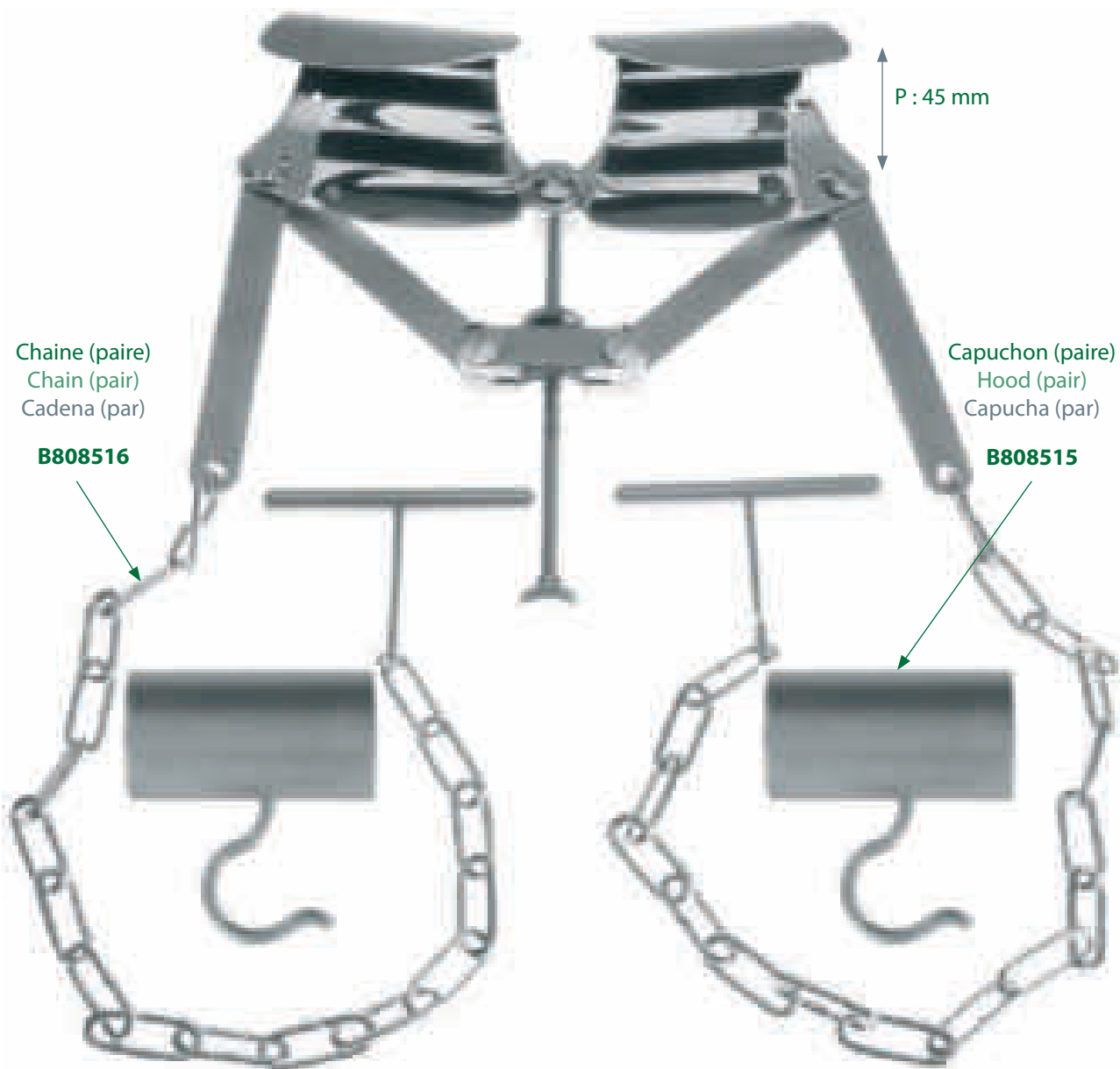

Chaine (paire)  
Chain (pair)  
Cadena (par)

**B808516**

Capuchon (paire)  
Hood (pair)  
Capucha (par)

**B808515**

P : 45 mm



**B80850**

P : 45 mm

Écarteur complet avec chaines et capuchons  
Complete retractor with chains and hoods  
Separadore completo con cadenas et capuchas

**B808510**

P : 107 mm

Écarteur complet avec chaines et capuchons pour obèse  
Complete retractor with chains and hoods for obese  
Separadore completo con cadenas et capuchas por obeso

O : Ouverture - Blades opening - Abertura de las hojas  
P : Profondeur - Depth - Profundidad  
L : Largeur - Width - Anchura

### KIRSCHNER

Cadre pliant avec 2 paires de valves  
Foldable frame with 2 pairs of blades  
Cuadro plegable con 2 pares de valvas

**B80820** = B808209 + 2 B808201 + 2 B808202

Cadre fixe avec 2 paires de valves  
Fixed frame with 2 pairs of blades  
Cuadro fijo con 2 pares de valvas

**B80815** = B808159 + 2 B808201 + 2 B808202

Cadre pliant seul  
Foldable frame only  
Cuadro plegable solo

**B808209**

Cadre fixe seul  
Fixed frame only  
Cuadro fijo solo

**B808159**

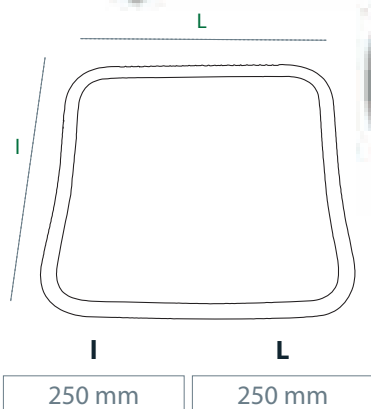

Cadre seul  
Frame only  
Cuadro solo

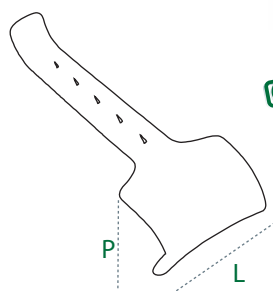

Valves seules  
Blades only  
Valvas sólas

	P	L
<b>B808201</b>	40 mm	55 mm
<b>B808202</b>	50 mm	65 mm
<b>B808203</b>	65 mm	80 mm
<b>B808204</b>	80 mm	80 mm
<b>B808205</b>	90 mm	65 mm
<b>B808206</b>	90 mm	90 mm

O : Ouverture - Blades opening - Abertura de las hojas

P : Profondeur - Depth - Profundidad

L : Largeur - Width - Anchura

### DENIS BROWN

Cadre 178 x 140 mm complet avec 2 paires de valves  
 Frame 7 " x 5 1/2 " complete with 2 pairs of blades  
 Cuadro 178 x 140 mm completo con 2 pares de valvas

**B808300** = B808310 + 2 x B808312 + 2 x B808313

Cadre 255 x 178 mm complet avec 2 paires de valves  
 Frame 10 " x 7 " complete with 2 pairs of blades  
 Cuadro 255 x 178 mm completo con 2 pares de valvas

**B808301** = B808311 + 2 x B808312 + 2 x B808313

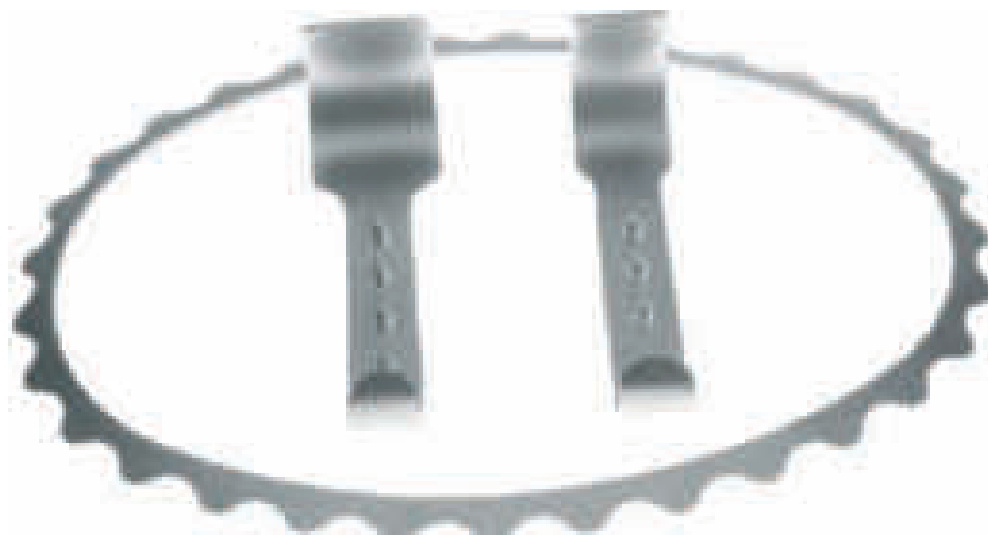

Cadre seul 178 x 140 mm  
 Frame only 7 x 5 1/2 "  
 Cuadro sólo 178 x 140 mm

**B808310**



Valve seule 38 x 25 mm  
 Blade only 1 1/2 " x 1 "  
 Valva sólo 38 x 25 mm

**B808312**



Valve seule 38 x 38 mm  
 Blade only 1 1/2 " x 1 1/2 "  
 Valva sólo 38 x 38 mm

**B808313**



Cadre seul 255 x 178 mm  
 Frame only 10" x 7"  
 Cuadro sólo 255 x 178 mm

**B808311**



### SEMM

Cadre complet  
avec 6 valves  
Frame complete  
with 6 blades  
Cuadro completo  
con 6 valvas

**B808270**

Cadre seul  
Frame only  
Cuadro sólo

**B808271**

**B808276**  
79 x 98 mm

**B808274**  
47 x 65 mm

**B808277**  
98 x 52 mm

**B808274**  
47 x 65 mm

**B808275**  
50 x 54 mm

**B808278**  
105 x 35 mm

### O'SULIVAN - O'CONNOR

68 x 25 mm

**2 x B808285**  
80 x 45 mm

Cadre complet  
avec 3 valves  
Frame complete  
with 3 blades  
Cuadro completo  
con 3 valvas

**B808280**

68 x 25 mm

**1 x B808286**  
110 x 70 mm

### AUVERT

Complet - Complete - Completo

**B80810**

B808110 + 8 x B80812 + 8 x B80813 + B808133 + B808134 + B808135 + B808136 + 2 x B808137 + 2 x B808138 + 1 x B808139

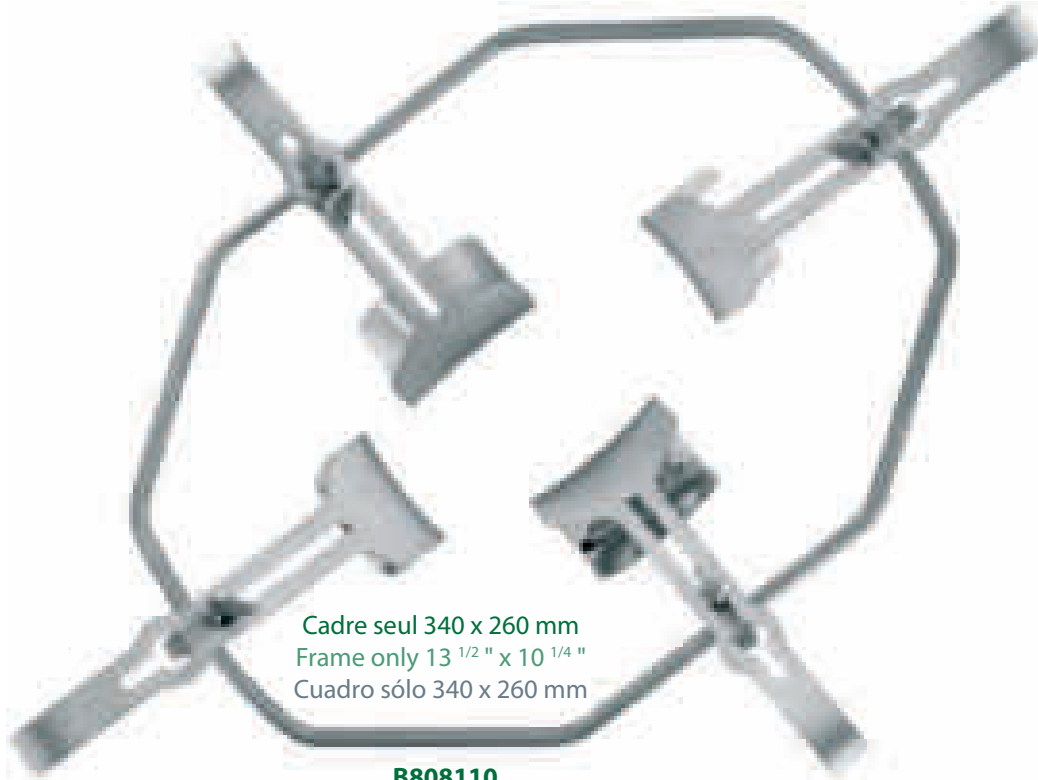

Cadre seul 340 x 260 mm  
Frame only 13 1/2 " x 10 1/4 "  
Cuadro sólo 340 x 260 mm

**B808110**



**B80813**

Vis anneau seule  
Ring screw only  
Tornillo anillo sólo



**B80812**

Étau seul  
Vice only  
Torno sólo



Valve recourbée  
Curved blade  
Valva curva

**B808135**

19,5 cm - 7 3/4 "

**P**

**L**



**B808135**

30 mm

60 mm

**B808133**

50 mm

80 mm

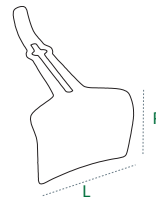

Valve oblique  
Oblic blade  
Valva oblicuo

**B808136**

18,5 cm - 7 1/4 "

**P**

**L**

**B808134**

50 mm

60 mm



**B808136**

65 mm

80 mm



Fer à cintrer (paire)  
Blade bender (pair)  
Llave para valva (par)

**B808139**

17 cm - 6 3/4 "



Valve malléable  
Malleable blade  
Valva maleable

**B808138**

32,5 cm - 12 3/4 "

**L**

**B808137**

35 mm



**B808138**

50 mm

O : Ouverture - Blades opening - Abertura de las hojas

P : Profondeur - Depth - Profundidad

L : Largeur - Width - Anchura

### GOSSET

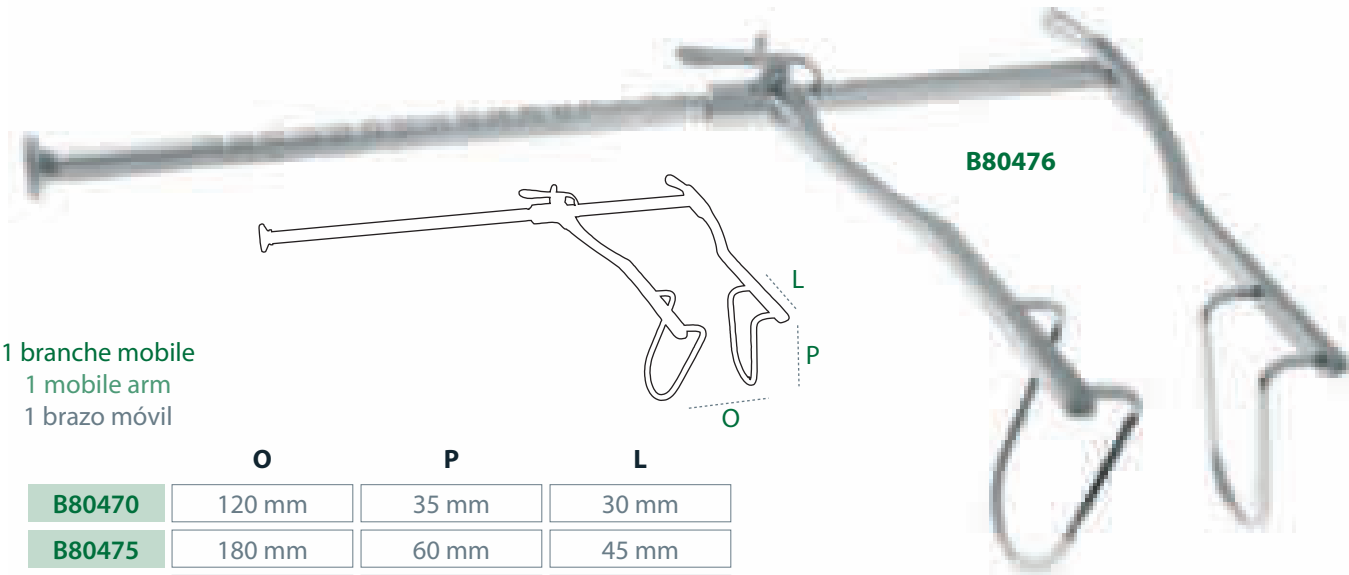

1 branche mobile  
1 mobile arm  
1 brazo móvil

	O	P	L
<b>B80470</b>	120 mm	35 mm	30 mm
<b>B80475</b>	180 mm	60 mm	45 mm
<b>B80476</b>	250 mm	60 mm	45 mm



### MONTESTRUC

1/3

	O	P	L
<b>B804770</b>	250 mm	120 mm	100 mm

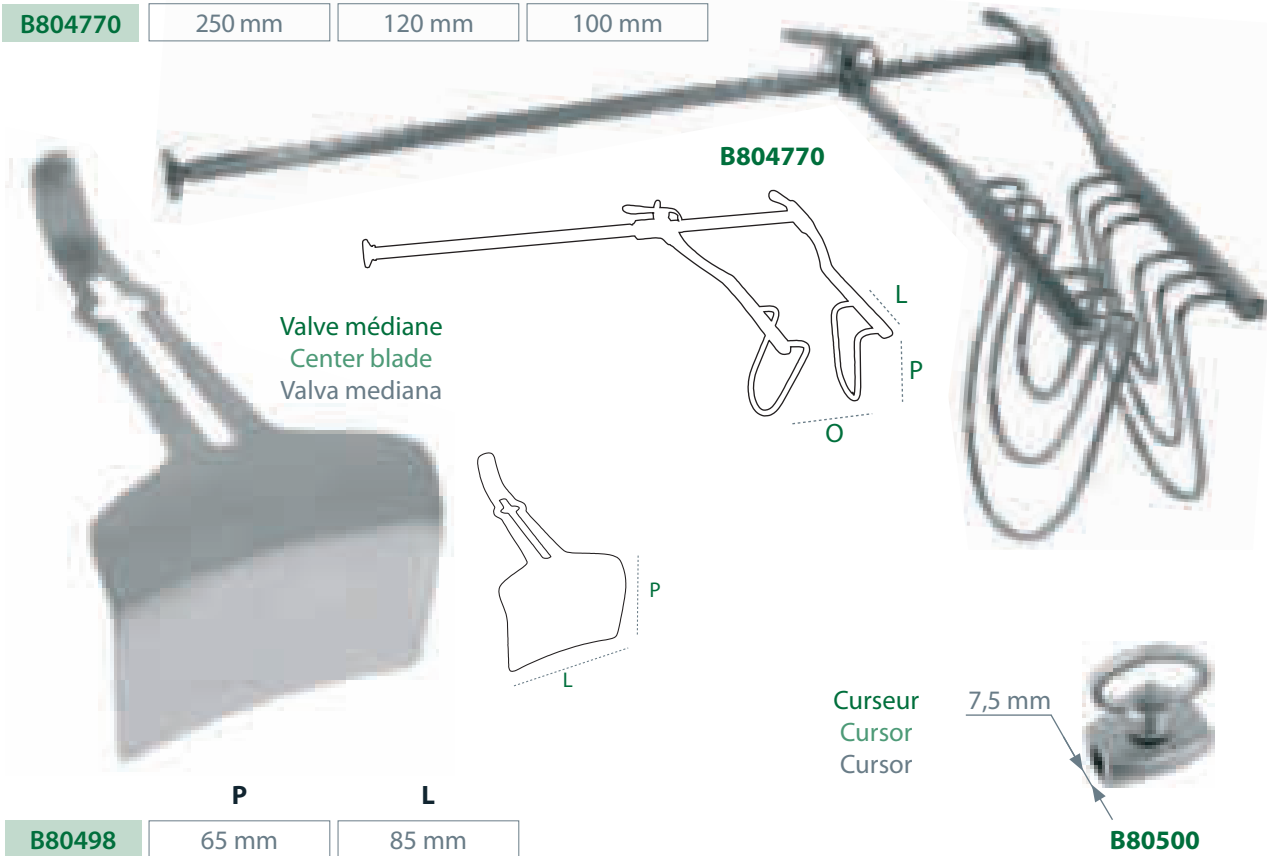

Valve médiane  
Center blade  
Valva mediana

Curseur  
Cursor  
Cursor

7,5 mm

**B80500**

	P	L
<b>B80498</b>	65 mm	85 mm

O : Ouverture - Blades opening - Abertura de las hojas  
P : Profondeur - Depth - Profundidad  
L : Largeur - Width - Anchura

1/2

### GOSSET

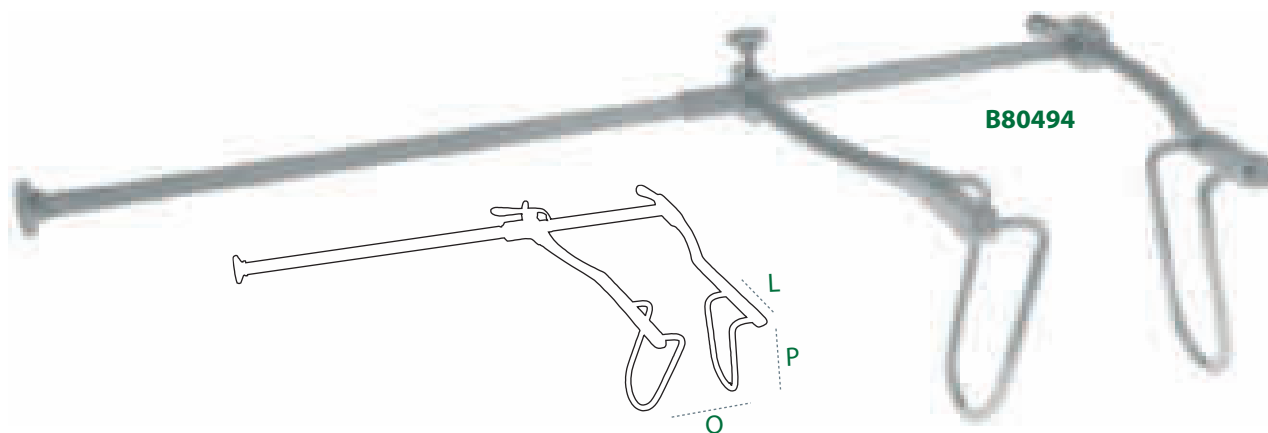

1 branche mobile  
1 mobile arm  
1 brazo móvil

	O	P	L
<b>B80486</b>	75 mm	25 mm	22 mm
<b>B80488</b>	120 mm	35 mm	30 mm
<b>B804900</b>	180 mm	60 mm	45 mm
<b>B80494</b>	280 mm	60 mm	45 mm

2 branches mobiles  
2 mobile arms  
2 brazos móviles

	O	P	L
<b>B80496</b>	260 mm	60 mm	45 mm



Valve médiane  
Center blade  
Valva mediana

	P	L
<b>B80498</b>	65 mm	85 mm

Curseur  
Cursor  
Cursor

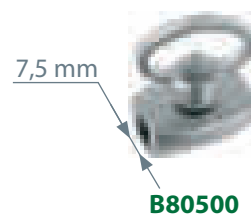

O : Ouverture - Blades opening - Abertura de las hojas  
P : Profondeur - Depth - Profundidad  
L : Largeur - Width - Anchura

### BALFOUR

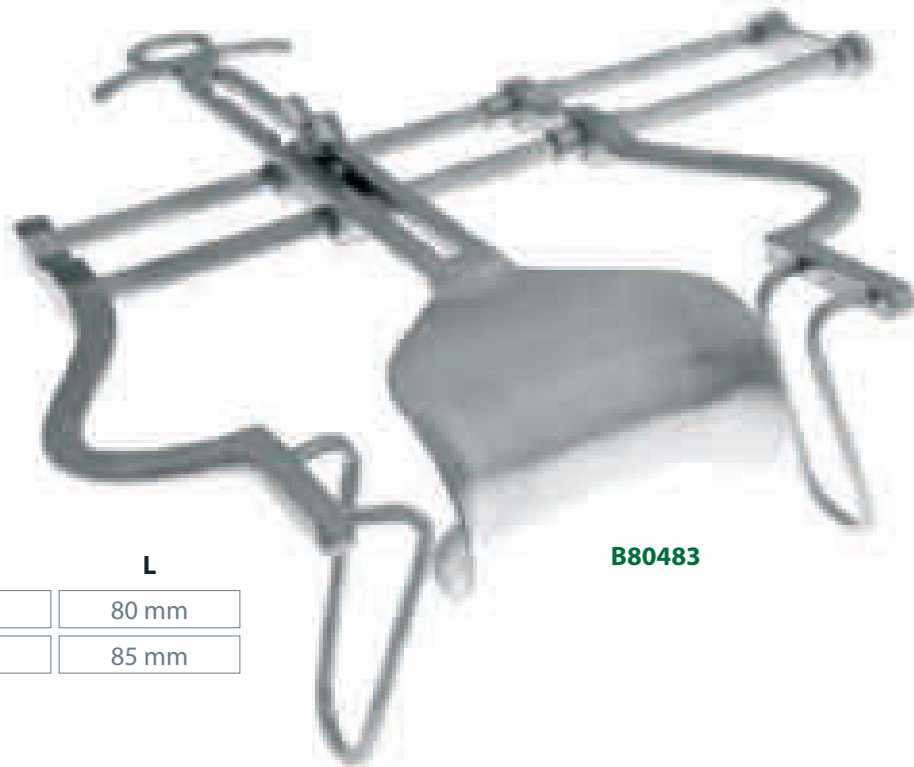
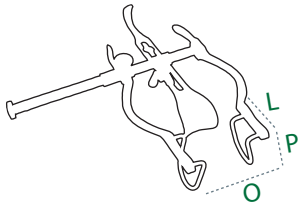

Valve médiane seule  
Center blade only  
Valva mediana sóla

	P	L
<b>B804832</b>	50 mm	80 mm
<b>B804842</b>	70 mm	85 mm

**B80483**

Complet  
Complete  
Completo

	O	P	L
 <b>B80483</b>	160 mm	65 mm	35 mm
<b>B80484</b>	250 mm	90 mm	35 mm

### BALFOUR-BABY

Complet  
Complete  
Completo

	O	P	L
 <b>B80482</b>	90 mm	27 mm	25 mm

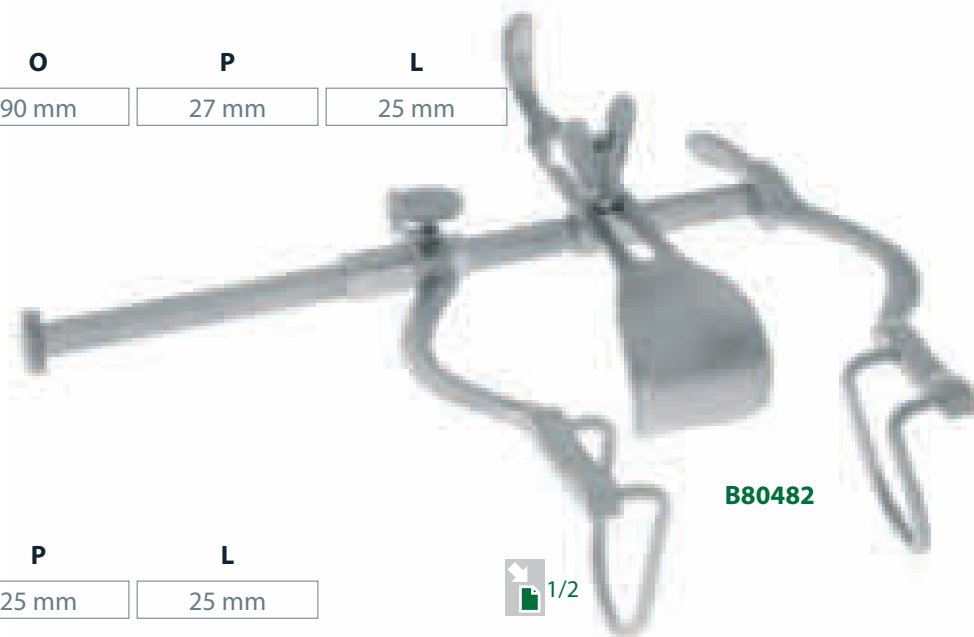

**B80482**

Valve médiane seule  
Center blade only  
Valva mediana sóla

	P	L
<b>B804822</b>	25 mm	25 mm



O : Ouverture - Blades opening - Abertura de las hojas  
P : Profondeur - Depth - Profundidad  
L : Largeur - Width - Anchura



### BALFOUR



Complet  
Complete  
Completo



**B804835**

**O**

180 mm

**P**

70 mm

**L**

35 mm

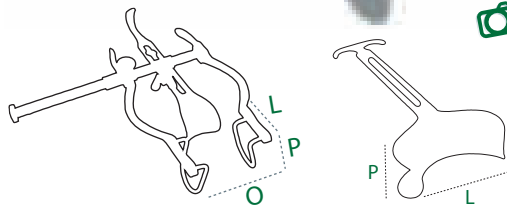

Valve médiane seule  
Center blade only  
Valva mediana sóla

**P**

45 mm

**L**

80 mm



Complet  
Complete  
Completo



**B804850**

**O**

200 mm

**P**

100 mm

**L**

35 mm

Valve médiane seule  
Center blade only  
Valva mediana sóla

**P**

100 mm

**L**

70 mm

# LANDANGER

## Écarteurs - Retractors - Separadores

### BALFOUR (USA-MODEL)



Écarteur seul  
Retractor only  
Separador sólo

**O**

**B804854**

180 mm

Valve médiane seule  
Center blade only  
Valva mediana sólo

**P**

**L**

**B804856**

45 mm

68 mm

**B804857**

68 mm

85 mm

Valves latérales seules (paire)  
Lateral blades only (pair)  
Valvas laterales sólo (par)

**P**

**L**

**B804858**

60 mm

35 mm

**B804859**

80 mm

35 mm

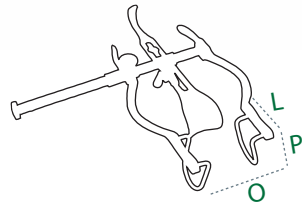
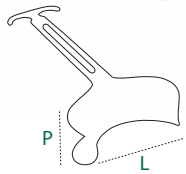

Complet  
Complete  
Completo

**O**

**P**

**L**



**B804855**

180 mm

60 mm

35 mm

### ABADIE

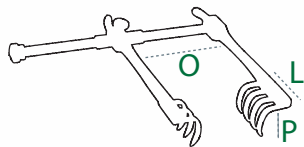
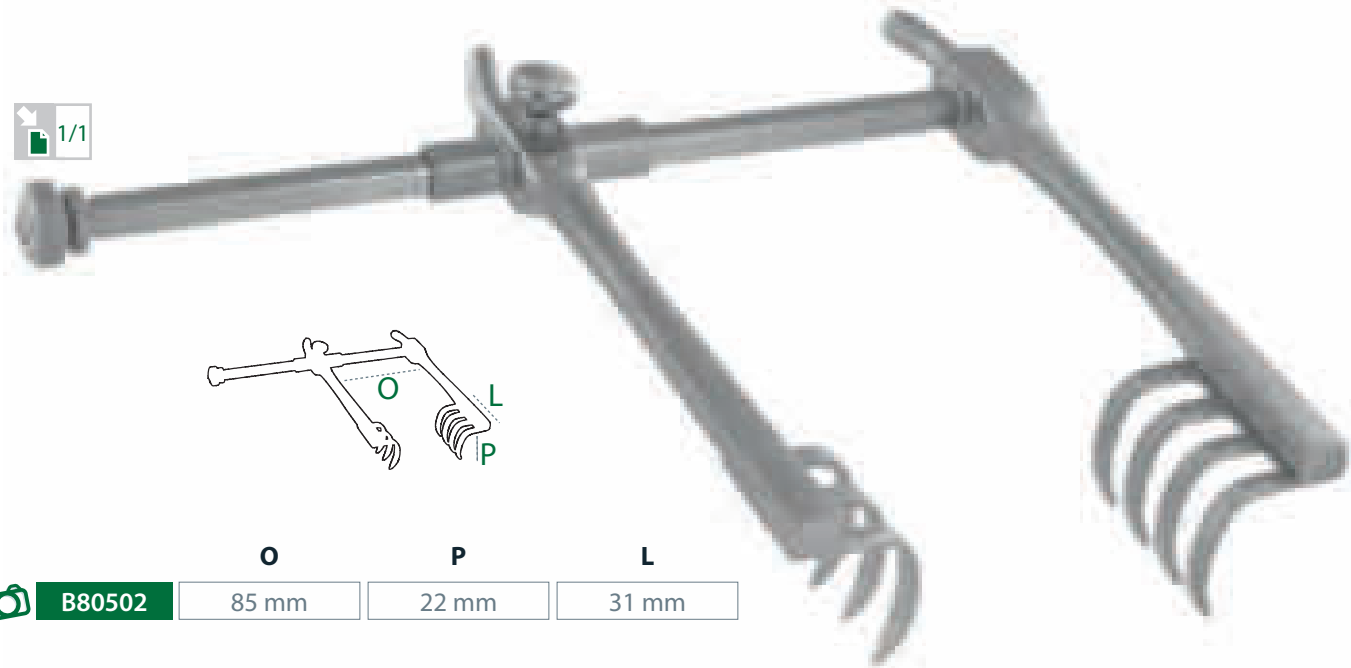

**O**

**P**

**L**



**B80502**

85 mm

22 mm

31 mm

O : Ouverture - Blades opening - Abertura de las hojas  
P : Profondeur - Depth - Profundidad  
L : Largeur - Width - Anchura



### HRYNTSCHAK

Valve médiane seule  
Center blade only  
Valva mediana sóla

	P	L
<b>B80507</b>	90 mm	40 mm

Adultes  
Adults  
Adultos

Complet  
Complete  
Completo

	O	P	L
<b>B80505</b>	115 mm	80 mm	35 mm

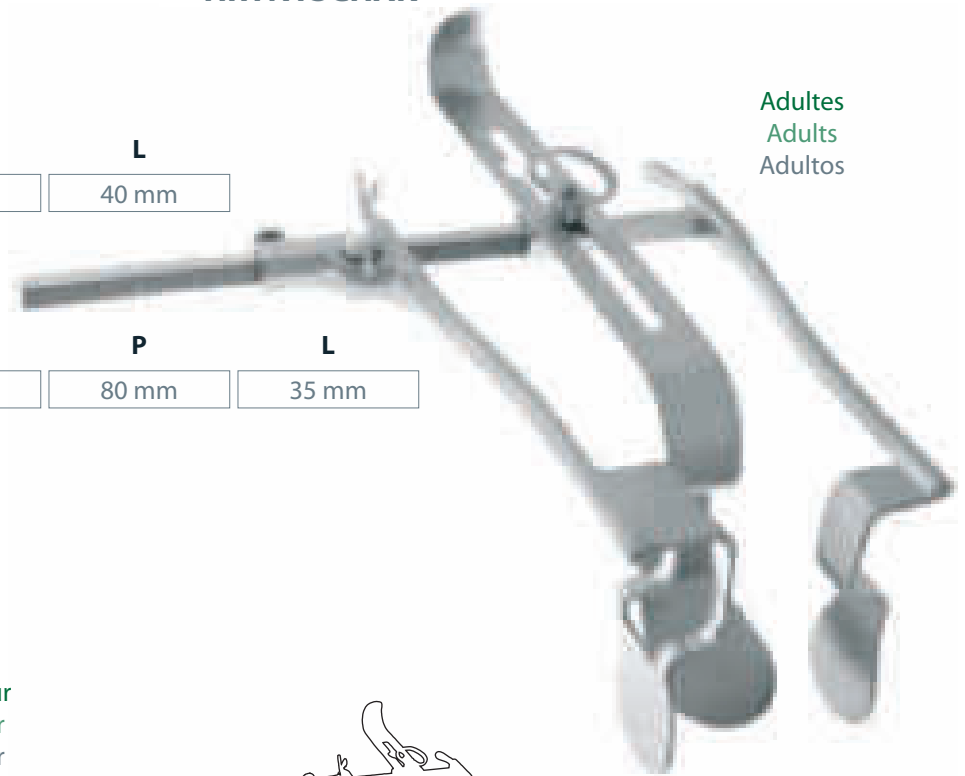

Curseur  
Cursor  
Cursor

8,2 mm



**B80513**

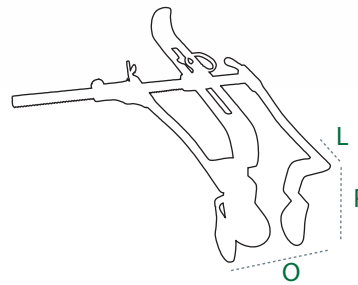

Enfants  
Children  
Niños

Valve médiane seule  
Center blade only  
Valva mediana sóla

	P	L
<b>B80511</b>	60 mm	25 mm

Complet  
Complete  
Completo

	O	P	L
<b>B80509</b>	85 mm	45 mm	18 mm

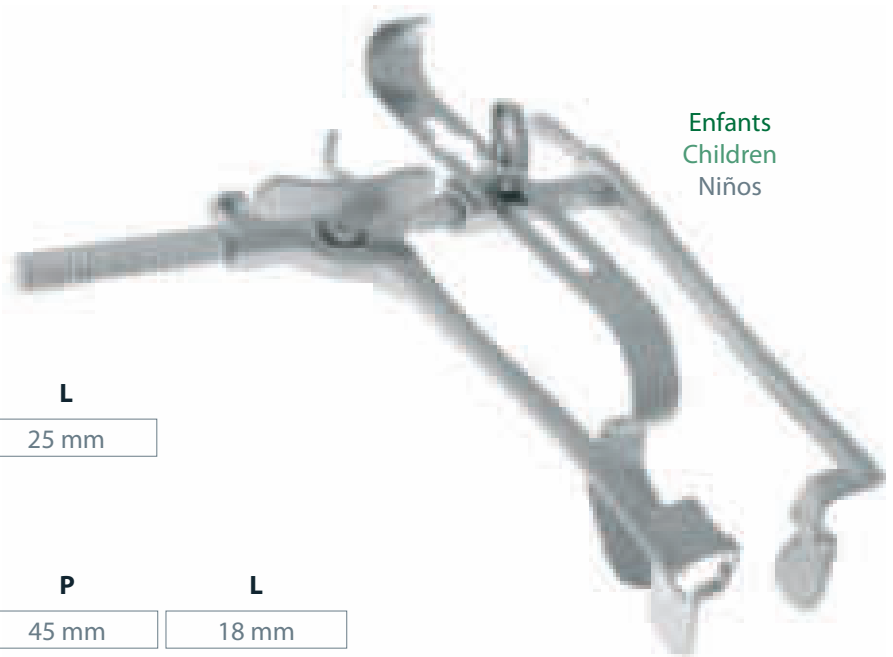

O : Ouverture - Blades opening - Abertura de las hojas  
P : Profondeur - Depth - Profundidad  
L : Largeur - Width - Anchura

### MILLIN

2 x 82 x 25 mm

2 x 57 x 25 mm

1 x 120 x 45 mm

Complet avec 5 valves  
Complete with 5 blades  
Completo con 5 valvas

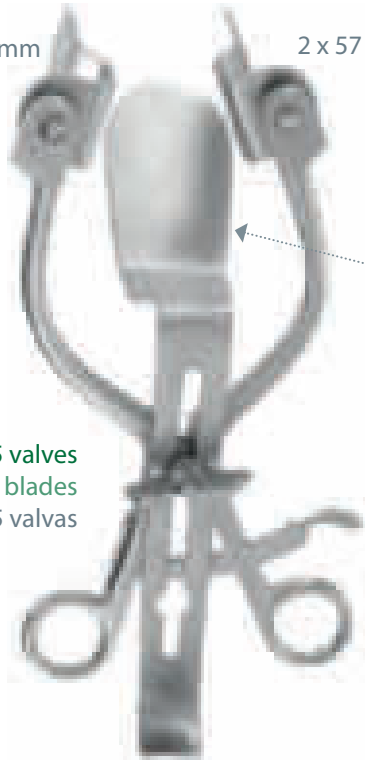

**B805140**

22 cm - 8 3/4"

### MILLIN



**H10170**

28 cm - 11"

### JUDD-MASSON

**B805150**

77 x 25 mm

72 x 25 mm

72 x 25 mm

O : 130 mm

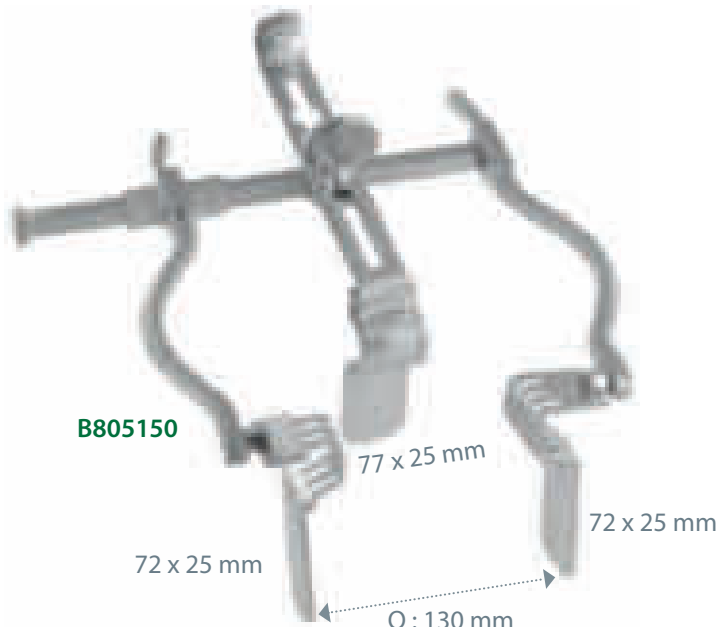

### LEGUEU

O : 100 mm

60 x 25 mm

80 x 30 mm

**B805160**

20 cm - 8"



O : Ouverture - Blades opening - Abertura de las hojas

P : Profondeur - Depth - Profundidad

L : Largeur - Width - Anchura

DARTIGUES (LAPAROSTAT)

29 cm - 11 1/2 " **B80450**

32 cm - 12 1/2 " **B80455** 



**B80455**  
32 cm - 12 1/2 "

### FINOCHIETTO

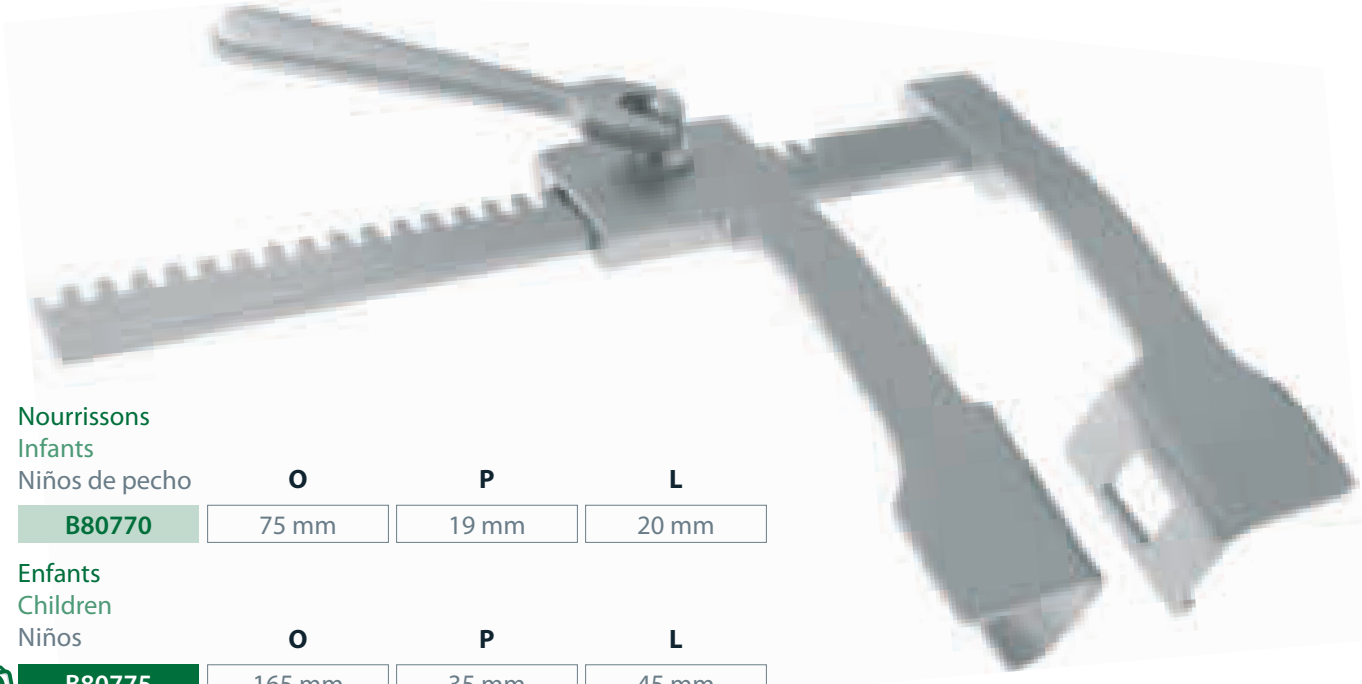

Nourrissons

Infants

Niños de pecho

	O	P	L
<b>B80770</b>	75 mm	19 mm	20 mm

Enfants

Children

Niños

	O	P	L
<b>B80775</b>	165 mm	35 mm	45 mm

Adultes

Adults

Adultos

	O	P	L
<b>B80780</b>	200 mm	45 mm	65 mm

<b>B807860</b>	200 mm	65 mm	65 mm
----------------	--------	-------	-------

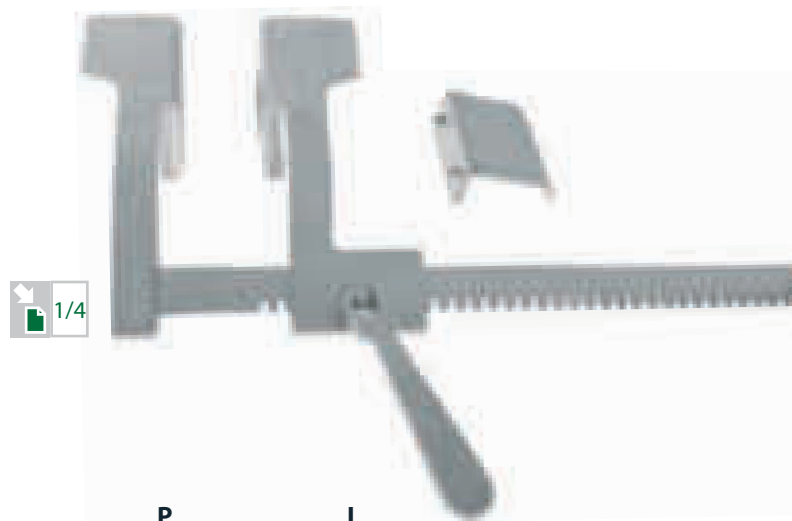
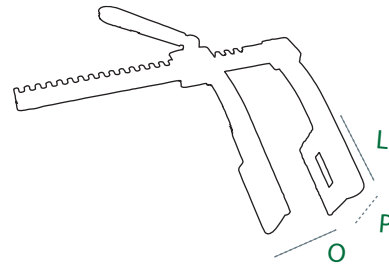

Complet avec valve supérieure

Complete with upper blade

Completo con válvula superior

	O	P	L
<b>B80785</b>	200 mm	45 mm	65 mm

O : Ouverture - Blades opening - Abertura de las hojas

P : Profondeur - Depth - Profundidad

L : Largeur - Width - Anchura

### FINOCHIETTO

Complet avec 3 paires de valves  
 Complete with 3 pairs of blades  
 Completo con 3 pares de valvas

 **B80790** 200 mm



P	L
45 mm	40 mm
40 mm	60 mm
50 mm	60 mm

O : Ouverture - Blades opening - Abertura de las hojas  
 P : Profondeur - Depth - Profundidad  
 L : Largeur - Width - Anchura

### FINOCHIETTO

Modèle Landanger complet avec 3 paires de valves  
 Complete Landanger model with 3 pairs of blades  
 Modelo Landanger completo con 3 pares de Valvas

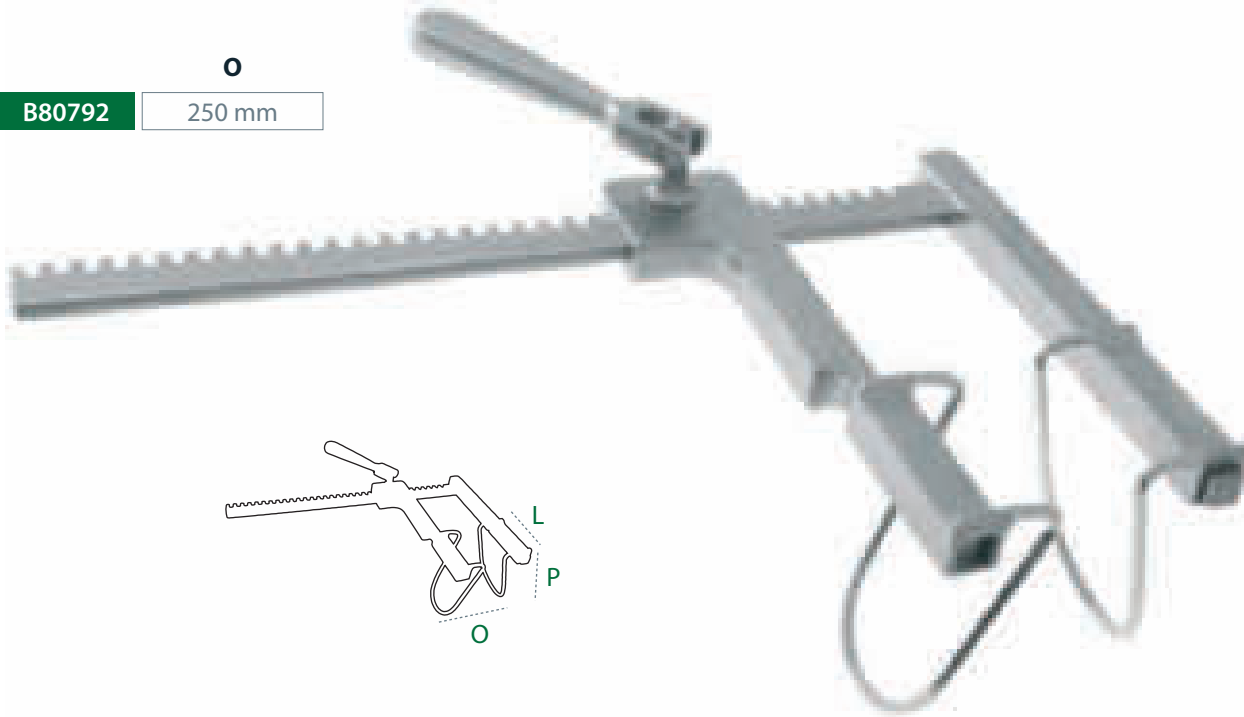

Valve genre Gosset  
 Gosset blade  
 Valva tipo Gosset

Valve thoracique  
 Thoracic blade  
 Valva toracica

Valve abdominale  
 Abdominal blade  
 Valva abdominale

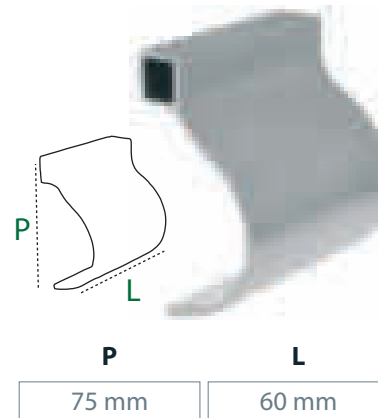
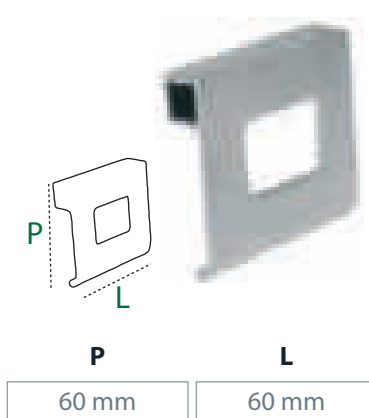
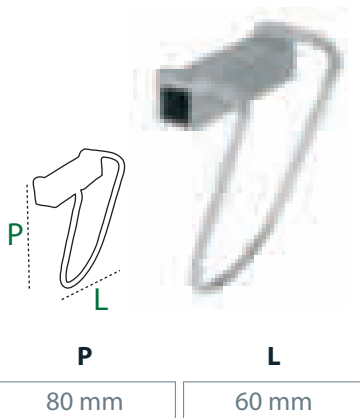

O : Ouverture - Blades opening - Abertura de las hojas  
 P : Profondeur - Depth - Profundidad  
 L : Largeur - Width - Anchura



 Aluminium  
Aluminum  
Aluminio

### FINOCHIETTO

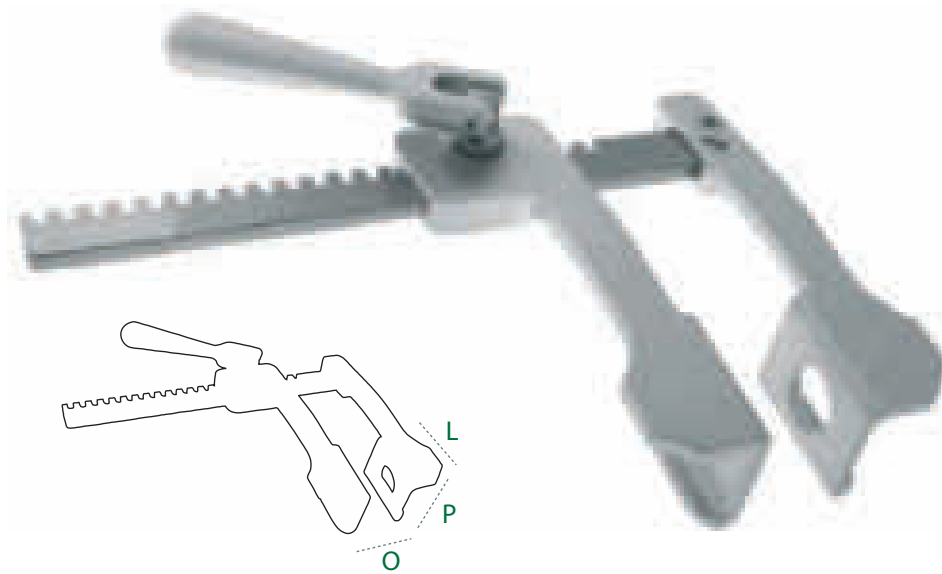

**B80895**

Nourrissons  
Infants  
Niños de pecho

	O	P	L
<b>B80890</b>	100 mm	31 mm	31 mm
<b>B808890</b>	70 mm	12 mm	15 mm

**BABY-HAIGHT**

Enfants  
Children  
Niños

	O	P	L
 <b>B80895</b>	150 mm	38 mm	44 mm

Adultes  
Adults  
Adultos

	O	P	L
<b>B80900</b>	180 mm	52 mm	62 mm

O : Ouverture - Blades opening - Abertura de las hojas  
P : Profondeur - Depth - Profundidad  
L : Largeur - Width - Anchura

### DUBOST

Complet avec 2 paires de valves (35 et 45 mm)  
 Complete with 2 pairs of blades (35 and 45 mm)  
 Completo con 2 pares de valvas (35 y 45 mm)

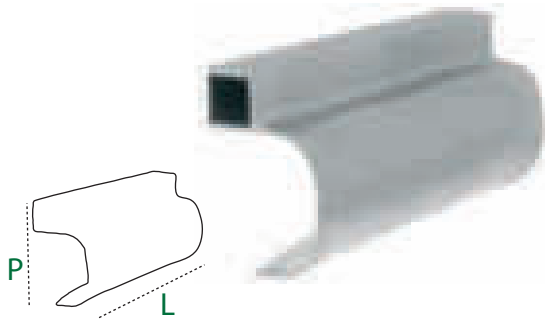
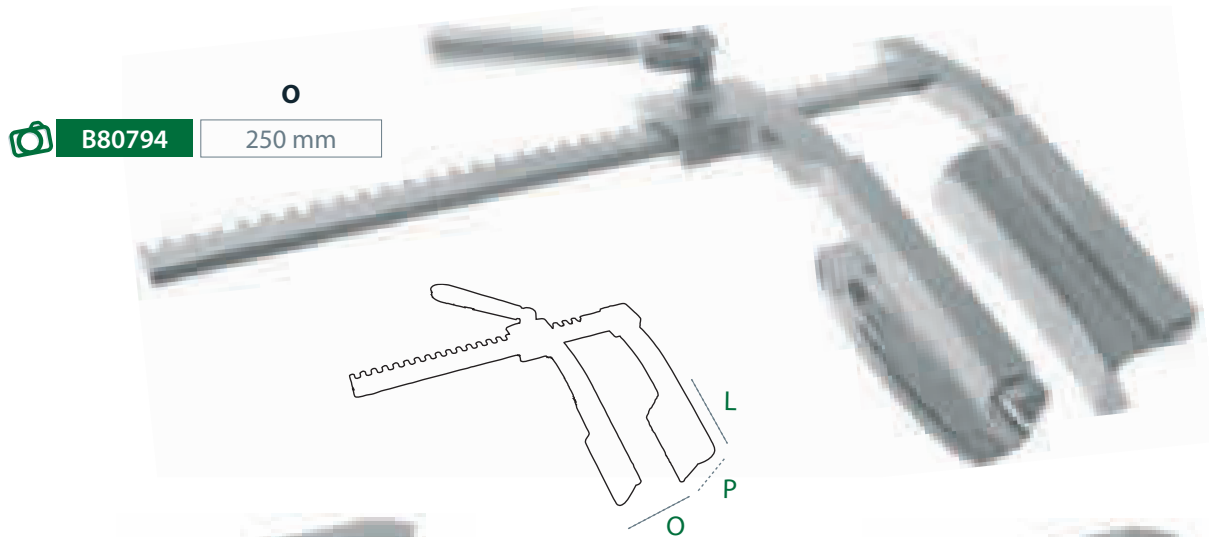

**P**      **L**  
 35 mm      100 mm

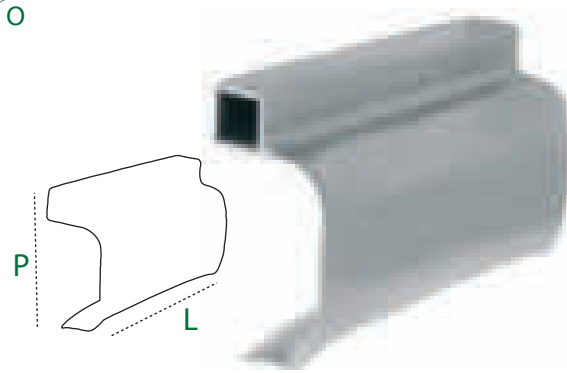

**P**      **L**  
 45 mm      100 mm

Valves complémentaires seules (paire)  
 Additional blades only (pair)  
 Valvas adicional sólas (par)

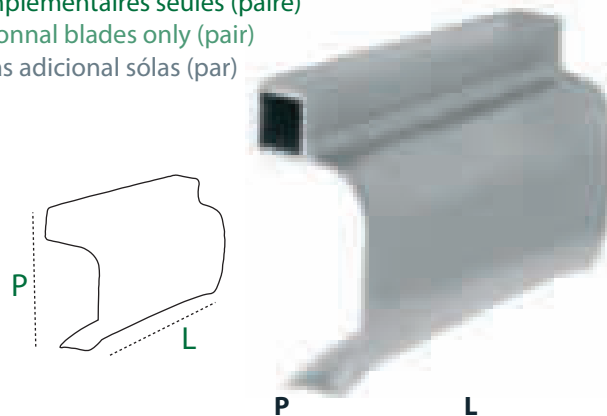

**P**      **L**  
 B807942      55 mm      100 mm

O : Ouverture - Blades opening - Abertura de las hojas  
 P : Profondeur - Depth - Profundidad  
 L : Largeur - Width - Anchura

### DUBOST NOGENT

Complet avec 3 paires de valves  
 Complete with 3 pairs of blades  
 Completo con 3 pares de valvas

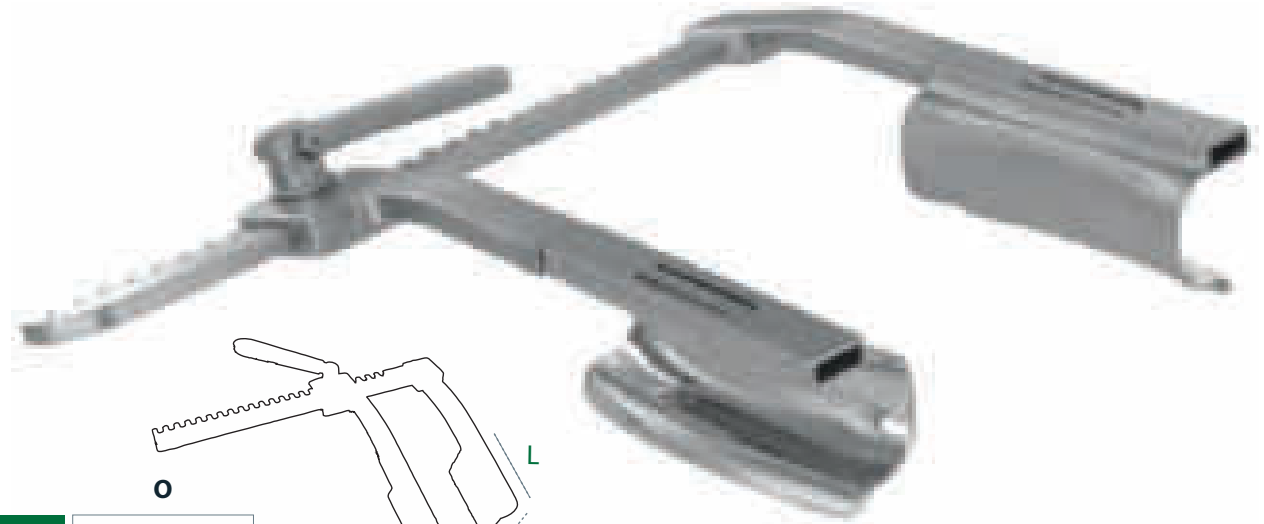

 **B807960** 280 mm

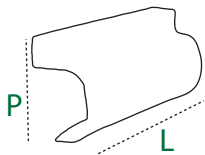
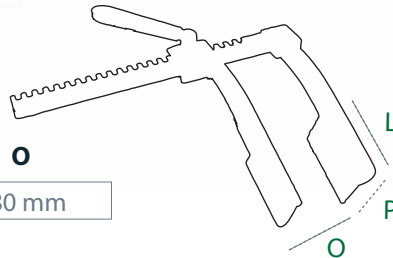

**B807961** 30 mm 100 mm

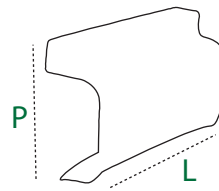

**B807962** 40 mm 100 mm

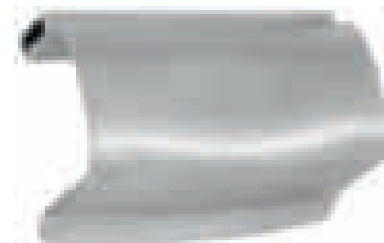
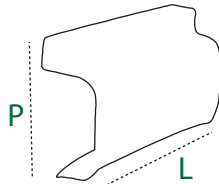

**B807963** 50 mm 100 mm

O : Ouverture - Blades opening - Abertura de las hojas  
 P : Profondeur - Depth - Profundidad  
 L : Largeur - Width - Anchura

### COOLEY

	O	P	L
 B807970	145 mm	21 mm	45 mm
 B807971	190 mm	32 mm	50 mm

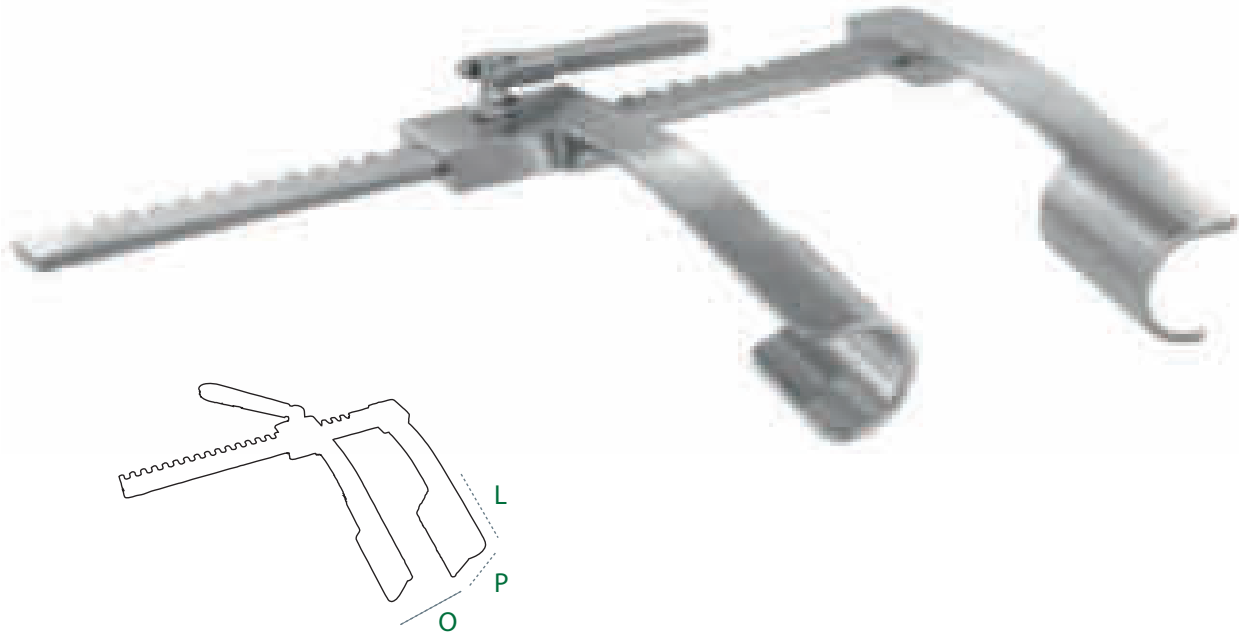

### HAIGHT

	O	P	L
 B807975	95 mm	30 mm	30 mm



O : Ouverture - Blades opening - Abertura de las hojas  
 P : Profondeur - Depth - Profundidad  
 L : Largeur - Width - Anchura

### DEBAKEY



Écarteur seul  
Retractor only  
Separador solo

O



**B807985** 150 mm

**B807986** 200 mm

Complet avec 3 paires de valves  
Complete with 3 pairs of blades  
Completo con 3 pares de valvas

**B807980** 150 mm

**B807985 + B807990 + B807991 + B807992**

**B807981** 200 mm

**B807986 + B807993 + B807994 + B807995**

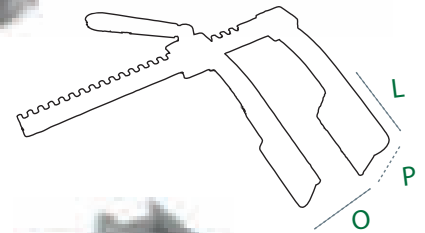

Pour B807985  
For B807985  
Para B807985



**B807990**  
30 x 30 mm

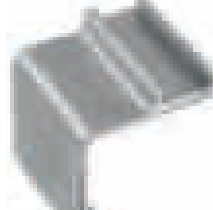

**B807991**  
40 x 40 mm



**B807992**  
50 x 50 mm

Valves latérales (paire)  
Lateral blades (pair)  
Valvas laterales (par)

Pour B807986  
For B807986  
Para B807986



**B807993**  
60 x 60 mm



**B807994**  
50 x 80 mm



**B807995**  
40 x 100 mm



**B807996**  
80 x 60 mm



**B807997**  
50 x 66 mm

O : Ouverture - Blades opening - Abertura de las hojas  
P : Profondeur - Depth - Profundidad  
L : Largeur - Width - Anchura



### MERCEDES

Écarteur seul  
Retractor only  
Separador sólo

**O**

<b>B807681</b>	280 mm
----------------	--------

Complet avec 2 paires de valves  
Complete with 2 pairs of blades  
Completo con 2 pares de valvas

**O**

 <b>B807680</b>	280 mm
---	--------

Valves latérales (paire)  
Lateral blades (pair)  
Valvas laterales (par)

**P**

**L**

<b>B807682</b>	75 mm	80 mm
----------------	-------	-------

<b>B807683</b>	48 mm	65 mm
----------------	-------	-------

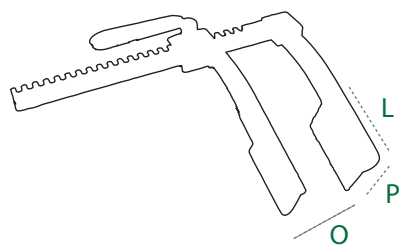
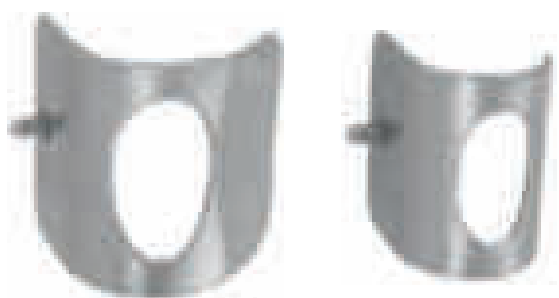

### MORSE-FAVALORO



**O**

**P**

**L**

<b>B807685</b>	155 mm	12 mm	20 mm
----------------	--------	-------	-------

 <b>B807686</b>	200 mm	40 mm	20 mm
--	--------	-------	-------

O : Ouverture - Blades opening - Abertura de las hojas

P : Profondeur - Depth - Profundidad

L : Largeur - Width - Anchura

### RACHIS NOGENT

Complet avec 6 paires de valves  
 Complete with 6 pairs of blades  
 Completo con 6 pares de valvas

O

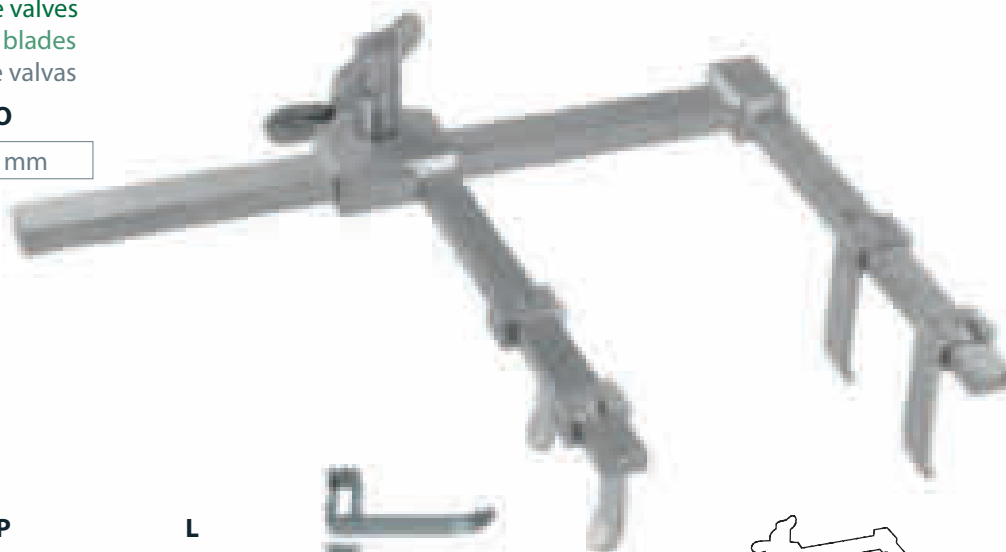

	<b>B809020</b>	180 mm
---	----------------	--------



Valves seules (2 paires)  
 Blades only (2 pairs)  
 Valvas sólo (2 pares)

P

L

	<b>B809021</b>	40 mm	12 mm
	<b>B809022</b>	50 mm	12 mm
	<b>B809023</b>	65 mm	12 mm

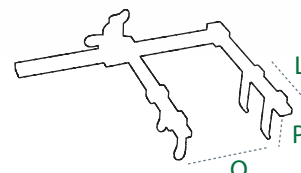

### CHANDLER

Complet avec 3 paires de valves  
 Complete with 3 pairs of blades  
 Completo con 3 pares de valvas



O

	<b>B809030</b>	100 mm
---	----------------	--------

Valves seules (paires)  
 Blades only (pairs)  
 Valvas sólo (pares)

P

L

	<b>B809031</b>	40 mm	15 mm
	<b>B809032</b>	50 mm	24 mm
	<b>B809033</b>	65 mm	24 mm

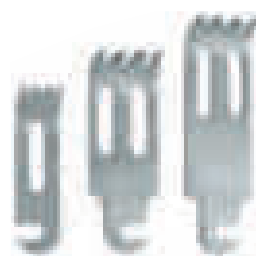

O : Ouverture - Blades opening - Abertura de las hojas  
 P : Profondeur - Depth - Profundidad  
 L : Largeur - Width - Anchura

### DRYSSEN

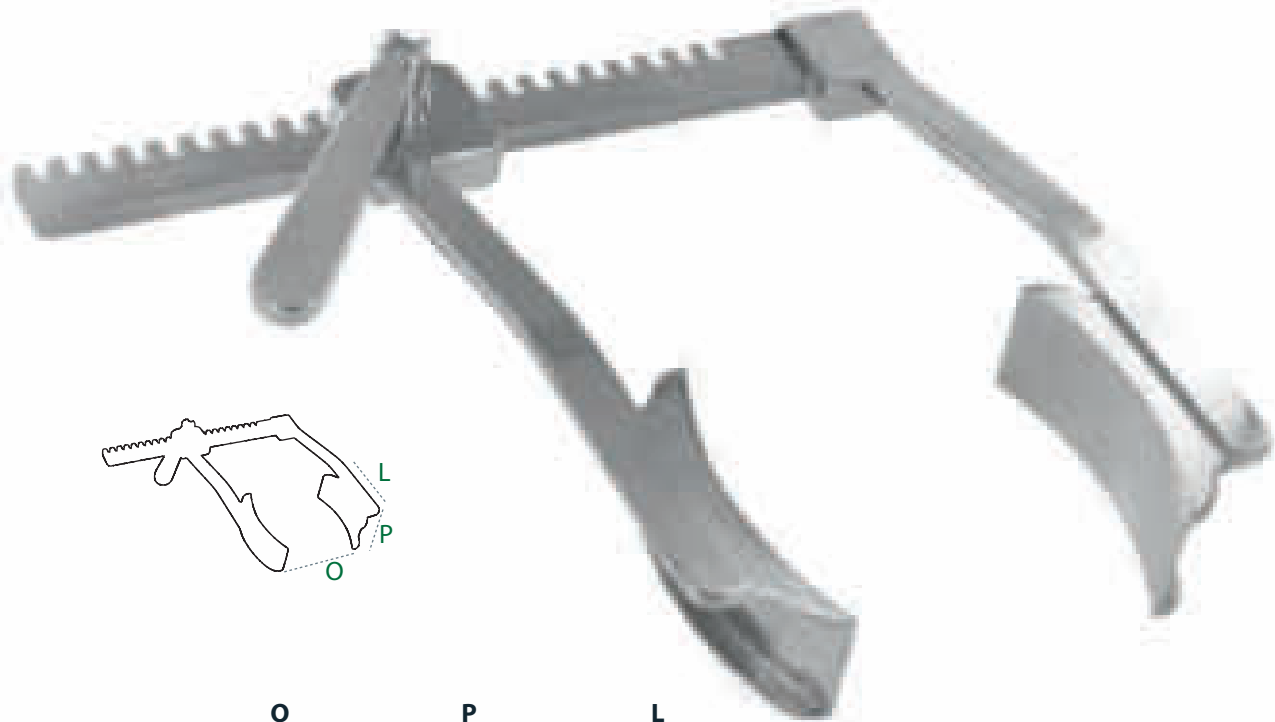

 <b>B807690</b>	<b>O</b> 185 mm	<b>P</b> 34 mm	<b>L</b> 90 mm
---	--------------------	-------------------	-------------------

### FINOCHIETTO-BURFORD

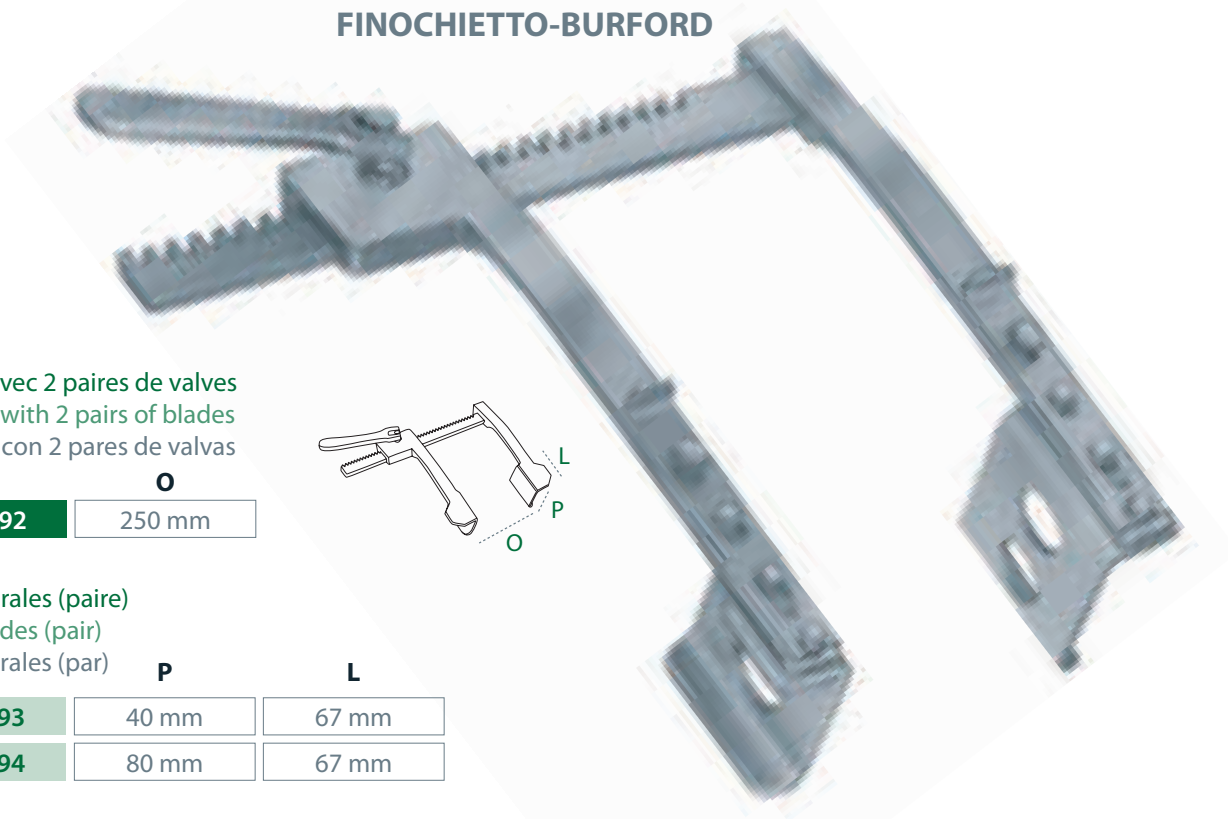

Complet avec 2 paires de valves  
Complete with 2 pairs of blades  
Completo con 2 pares de valvas

 <b>B807692</b>	<b>O</b> 250 mm
--	--------------------

Valves latérales (paire)  
Lateral blades (pair)  
Valvas laterales (par)

	<b>P</b>	<b>L</b>
<b>B807693</b>	40 mm	67 mm
<b>B807694</b>	80 mm	67 mm

O : Ouverture - Blades opening - Abertura de las hojas  
P : Profondeur - Depth - Profundidad  
L : Largeur - Width - Anchura



### HERTZLER

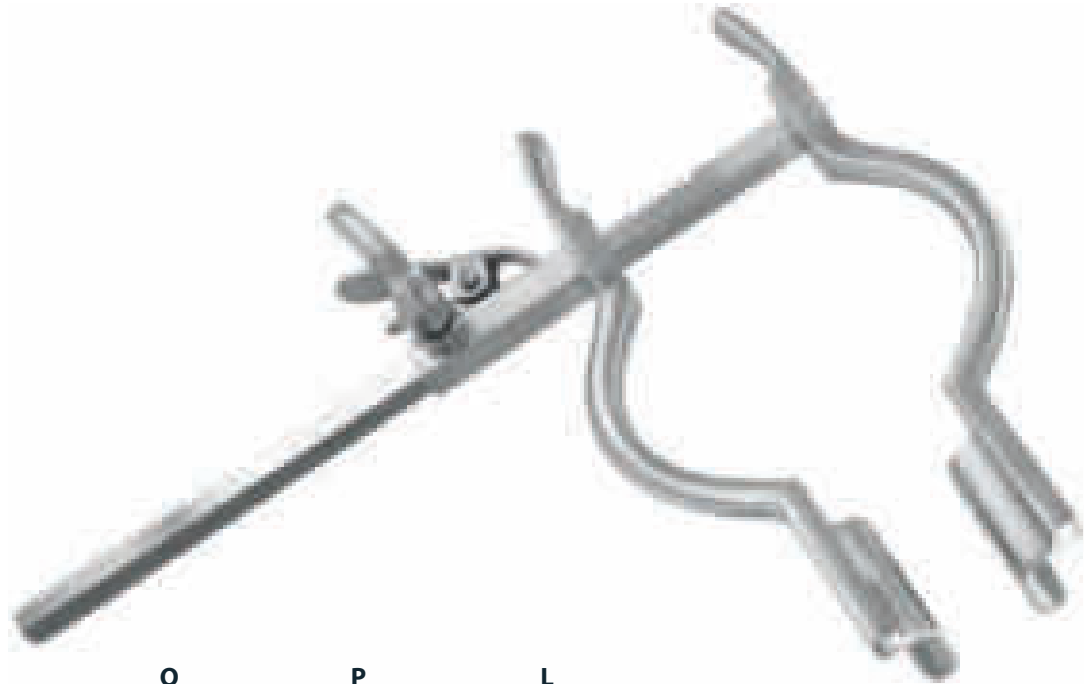

	O	P	L
 <b>B807955</b>	130 mm	21 mm	25 mm

### TUFFIER

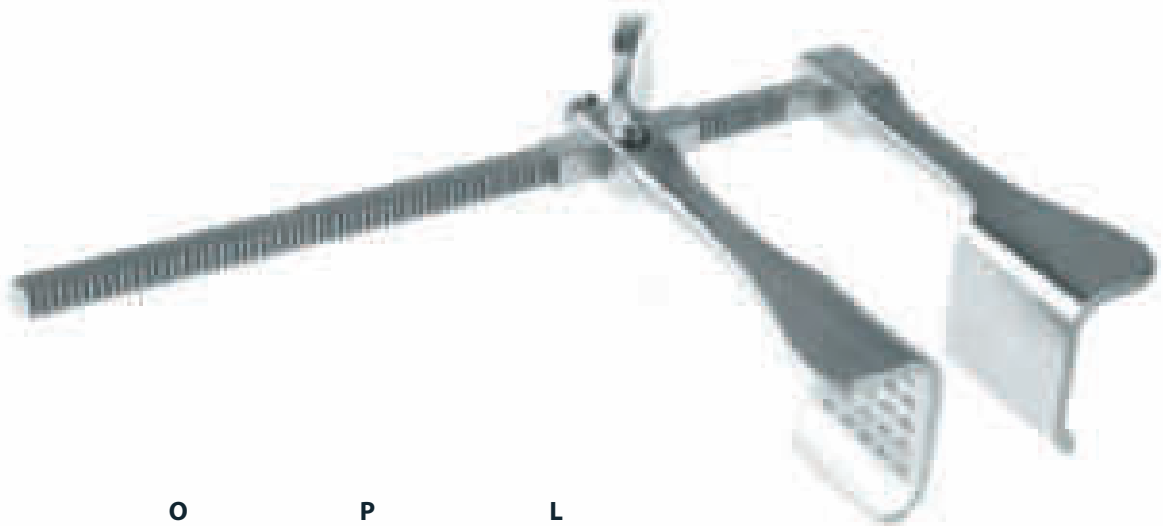
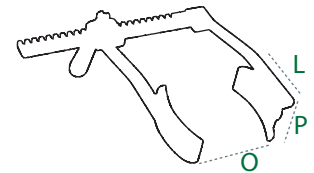

	O	P	L
 <b>B80795</b>	165 mm	42 mm	50 mm

O : Ouverture - Blades opening - Abertura de las hojas  
 P : Profondeur - Depth - Profundidad  
 L : Largeur - Width - Anchura

### BAILEY-BABY

Rapprocheur de cotes  
Rib contractor  
Contractor de costillas



**B808010**

14 cm - 5 1/2"

### BAILEY

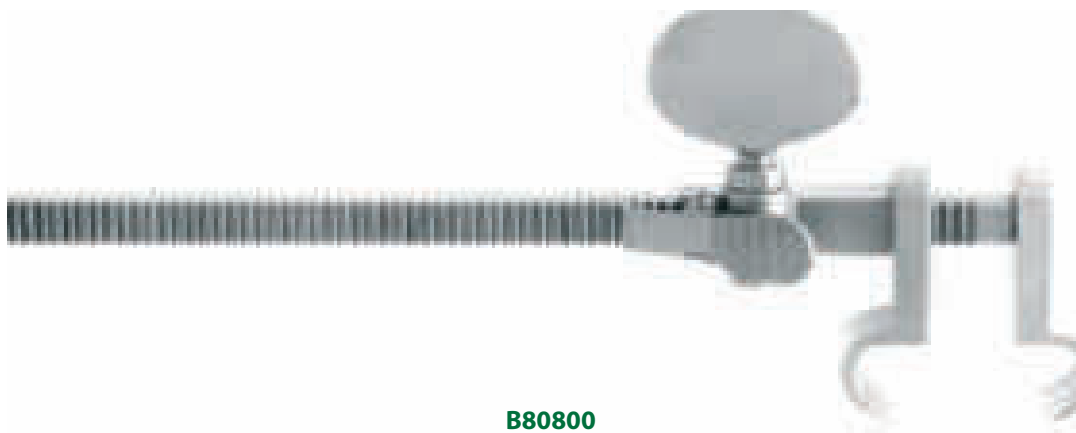

**B80800**

20 cm - 8"

### SELLORS



Valves pivotantes à 180°  
Swivel valves to 180°  
Valvas oscilantes hasta 180°

**B808020**

20 cm - 8"

### MAURER

Mors mobile  
Mobile jaws  
Bocados móviles



**J521850**  
19 cm - 7 1/2 "

### MATHEY



**J521860**  
18 cm - 7 "

### FINSEN

	Pointu Sharp Agudo	Mousse Blunt Romo
5 cm - 2" 	<b>B80295</b>	<b>B802951</b>
7 cm - 2 3/4"	<b>B80300</b>	<b>B803001</b>



**B80295**  
5 cm - 2"

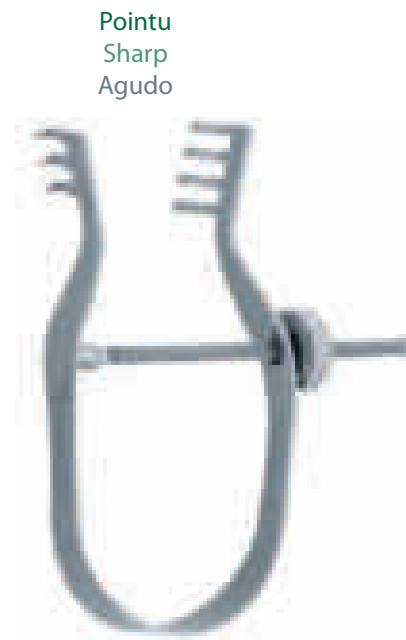

**B803005**  
7 cm - 2 3/4"

### ALM

	Pointu Sharp Agudo	Mousse Blunt Romo
7 cm - 2 3/4" 	<b>B802912</b>	<b>B802913</b>
10 cm - 4"	<b>B802914</b>	<b>B802915</b>

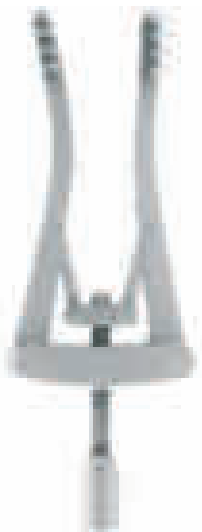

**B802912**  
7 cm - 2 3/4"

### HEISS (HOLZEIMER)

	Mousse Blunt Romo	Pointu Sharp Agudo
	<b>B80320</b>	<b>B803205</b>



**B80320**  
10 cm - 4"

### JANSEN-DEEP

Pointu	Mousse
Sharp	Blunt
Agudo	Romo

11,5 cm - 4<sup>1</sup>/<sub>2</sub>"

**B80290**

**B802901**



### JANSEN

Pointu	Mousse
Sharp	Blunt
Agudo	Romo

8 cm - 3<sup>1</sup>/<sub>4</sub>"



**B802905**

**B802910**



**B802901**

11,5 cm - 4<sup>1</sup>/<sub>2</sub>"



**B802905**

8 cm - 3<sup>1</sup>/<sub>4</sub>"

### PLESTER

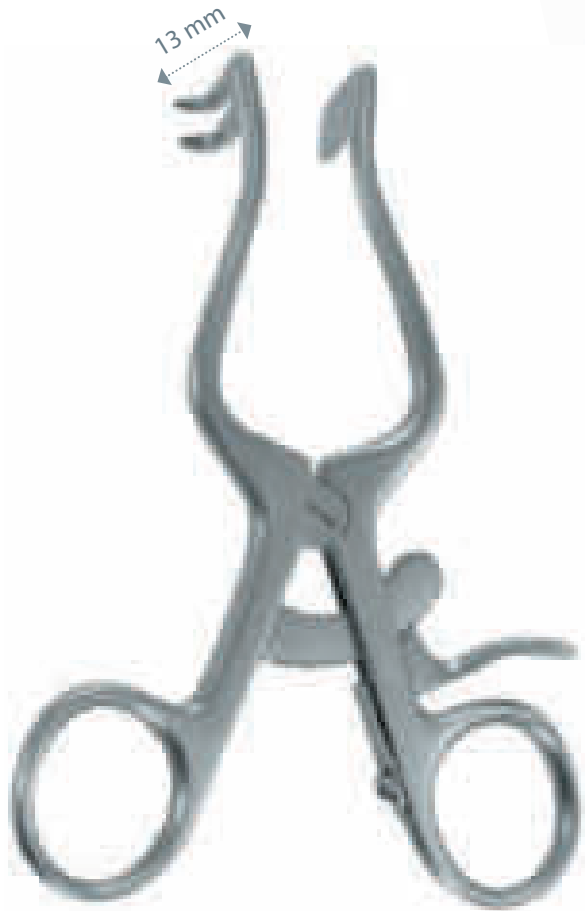

**B805241**  
11 cm - 4 1/2 "









**B805240**  
11 cm - 4 1/2 "



**B805246**  
13 cm - 5 "

	Pointu	Mousse
	Sharp	Blunt
	Agudo	Romo
13 cm - 5 "	<b>B805245</b>	<b>B805246</b>

### WEITLANER

	Pointu Sharp Agudo 	Semi-pointu Semi-sharp Semi-agudo 	Mousse Blunt Romo 
10,5 cm - 4 1/8 "	 <b>B80525</b>	<b>B805252</b>	<b>B805251</b>
13 cm - 5 "	<b>B80530</b>	<b>B805302</b>	 <b>B805301</b>
17 cm - 6 3/4 "	<b>B80535</b>	 <b>B805352</b>	<b>B805351</b>

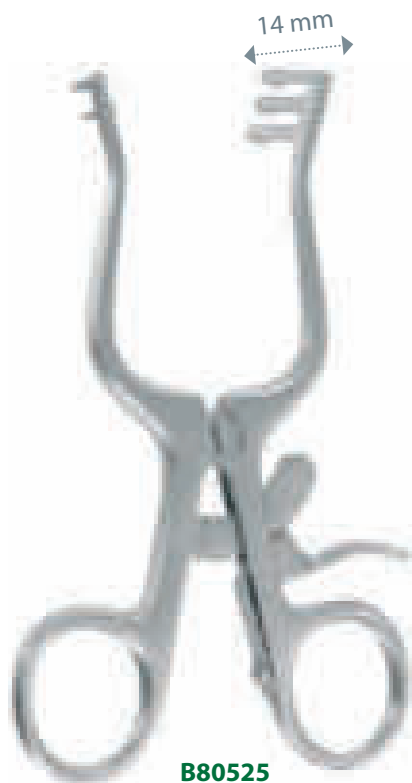

**B80525**  
10,5 cm - 4 1/8 "



**B805352**  
17 cm - 6 3/4 "



**B805301**  
13 cm - 5 "

### WEITLANER

Pointu  
Sharp  
Agudo

Mousse  
Blunt  
Romo



20 cm - 8" 	<b>B80537</b>	<b>B805371</b>
24 cm - 9 1/2"	<b>B805360</b>	<b>B805361</b>
25 cm - 9 3/4"	<b>B805390</b>	<b>B805391</b>



**B80537**  
20 cm - 8"

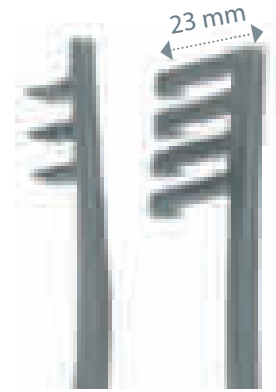

**B805360**  
24 cm - 9 1/2"

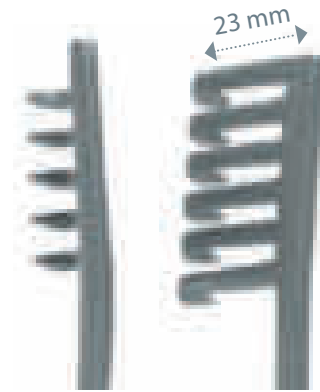

**B805390**  
25 cm - 9 3/4"



### HENLEY

Complet avec 1 valve médiane 16 x 25 mm  
 Complete with 1 center blade 16 x 25 mm  
 Completo con 1 valva mediana 16 x 25 mm

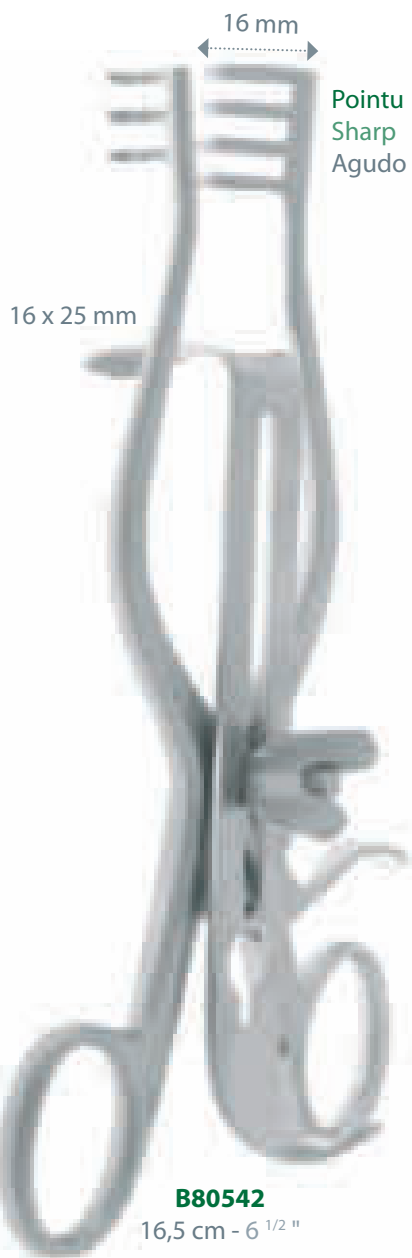

Valve médiane seule  
 Center blade only  
 Valva mediana sola

	P	L
<b>B805421</b>	16 mm	19 mm
<b>B805422</b>	16 mm	25 mm
<b>B805423</b>	16 mm	32 mm

### TRAVERS



### MAC KEE



**J52180**  
28 cm - 11 "

### NORFOLK-NORWICH



**B808655**  
22 cm - 8 3/4 "

### WEITLANER

### WEITLANER-WULLSTEIN

Courbe (dos d'âne) - Curved (back ass) - Curva (a bombado)

Pointu  
Sharp  
Agudo

Pointu  
Sharp  
Agudo

Mousse  
Blunt  
Romo

Dents  
Teeth  
Dientes

15 cm - 6 "

**B805382**

**MOLISSON**

13 cm - 5 "

**B805395**

**B805396**

3 x 3

16 cm - 6 1/4 "

**B80538**



16 cm - 6 1/4 "

**B80540**

**B805401**

3 x 4

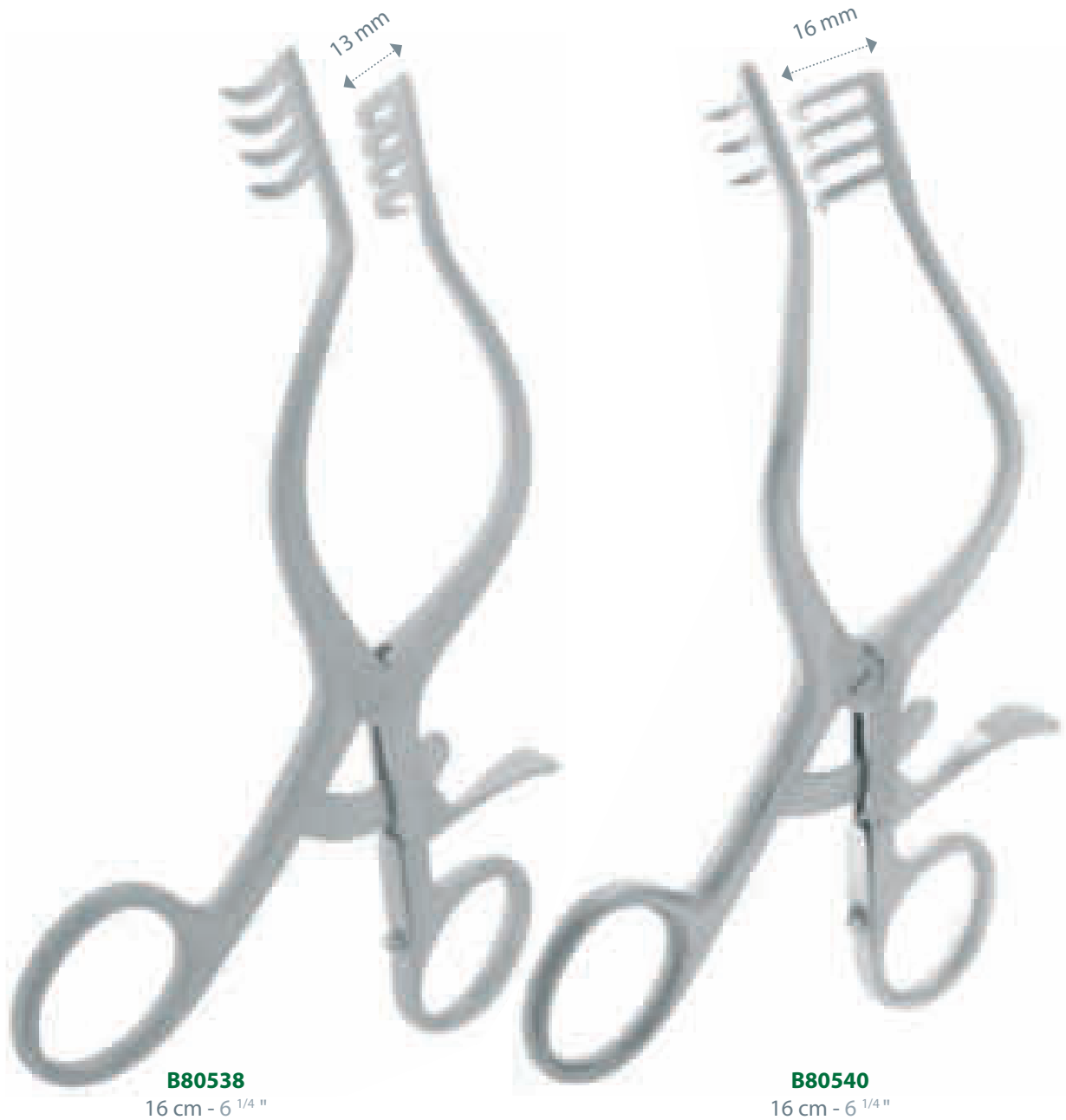

**B80538**

16 cm - 6 1/4 "

**B80540**

16 cm - 6 1/4 "

### WEITLANER-NEURO

### ANDERSON-ADSON

Courbe (dos d'âne) - Curved (back ass) - Curva (a bombado)

Pointu  
Sharp  
Agudo

Mousse  
Blunt  
Romo



20 cm - 8"

**B805412**

**B805413**





**B805410**  
20 cm - 8"



**B805413**  
20 cm - 8"

### BECKMANN CONE

	Pointu Sharp Agudo	Mousse Blunt Romo	Dents Teeth Dientes	
			P	
14 cm - 5 1/2 "	<b>B805425</b>	<b>B80543</b>	14 mm	3 x 4
17 cm - 6 3/4 "	<b>B805445</b>	<b>B80545</b>	14 mm	3 x 4
21 cm - 8 1/4 "	<b>B805495</b>	<b>B80550</b>	16 mm	3 x 4
26 cm - 10 1/4 "	<b>B805530</b>	<b>B805535</b>	25 mm	3 x 4

### BECKMANN

	Mousse Blunt Romo	Dents Teeth Dientes	
		P	
14 cm - 5 1/2 "	<b>B80544</b>	8 mm	4 x 4
17 cm - 6 3/4 "	<b>B80546</b>	10 mm	4 x 4
21 cm - 8 1/4 "	<b>B80551</b>	16 mm	4 x 4
21 cm - 8 1/4 "	<b>B80548</b>	30 mm	4 x 4

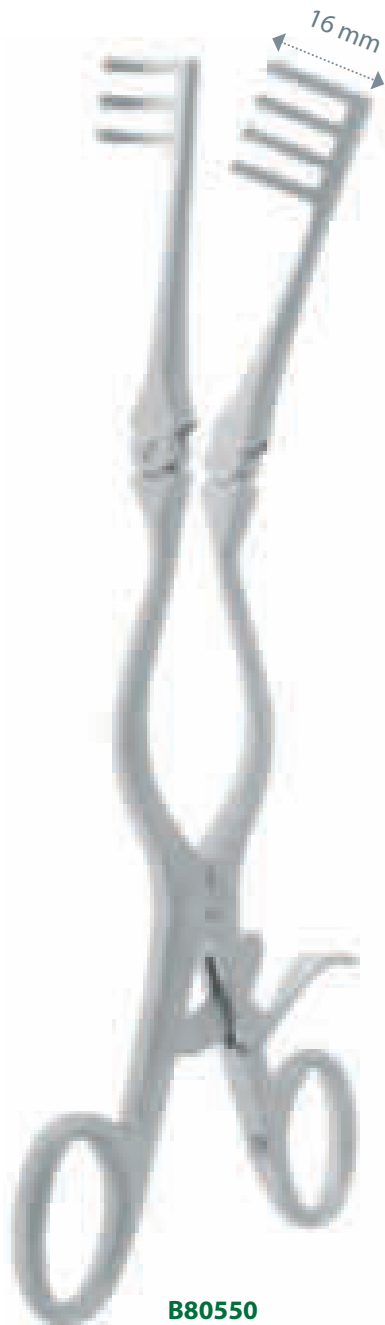

**B80550**  
21 cm - 8 1/4 "

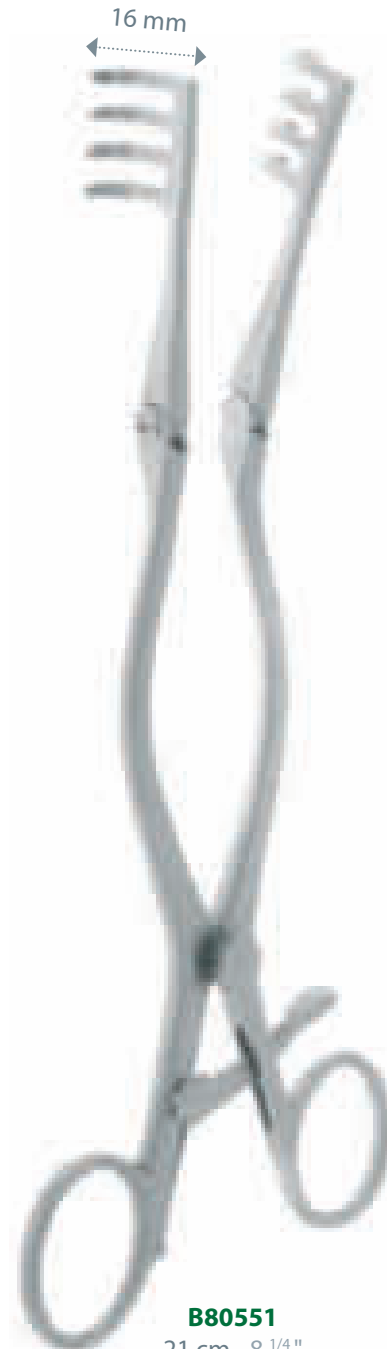

**B80551**  
21 cm - 8 1/4 "

P : Profondeur - Depth - Profundidad

### BECKMANN

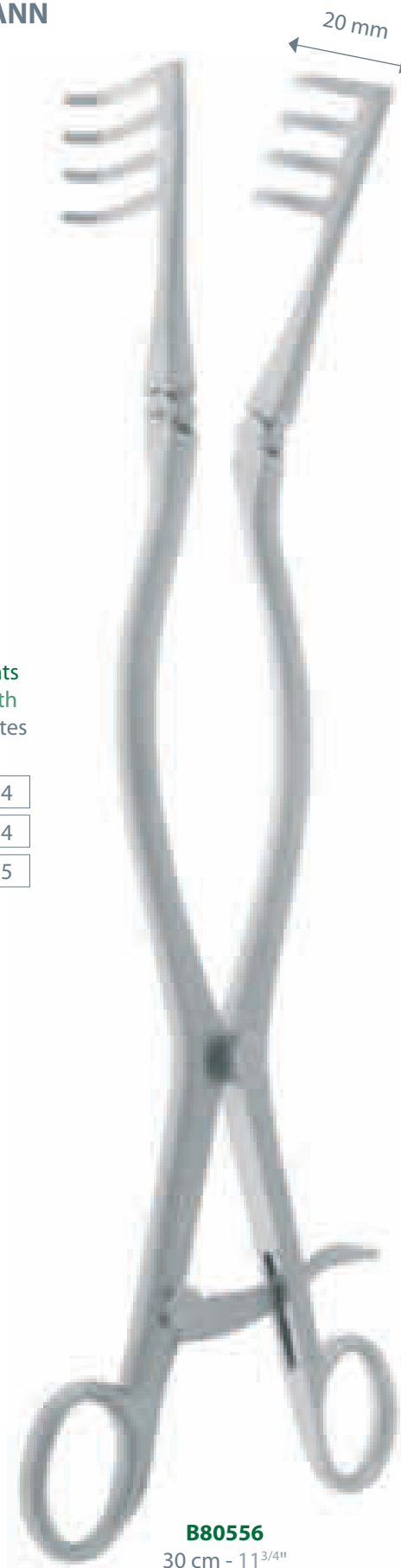

Mousse  
Blunt  
Romo

Dents  
Teeth  
Dientes

**P**

30 cm - 11 <sup>3/4</sup> " 	<b>B80556</b>	20 mm	4 x 4
30 cm - 11 <sup>3/4</sup> "	<b>B80561</b>	30 mm	4 x 4
30 cm - 11 <sup>3/4</sup> "	<b>B80566</b>	50 mm	5 x 5

**B80556**

30 cm - 11<sup>3/4</sup>"

P : Profondeur - Depth - Profundidad

### BECKMANN

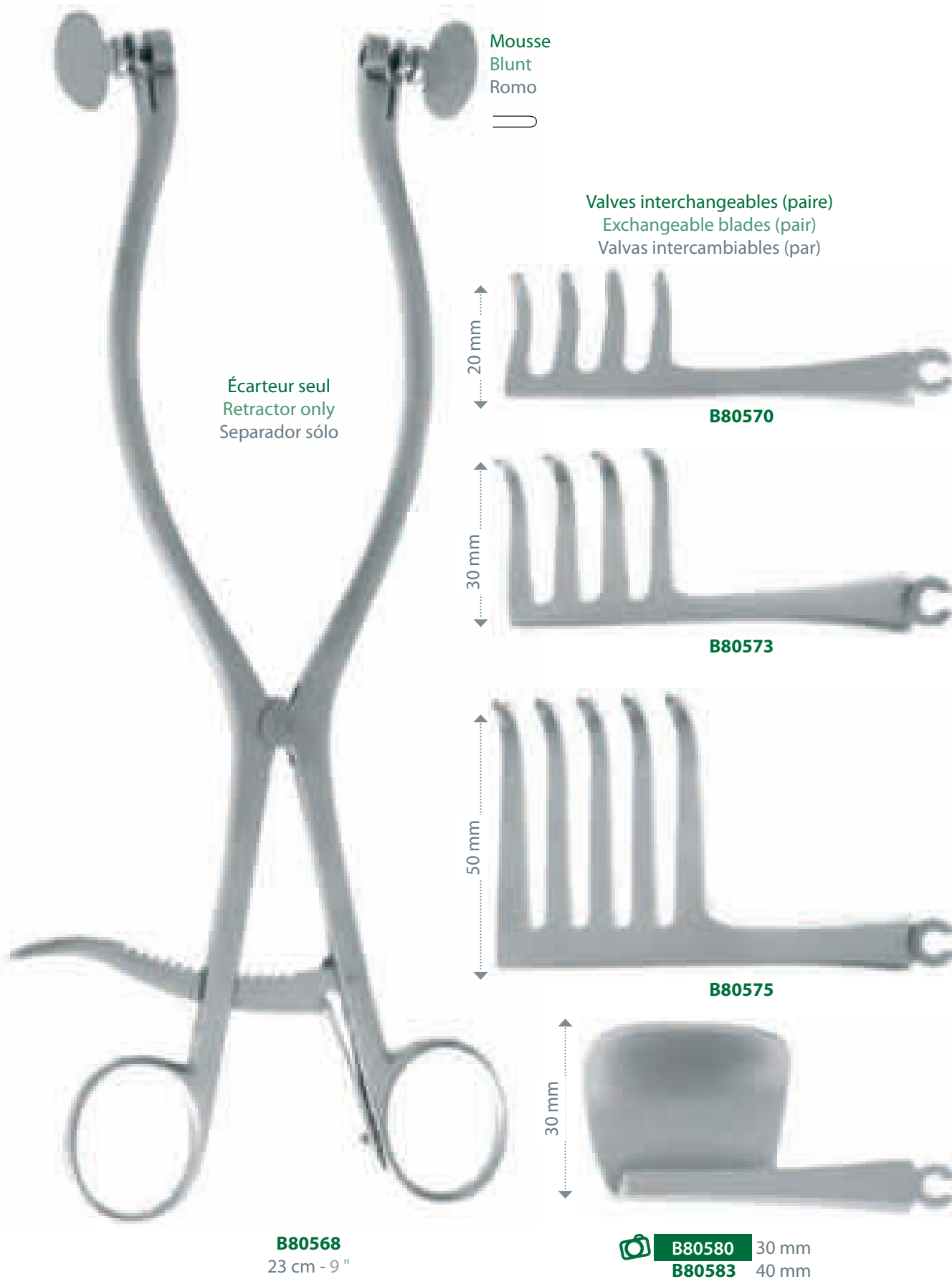

Mousse  
Blunt  
Romo



Valves interchangeables (paire)  
Exchangeable blades (pair)  
Valvas intercambiables (par)

Écarteur seul  
Retractor only  
Separador sólo

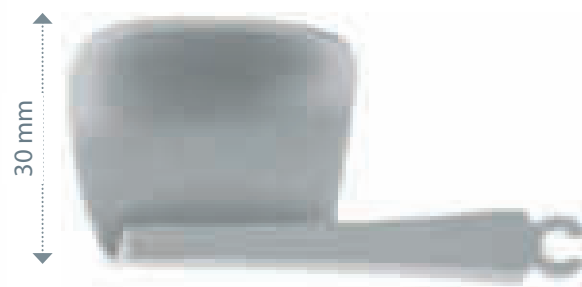
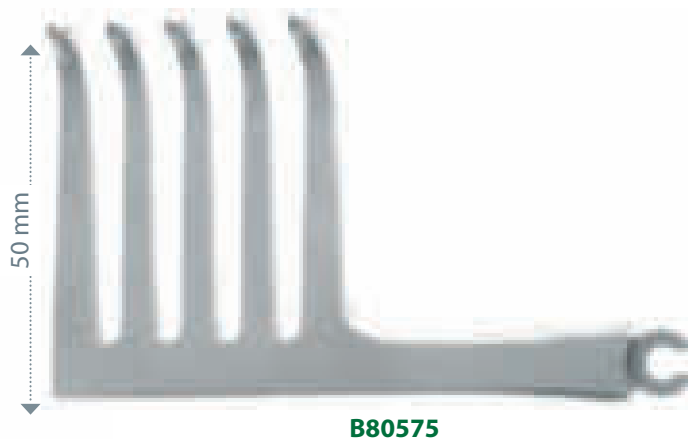

**B80568**  
23 cm - 9"

 **B80580** 30 mm  
**B80583** 40 mm

DECOULX

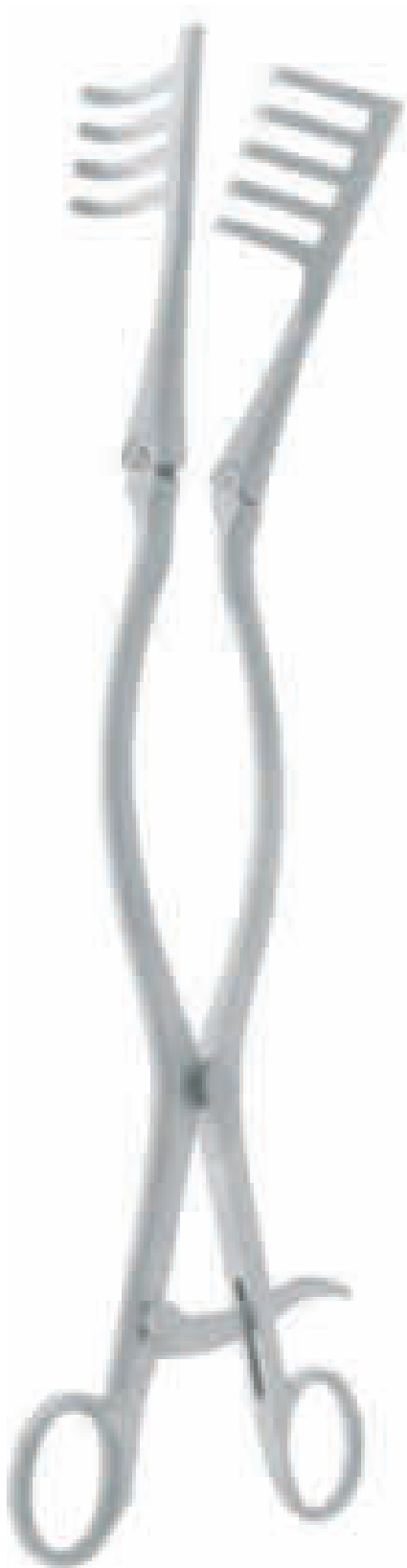

**B80588**  
33 cm - 13 "

Griffes rondes  
Round teeth  
Dientes redondos

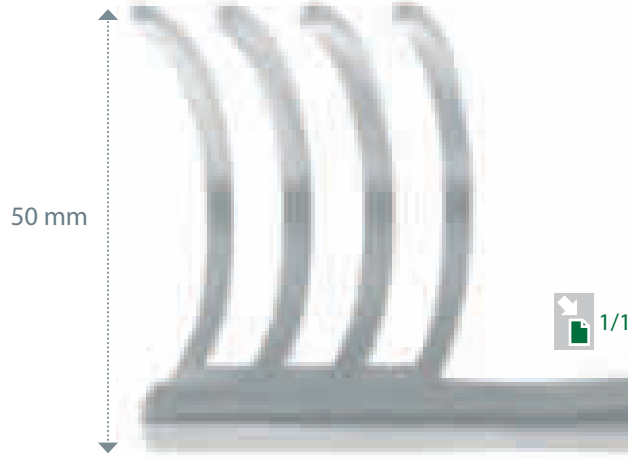

**B80586**

Griffes carrées  
Square teeth  
Dientes cuadradas

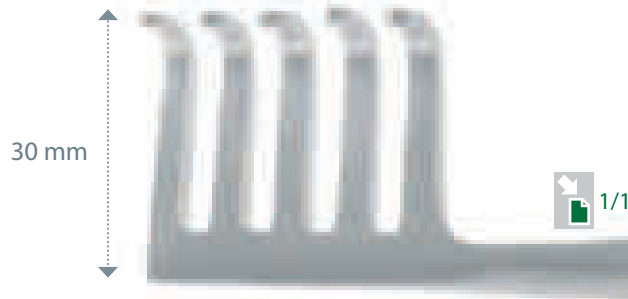

**B80588**



BECKMANN-EATON

ADSON

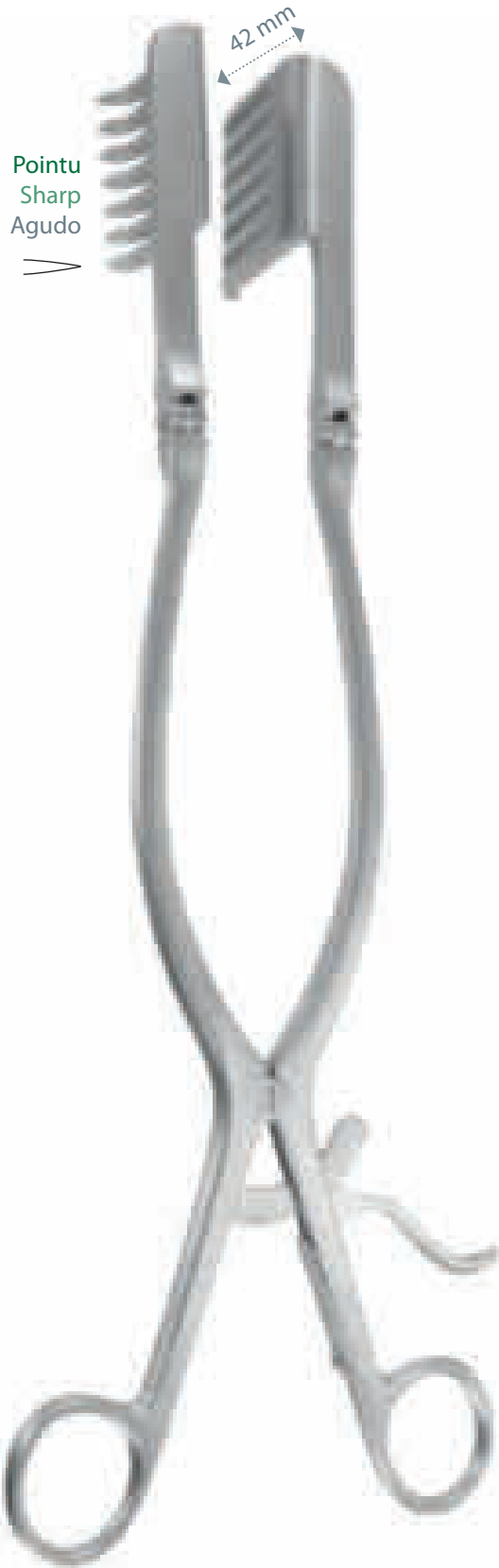

**B808580**  
33 cm - 13 "

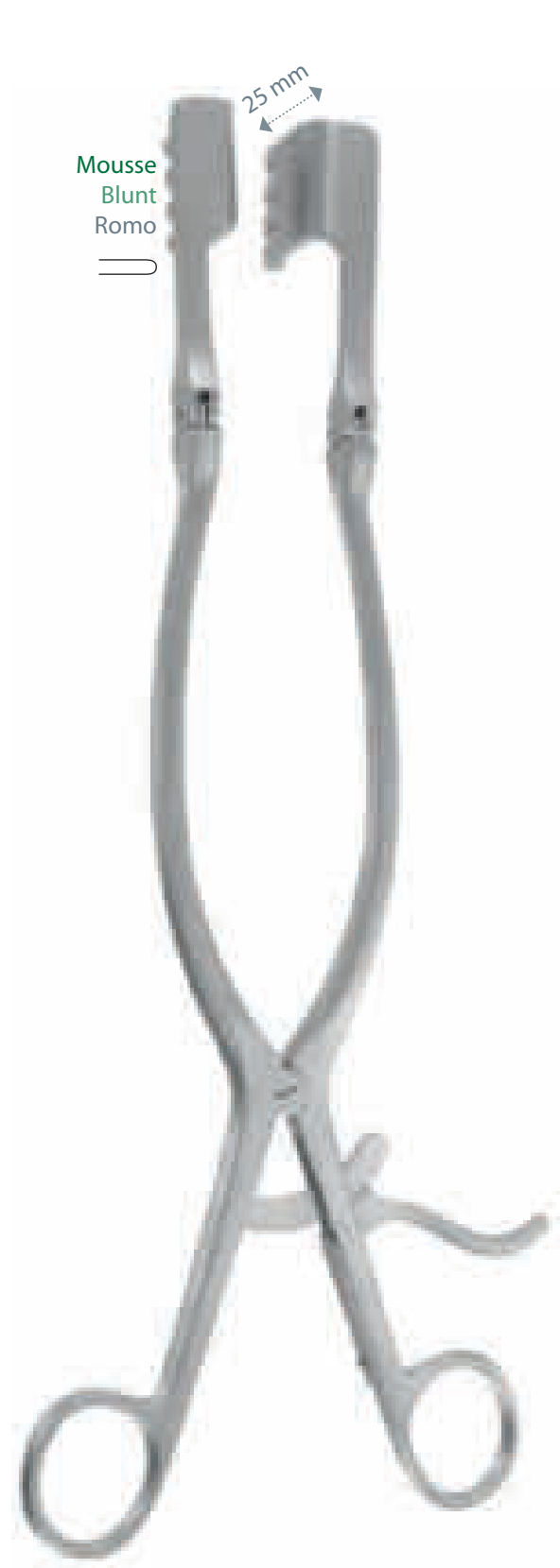

**B808590**  
31 cm - 12<sup>1/4</sup>"

### BECKMANN-ADSON

Pointu  
Sharp  
Agudo

Mousse  
Blunt  
Romo



25 mm  **B808680** **B808681**

44 mm **B808672** **B808673**

Pointu  
Sharp  
Agudo

Semi-pointu  
Semi-sharp  
Semi-agudo

Mousse  
Blunt  
Romo



22 mm **B808660** **B808662** **B808661**



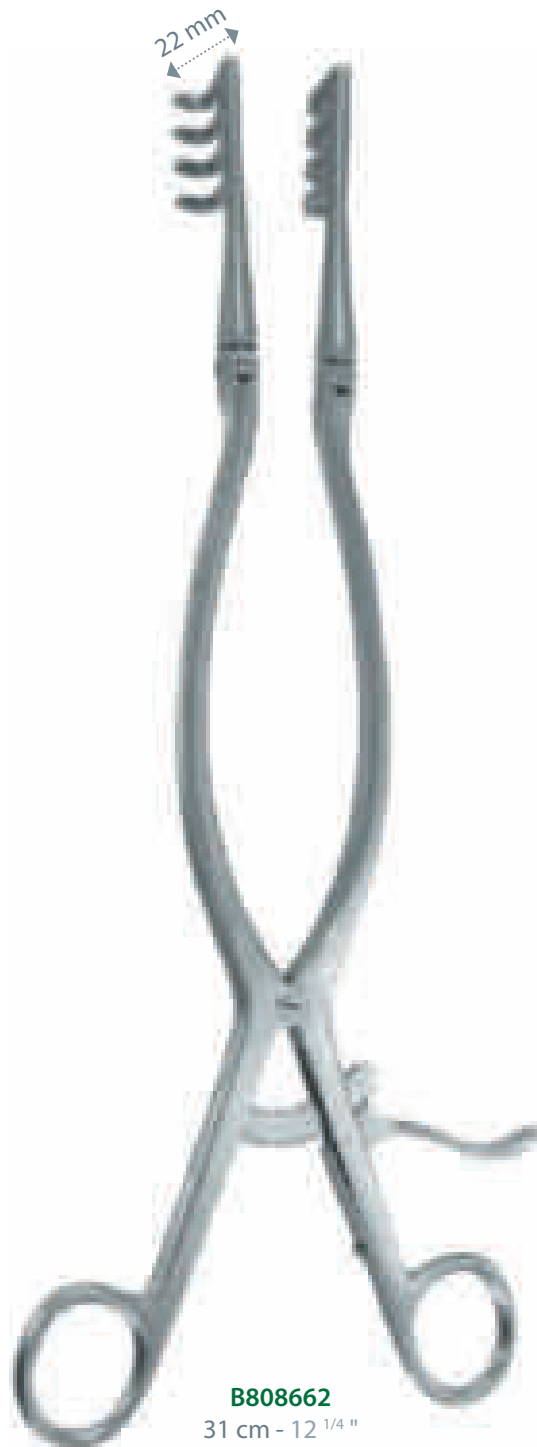

### ADSON

Pointu  
Sharp  
Agudo



Mousse  
Blunt  
Romo



Pointu  
Sharp  
Agudo



**B808694**

**B808695**



30 mm

6 griffes courtes 13 mm  
6 short teeth 13 mm  
6 dientes cortos 13 mm

A gauche      A droite  
On the left side      On the right side  
A la izquierda      A la derecha



**B80874**

**B80878**

6 x 6 griffes 32 mm  
6 x 6 teeth 32 mm  
6 x 6 dientes 32 mm

**B80870**



13 mm

32 mm

**B808694**  
27 cm - 10 1/2 "

**B80874**  
27 cm - 10 1/2 "

### WALTON

Pour hémilaminectomie  
For hemilaminectomy  
Para hémilaminectomía

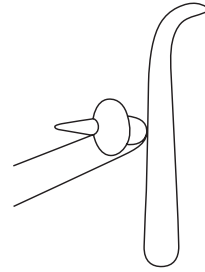
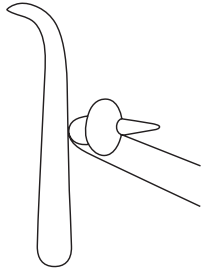

Griffes à gauche  
Teeth on the left side  
Dientes a la izquierda



Griffes à droite  
Teeth on the right side  
Dientes a la derecha

Pointue  
Sharp  
Aguda



**B80860**  
20 cm - 8 "



**B80865**  
20 cm - 8 "

MARKHAM-MEYERDING



42 x 26 mm

Valve à gauche  
Blade on the left side  
Valva a la izquierda

**B808570**  
18 cm - 7 "





42 x 26 mm

Valve à droite  
Blade on the right side  
Valva a la derecha

**B808571**  
18 cm - 7 "

### WILLIAMS

20 cm - 8"  **B808564** 70 x 10 mm  
 20 cm - 8"  **B808566** 70 x 20 mm

20 cm - 8"  **B808565** 70 x 10 mm  
 20 cm - 8"  **B808567** 70 x 20 mm

Valve à droite  
 Blade on the right side  
 Valva a la derecha

Valve à gauche  
 Blade on the left side  
 Valva a la izquierda



**B808564**  
 20 cm - 8"



**B808565**  
 20 cm - 8"



### GELPI

- 13 cm - 5 " **B808545**
- 19 cm - 7 1/2 " **B80855** 

### DEBAKEY

- 10 cm - 4 " **B808551**
- 12 cm - 4 3/4 " **B808552** 
- 17 cm - 6 3/4 " **B808553**



**B80855**  
19 cm - 7 1/2 "

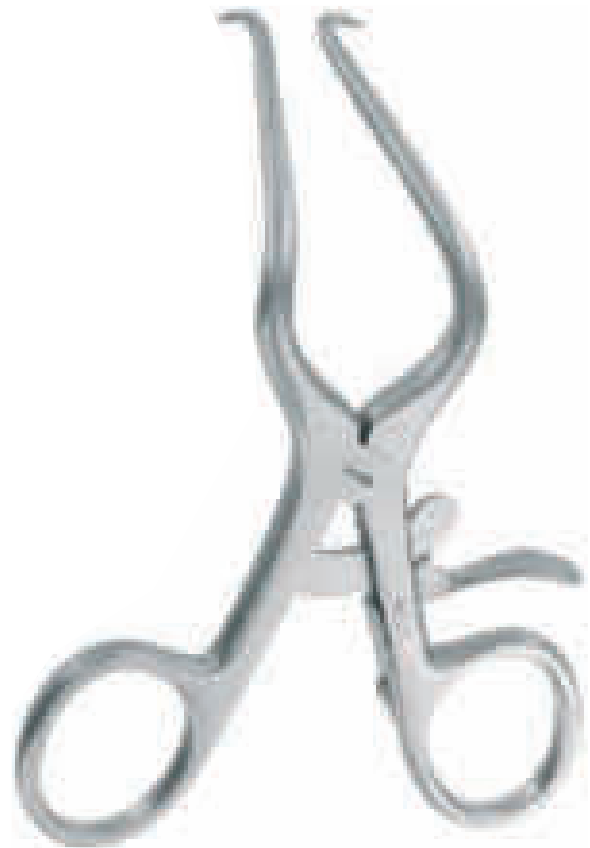

**B808552**  
12 cm - 4 3/4 "

JOLL

COURTY

Pour goître  
For goitre  
Para bocio



**B80845**  
14,5 cm - 5 3/4 "



**B808460**  
19 cm - 7 1/2 "



Leviers pour os du pied et de la main  
 Bone levers for foot and hand bones  
 Elevadores para huesos del pie y de la mano

**BUCK-GRAMCKO**

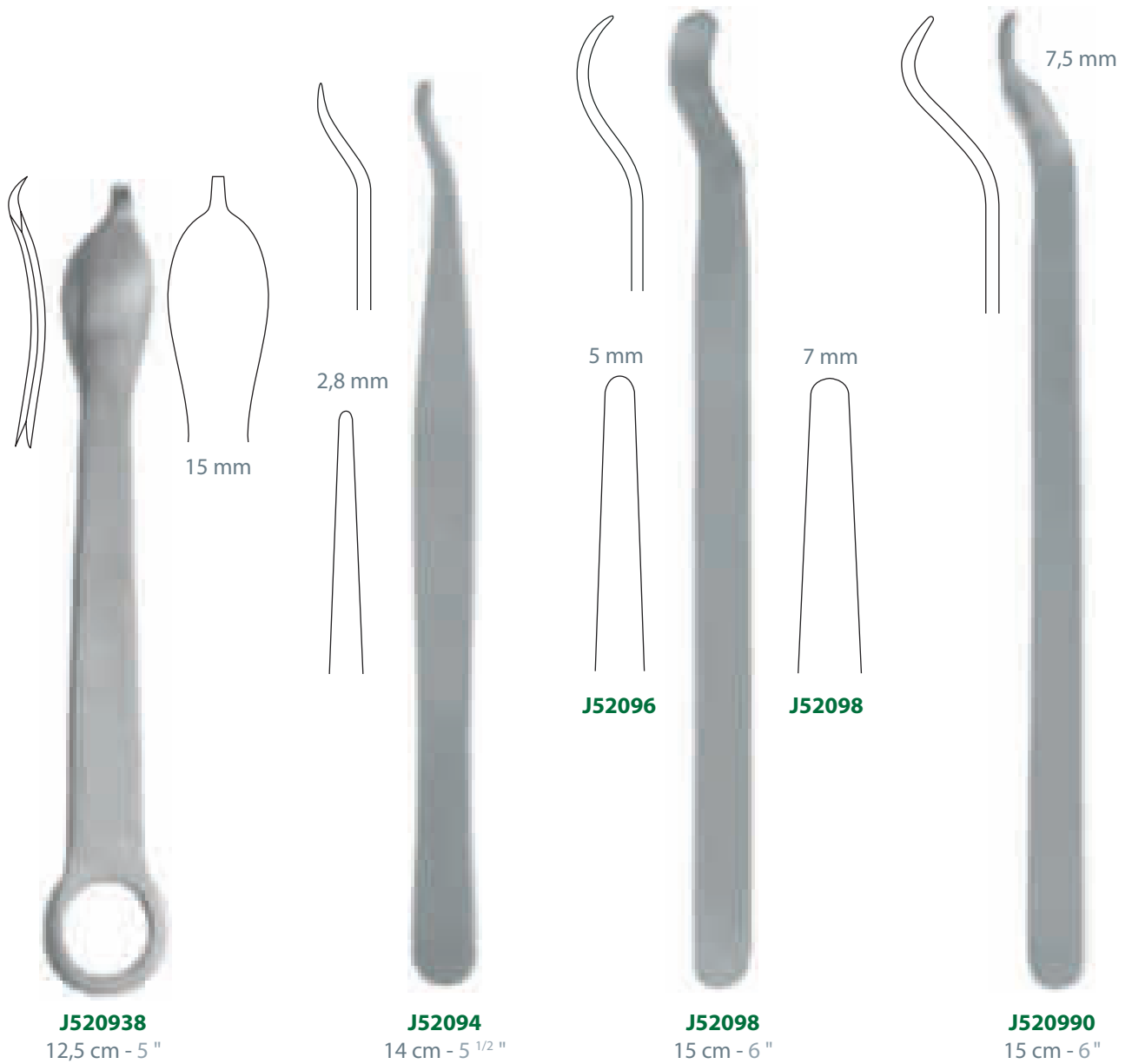

### LANGE-HOHMANN

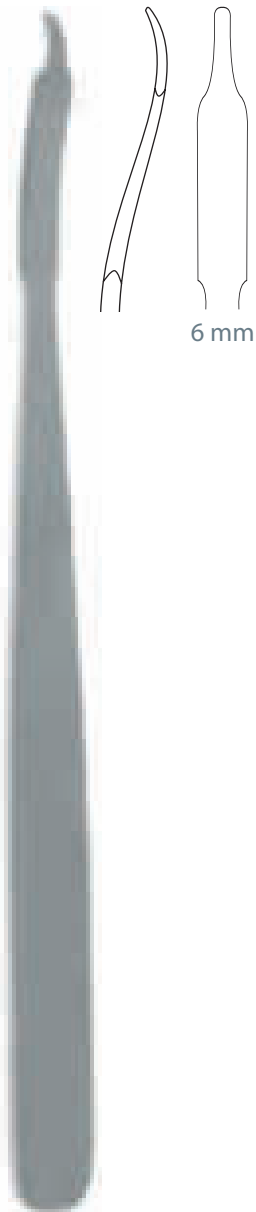

**J52072**  
16 cm - 6 1/4 "

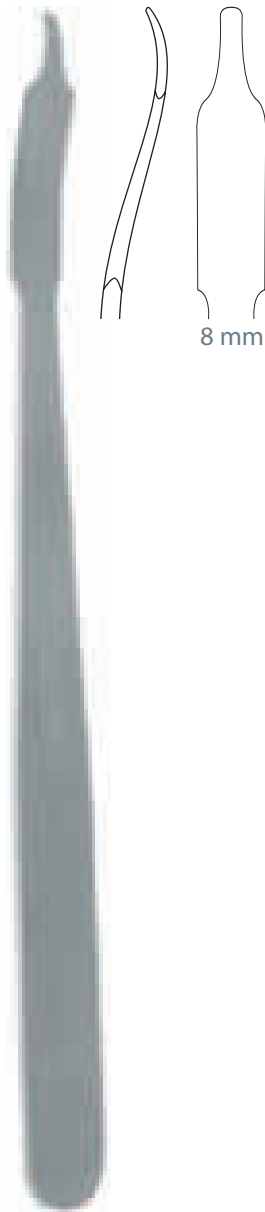

**J52074**  
16 cm - 6 1/4 "

### WAGNER



**J520770**  
22 cm - 8 3/4 "

### LANGE-HOHMANN

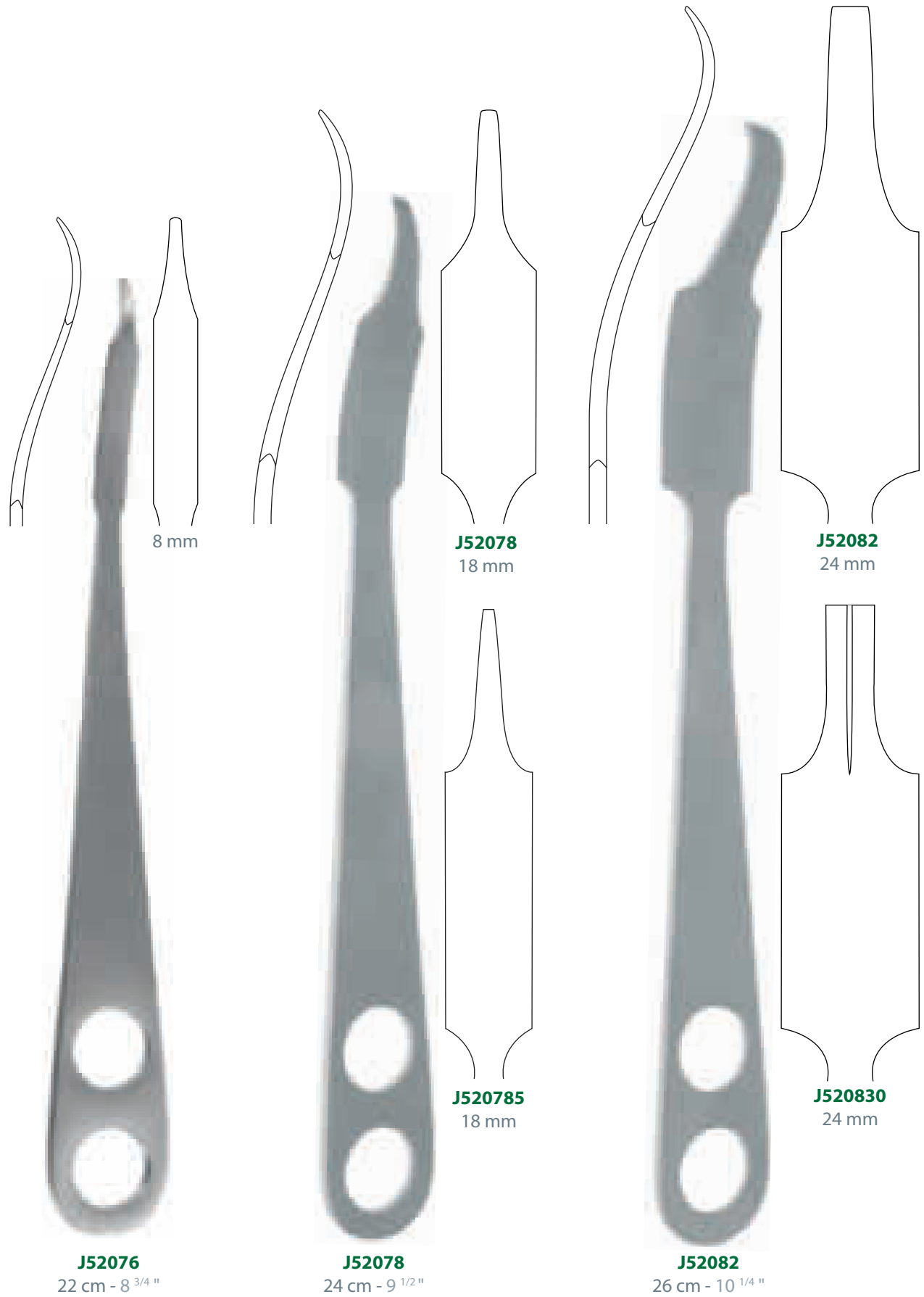

### LANGE-HOHMANN

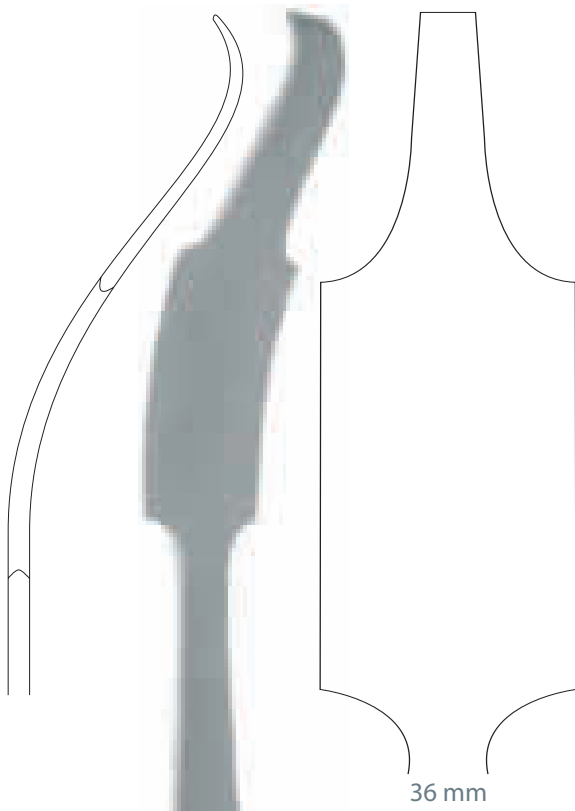

**J52084**  
28 cm - 11 "

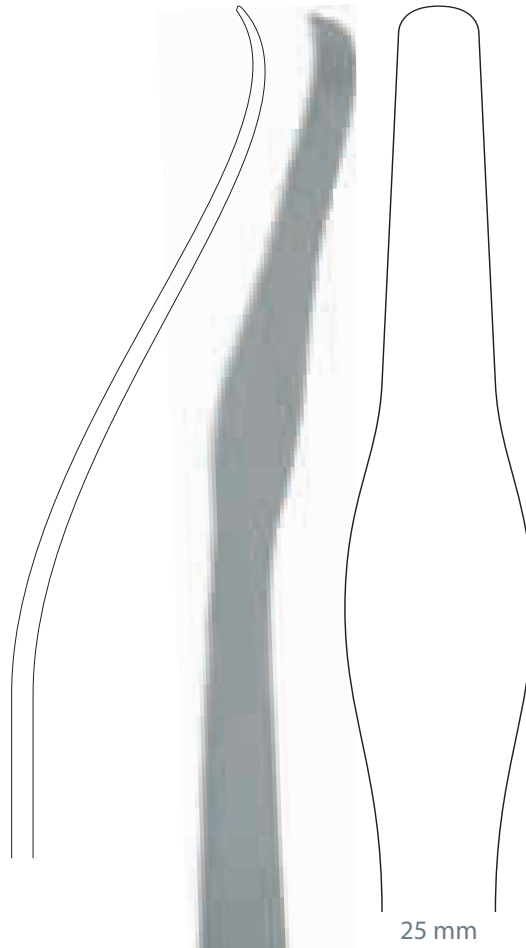

**J52092**  
27 cm - 10 1/2 "

VERBRUGGE-MULLER

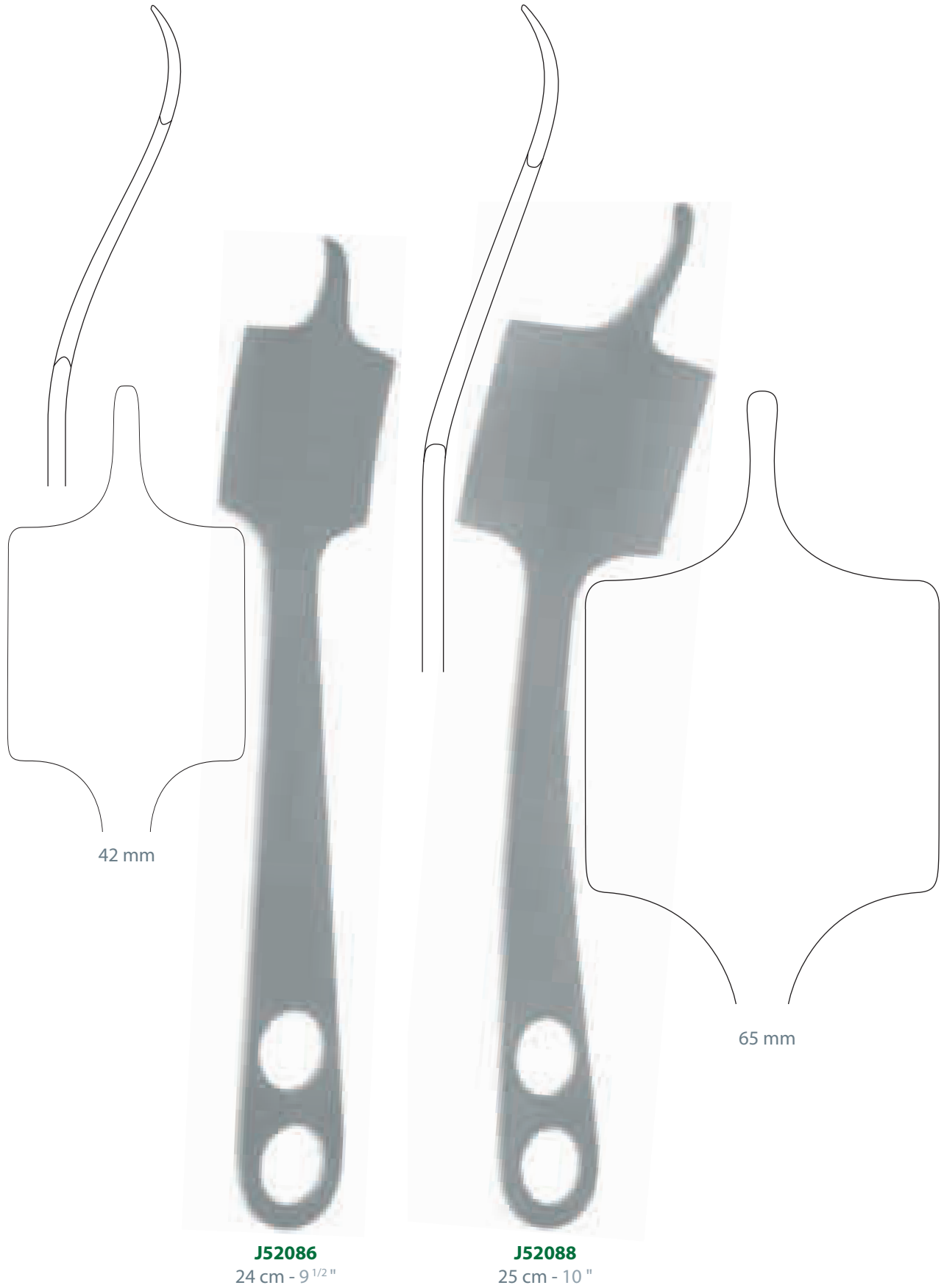

### LANGE-HOHMANN

26,5 cm - 10 1/2"  **J520925** 30 mm

29 cm - 11 1/2" **J520926** 33 mm

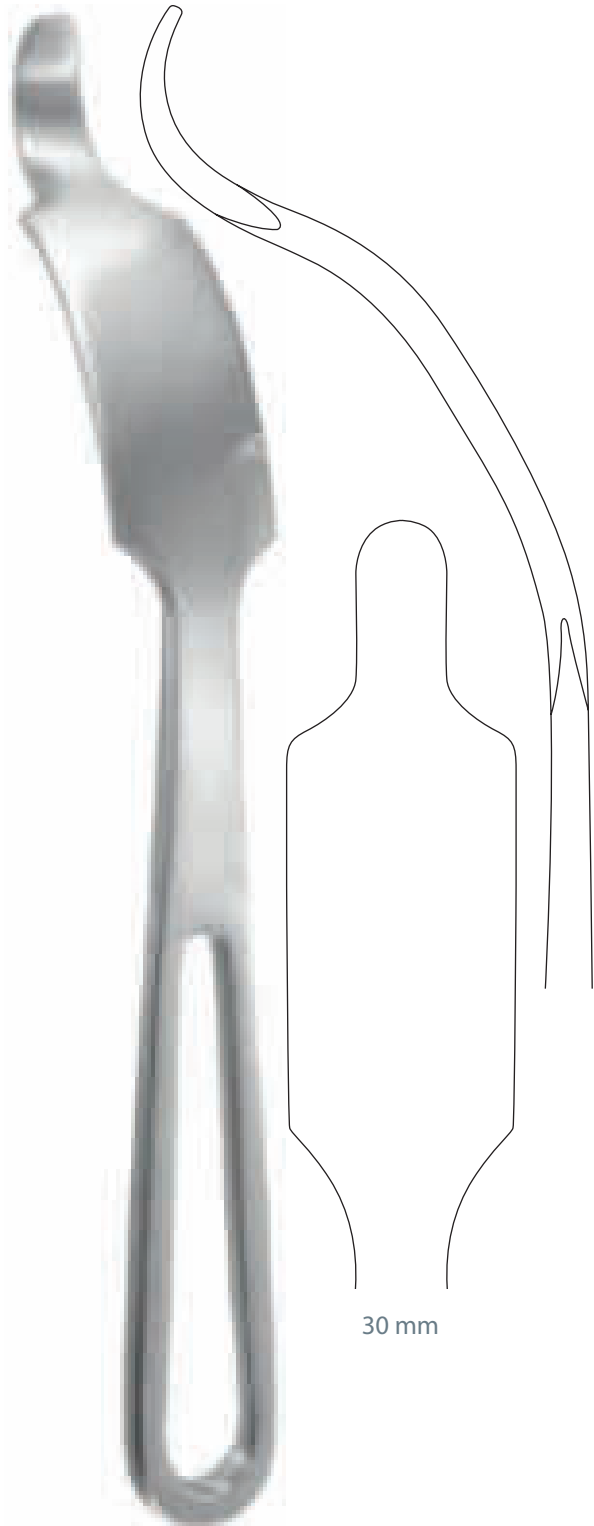

**J520925**

26,5 cm - 10 1/2"

### HOHMANN ALDINGER

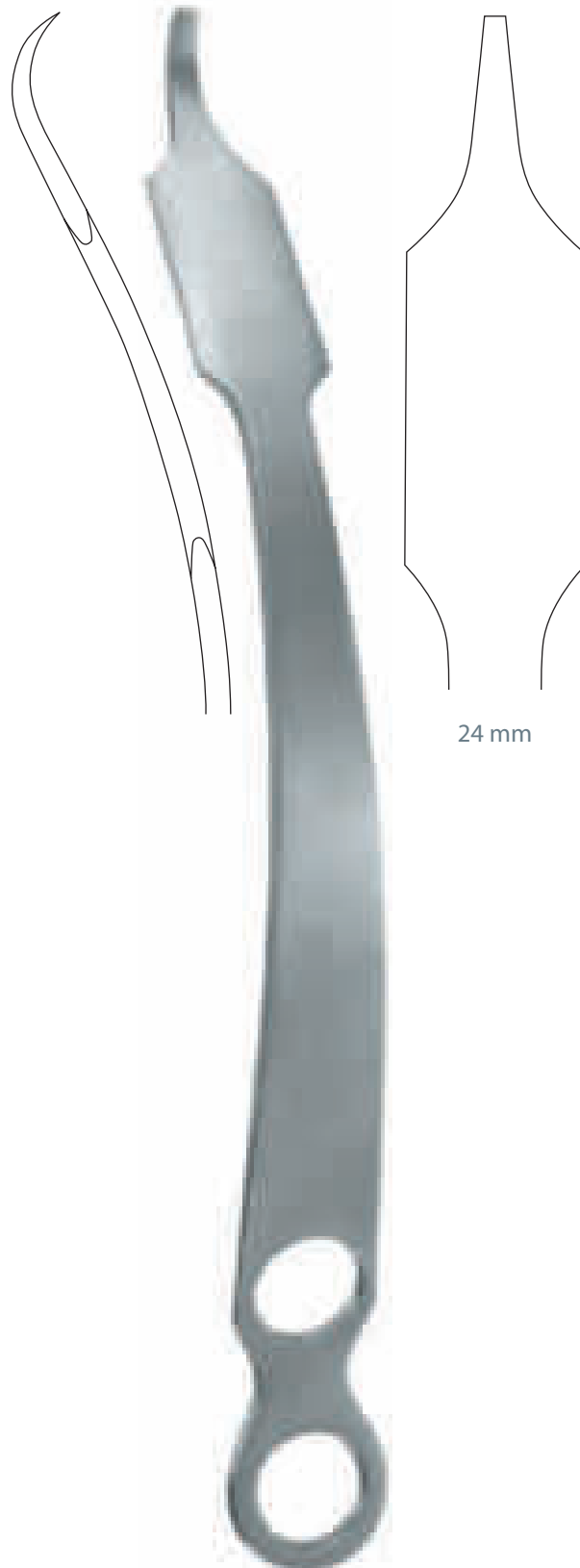

**J520930**

27 cm - 10 1/2"

18 mm

SCHUMACHER  
(WAGNER)

37 mm

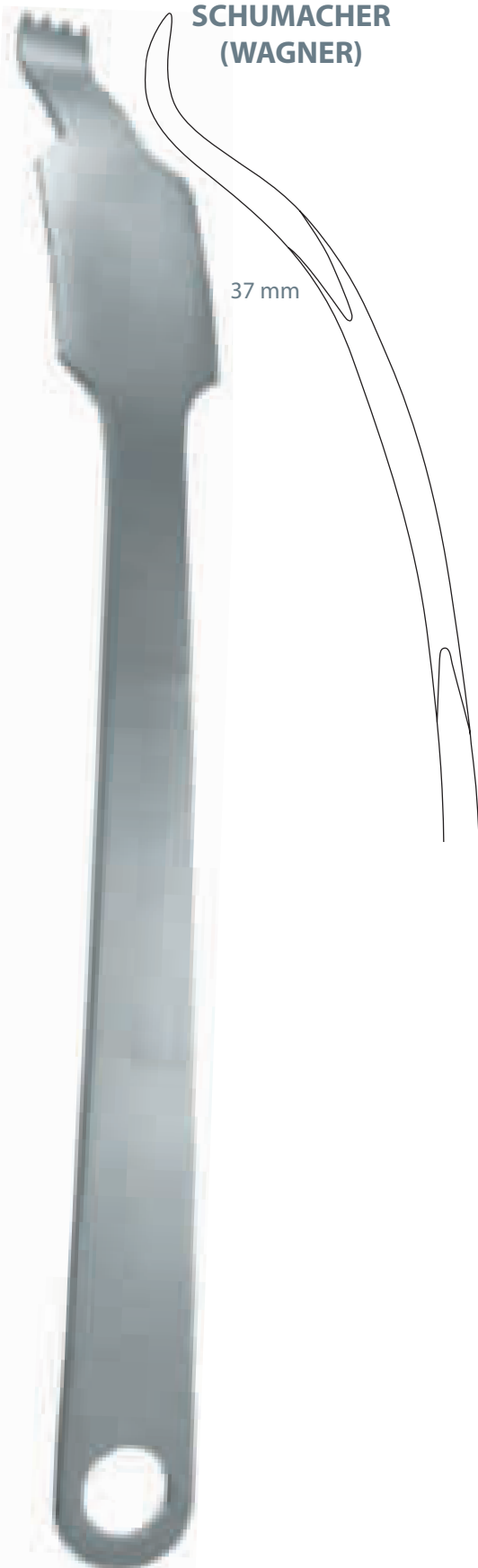

**J520935**

34,5 cm - 13 1/2 "

SCHUMACHER

18 mm

35 mm

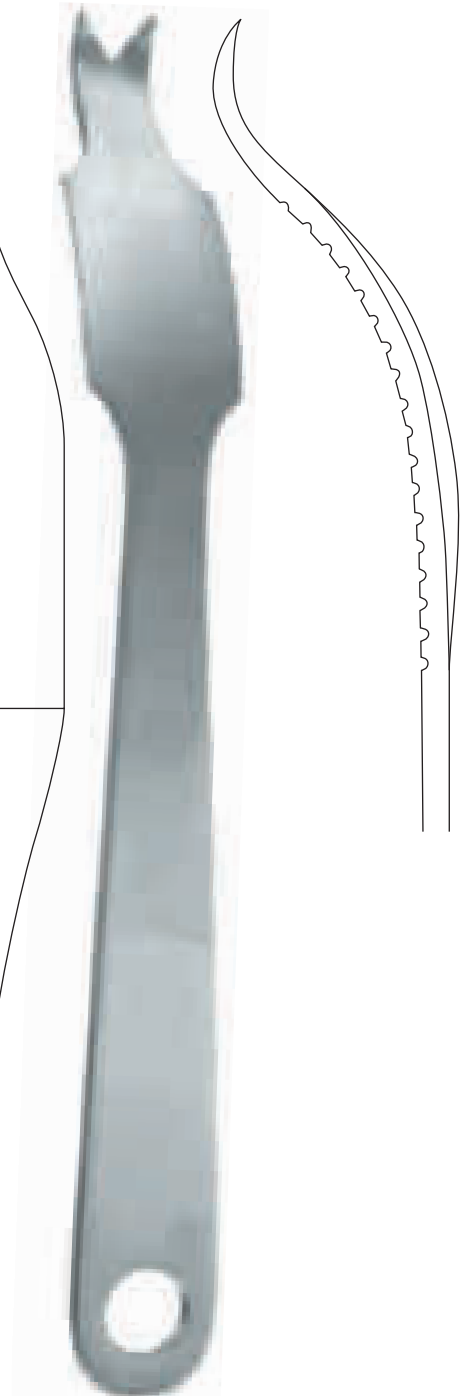

**J520936**

29 cm - 11 1/2 "

MERLE D'AUBIGNE

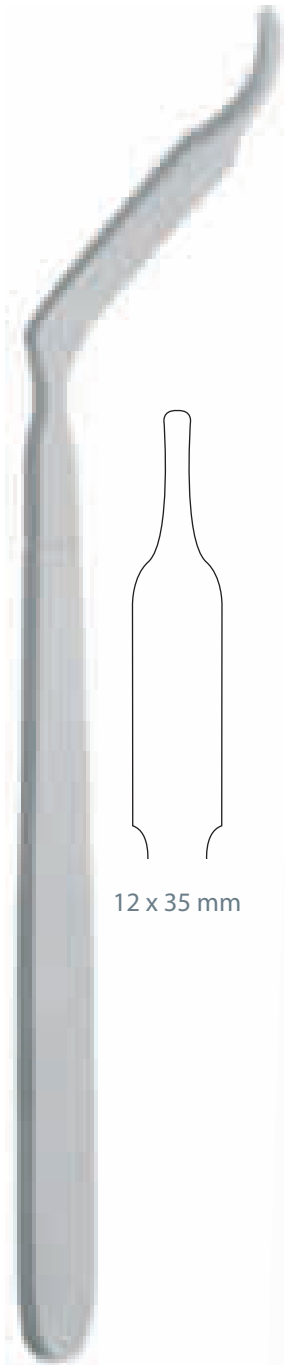

12 x 35 mm

**J52050**  
18 cm - 7 "

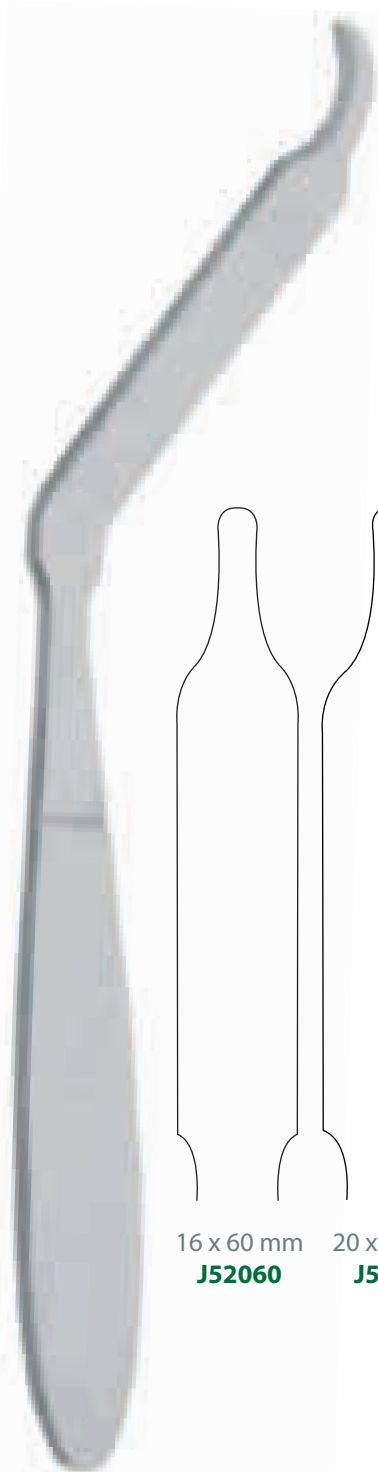

16 x 60 mm    20 x 60 mm

**J52060**    **J52070**

**J52060**  
20 cm - 8 "

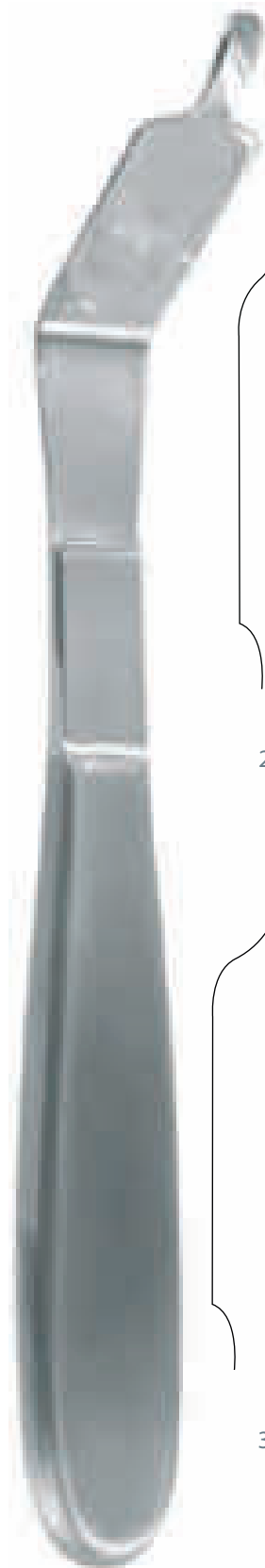

**J520230**  
20 x 40 mm

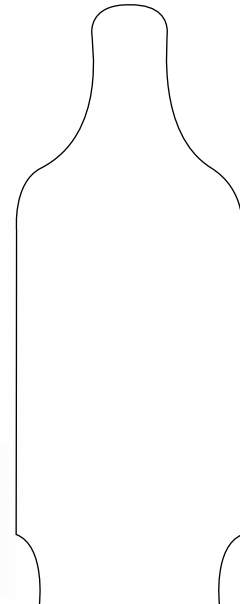

**J520231**  
30 x 40 mm

**J520230**  
22 cm - 8 <sup>3</sup>/<sub>4</sub> "



### MERLE D'AUBIGNE



**J52040**  
25 cm - 10 "

	P	L
J520240	80 mm	20 mm
J520260	90 mm	20 mm
J520280	110 mm	20 mm
J52030	80 mm	30 mm
J520320	90 mm	30 mm
J520340	110 mm	30 mm
 <b>J52040</b>	80 mm	50 mm
J520420	90 mm	50 mm
J520440	110 mm	50 mm

### JUDET



J520450

P	L
60 mm	33 mm

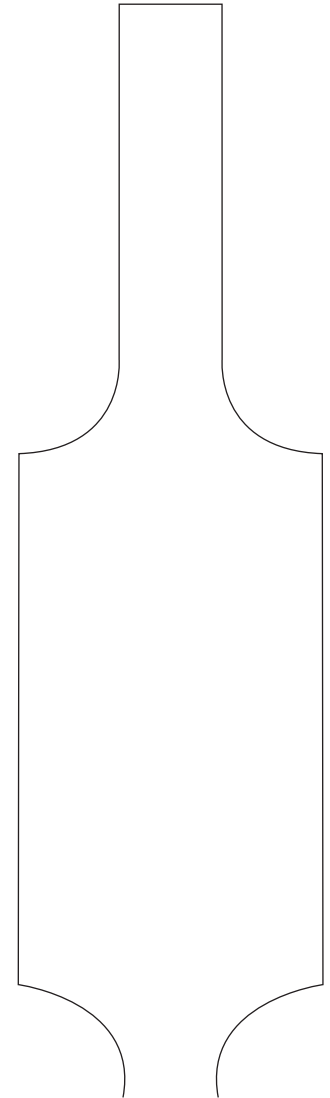

**J520450**  
31,5 cm - 12 1/4 "

# LANDANGER

## Écarteurs - Retractors - Separadores

### CHANDLER

18 cm - 7"	<b>J521001</b>	13 mm
20 cm - 8" 	<b>J521002</b>	19 mm
23 cm - 9"	<b>J521003</b>	25 mm
25 cm - 10"	<b>J521004</b>	30 mm

### LANE TRETOWAN

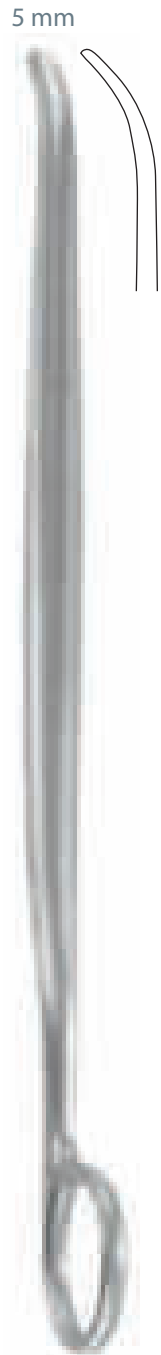

**J521010**  
21,5 cm - 8 1/2 "

### LANE

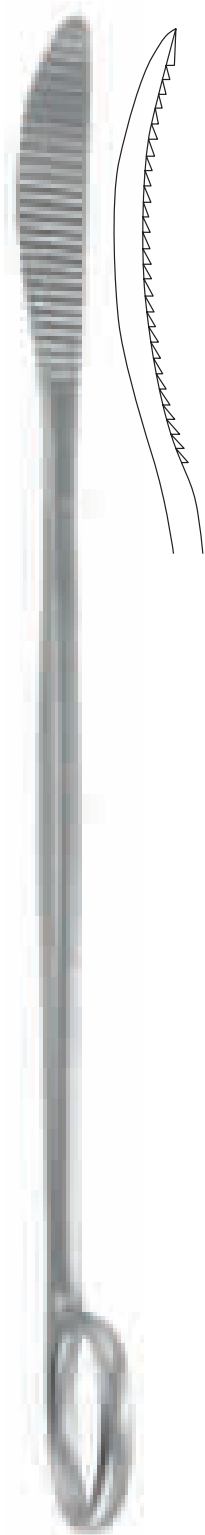

**J521015**  
25,5 cm - 10 "

### BRISTOW



**J521020**  
23 cm - 9 "

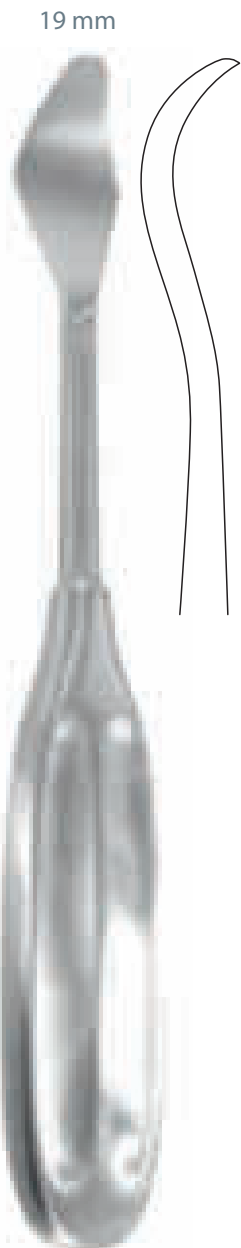

**J521002**  
20 cm - 8 "

BLOUNT

FUKUDA



### BENNET

### TRILLAT

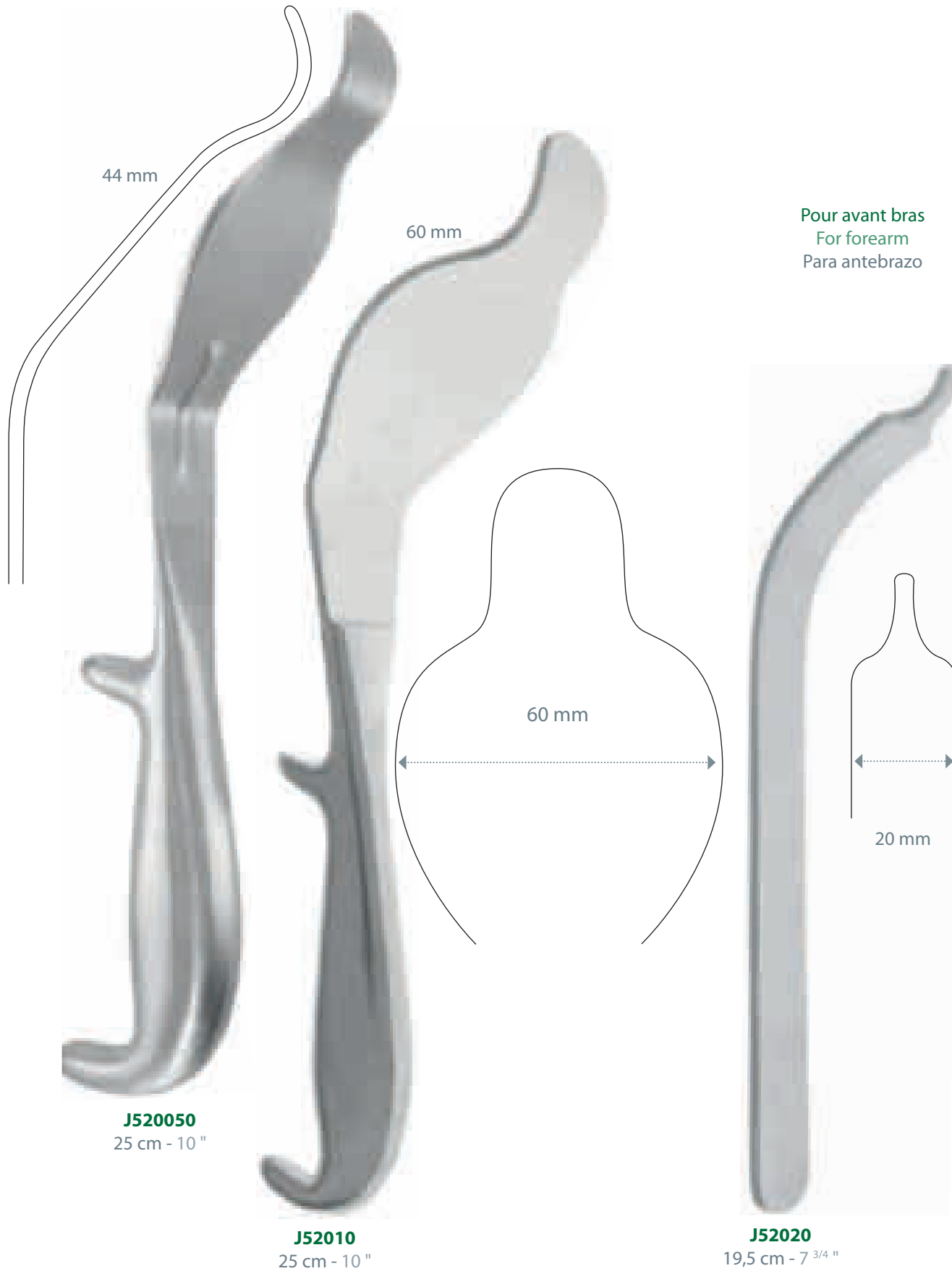

### CAUCHOIX

	P	L
J52210	60 mm	35 mm
 J52220	80 mm	35 mm
J52230	100 mm	40 mm
J522400	150 mm	40 mm

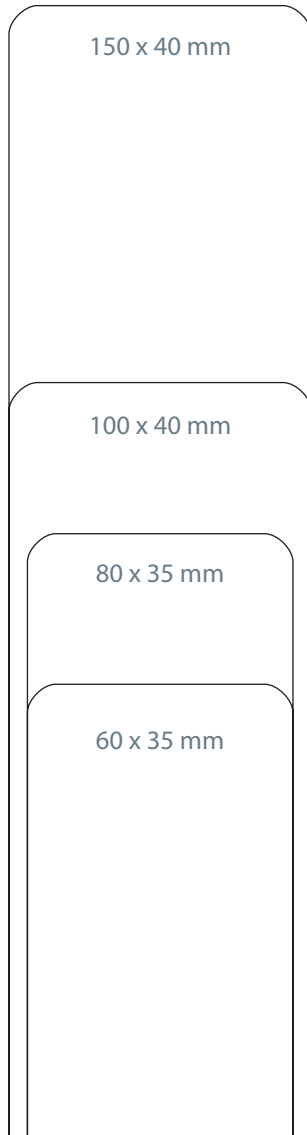

**J52220**  
23 cm - 9"

### SKID MURPHY



**J52130**  
34 cm - 13 1/2 "

### LAMBOTTE

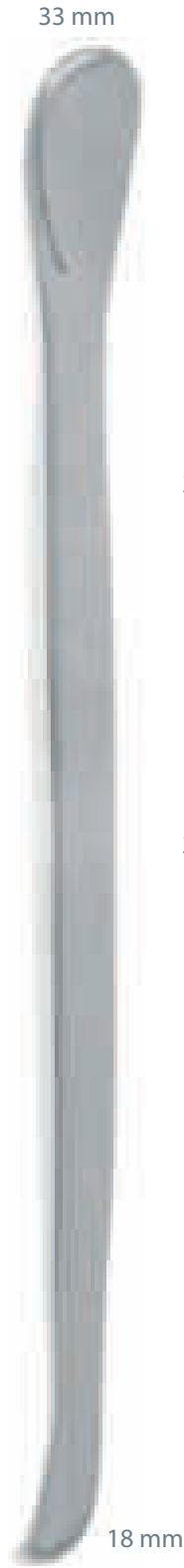

**J52150**  
31 cm - 12 1/4 "

Double  
Double  
Doble

**J52150**  
18 x 33 mm  
31 cm - 12 1/4 "

Simple  
Simple  
Simple

**J521505**  
33 mm  
29 cm - 11 1/2 "

### MOORE LAMBOTTE

**J521610** 20 cm  
 **J521600** 29 cm

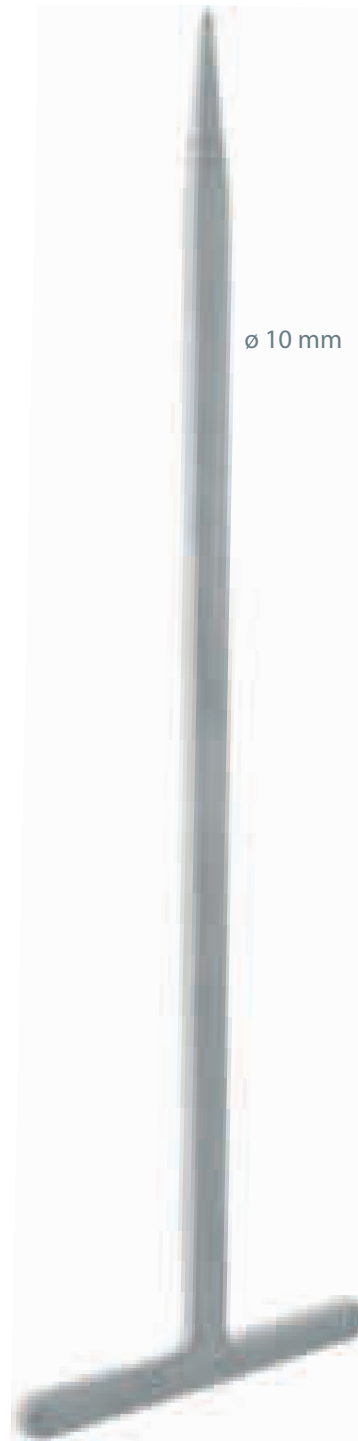

**J521600**  
29 cm - 11 1/2 "

### POSTEL

### MAURER

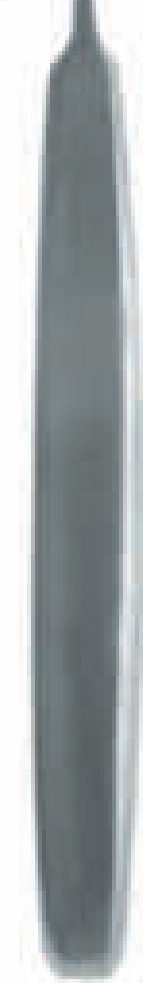

**J52170**  
19,5 cm - 8 "



**J521750**  
27 cm - 10 <sup>3</sup>/<sub>4</sub> "



# LANDANGER

## Pinces utérines - Uterines forceps - Pinzas uterinas

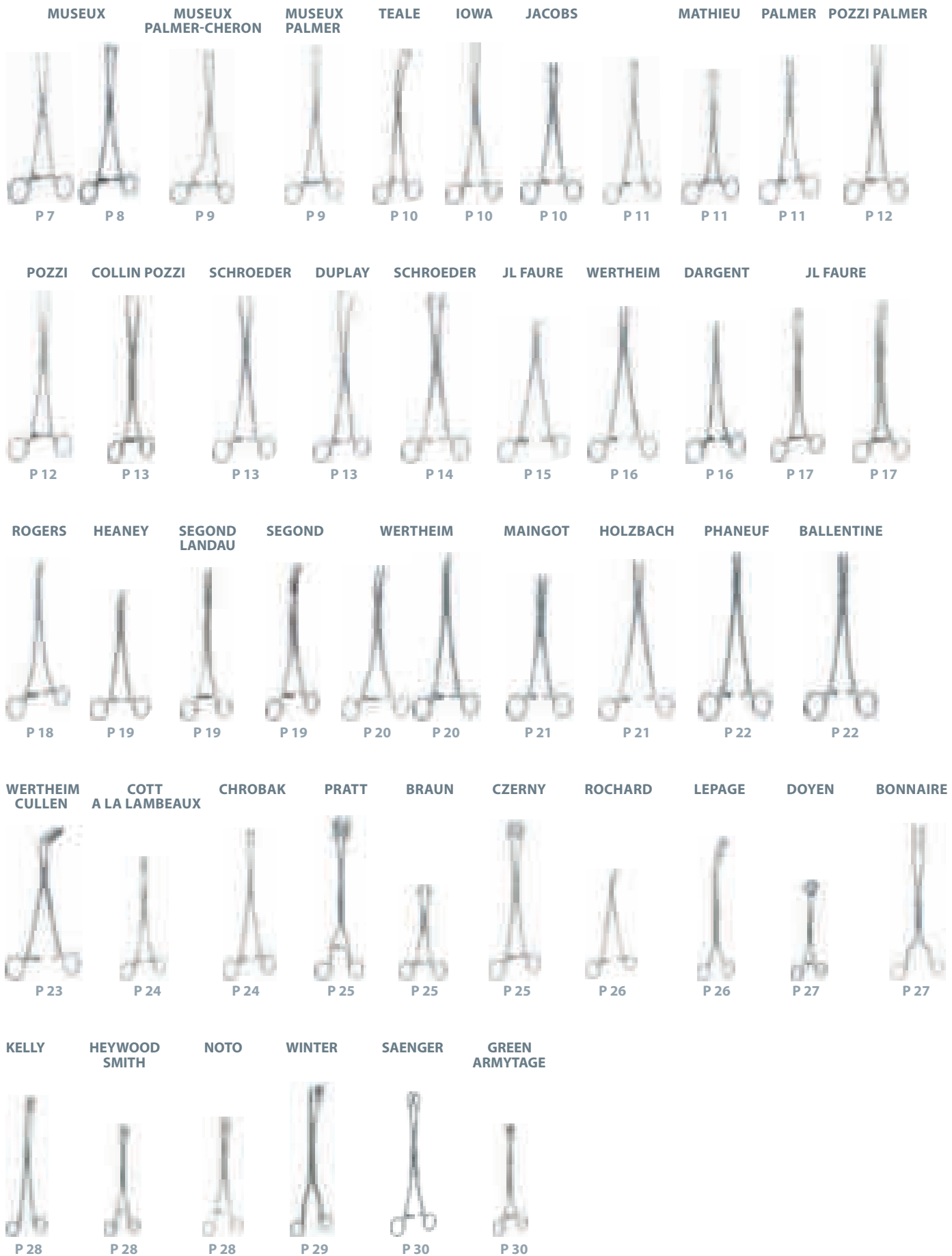



**Spéculums vaginaux - Vaginal speculas - Espéculos vaginales**

COLLIN    JAYLE    CUSCO    Spéculum pour vierge  
Virgin specula  
Espéculo para virgen    CUSCO    GRAVE    PEDERSON    SEYFFERT    SEMM



**Endospéculums - Endospeculas - Endoespéculos**

SCHERBAK

KOGAN



**Valves vaginales - Vaginal blades - Valvas vaginales**

DOYEN

MANGIAGALLI

DOUGLAS

DARGENT

LANDAU

BRIESKY



JACKSON

KRISTELLER

SIMS

DOYEN

MATHIEU

ST-MARKS

JAYLE

AUVARD

SCHERBAK

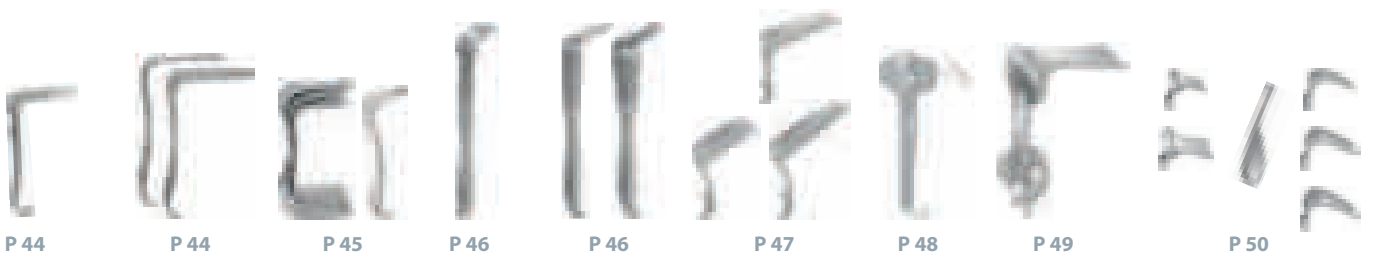

**Amnioscopes - Amnioscopes - Amnioscopo**



P 51

## Pince hystérolable - Uterine elevating forceps - Pinzas para coger el útero

COLLIN      DARTIGUES      SOMMER

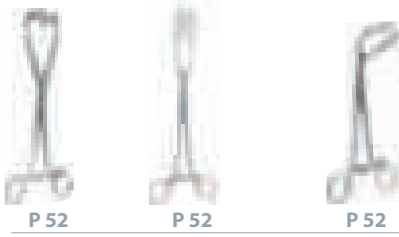

## Forceps spatules - Obstetrical forceps - Forceps obstétricos



## Divers - Miscellaneous - Diverso

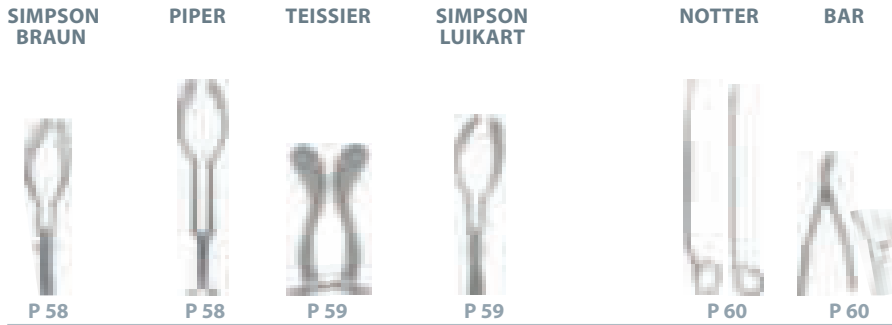

## Ventouse obstétricale - Obstetric vacuum cup - Ventosa obstétrica

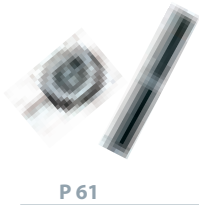

P 61

## Pinces à biopsie - Biopsy forceps - Pinzas para biopsia

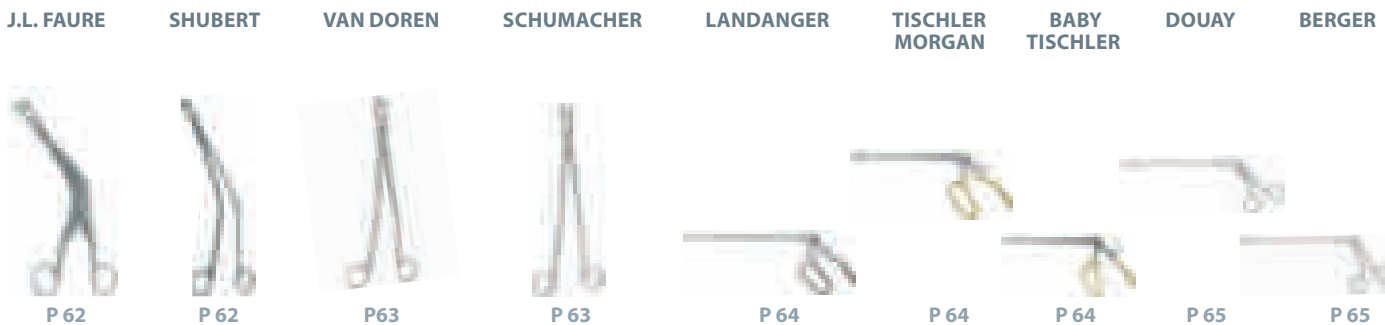

**Pinces à biopsie - Biopsy forceps - Pinzas para biopsia**

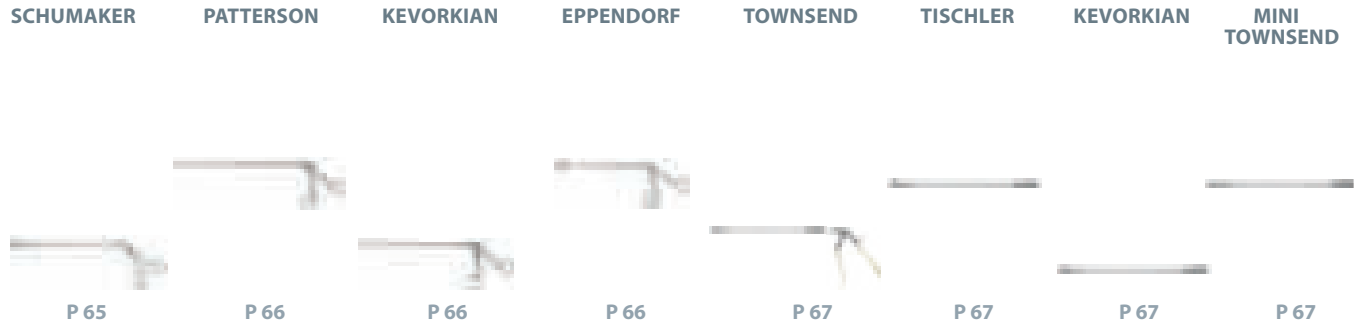

**Curettes utérines - Uterines curettes - Curetas uterinas**

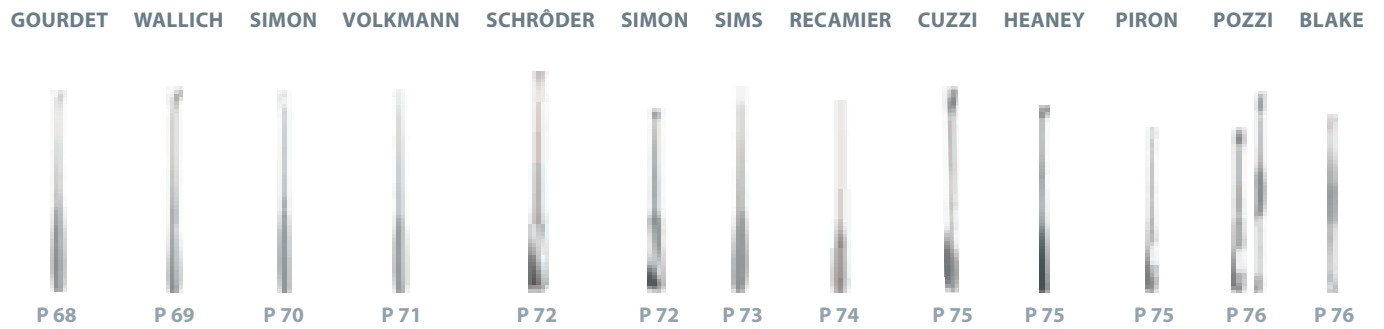

**Curettes à biopsie - Biopsy curettes - Curetas para biopsia**

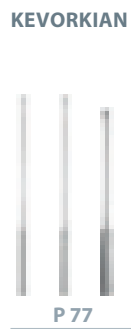

**Pelvimètres - Pelvimeters - Pelvimetros**

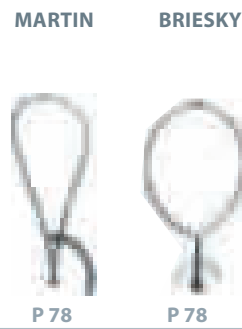

**Divers - Miscellaneous - Diverso**



**Dilatateurs utérins - Uterine dilators - Dilatadores uterinos**

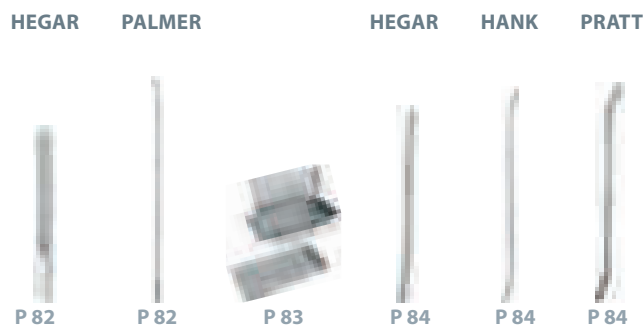

**Hysteromètres - Uterine sounds - Hysterómetros**

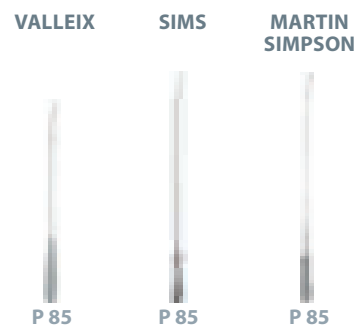

**Instruments pour urologie - Instruments for urology - Instrumentos para urología**

GUYON      Sondes métalliques  
Metal catheters  
Sondas metálicas      STRAUSS



**Spéculum rectaux - Rectal speculas - Espéculos rectales**

PRATT      MATHIEU      TRELAT      CZERNY      SIMS

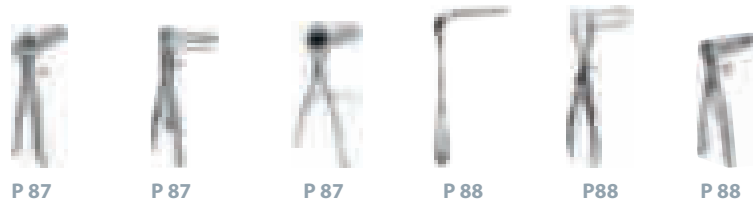

**Anusopes - Anusopes - Anuscopios**

KELLY      BENSAUDE      Sphinctéroscope  
Sphincteroscope  
Esfinteroscopio



**Écarteurs rectaux - Rectal retractors - Separadores rectales**

BARR      HALLE      ALAN PARKS



**Biopsie rectale - Biopsy forceps - Biopsia rectal**

YEOMAN



**Pincas hémorroïdales - Haemorrhoidal forceps - Pinzas hemorroidales**

MC GIVNEY      RUDD      HEYWOOD SMITH      MC GIVNEY

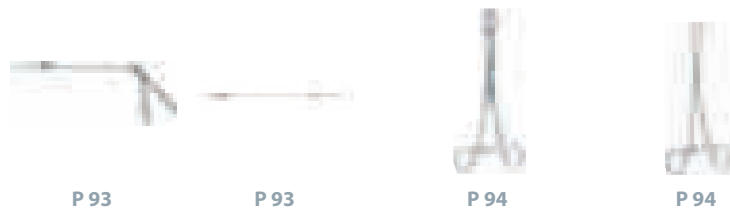

**Instruments pour prostate - Instruments for prostate - Instrumentos para prostate**

METZENBAUM      MILLIN      SANTORINI      O'SHAUGNESSY      YOUNG



**Ciseaux pour intervention en profondeur - Scissors for deep operations - Tijeras para intervención a fondo**

III - Ciseaux  
III - Scissors  
III - Tijeras

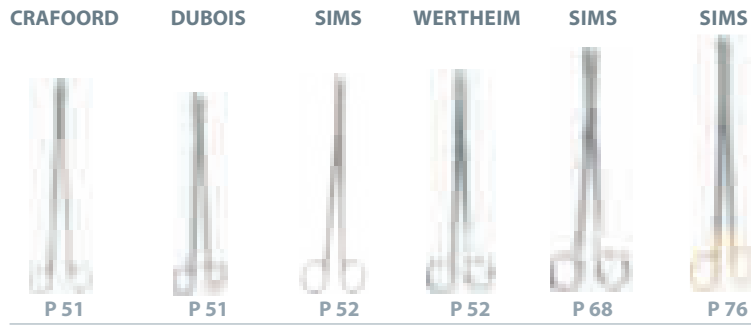

**Ciseaux pour le cordon ombilical - Scissors for umbilical cord - Tijeras para el cordón umbilical**

III - Ciseaux  
III - Scissors  
III - Tijeras

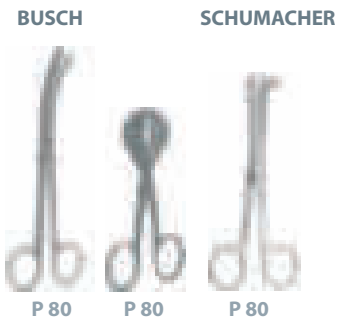

**Ciseaux à épisiotomie - Episiotomy scissors - Tijeras episiotomía**

III - Ciseaux  
III - Scissors  
III - Tijeras

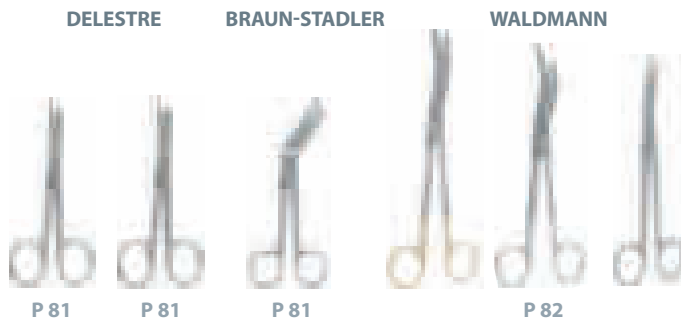

### MUSEUX

Droite  
Straight  
Recta

14 cm - 5 1/2"

**F10340**

16 cm - 6 1/4"

**F10350**



18 cm - 7"

**F10360**



5 mm

**F10350**  
16 cm - 6 1/4"



5 mm

**F10360**  
18 cm - 7"

### MUSEUX

Courbe latérale  
Lateral curved  
Curva lateral

4 griffes  
4 teeth  
4 dientes



**F10380**  
7 mm



**F103801**  
7 mm

**F10390**  
9 mm



**F103901**   
9 mm

 **F10400**  
11 mm

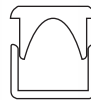

**F104001**  
11 mm

6 griffes  
6 teeth  
6 dientes

**F104100**  
11 mm

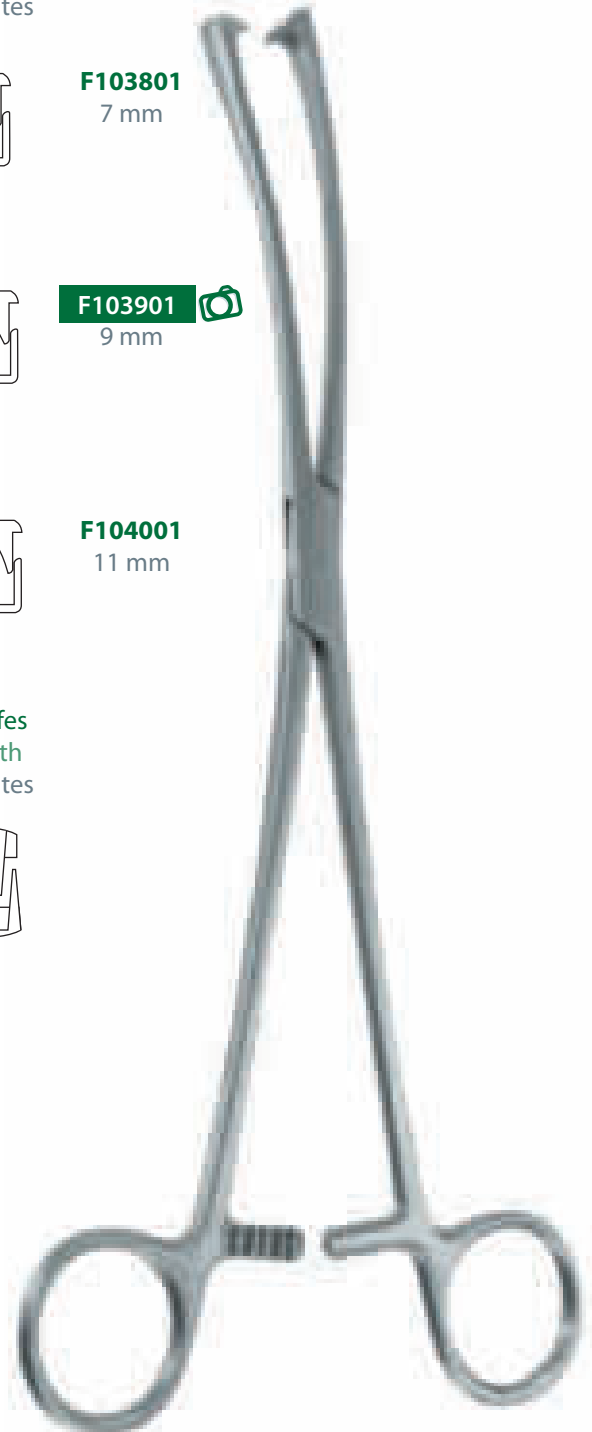

**F10400**  
24 cm - 9 1/2"

**F103901**  
24 cm - 9 1/2"

### MUSEUX PALMER-CHERON

### MUSEUX PALMER



**F10420**  
23 cm - 9"



**F10450**  
24 cm - 9 1/2"



## Pinces utérines - Uterines forceps - Pinzas uterinas

**TEALE**

**IOWA**

**JACOBS**

Pour la vésicule amniotique  
For the amnion bladder  
Para la vesícula amniótica

Courbe latérale  
Lateral curved  
Curva lateral



6 mm

Double courbure  
Double curvature  
Doble curvatura



6 mm



6 mm

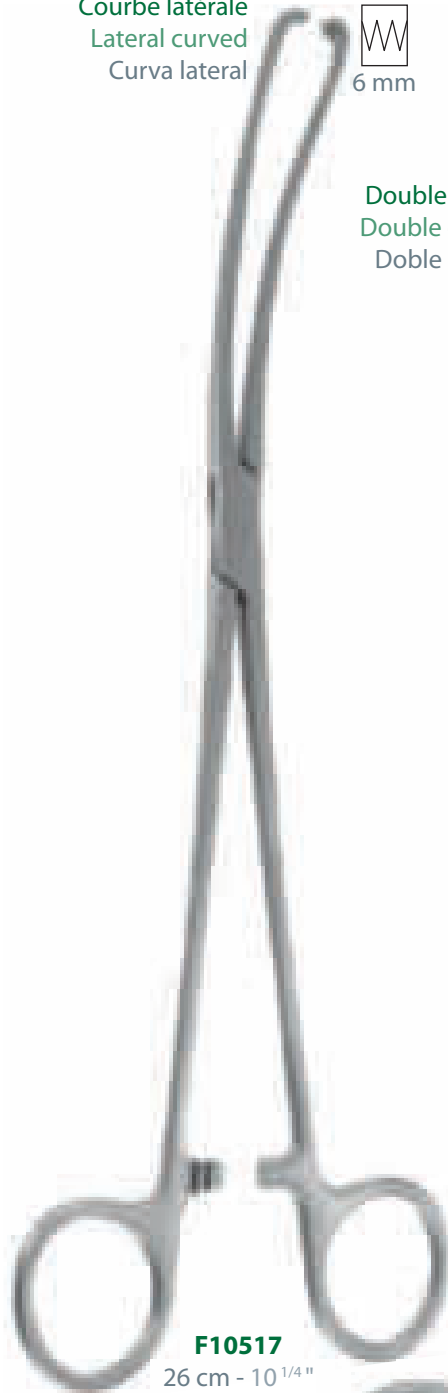

**F10517**  
26 cm - 10 1/4"



**F105175**  
26 cm - 10 1/4"



**F105185**  
21 cm - 8 1/4"

## Pinces utérines à polypes - Uterines polypus forceps - Pinzas uterinas para polipos

**MATHIEU**

**PALMER**

Pinces à polypes  
Polypus forceps  
Pinzas para polipos

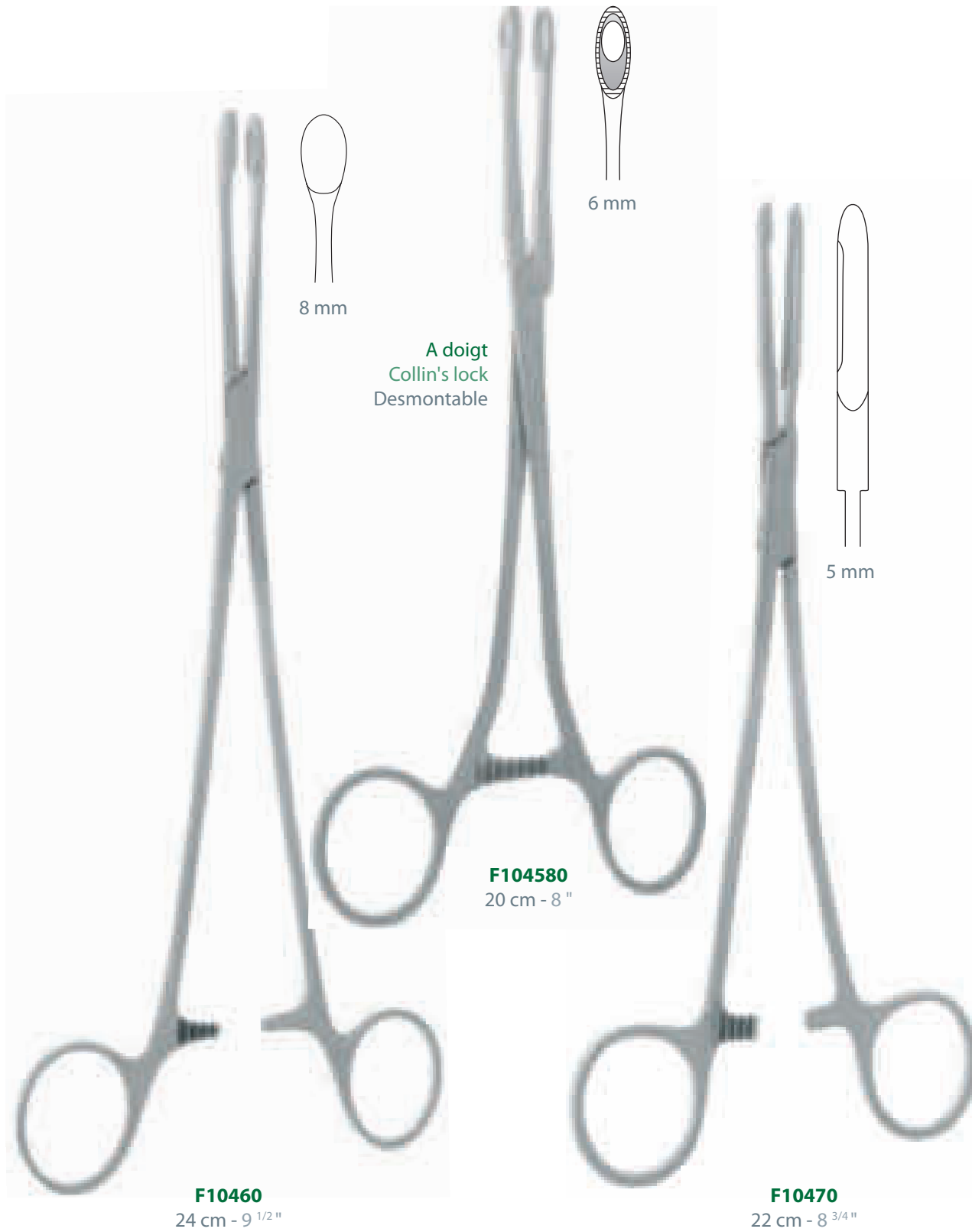

**F10460**  
24 cm - 9 1/2 "

**F104580**  
20 cm - 8 "

**F10470**  
22 cm - 8 3/4 "

A doigt  
Collin's lock  
Desmontable

POZZI PALMER

POZZI



**F10480**  
23 cm - 9 "



**F10505**  
18 cm - 7 "



**F10515**  
24 cm - 9 1/2 "

### COLLIN POZZI

### SCHROEDER

### DUPLAY

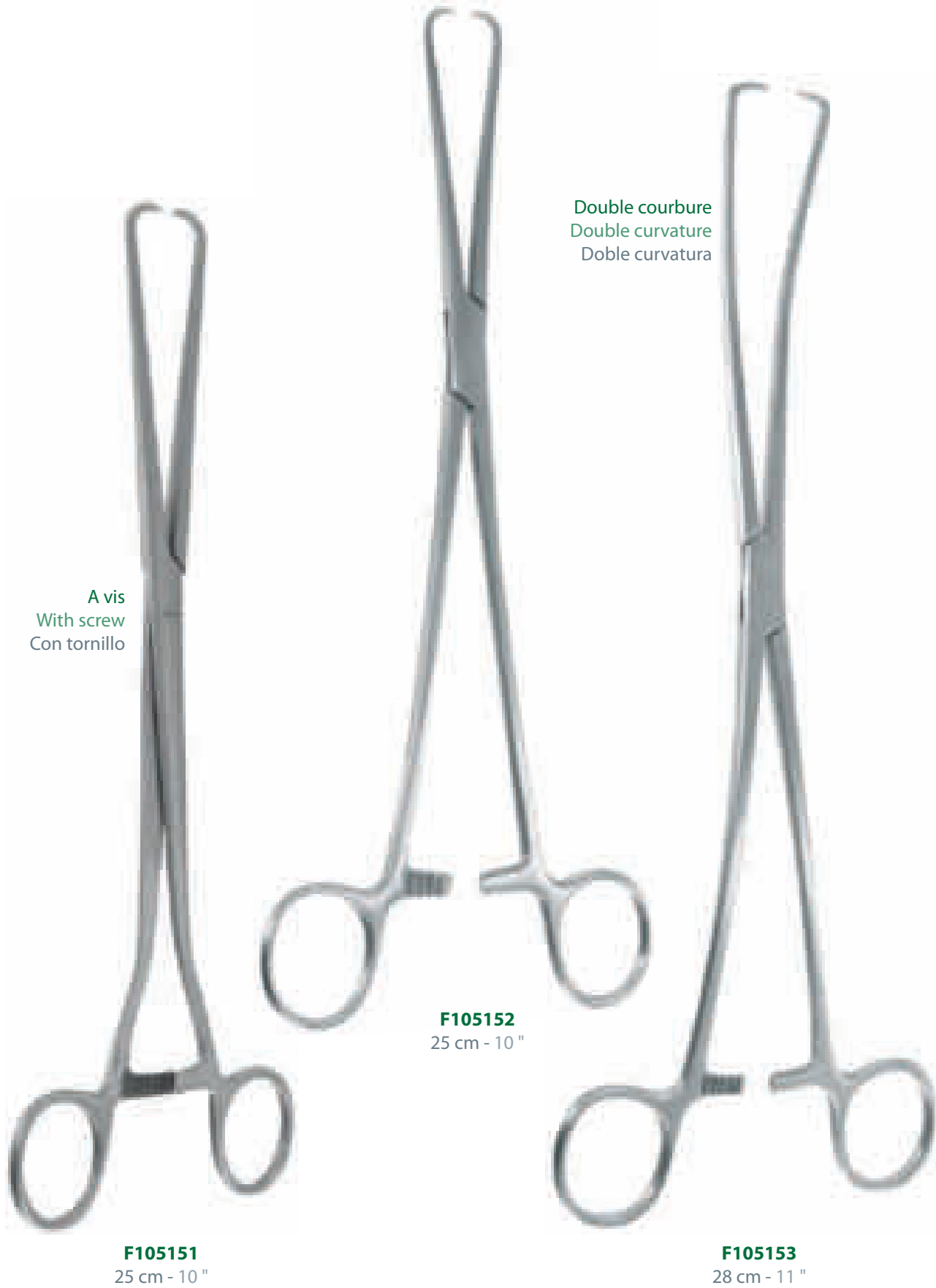

A vis  
With screw  
Con tornillo

Double courbure  
Double curvature  
Doble curvatura

**F105151**  
25 cm - 10 "

**F105152**  
25 cm - 10 "

**F105153**  
28 cm - 11 "



SCHROEDER



Courbe  
Curved  
Curva

Courbe latérale  
Lateral curved  
Curva lateral

**F10516**  
25 cm - 10"

**F105155**  
25 cm - 10"

**F105165**  
25 cm - 10"

### JL FAURE

Modèle léger  
Light model  
Modelo ligero

Modèle fort  
Strong model  
Modelo pesado

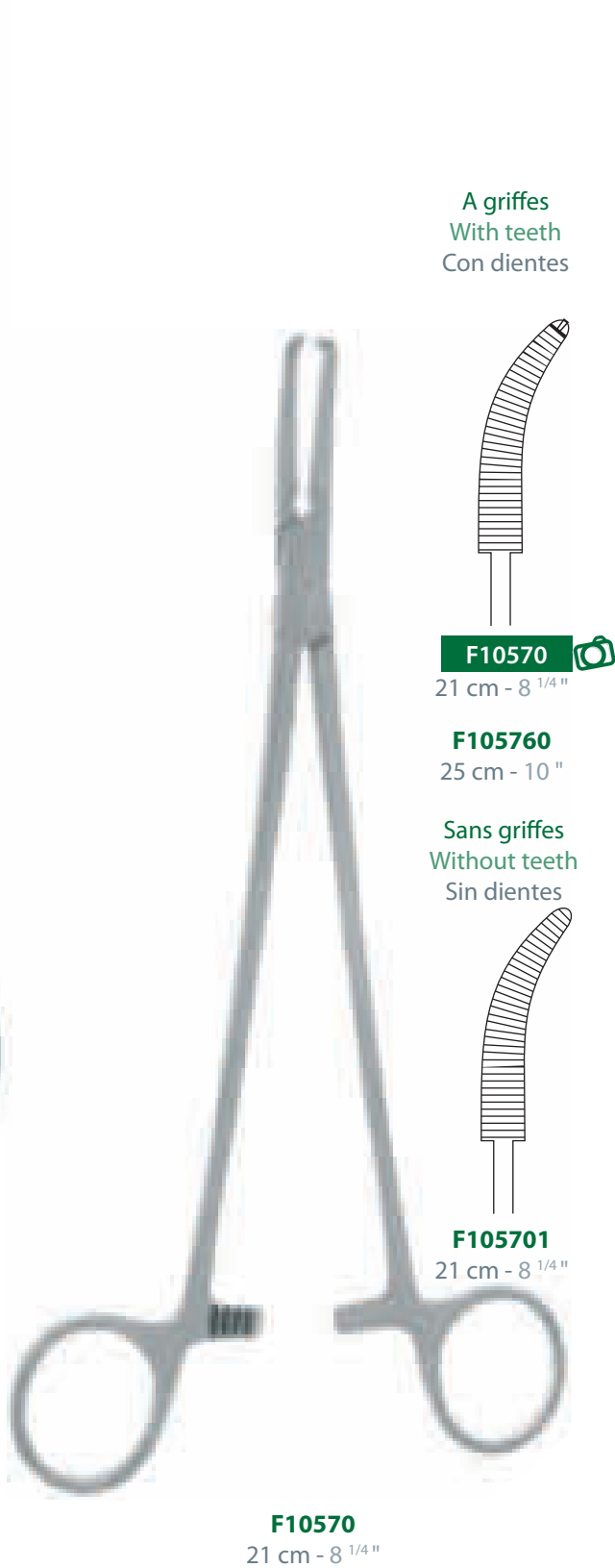

A griffes  
With teeth  
Con dientes

Sans griffes  
Without teeth  
Sin dientes

### WERTHEIM

### DARGENT

Dissecteur  
Dissector  
Disector

1/2 Courbe  
1/2 Courbe  
1/2 Courbe

Courbe  
Courbe  
Courbe

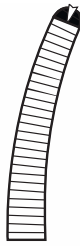

**F105970**

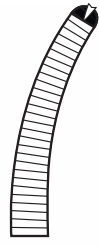

**F105971**



**F105970**  
22 cm - 8 3/4 "



**F105450**  
20 cm - 8 "

### JL FAURE

A plateaux  
With plates  
Con platos



**F10580**  
22 cm - 8 <sup>3</sup>/<sub>4</sub> "

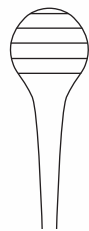

10 mm

A doigt  
Collin's lock  
Desmontable

A ligament large  
For wide ligament  
Para ligamento ancho

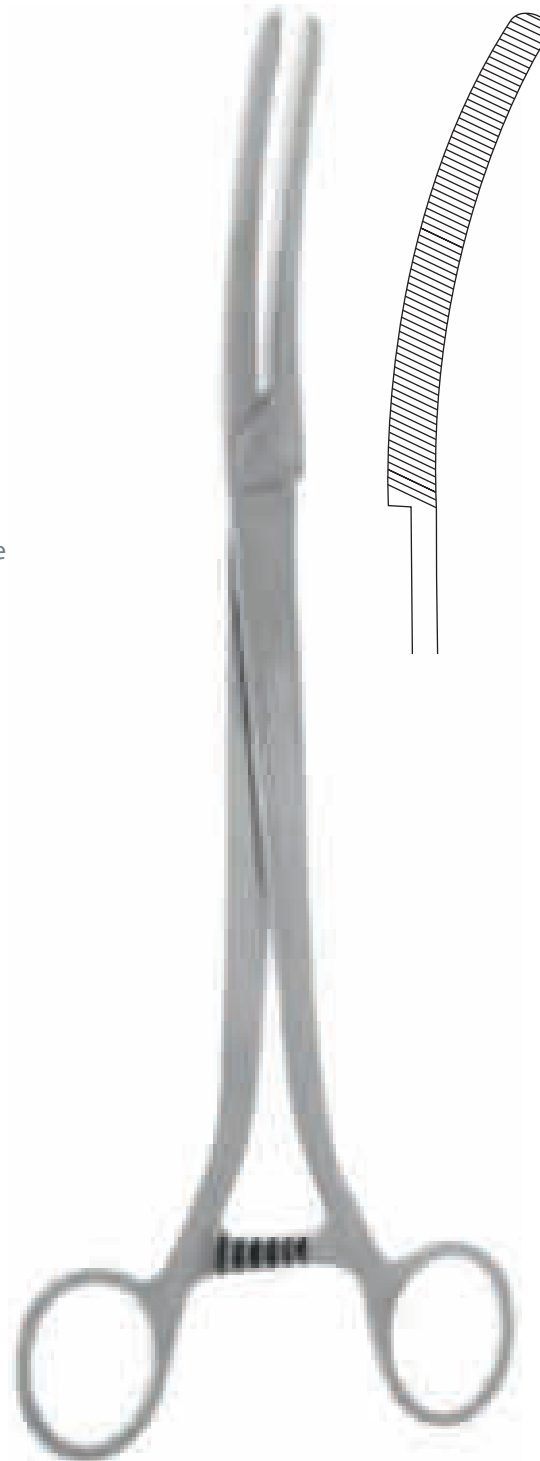

**F10590**  
25 cm - 10 "

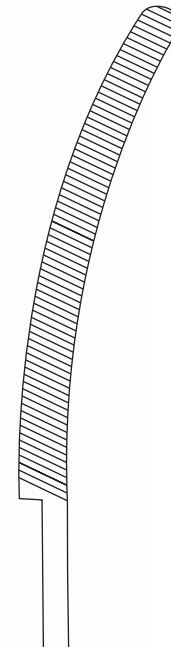



### ROGERS

	Droite Straight Recta	1/2 Courbe 1/2 Curved 1/2 Curva	Courbe Curved Curva	Coudée Angular Angulada			
22,5 cm - 8 <sup>3</sup> / <sub>4</sub> "	<b>F105910</b>	22 cm - 8 <sup>1</sup> / <sub>2</sub> "	<b>F105911</b>	21,5 cm - 8 <sup>1</sup> / <sub>2</sub> "	<b>F105912</b>	20,5 cm - 8 "	<b>F105913</b>
25 cm - 10 "	<b>F105920</b>	24,5 cm - 9 <sup>2</sup> / <sub>3</sub> "	<b>F105921</b> 	24 cm - 9 <sup>1</sup> / <sub>2</sub> "	<b>F105922</b>	23 cm - 9 "	<b>F105923</b>

Mors atraumatique  
Atraumatic jaws  
Bocas atraumáticas



**F105921**  
24,5 cm - 9 <sup>2</sup>/<sub>3</sub> "

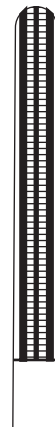

**F105920**  
25 cm - 10 "

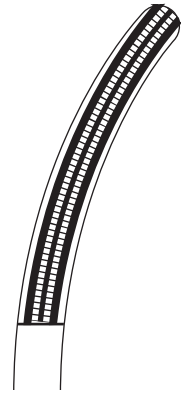

**F105921**  
24,5 cm - 9 <sup>3</sup>/<sub>4</sub> "

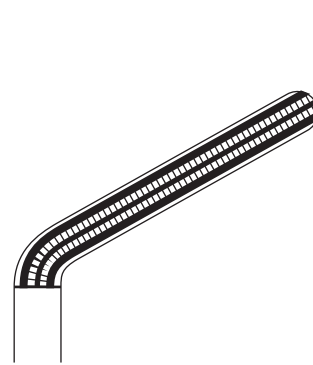

**F105923**  
23 cm - 9 "



**F105922**  
24 cm - 9 <sup>1</sup>/<sub>2</sub> "

## Pinces utérines - Uterines forceps - Pinzas uterinas

### HEANEY

2 dents  
2 teeth  
2 dientes



**F105930** 19,5 cm - 7 1/2"

**F105932** 21 cm - 8 1/4"

**F105934** 23 cm - 9"

### SEGOND-LANDAU

1 dent  
1 tooth  
1 diente

**F105931**

**F105933**

**F105935**



### SEGOND

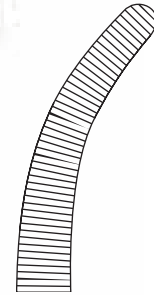

A vis  
With screw  
Con tornillo

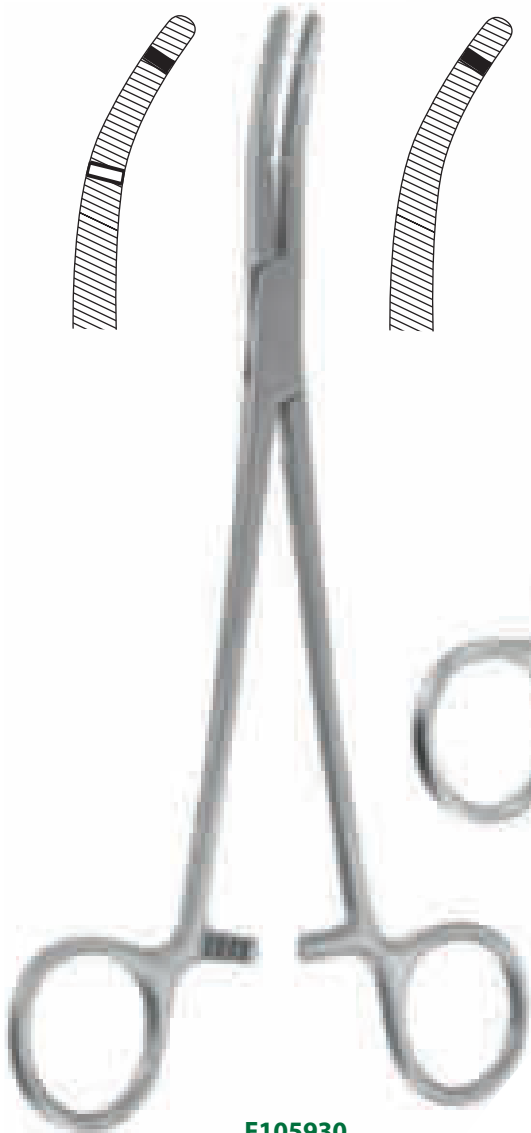

**F105930**  
19,5 cm - 7 1/2"

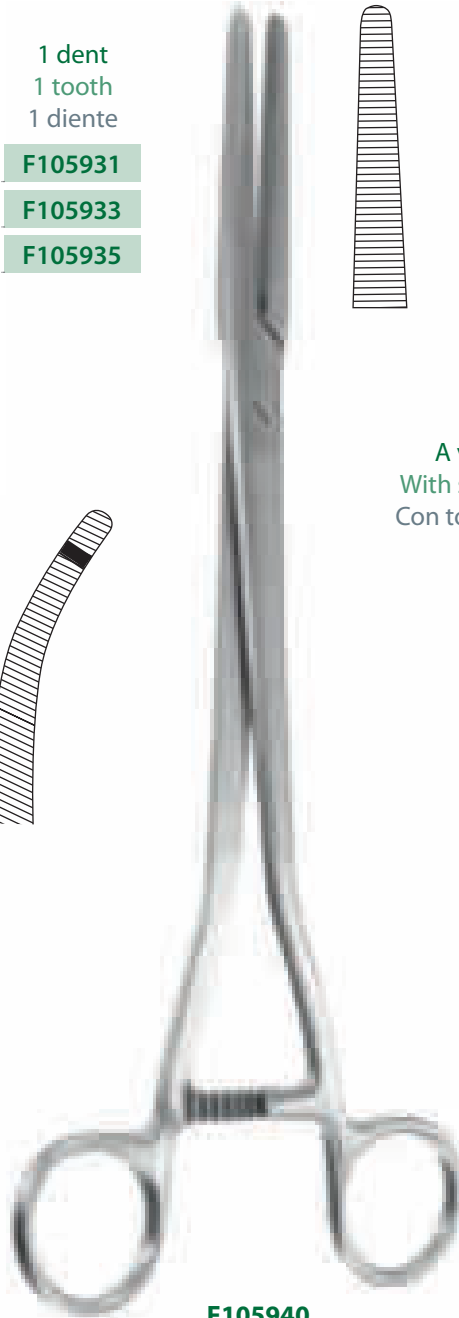

**F105940**  
24 cm - 9 1/2"



**F105941**  
24 cm - 9 1/2"

WERTHEIM



A vis  
With screw  
Con tornillo

**F105980**  
24 cm - 9 1/2 "

**F105981**  
25 cm - 10 "

# LANDANGER

## Pinces utérines - Uterines forceps - Pinzas uterinas

### MAINGOT

Courbe  
Curved  
Curva

20,5 cm - 8"

**F105946**



25 cm - 10"

**F105945**

### HOLZBACH

Droite  
Straight  
Recta

Courbe  
Curved  
Curva

23,5 cm - 9<sup>1/4</sup>"



**F105948**

**F105949**

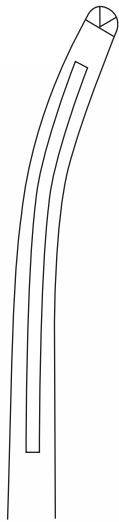

**F105945**

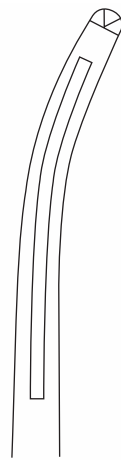

**F105946**

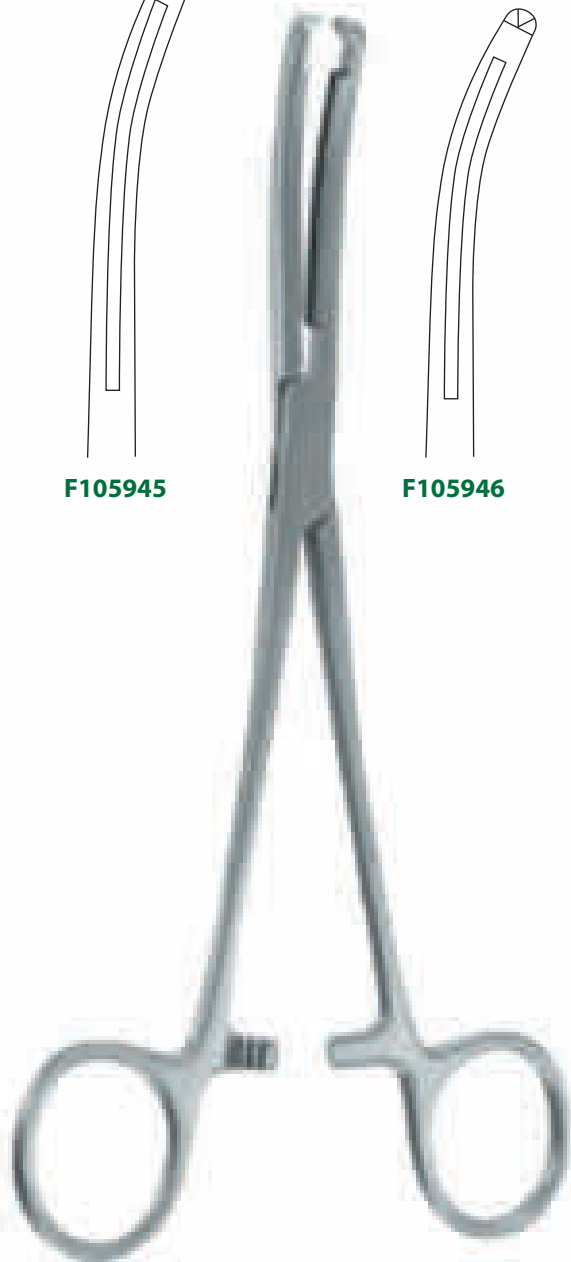
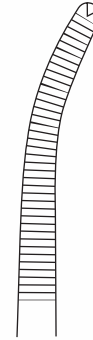

**F105946**  
20,5 cm - 8"



**F105948**  
23,5 cm - 9<sup>1/4</sup>"

## Pinces utérines - Uterines forceps - Pinzas uterinas

### PHANEUF

Droite  
Straight  
Recta

Coudée  
Angular  
Angulada

21,5 cm - 8 1/2"

**F105950**



**F105951**

### BALLENTINE

Droite  
Straight  
Recta

Courbe  
Curved  
Curva



**F105955**

21 cm - 8 1/4"

**F105956**



**F105950**

21,5 cm - 8 1/2"

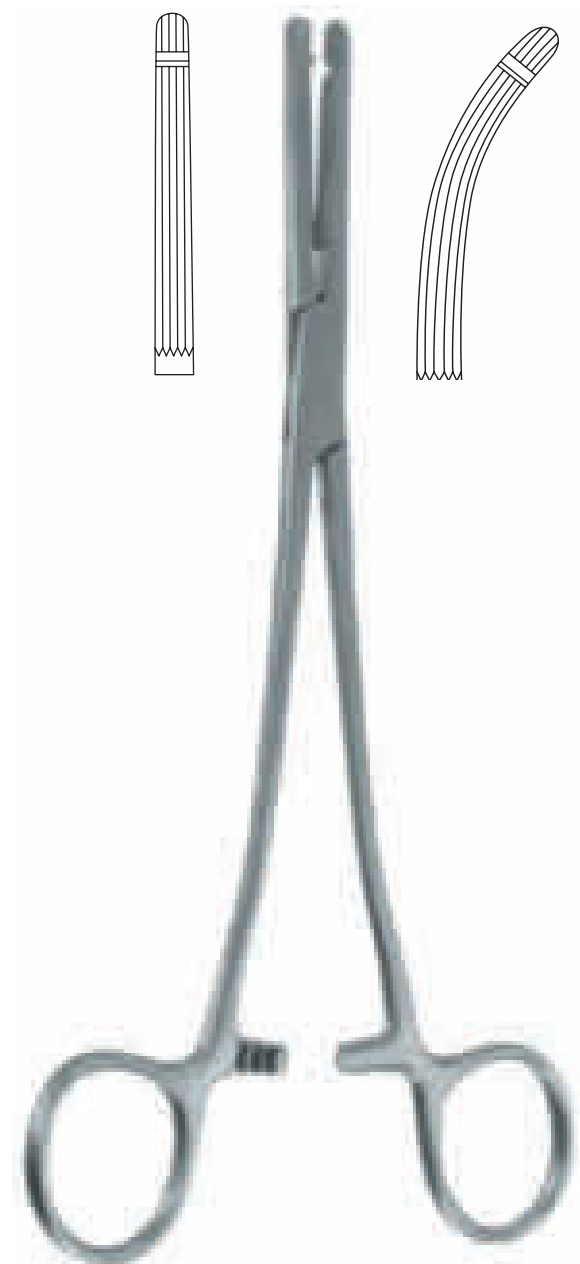

**F105955**

21 cm - 8 1/4"

### WERTHEIM CULLEN



**F105965**  
21,5 cm - 8 1/2 "

**F105961**  
23 cm - 9 "

## Pinces utérines - Uterines forceps - Pinzas uterinas

### COTT (À LAMBEAUX)

Mors  
Jaws  
Bocas

22,5 cm - 8 <sup>3</sup>/<sub>4</sub>" **F106040** 4,5 mm  
22 cm - 8 <sup>2</sup>/<sub>3</sub>" **F10605** 6,0 mm 

3 x 3 griffes  
3 x 3 teeth  
3 x 3 dientes



**F10605**  
22 cm - 8 <sup>2</sup>/<sub>3</sub>"

### CHROBAK

4 x 4 griffes  
4 x 4 teeth  
4 x 4 dientes



**F106060**  
26 cm - 10 <sup>1</sup>/<sub>4</sub>"

# LANDANGER

## Pinces utérines - Uterines forceps - Pinzas uterinas

### PRATT



A vis  
With screw  
Con tornillo

**F108180**  
28 cm - 11 "

### BRAUN

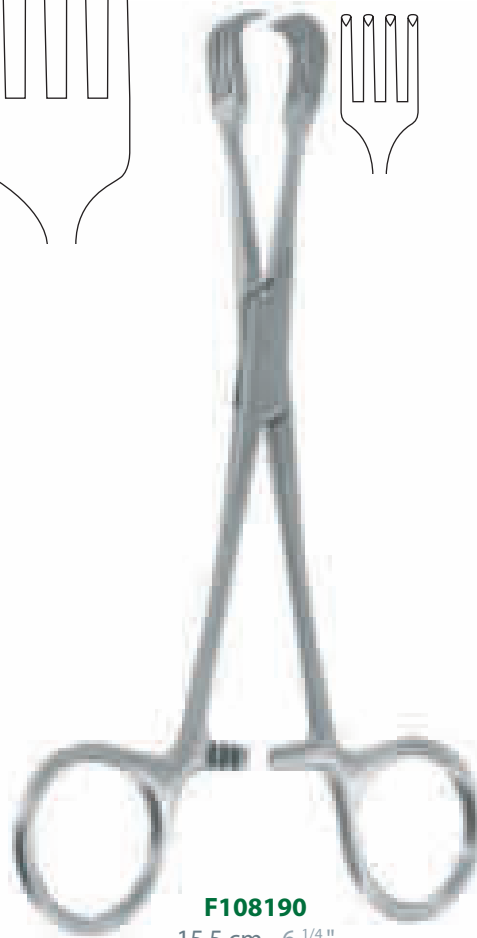

**F108190**  
15,5 cm - 6 1/4 "

### CZERNY

20,5 cm - 8"

**F108200**

26 cm - 10 1/4"

**F108205**



**F108205**  
26 cm - 10 1/4"



## ROCHARD



**F10610**  
21 cm - 8 1/4"

## LEPAGE

Pince à faux germes  
Ovum forceps  
Pinza para aborto

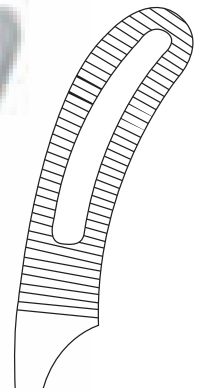

A tenon  
With tenon lock  
Con tenon



**F10630**  
27 cm - 10 1/2"

## Pinces utérines - Uterines forceps - Pinzas uterinas

### DOYEN

Pince à ovaire  
Ovarian forceps  
Pinza para ovarios

### BONNAIRE



**F10620**  
24 cm - 9 1/2 "

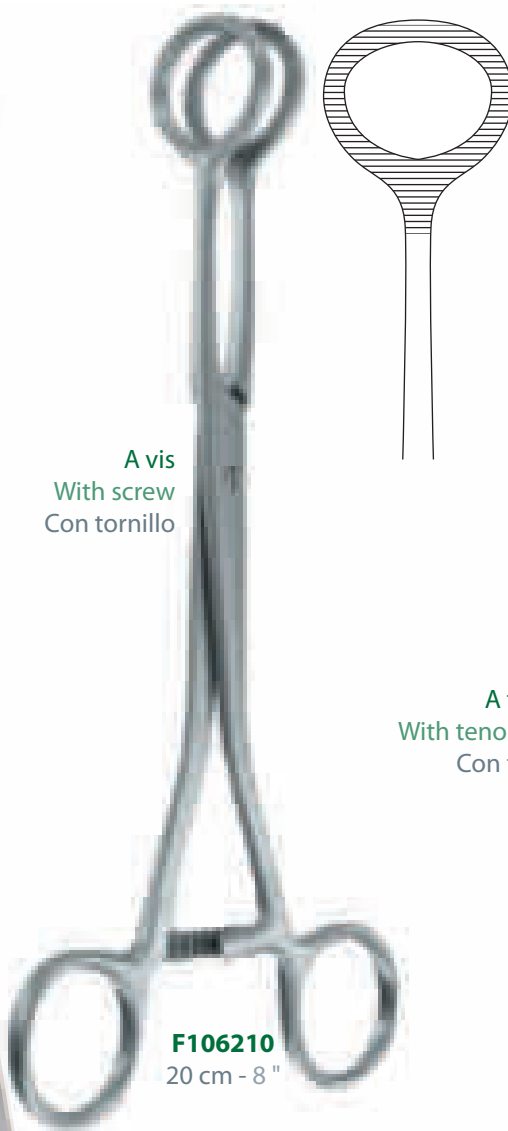

A vis  
With screw  
Con tornillo

**F106210**  
20 cm - 8 "



A tenon  
With tenon lock  
Con tenon

**F10640**  
31 cm - 12 1/4 "



## KELLY

## HEYWOOD-SMITH

## NOTO

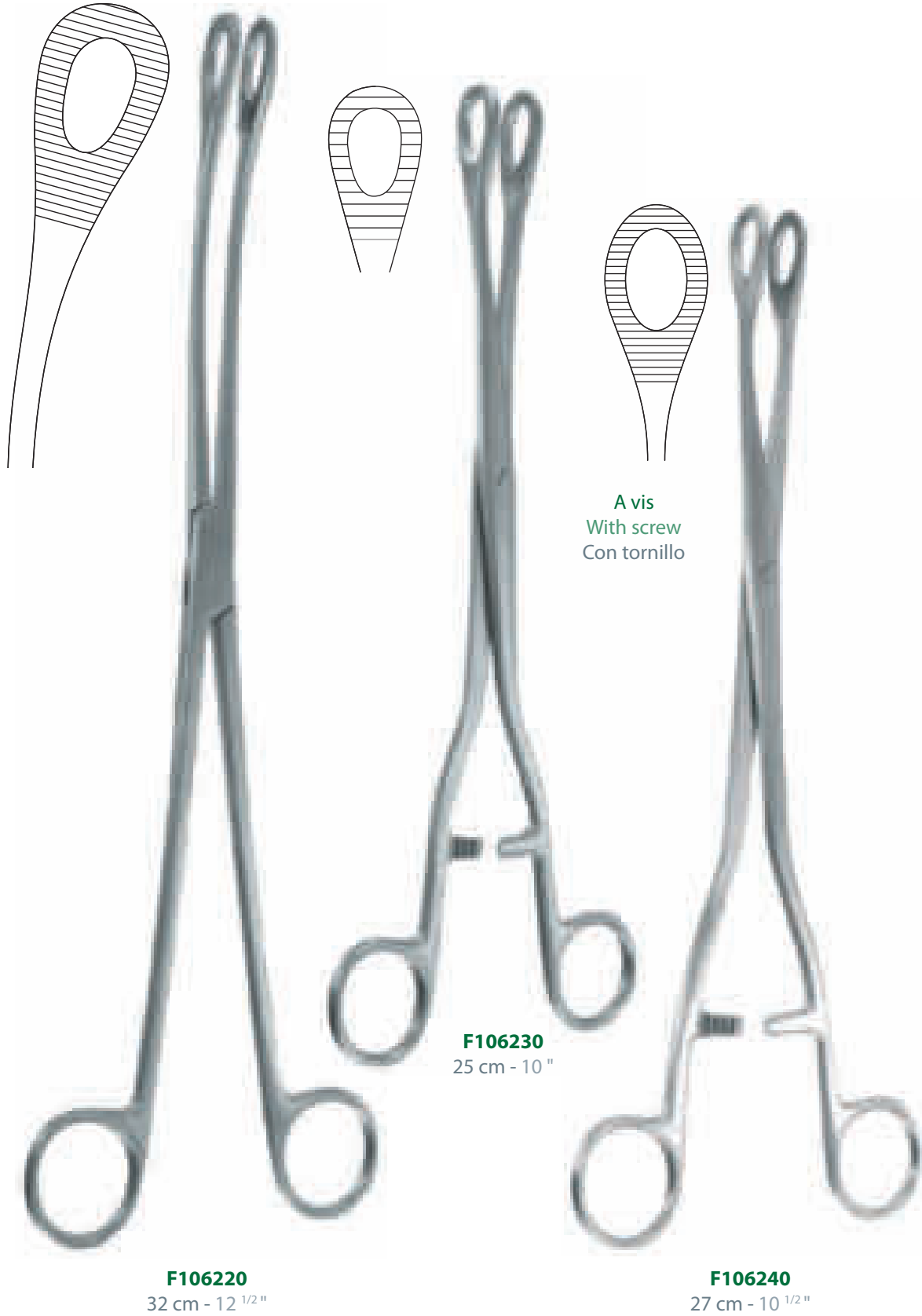

**F106220**

32 cm - 12 1/2 "

**F106230**

25 cm - 10 "

**F106240**

27 cm - 10 1/2 "

A vis  
With screw  
Con tornillo

## Pinces utérines - Uterines forceps - Pinzas uterinas

Avec embout de protection  
With protective cap  
Con tapa protectora



**F10650**  
29 cm - 11 1/2 "

WINTER

A vis  
With screw  
Con tornillo



**F106512**  
29 cm - 11 1/2 "



**F106521**



**F106522**



**F106523**

	Droite Straight Recta	Courbe Curved Curva
<b>F106511</b>	9 mm	<b>F106521</b>
<b>F106512</b>	11 mm	<b>F106522</b>
<b>F106513</b>	14 mm	<b>F106523</b>

## SAENGER

## GREEN-ARMYTAGE

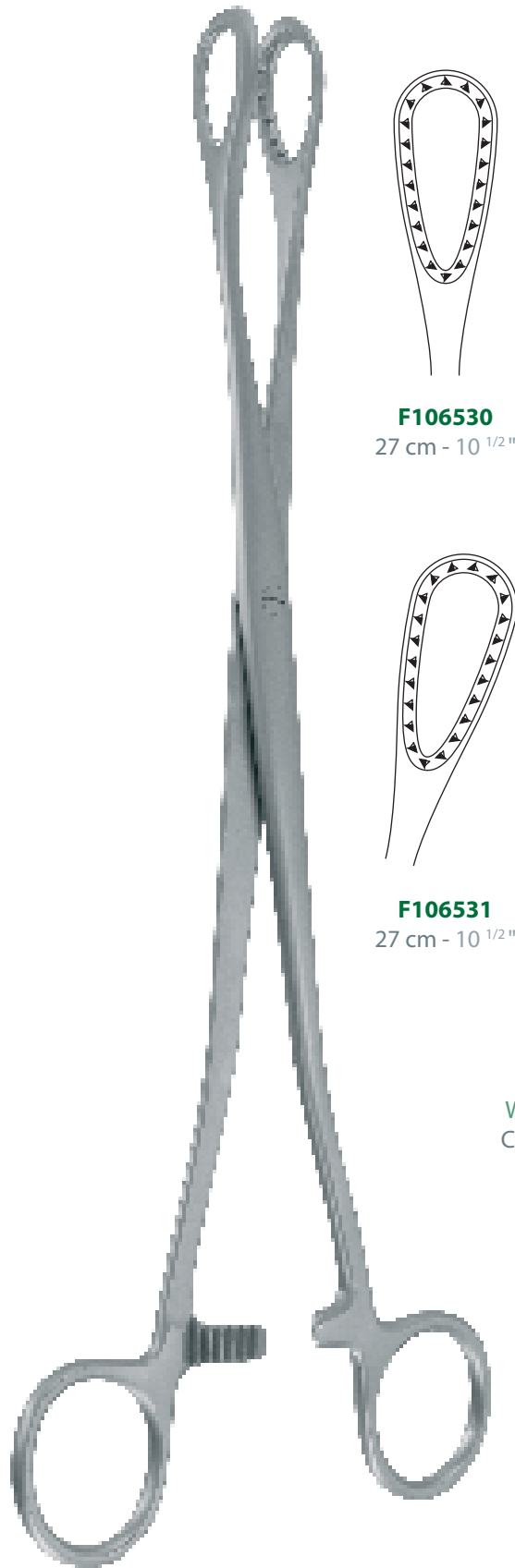

**F106530**

27 cm - 10 1/2"

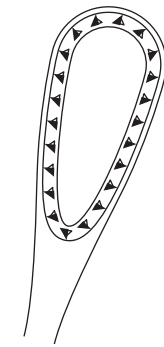

**F106531**

27 cm - 10 1/2"

A vis  
With screw  
Con tornillo

**F106530**

27 cm - 10 1/2"

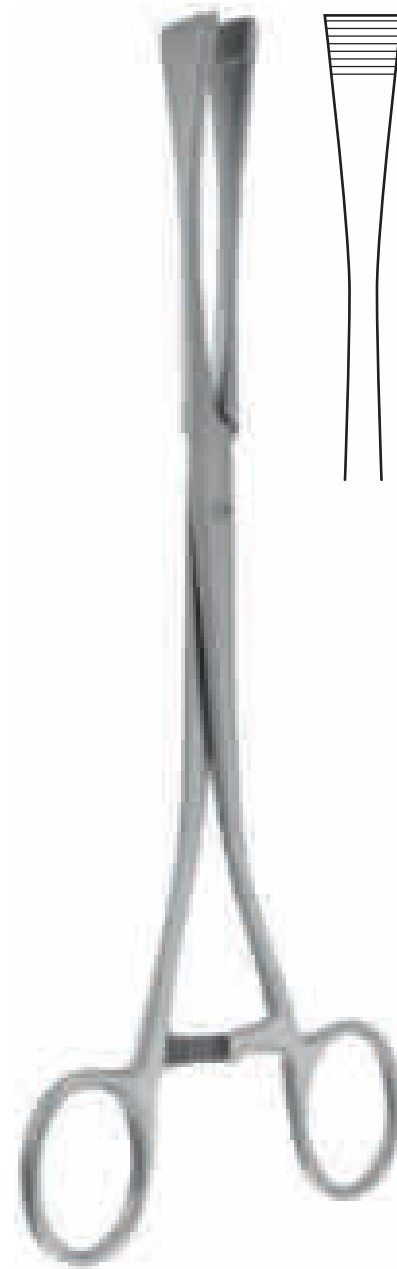

**F106540**

21 cm - 8 1/4"

### COLLIN

<b>F16000</b>	90 x 14 mm
<b>F16010</b>	90 x 16 mm
<b>F16020</b>	90 x 25 mm
<b>F16030</b>	90 x 30 mm
<b>F16034</b>	95 x 35 mm
<b>F16038</b>	105 x 30 mm
<b>F16040</b>	105 x 35 mm
<b>F16050</b>	105 x 38 mm
<b>F16060</b>	110 x 42 mm

Modèles avec tube d'aspiration  
Models with aspiration tube  
Modelos con tubo de aspiración

<b>F18125</b>	90 x 25 mm
<b>F18130</b>	90 x 30 mm
<b>F18135</b>	95 x 35 mm
<b>F18230</b>	105 x 30 mm
<b>F18235</b>	105 x 35 mm
<b>F18240</b>	110 x 42 mm

Modèle lourd  
Heavy model  
Fuerte modelo

<b>F17016</b>	100 x 16 mm
<b>F17025</b>	100 x 25 mm
<b>F17030</b>	100 x 30 mm
<b>F17035</b>	100 x 35 mm
<b>F17040</b>	100 x 40 mm

Longues valves  
Long blades  
Valvulas largas

<b>F17130</b>	150 x 30 mm
<b>F17135</b>	150 x 35 mm
<b>F17140</b>	150 x 40 mm



**F16010**

**F18125**

### PALMER

<b>F17165</b>	65 x 35 mm
---------------	------------

<b>F178000</b>	Adaptation d'un tube d'aspiration sur un spéculum vaginal Adaptation of one aspiration tube on a vaginal speculum Adaptación de un tubo de aspiración sobre un espéculo vaginal
----------------	---

### JAYLE

	<b>F17630</b>	100 x 30 mm
	<b>F17634</b>	100 x 34 mm
	<b>F17638</b>	100 x 38 mm

Longues valves  
Long blades  
Valvulas largas

<b>F17734</b>	150 x 34 mm
<b>F17738</b>	150 x 38 mm



**F17630**

**F178000**

Adaptation d'un tube d'aspiration sur un spéculum vaginal  
Adaptation of one aspiration tube on a vaginal speculum  
Adaptación de un tubo de aspiración sobre un espéculo vaginal

### CUSCO

Pliant Pliable Plegable		Fixe Fixed Fijo	
<b>F16070</b>	100 x 16 mm	<b>F16140</b>	
<b>F16080</b>	100 x 25 mm	<b>F16150</b>	
<b>F16090</b>	100 x 28 mm	<b>F16160</b> 	
 <b>F16100</b>	100 x 30 mm	<b>F16170</b>	
<b>F16110</b>	100 x 35 mm	<b>F16180</b>	
<b>F16120</b>	100 x 37 mm	<b>F16190</b>	
<b>F16130</b>	100 x 40 mm	<b>F16200</b>	

### SPÉCULUM POUR VIERGE VIRGIN SPECULA ESPÉCULO PARA VIRGEN

<b>F16210</b>	90 x 12 mm
<b>F16220</b>	90 x 14 mm
 <b>F16230</b>	90 x 16 mm
<b>F16240</b>	90 x 18 mm
<b>F16250</b>	90 x 20 mm



**F16100**

**F16160**

**F16230**



### CUSCO

Spéculum pour vierge  
Virgin specula  
Espéculo para virgen

**F163000** 75 x 17 mm

**F163001** 75 x 32 mm

 **F163002** 85 x 35 mm

**F163003** 100 x 37 mm

### GRAVE

**F163011** 75 x 20 mm

 **F163012** 95 x 30 mm

**F163013** 115 x 35 mm



**F163002**

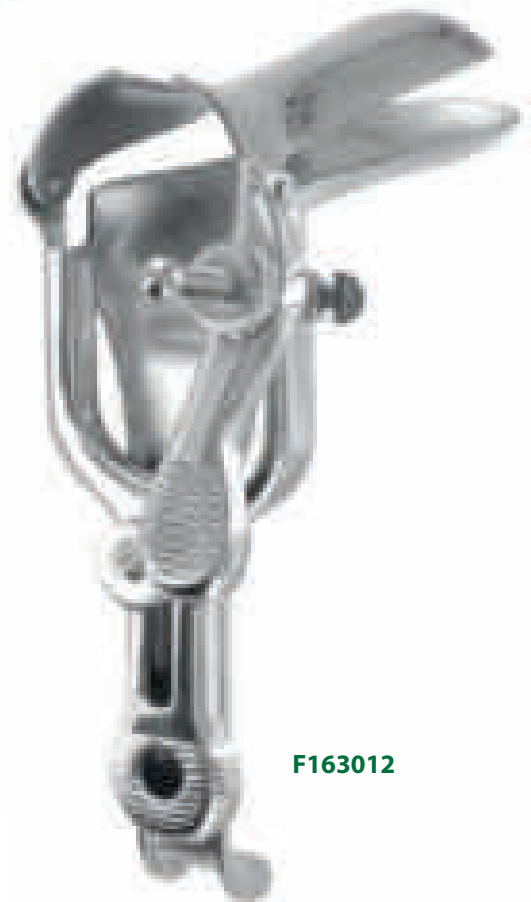

**F163012**

### PEDERSON

F163031 75 x 13 mm

 F163032 100 x 22 mm

F163033 120 x 25 mm

### SEYFFERT

F163021 100 x 17 mm

 F163022 110 x 33 mm

### SEMM

F163041 90 x 14/18 mm

F163042 100 x 17/20 mm

 F163043 100 x 25/30 mm



F163032



F163022



F163043

KOGAN



**F190010**  
24 cm - 9 1/2"



**F190020**  
24 cm - 9 1/2"

### DOYEN

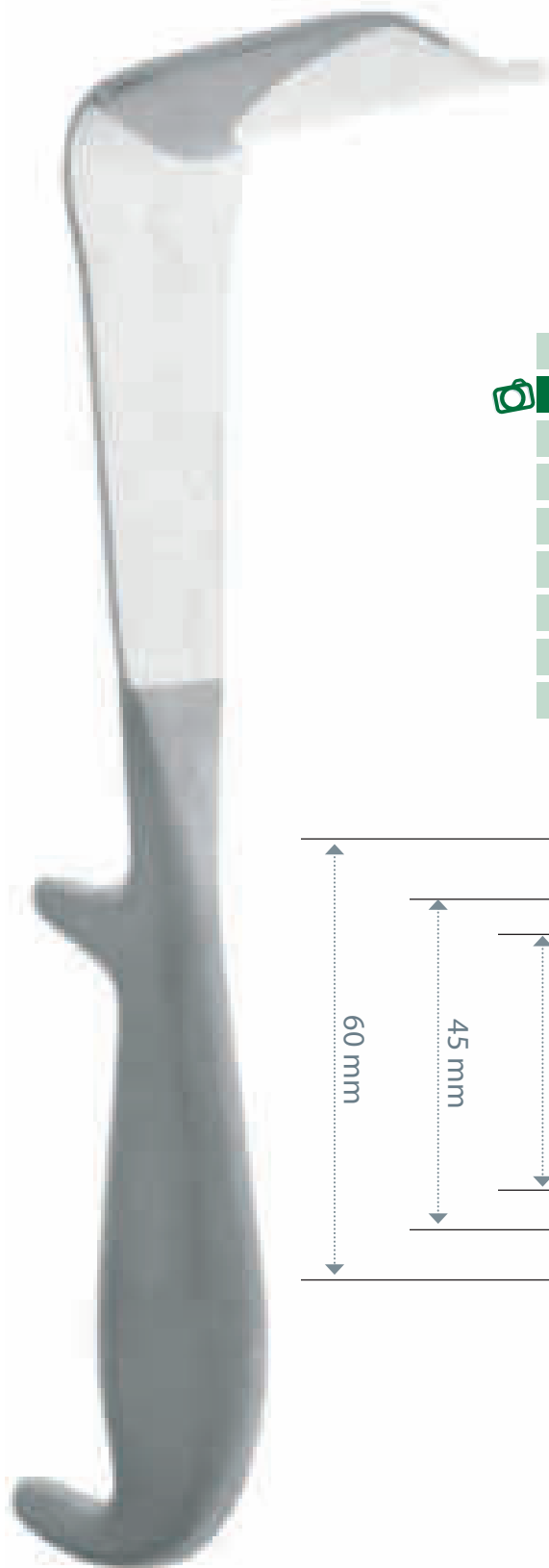

	Profondeur Depth Profundidad	Largeur Width Anchura
--	------------------------------------	-----------------------------

F250280	60 mm	35 mm
 F25030	60 mm	45 mm
F25060	60 mm	60 mm
F25035	90 mm	35 mm
F25040	90 mm	45 mm
F25070	90 mm	60 mm
F250450	120 mm	35 mm
F25050	120 mm	45 mm
F25080	120 mm	60 mm

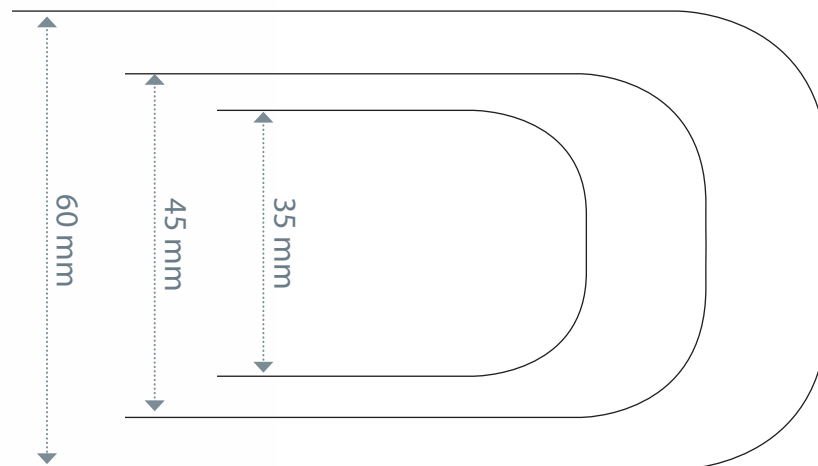

**F25030**  
23 cm - 9"



POUR INTERVENTION PAR VOIE VAGINALE  
FOR OPERATION THROUGH VAGINAL TRACT  
PARA INTERVENCIÓN POR VÍA VAGINAL

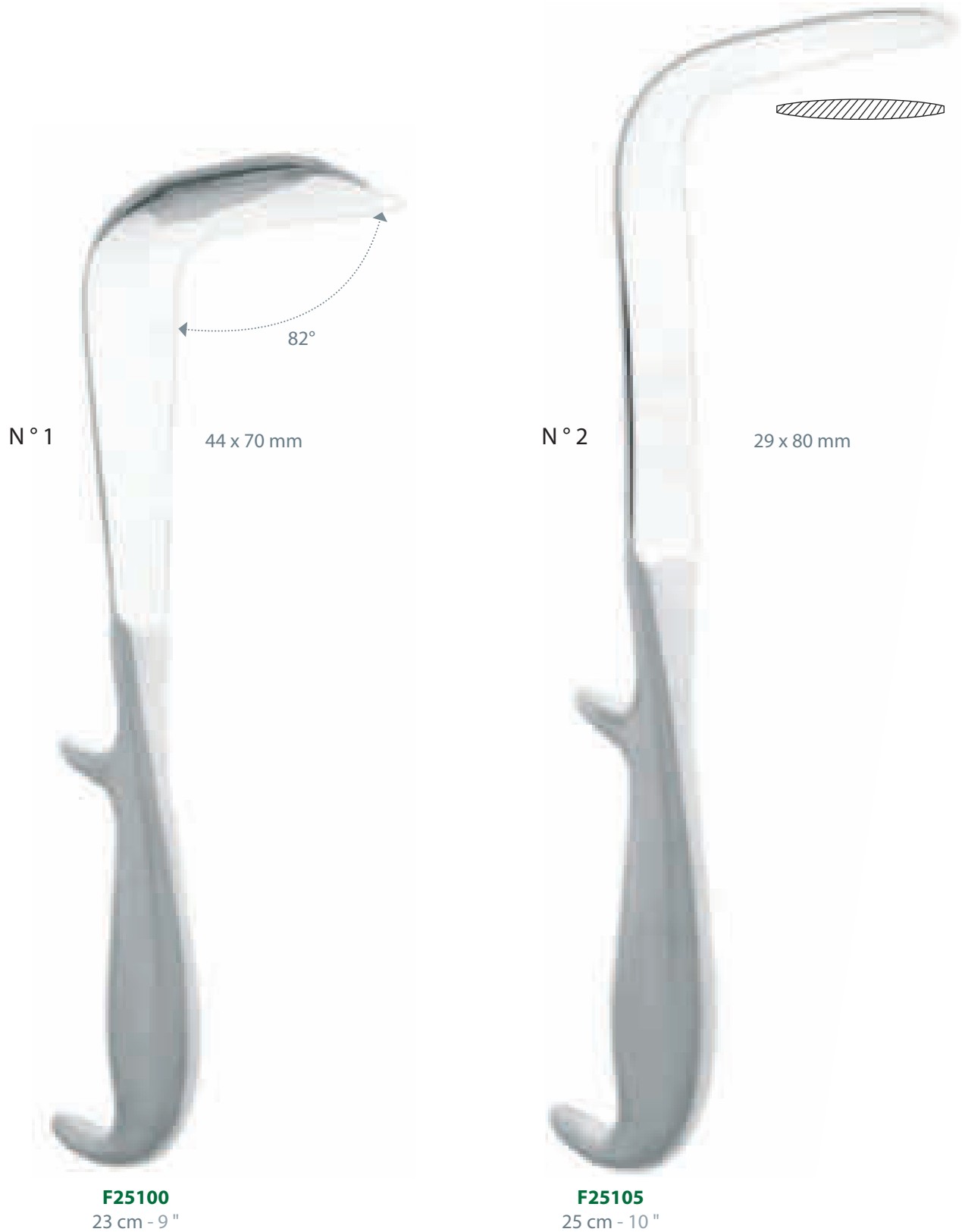

## Valves vaginales - Vaginal blades - Valvas vaginales

POUR INTERVENTION PAR VOIE VAGINALE  
FOR OPERATION THROUGH VAGINAL TRACT  
PARA INTERVENCIÓN POR VÍA VAGINAL

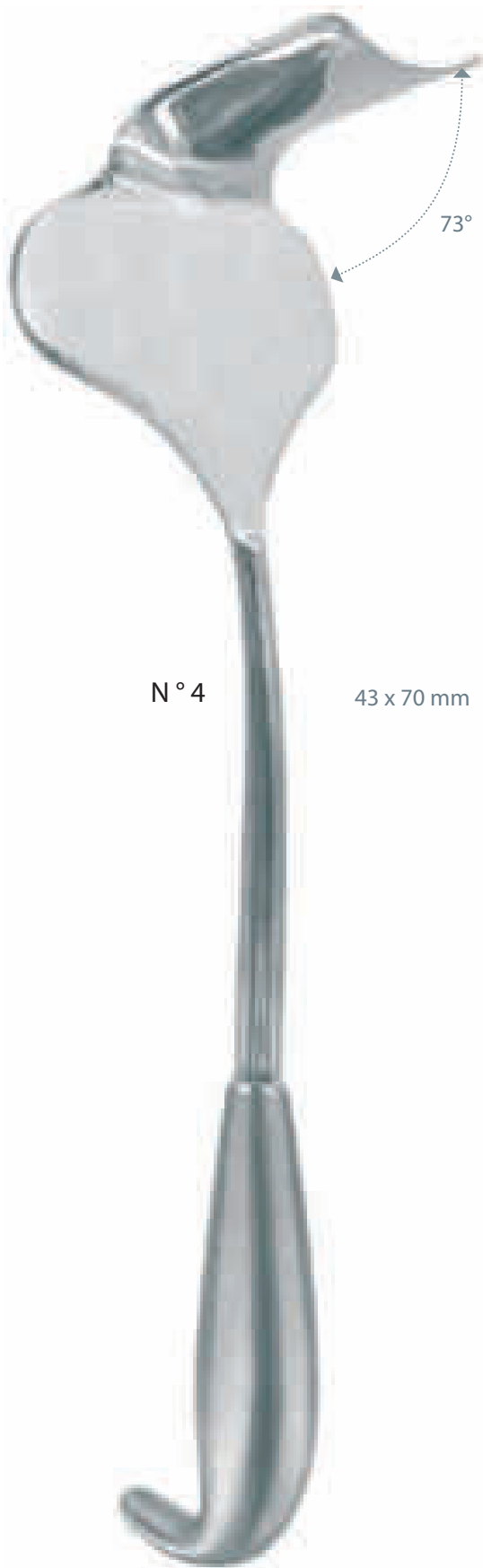

N° 4

43 x 70 mm

**F25110**

29 cm - 11 1/2"



N° 5

44 x 60 mm

**F25115**

23 cm - 9"

## Valves vaginales - Vaginal blades - Valvas vaginales

Pour intervention par voie vaginale  
For operation through vaginal tract  
Para intervención por vía vaginal



Convexe  
Convex  
Convexo

N° 6

28 x 131 mm

N° 7

40 x 128 mm

**F25120**

24 cm - 9 1/2"

**F25125**

23 cm - 9"

### MANGIAGALLI

### DOUGLAS



80 x 40 mm

**F251280**  
19 cm - 7 1/2 "



100 x 42 mm

**F251281**  
19 cm - 7 1/2 "

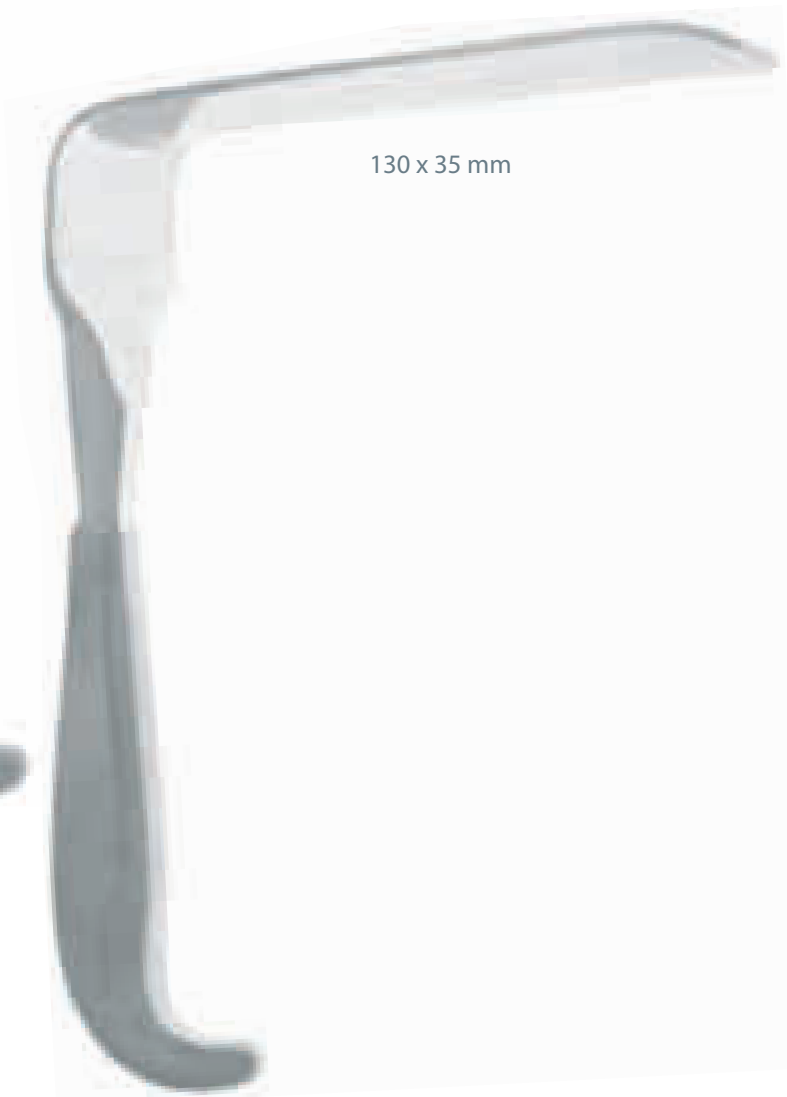

130 x 35 mm

**F251290**  
19 cm - 7 1/2 "



### DARGENT



Baïonette  
Bayonet  
Bayoneta

**F260010**  
38 cm - 15"

			Largueur Width Anchura	Longueur Length Largo
<b>N° 1</b>	38 cm - 15 "		<b>F260010</b>	40 mm 150 mm
<b>N° 2</b>	37 cm - 14 1/2 "		<b>F260020</b>	48 mm 135 mm
<b>N° 3</b>	35 cm - 13 3/4 "		<b>F260030</b>	50 mm 115 mm
<b>N° 4</b>	34 cm - 13 1/2 "		<b>F260040</b>	40 mm 115 mm
<b>N° 5</b>	33 cm - 13 "		<b>F260050</b>	38 mm 95 mm
<b>N° 6</b>	29 cm - 11 1/2 "		<b>F260060</b>	32 mm 90 mm
<b>N° 7</b>	28 cm - 11 "		<b>F260070</b>	28 mm 80 mm
<b>N° 8</b>	30 cm - 11 3/4 "		<b>F260080</b>	32 mm 90 mm
<b>N° 9</b>	30 cm - 11 3/4 "		<b>F260090</b>	30 mm 80 mm
<b>N° 10</b>	31 cm - 12 1/4 "		<b>F260100</b>	30 mm 85 mm
<b>N° 11</b>	31 cm - 12 1/4 "		<b>F260110</b>	22 mm 77 mm
<b>N° 12</b>	26 cm - 10 1/4 "		<b>F260120</b>	15 mm 70 mm

# LANDANGER

## Valves vaginales - Vaginal blades - Valvas vaginales

### LANDAU

		Largeur Width Anchura	Longueur Length Largo
29 cm - 11 1/2" 	<b>F251610</b>	28 mm	100 mm
29 cm - 11 1/2"	<b>F251615</b>	38 mm	100 mm

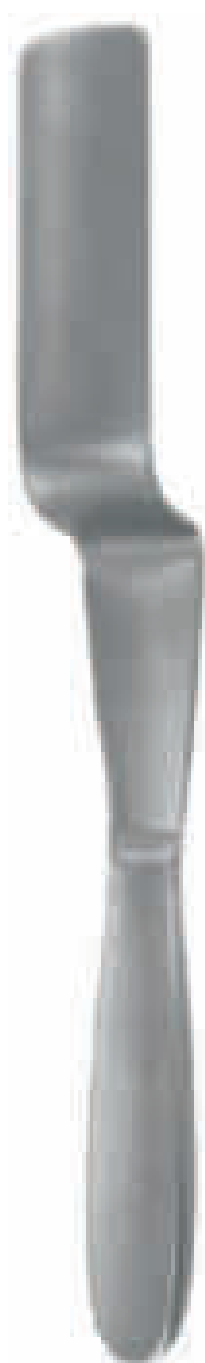

**F251610**  
29 cm - 11 1/2"

### BRIESKY

		Largeur Width Anchura	Longueur Length Largo
27 cm - 10 3/4"	<b>F251640</b>	15 mm	70 mm
27,5 cm - 10 4/5"	<b>F251720</b>	28 mm	80 mm
28 cm - 11 "	<b>F251770</b>	32 mm	90 mm
29 cm - 11 1/2"	<b>F251645</b>	20 mm	100 mm
29 cm - 11 1/2"	<b>F251690</b>	25 mm	100 mm
29 cm - 11 1/2"	<b>F251740</b>	30 mm	100 mm
29 cm - 11 1/2"	<b>F251790</b>	35 mm	100 mm
29 cm - 11 1/2"	<b>F251840</b>	40 mm	100 mm
32 cm - 12 1/2"	<b>F25165</b>	20 mm	130 mm
32 cm - 12 1/2"	<b>F25170</b>	25 mm	130 mm
32 cm - 12 1/2"	<b>F25175</b>	30 mm	130 mm
32 cm - 12 1/2"	<b>F25180</b>	35 mm	130 mm
32 cm - 12 1/2"	<b>F25185</b>	40 mm	130 mm
34 cm - 13 1/2"	<b>F251900</b>	40 mm	150 mm
37 cm - 14 1/2" 	<b>F251950</b>	40 mm	180 mm



**F251950**  
37 cm - 14 1/2"

### JACKSON

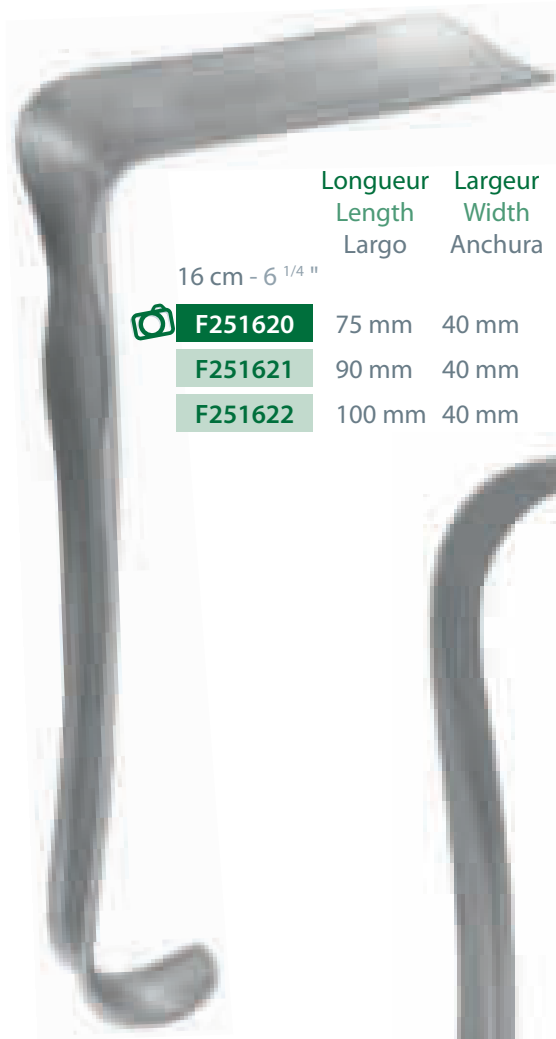

	Longueur Length Largo	Largeur Width Anchura
16 cm - 6 1/4 "		
 <b>F251620</b>	75 mm	40 mm
<b>F251621</b>	90 mm	40 mm
<b>F251622</b>	100 mm	40 mm

**F251620**

### KRISTELLER

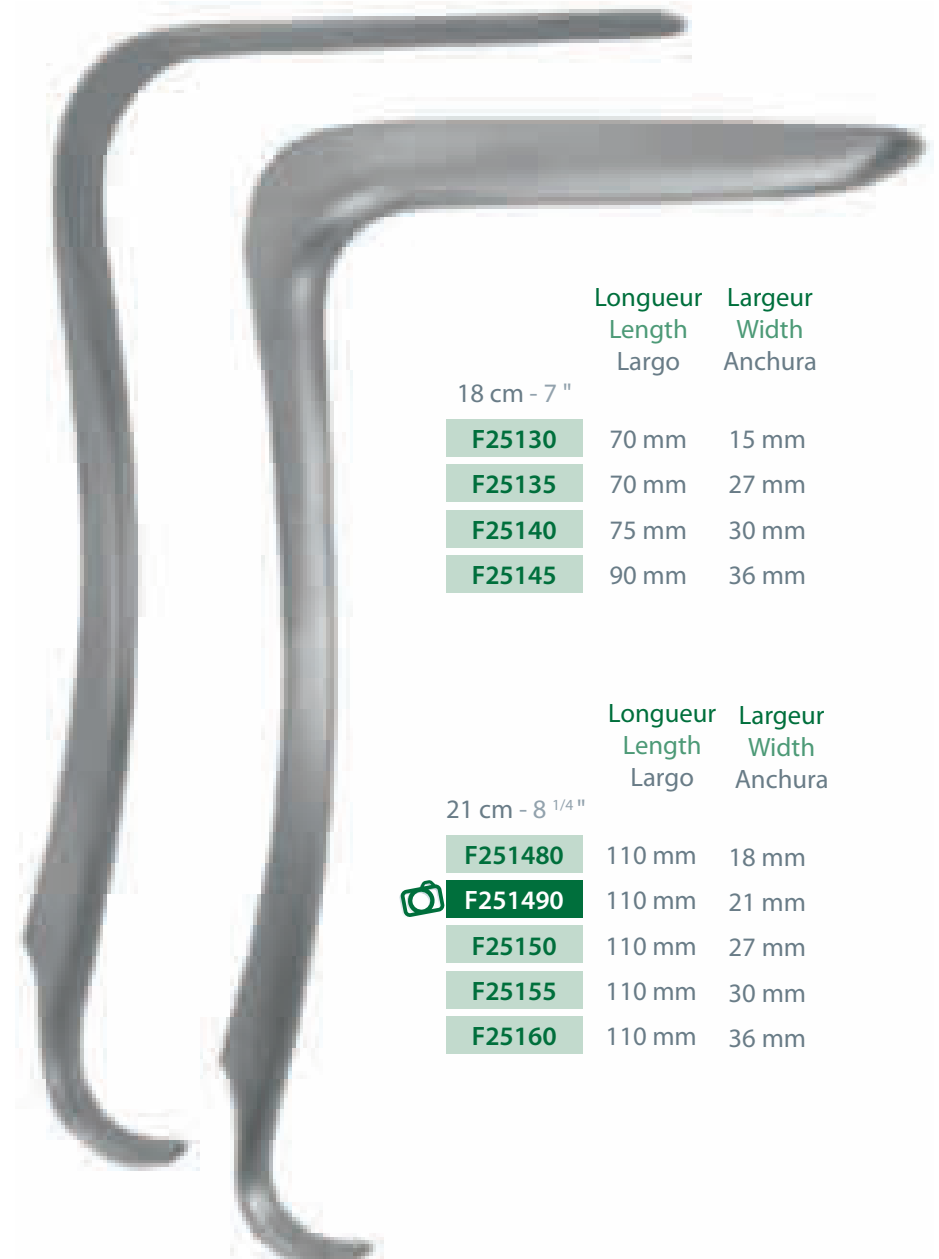

VALVE + SPECULUM  
BLADE + SPECULUM  
VALVULA + SPECULUM

	Longueur Length Largo	Largeur Width Anchura
18 cm - 7 "		
<b>F25130</b>	70 mm	15 mm
<b>F25135</b>	70 mm	27 mm
<b>F25140</b>	75 mm	30 mm
<b>F25145</b>	90 mm	36 mm

	Longueur Length Largo	Largeur Width Anchura
21 cm - 8 1/4 "		
<b>F251480</b>	110 mm	18 mm
 <b>F251490</b>	110 mm	21 mm
<b>F25150</b>	110 mm	27 mm
<b>F25155</b>	110 mm	30 mm
<b>F25160</b>	110 mm	36 mm

**F251490**

### SIMS

#### A l'unité - Per unit - La unidad

	Longueur Length Largo	Largeur Width Anchura	Longueur Length Largo	Largeur Width Anchura		Longueur Length Largo	Largeur Width Anchura
	A		B				
<b>F251631</b>	60 mm	25 mm	60 mm	30 mm	 <b>F251635</b>	63 mm	32 mm
<b>F251632</b>	70 mm	30 mm	70 mm	35 mm	<b>F251636</b>	76 mm	32 mm
<b>F251633</b>	80 mm	35 mm	80 mm	40 mm	<b>F251637</b>	89 mm	38 mm

#### Jeux de 3 - Set of 3 - Juego de 3

 **F251630**



**F251630**  
18 cm - 7 "



**F251635**  
17 cm - 6 <sup>3</sup>/<sub>4</sub> "

### DOYEN

F251270 60 x 30 mm

 F251271 70 x 30 mm

F251272 80 x 30 mm

### MATHIEU

Valve  
Blade  
Valva

Spéculum  
Specula  
Espéculo

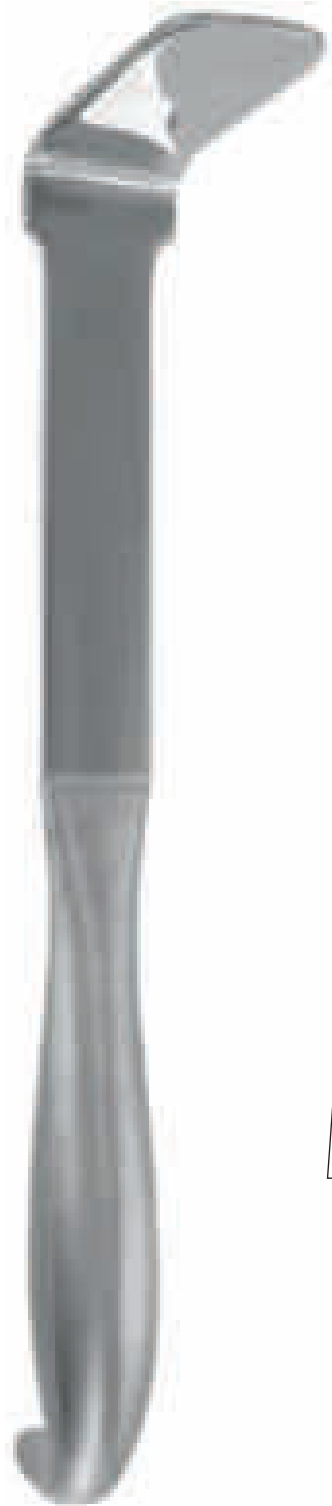

**F251271**  
25 cm - 10 "

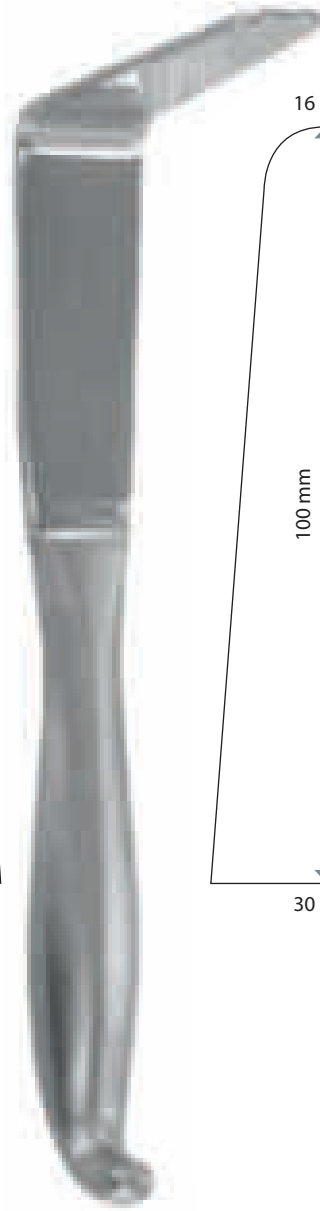
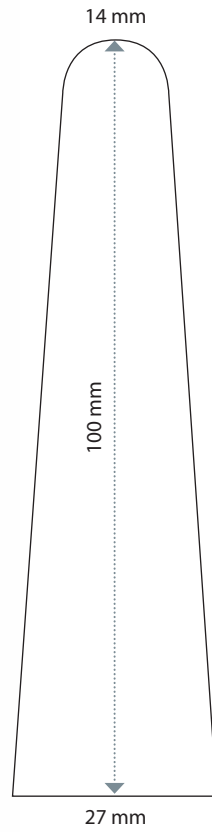

**F251275**  
20 cm - 8 "

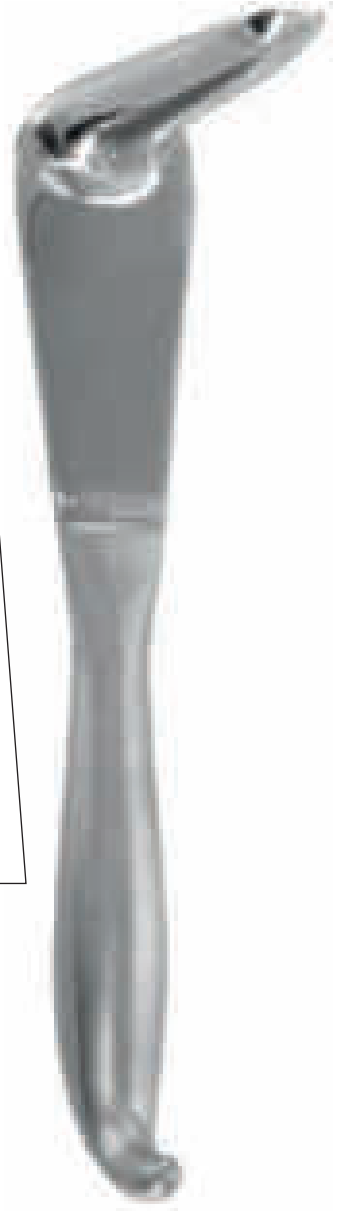
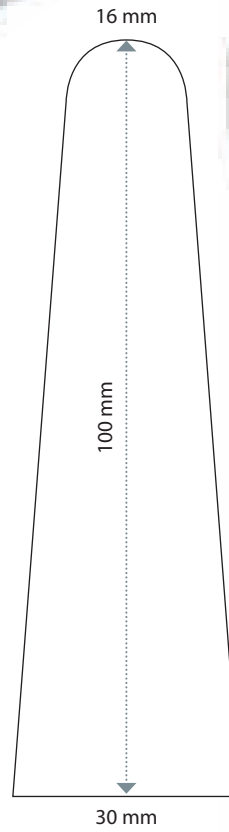

**F251276**  
20 cm - 8 "

### ST MARKS



180 x 60 mm

**F251261**

32,5 cm - 12<sup>3/4</sup> "



180 x 60 mm

**F251262**

33 cm - 13 "



130 x 60 mm

**F251260**

29 cm - 11<sup>1/2</sup> "

### JAYLE

Valve + Poids Blade + Weight Valva + Peso	Largeur Width Anchura	Longueur Length Largo
<b>F25010</b>	40 mm	60 mm
<b>F25020</b>	40 mm	90 mm



Poids seul (1000 g)  
Weight only (2,2 pounds)  
Peso sólo (1000 g)

Valve seule Blade only Valva sóla	Longueur Length Largo
<b>F250110</b>	60 mm
<b>F250210</b>	90 mm



**F250110**  
18 cm - 7 "

**F25025**  
16 cm - 6 1/4 "



### AUVARD

**F250265** 70 x 38 mm

 **F250266** 105 x 45 mm



Poids fixe  
Fixed weight  
Peso fijo

 **F250260** 80 x 38 mm

**F250261** 105 x 42 mm

Poids démontable  
Removable weight  
Peso desmontable

**F250266**  
23,5 cm - 9<sup>1</sup>/<sub>4</sub>"

**F250260**  
23 cm - 9"



### SCHERBAK

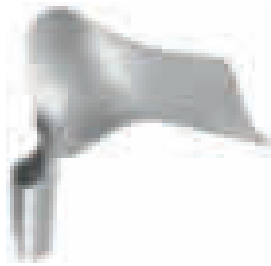

**F250277** 55 x 40/60 mm

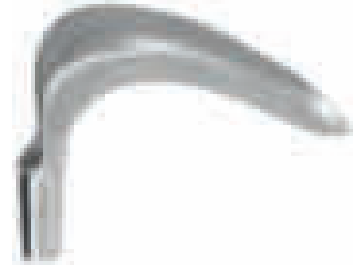

**F250274** 80 x 30 mm

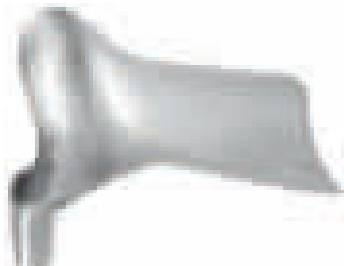

**F250278** 70 x 45/70 mm



Manche seul  
Handle only  
Mango solo  
17 cm - 6 3/4 " **F250271** 80 x 30 mm



**F250275** 85 x 35 mm



**F250276** 90 x 40 mm



Poids seul  
Weight only  
Peso solo

 **F250272** 400 Gr

**F250273** 800 Gr



**F250271**



**F250272**



**F250274**



**F250275**



**F250276**



**F250277**



**F250278**

Complet - Complete - Completo **F250270** 

# LANDANGER

## Amnioscopes - Amnioscopes - Amnioscopo

Complet avec mandrin  
Complete with mandril  
Completo con mandrino

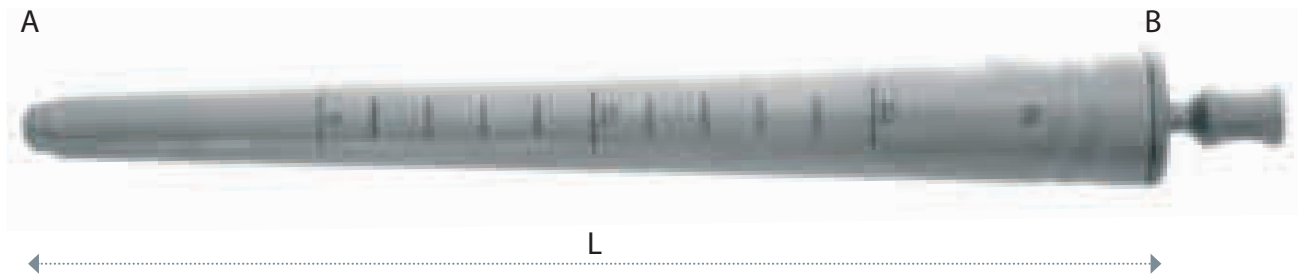

	Ø A	Ø B	L
 <b>F15370</b>	12 mm	24 mm	200 mm
<b>F15380</b>	16 mm	24 mm	200 mm
<b>F15390</b>	20 mm	24 mm	200 mm

Pince hystérolable - Uterine elevating forceps - Pinzas para coger el útero

COLLIN

DARTIGUES

SOMMER



TARNIER

Complet  
Complete  
Completo

**F10710**  
40 cm - 15 3/4 "

Tracteur seul  
Traction handle only  
Tractor sólo

**F107105**



DEMELIN-SUZOR

Système de serrage seul  
Screw system only  
Sistema de apreta solo

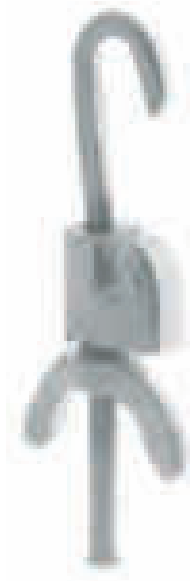

**F107210**

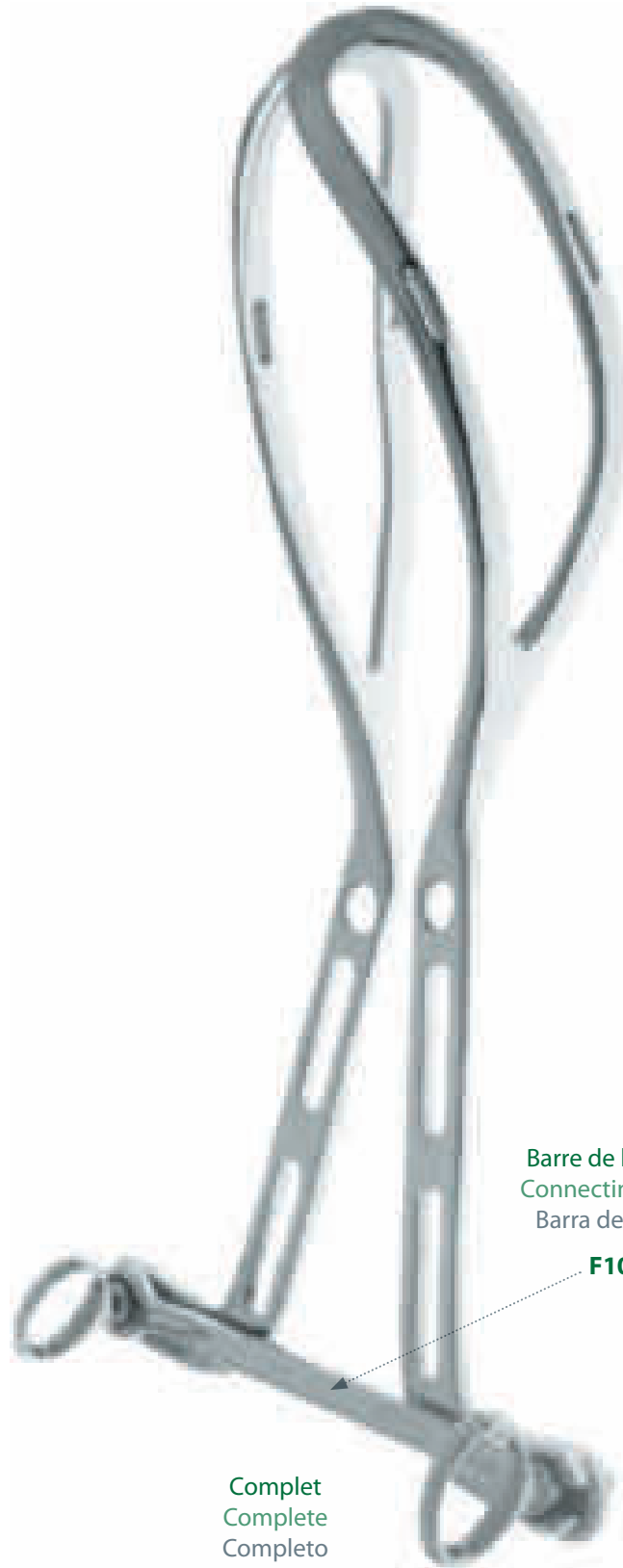

Barre de liaison seule  
Connecting plate only  
Barra de unión sólo

**F107205**

Complet  
Complete  
Completo

**F10720**  
32 cm - 12 1/2"

PAJOT



**F10730**  
36 cm - 14 1/4 "

MC LEAN

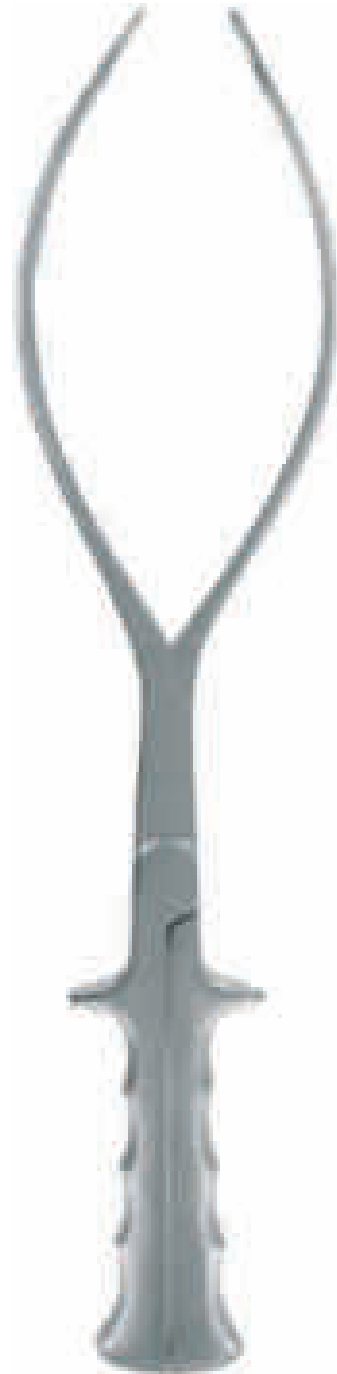

**F107870**  
36 cm - 14 1/4 "

KIELAND



**F10732**  
41 cm - 16 1/4 "

## Forceps spatules - Obstetrical forceps - Forceps obstetricos

### NAGELE

Spatules obstétricales (paire)  
 Obstetrical spatulas (pair)  
 Espatulas obstetricas (par)

36 cm - 14 1/4"  **F10736**

39 cm - 15 1/4" **F10735**



**F107330**  
 40 cm - 15 3/4"

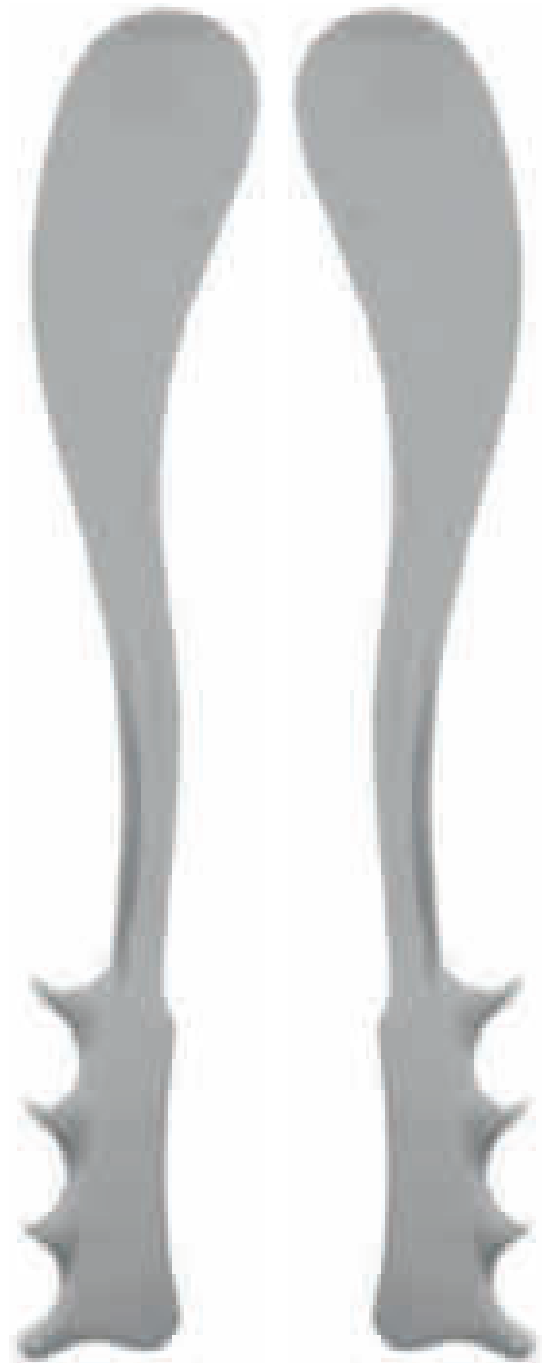

**F10736**  
 36 cm - 14 1/4"

WRIGLEY

SIMPSON



**F107220**  
28 cm - 11 "



**F107230**  
23 cm - 9 "



**F107240**  
30 cm - 12 "



LEVRET

SIMPSON BRAUN

PIPER



**F107250**  
41 cm - 16 1/4 "



**F107260**  
36 cm - 14 "



**F107270**  
44 cm - 17 1/4 "

### TEISSIER

Les 2 spatules sans tracteur  
The 2 spatulas without traction handle  
Las 2 espátulas sin tractor



**F10737**  
31 cm - 12 1/4"

Tracteur seul  
Traction handle only  
Tractor sólo



**F10738**

### SIMPSON LUIKART

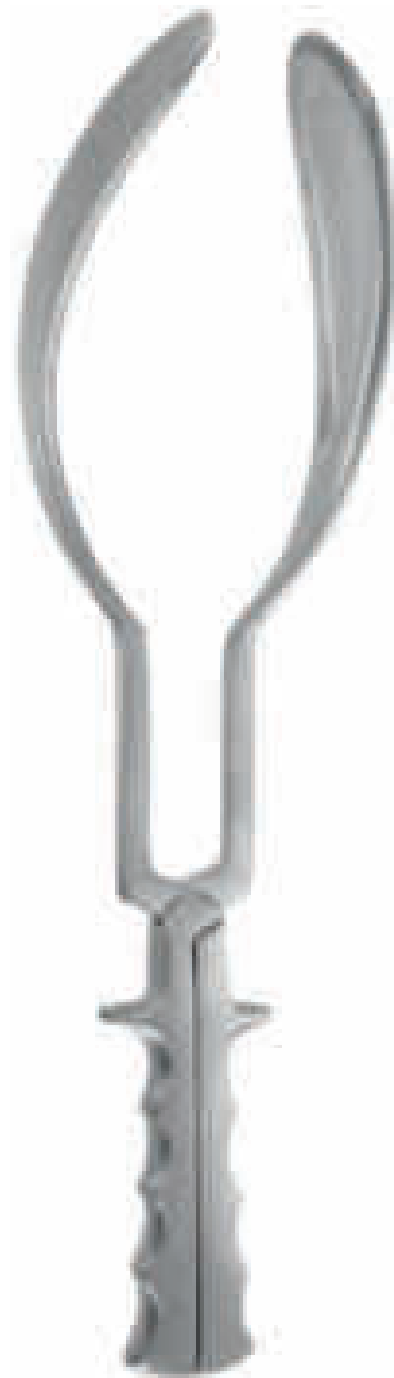

**F107340**  
36 cm - 14"

## NOTTER

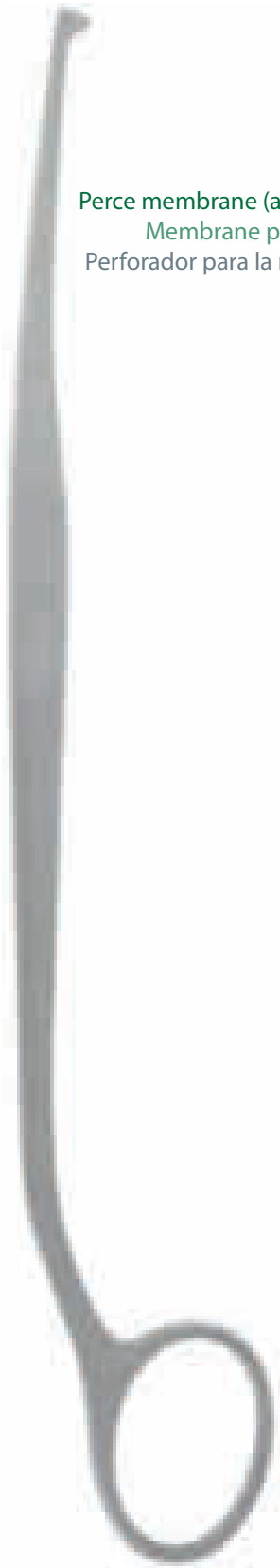

Perce membrane (amniotome)  
Membrane punch  
Perforador para la membrana

**F107900**  
22 cm - 8 3/4 "

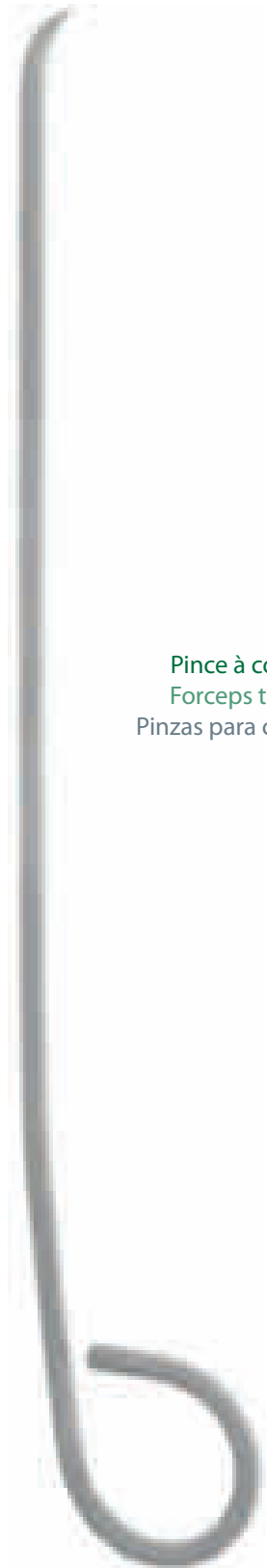

Pince à couper les clamps  
Forceps to cut the clamps  
Pinzas para cortar los clamps

**F10800**  
22 cm - 8 3/4 "

## BAR



**F10740**  
8,5 cm - 3 1/3 "



**F10755**  
15 cm - 6 "

## Ventouse obstétricale - Obstetric vacuum cup - Ventosa obstétrica

Ventouse  
Suction cup  
Ventosa

	Ø
 <b>F315005</b>	30 mm
<b>F315006</b>	40 mm
<b>F315007</b>	50 mm

Diaphragme  
Diaphragm  
Diafragma

	Ø
 <b>F315015</b>	40 mm
<b>F315016</b>	50 mm
<b>F315017</b>	60 mm

Poignée de traction  
Traction handle  
Puñado de tracción



Lac de traction (nylon)  
Vessel of traction (nylon)  
Bramante de tracción (nylon)

**F315021**

6 brins de 1 m  
6 wires of 39 1/4"  
6 hilos de 1 m

3 tubes silicone  
3 silicon tubs  
3 tubos de silicona

 **F315022**

2 m - Ø 3 x 7 mm

Rouleau tube silicone  
Roll tub silicon  
Rollo tubo silicona

**F315122**

25 m - Ø 3 x 7 mm

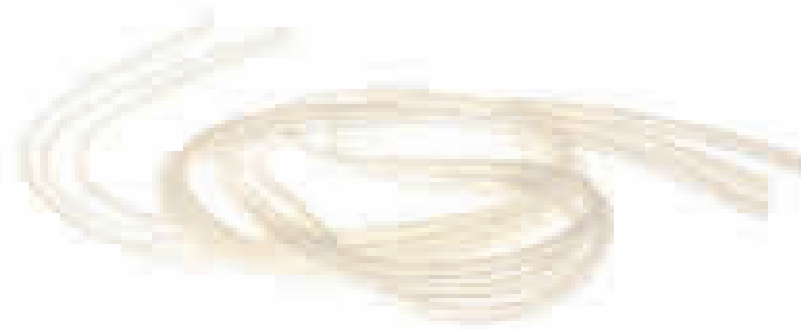

### J. L. FAURE

### SHUBERT

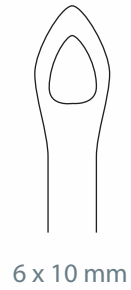

6 x 10 mm

A vis  
With screw  
Con tornillo

**F20160**  
25 cm - 10 "

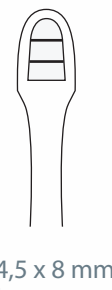

4,5 x 8 mm



**F20165**  
26 cm - 10 1/4 "

### VAN DOREN

### SCHUMACHER



4,5 mm



**F201660**  
4,5 mm



**F201665**  
6 mm

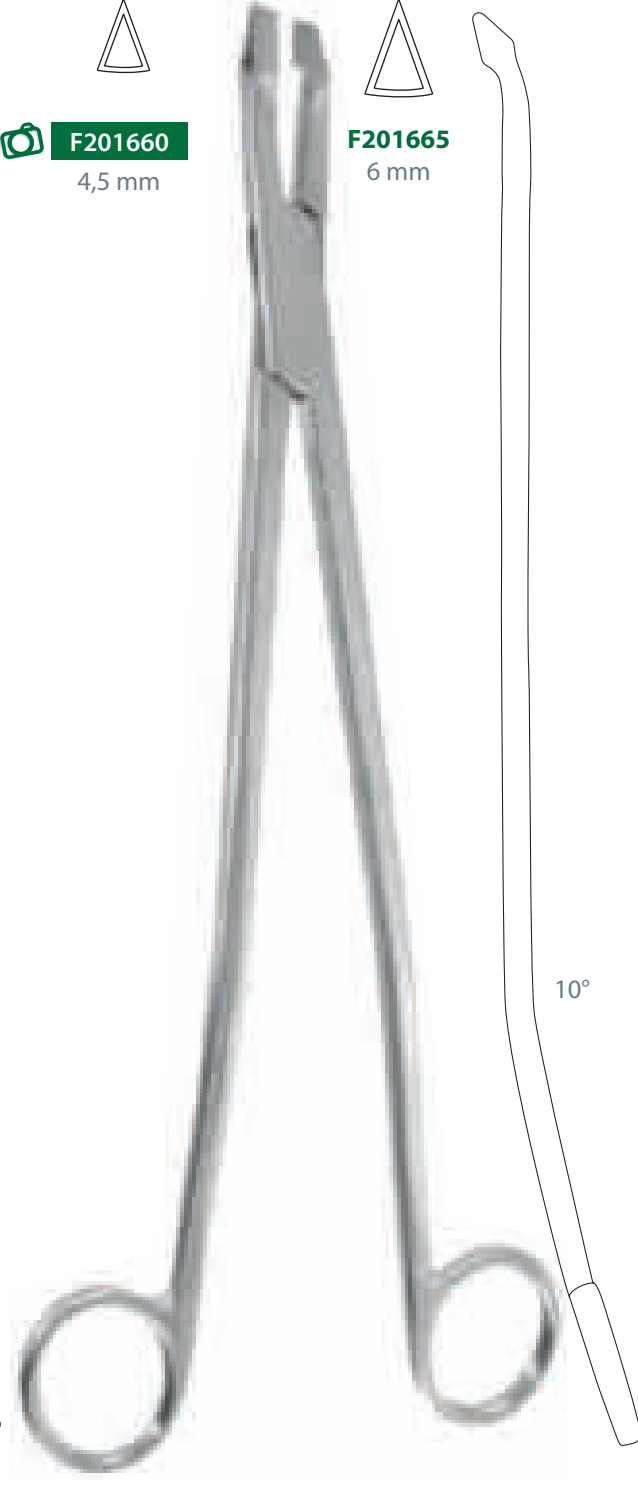
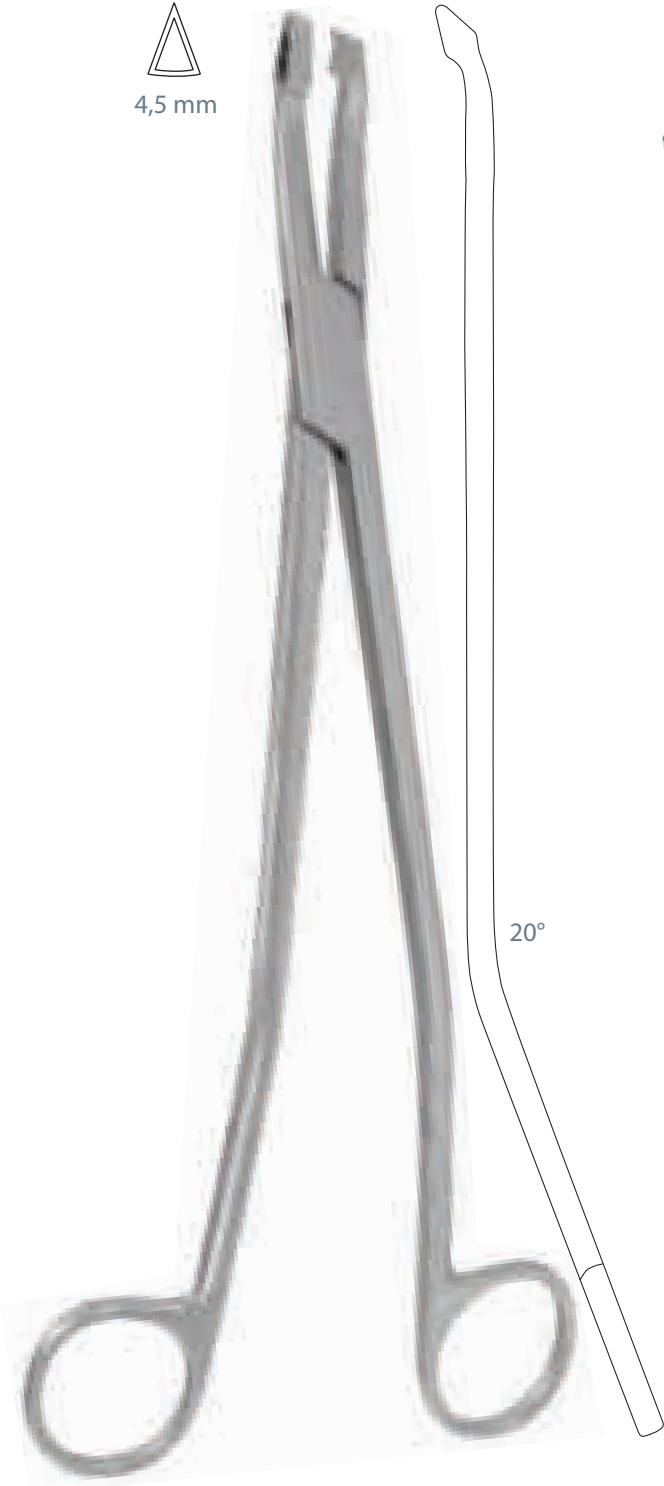

**F201655**  
24 cm - 9 1/2 "

**F201660**  
24 cm - 9 1/2 "

# LANDANGER

Pinces à biopsie - Biopsy forceps - Pinzas para biopsia

## LANDANGER

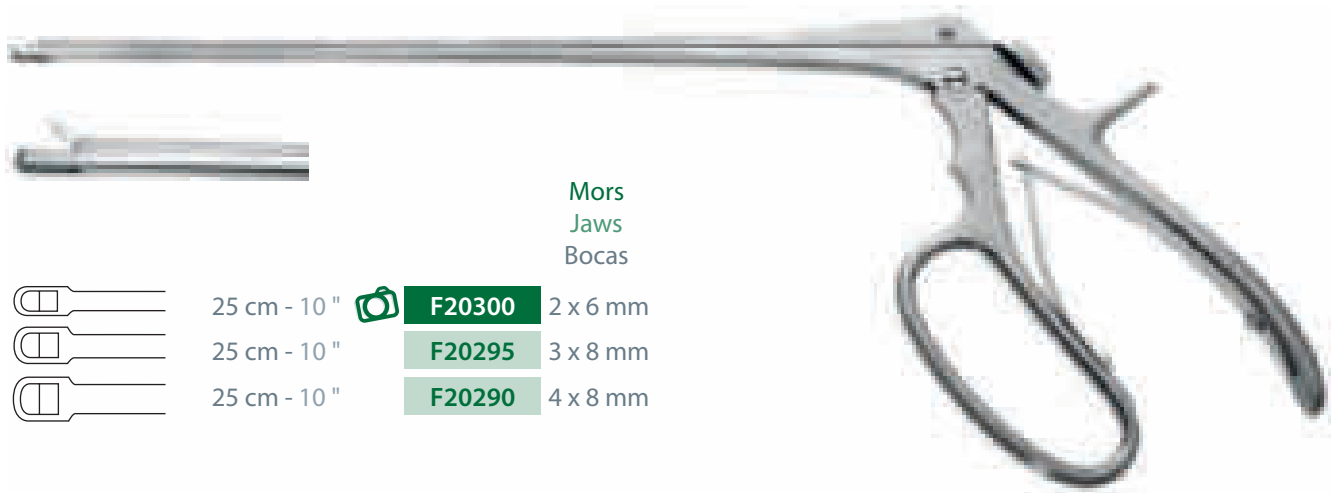

Mors  
Jaws  
Bocas

	25 cm - 10" 	<b>F20300</b>	2 x 6 mm
	25 cm - 10"	<b>F20295</b>	3 x 8 mm
	25 cm - 10"	<b>F20290</b>	4 x 8 mm

## TISCHLER-MORGAN

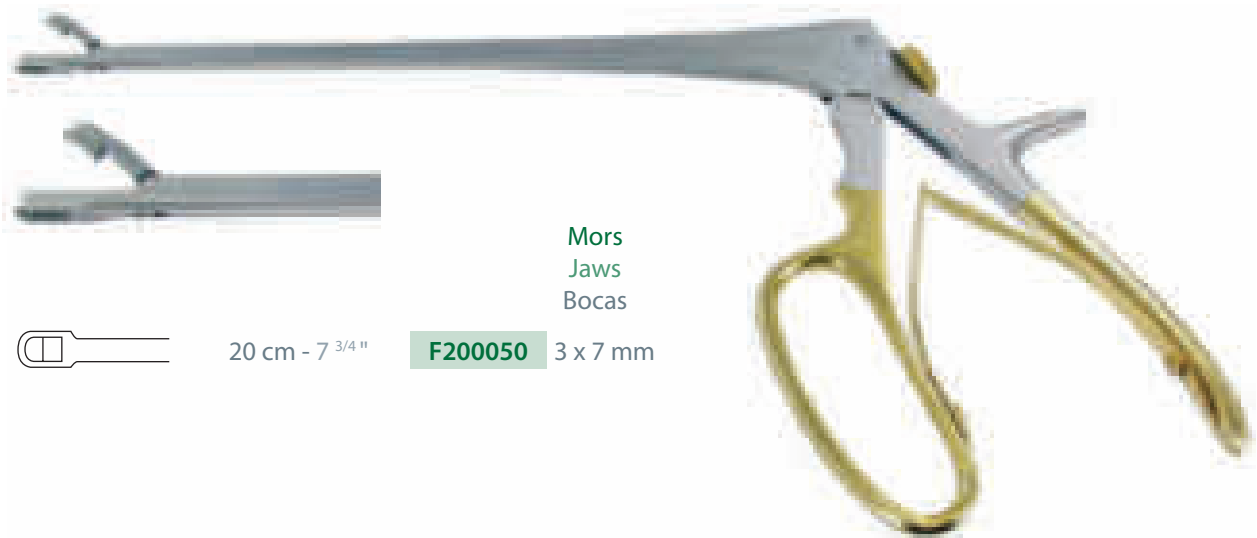

Mors  
Jaws  
Bocas

	20 cm - 7 3/4"	<b>F200050</b>	3 x 7 mm
---	----------------	----------------	----------

## BABY-TISCHLER (MINI-TOWNSEND)



Mors  
Jaws  
Bocas

	21 cm - 8"	<b>F200060</b>	2,3 x 4 mm
---	------------	----------------	------------

## Pinces à biopsie - Biopsy forceps - Pinzas para biopsia

### DOUAY



Mors  
Jaws  
Bocas

20 cm - 8 "	 <b>F20010</b>	4 x 10 mm
25 cm - 10 "	<b>F20020</b>	4 x 10 mm
30 cm - 11 3/4 "	<b>F20030</b>	4 x 10 mm

### BERGER



Coupe ronde  
Round cut  
Corte redonda

20 cm - 8 "	<b>F20070</b>	Ø 5 mm
-------------	---------------	--------

### SCHUMAKER

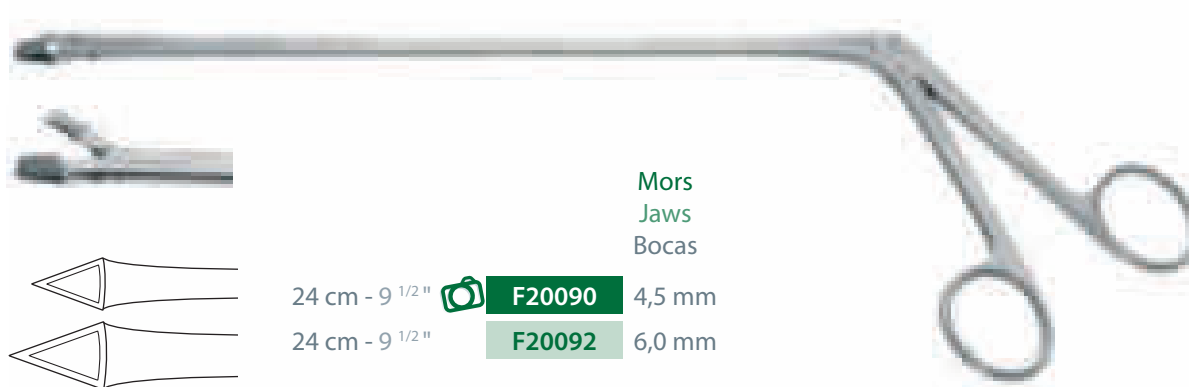

Mors  
Jaws  
Bocas

24 cm - 9 1/2 "	 <b>F20090</b>	4,5 mm
24 cm - 9 1/2 "	<b>F20092</b>	6,0 mm



## Pinces à biopsie - Biopsy forceps - Pinzas para biopsia

### PATTERSON

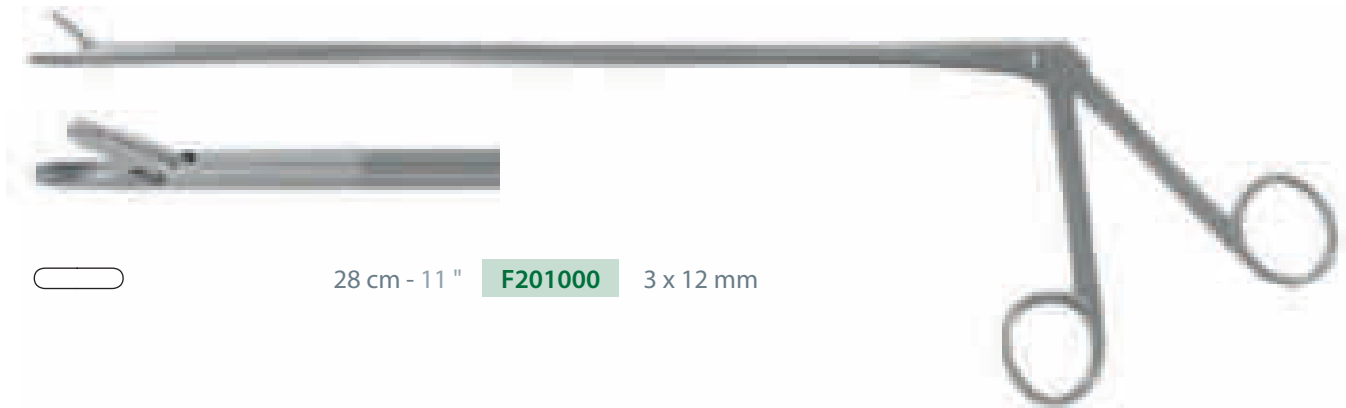

28 cm - 11 " **F201000** 3 x 12 mm

### KEVORKIAN



23 cm - 9" **F201010** 3 x 10 mm

### EPPENDORF



20 cm - 8" **F201020** 4 x 8 mm

### TOWNSEND

23 cm - 9"

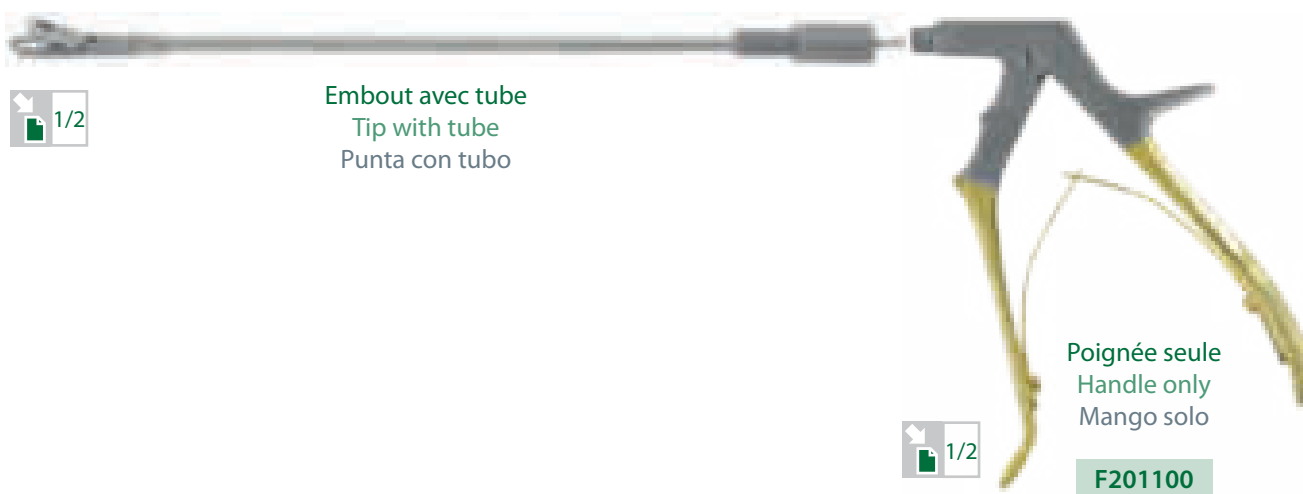

### TISCHLER



### KEVORKIAN



### MINI TOWNSEND

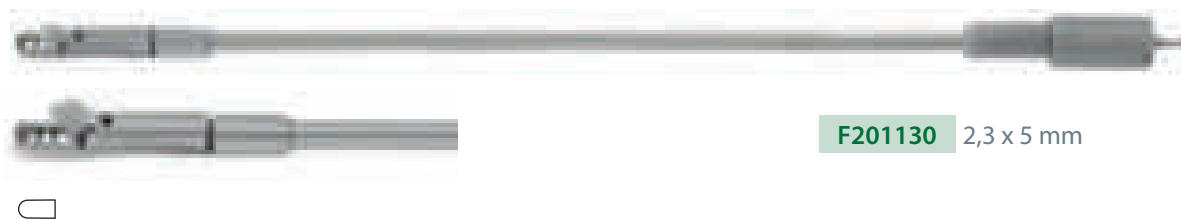

### GOURDET

Mousse  
Blunt  
Roma

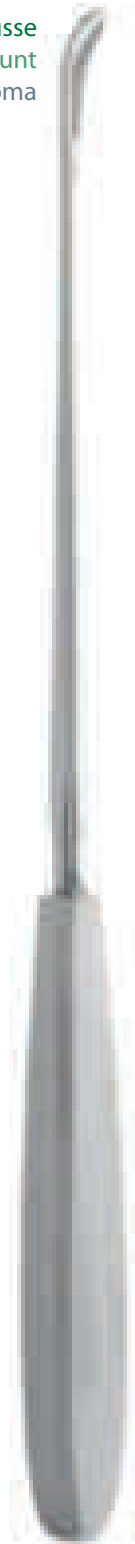

**F30180**  
26 cm - 10 1/4"

**F30170**

4 mm



**F30180**

6 mm



**F30190**

8 mm



**F30200**

10 mm



**F30210**

12 mm

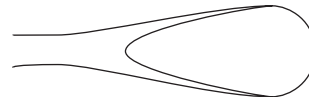

**F30220**

14 mm

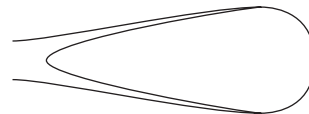

**F30230**

16 mm

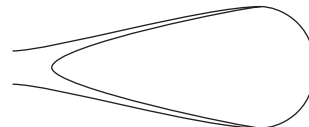

### WALLICH

Mousse  
Blunt  
Roma

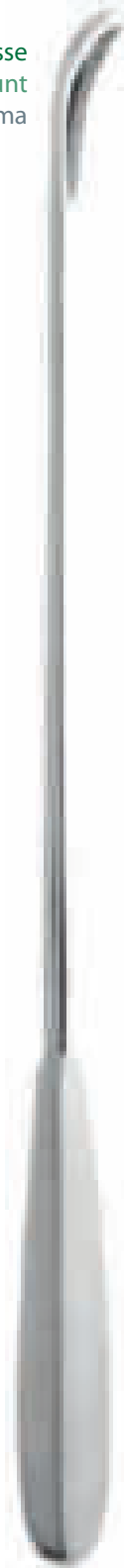

35 cm - 13 3/4"  **F30245**

12 mm

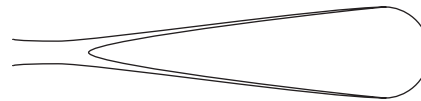

35 cm - 13 3/4" **F30250**

40 cm - 15 3/4" **F30280**

14 mm

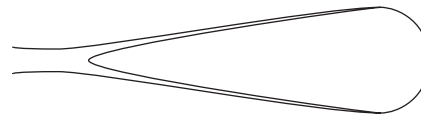

35 cm - 13 3/4" **F30260**

40 cm - 15 3/4" **F30290**

17 mm

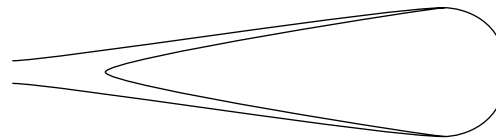

35 cm - 13 3/4" **F30270**

40 cm - 15 3/4" **F30300**

20 mm

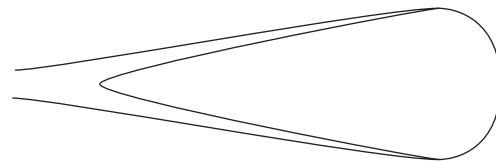

**F30245**

35 cm - 13 3/4"



### SIMON

Tranchante  
Sharp  
Cortante

Double courbure  
Double curvature  
Doble curvatura

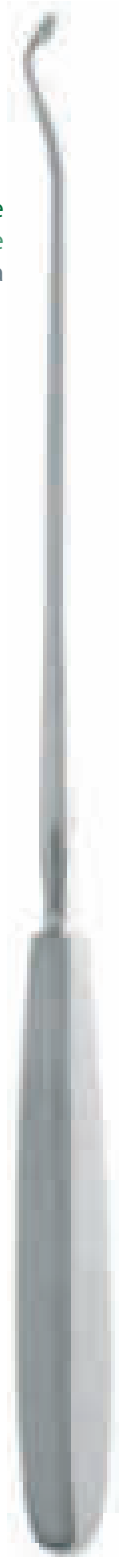

**F30010**  
27 cm - 10<sup>3/4</sup> "



**F30010**

4 mm



**F30015**

6 mm



**F30020**

8 mm

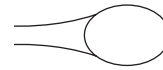

**F30030**

10 mm

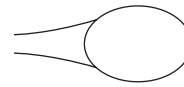

**F30040**

12 mm

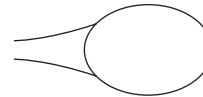

**F30050**

14 mm

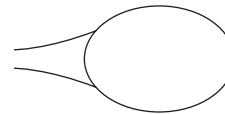

**F30060**

16 mm

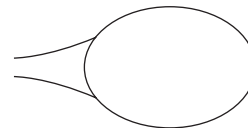

**F30070**

18 mm

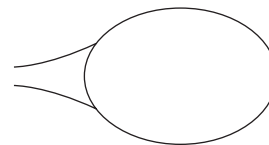

### VOLKMANN

Tranchante  
Sharp  
Cortante

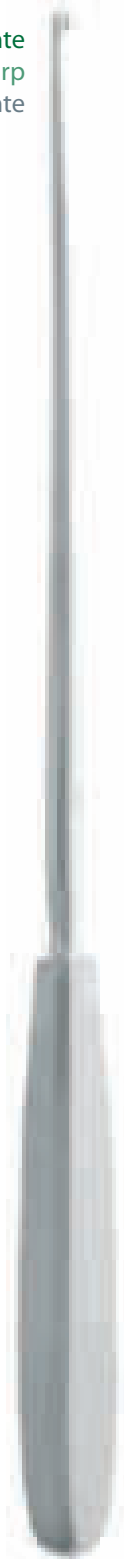

**F30340**  
28 cm - 11"



**F30340**

3 mm



**F30350**

6 mm

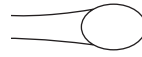

**F30360**

8 mm

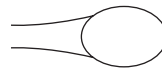

**F30370**

10 mm

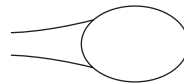

**F30380**

12 mm

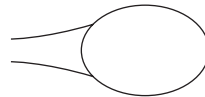

**F30390**

14 mm

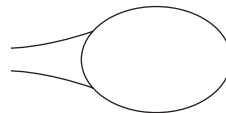

### SCHRÖDER

Tranchante  
Sharp  
Cortante

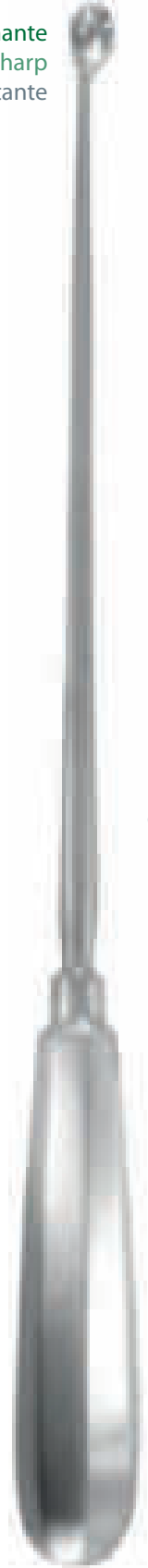

**F303913**  
30 cm - 12 "

### SIMON

Tranchante  
Sharp  
Cortante

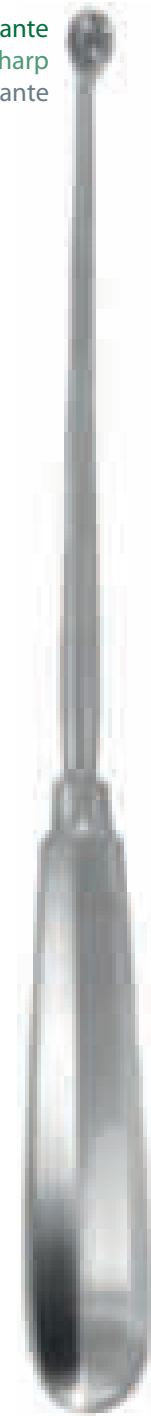

**F303922**  
25 cm - 10 "

**F303911**



N° 1 - 7,0 mm

**F303921**

**F303912**

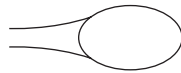

N° 2 - 8,5 mm

 **F303922**

 **F303913**

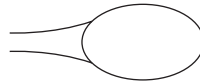

N° 3 - 10,0 mm

**F303923**

**F303914**

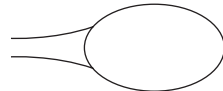

N° 4 - 11,5 mm

**F303924**

**F303915**

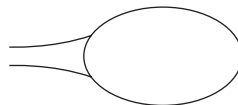

N° 5 - 13,0 mm

**F303925**

**F303916**

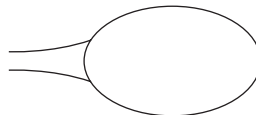

N° 6 - 14,5 mm

**F303926**

### SIMS

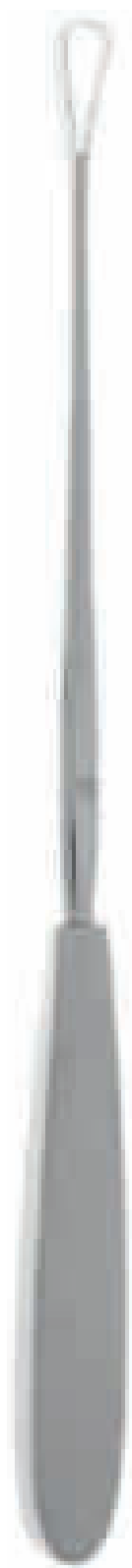

**F30130**  
28 cm - 11 "

Tranchante Sharp Cortante	Mousse Blunt Roma		
<b>F30080</b>	<b>F300801</b>	3 mm	
<b>F30090</b>	<b>F300901</b>	4 mm	
<b>F30100</b>	<b>F301001</b>	5 mm	
<b>F30110</b>	<b>F301101</b>	6 mm	
<b>F30120</b>	<b>F301201</b>	8 mm	
 <b>F30130</b>	<b>F301301</b>	10 mm	
<b>F30140</b>	<b>F301401</b>	12 mm	
<b>F30150</b>	<b>F301501</b>	14 mm	
<b>F30160</b>	<b>F301601</b>	16 mm	





### RECAMIER

Tranchante  
Sharp  
Cortante

Mousse  
Blunt  
Roma

**F30311** **F30332**    
N° 00 - 5 mm

**F30312** **F30333**   
N° 01 - 7 mm

**F30313** **F30334**   
N° 03 - 9 mm

**F30314** **F30335**   
N° 05 - 12 mm

**F30316** **F30336**   
N° 06 - 14 mm

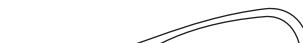
**F30317** **F30337**   
N° 08 - 16 mm

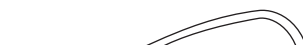
**F30319** **F30338**   
N° 09 - 19 mm

**F303200** **F303382**   
N°11 - 21 mm

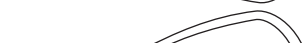
**F303210** **F303383**   
N° 12 - 23 mm

Tranchante  
Sharp  
Cortante

Mousse  
Blunt  
Roma

**F303220** **F303385**

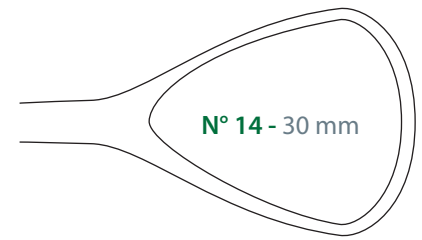
  
N° 14 - 30 mm

**F303230** **F303386**

  
N° 15 - 35 mm

**F303240** **F303387**

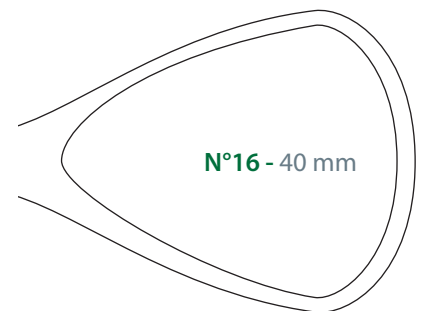
  
N°16 - 40 mm

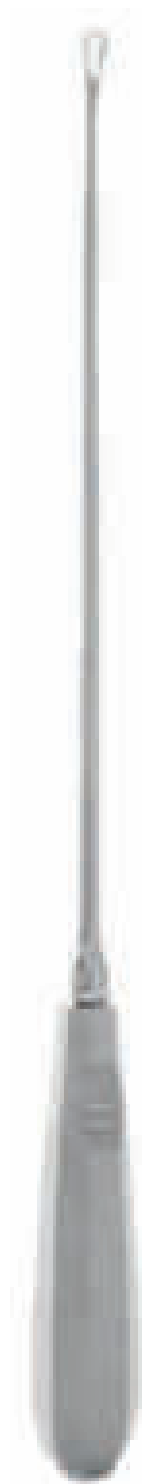

**F30332**  
31 cm - 12 1/4"

### CUZZI



**F304000**  
14 mm

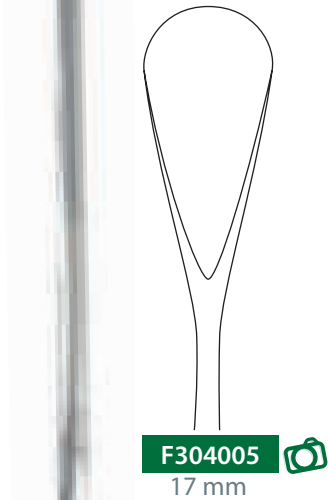

**F304005**   
17 mm

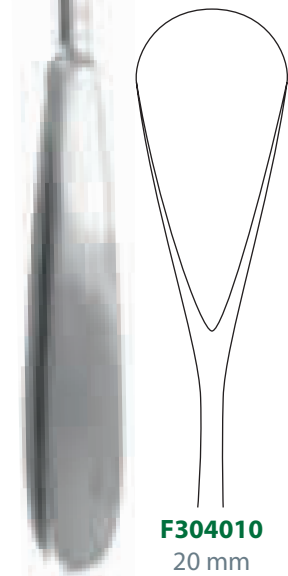

**F304010**  
20 mm

**F304005**  
35 cm - 13 <sup>3</sup>/<sub>4</sub> "

### HEANEY

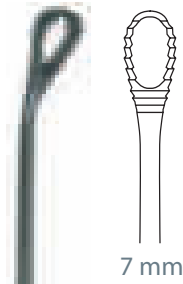

7 mm

**F304030**  
24 cm - 9 <sup>1</sup>/<sub>2</sub> "

### PIRON

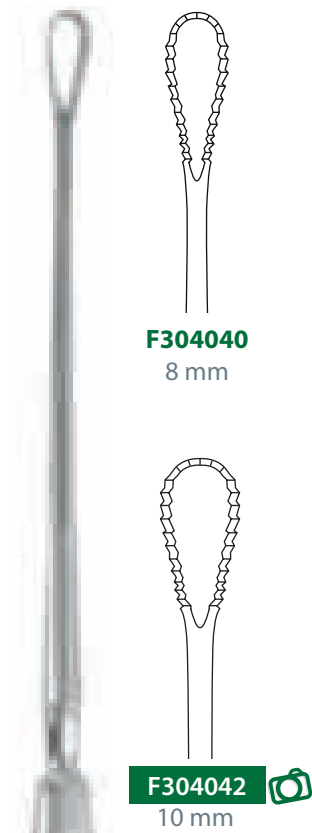

**F304040**  
8 mm

**F304042**   
10 mm

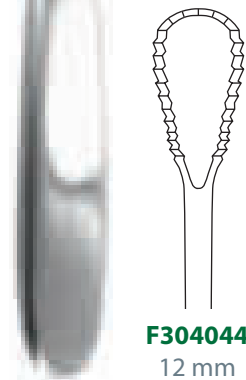

**F304044**  
12 mm

**F304042**  
28,5 cm - 11 <sup>1</sup>/<sub>4</sub> "

### POZZI

### BLAKE

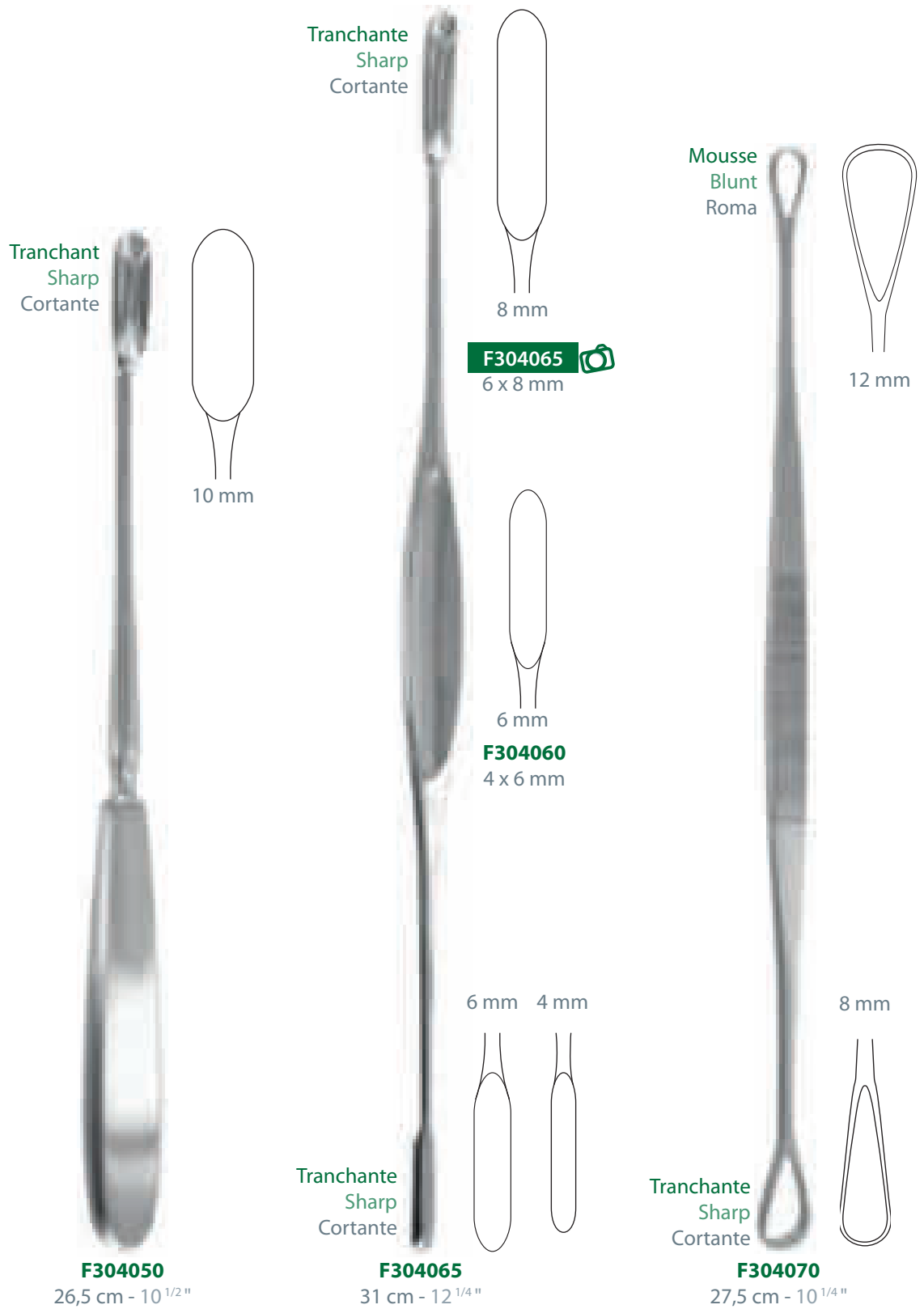

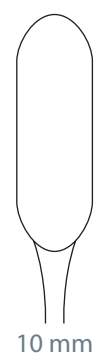

Tranchant  
Sharp  
Cortante

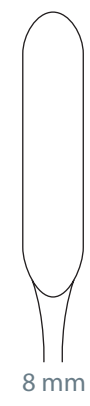

**F304050**  
26,5 cm - 10 1/2 "

Tranchante  
Sharp  
Cortante



**F304065**   
6 x 8 mm

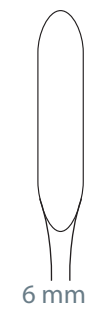

**F304060**  
4 x 6 mm

6 mm 4 mm

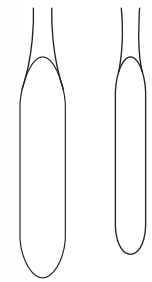

Tranchante  
Sharp  
Cortante

**F304065**  
31 cm - 12 1/4 "

Mousse  
Blunt  
Roma

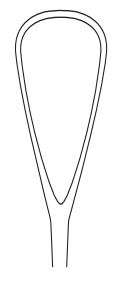

Tranchante  
Sharp  
Cortante

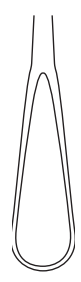

**F304070**  
27,5 cm - 10 1/4 "

### KEVORKIAN

Rigide  
Rigid  
Rigida

3,5 mm



**F304130**  
30 cm - 12 "

Rigide  
Rigid  
Rigida

3,5 mm



**F304140**  
30 cm - 12 "

Ø 6 mm

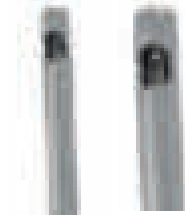

**F304106**  
28 cm - 11 "

**F304104** Ø 4 mm

 **F304106** Ø 6 mm

**F304108** Ø 8 mm

**F304110** Ø 10 mm

**F304112** Ø 12 mm

**F304114** Ø 14 mm

Raccord pour aspiration  
Connector for suction  
Accesorio de succión



Ø 12 mm

**F304120**  
11cm - 4 1/2 "

MARTIN



**F10805**  
34 cm - 13 1/2 "

BRIESKY



**F10810**  
33 cm - 13 "

## SCHULTZE

Instruments pour hystéro-salpingographie  
 Instruments for hystero-salpingography  
 Instrumentos para histero-salpingografía



Complet  
 Complete  
 Completo  
**F304160**

Sans manomètre  
 Without manometer  
 Sin manometro  
**F304170**

## BRAUN

Dépresseur utérin  
 Uterin depressor  
 Depresor uterino



**F304150**  
 28 cm - 11 "

## NOVACK

## POZZI CHERON

INSTRUMENTS POUR HYSTÉROGRAPHIE  
INSTRUMENTS FOR HYSTEROGRAPHY  
INSTRUMENTOS PARA HISTEROGRAFIA

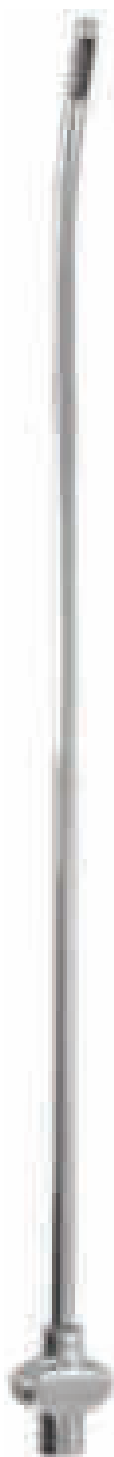

**F30420**  
24 cm - 9 1/2"  
Ø 4 mm

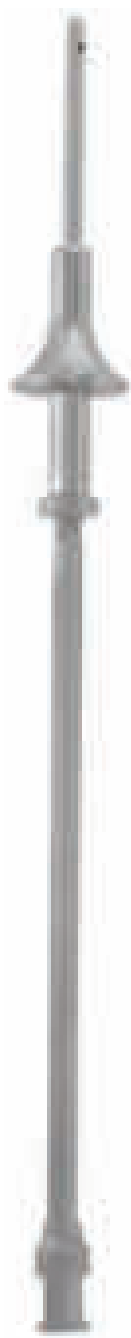

**F30435**  
22 cm - 8 3/4"  
Ø 5 mm

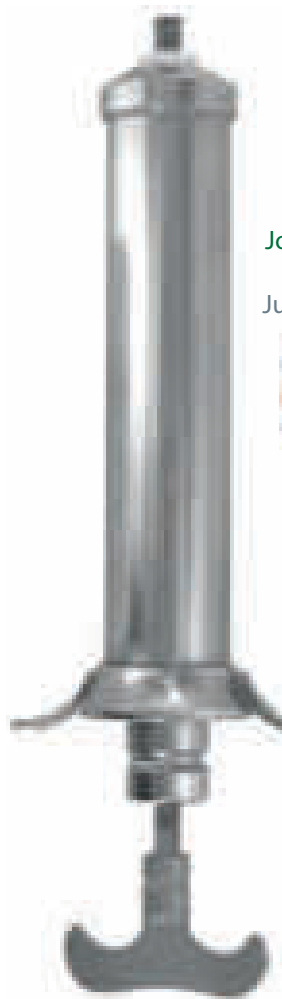

**F30430**  
16 cm - 6 1/4"  
Ø 20 mm / 20 cc

Joint pour l'embout  
Seal for nozzle  
Junta para contera



**F304322**

Joint du piston  
Piston seal  
Junta de piston



**F304321**



A doigt  
Collin's lock  
Desmontable

A crochets  
With hooks  
Con ganchos

**F30455**  
24 cm - 9 1/2"

## CIRCERON (MATHIEU)



## IVG

Manche à raccord tournant pour canule IVG  
Handle with rotating connection for IVG cannula  
Mango a racor rotativo para canula IVG

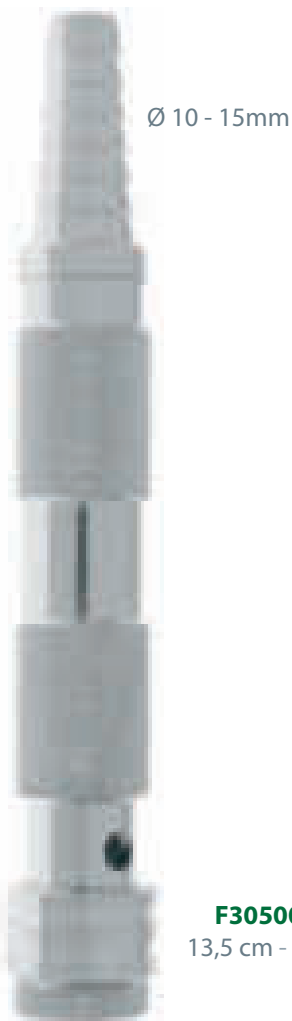

## DOYEN





### HEGAR

### PALMER

Modèle simple  
Simple model  
Modelo simple

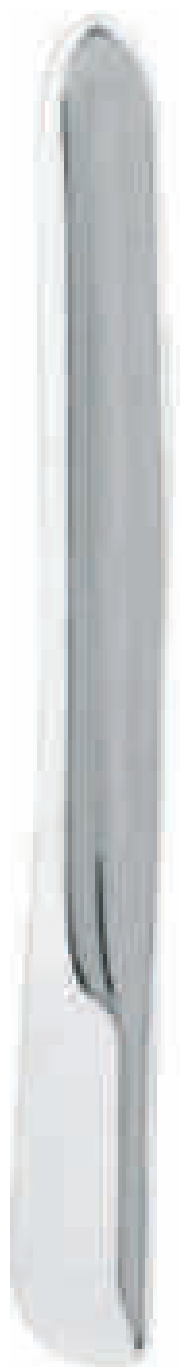

**F36160**  
18 cm - 7 "

	Ø		Ø
<b>F36010</b>	1 mm	<b>F36015</b>	1,5 mm
<b>F36020</b>	2 mm	<b>F36025</b>	2,5 mm
<b>F36030</b>	3 mm	<b>F36035</b>	3,5 mm
<b>F36040</b>	4 mm	<b>F36045</b>	4,5 mm
<b>F36050</b>	5 mm	<b>F36055</b>	5,5 mm
<b>F36060</b>	6 mm	<b>F36065</b>	6,5 mm
<b>F36070</b>	7 mm	<b>F36075</b>	7,5 mm
<b>F36080</b>	8 mm	<b>F36085</b>	8,5 mm
<b>F36090</b>	9 mm	<b>F36095</b>	9,5 mm
<b>F36100</b>	10 mm	<b>F36105</b>	10,5 mm
<b>F36110</b>	11 mm	<b>F36115</b>	11,5 mm
<b>F36120</b>	12 mm	<b>F36125</b>	12,5 mm
<b>F36130</b>	13 mm	<b>F36135</b>	13,5 mm
<b>F36140</b>	14 mm	<b>F36145</b>	14,5 mm
<b>F36150</b>	15 mm	<b>F36155</b>	15,5 mm
<b>F36160</b>	16 mm	<b>F36165</b>	16,5 mm
<b>F36170</b>	17 mm	<b>F36175</b>	17,5 mm
<b>F36180</b>	18 mm	<b>F36185</b>	18,5 mm
<b>F36190</b>	19 mm	<b>F36195</b>	19,5 mm
<b>F36200</b>	20 mm		
<b>F36210</b>	21 mm		
<b>F36220</b>	22 mm		
<b>F36230</b>	23 mm		
<b>F36240</b>	24 mm		
<b>F36250</b>	25 mm		
<b>F36260</b>	26 mm		
<b>F362610</b>	27 mm		
<b>F362620</b>	28 mm		
<b>F362630</b>	29 mm		
<b>F362640</b>	30 mm		



**F366012**  
23 cm - 9 "

	Ø
<b>F366006</b>	1 x 2 mm
<b>F366009</b>	2 x 3 mm
<b>F366012</b>	3 x 4 mm
<b>F366015</b>	4 x 5 mm
<b>F366018</b>	5 x 6 mm
<b>F366021</b>	6 x 7 mm
<b>F366024</b>	7 x 8 mm
<b>F366027</b>	8 x 9 mm
<b>F366030</b>	9 x 10 mm
<b>F366033</b>	10 x 11 mm
<b>F366036</b>	11 x 12 mm

## Dilatateurs utérins - Uterine dilators - Dilatadores uterinos



Boîte complète de 4 à 17 mm  
Complete case from 4 to 17 mm  
Caja completa de 4 a 17 mm

 **F36270**

Boîte seule  
Box only  
Caja sóla

**F36275** 205 x 105 x 55 mm



Boîte complète de 1 à 26 mm  
Complete case from 1 to 26 mm  
Caja completa de 1 a 26 mm

 **F36280**

Boîte seule  
Box only  
Caja sóla

**F36285** 310 x 200 x 60 mm

### HEGAR

### HANK

### PRATT

Modèle double  
Double model  
Modelo doble

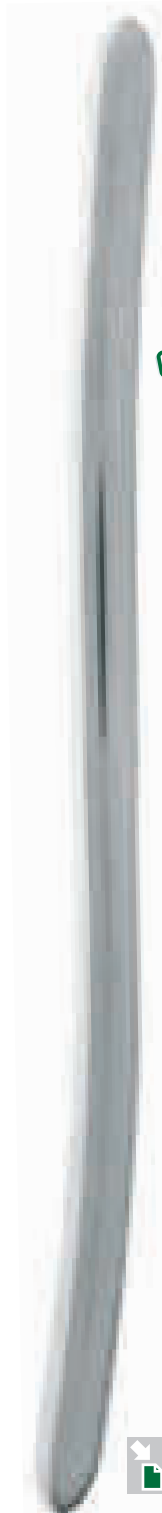

	Ø
F36400	1 x 2 mm
F36410	3 x 4 mm
F36420	5 x 6 mm
F36430	7 x 8 mm
<b>F36440</b>	9 x 10 mm
F36450	11 x 12 mm
F36460	13 x 14 mm
F36470	15 x 16 mm
F36480	17 x 18 mm
F36485	19 x 20 mm
F36490	21 x 22 mm
F36494	23 x 24 mm
F36498	25 x 26 mm



**F36440**  
20 cm - 8 "

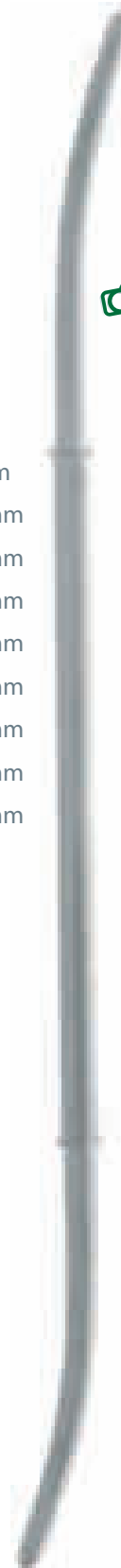

	Ø
<b>F365050</b>	4,5 x 5 mm
F365060	5,5 x 6 mm
F365070	6,5 x 7 mm
F365080	7,5 x 8 mm
F365090	8,5 x 9 mm
F365100	9,5 x 10 mm

**F365050**  
27,5 cm - 10 3/4 "

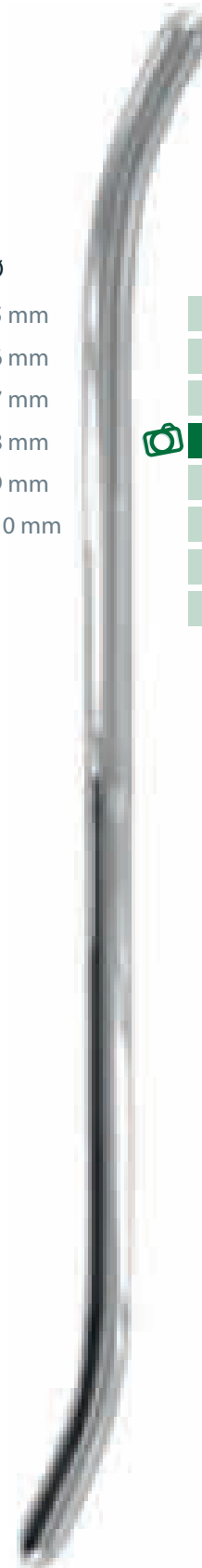

	Ø
F365200	4,5 x 5,0 mm
F365201	5,6 x 6,3 mm
F365202	7,0 x 7,6 mm
<b>F365203</b>	8,3 x 9,0 mm
F365204	9,6 x 10,3 mm
F365205	11,0 x 11,6 mm
F365206	12,3 x 13,0 mm
F365207	13,6 x 14,3 mm

**F365203**  
28 cm - 11 "



## Hysteromètres - Uterine sounds - Hysterómetros

### VALLEIX

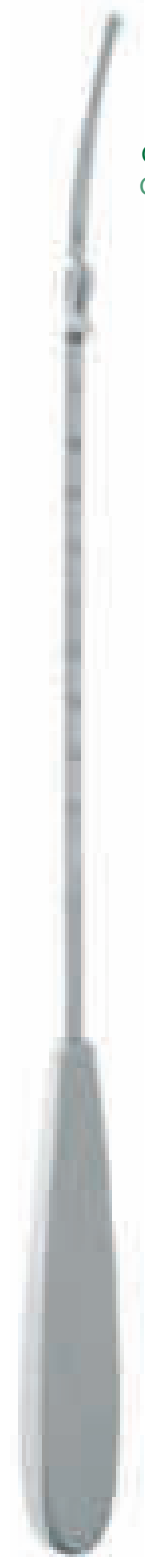

Curseur seul  
Cursor alone  
Cursor solo



**F36310**

**F36300**  
28 cm - 11 "

### SIMS

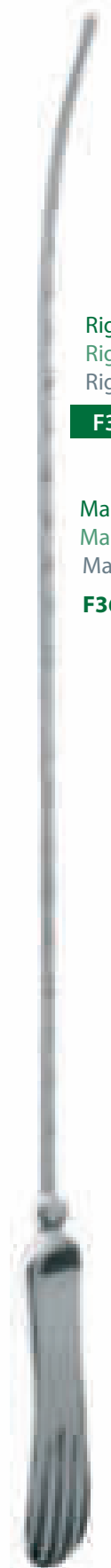

Rigide  
Rigid  
Rigido

**F36315** 

Malléable  
Malleable  
Maleable

**F363155**

**F36315**  
32 cm - 12 1/2 "

### MARTIN (SIMPSON)

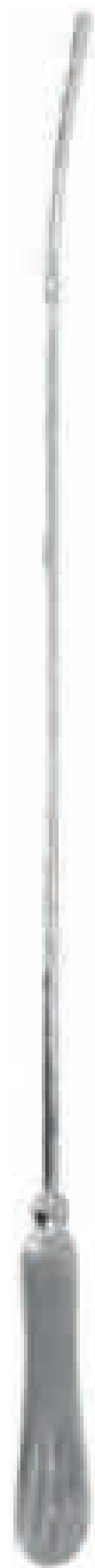

**F363200**  
32 cm - 12 1/2 "

### GUYON

Cathéter courbe (beniqué)  
Curved dilating bougie  
Bujia dilatadora curva

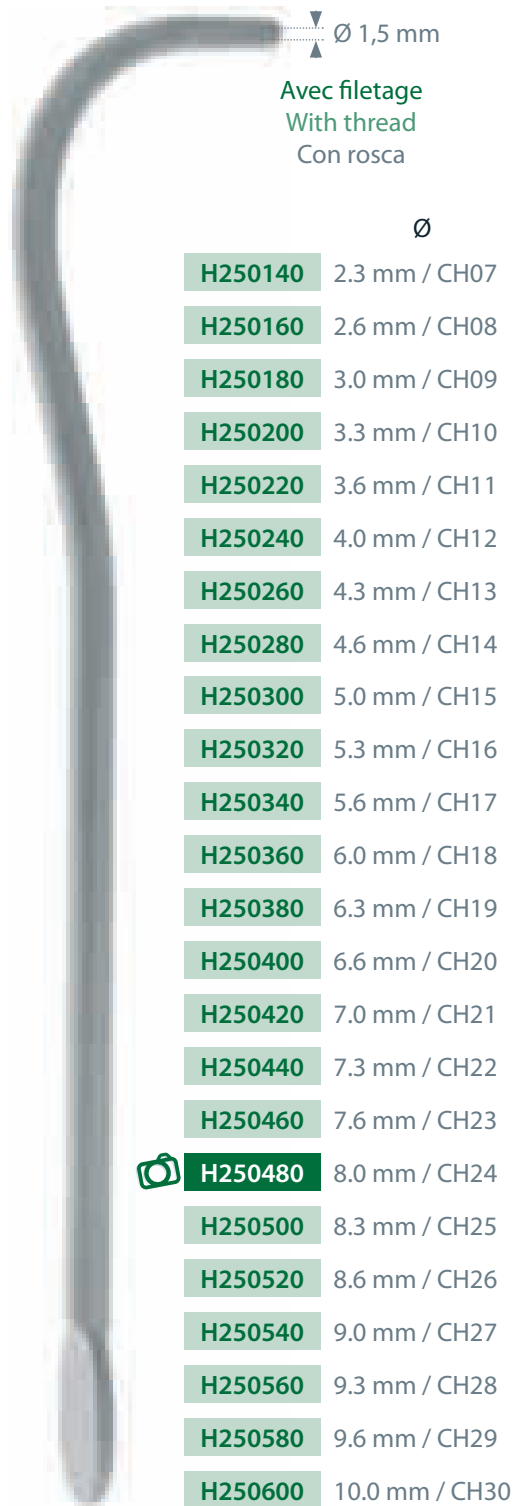

**H250480**  
27 cm - 10<sup>3/4</sup>"

Sondes métalliques  
Metal catheters  
Sondas metálicas



Acier chromé  
Chrome steel  
Acero cromado

Homme  
Man  
Hombre

Femme  
Woman  
Mujer

H251010	CH 10 - 3,3 mm	H251110
H251012	CH 12 - 4,0 mm	H251112
H251016	CH 16 - 5,3 mm	H251116
H251018	CH 18 - 6,0 mm	-

**H251012**  
25 cm - 10"

**H251112**  
15 cm - 6"

### STRAUSS

Compresseur de l'urètre  
Urethra compressor  
Compresor para uretra



**H20110-0**  
10,5 cm - 4<sup>1/8</sup>"

### PRATT

### MATHIEU

### TRELAT



**F153510**  
20,5 cm - 8"



**F153520**  
19,5 cm - 7<sup>3/4</sup>"

	Avec crémaillère With rack Con cremallera	Sans crémaillère Without rack Sin cremallera
	<b>F15340</b>	<b>F15350</b>

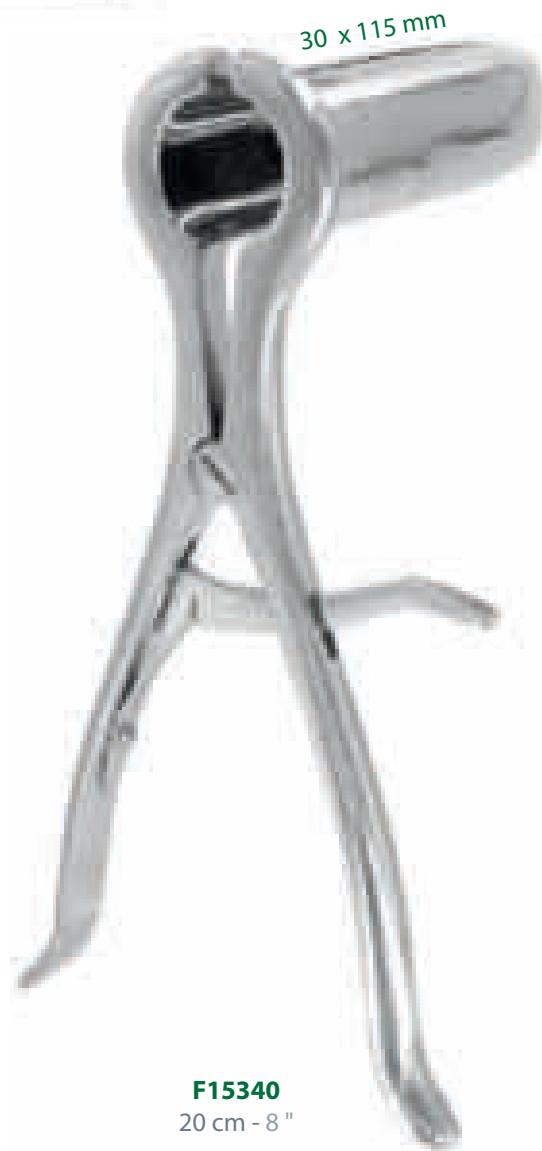

**F15340**  
20 cm - 8"

### CZERNY

23 x 106 mm



**F153540**  
22 cm - 8<sup>3/4</sup>''

- F153626** 60 mm
- F153628** 80 mm
- F153630** 125 mm



**F153628**  
22 cm - 8<sup>3/4</sup>''

### SIMS

18 x 80 mm

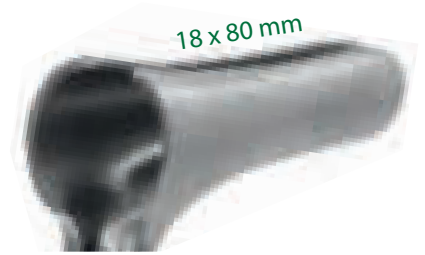

**F153610**

18 x 80 mm



**F153620**  
15 cm - 6''

### KELLY

Proctoscope  
Proctoscope  
Proctoscopio

**F153350** 22 x 100 mm

 **F153351** 22 x 140 mm

**F153352** 22 x 200 mm

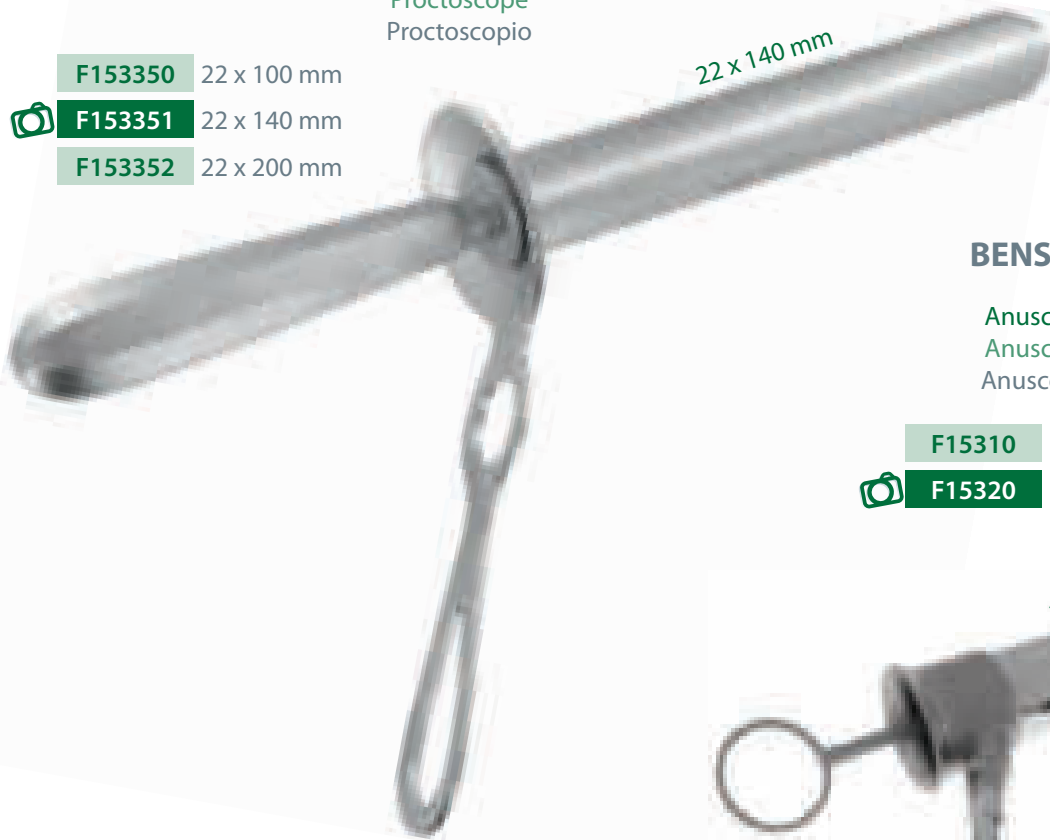

**F153351**

Sphinctéroscope  
Sphincteroscope  
Esfinteroscopio

**F153340** 21 x 50 mm

 **F153341** 27 x 50 mm



**F153341**

### BENSAUDE

Anuscope  
Anuscope  
Anuscopio

**F15310** 19 x 70 mm

 **F15320** 22 x 70 mm



**F15320**  
18 cm - 7"



BARR



**B80885**  
17 cm - 6 <sup>3</sup>/<sub>4</sub> "

HALLE



**F153360**  
9 cm - 3 <sup>1</sup>/<sub>2</sub> "

### ALAN PARKS

Avec 2 paires de valves latérales et 1 valve médiane  
 With 2 pairs of lateral blades and 1 center blade  
 Con 2 pares de Valvas laterales y 1 valva mediana

**B80880**

50 mm

Valves latérales (paire)  
 Lateral blades (pair)  
 Valvas laterales (par)

95 x 24 mm



**B808850**

75 x 24 mm



**B808851**



Valve médiane seule  
 Central blade only  
 Valvas mediana solas

95 x 24 mm

**B808852**

## Pinces à biopsie rectale - Rectal biopsy forceps - Pinzas para biopsia rectal

### YEOMAN

42 cm - 16 1/2 "



4 x 12 mm      4 x 12 mm



**F210010**      28 cm - 11 "      **F210110**  
**F210020**      35 cm - 13 3/4 "      **F210120**  
 **F210030**      42 cm - 16 1/2 "      **F210130**

### Rotative - Turntable - Giratorio

40 cm - 16 "



**F210210**      40 cm - 16 "      **F210250**

Tige seule  
Attachment only  
Vastago sola

 **F210220**      **F210260**

Pince complète  
Complete forceps  
Pinza completa

**F210220**

Poignée seule  
Handle only  
Mango solo  
**F210200**

### MC GIVNEY



### RUDD



Bague caoutchouc pour ligature, paquet de 100  
 Ligature rubber ring, box of 100  
 Arandelas de goma par ligadura, caja de 100

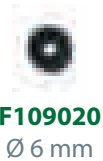

**F109020**  
 Ø 6 mm

HEYWOOD SMITH

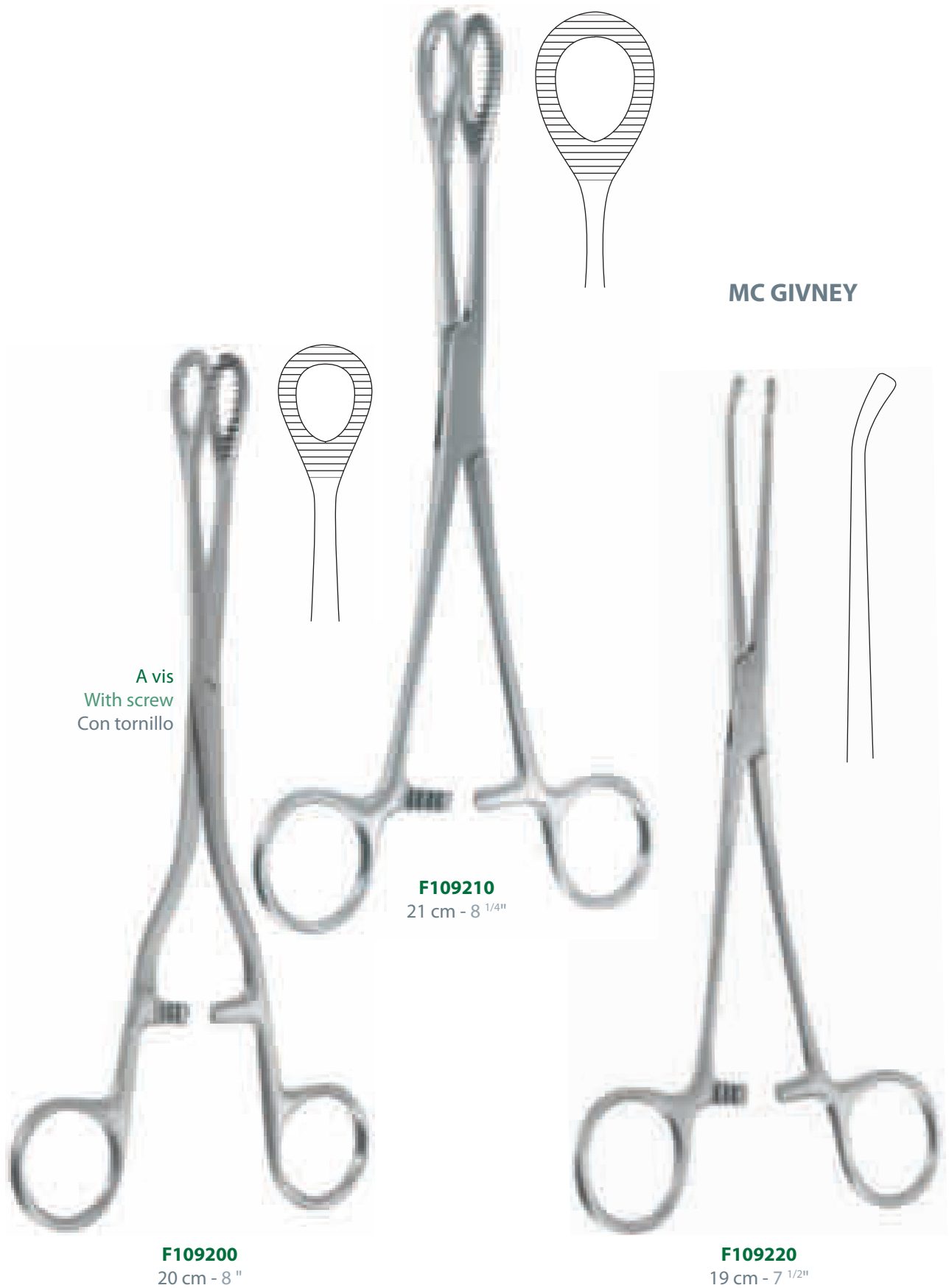

A vis  
With screw  
Con tornillo

**F109210**  
21 cm - 8 1/4"

**F109200**  
20 cm - 8"

**F109220**  
19 cm - 7 1/2"

## METZENBAUM

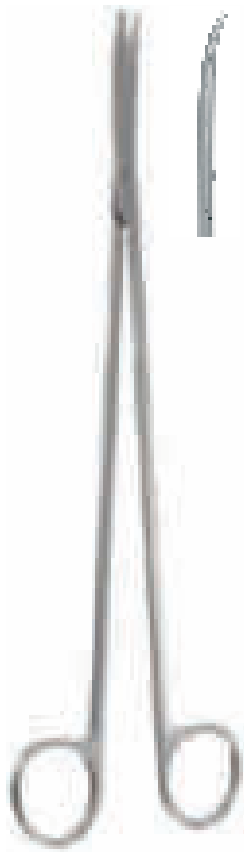

**B256770**  
28 cm - 11 "

## MILLIN

21 mm

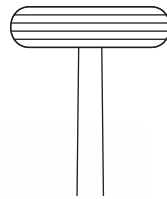

**H10140**  
23 cm - 9 "

10 mm

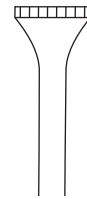

**H10145**  
23 cm - 9 "

10 mm

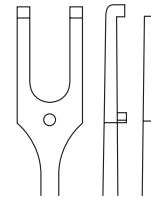

**H10150**  
23 cm - 9 "



**H10140**  
23 cm - 9 "

## O'SHAUGNESSY



**B606090**  
30 cm - 12 "

## SANTORINI



**B953000**  
20 cm - 8 "

### YOUNG

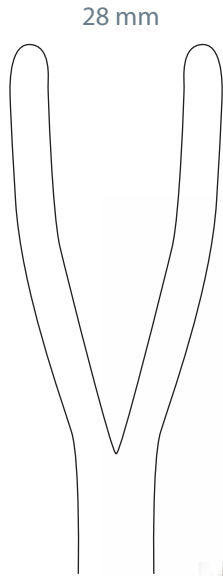

**B804600**  
36 cm - 14 "

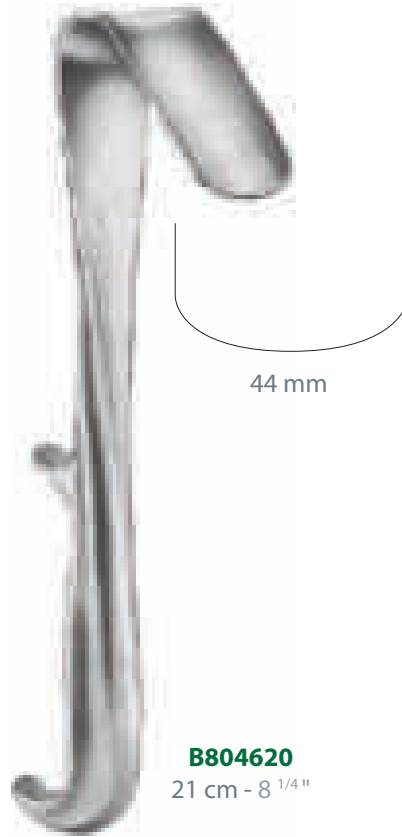

**B804620**  
21 cm - 8 1/4 "

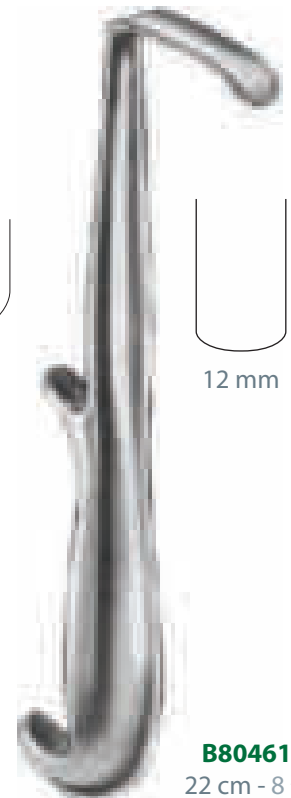

**B804610**  
22 cm - 8 3/4 "

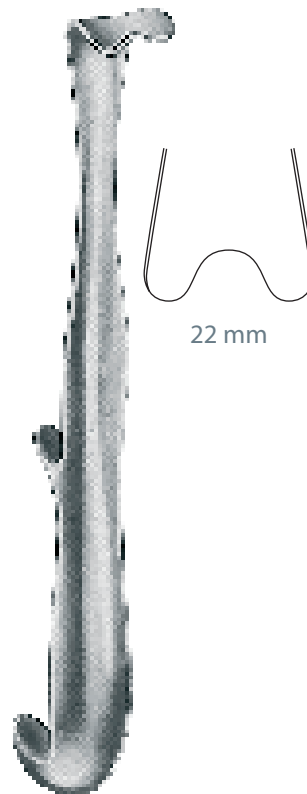

**B804630**  
21 cm - 8 1/4 "

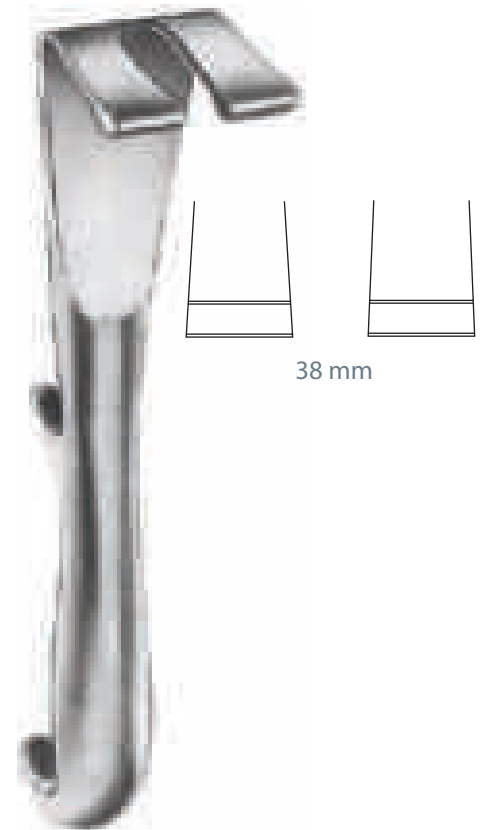

**B804640**  
22 cm - 8 3/4 "

**Pinces pour calculs rénaux - Forceps for kidney stones - Pinzas para calculos renales**



**Pinces pour calculs biliaires - Forceps gales stones - Pinzas para calculos biliares**



**Instruments pour pédicules rénaux - Instruments for kidney pedicle - Pinzas para pedunculos renales**



**Instruments pour voies biliaires - Instruments for bile ducts - Instrumentos para vías biliares**

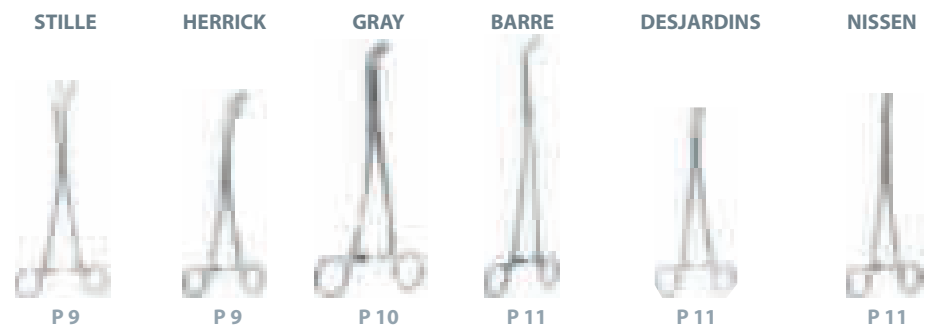

**Curettes pour voies biliaires - Curettes for bile ducts - Curetas para vías biliares**





Dilatateurs pour voies biliaires - Dilators for bile ducts - Diladores para vías biliares

BAKES



P14

## RANDALL



**H100910**

**H100910**  
19 cm - 7 1/2"

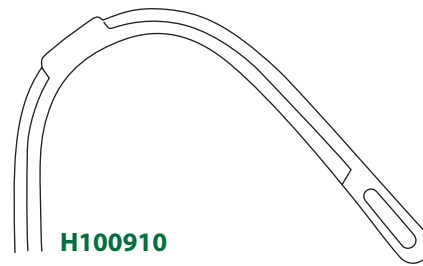

**H100910**

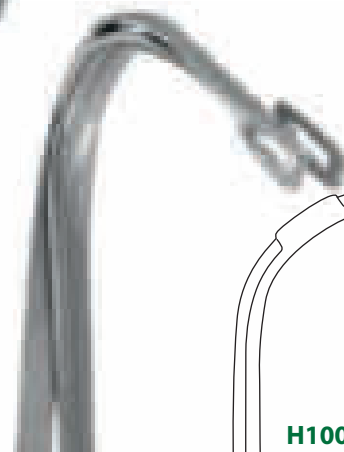

**H100911**

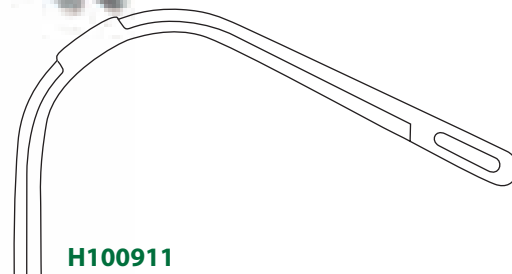

**H100911**

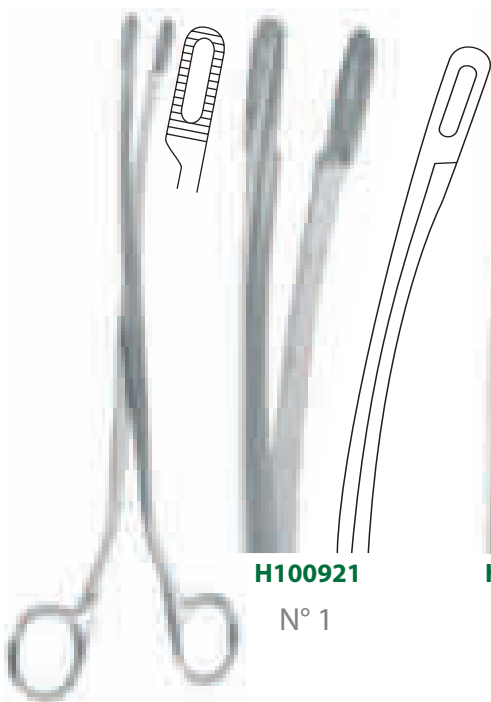

**H100921**

N° 1

**H100921**  
23 cm - 9"

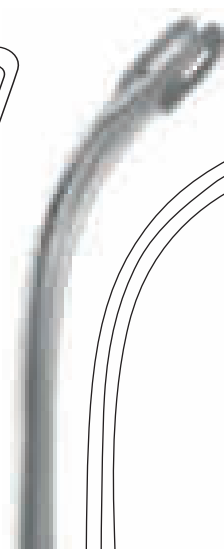

**H100922**

N° 2



**H100923**

N° 3

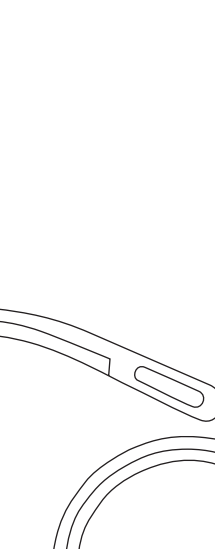

**H100924**

N° 4

MIRIZZI

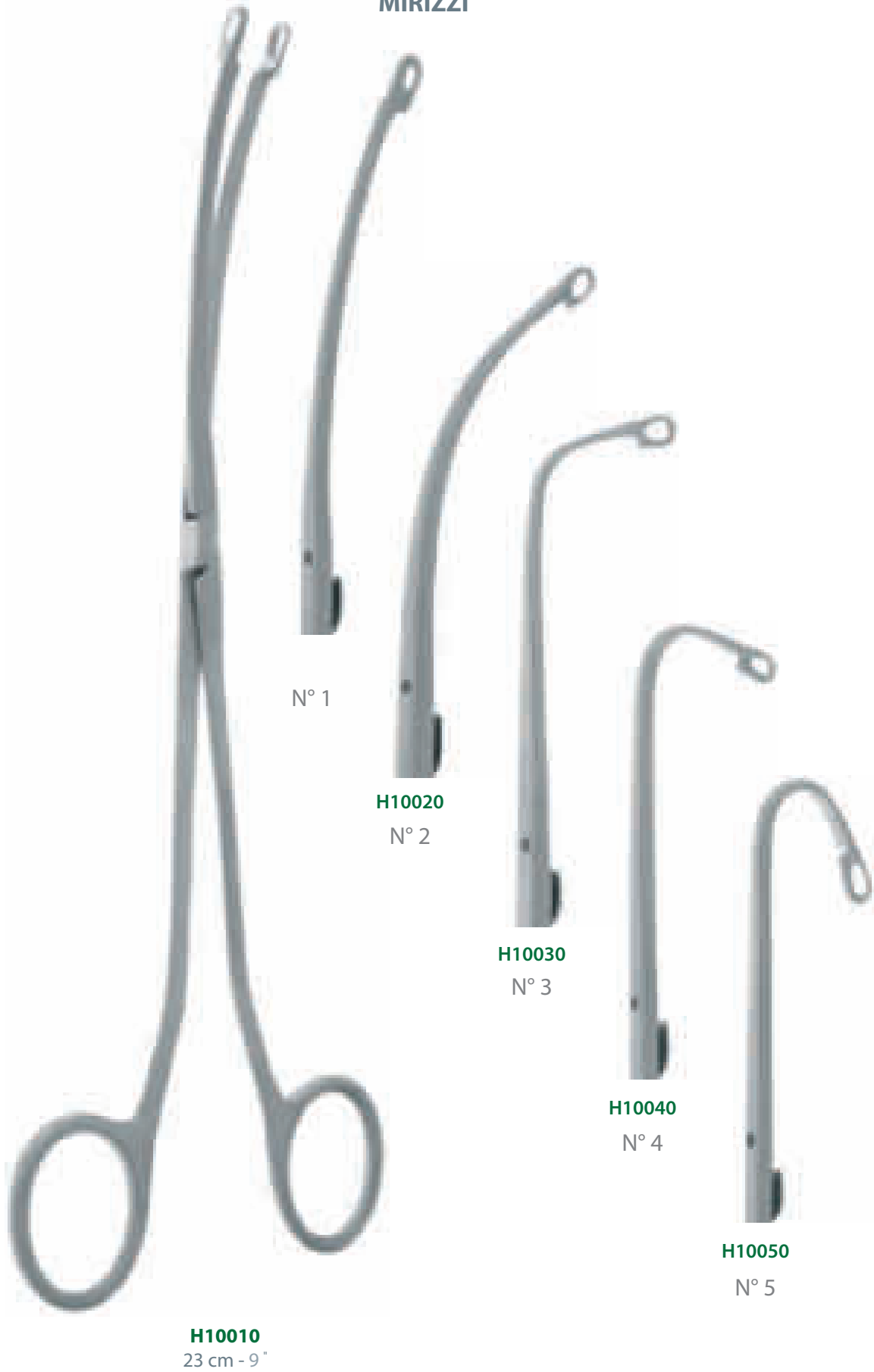

MIRIZZI



**H10060**  
23 cm - 9"  
N° 6

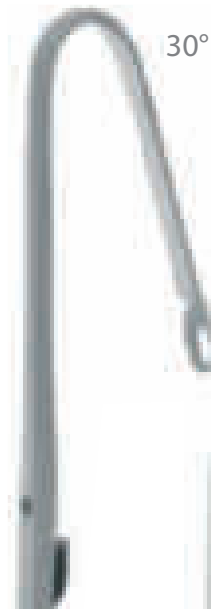

**H10070**  
N° 7

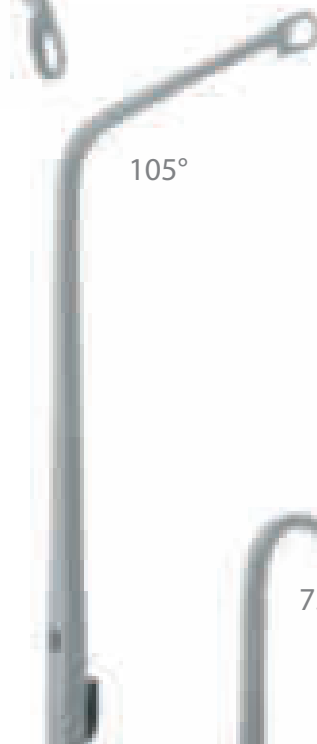

**H10080**  
N° 8



**H10090**  
N° 9



## SISTERON

## DESJARDINS

6 mm **H10115** 

8 mm **H10120**

9 mm **H10130**

5,5 mm



**H10100**  
40 cm - 15 3/4"

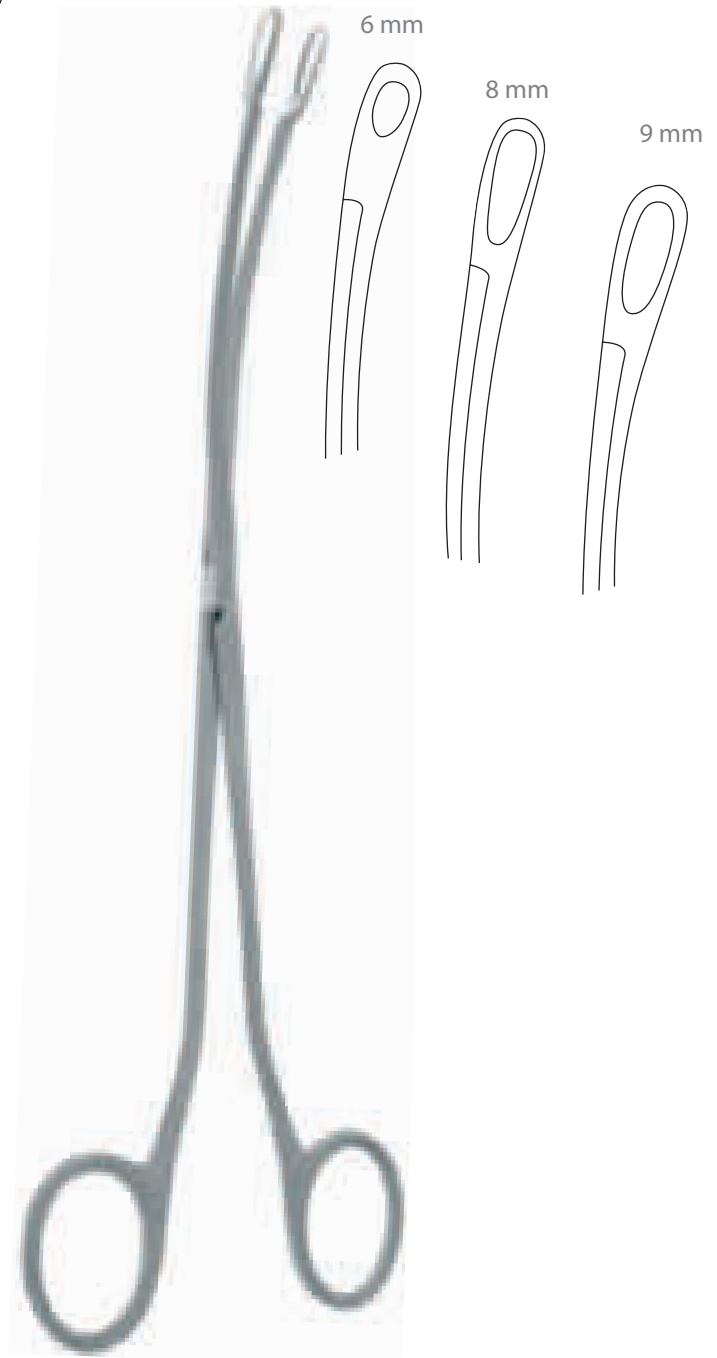

**H10115**  
24 cm - 9 1/2"

## BLAKE

## MAYO BLAKE

## CZERNY

Droit  
Straight  
Recta

Courbe  
Curved  
Curva

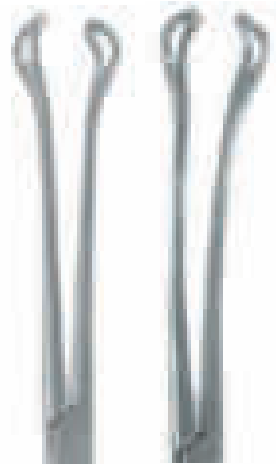
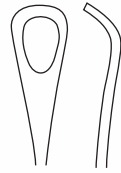

**H101321**  
20 cm - 8"

Droit  
Straight  
Recta

Courbe  
Curved  
Curva

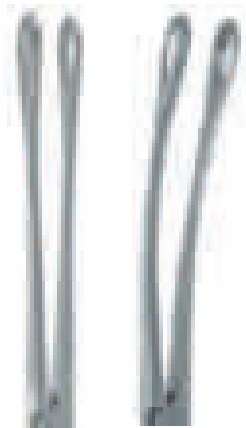

**H101311**  
20,5 cm - 8"



**H101320**  
20 cm - 8"

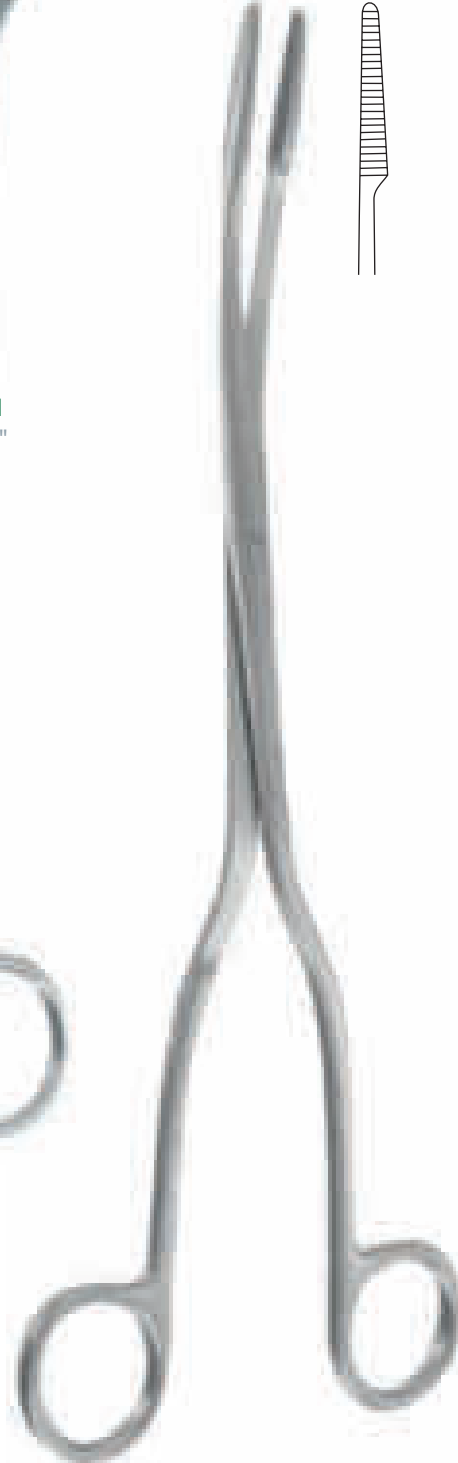

**H101330**  
24,5 cm - 9<sup>3/4</sup>"



**H101310**  
20,5 cm - 8"

### GUYON

- 20 cm - 8"  **B554000**
- 22 cm - 8 3/4" **B554005**
- 23 cm - 9" **B554025**
- 24 cm - 9 1/2" **B554010**

- Mors non traumatisants  
Non-traumatic jaws  
Bocas no traumáticas
- 23 cm - 9" **B554015**
- 24 cm - 9 1/2" **B554020**

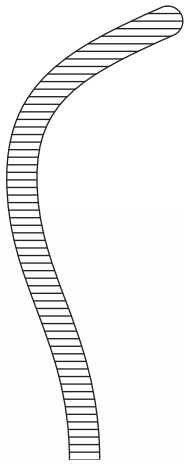

**B554000**

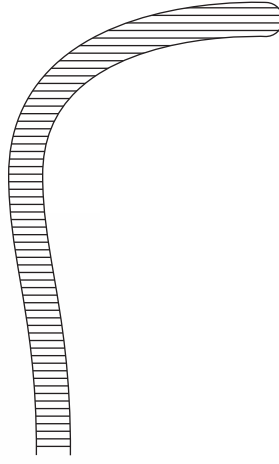

**B554025**

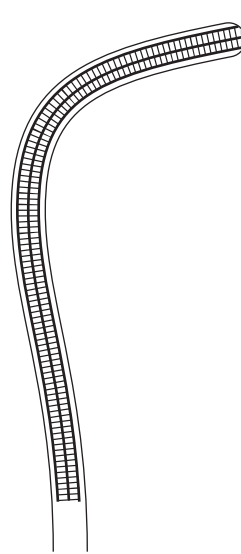

**B554015**

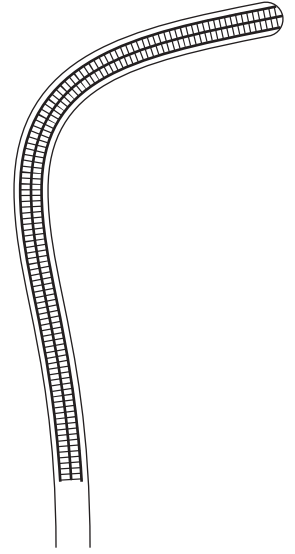

**B554020**

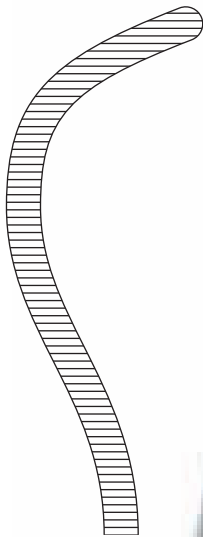

**B554005**

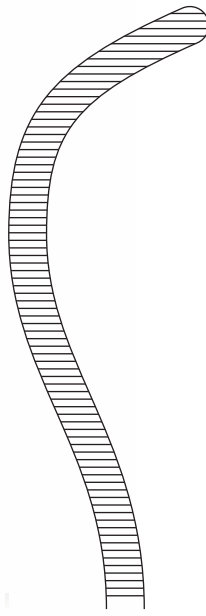

**B554010**

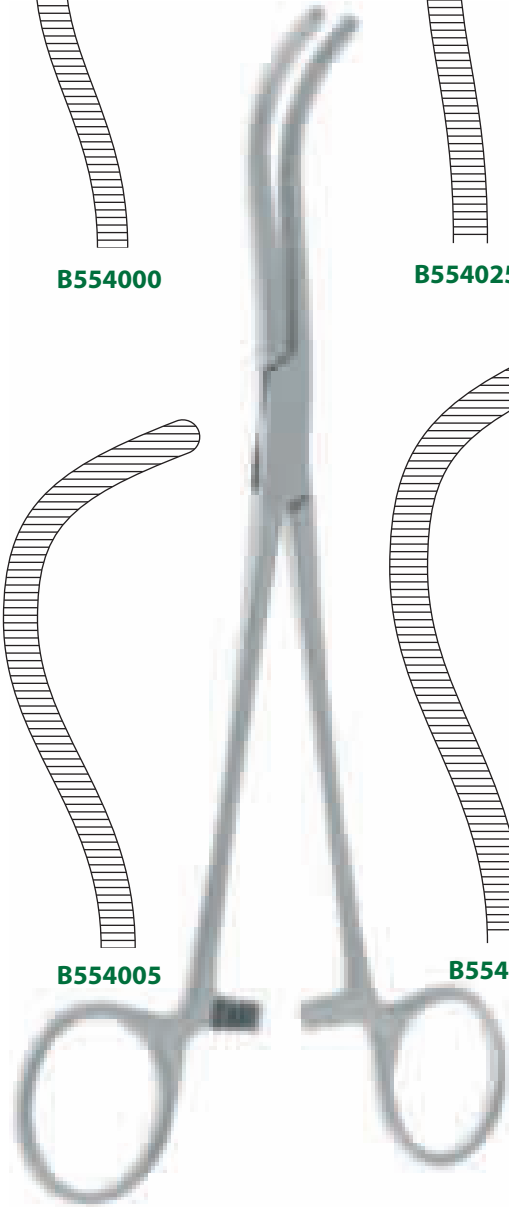

**B554000**  
20 cm - 8"

### MAYO-GUYON

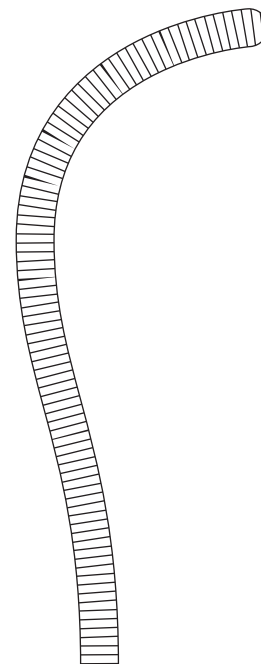

**B554030**  
23 cm - 9"

## STILLE

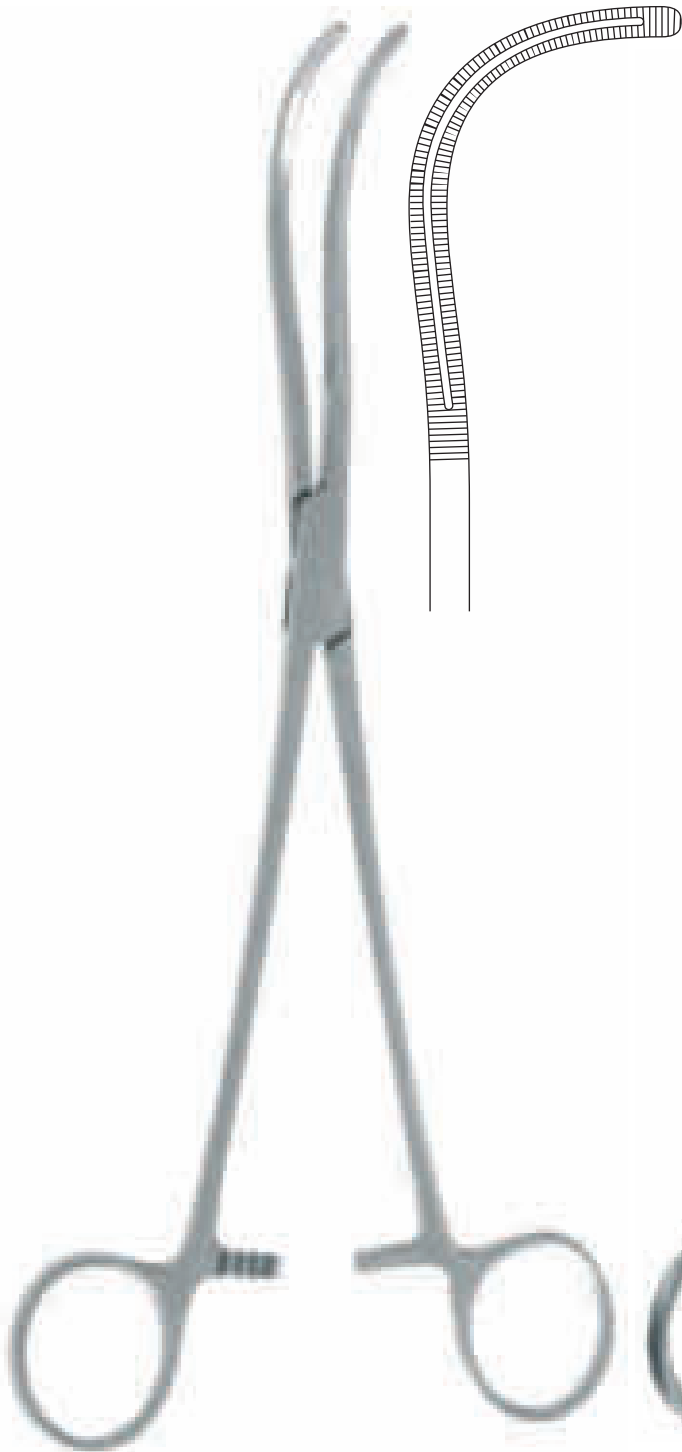

**B50835**  
24 cm - 9 1/2 "

## HERRICK

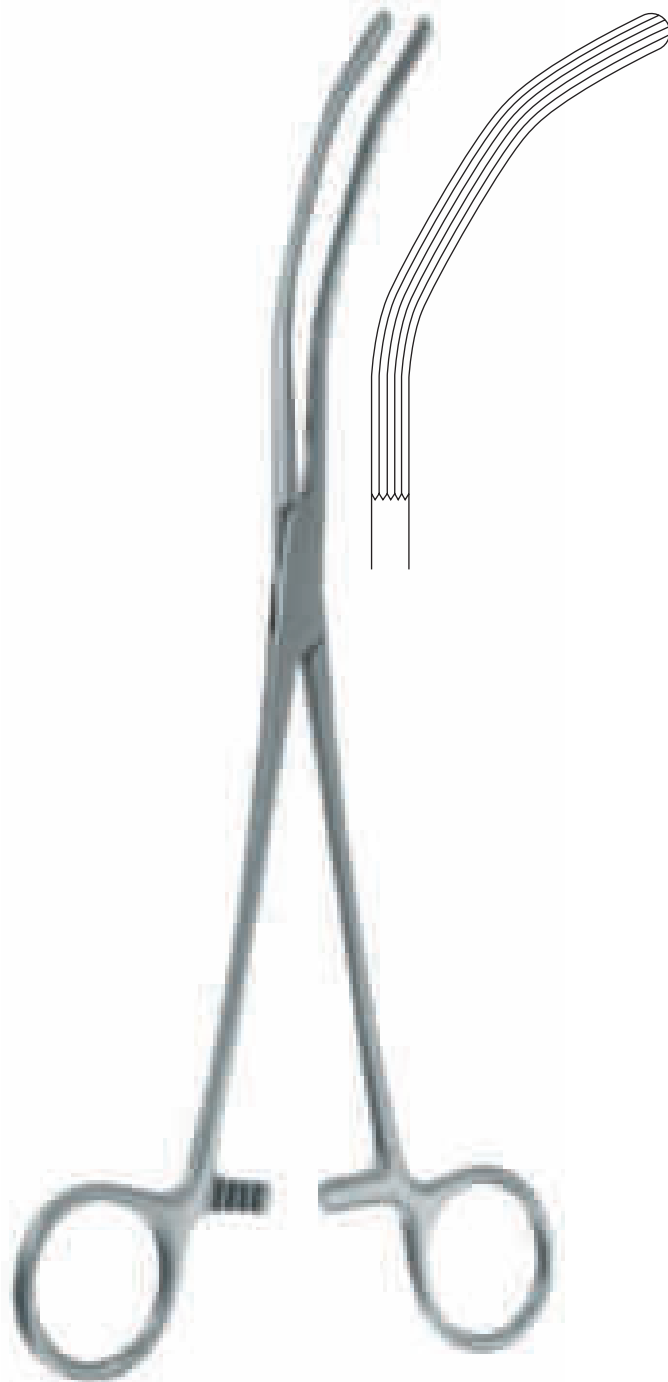

**B554100**  
23 cm - 9 "



## GRAY

Sans griffes  
Without teeth  
Sin dientes

22 cm - 8 3/4"

**B554210**

23 cm - 9"

**B554200** 

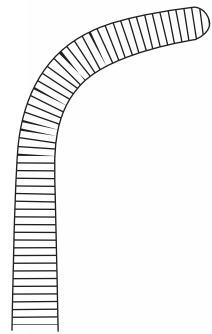

**B554210**

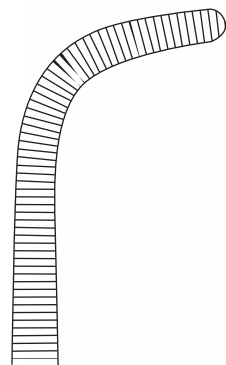

**B554200**

A griffes  
With teeth  
Con dientes

22 cm - 8 3/4"

**B554211**

23 cm - 9"

**B554201**

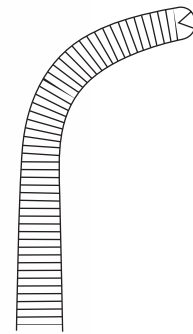

**B554211**

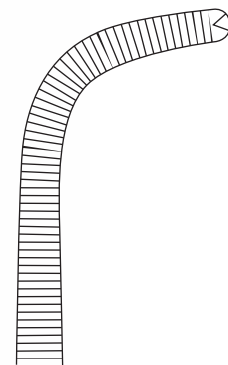

**B554201**

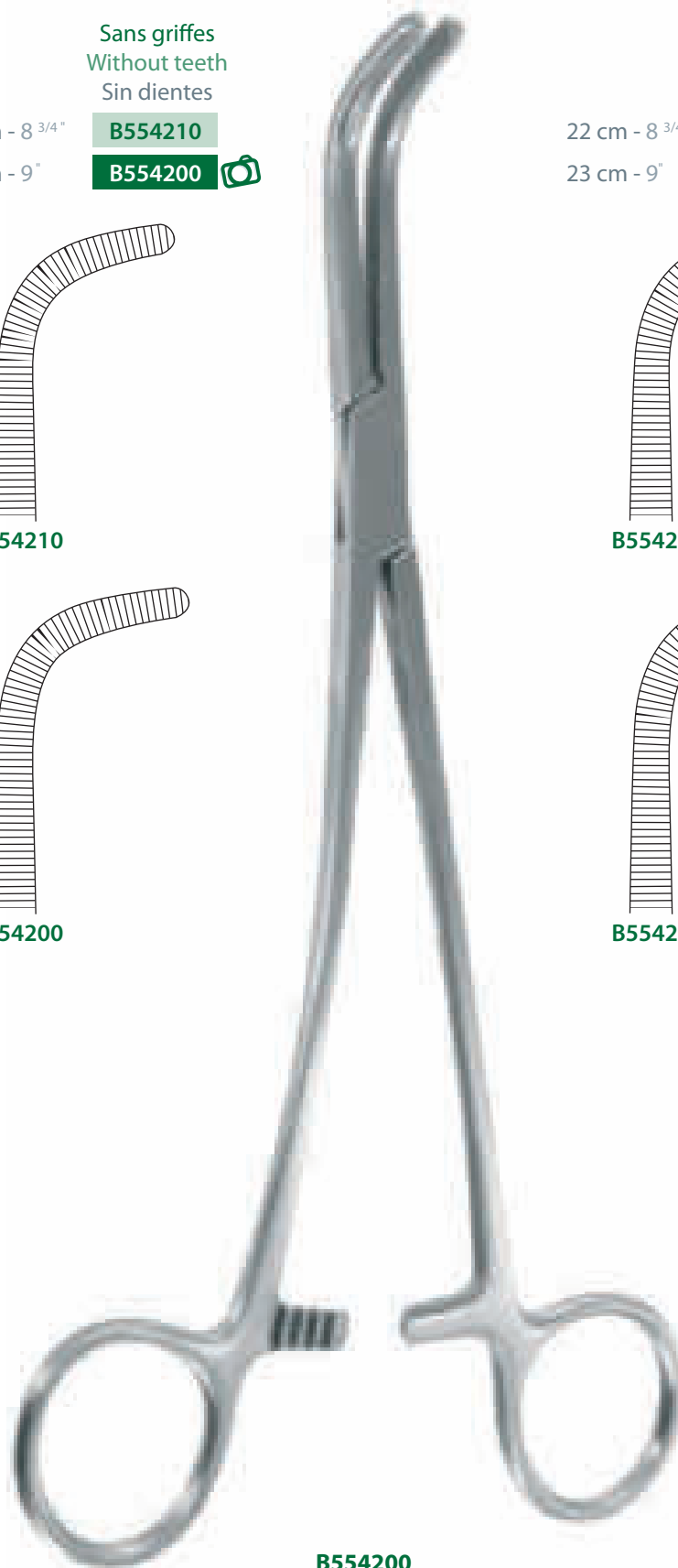

**B554200**  
23 cm - 9"

### BARRE

Pince à ailerons vésicaux  
Vesical forceps  
Pinzas para alabes vesicales

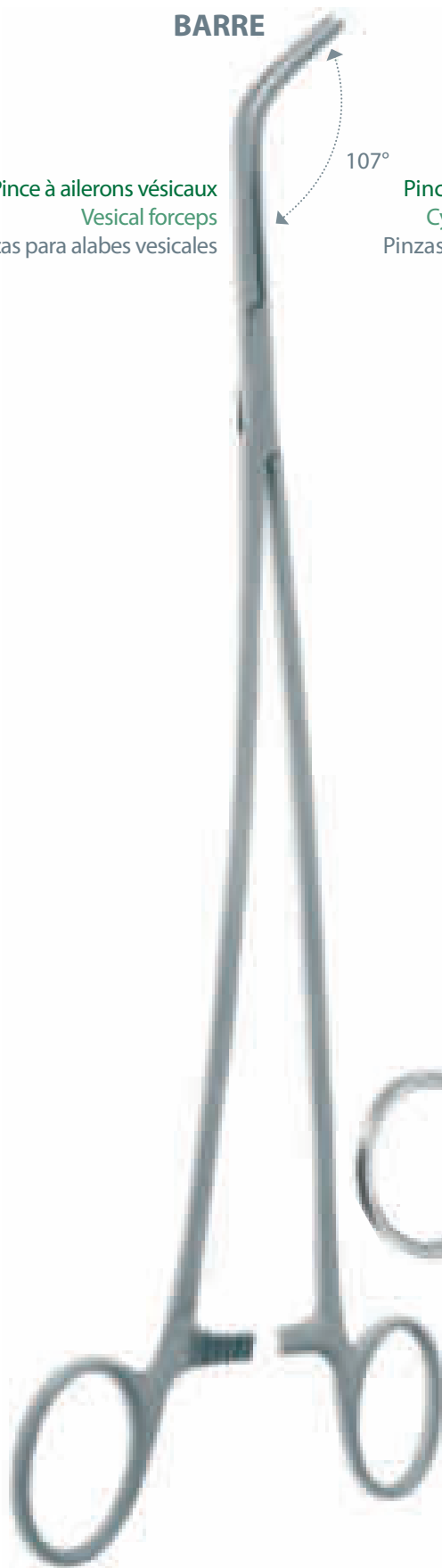

**H10175**  
29 cm - 11 1/2 "

### DESJARDINS

Pince à cystique  
Cystic forceps  
Pinzas para cístico



**H200110**  
21 cm - 8 1/4 "

### NISSEN

Pince à cystique  
Cystic forceps  
Pinzas para cístico



**H200120**  
21 cm - 8 1/4 "

### DESJARDINS

Curette  
Curette  
Cureta

4 mm **H20025**

6 mm **H20030**

8 mm **H20040**

10 mm **H20050** 

12 mm **H20060**

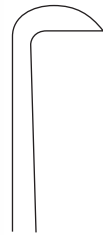

**H20050**



**H20050**



**H20050**  
26 cm - 10 1/4 "

Explorateur  
Probe  
Explorador

ø 4 mm **H20070**

ø 6 mm **H20071** 

ø 8 mm **H20072**



**H20071**  
28 cm - 11 "

Drague  
Scoop  
Draga

ø 6 mm **H20080**

ø 7 mm **H20081**

ø 8 mm **H20082**

ø 9 mm **H20083** 

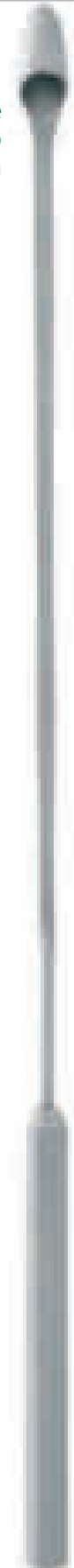

**H20083**  
30 cm - 11 3/4 "

### LUER KOERTE

Malléable  
Malleable  
Maleable

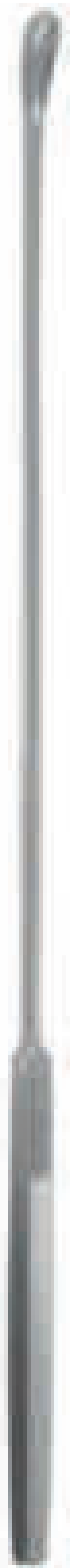

**H210002**  
2,8 mm



**H210006**  
6,7 mm



**H210003**  
3,4 mm



**H210008**  
8 mm



**H210004**  
4,3 mm



**H210011**  
11 mm



**H210005**  
5,5 mm



**H210015**  
15 mm



**H210008**  
32 cm - 12 1/2"

### MOORE



**H210100**  
28 cm - 11"

## BAKES

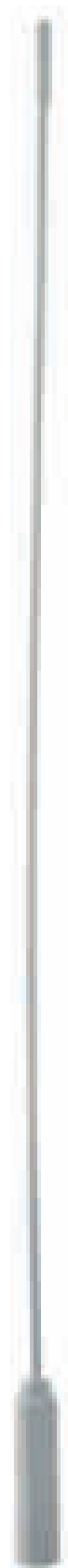

**H40030**  
30 cm - 11 3/4 "



1 mm  
**H40010**  
N° 1



2 mm  
**H40020**  
N° 2



3 mm  
**H40030**  
N° 3



4 mm  
**H40040**  
N° 4



5 mm  
**H40050**  
N° 5



6 mm  
**H40060**  
N° 6



7 mm  
**H40070**  
N° 7



8 mm  
**H40080**  
N° 8



9 mm  
**H40090**  
N° 9



10 mm  
**H40100**  
N° 10



11 mm  
**H40110**  
N° 11



12 mm  
**H40120**  
N° 12



13 mm  
**H40130**  
N° 13

## Microchirurgie ciseaux - Microsurgery scissors - Microcirugía tijeras

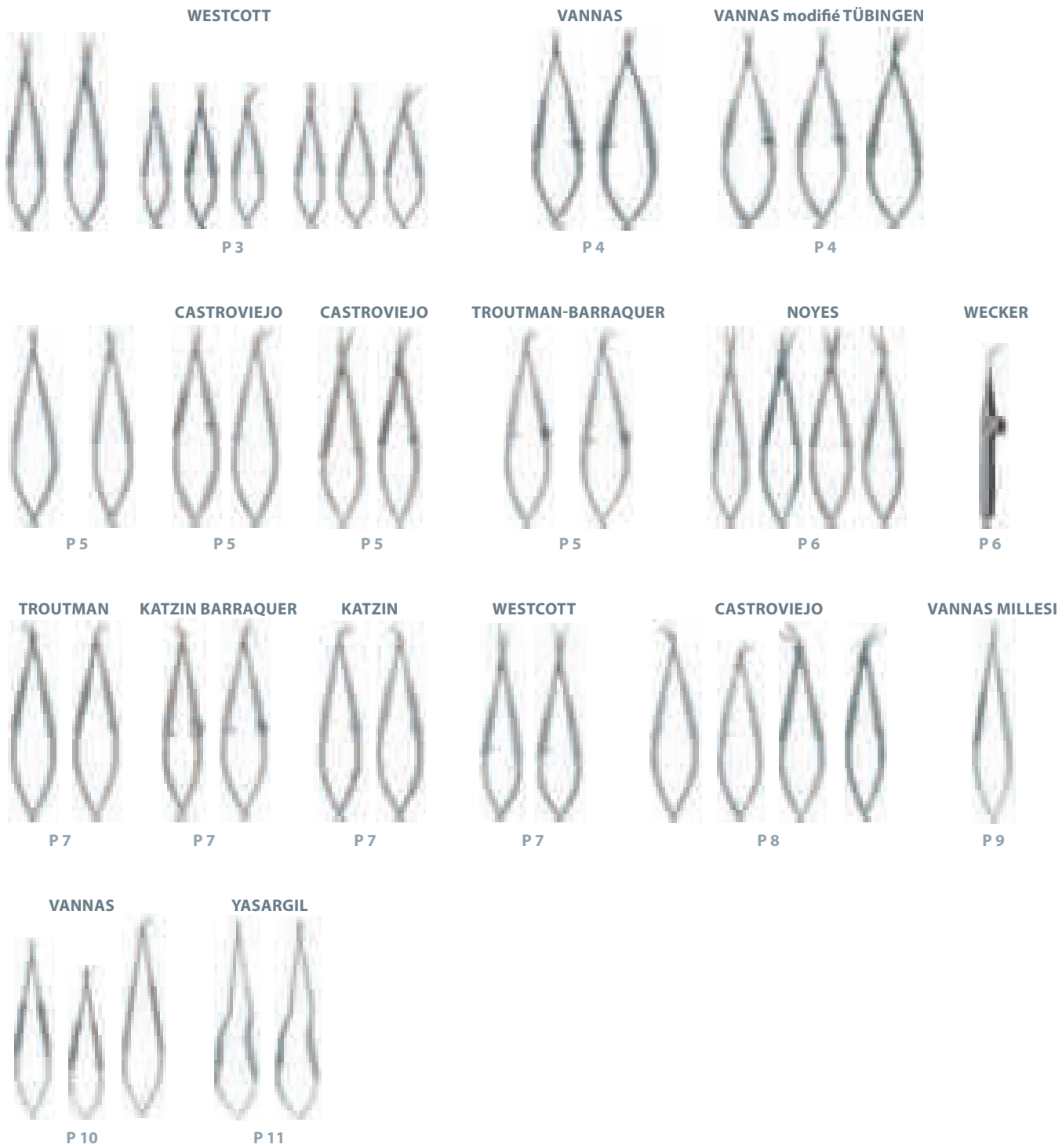

## Microchirurgie porte-aiguilles - Microsurgery needle-holders - Microcirugía porta-agujas

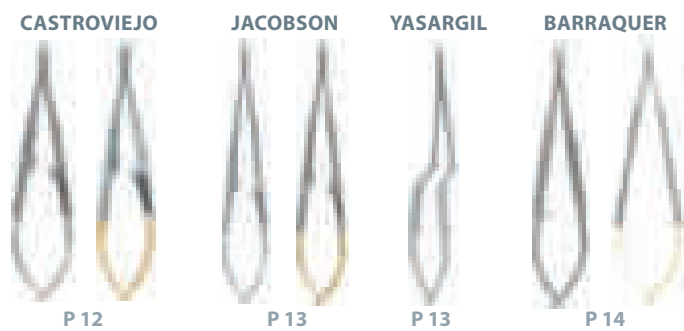

Microchirurgie pinces fines - Microsurgery fine forceps - Microcirugía pinzas finas

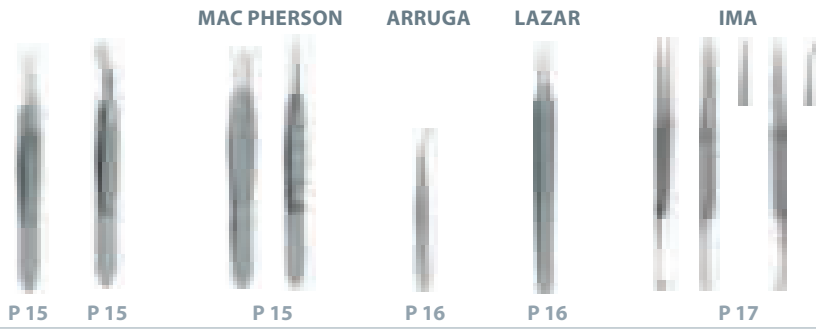

Microchirurgie crochets - Microsurgery hooks - Microcirugía ganchos

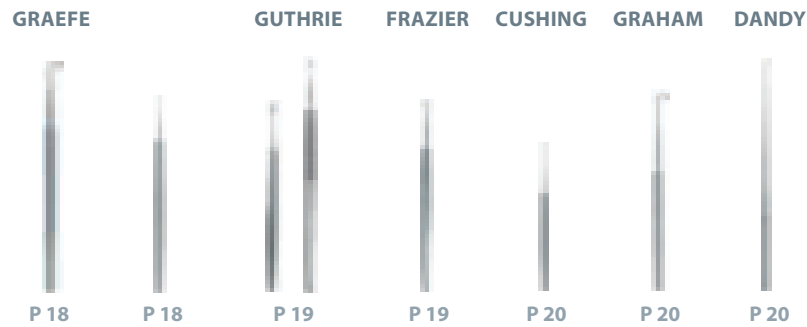

Écarteurs, crochets - Retractors, hooks - Separadores, ganchos

VII - Ecarteurs  
VII - Retractors  
VII - Separadores

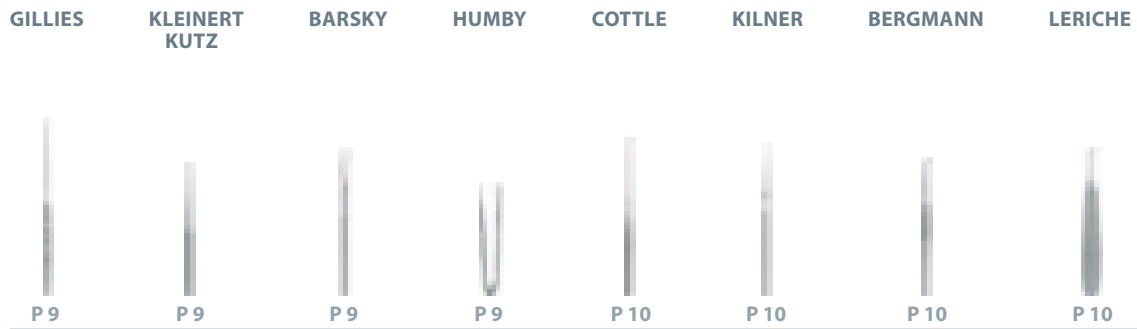

O.R.L. crochets - E.N.T. hooks - O.R.L. ganchos

XII - O.R.L.  
XII - E.N.T.  
XII - O.R.L.

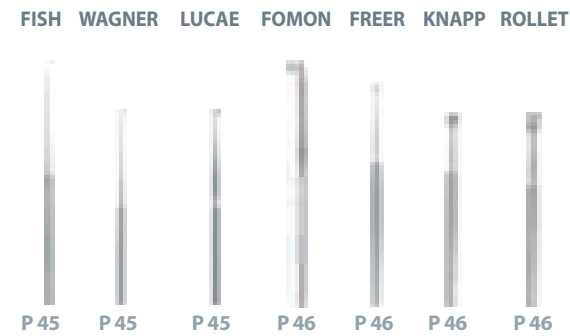

### WESTCOTT

Pointu - Sharp - Aguda



Droit  
Straight  
Recta

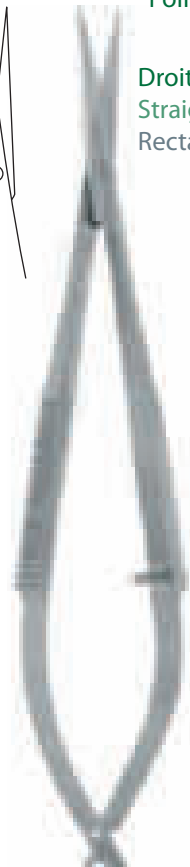

**D021042**  
11,5 cm - 4 1/2"



Courbe  
Curved  
Curva

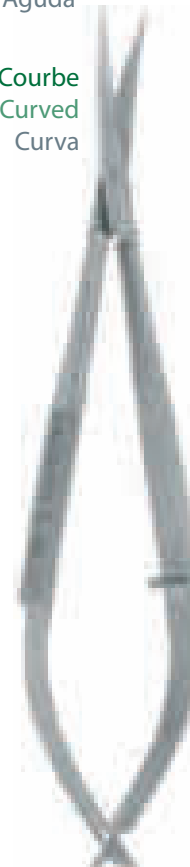

**D021052**  
11,5 cm - 4 1/2"

Pointu - Sharp - Aguda

Droit  
Straight  
Recta

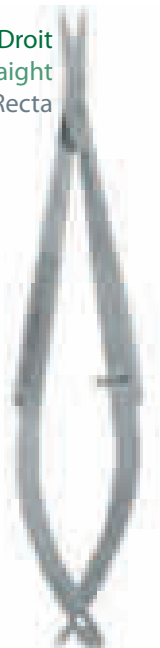

**D021062**  
9,5 cm - 3 3/4"

Droit  
Straight  
Recta



**D021061**  
9,5 cm - 3 3/4"

Coudé  
Angular  
Angulada



**D021082**  
9,5 cm - 3 3/4"

Mousse - Blunt - Roma

Droit  
Straight  
Recta

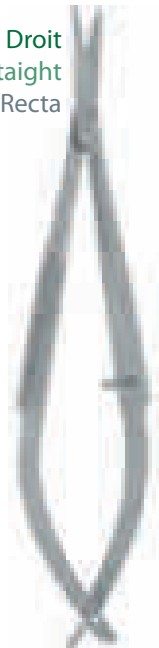

**D021060**  
9,5 cm - 3 3/4"

Courbe  
Curved  
Curva



**D021070**  
9,5 cm - 3 3/4"

Coudé  
Angular  
Angulada



**D021080**  
9,5 cm - 3 3/4"



### VANNAS

Pointu - Sharp - Aguda

Droit  
Straight  
Recta

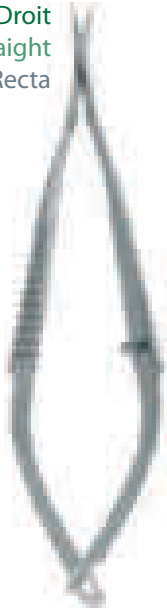

**D020010**  
8,5 cm - 3 1/2"

Courbe  
Curved  
Curva

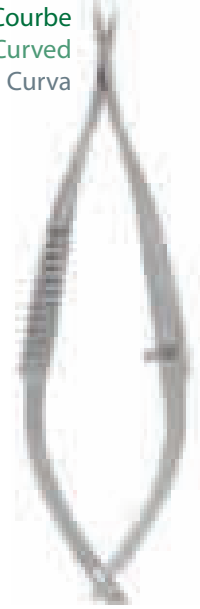

**D020020**  
8,5 cm - 3 1/2"

Coudé vers le haut  
Angled up  
Accodades hacia arriba

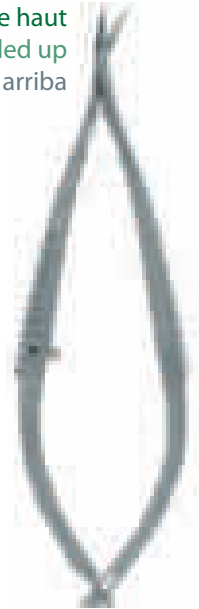

**D020035**  
8,5 cm - 3 1/2"

### VANNAS modifié TÜBINGEN

Droit  
Straight  
Recta

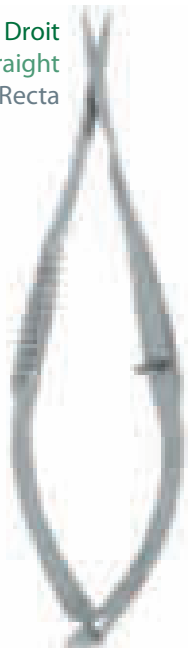

**D020040**  
8,5 cm - 3 1/2"

Courbe  
Curved  
Curva

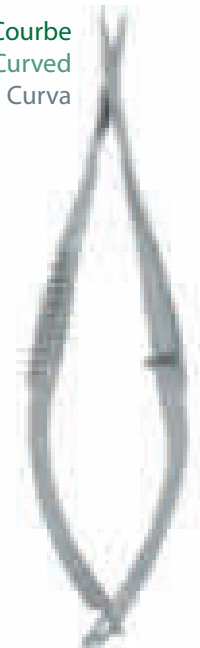

**D020045**  
8,5 cm - 3 1/2"

Coudé vers le haut  
Angled up  
Accodades hacia arriba



**D020055**  
8,5 cm - 3 1/2"

## Microchirurgie ciseaux - Microsurgery scissors - Microcirugía tijeras

### Pointu - Sharp - Aguda

Droit  
Straight  
Recta

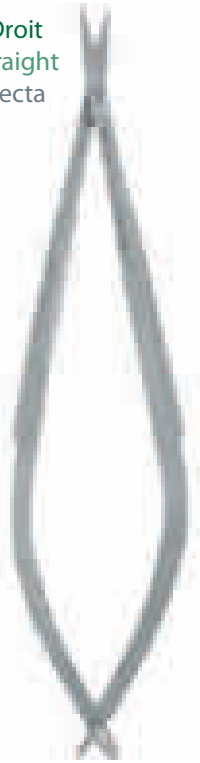

**D021102**  
10 cm - 4"

Courbe  
Curved  
Curva



**D021112**  
10 cm - 4"

Pointu  
Sharp  
Aguda

Courbe  
Curved  
Curva



**D021122**  
10 cm - 4"



Mousse  
Blunt  
Roma

Coudé  
Angled  
Angulada

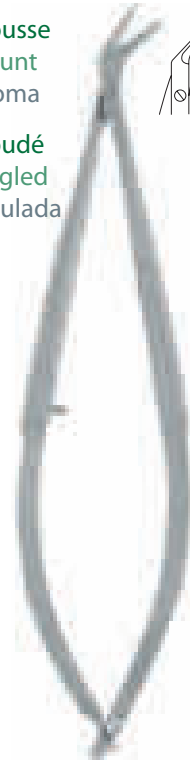

**D021130**  
10 cm - 4"

### CASTROVIEJO

Pointu / Pointu  
Sharp / Sharp  
Aguda / Aguda

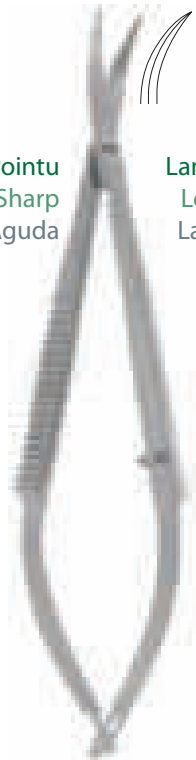

**D021142**  
10 cm - 4"

Lames longues  
Long baldes  
Lamas largas

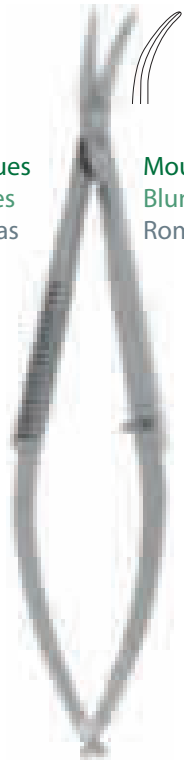

**D021140**  
10 cm - 4"

Mousse / Mousse  
Blunt / Blunt  
Roma / Roma

### TROUTMAN-BARRAQUER

A gauche  
On the left  
A la Izquierda

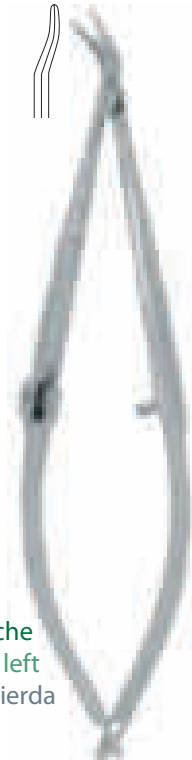

**D021150**  
10 cm - 4"

Coudé  
Angled  
Angulada

A droite  
On the right  
A la Derecha

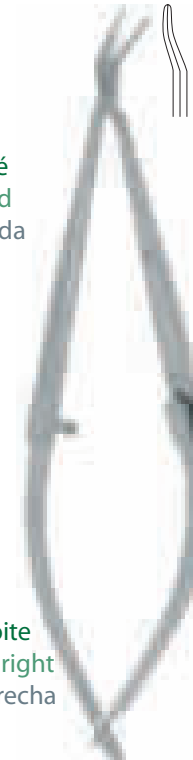

**D021160**  
10 cm - 4"

### NOYES

Pointu / Pointu  
Sharp / Sharp  
Aguda / Aguda

Pointu / Mousse  
Sharp / Blunt  
Aguda / Roma

Mousse / Mousse  
Blunt / Blunt  
Roma / Roma

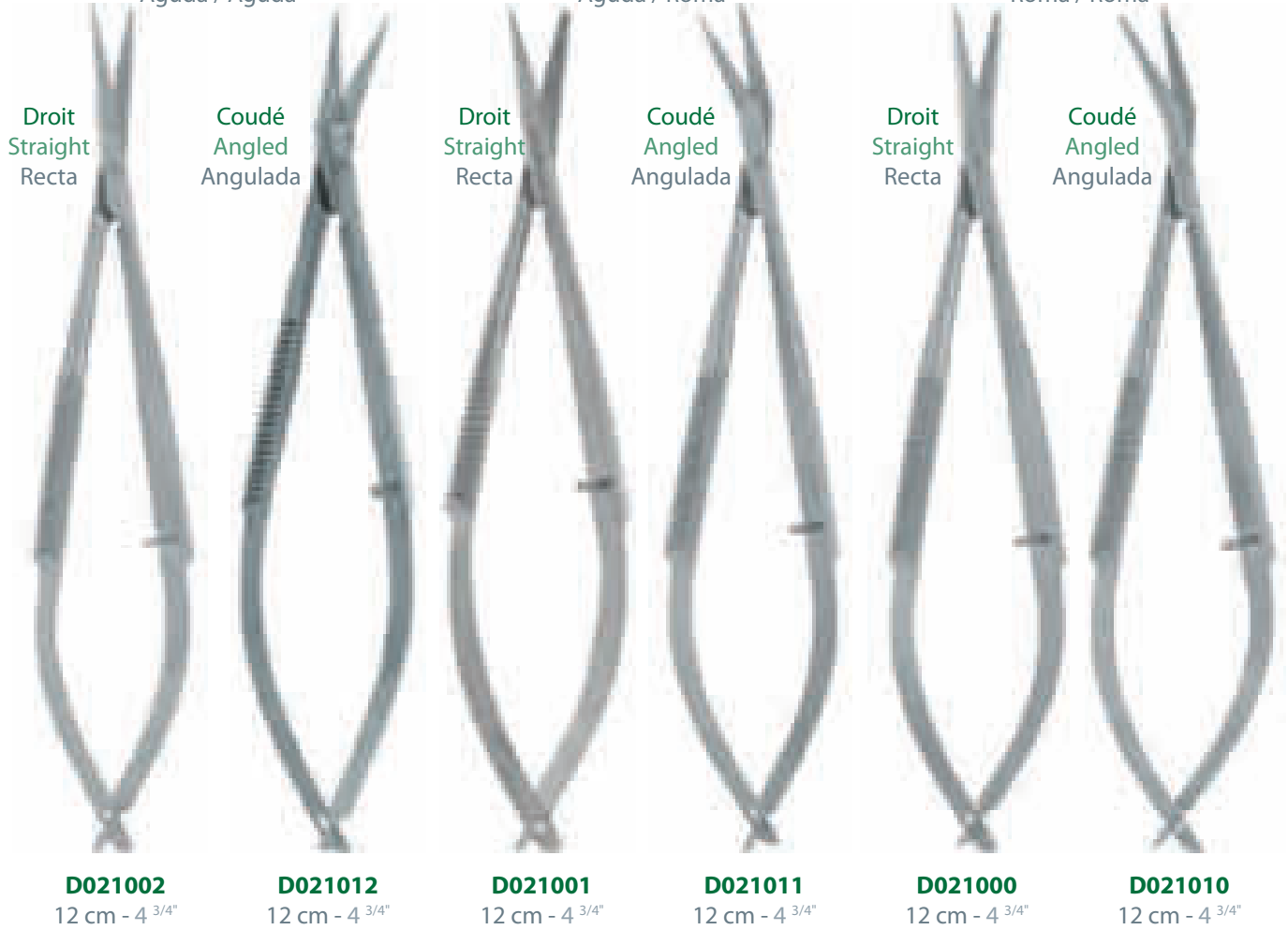

### WECKER

Coudé  
Angled  
Angulada

Pointu / Pointu  
Sharp / Sharp  
Aguda / Aguda

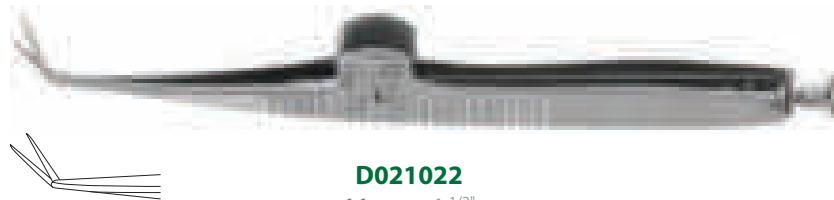

**D021022**  
11 cm - 4 1/2"

## Microchirurgie ciseaux - Microsurgery scissors - Microcirugía tijeras

### TROUTMAN

  
A gauche  
On the left  
A la Izquierda

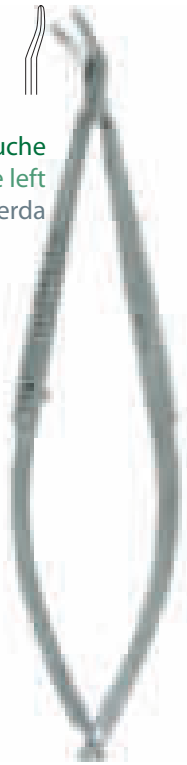

**D021170**  
10 cm - 4"

Coudé  
Angled  
Angulada  
  
Mousse  
Blunt  
Roma



**D021180**  
10 cm - 4"

  
A droite  
On the right  
A la Derecha

A gauche  
On the left  
A la Izquierda



**D021190**  
10 cm - 4"

Coudé  
Angled  
Angulada  
  
Pointu  
Sharp  
Aguda

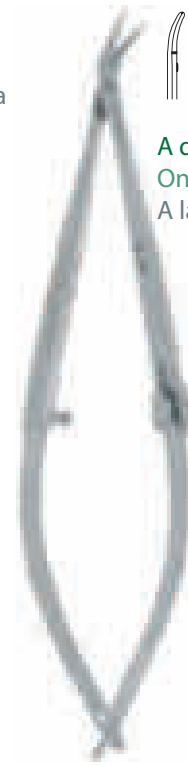

**D021200**  
10 cm - 4"

A droite  
On the right  
A la Derecha

### KATZIN

  
A gauche  
On the left  
A la Izquierda



**D021210**  
10 cm - 4"

Coudé  
Angled  
Angulada

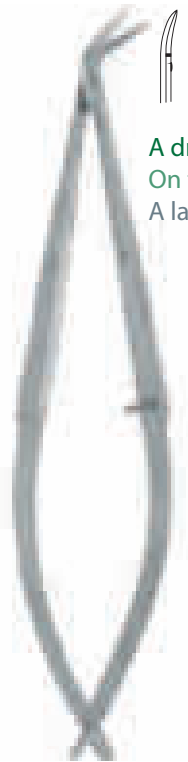

**D021220**  
10 cm - 4"

  
A droite  
On the right  
A la Derecha

Pointu / Pointu  
Sharp / Sharp  
Aguda / Aguda

Courbe  
Curved  
Curva

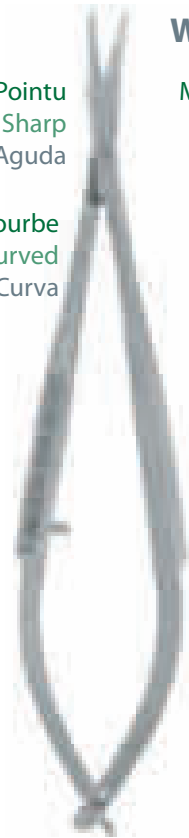

**D021232**  
11 cm - 4 1/2"

### WESTCOTT

Mousse / Mousse  
Blunt / Blunt  
Roma / Roma

Courbe  
Curved  
Curva

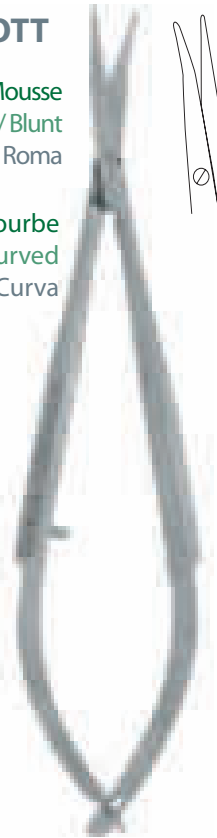

**D021230**  
11 cm - 4 1/2"



CASTROVIEJO

Mousse - Blunt - Roma

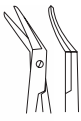
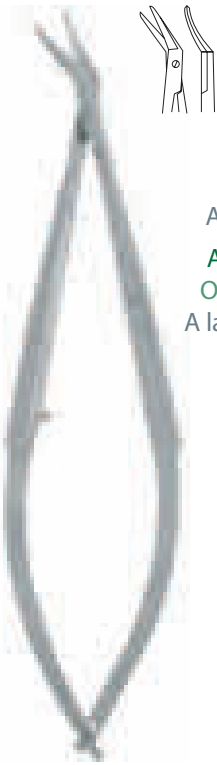

Coudé  
Angled  
Angulada  
A gauche  
On the left  
A la Izquierda

**D021250**  
10 cm - 4"



Coudé  
Angled  
Angulada  
A droite  
On the right  
A la Derecha

**D021260**  
10 cm - 4"

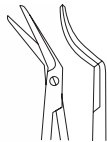

Coudé  
Angled  
Angulada  
A gauche  
On the left  
A la Izquierda

**D021270**  
11 cm - 4 1/2"

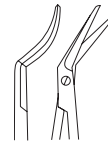
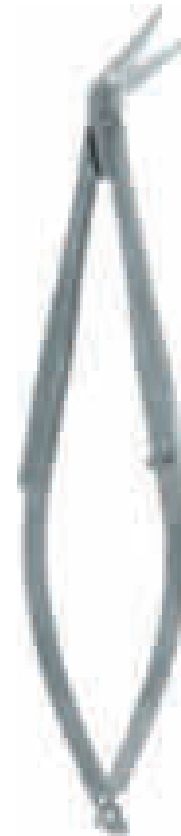

Coudé  
Angled  
Angulada  
A droite  
On the right  
A la Derecha

**D021280**  
11 cm - 4 1/2"

## Microchirurgie ciseaux - Microsurgery scissors - Microcirugía tijeras

	VANNAS		MILLES	
Droit Staight Recta	Pointu Sharp Aguda	Pointu, fin Sharp, fine Aguda, fina	Pointu, dentelé Sharp, serrated Aguda, dentellada	
16 cm - 6 1/4"	<b>D020400</b>	<b>D020410</b>	<b>D020420</b>	
Courbe Curved Curva	Pointu Sharp Aguda	Pointu, fin Sharp, fine Aguda, fina	Pointu, dentelé Sharp, serrated Aguda, dentellada	
16 cm - 6 1/4"	<b>D020401</b>	<b>D020411</b>	<b>D020421</b> 	



**D020400**  
**D020420**



**D020410**



**D020401**  
**D020421**



**D020411**

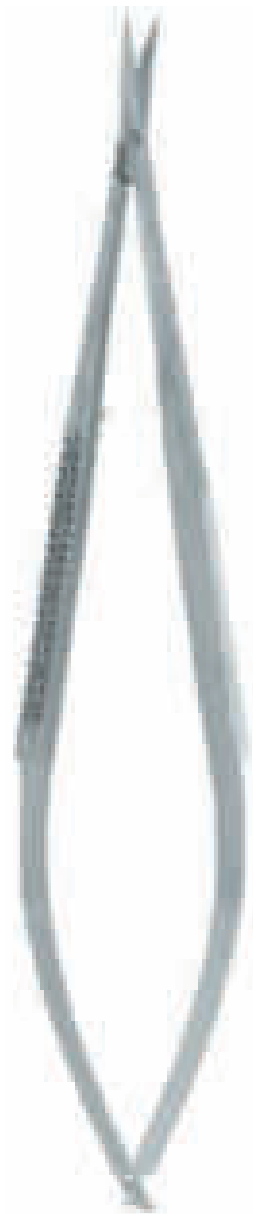

**D020421**  
16 cm - 6 1/4"

## Microchirurgie ciseaux - Microsurgery scissors - Microcirugía tijeras

Manche ronds - Round handle - Mango redondo

### VANNAS

	Droit Straight Recta	Pointu Sharp Aguda	Mousse Blunt Roma	Pointu, fin Sharp, fine Aguda, fina	Pointu, dentelé Sharp, serrated Aguda, dentellada
14 cm - 5 1/2 "	<b>D020090</b>	-	-	-	-
16 cm - 6 1/4 "	-	-	-	<b>D020210</b>	<b>D020220</b>
18 cm - 7 "	<b>D020290</b>	-	-	-	-
	Courbe Curved Curva	Pointu Sharp Aguda	Mousse Blunt Roma	Pointu, fin Sharp, fine Aguda, fina	Pointu, dentelé Sharp, serrated Aguda, dentellada
14 cm - 5 1/2 "	<b>D02010</b>	<b>D02020</b>	-	-	-
16 cm - 6 1/4 "	-	-	-	<b>D020211</b>	<b>D020221</b>
18 cm - 7 "	<b>D02030</b>	-	-	-	-
	Coudé Angular Angulada	Pointu Sharp Aguda			
18 cm - 7 "	<b>D020310</b>	-	-	-	-

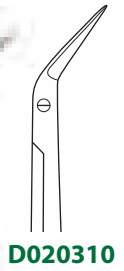

**D020310**

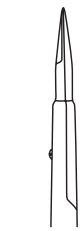
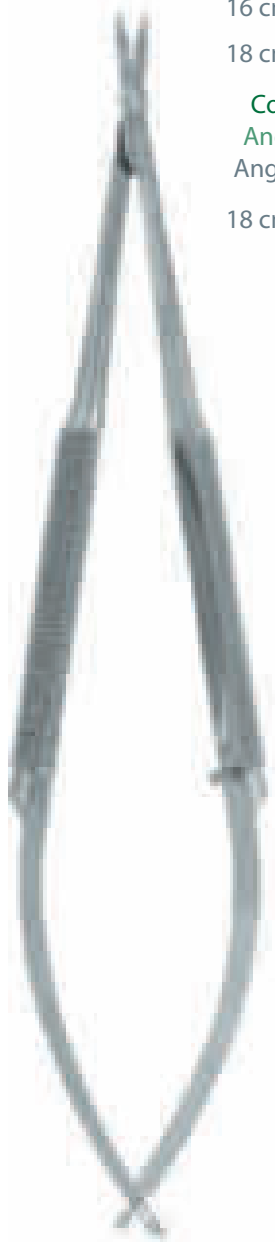

**D020210**

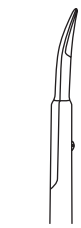

**D020211**

**D020210**  
16 cm - 6 1/4 "

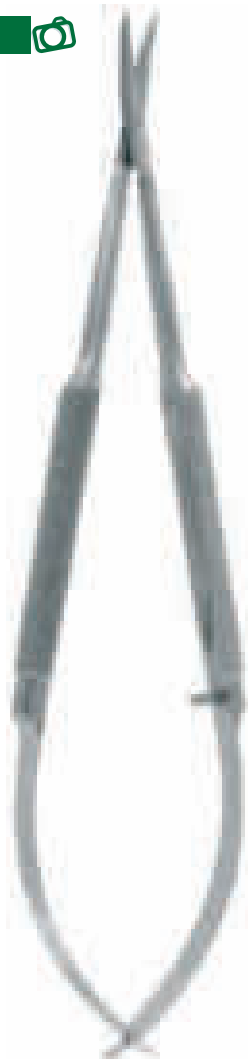

**D020290**



**D02010**

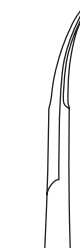

**D02020**

**D02020**  
14 cm - 5 1/2 "

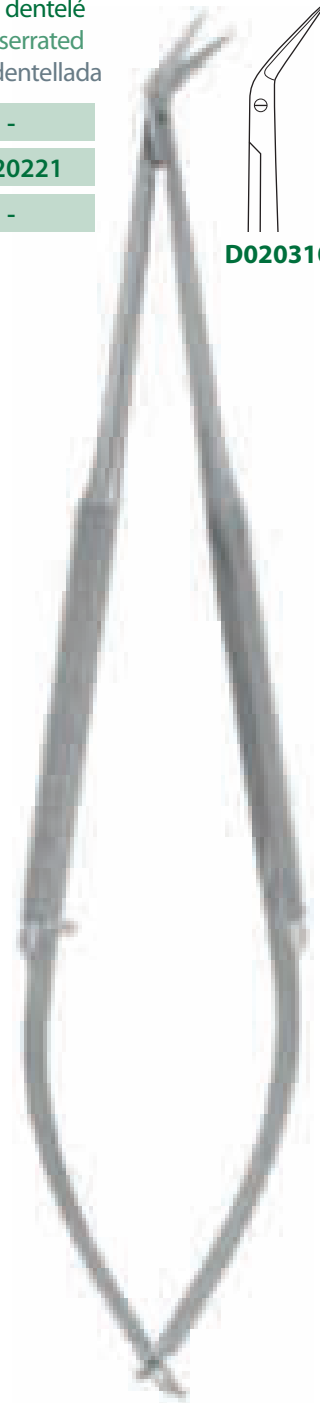

**D020310**  
18 cm - 7 "

### YASARGIL

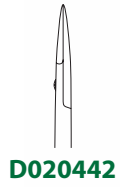
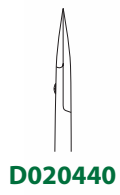

Droit Straight Recta	Pointu Sharp Aguda	Mousse Blunt Roma
16,5 cm - 6 1/2 "	<b>D020430</b>	-
20 cm - 8 "	<b>D020440</b>	<b>D020442</b>
22,5 cm - 8 3/4 "	<b>D020450</b>	<b>D020452</b>

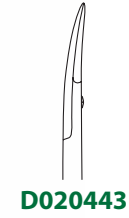
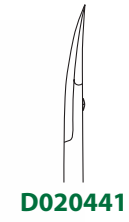

Courbe Curved Curva	Pointu Sharp Aguda	Mousse Blunt Roma
16,5 cm - 6 1/2 "	<b>D020431</b>	-
20 cm - 7 3/4 "	<b>D020441</b>	<b>D020443</b>
22,5 cm - 8 3/4 "	<b>D020451</b>	<b>D020453</b>



**D020450**  
22,5 cm - 8 3/4 "



**D020453**  
22,5 cm - 8 3/4 "



### CASTROVIEJO

Avec verrou - With lock - Con cerradura



Droit Straight Recto	Mors lisses Smooth jaws Boca lisa	Mors striés Stria jaws Boca estriada	Droit Straight Recto	Mors lisses Smooth jaws Boca lisa	Mors striés Stria jaws Boca estriada
14 cm - 5 1/2 "	<b>D01010</b>	<b>D010110</b>	14 cm - 5 1/2 "	<b>D010290</b>	<b>D01030</b>
Courbe Curved Curvo	Mors lisses Smooth jaws Boca lisa	Mors striés Stria jaws Boca estriada	Courbe Curved Curvo	Mors lisses Smooth jaws Bocca liso	Mors striés Stria jaws Estriado bocca
14 cm - 5 1/2 "	<b>D01020</b>	<b>D010210</b>	14 cm - 5 1/2 "	<b>D010390</b>	<b>D01040</b>

Mors lisses  
Smooth jaws  
Boca lisa



**D01010**



**D01020**

Mors striés  
Stria jaws  
Boca estriada



**D010110**



**D010210**

Mors lisses  
Smooth jaws  
Boca lisa



**D010290**



**D010390**

Mors striés  
Stria jaws  
Boca estriada



**D01030**



**D01040**



**D01010**  
14 cm - 5 1/2 "

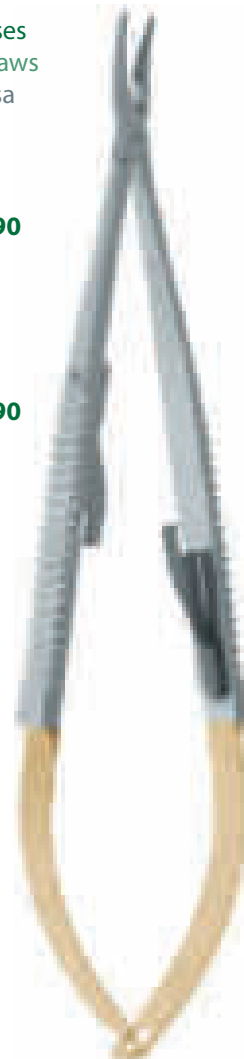

**D01040**  
14 cm - 5 1/2 "

### JACOBSON



### YASARGIL

	Droit Straight Recto	Courbe Curved Curvo	Droit Straight Recto	Courbe Curved Curvo	Droit Straight Recto	Courbe Curved Curvo
18 cm - 7"	<b>D010440</b>	<b>D010460</b>	<b>D01050</b>	<b>D010550</b>	<b>D012000</b>	<b>D012010</b>
20 cm - 8"	-	-	D010501	-	-	-
22,5 cm - 8 <sup>3/4</sup> "	-	-	D010502	-	D012020	D012030



D010440



D010460

Mors striés  
Stria jaws  
Boca estriada



D01050



D010550

Mors striés  
Stria jaws  
Boca estriada



D012000



D012010

Mors lisses  
Smooth jaws  
Boca lisa



**D010440**  
18 cm - 7"

Avec verrou  
With lock  
Con cerradura

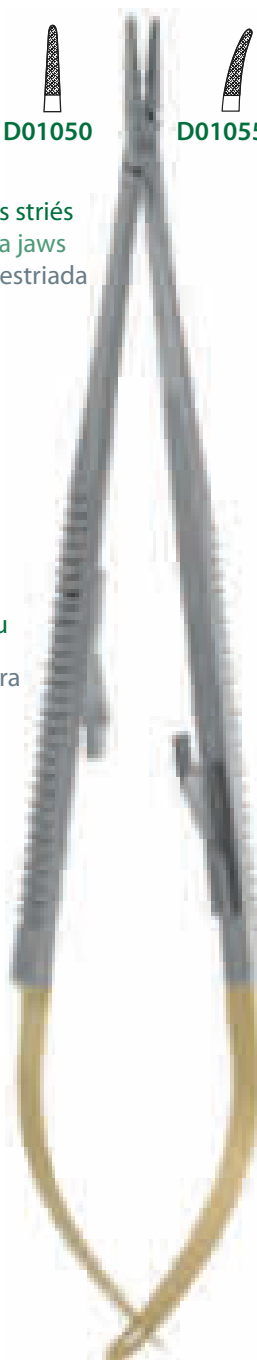



**D01050**  
18 cm - 7"



**D012000**  
18 cm - 7"

### BARRAQUER



Mors lisses Smooth jaws Boca lisa	Droit Straight Recto	Courbe Curved Curvo	Mors striés Stria jaws Boca estriada	Droit Straight Recto	Courbe Curved Curvo
13 cm - 5" 	<b>D01060</b>	D01070	14 cm - 5 1/2"	<b>D010790</b>	D01080
18 cm - 7"	D01090	D01100	18 cm - 7" 	<b>D011100</b>	D011110

Mors lisses  
Smooth jaws  
Boca lisa

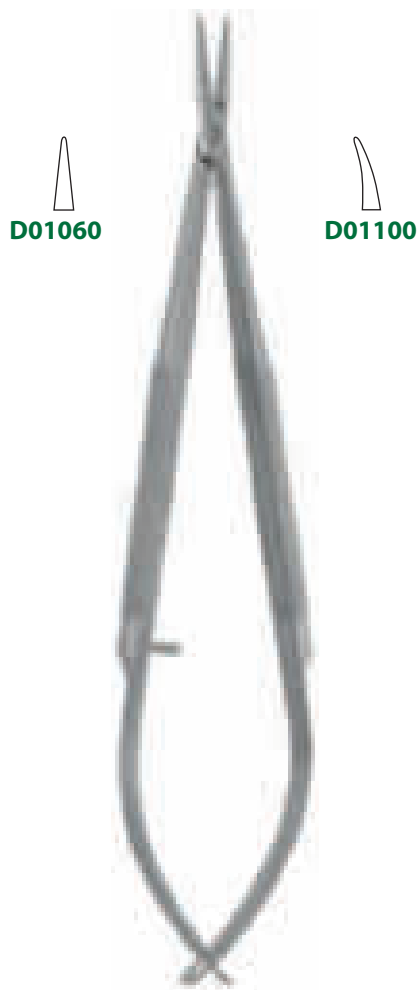

**D01060**  
13 cm - 5"

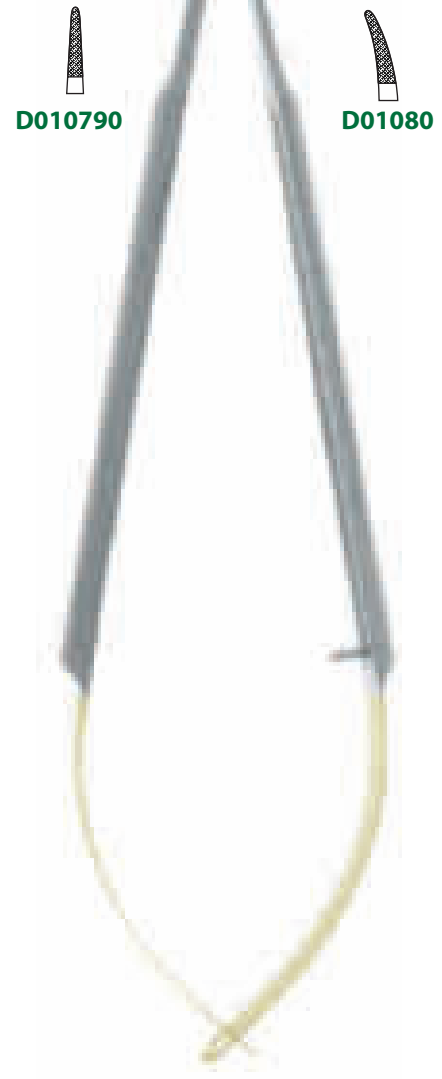

**D011100**  
18 cm - 7"

## Microchirurgie pinces fines - Microsurgery fine forceps - Microcirugía pinzas finas

Droite  
Straight  
Recta



**D03080**  
7 cm - 2 3/4"

Sans griffes  
Without teeth  
Sin dientes

Mors striés  
Striated jaws  
Bocas estriadas

Courbe  
Curved  
Curva

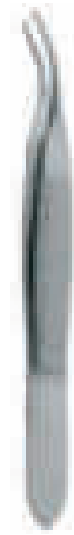

**D03090**  
7 cm - 2 3/4"

Droite  
Straight  
Recta

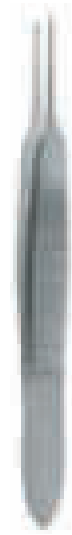

**D03060**  
7 cm - 2 3/4"

A griffes  
With teeth  
Con dientes

Courbe  
Curved  
Curva



**D03070**  
7 cm - 2 3/4"

### MAC PHERSON

A plateau - With platform - Con plataforma

Droite  
Straight  
Recta



**D03120**  
8 cm - 3 1/4"

Sans griffes  
Without teeth  
Sin dientes

Coudée  
Angled  
Angulada



**D03130**  
8 cm - 3 1/4"

Droite  
Straight  
Recta

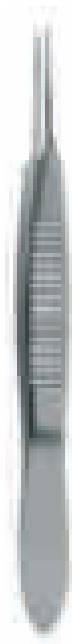

**D03100**  
8 cm - 3 1/4"

A griffes  
With teeth  
Con dientes

Coudée  
Angled  
Angulada



**D03110**  
8 cm - 3 1/4"

LAZAR

ARRUGA

0,5 mm

0,8 mm

Pince capsulaire  
Capsule forceps  
Pinza capsular

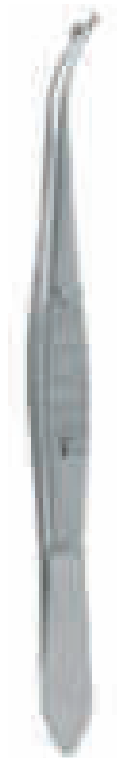

**D03160**  
10 cm - 4 "



**D031400**  
15,5 cm - 6 "

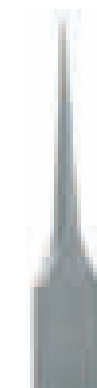

**D031400**



**D031405**

Avec plateau - With platform - Con plataforma

IMA

Droite  
Straight  
Recta

Courbe  
Curved  
Curva

D031410

12 cm - 4 <sup>3</sup>/<sub>4</sub> "

D031411

D031420

15 cm - 6 "

D031421



D031430

18 cm - 7 "

D031431



Droite  
Straight  
Recta

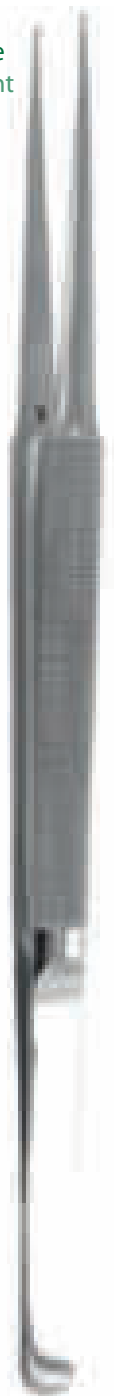

**D031440**  
18 cm - 7 "



A griffes  
With teeth  
Con dientes



**D031430**  
18 cm - 7 "

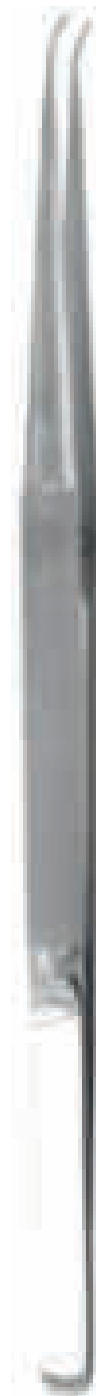

**D031431**  
18 cm - 7 "

### GRAEFE

Boutonné - Buttoned - Abotonado



**D040210**  
13,5 cm - 5 1/4"

**D040211**  
14 cm - 5 1/2"

**D040212**  
14,5 cm - 5 3/4"

Mousse  
Blunt  
Romo

Pointu  
Sharp  
Agudo

2 mm

2 mm

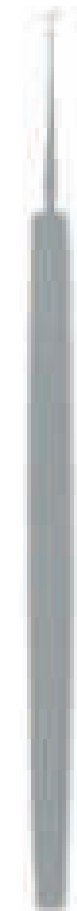

**D04010**  
12 cm - 4 3/4"

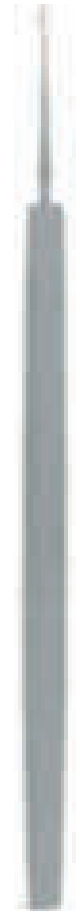

**D04020**  
12 cm - 4 3/4"

### GUTHRIE

### FRAZIER

À nerf - For nerve - Para nervios

Fin  
Fine  
Fino

Fort  
Strong  
Fuerte

2,5 mm

3 mm

13 cm - 5"

**D040440** 

18 cm - 7"

**D040441**

2,5 mm

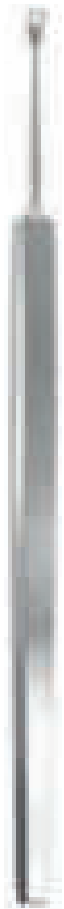

**D040390**  
12 cm - 4 3/4"

3 mm

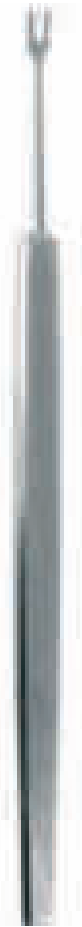

**D04040**  
12 cm - 3 3/4"



**D040410**  
16 cm - 6 1/4"

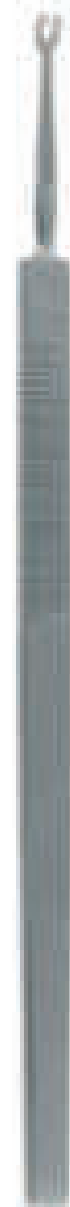

**D040411**  
16 cm - 6 1/4"

3,5 mm



**D040440**  
13 cm - 5"





### CUSHING

3 mm  
Pointu  
Sharp  
Agudo

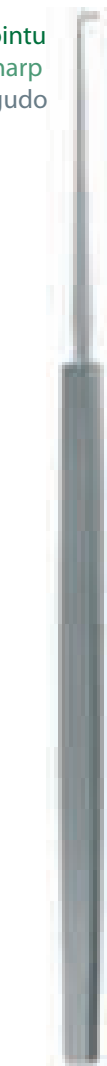

**D040420**  
14 cm - 5 1/2"

### GRAHAM

9 mm  
Mousse  
Blunt  
Romo

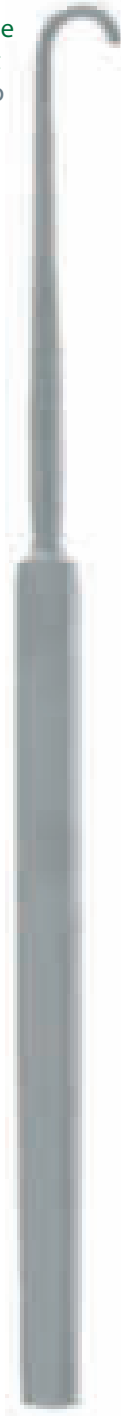

**D040700**  
16,5 cm - 6 1/2"

### DANDY

6 mm  
Mousse  
Blunt  
Romo

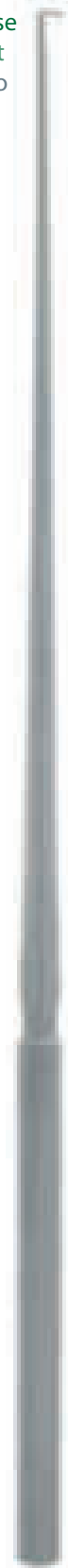

**D040710**  
22 cm - 8 1/2"

Neurochirurgie : spatules - Neurosurgery : spatulas - Neurocirugía : espátulas

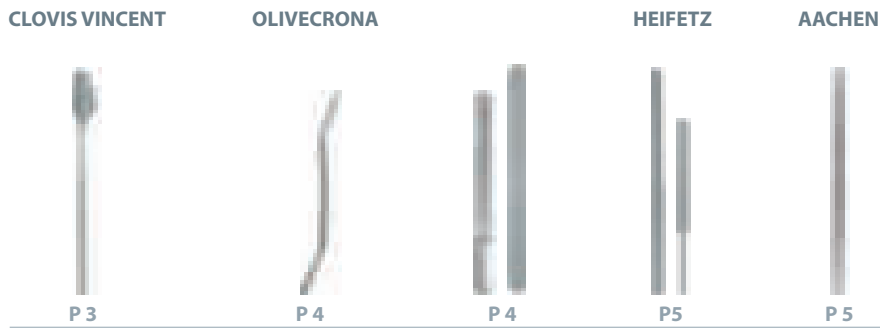

Neurochirurgie : écarteurs - Neurosurgery : retractors - Neurocirugía : separadores

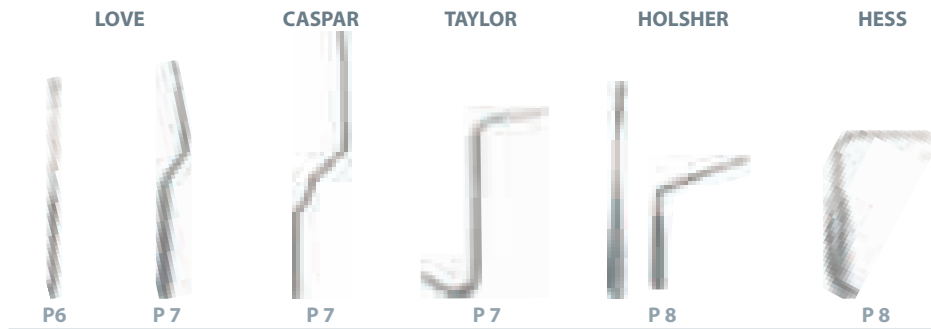

Neurochirurgie : perforateur - Neurosurgery : bone drill - Neurocirugía : perforador



Neurochirurgie : pincers rongeurs - Neurosurgery : laminectomy rongeurs - Neurocirugía : pinzas para laminectomía

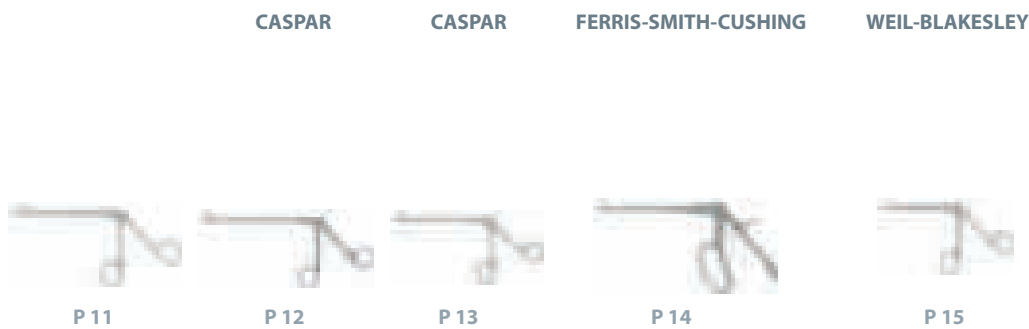

Neurochirurgie : emporte pièces - Neurosurgery : punches - Neurocirugía : sacabocados

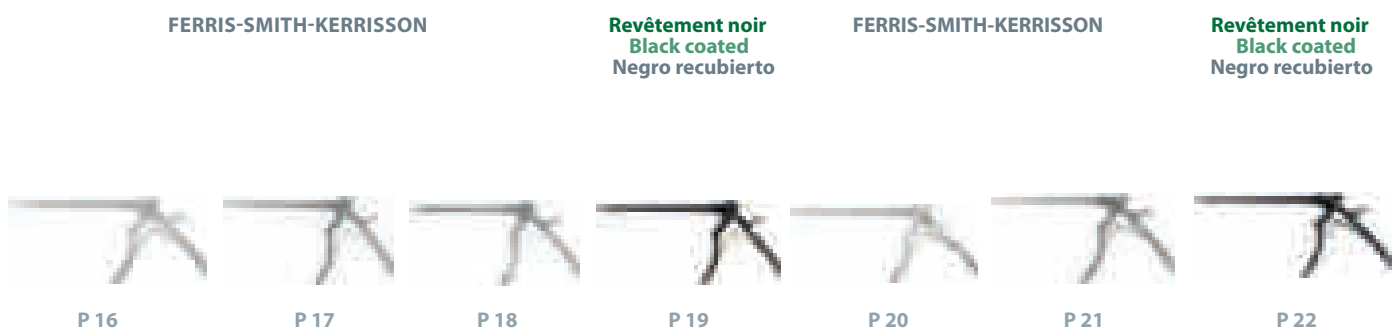

Écarteurs - Retractors - Separadores

VII - Ecarteurs  
VII - Retractors  
VII - Separadores

JANSEN    JANSEN    PLESTER    WEITLANER    WEITLANER    HENLEY    TRAVERS    MAC KEE    NORFOLK  
NORWICH    WEITLANER



P 110



P 110



P 111



P 112



P 113



P 114



P 114



P 115



P 115



P 116

WEITLANER  
WULLSTEIN



P 116

WEITLANER  
NEURO



P 117

ANDERSON  
ADSON



P 117

BECKMANN  
CONE



P 118

BECKMANN



P 118

BECKMANN



P 119

BECKMANN



P 120

DECOULX



P 121

BECKMANN  
EATON



P 122

ADSON



P 122

BECKMANN  
ADSON



P 123

ADSON



P 124

WALTON



P 125

MARKHAM  
MEYERDING



P 126

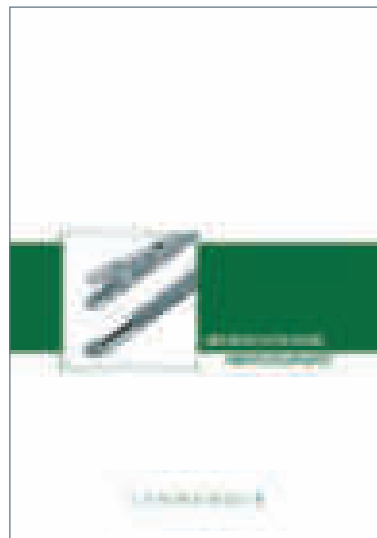

## CLOVIS VINCENT

Lame malléable - Malleable spatula - Espátula maleable

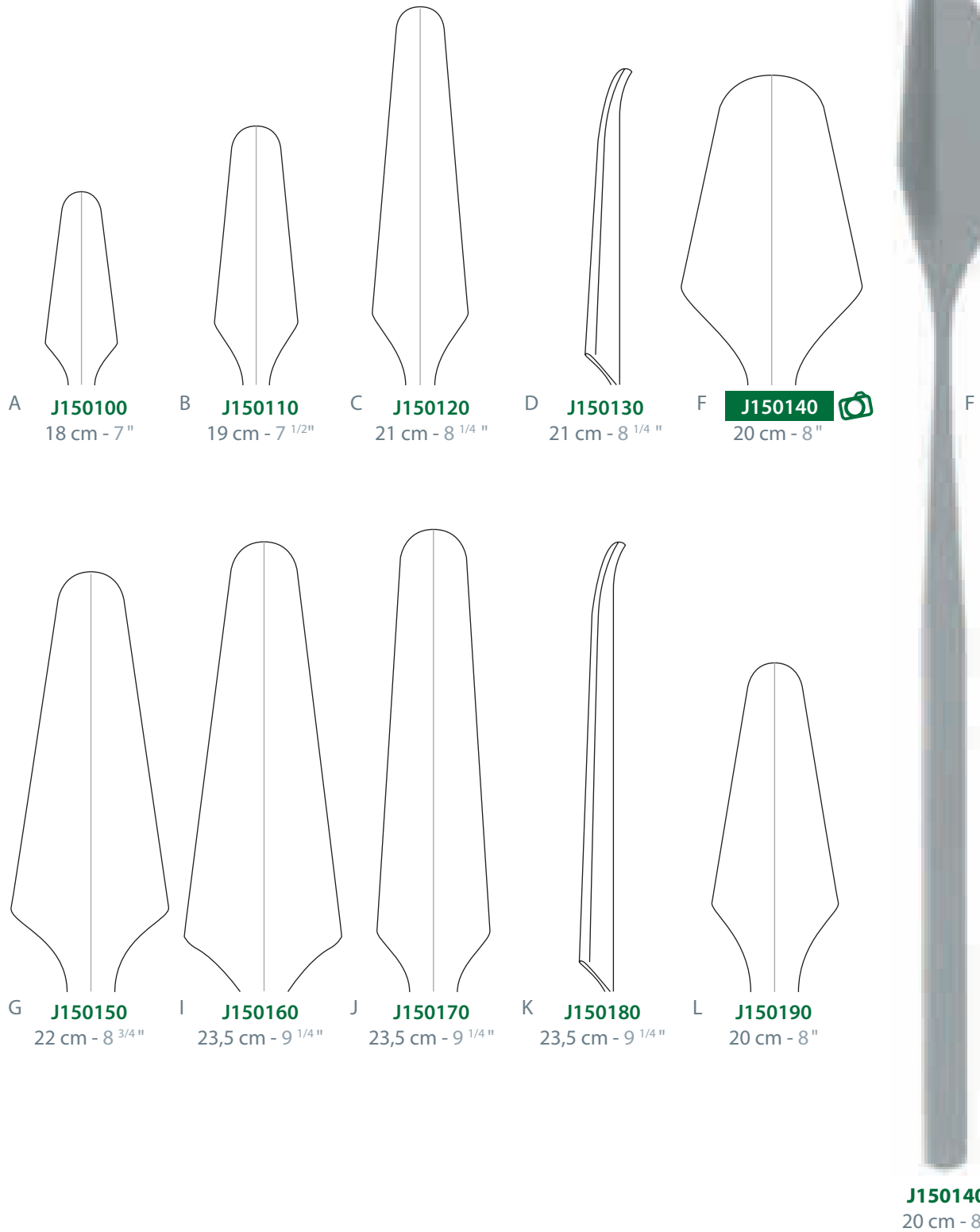

## OLIVECRONA

7 x 9 mm **J151010**   
 11 x 13 mm **J151011**  
 15 x 18 mm **J151012**  
 18 x 22 mm **J151013**

7 x 9 mm **J151020**  
 11 x 13 mm **J151021**  
 15 x 18 mm **J151022**   
 18 x 22 mm **J151023**

12 mm **J151030**  
 17 mm **J151031** 

Droite double  
 Double straight  
 Recta doble

Lame malléable  
 Malleable spatula  
 Espátula maleable

Concave  
 Concave  
 Cóncava

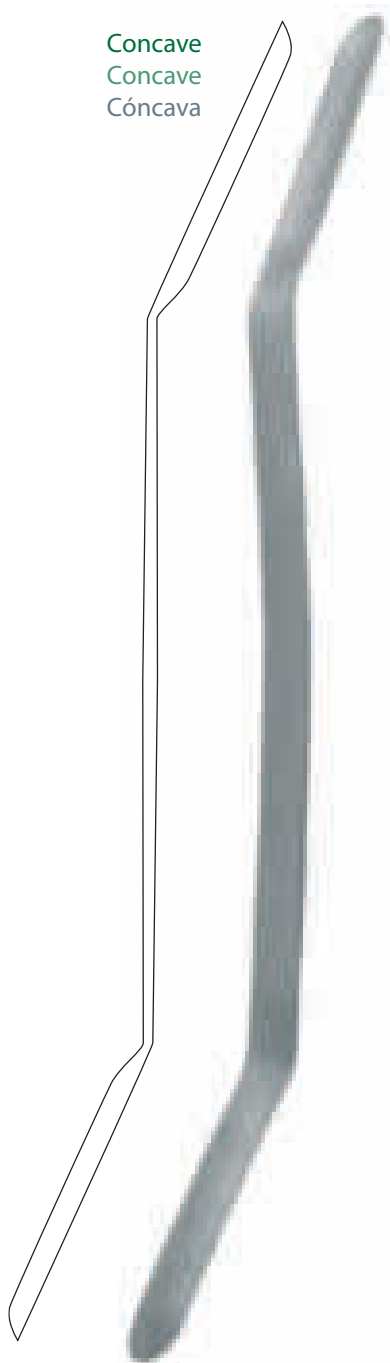

**J151010**  
 18 cm - 7 "

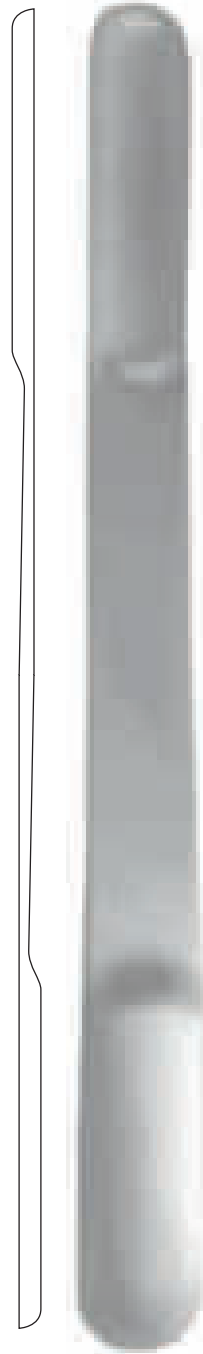

**J151021**  
 18 cm - 7 "



**J151031**  
 20 cm - 8 "

## HEIFETZ

## AACHEN

- 7 x 8 mm J151040
- 10 x 11 mm J151041 
- 13 x 14 mm J151042
- 16 x 17 mm J151043
- 19 x 20 mm J151044
- 22 x 25 mm J151045

- 8 mm J151050
- 11 mm J151051 
- 14 mm J151052
- 17 mm J151053

- 7 + 8 mm J151060
- 10 + 11 mm J151061 

Lames malléables  
Malleable spatulas  
Espátulas maleables

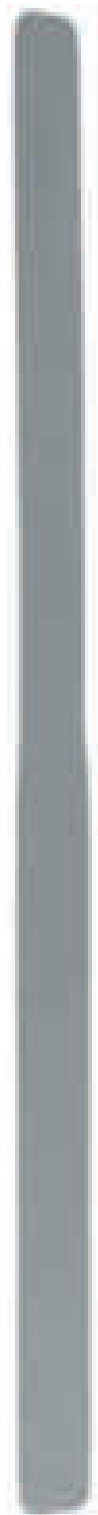

**J151041**  
20 cm - 8"

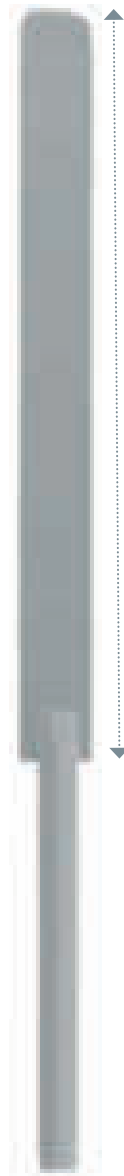

**J151051**  
15,5 cm - 6"



**J151061**  
20 cm - 8"

## LOVE

Ecarteurs à nerf  
Nerve retractors  
Nervios separadores

7 mm



**J152001**  
7 mm  
19,5 cm - 8"

7 mm



**J152002**  
7 mm  
19,5 cm - 8"

45°

90°

7 mm

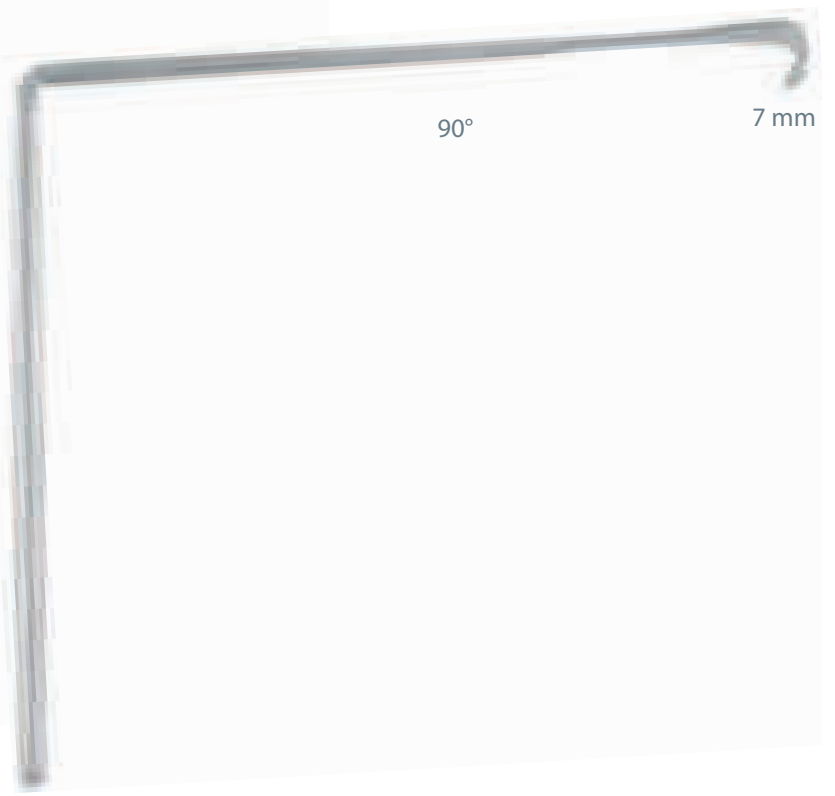

**J152003**  
7 mm  
19,5 cm - 8"

## LOVE

4 mm



**J152000**

21 cm - 8 1/4"



## CASPAR

4 mm **J152204**

6 mm **J152206** 

8 mm **J152208**

10 mm **J152210**

Ecarteurs à nerf  
Nerve retractors  
Nervios separadores

**J152206**

24 cm - 9 1/2"

## TAYLOR

30 x 70 mm

**J152120** 

30 x 100 mm

**J152121**

**J152120**

17 cm - 6 3/4"



## HOLSHER

Courbe  
Curved  
Curvo

7 mm **J152100** 

9 mm **J152101**

Coudé  
Angled  
Angulado

8 mm **J152110**

13 mm **J152111** 

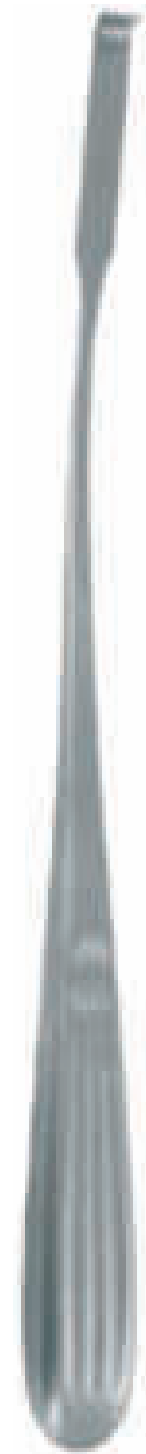

**J152100**  
24 cm - 9 1/2 "

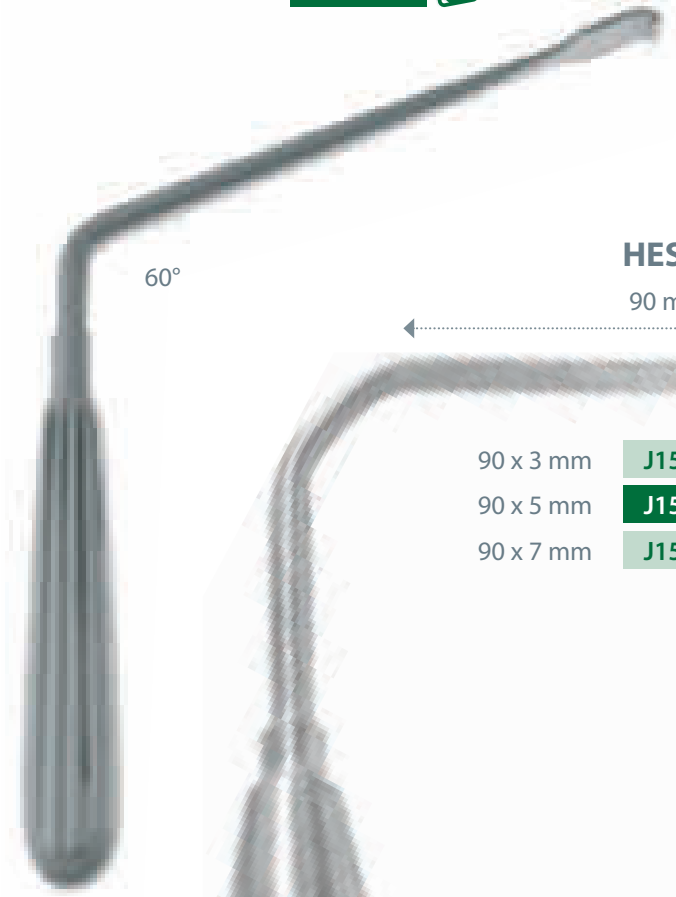

**J152111**  
20 cm - 8 "

## HESS

90 mm

90 x 3 mm **J152303**

90 x 5 mm **J152305** 

90 x 7 mm **J152307**

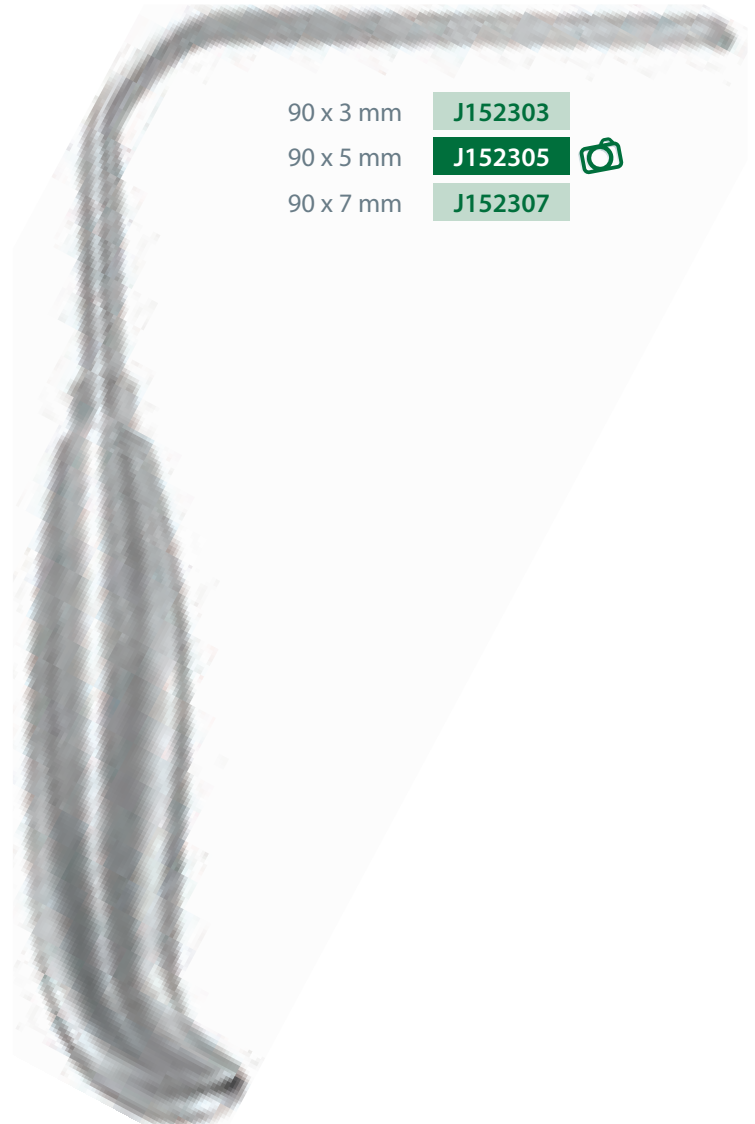

**J152305**  
18,5 cm - 7 1/4 "

## DOYEN

Perforateur initial - Initial drill - Perforador inicial

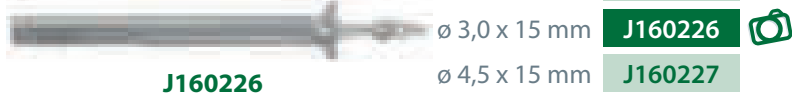

## DOYEN



## CLOVIS VINCENT



## DOYEN (COURONNE DE TRÉPAN)



11 cm - 4<sup>1/4</sup>"



Perforateur seul  
Drill only  
Perforador sólo

**J16010**

29 cm - 11<sup>1/3</sup>"

## HUDSON



**J161010**

ø 9 mm



**J161020**

ø 14 mm



**J161030**

ø 16 mm



**J161040**

ø 22 mm

## CUSHING



**J161050**

ø 14 mm

Rallonge  
Extension piece  
Pieza alargadera

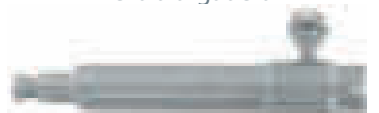

**J161060**

## McKENZIE



**J161080**

ø 13 mm



**J161090**

ø 2 mm

## ERRICO



**J161100**

ø 16 mm



Perforateur seul  
Drill only  
Perforador sólo

**J161000**  
29 cm - 11<sup>1/3</sup>"



<b>Largeur de mors</b> Width of jaw Anchura de boca	<b>Longueur tige</b> Length of shaft Largo del tallo	<b>Droite</b> Straight Recta	<b>Vers le haut</b> Upward Hacia arriba	<b>Vers le bas</b> Downward Hacia abajo
---	--	------------------------------------	---	---

### CUSHING



2 x 10 mm

13 cm - 5 <sup>1</sup> / <sub>8</sub> "	J17001	J17002	J17003
15 cm - 6 "	J170040	J170041	J170042
18 cm - 7 "	J17005	J17006	J17007
23 cm - 9 "	J170043	J170044	-
28 cm - 11 "	J170046	J170047	-

### LOVE-GRUENWALD

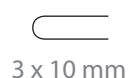

3 x 10 mm

13 cm - 5 <sup>1</sup> / <sub>8</sub> "	J17010	J17012	J17015
15 cm - 6 "	<b>J170160</b>	J170161	J170162
18 cm - 7 "	J17020	J17025	J17035
23 cm - 9 "	J170163	J170164	-
28 cm - 11 "	J170166	J170167	-

### SPURLING



4 x 10 mm

13 cm - 5 <sup>1</sup> / <sub>8</sub> "	J17045	J17050	J17055
15 cm - 6 "	J170560	J170561	J170562
18 cm - 7 "	J17060	J17065	J17070
23 cm - 9 "	J170563	J170564	-
28 cm - 11 "	J170566	J170567	-

## CASPAR

Mors fenêtrés et dentelés  
Serrated and fenestrated jaws  
Serrado con ventana bocas





16 cm - 6 1/4"



J170919



Largueur de mors Width of jaw Anchura de boca	Longueur tige Shaft length Largo del tallo	Droite Straight Recta	Vers le haut Upward Hacia arriba	Vers le bas Downward Hacia abajo
---	--	-----------------------------	--	--

	14 cm - 5 1/2 "	J170910	J170911	-
	16 cm - 6 1/4 "	J170913	J170914	-
	18,5 cm - 7 1/4 "	J1709330	-	-
	23 cm - 9 "	J1709341	-	-
	28 cm - 11 "	J1709342	-	-
	14 cm - 5 1/2 "	J170916	J170917	-
	16 cm - 6 1/4 "	<b>J170919</b>	J170920	J170921
	18,5 cm - 7 1/4 "	J1709333	J1709334	J1709335
	23 cm - 9 "	J1709343	-	-
	28 cm - 11 "	J1709344	-	-
	14 cm - 5 1/2 "	J170922	J170923	-
	16 cm - 6 1/4 "	J170925	J170926	J170927
	18,5 cm - 7 1/4 "	J1709336	J1709337	J1709338
	23 cm - 9 "	J1709345	-	-
	28 cm - 11 "	J1709346	-	-
	14 cm - 5 1/2 "	J170928	J170929	-
	16 cm - 6 1/4 "	J170931	J170932	-
	18,5 cm - 7 1/4 "	J1709339	J1709340	-
	23 cm - 9 "	J1709347	-	-
	28 cm - 11 "	J1709348	-	-

## CASPAR



<p>Largeur de mors Width of jaw Anchura de boca</p>	<p>Longueur tige Shaft length Largo del tallo</p>	<p>Droite Straight Recta</p>	<p>Vers le haut Upward Hacia arriba</p>	<p>Vers le bas Downward Hacia abajo</p>
---	---	--------------------------------------	---	---

	2 x 15 mm	15,5 cm - 6 <sup>1</sup> / <sub>8</sub> "	<b>J1709380</b>	J1709381	J1709382
	3 x 15 mm	15,5 cm - 6 <sup>1</sup> / <sub>8</sub> "	J1709383	J1709384	J1709385
	4 x 15 mm	15,5 cm - 6 <sup>1</sup> / <sub>8</sub> "	J1709386	J1709387	J1709388
	5 x 15 mm	15,5 cm - 6 <sup>1</sup> / <sub>8</sub> "	J1709389	-	-





FERRIS-SMITH-CUSHING



J170750







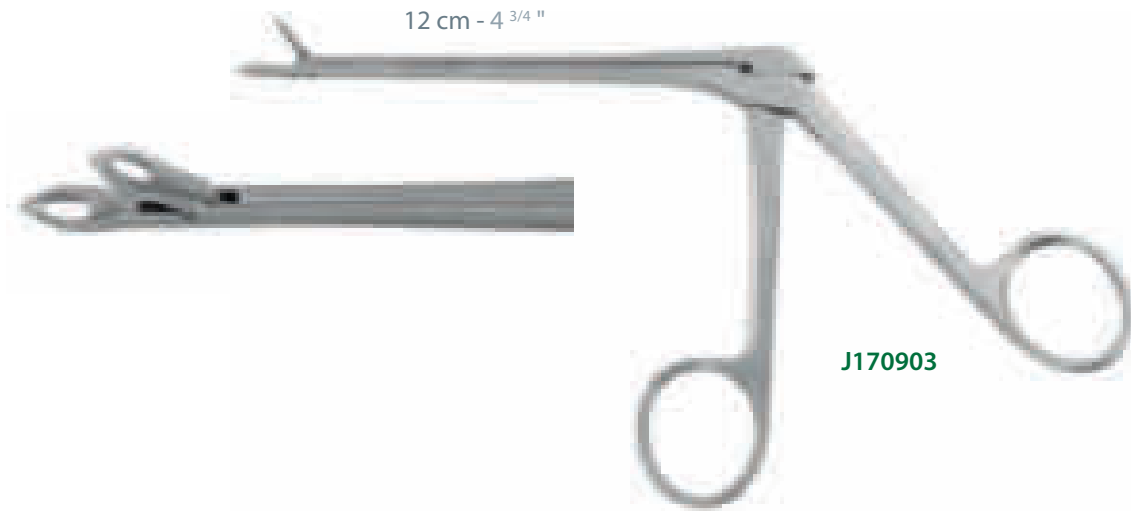

Largeur de mors Width of jaw Anchura de boca	Longueur tige Shaft length Largo del tallo	Droite Straight Recta	Vers le haut Upward Hacia arriba	Vers le bas Downward Hacia abajo
--	--	-----------------------------	--	--

	2 x 10 mm	18 cm - 7 " 	<b>J170750</b>	J170751	J170752
	3 x 10 mm	18 cm - 7 "	J17080	J17085	J170860
	4 x 10 mm	18 cm - 7 "	J17090	J170898	J170899

XI - Neurochirurgie  
XI - Neurosurgery  
XI - Neurocirugía

## WEIL-BLAKESLEY



Largueur de mors Width of jaw Anchura de boca	Longueur tige Shaft length Largo del tallo	Droite Straight Recta	Vers le haut Upward Hacia arriba
 3,0 x 10 mm	12 cm - 4 <sup>3/4</sup> "	J170901	J170902
 3,5 x 10 mm	12 cm - 4 <sup>3/4</sup> "	J170903	J170904
 4,5 x 10 mm	12 cm - 4 <sup>3/4</sup> "	J170905	J170906
 5,0 x 10 mm	12 cm - 4 <sup>3/4</sup> "	J170907	J170908
 6,0 x 10 mm	12 cm - 4 <sup>3/4</sup> "	J170909	-





## FERRIS SMITH KERRISSON



### 40° Haut / 40° Upward / 40° Arriba

Largeur de mors Width of jaw Anchura de boca	Longueur tige Shaft length - Largo del tallo				
	18 cm - 7"	20 cm - 8"	23 cm - 9"	25 cm - 10"	28 cm - 11"
1 mm	J171170	J172011	-	-	-
2 mm	J17118	J172012	J172312	J172512	-
3 mm	J17120	J172013	J172313	J172513	J172813
4 mm	J17130	J172014	J172314	J172514	J172814
5 mm	J17140	J172015	J172315	J172515	J172815
6 mm	-	J172016	-	-	-

### 40° Haut talon fin / 40° Upward thin foot plate / 40° Arriba talón fino

Largeur de mors Width of jaw Anchura de boca	Longueur tige Shaft length - Largo del tallo				
	18 cm - 7"	20 cm - 8"	23 cm - 9"	25 cm - 10"	28 cm - 11"
1 mm	J171170T	J172011T	-	-	-
2 mm	J171180T	J172012T	J172312T	J172512T	-
3 mm	J171200T	J172013T	J172313T	J172513T	J172813T
4 mm	J171300T	J172014T	J172314T	J172514T	J172814T
5 mm	J171400T	J172015T	J172315T	J172515T	J172815T
6 mm	-	J172016T	-	-	-

**T**: Talon fin - Thin footplate - Talón fino

## FERRIS SMITH KERRISSON

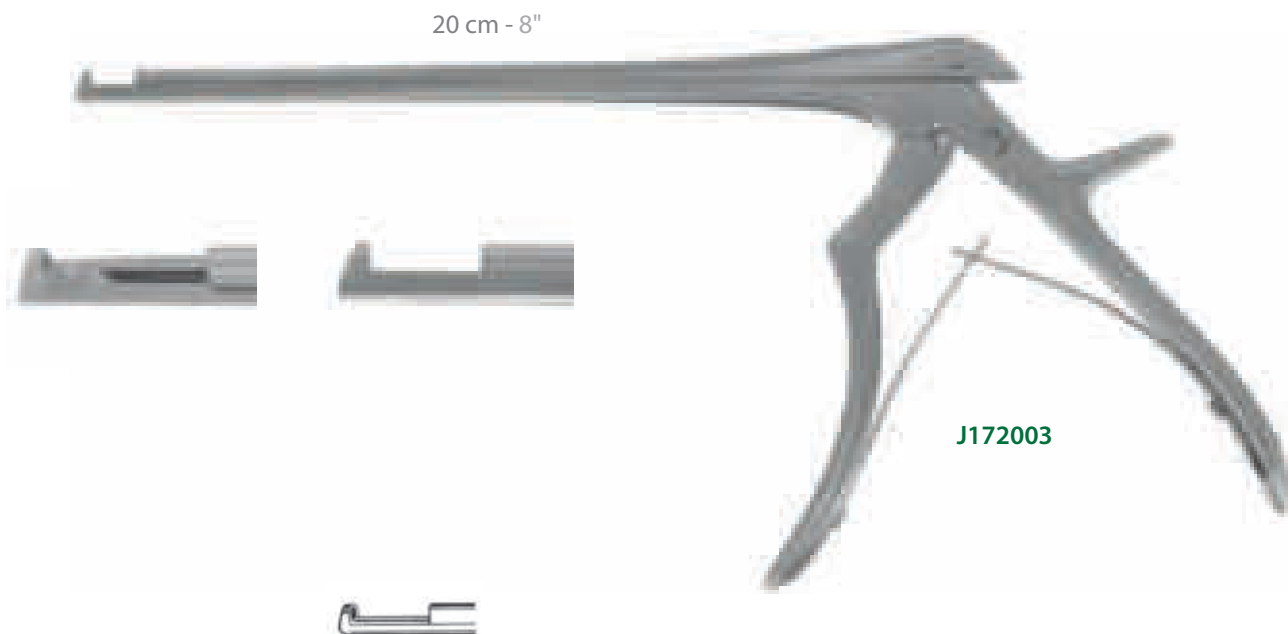

### 90° Haut / 90° Upward / 90° Arriba

Largeur de mors Width of jaw Anchura de boca	Longueur tige Shaft length - Largo del tallo		
	18 cm - 7"	20 cm - 8"	28 cm - 11"
1 mm	J170940	J172001	-
2 mm	J17095	J172002	-
3 mm	J17100	J172003	J172803
4 mm	J17110	J172004	J172804
5 mm	J17115	J172005	J172805



### 90° Bas / 90° Downward / 90° Abajo

Largeur de mors Width of jaw Anchura de boca	Longueur tige Shaft length - Largo del tallo	
	18 cm - 7"	20 cm - 8"
1 mm	J171821	J172021
2 mm	J171822	J172022
3 mm	J171823	J172023
4 mm	J171824	J172024
5 mm	J171825	J172025



### 40° Bas / 40° Downward / 40° Abajo

Largeur de mors Width of jaw Anchura de boca	Longueur tige Shaft length - Largo del tallo	
	18 cm - 7"	23 cm - 9"
1 mm	J171831	-
2 mm	J171832	-
3 mm	J171833	J172333
4 mm	J171834	J172334
5 mm	J171835	J172335

## FERRIS SMITH KERRISSON

Avec éjecteur - With ejector - Con Eyector

20 cm - 8"



J172015E

### 40° Haut / 40° Upward / 40° Arriba

Largeur de mors Width of jaw Anchura de boca	Longueur tige Shaft length - Largo del tallo	
	18 cm - 7"	20 cm - 8"
1 mm	J171170E	J172011E
2 mm	J17118E	J172012E
3 mm	J17120E	J172013E
4 mm	J17130E	J172014E
5 mm	J17140E	J172015E 
6 mm	-	J172016E



### 40° Haut talon fin / 40° Upward thin foot plate / 40° Arriba talón fino

Largeur de mors Width of jaw Anchura de boca	Longueur tige Shaft length - Largo del tallo	
	18 cm - 7"	20 cm - 8"
1 mm	J171170ET	J172011ET
2 mm	J171180ET	J172012ET
3 mm	J171200ET	J172013ET
4 mm	J171300ET	J172014ET
5 mm	J171400ET	J172015ET
6 mm	-	J172016ET



### 40° Bas talon fin / 40° Downward thin foot plate / 40° Abajo talón fino

Largeur de mors Width of jaw Anchura de boca	Longueur tige Shaft length - Largo del tallo	
	18 cm - 7"	20 cm - 8"
1 mm	J171831ET	-
2 mm	J171832ET	-
3 mm	J171833ET	J172333ET
4 mm	J171834ET	J172334ET
5 mm	J171835ET	J172335ET

**E** : Ejecteur - Ejector - Eyector  
**T** : Talon fin - Thin footplate - Talón fino

## FERRIS SMITH KERRISSON

Revêtement céramique noir - Black ceramic coating - Revestimiento de ceramica negro

20 cm - 8"



J172012TB

### 90° Haut / 90° Upward / 90° Arriba

Largeur de mors  
Width of jaw  
Anchura de boca

Longueur tige  
Shaft length - Largo del tallo

	18 cm - 7"	20 cm - 8"
1 mm	J170940B	-
2 mm	J17095B	-
3 mm	J17100B	J172003B
4 mm	J17110B	J172004B
5 mm	J17115B	J172005B

### 40° Haut / 40° Upward / 40° Arriba

Largeur de mors  
Width of jaw  
Anchura de boca

Longueur tige  
Shaft length - Largo del tallo

	18 cm - 7"	20 cm - 8"	25 cm - 10"
1 mm	J171170B	J172011B	-
2 mm	J17118B	J172012B	J172512B
3 mm	J17120B	J172013B	J172513B
4 mm	J17130B	J172014B	J172514B
5 mm	J17140B	J172015B	J172515B

### 40° Haut talon fin / 40° Upward thin foot plate 40° Arriba talón fino

Largeur de mors  
Width of jaw  
Anchura de boca

Longueur tige  
Shaft length - Largo del tallo

	18 cm - 7"	20 cm - 8"	25 cm - 10"
1 mm	J171170TB	J172011TB	-
2 mm	J171180TB	J172012TB	J172512TB
3 mm	J171200TB	J172013TB	J172513TB
4 mm	J171300TB	J172014TB	J172514TB
5 mm	J171400TB	J172015TB	J172515TB

**T** : Talon fin - Thin footplate - Talón fino

**B** : Revêtement céramique noir - Black ceramic coating - Revestimiento de ceramica negro

## FERRIS SMITH KERRISSON

Démontable - Detachable - Desmontable

20 cm - 8"

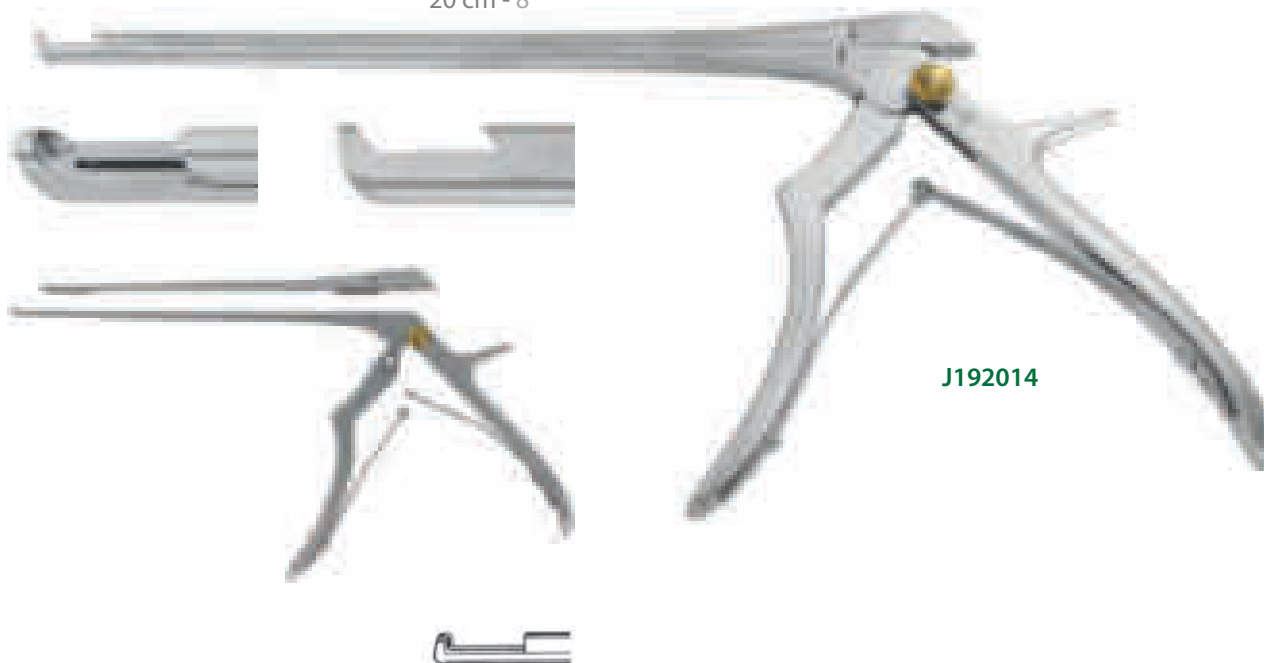

### 90° Haut / 90° Upward / 90° Arriba

Largeur de mors Width of jaw Anchura de boca	Longueur tige Shaft length - Largo del tallo	
	18 cm - 7"	20 cm - 8"
1 mm	J191801	-
2 mm	J191802	-
3 mm	J191803	J192003
4 mm	J191804	J192004
5 mm	J191805	J192005



### 40° Haut / 40° Upward / 40° Arriba

Largeur de mors Width of jaw Anchura de boca	Longueur tige Shaft length - Largo del tallo	
	18 cm - 7"	20 cm - 8"
1 mm	J191811	-
2 mm	J191812	-
3 mm	J191813	J192013
4 mm	J191814	J192014
5 mm	J191815	J192015



## FERRIS SMITH KERRISSON

Démontable - Detachable - Desmontable  
Avec éjecteur - With ejector - Con Eyector



J201813E

### 40° Haut / 40° Upward / 40° Arriba

Largeur de mors Width of jaw Anchura de boca	Longueur tige Shaft length - Largo del tallo			
	18 cm - 7"	20 cm - 8"	23 cm - 9"	28 cm - 11"
1 mm	J201811E	J202011E	J202311E	J202811E
2 mm	J201812E	J202012E	J202312E	J202812E
3 mm	J201813E	J202013E	J202313E	J202813E
4 mm	J201814E	J202014E	J202314E	J202814E
5 mm	J201815E	J202015E	J202315E	J202815E
6 mm	-	J202016E	-	-

### 90° Haut / 90° Upward / 40° Arriba

Largeur de mors Width of jaw Anchura de boca	Tige Shaft - Tallo
	18 cm - 7"
1 mm	J201831E
2 mm	J201832E
3 mm	J201833E
4 mm	J201834E
5 mm	J201835E

### 40° Haut talon fin / 40° Upward thin foot plate 40° Arriba talón fino

Largeur de mors Width of jaw Anchura de boca	Longueur tige Shaft length - Largo del tallo		
	18 cm - 7"	20 cm - 8"	23 cm - 9"
1 mm	J201811ET	J202011ET	-
2 mm	J201812ET	J202012ET	J202312ET
3 mm	J201813ET	J202013ET	J202313ET
4 mm	J201814ET	J202014ET	J202314ET
5 mm	J201815ET	J202015ET	J202315ET

### 40° Bas / 40° Downward / 40° Abajo

Largeur de mors Width of jaw Anchura de boca	Longueur tige Shaft length - Largo del tallo	
	18 cm - 7"	23 cm - 9"
1 mm	-	-
2 mm	-	-
3 mm	J201823E	J202323E
4 mm	J201824E	J202324E
5 mm	J201825E	J202325E

**E**: Ejecteur - Ejector - Eyector  
**T**: Talon fin - Thin footplate - Talón fino

## FERRIS SMITH KERRISSON

Démontable - Detachable - Desmontable  
 Avec éjecteur - With ejector - Con Eyector  
 Revêtement céramique noir - Black ceramic coating - Revestimiento de ceramica negro



### 40° Haut / 40° Upward / 40° Arriba

Largeur de mors Width of jaw Anchura de boca	Longueur tige Shaft length - Largo del tallo			
	18 cm - 7"	20 cm - 8"	23 cm - 9"	28 cm - 11"
1 mm	J201811EB	J202011EB	J202311EB	J202811EB
2 mm	J201812EB	J202012EB	J202312EB	J202812EB
3 mm	J201813EB	J202013EB	J202313EB	J202813EB
4 mm	J201814EB	J202014EB	J202314EB	J202814EB
5 mm	J201815EB	J202015EB	J202315EB	J202815EB
6 mm	-	J202016EB	-	-



### 40° Haut talon fin / 40° Upward thin foot plate 40° Arriba talón fino

Largeur de mors Width of jaw Anchura de boca	Longueur tige Shaft length - Largo del tallo		
	18 cm - 7"	20 cm - 8"	23 cm - 9"
1 mm	J201811ETB	J202011ETB	-
2 mm	J201812ETB	J202012ETB	J202312ETB
3 mm	J201813ETB	J202013ETB	J202313ETB
4 mm	J201814ETB	J202014ETB	J202314ETB
5 mm	J201815ETB	J202015ETB	J202315ETB

**E**: Ejecteur - Ejector - Eyector  
**T**: Talon fin - Thin footplate - Talón fino  
**B**: Revêtement céramique noir - Black ceramic coating - Revestimiento de ceramica negro

## O.R.L. ouvre-bouche - E.N.T. mouth gag - O.R.L. abre-boca

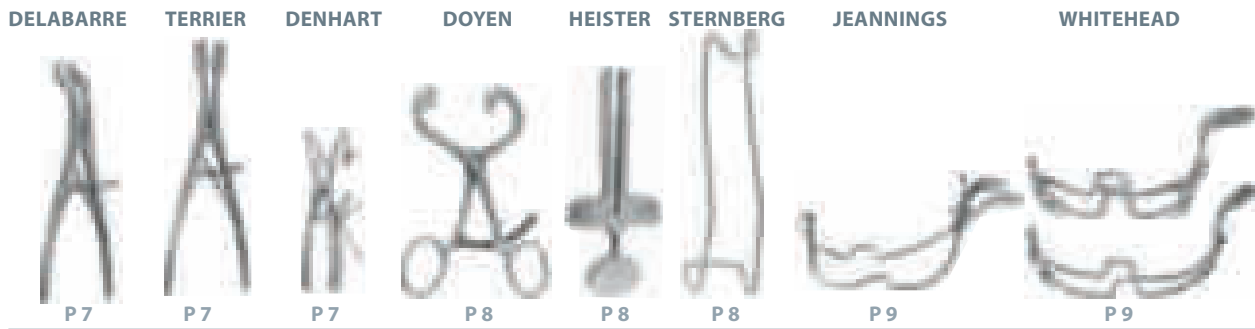

## O.R.L. dilatateurs - E.N.T. dilators - O.R.L. dilatadores



## O.R.L. pinces à préhension - E.N.T. grasping forceps - O.R.L. pinzas a presión

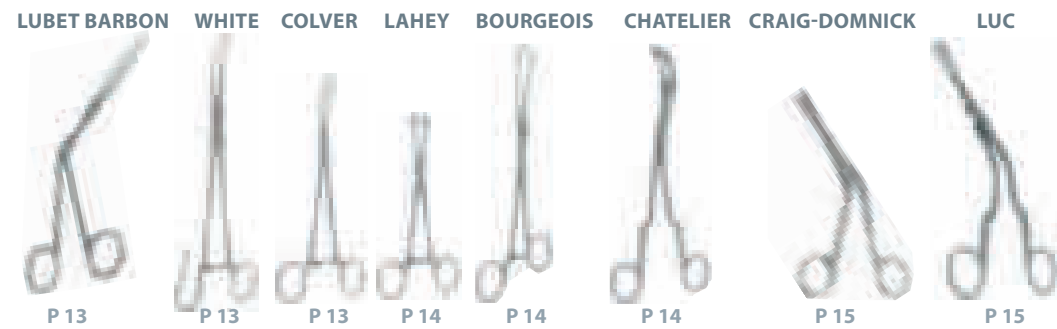

## O.R.L. speculums - E.N.T. specula - O.R.L. espéculos

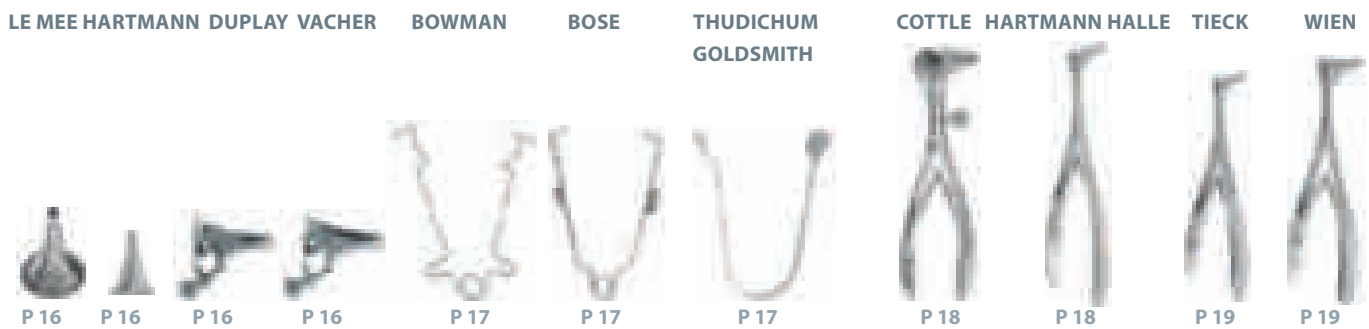

## O.R.L. Serre-noeuds - E.N.T. snares - O.R.L. cierra nudos

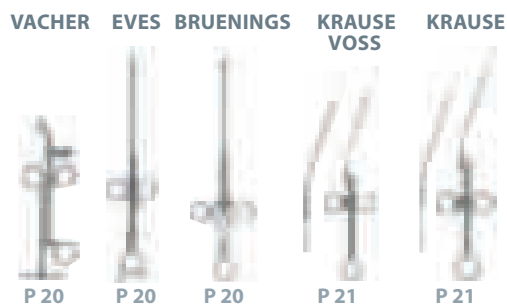

## O.R.L. aiguilles à paracentèse - E.N.T. paracentesis needles - O.R.L. agujas para paracentesis

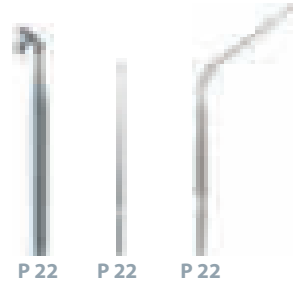

## O.R.L. couteaux à végétations - E.N.T. adenoids knives - O.R.L. cuchillos para vegetaciones

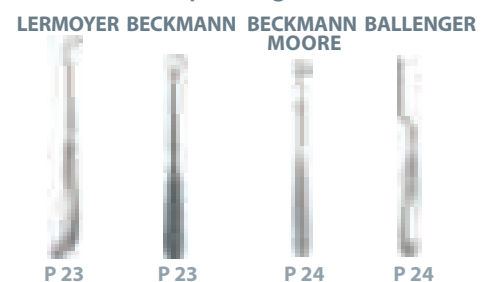



O.R.L. couteaux spatules - E.N.T. knives spatula - O.R.L. bistouris espátulas

O.R.L. amygdalotome - E.N.T. tonsillotome - O.R.L. amigdalotomo

KOCHER RUAULT ABRAHAM

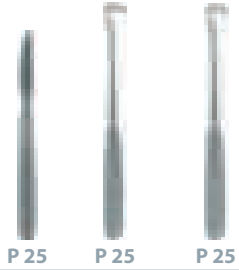

P 25 P 25 P 25

SLUDDER-BALLENGER

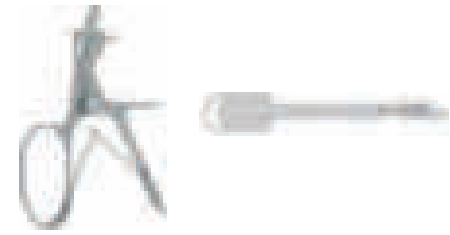

P 26 P 26

O.R.L. emporte pièces - E.N.T. punch forceps - O.R.L. sacabocados

KERRISSON CITELLI TAKAHASHI HARTMANN STRUYCKEN HAJEK GRUENWALD-HENKE JANSEN



P 27 P 27 P 28 P 28 P 28 P 28 P 28 P 28 P 29 P 29

O.R.L. pinces à polypes - E.N.T. polypus forceps - O.R.L. pinzas para pólipos

O.R.L. pinces pour oreilles - E.N.T. ear forceps - O.R.L. pinzas para orejas

HARTMANN HARTMANN CITELLI HARTMANN HARTMANN HARTMANN WEINGARTNER



P 30 P 30 P 30 P 31 P 31 P 31

O.R.L. pinces pour oreilles - E.N.T. ear forceps - O.R.L. pinzas para orejas

O.R.L. micro instruments - E.N.T. micro instruments - O.R.L. micro instrumentos

BUCK QUIRE HARTMANN

BELLUCI



P 32 P 32 P 32 P 33 P 33

O.R.L. pinces et cisaille - E.N.T. forceps and shear - O.R.L. pinzas y cizalla

MOORE ASCH RUBIN



P 34 P 34 P 34

O.R.L. pinces à repositionner - E.N.T. reposition forceps - O.R.L. pinzas para reposicionar

O.R.L. pinces pour oesophagoscopie - E.N.T. forceps for oesophagoscopy - O.R.L. pinzas para esofagoscopia

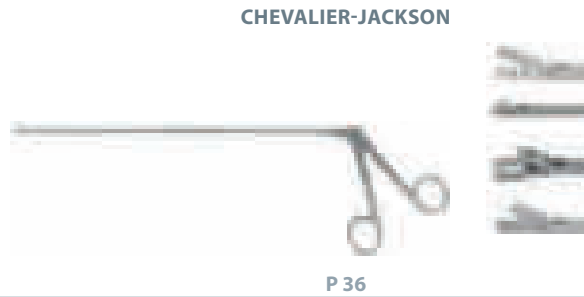
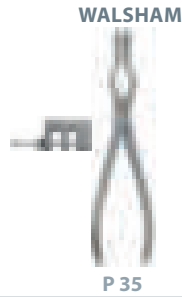
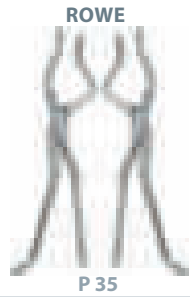

O.R.L. burins et gouges - E.N.T. chisels and gouges - O.R.L. cincelos y gubias O.R.L. ostéotomes - E.N.T. osteotome - O.R.L. osteotomos

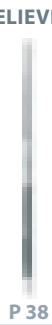
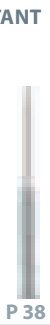
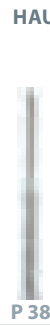
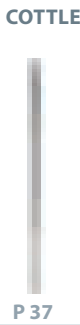
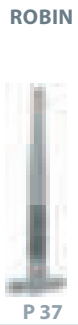

O.R.L. gouges - E.N.T. gouges - O.R.L. gubias

O.R.L. rugines - E.N.T. raspatories - O.R.L. raspadores

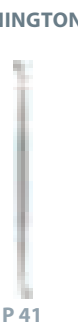
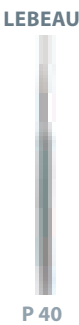
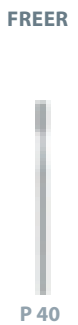

O.R.L. râpes - E.N.T. rasps - O.R.L. raspas

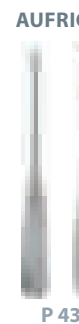
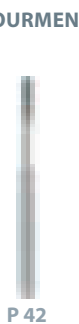
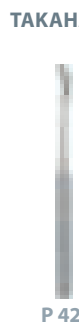

O.R.L. crochets - E.N.T. hooks - O.R.L. ganchos

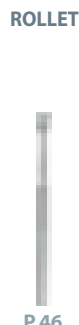
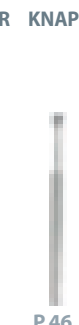

O.R.L. écarteurs - E.N.T. retractors - O.R.L. separadores



O.R.L. écarteurs et crochets - E.N.T. retractors and hooks - O.R.L. separadores y ganchos

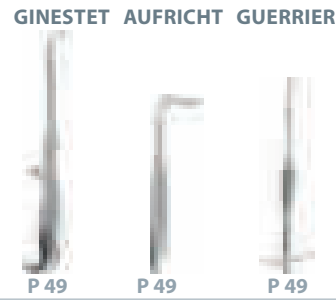

O.R.L. éleveurs - E.N.T. elevator - O.R.L. elevadores

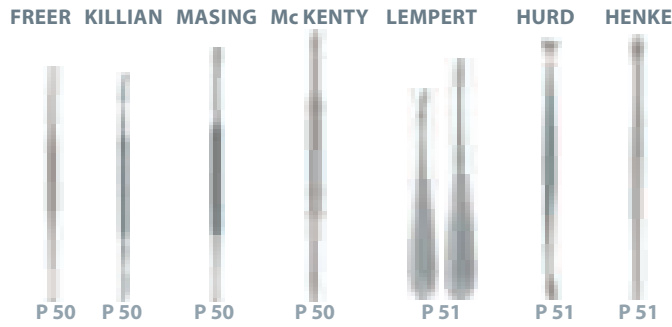

O.R.L. Instruments de Joseph - E.N.T. Joseph's instruments - O.R.L. Instrumentos de Joseph

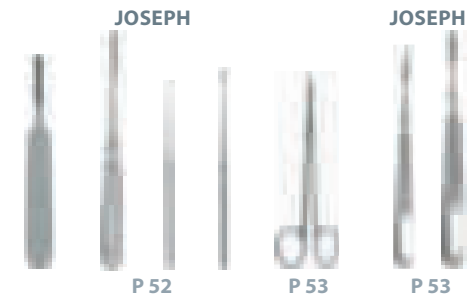

O.R.L. maillets et curettes - E.N.T. mallets and curettes - O.R.L. mazos y curetas

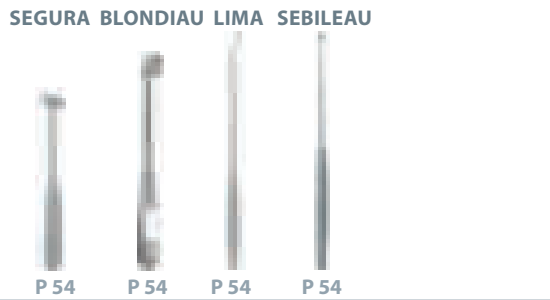

O.R.L. curettes - E.N.T. curettes - O.R.L. mazos y curetas

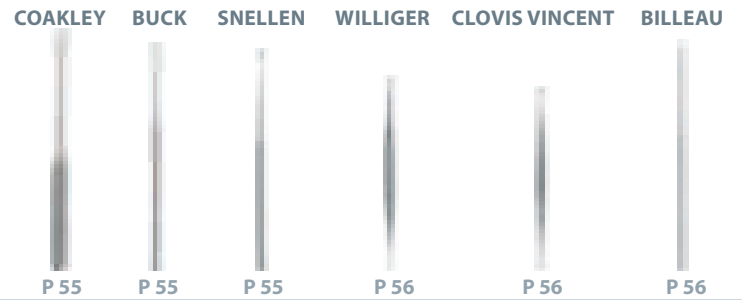

O.R.L. canules aspiratrices - E.N.T. suction tubes - O.R.L. canulas aspirantes

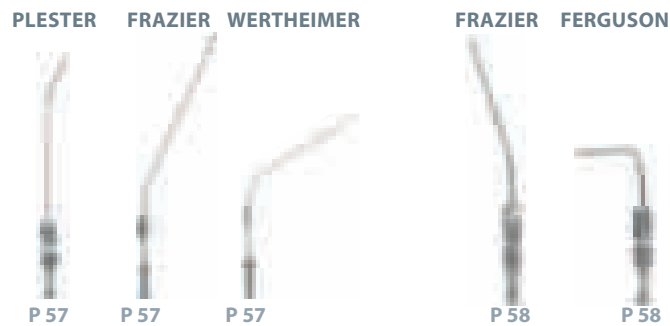

O.R.L. diapason - E.N.T. tuning forks - O.R.L. diapasones

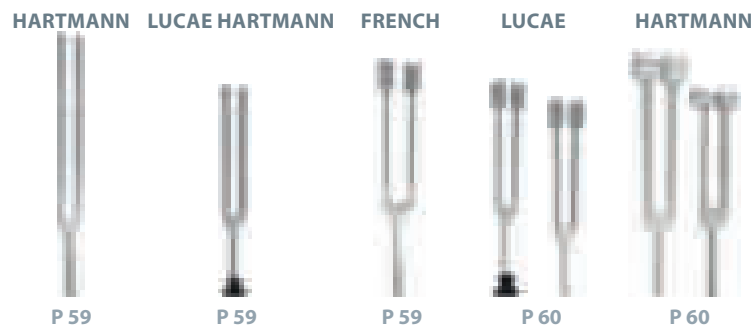

**Pinces à dissection ORL - ENT dissecting forceps - Pinzas para disección ORL**

II - Dissection  
II - Dissecting  
II - Disección

TROELTSCH

POLITZER

LUCAE

JANSEN LUCAE



P 38



P 39



P 40



P 40

**Ciseaux ORL - ENT scissors - Tijeras ORL**

III - Ciseaux  
III - Scissors  
III - Tijeras

JOSEPH

FOMON

HALLE

FOMON

COTTLE

HEYMANN

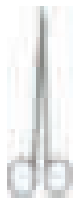

P 83



P 83



P 83



P 84



P 84



P 84



## DELABARRE

## TERRIER

## DENHART

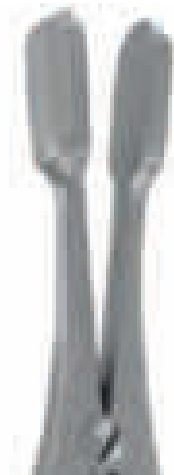

Mors droits  
Straight jaws  
Bocas rectas

**I05020**

21 cm - 8 1/4 "



Mors coudés  
Angled jaws  
Bocas anguladas

**I05010**

20 cm - 8 "



**I05030**

19 cm - 7 1/2 "



**I050410**

12 cm - 4 3/4 "



DOYEN

HEISTER

STERNBERG



Enfants  
Children  
Niños

I05050

11 cm - 4 3/8 "



Adultes  
Adults  
Adultos

I05060



12 cm - 4 3/4 "



I05120

13 cm - 5 "



I05060

12 cm - 4 3/4 "

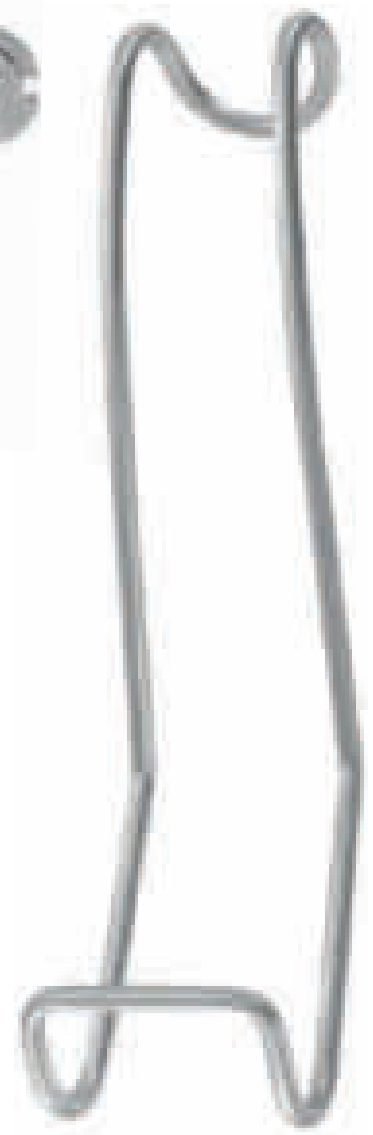

I051210

14 cm - 5 1/2 "



## JEANNINGS

9 cm - 3 1/2" **I050690**

11 cm - 4 1/4" **I05070**

13 cm - 5" **I05080**

15 cm - 6" **I050810** 



**I050810**  
15 cm - 6"

## WHITEHEAD

Avec abaisse langue  
With tongue depressor  
Con depresor de lengua



**I052130**  
13 cm - 5"



11 cm - 4 1/4" **I052100**

13 cm - 5" **I052110** 

15 cm - 6" **I052120**

**I052110**  
13 cm - 5"



## DAVIS-BOYLE



Seul  
Only  
Solo

**I051320**

Protections translucides seules (paire)  
Translucent protection only (pair)  
Protección translúcida sólo (par)

**I051310**

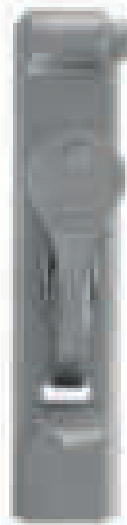

Complet avec 5 valves  
Complete with 5 blades  
Completo con 5 valvulas

**I05130**

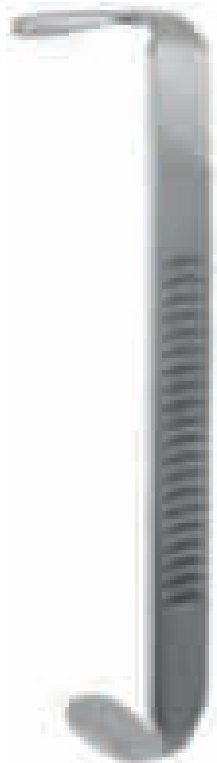

**I051325**  
20 x 35 mm

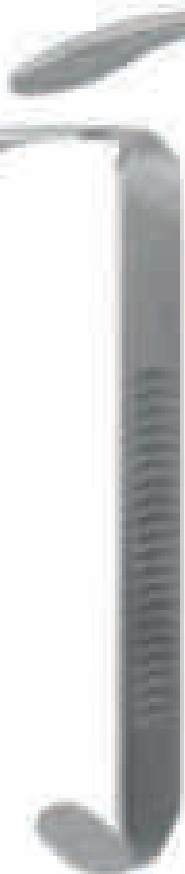

**I051326**  
23 x 70 mm



**I051327**  
24 x 80 mm

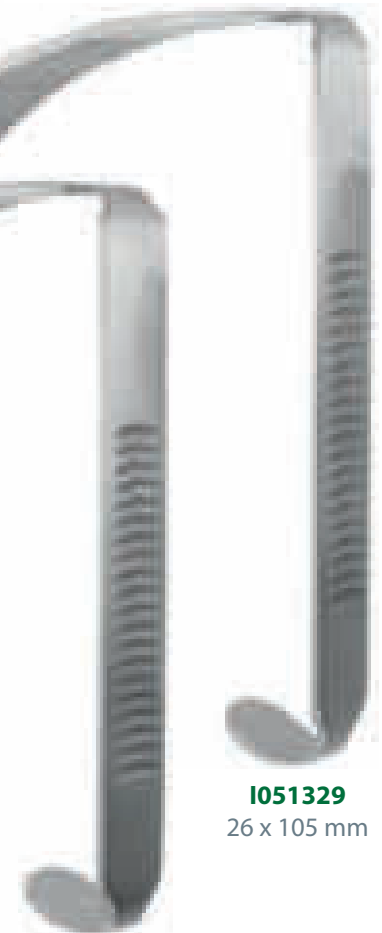

**I051328**  
25 x 90 mm

**I051329**  
26 x 105 mm

## KILNER-DOUGHTY



**I051410**



**I051415**  
28 x 65 mm

**I051416**  
32 x 75 mm

**I051417**  
37 x 80 mm

**I051418**  
41 x 94 mm

**I051419**  
46 x 103 mm

## DINGMANN

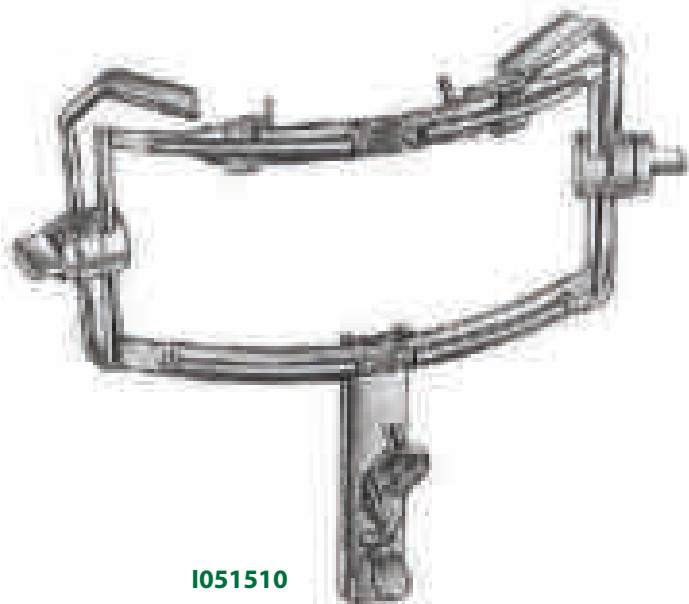

**I051510**



**I051515**  
24 x 62 mm

**I051516**  
28 x 65 mm

**I051517**  
31 x 75 mm

## LABORDE

12 cm - 4 3/4 "

**I10010**

15 cm - 6 "

**I10015**



## TROUSSEAU

2 branches  
2 mors  
2 bocas

**I10020**

12 cm - 4 3/4 "

## ABOULKER

Enfants  
Childrens  
Niños

18 cm - 7 "

**I10022**

8 mm

Adultes  
Adults  
Adultos

18 cm - 7 "

**I10024**

10 mm



3 branches  
3 mors  
3 bocas

**I10015**

15 cm - 6 "

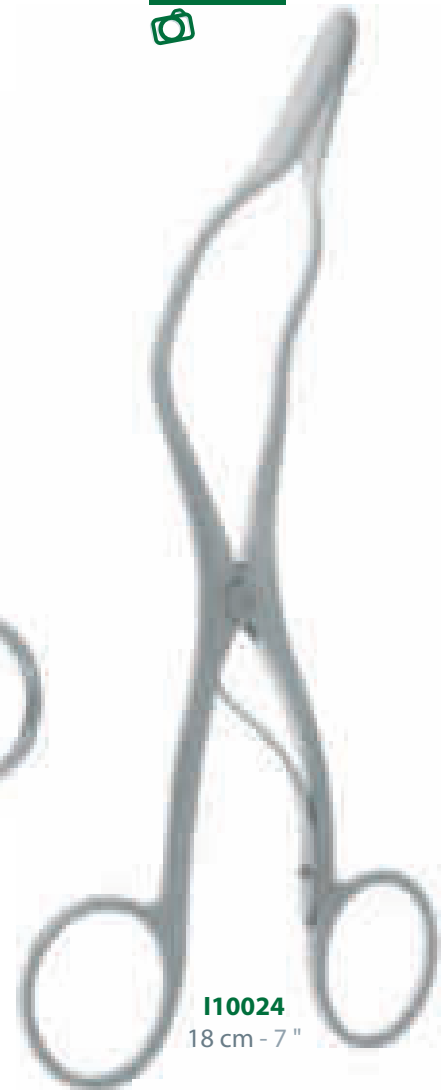

## UCKERMANN

ø 10 mm



1/1

**I100300**

13 cm - 5 "



4/5

# LANDANGER

O.R.L. pinces à préhension - E.N.T. grasping forceps - O.R.L. pinzas a presión

## LUBET BARBON

## WHITE

## COLVER

Sans griffes    A griffes  
Without teeth   With teeth  
Sin dientes    Con dientes

21 cm - 8 1/4"



I15080

I15070

18 cm - 7"

I150810

23 cm - 9"

I150815



XII - O.R.L.  
XII - E.N.T.  
XII - O.R.L.

## LAHEY

A goitre  
For goiter  
Para gocio

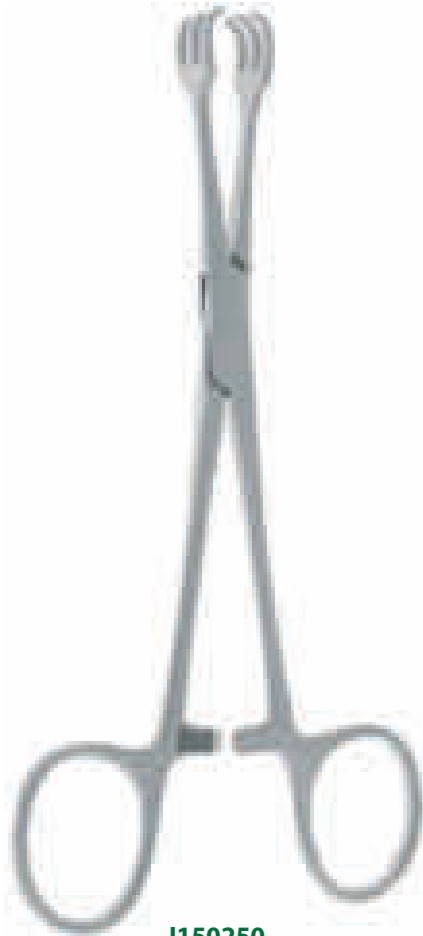

**I150250**  
15 cm - 6"

## BOURGEOIS

Anneaux décalés  
Displaced ring  
Anillos decalados



**I15030**  
21 cm - 8 1/4"

## CHATELIER

Enfants  
Childrens  
Niños

20 cm - 8" **I15020** 6 mm

Adultes  
Adults  
Adultos

22 cm - 8 3/4" **I15010** 10 mm

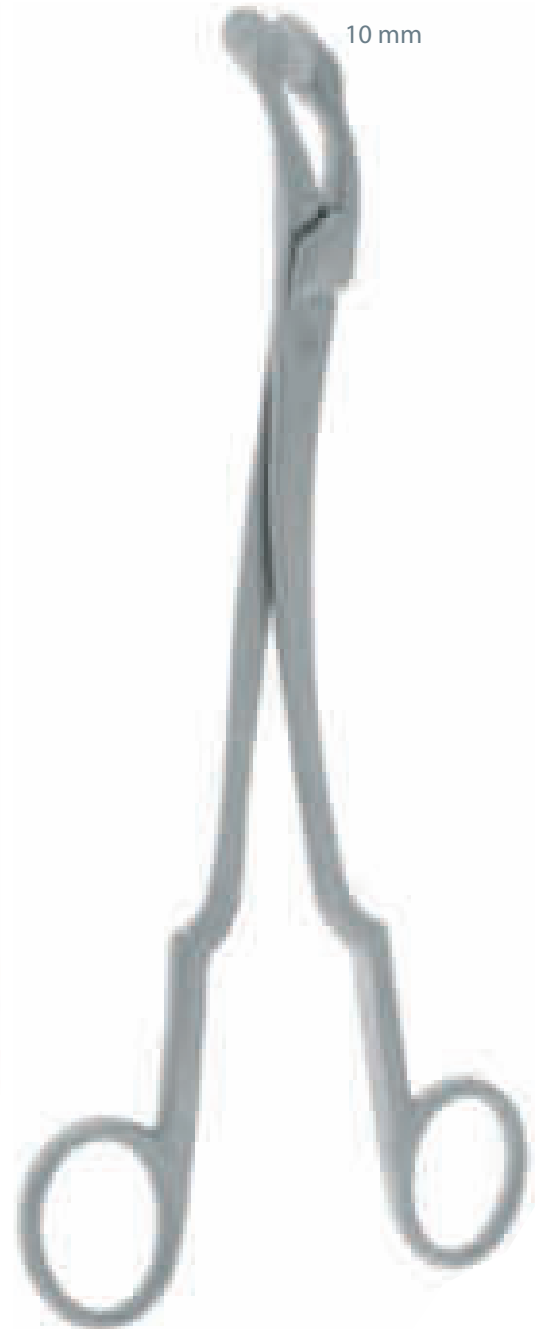

**I15010**  
22 cm - 8 3/4"

## CRAIG-DOMNICK

17,5 cm - 7" **I150310** 6 mm

17,5 cm - 7" **I150311** 6 mm



Vers le haut  
Upward  
Hacia arriba

6 mm

**I150310**



Vers le bas  
Downward  
Hacia abajo

6 mm

**I150311**



**I150311**  
17,5 cm - 7"

## LUC

Mors pleins Mors fenêtrés  
Full jaws Open work jaws  
Bocas llenas Bocas perforadas

20 cm - 8" **I15032** **I15038** 7 mm

20 cm - 8"  **I15034** **I15042** 9 mm

20 cm - 8" **I15036** **I15044** 11 mm

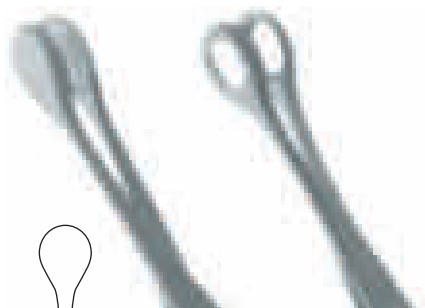

**I15042**



7 mm  
**I15032**



7 mm  
**I15038**



9 mm  
**I15034**



9 mm  
**I15042**



11 mm  
**I15036**



11 mm  
**I15044**



**I15034**  
20 cm - 8"

### LE MEE

- Ø 1 mm **I15141-0**
- Ø 2 mm **I15142-0**
- Ø 3 mm **I15145-0**
- Ø 4 mm **I15146-0** 
- Ø 5 mm **I15147-0**
- Ø 6 mm **I15148-0**

Jeu de 6  
Set of 6  
Juego de 6

**I15140-0**



**I15146-0**

### HARTMANN

- Ø 2 mm **I151382**
- Ø 3 mm **I151383**
- Ø 4 mm **I151384** 
- Ø 5,5 mm **I151385**
- Ø 6,5 mm **I151386**
- Ø 7,5 mm **I151388**

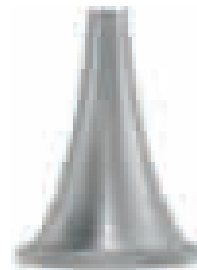

**I151384**

### DUPLAY

Adultes	Enfants
Adults	Children
Adultos	Niños

 **I15150**    **I15151**

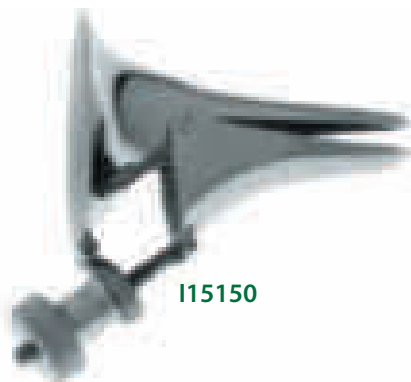

**I15150**

### VACHER

Adultes	Enfants
Adults	Children
Adultos	Niños

 **I15160**    **I15170**



**I15160**

## BOWMAN (PALMER)

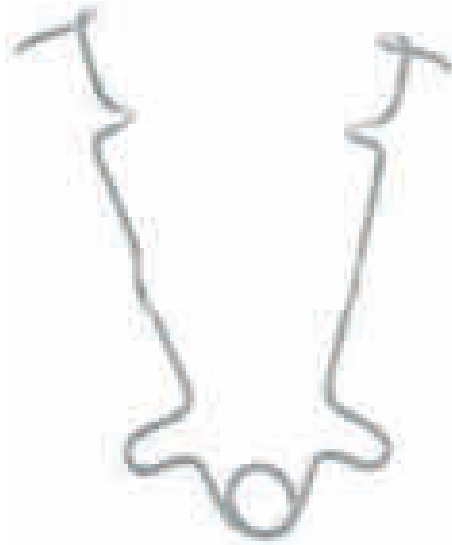

**I151305**  
7 cm - 2<sup>3/4</sup>"

## BOSE



**I151306**  
7 cm - 2<sup>3/4</sup>"

## THUDICHUM (GOLDSMITH)



**I151311**  
6,5 cm - 2<sup>1/2</sup>"

Petit  
Small  
Pequeñas

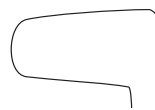

9 mm **I151310**

Moyen  
Medium  
Medianas

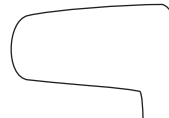

11 mm **I151311** 

Grand  
Large  
Grandes

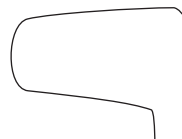

13 mm **I151312**



### COTTLE (KILLIAN)

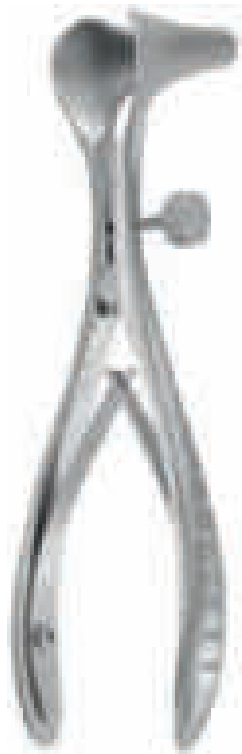

**I15175**  
14 cm - 5 1/2"

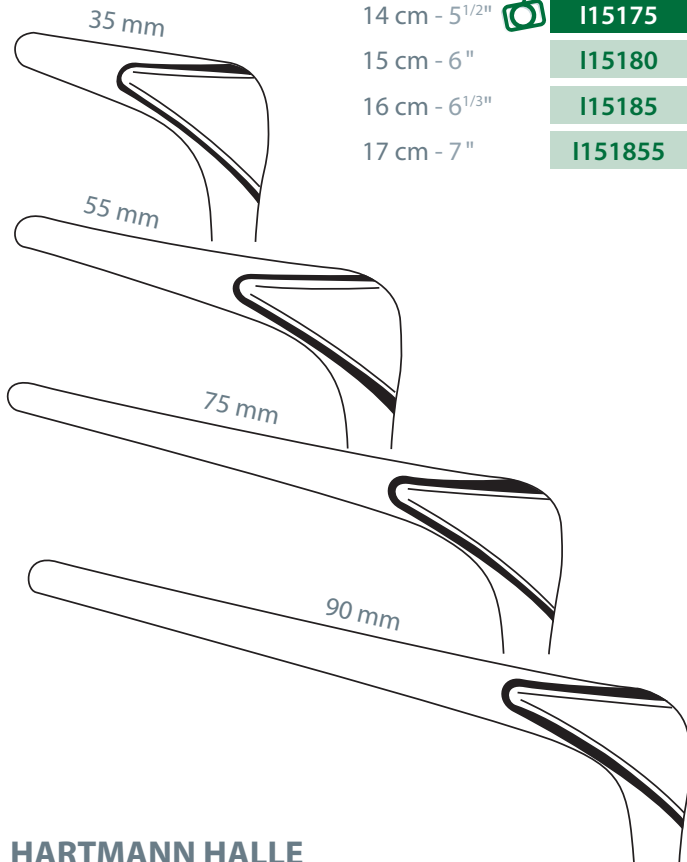

14 cm - 5 1/2"	 <b>I15175</b>	35 mm
15 cm - 6"	<b>I15180</b>	55 mm
16 cm - 6 1/3"	<b>I15185</b>	75 mm
17 cm - 7"	<b>I151855</b>	90 mm

### HARTMANN HALLE



**I151862**  
15 cm - 6"

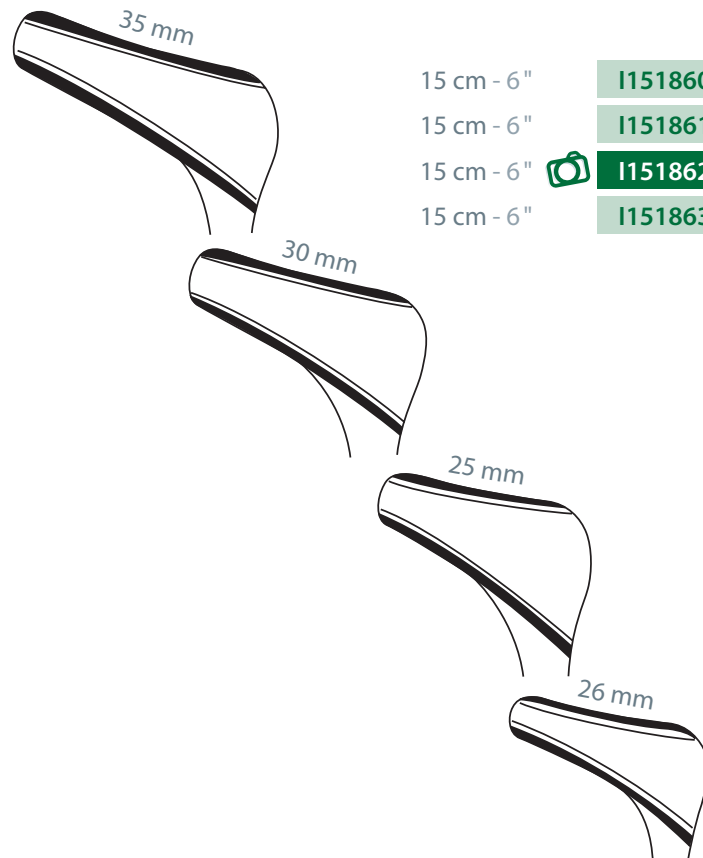

15 cm - 6"	<b>I151860</b>	26 mm
15 cm - 6"	<b>I151861</b>	25 mm
15 cm - 6"	 <b>I151862</b>	30 mm
15 cm - 6"	<b>I151863</b>	35 mm

### TIECK

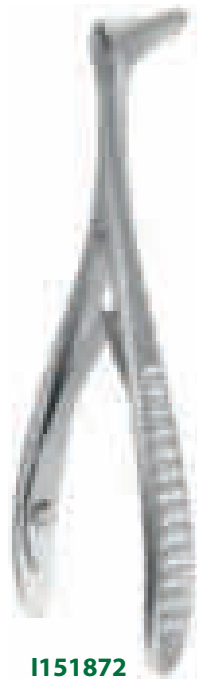

**I151872**  
13 cm - 5"



**I151871**



**I151872**

	Enfants Children Niños	Nourrissons Infants Niños de pecho
13 cm - 5"	<b>I151872</b> 22 mm	<b>I151871</b> 17 mm

### WIEN



**I151882**  
13 cm - 5 1/4"

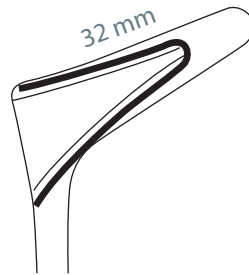

**I151883**

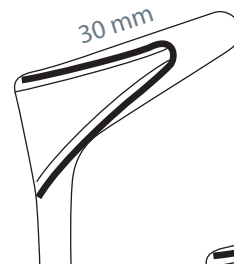

**I151882**



**I151881**

13 cm - 5 1/4"	<b>I151881</b>	28 mm
13 cm - 5 1/4"	<b>I151882</b>	30 mm
13 cm - 5 1/4"	<b>I151883</b>	32 mm

### VACHER

### EVES

### BRUENINGS

Canule seule  
Cannula only  
Canula sóla

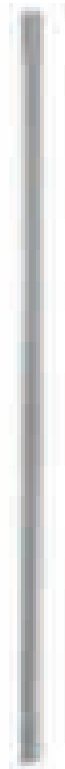

**I15200**

Complet avec canule  
Complete with cannula  
Completo con canula

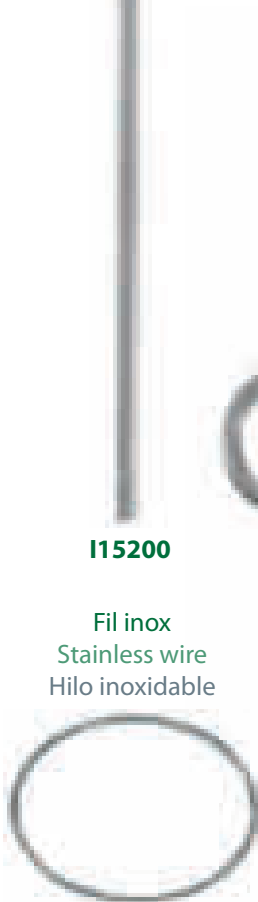

Fil inox  
Stainless wire  
Hilo inoxidable

**I152003**

Ø 0,3 mm - L : 10 m

**I152004**

Ø 0,4 mm - L : 10 m



**I15190**

22,5 cm - 32 cm - 8<sup>4</sup>/<sub>5</sub>" - 12<sup>1</sup>/<sub>2</sub>"



**I152090**

28 cm - 11"



**I152092**

28 cm - 11"

### KRAUSE-VOSS

### KRAUSE

Complet avec canule - Complete with cannula - Completo con canula

18 cm - 7 1/4"

**I152110**

18 cm - 7 1/4"

**I152115**

26 cm - 10 1/4"

**I152100**



26 cm - 10 1/4"

**I152105**



Verticale  
Vertikal  
Vertical

Horizontale  
Horizontal  
Horizontal

Canule seule  
Snare tube only  
Canula sóla

Canule seule  
Snare tube only  
Canula sóla

**I152101**

**I152102**

**I152106**

**I152100**  
26 cm - 10 1/4"

**I152105**  
26 cm - 10 1/4"

O.R.L. aiguilles à paracentèse - E.N.T. paracentesis needles - O.R.L. agujas e para paracentesis

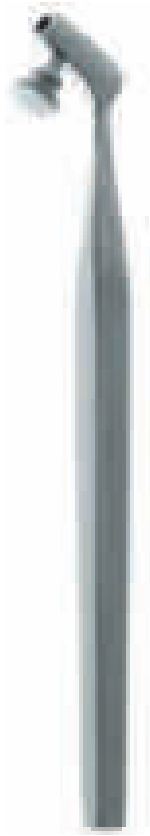

**I15240**  
11 cm - 4<sup>1/4</sup>"

Adultes  
Adults  
Adultos



**I15230**  
8 cm - 3<sup>1/4</sup>"

Enfants  
Children  
Niños



**I15232**  
8 cm - 3<sup>1/4</sup>"

Nourrissons  
Babies  
Niños de pecho



**I15234**  
8 cm - 3<sup>1/4</sup>"

CORPS ÉTRANGERS  
FOREIGN BODIES  
CUERPOS EXTRAÑOS

Droite  
Straight  
Recta

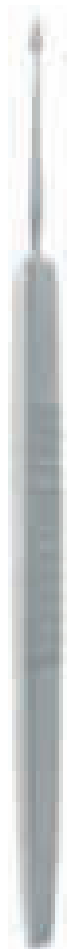

**I15250**  
13 cm - 5 "

Coudée  
Angled  
Angulada



**I15220**  
16,5 cm - 6<sup>1/2</sup> "

## LERMOYER

23 cm - 9"

10 mm	I15340
14 mm	I15342
16 mm	I15344 
20 mm	I15346

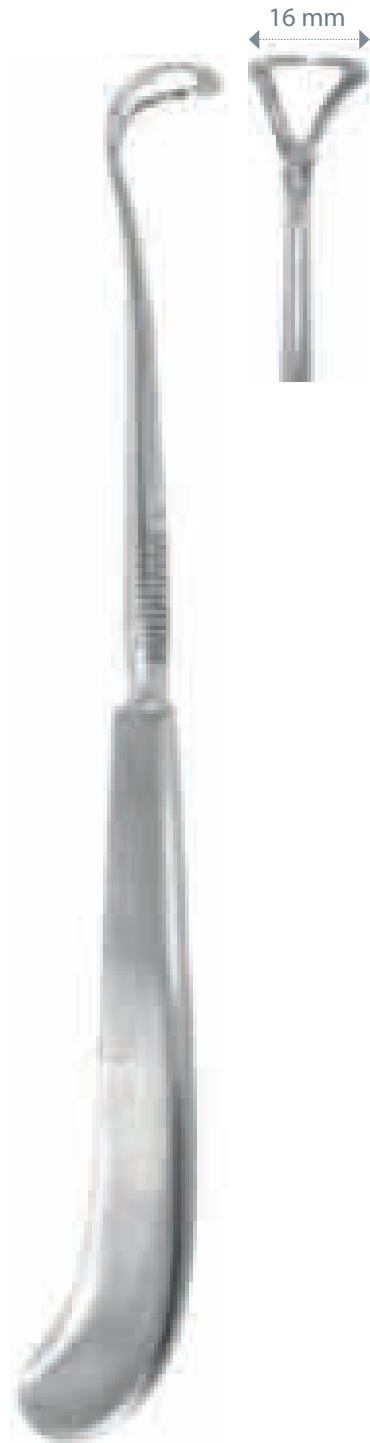

**I15344**  
23 cm - 9"

## BECKMANN

21 cm - 8 1/4"

12 mm	I15348
14 mm	I15350 
16 mm	I15360
18 mm	I15370

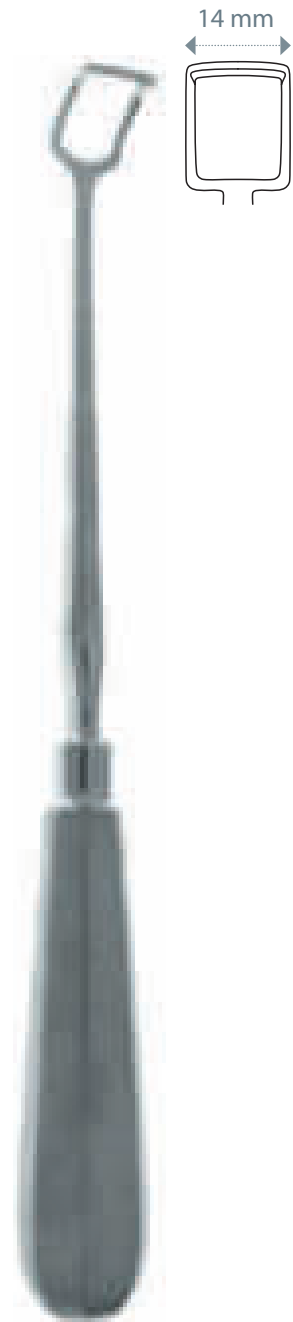

**I15350**  
21 cm - 8 1/4"

## BECKMANN (MOORE)

Avec panier With basket Con cesto		Sans panier Without basket Sin cesto
-	8 mm	I153978
I153990	10 mm	I153980
I153991	11 mm	I153981
 I153992	12 mm	I153982 
I153993	13 mm	I153983
I153995	15 mm	I153985
I153996	16 mm	I153986



I153992  
21,5 cm - 8 1/4"

I153982  
21,5 cm - 8 1/4"

## BALLENGER

 I154903	3 mm	I154913
 I154904	4 mm	I154914 

Droits  
Straight  
Rectas

Coudés  
Angled  
Angulada



I154904  
20 cm - 8"

I154914  
20 cm - 8"

## KOCHER

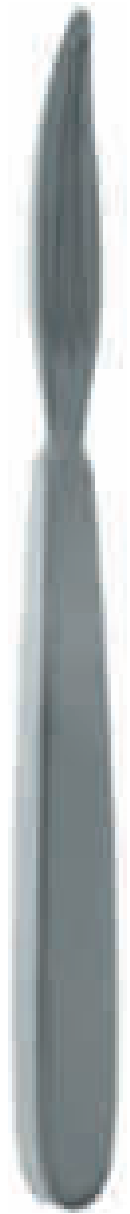

**I15330**  
16 cm - 6 1/4 "

## RUAULT



**I15495**  
22 cm - 8 3/4 "



**I15500**  
22 cm - 8 3/4 "

Boutonnée  
With tip  
Abotonado

## ABRAHAM

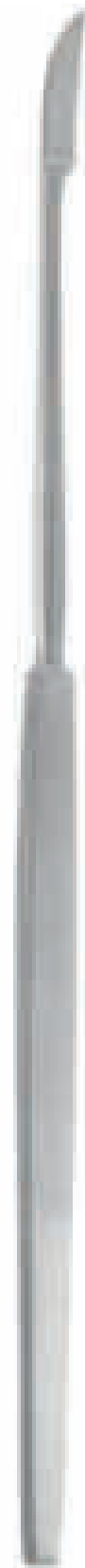

**I155010**  
22 cm - 8 3/4 "

Courbe  
Curved  
Curva



## SLUDDER-BALLENGER

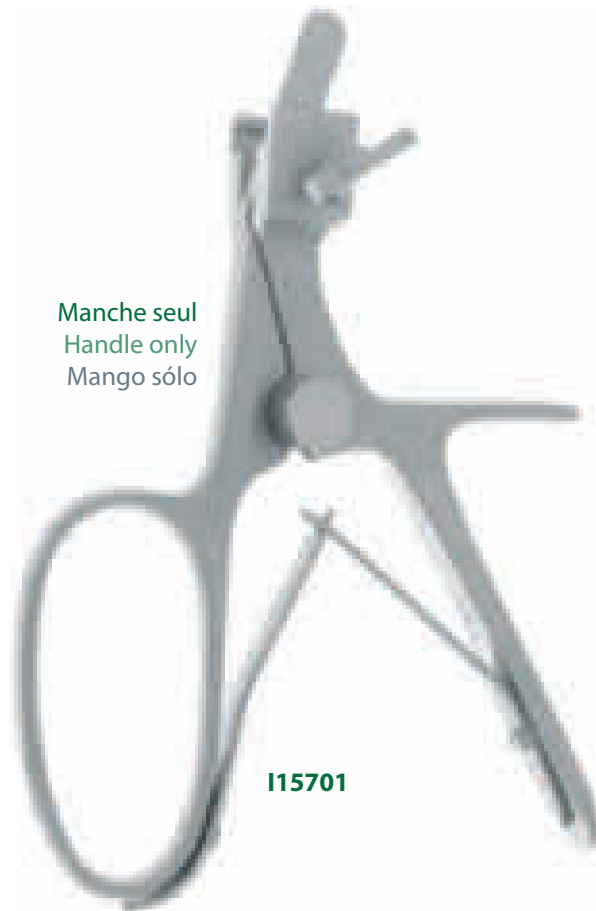

Manche seul  
Handle only  
Mango sólo

**I15701**

Lames seules  
Blades only  
Hojas sólo

N° 1 - 20 mm **I15703**

N° 2 - 24 mm **I15704**

N° 3 - 27 mm **I15705** 



**I15705**  
N° 3 - 27 mm

# LANDANGER

O.R.L. emporte pièces - E.N.T. punch forceps - O.R.L. sacabocados

## KERRISSON

- 4 mm **I16010** 
- 5 mm **I16015**
- 6 mm **I16020**



## CITELLI

- 2 mm **I160440**
- 3 mm **I16045** 



XII - O.R.L.  
XII - E.N.T.  
XII - O.R.L.

## TAKAHASHI

Droite  
Straight  
Recta

Coudée vers le haut  
Angled upward  
Angulada arriba

12 cm - 4 3/4"

**I160250**

3 x 10 mm

**I160260**



17 cm - 6 3/4"

**I160255**

3 x 10 mm



**I160250**

12 cm - 4 3/4"

**I160260**

## HARTMANN

12 cm - 4 3/4"

**I16055**

5 mm

12 cm - 4 3/4"

**I160570**

7 mm

12 cm - 4 3/4"

**I16060**

9 mm

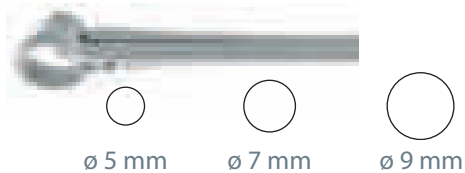

ø 5 mm

ø 7 mm

ø 9 mm

## STRUYCKEN

12 cm - 4 3/4"

**I160610**

1,2 x 19 mm



1,2 x 19 mm

## GRUENWALD-HENKE

12 cm - 4 3/4"

**I160630**

3,0 x 11 mm

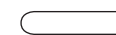

3,0 x 11 mm

## HAJEK

12 cm - 4 3/4"

**I160620**

3,5 x 14 mm



3,5 x 14 mm

## JANSEN (MIDDLETON)

5 mm

4 mm

4 articulations  
4 articulations  
4 articulaciones



**I16035**  
19 cm - 7 1/2 "



**I160360**  
19 cm - 7 1/2 "



## O.R.L. pinces à polypes - E.N.T. polypus forceps - O.R.L. pinzas para pólipos



## O.R.L. pinces pour oreilles - E.N.T. ear forceps - O.R.L. pinzas para orejas

### HARTMANN

8,5 cm - 3 1/4"

  
 Sans griffes  
 Without teeth  
 Sin dientes

8,5 cm - 3 1/4" **D03170** 

14 cm - 5 1/2" **D031900**

8,5 cm - 3 1/4"

  
 A griffes  
 With teeth  
 Con dientes

**D03170**

8,5 cm - 3 1/4" **D03180** 

14 cm - 5 1/2" **D031910**

**D03180**

### HARTMANN WEINGARTNER

8,5 cm - 3 1/4"



**D031920**

8,5 cm - 3 1/4"



## BUCK

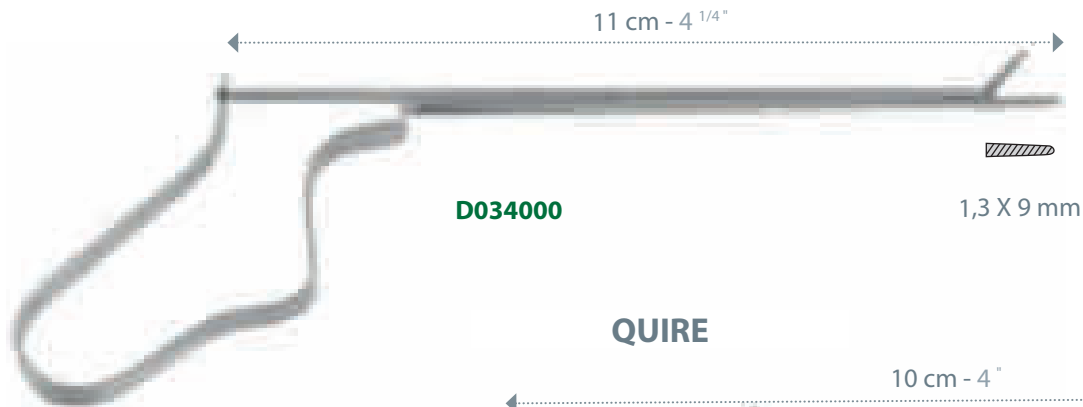

D034000

1,3 X 9 mm

## QUIRE

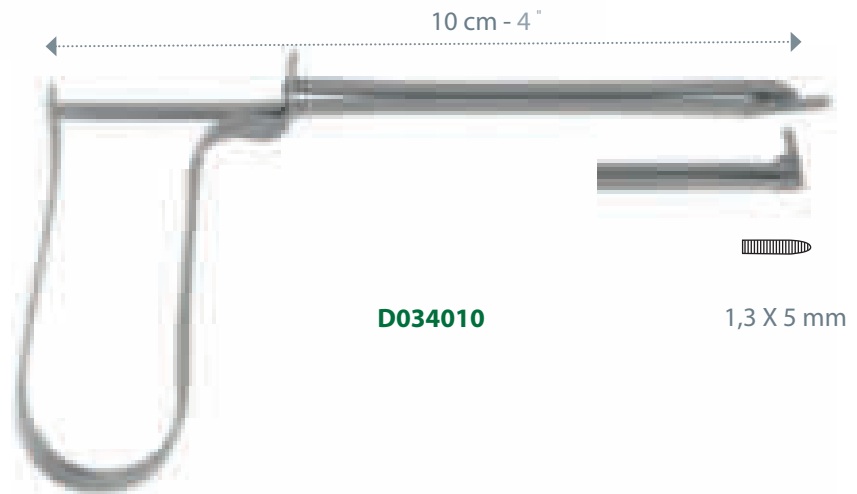

D034010

1,3 X 5 mm

## HARTMANN

- 12 cm - 4 <sup>3</sup>/<sub>4</sub> " D035000
- 14 cm - 5 <sup>1</sup>/<sub>2</sub> " D035010
- 16 cm - 6 <sup>1</sup>/<sub>4</sub> " D035020 
- 20 cm - 8 " D035030



D035020  
16 cm - 6 <sup>1</sup>/<sub>4</sub> "



8 cm - 3 1/4"



Micro-pince  
Micro-forceps  
Micro-pinzas

**D036010**

1,6 x 7,0 mm **D036010** 

0,7 x 3,5 mm **D036020**

0,8 x 4,0 mm **D036030**

0,6 x 4,0 mm **D036040**

0,4 x 4,0 mm **D036050**

**BELLUCI**

8 cm - 3 1/4"

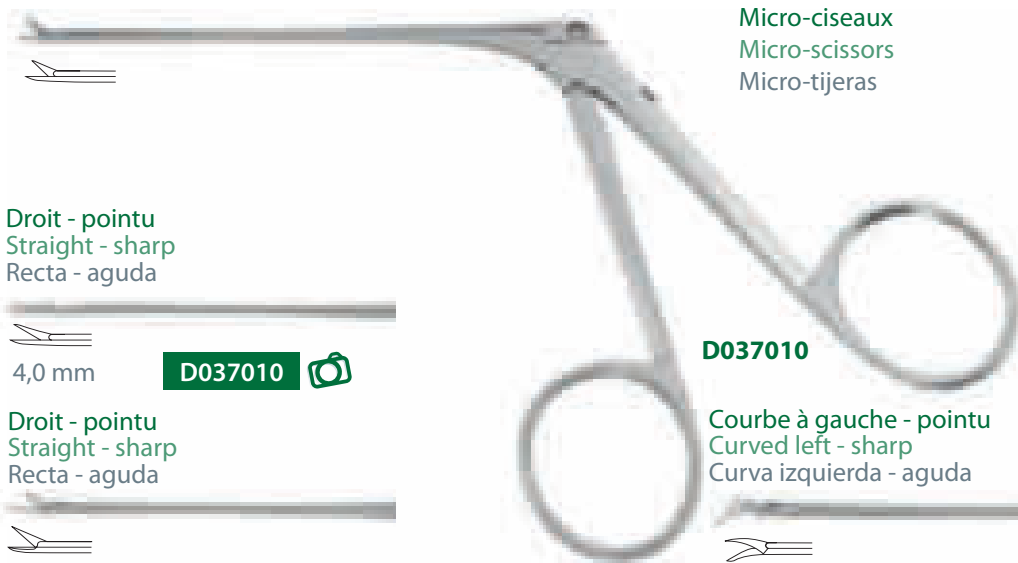

Micro-ciseaux  
Micro-scissors  
Micro-tijeras

**D037010**

Droit - pointu  
Straight - sharp  
Recta - aguda

4,0 mm **D037010** 

Droit - pointu  
Straight - sharp  
Recta - aguda

5,5 mm **D037020**

Coudé haut - pointu mousse  
Angled upward - sharp blunt  
Angulada arriba - aguda roma

5,5 mm **D037030**

Courbe à gauche - pointu  
Curved left - sharp  
Curva izquierda - aguda

5,5 mm **D037040**

Courbe à droite - pointu  
Curved right - sharp  
Curva derecha - aguda

5,5 mm **D037050**



MOORE

Cranté  
Serrated  
Serrado



**I16040**  
20 cm - 8 "

ASCH



**I160300**  
23 cm - 9 "

RUBIN



4 articulations  
4 articulations  
4 articulaciones

5 mm

**I160310**  
20 cm - 8 "

# LANDANGER

O.R.L. pinces à repositionner - E.N.T. reposition forceps - O.R.L. pinzas para reposicionar

## ROWE

Gauche  
Left  
Izquierda

**I162000**

22,5 cm - 8<sup>3</sup>/<sub>4</sub>"

Droit  
Right  
Derecha

**I162001**

23 cm - 9"

**I162010**

23,5 cm - 9<sup>1</sup>/<sub>4</sub>"

**I162011**



**I162020**

24,0 cm - 9<sup>1</sup>/<sub>2</sub>"

**I162021**



## WALSHAM

Gauche  
Left  
Izquierda

**I162041**

**I162040**

Droit  
Right  
Derecha

**I162042**

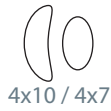
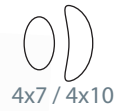

**I162041**

**I162042**

**I162040**  
23 cm - 9"



**I162020**  
24 cm - 9<sup>1</sup>/<sub>2</sub>"

**I162021**  
24 cm - 9<sup>1</sup>/<sub>2</sub>"

Connecteur  
Connector  
Conector



**I162030**  
5 cm - 2"

XII - O.R.L.  
XII - E.N.T.  
XII - O.R.L.

## CHEVALIER-JACKSON

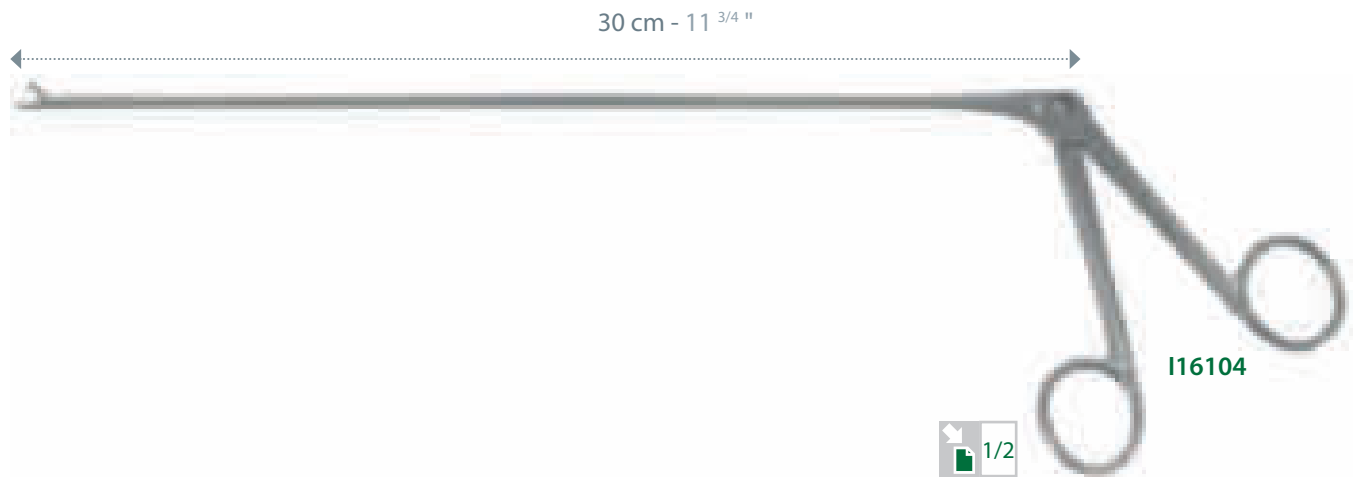

30 cm - 11 <sup>3</sup>/<sub>4</sub> "

Mors dents de brochet - Pike teeth jaws - Bocas dientes lucio

116100



116102

50 cm - 19 <sup>3</sup>/<sub>4</sub> "

Mors en curette - Curette jaws - Bocas curetas



116104



Ø 2 mm

116106

Mors emporte pièce - Punch jaws - Bocas cortador

116108



3 x 6 mm

116110

Mors en creux - Hollow jaws - Bocas hueco

116112



4 x 10 mm

116114

## ROBIN

8 x 12 mm	<b>I17001</b>	
10 x 14 mm	<b>I170009</b>	
12 x 16 mm	<b>I170008</b>	
14 x 18 mm	<b>I170007</b>	

## FREER

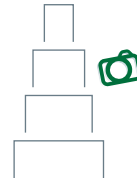

<b>I170020</b>	4 mm	<b>I170010</b>
<b>I170021</b>	7 mm	<b>I170011</b>
<b>I170022</b>	9 mm	<b>I170012</b>
<b>I170023</b>	12 mm	<b>I170013</b>

## COTTLE



Burin  
Chisel  
Cinceles

Ostéotome  
Osteotome  
Osteotomo

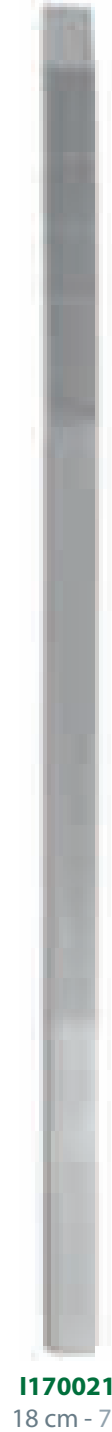
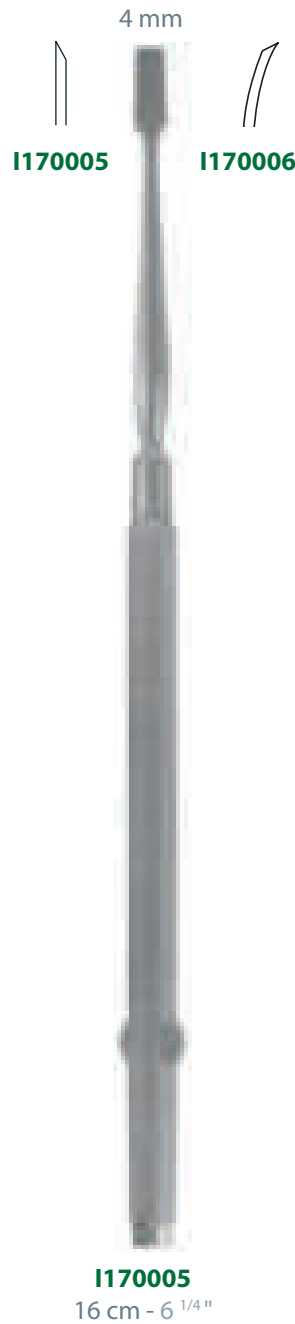
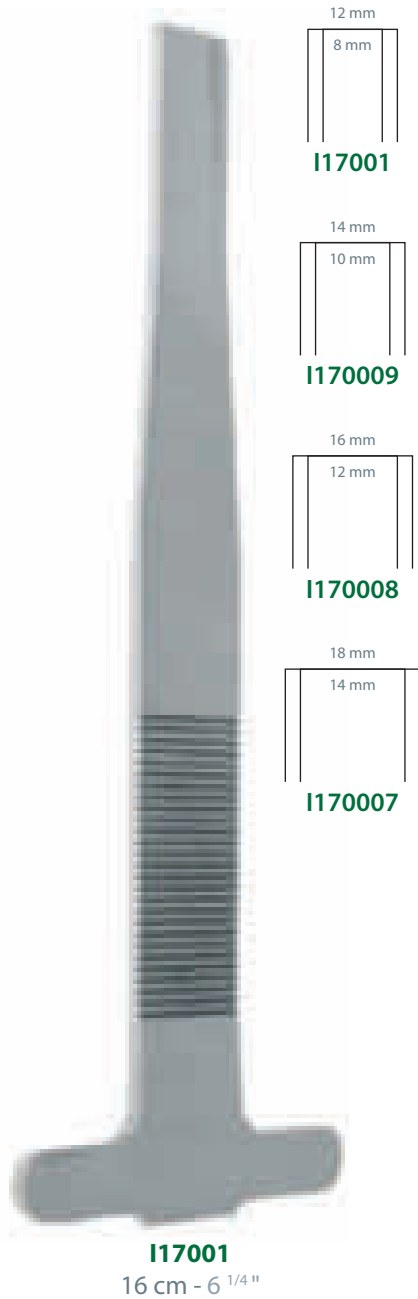
7 mm



## HAUTANT

2 mm	I17005		I17050
3 mm	I17010		<b>I17055</b> 
4 mm	I17015		I17060
5 mm	I17020		I17065
6 mm	<b>I17025</b> 		I17070
7 mm	I17030		I17075
8 mm	I17035		I17080
10 mm	I17040		I17085
12 mm	I17045		I17090

## LELIEVRE

		Burin fin Fine chisel Cinzel fino	6 mm
4 mm		<b>I170460</b>	
6 mm		<b>I170461</b>	

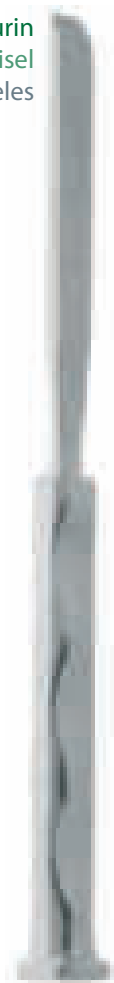

**I17025**  
13 cm - 5 "



**I17055**  
13 cm - 5 "

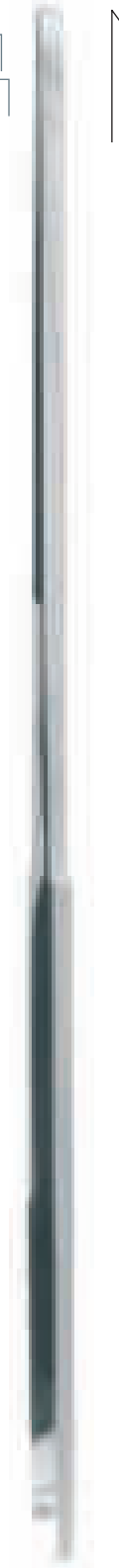

**I170461**  
21 cm - 8 1/4 "

## MASING (SILVER)

## CINELLI

A gauche  
On the left  
A la Izquierda

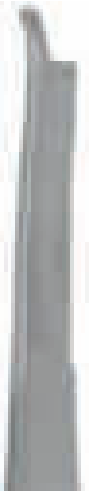

**I170031**  
17,5 cm - 7 "

Droit  
Straight  
Recta



**I170030**  
17,5 cm - 7 "

A droite  
On the right  
A la Derecha

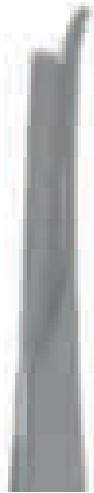

**I170032**  
17,5 cm - 7 "

10 mm **I170040**

12 mm **I170042** 

14 mm **I170044**

16 mm **I170046**



**I170042**  
16 cm - 6 1/4 "

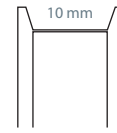

**I170040**

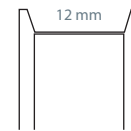

**I170042**

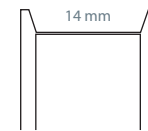

**I170044**

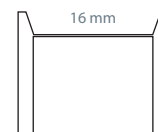





**I170046**





## LEBEAU

### FREER

### BALLENGER

	3 mm	<b>I170940</b> 
	4 mm	<b>I170941</b>
	7 mm	<b>I170942</b>

### KILLIAN

	4 mm	<b>I170924</b>
	6 mm	<b>I170926</b>
	8 mm	<b>I170928</b> 

3 mm

Droite  
Straight  
Recta

En V  
V form  
Forma V

7 mm

7 mm

6 mm

8 mm

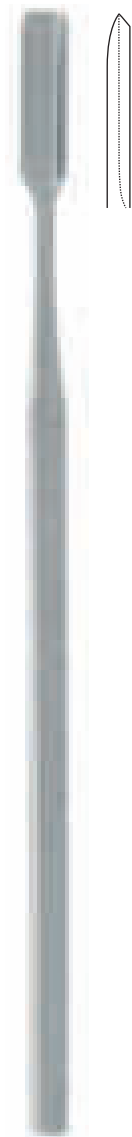

**I170920**  
15 cm - 6 "

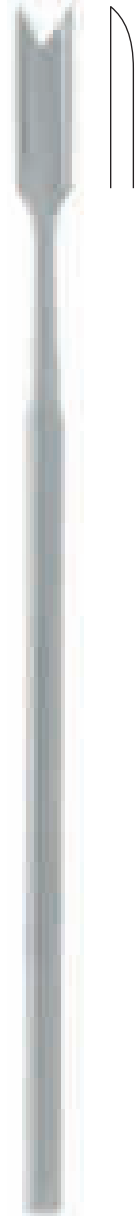

**I170928**  
16 cm - 6 1/4 "

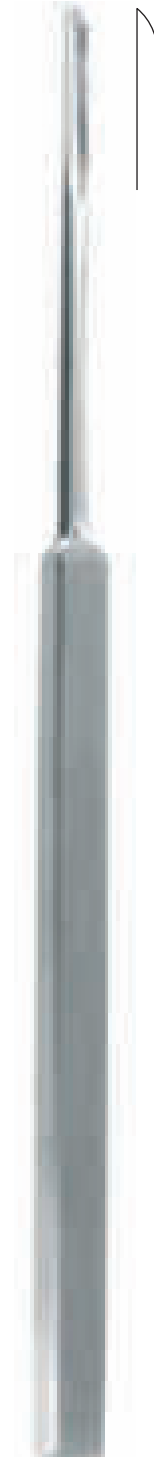

**I170940**  
20 cm - 8 "



Baïonnette  
Bayonet  
Bayoneta

**I17108**  
15 cm - 6 "



**I17110**  
15 cm - 6 "

# LANDANGER

O.R.L. rugines - E.N.T. raspatories - O.R.L. raspadores

## SEBILEAU

## PENNINGTON

## FREER

Droite  
Straight  
Recta

4 mm

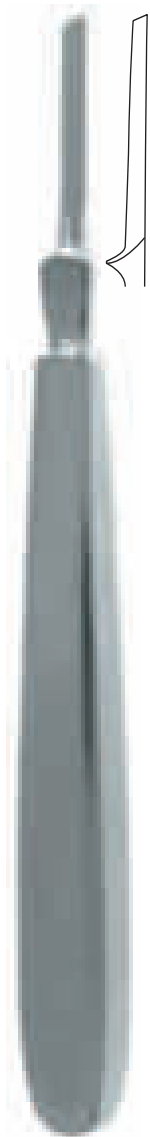

**I17100**  
15 cm - 6"

1/2 courbe  
1/2 curved  
Media curva

4 mm

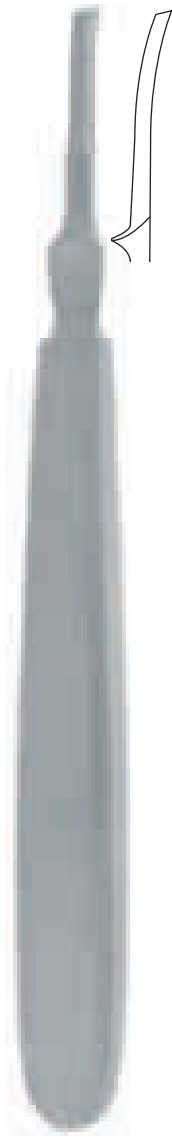

**I17102**  
15 cm - 6"

Courbe  
Curved  
Curva

4 mm

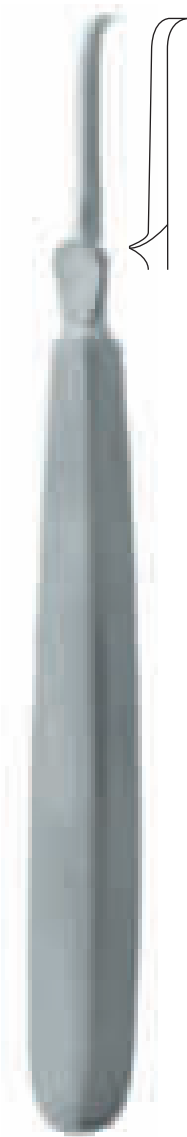
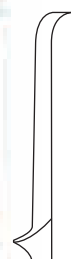

**I17104**  
15 cm - 6"

5 mm

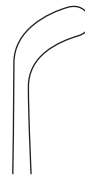

5 mm

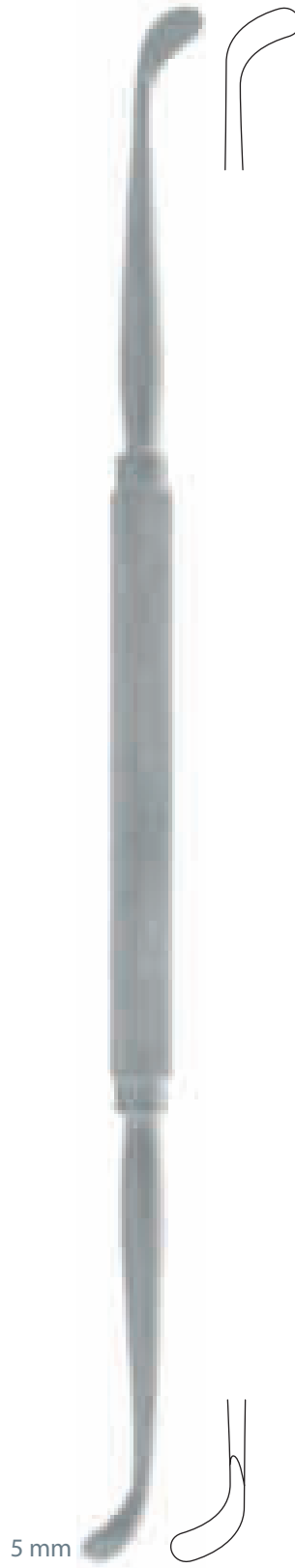

**I171060**  
21 cm - 8 1/4"

Courbe  
Curved  
Curva

4 mm

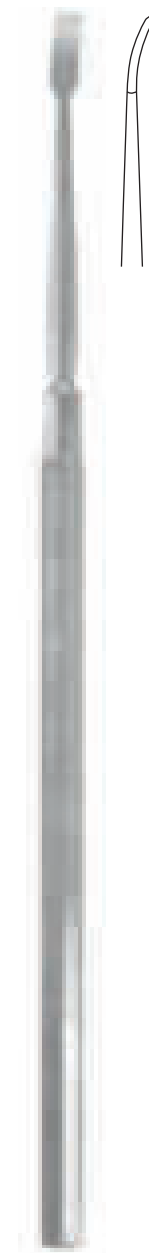

**I171065**  
16,5 cm - 6 1/2"

XII - O.R.L.  
XII - E.N.T.  
XII - O.R.L.



## TAKAHASHI

Convexe  
Convex  
Convexo

7 mm

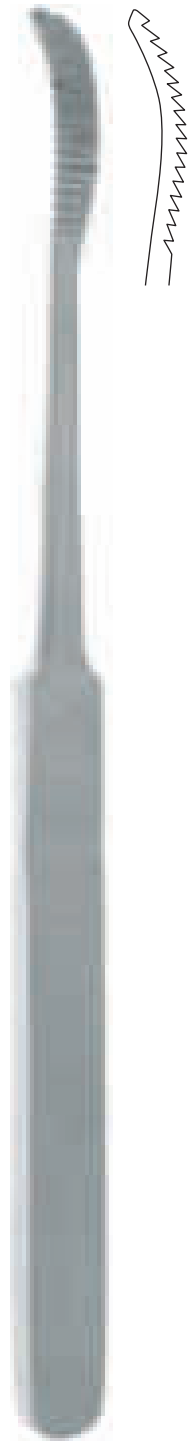

**I17112**  
19 cm - 7 1/2"

## DUFOURMENTEL

Concave  
Concave  
Concava

7,5 mm

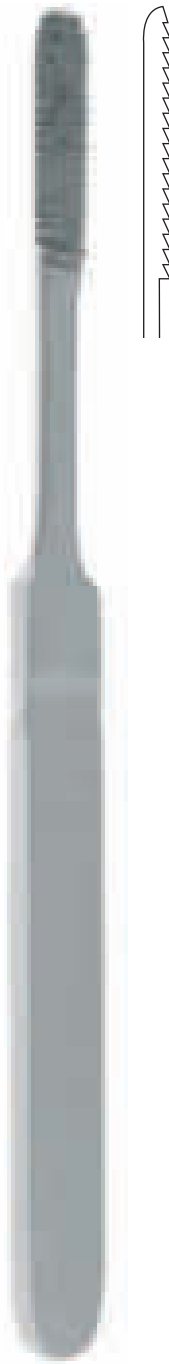

**I17116**  
18 cm - 7"

## MALTZ

9 mm



**I171170**  
18 cm - 7"

## GALLAHER

Droite  
Straight  
Recta

7 mm

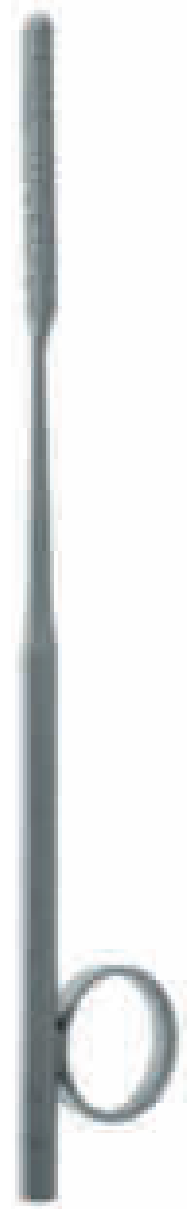

**I17118**  
16 cm - 6 1/4"



### LEWIS

Denture large  
Wide tothing  
Dentado ancho

Denture fine  
Fine tothing  
Dentado fino



**I171260**  
18 cm - 7"

**I171265**  
18 cm - 7"

### COTTLE

7 mm

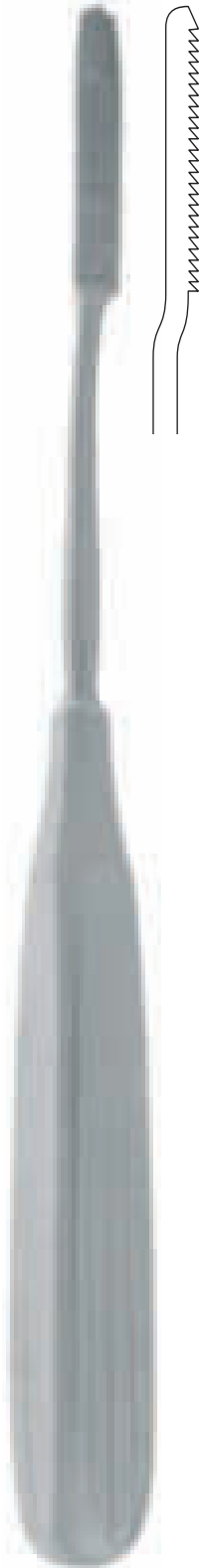

**I171270**  
21 cm - 8 1/4"

### AUFRICHT

Denture vers l'avant  
Tothing forwards  
Dentado acia adelante

Denture vers l'arrière  
Tothing backwards  
Dentado hacia atrás

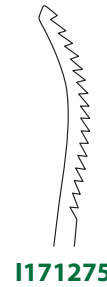
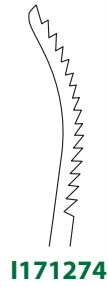

**I171274**

**I171275**

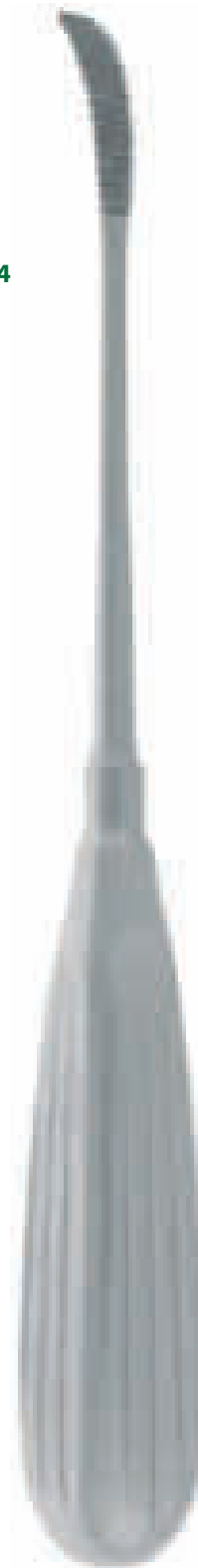

**I171275**  
21 cm - 8 1/4"

### MILLER



**I171280**  
18 cm - 7"

### FOMON

Denture fine  
Toothing fine  
Dentado fino

6.5 mm

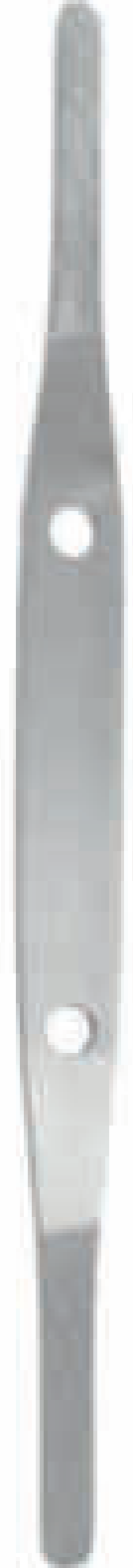

**I171242**  
7.5 mm  
20.5 cm - 8"

Denture forte  
Toothing strong  
Dentado fuerte

6.5 mm

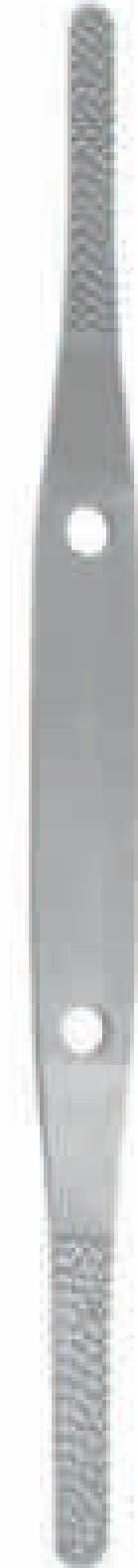

**I171243**  
7.5 mm  
20.5 cm - 8"

7.5 mm



**I171245**  
7.5 mm  
20.5 cm - 8"

12 dents  
12 teeth  
12 dientes

Denture  
Toothing  
Dentado

16/20

24/30

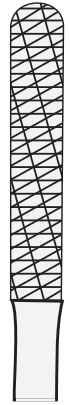

**I171246**  
20.5 cm - 8"

**I171247**  
20.5 cm - 8"

36/44

52/62

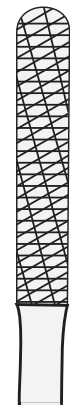

**I171248**  
20.5 cm - 8"

**I171249**  
20.5 cm - 8"

14 dents  
14 teeth  
14 dientes

# LANDANGER

O.R.L. crochets - E.N.T. hooks - O.R.L. ganchos

## FISH

2 mm

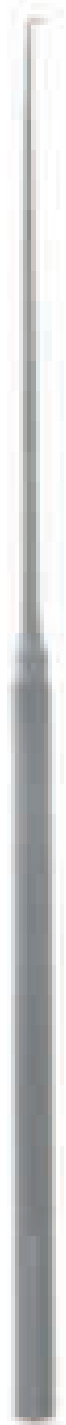

**J08035**

18,5 cm - 7 1/4"

## WAGNER

Fin  
Fine  
Fino

2.5 mm

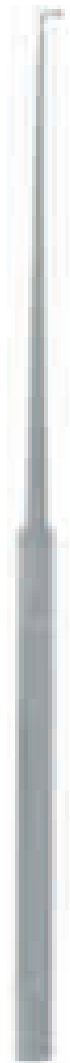

**D04060**

14 cm - 5 1/2"

Fort  
Strong  
Fuerte

3 mm

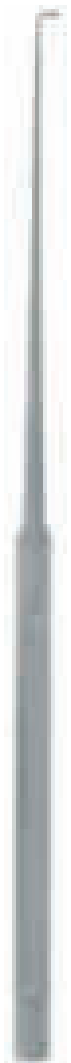

**D04050**

14 cm - 5 1/2"

## LUCAE

Petit  
Small  
Pequeñas

2 mm



**D040800**

14 cm - 5 1/2"

Moyen  
Medium  
Medianas

2.5 mm



**D040801**

14 cm - 5 1/2"

Grand  
Large  
Grandes

3 mm



**D040802**

14 cm - 5 1/2"

XII - O.R.L.  
XII - E.N.T.  
XII - O.R.L.

### FOMON

Boutonnée  
With tip  
Abotonado

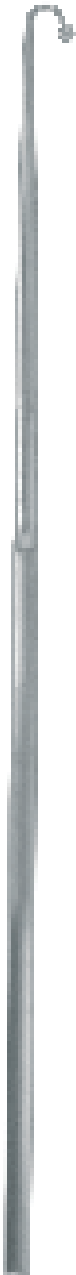

**I171308**  
17 cm - 6 <sup>3</sup>/<sub>4</sub> "

### FREER

Crochet double  
Double hook  
Doble gancho

Pointu  
Sharp  
Aguda

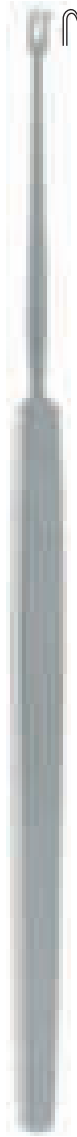

**I171305**  
15 cm - 6 "

### KNAPP

Mousse  
Blunt  
Roma



**I171306**



**I171306**  
13 cm - 5 "

### ROLLET

Pointu  
Sharp  
Aguda



**I171307**  
13 cm - 5 "

### CASTROVIEJO



15 mm

**I171355**  
8 cm - 3 <sup>1</sup>/<sub>4</sub> "

## COTTLE NEIVERT

Boutonnée  
With tip  
Abotonado  
5 x 10 mm

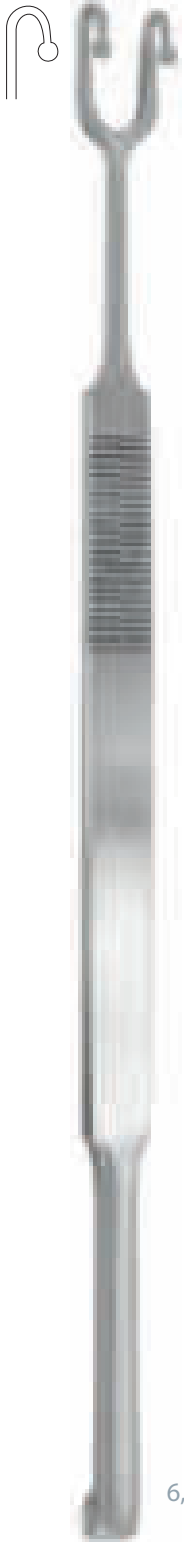

**I171315**  
20 cm - 8"

## COTTLE

Boutonné - pointu  
With tip - sharp  
Abotonado - aguda



**I171311**

Pointu - boutonné  
Sharp - with tip  
Aguda - abotonado



**I171312**

4 x 9 mm



**I171310**  
14 cm - 5 1/2"

## CONVERSE

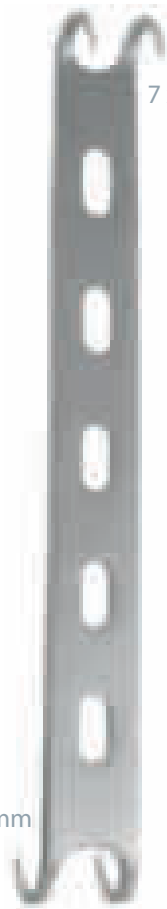

**I171322**  
12 cm - 4 3/4"

8 x 12 mm

## COTTLE

10 x 12 mm

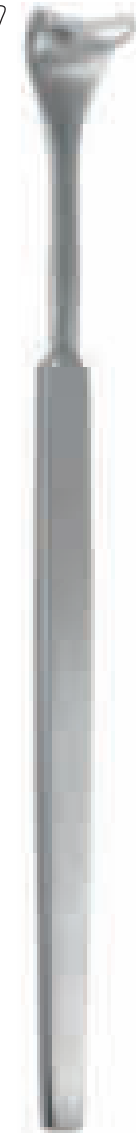

**I171325**  
15 cm - 6"

## KILNER

Pointu  
Sharp  
Aguda

3 x 10 mm

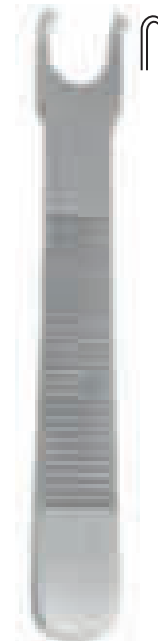

**I171320**  
8 cm - 3 1/4"

## CLAOUE

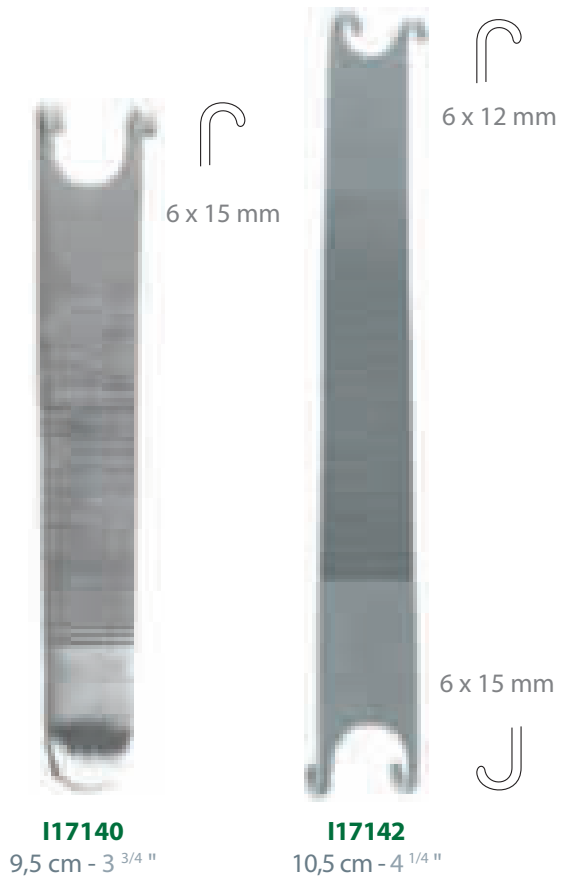

## AUBRY (en Z)



## DAUTREY



## GINESTET

20 mm **I171330**

23 mm **I171331** 

27 mm **I171332**

Petit  
Small  
Pequeñas

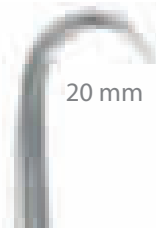

20 mm

**I171330**

Moyen  
Medium  
Medianas

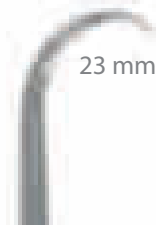

23 mm

**I171331**

Grand  
Large  
Grandes

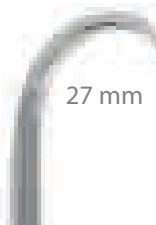

27 mm

**I171332**



**I171331**  
24,5 cm - 10"

## AUFRICHT

45 x 8 mm

Bi-coudé  
Bi-angled  
Bi-angulada

**I171340**  
16 cm - 6 1/4"

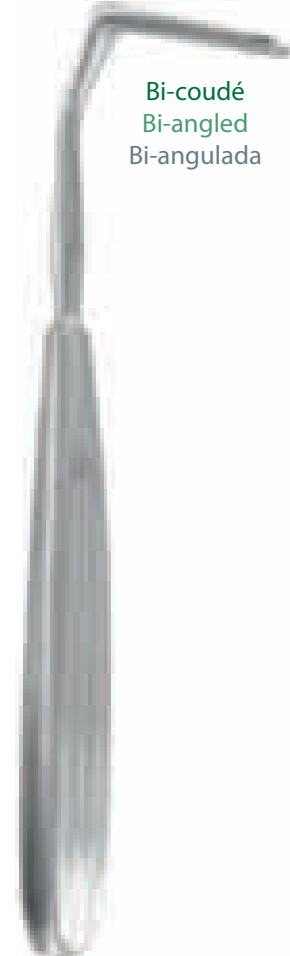

## GUERRIER

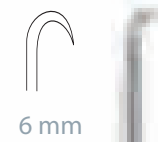

6 mm

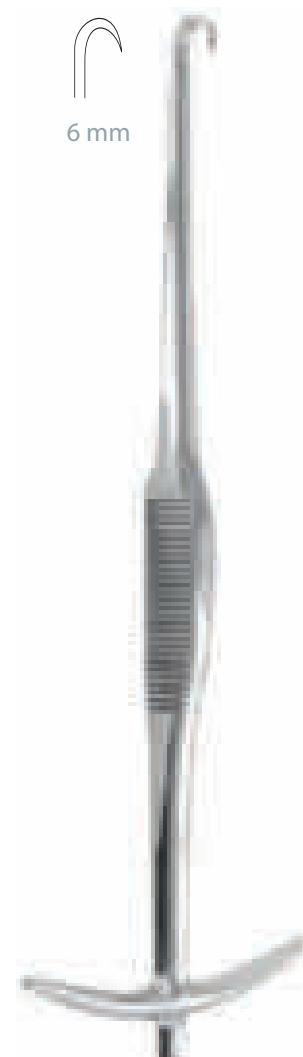

**I171335**  
17 cm - 6 3/4"



## FREER

Tranchant  
Sharp  
Cortante

5 mm



I171360

Mousse  
Blunt  
Romo



I171361



I171360  
18,5 cm - 7 1/4 "

ø 4,5 mm

## KILLIAN

Tranchant  
Sharp  
Cortante



4,5 mm



I171365  
18,5 cm - 7 1/4 "

4,5 mm

Mousse  
Blunt  
Romo



## MASING

Mousse  
Blunt  
Romo



4 mm



I171370  
20,5 cm - 8 "

4,5 mm

Tranchant  
Sharp  
Cortante



## Mc KENTY

Tranchant  
Sharp  
Cortante

5 mm



I171375  
22cm - 8 3/4 "

5 mm

Tranchant  
Sharp  
Cortante



## LEMPERT



**I171380**  
18 cm - 7"

**I171381**  
20,5 cm - 8"

## HURD

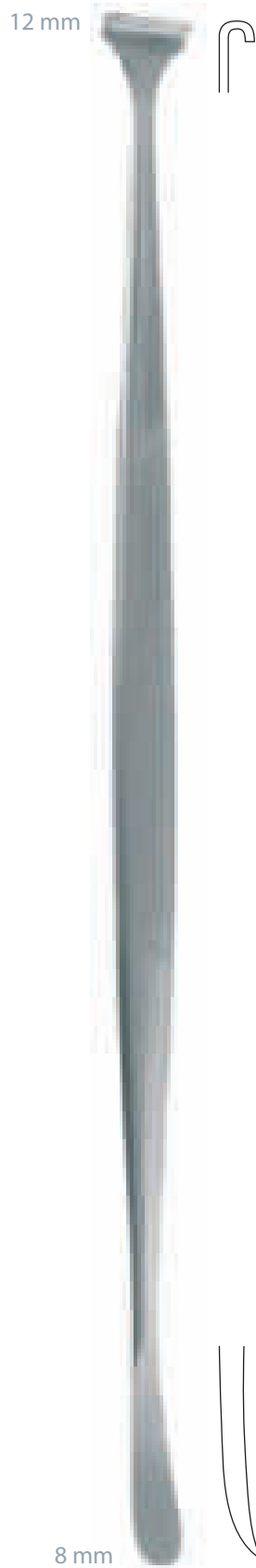

**I171390**  
22,5 cm - 8 3/4"

## HENKE

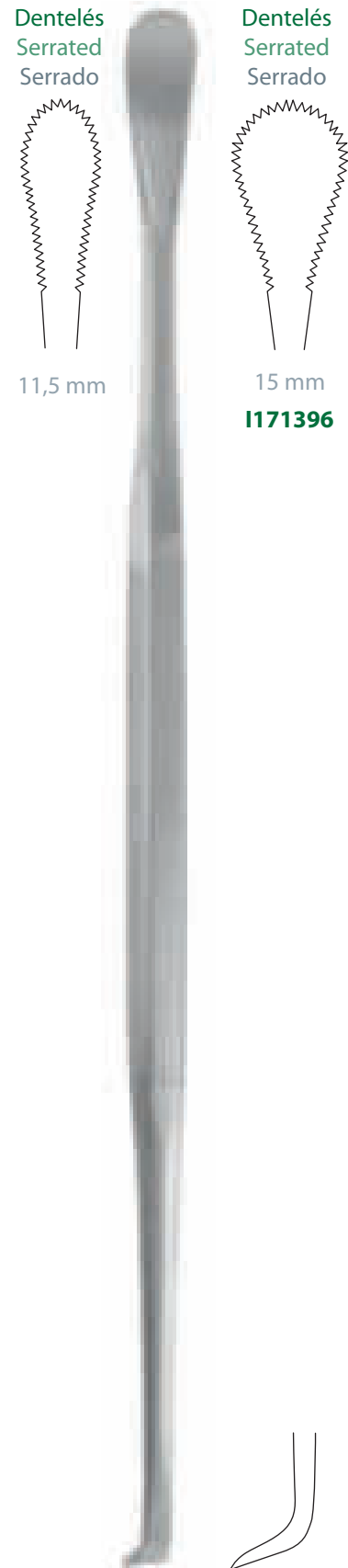

**I171395**  
23 cm - 9"



## JOSEPH

3 mm	<b>I171292</b> 
5 mm	<b>I171295</b>
7 mm	<b>I171297</b>
10 mm	<b>I171300</b>

Baïonnette à gauche  
Bayonet left  
Bayoneta a la izquierda

Baïonnette à droite  
Bayonet right  
Bayoneta a la derecha

7 mm

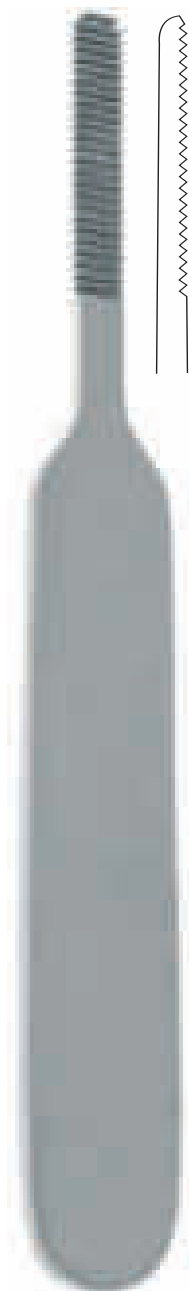

**I17114**  
17 cm - 6 <sup>3</sup>/<sub>4</sub> "



**I17155**  
19,5 cm - 7 <sup>3</sup>/<sub>4</sub> "

**I17150**  
19,5 cm - 7 <sup>3</sup>/<sub>4</sub> "

5 mm



**I171290**  
15 cm - 6 "

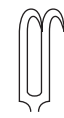

3 mm  
**I171292**



5 mm  
**I171295**



7 mm  
**I171297**



10 mm  
**I171300**

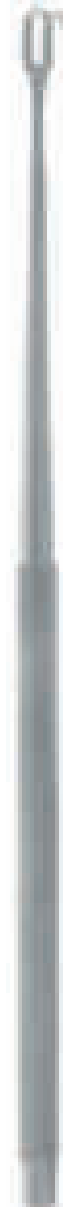

**I171292**  
16 cm - 6 <sup>1</sup>/<sub>4</sub> "

## JOSEPH

### TRANCHANT - SHARP - CORTANTE

Droit  
Straight  
Recta

Courbe  
Curved  
Curva

14 cm - 5 1/2"

**I19010**

**I19020**



Élévateur  
Elevator  
Elevador

Rugine  
Raspatory  
Raspador

Droite  
Straight  
Recta

Courbe  
Curved  
Curva

5 mm

5 mm

5 mm



**I19010**  
14 cm - 5 1/2"



**I19030**  
16,5 cm - 6 1/2"

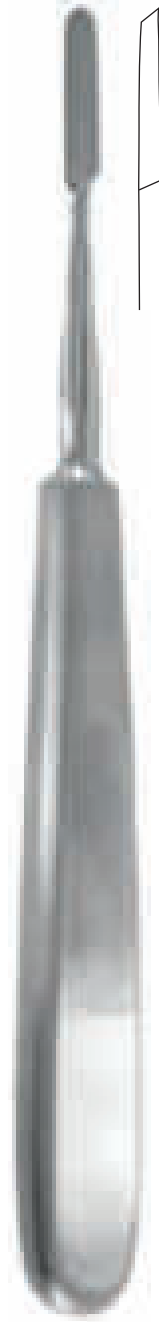

**I19040**  
17 cm - 6 3/4"

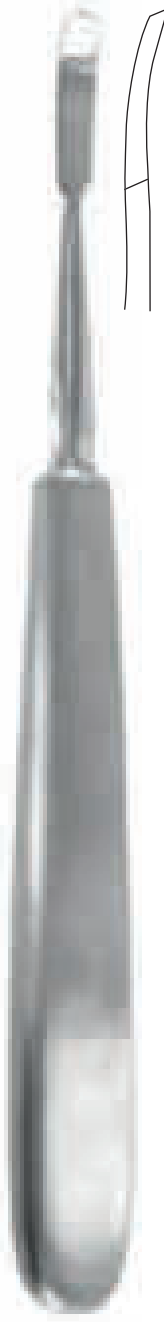

**I19050**  
17 cm - 6 3/4"



## SEGURA

95 g **I17160** Ø 18 mm  
 115 g **I17162** Ø 20 mm

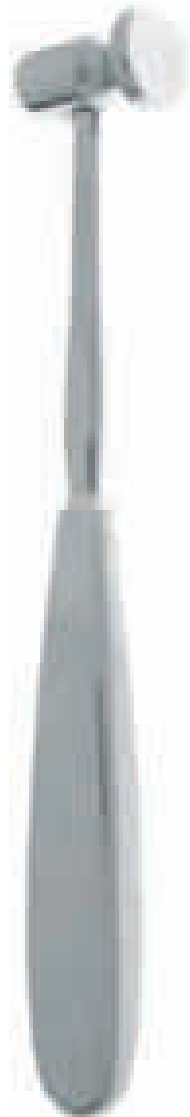

**I17162**  
20 cm - 8"

## BLONDIAU

Mousse  
Blunt  
Roma  
20 mm

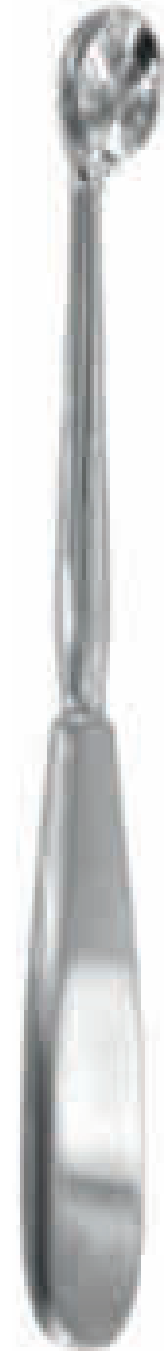

**I180000**  
24 cm - 9 1/2"

## LIMA

3 mm **I18005**   
 5 mm **I18010**  
 7 mm **I18020**

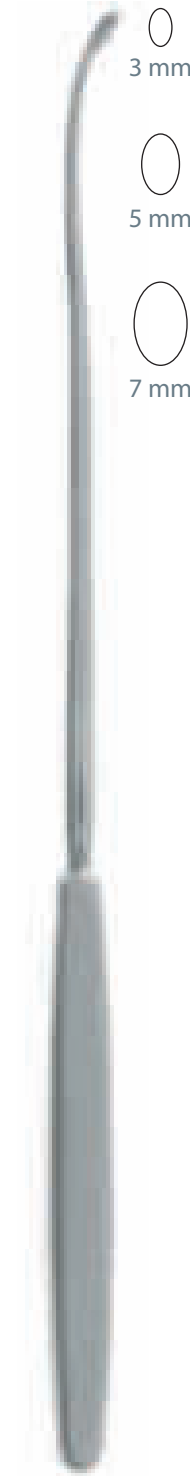

**I18005**  
26 cm - 10 1/4"

## SEBILEAU

Pleine  
Full  
Llena

4 mm Ø  
5 mm Ø

Droite  
Straight  
Recta

Ø 4 mm **I18021**

Ø 5 mm **I18022**

1/2 Courbe  
1/2 Curved  
1/2 Curva

Ø 4 mm **I18024**

Ø 5 mm **I18025**

Courbe  
Curved  
Curva

Ø 4 mm **I18027**

Ø 5 mm **I18028**

Fenêtrée  
Open work  
Conventana

4 mm Ø  
5 mm Ø

Droite  
Straight  
Recta

Ø 4 mm **I18030**

Ø 5 mm **I18031**

1/2 Courbe  
1/2 Curved  
1/2 Curva

Ø 4 mm **I18033**

Ø 5 mm **I18034**

Courbe  
Curved  
Curva

Ø 4 mm **I18036**

Ø 5 mm **I18037**

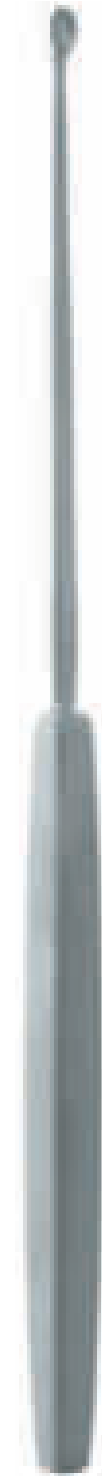

**I18021**  
26 cm - 10 1/4"

# LANDANGER

O.R.L. cures - E.N.T. cures - O.R.L. mazos y curetas

## COAKLEY

## BUCK

## SNELLEN

Droite  
Straight  
Recta

Courbe  
Curved  
Curva

N° 1 **I180380** 3,2 mm

N° 2 **I180381** 3,7 mm

**I180372** 2 mm

**I180373**

**I180374** 2,5 mm

**I180375**

**I180376** 3 mm

**I180377**

7 mm



15°

**I180002**



30°

**I180003**



120°

**I180004**

**I180002**

17 cm - 6 3/4"

Mousse fenêtrée  
Blunt fenestrated  
Roma fenestrado



2 mm



2,5mm



3 mm

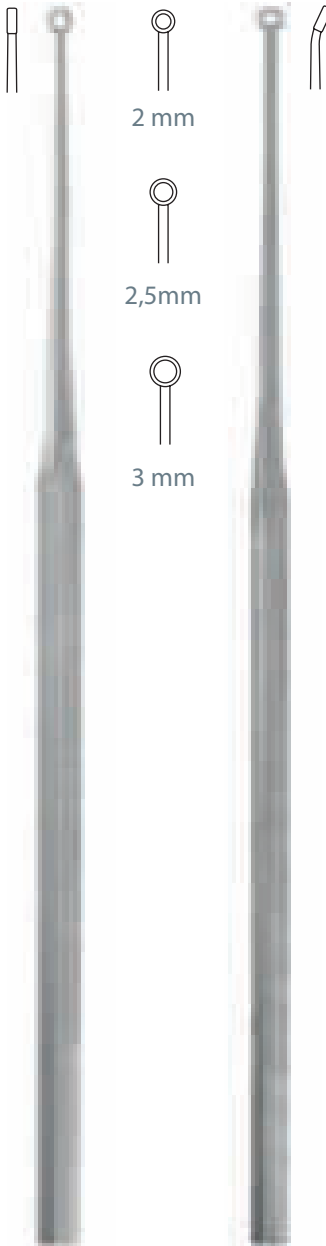

**I180374**

16,5 cm - 6 1/2"

**I180375**

16,5 cm - 6 1/2"



N° 1



N° 2

**I180381**

16 cm - 6 1/4"

XII - O.R.L.  
XII - E.N.T.  
XII - O.R.L.

## WILLIGER

2,0 x 3,0 mm **I180022**   
 3,0 x 3,5 mm **I180023**

## CLOVIS VINCENT

Malléable      Rigide  
 Malleable      Rigid  
 Maleable      Rigida

3 x 4 mm **I180030** **I180035**   
 5 x 6 mm **I180031** **I180036**  
 7 x 8 mm **I180032** **I180037**  
 9 x 10 mm **I180033** **I180038**

## BILLEAU

N° 1 **I180385**   
 N° 2 **I180386**  
 N° 3 **I180387**

Anses  
 Loops  
 Bucle

Double ronde  
 Double round  
 Doble ronda

3 mm

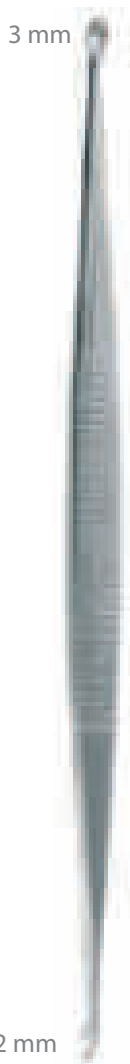

2 mm

**I180022**  
 14 cm - 5 1/2"

0      0  
 2,0 mm    3,0 mm  
 3,0 mm    3,5 mm

Double  
 Double  
 Doble

3 mm

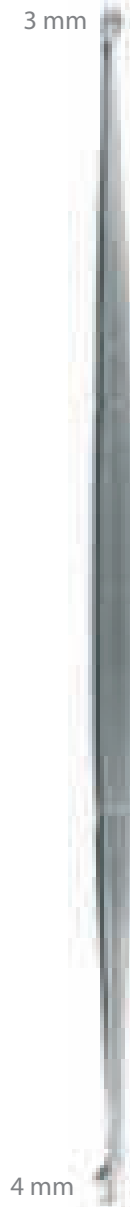

4 mm

**I180035**  
 20 cm - 8"

3 mm      4 mm  
 5 mm      6 mm  
 7 mm      8 mm  
 9 mm      10 mm

 4/5

  
 N° 1  
 3,4 mm

  
 N° 2  
 3,9 mm

  
 N° 3  
 4,6 mm

**I180385**  
 16,5 cm - 6 1/2"

 1/1



# LANDANGER

O.R.L. canules aspiratrices - E.N.T. suction tubes - O.R.L. canulas aspirantes

## PLESTER

## FRAZIER

## WERTHEIMER

Ø 1,5 mm	<b>I182015</b>	Ch 5	Ø 2,0 mm	<b>I18040-0</b>	Ch 6	Ø 2,0 mm	<b>I180502</b>	Ch 6	
Ø 2,0 mm	<b>I182020</b>	Ch 6	Ø 2,5 mm	<b>I18042-0</b>	Ch 8	Ø 3,0 mm	<b>I180503</b>	Ch 9	
 Ø 2,5 mm	<b>I182025</b>	Ch 8	Ø 3,3 mm	<b>I18044-0</b>	Ch 10	Ø 4,0 mm	<b>I180504</b>	Ch 12	
Ø 3,0 mm	<b>I182030</b>	Ch 9	Ø 4,0 mm	<b>I18046-0</b>	Ch 12	Ø 5,0 mm	<b>I180515</b>	Ch 15	



 1/1

 4/5

XII - O.R.L.  
XII - E.N.T.  
XII - O.R.L.



### FRAZIER

Ø 2,0 mm	<b>I182102</b>	Ch 6
Ø 2,3 mm	<b>I182103</b>	Ch 7
Ø 2,6 mm	<b>I182104</b>	Ch 8
Ø 3,0 mm	<b>I182105</b>	Ch 9 
Ø 3,3 mm	<b>I182106</b>	Ch 10
Ø 4,0 mm	<b>I182108</b>	Ch 12
Ø 5,0 mm	<b>I182109</b>	Ch 15

### FERGUSSON

Ø 2,0 mm	<b>I182202</b>	Ch 6
Ø 2,3 mm	<b>I182203</b>	Ch 7
Ø 2,6 mm	<b>I182204</b>	Ch 8
Ø 3,0 mm	<b>I182205</b>	Ch 9 
Ø 3,3 mm	<b>I182206</b>	Ch 10
Ø 4,0 mm	<b>I182208</b>	Ch 12
Ø 5,0 mm	<b>I182209</b>	Ch 15

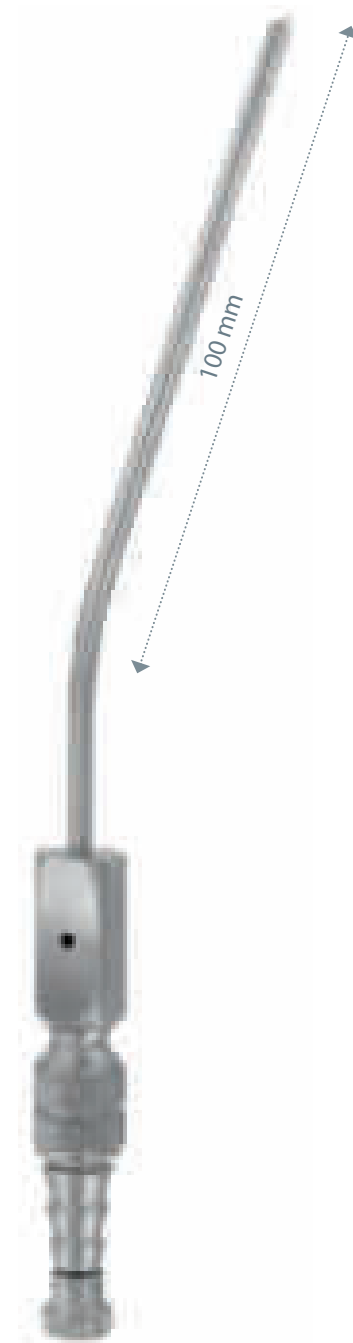

**I182105**  
17 cm - 6 <sup>3</sup>/<sub>4</sub>"



**I182205**  
17 cm - 6 <sup>3</sup>/<sub>4</sub>"

### HARTMANN

C 128	<b>I180703</b> 
C 256	<b>I180704</b>
C 512	<b>I180705</b>
C 1024	<b>I180706</b>
C 2048	<b>I180707</b>
C 4096	<b>I180708</b>

Sans curseur  
Without cursor  
Sin cursor

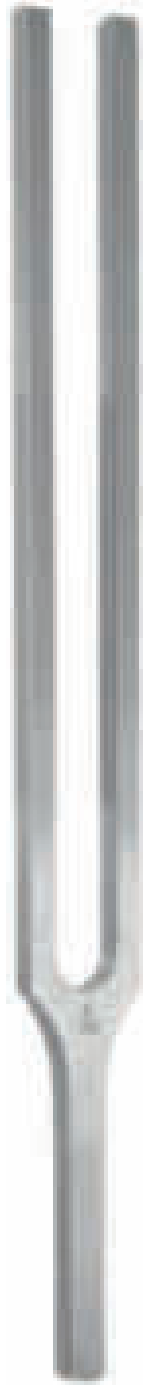

**I180703**  
25 cm - 10 "

### LUCAE HARTMANN

C 128	<b>I180713</b>
C 256	<b>I180714</b> 
C 512	<b>I180715</b>
C 1024	<b>I180716</b>
C 2048	<b>I180717</b>
C 4096	<b>I180718</b>

Sans curseur avec pied  
without cursor with foot  
Sin cursor con el pie

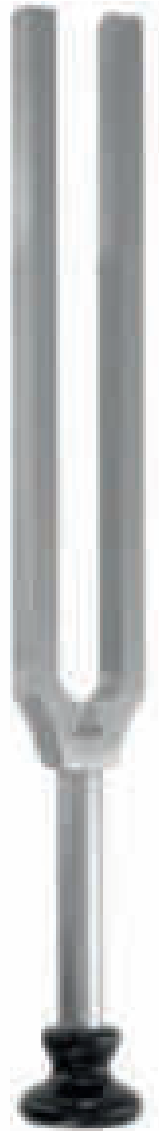

**I180714**  
20 cm - 8 "

Pied  
Foot  
Pie

### FRENCH

C 16	<b>I180720</b>
C 32	<b>I180721</b>
C 64	<b>I180722</b> 
C 128	<b>I180723</b>
C 256	<b>I180724</b>

Avec curseur  
With cursor  
Con cursor

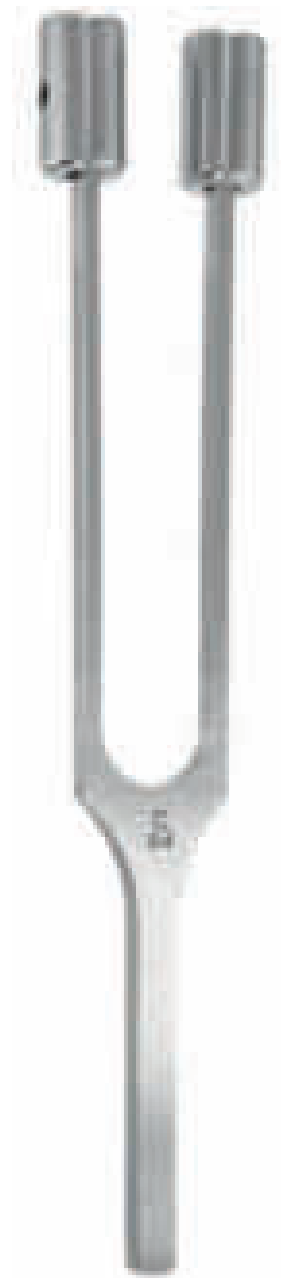

**I180722**  
22,5 cm - 8 <sup>3</sup>/<sub>4</sub> "

### LUCAE

### HARTMANN

Avec curseur et pied  
With cursor and foot  
Sin cursor y el pie

C 128

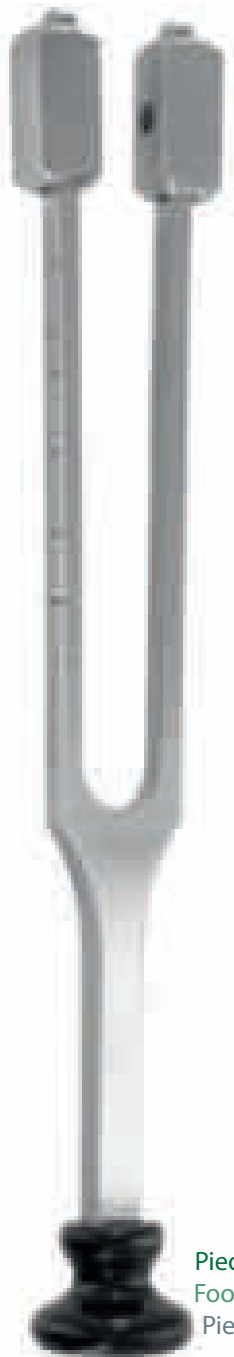

**I180733**  
18 cm - 7"

Pied  
Foot  
Pie

Avec curseur  
With cursor  
Con cursor  
C 128

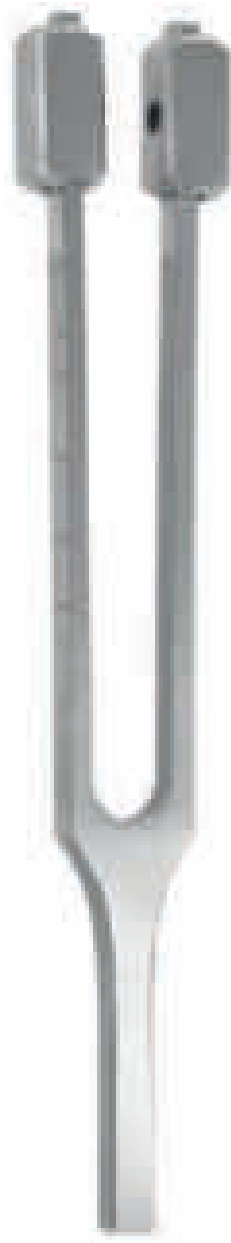

**I180743**  
16 cm - 6 1/4"

C 128

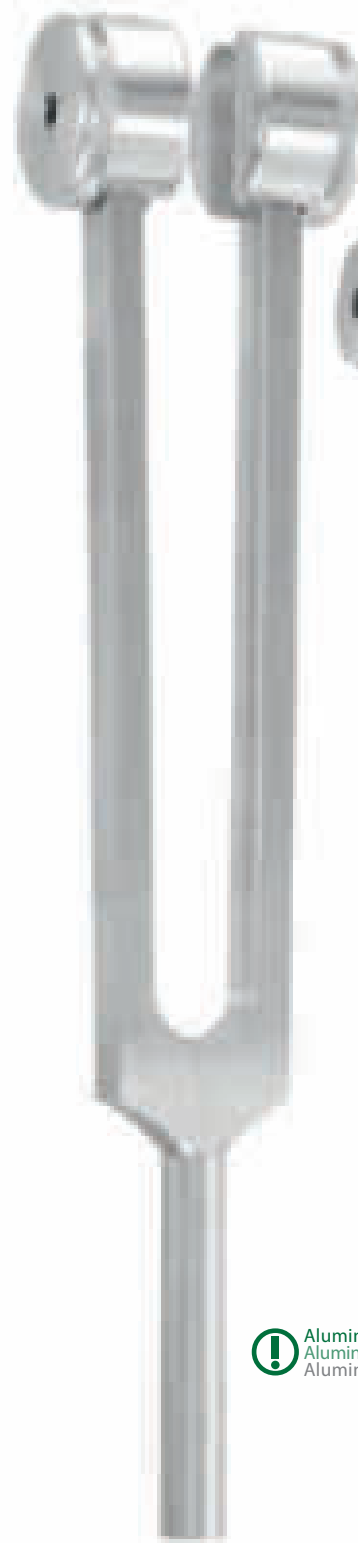

**I180753**  
20,5 cm - 8"

! Aluminium  
Aluminum  
Aluminio

Avec curseur  
With cursor  
Con cursor

C 256

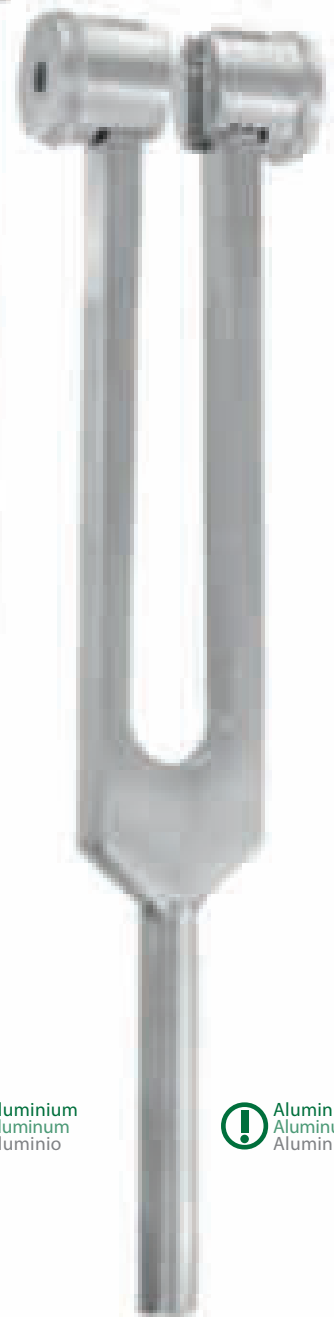

**I180754**  
17 cm - 6 3/4"

! Aluminium  
Aluminum  
Aluminio

## Chirurgie des tendons - Surgery for tendons - Cirugía para tendones

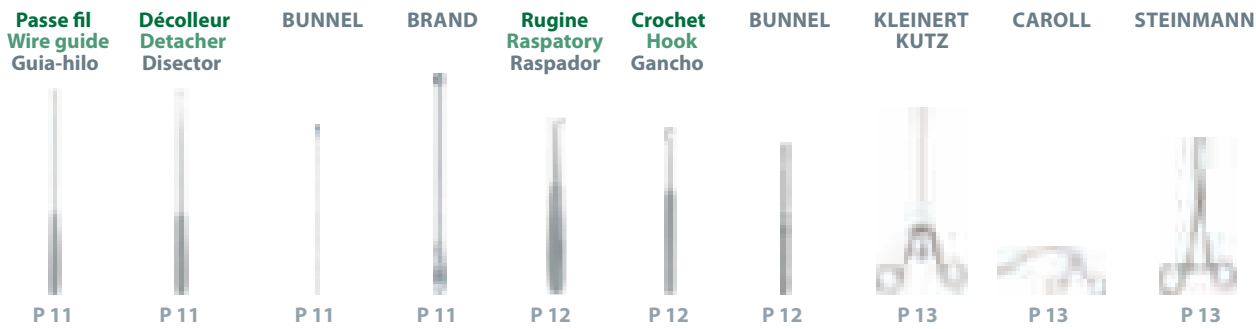

## Instrument pour amputation - Instruments for amputation - Instrumentos para amputación

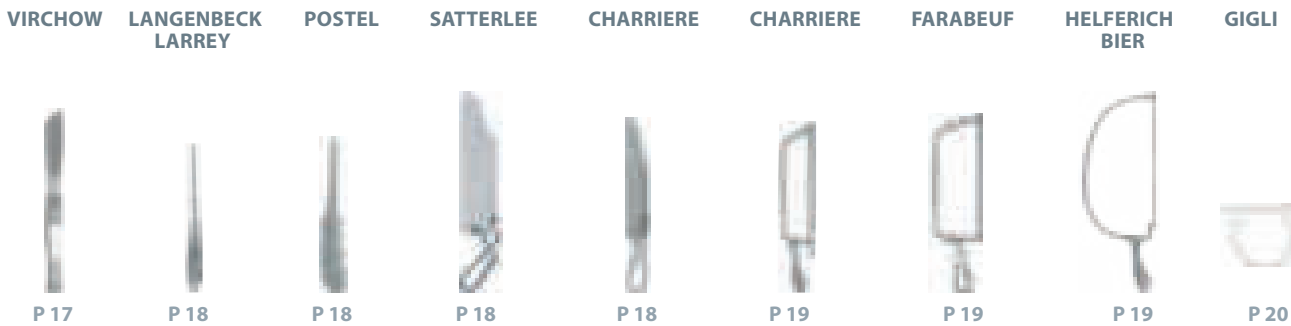
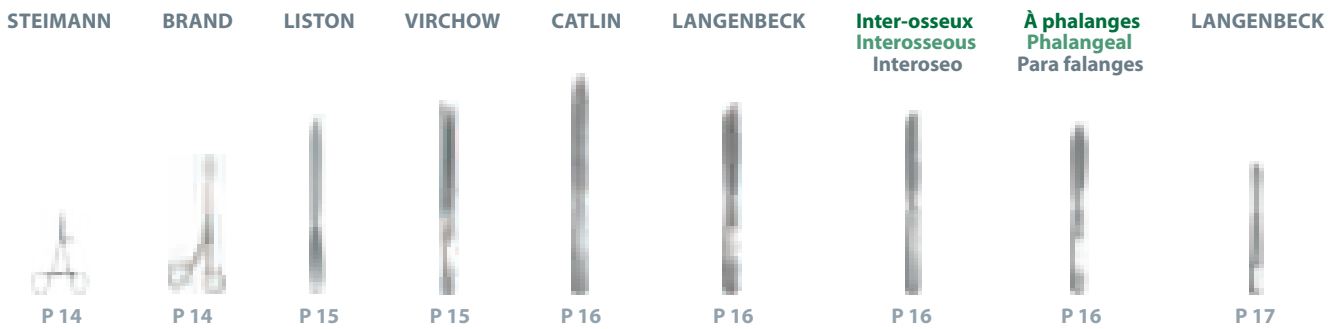

## Instruments pour autopsie - Instruments for autopsy - Instrumentos para autopsia

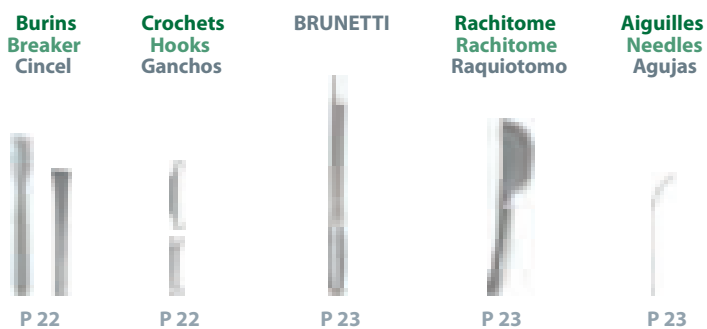

## Crochets - Hooks - Ganchos

ADSON CLOWARD CRILE CUSHING CASPAR



## Rugines et dissecteurs - Raspatories and elevators - Raspadores y elevadores

OLIVECRONA RIZZUTI FREER FREER YASARGIL MOREL FATIO HOWARTH DAVIS MOLT WOODSON CREED

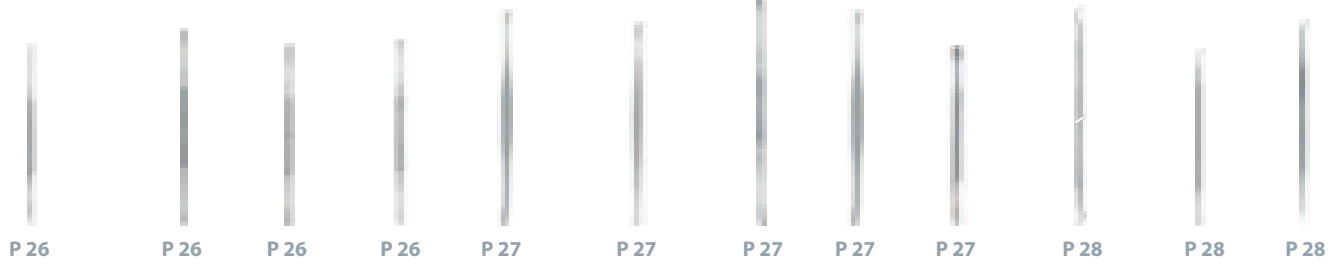

MILLIGAN CARPENTER ROBB SYME JOST ALEXANDER PENFIELD MC DONALD YASARGIL COTTLE WATSON CHEYNE

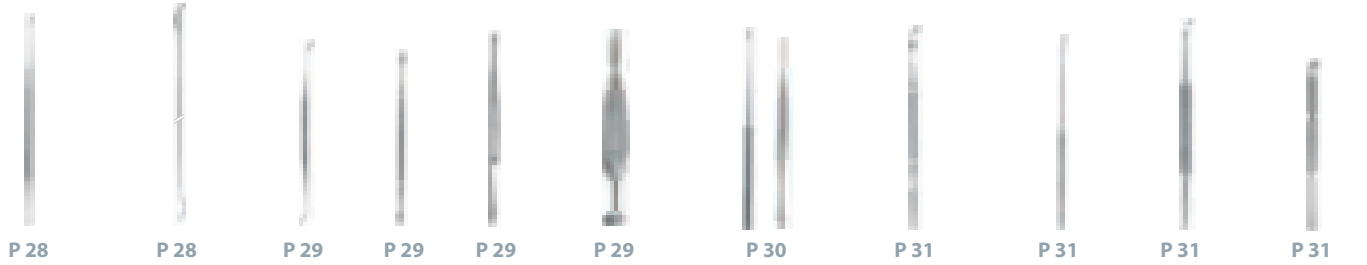



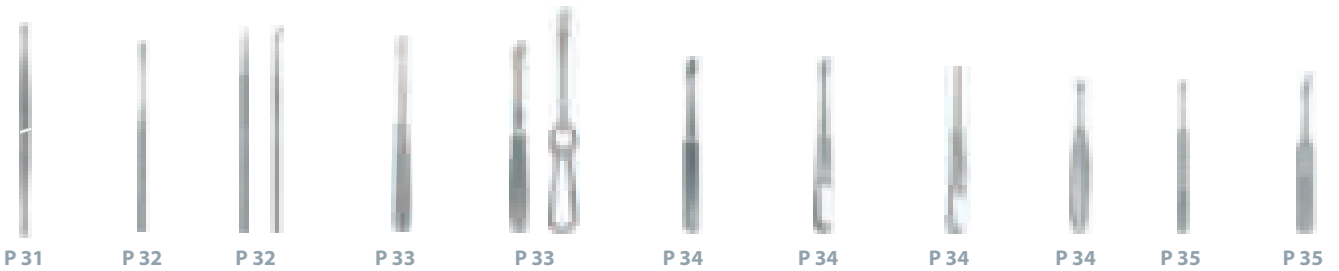



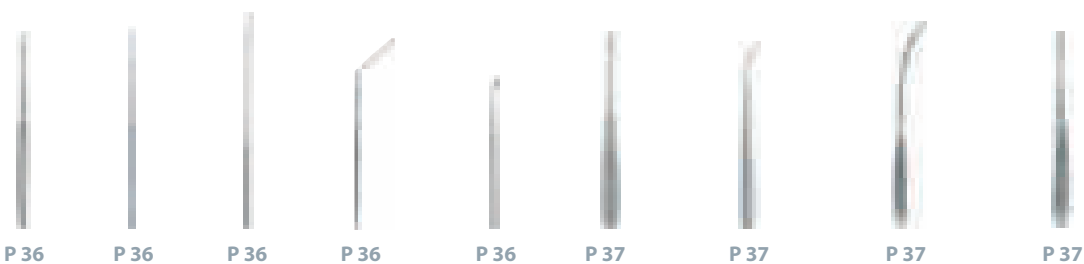



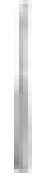
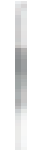
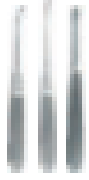
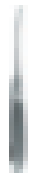

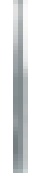



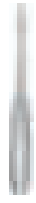

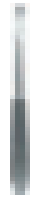

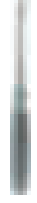

TOENNIS HALLE ABULKER LERICHE LANGENBECK LEBEAU YANKAUER SEBILEAU HOEN KÖNIG WILLIGER



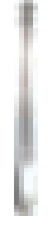
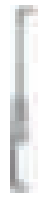

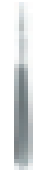

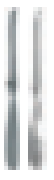

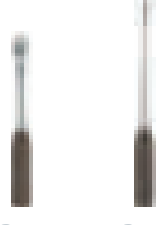



SEWALL SACHS HORSLEY FRAZIER SICART CAIRNS CLOVIS VINCENT DE MARTEL PETIT DUTAILLY



## Rugines - Raspatories - Raspadores

ADSON	LOVE ADSON	MC KENTY	CASPAR	MUHLING	JANSEN	KRAMER	KEY	CUSHING	PENNYBACKER	
										
P 38	P 38	P 39	P 39	P 40	P 40	P 41	P 41	P 41	P 41	P 42
LANGENBECK	CUSHING	MITCHELL	KRAEMER	SEDILLOT	COTTLE	FARABEUF	OLLIER	DOYEN		
										
P 42	P 42	P 42	P 43	P 43	P 43	P 44	P 44	P 45	P 46	
SEMB	LANGENBECK	ROUX	<b>Pour ligament jaune</b> <b>For yellow ligament</b> <b>Para ligamento amarillo</b>	CLOVIS VINCENT	LELIEVRE	MERLE D'AUBIGNE	LAMBOTTE	MAURER		
										
P 47	P 47	P 47	P 47	P 48	P 48	P 48	P 49	P 49	P 50	
COBB	WAGNER									
										
P 51	P 51	P 51								

## Curettes - Curettes - Curetetas

VIDAL	BROCK	BESNIER	UNNA	MARTINI	WILLIGER	JACOBSON	JANSEN	VOLKMANN	BARTH
									
P 52	P 52	P 52	P 53	P 53	P 53	P 53	P 54	P 54	P 54

**Curettes - Curettes - Curetas**

VOLKMANN VOLKMANN VOLKMANN SCHEDE BRUNS UFFENORDE CLOWARD HALLE DAUBENSPECK

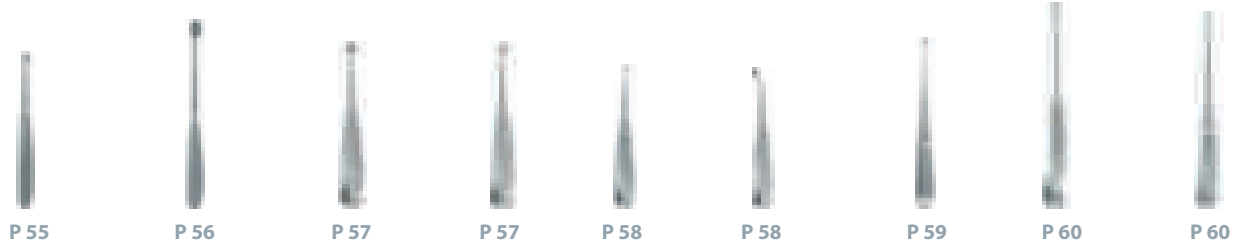

LEMPERT BRUNS BUSCHE SCOVILLE CASPAR CHARNLEY LETOURNEL

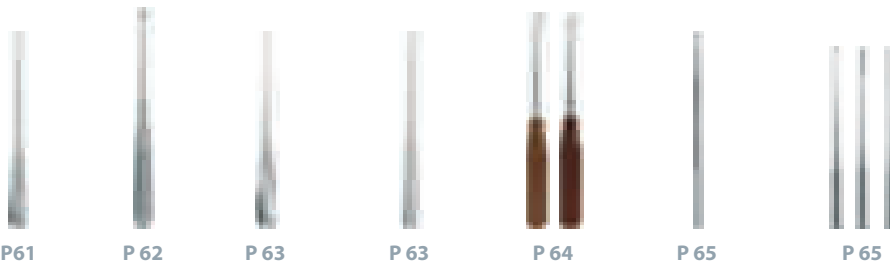

**Ciseaux ostéotomes - Osteotomes - Osteotomos**

LAMBOTTE PAUWELLS LAMBOTTE DUPONT OBWEGESER



**Ciseaux burins, gouges - Bone chisels, gouges - Osea cincelas, gubias**

PARTSCH LUCAS **Ciseaux burins** POIRIER OMBREDANNE ALEXANDER SMITH STILLE LUCAS HIBBS  
**Bone chisels**  
**Osea cincelas**

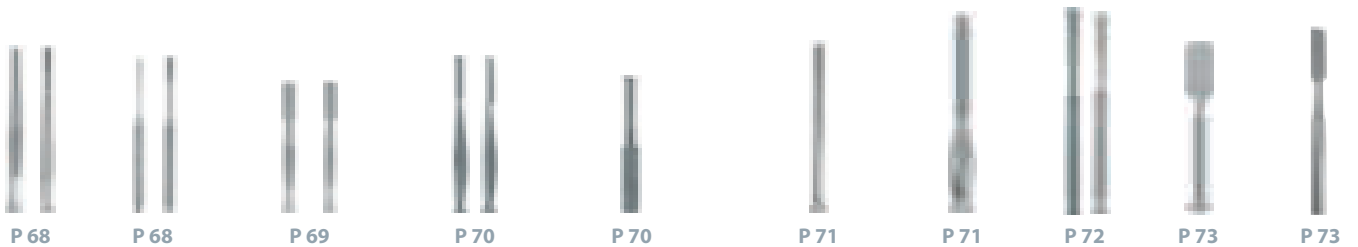

MAC EVEN JUDET FARABEUFF CAUCHOIX GUILLAUME NANCY SMITH HONTON STAGNARA COBB  
 PETERSEN

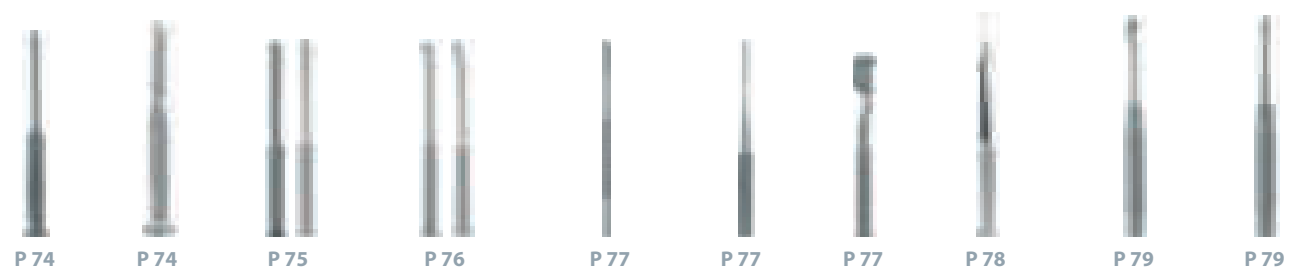

## Râpes - Rasps - Raspas

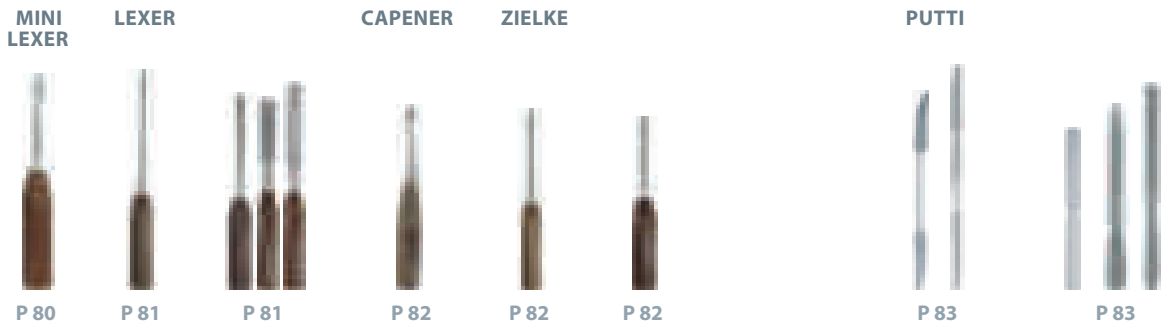

## Maillets - Mallets - Martillos



## Poinçons - Punches - Punzones

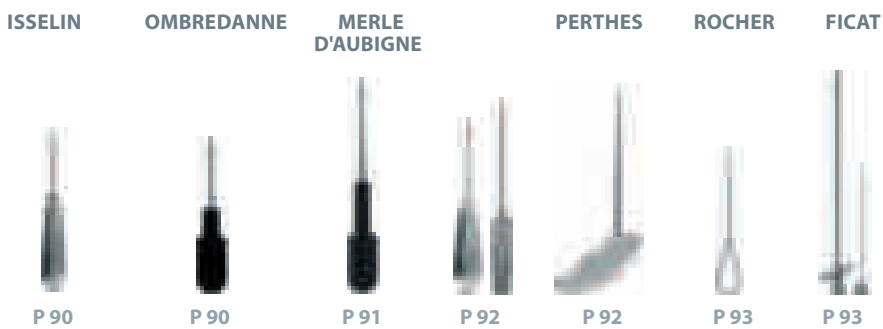

## Crochets - Hooks - Ganchos

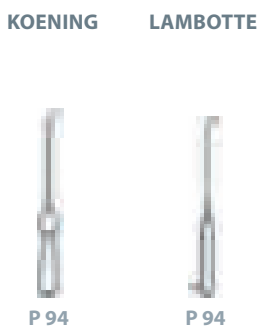

## Goniomètres - Goniometers - Goniometros

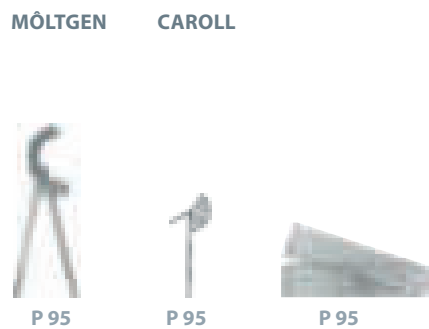

## Mesureurs - Measures - Medidores



## Pinces gouges - Bone rongeur forceps - Pinzas gubias

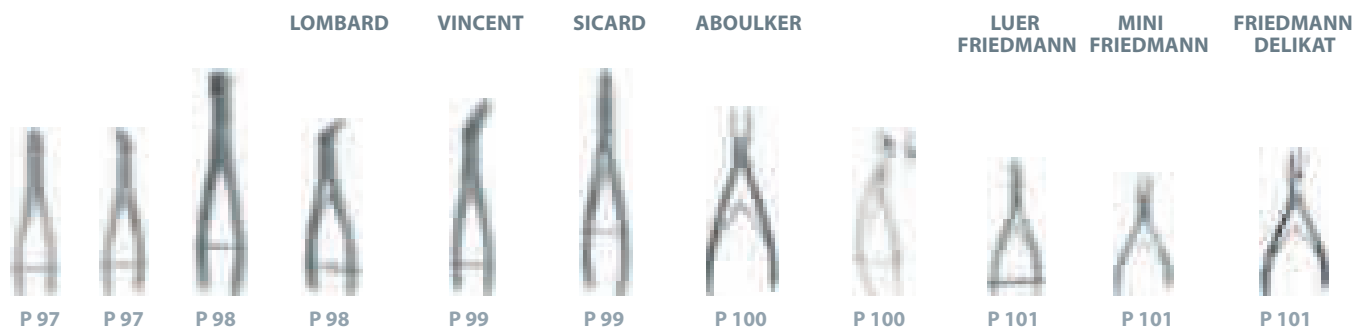



BLUMENTHAL    MEAD    LUER    CLEVELAND    HAKANSSON    LUER    ADSON    STELLBRINK    BANE HARTMANN    JANSEN



P 102



P 102



P 103



P 103



P 103



P 104



P 104



P 105



P 105



P 105

OLIVECRONA    BEYER    LEMPERT    NORTHFIELD    PENNYBACKER    JANSEN    STOOKEY    BACON    BOEHLER



P 106



P 106



P 106



P 107



P 107



P 108



P 108



P 108



P 109

BEYER    BEYER    MARQUARDT    MAYFIELD    RUSKIN    STILLE    RÖTTGEN RUSKIN    SMITH PETERSEN    LEKSELL STILLE    ECHLIN    FRYKHOLM



P 109



P 109



P 110



P 110



P 110



P 111



P 112



P 112



P 112



P 113



P 113

SAUERBRUCH    DAVID    SEMB    STILLE LUER



P 114



P 114



P 115



P 115

## Pinces coupantes - Bone cutting forceps - Pinzas cortantes

LISTON    LITTAUER LISTON    CLEVELAND    KAZANJIAN    RUSKIN LISTON    BOEHLER    MACINDOE    LISTON    LISTON-KEY HORSLEY    SEMB



P 116



P 117



P 117



P 117



P 118



P 118



P 118



P 119













P 120







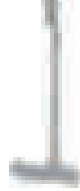





P 120

## Costotomes - Costotomes - Costotomos

<b>COLLIN</b>	<b>BETHUNE</b>	<b>MAURER</b>	<b>BRUNNER</b>	<b>GLUCK</b>	<b>GIERTZ STILLE</b>	<b>SAUERBRUCH FREY</b>	<b>SAUERBRUCH</b>	<b>VELPEAU TRICOISE</b>	<b>DOYEN</b>	<b>LEBSCHÉ</b>
										
P 121	P 122	P 122	P 123	P 123	P 123	P 124	P 124	P 125	P 125	P 125

## Daviers - Bone holding forceps - Pinzas para huesos

<b>REILL</b>	<b>DINGMANN</b>	<b>VERBRUGGE</b>	<b>LANDANGER</b>	<b>VERBRUGGE</b>	<b>VERBRUGGE</b>	<b>FARABEUF</b>	<b>LAMBOTTE</b>	<b>LANE</b>	<b>KERN</b>
									
P 126	P 127	P 127	P 128	P 129	P 130	P 132	P 133	P 134	P 134

<b>OLLIER</b>	<b>SETTER</b>	<b>HEY GROVES</b>	<b>SEMB</b>	<b>LANGENBECK</b>	<b>FERGUSON</b>	<b>OLLIER</b>	<b>Résection Resection Resección</b>	<b>A sequestre Sequester Secuestro</b>	<b>Distraction Distractor Distracción</b>
									
P 135	P 136	P 136	P 137	P 138	P 138	P 139	P 139	P 1379	P 140

## Écarteur - Retractor - Separador



<b>LOWMAN HUGLUND</b>	<b>LOWMAN</b>	<b>MUSEUX</b>	<b>LERAT</b>	<b>LEWIN</b>	<b>CHARNLEY</b>
					
P 140	P 140	P 141	P 141	P 141	P 142

## Mains de plomb - Lead hands - Manos de plomo

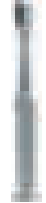

P 142

## Chasse-greffons - Grafts pusher - Empujador de injertos

<b>TRILLAT</b>	<b>DEMOISELLE</b>	<b>PASSOW</b>
		
P 143	P 143	P 143



P 144

## Instrumentation pour épaule - Shoulder instrumentation - Instrumentación para hombro

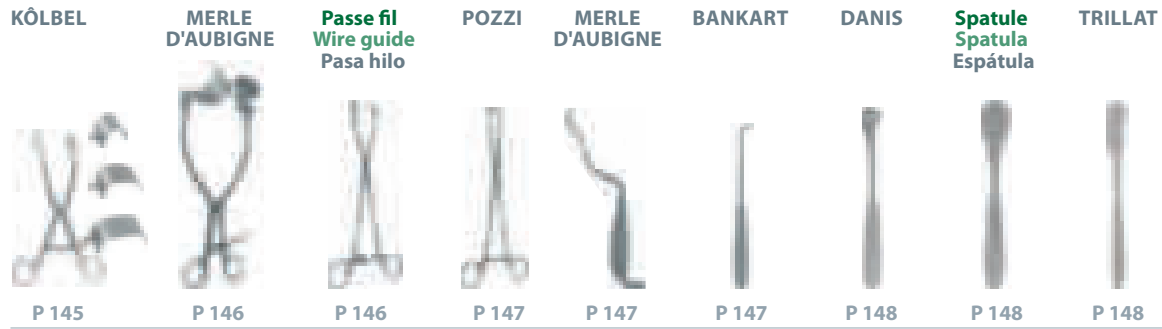

## Pour ligatures - For ligatures - Para ligaduras



## Pour ménisque - For meniscus - Para menisco



## Pour genou - For knee - Para rodilla

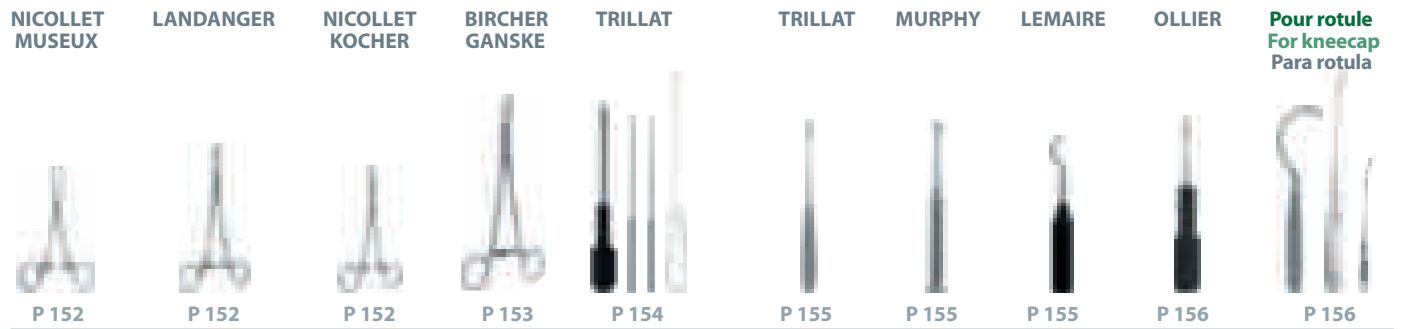

## Étriers de traction - Traction bows - Estribos de tracción

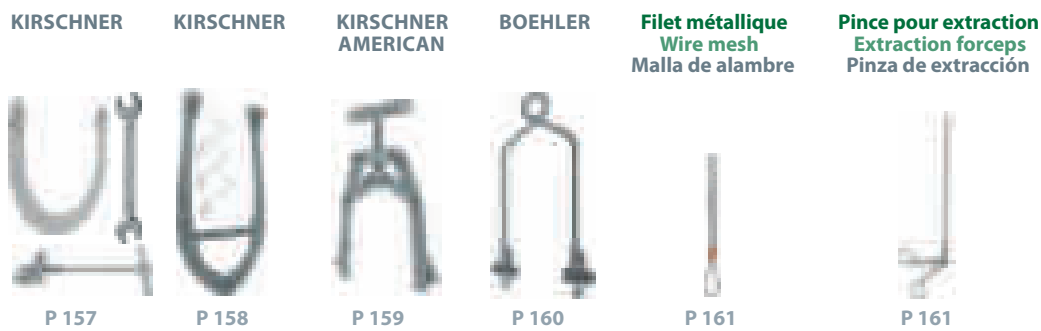

## Ciseaux pour chirurgie osseuse - Bone surgery scissors - Tijeras para cirugía ósea

III - Ciseaux  
III - Scissors  
III - Tijeras

Ciseaux à ménisque  
Meniscus scissors  
Tijeras para menisco

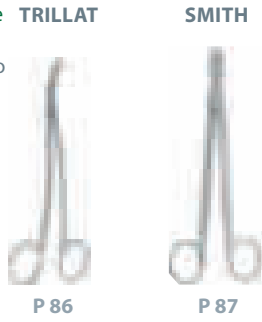

VII - Ecarteurs  
VII - Retractors  
VII - Separadores

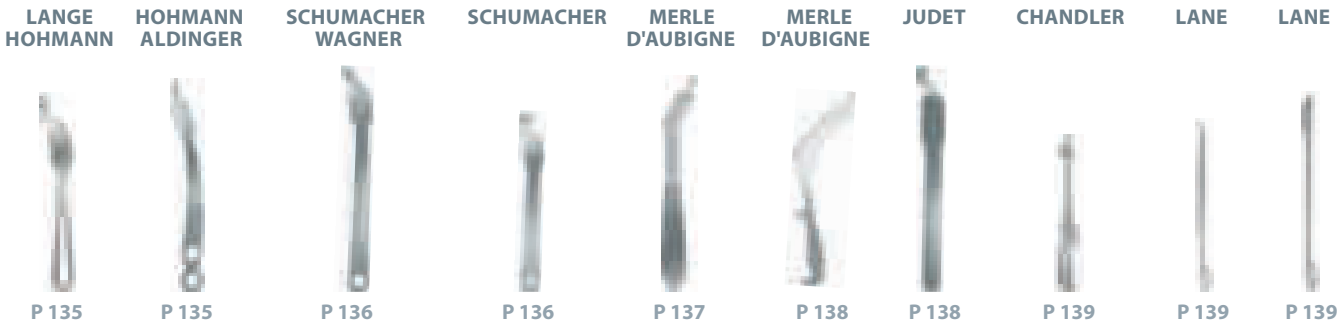
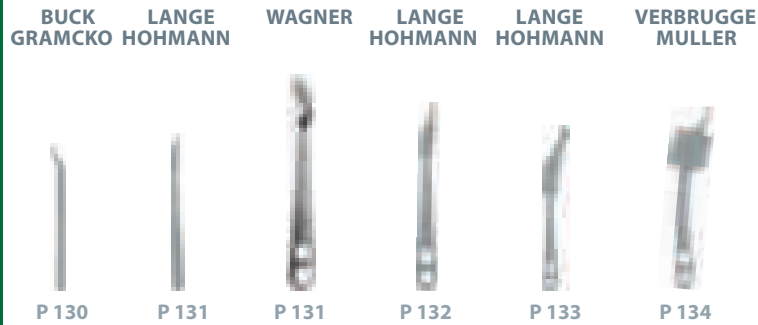

XII - O.R.L.  
XII - E.N.T.  
XII - O.R.L.

## O.R.L. burins et gouges - E.N.T. chisels and gouges - O.R.L. cinceles y gubias

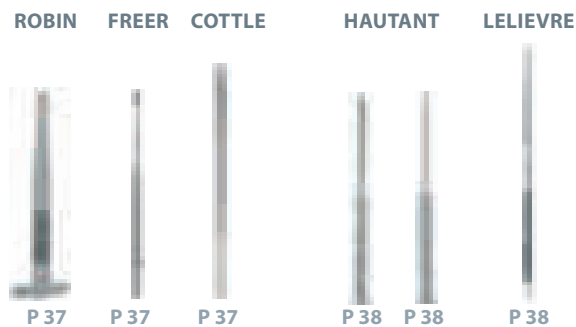

XIII - Osseux  
XIII - Bone surgery  
XIII - Cirugía ósea

O.R.L. râpes - E.N.T. rasps - O.R.L. raspas

XII - O.R.L.  
XII - E.N.T.  
XII - O.R.L.

TAKAHASHI DUFORMENTEL MALTZ GALLAHER LEWIS COTTLE AUFRICHT MILLER FOMON

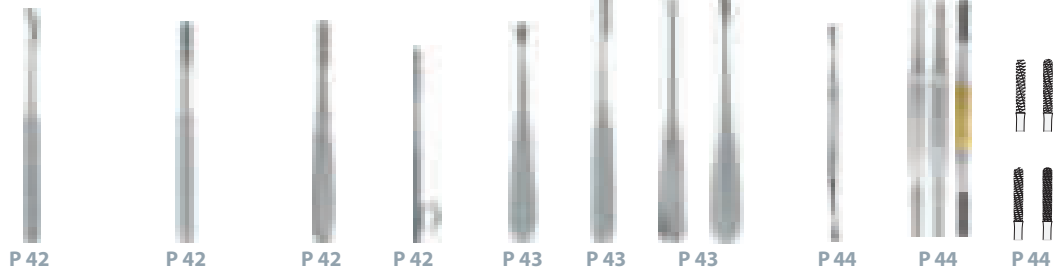

Passe fil  
Wire guide  
Guia - hilo

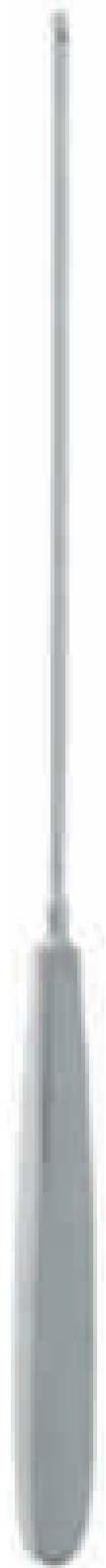

**J04010**  
28 cm - 11 "

Décolleur  
Detachet  
Disector

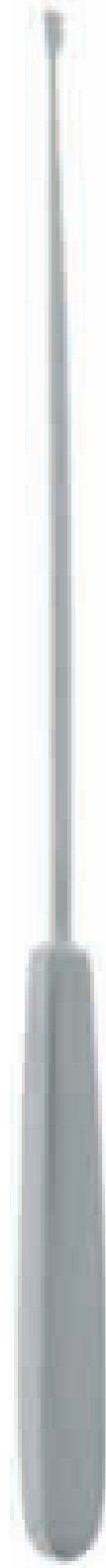

**J04040**  
28 cm - 11 "

## BUNNEL

Guide  
Guide  
Guia

Malléable  
Malleable  
Maleable



**J040410**  
23 cm - 9 "

## BRAND

Guide  
Guide  
Guia



3 mm

**J040420**



30 cm - 11 <sup>3</sup>/<sub>4</sub> "



6 mm

**J040430**

50 cm - 19 <sup>3</sup>/<sub>4</sub> "

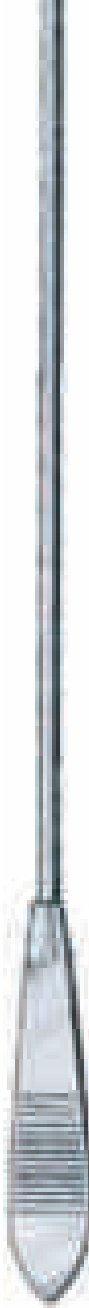

**J040420**  
30 cm - 11 <sup>3</sup>/<sub>4</sub> "

### BUNNEL

Rugine  
Raspatory  
Raspador



**J04050**  
18 cm - 7 "

Crochet  
Hook  
Gancho

9 mm      6 mm

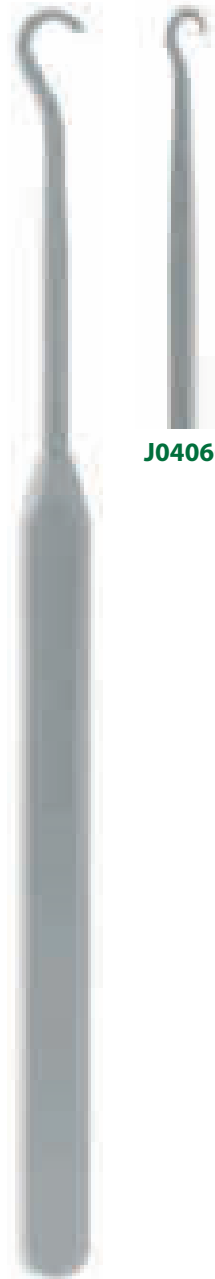

**J04070**  
17 cm - 6 <sup>3</sup>/<sub>4</sub> "

**J04060**

Stripper à tendons  
Tendon stripper  
Enucleator de tendones

Ø 2 mm      **J040802**

Ø 3 mm      **J040803** 

Ø 4 mm      **J040804**

Ø 6 mm      **J040806**



**J040803**  
15 cm - 6 "

### KLEINERT-KUTZ

Pour saisir les tendons - To grasp Tendons - Para coger tendones



**J041090**  
11 cm - 4 1/2 "

### CAROLL



### STEINMANN



**J041095**  
20 cm - 8 "

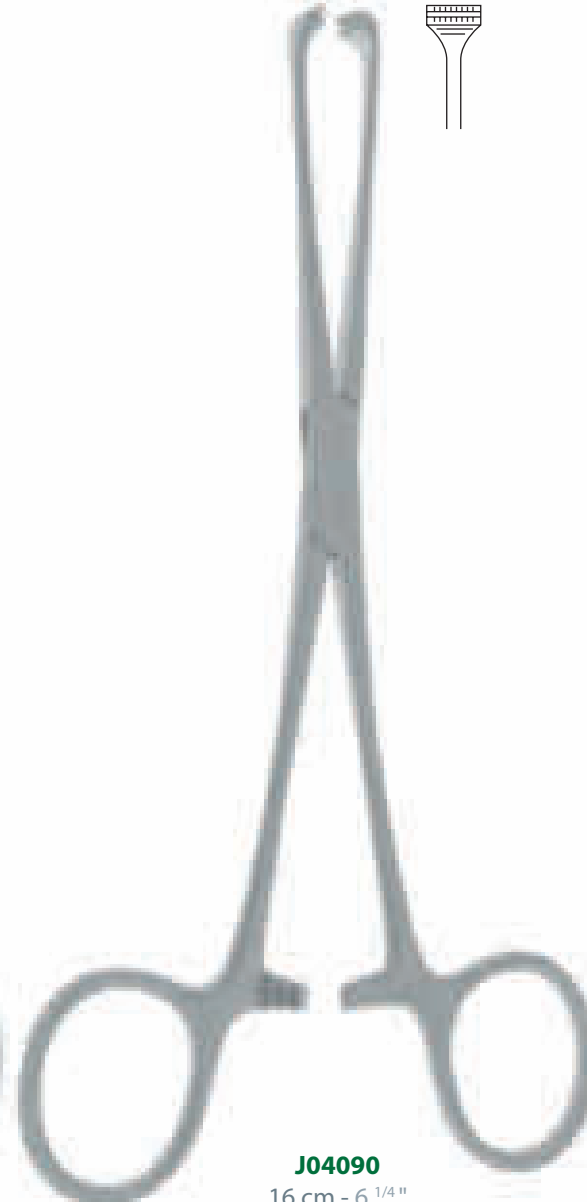

**J04090**  
16 cm - 6 1/4 "





### STEINMANN

### BRAND

Pour saisir les tendons - To grasp Tendons - Para coger tendones



**J041060**  
13 cm - 5 "

	Courbe Curved Curva	Droite Straight Recta
	<b>J041030</b> 15 cm - 5 3/4 "	<b>J041000</b>
	<b>J041040</b> 19 cm - 7 1/2 "	<b>J041010</b>
	<b>J041050</b> 24 cm - 9 1/2 "	<b>J041020</b>

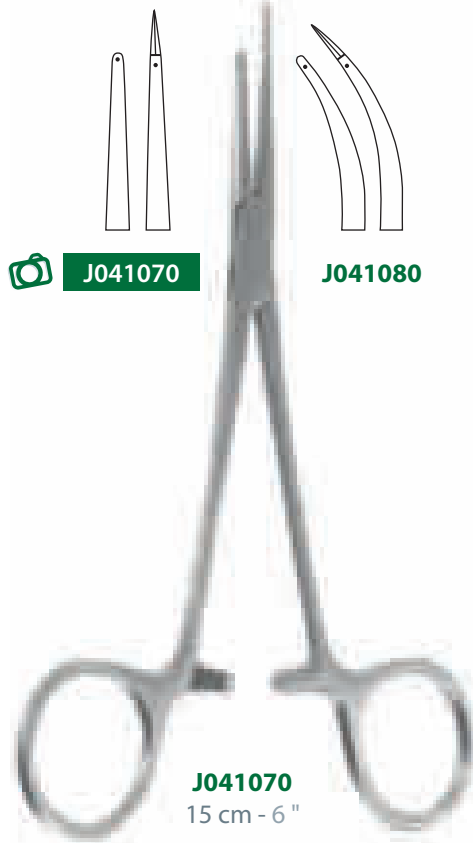
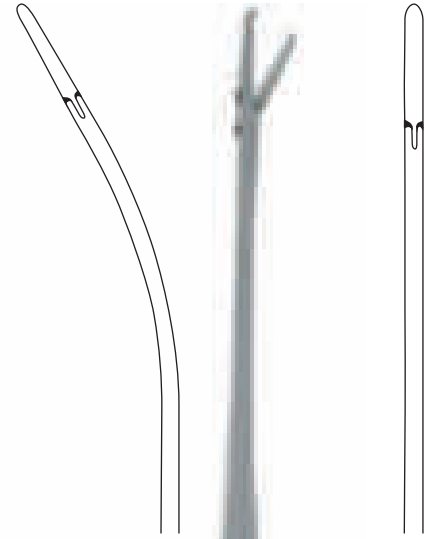

**J041070**

**J041080**

**J041070**  
15 cm - 6 "

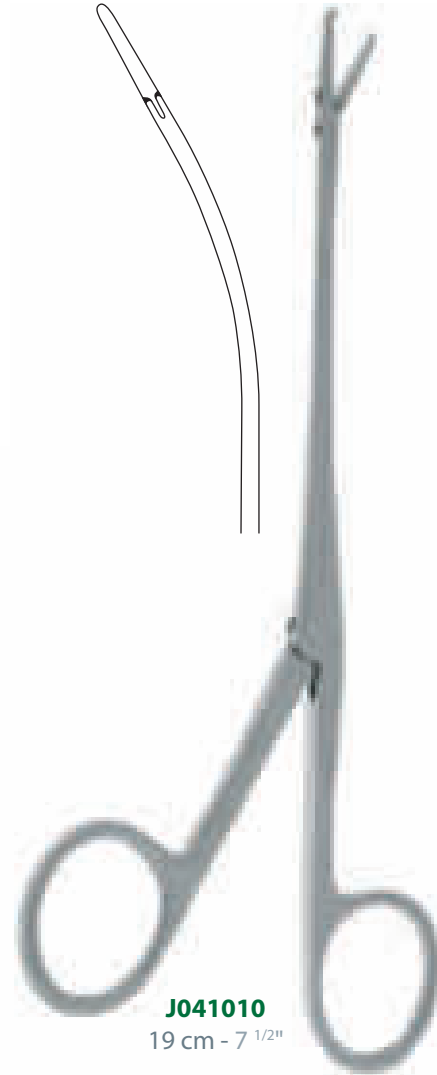

**J041010**  
19 cm - 7 1/2 "

## LISTON

## VIRCHOW

### COUTEAUX À CERVEAU BRAIN KNIVES CUCHILLOS PARA CEREBRO

190 mm

Lame  
Blade  
Hoja

130 mm

**J120649**

26,5 cm - 10 1/2"

160 mm

**J120650**

29,5 cm - 11 1/2"

190 mm

**J120651**

32,5 cm - 12 3/4"

220 mm

**J120652**

35,5 cm - 14"

**J120650**

29,5 cm - 11 1/2"

Lame  
Blade  
Hoja

150 mm

**J12030**

26 cm - 10 1/4"

200 mm

**J12060**

31 cm - 12 1/4"

**J12030**

26 cm - 10 1/4"

Lame  
Blade  
Hoja

160 mm

**J141290**

28 cm - 11"

200 mm

**J141300**

32 cm - 12 1/2"

240 mm

**J141310**

36 cm - 14 1/4"

**J141300**

32 cm - 12 1/2"

195 mm

**J14140**

31 cm - 12 1/4"

## CATLIN

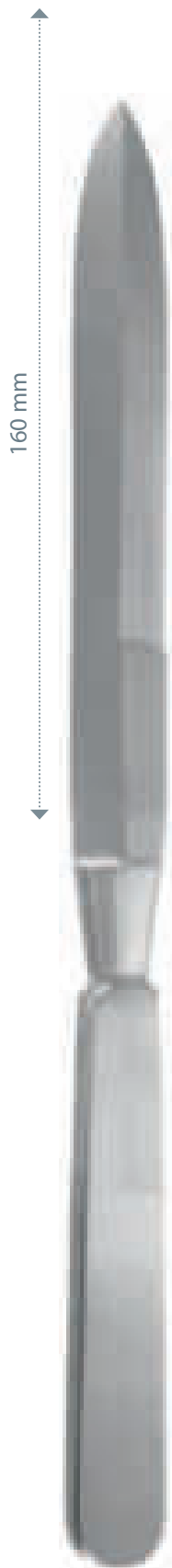

**J141100**  
28 cm - 11"

## LANGENBECK

Couteaux pour lobes  
Flap knives  
Cuchillos para lóbulos

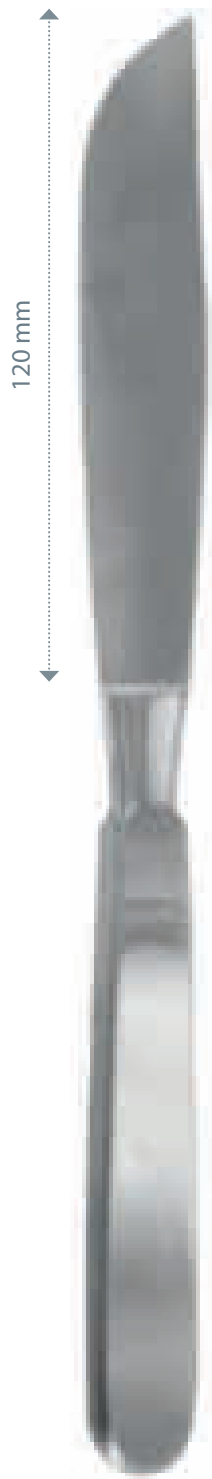

**J141110**  
26 cm - 10 1/4"

Couteau inter-osseux  
Interosseous knife  
Cuchillo interóseo



**J141120**  
25 cm - 10"

Couteau à phalanges  
Phalangeal knife  
Cuchillo para falanges

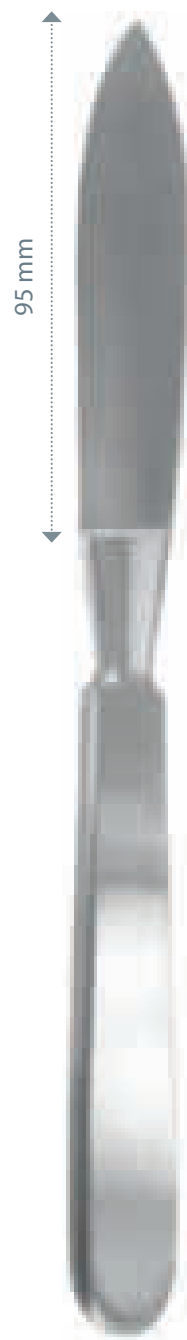

**J141130**  
23 cm - 9"

## LANGENBECK

## VIRCHOW

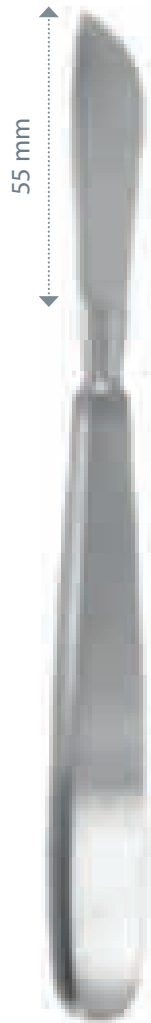

**J141140**  
18 cm - 7"

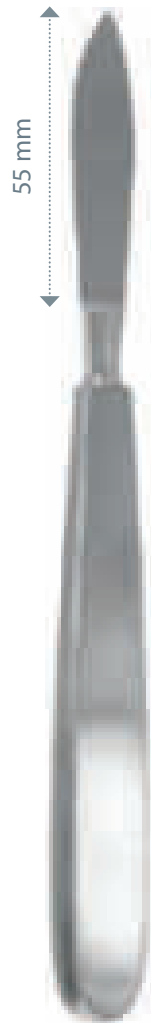

**J141150**  
18 cm - 7"



**J141160**  
25 cm - 10"

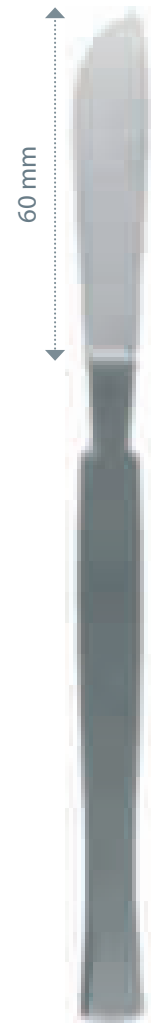

**J141200**  
17,5 cm - 7"

## LANGENBECK (LARREY)



**J12230**  
23 cm - 9"

## POSTEL

Lame seule  
Blade only  
Hoja sólo

**J120932**  
23 cm - 9"

Lame seule  
Blade only  
Hoja sólo

**J120710**  
14,5 cm - 5 <sup>3</sup>/<sub>4</sub> "

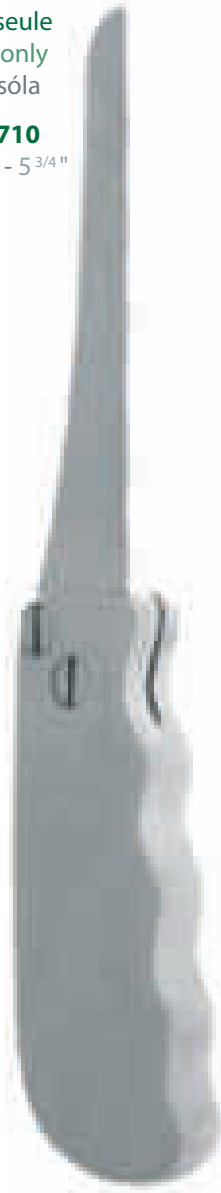

**J120700**  
23,5 cm - 9 <sup>1</sup>/<sub>4</sub> "

## SATTERLEE



**J120931**  
31 cm - 12 <sup>1</sup>/<sub>4</sub> "

## CHARRIERE

27 cm - 10 <sup>3</sup>/<sub>4</sub> "

**J120827**



30 cm - 11 <sup>3</sup>/<sub>4</sub> "

**J120830**

Lame seule  
Blade only  
Hoja sólo

18,3 cm - 7 <sup>1</sup>/<sub>4</sub> "

**J120828**

21,3 cm - 8 <sup>1</sup>/<sub>2</sub> "

**J120831**

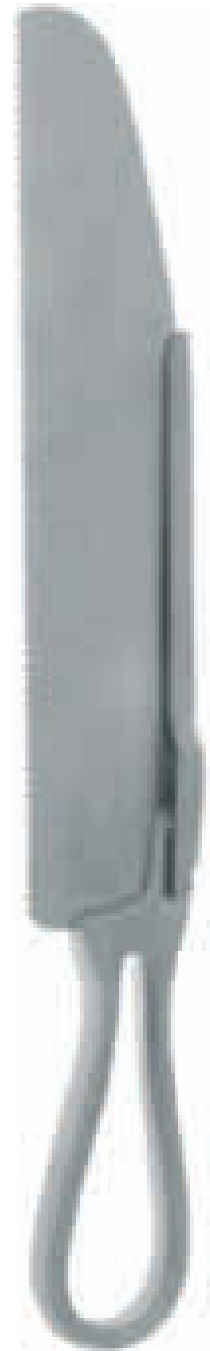

**J120827**  
27 cm - 10 <sup>3</sup>/<sub>4</sub> "

### CHARRIERE

Complète avec 2 lames  
Complete with 2 blades  
Completa con 2 hojas

Lame seule - Blade only - Hoja sólo

12 mm **J121612**

15 mm **J121615**

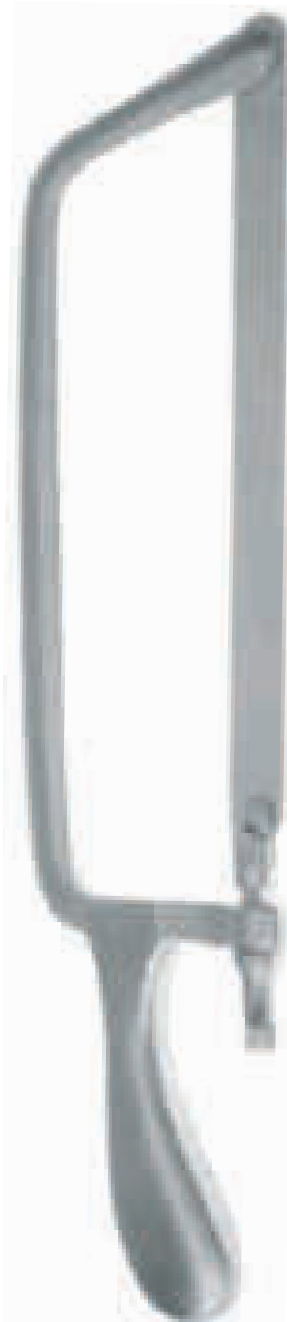

**J121610**

35 cm - 13 <sup>3</sup>/<sub>4</sub> "

### FARABEUF

Complète avec 3 lames  
Complete with 3 blades  
Completa con 3 hojas

Lame seule - Blade only - Hoja sólo

8 mm **J12190**

16 mm **J12220**

20 mm **J12225**



**J12180**

37 cm - 14 <sup>1</sup>/<sub>2</sub> "

### HELFERICH-BIER

Complète avec 3 lames  
Complete with 3 blades  
Completa con 3 hojas

Lame seule  
Blade only  
Hoja sólo

4 mm **J121623**

6 mm **J121625**

8 mm **J121627**



**J121620**

42 cm - 16 <sup>1</sup>/<sub>4</sub> "

### GIGLI

### DE MARTEL

Conducteur à crochet simple  
 Conductor with simple hook  
 Conductor con ganchura simple



- 30 cm - 11 <sup>3</sup>/<sub>4</sub> " **J122530**
- 40 cm - 15 <sup>3</sup>/<sub>4</sub> " **J122540**
- 45 cm - 17 <sup>3</sup>/<sub>4</sub> " **J12250**
- 50 cm - 19 <sup>3</sup>/<sub>4</sub> " **J122550**

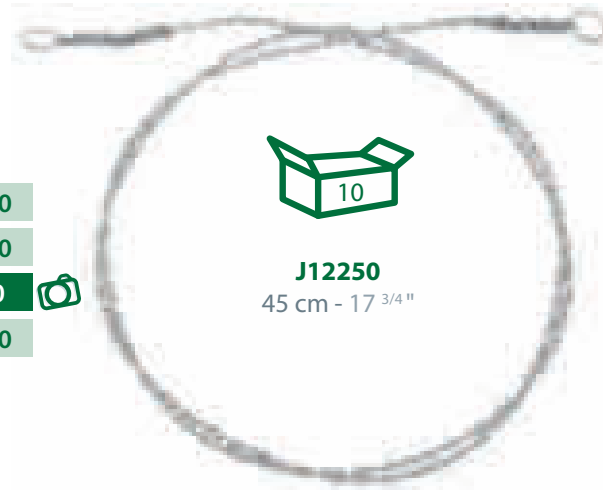

**J12250**  
 45 cm - 17 <sup>3</sup>/<sub>4</sub> "

### OLIVECRONA



- 30 cm - 11 <sup>3</sup>/<sub>4</sub> " **J122590**
- 40 cm - 15 <sup>3</sup>/<sub>4</sub> " **J12260**
- 50 cm - 19 <sup>3</sup>/<sub>4</sub> " **J122610**



**J12260**  
 40 cm - 15 <sup>3</sup>/<sub>4</sub> "

Poignée pour scie  
 Handle for saw  
 Puñado para sierra



**J12240**



**J12285**  
 35 cm - 13 <sup>3</sup>/<sub>4</sub> "

### PERCY



**J12270**

### ENGEL

Pour os et plâtre  
For bone and plaster  
Para hueso y yeso



**J14090**  
15 cm - 6"





BURIN POUR LE CRÂNE  
SKULL BREAKER  
CINCEL ROMPE-CRÂNEO



**J140310**  
14 cm - 5 1/2"

CROCHETS POUR MUSCLES  
MUSCLE HOOKS  
GANCHOS MUSCULARES

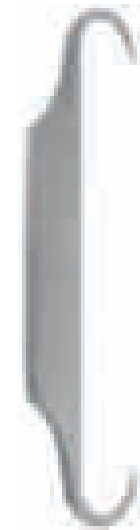

**J140400**  
7 cm - 2 3/4"

22 mm

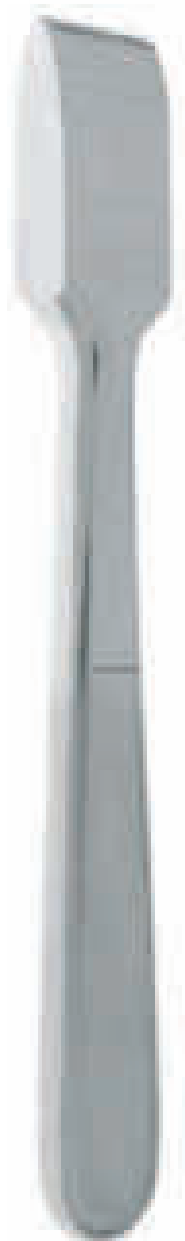

**J14020**  
16,5 cm - 6 1/2"

22 mm

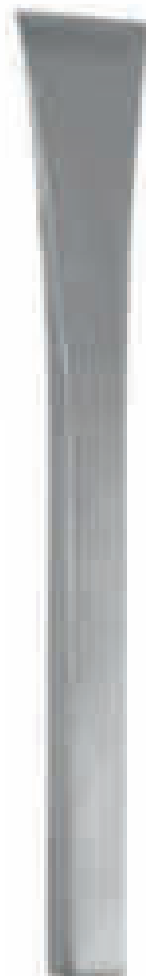

**J140210**  
13 cm - 5"

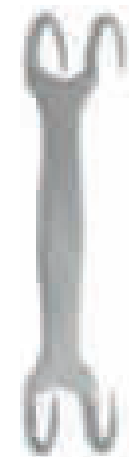

**J140410**  
6 cm - 2 1/4"

## BRUNETTI



15 mm

**J140620**

RACHITOME  
RACHITOME  
RAQUIOTOMO



**J140710**

22 cm - 8<sup>3/4</sup> "

AIGUILLES  
NEEDLES  
AGUJAS

N° 1 - 135 mm **J140801**

N° 2 - 125 mm **J140802** 

N° 3 - 110 mm **J140803**

N° 4 - 100 mm **J140804**

N° 5 - 85 mm **J140805**

N° 6 - 75 mm **J140806**



**J140802**

12,5 cm - 5 "



1/1

FISH

ADSON

CLOWARD

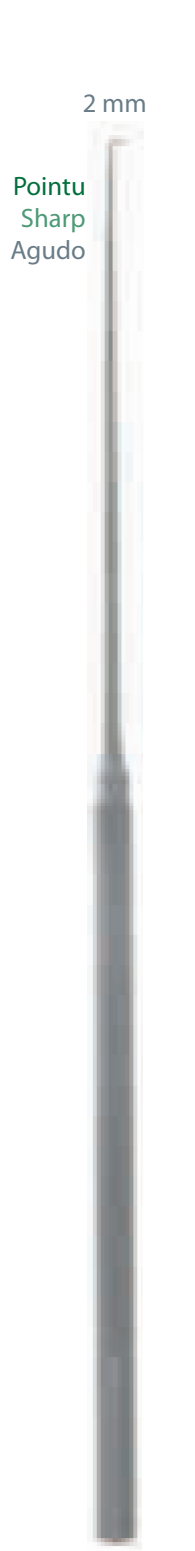

**J08035**  
18,5 cm - 7 1/4 "

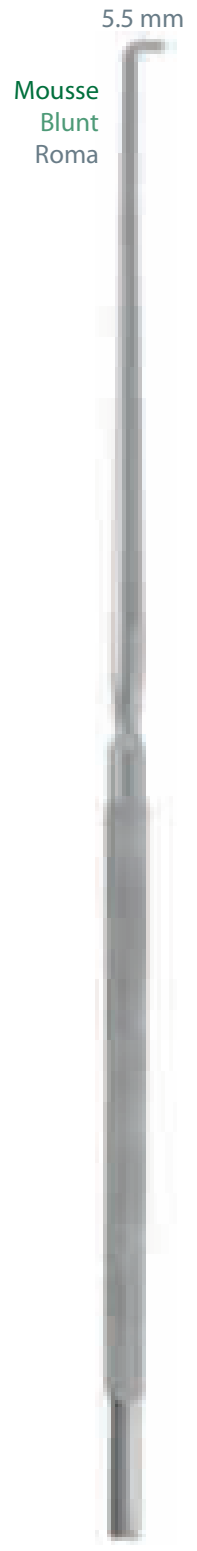

**J162320**  
20 cm - 8 "

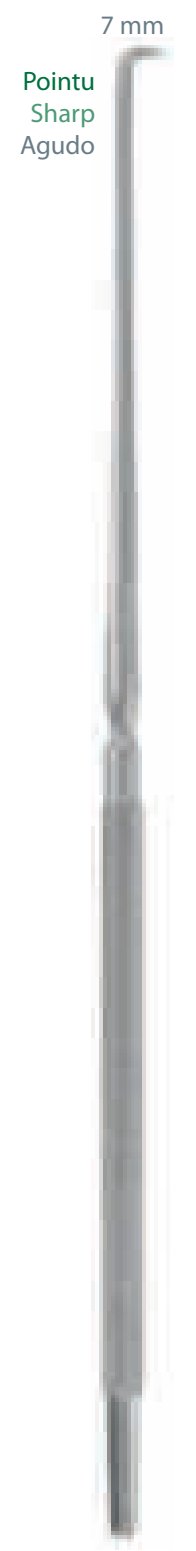

**J162330**  
20 cm - 8 "



**J162310**  
16 cm - 6 1/2 "

### CRILE

7 mm



**J162350**  
20 cm - 8"

### CUSHING



**J16240**

19 cm - 7 1/2"

**J16245**



**J162410**

28 cm - 11"

**J162460**

4 mm

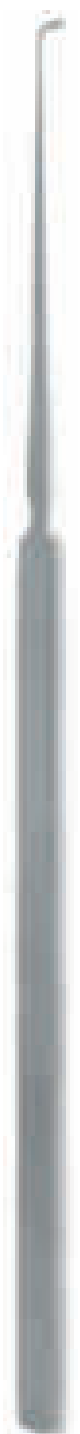

**J16240**  
19 cm - 7 1/2"

6 mm

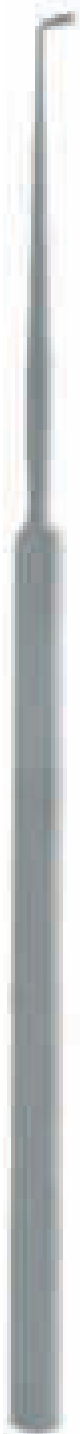

**J16245**  
19 cm - 7 1/2"

### CASPAR

4 mm

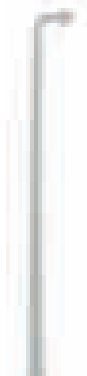

**J162801**

5,5 mm

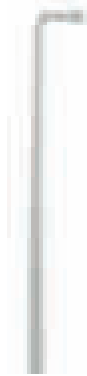

**J162802**



7 mm



**J162803**



4/5



**J162802**  
24,5 cm - 9 5/8"





### OLIVECRONA

### RIZZUTI

### FREER

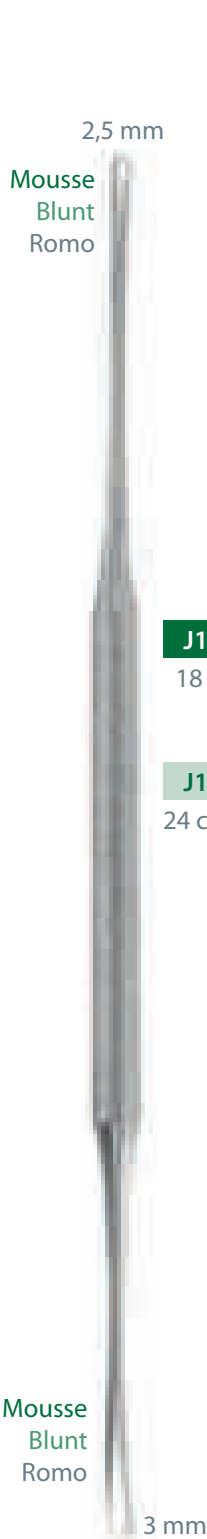
### FREER-YASARGIL



**J162230**   
18 cm - 7"

**J162240**  
24 cm - 9 1/2"

**J162230**  
18 cm - 7"

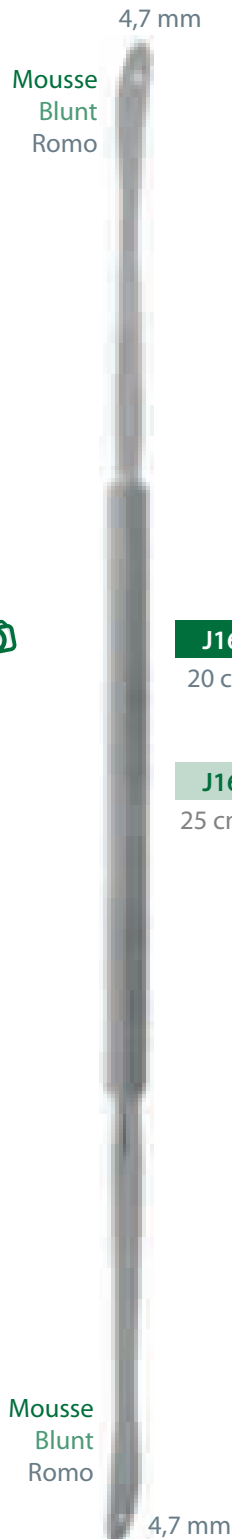

**J16260**   
20 cm - 8"

**J16265**  
25 cm - 10"

**J16260**  
20 cm - 8"



**J243720**  
18,5 cm - 7 1/4"

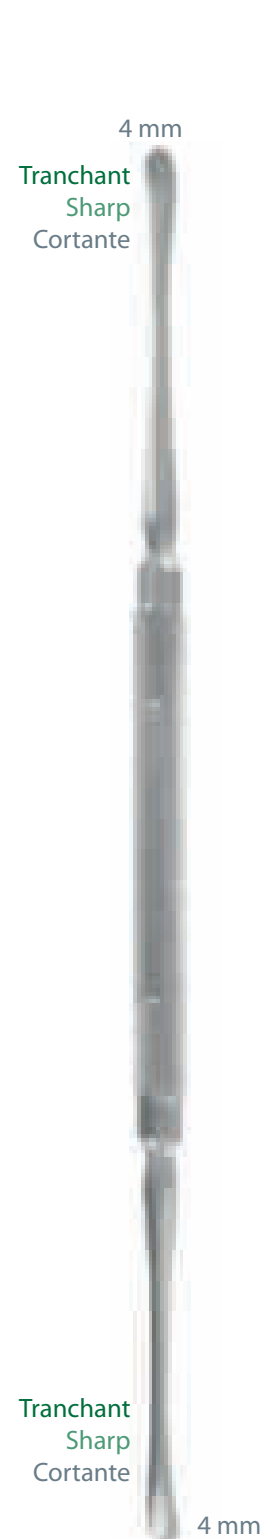

**J243721**  
18,5 cm - 7 1/4"

## Rugines et dissecteurs - Raspatories and elevators - Raspadores y elevadores



## Rugines et dissecteurs - Raspatories and elevators - Raspadores y elevadores

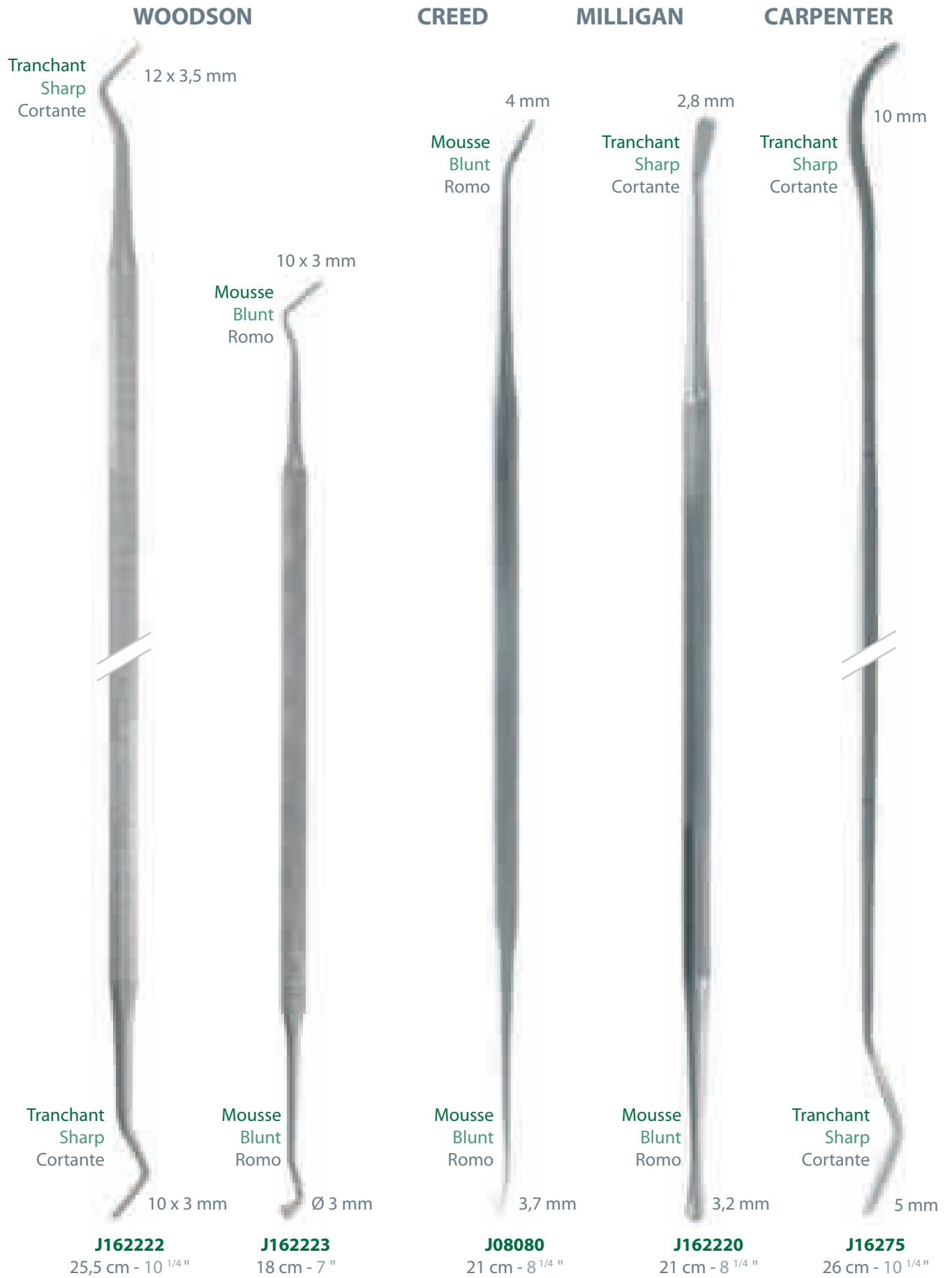

XIII - Osseux  
XIII - Bones surgery  
XIII - Cirugía osea

### ROBB

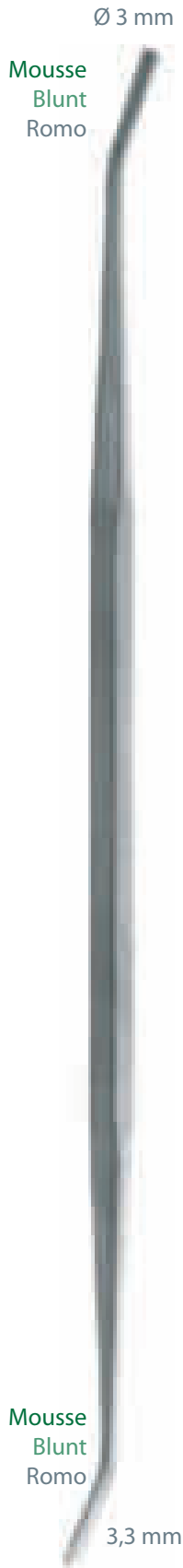

**J16270**  
22 cm - 8 3/4 "

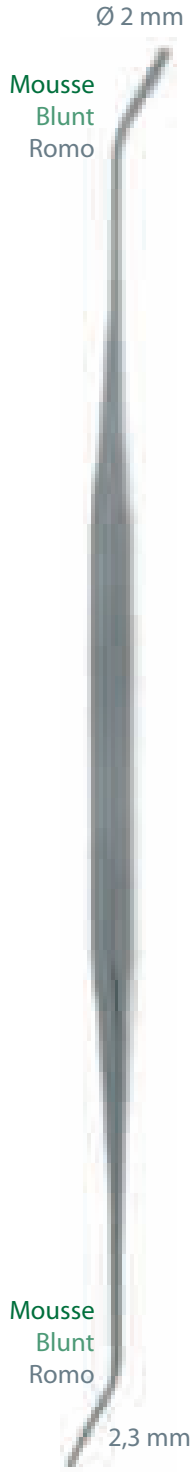

**J162702**  
19 cm - 7 1/2 "

### SYME

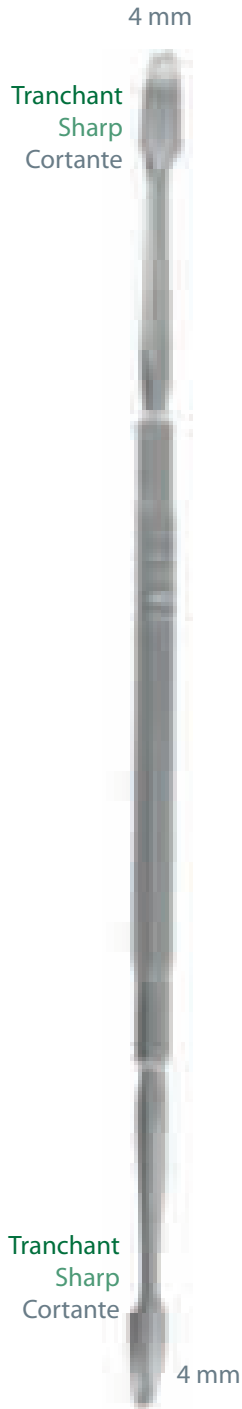

**J235505**  
18,5 cm - 7 1/4 "

### JOST



**J162710**  
20 cm - 8 "

### ALEXANDER



**J162720**  
21 cm - 8 1/4 "



### PENFIELD



### MC DONALD

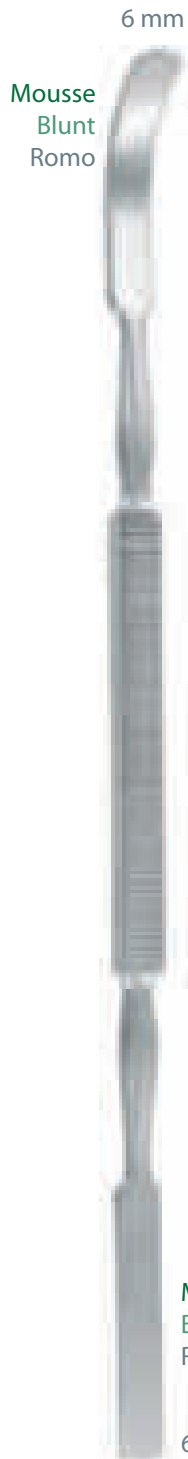

**J243724**  
19 cm - 7 1/2 "

### YASARGIL

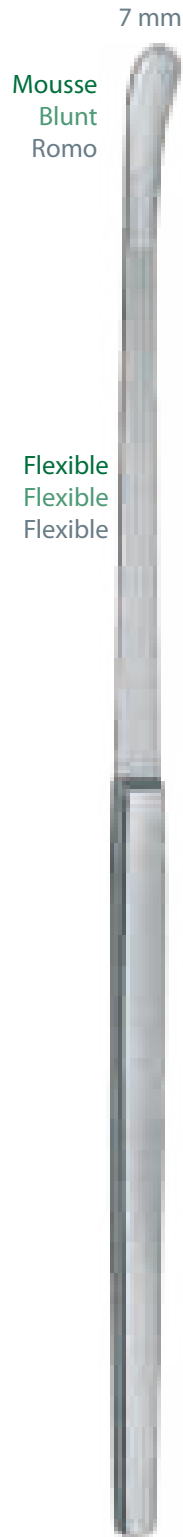

**J243726**  
19,5 cm - 7 3/4 "

### COTTLE

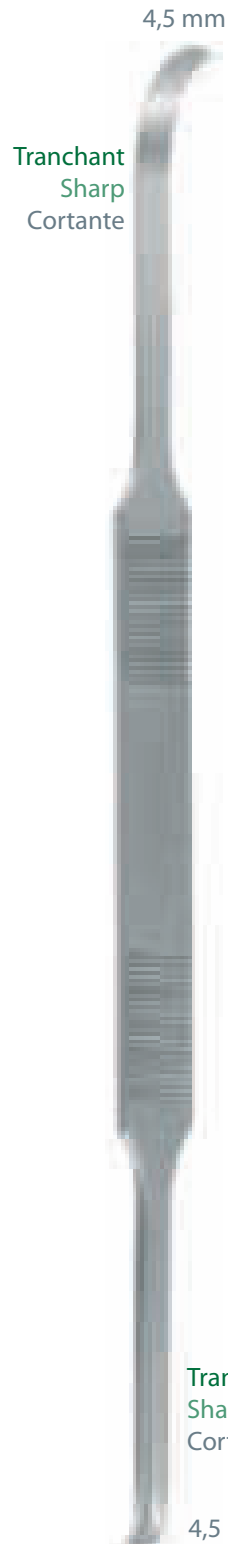

**J243727**  
20 cm - 8 "

### WATSON CHEYNE



**J243712**  
17,5 cm - 7 "

### TOENNIS

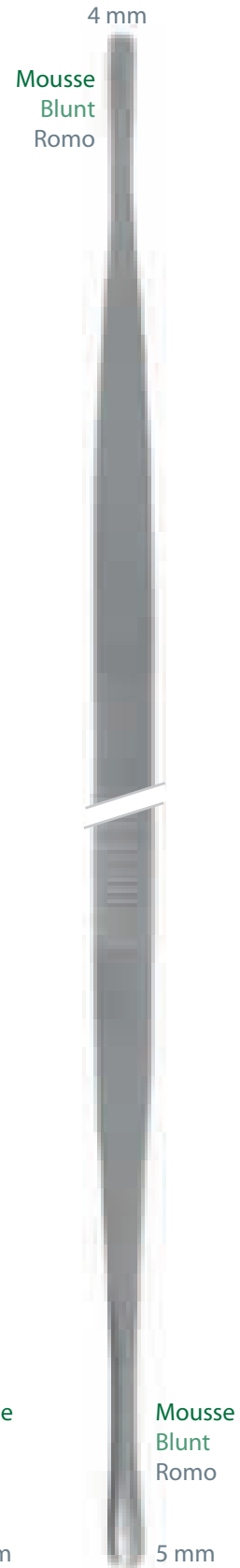

**J243713**  
24 cm - 9 1/2 "

### HALLE

### ABOULKER



### LERICHE



Mousse  
Blunt  
Romo

5 mm

16 cm - 6 1/4 "

**J24378** 3 mm

**J24380** 4 mm

**J24390** 5 mm

**J243910** 6 mm

**J243920** 7 mm

20 cm - 8 "

**J243990** 3 mm

**J24400** 4 mm

**J24405** 5 mm 

**J24410** 6 mm

25 cm - 10 "

**J244130** 3 mm

**J244140** 4 mm

**J24415** 5 mm

**J24420** 6 mm

**J24425** 7 mm

**J24405**  
20 cm - 8 "

### LANGENBECK

11 mm

8 mm **J244300**   
10 mm **J244310**

Mousse  
Blunt  
Romo



Mousse  
Blunt  
Romo

8 mm

**J244300**  
20 cm - 8 "

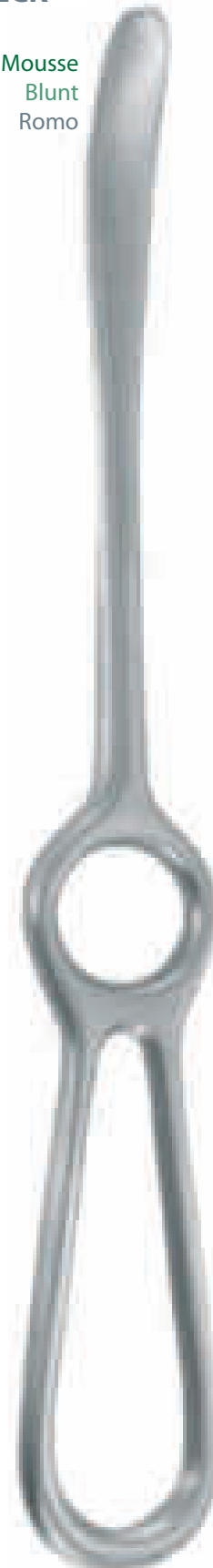

**J244320**  
23 cm - 9 "

LEBEAU

YANKAUER

SEBILEAU

HOEN

16 cm - 6 1/4"	<b>J244350</b>	7 mm 
18,5 cm - 7 1/4"	<b>J244360</b>	15 mm
19 cm - 7 1/2"	<b>J244370</b>	20 mm



**J162210**  
18 cm - 7"



**J244330**  
18 cm - 7"

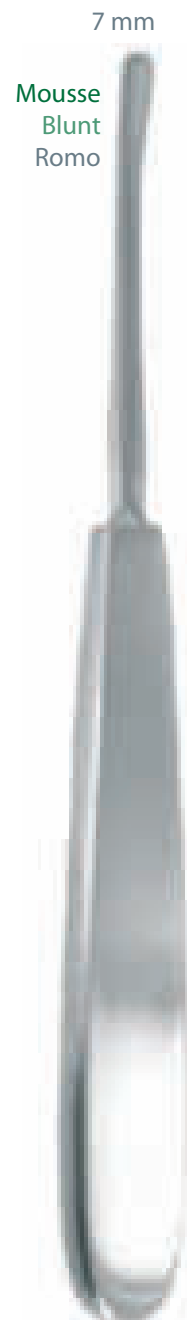

**J244340**  
17 cm - 6 3/4"

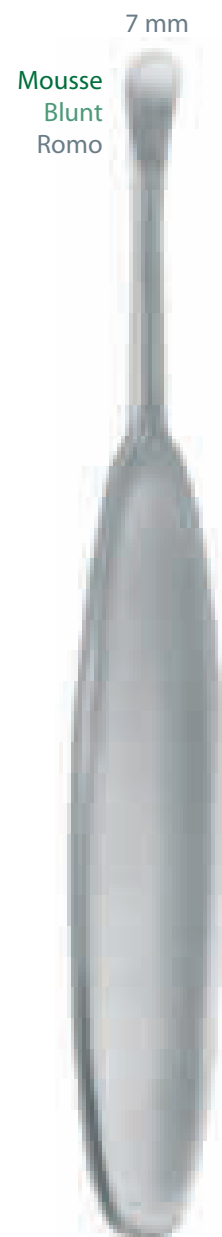

**J244350**  
16 cm - 6 1/4"

### KÖNIG

### WILLIGER

6 mm **J24373** 

16 cm - 6 1/4" **J243729** 5,0 mm 

8 mm **J243731**

17 cm - 6 1/4" **J243732** 5,5 mm

4,5 mm  
Mousse  
Blunt  
Romo



**J243735**  
15,5 cm - 6 "

4,5 mm

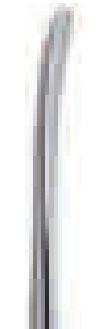

**J243735** 

4,5 mm



**J243736**

6 mm  
Tranchant  
Sharp  
Cortante



**J24373**  
16 cm - 6 1/4 "

5 mm

Mousse  
Blunt  
Romo



**J243729**  
16 cm - 6 1/4 "

4,5 mm

Tranchant  
Sharp  
Cortante



**J243728**  
12,5 cm - 5 "



### SEWALL

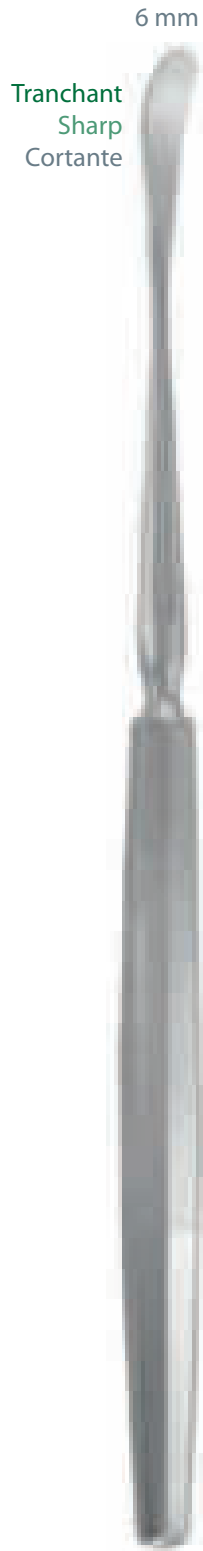

6 mm

Tranchant  
Sharp  
Cortante

**J080710**  
20 cm - 8"

### SACHS

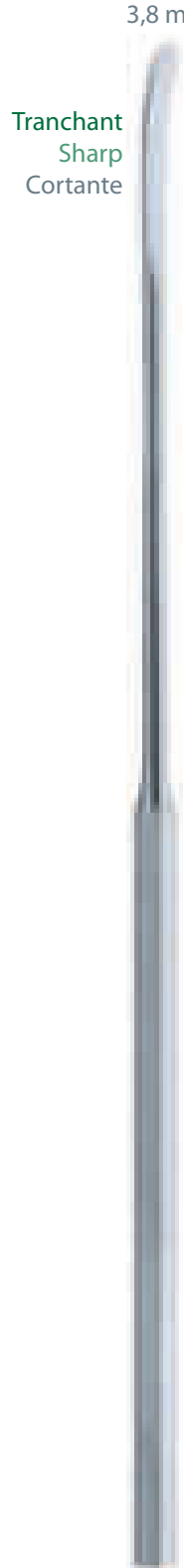

3,8 mm

Tranchant  
Sharp  
Cortante

**J081000**  
20,5 cm - 8"

3,2 mm

Mousse  
Blunt  
Romo

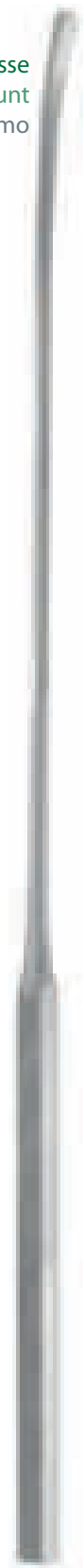

**J081010**  
21 cm - 8 1/4"

### HORSLEY



50 X 6 mm

Mousse  
Blunt  
Romo

**J081020**  
19,5 cm - 7 3/4"

### FRAZIER

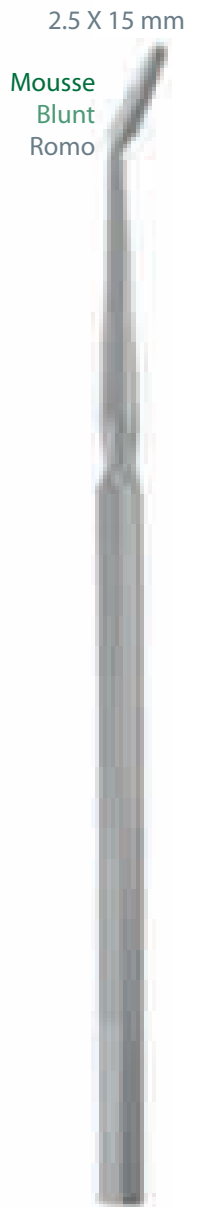

2,5 X 15 mm

Mousse  
Blunt  
Romo

**J081030**  
15 cm - 6"

### SICART

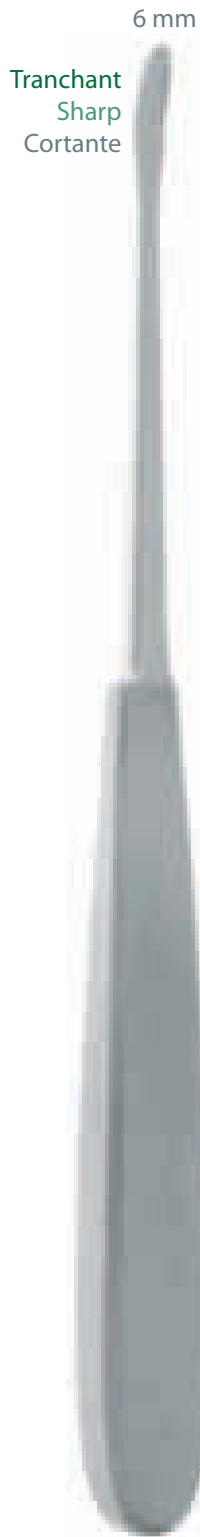

**J08060**  
20 cm - 8 "

### CAIRNS (CLOVIS VINCENT)



**J08070**  
19 cm - 7 1/2 "

### DE MARTEL

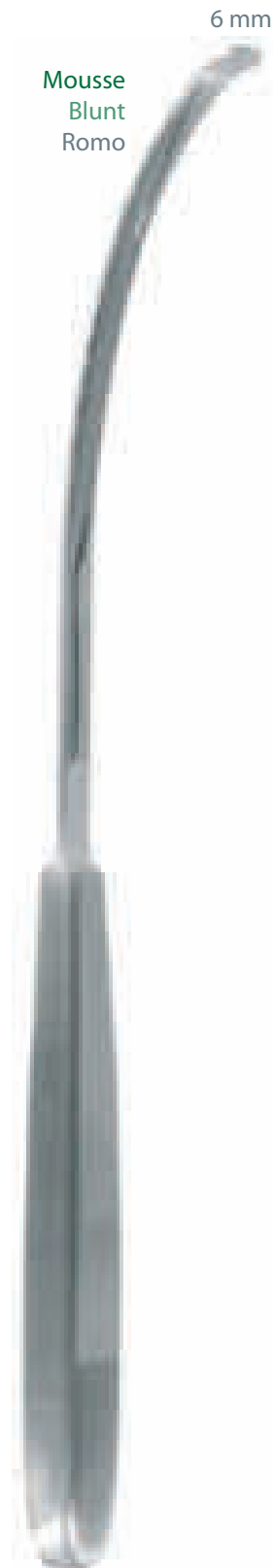

**J162200**  
21 cm - 8 1/4 "

### PETIT DUTAILLY



**J080900**  
20 cm - 8 "



ADSON

LOVE-ADSON

8 mm

Tranchant  
Sharp  
Cortante

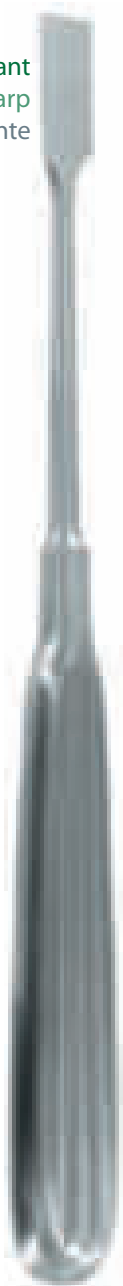

**J241910**  
17 cm - 6 3/4"

7 mm

Tranchant  
Sharp  
Cortante

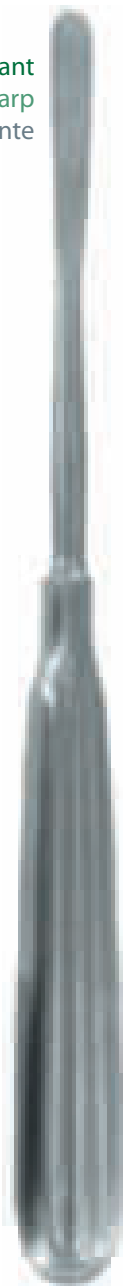

**J241912**  
17 cm - 6 3/4"

7 mm

Mousse  
Blunt  
Romo

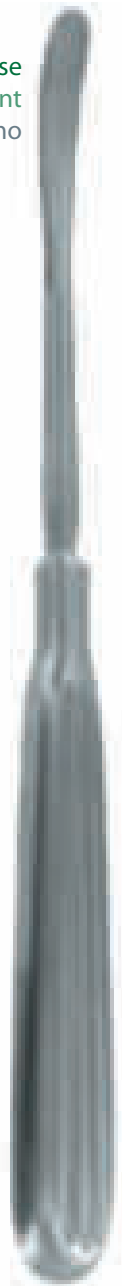

**J241911**  
17 cm - 6 3/4"

7 mm

Tranchant  
Sharp  
Cortante

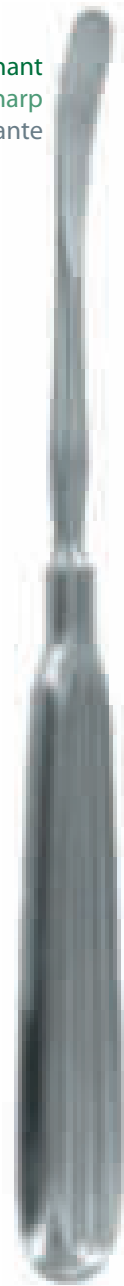

**J241913**  
17 cm - 6 3/4"

7,5 mm

Tranchant  
Sharp  
Cortante

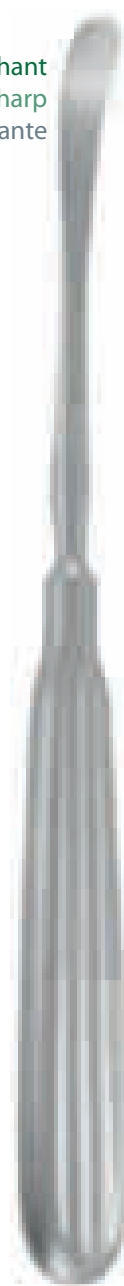

**J241915**  
17 cm - 6 3/4"

### MC KENTY

### CASPAR

6 mm **J245303**

8 mm **J245304** 

4 mm



**J245220**  
15 cm - 6 "

6 mm

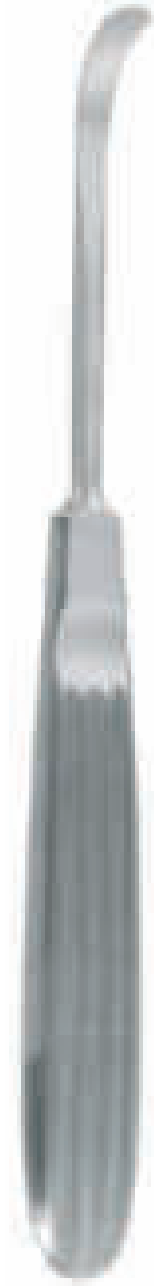

**J245301**  
17 cm - 6 <sup>3</sup>/<sub>4</sub> "

6,2 mm

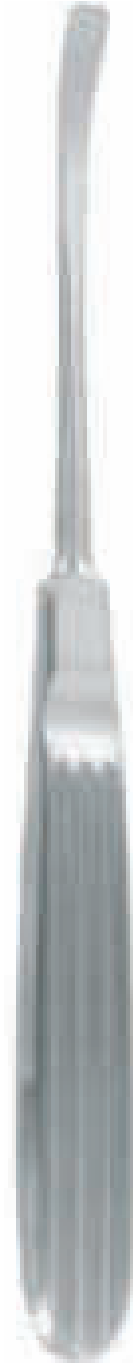

**J245302**  
18 cm - 7 "

8 mm

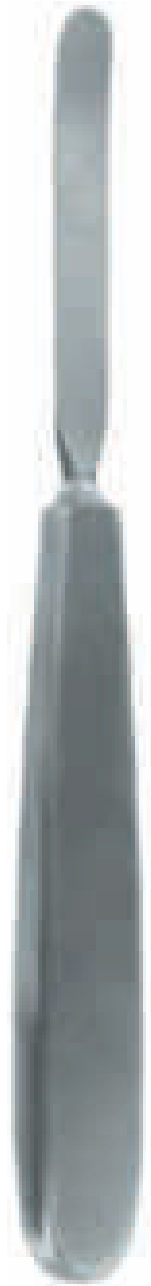

**J245304**  
17 cm - 6 <sup>3</sup>/<sub>4</sub> "



MUHLING



### JANSEN

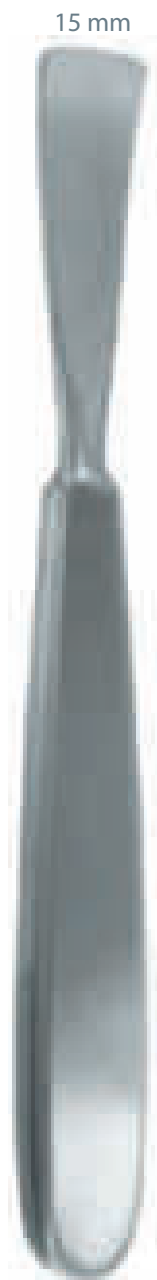

**J245110**  
16,5 cm - 6 1/4 "

### KRAMER



**J245120**  
19 cm - 7 1/2 "

### KEY

- 6 mm **J245130** 
- 10 mm **J245131**
- 13 mm **J245132**
- 16 mm **J245133**
- 19 mm **J245134**
- 25 mm **J245135**

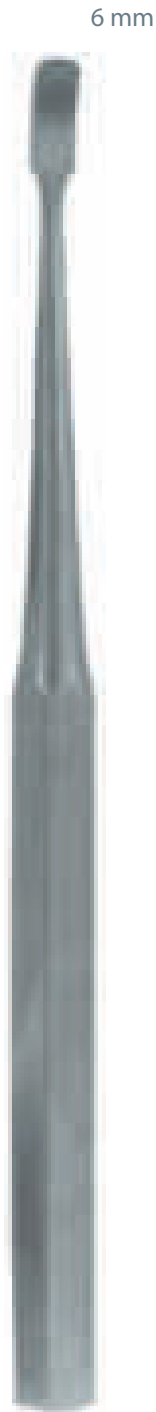

**J245130**  
18 cm - 7 "

### CUSHING

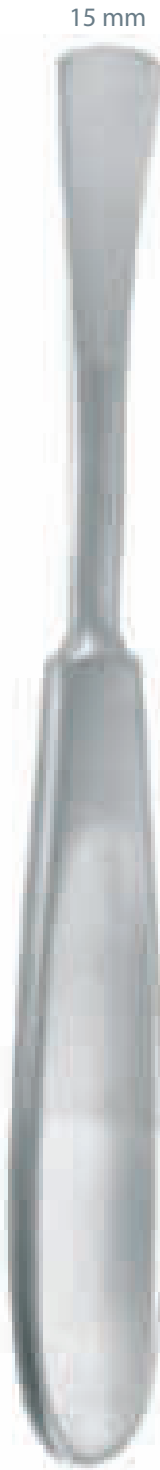

**J245137**  
18,5 cm - 7 1/4 "



**J245138**  
18,5 cm - 7 1/4 "



### PENNYBACKER

4 mm **J245139**

6 mm **J245140** 

8 mm **J245141**

### LANGENBECK

16 mm

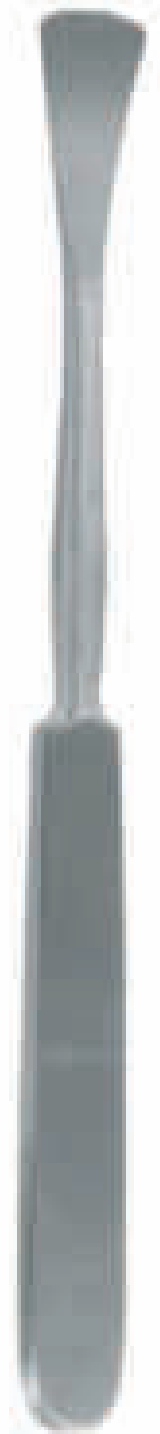

**J245150**

19 cm - 7 1/2 "

### CUSHING

5,0 mm **J245145** 

7,0 mm **J245146**

5 mm

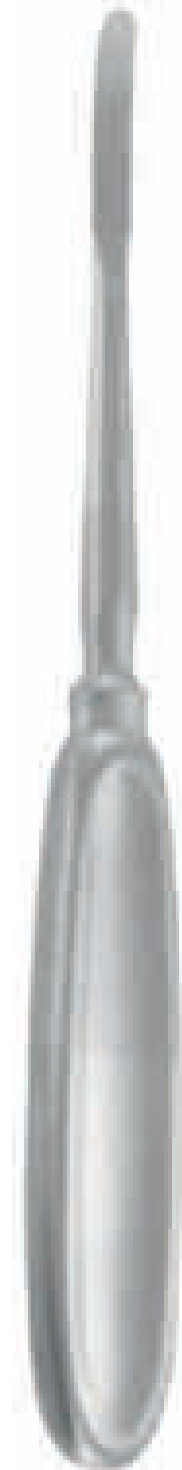

**J245145**

19,5 cm - 7 3/4 "

### MITCHELL

17 mm



**J245147**

19 cm - 7 1/2 "

6 mm  
Mousse  
Blunt  
Romo

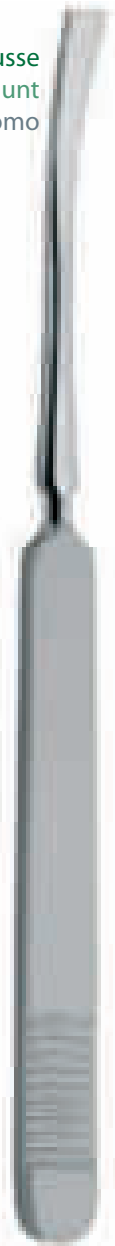

**J245140**

16,5 cm - 6 1/4 "

### KRAEMER

10 mm



**J244900**  
18,5 cm - 7 1/4 "

### SEDILLOT

18 mm



**J245000**  
19 cm - 7 1/2 "

15 mm



**J245010**  
21 cm - 8 1/4 "

### COTTLE

8 mm

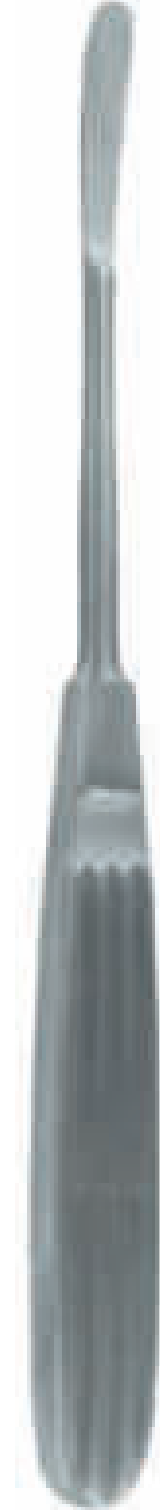

**J245020**  
19,5 cm - 7 3/4 "

### FARABEUF

Droite Straight Recta	Largeur Width Anchura	Courbe Curved Curva
-----------------------------	-----------------------------	---------------------------

J24010	3 mm	J24078
--------	------	--------

J24020	4 mm	J24080
--------	------	--------

J24030	6 mm	J24090
--------	------	--------

 J24040	8 mm	J24100	
--	------	--------	---

J24050	10 mm	J24110
--------	-------	--------

J24060	12 mm	J24120
--------	-------	--------

J24070	14 mm	J24130
--------	-------	--------

### OLLIER

Droite  
Straight  
Recta

Convexe  
Convex  
Convexa

Concave  
Concave  
Concava

8 mm

8 mm

10 mm

10 mm

10 mm

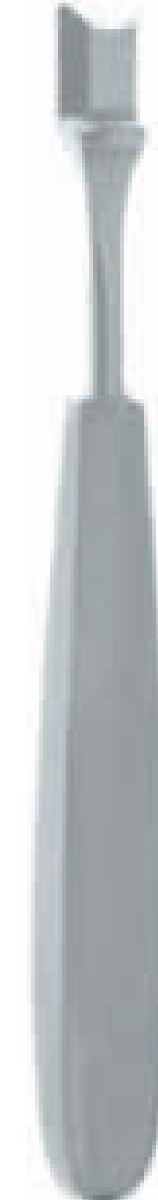
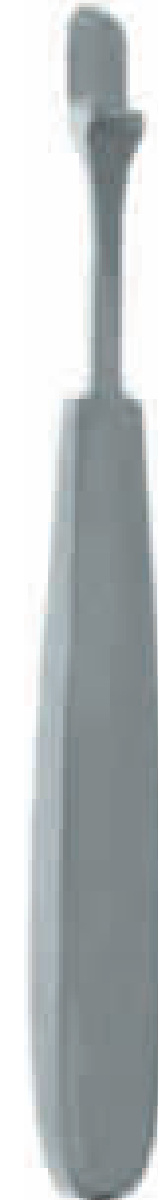
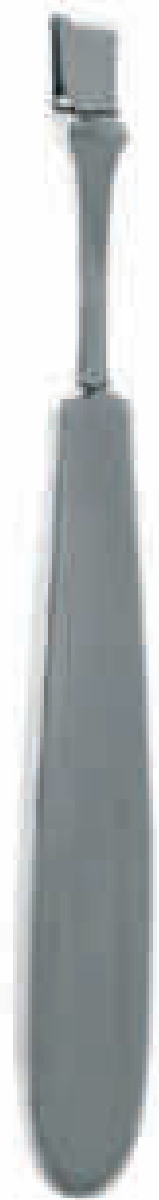
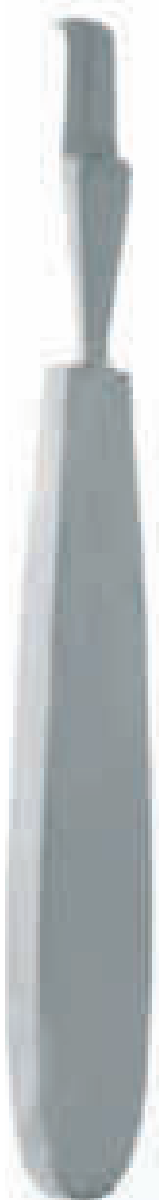
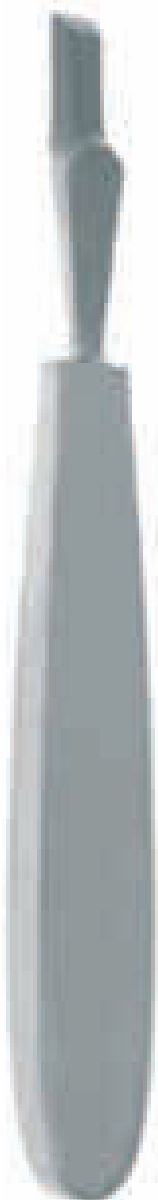
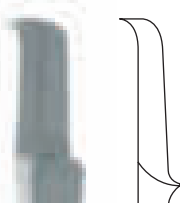
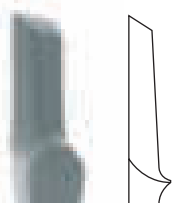

**J24040**

16 cm - 6 1/4 "

**J24100**

16 cm - 6 1/4 "

**J24140**

16 cm - 6 1/4 "

**J24150**

16 cm - 6 1/4 "

**J24160**

16 cm - 6 1/4 "

### DOYEN

Gauche  
Left  
Izquierdo

Droite  
Right  
Derecho



**J24170**  
16 cm - 6 1/2 "

**J24180**  
16 cm - 6 1/2 "

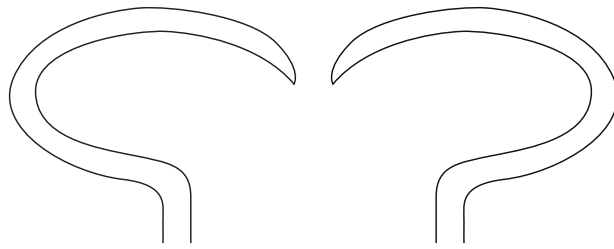

Gauche  
Left  
Izquierdo

Droite  
Right  
Derecho

**J24170** 17 cm - 6 3/4 "

**J24180**

**J241810** 24 cm - 9 1/2 "

**J241811**

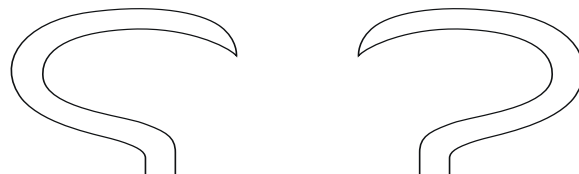

Gauche  
Left  
Izquierdo

Droite  
Right  
Derecho

**J241690** 17 cm - 6 3/4 "

**J241790**





## Rugines - Raspatories - Raspadores

 3 mm	<b>J241902</b>	6 mm	<b>J241904</b>		14 mm	<b>J241906</b>
6 mm	<b>J241903</b>	14 mm	<b>J241907</b>		20 mm	<b>J241908</b> 

### Tranchant - Sharp - Cortante



### SEMB

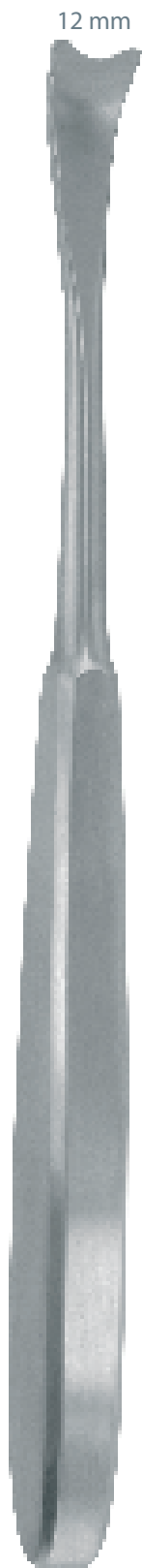

**J242005**  
21 cm - 8 1/4 "

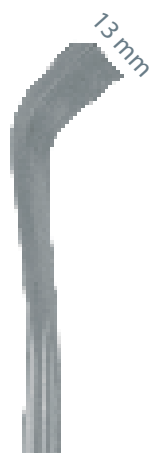

**J242155**  
22 cm - 8 1/4 "

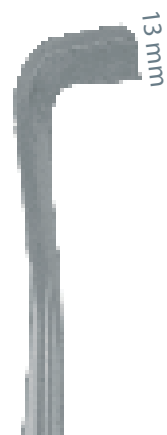

**J242160**  
21,5 cm - 8 1/2 "

### LANGENBECK

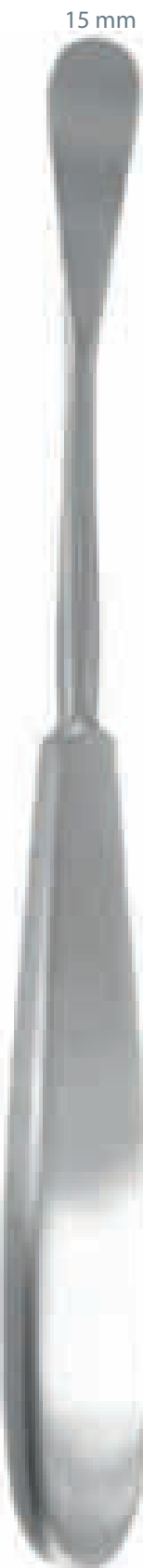

**J242170**  
22 cm - 8 1/2 "

Tranchant  
Sharp  
Cortante



**J242180**  
18 cm - 7"

### ROUX

23 mm **J24360**

26 mm **J24370**



2/3

**J24360**  
28 cm - 11 "

1/1

## Rugines - Raspatories - Raspadores

Pour ligament jaune  
For yellow ligament  
Para ligamento amarillo

7 mm



**J24371**  
20 cm - 8"

### CLOVIS-VINCENT

A sciatique  
For sciatica  
con ciática



6 mm **J08010** 17 cm - 6 <sup>3</sup>/<sub>4</sub>"  
10 mm **J080101** 19 cm - 7 <sup>1</sup>/<sub>2</sub>"

Courbe  
Curved  
Curva

6 mm

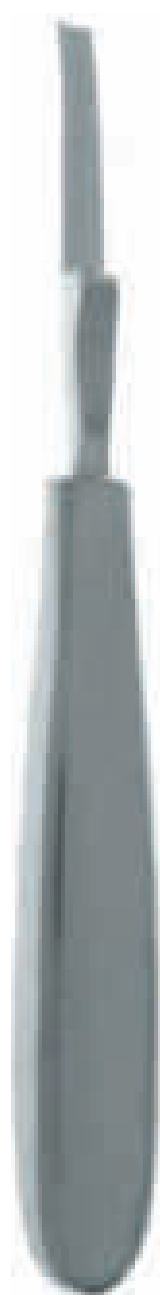

**J08010**  
17 cm - 6 <sup>3</sup>/<sub>4</sub>"

Droite  
Straight  
Recta

**J080101**

### LELIEVRE

Pour les doigts  
For fingers  
Para los dedos

4 mm **J243705**   
4 mm **J243706**

Droite  
Straight  
Recta

4 mm

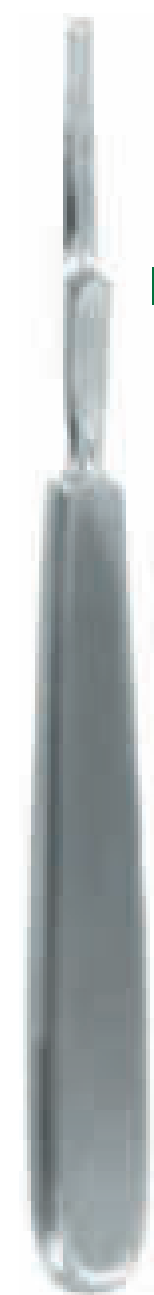

**J243705**  
17 cm - 6 <sup>3</sup>/<sub>4</sub>"

Courbe  
Curved  
Curva

**J243706**

### MERLE D'AUBIGNE

10 mm



Droite  
Straight  
Recta



**J24192**

10 mm

J24193

12 mm

12 mm

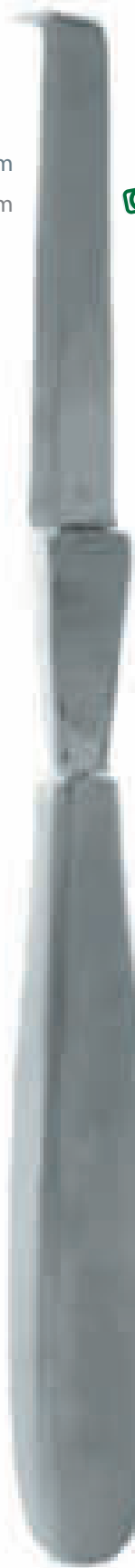

Courbe  
Curved  
Curva



J24194

10 mm

J24195

12 mm

**J24192**

23 cm - 9"

**J24195**

23 cm - 9"

### LAMBOTTE

15 mm

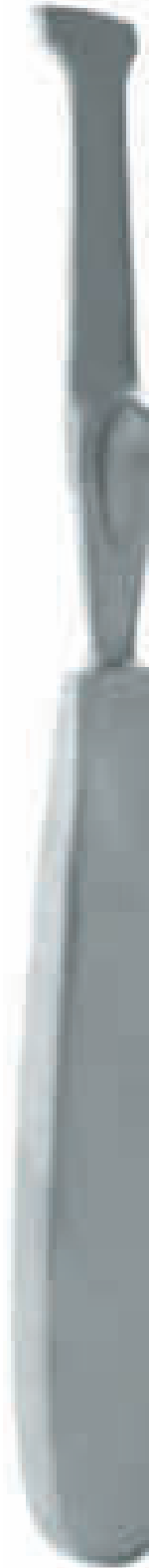

6 mm

J24219

10 mm

J24220

12 mm

J24230

15 mm

**J24240**



18 mm

J24250

20 mm

J24260

25 mm

J24270

**J24240**

21 cm - 8 1/4"



### MAURER



En fourche  
Forked  
Forma de horca

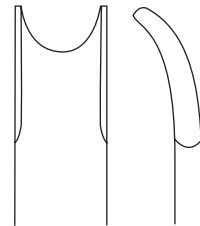

Droite  
Straight  
Recta

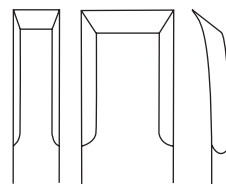

-	6 mm	J24282
J24280	12 mm	J24284

1/2 courbe  
Half curved  
Medio curva

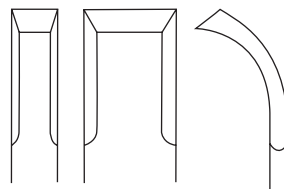

Courbe  
Curved  
Curva

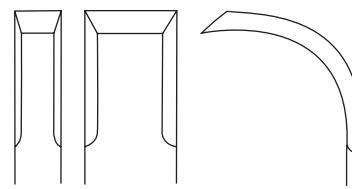

J24310	6 mm	J24290
J24320	12 mm	J24300



**J24280**  
26 cm - 10 1/4 "

**J24290**  
26 cm - 10 1/4 "



### COBB

Tranchante - Sharp - Cortante

### WAGNER

17 mm

8 mm

 J24374	9 mm	J243775 
J24376	13 mm	J243776
J243770	19 mm	J243777
J243772	25 mm	J243778

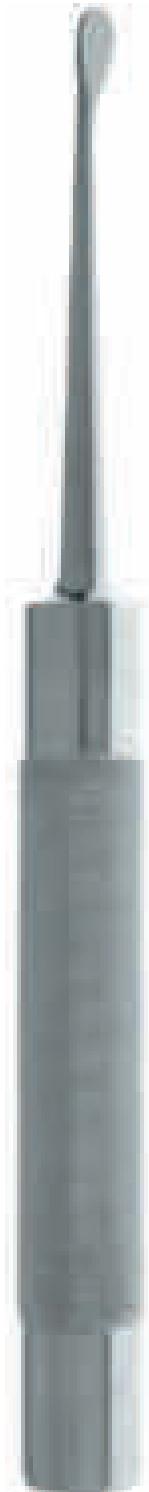

9 mm



13 mm

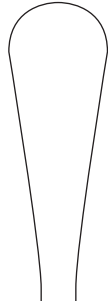

19 mm

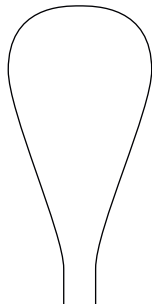

25 mm

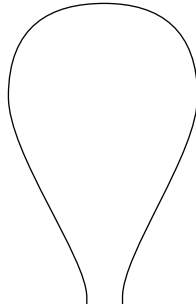

**J24376**

30 cm - 11 <sup>3</sup>/<sub>4</sub> "

Tranchant  
Sharp  
Cortante

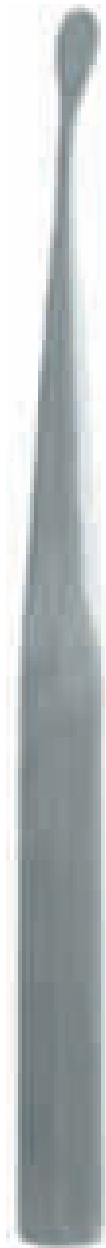

**J243775**

25 cm - 10 "

20 mm

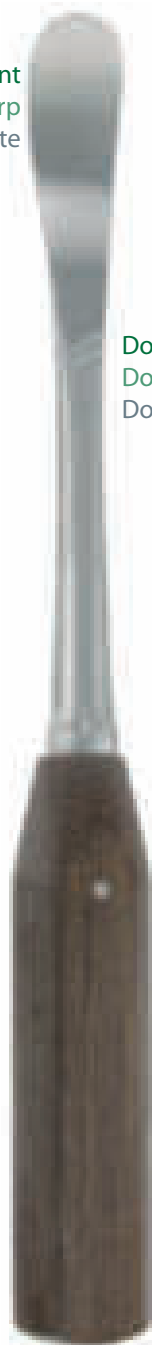

**J243739**

27,5 cm - 10 <sup>3</sup>/<sub>4</sub> "

Double courbure  
Double curvature  
Doble curvatura

**J244410**



**J244400**

33 cm - 13 "

### VIDAL

















### BROCK

### BESNIER

GRATTOIR  
SCRAPER  
RASPADOR

Pleine  
Full  
Llena

Fenêtrée  
Open work  
Con ventana

J28402		2 mm		J28412
J284030		3 mm		J284130
 J28404		4 mm		J28414 
J284050		5 mm		J284150
J284060		6 mm		J284160
J284070		7 mm		J284170
J284080		8 mm		J284180

4 mm  
Tranchant  
Sharp  
Cortant



**J28420**  
13,5 cm - 5 1/4 "

4 mm  
Mousse  
Blunt  
Romo



**J28425**  
13,5 cm - 5 1/4 "



**J28404**  
13 cm - 5 "





**J28414**  
13 cm - 5 "

### UNNA

### MARTINI

### WILLIGER

### JACOBSON

	2,6 / 3,1 mm	<b>J284279</b>	2,5 / 3,0 mm	<b>J284274</b> 
	3,1 / 4,2 mm	<b>J284280</b>	3,0 / 3,5 mm	<b>J284275</b>
	4,2 / 4,8 mm	<b>J284281</b>	3,5 / 4,2 mm	<b>J284276</b>

Tire-comédon  
Comedone extractor  
Saca comedone

Fenêtré  
Open work  
Con ventana

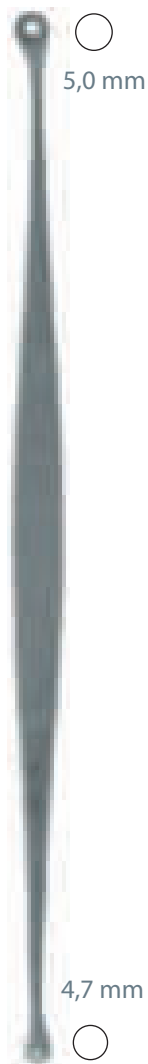

**J284260**  
14 cm - 5 1/2 "



**J284280**  
13,5 cm - 5 1/4 "

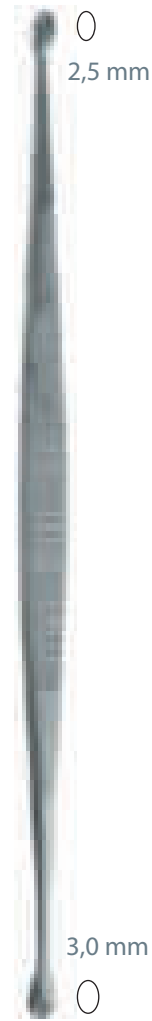

**J284274**  
13,5 cm - 5 1/4 "



**J284290**  
13,5 cm - 5 1/4 "





## Curettes - Curettes - Curetas

### JANSEN

### VOLKMANN

### BARTH

13 cm - 5" **J284310** 7 mm

14 cm - 5 1/2" **J284320** 7 mm

17 cm - 6 3/4" **J284330** 7 mm 

20 cm - 8" **J284340** 6 mm

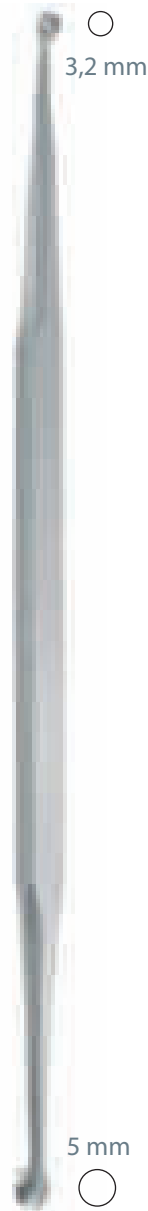

**J284300**  
16 cm - 6 1/4"



**J284330**  
17 cm - 6 3/4"



**J284350**  
18,5 cm - 7 1/4"

## Curettes - Curettes - Curetas

### VOLKMANN

16 cm - 6 1/4 "

20 cm - 8 "

**J28005**

1 mm

**J281507**



**J28010**

2 mm

**J281508**



**J28020**

3 mm

**J281509**



**J28030**

4 mm

**J28151**



**J28040**

5 mm

**J281515**



**J28050**

6 mm

**J28152**



**J28060**

7 mm

**J281525**



**J28070**

8 mm

**J28153**



**J28080**

9 mm

**J281535**



**J28090**

10 mm

**J28155**



**J28110**

12 mm

**J28156**



**J28130**

14 mm

**J28157**



**J28150**

16 mm

**J28158**

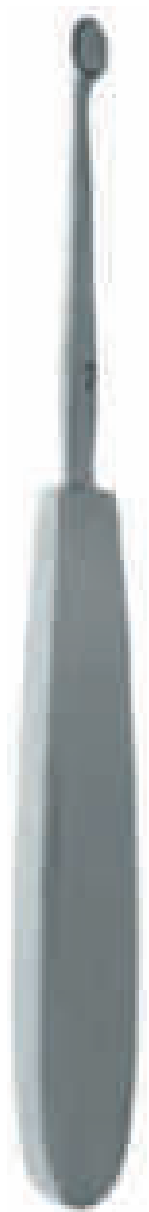
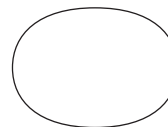





**J28060**

16 cm - 6 1/4 "

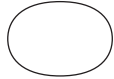
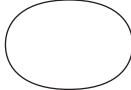
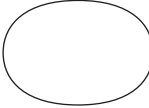
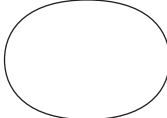

1/1

### VOLKMANN

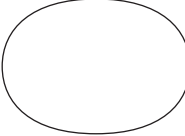
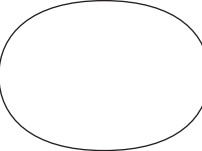
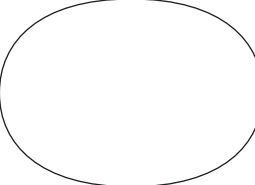
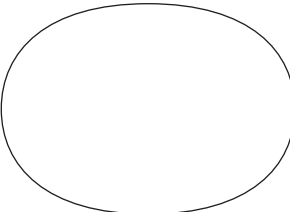
	24 cm - 9 1/2 "	28 cm - 11 "
	<b>J281620</b> 4 mm	<b>J282310</b>
	<b>J28163</b> 6 mm	<b>J28232</b>
	<b>J28170</b> 8 mm	<b>J28234</b>
	<b>J28180</b> 10 mm	<b>J28236</b>
	<b>J28190</b> 12 mm	<b>J28240</b>
	<b>J28200</b> 14 mm	<b>J28250</b>
	 <b>J28210</b> 16 mm	<b>J28260</b>
	<b>J28220</b> 18 mm	<b>J28270</b>
	<b>J28230</b> 20 mm	<b>J28280</b>
	- 25 mm	<b>J28290</b>
	- 28 mm	<b>J28300</b>

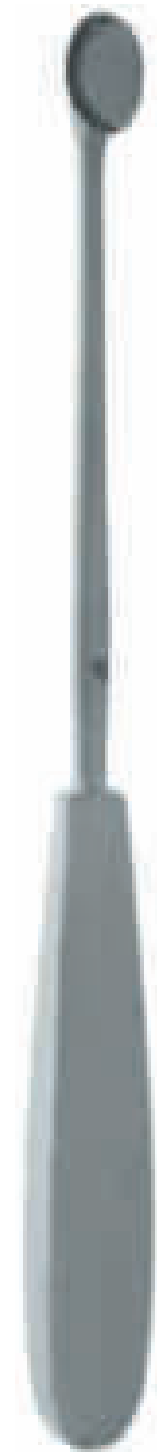

**J28210**  
24 cm - 9 1/2 "

### VOLKMANN

	17 cm - 6 <sup>3/4</sup> ''	Fig.
2,5 mm	<b>J283001</b>	○ 0000
3,6 mm	<b>J283002</b>	○ 000
4,4 mm	<b>J283003</b>	○ 00
5,2 mm	<b>J283004</b>	○ 0
6,8 mm	<b>J283005</b>	○ 1
 8,5 mm	<b>J283006</b>	○ 2
10,0 mm	<b>J283007</b>	○ 3
11,5 mm	<b>J283008</b>	○ 4
13,0 mm	<b>J283009</b>	○ 5
14,5 mm	<b>J283010</b>	○ 6

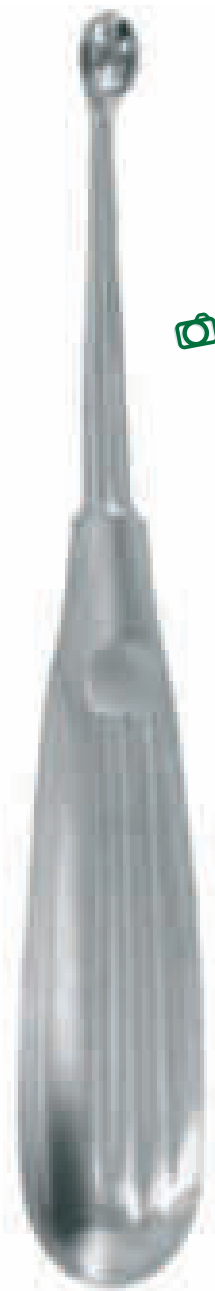

**J283006**  
17 cm - 6 <sup>3/4</sup>''

### SCHEDE

	17 cm - 6 <sup>3/4</sup> ''	Fig.
2,5 mm	<b>J283021</b>	○ 000
3,4 mm	<b>J283022</b>	○ 00
4,2 mm	<b>J283023</b>	○ 0
5,2 mm	<b>J283024</b>	○ 1
 6,3 mm	<b>J283025</b>	○ 2
7,4 mm	<b>J283026</b>	○ 3
8,0 mm	<b>J283027</b>	○ 4

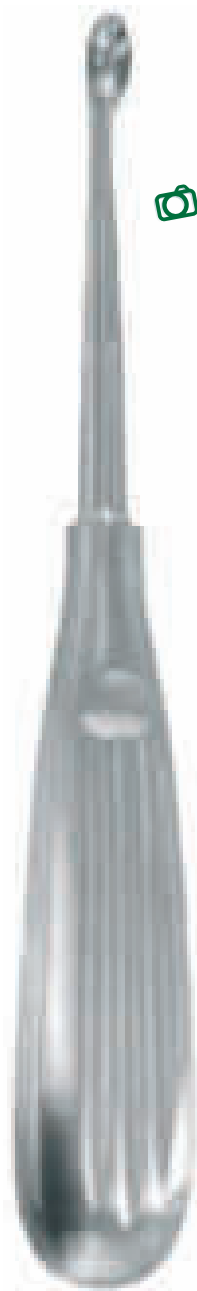

**J283025**  
17 cm - 6 <sup>3/4</sup>''

### BRUNS

### UFFENORDE

Fig. Ø 17 cm - 6 <sup>3</sup>/<sub>4</sub>"

○ 3,3 mm **J283100**

○ 4,2 mm **J283101**

Ronde  
Round  
Redonda

○ 5,0 mm **J283102** 

○ 7,0 mm **J283103**

○ 8,5 mm **J283104**

○ 10,0 mm **J283105**

○ 12,5 mm **J283106**

○ 14,0 mm **J283107**

○ 15,0 mm **J283108**

A gauche  
To left  
A la izquierda

A droite  
To right  
A la derecha

6,3 mm

**J283120**

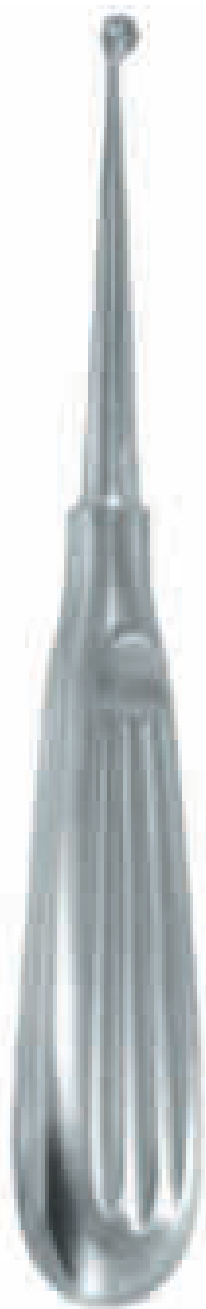

**J283102**  
17 cm - 6 <sup>3</sup>/<sub>4</sub>"

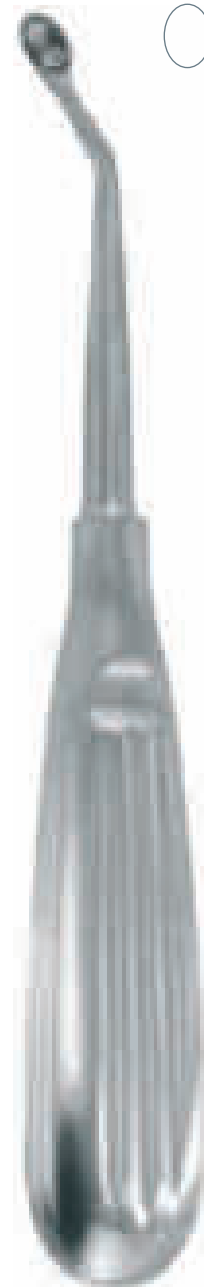

**J283110**  
17 cm - 6 <sup>3</sup>/<sub>4</sub>"



### CLOWARD

Ovale  
Oval  
Ovalada

Droite  
Right  
Derecho

Coudée  
Angular  
Angulada

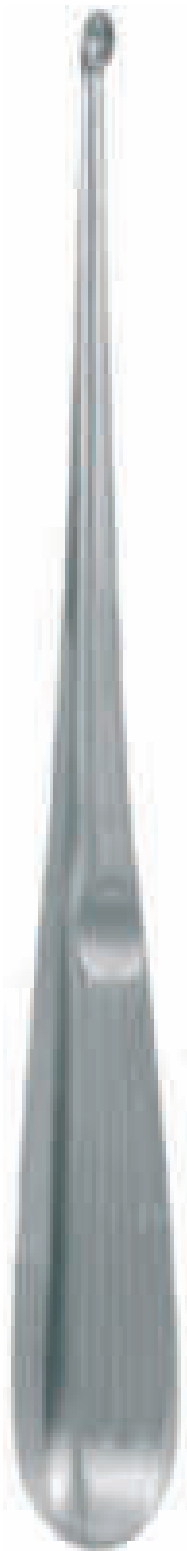

**J283404**  
20 cm - 8"

Fig.

○  
000

2,0 mm

J283400

J283410

J283420

○  
00

2,5 mm

J283401

J283411

J283421

○  
0

3,0 mm

J283402

J283412

J283422

○  
1

3,5 mm

J283403

J283413

J283423

○  
2

4,5 mm

J283404 

J283414

J283424

○  
3

5,5 mm

J283405

J283415

J283425

○  
4

7,5 mm

J283406

J283416

J283426

○  
5

8,5 mm

J283407

J283417

J283427

○  
6

10,0 mm

J283408

J283418

J283428

### HALLE

Malléable  
Malleable  
Maleable

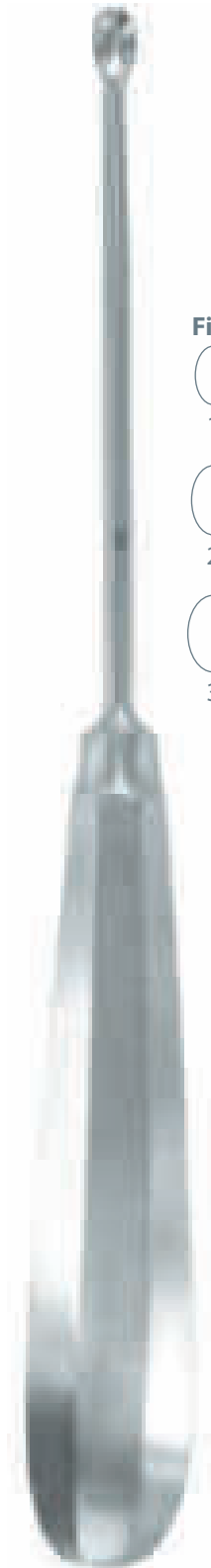

Fig.



1

4,8 mm

J283790



2

5,8 mm

J283791 



3

6,8 mm

J283792



### DAUBENSPECK

Coudée  
Angular  
Angulada

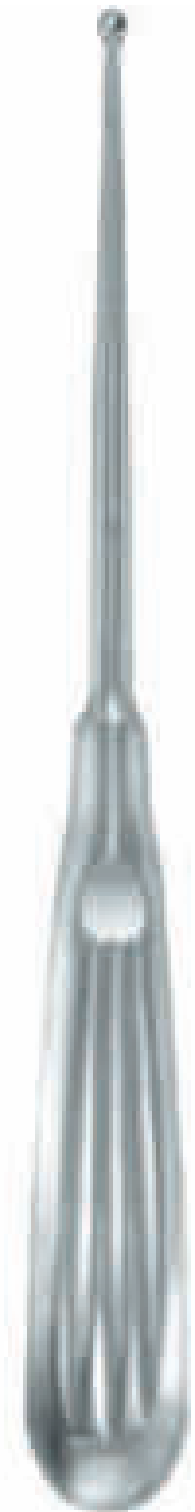

Fig.



00

2,8 mm

J283800



0

3,6 mm

J283801 



1

4,4 mm

J283802



2

5,2 mm

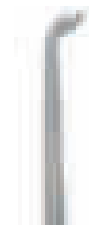

J283803



**J283791**  
21 cm - 8 1/4 "

**J283801**  
20 cm - 8 "

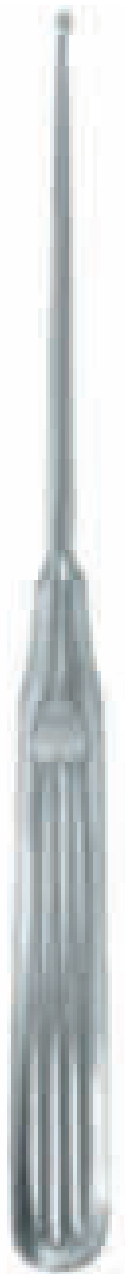
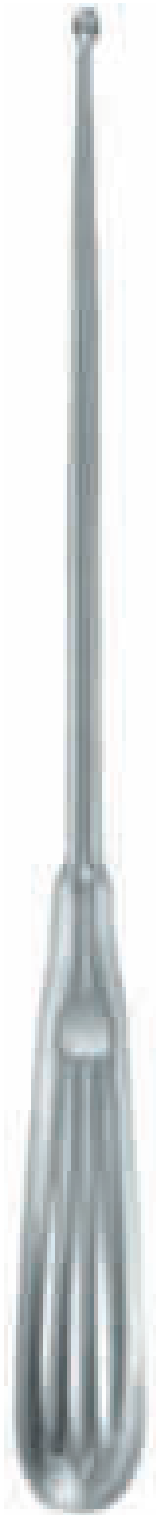
### LEMPERT

		Droite Straight Recta		Droite Straight Recta		Coudée Angular Angulada		
 <p><b>J283812</b> 21,5 cm - 8 1/2 "</p>	○	1,7 mm	<b>J283810</b>	 <p><b>J283821</b> 25 cm - 10 "</p>	○	<b>J283820</b>	3,6 mm	<b>J283830</b>
	○	2,0 mm	<b>J283811</b>		○	<b>J283821</b>	4,4 mm	<b>J283831</b>
	○	2,4 mm	<b>J283812</b> 		○	<b>J283822</b>	5,2 mm	<b>J283832</b>
	○	2,7 mm	<b>J283813</b>		○	<b>J283823</b>	6,0 mm	<b>J283833</b>
	○	3,0 mm	<b>J283814</b>		○			



### BRUNS

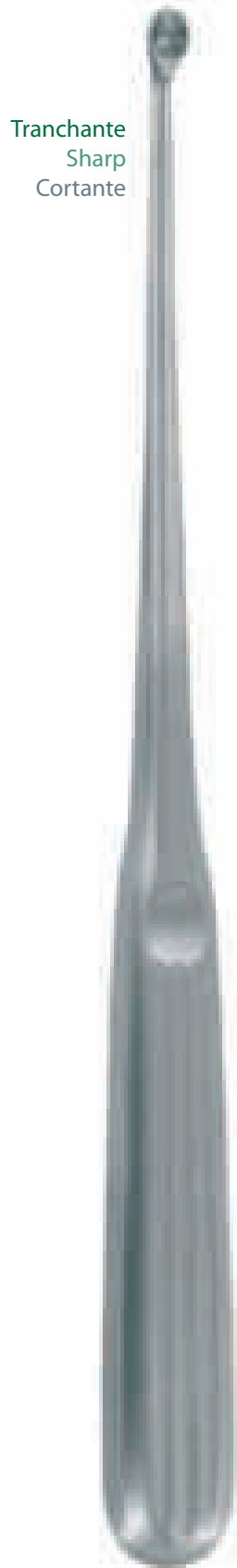

Tranchante  
Sharp  
Cortante

**J283204**  
23 cm - 9"

Droite  
Right  
Derecho

Coudée  
Angular  
Angulada

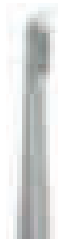









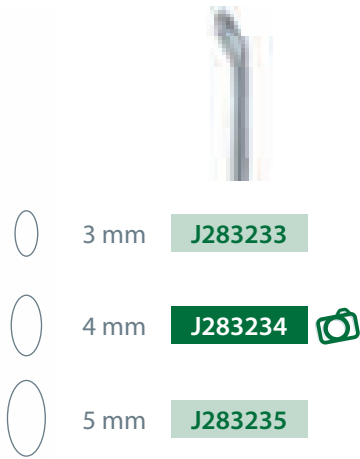

Fig.	Ø	Droite Right Derecho	Coudée Angular Angulada
 000	3,3 mm	<b>J283200</b>	<b>J283210</b> <b>J283220</b>
 00	3,9 mm	<b>J283201</b>	<b>J283211</b> <b>J283221</b>
 0	4,7 mm	<b>J283202</b>	<b>J283212</b> <b>J283222</b>
 1	5,3 mm	<b>J283203</b>	<b>J283213</b> <b>J283223</b>
 2	6,0 mm	<b>J283204</b> 	<b>J283214</b> <b>J283224</b>
 3	7,2 mm	<b>J283205</b>	<b>J283215</b> <b>J283225</b>
 4	8,2 mm	<b>J283206</b>	<b>J283216</b> <b>J283226</b>
 5	9,8 mm	<b>J283207</b>	<b>J283217</b> <b>J283227</b>
 6	12 mm	<b>J283208</b>	<b>J283218</b> <b>J283228</b>

### BUSCHE

Coudée  
Angular  
Angulada



### SCOVILLE

A sciatique - For sciatica - con ciática

Droite  
Right  
Derecho

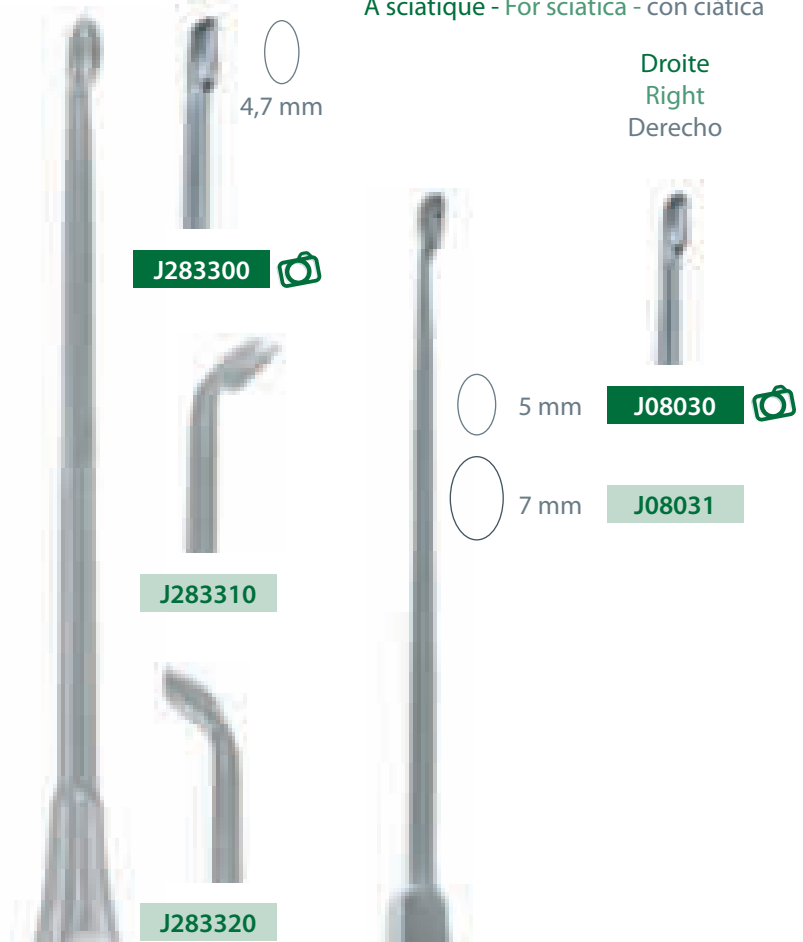

**J283234**  
25 cm - 10 "

**J283300**  
25 cm - 10 "

**J08030**  
22 cm - 8<sup>3/4</sup> "

### CASPAR

Droite Right Derecho	Coudée Angular Angulada	Fenêtré Open work Con ventana
  3,6 mm <b>J283850</b>	  3,6 mm <b>J283860</b>	  4 mm <b>J283840</b>
  4,4 mm <b>J283851</b>	  4,4 mm <b>J283861</b>	  5 mm <b>J283841</b>
  5,2 mm <b>J283852</b>	  5,2 mm <b>J283862</b>	  6 mm <b>J283842</b>
 <b>J283851</b> 22 cm - 8 <sup>3</sup> / <sub>4</sub> "	 <b>J283861</b> 22 cm - 8 <sup>3</sup> / <sub>4</sub> "	 <b>J283841</b> 22 cm - 8 <sup>3</sup> / <sub>4</sub> "

### CHARNLEY

### LETOURNEL



**J28350**  
40 cm - 15 3/4 "

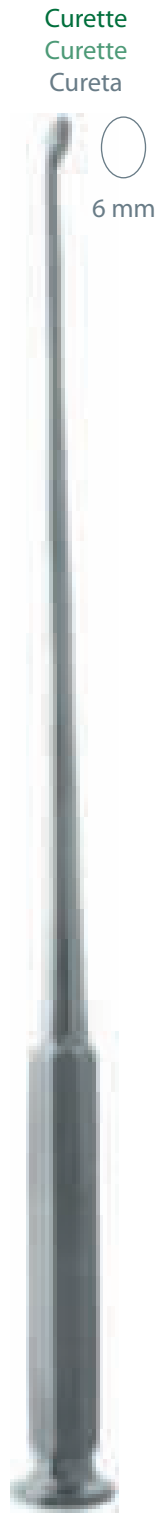

**J28400**  
37 cm - 14 1/2 "

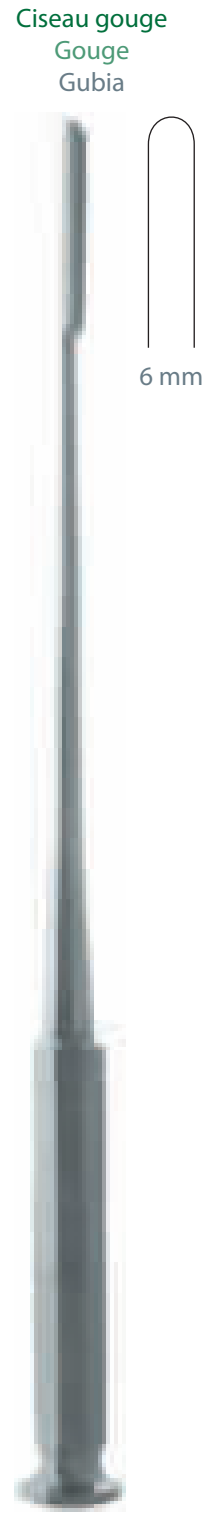

**J36650**  
37 cm - 14 1/2 "

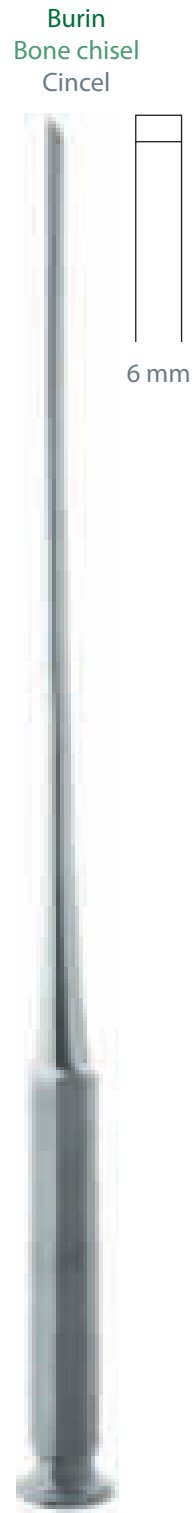

**J32675**  
37 cm - 14 1/2 "



### LAMBOTTE (PAUWELLS)



2.5 mm

12,5 cm - 5"

Droit  
Straight  
Recto



3.2 mm

16 cm - 6 1/4"

Droit  
Straight  
Recto



3.2 mm

24 cm - 9 1/2"

Droit  
Straight  
Recto



3.2 mm

24 cm - 9 1/2"

Courbe  
Curved  
Curvo

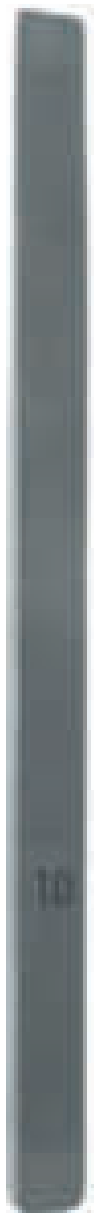

**J32470**  
16 cm - 6 1/4"

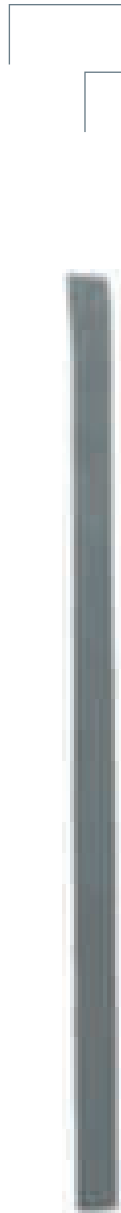

**J324623**  
12,5 cm - 5"

Width	J32470	J324623	J32540	J32620	J325430
50 mm	-	-	J32540	J32620	J325430
40 mm	-	-	J32530	J32610	J325429
35 mm	-	-	J32520	J32600	J325428
30 mm	-	-	J32510	J32590	J325427
25 mm	-	-	J32500	J32580	J325426
20 mm	-	-	J32490	J32570	J325425
18 mm	-	-	J324850	J32565	J325424
15 mm	J324627	-	J32480	J32560	J325423
13 mm	-	-	J324750	J32555	J325422
12 mm	J324626	-	-	-	-
10 mm	J324625	J32470	J32470	J32550	J325421
8 mm	J324624	-	J324658	J325455	J325418
6 mm	J324623	-	-	-	-
5 mm	-	-	J32465	J325450	J325420
4 mm	J324622	-	-	-	-
3 mm	J324621	-	-	-	-
2 mm	J324620	-	-	-	-

### LAMBOTTE

### DUPONT

### OBWEGESER

Acier extra dur  
Extra hard steel  
Acero extra duro



23 cm - 9"	J32623	25 mm	J32688
	J32622	20 mm	J32686
	J32621	15 mm	J32684
	J32625	10 mm	J32682
	J32624	5 mm	J32678

**J32621**  
23 cm - 9"

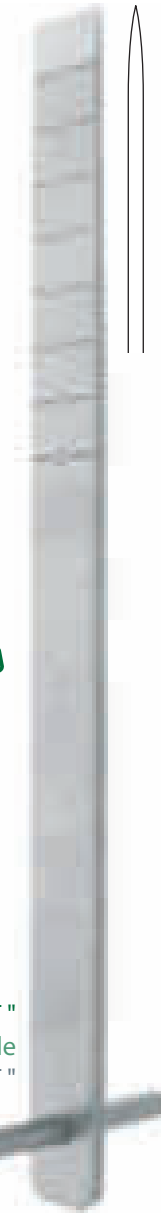

Poignée en "T"  
"T" handle  
Mango en "T"

**J32684**  
20 cm - 8"

11 mm

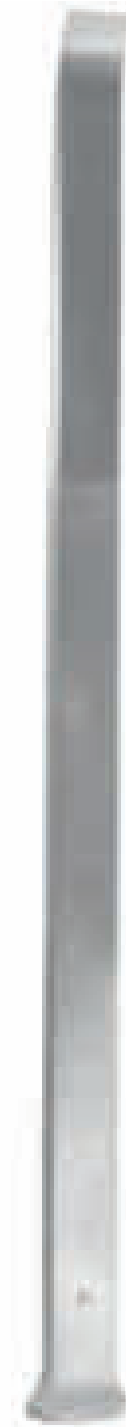
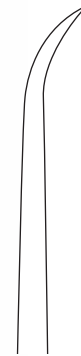

**J326260**  
23,5 cm - 9<sup>1</sup>/<sub>4</sub>"

### PARTSCH

### LUCAS

 <b>J320636</b>	6 mm	<b>J361536</b>
 <b>J320634</b>	4 mm	<b>J361534</b> 

Burin  
Bone chisel  
Osea cincela

Gouge  
Gouge  
Gubia

Burin  
Bone chisel  
Osea cincela

Gouge  
Gouge  
Gubia

13,5 cm - 5 1/4"

<b>J320617</b>		7 mm	<b>J361517</b>
<b>J320616</b>		6 mm	<b>J361516</b>
<b>J320615</b>		5 mm	<b>J361515</b>
<b>J320614</b>		4 mm	<b>J361514</b>
<b>J320613</b>		3 mm	<b>J361513</b>

17 cm - 6 3/4"

<b>J320627</b>		7 mm	<b>J361527</b>
<b>J320626</b>		6 mm	<b>J361526</b>
 <b>J320625</b>		5 mm	 <b>J361525</b>
<b>J320624</b>		4 mm	<b>J361524</b>
<b>J320623</b>		3 mm	<b>J361523</b>

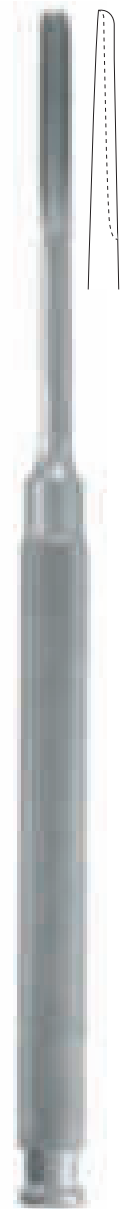
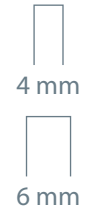
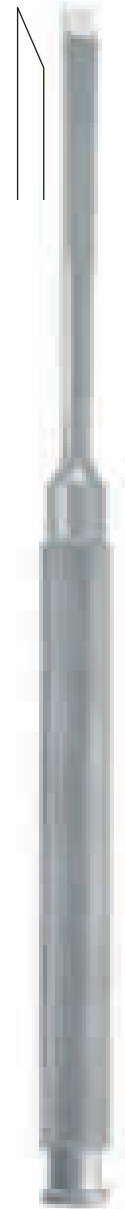
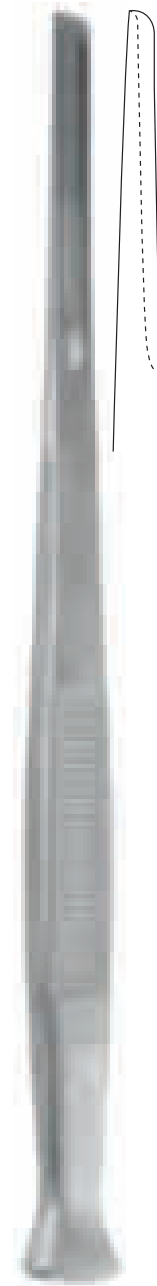

**J320625**  
17 cm - 6 3/4"







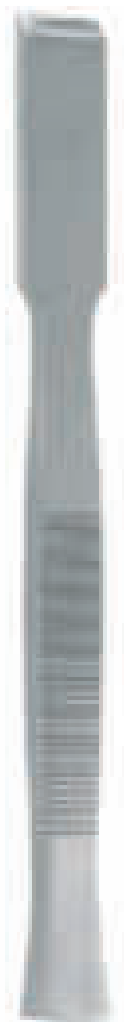

**J361525**  
17 cm - 6 3/4"

**J320634**  
16 cm - 6 1/4"

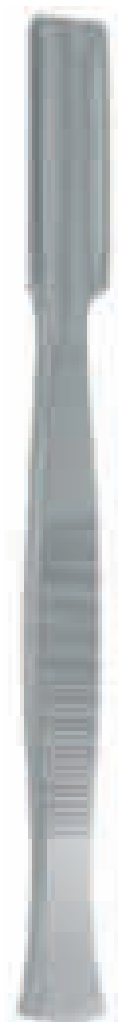
**J361534**  
16 cm - 6 1/4"

# LANDANGER

Ciseaux burins, ostéotomes, gouges - Bone chisels, osteotomes, gouges - Osea cincelas, osteotomos, gubias

		Burin Bone chisel Osea cincela	Osteotome Osteotome Osteotomo	Gouge Gouge Gubia	
	 16 mm	<b>J320016</b>	<b>J320036</b>	<b>J360916</b>	
	 14 mm	<b>J320014</b>	<b>J320034</b>	<b>J360914</b>	
	 12 mm	<b>J320012</b>	<b>J320032</b>	<b>J360912</b>	
	 10 mm	<b>J320010</b>	<b>J320030</b>	<b>J360910</b>	
	 8 mm	<b>J320008</b>	<b>J320028</b>	<b>J360908</b>	
	 6 mm	<b>J320006</b>	<b>J320026</b>	<b>J360906</b>	
	 4 mm	<b>J320004</b>	<b>J320024</b>	<b>J360904</b>	
<b>J320012</b> 13,5 cm - 5 1/4"				<b>J360912</b> 13,5 cm - 5 1/4"	

XIII - Osseux  
XIII - Bone surgery  
XIII - Cirugía osea











### POIRIER

### OMBREDANNE

Burin  
Bone chisel  
Osea cincela

Gouge  
Gouge  
Gubia

Burin  
Bone chisel  
Osea cincela

	16 cm - 6 1/4"		16 cm - 6 1/4"		14 cm - 5 1/2"
	<b>J32060</b> 14 mm		<b>J36150</b>		20 mm <b>J32420</b>
	<b>J32050</b> 12 mm		<b>J36140</b>		15 mm <b>J32410</b>
	<b>J32040</b> 10 mm		<b>J36130</b> 		10 mm <b>J32400</b> 
	<b>J32030</b> 8 mm		<b>J36120</b>		Lame mince Thin blade Hoja fina
	<b>J32020</b> 6 mm		<b>J36110</b>		
	<b>J32010</b> 4 mm		<b>J36100</b>		

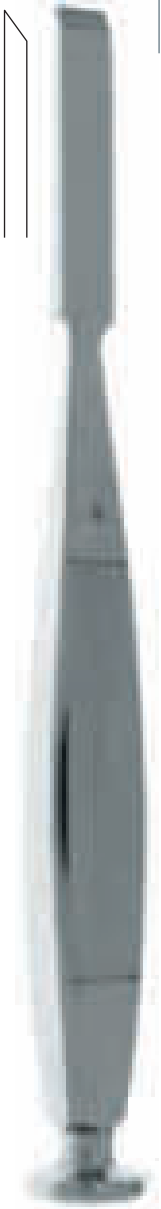

	<b>J32030</b> 16 cm - 6 1/4"		<b>J36130</b> 16 cm - 6 1/4"		<b>J32400</b> 14 cm - 5 1/2"
--	---------------------------------	---	---------------------------------	--	---------------------------------

## ALEXANDER

Burin  
Bone chisel  
Osea cincela

Gouge  
Gouge  
Gubia

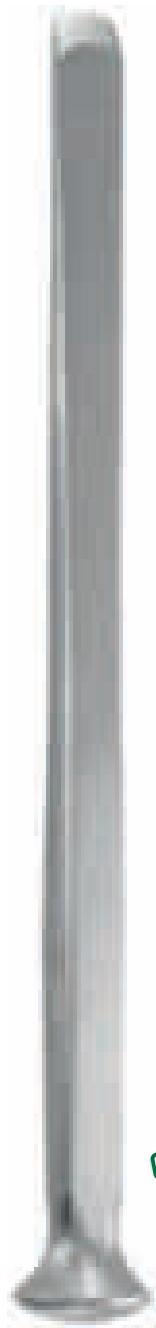

**J320650**  
18 cm - 7 "

		32 mm	
-	-	25 mm	
-	-	19 mm	
-	-	16 mm	
-	-	14 mm	
J320654	J361554	13 mm	
-	-	12 mm	
J320652	J361552	10 mm	
J320650	J361550	9 mm	
-	-	8 mm	
J320648	J361548	6 mm	
J320646	J361546	4 mm	
J320644	J361544		

## SMITH-PETERSEN

Osteotome  
Osteotome  
Osteotomo

J320672	J320682
-	-
-	-
J320671	J320681
-	-
J320670	J320680
-	-

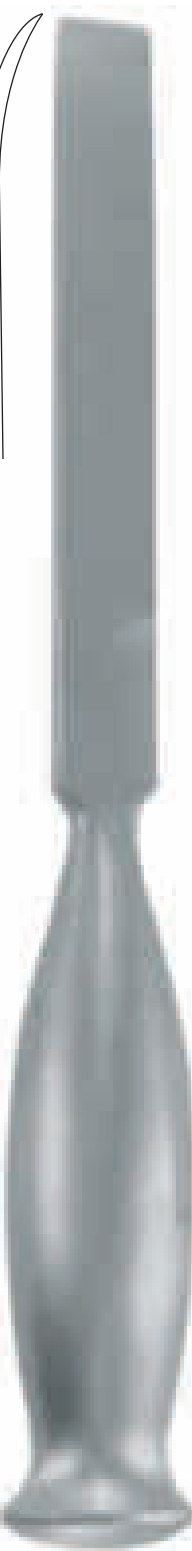

**J320672**  
20,5 cm - 8 "

## STILLE

Lame mince  
Thin blade  
Hoja fina

12 mm

12 mm

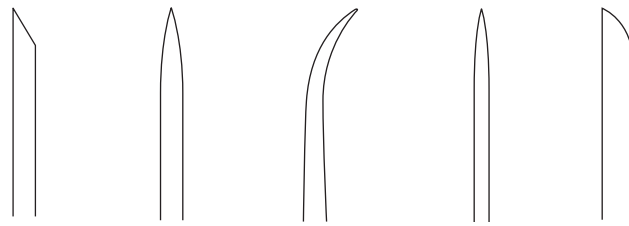

Droit Straight Recto	Droit Straight Recto	Courbe Curved Curvo	Droit Straight Recto	Droit Straight Recto
----------------------------	----------------------------	---------------------------	----------------------------	----------------------------

20 cm - 8 1/4 "

30 mm	J32310	J327030	J327230	-	J36250
25 mm	J32300	J327025	J327225	J326925	J36240
20 mm	J32290	J327020	J327220	J326920	J36230
15 mm	J32280	J327015	J327215	J326915	J36220
12 mm	J32270	J327012	J327212	J326912	J36210
10 mm	J32260	J327010	J327210	J326910	J36200
8 mm	J32250	J327008	J327208	-	J36190
6 mm	J32240	J327006	J327206	-	J36180

25 cm - 10 "

30 mm	J32390	J327130	-	-	J36330
25 mm	J32380	J327125	-	-	J36320
20 mm	J32370	J327120	-	-	J36310
15 mm	J32360	J327115	-	-	J36300
12 mm	J32350	J327112	-	-	J36290
10 mm	J32340	J327110	-	-	J36280
8 mm	J32330	J327108	-	-	J36270
6 mm	J32320	J327106	-	-	J36260

**J32270**  
20 cm - 8 "

**J36210**  
20 cm - 8 "

## LUCAS

Burin  
Bone chisel  
Osea cincela

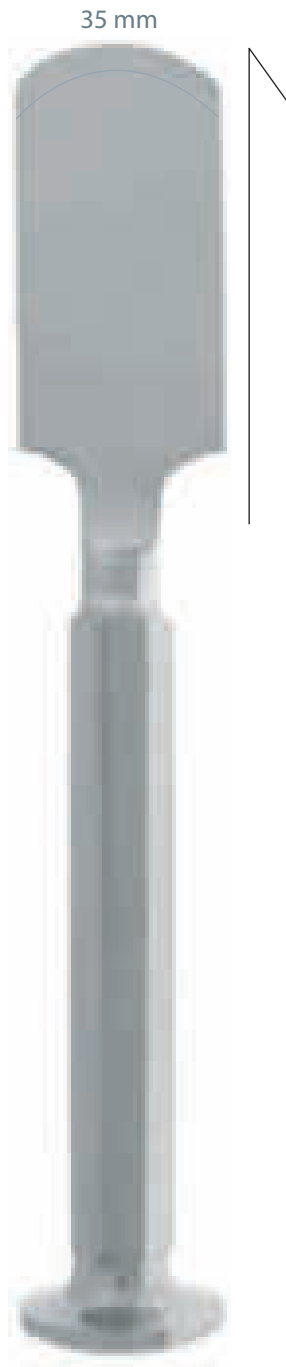

**J32235**  
21 cm - 8 1/4"



## HIBBS

Osteotome  
Osteotome  
Osteotomo

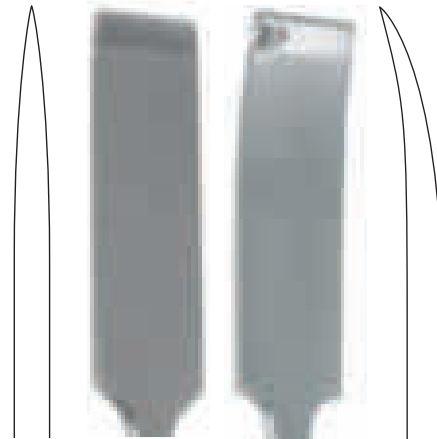

24 cm - 9 1/2"    24 cm - 9 1/2"

Droit  
Straight  
Recto

Courbe  
Curved  
Curvo

38 mm	<b>J326909</b>	<b>J326899</b>
32 mm	<b>J326908</b>	<b>J326898</b>
28 mm	<b>J326907</b>	<b>J326897</b>
25 mm	<b>J326906</b>	<b>J326896</b>
22 mm	<b>J326905</b>	<b>J326895</b>
19 mm	<b>J326904</b>	<b>J326894</b>
16 mm	<b>J326903</b>	<b>J326893</b>
13 mm	<b>J326902</b>	<b>J326892</b>
9 mm	<b>J326901</b>	<b>J326891</b>
6 mm	<b>J326900</b>	<b>J326890</b>

19 mm



**J326904**  
24 cm - 9 1/2"

## MAC EVEN

## JUDET

**10 mm**

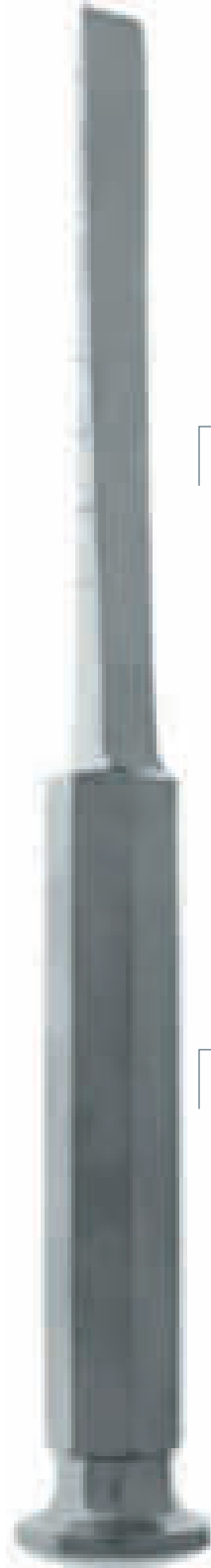

**J32430**  
20 cm - 8"

Osteotome  
Osteotome  
Osteotomo

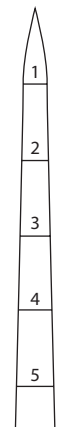

1  
2  
3  
4  
5

Droit  
Straight  
Recto

15 mm **J32440**

10 mm **J32430**

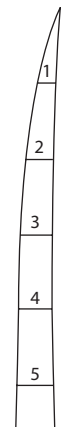

1  
2  
3  
4  
5

Courbe  
Curved  
Curvo

15 mm **J32460**

10 mm **J32450**

**15 mm**



**J320715**  
22 cm - 8 3/4"

Burin  
Bone chisel  
Osea cincela



Droit  
Straight  
Recto

40 mm **J320740**

35 mm **J320735**

30 mm **J320730**

25 mm **J320725**

20 mm **J320720**

15 mm **J320715**

10 mm **J320710**



Courbe  
Curved  
Curvo

18 mm **J320768**

16 mm **J320766**

12 mm **J320762**

### FARABEUF

Burin  
Bone chisel  
Osea cincela

15 mm

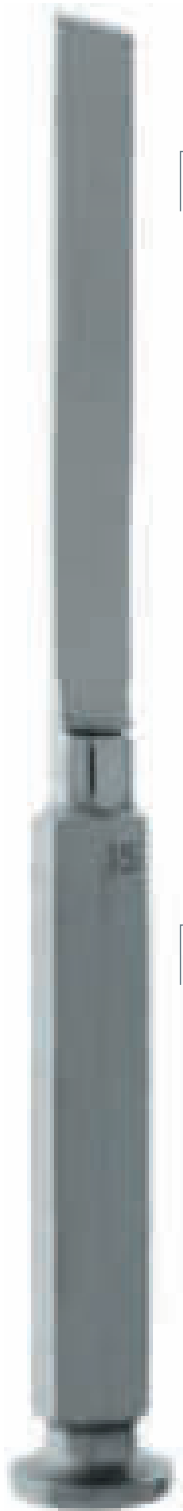

**J32190**  
25 cm - 10"

Gouge  
Gouge  
Gubia

14 mm

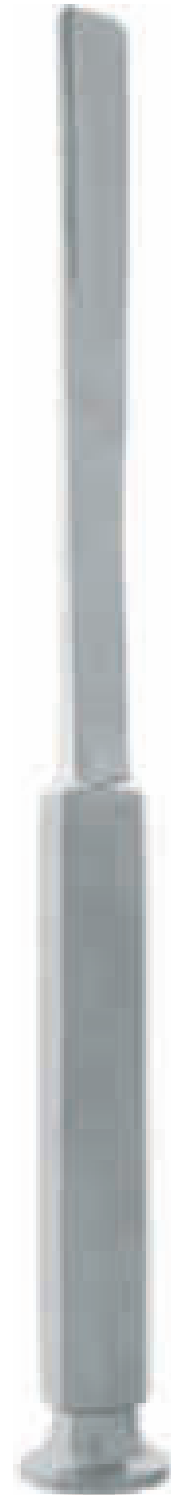

**J36600**  
25 cm - 10"

25 cm - 10"

30 mm	J32220	J320815	J328030	-
25 mm	J32210	J320814	J328025	-
20 mm	J32200	J320813	J328020	-
15 mm	J32190	J320812	J328015	-
14 mm	-	-	-	J36600
12 mm	J32170	-	J328012	J36590
10 mm	J32160	J320810	J328010	J36580
8 mm	J32150	-	J328008	J36570
6 mm	J32140	-	J328006	J36560

20 cm - 8"

30 mm	J321102	J320805	-	-
25 mm	J321101	J320804	-	-
20 mm	J32110	J320803	-	-
15 mm	J32100	J320802	-	-
12 mm	J320993	-	-	-
10 mm	J320992	J320800	-	-
8 mm	J320991	-	-	-
6 mm	J320990	-	-	-

### CAUCHOIX

		Osteotome Osteotome Osteotomo		Gouge Gouge Gubia	
20 mm					16 mm
			Convexe Convexe Convexa	Concave Concave Concava	
	25 cm - 10"				
		25 mm <b>J32665</b>	-	-	
		20 mm <b>J32660</b>	<b>J36430</b>	<b>J36370</b>	
		18 mm <b>J32650</b>	<b>J36420</b>	<b>J36360</b>	
		16 mm <b>J32640</b>	<b>J36410</b>	<b>J36350</b>	
		14 mm <b>J32630</b>	-	-	
		12 mm <b>J32629</b>	-	-	
		10 mm <b>J32628</b>	-	-	
		8 mm <b>J32627</b>	-	-	
	30 cm - 11 <sup>3/4</sup> "				
		20 mm -	<b>J36460</b>	<b>J36400</b>	
		18 mm -	<b>J36450</b>	<b>J36390</b>	
		16 mm -	<b>J36440</b>	<b>J36380</b>	
<b>J32650</b> 25 cm - 10"					<b>J36410</b> 25 cm - 10"

### GUILLAUME

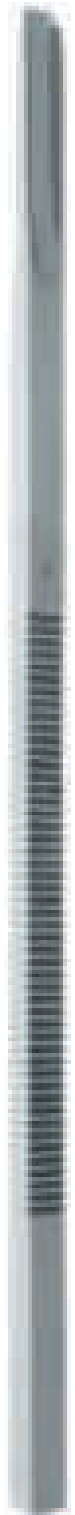

8 mm



**J36040**



7 mm

**J36030**



6 mm

**J36020**



5 mm

**J36044**



4 mm

**J36042**

**J36040**

25 cm - 10"



### NANCY



10 mm

**J36080**



8 mm

**J36070**



6 mm

**J36060**

**J36060**

25 cm - 10"

### SMITH PETERSEN

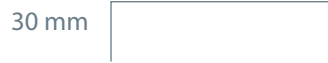

30 mm

**J36345**



27 mm

**J36340**



22 mm

**J36335**

Modèle Lyon  
Lyon's mode  
Modelo Lyon

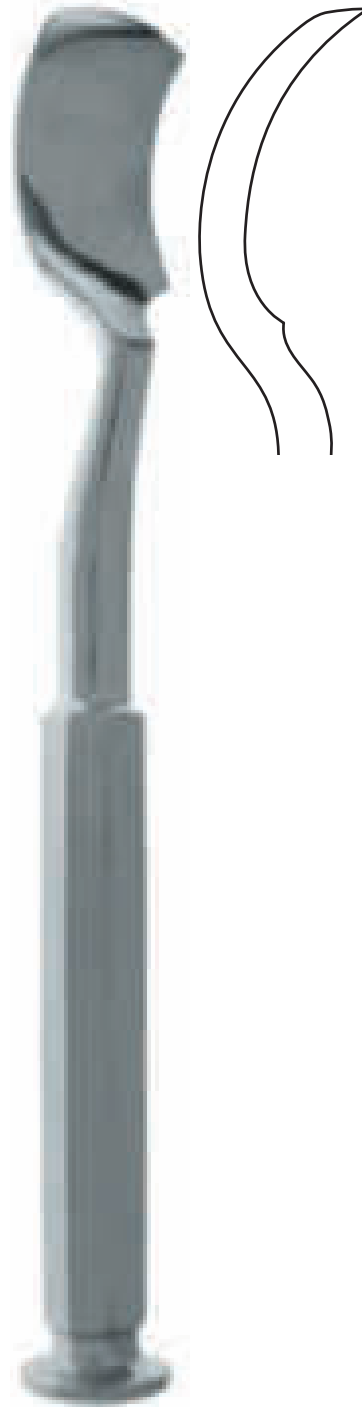

**J36345**

23,5 cm - 9 1/4"



### HONTON

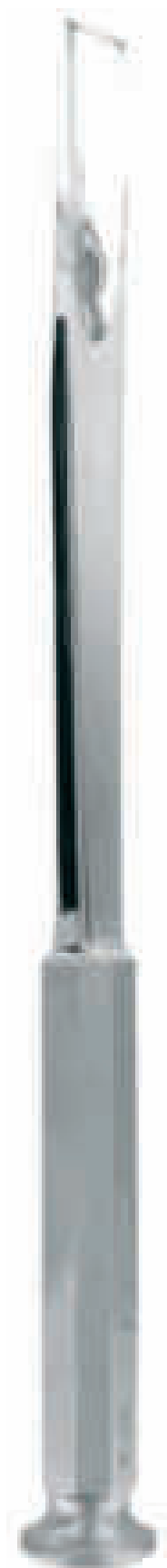

**J364718**  
30 cm - 11 3/4"

30 cm - 11 3/4"



20 mm

**J364720**



18 mm

**J364718**



16 mm

**J364716**



14 mm

**J364714**

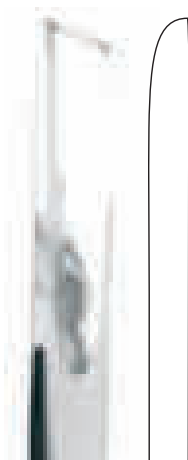

Droit  
Straight  
Recta



Convexe  
Convexe  
Convexa

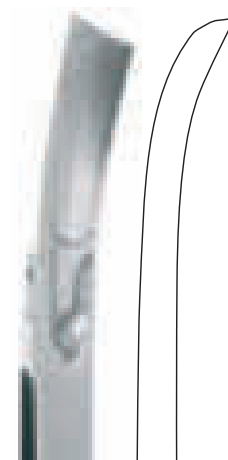

Concave  
Concave  
Concava

**J364920**

**J364918**

**J364916**

**J364914**

**J364820**

**J364818**

**J364816**

**J364814**

# LANDANGER

## Ciseaux gouges - Gouges - Gubias

### STAGNARA

### COBB

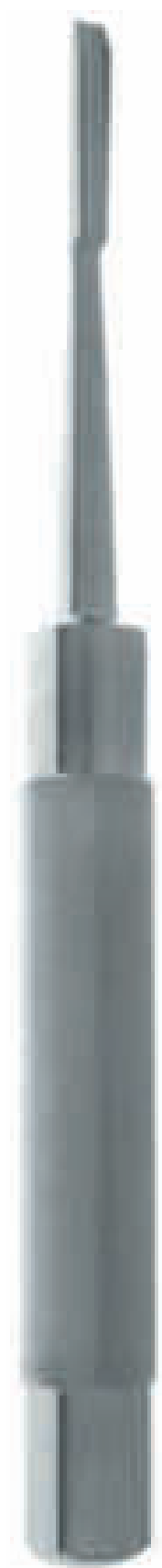
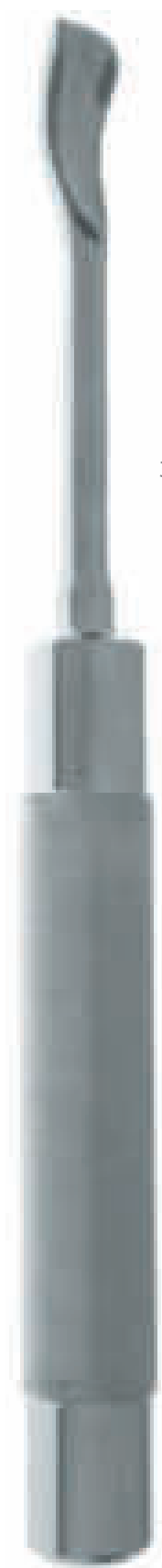

Très courbe  
Very curved  
Muy curva

Droite  
Straight  
Recta

1/2 Courbe  
Half Curved  
Media curva

Courbe  
Curved  
Curva

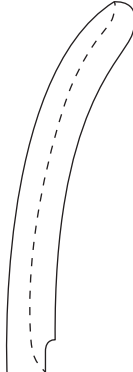
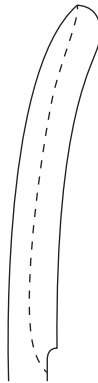
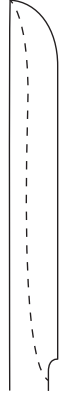
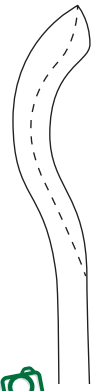

30 cm - 11 3/4"

	16 mm	<b>J36635</b>			
	14 mm	<b>J36625</b>	-	-	-
	12 mm	<b>J36620</b>	-	-	-
	10 mm	<b>J366190</b>	-	-	-
	8 mm	<b>J366180</b>	<b>J36700</b>	<b>J36705</b>	<b>J36710</b>
	6 mm	<b>J366170</b>	-	-	-

MANCHE ANTIDÉRAPANT  
ANTISLIPING HANDLE  
MANGO ANTIDESLIZANTE

**J36635**

30 cm - 11 3/4"

**J36700**

30 cm - 11 3/4"



## MINI LEXER

10 mm



Osteotome  
Osteotome  
Osteotomo

10 mm



Gouge  
Gouge  
Gubias

	18 cm - 7"		18 cm - 7"
	<b>J328912</b>	12 mm	<b>J368912</b>
	<b>J328910</b>	10 mm	<b>J368910</b>
	<b>J328908</b>	8 mm	<b>J368908</b>
	<b>J328906</b>	6 mm	<b>J368906</b>
	<b>J328904</b>	4 mm	<b>J368904</b>

## LEXER

	22 cm - 8 3/4"		22 cm - 8 3/4"
	<b>J329030</b>	30 mm	<b>J369030</b>
	<b>J329025</b>	25 mm	<b>J369025</b>
	<b>J329020</b>	20 mm	<b>J369020</b>
	<b>J329015</b>	15 mm	<b>J369015</b>
	<b>J329010</b>	10 mm	<b>J369010</b>
	<b>J329007</b>	7 mm	<b>J369007</b>
	<b>J329005</b>	5 mm	<b>J369005</b>

**J329010**  
22 cm - 8 3/4"

**J369010**  
22 cm - 8 3/4"

## LEXER

Gouge  
Gouge  
Gubia

Gouge  
Gouge  
Gubia

Burin  
Bone chisel  
Osea cincela

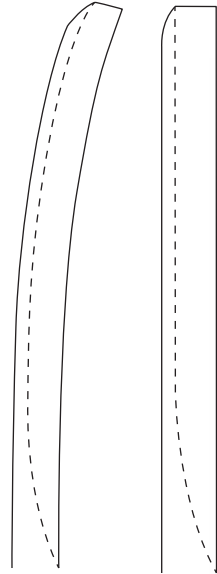

-	15 mm	J369215	J369315
J369110	10 mm	J369210	J369310
J369105	5 mm	J369205	J369305

**J369105**  
28 cm - 11"

**J369310**  
25 cm - 10"

**J329120**  
24,5 cm - 9<sup>3/4</sup>"

**J329130**  
26,5 cm - 10<sup>1/2</sup>"



### CAPENER

### ZIELKE



- 16 mm **J369416**
- 13 mm **J369413**
- 11 mm **J369411**
- 8 mm **J369408**
- 6 mm **J369406**

**J369413**  
23,5 cm - 9 1/4"



- 9 mm **J369429**
- 5,5 mm **J369425**

**J369425**  
23 cm - 9"



**J369440**  
22 cm - 8 3/4"

Râpes - Rasps - Raspas

PUTTI

1 face  
1 side  
1 lado

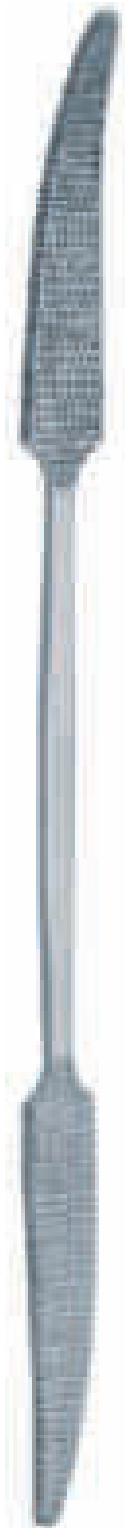

**J244670**  
27 cm - 10 1/2 "

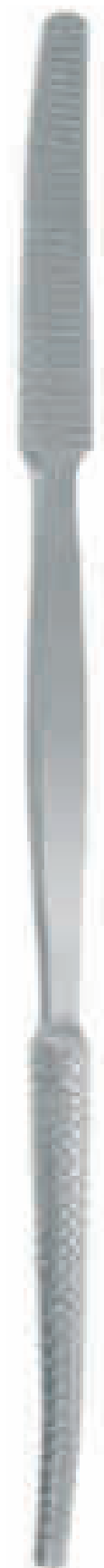

**J244680**  
30 cm - 12 "

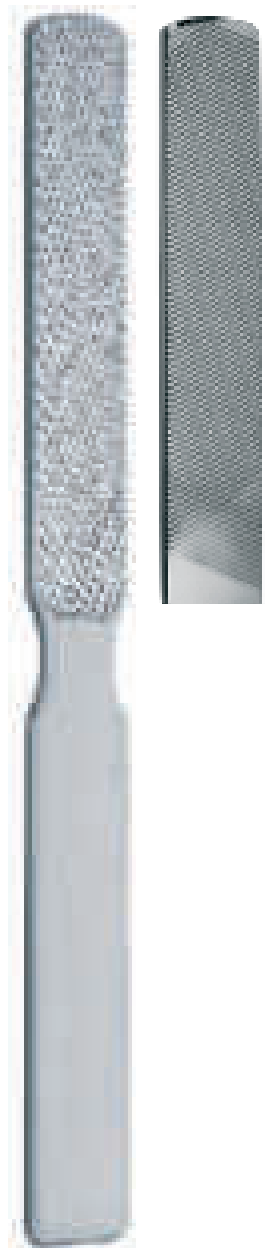

2 faces  
2 sides  
2 lados

**J244705**  
22 cm - 9 "

Demi ronde  
Half round  
Mitad redonda

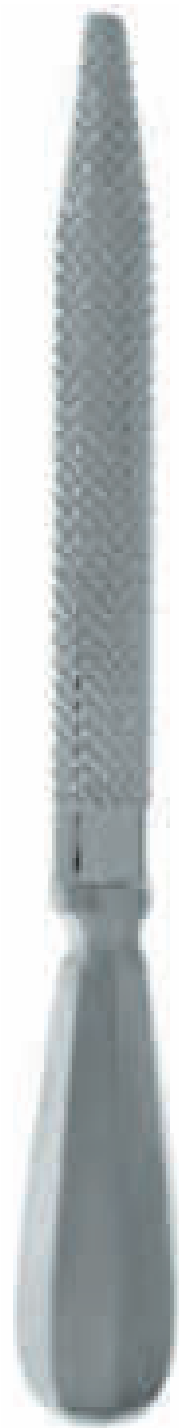

**J244650**  
25 cm - 10 "

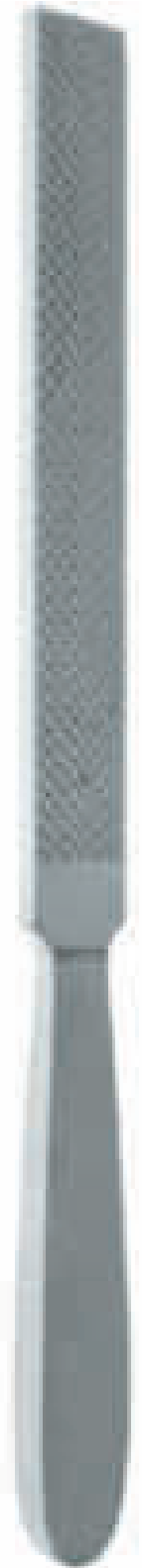

**J24466**  
28 cm - 11 "



### OMBREDANNE

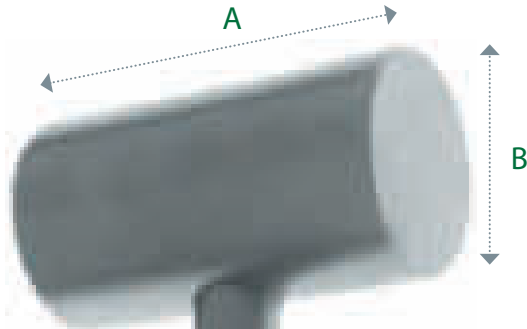

A	B	Model	Weight
57 mm	30 mm	J40010	500 g
61 mm	35 mm	J40020	700 g
64 mm	40 mm	J40025	900 g
64 mm	45 mm	J40030	1200 g

**J40010**  
22 cm - 8 3/4"

### PARTSCH

A	B	Model	Weight
38 mm	22 mm	J400010	170 g

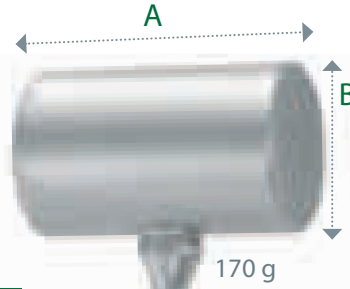

170 g

**J400010**  
19 cm - 7 1/2"

A	B	Model	Weight
36 mm	22 mm	J400020	115 g

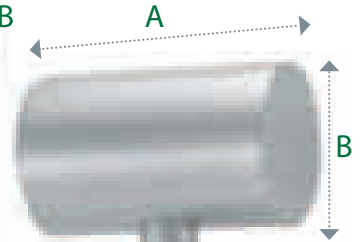

**J400020**  
18 cm - 7"

### MAC EVEN

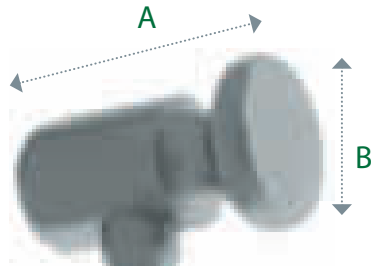

A	B		
45 mm	25 mm	 <b>J40040</b>	250 g
48 mm	30 mm	<b>J40045</b>	400 g
54 mm	35 mm	<b>J40050</b>	500 g
62 mm	40 mm	<b>J40055</b>	700 g

**J40040**

22 cm - 8 1/2"

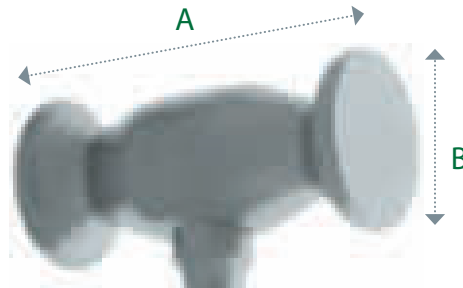

A	B		
54 mm	25 mm	 <b>J40060</b>	250 g
54 mm	30 mm	<b>J40070</b>	350 g
52 mm	35 mm	<b>J40075</b>	500 g
66 mm	40 mm	<b>J40080</b>	600 g
70 mm	45 mm	<b>J40090</b>	750 g

**J40060**

22 cm - 8 1/2"





### BERGMANN

A B  
60 mm 30 mm **J400950** 300 g



**J400950**  
23 cm - 9"

### LUCAE

A B   
51 mm 19 mm **J401500** 80 g  
52 mm 25 mm **J401505** 150 g



**J401500**  
19 cm - 7 1/2"

### HAJEK

A B  
44 mm 27 mm **J401600** 140 g

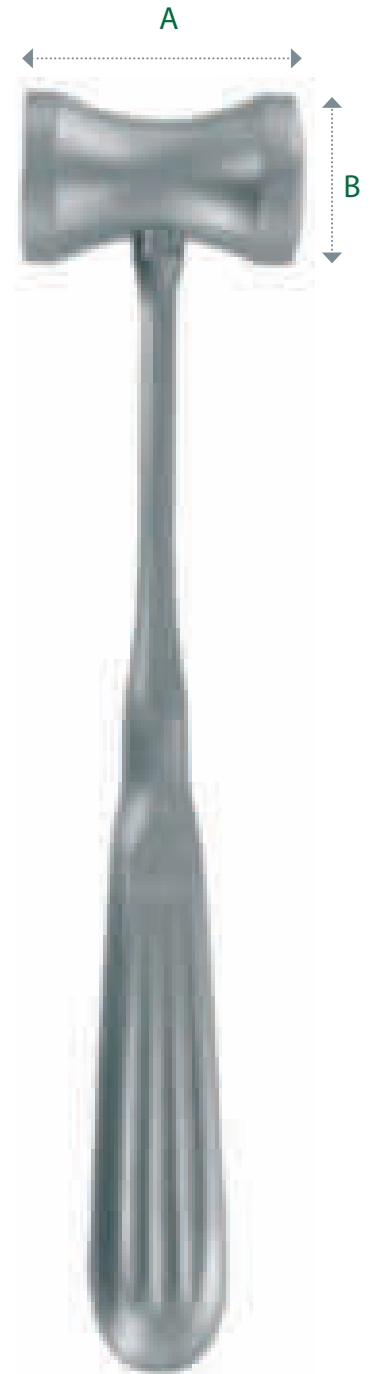

**J401600**  
21,5 cm - 8 1/2"



Aluminium  
Aluminum  
Aluminio

### MEAD

A B  
60 mm 30 mm **J401700** 230 g

A B  
60 mm 26 mm **J401800** 170 g

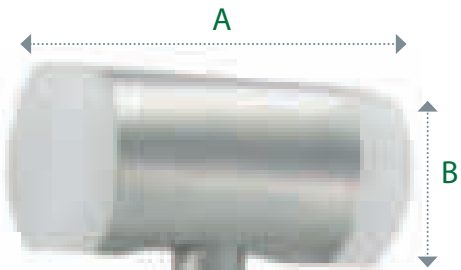

Paire de disques interchangeables  
Pair of interchangeable discs  
Par de discos intercambiables

**J401710**

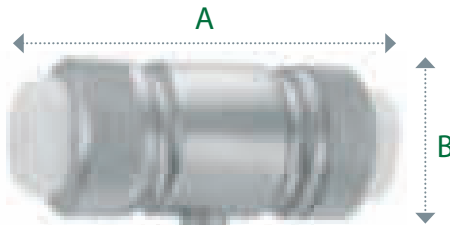

Paire de disques FERROZELL interchangeables  
Pair of interchangeable FERROZELL discs  
Par de discos FERROZELL intercambiables

**J401810**

**J401700**  
24,5 cm - 9<sup>3/4</sup>''

**J401800**  
17 cm - 6<sup>3/4</sup>''

### COTTLE

### LOMBARD

A	B	Model	Weight
50 mm	30 mm	J401405	240 g
55 mm	25 mm	J401400	135 g
47 mm	20 mm	J401000	350 g

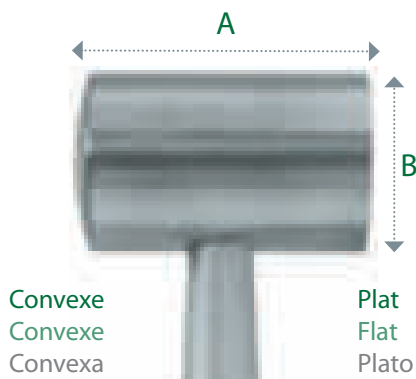

**J401405**  
19 cm - 7 1/2"

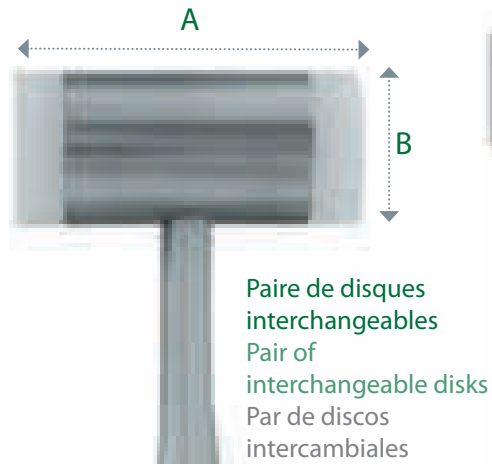

**J401401**

**J401400**  
19 cm - 7 1/2"

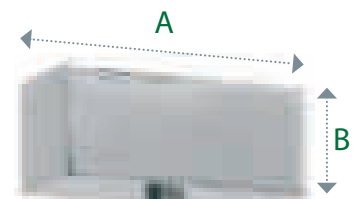

**J401000**  
20 cm - 8"

**!** Aluminium  
Aluminum  
Aluminio

### JUDET



- 20 cm - 8"  
J401180 600 g
- 25 cm - 10"  
J401190 800 g
- J40120 1000 g

**J40120**  
25 cm - 10"



- |       |       |   |       |
|-------|-------|---|-------|
| A     | B     | 23 cm - 9"  |       |
| 65 mm | 30 mm | <span style="background-color: #4CAF50; color: white; padding: 2px;">J401300</span> | 180 g |
|       |       | 24 cm - 9 1/2"  |       |
| 65 mm | 35 mm | <span style="background-color: #4CAF50; color: white; padding: 2px;">J401301</span> | 350 g |
| 68 mm | 45 mm | <span style="background-color: #4CAF50; color: white; padding: 2px;">J401302</span> | 500 g |
| 75 mm | 50 mm | <span style="background-color: #4CAF50; color: white; padding: 2px;">J401303</span> | 700 g |

**J401301**  
24 cm - 9 1/2"

### ISSELIN

Avec œillet  
With hole  
Con agujero

2,5 mm **J440070**

Sans œillet  
Without hole  
Sin agujero

2,5 mm **J440075** 



**J440075**  
16,5 cm - 6 1/2 "

### OMBREDANNE

Pointe carrée  
Square point  
Punta cuadrada

16 cm - 6 5/16 "

2 mm **J44032**

3 mm **J44035**

4 mm **J44010** 

5 mm **J44020**



**J44005**  
13 cm - 5 1/8 "



**J44010**  
16 cm - 6 5/16 "



**J44060**  
22 cm - 8 3/4 "

Pointe carrée  
Square point  
Punta cuadrada

22 cm - 8 3/4 "

3 mm **J44040**

4 mm **J44050**

5 mm **J44060** 

6 mm **J44066**

7 mm **J44070**

25 cm - 10 "

3 mm **J44045**

4 mm **J44055**

5 mm **J44065**

6 mm **J44068**

7 mm **J44071**

### MERLE D'AUBIGNE





Pointe triangulaire  
Triangular point  
Punta triangular

- Ø 22 cm - 8 3/4 "
- 3 mm **J44075**
  - 4 mm **J44085**
  - 5 mm **J44100** 
  - 6 mm **J44105**
  - 7 mm **J44110**

**J44100**  
22 cm - 8 3/4 "



Pointe quadrangulaire  
Quadrangular point  
Punta cuadrangular

- Ø 22 cm - 8 3/4 "
-  4 mm **J44115**
  -  5 mm **J44116** 
  -  6 mm **J44117**

**J44116**  
22 cm - 8 3/4 "



### PERTHES

Pointe carrée  
Square point  
Punta cuadrada

Pointe triangulaire  
Triangular point  
Punta triangular

18 cm - 7"

25 cm - 10"

- 3 mm **J440723**
- 4 mm **J440724**
- 5 mm **J440725** 
- 6 mm **J440726**
- 8 mm **J440728**

- Ø 3 mm **J441113** 
- Ø 4 mm **J441114**
- Ø 5 mm **J441115**

25 cm - 10"

- 3 mm **J440733**
- 4 mm **J440734**
- 5 mm **J440735**
- 6 mm **J440736**
- 8 mm **J440738**

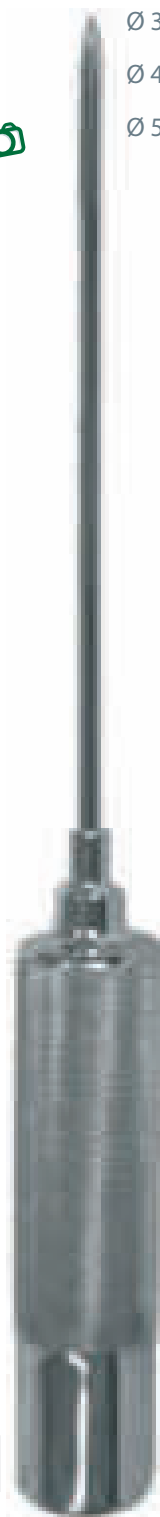

6 mm

 Aluminium  
Aluminum  
Aluminio

**J440725**  
18 cm - 7"

**J441113**  
25 cm - 10"

**J441200**  
21 cm - 8 1/4"



### ROCHER

- 15 cm - 6" **J44121** 
- 18 cm - 7" **J44122**
- 20 cm - 8" **J44123**



**J44121**  
15 cm - 6"

### FICAT

- Ø 8 mm **J442008** 
- Ø 10 mm **J442010**
- Ø 12 mm **J442012**



**J442008**  
34,5 cm - 13 1/2"





### KOENING

### LAMBOTTE

23 cm - 9"

**J48030** 

25 cm - 10"

**J48040**

27 cm - 10<sup>3/4</sup>"

**J48050**

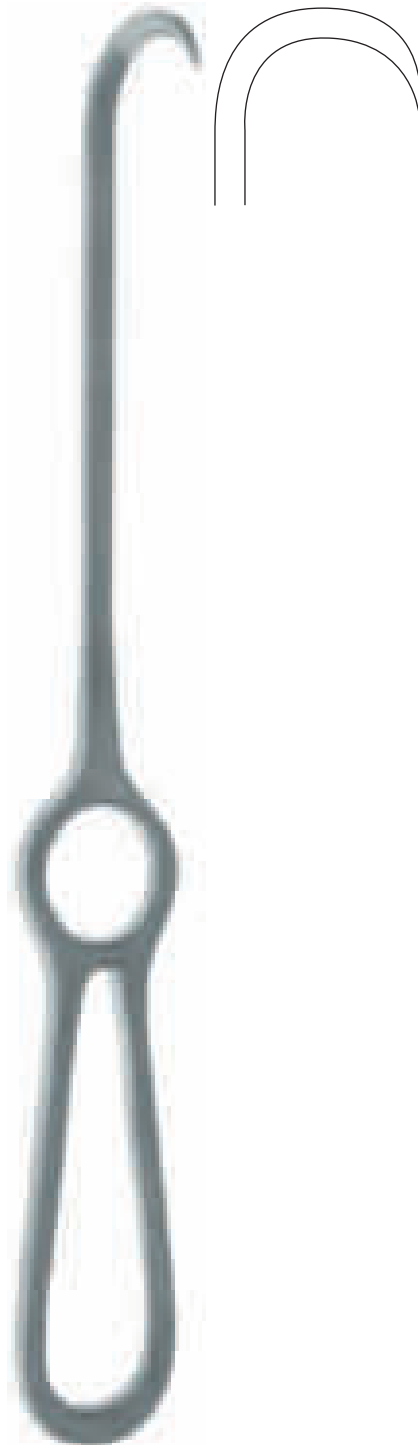

**J48020**

24 cm - 9 1/2"



**J48030**

**J48040**

**J48050**

**J48030**

23 cm - 9"

### MÖLTGEN



**J561120**  
20.5 cm - 8 "

### CAROLL

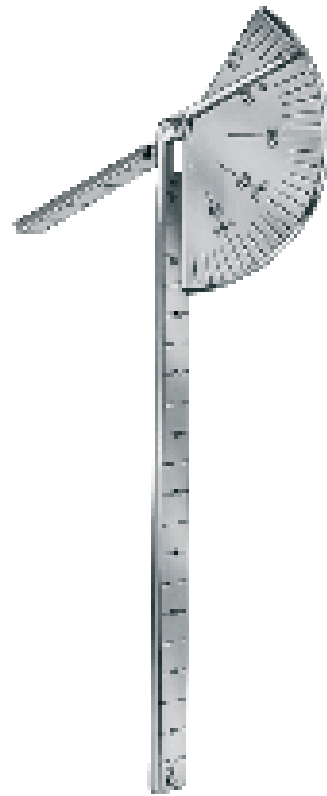

**J561130**  
14 cm - 5 1/2"



Non compatible avec les traitements  
de nettoyage/stérilisation  
No compatible with treatments  
for cleaning/sterilization  
No compatible con los tratamientos  
de limpieza/esterilización

Dispositif non médical  
Not medical device  
Dispositivo no medica

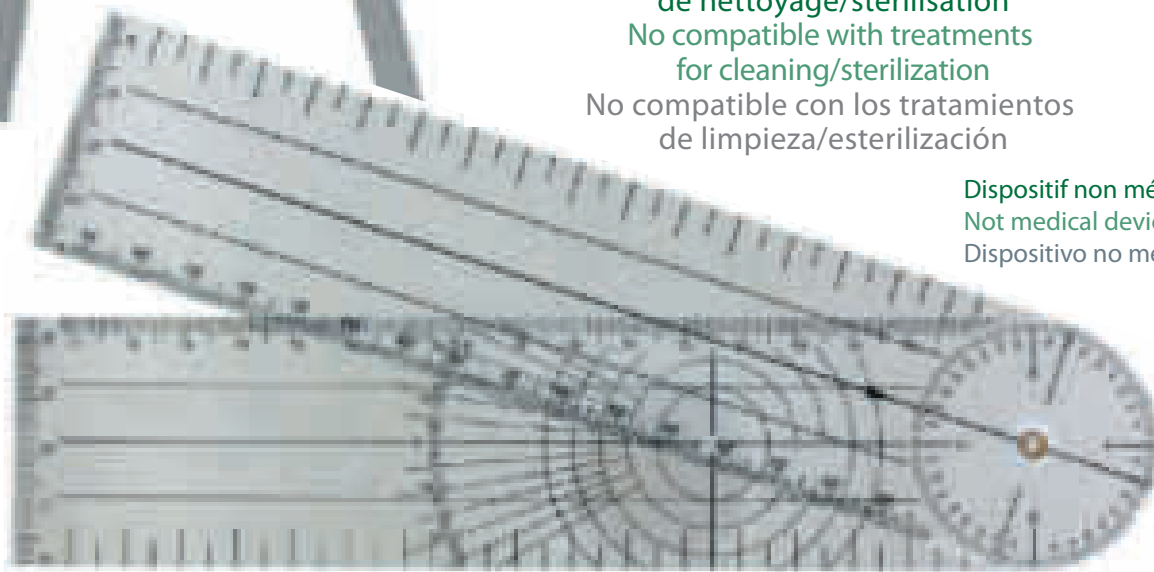

**J561200**  
20 cm - 8 "



Régllet inox  
Stainless ruler  
Regla inoxidable

- 15 cm - 6" J560350
- 20 cm - 8" J56040
- 30 cm - 11 3/4" J56050
- 50 cm - 19 3/4" J56055

**J56040**  
20 cm - 8"



Pied à coulisses inox  
Stainless caliper  
Calibre de medición

**J56070**  
23 cm - 9"











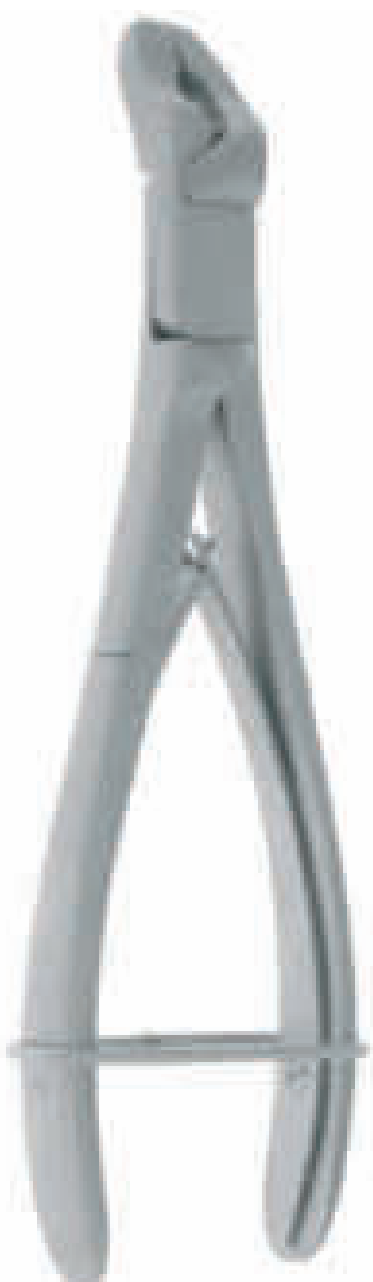

Dispositifs non médicaux  
Not medical devices  
Dispositivos no médicos



Non compatible avec les traitements  
de nettoyage/stérilisation  
No compatible with treatments  
for cleaning/sterilization  
No compatible con los tratamientos  
de limpieza/esterilización

# LANDANGER

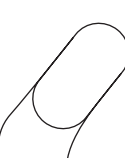
## Pinces gouges - Bone rongeur forceps - Pinzas gubias

	17 cm - 6 <sup>3</sup> / <sub>4</sub> "	<p>Droite Straight Recta</p>  <p>5 mm <b>J64020</b></p>		17 cm - 6 <sup>3</sup> / <sub>4</sub> "	<p>Courbe Curved Curva</p>  <p>5 mm <b>J64060</b> </p>		
		 <p>7 mm <b>J64030</b></p>			 <p>7 mm <b>J64070</b></p>		
		 <p>9 mm <b>J64040</b> </p>			 <p>9 mm <b>J64080</b></p>		
		20 cm - 8 "		 <p>8 mm <b>J64090</b></p>		20 cm - 8 "	 <p>8 mm <b>J64120</b></p>
	<p><b>J64040</b> 17 cm - 6 <sup>3</sup>/<sub>4</sub> "</p>	 <p>10 mm <b>J64100</b></p>			<p><b>J64060</b> 17 cm - 6 <sup>3</sup>/<sub>4</sub> "</p>	 <p>10 mm <b>J64130</b></p>	

### LOMBARD

Mors carrés  
Quadrangular jaws  
Bocas cuadradas

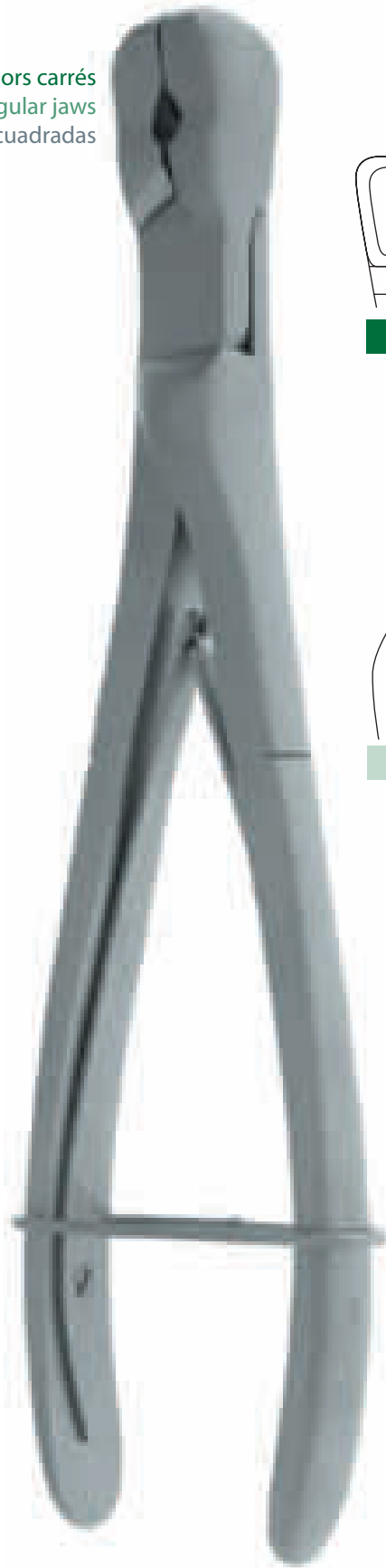

Droite  
Straight  
Recta



J64150 

Courbe  
Curved  
Curva

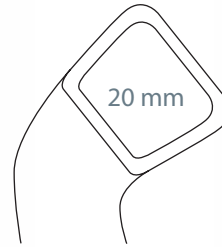

J64160

Coudée  
Angular  
Acodada



3 mm

J64150  
23 cm - 9"

J64260  
18 cm - 7"

# LANDANGER

## Pinces gouges - Bone rongeur forceps - Pinzas gubias

### VINCENT

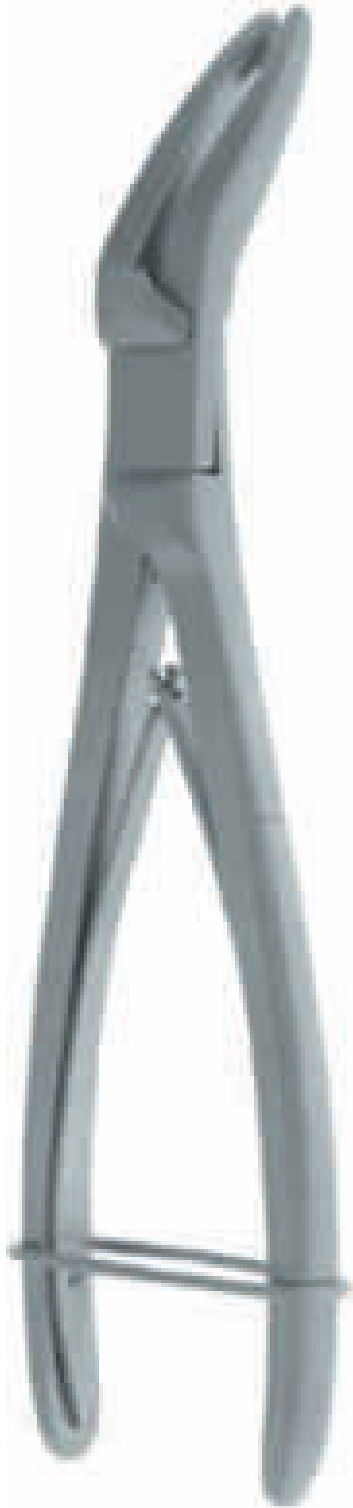

**J64290**  
20 cm - 8"

Mors courts  
Short jaws  
Bocas cortas



Courbe  
Curved  
Curva

20 cm - 8" **J64310**  
24 cm - 9 1/2" **J64350**

Mors longs  
Long jaws  
Bocas largas

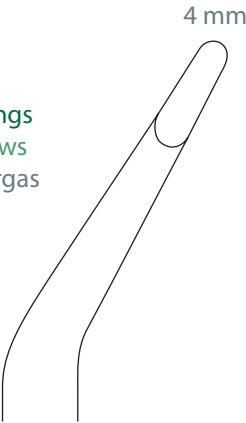

Courbe  
Curved  
Curva

20 cm - 8" **J64290**   
24 cm - 9 1/2" **J64330**

Droite  
Straight  
Recta

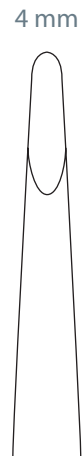

25 cm - 10" **J64340**

### SICARD

Droite  
Straight  
Recta

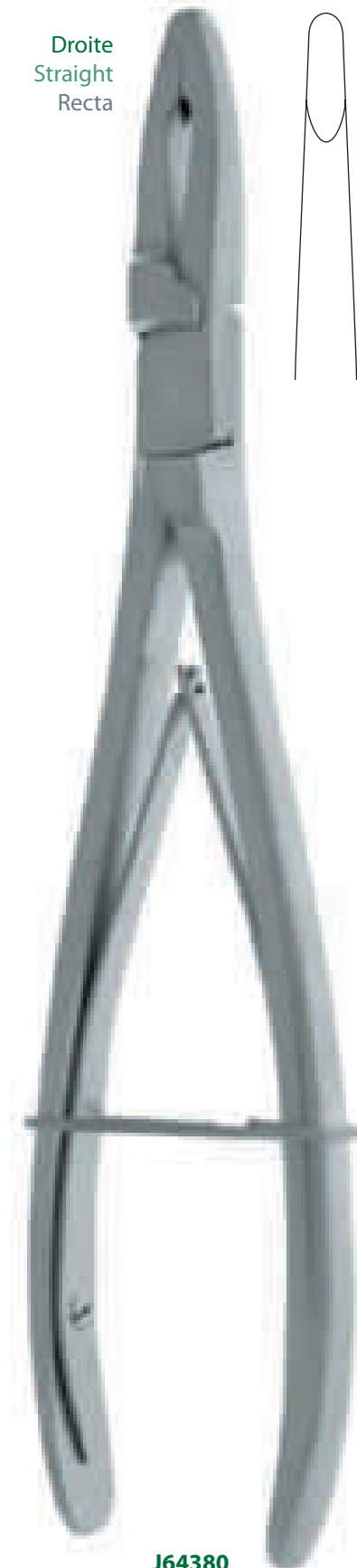

**J64380**  
23 cm - 9"

6 mm



ABOULKER

Droite  
Straight  
Recta

5 mm



**J643810**  
24 cm - 9 1/2"

Courbe latérale  
Curved laterally  
Curva lateral

8 mm



**J64270**  
17 cm - 6 3/4"



### LUER-FRIEDMANN

### MINI-FRIEDMANN

### FRIEDMANN DELIKAT

Courbe  
Curved  
Curva

2 mm

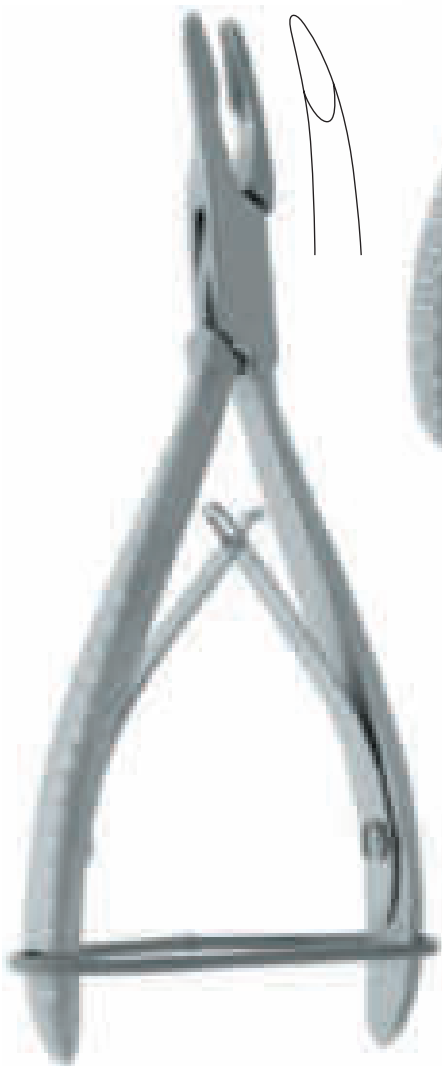

**J64400**  
14 cm - 5 1/2"

Courbe  
Curved  
Curva

2,5 mm



**J644005**  
12,5 cm - 5"

Courbe  
Curved  
Curva

2 mm



**J644010**  
15 cm - 6"



## Pinces gouges - Bone rongeur forceps - Pinzas gubias

### BLUMENTHAL

Légèrement Courbe  
Lightly curved  
Ligeramenta curva

Courbe  
Curved  
Curva

Coudée  
Angular  
Acodada

3 mm



J644990



3 mm

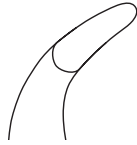

J644995

3 mm



J644996

### MEAD

Mors ronds  
Round jaws  
Bocas redondas

Mors carrés  
Square jaws  
Bocas cuadradas

5 mm



J645200

4 mm



J645205



**J644990**  
15,5 cm - 6 "



**J645200**  
16,5 cm - 6 1/2 "

# LANDANGER

Pinces gouges - Bone rongeur forceps - Pinzas gubias

## LUER

## CLEVELAND

## HAKANSSON

3 mm

Courbe  
Curved  
Curva

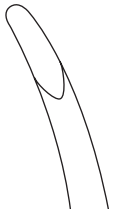

**J644890**

4 mm



**J64490**

Courbe  
Curved  
Curva

4 mm



**J644880**



14 cm - 5 1/2"

**J644885**

17 cm - 6 1/4"

Courbe latérale  
Laterally curved  
Curva lateral

5 mm



**J644880**

14 cm - 5 1/2"

**J64490**

15 cm - 6"

**J644875**

15,5 cm - 6"



### LUER

Droite  
Straight  
Recta

Courbe  
Curved  
Curva



8 mm



**J644950**

**J644960**



17 cm - 6<sup>3</sup>/<sub>4</sub>"

Modèle fort  
Heavy pattern  
Modelo fuerte



10 mm



**J644970**

**J644980**

18,5 cm - 7<sup>1</sup>/<sub>4</sub>"

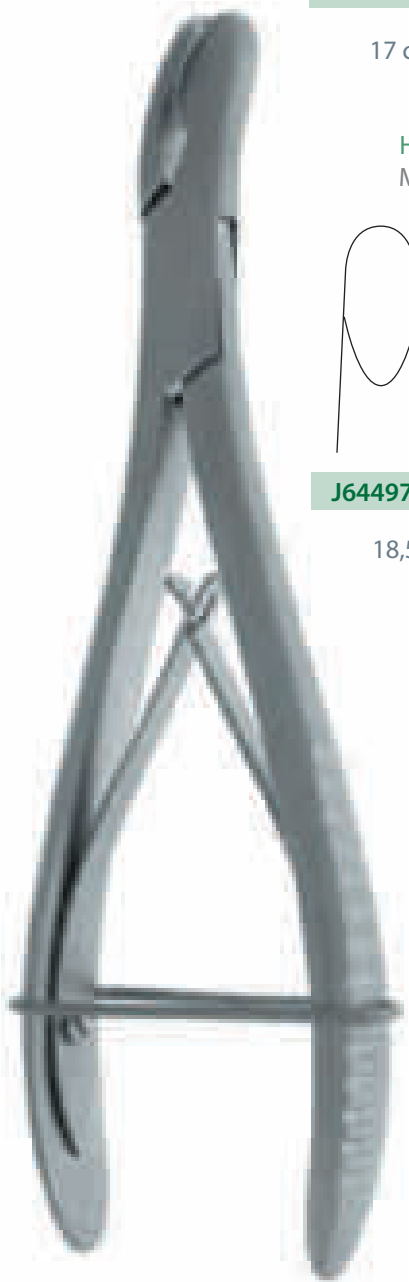

**J644960**  
17 cm - 6<sup>3</sup>/<sub>4</sub>"

### ADSON

Droite  
Straight  
Recta

8 mm

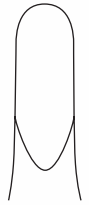

**J644984**

8 mm

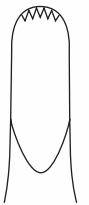

**J644986**

Dentelées  
Saw edge  
Dentadas

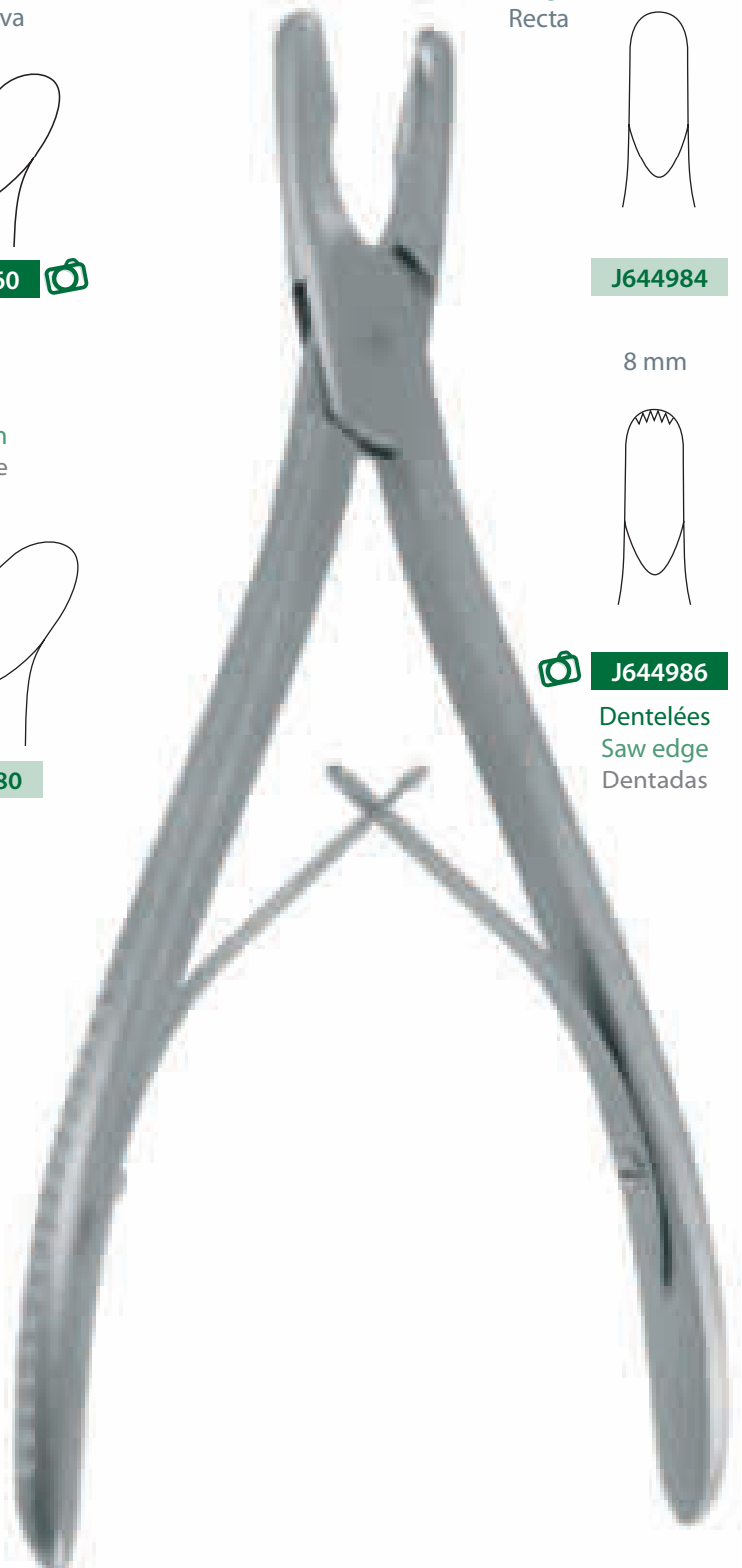

**J644986**  
20 cm - 8"

### STELLBRINK

Courbe  
Curved  
Curva

2 mm



2 mm

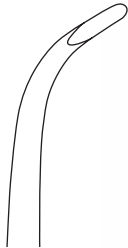

J645000

J645010

### BANE HARTMANN

Courbe  
Curved  
Curva

3 mm



J645210  
17,5 cm - 7"

### JANSEN

Droite  
Straight  
Recta

4 mm



Courbe  
Curved  
Curva

4 mm



J645110

J645120



J645000  
17,5 cm - 7"



J645110  
17,5 cm - 7"

### OLIVECRONA



**J645100**  
20 cm - 8"

### BEYER

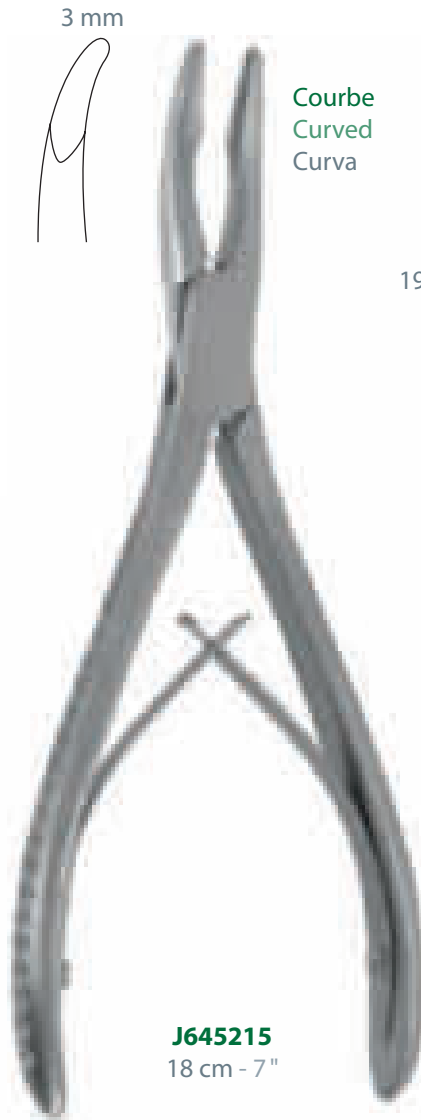

### LEMPERT

	Droite Straight Recta	Courbe Curved Curva	
19 cm - 7 1/2"	<b>J64190</b>	<b>J64192</b>	

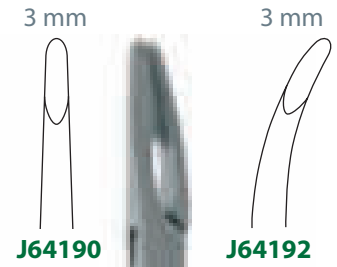

**J64192**  
19 cm - 7 1/2"

### NORTHFIELD

Courbe latérale  
Curved laterally  
Curva lateral

9 mm



**J645230**  
20,5 cm - 8"

### PENNYBACKER

Droite  
Straight  
Recta

4 mm



**J645220**  
20,5 cm - 8"



### JANSEN

Mors baïonnette  
Bayonet jaws  
Bocas bayoneta



**J645235**  
18 cm - 7 "

### STOOKEY

Courbe latérale  
Curved laterally  
Curva lateral

4 mm

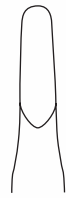

**J645240**  
18,5 cm - 7 1/4 "

### BACON

Courbe latérale  
Curved laterally  
Curva lateral

7 mm



**J645245**  
20 cm - 8 "

### BOEHLER

3 mm



Droite  
Straight  
Recta

**J64384**



3 mm



Courbe  
Curved  
Curva

**J64386**

2 mm



**J64385**

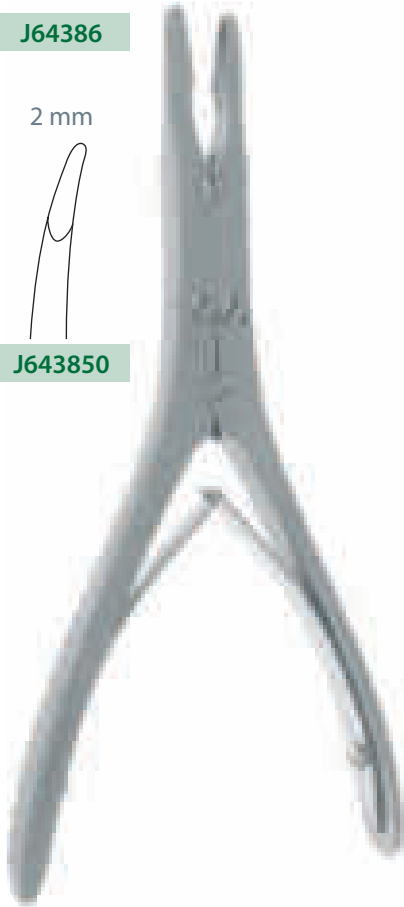

**J64384**  
15 cm - 6 "

### BEYER-ZAUFAL

5 mm



Courbe  
Curved  
Curva

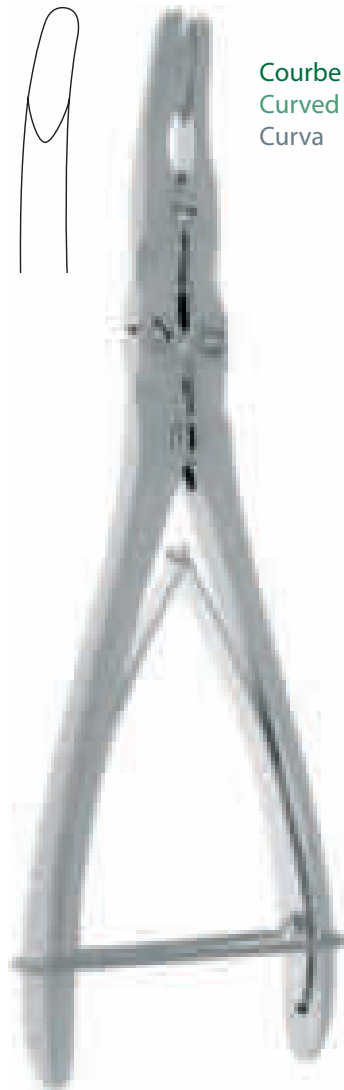

**J64480**  
18 cm - 7 "

### BEYER

2,5 mm



Courbe  
Curved  
Curva

**J64395**

18 cm - 7 "

4 mm



**J64390**



**J64390**  
18 cm - 7 "

6 mm



**J64410**

20 cm - 8 "



### MARQUARDT



**J644850**  
20 cm - 8 "

Courbe  
Curved  
Curva

3 mm



### MAYFIELD



**J644830**  
17 cm - 6 3/4 "

Courbe  
Curved  
Curva

3 mm



### RUSKIN



**J645251**  
18 cm - 7 "

Courbe  
Curved  
Curva

6 mm



Droite  
Straight  
Recta

6 mm

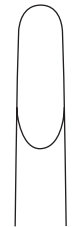

**J645250**

**J645251**



### STILLE

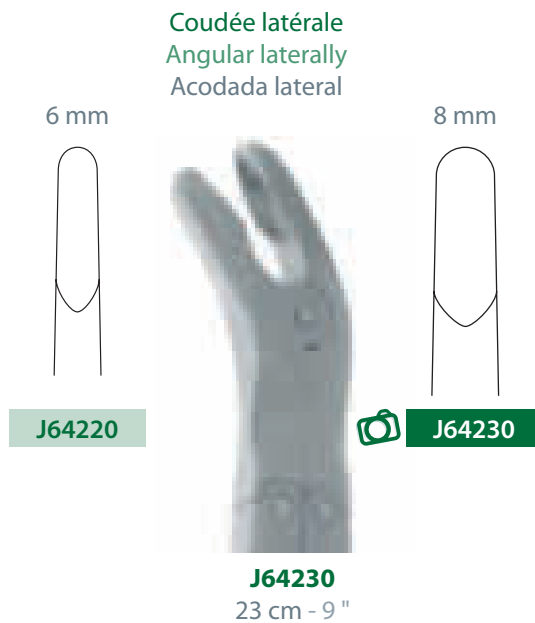
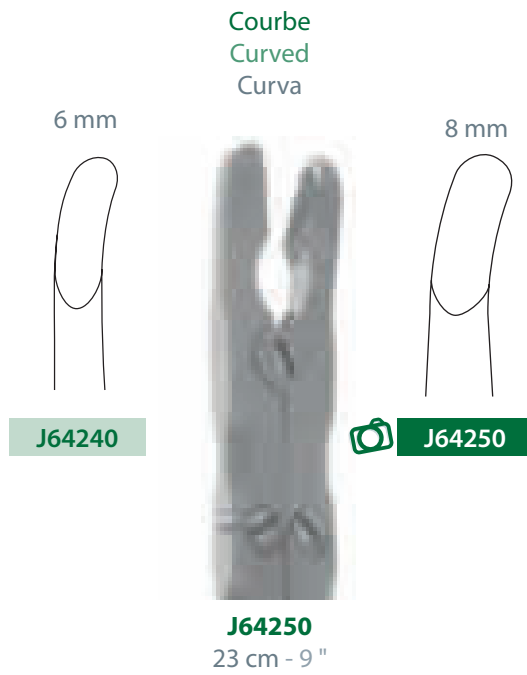

### RÖTTGEN-RUSKIN

### SMITH-PETERSEN

### LEKSELL- STILLE

5 mm  
Courbe  
Curved  
Curva

4 mm  
Courbe  
Curved  
Curva

3 mm  
Coudée latérale  
Angular laterally  
Acodada lateral

J64416

J64418

J64422

J64412  
19 cm - 7 1/2 "

J64414  
23 cm - 9 "

J644870  
24 cm - 9 1/2 "

J64416  
24 cm - 9 1/2 "

### ECHLIN

### FRYKHOLM

Coudées latérales  
Angular laterally  
Acodadas laterale

2 mm

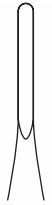

J64254

3 mm



J64256

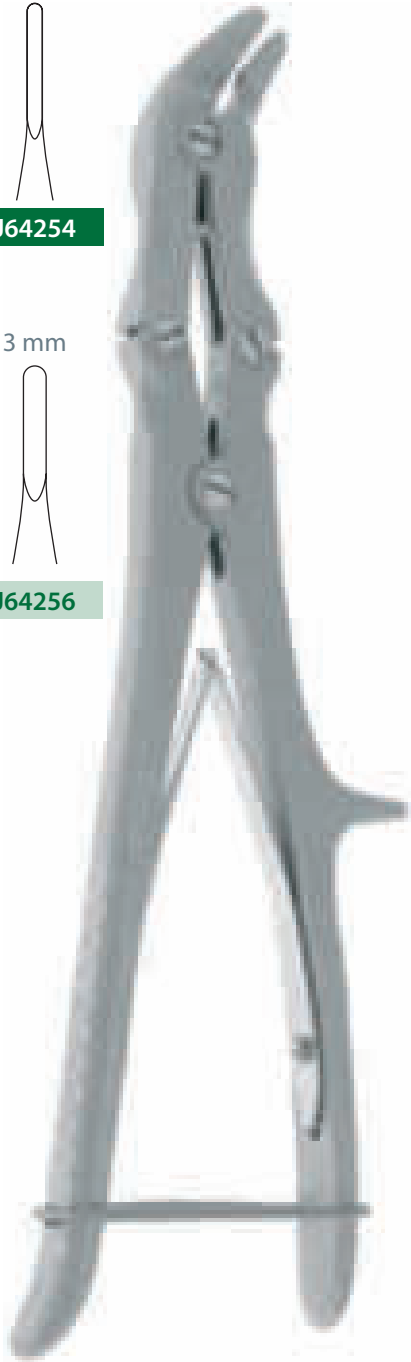

J64254

23 cm - 9 "

4 mm



J642570

24 cm - 9 1/2 "

SAUERBRUCH

Droite  
Straight  
Recta

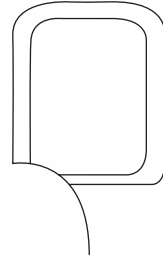
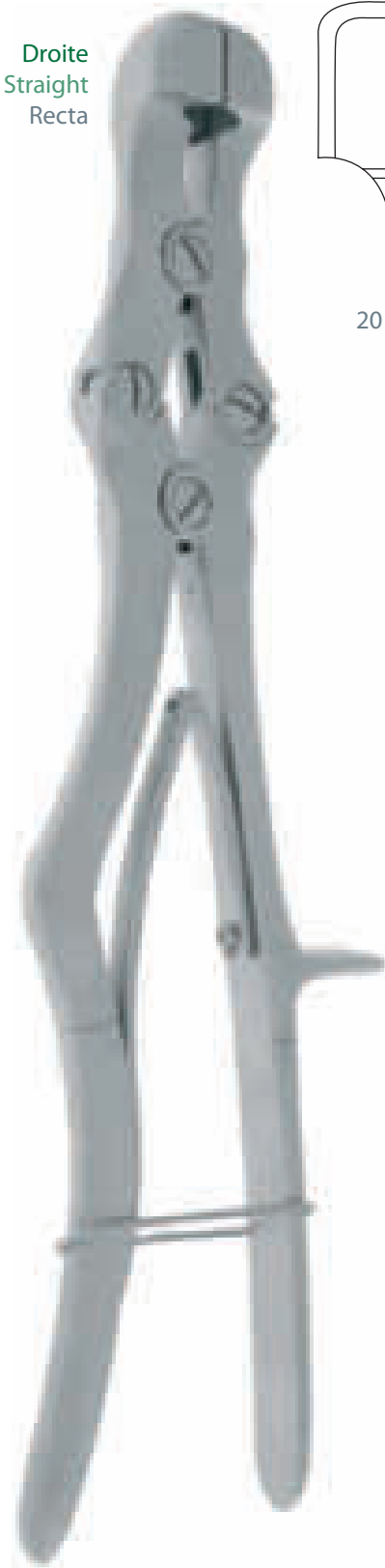

20 mm

**J64280**

31 cm - 12 1/4 "

DAVID

Coudée latérale  
Angular laterally  
Acodada lateral



6 mm



**J64370**

26 cm - 10 1/4 "

# LANDANGER

## Pinces gouges - Bone rongeur forceps - Pinzas gubias

### SEMB

### STILLE-LUER

Courbe  
Curved  
Curva

18 mm

17 mm

Droite  
Straight  
Recta



J645310

17 mm

Courbe  
Curved  
Curva

J645315

**J645300**  
23 cm - 9"

**J645310**  
27 cm - 10 1/2"

### LISTON

Double doigt  
Double Collin's lock  
Doble articulación

Droite  
Straight  
Recta

-	14 cm - 5 1/2 "	J68022
-	17 cm - 6 3/4 "	J68026
J68062	19 cm - 7 1/2 "	J68030
J68066	22 cm - 8 3/4 "	J68050

Coudée  
Angular  
Acodada

-	14 cm - 5 1/2 "	J68024
-	17 cm - 6 3/4 "	J68028
J68064	19 cm - 7 1/2 "	J68040
J68068	22 cm - 8 3/4 "	J68060

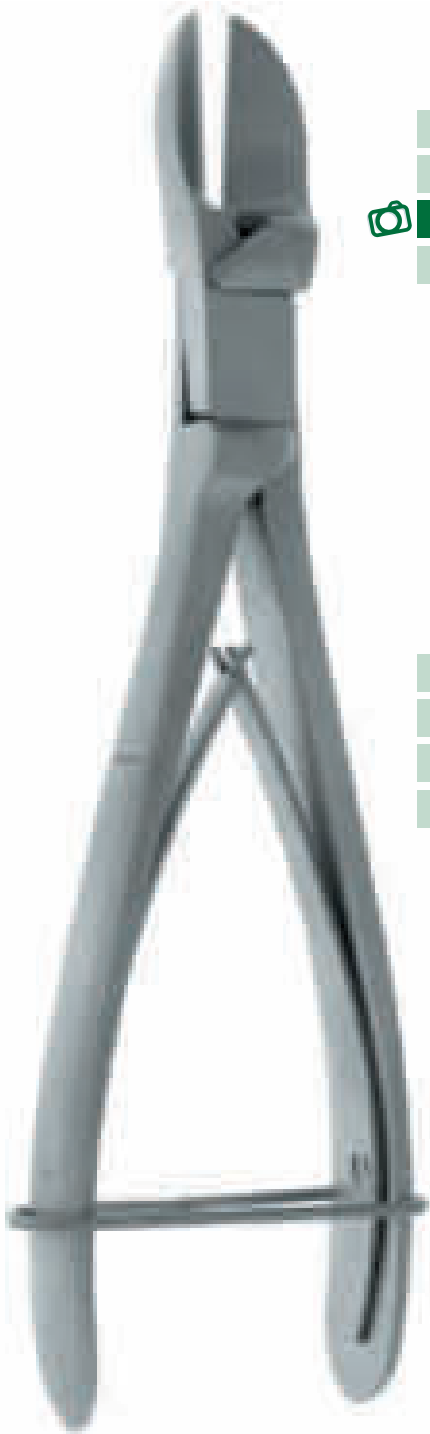

**J68062**  
19 cm - 7 1/2 "

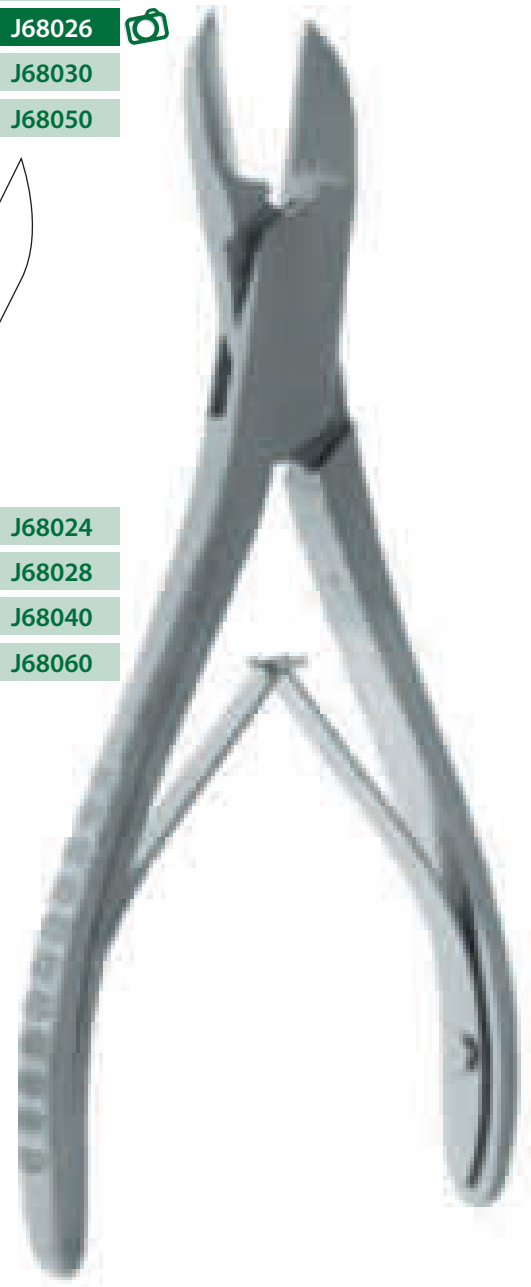

**J68026**  
17 cm - 6 3/4 "

## LITTAUER-LISTON

## CLEVELAND

## KAZANJIAN

Coudée  
Angular  
Acodada

13 cm - 5" **J680710**

17 cm - 6<sup>3</sup>/<sub>4</sub>" **J680715** 



Droite  
Straight  
Recta

Droite  
Straight  
Recta

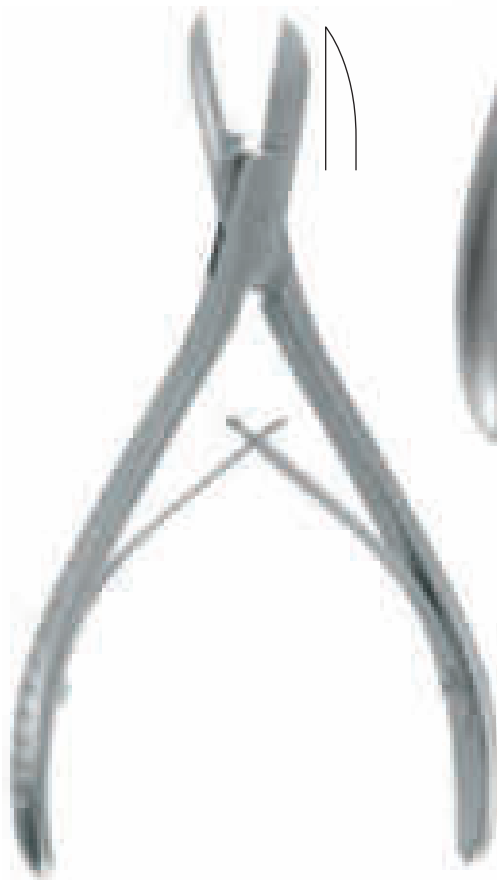

**J680700**  
15 cm - 6"



**J680715**  
17 cm - 6<sup>3</sup>/<sub>4</sub>"



**J680720**  
18,5 cm - 7<sup>1</sup>/<sub>4</sub>"





## RUSKIN-LISTON

Droite  
Straight  
Recta



**J68275**

Coudée  
Angular  
Acodada



**J68280**

## BOEHLER

Droite  
Straight  
Recta



**J68010**

Coudée  
Angular  
Acodada



**J68012**

## MAC INDOE

Coudée  
Angular  
Acodada



17 cm - 6 <sup>3</sup>/<sub>4</sub> "

**J68015**



19 cm - 7 <sup>1</sup>/<sub>2</sub> "

**J68020**

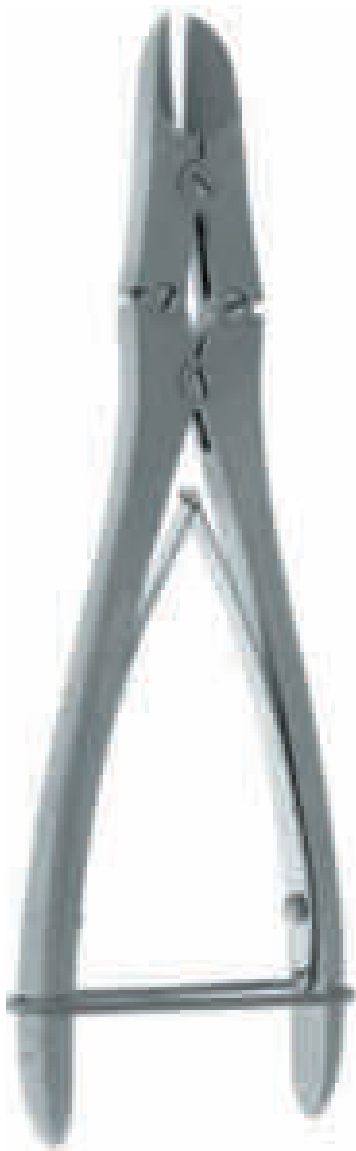

**J68275**  
19 cm - 7 <sup>1</sup>/<sub>2</sub> "

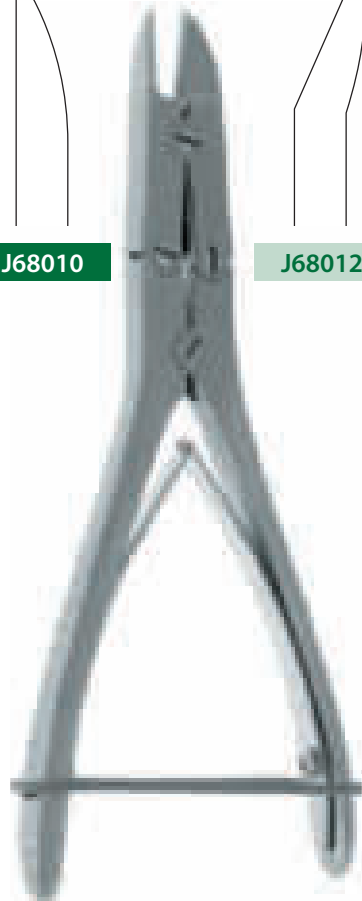

**J68010**  
15 cm - 6 "



**J68015**  
17 cm - 6 <sup>3</sup>/<sub>4</sub> "

## LISTON

Droite  
Straight  
Recta

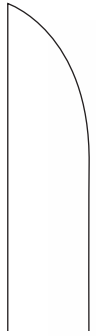

 **J68090**

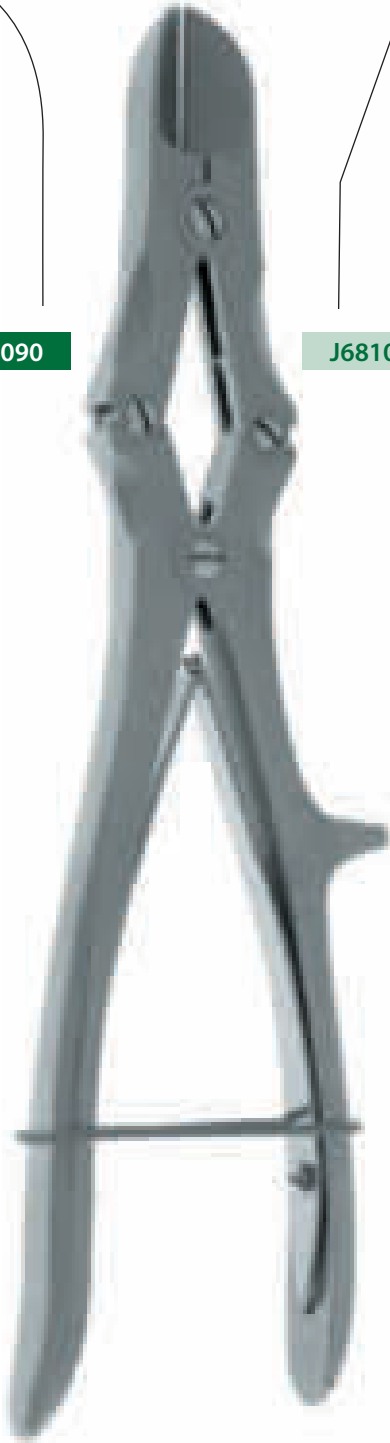

**J68090**  
24 cm - 9 1/2 "

Coudée  
Angular  
Acodada



**J68100**

Droite  
Straight  
Recta

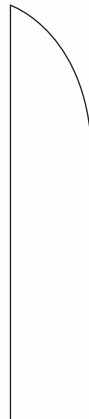

**J681190**



**J68120**  
28 cm - 11 "

Courbe - Forte  
Curved - Strong  
Curva - Fuerte



**J68120** 

## LISTON-KEY (HORSLEY)

## SEMB

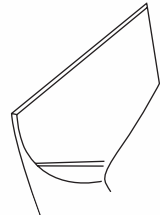

Coudée  
Angular  
Acodada

Contre-coudée - Forte  
Conterbent - Strong  
Curva doble - Fuerte

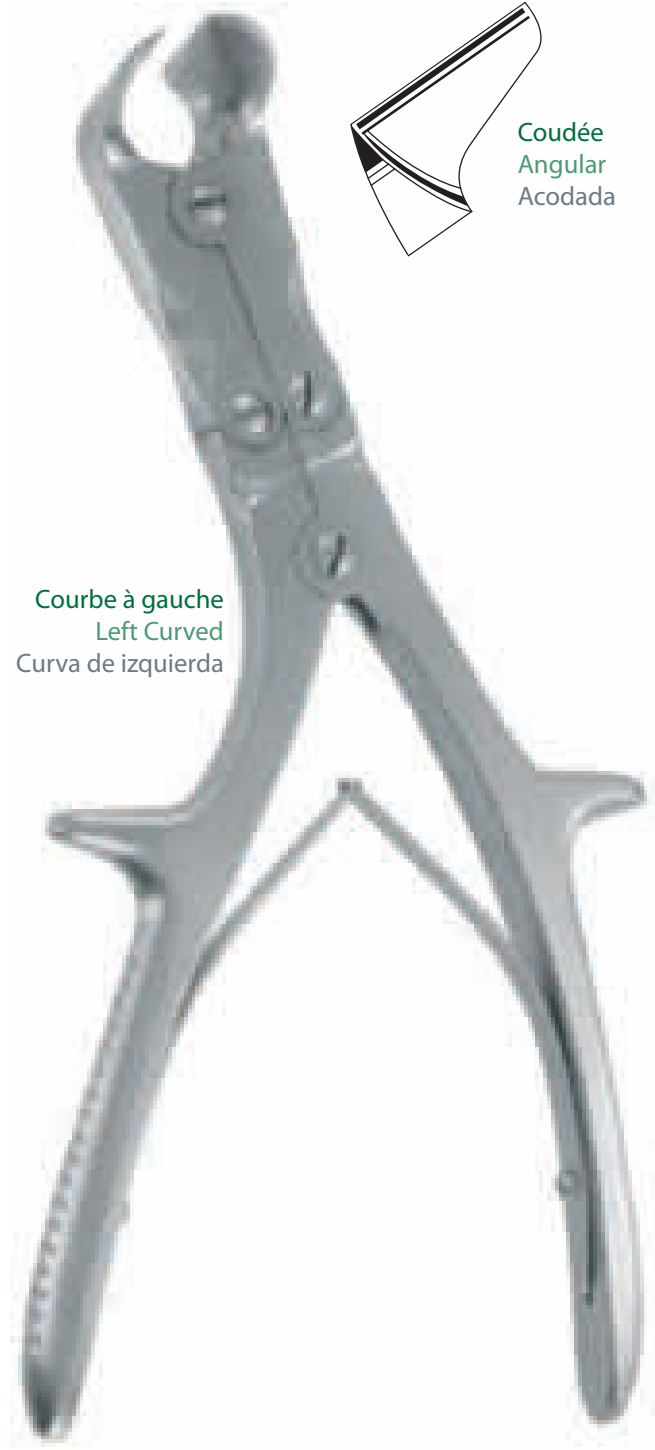

Coudée  
Angular  
Acodada

Courbe à gauche  
Left Curved  
Curva de izquierda

**J68110**  
28 cm - 11"

**J681090**  
24 cm - 9 1/2"

### COLLIN

Enfants  
Children  
Niños

17 cm - 6 <sup>3</sup>/<sub>4</sub>" **J68170**

Adultes  
Adults  
Adultos

19 cm - 7 <sup>1</sup>/<sub>2</sub>" **J68180** 

### LISTON

Cisaille  
Shear  
Cizalla

19 cm - 7 <sup>1</sup>/<sub>2</sub>" **J68150**

25 cm - 10" **J68130** 

A doigt  
Collin's lock  
Demontable

A doigt  
Collin's lock  
Demontable

**J68180**  
19 cm - 7 <sup>1</sup>/<sub>2</sub>"

**J681900**  
22 cm - 8 <sup>3</sup>/<sub>4</sub>"

**J68130**  
25 cm - 10"

### BETHUNE



**J681605**  
34 cm - 13 1/2 "

### MAURER



A droite  
Right curved  
Derecha

**J68240**  
24 cm - 9 1/2 "

	A droite Right curved Derecha	À gauche Left curved Izquierda
24 cm - 9 1/2 "	 <b>J68240</b>	<b>J68230</b>
31 cm - 12 1/4 "	 <b>J68210</b>	<b>J68220</b>



A droite  
Right curved  
Derecha

A doigt  
Collin's lock  
Demontable

**J68210**  
31 cm - 12 1/4 "

### BRUNNER

Pour main droite  
For right hand  
Para mano derecha



**J681615**

Pour main gauche  
For left hand  
Para mano izquierda

**J681610**

### GLUCK



**J681620**

22 cm - 8 <sup>3</sup>/<sub>4</sub> "

### GIERTZ-STILLE



**J681630**

25 cm - 10 "

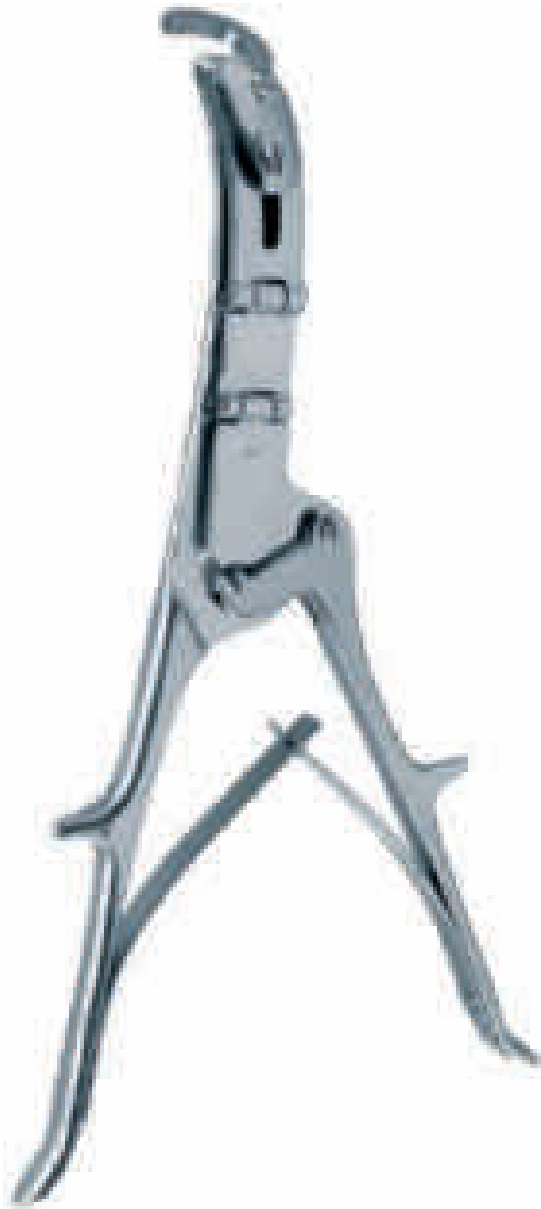

**J681615**

32 cm - 12 <sup>1</sup>/<sub>2</sub> "



SAUERBRUCH

SAUERBRUCH-FREY



**J681600**  
26 cm - 10 1/4"



**J681601**  
36 cm - 14 1/4"

### VELPEAU (TRICOISE)

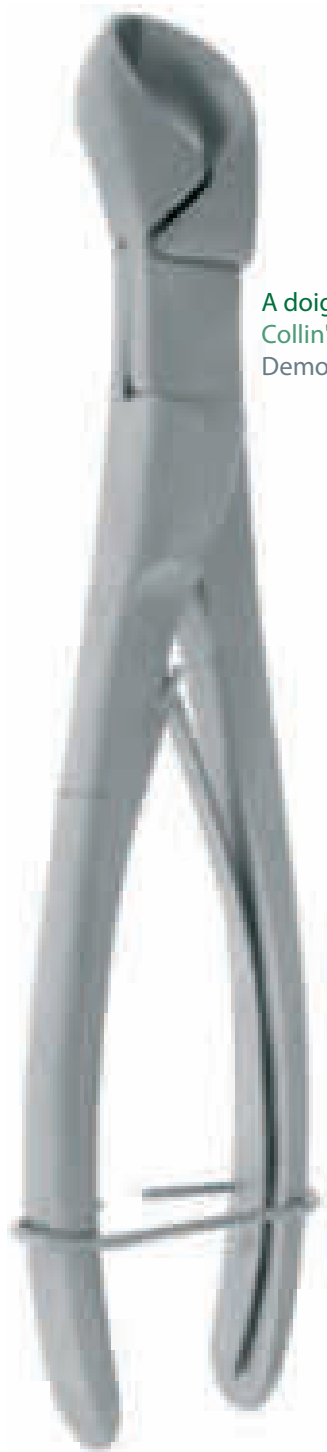

A doigt  
Collin's lock  
Demontable

**J68250**  
24 cm - 9 1/2"

### DOYEN

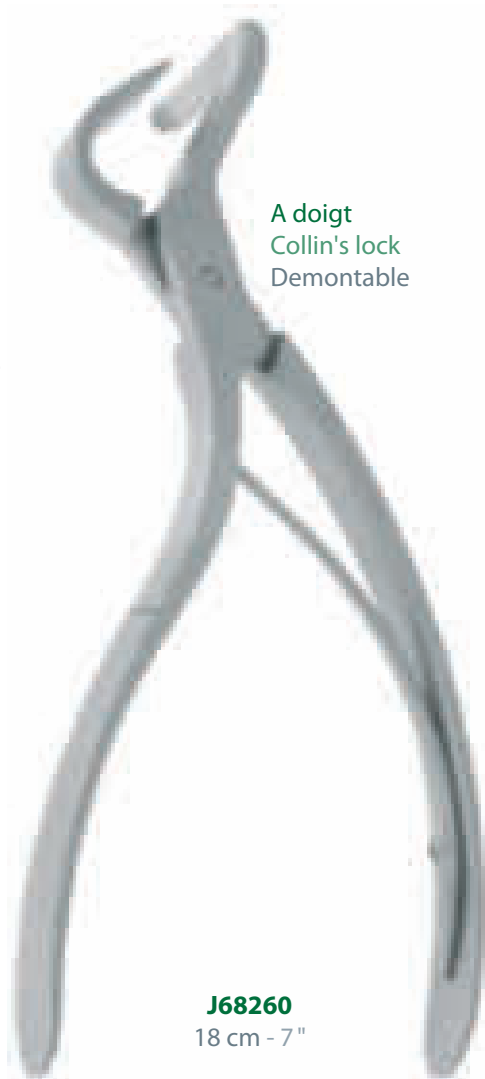

A doigt  
Collin's lock  
Demontable

**J68260**  
18 cm - 7"

### LEBSCHÉ

Sternotome  
Sternum chisel  
Cinzel par esternón



**J68270**  
24 cm - 9 1/2"



Daviers - Bone holding forceps - Pinzas para huesos

Réducteurs  
Reducing  
Reductor

Préhenseur  
Prehensile  
Prensador

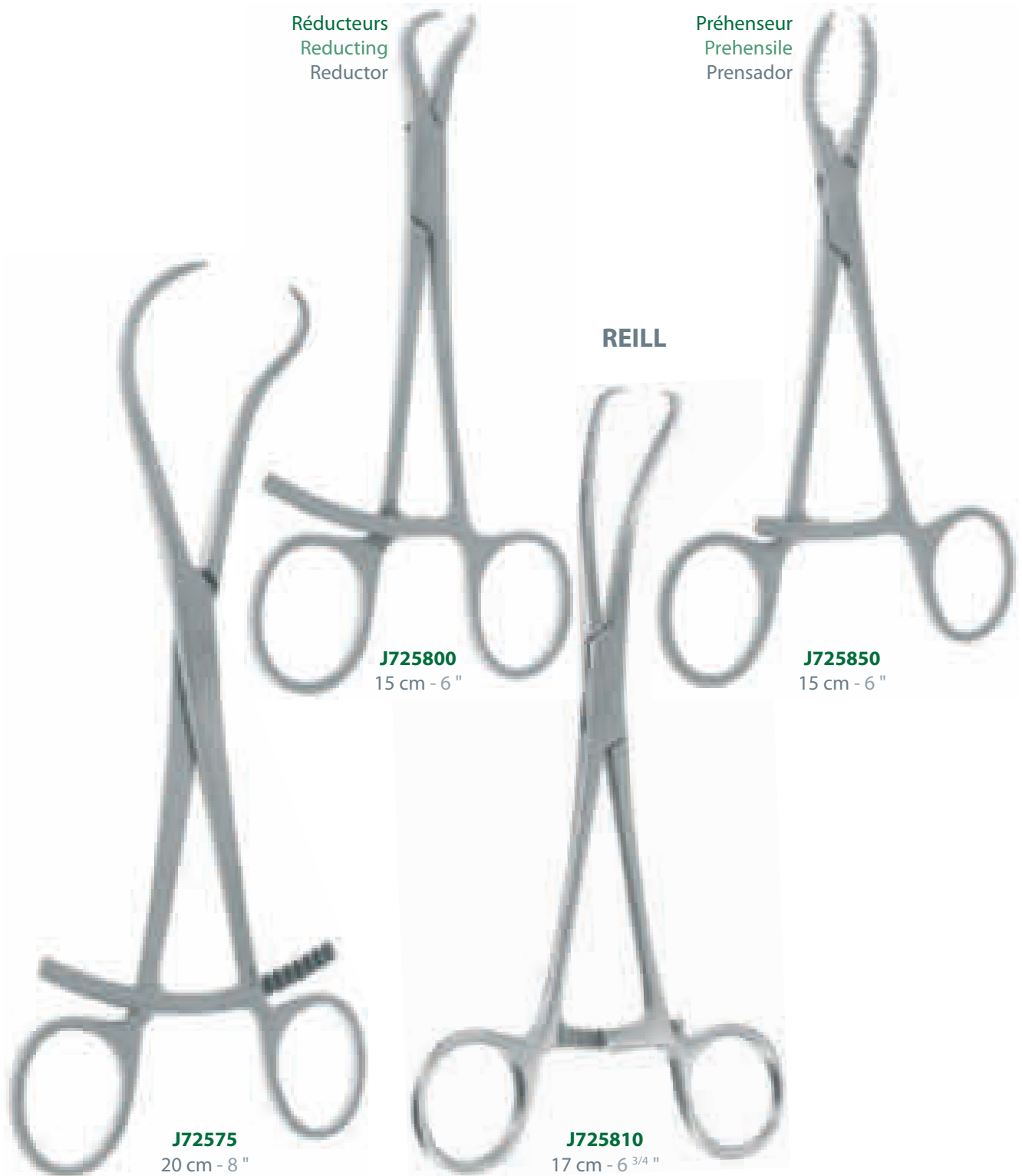

Réducteurs : 2 mors pointus  
Reducing : 2 sharped jaws  
Reductor : 2 bocas aceradas

Préhenseur : 2 mors dentés  
Prehensile : 2 toothed jaws  
Prensador : 2 bocas dentadas

### DINGMANN

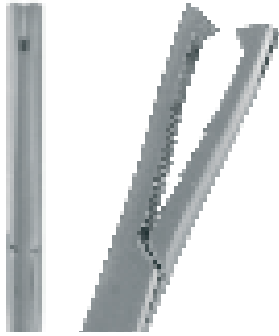

**J721901**  
19 cm - 7 1/2"

Pour os de la main  
For hand bones  
Para huesos de la mano

Préhenseur  
Prehensile  
Prensador

### VERBRUGGE

Préhenseur  
Prehensile  
Prensador



**J72350**  
16 cm - 6 1/4"

Réducteurs  
Reducing  
Reductor

Réducteurs  
Reducing  
Reductor



**J72400**  
16 cm - 6 1/4"



**J72190**  
19 cm - 7 1/2"

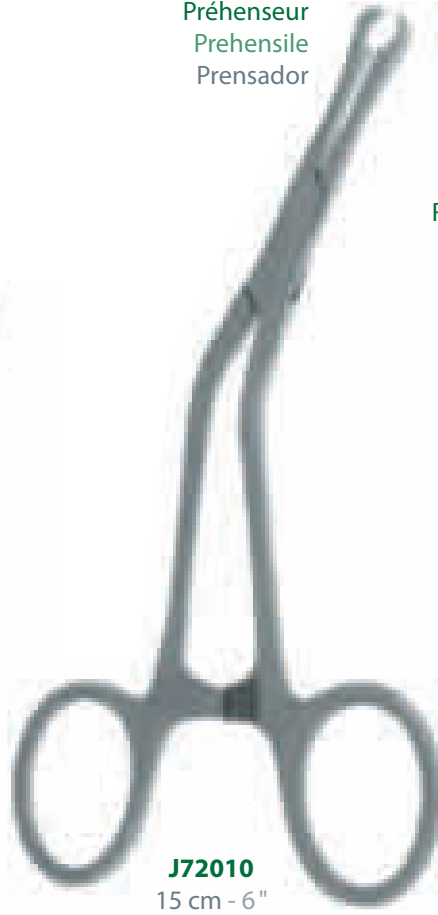

**J72010**  
15 cm - 6"



**J72400**  
16 cm - 6 1/4"

Réducteurs : 1 mors denté 1 mors acéré  
Reducing : 1 toothed jaw 1 sharpened jaw  
Reductor : 1 boca dentada 1 boca acerada

Préhenseur : 2 mors dentés  
Prehensile : 2 toothed jaws  
Prensador : 2 bocas dentadas

# LANDANGER

## Daviers - Bone holding forceps - Pinzas para huesos

### LANDANGER



**J72595**  
26 cm - 10 1/4"

Préhenseur  
Prehensile  
Prensador



Humérus  
Humerus  
Humero

26 cm - 10 1/4"

**J72600**



Tibia  
Tibia  
Tibia

**J72595**

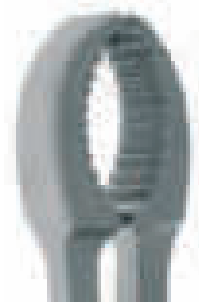

Fémur  
Femur  
Femur

**J72590**

Réducteurs  
Reducing  
Reductor



Humérus  
Humerus  
Humero

26 cm - 10 1/4"

**J72612**



Tibia  
Tibia  
Tibia

**J72610**

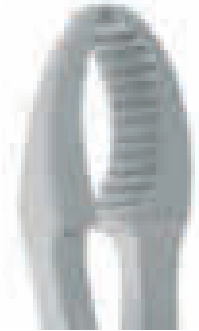

Fémur  
Femur  
Femur

**J72605**

Porte-plaque  
Plate holder  
Porta placa



Humérus  
Humerus  
Humero

26 cm - 10 1/4"

-

Tibia  
Tibia  
Tibia

**J72620**

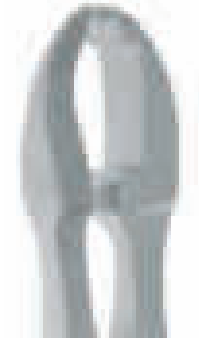

Fémur  
Femur  
Femur

**J72615**

Réducteurs : 1 mors denté 1 mors acéré  
Reducing : 1 toothed jaw 1 sharped jaw  
Reductor : 1 boca dentada 1 boca acerada

Préhenseur : 2 mors dentés  
Prehensile : 2 toothed jaws  
Prensador : 2 bocas dentadas

### VERBRUGGE

Préhenseur  
Prehensile  
Prensador

Réducteurs  
Reducing  
Reductor



J72355

15 cm - 6 "



J72405



J72360

18 cm - 7 "



J72410

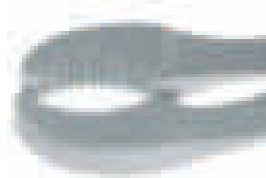

J72370

24 cm - 9 1/2 "



J72420



J72380

26 cm - 10 1/4 "



J72430



J72390

28 cm - 11 "



J72440



J72360

18 cm - 7 "

Réducteurs  
Reducing  
Reductor

: 1 mors denté 1 mors acéré  
: 1 toothed jaw 1 sharpened jaw  
: 1 boca dentada 1 boca acerada

Préhenseur  
Prehensile  
Prensador

: 2 mors dentés  
: 2 toothed jaws  
: 2 bocas dentadas



## Daviers - Bone holding forceps - Pinzas para huesos

### VERBRUGGE

1 mors mobile  
1 moving jaw  
1 boca móvil L

Porte-plaque  
Plate holder  
Porta placa

24 cm - 9 1/2 " **J72490** 25 mm  
26 cm - 10 1/4 " **J72500** 30 mm  
28 cm - 11 " **J72510** 38 mm

24 cm - 9 1/2 " **J72460** 10 mm  
26 cm - 10 1/4 " **J72470** 13 mm  
28 cm - 11 " **J72480** 16 mm

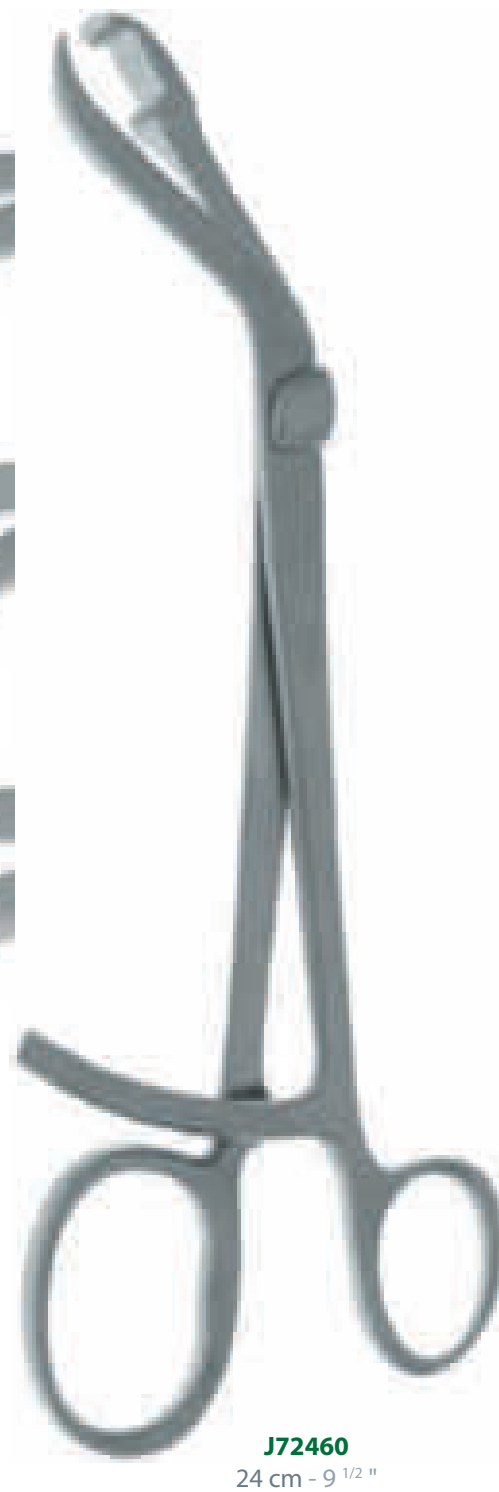
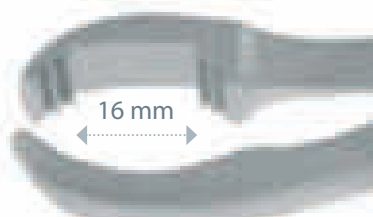
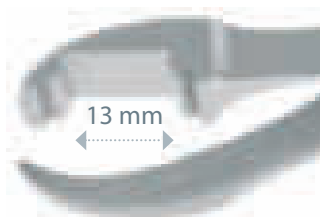
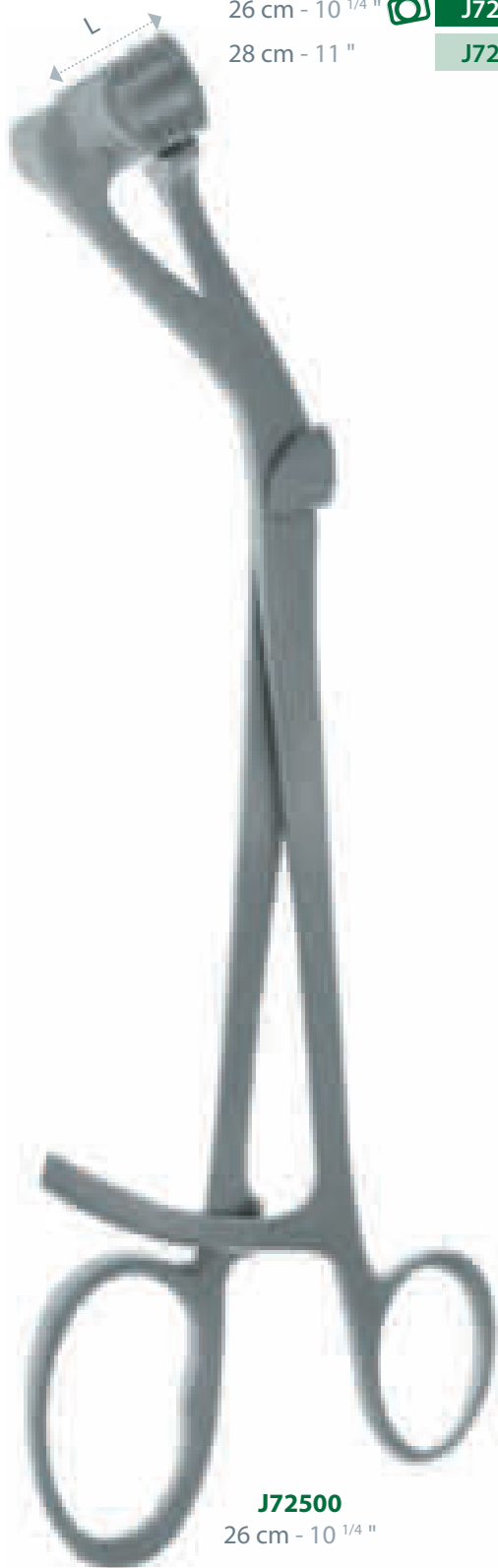

## Daviers - Bone holding forceps - Pinzas para huesos

Auto-centreur avec système d'arrêt fileté  
 Auto-centering with threaded blocking system  
 Auto-centrador con sistema de bloqueo roscado

- 15 cm - 6" **J725200**
- 19 cm - 7 1/2" **J725201**
- 24 cm - 9 1/2" **J725202** 
- 26 cm - 10 1/4" **J725203**
- 28 cm - 11" **J725204**



**J725200**



**J725201**



**J725202**



**J725202**  
 24 cm - 9 1/2"

### FARABEUF

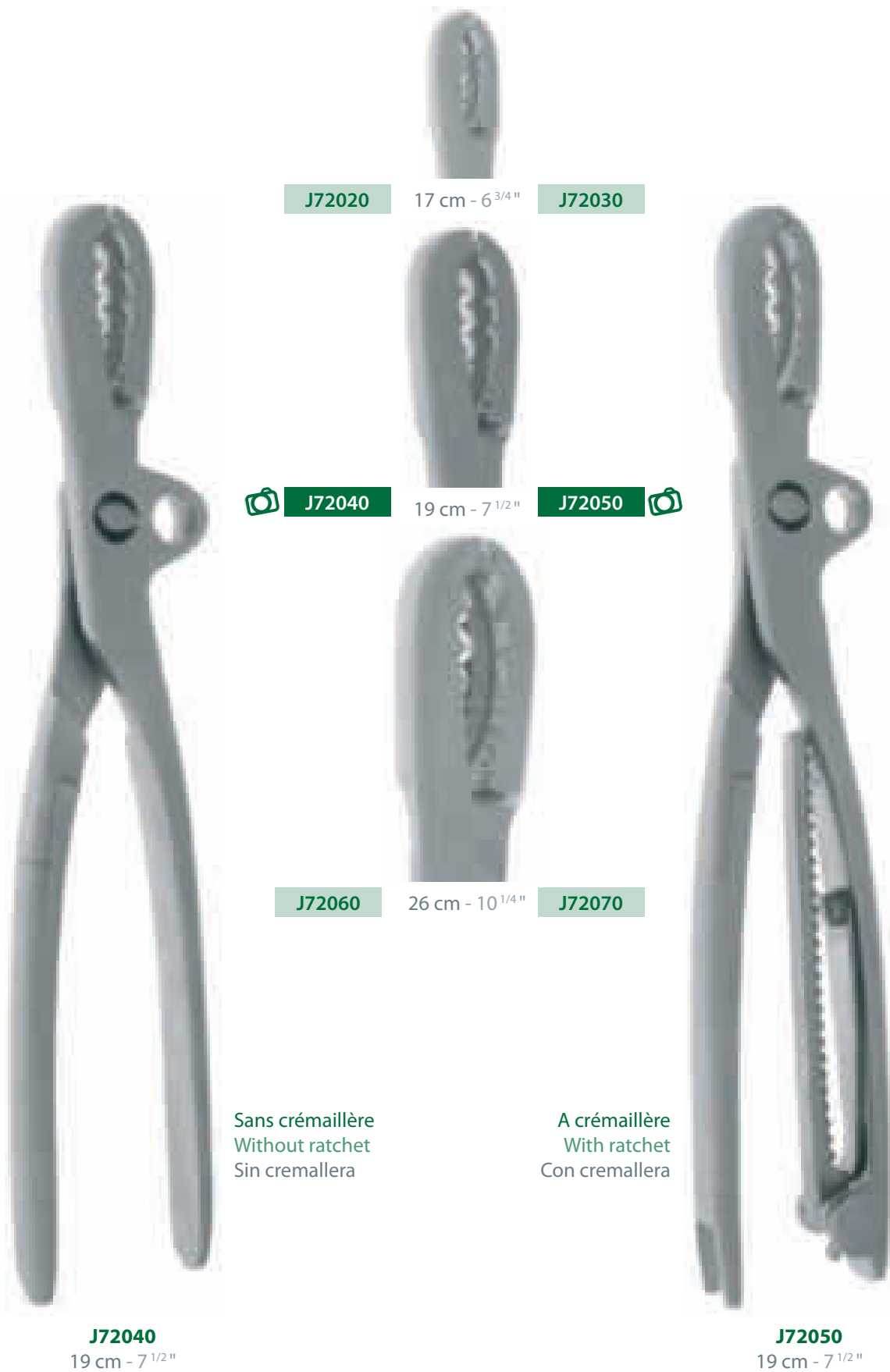

**J72040**  
19 cm - 7 1/2 "

Sans crémaillère  
Without ratchet  
Sin cremallera

A crémaillère  
With ratchet  
Con cremallera

**J72050**  
19 cm - 7 1/2 "

### LAMBOTTE

22 cm - 8 3/4" **J72230** 

26 cm - 10 1/4" **J72240**

35 cm - 13 3/4" **J72250**

22 cm - 8 3/4" **J72260** 

26 cm - 10 1/4" **J72270**

33 cm - 13" **J72280**

22 cm - 8 3/4" **J72200** 

26 cm - 10 1/4" **J72210**

33 cm - 13" **J72220**

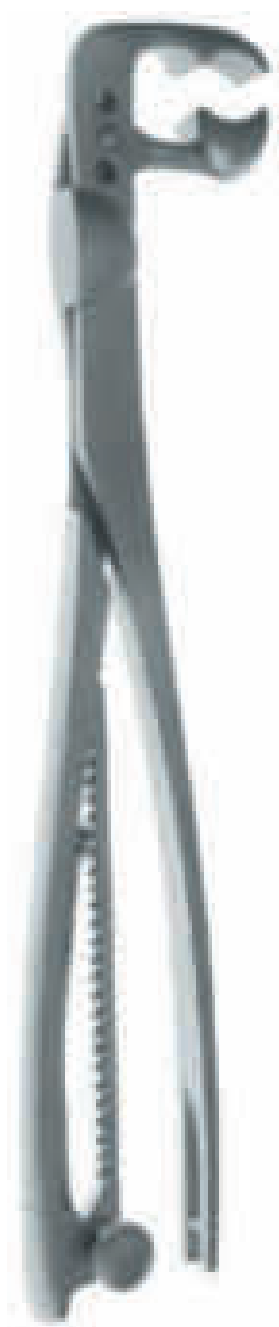

**J72230**  
22 cm - 8 3/4"

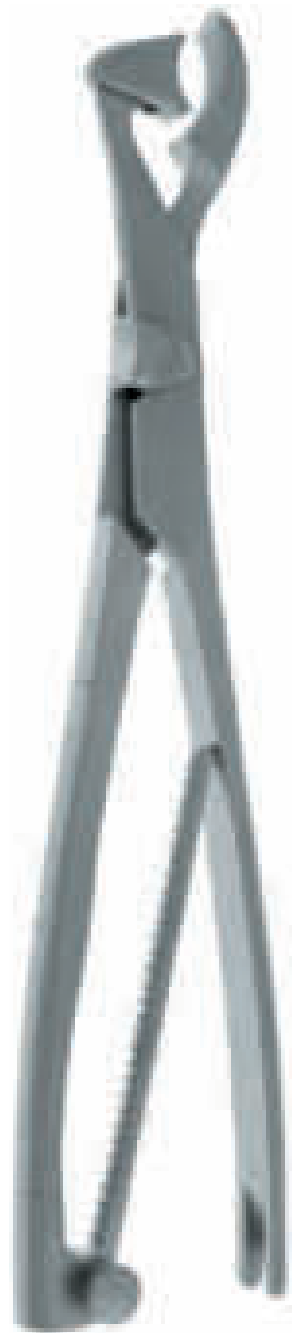

**J72260**  
22 cm - 8 3/4"



**J72200**

**J72210**

**J72220**

**J72200**  
22 cm - 8 3/4"



## Daviers - Bone holding forceps - Pinzas para huesos

LANE

KERN

Sans crémaillère  
Without ratchet  
Sin cremallera

21 cm - 8 1/4 " **J72310**

34 cm - 13 1/2 " **J72330**

À crémaillère  
With ratchet  
Con cremallera

21 cm - 8 1/4 " **J72320** 

34 cm - 13 1/2 " **J72340**



**J72320**  
21 cm - 8 1/4 "



**J72540**  
16,5 cm - 6 1/2 "

### OLLIER

16 cm - 6 1/4" **J72120**

18 cm - 7" **J72130** 

22 cm - 8 3/4" **J72140**

Pour os mous  
For soft bones  
Para huesos blandos

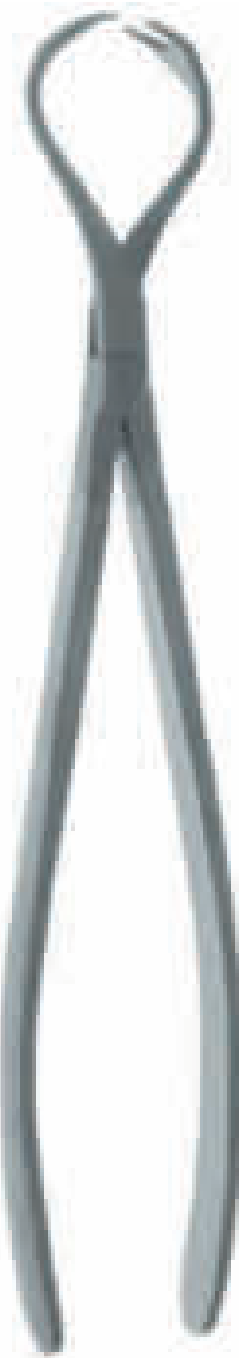

Sans crémaillère  
Without ratchet  
Sin cremallera

**J72130**  
18 cm - 7"

19 cm - 7 1/2" **J72150** 

22 cm - 8 3/4" **J72160**

27 cm - 10 3/4" **J72170**

Pour rotule  
For the kneecap  
Para rotula

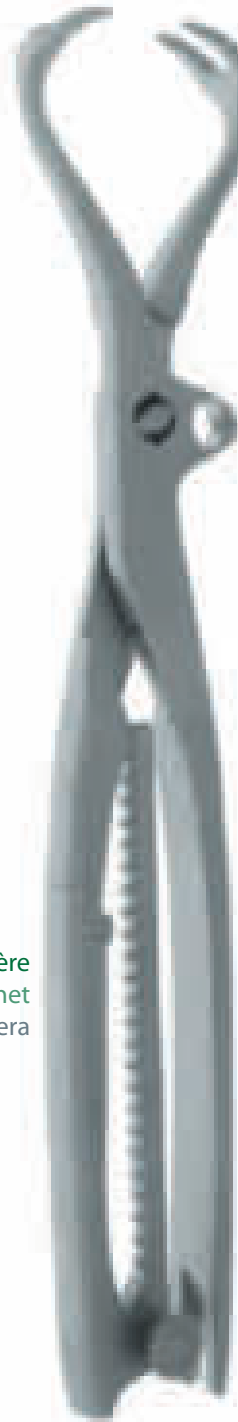

À crémaillère  
With ratchet  
Con cremallera

**J72150**  
19 cm - 7 1/2"



**J72160**



**J72170**

## Daviers - Bone holding forceps - Pinzas para huesos

### SETTER

16 cm - 6 1/4" **J725860** 

24 cm - 9 1/2" **J725870**

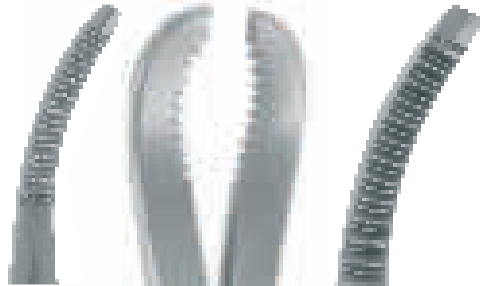

**J725860**

**J725870**



**J725860**  
16 cm - 6 1/4"

### HEY GROVES

20 cm - 8" **J725880** 

25 cm - 10" **J725885**

30,5 cm - 12" **J725890**



**J725885**

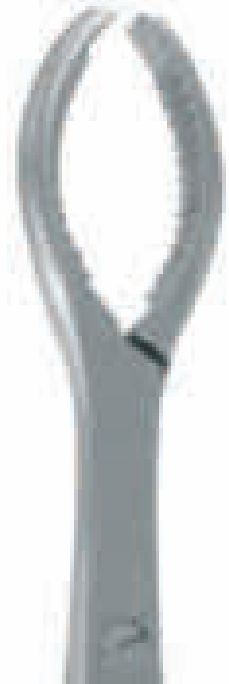

**J725890**



**J725880**  
20 cm - 8"

SEMB

9 mm

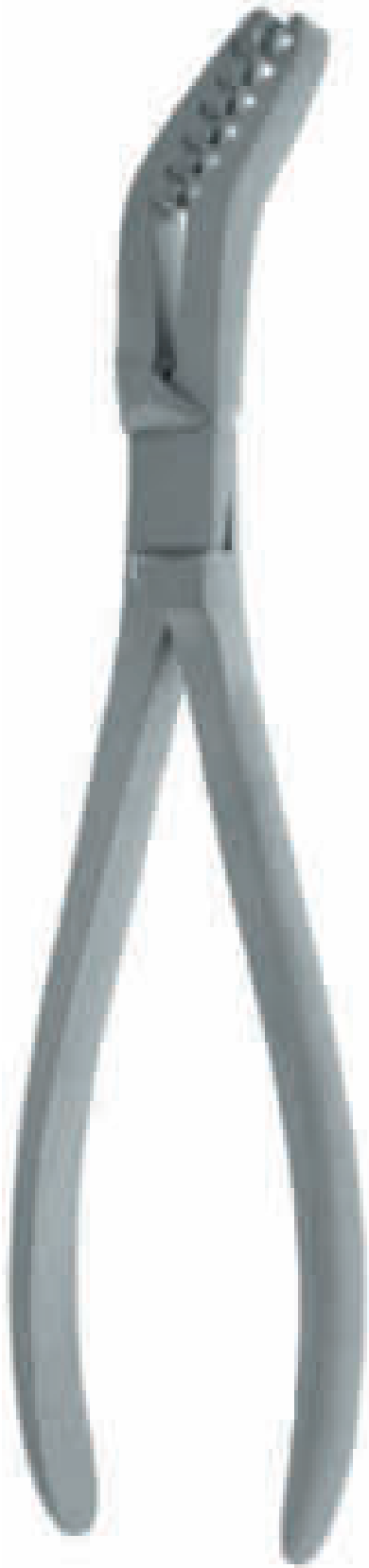

**J72180**  
22 cm - 8 3/4"

8 mm



**J721810**  
19 cm - 7 1/2"

7,5 mm



**J721820**  
19 cm - 7 1/2"

Codé latéral  
Angular laterally  
Acodado lateral



LANGENBECK

FERGUSSON

DENTS DE LION  
LION'S TEETH  
DIENTES DE LEÓN

11 mm

11 mm

8 mm

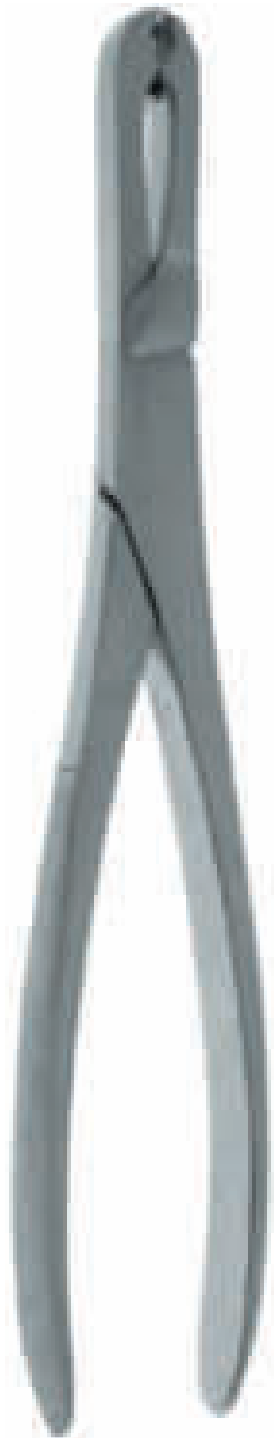

**J72100**  
19 cm - 7 1/2"



**J721010**  
21 cm - 8 1/4"



**J721020**  
21 cm - 8 1/4"

### OLLIER

POUR RÉSECTION  
FOR RESECTION  
PARA RESECCIÓN

PINCES À SEQUESTRE  
SEQUESTER FORCEPS  
PINZAS PARA SECUESTRO

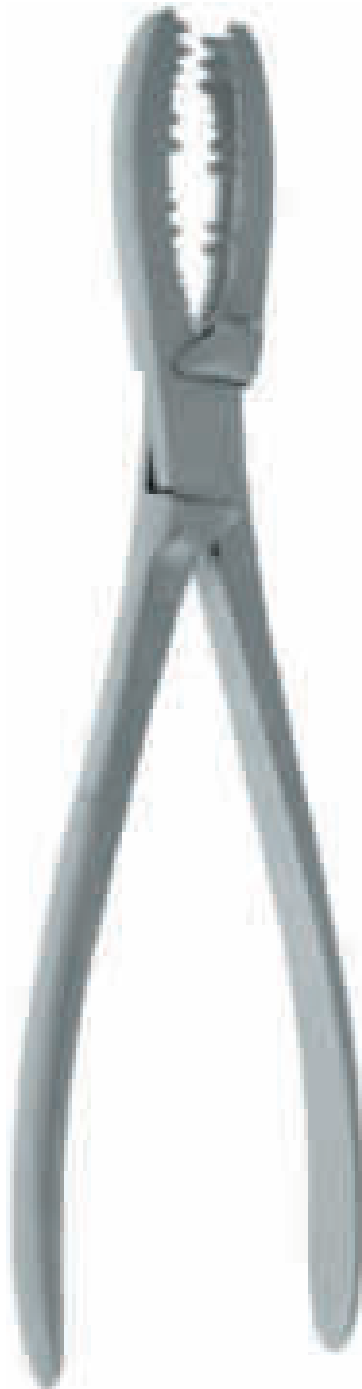

**J72090**  
23 cm - 9"



**J72110**  
19 cm - 7 1/2"



**J72550**  
21 cm - 8 1/4"

Droite  
Straight  
Recta

Courbe  
Curved  
Curva

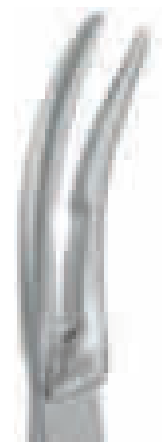

**J72560**

Double courbure  
Double curved  
Doble curvatura



**J72570**

### LOWMAN-HOGLUND

### LOWMAN

12 cm - 4 3/4" **J727550**

18 cm - 7" **J727560**

20 cm - 8" **J727570** 

22 cm - 8 3/4" **J727580**

Système de distraction  
Distractor system  
Sistema de distracción



**J727590**  
15,5 cm - 6"

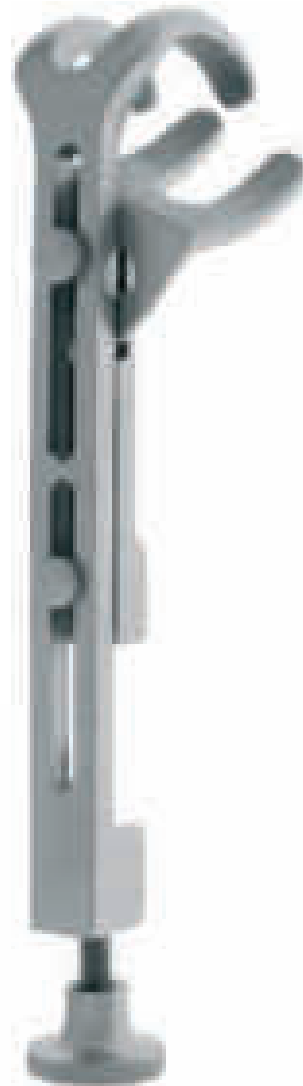

**J727500**  
19 cm - 7 1/2"

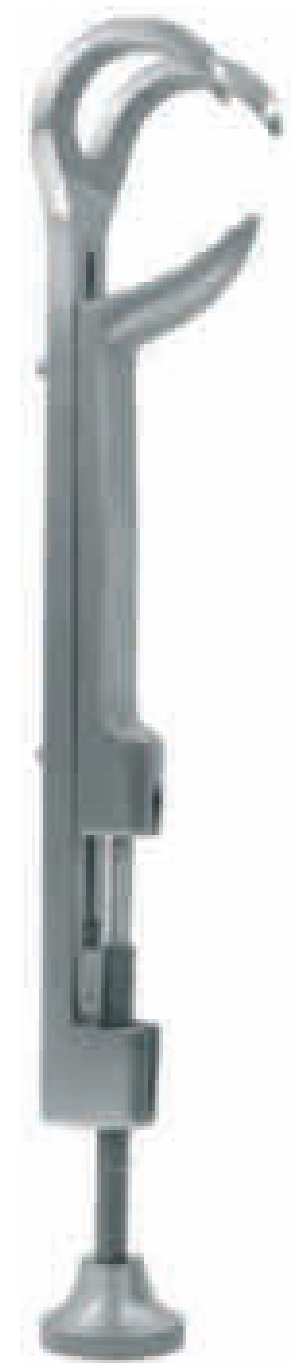

**J727570**  
20 cm - 8"

# LANDANGER

## Daviers - Bone holding forceps - Pinzas para huesos

MUSEUX

LERAT

LEWIN

PINCES À CAPSULE  
CAPSULE FORCEPS  
PINZAS PARA CAPSULA

22 cm - 8 <sup>3</sup>/<sub>4</sub> " **J727100**  60 mm

24 cm - 9 <sup>3</sup>/<sub>4</sub> " **J727110** 80 mm

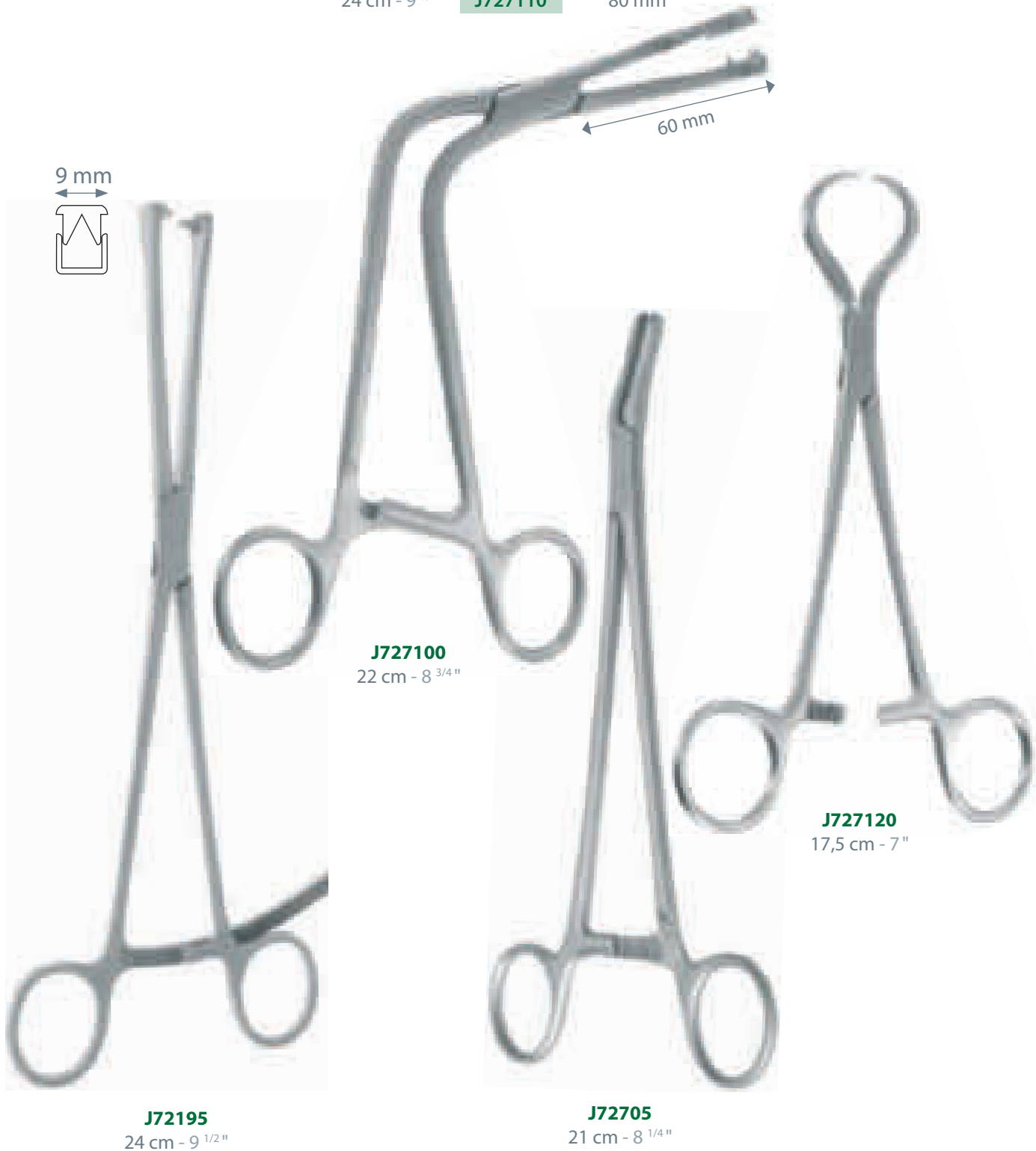



## Écarteur, mains de plomb - Retractor, lead hands - Separador, manos de plomo

Grande valve seule  
Large blade only  
Valvula grande sóla

**J732010**  
25 x 40 mm

**CHARNLEY**

Petite valve seule  
Small blade only  
Valvula pequena sóla

**J732005**  
25 x 50 mm

Poids seul avec chaîne  
Weight only with chain  
Peso sólo con cadena

**J732020**



CADRE COMPLET AVEC 2 VALVES ET 1 POIDS  
COMPLETE FRAME WITH 2 BLADES AND 1 WEIGHT  
CUADRO COMPLETO CON 2 VALVAS Y 1 PESO

**J732000**

24 x 30 cm  
9 1/2" x 11 3/4"

MAIN DE PLOMB ADULTE  
ADULT LEAD HANDS  
MANOS DE PLOMO ADULTO

MAIN MALLÉABLE SILICONNÉE  
MALLEABLE HAND SILICONE  
MANOS MALLEABLE SILICONA



**J733000**  
33 cm - 13"



**J733050**  
33 cm - 13"

Non lestée  
No weighted  
Sin ponderada

**J733050**

Lestée  
Weighted  
Ponderada

**J733060**

# LANDANGER

## Chasse-greffons - Grafts pusher - Empujador de injertos

### TRILLAT

9 x 9 mm **J804510**  
 9 x 16 mm **J804520**   
 9 x 19 mm **J804530**

6 x 13 mm **J80460**   
 10 x 15 mm **J80470**  
 11 x 20 mm **J80480**

### DEMOISELLE

5 x 8 mm **J804850**   
 8 x 12 mm **J804860**  
 12 x 20 mm **J804870**

### PASSOW

2,5 x 2,5 mm **J804880**   
 3,5 x 3,5 mm **J804885**

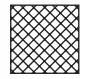

**J804510**

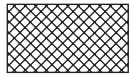

**J804520**

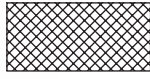

**J804530**

**J804520**  
20 cm - 8"

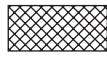
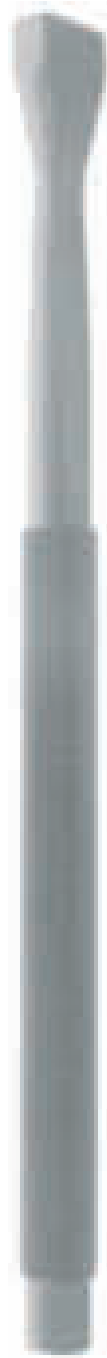

**J80460**

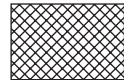

**J80470**

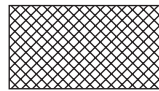

**J80480**

**J80460**  
18 cm - 7"

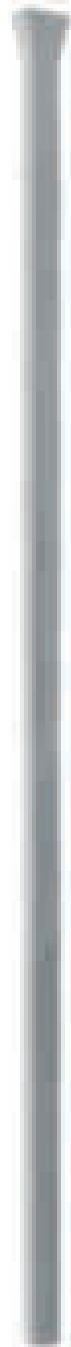

**J804850**

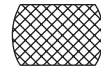

**J804860**

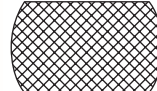

**J804870**

**J804850**  
18 cm - 7"

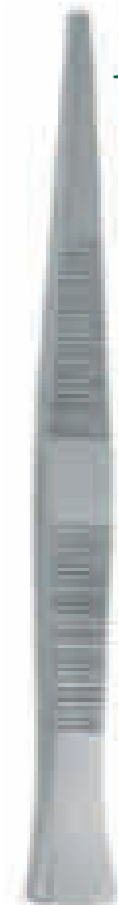

**J804880**



**J804885**

**J804880**  
12 cm - 5"

# LANDANGER

## Chasse-greffons - Grafts pusher - Empujador de injertos

Simple  
Simple  
Simple

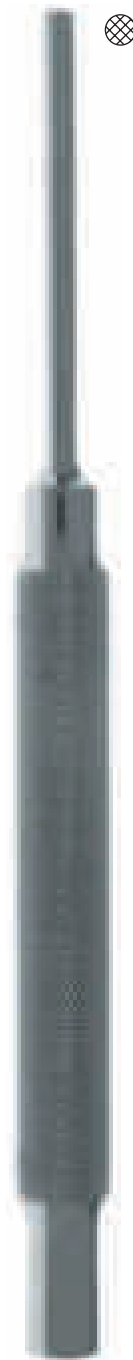

**J80510**  
18 cm - 7"



3 mm

**J805050**



4 mm

**J80510**



6 mm

**J80520**



8 mm

**J80530**



10 mm

**J805310**

Double  
Double  
Doble



**J80540**  
21 cm - 8 1/4"



6 x 8 mm

**J80540**

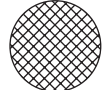

10 x 12 mm

**J80550**



## KÖLBEL

Complet avec 3 paires de valves laterales  
 Complete with 3 pair of lateral blades  
 Completo con 3 pares de valvas laterales

**J821000**

Valves latérales (la paire)  
 Lateral blades (pair)  
 Valvas laterales (par)



Compas seul  
 Compass only  
 Compas sólo

**J821010**  
 20 cm - 8"



**J821020**  
 36 x 36 mm



**J821030**  
 53 x 36 mm



**J821040**  
 68 x 36 mm

**MERLE D'AUBIGNÉ  
(BANKART)**



Valves pivotantes  
Swivel blades  
Valvula pivotentes

Écarteur pour épaule  
Shoulder retractor  
Separador para hombro

**J82010**  
29 cm - 11 1/2"

Passe fil avec aiguille  
Wire guide with needle  
Pasa hilo con aguja

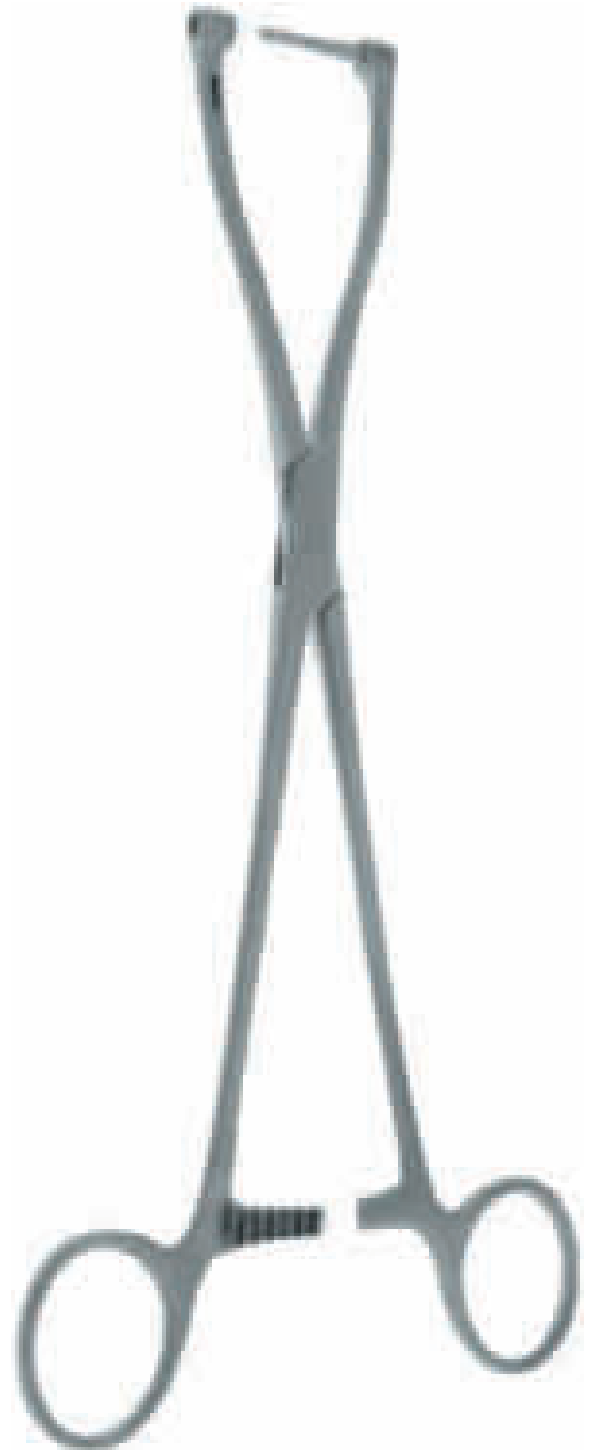

**J82020**  
24 cm - 9 1/2"

POZZI

MERLE D'AUBIGNÉ

BANKART



**J82030**  
24 cm - 9 1/2"



**J82040**  
23 cm - 9"

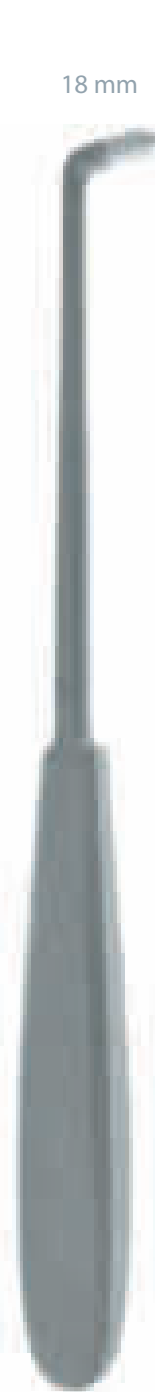

**J82050**  
21 cm - 8 1/4"

18 mm

### DANIS

Écarteur  
Retractor  
Separador

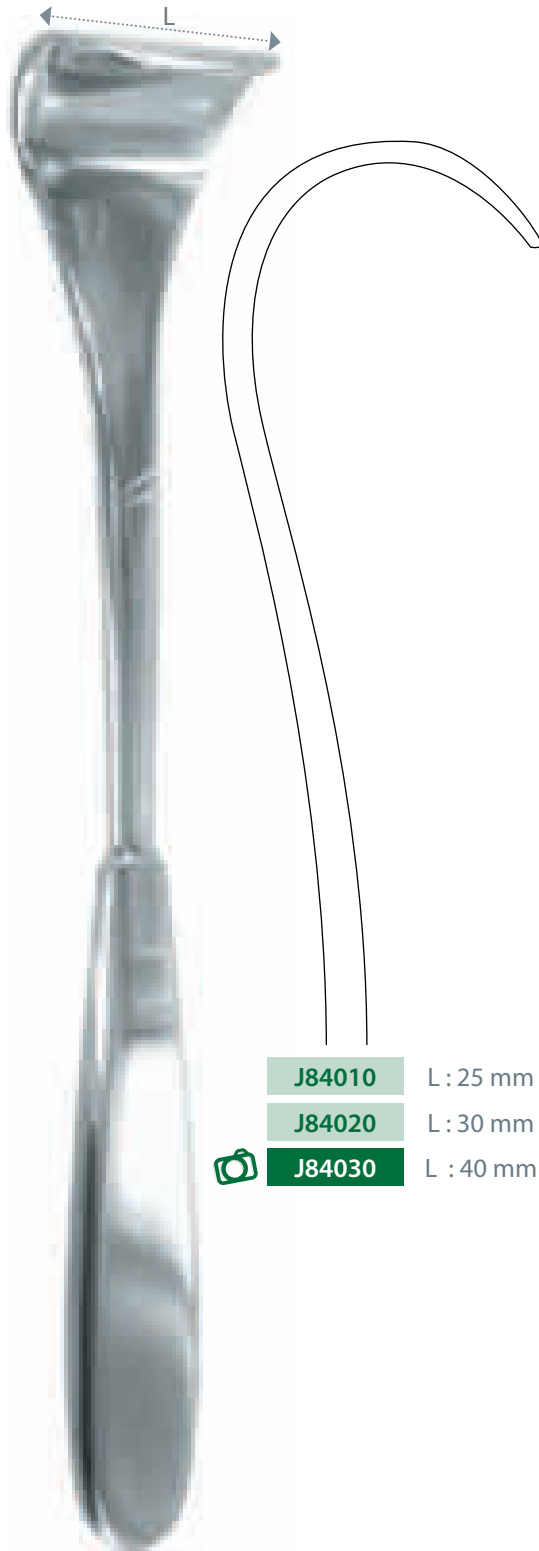

**J84010** L : 25 mm

**J84020** L : 30 mm

 **J84030** L : 40 mm

**J84030**  
23 cm - 9"

Spatule  
Spatula  
Espátula

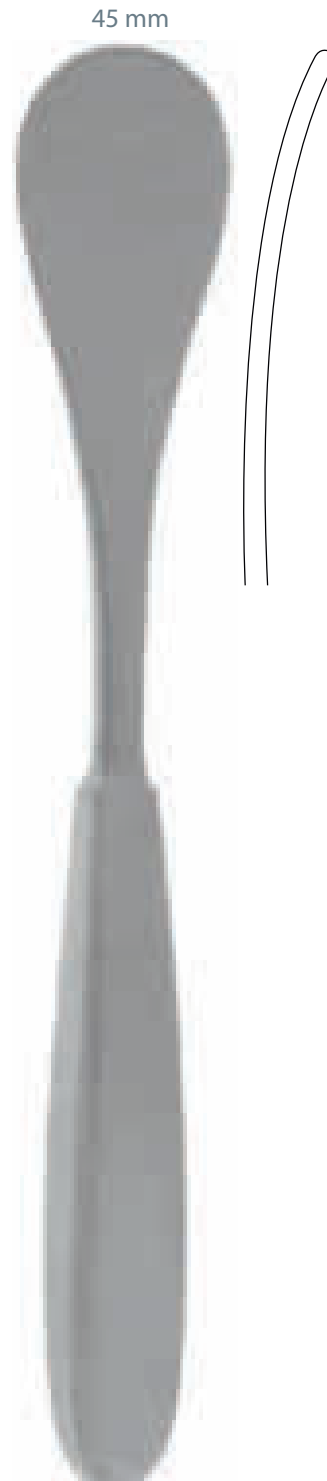

45 mm

**J84040**  
24 cm - 9 1/2"

### TRILLAT

Levier pour épaule  
Lever for shoulder  
Elevador para hombro

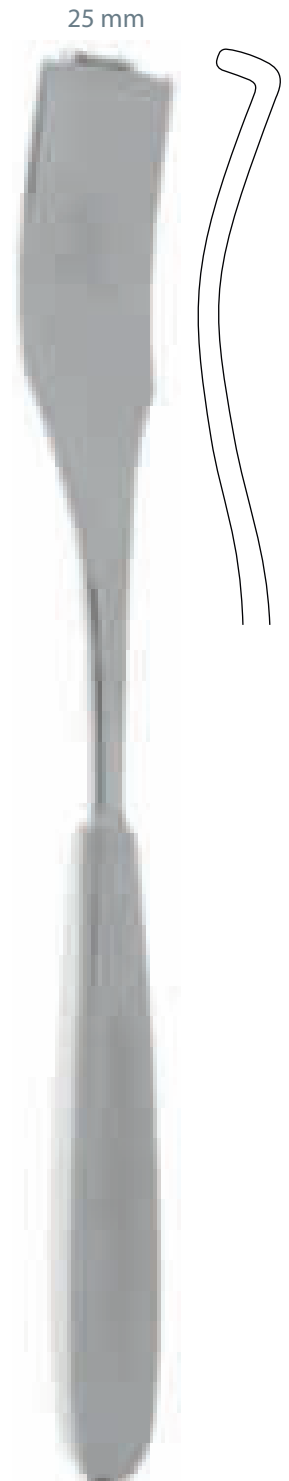

25 mm

**J80210**  
24 cm - 9 1/2"

## DANIS

Refouloir  
Tamping tool  
Recalcador

Passe fil - Wire guide - Pasa hilo



**J84070**

17,5 cm - 6 3/4"

**J84130**

21 cm - 8 1/4"

**J84120**

19 cm - 7 1/2"

**J84110**

17,5 cm - 6 3/4"





## SMILLIE-TRILLAT

## NEFF

## BIRCHER

Tranchant - Sharp - Cortante

8 mm

Droit  
Straight  
Recto

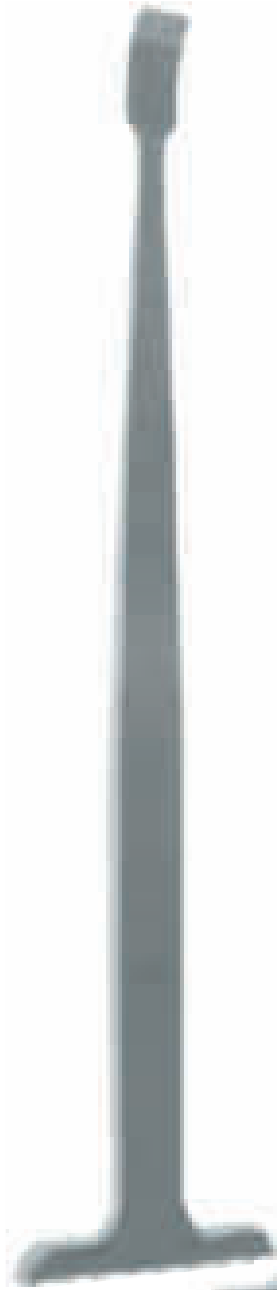

**J80010**  
17 cm - 6 3/4 "

Courbe  
Curved  
Curvo

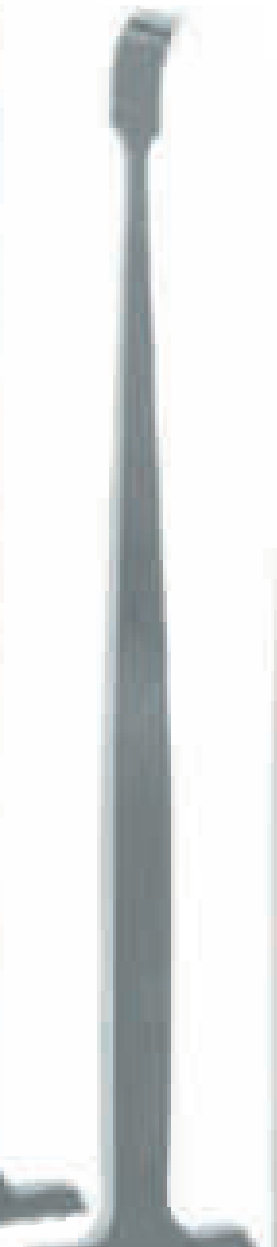

**J80015**

Gauche  
Left  
Izquierda

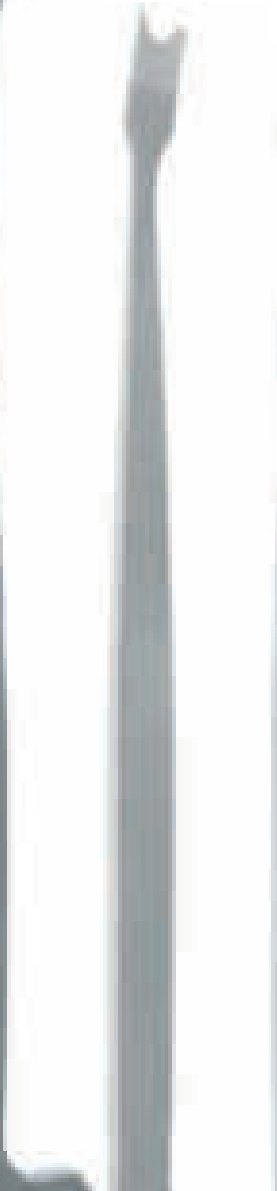

**J80020**

Droite  
Right  
Derecha

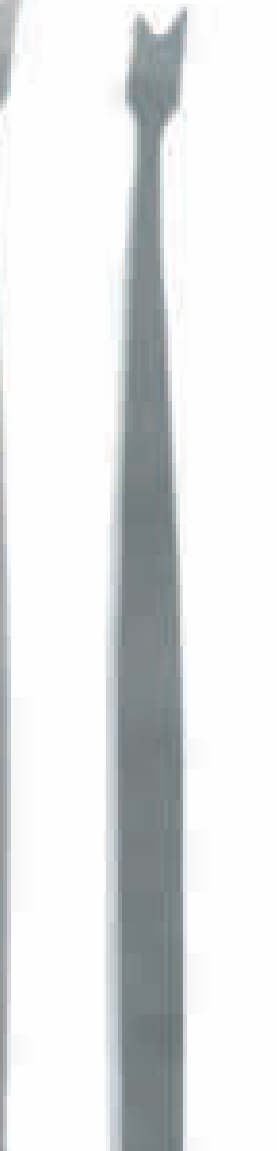

**J80030**

Gauche  
Left  
Izquierda

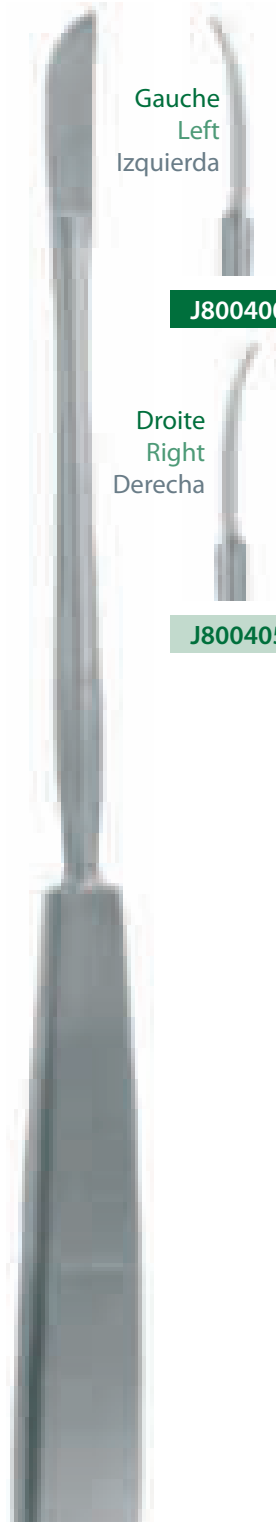

**J800400**

Droite  
Right  
Derecha



**J800405**



**J800500**  
19 cm - 7 1/2 "



## SMILLIE-TRILLAT

## BLOUNT

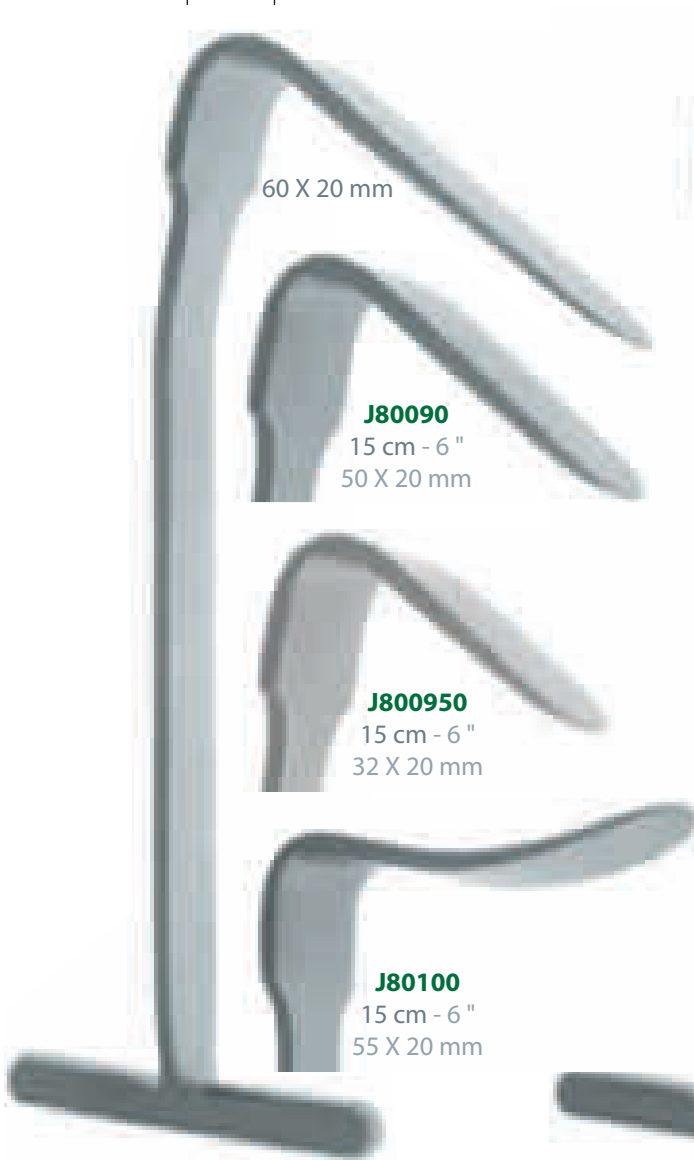
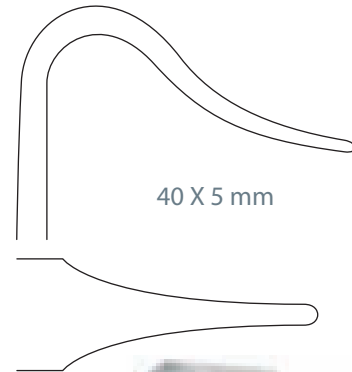
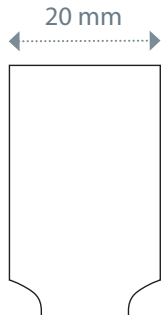

60 X 20 mm

**J80090**  
15 cm - 6 "  
50 X 20 mm

**J800950**  
15 cm - 6 "  
32 X 20 mm

**J80100**  
15 cm - 6 "  
55 X 20 mm

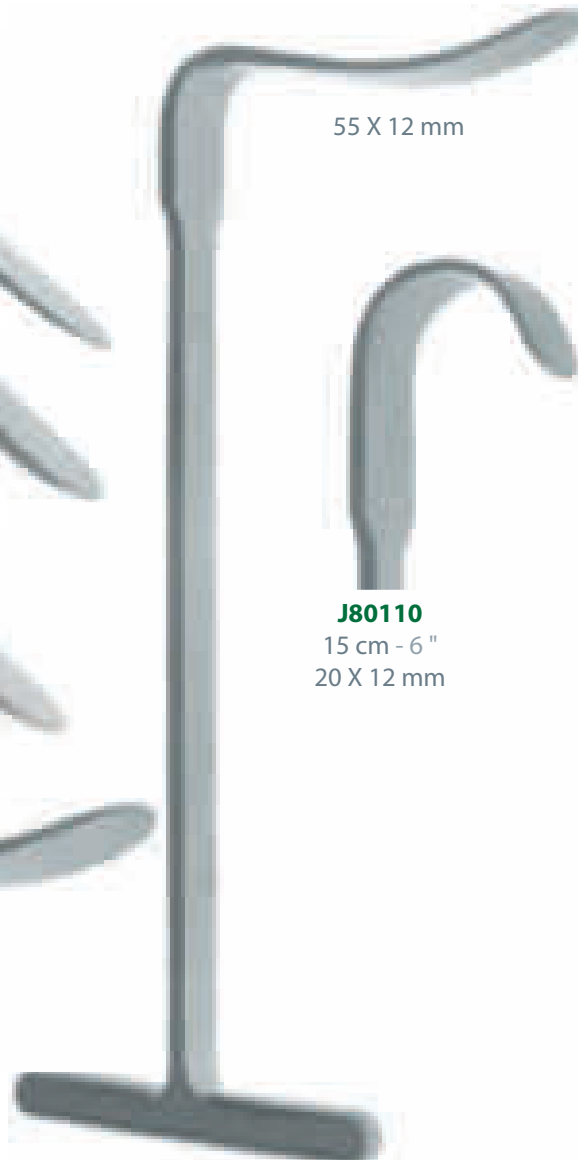

55 X 12 mm

**J80110**  
15 cm - 6 "  
20 X 12 mm

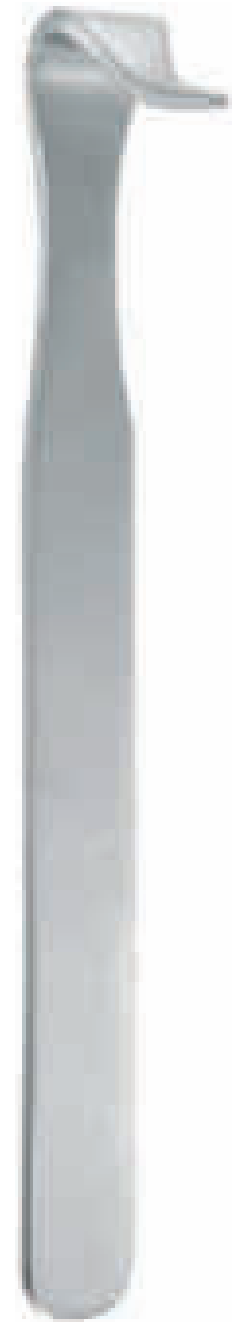

**J801110**  
17,5 cm - 7 "

**J80080**  
15 cm - 6 "

**J80075**  
15 cm - 6 "



NICOLLET-MUSEUX

LANDANGER

NICOLLET-KOCHER



**J80130**  
16 cm - 6 1/4"



**J80120**  
19 cm - 7 1/2"



**J80140**  
16 cm - 6 1/4"

BIRCHER-GANSKE

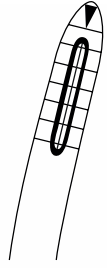

J80150

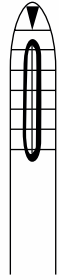

J801450

Courbe latérale  
Crrved lateraly  
Curva lateral



J80150  
20 cm - 8"



J801550  
20 cm - 8"

### TRILLAT

Triangulaire  
Triangular  
Triangular

Ø 8 mm



**J80370**  
26 cm - 10 <sup>1</sup>/<sub>4</sub> "

Crochet  
Hook  
Ganchura

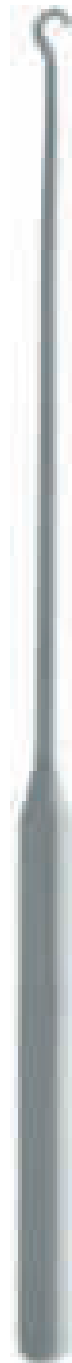

**J80390**  
24 cm - 9 <sup>1</sup>/<sub>2</sub> "

Explorateur  
Hook probe  
Explorador



**J80420**  
24 cm - 9 <sup>1</sup>/<sub>2</sub> "

Ø 2,5 mm

Passe-fil  
Wire guide  
Guia hilo

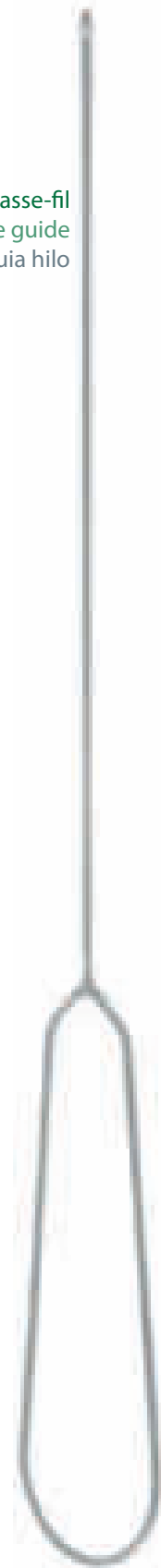

**J80200**  
30 cm - 11 <sup>3</sup>/<sub>4</sub> "

## TRILLAT

- 6 mm **J80270** 
- 8 mm **J80280**
- 10 mm **J80290**
- 12 mm **J80300**
- 14 mm **J80305**

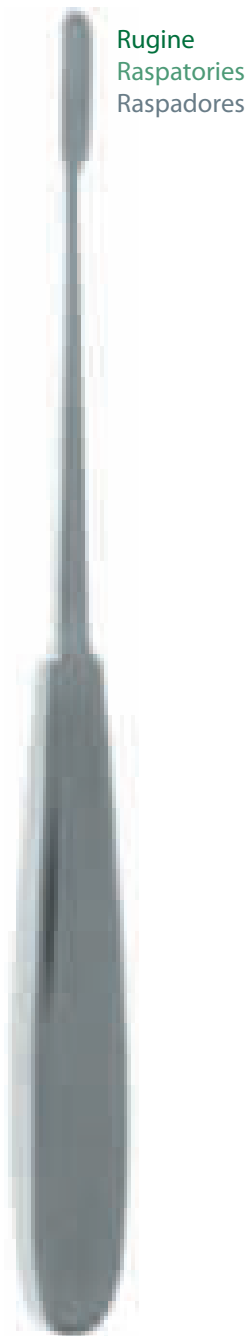

Rugine  
Raspatories  
Raspadores

**J80270**  
22 cm - 8 3/4"

## MURPHY

Gouge  
Gouge  
Gubia

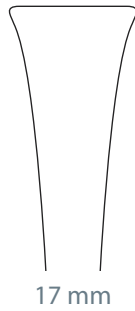

Droite  
Straight  
Recta

- 17 mm
- 22 cm - 8 3/4" **J80435**
- 28 cm - 11" **J80430**



Concave  
Concave  
Concavo

- 17 mm
- 22 cm - 8 3/4" **J80445** 
- 28 cm - 11" **J80440**



Convexe  
Convex  
Convexo

- 17 mm
- 22 cm - 8 3/4" **J80455**
- 28 cm - 11" **J80450**

**J80445**  
22 cm - 8 3/4"

## LEMAIRE



Rifloir  
Rasp  
Lima

Ø 32 mm

**J80500**  
20 cm - 8"

OLLIER

18 cm - 7" **J80220** 

20 cm - 8" **J80230**

Aiguille pour rotule  
Needle for kneecap  
Aguja para rótula

Poinçon  
Point  
Punzón

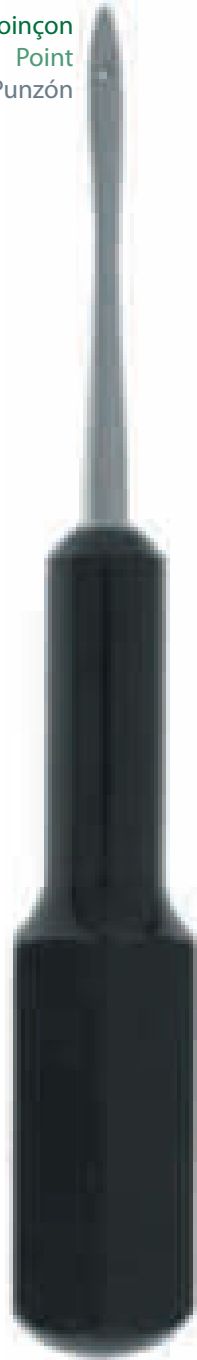

**J80220**  
18 cm - 7"



**J80495**  
19 cm - 7 1/2"



**J804970**  
23 cm - 9"

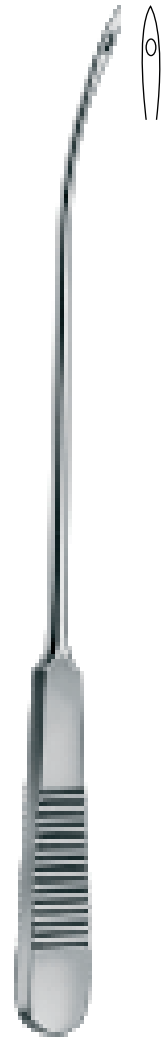

**J804960**  
14 cm - 5 1/2"



### KIRSCHNER



- A
- 115 mm **J90030**
  - 135 mm **J90040** 
  - 145 mm **J90050**

**J90040**

Clé seule  
Wrench only  
Llave sólo

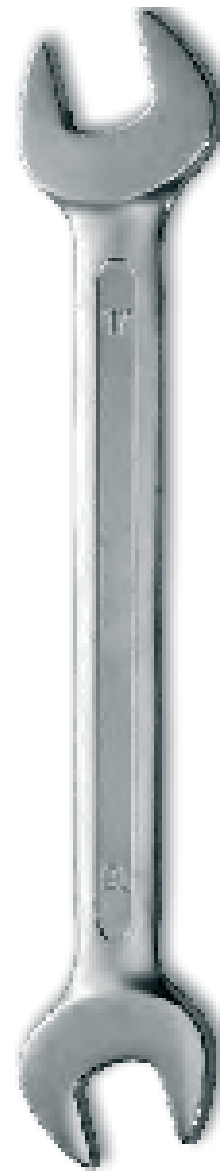

17 mm

16 mm

**J901010**  
20,5 cm - 8"

Crochet seul  
Hook only  
Ganchura sólo



**J90080**

Tendeur  
Tensioner  
Tensor

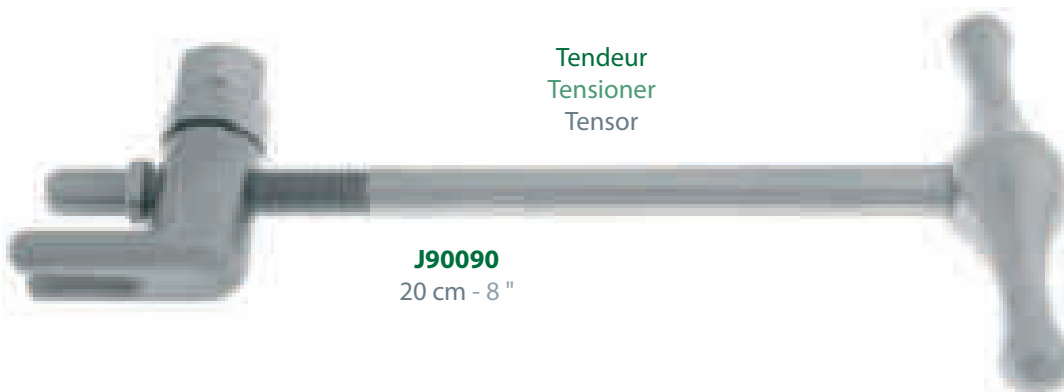

**J90090**  
20 cm - 8"



### KIRSCHNER

Extension réglable - Adjustable traction bow - Extensión regulable

40 - 140 mm	J90060
60 - 220 mm	J90070 



Clé seule  
Wrench only  
Llave sólo

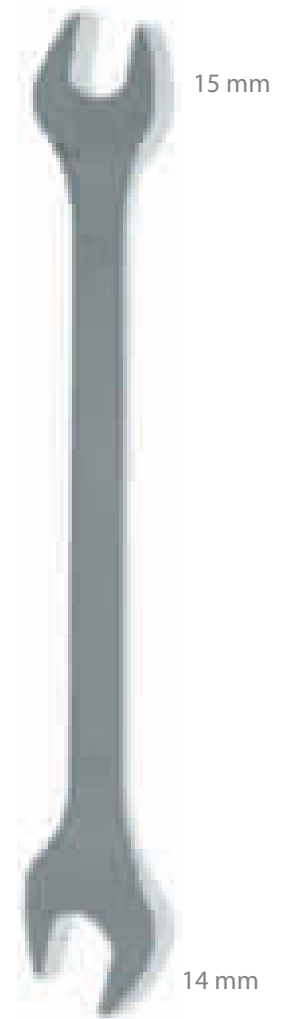

**J90065**  
18 cm - 7"

**J90070**  
60 - 220 mm

### KIRSCHNER (AMERICAN)

Extensible - Avec 2 crochets - Adjustable - With 2 hooks - Extensible - Con 2 ganchuras

55 - 120 mm	J90110
65 - 130 mm	J90120 
90 - 200 mm	J90130
90 - 250 mm	J90140



Crochets seuls (paire)  
Hooks only (pair)  
Ganchuras sólo (par)

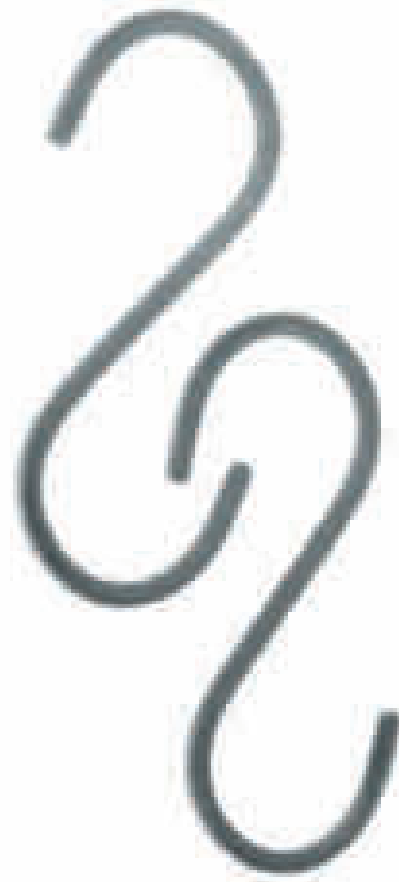

J90150

**J90120**  
65 - 130 mm



### BOEHLER

A	B	
90 mm	100 mm	<b>J90220</b> 
120 mm	110 mm	J90230
115 mm	150 mm	J90240

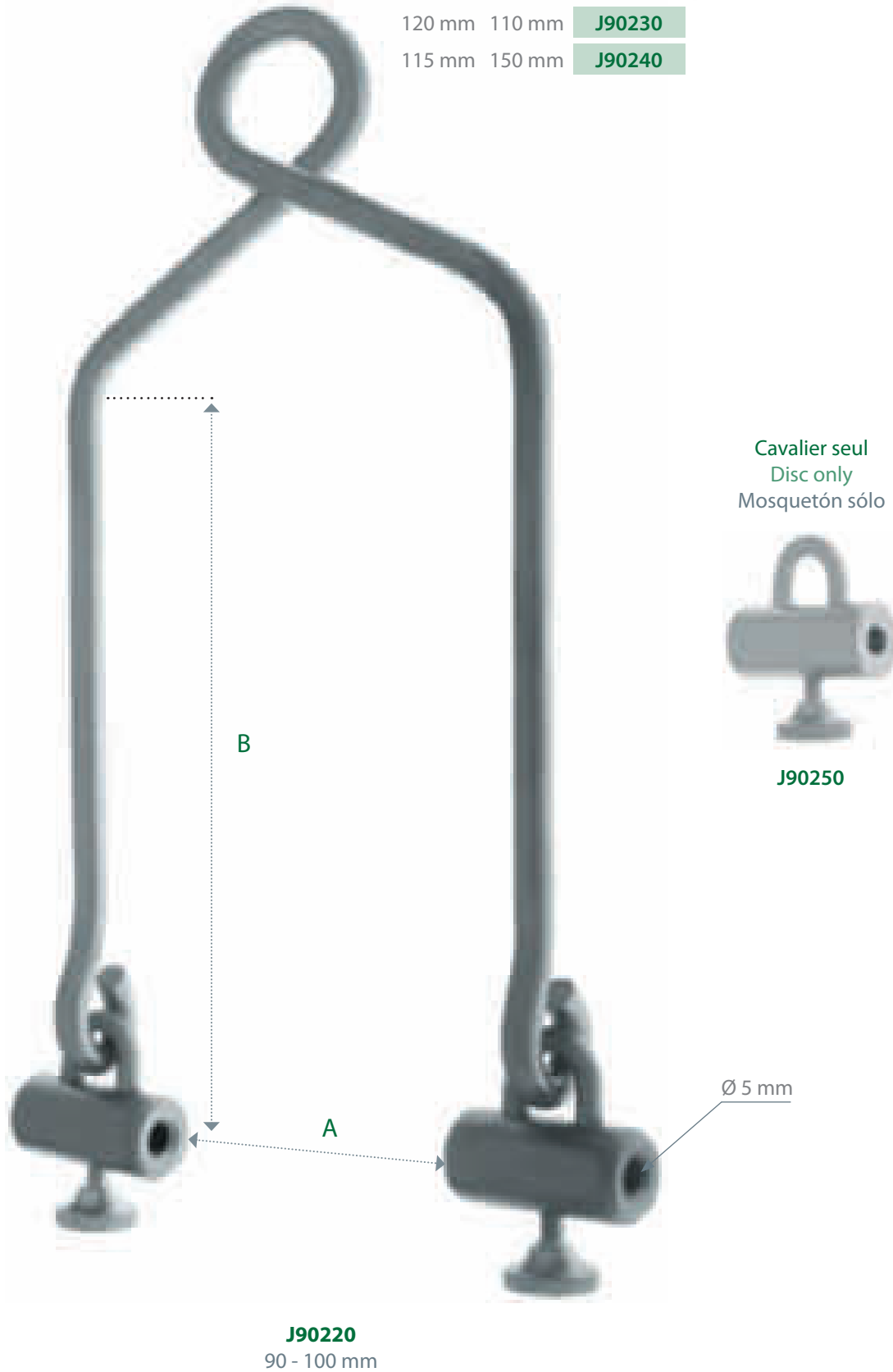

**J90220**  
90 - 100 mm

Cavalier seul  
Disc only  
Mosquetón sólo

**J90250**

Ø 5 mm

Filet métallique pour la traction des doigts  
Wire mesh for traction of fingers  
Malla de alambre para tracción de los dedos

Petit  
Small  
Pequeño

154 mm

**J904000** 

Moyen  
Medium  
Medio

170 mm

**J904010**

Grand  
Large  
Grande

183 mm

**J904020**



**J904000**  
14,5 cm - 5 1/2"

Pince pour extraction du ciment  
Cement extraction forceps  
Pinza de extracción de cemento

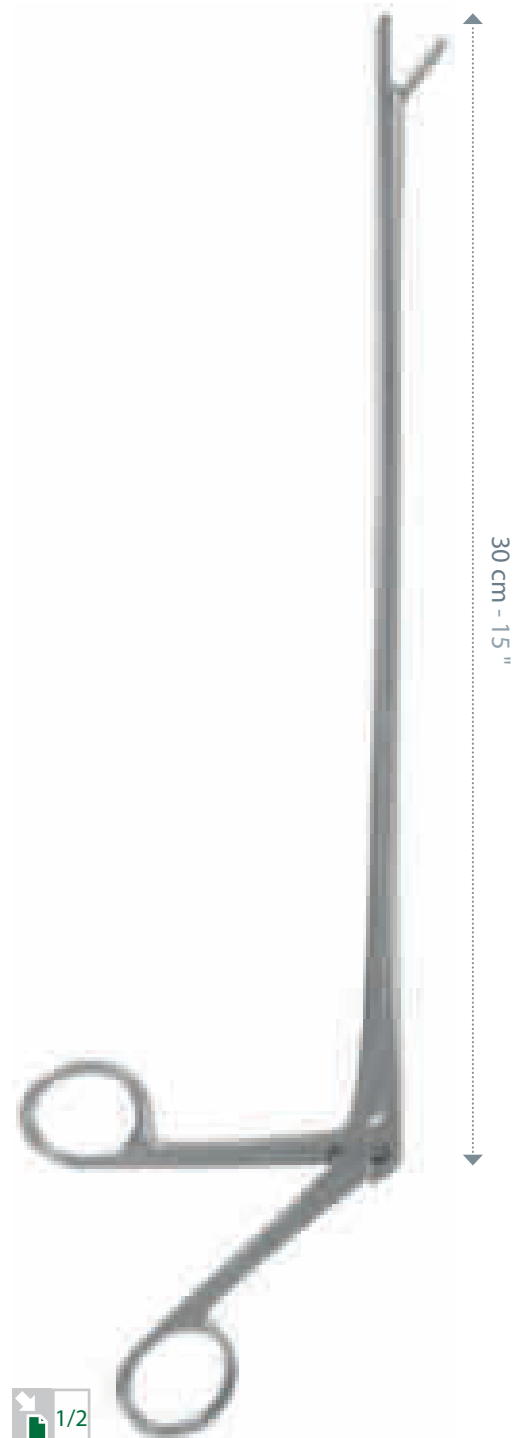

 1/2

**J780000**  
38 cm - 15"

 1/1



**Forets - Drills - Brocas Tarauds - Taps - Terrajas Mandrins - Chucks - Mandriles**

**Mandrins universels - Universal chucks - Mandriles universales**



**Perforateurs manuels - Bone hand drills - Perforadores manuales**

**Fraises et jauges - Reamers and gauges - Fresas y medidores**

**Tournevis - Screw driver - Destornilladores**



**Tournevis - Screw driver - Destornilladores**

**Guide mèches - Drills guide - Guías de brocas**

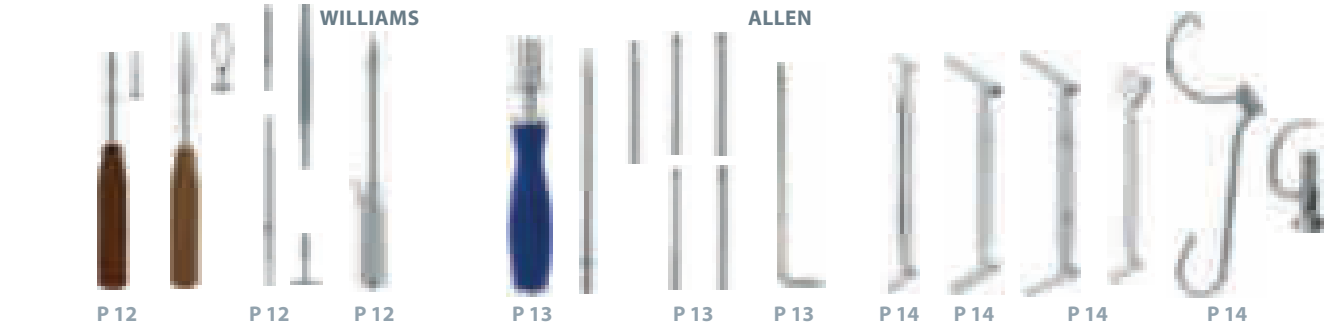

**Guide mèches - Drills guide - Guías de brocas**

**Instrumentation pour plaques - Instruments for plates - Instrumentación para placas**

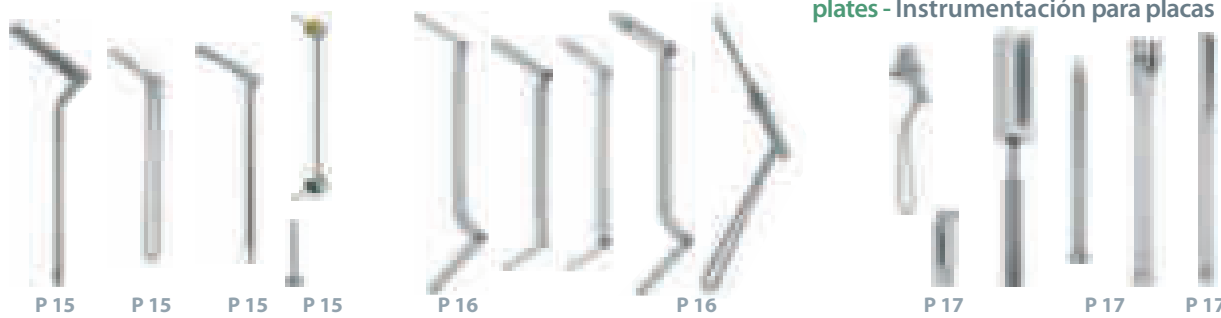

**Instrumentation pour plaques - Instruments for plates - Instrumentación para placas**

**Instrumentation de cambrage - Instruments for bending - Instrumentación para doblar**



Instrumentation de cambrage - Instruments for bending -  
Instrumentación para doblar



P 21



P 22

Instrumentation pour plaques - Instruments for  
plates - Instrumentación para placas



P 23

P 23

Ciseau à os - Osseous chisel -  
Cinzel para huesos



P 24

P 24

Pinces spécifiques - Specific forceps - Pinzas específicas



LAMBOTTE

P 25

HERCULES

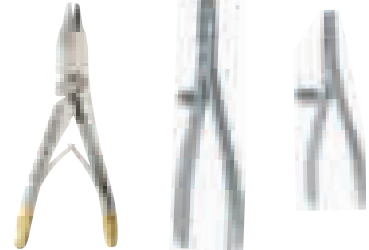

P 26

Pinces multiservices - Multiservices forceps -  
Pinzas multiservicios



P 27

P 27

P 27

P 27

Pinces à fils métalliques - Wire pliers - Pinzas de alambre



P 28

P 28

LOUTE DANIS HARRIS DEMEL



P 29

P 29

P 29

Pinces à couper les fils - Wire cutting pliers - Alicates para cortar alambre



P 30

P 30

P 30

P 30



P 31

P 31



P 32

P 32

P 32

P 33

HERCULES

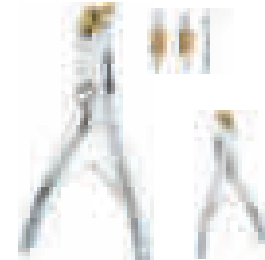

P 34

P 34

HERCULES



P 35

P 35

HERCULES



P 36

**Tréphines et perforateurs - Trephine and drills -  
Trepine y perforadores**

MICHELE NELATON LUCAS-CHAMPIONNIERE

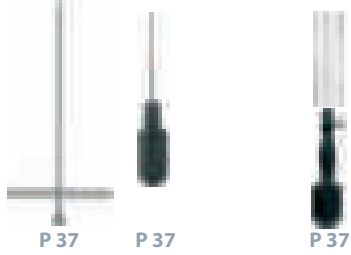

P 37 P 37 P 37

**Alésoirs médullaires rigides - Rigid medulary reamers -  
Brocas rigidas para la medula**



P 38

**Guide pour alésoirs et clous IM - Guide for reamers  
and nails IM - Guía para brocas y clavos IM**



P 39

**Instrumentation pour enclouage IM - Instruments for  
IM nails - Instrumentación para clavos IM**



P 40 P 40 P 40 P 40

**Instrumentation pour enclouage IM - Instruments for  
IM nails - Instrumentación para clavos IM**



P 41 P 41 P 41 P 41

**Instrumentation pour clou RUSH - Instruments for RUSH  
nails - Instrumentación para clavos RUSH**



P 42 P 42 P 42

**Instrumentation pour clous élastiques - Instrument for flexible nails - Instrumentación para clavos flexibles**



P 43 P 43 P 43 P 43

P 44

P 45

**Instrumentation pour enclouage - Instruments for nails - Instrumentación para clavos**

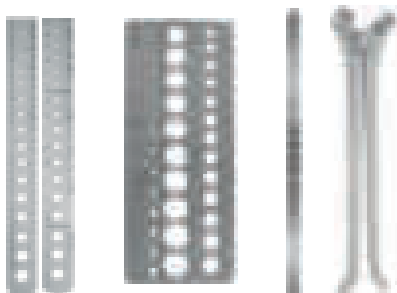

P 46 P 46 P 46 P 46



Instrumentation pour vis perforées - Instruments for cannulated screw - Instrumentación para tornillos canulados



Instrumentation pour agrafes - Instruments for staples - Instrumentación para grapas

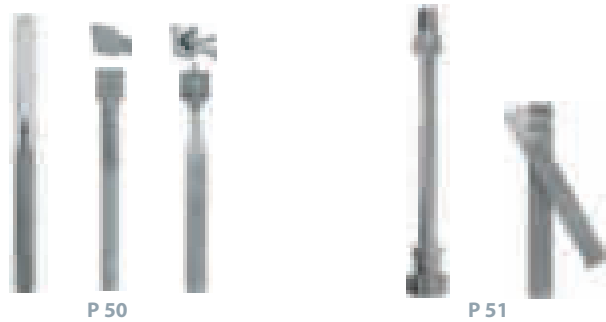

Instrumentation pour cerclage - Instruments for cerclage - Instrumentación para cerclage





Embase cylindrique - Cylindric neck sleeve - Apoyo cilíndrico

Ø mm	L : mm	
1,0	55	M004510
1,5	70	M004511
2,0	85	M004512
2,5	95	M004513
2,7	100	M004514
3,2	130	M004515
3,5	112	M004516
4,5	130	M004517



**M004513**  
95 mm - 3<sup>3</sup>/<sub>4</sub>"

Verrouillage rapide AO - Quick locking system AO - Bloqueo rápido AO

Ø mm	L : mm	
1,1	60	M004530
1,5	85	M004531
2,0	100	M004532
2,0	125	M004533
2,5	110	M004534
2,7	100	M004535
2,7	125	M004536
3,2	145	M004537
3,2	195	M004538
3,5	110	M004539
3,5	145	M004540
3,5	195	M004541
4,5	145	M004542
4,5	195	M004543



AO

**M004534**  
110 mm - 4<sup>1</sup>/<sub>3</sub> "

## Tarauds - Taps - Terrajas

### Poignée en T T handle Mango T

Ø 2,7 mm	<b>M00460</b>	Pitch 1,25
Ø 3,5 mm	<b>M00461</b>	Pitch 1,25
Ø 3,5 mm 	<b>M00462</b>	Pitch 1,75
Ø 4,0 mm	<b>M004625</b>	Pitch 1,75
Ø 4,5 mm long	<b>M00463</b>	Pitch 1,75
Ø 6,5 mm	<b>M00464</b>	Pitch 2,75

### Verrouillage rapide AO Quick locking system AO Bloqueo rápido AO

Ø 1,5 mm	<b>M00470</b>	Pitch 0,50
Ø 2,0 mm	<b>M00471</b>	Pitch 0,60
Ø 2,7 mm	<b>M00472</b>	Pitch 1,00
Ø 3,5 mm 	<b>M00473</b>	Pitch 1,25
Ø 3,5 mm	<b>M00474</b>	Pitch 1,75
Ø 4,0 mm	<b>M00475</b>	Pitch 1,75
Ø 4,5 mm court	<b>M00476</b>	Pitch 1,75
Ø 4,5 mm long	<b>M00477</b>	Pitch 1,75
Ø 6,5 mm	<b>M00478</b>	Pitch 2,75



**M00462**  
Ø 3,5 mm  
16 cm - 6 1/4 "



AO

**M00473**  
Ø 3,5 mm  
11 cm - 4 1/4 "

Ø 1 - 1,5 mm



**M01112**

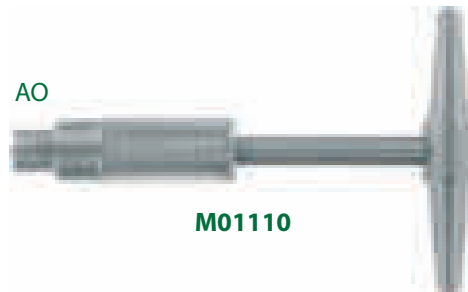

AO

**M01110**

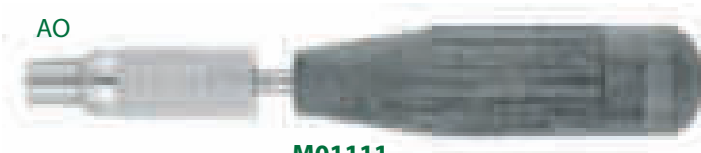

AO

**M01111**

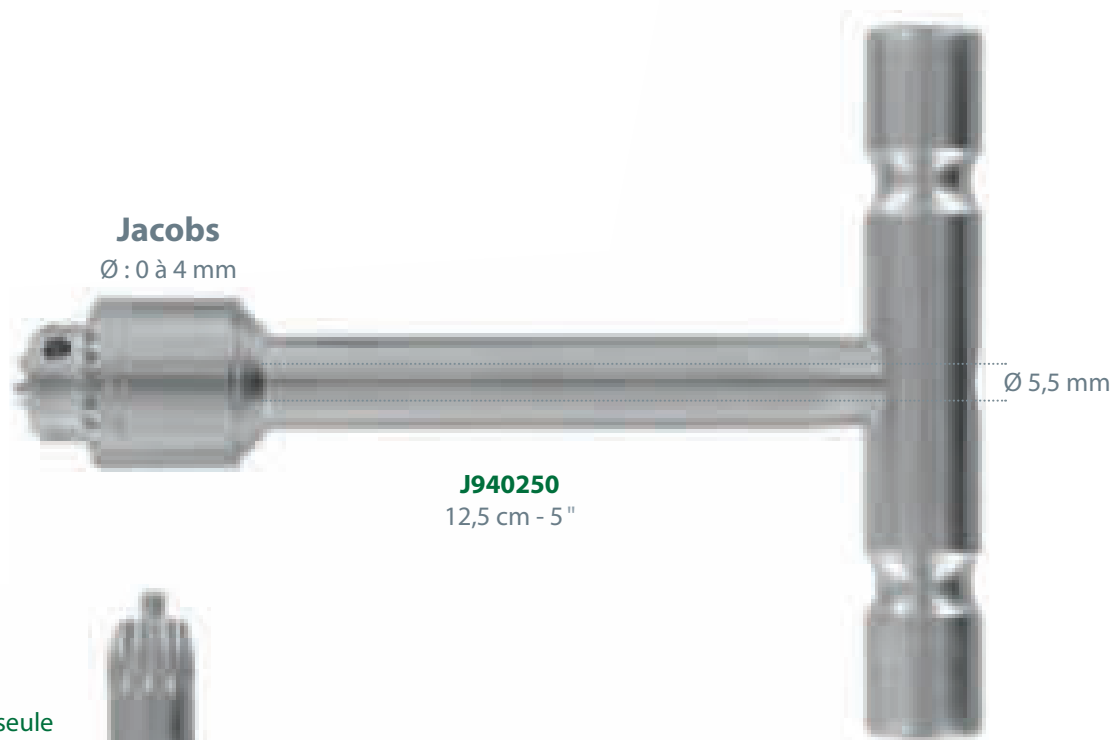

**Jacobs**

Ø: 0 à 4 mm

Ø 5,5 mm

**J940250**

12,5 cm - 5"

Clé seule  
Key only  
Llave sola



**J94210**

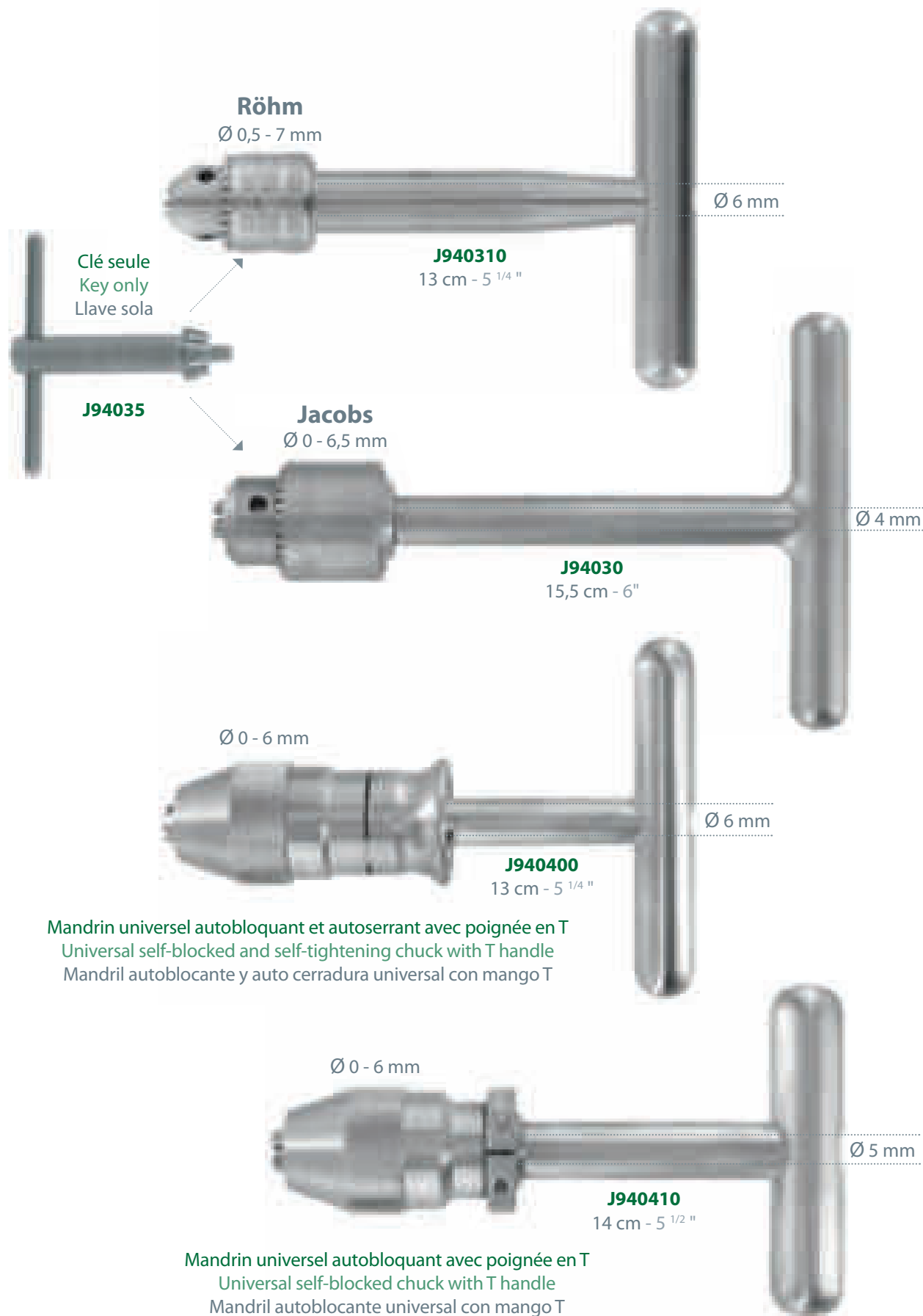

### RALK

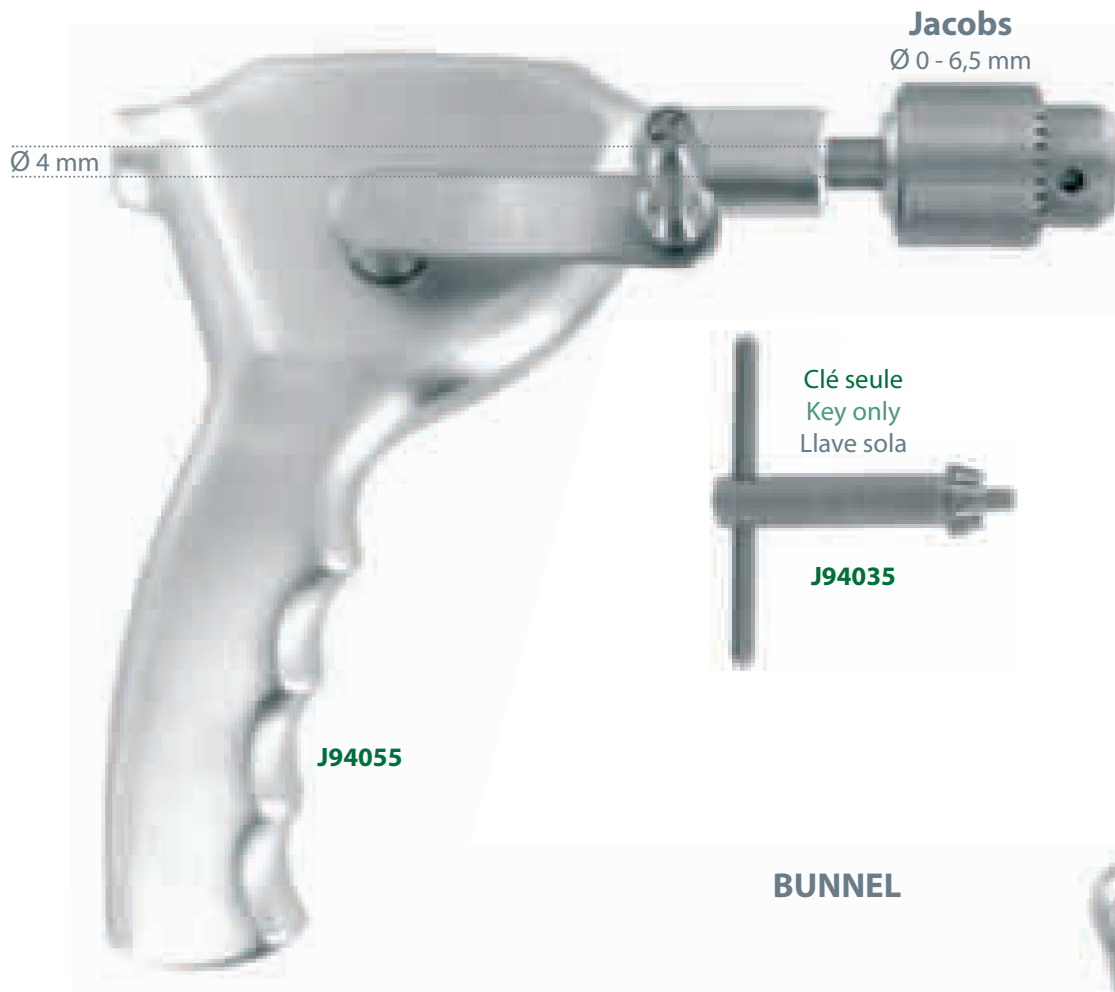

### BUNNEL

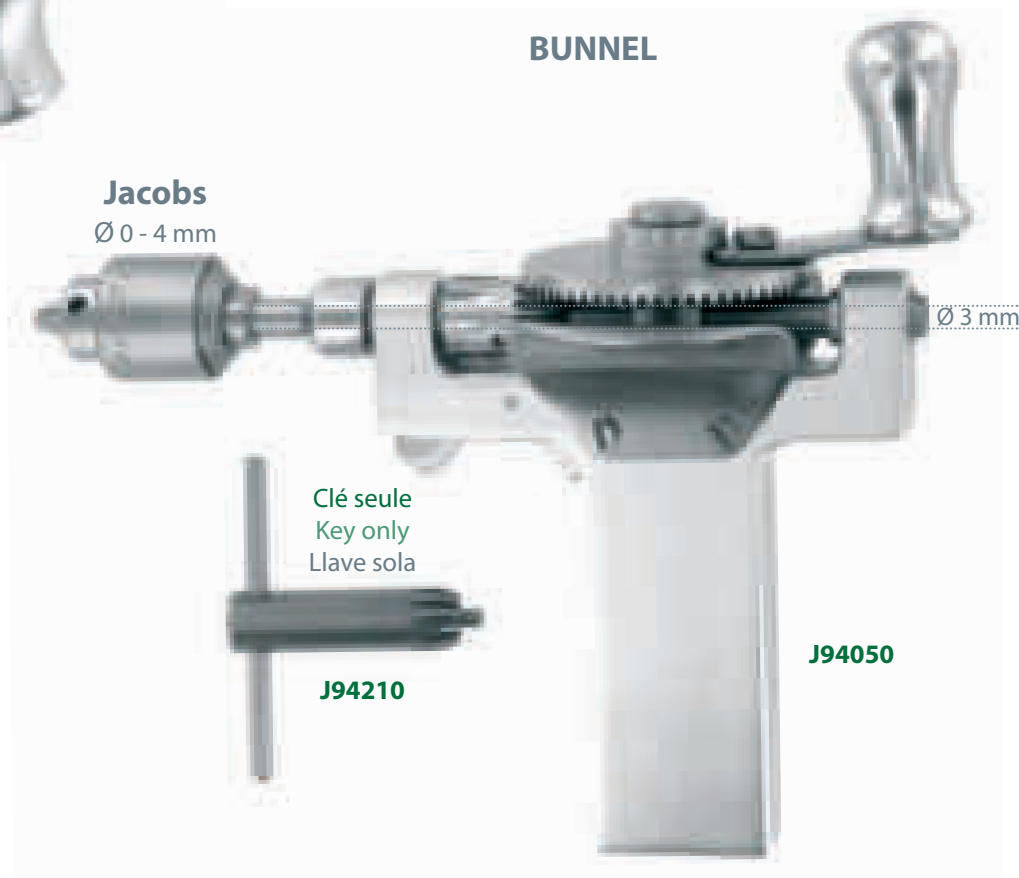

Pour mini vis Ø 1,5 - 2,0 mm  
 For mini screw Ø 1,5 - 2,0 mm  
 Para mini tornillos Ø 1,5 - 2,0 mm



**M00490**

Pour vis Ø 2,7 - 3,5 - 4,0 mm  
 For screw Ø 2,7 - 3,5 - 4,0 mm  
 Para tornillos Ø 2,7 - 3,5 - 4,0 mm



**M00491**

AO

Pour vis malléole Ø 4,5 mm  
 For malleolar screw Ø 4,5 mm  
 Para tornillo de maleolo Ø 4,5 mm



**M00492**

AO

Pour vis Ø 4,5 - 6,5 mm  
 For screw Ø 4,5 - 6,5 mm  
 Para tornillos Ø 4,5 - 6,5 mm



**M00510**



Pour vis Ø 4,5 - 6,5 mm  
 For screw Ø 4,5 - 6,5 mm  
 Para tornillos Ø 4,5 - 6,5 mm

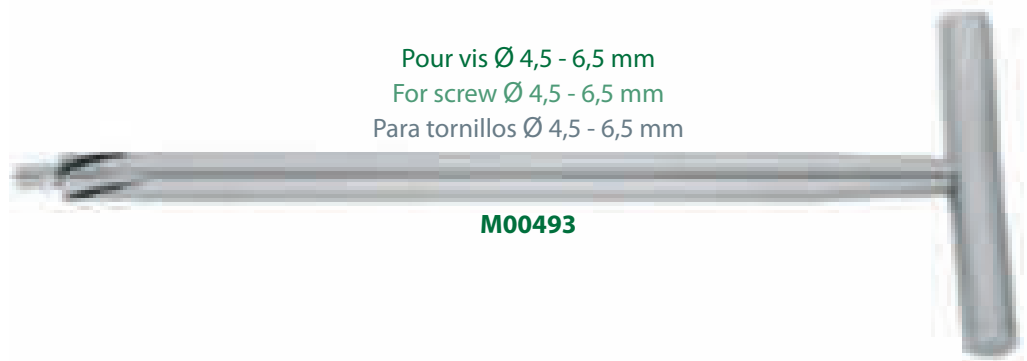

**M00493**

Jauge de profondeur pour vis  
 Depth gauge for screw  
 Medidor de profundidad para tornillos



**J56020**

12 cm - 4 3/4 "



1/2



Pour vis  
 For screw  
 Para tornillos

**M03024**

Ø 1,5 - 2,0 mm

**M03020**

Ø 2,7 - 3,5 - 4,0 mm

**M03022**

Ø 4,5 - 6,5 mm

**M03024**



3/4

## Tournevis - Screw driver - Destornillador



Tournevis pour vis à tête hexagonale  
Screw driver for hexagonal head  
Destornillador para tornillos con cabeza hexagonal

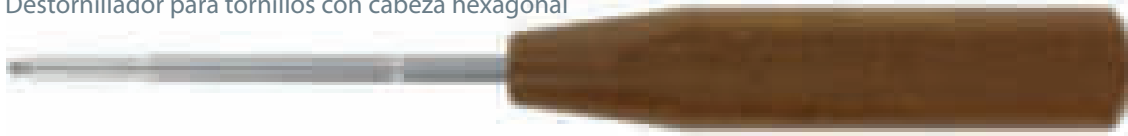

**M01122**  
20 cm - 8 "

Pour vis - For screw - Para tornillos

1,5 mm	<b>M01120</b>	Ø 1,5 - 2,0 mm
2,5 mm	<b>M01122</b>	Ø 2,7 - 3,5 - 4,0 mm
3,5 mm	<b>M01124</b>	Ø 4,5 - 6,5 mm



Tournevis de Philips  
Screw driver for Philips head  
Destornillador para cabeza Philips



**M01126**  
20 cm - 8 "



Tournevis pour vis à tête fendue  
Screw driver for single head  
Destornillador para cabeza simple



**M01128**  
20 cm - 8 "



Tournevis pour vis tête en croix  
Screw driver for slotted head  
Destornillador para cabeza cruz



**M01130**  
20 cm - 8 "

Crochet pour tête de vis  
Hook for screw head  
Gancho para cabeza de tornillos

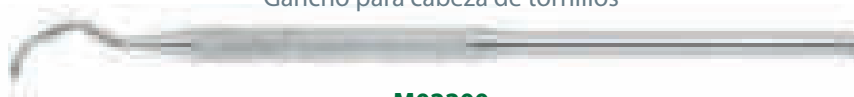

**M02200**



## Tournevis - Screw driver - Destornillador



Tournevis avec préhenseur pour vis à tête hexagonale  
Screw driver with holding sleeve for hexagonal head  
Destornillador cone pinza de sujeción para tornillos con cabeza hexagonal

Préhenseur seul 1,5 mm  
Holding sleeve only 1,5mm  
Pinza de sujeción sólo 1,5 mm



**M01150**

**M01140**  
1,5 mm  
18 cm - 7 "

Pour vis  
For screw  
Para tornillos  
Ø 1,5 - 2,0 mm



Préhenseur seul 2,5 mm  
Holding sleeve only 2,5 mm  
Pinza de sujeción sólo 2,5 mm



**M01170**

**M01160**  
2,5 mm  
20 cm - 8 "

Pour vis  
For screw  
Para tornillos  
Ø 2,7 - 3,5 - 4,0 mm

Pince autoserrante - Porte vis  
Self holding forceps -Screw holder  
Pinza autofijadora - Porta tornillos



**M03060**  
8 cm - 3 "

Embout avec verrouillage rapide - Tip with quick locking system - Punta con bloqueo rápido



1,5 mm

**M01175**



2,5 mm

**M01176**

AO



3,5 mm

**M01177**

AO

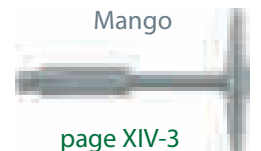

Poignée  
Handle  
Mango

page XIV-3

**WILLIAMS**

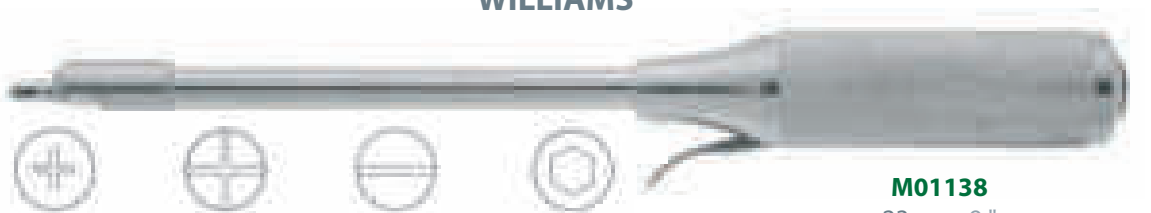

**M01138**  
23 cm - 9 "



**M01132**



**M01134**



**M01136**



**M01138**  
3,5 mm

## Tournevis - Screw driver - Destornillador

Manche pour tournevis - encliquetage cylindrique  
 Handle for screw driver - cylindric locking system  
 Mango para destornillador - bloqueo cilindrico

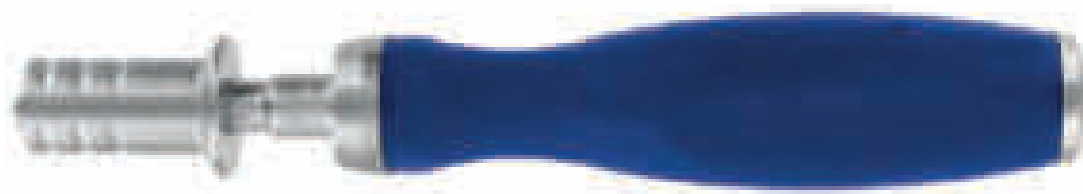

Tournevis 2,5 mm  
 Screw driver 2,5 mm  
 Destornillador 2,5 mm

**M01220**  
 18 cm - 7 "



**M01230**  
 17 cm - 6 3/4 "



Tournevis 3,5 mm  
 Screw driver 3,5 mm  
 Destornillador 3,5 mm



**M01235**  
 17 cm - 6 3/4 "



Tournevis Philips  
 Screw driver Philips  
 Destornillador Philips



**M01240**  
 17 cm - 6 3/4 "



Petit tournevis de Philips  
 Screw driver Philips head small  
 Destornillador Philips pequeño



**M01241**  
 17 cm - 6 3/4 "



Tournevis à tête fendue  
 Screw driver for single head  
 Destornillador cabeza simple



**M01200**  
 17 cm - 6 3/4 "



Tournevis à tête en croix  
 Screw driver for slotted head  
 Destornillador para cabeza cruz



**M01210**  
 17 cm - 6 3/4 "

## ALLEN

Clés hexagonales  
 Hexagonal keys  
 Llaves hexagonales

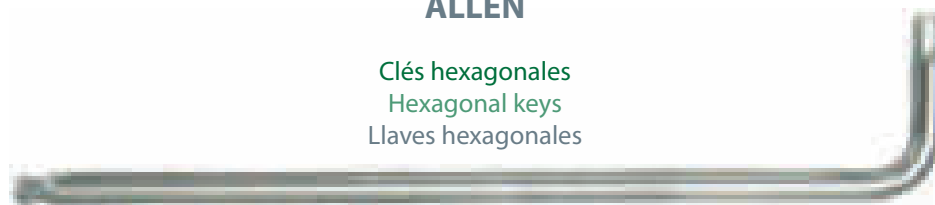

1,5 mm	<b>M012915</b>	9 cm - 3 1/4 "
2,0 mm	<b>M012920</b>	10 cm - 4 "
2,5 mm	<b>M012925</b>	11 cm - 4 1/4 "
3,0 mm	<b>M012930</b>	12,5 cm - 5 "

4,0 mm	<b>M012940</b>	13,5 cm - 5 1/4 "
5,0 mm	<b>M012950</b>	15,5 cm - 6 "
6,0 mm	<b>M012960</b>	17 cm - 6 3/4 "

# LANDANGER

## Guide mèches - Drills guide - Guías de brocas



Ø 1,1 mm  
Ø 1,5 mm

**M03380**

**M03382**

Ø 1,5 mm  
Ø 2,0 mm

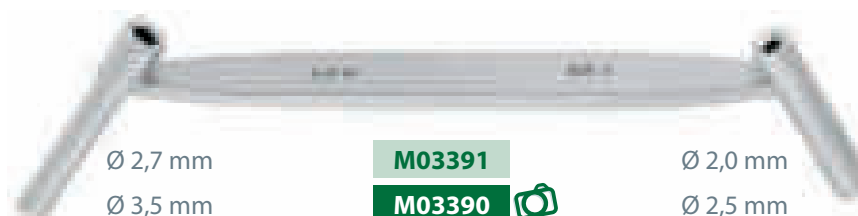

Ø 2,7 mm  
Ø 3,5 mm

**M03391**

**M03390**

Ø 2,0 mm  
Ø 2,5 mm



**M03393**

Ø 2,7 mm

Ø 1,0 mm



Ø 2,0 mm

**M03381**

Ø 2,0 mm

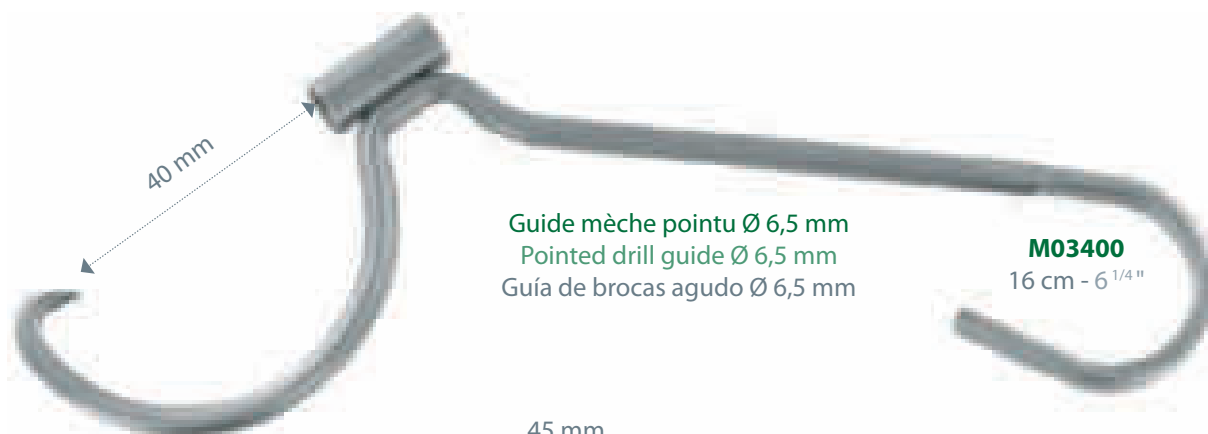

Guide mèche pointu Ø 6,5 mm  
Pointed drill guide Ø 6,5 mm  
Guía de brocas agudo Ø 6,5 mm

**M03400**  
16 cm - 6 1/4"



Guide mèche réglable Ø 4,5 mm  
Adjustable drill guide Ø 4,5 mm  
Guía de brocas ajustable Ø 4,5 mm

**M034010**  
11,5 cm - 4 1/2"



Guide pour taraud  
Tap guide  
Guía de terraja

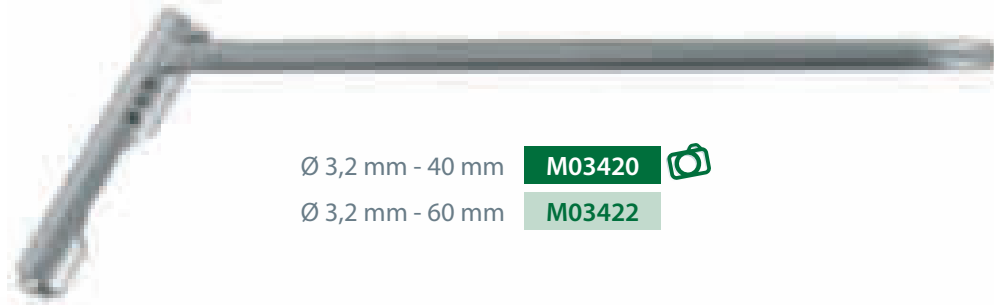

Ø 3,2 mm - 40 mm **M03420**   
Ø 3,2 mm - 60 mm **M03422**

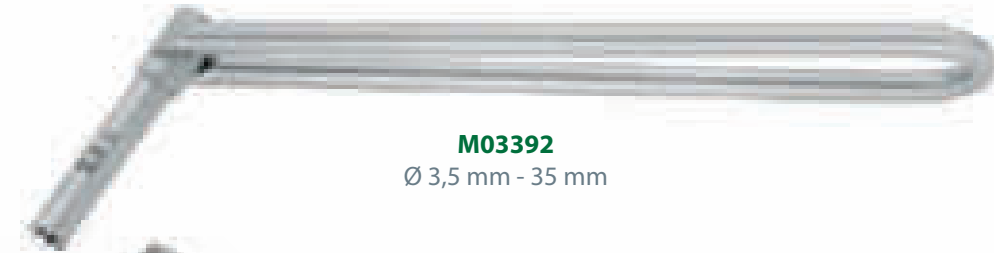

**M03392**  
Ø 3,5 mm - 35 mm



**M03410**  
Ø 4,5 mm - 50 mm

Guide mèche pour position neutre et de tension  
Neutral and for tension drill guide  
Guía de broca neutral y para tensión

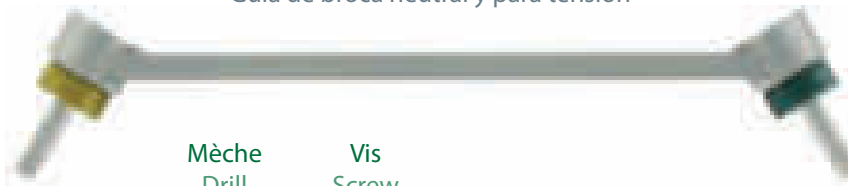

Mèche	Vis
Drill	Screw
Broca	Tornillo

Ø 1,5 mm	Ø 2,0 mm
Ø 2,0 mm	Ø 2,7 mm
Ø 2,5mm	Ø 3,5 mm
Ø 3,2 mm	Ø 4,5 mm
Ø 3,2 mm	Ø 4,5 mm

**M03430**

**M03431**

**M03432**

**M03433** 

**M03435**

Douille de centrage  
Insert drill sleeve  
Casquillo dentado



Douille	Mèche
Insert	Drill
Casquillo	Broca

Ø 2,7 mm Ø 2,0 mm **M03436** 

Ø 3,5 mm Ø 2,5 mm **M03437**

Ø 4,5mm Ø 3,2 mm **M03438**

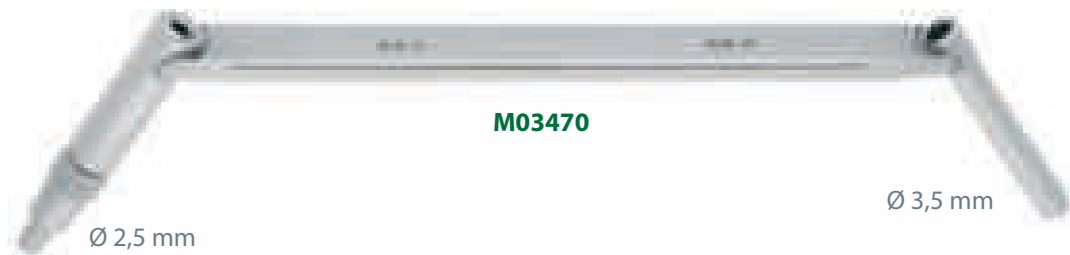

Gabarit de forage triple 130° - Ø 3,2 mm  
Triple drill guide angle 130° - Ø 3,2 mm  
Guía de broca triple 130° - Ø 3,2 mm



**M02215**

Plaque repère angle ajustable pour  
ciseaux conducteurs  
Chisel guide with adjustable angle  
Controlador de angulo



**M02235**

Marteau diapason  
Slotted hammer  
Martillo diapason

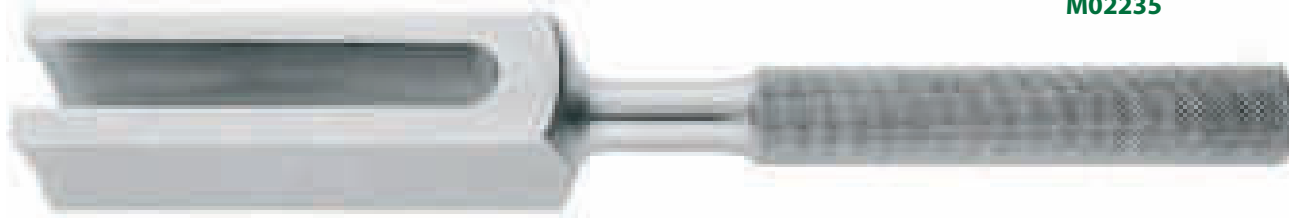

**M02190**

26 cm - 10 1/4 "

Impacteur  
Impactor  
Impactor



**M02130**

20,5 cm - 8 "

Impacteur extracteur  
Impactor extractor  
Portaplacas y extractor

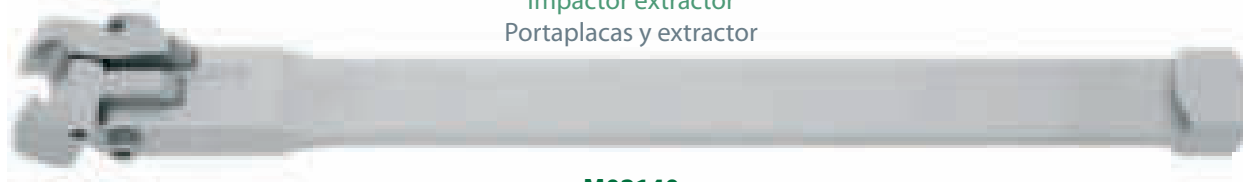

**M02140**

Ciseau conducteur pour plaque de hanche profil "U"  
Graduated seating chisel "U" shaped  
Escoplo - guía graduado perfil "U"

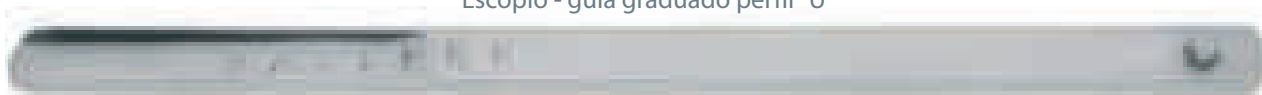

Adultes - Adults - Adultos

**M02230**

16 mm  
25 cm - 10 "

Viseur pour plaques condyliennes  
 Condylar positioning plate  
 Plantilla para placas condileas



**M03440**

Etalon d'angle  
 Positioning plate  
 Patron de angulo



**M03030**



**M03031**



**M03032**

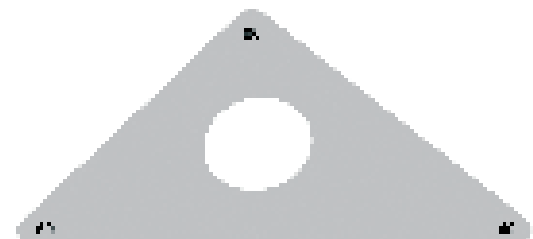

**M03033**

Impacteur de plaques de hanches pour enfants et adolescents  
 Introducer extractor for angled plates - adolescents and children  
 Porta placas y extractor para placas anguladas adolescentes y niños



**M02150**  
 26 cm - 10 1/4 "

Ciseau conducteur pour plaques coudées en "L"  
 Graduated seating chisel for plates "L" shaped  
 Escoplo-guía graduado para placas perfil "L"



**Adolescents - Teenagers - Adolescentes**

**M02240**  
 13 mm  
 25 cm - 10 "

**Enfants - Children - Niños**

**M02241**  
 11 mm  
 25 cm - 10 "

Etalon d'angle  
 Positioning plate  
 Patron de angulo



**M03034**

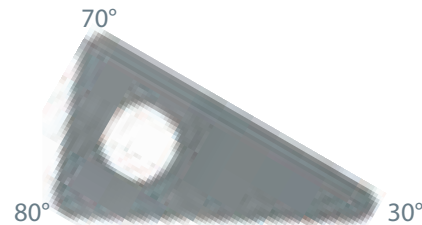

**M03035**



**M03036**

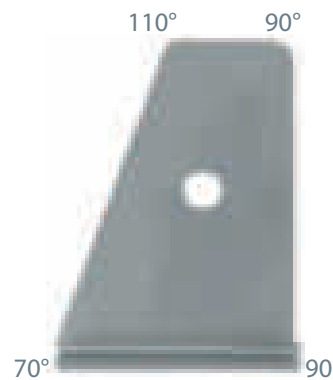

**M03037**





Fer à cintrer les mini plaques  
 Plate bender for mini plates  
 Llave para doblar mini placas



1,8 mm

**M01250**  
 12 cm - 4 3/4 "

Fer à cintrer les plaques de reconstruction  
 Plate bender for reconstruction plates  
 Llave para doblar placas de reconstrucción



4,0 mm / 2,4 mm

**M01251**  
 14,5 cm - 5 3/4 "

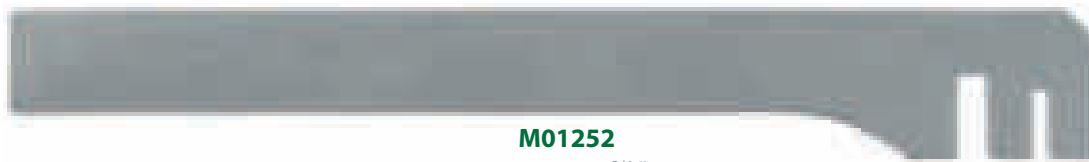

**M01252**  
 14,5 cm - 5 3/4 "

4 mm / 2,4 mm



5 mm

Fer à cintrer les plaques standards  
 Plate bender for standard plates  
 Llave para doblar placas rectas

7,3 mm

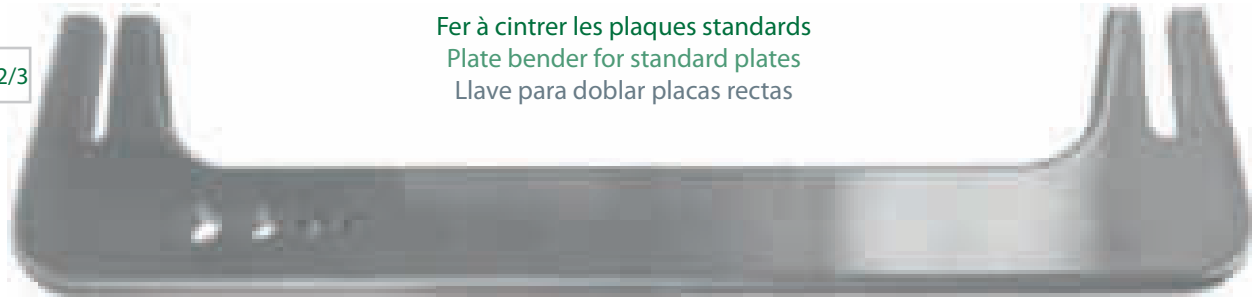

**M01253**  
 25 cm - 5 1/2 "

6,0 mm

Gabarit de cintrage - Template bending - Modelo para doblar



**M01050**

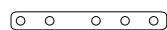

**M01051**

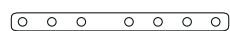

**M01052**

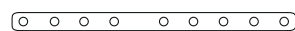

Petite plaque - Small plate - placa pequeña

**M03520**

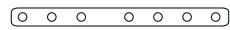

**M03530**

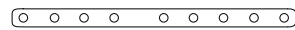

Aluminium  
 Aluminum  
 Aluminio



**M01050**  
 12 x 84 mm



Pince pour cintrer les plaques  
 Plate bending pliers  
 Alicates para doblar placas

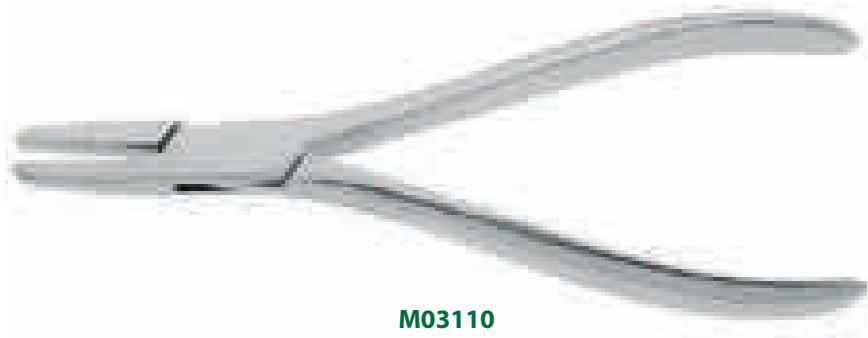

**M03110**  
 15 cm - 6 "



7 mm

**M03120**  
 14 cm - 5 1/2 "

Plaques  
 Plates  
 Placas

1,0 - 2,0 mm

**M03125**

2,7 - 3,5 mm

**M03126**



**M03125**  
 20 cm - 8 "

Pince pour cintrer les plaques droites 4 et 6 mm  
 Plate bender for straight plates 4 and 6 mm  
 Pinza para doblar placas rectas 4 y 6 mm



Presse pour cintrer les plaques  
 Bending press for plates  
 Prensa para doblar placas



Guide mèche pour tendeur 8 et 16 mm  
Drill guide for tension device 8 and 16 mm  
Guía de perforación para tensor 8 y 16 mm

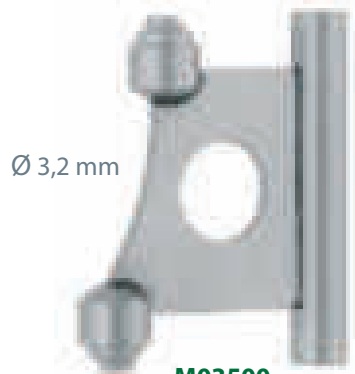

**M03500**

Tendeur de plaque  
Tension device for plate  
Tensor para placas



**M03510**

Course 8 mm  
8 mm span  
Curso 8 mm

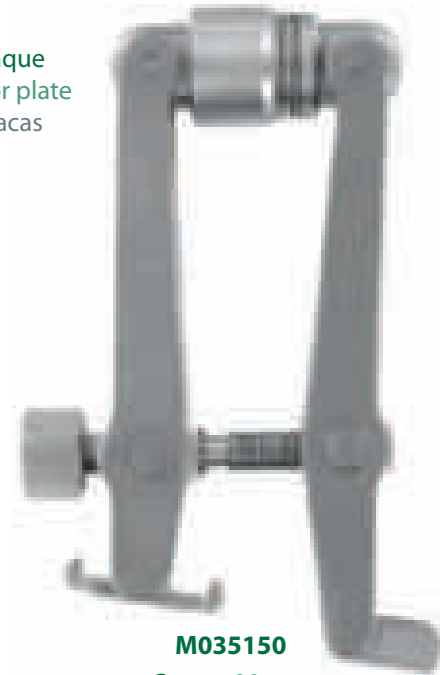

**M035150**

Course 20 mm  
20 mm span  
Curso 20 mm

Clé pour tendeur  
Pin wrench for tension device  
Llave para tensor



**M035160**

Clé à cardan 11 mm  
Socket wrench 11 mm  
Llave cardan 11 mm

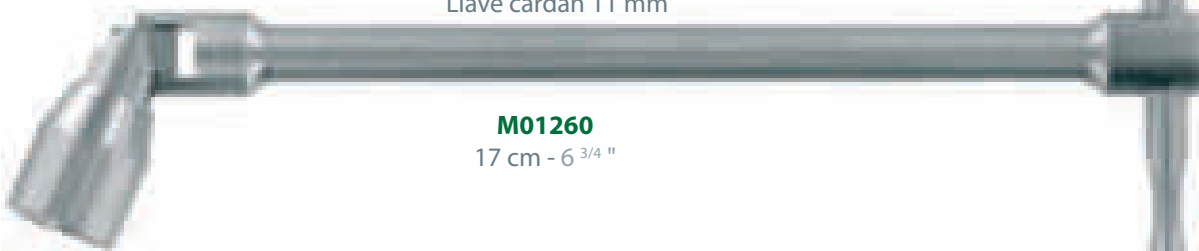

**M01260**

17 cm - 6 3/4 "

Clé mixte de 11 mm  
Open end wrench 11 mm  
Llave figa 11 mm

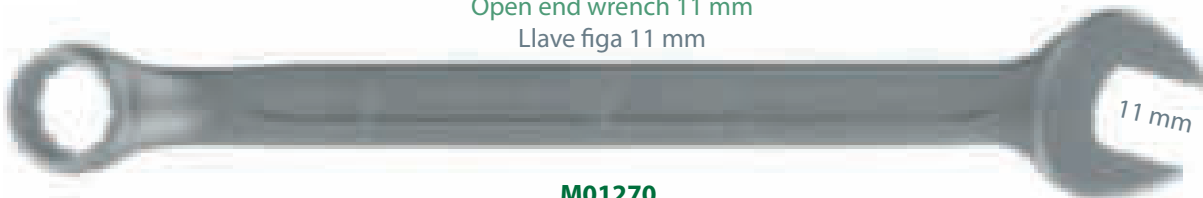

**M01270**

16 cm - 6 1/4 "



**M01040**

20 cm - 8 "



4/5



1/1

## Ciseau à os - Osseous chisel - Cincel para huesos

Manche seul  
Handle only  
Mango solo



**M02270**  
18,5 cm - 7 1/4 "

Lame de burin  
Bone chisel blade  
Hoja de cincel

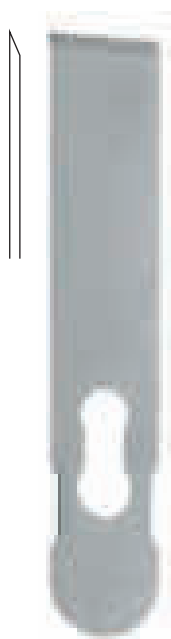

**M02272**  
8 cm - 3 1/4 "

M02274	5 mm
M02271	10 mm
M02272	16 mm
M02273	25 mm

Lame ostéotome  
Osteotome blade  
Hoja de osteotomo



**M022780**  
8 cm - 3 1/4 "

Clé pour manche de burin  
Wrench for bone chisel  
Llave para mandril



**M02275**  
85 mm

### LAMBOTTE

Porte-vis ou plaque  
Screw Holder  
Porta-tornillos o placa

Tord-broches  
Iron for pins  
Tubo para curvar agujas

Pince pour mini plaque  
Forceps for mini plates  
Pinza para placa mini



**M03170**

13,5 cm - 5 1/4 "



**J756900**

16 cm - 6 1/4 "

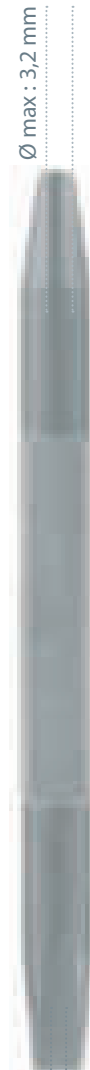

Ø max : 2,0 mm

**M03600**

15 cm - 6 "

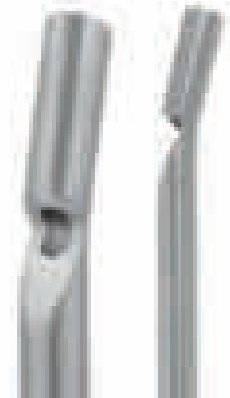

Ø max  
3,5 mm



**M036010**

30 cm - 11 3/4 "



**J757900**  
13 cm - 5 "

Pince tire-broches  
Wire seizing forceps  
Pinza para coger agujas

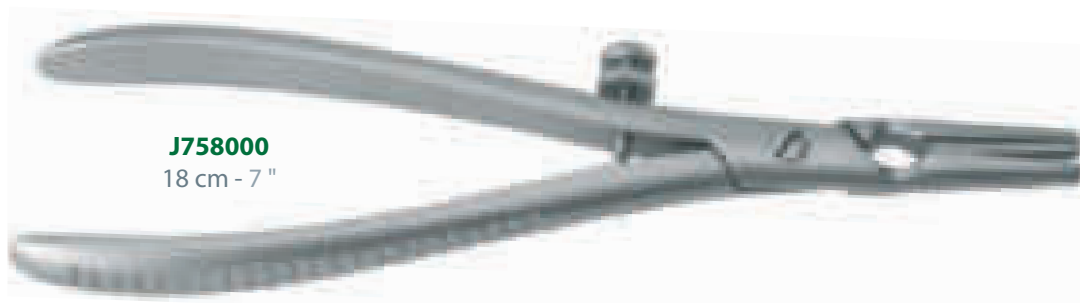

**J758000**  
18 cm - 7 "



### HERCULES

Extraction  
Extraction  
Extracción

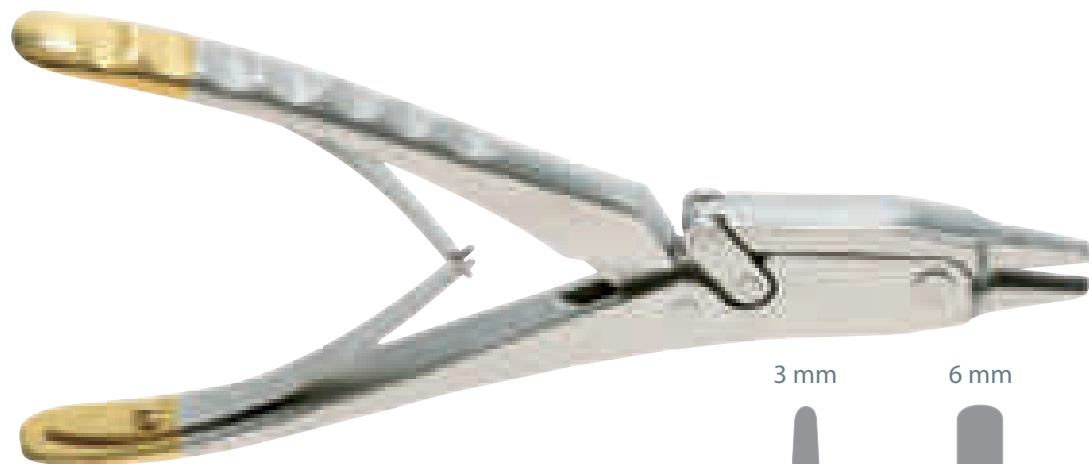

3 mm

6 mm



**J758430**  
18 cm - 7 "

**J758431**  
18 cm - 7 "

## Pinces multiservices - Multiservices forceps - Pinzas multiservicios

Pince universelle  
Universal forceps  
Pinza universal



Coupe - Cut - Corte  
Ø max : 1,5 mm

**J757410**  
20 cm - 8 "

Mors parallèles  
Parallel jaws  
Bocas paralelas

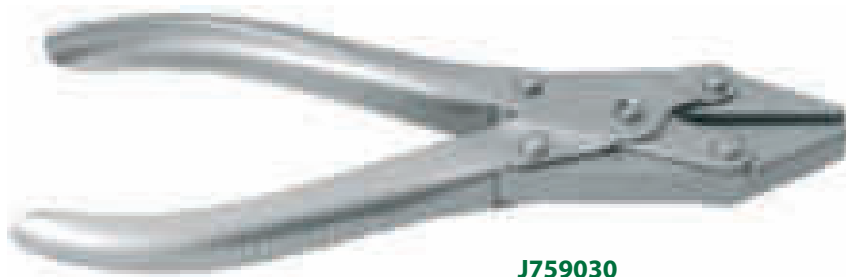

**J759030**  
17 cm - 6 <sup>3</sup>/<sub>4</sub> "

### Pinces étau - Vise grip forceps - Pinzas de fijación

18 cm - 7 "

**J759040**



20 cm - 8 "

**J759041**

24 cm - 9 <sup>1</sup>/<sub>2</sub> "

**J759042**

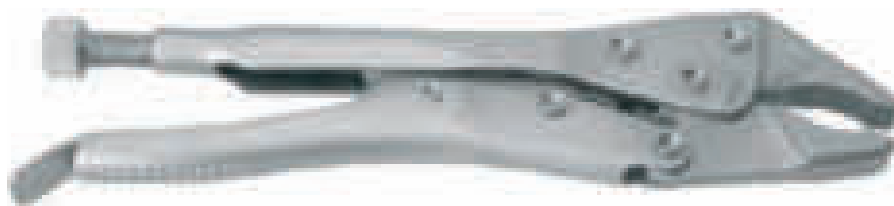

**J759040**  
18 cm - 7 "



**J759050**  
25 cm - 10 "



# LANDANGER

## Pinces à fils métalliques - Wire pliers - Pinzas de alambre



Mors Tunstène - Tungsten jaws - Bocas Tungsteno

Mors inox  
Stainless jaws  
Bocas inox



**J759060**  
18 cm - 7 "  
3 mm



**J759061**  
18 cm - 7 "  
4 mm



**J759062**  
18 cm - 7 "  
6 mm



**J759063**  
18 cm - 7 "  
5 mm

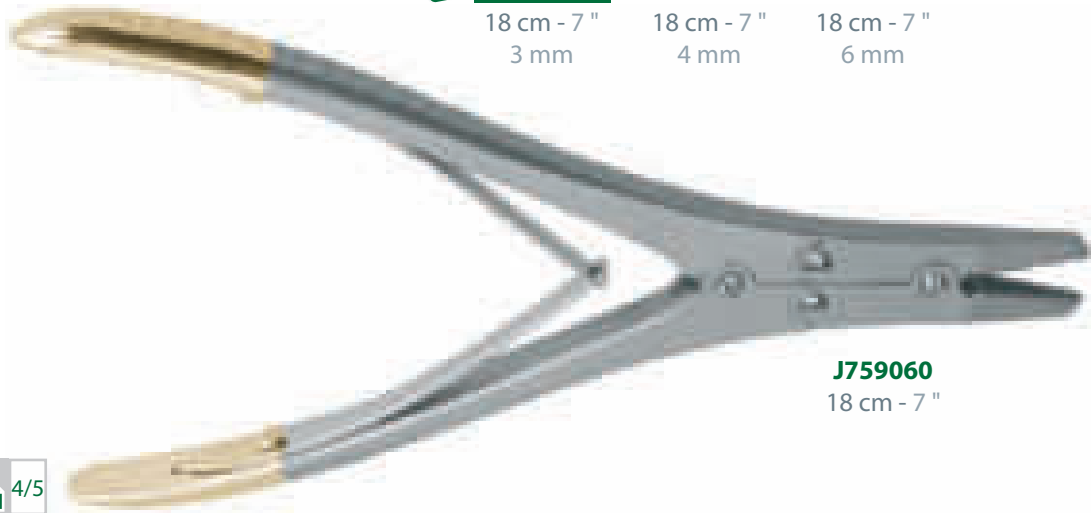

**J759060**  
18 cm - 7 "



Mors inox - Stainless jaws - Bocas inox



**J759100**  
14 cm - 5 1/2 "



**J759105**  
17 cm - 6 3/4 "



**J759110**  
17 cm - 6 3/4 "

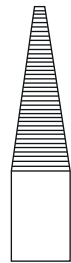

**J759115**  
19 cm - 7 1/2 "

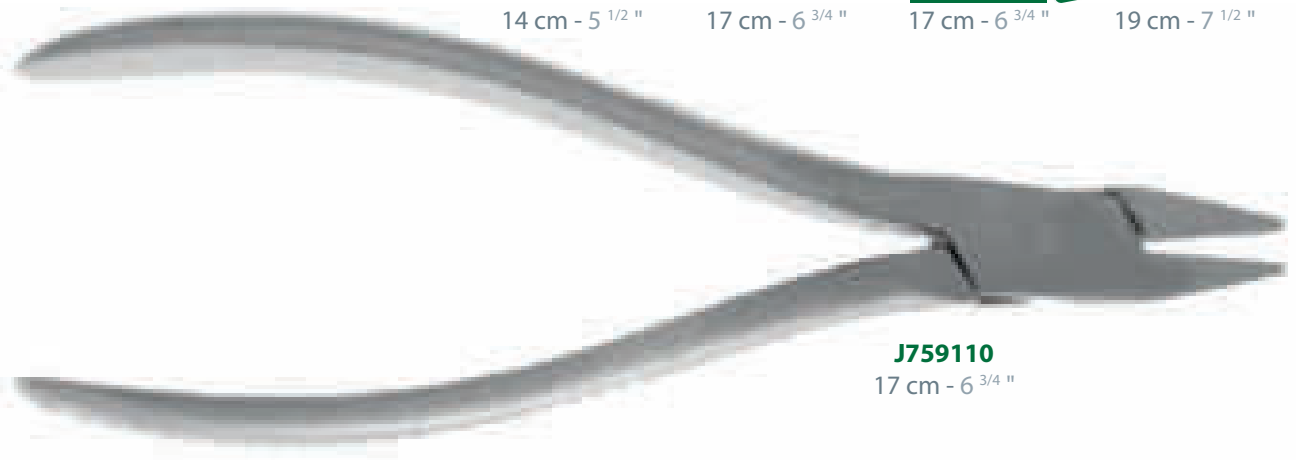

**J759110**  
17 cm - 6 3/4 "



## Pinces à fils métalliques - Wire pliers - Pinzas de alambre



Mors Tunstène - Tungsten jaws - Bocas Tungsteno



**G306300**



**G30640**

**G30610**

15 cm - 6 "

19 cm - 7 1/2 "

18 cm - 7 "

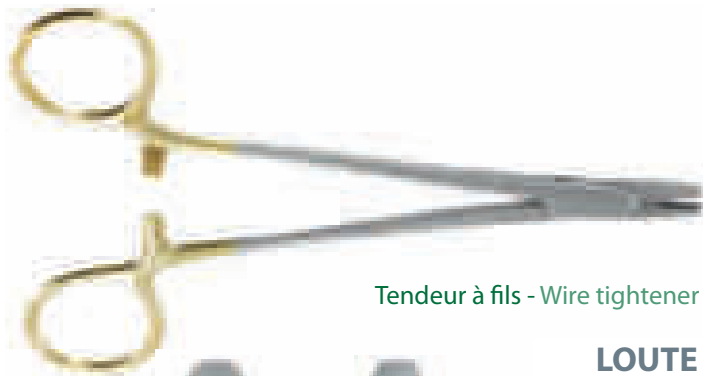

Tendeur à fils - Wire tightener - Tensor de alambre

**LOUTE**

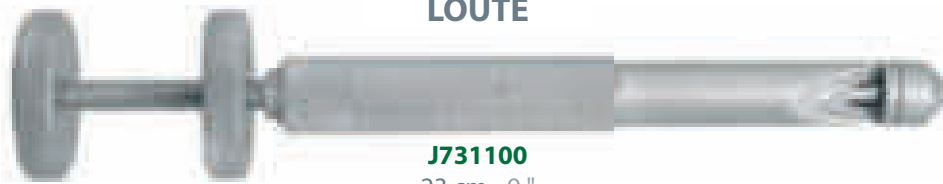

**J731100**

23 cm - 9 "

**DANIS**



**J731200**

21 cm - 8 1/4 "

**HARRIS**



**J731300**

25 cm - 10 "

**DEMEL**



**J731400**

28 cm - 11 "

### COUPE LATÉRALE ET FRONTALE - LATERAL AND FRONTAL CUTTING - CORTE LATERAL Y FRONTAL

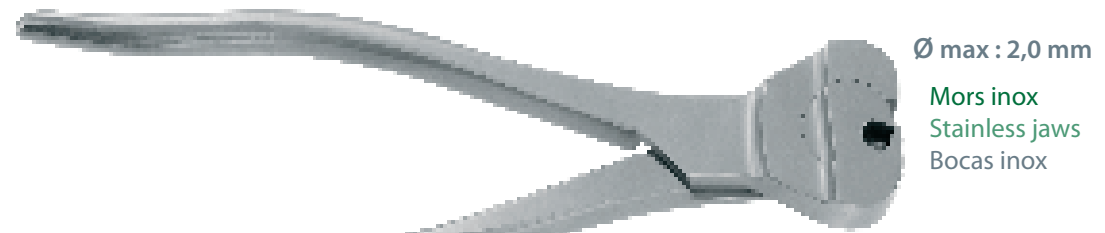

Ø max : 2,0 mm

Mors inox  
Stainless jaws  
Bocas inox

**J757506**  
16 cm - 6 1/4 "



Ø max : 1,7 mm

**J757508**  
18 cm - 7 "

### COUPE FRONTALE - FRONTAL CUTTING - CORTE FRONTAL

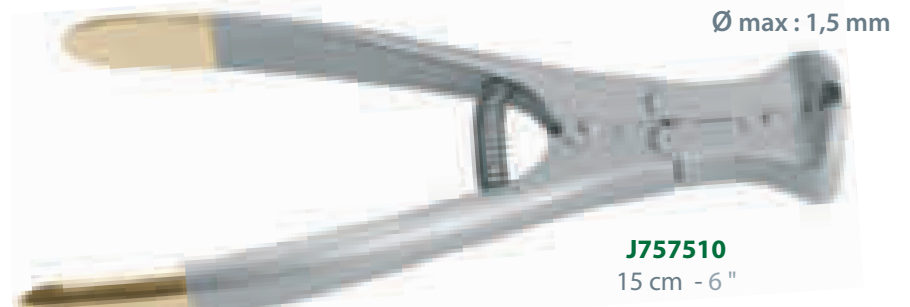

Ø max : 1,5 mm

**J757510**  
15 cm - 6 "



Ø max : 2,2 mm

**J757520**  
22 cm - 8 3/4 "

# LANDANGER

Pinces à couper les fils - Wire cutting pliers - Alicates para cortar alambre

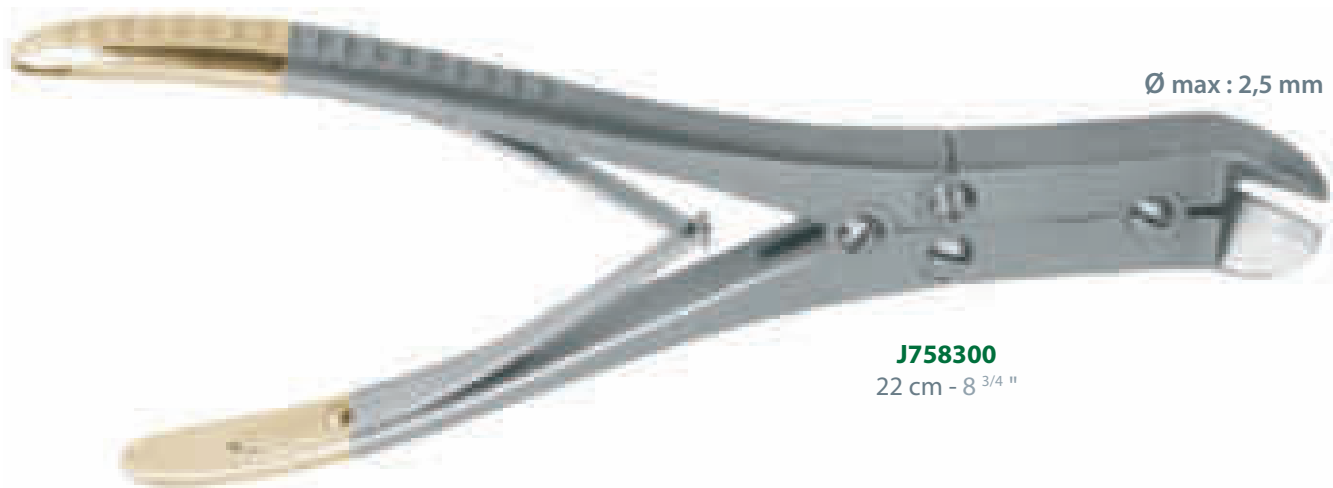
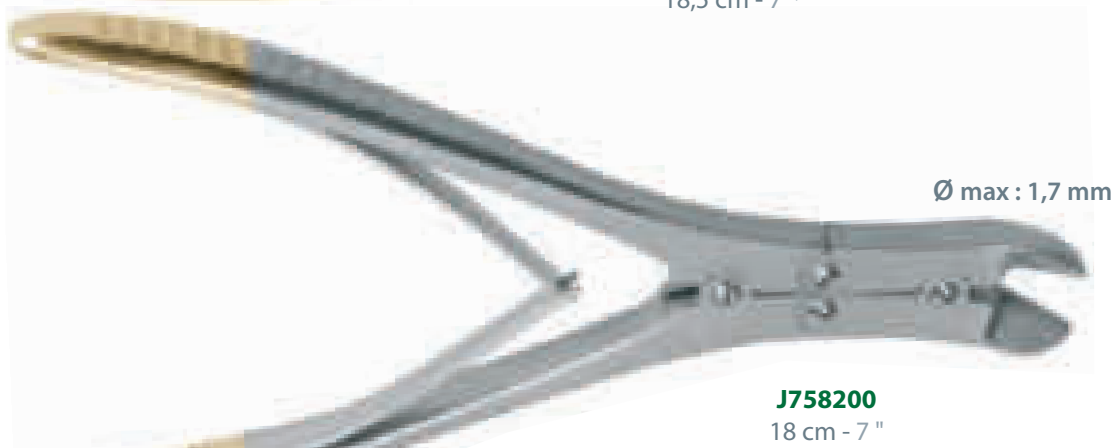
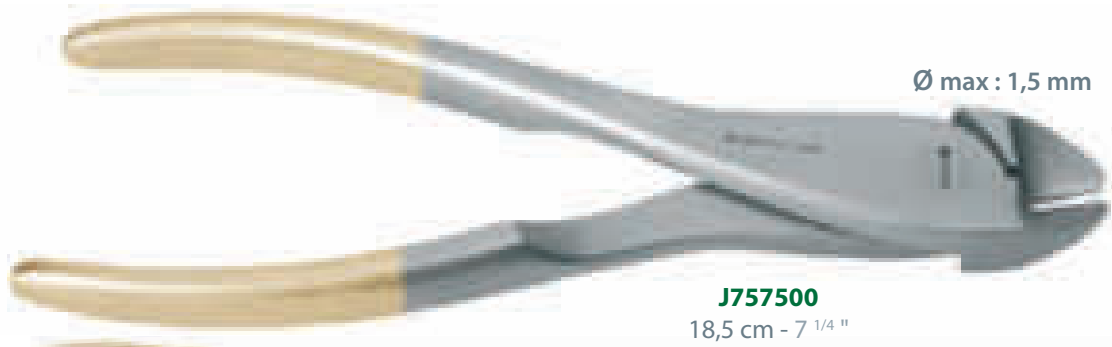

## Pinces à couper les fils - Wire cutting pliers - Alicates para cortar alambre

Ø max : 5 mm



Mors seuls  
Jaws only  
Bocas solas  
**J758060**

**J758050**  
47 cm - 18 1/2 "

Ø max : 3 mm



**J758010**  
32 cm - 12 1/2 "



Ø max : 4 mm



Mors seuls  
Jaws only  
Bocas solas  
**J758080**

**J758070**  
38 cm - 15 "



## HERCULES

Ø max : 3,0 mm



 **J758400**  
Ø max : 3,0 mm  
23 cm - 9 "

**J758403**  
Ø max : 3,5 mm  
28 cm - 11 "

Mors tungstène de rechange (paire)  
Tungsten jaw for exchange (pair)  
Boca de tungsteno de recambio (par)



**J758420** pour/for/para **J758400**

**J758423** pour/for/para **J758403**

Mors caoutchouc de rechange (paire)  
Rubber jaws for exchange (par)  
Bocas caucho de recambio (par)



**J758410**



### HERCULES

Ø max : 2,2 mm



**J758402**  
18 cm - 7 "

Pour droitier  
For right-handed  
Para diestro

Mors tungstène de rechange (paire)  
Tungsten jaw for exchange (pair)  
Boca de tungsteno de recambio (par)



**J758421**



1/2



**J758401**  
18 cm - 7 "

Pour gaucher  
For left-handed  
Para zurdo



1/1



Ø max : 1,6 mm

**HERCULES**

Ø max : 2,0 mm



**J758406**  
15 cm - 6 "



**J758407**  
18 cm - 7 "

Mors caoutchouc de rechange (paire)  
Rubber jaws for exchange (pair)  
Bocas caucho de recambio (par)



**J758416**

Mors tungstène de rechange (paire)  
Tungsten jaw for exchange (pair)  
Boca de tungsteno de recambio (par)



**J758426**



**PINCE POUR TORSADER ET COUPER LES FILS.  
NE PAS UTILISER POUR LA TRACTION DES BROCHES.  
PLIERS FOR TWISTING AND CUTTING THE WIRES.  
DO NOT USE FOR THE PINS TRACTION.  
ALICATE PARA TORCER Y CORTAR LOS ALAMBRES.  
NO USO PARA EXTRACCIÓN DE PINES.**





### HERCULES

Coupe latérale  
Lateral cutting  
Corte lateral

Ø max : 2,0 mm

Coupe latérale et frontale  
Lateral and frontal cutting  
Corte lateral y frontal

Ø max : 1,6 mm



Coupe câble  
Cable cut  
Corta cables

**J758405**  
18 cm - 7 "

**J758404**  
18 cm - 7 "

Mors tungstène de rechange (paire)  
Tungsten jaw for exchange (pair)  
Boca de tungsteno de recambio (par)

**J758425**

Mors tungstène de rechange avec protection caoutchouc (paire)  
Tungsten jaw for exchange with rubber protection (pair)  
Boca de tungsteno de recambio con protección de caucho (par)

**J758424**

### MICHELE

Pour enlever les vis cassées  
For removal broken screws  
Para Retirar los tornillos rotos



**M006050**

3,0 - 5,0 mm



**M006055**

4,0 - 5,5 mm



**M006080**

6,0 - 8,0 mm



**M006050**

20,5 cm - 8 "

### LUCAS-CHAMPIONNIERE

Fixe  
Fixed  
Fijo

Ø 3 mm



**J94150**

17 cm - 6 3/4 "

### NELATON

Perforateur complet avec 3 forets  
Complete perforator with 3 drills  
Perforador completo con 3 bocas

Foret seul  
Drill only  
Broca sólo

9,5 cm - 3 3/4 "

Ø

2 mm

**J94170**

3 mm

**J94180**

4 mm

**J94190**

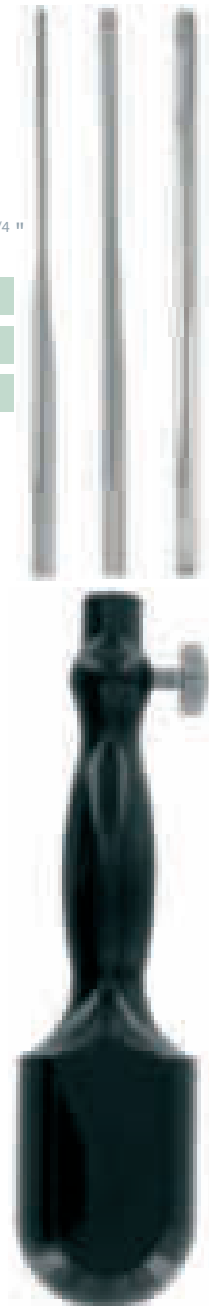

**J94160**

12 cm - 4 3/4 "

## Alésoirs médullaires rigides - Rigid medulary reamers - Brocas rigidas para la medula

Poignée en T  
Handle T  
Mango T



**M00207**  
52 cm - 20 1/2 "

Ø 6,0 mm **M00200**

Ø 7,0 mm **M00201**

Ø 8,0 mm **M00202**

Ø 9,0 mm **M00203**

Ø 10 mm **M00204**

Ø 11 mm **M00205**

Ø 12 mm **M00206**

Ø 13 mm **M00207** 

Ø 14 mm **M00208**

Ø 15 mm **M00209**

Ø 16 mm **M00210**

Ø 17 mm **M00211**

Ø 18 mm **M00212**

Ø 19 mm **M00213**

Ø 20 mm **M00214**





Protecteur de peau  
Skin protector  
Protector de piel



 1/2

**M002200**  
15 cm - 6 "

 1/3

Ø 3,0 mm	<b>M03200</b> 	Ø 2,4 mm	<b>M03240</b> 	Ø 2,4 mm	<b>M03291</b>	Ø 2.0 x 3 mm	<b>M03250</b> 
Ø 3,5 mm	<b>M03201</b>	Ø 3,0 mm	<b>M03241</b>	Ø 3,0 mm	<b>M03290</b> 	Ø 3.0 x 4 mm	<b>M03280</b>
Ø 4,0 mm	<b>M03202</b>						
Ø 5,0 mm	<b>M03203</b>						

Droit  
Straight  
Recto

Courbe  
Curved  
Curvo

Pour alésoir flexible  
For flexible reamer  
Para broca flexible

Ø 3,0 mm

Pour clous IM  
For IM nails  
Para clavos IM

Pour clous Kuntscher  
For Kuntscher nails  
Para clavos Kuntscher



**M03200**  
Ø 3,0 mm  
60 cm - 23 <sup>3</sup>/<sub>4</sub> "



**M03240**  
Ø 2,4 mm  
90 cm - 35 <sup>1</sup>/<sub>2</sub> "

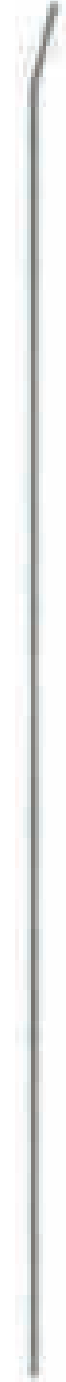

**M03290**  
Ø 3,0 mm  
90 cm - 35 <sup>1</sup>/<sub>2</sub> "



**M03250**  
Ø 2,0 mm  
90 cm - 35 <sup>1</sup>/<sub>2</sub> "



Marteau diapason - Slotted hammer - Martillo diapason



Guide clou fendu  
Slotted nail driver  
Conductor clavo ranurado

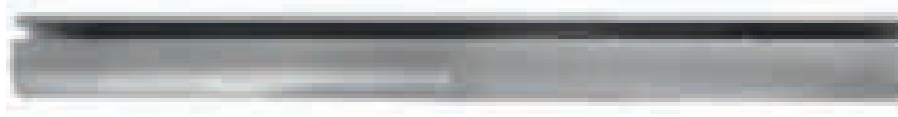

**M020220**  
20 cm - 8 "

Impacteur final  
Final impactor  
Impactor final

Ø 6 - 8 mm  
Ø 9 - 12 mm  
Ø 13 - 20 mm

**M020230**  
**M020231**  
**M020232**



**M020230**  
20 cm - 8 "

Crochet d'extraction  
Extraction hook  
Gancho de extracción

29 cm - 11 1/2 "  
37 cm - 14 1/2 "  
43 cm - 17 "  
51 cm - 20 "

**M02000**  
**M02001**  
**M02002**  
**M02003**

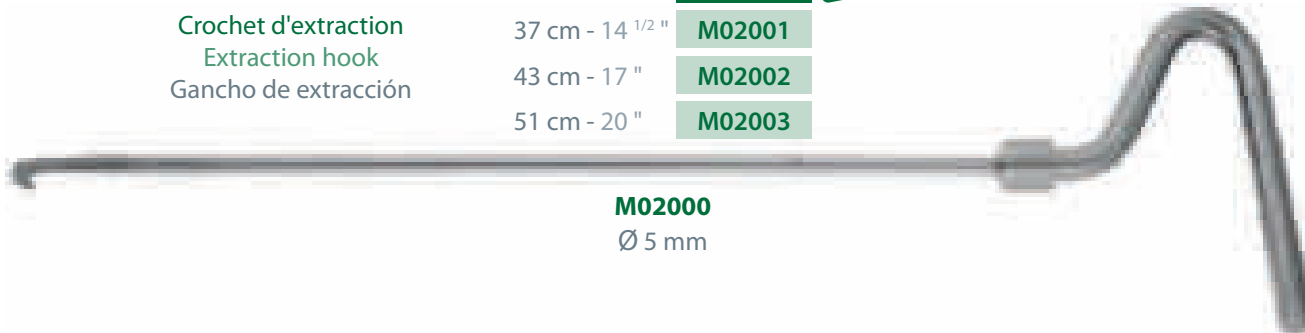

**M02000**  
Ø 5 mm

Arrache clou à masse coulissante avec 2 crochets  
Nail extractor with 2 hooks - sliding Mallet  
Extractor de clavos con 2 ganchos

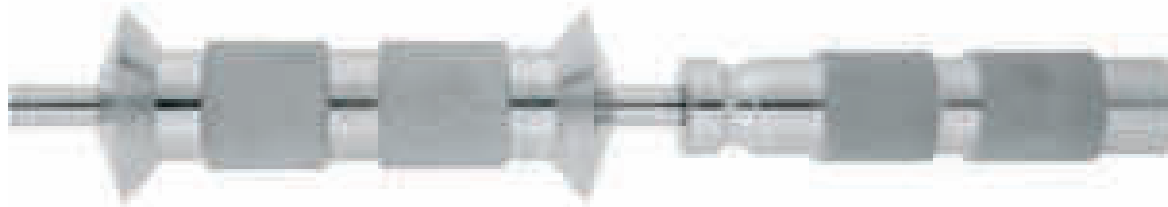

**M02010**  
63 cm - 24 3/4 "

Crochets seuls - Hooks only - Ganchos solo

Petit - Small - Pequeño

Grand - Large - Largo



**M02020**  
9 cm - 3 1/2 "

**M02021**  
9 cm - 3 1/2 "

Alésoirs  
Reamers  
Brocas

- Ø 6,4 mm **M00300** 
- Ø 4,8 mm **M00301**
- Ø 3,2 mm **M00302**
- Ø 2,4 mm **M00303**

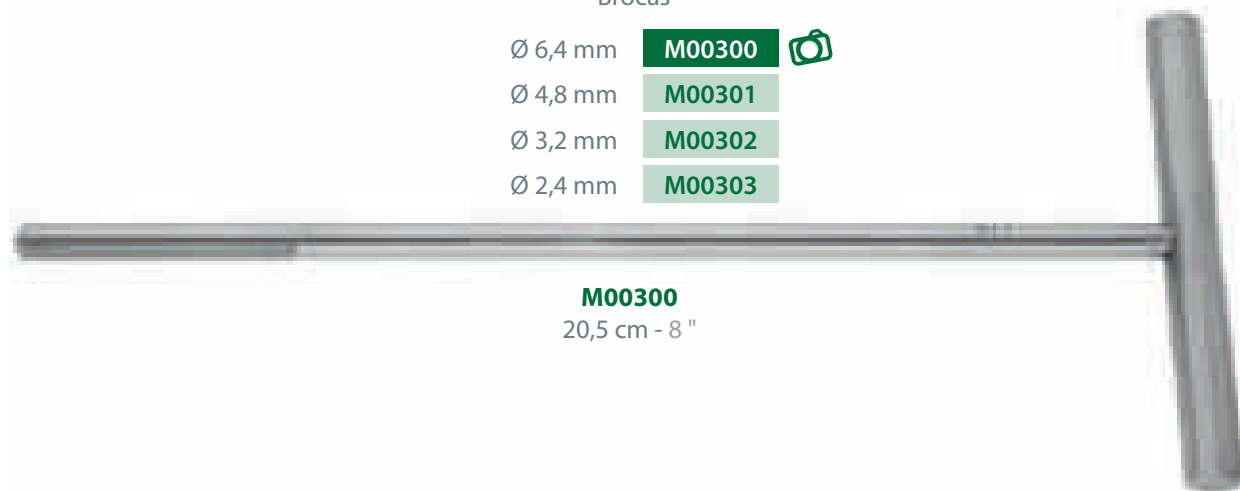

**M00300**  
20,5 cm - 8 "

Guide et extracteur  
Driver and extractor  
Conductor y extractor

- 6,4 x 18 mm **M03210** 
- 4,8 x 14 mm **M03211**
- 3,2 x 10 mm **M03212**
- 2,4 x 8 mm **M03213**



**M03210**  
19 cm - 7 1/2 "



6,4 x 18 mm

Fer à cintrer les clous de RUSH et clous à palette  
Plate bender for RUSH nails and palet nails  
Llave para doblar clavos de RUSH y clavos paleta



6,5 mm

**M01000**  
20,5 cm - 8 "

Ø 3,4 mm / Ø 2,7 mm

5,0 mm

Pousse clou  
Nail inserter  
Impactor

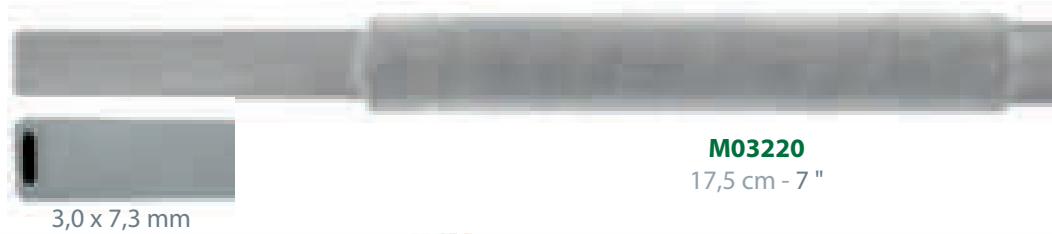

**M03220**  
17,5 cm - 7 "

3,0 x 7,3 mm

Guide clou  
Impactor guide  
Mango impactor - conductor

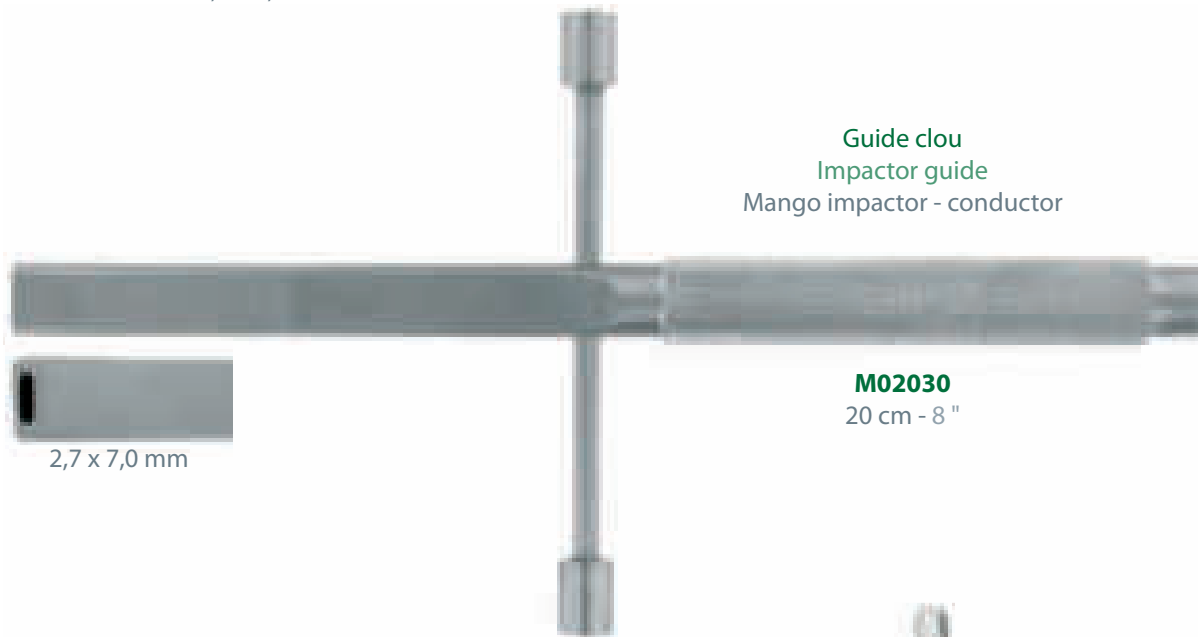

**M02030**  
20 cm - 8 "

2,7 x 7,0 mm

Impacteur extracteur  
Impactor extractor  
Impactor extractor



**M02040**  
19,5 cm - 7 <sup>3</sup>/<sub>4</sub> "

Extracteur  
Extractor hook  
Gancho extractor

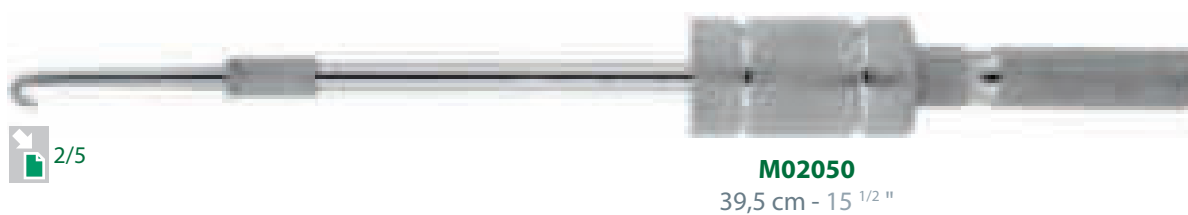

**M02050**  
39,5 cm - 15 <sup>1</sup>/<sub>2</sub> "

2/5

4/5





Impacteur pour clous élastiques (sans mandrin)  
Impactor for gliding nails (without sleeve)  
Impactor para clavos flexible (sin mandril)



Mandrin de centrage  
Centering sleeve  
Mandril para centrar

**M02092**

Pour clous  
For nails  
Para clavos

Ø 1,5 - 2,0 mm    **M02090**

Ø 2,5 - 3,0 mm    **M02091**

Ø 3,5 - 5,0 mm    **M02092**

Pince extractrice  
Extraction forceps  
Pinza de extracción



**M03050**  
22 cm - 8 <sup>3</sup>/<sub>4</sub> "

Impacteur de clous  
Nails impactor  
Impactor de clavos

Ø 3,0 mm



**M02071**  
15,5 cm - 6 "

Pour clous  
For nails  
Para clavos

Ø 1,5 - 2,5 mm

**M02070**

Ø 2,5 - 3,0 mm

**M02071**



Ø 3,5 - 5,0 mm

**M02072**

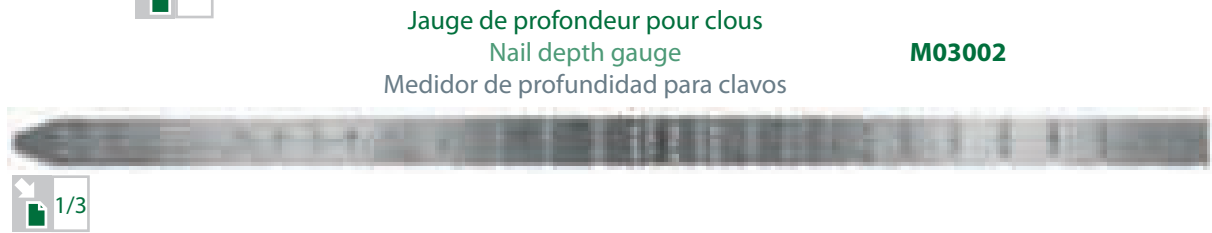

			Ø 2,7 mm  <b>M00382</b> AO
			Ø 3,2 mm <b>M00411</b> AO
	Ø 3,5 mm <b>M00400</b>		Ø 3,5 mm <b>M00381</b> AO
	Ø 4,5 mm <b>M00390</b>		Ø 4,5 mm <b>M00410</b> AO
	Ø 7,0 mm  <b>M00391</b>		Ø 5,0 mm  <b>M00383</b> 

<p>Mandrin perforé Cannulated chuck Mandrill canulado</p> <p><b>M003890</b> 9,5 cm - 3 3/4 "</p> <p>Ø 2,3 mm</p>	<p><b>M004001</b> 16 cm - 6 1/4 "</p> <p>Ø 3,5 mm</p>	<p>Taraud perforé Cannulated tap Terraaja canulado</p> <p><b>M00391</b> 21,5 cm - 8 1/2 "</p> <p>Ø 7,0 mm</p>	<p>Foret perforé Drill cannulated Broca canulada</p> <p><b>M00382</b> 16 cm - 6 1/4 "</p> <p>Ø 2,7 mm</p>	<p><b>M00383</b> 16 cm - 6 1/4 "</p> <p>Ø 5,0 mm</p>
--	---	---	---	--

XIV - Traumatologie  
XIV - Traumatology  
XIV - Traumatología

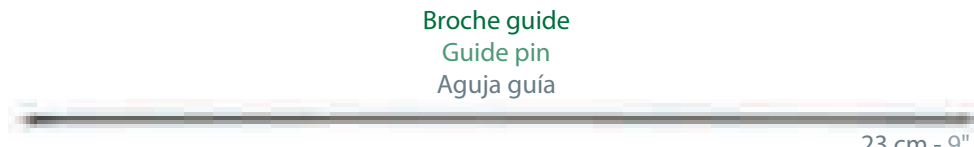

Broche Pin Aguja		Pour vis For screw Para tornillo
Ø 1,0 mm	<b>M03355</b>	Ø 3,5 mm
Ø 1,6 mm	<b>M03356</b>	Ø 4,5 mm
Ø 2,0 mm	<b>M03357</b>	Ø 7,0 mm



### Tournevis pour vis perforées - Screw driver for cannulated screw - Atornillador para tornillos canulados



Pour vis Ø 3,5 mm  
For screw Ø 3,5 mm  
Para tornillos Ø 3,5 mm

2,5 mm  
Ø 1,3 mm

**M01080**

19,5 cm - 7<sup>3/4</sup> "



Pour vis Ø 4,5 mm  
For screw Ø 4,5 mm  
Para tornillos Ø 4,5 mm

3,5 mm  
Ø 1,8 mm

**M01070**

**M01070**

22 cm - 8<sup>3/4</sup> "



Pour vis Ø 7,0 mm  
For screw Ø 7,0 mm  
Para tornillos Ø 7,0 mm

3,5 mm  
Ø 2,2 mm

**M01060**

### Jauge de longueur directe - Direct length gauge - Medidor de largo directo



Pour vis  
For screw  
Para tornillos

**M03010**

23 cm - 9 "

Ø 7,0 mm **M03010** 230 mm

Ø 4,5 mm **M03011** 230 mm

Ø 3,5 mm **M03012** 210 mm

### Tige de nettoyage - Canal cleaner - Hilo para limpiar

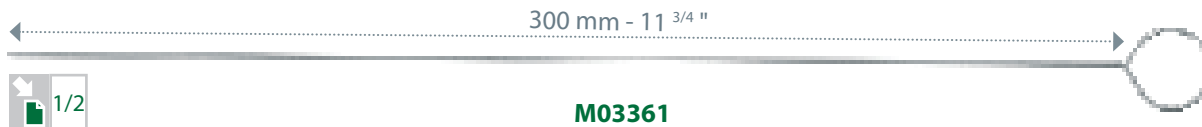

1/2

**M03361**

Ø 2,0 mm 300 mm

**M03360**

Ø 1,6 mm 300 mm

**M03361**

Ø 1,2 mm 300 mm

**M03362**

Pour agrafes épiphysaires - For epiphyseal staples - Para grapas para epifisis

Extracteur à agrafes  
Staples extractor  
Extractor de grapas



**M02100**  
20,5 cm - 8 "

Impacteur à agrafes  
Staples inserter  
Impactor de grapas

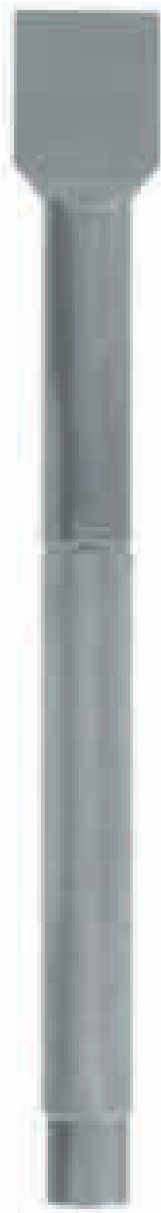

**M02110**  
16 cm - 6 1/4 "

Porte agrafes  
Staples driver  
Porta grapas

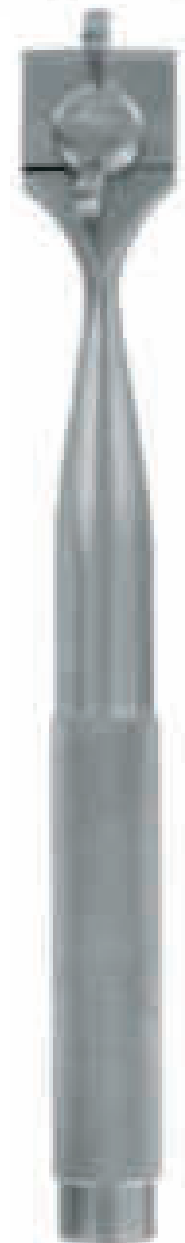

**M02120**  
16 cm - 6 1/4 "

Impacteur  
Impactor  
Impactor

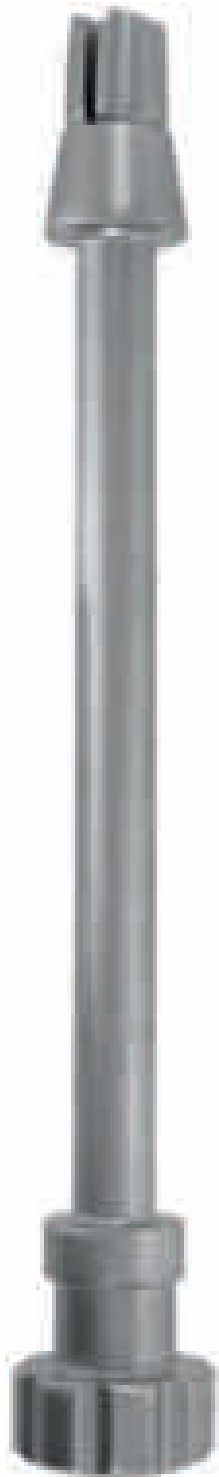

**M02122**  
24,5 cm - 9 <sup>3</sup>/<sub>4</sub> "

Impacteur pour agrafes épiphysaires  
Impactor for epiphyseal staples  
Impactor para grapas para epifisis

**M02124**  
16,5 cm - 6 <sup>1</sup>/<sub>2</sub> "

Impacteur pour agrafes décalées  
Impactor for stepped staples  
Impactor para grapas escalonadas

**M02126**  
16,5 cm - 6 <sup>1</sup>/<sub>2</sub> "



**M02124**  
16,5 cm - 6 <sup>1</sup>/<sub>2</sub> "



### TENDEUR DE FILS - WIRE TIGHTENER - TENSOR DE ALAMBRE

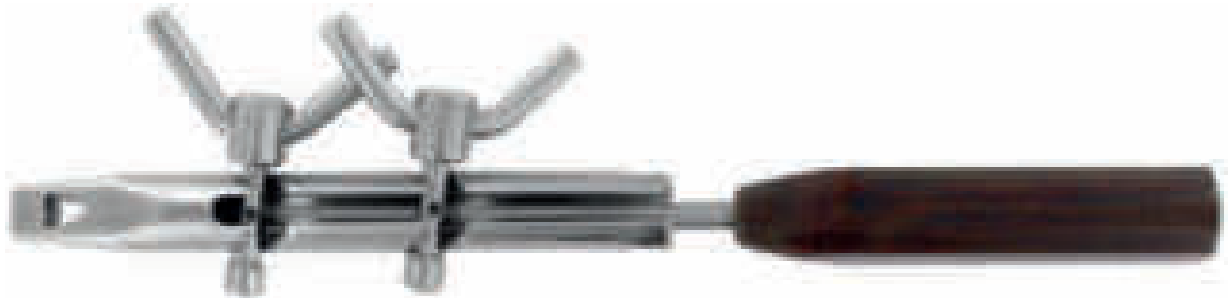

2 x Ø 2,7 mm

**M03700**  
24,5 cm - 9 <sup>3</sup>/<sub>4</sub> "

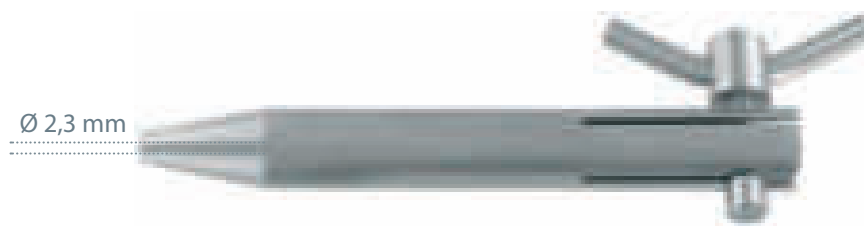

Ø 2,3 mm

**M03710**  
13 cm - 5 <sup>1</sup>/<sub>4</sub> "

### GUIDE FIL - WIRE PASSER - PASAHILOS



Ø 45 mm

**M03745**  
22 cm - 8 <sup>2</sup>/<sub>3</sub> "



Ø 70 mm

**M03770**  
23,5 cm - 9 <sup>1</sup>/<sub>4</sub> "

**Marteau à réflexes - Percussion hammers - Martillos a reflejos**

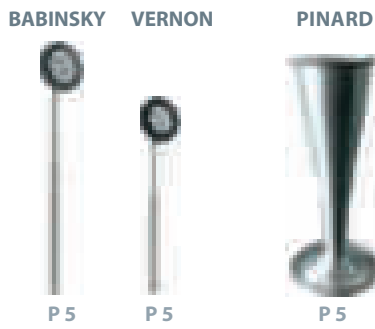

**Abaisse langue - Tongue depressor - Depresor lingual**

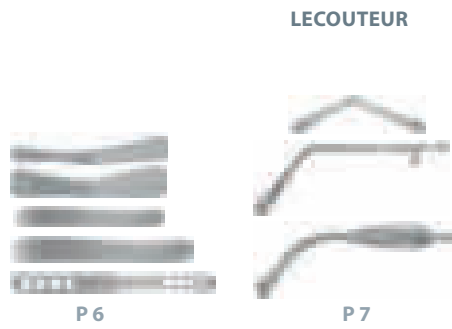

**Miroir laryngien - Laryngeal mirror - Espejo laringeo**

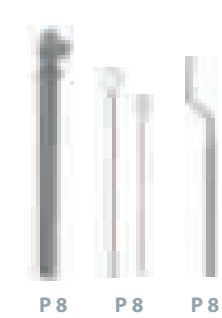

**Instrumentation de service - Instrumentation for services - Instrumentación de servicio**

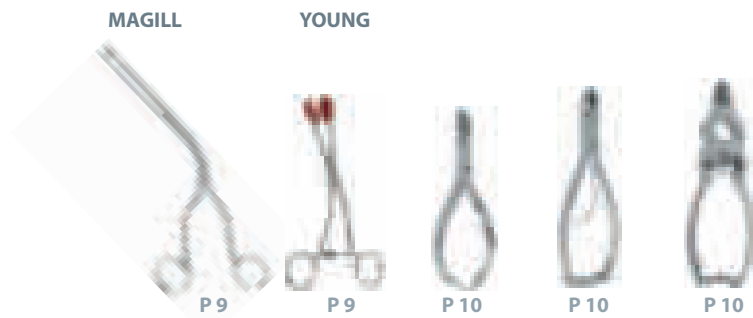

**Scie coupe-bague - Saw to cut the ring - Sierra para cortar los anillos**

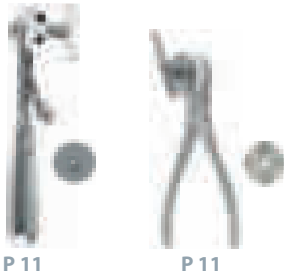

**Stylets - Probes - Estiletos**



**Sondes cannelées - Fluted directors - Sondas acanaladas**

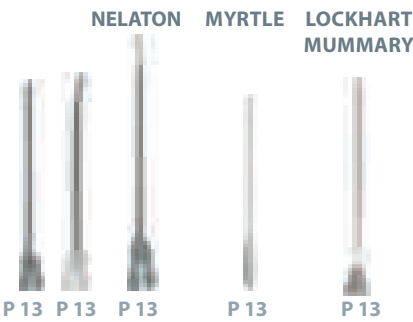

**Porte-coton - Cotton holder - Porta algodón**

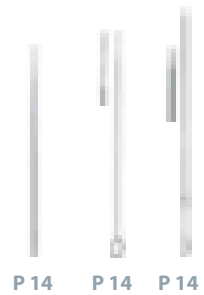

**Instrumentation de service - Instrumentation for services - Instrumentación de servicio**



**Instrumentation de service - Instrumentation for services - Instrumentación de servicio**

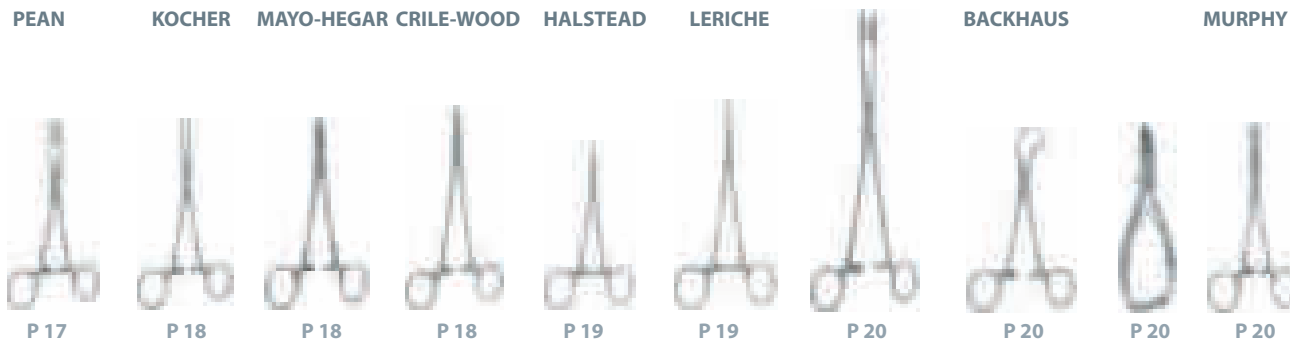

**Pinces diverses - Miscellaneous forceps - Pinzas diversas**

SEUTIN

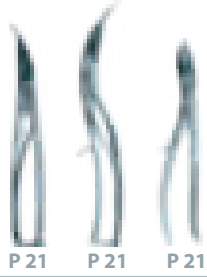

P 21 P 21 P 21

**Ciseaux pour plâtre - Plaster scissors - Tijeras para escayolas**

BRUNS SEUTIN

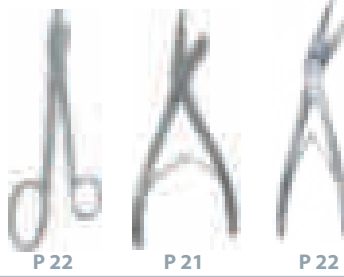

P 22 P 21 P 22

**Pinces pour plâtres - Plaster forceps - Pinza para escayolas**

STILLE WOLF USA MODEL



P 23 P 23 P 23

**Pinces pour plâtres - Plaster forceps - Pinzas para escayolas**

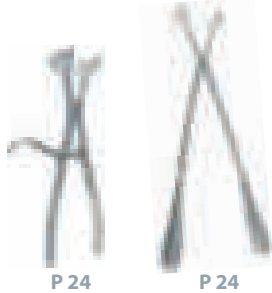

P 24 P 24

**Attelles malléables - Malleable splints - Tablillas maleables**

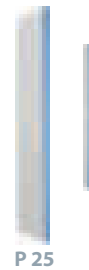

P 25

**Canules - Cannulas - Cánulas**

SANTY YANKAUER NUBOER ANDREW PYNCHON AUBERT POOLE

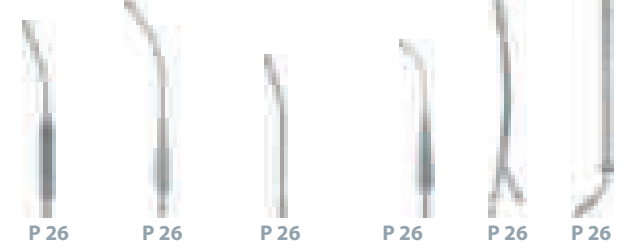

P 26 P 26 P 26 P 26 P 26 P 26

**Canules - Cannulas - Cánulas Trocarts - Trocars - Trocares**

HÉPARINE LUER LOCK MONOD BORDIER-MEUNIER STANDARD NELSON UNIVERSAL LANDAU PEAN

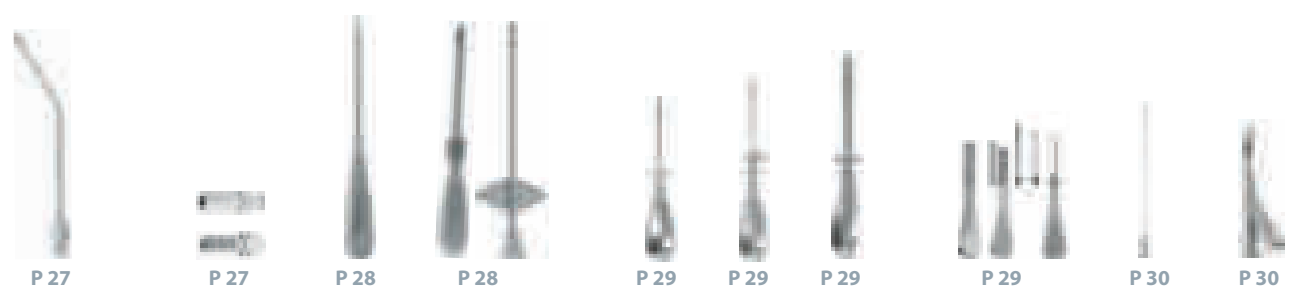

P 27 P 27 P 28 P 28 P 29 P 29 P 29 P 29 P 30 P 30

**Trocarts - Trocars - Trocares**

BUELAU KRAUSE LICHTWITZ

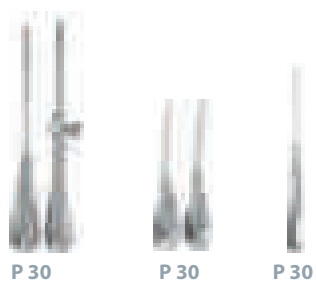

P 30 P 30 P 30

**Matériels divers - Miscellaneous materials - Materiales varios**

ESMARCH LORTAT-JACOB CHEATLE MAYO GUYON-FREUDENBERG



P 31 P 31 P 32 P 32 P 32

**Matériels divers - Miscellaneous materials - Materiales varios**



P 33 P 33 P 33 P 33

**Gomme  
Rubber  
Goma**

## Instruments pour plâtres - Plaster instruments - Instrumentos para escayolas

III - Ciseaux  
III - Scissors  
III - Tijeras

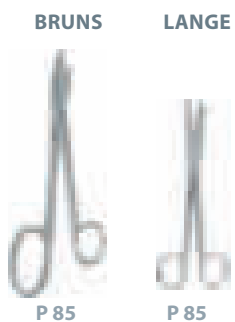

## O.R.L. canules aspiratrices - E.N.T. suction tubes - O.R.L. canulas aspirantes

XII - O.R.L.  
XII - E.N.T.  
XII - O.R.L.

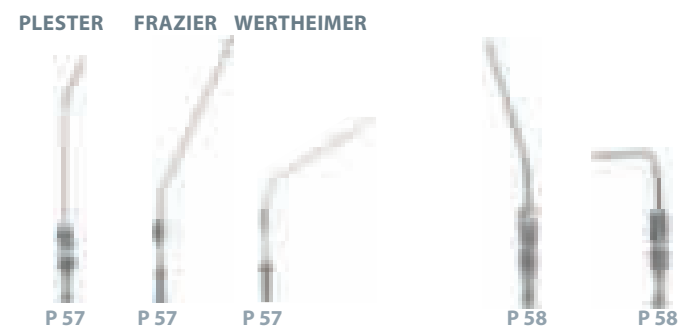



## BABINSKY



Caoutchouc pour Babinsky  
Rubber for Babinsky  
Caucho para Babinsky



**A05020**

**A05010**  
23 cm - 9"

## VERNON

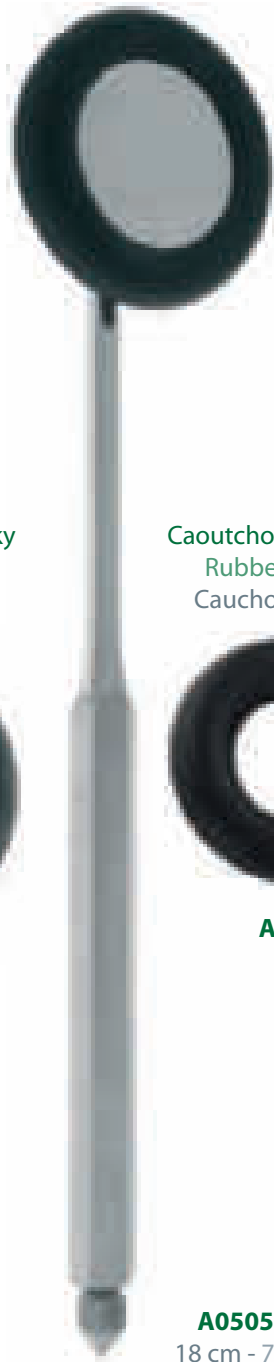

Caoutchouc pour Vernon  
Rubber for Vernon  
Caucho para Vernon



**A05060**

**A05050**  
18 cm - 7 1/4"

## PINARD

STÉTHOSCOPE  
STETHOSCOPI  
ESTETOSCOPIO



Aluminium  
Aluminum  
Aluminio



**A15160**  
15 cm - 6"

# LANDANGER

## Abaisse langue - Tongue depressor - Depresor lingual

Coudé pour enfants  
Angled for children  
Acodado para niños



Coudé pour adultes  
Angled for adults  
Acodado para adultos



### MAYO

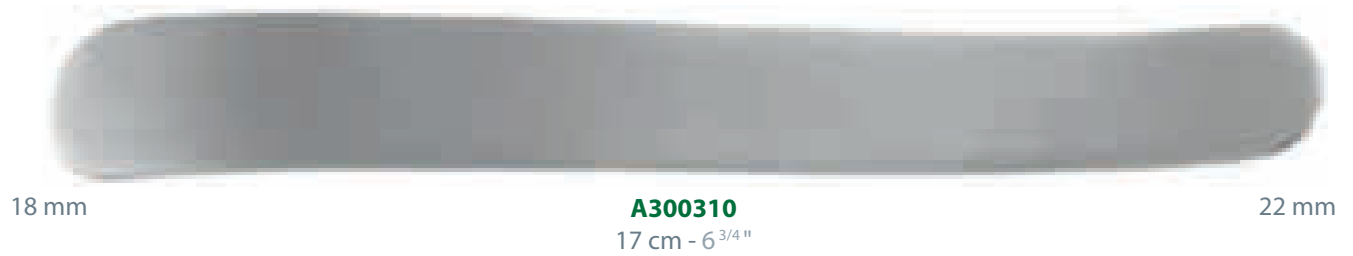

### BRUENINGS

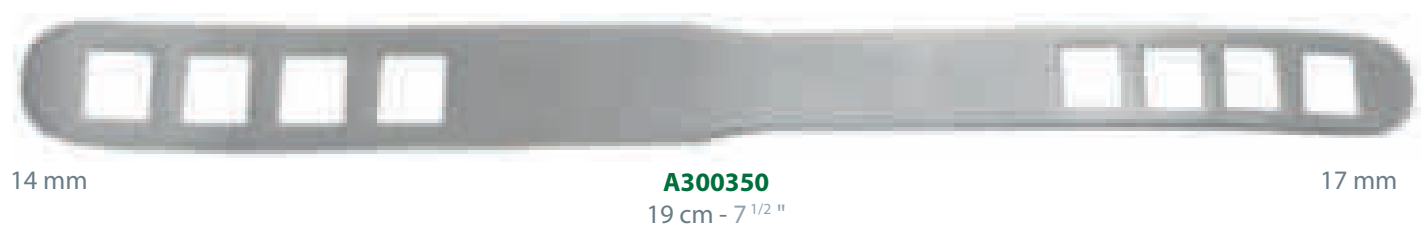

### LECOUTEUR



### LE MEE





## Miroir laryngien - Laryngeal mirror - Espejo laríngeo



Acier chromé  
Chrome steel  
Acero cromado



	Ø 6 mm	J231360
	Ø 8 mm	J231362
	Ø 10 mm	J231364
A25003	Ø 12 mm	J231366
A25004	Ø 14 mm	
<b>A25005</b>	Ø 16 mm	
A25006	Ø 18 mm	
A25007	Ø 20 mm	
A25008	Ø 22 mm	
A25009	Ø 24 mm	
A25010	Ø 26 mm	



Acier chromé  
Chrome steel  
Acero cromado



Ø 2,4 mm

**A25005**

13,5 cm - 5 1/4 "

**A25020**

11 cm - 4 1/4 "

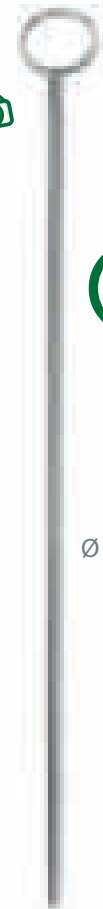

Ø 2,1 mm

**J231364**

12 cm - 4 3/4 "

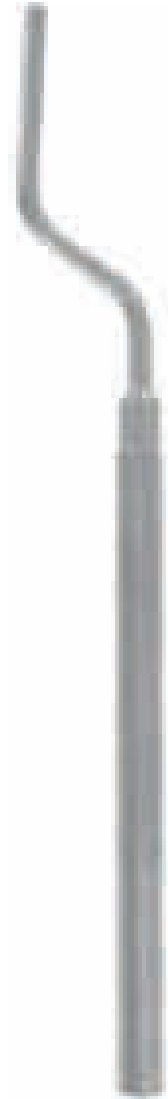

**J231370**

14,5 cm - 5 3/4 "

## MAGILL

PINCES À SONDES  
CATHETER FORCEPS  
PINZAS PARA SONDAS

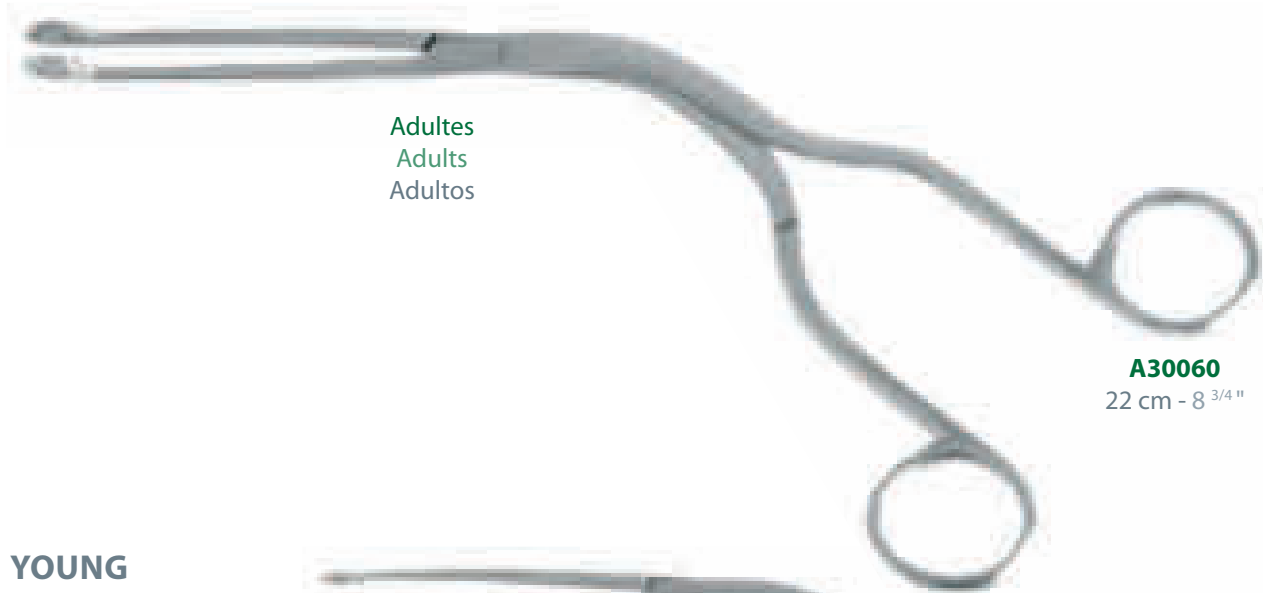

Adultes  
Adults  
Adultos

**A30060**  
22 cm - 8 3/4 "

## YOUNG

PINCE TIRE-LANGUE  
TONGUE HOLDING FORCEPS  
PINZA PARA TIRAR LA LENGUA

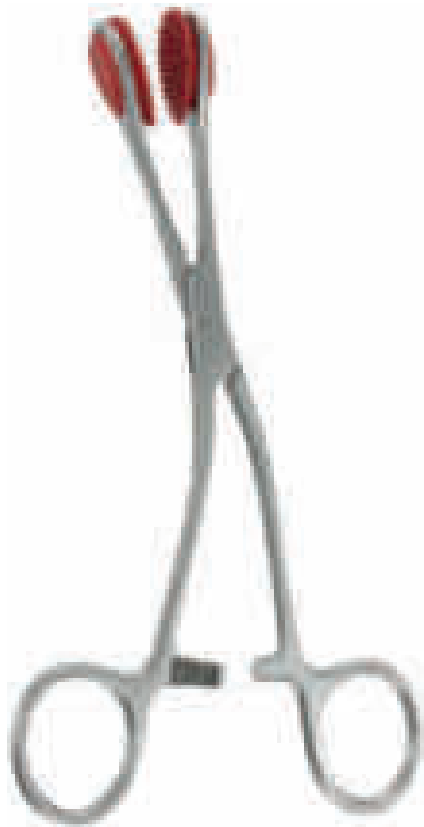

**A30090**  
16,5 cm - 6 1/4 "

Enfants  
Children  
Niños



**A30070**  
17 cm - 6 3/4 "

Nourrissons  
Babies  
Niños de pecho



**A30075**  
15 cm - 6 "

Mors caoutchouc (paire)  
Rubber jaws (pair)  
Bocas de goma (par)

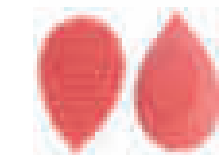

**A30095**  
(pour/for/para A30090)

PINCES À ONGLES - NAIL CUTTERS - PINZAS PARA UÑAS

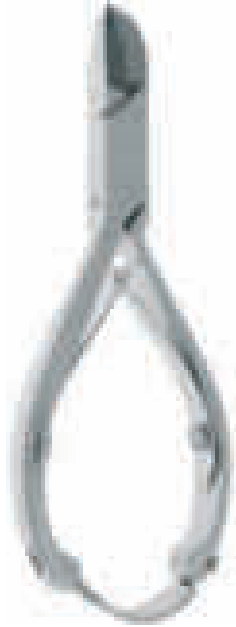

**A86010**  
11 cm - 4 1/4 "



**A86020**  
13 cm - 5 "



**A86060**  
14 cm - 5 1/2 "

Oblique  
Oblique  
Oblicuo

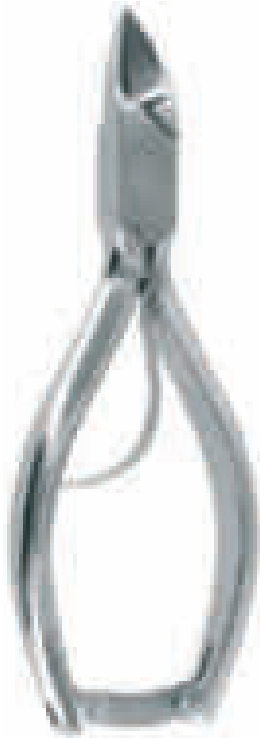

**A860300**  
13 cm - 5 "



**A85030**  
14 cm - 5 1/2 "



**A85040**  
15 cm - 6 "

# LANDANGER

Scie coupe-bague - Saw to cut the ring - Sierra para cortar los anillos



! Acier chromé  
Chrome steel  
Acero cromado

Pour or et argent  
For gold and silver  
Para oro y plata

**A85160**  
18,5 cm - 7 1/4 "

Avec une lame **A85170**  
With one blade **A85170**  
Con una hoja **A85170**



Ø 30 mm **A85170**  
(pour/for/para A85160)



**A851800**  
15 cm - 6 "

Avec une lame **A851810**  
With one blade **A851810**  
Con una hoja **A851810**

Pour or et argent Pour acier  
For gold and silver For steel  
Para oro y plata Para acero

Ø 30 mm  **A851810** **A851820**  
(pour/for/para A851800)



## Stylets - Probes - Estiletos

WATSON  
CHEYNE

FISH

Ø 1,5 mm

Ø 2 mm

Double  
Double  
Doble

Simple  
Simple  
Simple

Cannelé  
Fluted  
Acanalado

Aiguillé  
With eye  
Agujada

Ø 2 mm

Ø 2 mm

Ø 2 mm

Ø 2 mm

Ø 1,0 mm

14 cm - 5 1/2 "

A800110

Ø 1,5 mm

13 cm - 5 1/4 "

A800151

14 cm - 5 1/2 "

A800152

16 cm - 6 1/4 "

A800153

18 cm - 7 "

A800154

20 cm - 8 "

A800155

Ø 2,0 mm

14 cm - 5 1/2 "

A80020



16 cm - 6 1/4 "

A800201

18 cm - 7 "

A800202

20 cm - 8 "

A800203

25 cm - 9 3/4 "

A800204

Ø 2 mm

Ø 2 mm

2 mm

5 mm

3.7 mm

A80020

A80010

A80030

A80040

A800410

A800420

14 cm - 5 1/2 "

14 cm - 5 1/2 "

14 cm - 5 1/2 "

14 cm - 5 1/2 "

18 cm - 7 "

18 cm - 7 "

# LANDANGER

Sondes cannelées - Fluted directors - Sondas acanaladas

LOCKHART  
MUMMARY

- 12 cm - 4 3/4 " **A80070**
- 14 cm - 5 1/2 " **A80080** 
- 16 cm - 6 1/4 " **A80090**
- 20 cm - 8 " **A800910**

NELATON

MYRTLE

Courbe  
Curved  
Curva

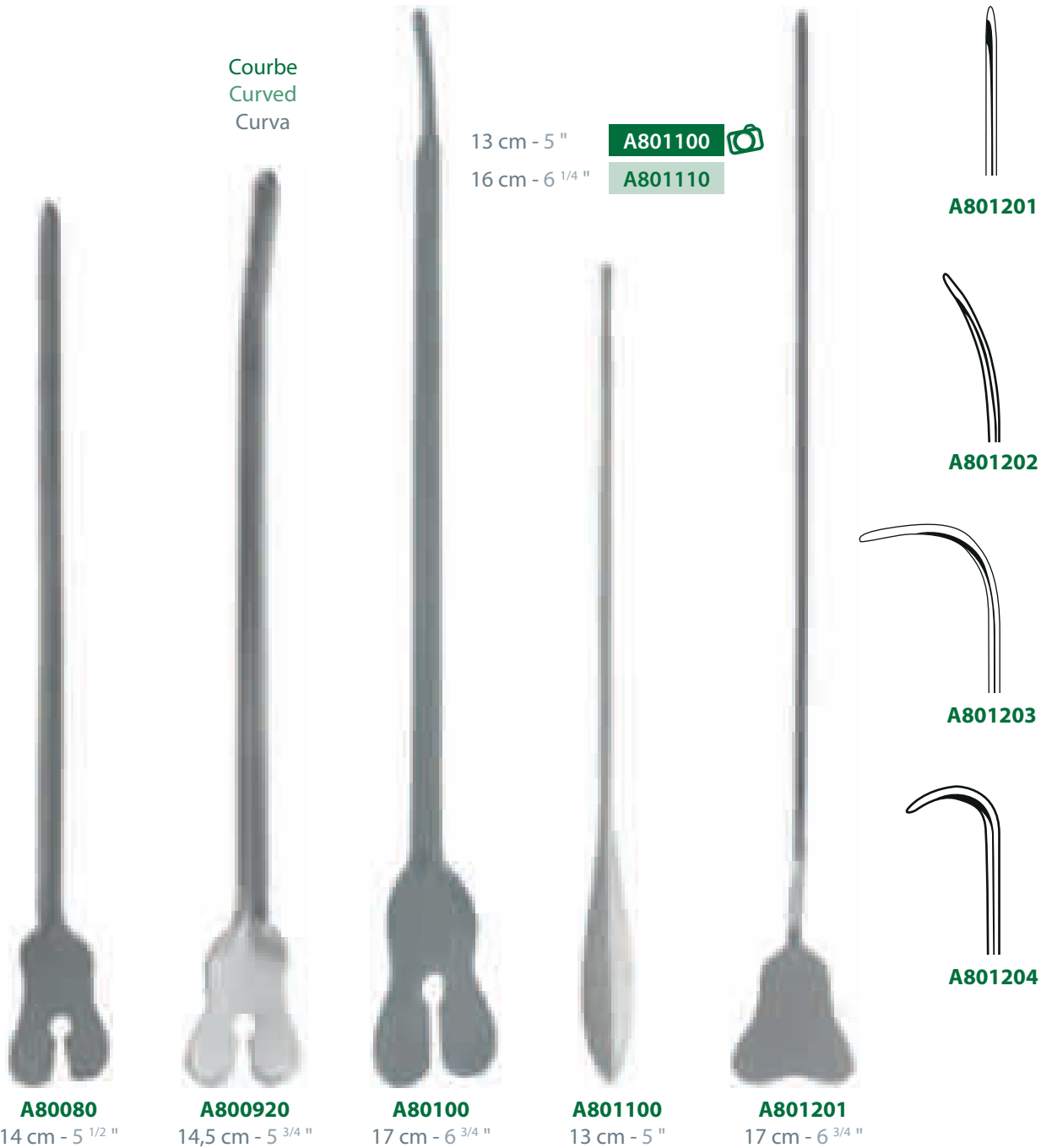

**A80080**  
14 cm - 5 1/2 "

**A800920**  
14,5 cm - 5 3/4 "

**A80100**  
17 cm - 6 3/4 "

**A801100**  
13 cm - 5 "

**A801201**  
17 cm - 6 3/4 "

**A801201**

**A801202**

**A801203**

**A801204**



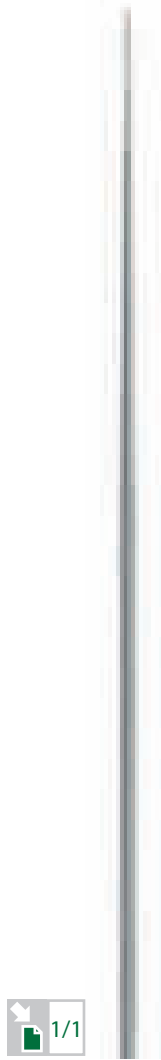

**A80050**  
14 cm - 5 1/2 "

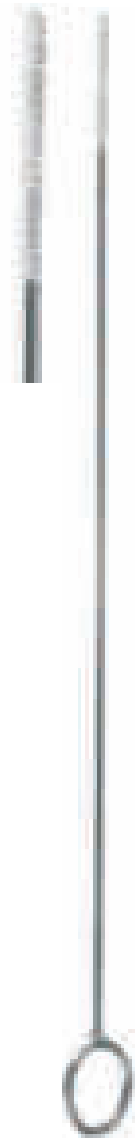

**A80150**  
30 cm - 11 "

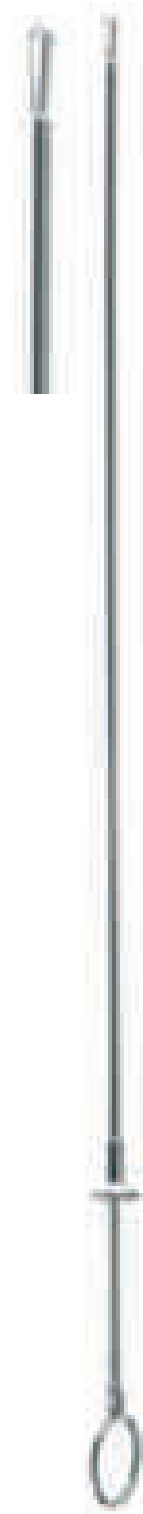

**A80140**  
40 cm - 15 3/4 "



# LANDANGER

Instrumentation de service - Instrumentation for services - Instrumentación de servicio



## LISTER

14 cm - 5 1/2 " **B890375**

18 cm - 7 " **B89038** 

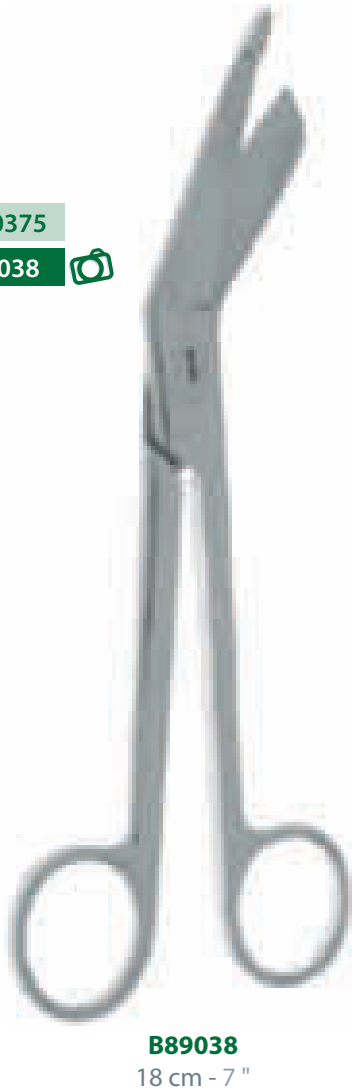

## CISEAUX À ONGLES

NAIL SCISSORS  
TIJERAS PARA UÑAS

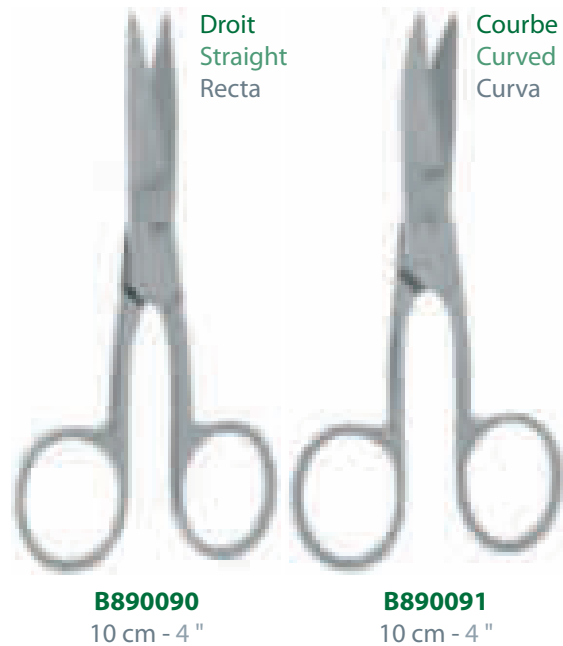



CISEAUX MOUSSES  
BLUNT SCISSORS  
TIJERAS ROMAS

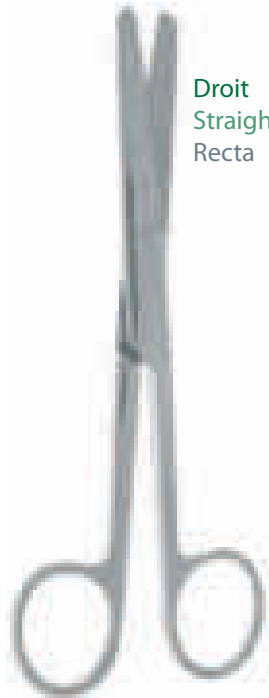

Droit  
Straight  
Recta

**B89010**  
14 cm - 5 1/2 "

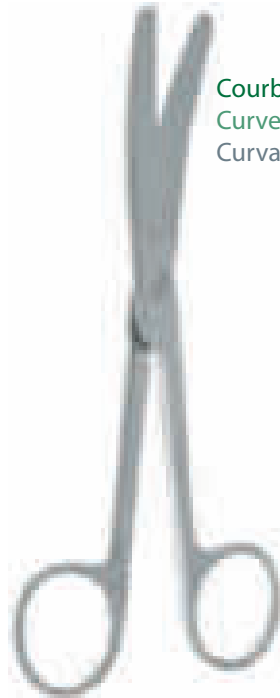

Courbe  
Curved  
Curva

**B89015**  
14 cm - 5 1/2 "

CISEAUX DAUPHIN - POINTU/MOUSSE  
SHARP/BLUNT SCISSORS  
TIJERAS AGUDAS/ROMAS



Droit  
Straight  
Recta

**B89020**  
14 cm - 5 1/2 "

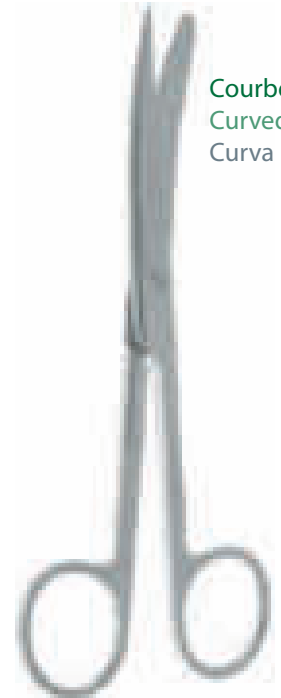

Courbe  
Curved  
Curva

**B89025**  
14 cm - 5 1/2 "

MAYO

CISEAUX POINTUS  
SHARP SCISSORS  
TIJERAS AGUDAS

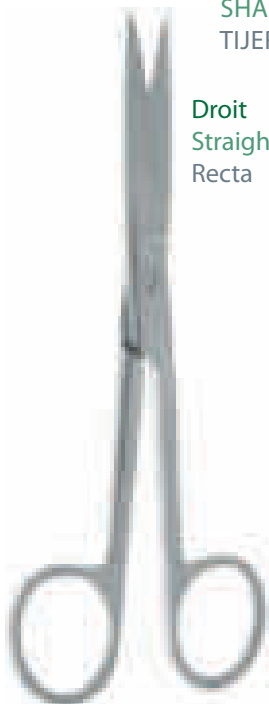

Droit  
Straight  
Recta

**B89030**  
14 cm - 5 1/2 "



Courbe  
Curved  
Curva

**B89035**  
14 cm - 5 1/2 "



Droit  
Straight  
Recta

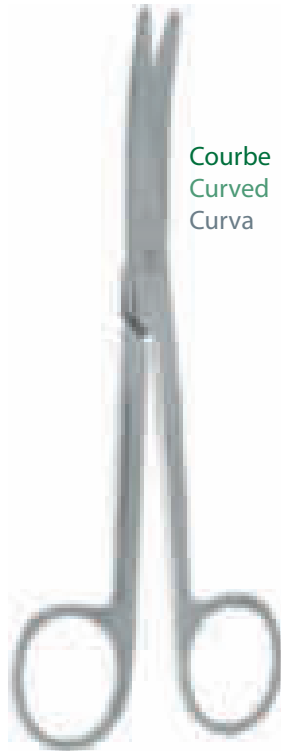

**B89036**  
15 cm - 6 "



Courbe  
Curved  
Curva



**B89037**  
15 cm - 6 "

## METZENBAUM

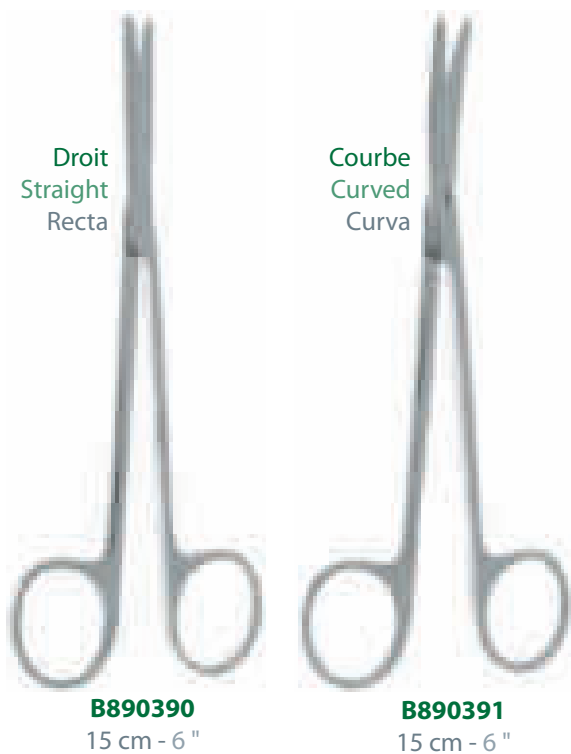
 <b>B890390</b> 15 cm - 6 "	<b>B890391</b> 
<b>B890392</b> 18 cm - 7 "	<b>B890393</b>



## PINCE À DISSECTION DISSECTION FORCEPS PINZAS PARA DISECCIÓN

 <b>B89040</b> 14 cm - 5 1/2 "	<b>B89045</b> 
<b>B89050</b> 16 cm - 6 1/4 "	<b>B89055</b>

Fine - Fine - Aguda

<b>B890460</b> 14 cm - 5 1/2 "	<b>B890461</b>
--------------------------------	----------------



## ADSON

**A griffes**  
With teeth  
Con dientes

**Sans griffes**  
Without teeth  
Sin dientes



## PEAN



## KOCHER

Droite  
Straight  
Recta

Courbe  
Curved  
Curva



## PORTE-AIGUILLE - NEEDLE HOLDER - PORTA AGUJAS

### MAYO-HEGAR

### CRILE-WOOD



## HALSTEAD

PINCE DROITE  
STRAIGHT FORCEPS  
PINZA RECTA



A griffes  
With teeth  
Con dientes

**B89140**

12 cm - 4 3/4 "



Sans griffes  
Without teeth  
Sin dientes

**B89130**

12 cm - 4 3/4 "



A griffes  
With teeth  
Con dientes

**B89120**

12 cm - 4 3/4 "



Sans griffes  
Without teeth  
Sin dientes

**B89110**

12 cm - 4 3/4 "



## LERICHE

PINCE DROITE  
STRAIGHT FORCEPS  
PINZA RECTA

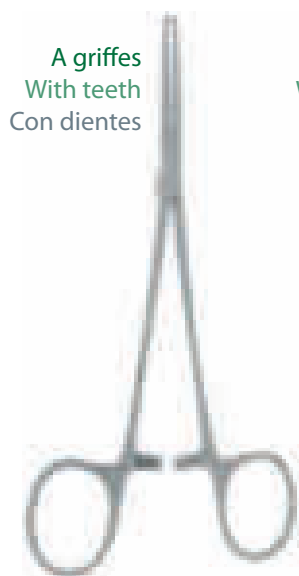

A griffes  
With teeth  
Con dientes

**B89180**

15 cm - 6 "



Sans griffes  
Without teeth  
Sin dientes

**B89170**

15 cm - 6 "

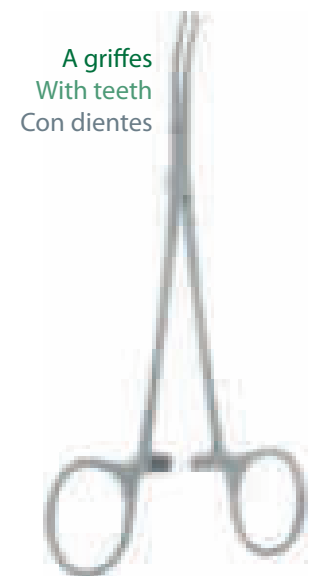

A griffes  
With teeth  
Con dientes

**B89160**

15 cm - 6 "



Sans griffes  
Without teeth  
Sin dientes

**B89150**

15 cm - 6 "



PINCE À PANSEMENT  
DRESSING FORCEPS  
PINZA PARA VENDAJES

Droite  
Straight  
Recta

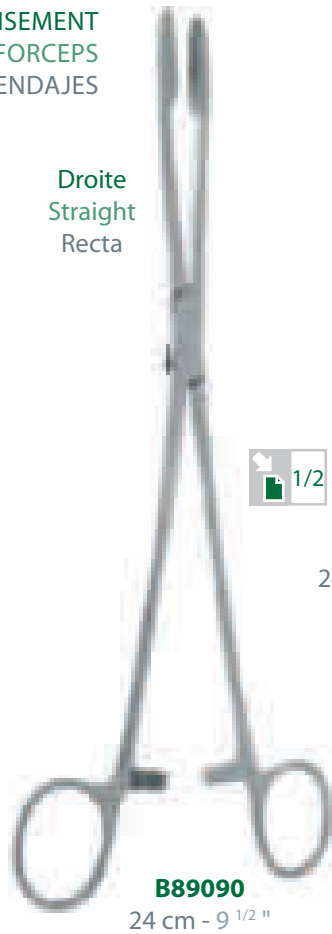

**B89090**  
24 cm - 9 1/2 "

Courbe  
Curved  
Curva



**B89095**  
24 cm - 9 1/2 "

## BACKHAUS

PINCE À CHAMPS  
TOWEL FORCEPS  
PINZA PARA CAMPOS

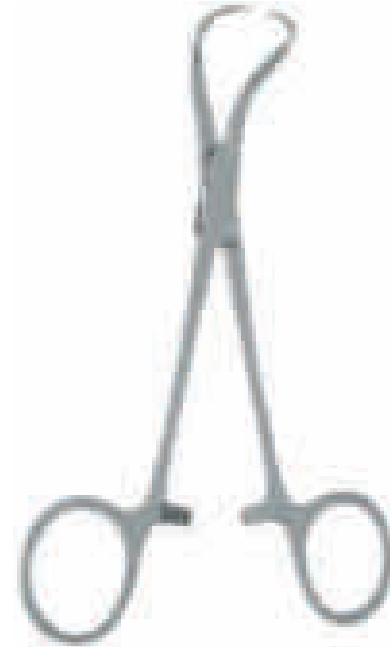

**B89100**  
13 cm - 5 "

PINCE À ONGLES  
NAIL CUTTERS  
PINZA PARA UÑAS

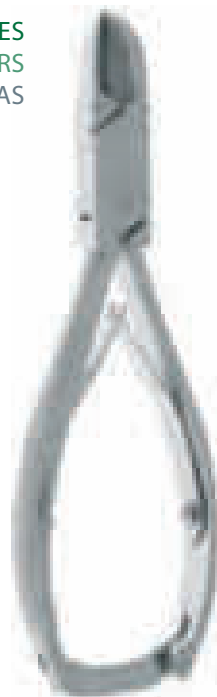

**B891900**  
14 cm - 5 1/2 "

PRESE TUBE  
PINCHOC CLAMPS  
CIERRA TUBOS

14 cm - 5 1/2 "

**B892000**

18 cm - 7 "

**B892010**



**B892000**  
14 cm - 5 1/2 "

### SEUTIN

Droite  
Straight  
Recta



**J76050**  
23 cm - 9"

Double courbure  
Double curvature  
Doble curvatura



**J76060**  
25 cm - 10"



**J76070**  
21 cm - 8 1/4"

## Ciseaux pour plâtres - Plaster scissors - Tijeras para escayolas

Lame dentelée  
Serrated blade  
Hoja serrada

### BRUNS

Lame dentelée  
Serrated blade  
Hoja serrada

 **J76140** 23,5 cm - 9 1/4 " **J761410**

Lame lisse  
Smooth blade  
Hoja lisa

### SEUTIN



**J761450**  
20 cm - 8 "

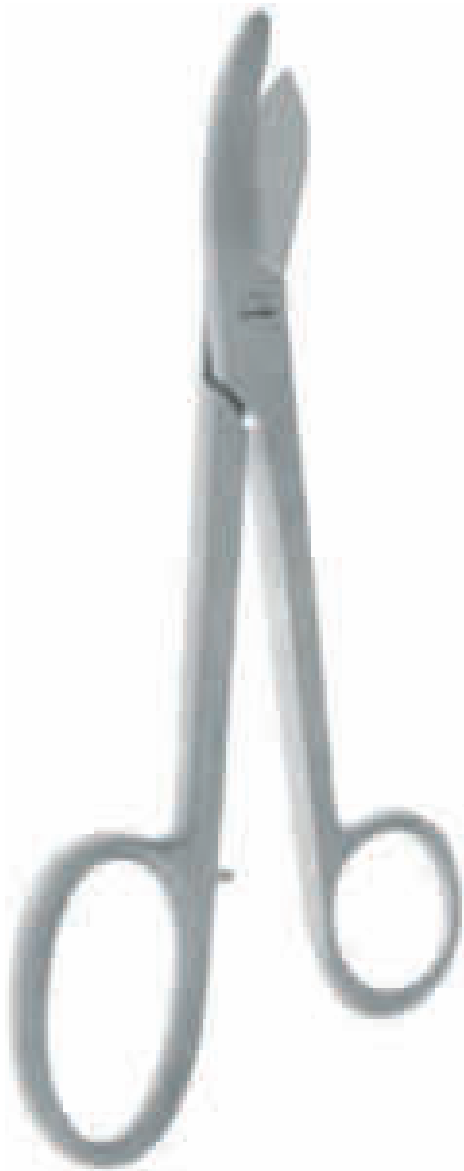

**J76140**  
23,5 cm - 9 1/4 "



**J761500**  
24 cm - 9 1/2 "

# LANDANGER

Pince pour plâtres - Plaster forceps - Pinza para escayolas

## STILLE

- 23 cm - 9 " **J76020** 
- 26 cm - 10 1/4 " **J760250**
- 37 cm - 14 1/2 " **J76030**

Pour couper  
For cutting  
Para cortar

## WOLF

- 18 cm - 7 " **J76128** 
- 24 cm - 9 1/2 " **J76130**

## USA MODEL

Pour couper  
For cutting  
Para cortar



**J76020**  
23 cm - 9 "



**J76128**  
18 cm - 7 "



**J760310**  
23 cm - 9 "





### HENNING

Pour écarter - To spread - Para romper

Sans crémaillère  
Without rack  
Sin cremallera

17 mm **J76080**

54 mm **J76100**

A crémaillère  
With rack  
Con cremallera

17 mm **J76090**

54 mm **J76110** 

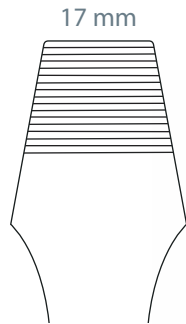

37 mm

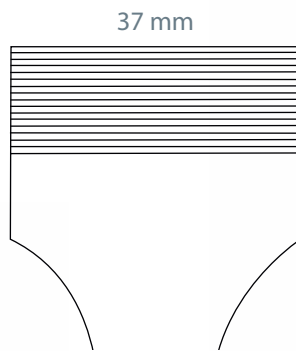

54 mm

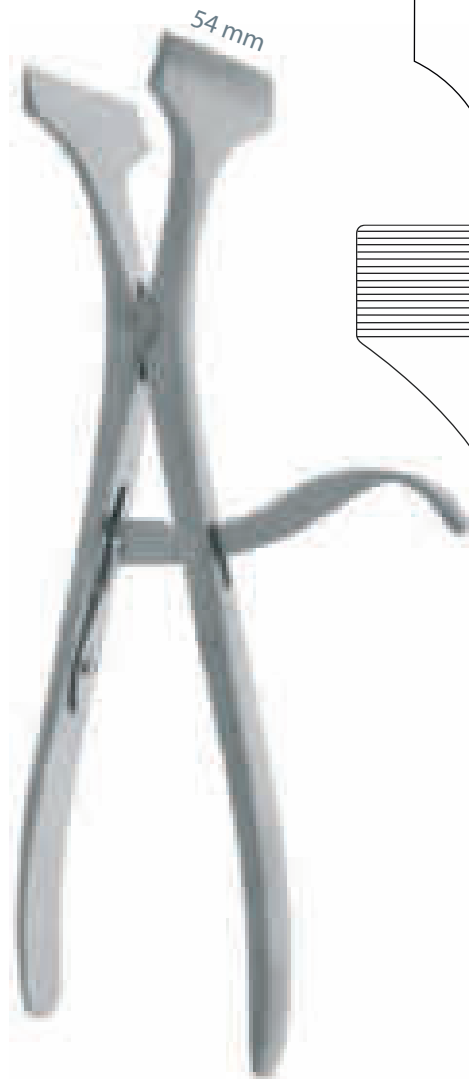
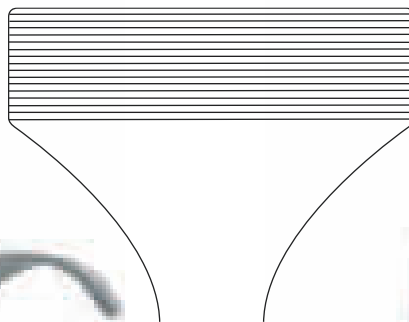

**J76110**  
28 cm - 11 "

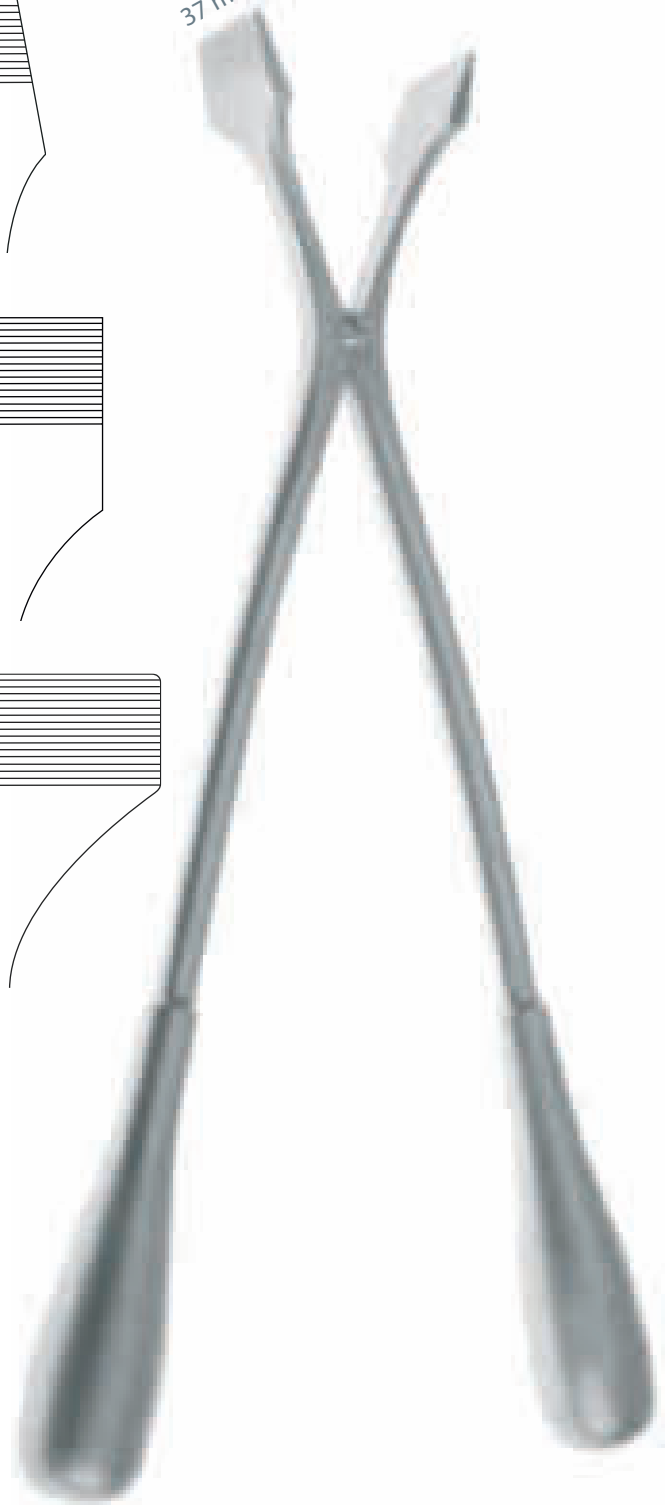

**J76120**  
40 cm - 15 <sup>3</sup>/<sub>4</sub> "

## Atelles malléables - Malleables splints - Tablillas maleables



ATELLES MALLÉABLES ALUMINIUM - GARNIES MOUSSE  
 MALLEABLES SPLINTS ALUMINIUM - FOAM COVERED  
 TABLILLAS MALEABLES DE ALUMINO - ADORNADAS DE ESPUMA

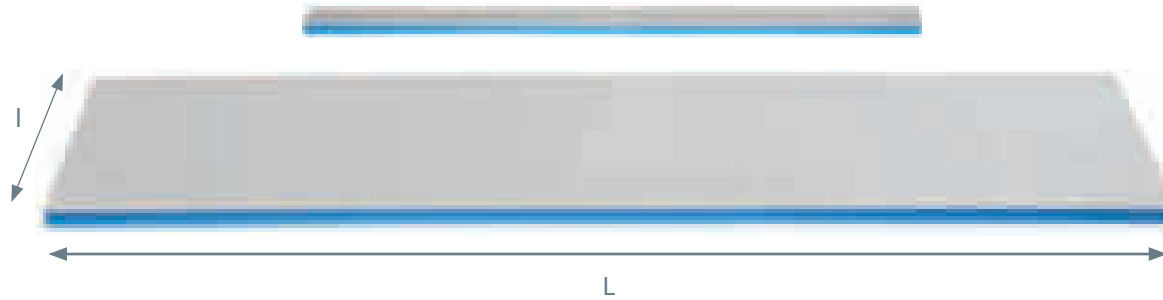

L : 25 cm - l : 15 mm	<b>T90090</b>	
L : 45 cm - l : 20 mm	<b>T90095</b>	
L : 45 cm - l : 25 mm	<b>T90098</b>	
L : 45 cm - l : 30 mm	<b>T90100</b>	
L : 45 cm - l : 40 mm	<b>T90110</b>	
L : 45 cm - l : 50 mm	<b>T90120</b>	
L : 45 cm - l : 60 mm	<b>T90130</b>	
L : 45 cm - l : 70 mm	<b>T90140</b>	
L : 45 cm - l : 80 mm	<b>T90141</b>	
L : 45 cm - l : 90 mm	<b>T90143</b>	
L : 45 cm - l : 100 mm	<b>T90145</b>	

# LANDANGER

## Canules aspiratrices - Suction tubes - Cánulas aspirantes

**SANTY**



**A90015**  
26 cm - 10 <sup>1</sup>/<sub>4</sub> "

Ø 9 x 6 mm

**YANKAUER**



**A90090**  
28 cm - 11 "

Ø 10 x 6 mm

**NUBOER**



**A902000**  
21 cm - 8 <sup>1</sup>/<sub>4</sub> "

Ø 6 mm

**ANDREW PYNCHON**

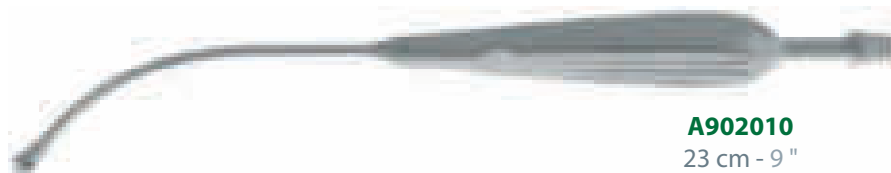

**A902010**  
23 cm - 9 "

Ø 6 x 3,4 mm

**AUBERT  
(FINSTERER)**

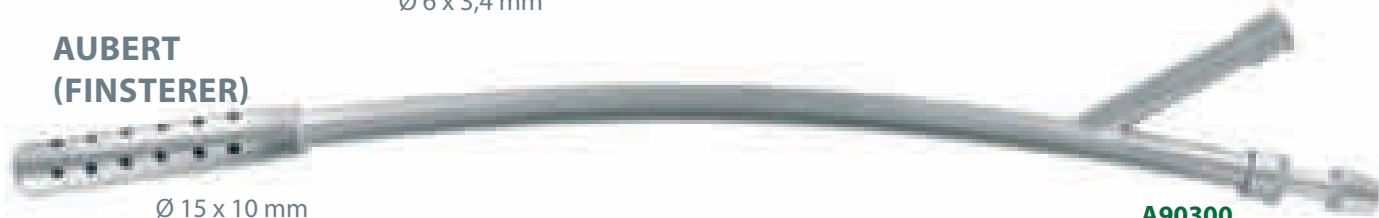

Ø 15 x 10 mm

**A90300**  
30 cm - 12 "

**BABY POOLE**



Ø 6 mm

**A903100**  
20 cm - 8 "

**POOLE**



Ø 8 mm

**A903110**  
22 cm - 8 <sup>3</sup>/<sub>4</sub> "

**POOLE**

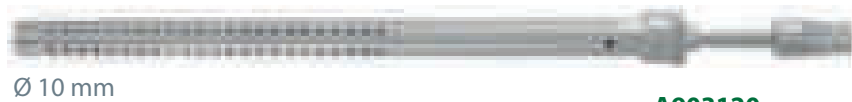

Ø 10 mm

**A903120**  
22 cm - 8 <sup>3</sup>/<sub>4</sub> "

## Canules - Cannulas - Cánulas

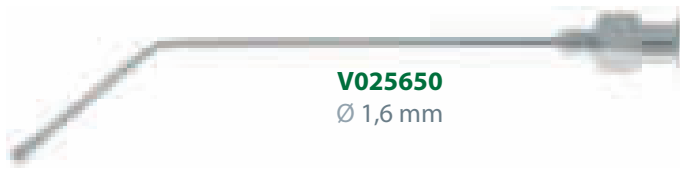

**V025650**  
Ø 1,6 mm

Canule à héparine coudée court n°1  
Heparin cannula short angled n° 1  
Cánula de heparina angulada corta n°1

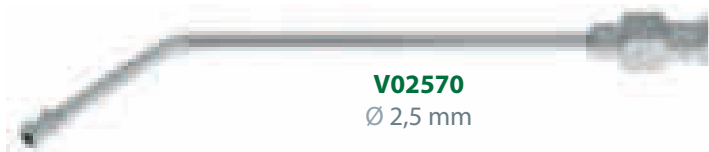

**V02570**  
Ø 2,5 mm

Canule à héparine coudée court n°1  
Heparin cannula short angled n° 1  
Cánula de heparina angulada corta n°1

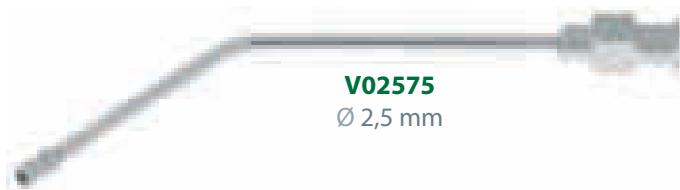

**V02575**  
Ø 2,5 mm

Canule à héparine coudée au milieu n°2  
Heparin cannula angled n° 2  
Cánula de heparina angulada n° 2



**V02580**  
Ø 2,5 mm

Canule à héparine coudée long n°3  
Heparin cannula long angled n°3  
Cánula de heparina angulada larga n° 3

## LUER LOCK

Femelle  
Female  
Hembra



**V028000**

Mâle  
Male  
Macho



**V028001**

Ø 6 mm

### MONOD

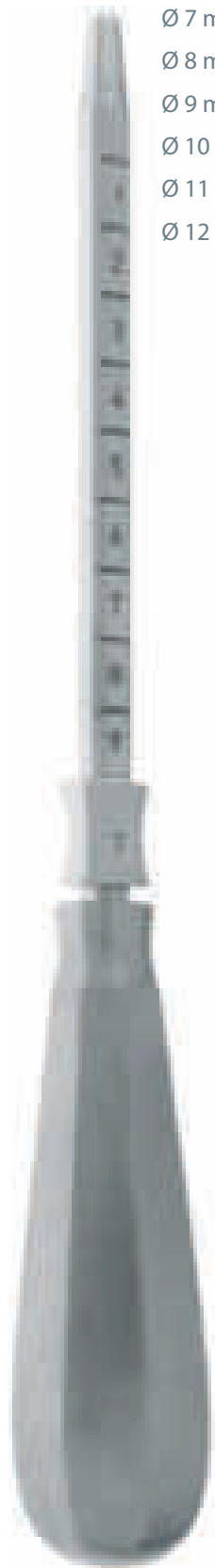

Ø 7 mm	<b>V02610</b> 
Ø 8 mm	<b>V02620</b>
Ø 9 mm	<b>V02630</b>
Ø 10 mm	<b>V02640</b>
Ø 11 mm	<b>V02650</b>
Ø 12 mm	<b>V02660</b>

**V02610**  
22 cm - 8 3/4 "

### BORDIER-MEUNIER

TROCART À BIOPSIE OSSEUSE  
TROCAR IN OSSEOUS BIOPSY  
TROCARE A BIOPSIA ÓSEA



**V036000**  
20 cm - 8 "

22 cm - 8 3/4 "



Acier chromé  
Chrome steel  
Acero cromado

### STANDARD

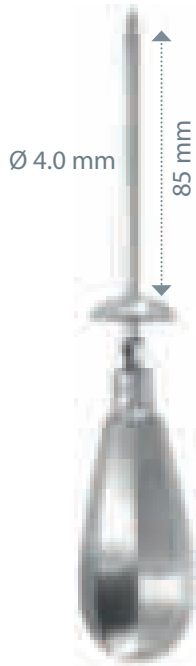

**V029002**  
19 cm - 7 1/2"

<b>V029000</b>	Ø 3.0 mm	<b>V029100</b>
<b>V029001</b>	Ø 3.5 mm	<b>V029101</b>
<b>V029002</b>	Ø 4.0 mm	<b>V029102</b>
<b>V029003</b>	Ø 4.5 mm	<b>V029103</b>
<b>V029004</b>	Ø 5.0 mm	
<b>V029005</b>	Ø 5.5 mm	
<b>V029006</b>	Ø 6.0 mm	

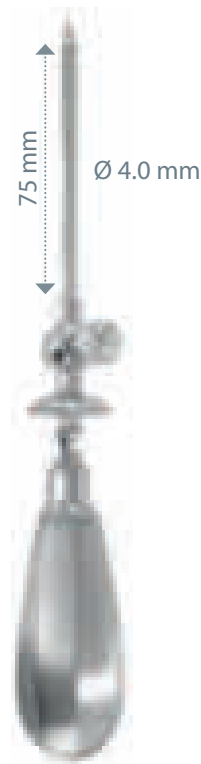

**V029102**  
20 cm - 8"

### NELSON

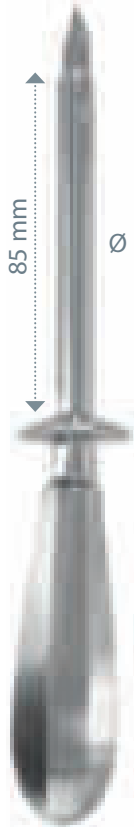

**V029451**  
22 cm - 8 3/4"

<b>V029450</b>	Ø 9.0 mm
<b>V029451</b>	Ø 10.0 mm
<b>V029452</b>	Ø 12.0 mm

### UNIVERSAL

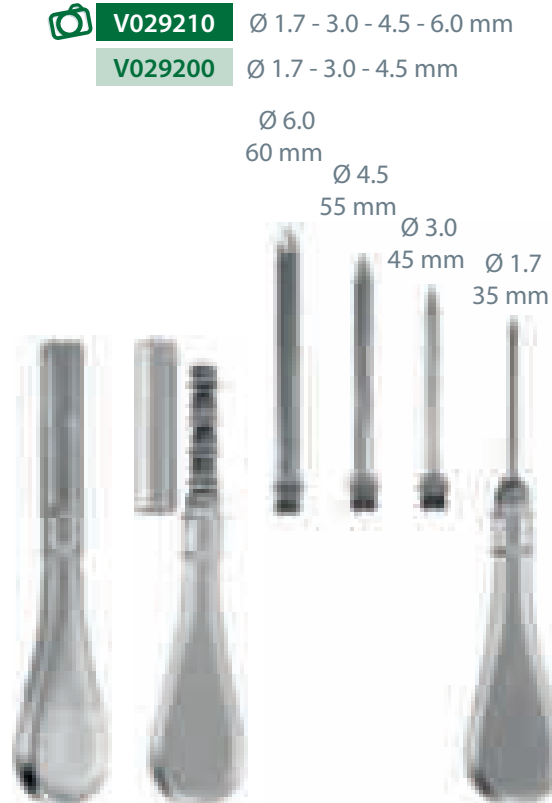

**V029210**  
12,5 cm - 5"

<b>V029210</b>	Ø 1.7 - 3.0 - 4.5 - 6.0 mm
<b>V029200</b>	Ø 1.7 - 3.0 - 4.5 mm

Ø 6.0  
60 mm  
Ø 4.5  
55 mm  
Ø 3.0  
45 mm  
Ø 1.7  
35 mm

**!** Acier chromé  
 Chrome steel  
 Acero cromado

**LANDAU**



**V029300**  
 16 cm - 6 1/4"

**PEAN**

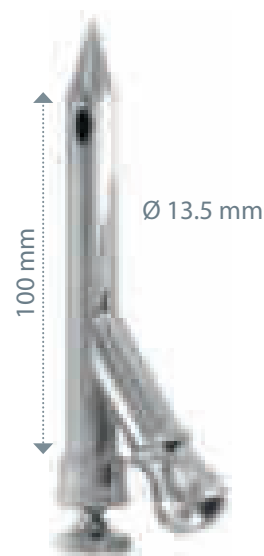

**V029350**  
 14,5 cm - 5 3/4"

**BUELAU**

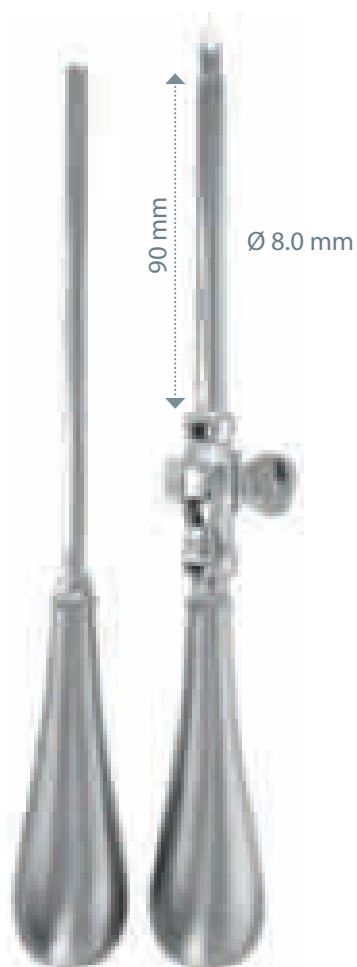

**V029400**  
 24 cm - 9 1/2"

**KRAUSE**

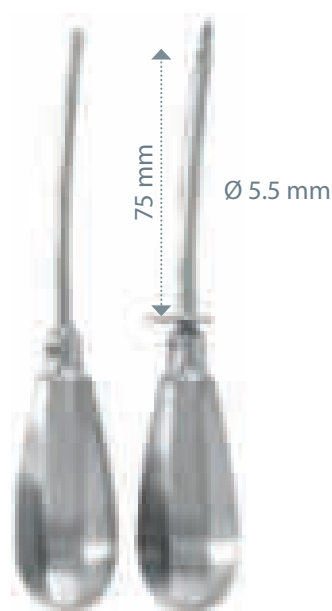

**V029500**  
 16 cm - 6 1/4"

**LICHTWITZ**

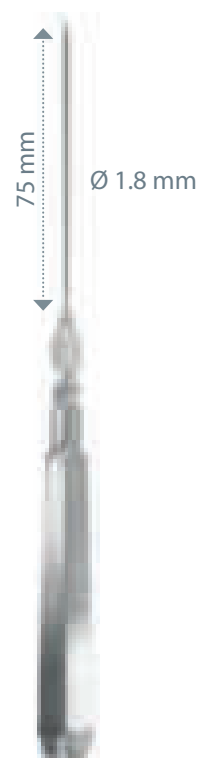

**V029550**  
 20 cm - 8"



### ESMARCH

BANDE  
BANDAGE  
BANDA



**A20560**

6 cm x 3,50 m

**A20570**

8 cm x 3,50 m



**A20580**

10 cm x 3,50 m

SPATULE À POMMADE  
OINTMENT SPATULA  
ESPÁTULA DE POMADA

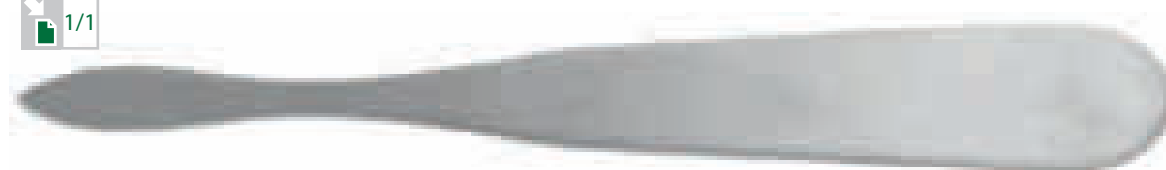

**A80170**

15 cm - 6 "





### LORTAT-JACOB

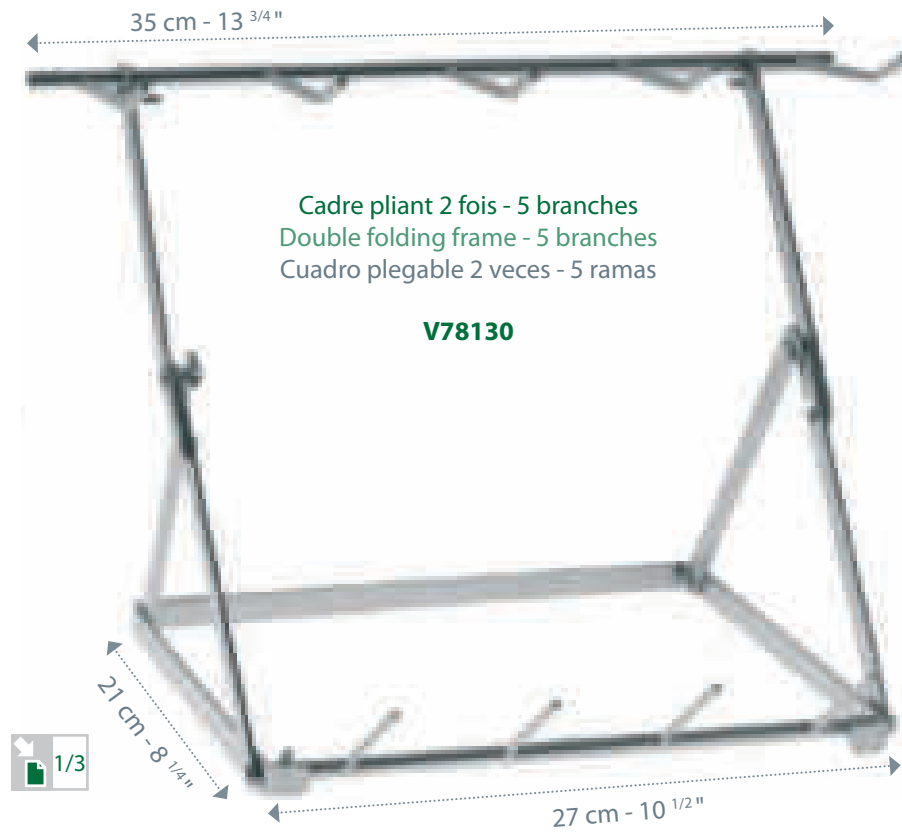

Cadre pliant 2 fois - 5 branches  
Double folding frame - 5 branches  
Cuadro plegable 2 veces - 5 ramas

**V78130**

### CHEATLE

Pour instruments  
For instruments  
Para instrumentos



**V782000**  
27 cm - 10 <sup>1</sup>/<sub>2</sub> "

### MAYO



Epingles à instruments  
Instruments pins  
Alfileres de instrumentos

**V78090**

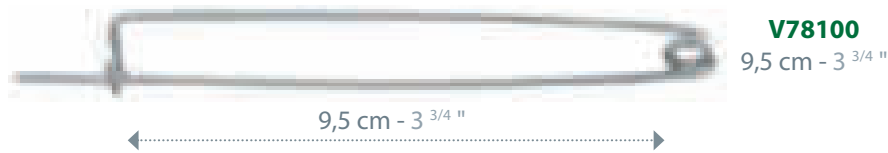

**V78100**

9,5 cm - 3 <sup>3</sup>/<sub>4</sub> "

9,5 cm - 3 <sup>3</sup>/<sub>4</sub> "

**V78100**

12,5 cm - 4 <sup>3</sup>/<sub>4</sub> "

**V78110**

20 cm - 8 "

**V781150**

### GUYON-FREUDENBERG

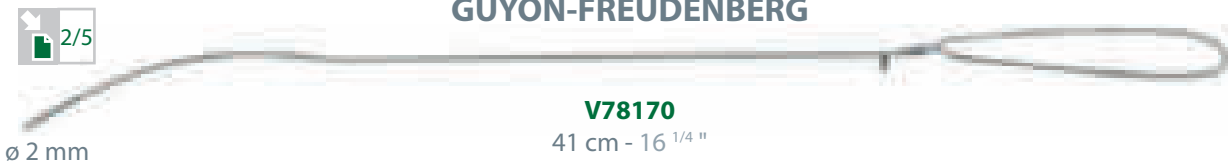

**V78170**

41 cm - 16 <sup>1</sup>/<sub>4</sub> "

3/4

## Matériel divers - Miscellaneous materials - Materiales varios

IP SPRAY POUR LA LUBRIFICATION  
IP SPRAY FOR LUBRICATION  
IP SPRAY PARA LUBRIFICACIÓN



**V78070**  
400 ml

NETTOYAGE ET RÉNOVATION DES INSTRUMENTS EN INOX  
CLEANING AND RENOVATION OF S.S. INSTRUMENTS  
LIMPIEZA Y RENOVACIÓN DE LOS INSTRUMENTOS INOX



**V78300**  
1 L

GOMME DE POLISSAGE  
POLISH RUBBER  
GOMA DE PULIMENTO

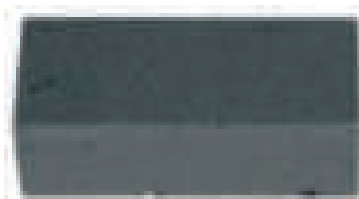

**V784000**  
60 x 25 x 20 mm

SPRAY SILICONÉ  
SILICONE SPRAY  
SPRAY DE SILICONA



**V78320**  
500 ml



## Index numérique - Numerical index - Índice numérico

Références References Referencias	Chapitre Chapter Capítulo	Page Page Página	Références References Referencias	Chapitre Chapter Capítulo	Page Page Página	Références References Referencias	Chapitre Chapter Capítulo	Page Page Página	Références References Referencias	Chapitre Chapter Capítulo	Page Page Página
A05010	XV	5	A85160	XV	11	B160013	I	6	B25403	III	13
A05020	XV	5	A85170	XV	11	B160015	I	6	B254031	III	13
A05050	XV	5	A851800	XV	11	B160020	I	6	B254032	III	13
A05060	XV	5	A851810	XV	11	B160021	I	6	B25405	III	13
A15160	XV	5	A851820	XV	11	B160025	I	6	B254051	III	13
A20560	XV	31	A86010	XV	10	B160080	I	6	B254052	III	13
A20570	XV	31	A86020	XV	10	B161064	I	6	B25410	III	13
A20580	XV	31	A860300	XV	10	B161065	I	6	B254101	III	13
A25003	XV	8	A86060	XV	10	B161067	I	6	B254102	III	13
A25004	XV	8	A90015	XV	26	B161069	I	6	B25415	III	15
A25005	XV	8	A90090	XV	26	B20010	I	8	B25418	III	15
A25006	XV	8	A902000	XV	26	B20015	I	9	B25421	III	15
A25007	XV	8	A902010	XV	26	B20020	I	9	B254220	III	15
A25008	XV	8	A90300	XV	26	B20025	I	9	B25426	III	15
A25009	XV	8	A903100	XV	26	B20030	I	8	B25460	III	18
A25010	XV	8	A903110	XV	26	B20040	I	8	B25465	III	18
A25020	XV	8	A903120	XV	26	B20045	I	9	B25470	III	18
A300020	XV	7	B05033	I	2	B20050	I	9	B25475	III	18
A300030	XV	7	B05060	I	2	B20060	I	9	B25480	III	18
A300040	XV	7	B05070	I	2	B201020	I	10	B25483	III	16
A300050	XV	7	B05090	I	2	B201040	I	10	B25485	III	16
A30010	XV	6	B05103	I	2	B201060	I	10	B25486	III	16
A30020	XV	6	B05104	I	2	B25255	III	9	B25489	III	16
A300300	XV	6	B110050	I	3	B25260	III	9	B254891	III	16
A300310	XV	6	B11013	I	3	B25261	III	9	B254892	III	16
A300350	XV	6	B11014	I	4	B25262	III	9	B254893	III	16
A30060	XV	9	B12000	I	3	B25265	III	12	B254894	III	16
A30070	XV	9	B12000G	I	3	B25270	III	12	B25490	III	17
A30075	XV	9	B12001	I	4	B25275	III	9	B25495	III	17
A30090	XV	9	B12001G	I	4	B25280	III	9	B25497	III	17
A30095	XV	9	B12008	I	3	B25285	III	9	B25498	III	17
A80010	XV	12	B12009	I	4	B25290	III	9	B254981	III	17
A800110	XV	12	B123000	I	5	B25295	III	9	B254982	III	17
A800151	XV	12	B123001	I	5	B25300	III	9	B254983	III	17
A800152	XV	12	B123002	I	5	B25302	III	9	B255100	III	16
A800153	XV	12	B130100	I	3	B25303	III	9	B255101	III	16
A800154	XV	12	B13011P	I	3	B25305	III	10	B25572	III	19
A800155	XV	12	B130120	I	3	B25310	III	10	B25574	III	19
A80020	XV	12	B130155	I	3	B25311	III	10	B25576	III	19
A800201	XV	12	B130180	I	4	B25312	III	10	B25578	III	19
A800202	XV	12	B130190	I	4	B25315	III	12	B255800	III	19
A800203	XV	12	B130200	I	4	B25320	III	12	B255801	III	19
A800204	XV	12	B130210	I	4	B25325	III	10	B25600	III	19
A80030	XV	12	B130220	I	4	B25330	III	10	B25605	III	19
A80040	XV	12	B130230	I	4	B25335	III	10	B256070	III	21
A800410	XV	12	B130240	I	4	B25340	III	10	B256071	III	21
A800420	XV	12	B130360	I	4	B25345	III	10	B256080	III	21
A80050	XV	14	B130710	I	3	B253470	III	10	B256081	III	21
A80070	XV	13	B132100	I	7	B25350	III	10	B256090	III	21
A80080	XV	13	B13211P	I	7	B253520	III	10	B256091	III	21
A80090	XV	13	B132120	I	7	B25355	III	11	B25610	III	22
A800910	XV	13	B132155	I	7	B25360	III	11	B25615	III	22
A800920	XV	13	B132180	I	7	B25365	III	11	B25620	III	22
A80100	XV	13	B132190	I	7	B253680	III	12	B256201	III	23
A801100	XV	13	B132200	I	7	B25370	III	11	B256202	III	23
A801110	XV	13	B132210	I	7	B253730	III	12	B256205	III	24
A801201	XV	13	B132220	I	7	B25375	III	11	B256215	III	24
A801202	XV	13	B132230	I	7	B25380	III	11	B25625	III	22
A801203	XV	13	B132240	I	7	B25385	III	11	B256251	III	23
A801204	XV	13	B132700	I	7	B25390	III	11	B256252	III	23
A80140	XV	14	B134100	I	7	B25395	III	11	B256255	III	24
A80150	XV	14	B13411P	I	7	B253970	III	11	B256265	III	24
A80170	XV	31	B134120	I	7	B25400	III	11	B25630	III	22
A85030	XV	10	B134155	I	7	B254010	III	11	B256301	III	23
A85040	XV	10	B134180	I	7	B254012	III	45	B256302	III	23
A85090	III	88	B134190	I	7	B254013	III	45	B256305	III	24
A85100	III	88	B134200	I	7	B254014	III	45	B25635	III	22
A851010	III	88	B134210	I	7	B254015	III	45	B256351	III	23
A851015	III	88	B134220	I	7	B25402	III	13	B256352	III	23
A851113	III	88	B134230	I	7	B254021	III	13	B256355	III	24
A851115	III	88	B134240	I	7	B254022	III	13	B25640	III	22

## Index numérique - Numerical index - Índice numérico

Références References Referencias	Chapitre Chapter Capítulo	Page Page Página	Références References Referencias	Chapitre Chapter Capítulo	Page Page Página	Références References Referencias	Chapitre Chapter Capítulo	Page Page Página	Références References Referencias	Chapitre Chapter Capítulo	Page Page Página
B256401	III	23	B257609	III	27	B258185	III	38	B259054	III	56
B256402	III	23	B257610	III	27	B25820	III	36	B259100	III	87
B256405	III	24	B257614	III	27	B25825	III	41	B25920	III	50
B25645	III	22	B257615	III	27	B25830	III	41	B25925	III	50
B256451	III	23	B257618	III	85	B25835	III	41	B25930	III	50
B256452	III	23	B257640	III	28	B25840	III	41	B259330	III	51
B256455	III	24	B257641	III	28	B258405	III	42	B259340	III	51
B25650	III	22	B257642	III	28	B258410	III	42	B25935	III	51
B256501	III	23	B257645	III	28	B258415	III	42	B259610	III	14
B256502	III	23	B257650	III	28	B258445	III	31	B259611	III	14
B256505	III	24	B257651	III	28	B25845	III	31	B259620	III	14
B25655	III	22	B257660	III	28	B258451	III	31	B259621	III	14
B256551	III	23	B257661	III	28	B258460	III	31	B259630	III	14
B256552	III	23	B257695	III	28	B258465	III	31	B259631	III	14
B256555	III	24	B25770	III	28	B258468	III	48	B259640	III	14
B25660	III	22	B25775	III	27	B258469	III	48	B259641	III	14
B256601	III	23	B25780	III	31	B25847	III	48	B259650	III	14
B256602	III	23	B25786	III	31	B258478	III	48	B259651	III	14
B256605	III	24	B25795	VI	24	B258479	III	48	B259660	III	14
B25665	III	22	B25800	VI	24	B25848	III	48	B259661	III	14
B256651	III	23	B258010	III	36	B258481	III	37	B259670	III	14
B256652	III	23	B258014	III	36	B258483	III	37	B259671	III	14
B256655	III	24	B258015	III	36	B258485	III	37	B259730	III	49
B25670	III	22	B258016	III	36	B258487	III	37	B259731	III	49
B256701	III	23	B25802	III	32	B258489	III	37	B259740	III	49
B256702	III	23	B258023	III	33	B258490	III	37	B259741	III	49
B25675	III	22	B258024	III	33	B258491	III	37	B259750	III	49
B256751	III	23	B258025	III	33	B258495	III	46	B259751	III	49
B256752	III	23	B258027	III	34	B258499	III	46	B259800	III	39
B256760	III	24	B258028	III	34	B25850	III	46	B259801	III	39
B256770	III	24	B258029	III	34	B258509	III	46	B259810	III	39
	VIII	95		III	32	B25851	III	46	B259811	III	39
B25680	III	22	B258043	III	33	B25852	III	47	B259820	III	39
B256801	III	23	B258044	III	33	B25853	III	47	B259830	III	39
B256802	III	23	B258045	III	33	B258531	III	47	B259831	III	39
B25685	III	22	B258047	III	34	B258532	III	47	B259840	III	39
B256851	III	23	B258048	III	34	B258538	III	48	B259841	III	39
B256852	III	23	B258049	III	34	B25854	III	51	B259850	III	39
B25686	III	20	B25806	III	32	B25855	III	51	B259851	III	39
B25688	III	20	B258063	III	33	B25856	III	43	B259860	III	40
B25692	III	20	B258064	III	33	B258561	III	43	B259865	III	40
B25694	III	20	B258065	III	33	B258562	III	43	B259870	III	40
B25696	III	20	B258067	III	34	B25857	III	43	B259900	III	40
B25700	III	20	B258068	III	34	B258571	III	43	B259901	III	40
B25705	III	25	B258069	III	34	B258572	III	43	B259910	III	40
B25706	III	25	B258107	III	34	B25858	III	43	B259911	III	40
B25707	III	26	B258108	III	34	B25859	III	43	B259915	III	40
B25715	III	25	B258109	III	34	B258590	III	44	B35001M	III	57
B25716	III	25	B25812	III	32	B258591	III	44	B35002	III	57
B25717	III	26	B258121	III	35	B258595	III	44	B35002M	III	57
B25725	III	25	B258123	III	35	B258596	III	44	B35002SB	III	57
B25726	III	25	B258125	III	34	B258597	III	45	B35003	III	58
B25727	III	26	B258128	III	34	B258598	III	45	B350031	III	58
B257340	III	30	B258129	III	34	B258599	III	45	B35004	III	58
B257350	III	29	B25813	III	35	B25860	III	53	B350041	III	58
B257360	III	29	B25814	III	35	B25865	III	53	B35005	III	58
B25737	III	29	B258150	III	36	B25870	III	54	B35006	III	58
B25740	III	29	B258155	III	36	B25875	III	54	B35007	III	60
B25745	III	29	B25816	III	38	B25880	III	54	B35008	III	61
B257460	III	30	B258161	III	38	B25885	III	55	B35008M	III	61
B257462	III	30	B258162	III	38	B25890	III	55	B35008SB	III	61
B257465	III	30	B25817	III	38	B25900	III	55	B350090	III	60
B257470	III	80	B258171	III	38	B259040	III	56	B350095	III	61
B257471	III	80	B258172	III	38	B259041	III	56	B350095SB	III	61
B257500	III	80	B258175	III	38	B259042	III	56	B35010	III	60
B257540	III	81	B258176	III	38	B259043	III	56	B35020	III	61
B25755	III	81	B258180	III	38	B259044	III	56	B35030	III	60
B257550	III	81	B258181	III	38	B25905	III	56	B35030M	III	60
B25760	III	81	B258182	III	38	B259051	III	56	B35040	III	61
B257602	III	81	B258183	III	38	B259052	III	56	B35040M	III	61
B257605	III	27	B258184	III	38	B259053	III	56	B35042	III	59

## Index numérique - Numerical index - Índice numérico

Références References Referencias	Chapitre Chapter Capítulo	Page Page Página	Références References Referencias	Chapitre Chapter Capítulo	Page Page Página	Références References Referencias	Chapitre Chapter Capítulo	Page Page Página	Références References Referencias	Chapitre Chapter Capítulo	Page Page Página
B35043	III	59	B352580	III	66	B401145	II	5	B40235	II	14
B35044	III	59	B352581	III	66	B401150	II	5	B40240	II	14
B35044M	III	59	B35260	III	65	B401151	II	5	B40245	II	14
B35045	III	59	B35260SB	III	65	B401152	II	5	B402451	II	14
B35045M	III	59	B35270	III	66	B401153	II	5	B402455	II	14
B35045SB	III	59	B35280	III	66	B401154	II	5	B40246	II	14
B35046	III	59	B353000	III	57	B401155	II	5	B40248	II	14
B35047	III	59	B353005	III	57	B40120	II	9	B40249	II	14
B35048	III	63	B353015	III	57	B401220	II	10	B402491	II	14
B350482	III	63	B354025	III	69	B40125	II	9	B40250	II	17
B35049	III	64	B354045	III	69	B401270	II	10	B40255	II	17
B350492	III	64	B354060	III	69	B40130	II	9	B40260	II	17
B350495B	III	64	B354125	III	69	B40132	II	10	B40265	II	17
B35050	III	63	B354145	III	69	B40135	II	9	B402655	II	17
B350502	III	63	B354160	III	69	B401370	II	10	B402656	II	17
B35060	III	64	B355000	III	84	B40140	II	9	B402657	II	17
B350602	III	64	B355010	III	84	B401420	II	10	B402660	II	17
B35060M	III	64	B40005	II	5	B401430	II	9	B40270	II	19
B35060SB	III	64	B40010	II	5	B401431	II	10	B40275	II	19
B35070	III	63	B40015	II	5	B401432	II	9	B40280	II	18
B350702	III	63	B40020	II	5	B401433	II	10	B40285	II	18
B35080	III	64	B40021	II	7	B401434	II	9	B40290	II	18
B350802	III	64	B40025	II	5	B401435	II	10	B40295	II	18
B350805B	III	64	B40026	II	7	B40145	II	9	B40300	II	18
B35090	III	63	B40030	II	5	B401470	II	10	B403040	II	18
B350902	III	63	B40031	II	7	B40150	II	9	B40305	II	18
B35100	III	64	B40035	II	5	B401520	II	10	B40310	II	18
B351002	III	64	B40040	II	5	B40155	II	9	B40315	II	18
B351005B	III	64	B40045	II	5	B40157	II	10	B40325	II	20
B351010	III	63	B40050	II	5	B40160	II	9	B40330	II	20
B351011	III	64	B40055	II	5	B401620	II	10	B40335	II	20
B3510115B	III	64	B40060	II	5	B40165	II	9	B40340	II	20
B351020	III	63	B40061	II	7	B401670	II	10	B40345	II	20
B351021	III	64	B40065	II	5	B401680	II	9	B40350	II	20
B3510215B	III	64	B40066	II	7	B401681	II	10	B40355	II	21
B35104	III	62	B40070	II	5	B401682	II	9	B40360	II	21
B35104M	III	62	B40071	II	7	B401683	II	10	B40365	II	21
B35106	III	62	B40075	II	5	B401684	II	9	B403655	II	21
B35106M	III	62	B40080	II	5	B401685	II	10	B403660	II	21
B351065B	III	62	B40090	II	6	B401698	II	11	B403670	II	21
B35110	III	62	B400901	II	6	B401699	II	11	B403680	II	21
B35120	III	62	B400902	II	6	B40170	II	11	B403690	II	21
B35120M	III	62	B40092	II	6	B401710	II	11	B40374	II	16
B351205B	III	62	B40095	II	6	B401711	II	11	B40375	II	16
B35130	III	62	B400951	II	6	B401748	II	11	B40380	II	16
B35140	III	62	B400952	II	6	B401749	II	11	B40385	II	16
B35140M	III	62	B40100	II	6	B40175	II	11	B40390	II	16
B351405B	III	62	B40105	II	6	B401760	II	11	B403950	II	16
B35150	III	62	B40110	II	8	B401761	II	11	B403952	II	29
B35160	III	62	B401111	II	8	B401800	II	13	B403953	II	29
B35160M	III	62	B401112	II	8	B401801	II	13	B403954	II	29
B351605B	III	62	B401113	II	8	B401810	II	13	B403955	II	29
B35172	III	62	B401114	II	8	B401811	II	13	B403959	II	16
B35174	III	62	B401115	II	8	B401820	II	12	B403960	II	16
B35174M	III	62	B401120	II	8	B401821	II	12	B403961	II	16
B351745B	III	62	B401121	II	8	B401830	II	12	B403962	II	16
B351750	III	62	B401122	II	8	B401831	II	12	B403963	II	16
B351751	III	62	B401123	II	8	B401840	II	12	B40400	II	25
B351780	III	62	B401124	II	8	B401841	II	12	B404005	II	25
B351781	III	62	B401125	II	8	B40200	II	13	B404010	II	31
B35180	III	67	B401130	II	8	B40205	II	13	B404020	II	25
B35190	III	67	B401131	II	8	B40210	II	13	B404021	II	25
B35200	III	67	B401132	II	8	B40215	II	13	B404022	II	25
B35210	III	67	B401133	II	8	B402151	II	13	B40404	II	30
B35220	III	67	B401134	II	8	B402152	II	13	B404041	II	30
B35228	III	65	B401135	II	8	B402200	II	15	B40406	II	30
B35230	III	65	B401140	II	5	B402201	II	15	B404061	II	30
B35232	III	65	B401141	II	5	B402202	II	15	B404090	II	27
B35234	III	65	B401142	II	5	B402203	II	15	B404091	II	27
B35240	III	62	B401143	II	5	B40225	II	14	B404100	II	27
B35250	III	62	B401144	II	5	B40230	II	14	B404101	II	27

## Index numérique - Numerical index - Índice numérico

Références References Referencias	Chapitre Chapter Capítulo	Page Page Página	Références References Referencias	Chapitre Chapter Capítulo	Page Page Página	Références References Referencias	Chapitre Chapter Capítulo	Page Page Página	Références References Referencias	Chapitre Chapter Capítulo	Page Page Página
B404110	II	28	B407841	II	26	B50200	IV	10	B504566	IV	23
B404111	II	28	B407850	II	26	B50202	IV	10	B504567	IV	23
B404120	II	28	B407851	II	26	B50205	IV	10	B504580	IV	23
B404121	II	28	B407860	II	26	B50207	IV	10	B504581	IV	23
B40415	II	19	B407861	II	26	B50210	IV	10	B504582	IV	23
B40420	II	19	B407900	II	45	B50212	IV	10	B504583	IV	23
B40425	II	19	B40800	II	51	B50215	IV	10	B504584	IV	23
B404251	II	19	B408010	II	35	B50217	IV	10	B504585	IV	23
B404349	II	20	B408020	II	35	B50220	IV	10	B504586	IV	23
B40435	II	20	B408030	II	35	B50225	IV	10	B504587	IV	23
B404360	II	20	B408040	II	51	B50230	IV	10	B504590	IV	21
B40440	II	22	B40810	II	37	B50231	IV	10	B504591	IV	21
B404430	II	22	B408110	II	37	B50235	IV	11	B504592	IV	21
B404440	II	22	B40820	II	37	B50236	IV	11	B504593	IV	21
B404441	II	22	B408210	II	37	B50240	IV	11	B504594	IV	21
B40445	II	22	B408250	II	37	B50242	IV	11	B504595	IV	21
B404450	II	22	B40830	II	36	B50245	IV	11	B504596	IV	21
B404451	II	22	B40840	II	36	B50247	IV	11	B504597	IV	21
B404453	II	22	B408500	II	32	B50250	IV	11	B504598	IV	22
B404454	II	22	B408501	II	32	B50252	IV	11	B504599	IV	22
B404456	II	24	B408502	II	32	B50255	IV	11	B50465	IV	15
B404457	II	24	B408510	II	32	B50257	IV	11	B504651	IV	18
B404458	II	23	B408511	II	32	B50265	IV	11	B504652	IV	18
B404459	II	23	B408512	II	32	B50267	IV	11	B504653	IV	18
B40446	II	23	B408515	II	32	B50272	IV	10	B504654	IV	18
B40447	II	23	B408516	II	32	B50274	IV	10	B504661	IV	18
B404470	II	23	B408522	II	32	B50276	IV	11	B504662	IV	18
B404471	II	23	B408526	II	32	B50278	IV	11	B504663	IV	18
B404475	II	24	B408601	II	31	B50282	IV	27	B504664	IV	18
B40448	II	22	B408602	II	31	B50284	IV	27	B50555	IV	31
B404490	II	22	B408603	II	31	B50286	IV	27	B50560	IV	31
B404495	II	24	B408610	II	31	B50288	IV	27	B50565	IV	31
B404496	II	24	B408611	II	31	B503000	IV	24	B50570	IV	31
B40600	II	47	B408620	II	31	B503001	IV	24	B50575	IV	31
B406001	II	47	B408621	II	31	B503010	IV	24	B50580	IV	31
B406010	II	47	B408701	II	35	B503011	IV	24	B50585	IV	31
B406011	II	47	B408702	II	35	B50330	IV	25	B50590	IV	31
B406020	II	47	B408703	II	35	B50335	IV	25	B50595	IV	31
B406021	II	47	B408704	II	35	B50345	IV	25	B50600	IV	31
B40610	II	45	B408705	II	35	B50350	IV	25	B50605	IV	31
B40620	II	45	B408707	II	35	B50360	IV	25	B50610	IV	31
B40640	II	45	B408801	II	33	B50365	IV	25	B50615	IV	31
B40650	II	45	B408802	II	33	B50375	IV	25	B50620	IV	31
B40660	II	45	B408804	II	33	B50380	IV	25	B50625	IV	31
B40670	II	45	B408810	II	33	B50410	IV	20	B50630	IV	31
B406810	II	45	B408820	II	33	B50415	IV	20	B50632	IV	32
B406811	II	45	B408821	II	33	B50420	IV	20	B50634	IV	32
B406812	II	45	B408830	II	34	B50425	IV	20	B50660	IV	28
B406813	II	45	B408831	II	34	B50430	IV	19	B50665	IV	28
B406814	II	45	B408835	II	34	B50435	IV	19	B50670	IV	28
B406815	II	45	B408836	II	34	B50440	IV	19	B50675	IV	28
B406910	II	45	B408838	II	34	B50445	IV	19	B50680	IV	28
B406911	II	45	B410011	II	51	B50446	IV	20	B50685	IV	28
B406912	II	45	B410021	II	51	B50447	IV	20	B50690	IV	28
B406950	II	47	B410031	II	51	B50448	IV	20	B50695	IV	28
B406960	II	47	B410041	II	51	B50449	IV	20	B506951	IV	29
B40750	II	46	B410100	II	51	B504500	IV	16	B506952	IV	29
B407510	II	46	B410101	II	51	B504510	IV	16	B506953	IV	29
B407520	II	46	B410102	II	51	B504520	IV	17	B506954	IV	29
B407550	II	46	B410110	II	51	B504530	IV	17	B506955	IV	29
B40760	II	46	B410111	II	51	B504540	IV	36	B506956	IV	29
B40770	II	46	B410120	II	51	B504545	IV	36	B506957	IV	29
B407750	II	46	B410121	II	51	B504547	IV	36	B506958	IV	29
B40780	II	46	B50010	IV	118	B504548	IV	36	B506960	IV	30
B407810	II	26	B50020	IV	118	B50455	IV	15	B506961	IV	30
B407811	II	26	B50025	IV	118	B504560	IV	23	B506962	IV	30
B407820	II	26	B50050	IV	118	B504561	IV	23	B506963	IV	30
B407821	II	26	B50055	IV	118	B504562	IV	23	B506966	IV	30
B407830	II	26	B50070	IV	9	B504563	IV	23	B506967	IV	30
B407831	II	26	B50075	IV	9	B504564	IV	23	B506968	IV	30
B407840	II	26	B50085	IV	9	B504565	IV	23	B506969	IV	30

Références References Referencias	Chapitre Chapter Capítulo	Page Page Página	Références References Referencias	Chapitre Chapter Capítulo	Page Page Página	Références References Referencias	Chapitre Chapter Capítulo	Page Page Página	Références References Referencias	Chapitre Chapter Capítulo	Page Page Página
B506990	IV	12	B508090	IV	109	B604971	IV	60	B607902	IV	45
B50700	IV	12	B508095	IV	109	B604980	IV	60	B60810	IV	64
B50705	IV	12	B50810	IV	109	B604981	IV	60	B60820	IV	64
B50706	IV	12	B50815	IV	109	B604982	IV	60	B60860	IV	65
B507065	IV	12	B50830	II	52	B604990	IV	58	B60870	IV	65
B50707	IV	12	B508310	II	52	B605000	IV	55	B60880	IV	81
B507080	IV	12	B508311	II	52	B605001	IV	55	B60885	IV	81
B507081	IV	12	B50835	IX	9	B605002	IV	55	B60890	IV	81
B507090	IV	12	B508400	IV	26	B605003	IV	55	B60891	IV	66
B50710	IV	12	B508401	IV	26	B605004	IV	55	B60892	IV	66
B50715	IV	12	B508450	IV	26	B605005	IV	55	B60893	IV	66
B50720	IV	12	B508451	IV	26	B605006	IV	55	B60894	IV	53
B507210	IV	12	B508455	IV	26	B605007	IV	55	B60895	IV	53
B50725	IV	12	B55260	IV	46	B605008	IV	55	B60896	IV	69
B507261	IV	12	B55280	IV	46	B605009	IV	61	B60897	IV	69
B507262	IV	12	B55300	IV	47	B605250	IV	57	B609000	IV	56
B507295	IV	13	B55310	IV	47	B605251	IV	57	B609001	IV	56
B50730	IV	13	B554000	IX	8	B605252	IV	57	B609095	IV	34
B50735	IV	13	B554005	IX	8	B605253	IV	57	B609096	IV	34
B507351	IV	13	B554010	IX	8	B605254	IV	57	B609097	IV	34
B507352	IV	13	B554015	IX	8	B605255	IV	57	B609100	IV	35
B507353	IV	13	B554020	IX	8	B605256	IV	57	B609101	IV	35
B507354	IV	13	B554025	IX	8	B605257	IV	57	B609102	IV	35
B507355	IV	13	B554030	IX	8	B605258	IV	57	B609103	IV	35
B507395	IV	13	B554100	IX	9	B605259	IV	57	B609104	IV	56
B50740	IV	13	B554200	IX	10	B605300	IV	50	B609105	IV	56
B50745	IV	13	B554201	IX	10	B605301	IV	50	B609106	IV	56
B507451	IV	13	B554210	IX	10	B60535	IV	50	B609108	IV	37
B507452	IV	13	B554211	IX	10	B60540	IV	51	B609109	IV	37
B507453	IV	13	B60140	IV	39	B60545	IV	51	B609110	IV	41
B507454	IV	13	B60150	IV	39	B60550	IV	51	B609111	IV	41
B507455	IV	13	B60160	IV	39	B60560	IV	51	B609112	IV	35
B50746	IV	14	B60180	IV	39	B60570	IV	51	B609113	IV	35
B50747	IV	14	B60190	IV	39	B60580	IV	51	B609115	IV	41
B50748	IV	14	B60200	IV	39	B60590	IV	51	B609116	IV	41
B50749	IV	14	B60220	IV	39	B60600	IV	51	B609122	IV	43
B50750	IV	33	B60230	IV	39	B60601	IV	51	B609123	IV	43
B50755	IV	33	B60240	IV	39	B60602	IV	51	B609125	IV	58
B50760	IV	33	B60260	IV	39	B60603	IV	51	B609126	IV	58
B50765	IV	33	B60270	IV	39	B60604	IV	51	B609127	IV	58
B507660	IV	48	B60280	IV	39	B60605	IV	51	B609129	IV	58
B507661	IV	48	B602900	IV	40	B60606	IV	51	B609130	IV	58
B507662	IV	48	B602902	IV	40	B60607	IV	51	B609135	IV	58
B50767	IV	48	B602904	IV	40	B60608	IV	51	B609140	IV	58
B507680	IV	49	B602906	IV	40	B606090	VIII	95	B609150	IV	59
B507690	IV	59	B602908	IV	40	B60610	IV	52	B609151	IV	59
B507695	IV	49	B602910	IV	40	B60615	IV	52	B609152	IV	59
B507701	IV	120	B602912	IV	40	B60620	IV	52	B609155	IV	59
B507702	IV	120	B602914	IV	40	B60630	IV	52	B609160	IV	59
B50780	IV	120	B60330	IV	42	B60640	IV	52	B612100	IV	54
B50785	IV	120	B60340	IV	42	B60650	IV	52	B612110	IV	54
B507900	IV	121	B60350	IV	42	B60660	IV	52	B612120	IV	54
B507901	IV	121	B60360	IV	42	B60670	IV	52	B612130	IV	54
B507910	IV	121	B603650	IV	100	B60700	IV	53	B612140	IV	54
B507911	IV	121	B60370	IV	100	B60710	IV	52	B612150	IV	54
B50793	IV	122	B603800	IV	100	B60715	IV	52	B612160	IV	54
B50794	IV	122	B60390	IV	100	B60720	IV	52	B612700	IV	54
B507950	IV	126	B603950	IV	100	B60730	IV	52	B612710	IV	54
B507955	IV	126	B60400	IV	101	B60740	IV	52	B612720	IV	54
B507960	IV	126	B60420	IV	101	B60750	IV	52	B612730	IV	54
B507970	IV	126	B60422	IV	100	B60752	IV	52	B612740	IV	54
B507975	IV	126	B60424	IV	100	B60753	IV	52	B612750	IV	54
B507980	IV	127	B604390	IV	43	B60756	IV	53	B612760	IV	54
B507981	IV	127	B60440	IV	43	B607569	IV	61	B613020	IV	62
B507990	IV	127	B60450	IV	38	B607570	IV	61	B613040	IV	62
B507991	IV	127	B60460	IV	38	B607571	IV	61	B613041	IV	62
B508000	IV	44	B60470	IV	38	B607572	IV	67	B613080	IV	62
B508001	IV	44	B60480	IV	38	B607574	IV	67	B613100	IV	62
B508002	IV	44	B604810	IV	38	B60770	IV	45	B613110	IV	63
B508003	IV	44	B604960	IV	60	B60790	IV	45	B613111	IV	63
B50805	IV	98	B604970	IV	60	B607901	IV	45	B613112	IV	63



## Index numérique - Numerical index - Índice numérico

Références References Referencias	Chapitre Chapter Capítulo	Page Page Página	Références References Referencias	Chapitre Chapter Capítulo	Page Page Página	Références References Referencias	Chapitre Chapter Capítulo	Page Page Página	Références References Referencias	Chapitre Chapter Capítulo	Page Page Página
B613114	IV	63	B654650	IV	97	B80145	VII	34	B802673	VII	28
B613120	IV	63	B654660	IV	97	B801451	VII	34	B802674	VII	28
B613130	IV	59	B65470	IV	94	B801452	VII	34	B802675	VII	28
B616113	IV	63	B65480	IV	94	B801453	VII	34	B802679	VII	29
B640000	IV	67	B65490	IV	94	B801455	VII	34	B80268	VII	29
B640009	IV	82	B654905	IV	94	B801456	VII	34	B80269	VII	29
B640010	IV	82	B65495	IV	94	B801457	VII	34	B80270	VII	29
B640015	IV	82	B65500	IV	94	B801458	VII	35	B80271	VII	29
B640016	IV	82	B655010	IV	94	B801459	VII	35	B802711	VII	55
B640020	IV	82	B655020	IV	94	B801460	VII	35	B802712	VII	55
B640031	IV	83	B65515	IV	98	B801462	VII	50	B802714	VII	51
B640032	IV	83	B655200	IV	99	B801464	VII	50	B802715	VII	51
B640033	IV	83	B65530	IV	99	B801466	VII	50	B802716	VII	51
B640034	IV	83	B655340	IV	102	B801468	VII	50	B802717	VII	51
B641000	IV	77	B655360	IV	102	B801470	VII	50	B802719	VII	55
B641100	IV	80	B655365	IV	92	B801471	VII	50	B80272	VII	54
B641105	IV	80	B655370	IV	92	B801472	VII	50	B80273	VII	54
B641110	IV	80	B656025	IV	92	B801473	VII	50	B80274	VII	54
B641115	IV	80	B70070	IV	103	B801474	VII	50	B802740	VII	46
B641120	IV	80	B70100	IV	103	B801476	VII	50	B802741	VII	46
B65030	IV	69	B70130	IV	104	B801478	VII	50	B802742	VII	55
B65040	IV	69	B70140	IV	104	B801480	VII	35	B802743	VII	46
B65070	IV	68	B70150	IV	104	B801483	VII	36	B802744	VII	46
B65080	IV	68	B70160	IV	104	B801484	VII	36	B802745	VII	46
B650900	IV	68	B70190	IV	105	B801485	VII	36	B802746	VII	46
B651000	IV	68	B70200	IV	105	B801486	VII	36	B802747	VII	46
B65113	IV	85	B70210	IV	107	B801487	VII	36	B802748	VII	46
B65119	IV	85	B70220	IV	107	B801488	VII	36	B802749	VII	46
B65123	IV	85	B702250	IV	107	B801490	VII	25	B80275	VII	43
B65125	IV	85	B702300	IV	103	B801491	VII	25	B802755	VII	43
B65126	IV	85	B702350	IV	103	B801492	VII	24	B80276	VII	43
B651265	IV	85	B702355	IV	103	B801493	VII	24	B802765	VII	43
B65127	IV	87	B702400	IV	103	B80150	VII	24	B802770	VII	43
B651280	IV	88	B702450	IV	106	B80151	VII	25	B802771	VII	45
B65129	IV	87	B702451	IV	106	B80155	VII	24	B802772	VII	45
B65131	IV	87	B702500	IV	106	B80156	VII	25	B802774	VII	45
B651315	IV	87	B702505	IV	106	B801570	VII	24	B802776	VII	45
B651320	IV	87	B80081	VII	16	B801575	VII	25	B802777	VII	43, 45
B65135	IV	84	B80083	VII	16	B80160	VII	24	B802778	VII	45
B651350	IV	84	B80085	VII	42	B80161	VII	25	B802779	VII	45
B651360	IV	84	B80090	VII	42	B80165	VII	24	B80278	VII	44
B651500	IV	89	B80095	VII	42	B80166	VII	25	B802785	VII	44
B651550	IV	89	B80100	VII	42	B801670	VII	24	B80279	VII	44
B651555	IV	90	B80105	VII	42	B801675	VII	25	B80280	VII	44
B651560	IV	90	B80110	VII	42	B80170	VII	24	B80281	VII	44
B651565	IV	90	B80115	VII	42	B80171	VII	25	B802815	VII	44
B651580	IV	90	B80117	VII	31	B80175	VII	24	B80282	VII	44
B65170	IV	90	B80120	VII	31	B80176	VII	25	B802825	VII	44
B65190	IV	89	B80125	VII	31	B801770	VII	24	B802826	VII	44
B65191	IV	89	B801255	VII	31	B801775	VII	25	B80283	VII	44
B65192	IV	90	B80130	VII	31	B80190	VII	24	B80285	VII	44
B65193	IV	90	B80135	VII	31	B80191	VII	25	B802852	VII	26
B65210	IV	91	B801351	VII	31	B80195	VII	24	B802853	VII	26
B652110	IV	91	B801352	VII	31	B80196	VII	25	B802854	VII	26
B65215	IV	91	B801353	VII	31	B801970	VII	24	B802855	VII	26
B65230	IV	86	B801354	VII	31	B801975	VII	25	B802856	VII	26
B65240	IV	86	B801356	VII	31	B80210	VII	24	B802860	VII	44
B65250	IV	86	B801358	VII	31	B80211	VII	25	B802861	VII	47
B65290	IV	88	B801359	VII	31	B80215	VII	24	B802862	VII	16
B65310	IV	88	B80136	VII	33	B80216	VII	25	B802863	VII	16
B65330	IV	93	B801363	VII	33	B802175	VII	25	B802864	VII	16
B65335	IV	93	B801364	VII	37	B80218	VII	22	B802865	VII	16
B65370	IV	93	B801365	VII	37	B80219	VII	22	B802866	VII	26
B65420	IV	93	B801366	VII	37	B80220	VII	22	B802867	VII	26
B65430	IV	93	B801367	VII	37	B80225	VII	22	B802868	VII	26
B65440	IV	93	B801368	VII	37	B80240	VII	22	B802869	VII	26
B654600	IV	95	B80137	VII	33	B80245	VII	22	B802870	VII	26
B654610	IV	95	B801375	VII	37	B80266	VII	22	B802871	VII	26
B654620	IV	95	B801376	VII	37	B80267	VII	22	B802872	VII	26
B654630	IV	96	B80140	VII	36	B802671	VII	28	B802873	VII	26
B654640	IV	96	B801422	VII	33	B802672	VII	28	B802874	VII	26

## Index numérique - Numerical index - Índice numérico

Références References Referencias	Chapitre Chapter Capítulo	Page Page Página	Références References Referencias	Chapitre Chapter Capítulo	Page Page Página	Références References Referencias	Chapitre Chapter Capítulo	Page Page Página	Références References Referencias	Chapitre Chapter Capítulo	Page Page Página
B802875	VII	26	B803070	VII	11	B80351	VII	9	B80443	VII	57
B802876	VII	26	B803071	VII	11	B80353	VII	9	B80444	VII	57
B802877	VII	26	B803072	VII	11	B803533	VII	9	B80445	VII	57
B802878	VII	27	B803073	VII	11	B803535	VII	9	B804460	VII	59
B802880	VII	27	B803074	VII	13	B803537	VII	9	B804461	VII	59
B802881	VII	27	B803075	VII	13	B803540	VII	9	B804462	VII	59
B802883	VII	27	B803076	VII	13	B803541	VII	9	B804463	VII	59
B802885	VII	42	B803077	VII	13	B803543	VII	10	B804464	VII	59
B802886	VII	42	B803078	VII	13	B803545	VII	9	B804465	VII	59
B802887	VII	42	B803079	VII	13	B803550	VII	10	B804466	VII	59
B802888	VII	42	B803080	VII	13	B803551	VII	10	B804467	VII	59
B802889	VII	42	B803081	VII	13	B80360	VII	30	B804468	VII	59
B802890	VII	42	B803082	VII	13	B80365	VII	30	B804470	VII	60
B802891	VII	42	B803083	VII	13	B80370	VII	30	B804471	VII	60
B802892	VII	42	B803084	VII	13	B80375	VII	30	B804472	VII	60
B802893	VII	42	B803085	VII	13	B803790	VII	38	B804473	VII	60
B802894	VII	42	B803086	VII	13	B80380	VII	38	B80450	VII	94
B802896	VII	51	B803087	VII	13	B80382	VII	38	B80455	VII	94
B802897	VII	51	B803090	VII	13	B803830	VII	38	B804590	VII	60
B802898	VII	51	B803091	VII	13	B803831	VII	38	B804600	VII	60
B80290	VII	110	B803092	VII	13	B803832	VII	38		VIII	96
B802901	VII	110	B803093	VII	13	B80385	VII	38	B804610	VIII	96
B802905	VII	110	B803094	VII	13	B80386	VII	39	B804620	VIII	96
B802910	VII	110	B803095	VII	13	B80388	VII	39	B804630	VIII	96
B802912	VII	109	B803101	VII	18	B803890	VII	38	B804640	VIII	96
B802913	VII	109	B803102	VII	18	B80390	VII	39	B80470	VII	87
B802914	VII	109	B803103	VII	18	B803905	VII	39	B80475	VII	87
B802915	VII	109	B803104	VII	18	B803910	VII	39	B80476	VII	87
B802917	VII	62	B803105	VII	18	B803911	VII	39	B804770	VII	87
B802918	VII	62	B803106	VII	18	B803912	VII	39	B80482	VII	89
B802919	VII	52	B803108	VII	17	B803913	VII	39	B804822	VII	89
B802920	VII	52	B803109	VII	17	B803914	VII	39	B80483	VII	89
B802921	VII	52	B803110	VII	17	B803915	VII	39	B804832	VII	89
B802922	VII	62	B803112	VII	17	B803920	VII	39	B804835	VII	90
B802923	VII	62	B803113	VII	17	B803930	VII	39	B804837	VII	90
B802924	VII	62	B80312	VII	11	B803931	VII	39	B80484	VII	89
B802925	VII	62	B80314	VII	11	B803932	VII	39	B804842	VII	89
B802926	VII	61	B80316	VII	11	B803933	VII	39	B804850	VII	90
B802927	VII	61	B80318	VII	11	B803934	VII	39	B804852	VII	90
B802928	VII	61	B80320	VII	109, 110	B803935	VII	39	B804854	VII	91
B802929	VII	61	B803205	VII	109	B803936	VII	39	B804855	VII	91
B802930	VII	61	B80325	VII	19	B803937	VII	39	B804856	VII	91
B802931	VII	61	B803255	VII	19	B803938	VII	39	B804857	VII	91
B802932	VII	61	B80327	VII	19	B803939	VII	39	B804858	VII	91
B802933	VII	61	B803275	VII	19	B803940	VII	41	B804859	VII	91
B802934	VII	52	B80328	VII	19	B803941	VII	41	B80486	VII	88
B802935	VII	52	B803282	VII	15	B803942	VII	41	B80488	VII	88
B802936	VII	52	B803284	VII	15	B803990	VII	40	B804900	VII	88
B802937	VII	53	B803286	VII	15	B80400	VII	40	B80494	VII	88
B802938	VII	53	B803290	VII	62	B80405	VII	40	B80496	VII	88
B802939	VII	53	B80330	VII	19	B80410	VII	40	B80498	VII	87, 88
B802940	VII	53	B803301	VII	20	B804105	VII	40	B80500	VII	87, 88
B802941	VII	54	B803302	VII	20	B804110	VII	40	B80502	VII	91
B802942	VII	55	B803303	VII	20	B804120	VII	40	B80505	VII	92
B802943	VII	55	B803305	VII	20	B804150	VII	56	B80507	VII	92
B802944	VII	55	B803306	VII	20	B80420	VII	56	B80509	VII	92
B802945	VII	55	B803307	VII	20	B80422	VII	56	B80511	VII	92
B802946	VII	62	B803310	VII	20	B80425	VII	56	B80513	VII	92
B802949	VII	61	B803311	VII	20	B80427	VII	56	B805140	VII	93
B80295	VII	109	B803312	VII	20	B804280	VII	57	B805150	VII	93
B802951	VII	109	B803320	VII	10	B804285	VII	57	B805160	VII	93
B80300	VII	109	B80335	VII	10	B804308	VII	58	B805240	VII	111
B803001	VII	109	B80336	VII	10	B804310	VII	58	B805241	VII	111
B803005	VII	109	B80337	VII	10	B804312	VII	58	B805245	VII	111
B80301	VII	11	B80338	VII	14	B804320	VII	58	B805246	VII	111
B80302	VII	11	B80340	VII	14	B80435	VII	57	B80525	VII	112
B80303	VII	11	B80341	VII	14	B80440	VII	57	B805251	VII	112
B80304	VII	11	B80342	VII	14	B80442	VII	57	B805252	VII	112
B80306	VII	11	B80348	VII	9	B804422	VII	57	B80530	VII	112
B803062	VII	11	B80349	VII	9	B804424	VII	57	B805301	VII	112
B803064	VII	11	B80350	VII	9	B804426	VII	57	B805302	VII	112

Références References Referencias	Chapitre Chapter Capítulo	Page Page Página	Références References Referencias	Chapitre Chapter Capítulo	Page Page Página	Références References Referencias	Chapitre Chapter Capítulo	Page Page Página	Références References Referencias	Chapitre Chapter Capítulo	Page Page Página
B80535	VII	112	B80645	VII	73, 78	B807997	VII	102	B808661	VII	123
B805351	VII	112	B80650	VII	73, 78	B80800	VII	107	B808662	VII	123
B805352	VII	112	B80655	VII	73, 78	B808010	VII	107	B808672	VII	123
B805360	VII	113	B80660	VII	73	B808020	VII	107	B808673	VII	123
B805361	VII	113	B80665	VII	73	B808085	VII	72	B808680	VII	123
B80537	VII	113	B80670	VII	73	B808086	VII	73	B808681	VII	123
B805371	VII	113	B80675	VII	73	B808087	VII	73	B808694	VII	124
B80538	VII	116	B80680	VII	73	B80810	VII	86	B808695	VII	124
B805382	VII	116	B80685	VII	75	B808110	VII	86	B80870	VII	124
B805390	VII	113	B80690	VII	75	B80812	VII	86	B80874	VII	124
B805391	VII	113	B80695	VII	75	B80813	VII	86	B80878	VII	124
B805395	VII	116	B80700	VII	75	B808133	VII	86	B80880	VIII	91
B805396	VII	116	B80705	VII	74	B808134	VII	86	B80885	VIII	90
B80540	VII	116	B80710	VII	74	B808135	VII	86	B808850	VIII	91
B805401	VII	116	B80715	VII	74	B808136	VII	86	B808851	VIII	91
B805410	VII	117	B80720	VII	74	B808137	VII	86	B808852	VIII	91
B805412	VII	117	B80725	VII	74	B808138	VII	86	B808890	VII	98
B805413	VII	117	B80730	VII	74	B808139	VII	86	B80890	VII	98
B805415	VII	114	B80735	VII	74	B80815	VII	83	B80895	VII	98
B80542	VII	114	B80740	VII	74	B808159	VII	83	B80900	VII	98
B805421	VII	114	B80745	VII	76	B80820	VII	83	B809020	VII	104
B805422	VII	114	B807455	VII	76	B808201	VII	83	B809021	VII	104
B805423	VII	114	B80750	VII	77	B808202	VII	83	B809022	VII	104
B805425	VII	118	B80755	VII	77	B808203	VII	83	B809023	VII	104
B80543	VII	118	B80756	VII	77	B808204	VII	83	B809030	VII	104
B80544	VII	118	B807580	VII	77	B808205	VII	83	B809031	VII	104
B805445	VII	118	B80759	VII	77	B808206	VII	83	B809032	VII	104
B80545	VII	118	B80760	VII	77	B808209	VII	83	B809033	VII	104
B80546	VII	118	B807610	VII	77	B808270	VII	85	B812001	VII	22
B80548	VII	118	B807620	VII	77	B808271	VII	85	B812002	VII	22
B805495	VII	118	B80763	VII	77, 78	B808274	VII	85	B812003	VII	22
B80550	VII	118	B80765	VII	77	B808275	VII	85	B812004	VII	22
B80551	VII	118	B80767	VII	78	B808276	VII	85	B812005	VII	22
B805530	VII	118	B807680	VII	103	B808277	VII	85	B812006	VII	22
B805535	VII	118	B807682	VII	103	B808278	VII	85	B812007	VII	22
B80556	VII	119	B807683	VII	103	B808280	VII	85	B812008	VII	22
B80561	VII	119	B807685	VII	103	B808285	VII	85	B812011	VII	22
B80566	VII	119	B807686	VII	103	B808286	VII	85	B812012	VII	22
B80568	VII	120	B807690	VII	105	B808300	VII	84	B812013	VII	22
B80570	VII	120	B807692	VII	105	B808301	VII	84	B812014	VII	22
B80573	VII	120	B807693	VII	105	B808310	VII	84	B812015	VII	22
B80575	VII	120	B807694	VII	105	B808311	VII	84	B812016	VII	22
B80580	VII	120	B80770	VII	95	B808312	VII	84	B812017	VII	22
B80583	VII	120	B80775	VII	95	B808313	VII	84	B812018	VII	22
B80586	VII	121	B80780	VII	95	B808340	VII	72	B812025	VII	21
B80588	VII	121	B80785	VII	95	B80835	VII	72	B812026	VII	21
B80590	VII	67	B807860	VII	95	B808360	VII	72	B812101	VII	21
B805910	VII	67	B80790	VII	96	B80840	VII	72	B812102	VII	21
B805920	VII	67	B80792	VII	97	B808410	VII	72	B812103	VII	21
B80601	VII	68	B80794	VII	99	B80845	VII	129	B812104	VII	21
B80603	VII	70	B807942	VII	99	B808460	VII	129	B812105	VII	21
B80604	VII	70	B80795	VII	106	B80850	VII	82	B812106	VII	21
B80605	VII	68	B807955	VII	106	B808510	VII	82	B812107	VII	21
B80607	VII	69	B807960	VII	100	B808515	VII	82	B812108	VII	21
B80610	VII	68	B807961	VII	100	B808516	VII	82	B812203	VII	23
B80612	VII	69	B807962	VII	100	B808545	VII	128	B812204	VII	23
B80615	VII	68	B807963	VII	100	B80855	VII	128	B812205	VII	23
B806152	VII	68	B807970	VII	101	B808552	VII	128	B812206	VII	23
B806154	VII	68	B807971	VII	101	B808553	VII	128	B812207	VII	23
B80617	VII	69	B807975	VII	101	B808564	VII	127	B812208	VII	23
B806178	VII	71	B807980	VII	102	B808565	VII	127	B812209	VII	23
B80618	VII	72	B807981	VII	102	B808566	VII	127	B812210	VII	23
B806185	VII	71	B807985	VII	102	B808567	VII	127	B812305	VII	23
B806187	VII	71	B807986	VII	102	B808570	VII	126	B812306	VII	23
B806188	VII	71	B807990	VII	102	B808571	VII	126	B812307	VII	23
B806189	VII	71	B807991	VII	102	B808580	VII	122	B812308	VII	23
B80620	VII	75	B807992	VII	102	B808590	VII	122	B812770	VII	45
B80625	VII	75	B807993	VII	102	B80860	VII	125	B812771	VII	45
B80630	VII	75	B807994	VII	102	B80865	VII	125	B812773	VII	45
B80635	VII	75	B807995	VII	102	B808655	VII	115	B812774	VII	45
B80640	VII	74	B807996	VII	102	B808660	VII	123	B812775	VII	45

## Index numérique - Numerical index - Índice numérico

Références References Referencias	Chapitre Chapter Capítulo	Page Page Página	Références References Referencias	Chapitre Chapter Capítulo	Page Page Página	Références References Referencias	Chapitre Chapter Capítulo	Page Page Página	Références References Referencias	Chapitre Chapter Capítulo	Page Page Página
B812800	VII	46	B86280	III	71	B86765	II	50	B951020	IV	108
B812810	VII	47	B86285	III	71	B86770	II	50	B951030	IV	108
B812811	VII	47	B86290	III	71	B86775	II	50	B95150	IV	112
B812820	VII	47	B86295	III	71	B86780	II	50	B95200	IV	112
B812830	VII	48	B86300	III	71	B86785	II	50	B952014	IV	112
B812831	VII	48	B86305	III	71	B89000	XV	15	B952018	IV	112
B812832	VII	48	B86310	III	71	B89005	XV	15	B952020	IV	112
B812833	VII	48	B86315	III	71	B89007	XV	15	B95205	IV	112
B812840	VII	48	B86320	III	71	B890090	XV	15	B95210	IV	112
B812845	VII	48	B86325	III	72	B890091	XV	15	B952400	IV	111
B812850	VII	49	B86330	III	72	B89010	XV	16	B952450	IV	111
B812851	VII	49	B86335	III	72	B89015	XV	16	B95250	IV	111
B812852	VII	49	B86340	III	72	B89020	XV	16	B953000	VIII	95
B812860	VII	49	B86345	III	72	B89025	XV	16	C010001	V	7
B812870	VII	49	B86350	III	72	B89030	XV	16	C010002	V	7
B812871	VII	49	B86355	III	73	B89035	XV	16	C010003	V	7
B812872	VII	49	B86360	III	73	B89036	XV	16	C010106	V	7
B813000	VII	63	B86365	III	73	B89037	XV	16	C010206	V	7
B813001	VII	63	B86370	III	73	B890375	XV	15	C010306	V	7
B813002	VII	63	B86375	III	73	B89038	XV	15	C010406	V	7
B813003	VII	63	B86380	III	73	B890390	XV	17	C011010	V	8
B813004	VII	63	B86385	III	73	B890391	XV	17	C011020	V	8
B813005	VII	63	B86390	III	74	B890392	XV	17	C011030	V	8
B813012	VII	63	B86395	III	74	B890393	XV	17	C011040	V	8
B813013	VII	63	B86400	III	74	B89040	XV	17	C011050	V	8
B813015	VII	63	B864020	III	75	B89045	XV	17	C011060	V	8
B813020	VII	64	B864025	III	75	B890460	XV	17	C012003	V	7
B813021	VII	64	B86405	III	82	B890461	XV	17	C012004	V	7
B813030	VII	64	B86410	III	76	B89050	XV	17	C09150	V	7
B813031	VII	64	B86415	III	76	B89055	XV	17	C091510	V	7
B813040	VII	65	B86420	III	76	B890570	XV	17	C095000	V	5
B813041	VII	65	B86425	III	76	B890571	XV	17	C095010	V	5
B813050	VII	65	B864300	III	77	B89058	XV	17	C095020	V	5
B813055	VII	65	B864400	III	77	B89060	XV	17	C095030	V	5
B813060	VII	66	B864405	III	77	B89061	XV	18	C095033	V	5
B813065	VII	66	B864500	III	78	B89062	XV	18	C095036	V	5
B813066	VII	66	B864505	III	78	B89063	XV	18	C095039	V	5
B817000	VII	79	B864510	III	79	B89064	XV	18	C095042	V	5
B817001	VII	79	B864515	III	79	B89065	XV	18	C095045	V	5
B817002	VII	79	B86500	IV	113	B89066	XV	18	C095106	V	5
B817010	VII	79	B86505	IV	113	B89067	XV	18	C095109	V	5
B817020	VII	79	B86510	IV	113	B89068	XV	18	C095112	V	5
B817021	VII	79	B86515	IV	113	B89070	XV	18	C095115	V	5
B817022	VII	79	B86520	IV	114	B89072	XV	18	C095200	V	6
B817030	VII	79	B86525	IV	114	B890740	XV	18	C095202	V	6
B817031	VII	79	B86530	IV	114	B890750	XV	18	C095203	V	6
B817100	VII	80	B86535	IV	114	B89090	XV	20	C095204	V	6
B817110	VII	80	B86540	IV	114	B89095	XV	20	C095206	V	6
B817120	VII	80	B86545	IV	114	B89100	XV	20	C095207	V	6
B817130	VII	80	B86550	IV	114	B89110	XV	19	C095208	V	6
B817200	VII	81	B86555	IV	114	B89120	XV	19	C095210	V	6
B817210	VII	81	B86560	IV	115	B89130	XV	19	C095212	V	6
B817220	VII	81	B86570	IV	115	B89140	XV	19	C095214	V	6
B817221	VII	81	B86580	IV	116	B89150	XV	19	C100010	II	44
B817300	VII	81	B86590	IV	116	B89160	XV	19	C100011	II	44
B817301	VII	81	B86595	IV	116	B89170	XV	19	C100012	II	44
B86205	III	70	B86600	IV	117	B89180	XV	19	C100020	II	44
B86210	III	70	B86610	IV	117	B891900	XV	20	C100021	II	44
B86215	III	70	B86700	II	48	B892000	XV	20	C100022	II	44
B86220	III	70	B86705	II	48	B892010	XV	20	C100030	II	44
B86225	III	70	B86710	II	48	B95017	IV	110	C100031	II	44
B86230	III	70	B86715	II	48	B95020	IV	110	C100032	II	44
B86235	III	70	B86720	II	48	B95025	IV	110	C100040	II	44
B86240	III	70	B86725	II	48	B950300	IV	110	C100041	II	44
B86245	III	70	B86730	II	49	B950400	IV	110	C100042	II	44
B86250	III	70	B86735	II	49	B950450	IV	110	C10005	II	41
B86255	III	70	B86740	II	49	B950460	IV	110	C10010	II	41
B86260	III	70	B86745	II	49	B950470	IV	110	C10012	II	41
B86265	III	71	B86750	II	50	B950480	IV	110	C10013	II	41
B86270	III	71	B86755	II	50	B95060	IV	110	C10015	II	41
B86275	III	71	B86760	II	50	B95100	IV	108	C10020	II	41

Références References Referencias	Chapitre Chapter Capítulo	Page Page Página	Références References Referencias	Chapitre Chapter Capítulo	Page Page Página	Références References Referencias	Chapitre Chapter Capítulo	Page Page Página	Références References Referencias	Chapitre Chapter Capítulo	Page Page Página
C10025	II	41	C102303	V	9	C10555	V	25	C10785	V	34
C10027	II	41	C102304	V	9	C10560	V	25	C10790	V	34
C10030	II	41	C102305	V	9	C10565	V	25	C10795	V	34
C10035	II	41	C102306	V	9	C10570	V	25	C10800	V	34
C10040	II	41	C102307	V	9	C10575	V	26	C10805	V	36
C10041	II	42	C102401	V	9	C10580	V	26	C10810	V	36
C10042	II	42	C102402	V	9	C10585	V	26	C10815	V	36
C10043	II	42	C102403	V	9	C10590	V	26	C10820	V	36
C10044	II	42	C102404	V	9	C10595	V	23	C10825	V	36
C10045	II	42	C102405	V	9	C10600	V	23	C10830	V	34
C10047	II	41	C102406	V	9	C10605	V	23	C10835	V	34
C10050	II	42	C102407	V	9	C10610	V	23	C10840	V	34
C10055	II	42	C10265	V	12	C10615	V	24	C108410	V	35
C10057	II	42	C10270	V	12	C10620	V	24	C10842	V	36
C100580	II	43	C10275	V	12	C10625	V	24	C10845	V	37
C100581	II	43	C10280	V	12	C10630	V	24	C10850	IV	70, 93
C100582	II	43	C10285	V	12	C10631	V	27	C108530	IV	79
C100583	II	43	C10290	V	12	C10632	V	27	C108531	IV	79
C100584	II	43	C10295	V	12	C10633	V	27	C108540	IV	70
C100590	II	43	C10300	V	12	C10634	V	27	C108545	IV	70
C100595	II	43	C10310	V	13	C10635	V	27	C10855	IV	70
C100596	II	43	C10315	V	13	C10640	V	26	C10860	IV	70
C100597	II	43	C10320	V	13	C10641	V	26	C10865	IV	72
C10060	V	10	C10325	V	13	C10642	V	26	C10870	IV	72
C10065	V	10	C10330	V	13	C10643	V	26	C10875	IV	72
C10070	V	10	C10335	V	14	C10645	V	27	C10880	IV	72
C10075	V	10	C10340	V	14	C10650	V	26	C10890	IV	72
C10080	V	10	C10345	V	14	C10651	V	26	C10895	IV	72
C10085	V	10	C10350	V	14	C10652	V	26	C108990	IV	71
C10090	V	10	C10355	V	14	C10653	V	26	C108991	IV	71
C10095	V	10	C10360	V	14	C10655	V	28	C108992	IV	71
C10096	V	10	C10365	V	14	C10660	V	27	C108995	IV	71
C10098	V	10	C10370	V	15	C10665	V	27	C108996	IV	71
C10099	V	10	C10375	V	15	C10670	V	27	C109090	IV	73
C10100	V	10	C10380	V	15	C10675	V	28	C109091	IV	73
C101051	V	11	C10385	V	15	C10680	V	28	C109092	IV	73
C101101	V	11	C10390	V	15	C10685	V	28	C109095	IV	73
C101151	V	11	C103905	V	16	C10690	V	29	C109096	IV	73
C101201	V	11	C103910	V	16	C10695	V	29	C109097	IV	73
C101231	V	11	C103920	V	16	C10700	V	29	C10910	IV	74
C101251	V	11	C10395	V	17	C10705	V	29	C10915	IV	74
C101301	V	11	C10400	V	17	C10710	V	29	C10920	IV	74
C101351	V	11	C10405	V	20	C10715	V	23	C10925	IV	74
C101401	V	11	C10410	V	20	C10720	V	32	C10930	IV	74
C101421	V	11	C10415	V	20	C10725	V	32	C10935	IV	74
C10145	V	11	C10420	V	21	C10730	V	32	C10940	IV	78
C10150	V	11	C10425	V	21	C10735	V	32	C10945	IV	78
C10155	V	11	C10430	V	21	C10740	V	32	C109460	IV	76
C10170	V	9	C10435	V	21	C10742	V	17	C109461	IV	76
C101701	V	9	C10440	V	22	C10744	V	18	C109465	IV	78
C10175	V	9	C10445	V	22	C10746	V	30	C109470	IV	78
C101751	V	9	C10447	V	22	C10748	V	30	C109480	IV	79
C10180	V	9	C10450	V	22	C10749	V	30	C109485	IV	79
C101801	V	9	C10455	V	22	C10751	V	30	C109500	IV	75
C10185	V	9	C10485	V	18	C10753	V	31	C109501	IV	75
C101851	V	9	C10490	V	18	C10754	V	31	C109502	IV	75
C10190	V	9	C10495	V	18	C10756	V	31	C109503	IV	75
C101901	V	9	C10500	V	18	C10758	V	33	C11005	V	31
C10195	V	9	C10505	V	19	C10759	V	33	C11010	V	31
C101951	V	9	C10510	V	19	C10761	V	33	C11015	V	31
C10200	V	9	C10515	V	19	C10762	V	33	C11020	V	37
C102001	V	9	C10520	V	22	C10763	V	33	C11025	V	37
C10205	V	9	C10522	V	22	C10764	V	33	C11030	V	37
C102051	V	9	C10525	V	22	C10765	II	42	C11035	V	37
C10210	V	9	C10528	V	24	C10770	II	42	C11040	V	37
C102101	V	9	C10530	V	24	C10772	V	33	C11045	V	38
C10215	V	9	C10532	V	24	C10774	V	33	C11050	V	38
C102151	V	9	C10535	V	24	C10775	V	36	C11055	V	38
C10220	V	9	C10540	V	25	C107790	V	35	C11060	V	38
C102301	V	9	C10545	V	25	C10780	V	35	C11065	V	38
C102302	V	9	C10550	V	25	C107810	V	35	C11070	V	38

## Index numérique - Numerical index - Índice numérico

Références References Referencias	Chapitre Chapter Capítulo	Page Page Página	Références References Referencias	Chapitre Chapter Capítulo	Page Page Página	Références References Referencias	Chapitre Chapter Capítulo	Page Page Página	Références References Referencias	Chapitre Chapter Capítulo	Page Page Página
C11075	V	38	D01070	X	14	D021190	X	7	D040800	XII	45
C11080	V	38	D010790	X	14	D021200	X	7	D040801	XII	45
C11085	V	38	D01080	X	14	D021210	X	7	D040802	XII	45
C11090	V	38	D01090	X	14	D021220	X	7	F05100	III	52
C11095	V	38	D01100	X	14	D021230	X	7	F051001	III	52
C11100	V	38	D01110	VI	24	D021232	X	7	F051002	III	52
C11105	V	38	D011100	X	14	D021250	X	8	F05110	III	52
C11110	V	38	D011110	X	14	D021260	X	8	F051101	III	52
C11115	V	39	D01120	VI	23	D021270	X	8	F051102	III	52
C11120	V	39	D01130	VI	23	D021280	X	8	F05120	III	52
C11125	V	39	D012000	X	13	D03060	X	15	F051201	III	52
C11130	V	39	D012010	X	13	D03070	X	15	F051202	III	52
C11135	V	39	D012020	X	13	D03080	X	15	F05130	III	80
C11140	V	39	D012030	X	13	D03090	X	15	F051310	III	80
C11145	V	39	D020010	X	4	D03100	X	15	F05160	III	52
C11200	V	38	D020020	X	4	D03110	X	15	F051601	III	52
C11205	V	38	D020035	X	4	D03120	X	15	F051602	III	52
C11210	V	38	D020040	X	4	D03130	X	15	F051650	III	68
C11215	V	38	D020045	X	4	D031400	X	16	F05170	III	68
C11220	V	38	D020055	X	4	D031405	X	16	F05175	III	68
C11225	V	38	D020090	X	10	D031410	X	17	F05180	III	82
C11230	V	38	D02010	X	10	D031411	X	17	F051850	III	82
C11235	V	38	D02020	X	10	D031420	X	17	F051900	III	82
C11240	V	38	D020210	X	10	D031421	X	17	F052000	III	68
C120005	V	40	D020211	X	10	D031430	X	17	F052010	III	68
C120010	V	40	D020220	X	10	D031431	X	17	F053014	III	52
C120015	V	40	D020221	X	10	D031440	X	17	F053019	III	52
C120020	V	40	D020290	X	10	D03160	X	16	F053022	III	52
C120025	V	40	D02030	X	10	D03170	XII	31	F10010	IV	119
C120030	V	40	D020310	X	10	D03180	XII	31	F10020	IV	119
C120035	V	40	D020400	X	9	D031900	XII	31	F10030	IV	119
C120040	V	40	D020401	X	9	D031910	XII	31	F10040	IV	119
C120045	V	40	D020410	X	9	D031920	XII	31	F10050	IV	119
C120050	V	40	D020411	X	9	D031990	XII	30	F10060	IV	119
C120070	V	40	D020420	X	9	D032000	XII	30	F10100	IV	119
C120090	V	40	D020421	X	9	D032010	XII	30	F101900	IV	123
C120110	V	40	D020430	X	11	D032020	XII	30	F101910	V	123
C120115	V	40	D020431	X	11	D032030	XII	30	F102000	IV	124
C120120	V	40	D020440	X	11	D033000	XII	30	F102001	IV	124
C120125	V	40	D020441	X	11	D034000	XII	32	F102005	IV	124
C120130	V	40	D020442	X	11	D034010	XII	32	F102006	IV	124
C120135	V	40	D020443	X	11	D035000	XII	32	F102010	IV	124
C120140	V	40	D020450	X	11	D035010	XII	32	F102011	IV	124
C120145	V	40	D020451	X	11	D035020	XII	32	F102049	IV	125
C120150	V	40	D020452	X	11	D035030	XII	32	F102050	IV	125
C120170	V	40	D020453	X	11	D036010	XII	33	F102051	IV	125
C120190	V	40	D021000	X	6	D036020	XII	33	F102052	IV	125
C120205	V	40	D021001	X	6	D036030	XII	33	F102080	IV	124
C120210	V	40	D021002	X	6	D036040	XII	33	F102090	IV	124
C120215	V	40	D021010	X	6	D036050	XII	33	F10210	IV	124
C120220	V	40	D021011	X	6	D037010	XII	33	F10220	IV	124
C120225	V	40	D021012	X	6	D037020	XII	33	F10230	IV	124
C120230	V	40	D021022	X	6	D037030	XII	33	F10240	IV	124
C120240	V	40	D021042	X	3	D037040	XII	33	F10340	VIII	7
C120250	V	40	D021052	X	3	D037050	XII	33	F10350	VIII	7
C120300	V	40	D021060	X	3	D04010	X	18	F10360	VIII	7
D01010	X	12	D021061	X	3	D04020	X	18	F10380	VIII	8
D010110	X	12	D021062	X	3	D040210	X	18	F103801	VIII	8
D01020	X	12	D021070	X	3	D040211	X	18	F10390	VIII	8
D010210	X	12	D021080	X	3	D040212	X	18	F103901	VIII	8
D010290	X	12	D021082	X	3	D040390	X	19	F10400	VIII	8
D01030	X	12	D021102	X	5	D04040	X	19	F104001	VIII	8
D010390	X	12	D021112	X	5	D040410	X	19	F104100	VIII	8
D01040	X	12	D021122	X	5	D040411	X	19	F10420	VIII	9
D010440	X	13	D021130	X	5	D040420	X	20	F10450	VIII	9
D010460	X	13	D021140	X	5	D040440	X	19	F104580	VIII	11
D01050	X	13	D021142	X	5	D040441	X	19	F10460	VIII	11
D010501	X	13	D021150	X	5	D04050	XII	45	F10470	VIII	11
D010502	X	13	D021160	X	5	D04060	XII	45	F10480	VIII	12
D010550	X	13	D021170	X	7	D040700	X	20	F10505	VIII	12
D01060	X	14	D021180	X	7	D040710	X	20	F10515	VIII	12

## Index numérique - Numerical index - Índice numérico

Références References Referencias	Chapitre Chapter Capítulo	Page Page Página	Références References Referencias	Chapitre Chapter Capítulo	Page Page Página	Références References Referencias	Chapitre Chapter Capítulo	Page Page Página	Références References Referencias	Chapitre Chapter Capítulo	Page Page Página
F105151	VIII	13	F107050	VIII	81	F16070	VIII	33	F201130	VIII	67
F105152	VIII	13	F107055	VIII	81	F16080	VIII	33	F20160	VIII	62
F105153	VIII	13	F10710	VIII	53	F16090	VIII	33	F20165	VIII	62
F105155	VIII	14	F107105	VIII	53	F16100	VIII	33	F201655	VIII	63
F10516	VIII	14	F10720	VIII	54	F16110	VIII	33	F201660	VIII	63
F105165	VIII	14	F107205	VIII	54	F16120	VIII	33	F201665	VIII	63
F10517	VIII	10	F107210	VIII	54	F16130	VIII	33	F20290	VIII	64
F105175	VIII	10	F107220	VIII	57	F16140	VIII	33	F20295	VIII	64
F105185	VIII	10	F107230	VIII	57	F16150	VIII	33	F20300	VIII	64
F105450	VIII	16	F107240	VIII	57	F16160	VIII	33	F210010	VIII	92
F10550	VIII	15	F107250	VIII	58	F16170	VIII	33	F210020	VIII	92
F10570	VIII	15	F107260	VIII	58	F16180	VIII	33	F210030	VIII	92
F105701	VIII	15	F107270	VIII	58	F16190	VIII	33	F210110	VIII	92
F105760	VIII	15	F10730	VIII	55	F16200	VIII	33	F210120	VIII	92
F10580	VIII	17	F10732	VIII	55	F16210	VIII	33	F210130	VIII	92
F10590	VIII	17	F107330	VIII	56	F16220	VIII	33	F210200	VIII	92
F105910	VIII	18	F107340	VIII	59	F16230	VIII	33	F210210	VIII	92
F105911	VIII	18	F10735	VIII	56	F16240	VIII	33	F210220	VIII	92
F105912	VIII	18	F10736	VIII	56	F16250	VIII	33	F210250	VIII	92
F105913	VIII	18	F10737	VIII	59	F163000	VIII	34	F210260	VIII	92
F105920	VIII	18	F10738	VIII	59	F163001	VIII	34	F25010	VIII	48
F105921	VIII	18	F10740	VIII	60	F163002	VIII	34	F250110	VIII	48
F105922	VIII	18	F10755	VIII	60	F163003	VIII	34	F25020	VIII	48
F105923	VIII	18	F10780	VIII	81	F163011	VIII	34	F250210	VIII	48
F105930	VIII	19	F107870	VIII	55	F163012	VIII	34	F25025	VIII	48
F105931	VIII	19	F107900	VIII	60	F163013	VIII	34	F250260	VIII	49
F105932	VIII	19	F10800	VIII	60	F163021	VIII	35	F250261	VIII	49
F105933	VIII	19	F10805	VIII	78	F163022	VIII	35	F250265	VIII	49
F105934	VIII	19	F10810	VIII	78	F163031	VIII	35	F250266	VIII	49
F105935	VIII	19	F108180	VIII	25	F163032	VIII	35	F250270	VIII	50
F105940	VIII	19	F108190	VIII	25	F163033	VIII	35	F250271	VIII	50
F105941	VIII	19	F108200	VIII	25	F163041	VIII	35	F250272	VIII	50
F105945	VIII	21	F108205	VIII	25	F163042	VIII	35	F250273	VIII	50
F105946	VIII	21	F109000	VIII	93	F163043	VIII	35	F250274	VIII	50
F105948	VIII	21	F109010	VIII	93	F17016	VIII	31	F250275	VIII	50
F105949	VIII	21	F109020	VIII	93	F17025	VIII	31	F250276	VIII	50
F105950	VIII	22	F109030	VIII	93	F17030	VIII	31	F250277	VIII	50
F105951	VIII	22	F109040	VIII	93	F17035	VIII	31	F250278	VIII	50
F105955	VIII	22	F109200	VIII	94	F17040	VIII	31	F250280	VIII	37
F105956	VIII	22	F109210	VIII	94	F17130	VIII	31	F25030	VIII	37
F105960	VIII	23	F109220	VIII	94	F17135	VIII	31	F25035	VIII	37
F105961	VIII	23	F15310	VIII	89	F17140	VIII	31	F25040	VIII	37
F105965	VIII	23	F15320	VIII	89	F17165	VIII	31	F250450	VIII	37
F105970	VIII	16	F153340	VIII	89	F17630	VIII	32	F25050	VIII	37
F105971	VIII	16	F153341	VIII	89	F17634	VIII	32	F25060	VIII	37
F105980	VIII	20	F153350	VIII	89	F17638	VIII	32	F25070	VIII	37
F105981	VIII	20	F153351	VIII	89	F17734	VIII	32	F25080	VIII	37
F106040	VIII	24	F153352	VIII	89	F17738	VIII	32	F25100	VIII	38
F10605	VIII	24	F153360	VIII	90	F178000	VIII	31,32	F25105	VIII	38
F106060	VIII	24	F15340	VIII	87	F18125	VIII	31	F25110	VIII	39
F10610	VIII	26	F15350	VIII	87	F18130	VIII	31	F25115	VIII	39
F10620	VIII	27	F153510	VIII	87	F18135	VIII	31	F25120	VIII	40
F106210	VIII	27	F153520	VIII	87	F18230	VIII	31	F25125	VIII	40
F106220	VIII	28	F153540	VIII	87	F18235	VIII	31	F251260	VIII	47
F106230	VIII	28	F153610	VIII	88	F18240	VIII	31	F251261	VIII	47
F106240	VIII	28	F153620	VIII	88	F190010	VIII	36	F251262	VIII	47
F10630	VIII	26	F153626	VIII	88	F190020	VIII	36	F251270	VIII	46
F10640	VIII	27	F153628	VIII	88	F200050	VIII	64	F251271	VIII	46
F10650	VIII	29	F153630	VIII	88	F200060	VIII	64	F251272	VIII	46
F106511	VIII	29	F15370	VIII	51	F20010	VIII	65	F251275	VIII	46
F106512	VIII	29	F15380	VIII	51	F20020	VIII	65	F251276	VIII	46
F106513	VIII	29	F15390	VIII	51	F20030	VIII	65	F251280	VIII	41
F106521	VIII	29	F16000	VIII	31	F20070	VIII	65	F251281	VIII	41
F106522	VIII	29	F16010	VIII	31	F20090	VIII	65	F251290	VIII	41
F106523	VIII	29	F16020	VIII	31	F20092	VIII	65	F25130	VIII	44
F106530	VIII	30	F16030	VIII	31	F201000	VIII	66	F25135	VIII	44
F106531	VIII	30	F16034	VIII	31	F201010	VIII	66	F25140	VIII	44
F106540	VIII	30	F16038	VIII	31	F201020	VIII	66	F25145	VIII	44
F10690	VIII	52	F16040	VIII	31	F201100	VIII	67	F251480	VIII	44
F106910	VIII	52	F16050	VIII	31	F201110	VIII	67	F251490	VIII	44
F10700	VIII	52	F16060	VIII	31	F201120	VIII	67	F25150	VIII	44



## Index numérique - Numerical index - Índice numérico

Références References Referencias	Chapitre Chapter Capítulo	Page Page Página	Références References Referencias	Chapitre Chapter Capítulo	Page Page Página	Références References Referencias	Chapitre Chapter Capítulo	Page Page Página	Références References Referencias	Chapitre Chapter Capítulo	Page Page Página
F25155	VIII	44	F30210	VIII	68	F304140	VIII	77	F36275	VIII	83
F25160	VIII	44	F30220	VIII	68	F304150	VIII	79	F36280	VIII	83
F251610	VIII	43	F30230	VIII	68	F304160	VIII	79	F36285	VIII	83
F251615	VIII	43	F30245	VIII	69	F304170	VIII	79	F36300	VIII	85
F251620	VIII	44	F30250	VIII	69	F30420	VIII	80	F36310	VIII	85
F251621	VIII	44	F30260	VIII	69	F304300	VIII	80	F36315	VIII	85
F251622	VIII	44	F30270	VIII	69	F304321	VIII	80	F363155	VIII	85
F251630	VIII	45	F30280	VIII	69	F304322	VIII	80	F363200	VIII	85
F251631	VIII	45	F30290	VIII	69	F30435	VIII	80	F36400	VIII	84
F251632	VIII	45	F30300	VIII	69	F30455	VIII	80	F36410	VIII	84
F251633	VIII	45	F30311	VIII	74	F305000	VIII	81	F36420	VIII	84
F251635	VIII	45	F30312	VIII	74	F315005	VIII	61	F36430	VIII	84
F251636	VIII	45	F30313	VIII	74	F315006	VIII	61	F36440	VIII	84
F251637	VIII	45	F30314	VIII	74	F315007	VIII	61	F36450	VIII	84
F251640	VIII	43	F30316	VIII	74	F315015	VIII	61	F36460	VIII	84
F251645	VIII	43	F30317	VIII	74	F315016	VIII	61	F36470	VIII	84
F25165	VIII	43	F30319	VIII	74	F315017	VIII	61	F36480	VIII	84
F251690	VIII	43	F303200	VIII	74	F315020	VIII	61	F36485	VIII	84
F25170	VIII	43	F303210	VIII	74	F315021	VIII	61	F36490	VIII	84
F251720	VIII	43	F303220	VIII	74	F315022	VIII	61	F36494	VIII	84
F251740	VIII	43	F303230	VIII	74	F315122	VIII	61	F36498	VIII	84
F25175	VIII	43	F303240	VIII	74	F36010	VIII	82	F365050	VIII	84
F251770	VIII	43	F30332	VIII	74	F36015	VIII	82	F365060	VIII	84
F251790	VIII	43	F30333	VIII	74	F36020	VIII	82	F365070	VIII	84
F25180	VIII	43	F30334	VIII	74	F36025	VIII	82	F365080	VIII	84
F251840	VIII	43	F30335	VIII	74	F36030	VIII	82	F365090	VIII	84
F25185	VIII	43	F30336	VIII	74	F36035	VIII	82	F365100	VIII	84
F251900	VIII	43	F30337	VIII	74	F36040	VIII	82	F365200	VIII	84
F251950	VIII	43	F30338	VIII	74	F36045	VIII	82	F365201	VIII	84
F260010	VIII	42	F303382	VIII	74	F36050	VIII	82	F365202	VIII	84
F260020	VIII	42	F303383	VIII	74	F36055	VIII	82	F365203	VIII	84
F260030	VIII	42	F303385	VIII	74	F36060	VIII	82	F365204	VIII	84
F260040	VIII	42	F303386	VIII	74	F36065	VIII	82	F365205	VIII	84
F260050	VIII	42	F303387	VIII	74	F36070	VIII	82	F365206	VIII	84
F260060	VIII	42	F30340	VIII	71	F36075	VIII	82	F365207	VIII	84
F260070	VIII	42	F30350	VIII	71	F36080	VIII	82	F366006	VIII	82
F260080	VIII	42	F30360	VIII	71	F36085	VIII	82	F366009	VIII	82
F260090	VIII	42	F30370	VIII	71	F36090	VIII	82	F366012	VIII	82
F260100	VIII	42	F30380	VIII	71	F36095	VIII	82	F366015	VIII	82
F260110	VIII	42	F30390	VIII	71	F36100	VIII	82	F366018	VIII	82
F260120	VIII	42	F303911	VIII	72	F36105	VIII	82	F366021	VIII	82
F30010	VIII	70	F303912	VIII	72	F36110	VIII	82	F366024	VIII	82
F30015	VIII	70	F303913	VIII	72	F36115	VIII	82	F366027	VIII	82
F30020	VIII	70	F303914	VIII	72	F36120	VIII	82	F366030	VIII	82
F30030	VIII	70	F303915	VIII	72	F36125	VIII	82	F366033	VIII	82
F30040	VIII	70	F303916	VIII	72	F36130	VIII	82	F366036	VIII	82
F30050	VIII	70	F303921	VIII	72	F36135	VIII	82	G25010	VI	5
F30060	VIII	70	F303922	VIII	72	F36140	VIII	82	G25020	VI	5
F30070	VIII	70	F303923	VIII	72	F36145	VIII	82	G25030	VI	5
F30080	VIII	73	F303924	VIII	72	F36150	VIII	82	G25040	VI	5
F300801	VIII	73	F303925	VIII	72	F36155	VIII	82	G250410	VI	5
F30090	VIII	73	F303926	VIII	72	F36160	VIII	82	G25050	VI	7
F300901	VIII	73	F304000	VIII	75	F36165	VIII	82	G25060	VI	7
F30100	VIII	73	F304005	VIII	75	F36170	VIII	82	G25061	VI	7
F301001	VIII	73	F304010	VIII	75	F36175	VIII	82	G25080	VI	7
F30110	VIII	73	F304030	VIII	75	F36180	VIII	82	G25135	VI	6
F301101	VIII	73	F304040	VIII	75	F36185	VIII	82	G25140	VI	6
F30120	VIII	73	F304042	VIII	75	F36190	VIII	82	G25150	VI	6
F301201	VIII	73	F304044	VIII	75	F36195	VIII	82	G25160	VI	6
F30130	VIII	73	F304050	VIII	76	F36200	VIII	82	G254607	VI	6
F301301	VIII	73	F304060	VIII	76	F36210	VIII	82	G254612	VI	6
F30140	VIII	73	F304065	VIII	76	F36220	VIII	82	G254614	VI	6
F301401	VIII	73	F304070	VIII	76	F36230	VIII	82	G254616	VI	6
F30150	VIII	73	F304104	VIII	77	F36240	VIII	82	G254618	VI	6
F301501	VIII	73	F304106	VIII	77	F36250	VIII	82	G254620	VI	6
F30160	VIII	73	F304108	VIII	77	F36260	VIII	82	G300050	VI	9
F301601	VIII	73	F304110	VIII	77	F362610	VIII	82	G30010	VI	9
F30170	VIII	68	F304112	VIII	77	F362620	VIII	82	G300150	VI	9
F30180	VIII	68	F304114	VIII	77	F362630	VIII	82	G300200	VI	8
F30190	VIII	68	F304120	VIII	77	F362640	VIII	82	G300205	VI	8
F30200	VIII	68	F304130	VIII	77	F36270	VIII	83	G300210	VI	8



Références References Referencias	Chapitre Chapter Capítulo	Page Page Página	Références References Referencias	Chapitre Chapter Capítulo	Page Page Página	Références References Referencias	Chapitre Chapter Capítulo	Page Page Página	Références References Referencias	Chapitre Chapter Capítulo	Page Page Página
G300215	VI	8	G30230	VI	16	G402050	VI	30	H20083	IX	12
G300220	VI	8	G30230L	VI	16	G402070	VI	30	H20085	VII	12
G300230	VI	10	G30240	VI	16	G40210	VI	30	H20087	VII	12
G300240	VI	10	G30240L	VI	16	G40215	VI	30	H20089	VII	12
G300250	VI	12	G30250	VI	16	G402350	VI	30	H20091	VII	12
G300260	VI	12	G30260	VI	16	G40240	VI	30	H20093	VII	12
G300300	VI	12	G30270	VI	16	G40250	VI	30	H20095	VII	12
G300305	VI	12	G30280	VI	18	G402550	VI	30	H200961	VII	12
G300310	VI	12	G30290	VI	18	G40260	VI	30	H200962	VII	12
G30050	VI	10	G30300	VI	18	G402650	VI	30	H200963	VII	12
G30060	VI	10	G30310	VI	18	G402670	VI	30	H200964	VII	12
G30070	VI	10	G303110	VI	18	G40270	VI	30	H200965	VII	12
G30080	VI	9	G303120	VI	18	G40275	VI	30	H200966	VII	12
G300805	VI	11	G303200	VI	22	G40340	VI	32	H20110-0	VIII	86
G300810	VI	11	G303201	VI	22	G403401	VI	32	H210002	IX	13
G300815	VI	11	G303202	VI	22	G403402	VI	32	H210003	IX	13
G30082	VI	11	G303203	VI	22	G40350	VI	32	H210004	IX	13
G30084	VI	11	G303210	VI	22	G403501	VI	32	H210005	IX	13
G30086	VI	11	G303215	VI	22	G403502	VI	32	H210006	IX	13
G30088	VI	11	G303290	VI	17	G403510	VI	31	H210008	IX	13
G300891	VI	14	G303300	VI	17	G403520	VI	31	H210011	IX	13
G300892	VI	14	G303301	VI	17	G403540	VI	31	H210015	IX	13
G300893	VI	14	G303310	VI	17	G403550	VI	31	H210100	IX	13
G30090	VI	15	G303320	VI	17	G403600	VI	33	H250140	VIII	86
G300950	VI	15	G30370	VI	19	G403610	VI	33	H250160	VIII	86
G30100	VI	15	G30380	VI	19	G403620	VI	33	H250180	VIII	86
G30100L	VI	15	G30390	VI	19	G403630	VI	34	H250200	VIII	86
G30110	VI	15	G30440	VI	22	G403640	VI	34	H250220	VIII	86
G30110L	VI	15	G30450	VI	22	G403650	VI	34	H250240	VIII	86
G30120	VI	15	G30460	VI	22	H10010	IX	4	H250260	VIII	86
G30120L	VI	15	G305000	VI	25	H10020	IX	4	H250280	VIII	86
G30130	VI	15	G305010	VI	25	H10030	IX	4	H250300	VIII	86
G30140	VI	15	G305015	VI	25	H10040	IX	4	H250320	VIII	86
G30150	VI	15	G305020	VI	25	H10050	IX	4	H250340	VIII	86
G30151	VI	13	G305100	VI	25	H10060	IX	5	H250360	VIII	86
G30152	VI	20	G305110	VI	25	H10070	IX	5	H250380	VIII	86
G301521	VI	20	G305115	VI	25	H10080	IX	5	H250400	VIII	86
G30152L	VI	20	G305120	VI	25	H10090	IX	5	H250420	VIII	86
G30153	VI	20	G305215	VI	25	H100910	IX	3	H250440	VIII	86
G301531	VI	20	G305220	VI	25	H100911	IX	3	H250460	VIII	86
G30153L	VI	20	G305600	VI	26	H100921	IX	3	H250480	VIII	86
G30154	VI	20	G305630	VI	26	H100922	IX	3	H250500	VIII	86
G301541	VI	20	G305640	VI	26	H100923	IX	3	H250520	VIII	86
G30154L	VI	20	G305660	VI	26	H100924	IX	3	H250540	VIII	86
G30155	VI	20	G305670	VI	26	H10100	IX	6	H250560	VIII	86
G301551	VI	20	G305680	VI	26	H10115	IX	6	H250580	VIII	86
G30156	VI	20	G30610	XIV	29	H10120	IX	6	H250600	VIII	86
G301561	VI	20	G306300	XIV	29	H10130	IX	6	H251010	VIII	86
G30158	VI	13	G30640	XIV	29	H101310	IX	7	H251012	VIII	86
G30159	VI	13	G35004	VI	27	H101311	IX	7	H251016	VIII	86
G30160	VI	21	G35008	VI	27	H101320	IX	7	H251018	VIII	86
G301601	VI	21	G35012	VI	27	H101321	IX	7	H251110	VIII	86
G30164	VI	21	G35016	VI	27	H101330	IX	7	H251112	VIII	86
G301641	VI	21	G35132	VI	27	H10140	VIII	95	H251116	VIII	86
G30164L	VI	21	G35136	VI	27	H10145	VIII	95	H40010	IX	14
G30170	VI	21	G35140	VI	27	H10150	VIII	95	H40020	IX	14
G301701	VI	21	G35144	VI	27	H10170	VII	93	H40030	IX	14
G30170L	VI	21	G40050	VI	28	H10175	IX	11	H40040	IX	14
G30180	VI	21	G40060	VI	28	H200110	IX	11	H40050	IX	14
G301801	VI	21	G40070	VI	28	H200120	IX	11	H40060	IX	14
G30182	VI	21	G40080	VI	28	H20025	IX	12	H40070	IX	14
G301821	VI	21	G40100	VI	29	H20030	IX	12	H40080	IX	14
G30190	VI	21	G40110	VI	29	H20040	IX	12	H40090	IX	14
G301901	VI	21	G40120	VI	29	H20050	IX	12	H40100	IX	14
G301950	VI	23	G40135	VI	29	H20060	IX	12	H40110	IX	14
G301960	VI	23	G401360	VI	29	H20070	IX	12	H40120	IX	14
G301990	VI	23	G401750	VI	30	H20071	IX	12	H40130	IX	14
G30200	VI	23	G40180	VI	30	H20072	IX	12	I05010	XII	7
G30210	VI	16	G40190	VI	30	H20080	IX	12	I05020	XII	7
G30220	VI	16	G401950	VI	30	H20081	IX	12	I05030	XII	7
G30220L	VI	16	G40200	VI	30	H20082	IX	12	I050410	XII	7

## Index numérique - Numerical index - Índice numérico

Références References Referencias	Chapitre Chapter Capítulo	Page Page Página	Références References Referencias	Chapitre Chapter Capítulo	Page Page Página	Références References Referencias	Chapitre Chapter Capítulo	Page Page Página	Références References Referencias	Chapitre Chapter Capítulo	Page Page Página
I05050	XII	8	I150621	II	40	I15340	XII	23	I17001	XII	37
I05060	XII	8	I150630	II	40	I15342	XII	23	I170010	XII	37
I050690	XII	9	I15070	XII	13	I15344	XII	23	I170011	XII	37
I05070	XII	9	I15080	XII	13	I15346	XII	23	I170012	XII	37
I050810	XII	9	I150810	XII	13	I15348	XII	23	I170013	XII	37
I05120	XII	8	I150815	XII	13	I15350	XII	23	I170020	XII	37
I051210	XII	8	I150820	XII	13	I15360	XII	23	I170021	XII	37
I05130	XII	10	I150880	II	36	I15370	XII	23	I170022	XII	37
I051310	XII	10	I150881	II	36	I153978	XII	24	I170023	XII	37
I051320	XII	10	I150882	II	36	I153980	XII	24	I170030	XII	39
I051325	XII	10	I150885	II	36	I153981	XII	24	I170031	XII	39
I051326	XII	10	I150886	II	36	I153982	XII	24	I170032	XII	39
I051327	XII	10	I150887	II	36	I153983	XII	24	I170040	XII	39
I051328	XII	10	I150890	II	36	I153985	XII	24	I170042	XII	39
I051329	XII	10	I150895	II	36	I153986	XII	24	I170044	XII	39
I051410	XII	11	I15110	II	36	I153990	XII	24	I170046	XII	39
I051415	XII	11	I15120	II	36	I153991	XII	24	I17005	XII	38
I051416	XII	11	I151305	XII	17	I153992	XII	24	I17010	XII	38
I051417	XII	11	I151306	XII	17	I153993	XII	24	I17015	XII	38
I051418	XII	11	I151311	XII	17	I153995	XII	24	I17020	XII	38
I051419	XII	11	I151312	XII	17	I153996	XII	24	I17025	XII	38
I051510	XII	11	I151382	XII	16	I154903	XII	24	I17030	XII	38
I051515	XII	11	I151383	XII	16	I154904	XII	24	I17035	XII	38
I051516	XII	11	I151384	XII	16	I154913	XII	24	I17040	XII	38
I051517	XII	11	I151385	XII	16	I154914	XII	24	I17045	XII	38
I052100	XII	9	I151386	XII	16	I15495	XII	25	I170460	XII	38
I052110	XII	9	I151388	XII	16	I15500	XII	25	I170461	XII	38
I052120	XII	9	I15140-0	XII	16	I155010	XII	25	I17050	XII	38
I052130	XII	9	I15141-0	XII	16	I15701	XII	26	I17055	XII	38
I10010	XII	12	I15142-0	XII	16	I15703	XII	26	I17060	XII	38
I10015	XII	12	I15145-0	XII	16	I15704	XII	26	I17065	XII	38
I10020	XII	12	I15146-0	XII	16	I15705	XII	26	I17070	XII	38
I10022	XII	12	I15147-0	XII	16	I16010	XII	27	I17075	XII	38
I10024	XII	12	I15148-0	XII	16	I16015	XII	27	I17080	XII	38
I100300	XII	12	I15150	XII	16	I16020	XII	27	I17085	XII	38
I15010	XII	14	I15151	XII	16	I160250	XII	28	I17090	XII	38
I15020	XII	14	I15160	XII	16	I160255	XII	28	I170920	XII	40
I150250	XII	14	I15170	XII	16	I160260	XII	28	I170924	XII	40
I15030	XII	14	I15175	XII	18	I160300	XII	34	I170926	XII	40
I150310	XII	15	I15180	XII	18	I160310	XII	34	I170928	XII	40
I150311	XII	15	I15185	XII	18	I16035	XII	29	I170940	XII	40
I15032	XII	15	I151855	XII	18	I160360	XII	29	I170941	XII	40
I15034	XII	15	I151860	XII	18	I16040	XII	34	I170942	XII	40
I15036	XII	15	I151861	XII	18	I160440	XII	27	I17100	XII	41
I15038	XII	15	I151862	XII	18	I16045	XII	27	I17102	XII	41
I15042	XII	15	I151863	XII	18	I16055	XII	28	I17104	XII	41
I15044	XII	15	I151871	XII	19	I160570	XII	28	I171060	XII	41
I150441	II	40	I151872	XII	19	I16060	XII	28	I171065	XII	41
I150442	II	40	I151881	XII	19	I160610	XII	28	I17108	XII	40
I150443	II	40	I151882	XII	19	I160620	XII	28	I17110	XII	40
I150444	II	40	I151883	XII	19	I160630	XII	28	I17112	XII	42
I150445	II	40	I15190	XII	20	I16100	XII	36	I17114	XII	52
I150446	II	40	I15200	XII	20	I16102	XII	36	I17116	XII	42
I150490	II	38	I152003	XII	20	I16104	XII	36	I171170	XII	42
I15050	II	38	I152004	XII	20	I16106	XII	36	I17118	XII	42
I150501	II	38	I152090	XII	20	I16108	XII	36	I171242	XII	44
I150502	II	38	I152092	XII	20	I16110	XII	36	I171243	XII	44
I150503	II	38	I152100	XII	21	I16112	XII	36	I171245	XII	44
I150504	II	38	I152101	XII	21	I16114	XII	36	I171246	XII	44
I150505	II	38	I152102	XII	21	I162000	XII	35	I171247	XII	44
I150590	II	38	I152105	XII	21	I162001	XII	35	I171248	XII	44
I15060	II	38	I152106	XII	21	I162010	XII	35	I171249	XII	44
I150601	II	38	I152110	XII	21	I162011	XII	35	I171260	XII	43
I150602	II	38	I152115	XII	21	I162020	XII	35	I171265	XII	43
I150603	II	38	I15220	XII	22	I162021	XII	35	I171270	XII	43
I150604	II	38	I15230	XII	22	I162030	XII	35	I171274	XII	43
I150605	II	38	I15232	XII	22	I162040	XII	35	I171275	XII	43
I150610	II	39	I15234	XII	22	I170005	XII	37	I171280	XII	44
I150611	II	39	I15240	XII	22	I170007	XII	37	I171290	XII	52
I150612	II	39	I15250	XII	22	I170008	XII	37	I171292	XII	52
I150620	II	40	I15330	XII	25	I170009	XII	37	I171295	XII	52

## Index numérique - Numerical index - Índice numérico

Références References Referencias	Chapitre Chapter Capítulo	Page Page Página	Références References Referencias	Chapitre Chapter Capítulo	Page Page Página	Références References Referencias	Chapitre Chapter Capítulo	Page Page Página	Références References Referencias	Chapitre Chapter Capítulo	Page Page Página
I171297	XII	52	I180374	XII	55	J04040	XIII	11	J122540	XIII	20
I171300	XII	52	I180375	XII	55	J040410	XIII	11	J122550	XIII	20
I171305	XII	46	I180376	XII	55	J040420	XIII	11	J122590	XIII	20
I171306	XII	46	I180377	XII	55	J040430	XIII	11	J12260	XIII	20
I171307	XII	46	I180380	XII	55	J04050	XIII	12	J122610	XIII	20
I171308	XII	46	I180381	XII	55	J04060	XIII	12	J12270	XIII	21
I171310	XII	47	I180385	XII	56	J04070	XIII	12	J12285	XIII	20
I171311	XII	47	I180386	XII	56	J040802	XIII	12	J14020	XIII	22
I171312	XII	47	I180387	XII	56	J040803	XIII	12	J140210	XIII	22
I171315	XII	47	I18040-0	XII	57	J040804	XIII	12	J140310	XIII	22
I171320	XII	47	I18042-0	XII	57	J040806	XIII	12	J140400	XIII	22
I171322	XII	47	I18044-0	XII	57	J04090	XIII	13	J140410	XIII	22
I171325	XII	47	I18046-0	XII	57	J041000	XIII	14	J140610	XIII	23
I171330	XII	49	I180502	XII	57	J041010	XIII	14	J140620	XIII	23
I171331	XII	49	I180503	XII	57	J041020	XIII	14	J140710	XIII	23
I171332	XII	49	I180504	XII	57	J041030	XIII	14	J140801	XIII	23
I171335	XII	49	I180515	XII	57	J041040	XIII	14	J140802	XIII	23
I171340	XII	49	I180703	XII	59	J041050	XIII	14	J140803	XIII	23
I171355	XII	46	I180704	XII	59	J041060	XIII	14	J140804	XIII	23
I171360	XII	50	I180705	XII	59	J041070	XIII	14	J140805	XIII	23
I171361	XII	50	I180706	XII	59	J041080	XIII	14	J140806	XIII	23
I171365	XII	50	I180707	XII	59	J041090	XIII	13	J14090	XIII	21
I171370	XII	50	I180708	XII	59	J041095	XIII	13	J141100	XIII	16
I171375	XII	50	I180713	XII	59	J08010	XIII	48	J141110	XIII	16
I171380	XII	51	I180714	XII	59	J080101	XIII	48	J141120	XIII	16
I171381	XII	51	I180715	XII	59	J08030	XIII	63	J141130	XIII	16
I171390	XII	51	I180716	XII	59	J08031	XIII	63	J141140	XIII	17
I171395	XII	51	I180717	XII	59	J08035	XII	45	J141150	XIII	17
I171396	XII	51	I180718	XII	59		XIII	24	J141160	XIII	17
I17140	XII	48	I180720	XII	59	J08060	XIII	37	J141200	XIII	17
I17142	XII	48	I180721	XII	59	J08070	XIII	37	J141290	XIII	15
I17144	XII	48	I180722	XII	59	J080710	XIII	36	J141300	XIII	15
I17146	XII	48	I180723	XII	59	J08080	XIII	28	J141310	XIII	15
I17148	XII	48	I180724	XII	59	J080900	XIII	37	J14140	XIII	15
I171481	XII	48	I180733	XII	60	J080901	XIII	37	J14145	III	87
I171490	XII	52	I180743	XII	58	J081000	XIII	36	J141460	III	87
I17150	XII	52	I180753	XII	58	J081010	XIII	36	J150100	XI	3
I17155	XII	52	I180754	XII	58	J081020	XIII	36	J150110	XI	3
I17160	XII	54	I182015	XII	57	J081030	XIII	36	J150120	XI	3
I17162	XII	54	I182020	XII	57	J082010	V	6	J150130	XI	3
I180000	XII	54	I182025	XII	57	J082020	V	6	J150140	XI	3
I180002	XII	55	I182030	XII	57	J082030	V	6	J150150	XI	3
I180003	XII	55	I182102	XII	58	J12030	XIII	15	J150160	XI	3
I180004	XII	55	I182103	XII	58	J12060	XIII	15	J150170	XI	3
I180022	XII	56	I182104	XII	58	J120649	XIII	15	J150180	XI	3
I180023	XII	56	I182105	XII	58	J120650	XIII	15	J150190	XI	3
I180030	XII	56	I182106	XII	58	J120651	XIII	15	J151010	XI	4
I180031	XII	56	I182108	XII	58	J120652	XIII	15	J151011	XI	4
I180032	XII	56	I182109	XII	58	J120700	XIII	18	J151012	XI	4
I180033	XII	56	I182202	XII	58	J120710	XIII	18	J151013	XI	4
I180035	XII	56	I182203	XII	58	J120827	XIII	18	J151020	XI	4
I180036	XII	56	I182204	XII	58	J120828	XIII	18	J151021	XI	4
I180037	XII	56	I182205	XII	58	J120830	XIII	18	J151022	XI	4
I180038	XII	56	I182206	XII	58	J120831	XIII	18	J151023	XI	4
I18005	XII	54	I182208	XII	58	J120931	XIII	18	J151030	XI	4
I18010	XII	54	I182209	XII	58	J120932	XIII	18	J151031	XI	4
I18020	XII	54	I190050	XII	84	J121610	XIII	19	J151040	XI	5
I18021	XII	54	I190060	III	84	J121612	XIII	19	J151041	XI	5
I18022	XII	54	I190070	III	83	J121615	XIII	19	J151042	XI	5
I18024	XII	54	I190075	III	83	J121620	XIII	19	J151043	XI	5
I18025	XII	54	I190080	III	84	J121623	XIII	19	J151044	XI	5
I18027	XII	54	I190085	III	84	J121625	XIII	19	J151045	XI	5
I18028	XII	54	I190090	III	84	J121627	XIII	19	J151050	XI	5
I18030	XII	54	I19010	III	83	J12180	XIII	19	J151051	XI	5
I18031	XII	54		XII	53	J12190	XIII	19	J151052	XI	5
I18033	XII	54	I19020	III	83	J12220	XIII	19	J151053	XI	5
I18034	XII	54		XII	53	J12225	XIII	19	J151060	XI	5
I18036	XII	54	I19030	XII	53	J12230	XIII	18	J151061	XI	5
I18037	XII	54	I19040	XII	53	J12240	XIII	20	J152000	XI	7
I180372	XII	55	I19050	XII	53	J12250	XIII	20	J152001	XI	6
I180373	XII	55	J04010	XIII	11	J122530	XIII	20	J152002	XI	6

## Index numérique - Numerical index - Índice numérico

Références Referencias Referencias	Chapitre Chapter Capítulo	Page Page Página	Références Referencias Referencias	Chapitre Chapter Capítulo	Page Page Página	Références Referencias Referencias	Chapitre Chapter Capítulo	Page Page Página	Références Referencias Referencias	Chapitre Chapter Capítulo	Page Page Página
J152003	XI	6	J162803	XIII	25	J170927	XI	12	J17140E	XI	18
J152100	XI	8	J17001	XI	11	J170928	XI	12	J171821	XI	17
J152101	XI	8	J17002	XI	11	J170929	XI	12	J171822	XI	17
J152110	XI	8	J17003	XI	11	J170931	XI	12	J171823	XI	17
J152111	XI	8	J170040	XI	11	J170932	XI	12	J171824	XI	17
J152120	XI	7	J170041	XI	11	J1709330	XI	12	J171825	XI	17
J152121	XI	7	J170042	XI	11	J1709333	XI	12	J171831	XI	17
J152204	XI	7	J170043	XI	11	J1709334	XI	12	J171831ET	XI	18
J152206	XI	7	J170044	XI	11	J1709335	XI	12	J171832	XI	17
J152208	XI	7	J170046	XI	11	J1709336	XI	12	J171832ET	XI	18
J152210	XI	7	J170047	XI	11	J1709337	XI	12	J171833	XI	17
J152303	XI	8	J17005	XI	11	J1709338	XI	12	J171833ET	XI	18
J152305	XI	8	J17006	XI	11	J1709339	XI	12	J171834	XI	17
J152307	XI	8	J17007	XI	11	J1709340	XI	12	J171834ET	XI	18
J16010	XI	9	J17010	XI	11	J1709341	XI	12	J171835	XI	17
J16020	XI	9	J17012	XI	11	J1709342	XI	12	J171835ET	XI	18
J160210	XI	9	J17015	XI	11	J1709343	XI	12	J172001	XI	17
J160225	XI	9	J170160	XI	11	J1709344	XI	12	J172002	XI	17
J160226	XI	9	J170161	XI	11	J1709345	XI	12	J172003	XI	17
J160227	XI	9	J170162	XI	11	J1709346	XI	12	J172003B	XI	19
J16030	XI	9	J170163	XI	11	J1709347	XI	12	J172004	XI	17
J16040	XI	9	J170164	XI	11	J1709348	XI	12	J172004B	XI	19
J16050	XI	9	J170166	XI	11	J1709380	XI	13	J172005	XI	17
J16060	XI	9	J170167	XI	11	J1709381	XI	13	J172005B	XI	19
J16065	XI	9	J17020	XI	11	J1709382	XI	13	J172011	XI	16
J16075	XI	9	J17025	XI	11	J1709383	XI	13	J172011B	XI	19
J160760	XI	9	J17035	XI	11	J1709384	XI	13	J172011E	XI	18
J160770	XI	9	J17045	XI	11	J1709385	XI	13	J172011ET	XI	18
J160780	XI	9	J17050	XI	11	J1709386	XI	13	J172011T	XI	16
J160790	XI	9	J17055	XI	11	J1709387	XI	13	J172011TB	XI	19
J161000	XI	10	J170560	XI	11	J1709388	XI	13	J172012	XI	16
J161010	XI	10	J170561	XI	11	J1709389	XI	13	J172012B	XI	19
J161020	XI	10	J170562	XI	11	J170940	XI	17	J172012E	XI	18
J161030	XI	10	J170563	XI	11	J170940B	XI	19	J172012ET	XI	18
J161040	XI	10	J170564	XI	11	J17095	XI	17	J172012T	XI	16
J161050	XI	10	J170566	XI	11	J17095B	XI	19	J172012TB	XI	19
J161060	XI	10	J170567	XI	11	J17100	XI	17	J172013	XI	16
J161080	XI	10	J17060	XI	11	J17100B	XI	19	J172013B	XI	19
J161090	XI	10	J17065	XI	11	J17110	XI	17	J172013E	XI	18
J161100	XI	10	J17070	XI	11	J17110B	XI	19	J172013ET	XI	18
J162200	XIII	37	J170750	XI	14	J17115	XI	17	J172013T	XI	16
J162210	XIII	34	J170751	XI	14	J17115B	XI	19	J172013TB	XI	19
J162220	XIII	28	J170752	XI	14	J171170	XI	16	J172014	XI	16
J162222	XIII	28	J17080	XI	14	J171170B	XI	19	J172014B	XI	19
J162223	XIII	28	J17085	XI	14	J171170E	XI	18	J172014E	XI	18
J162230	XIII	26	J170860	XI	14	J171170ET	XI	18	J172014ET	XI	18
J162240	XIII	26	J170898	XI	14	J171170T	XI	16	J172014T	XI	16
J16230	XIII	27	J170899	XI	14	J171170TB	XI	19	J172014TB	XI	19
J162310	XIII	24	J17090	XI	14	J17118	XI	16	J172015	XI	16
J162320	XIII	24	J170901	XI	15	J171180ET	XI	18	J172015B	XI	19
J162330	XIII	24	J170902	XI	15	J171180T	XI	16	J172015E	XI	18
J162345	XIII	27	J170903	XI	15	J171180TB	XI	19	J172015ET	XI	18
J162350	XIII	25	J170904	XI	15	J17118B	XI	19	J172015T	XI	16
J16240	XIII	25	J170905	XI	15	J17118E	XI	18	J172015TB	XI	19
J162410	XIII	25	J170906	XI	15	J17120	XI	16	J172016	XI	16
J16245	XIII	25	J170907	XI	15	J171200ET	XI	18	J172016E	XI	18
J162460	XIII	25	J170908	XI	15	J171200T	XI	16	J172016ET	XI	18
J16250	XIII	32	J170909	XI	15	J171200TB	XI	19	J172016T	XI	16
J16255	XIII	32	J170910	XI	12	J17120B	XI	19	J172021	XI	17
J162561	XIII	32	J170911	XI	12	J17120E	XI	18	J172022	XI	17
J162563	XIII	32	J170913	XI	12	J17130	XI	16	J172023	XI	17
J162565	XIII	32	J170914	XI	12	J171300ET	XI	18	J172024	XI	17
J16260	XIII	26	J170916	XI	12	J171300T	XI	16	J172025	XI	17
J16265	XIII	26	J170917	XI	12	J171300TB	XI	19	J172312	XI	16
J16270	XIII	29	J170919	XI	12	J17130B	XI	19	J172312T	XI	16
J162702	XIII	29	J170920	XI	12	J17130E	XI	18	J172313	XI	16
J162710	XIII	29	J170921	XI	12	J17140	XI	16	J172313T	XI	16
J162720	XIII	29	J170922	XI	12	J171400ET	XI	18	J172314	XI	16
J16275	XIII	28	J170923	XI	12	J171400T	XI	16	J172314T	XI	16
J162801	XIII	25	J170925	XI	12	J171400TB	XI	19	J172315	XI	16
J162802	XIII	25	J170926	XI	12	J17140B	XI	19	J172315T	XI	16

Index numérique - Numerical index - Índice numérico

Références References Referencias	Chapitre Chapter Capítulo	Page Page Página	Références References Referencias	Chapitre Chapter Capítulo	Page Page Página	Références References Referencias	Chapitre Chapter Capítulo	Page Page Página	Références References Referencias	Chapitre Chapter Capítulo	Page Page Página
J172333	XI	17	J201832E	XI	21	J24078	XIII	44	J243728	XIII	35
J172333ET	XI	18	J201833E	XI	21	J24080	XIII	44	J243729	XIII	35
J172334	XI	17	J201834E	XI	21	J24090	XIII	44	J24373	XIII	35
J172334ET	XI	18	J201835E	XI	21	J24100	XIII	44	J243731	XIII	35
J172335	XI	17	J202011E	XI	21	J24110	XIII	44	J243732	XIII	35
J172335ET	XI	18	J202011EB	XI	22	J24120	XIII	44	J243735	XIII	35
J172512	XI	16	J202011ET	XI	21	J24130	XIII	44	J243736	XIII	35
J172512B	XI	19	J202011ETB	XI	22	J24140	XIII	44	J243738	XIII	32
J172512T	XI	16	J202012E	XI	21	J24150	XIII	44	J243739	XIII	51
J172512TB	XI	19	J202012EB	XI	22	J24160	XIII	44	J24374	XIII	51
J172513	XI	16	J202012ET	XI	21	J241690	XIII	45	J24376	XIII	51
J172513B	XI	19	J202012ETB	XI	22	J24170	XIII	45	J243770	XIII	51
J172513T	XI	16	J202013E	XI	21	J241790	XIII	45	J243772	XIII	51
J172513TB	XI	19	J202013EB	XI	22	J24180	XIII	45	J243775	XIII	51
J172514	XI	16	J202013ET	XI	21	J241810	XIII	45	J243777	XIII	51
J172514B	XI	19	J202013ETB	XI	22	J241811	XIII	45	J243778	XIII	51
J172514T	XI	16	J202014E	XI	21	J241901	XIII	46	J24378	XIII	33
J172514TB	XI	19	J202014EB	XI	22	J241902	XIII	46	J24380	XIII	33
J172515	XI	16	J202014ET	XI	21	J241903	XIII	46	J24390	XIII	33
J172515B	XI	19	J202014ETB	XI	22	J241904	XIII	46	J243910	XIII	33
J172515T	XI	16	J202015E	XI	21	J241905	XIII	46	J243920	XIII	33
J172515TB	XI	19	J202015EB	XI	22	J241906	XIII	46	J243990	XIII	33
J172803	XI	17	J202015ET	XI	21	J241907	XIII	46	J24400	XIII	33
J172804	XI	17	J202015ETB	XI	22	J241908	XIII	46	J24405	XIII	33
J172805	XI	17	J202016E	XI	21	J241910	XIII	38	J24410	XIII	33
J172813	XI	16	J202016EB	XI	22	J241911	XIII	38	J244130	XIII	33
J172813T	XI	16	J202311E	XI	21	J241912	XIII	38	J244140	XIII	33
J172814	XI	16	J202311EB	XI	22	J241913	XIII	38	J24415	XIII	33
J172814T	XI	16	J202312E	XI	21	J241915	XIII	38	J24420	XIII	33
J172815	XI	16	J202312EB	XI	22	J24192	XIII	49	J24425	XIII	33
J172815T	XI	16	J202312ET	XI	21	J24193	XIII	49	J244300	XIII	33
J191801	XI	20	J202312ETB	XI	22	J24194	XIII	49	J244310	XIII	33
J191802	XI	20	J202313E	XI	21	J24195	XIII	49	J244320	XIII	33
J191803	XI	20	J202313EB	XI	22	J242005	XIII	47	J244330	XIII	34
J191804	XI	20	J202313ET	XI	21	J242155	XIII	47	J244340	XIII	34
J191805	XI	20	J202313ETB	XI	22	J242160	XIII	47	J244350	XIII	34
J191811	XI	20	J202314E	XI	21	J242170	XIII	47	J244360	XIII	34
J191812	XI	20	J202314EB	XI	22	J242180	XIII	47	J244370	XIII	34
J191813	XI	20	J202314ET	XI	21	J24219	XIII	49	J244400	XIII	51
J191814	XI	20	J202314ETB	XI	22	J24220	XIII	49	J244410	XIII	51
J191815	XI	20	J202315E	XI	21	J24230	XIII	49	J244650	XIII	83
J192003	XI	20	J202315EB	XI	22	J24240	XIII	49	J24466	XIII	83
J192004	XI	20	J202315ET	XI	21	J24250	XIII	49	J244670	XIII	83
J192005	XI	20	J202315ETB	XI	22	J24260	XIII	49	J244680	XIII	83
J192013	XI	20	J202323E	XI	21	J24270	XIII	49	J244705	XIII	83
J192014	XI	20	J202324E	XI	21	J24280	XIII	50	J244900	XIII	43
J192015	XI	20	J202325E	XI	21	J24282	XIII	50	J245000	XIII	43
J201811E	XI	21	J202811E	XI	21	J24284	XIII	50	J245010	XIII	43
J201811EB	XI	22	J202811EB	XI	22	J24290	XIII	50	J245020	XIII	43
J201811ET	XI	21	J202812E	XI	21	J24300	XIII	50	J245110	XIII	41
J201811ETB	XI	22	J202812EB	XI	22	J24310	XIII	50	J245120	XIII	41
J201812E	XI	21	J202813E	XI	21	J24320	XIII	50	J245130	XIII	41
J201812EB	XI	22	J202813EB	XI	22	J24360	XIII	47	J245131	XIII	41
J201812ET	XI	21	J202814E	XI	21	J24370	XIII	47	J245132	XIII	41
J201812ETB	XI	22	J202814EB	XI	22	J243705	XIII	48	J245133	XIII	41
J201813E	XI	21	J202815E	XI	21	J243706	XIII	48	J245134	XIII	41
J201813EB	XI	22	J202815EB	XI	22	J24371	XIII	48	J245135	XIII	41
J201813ET	XI	21	J231360	XV	8	J243712	XIII	31	J245137	XIII	41
J201813ETB	XI	22	J231362	XV	8	J243713	XIII	31	J245138	XIII	41
J201814E	XI	21	J231364	XV	8	J243716	XIII	30	J245139	XIII	42
J201814EB	XI	22	J231366	XV	8	J243717	XIII	30	J245140	XIII	42
J201814ET	XI	21	J231370	XV	8	J243718	XIII	30	J245141	XIII	42
J201814ETB	XI	22	J235504	XIII	27	J243719	XIII	30	J245145	XIII	42
J201815E	XI	21	J235505	XIII	29	J24372	XIII	27	J245146	XIII	42
J201815EB	XI	22	J24010	XIII	44	J243720	XIII	26	J245147	XIII	42
J201815ET	XI	21	J24020	XIII	44	J243721	XIII	26	J245150	XIII	42
J201815ETB	XI	22	J24030	XIII	44	J243722	XIII	27	J245200	XIII	40
J201823E	XI	21	J24040	XIII	44	J243724	XIII	31	J245201	XIII	40
J201824E	XI	21	J24050	XIII	44	J243725	XIII	30	J245202	XIII	40
J201825E	XI	21	J24060	XIII	44	J243726	XIII	31	J245203	XIII	40
J201831E	XI	21	J24070	XIII	44	J243727	XIII	31	J245210	XIII	40

## Index numérique - Numerical index - Índice numérico

Références References Referencias	Chapitre Chapter Capítulo	Page Page Página	Références References Referencias	Chapitre Chapter Capítulo	Page Page Página	Références References Referencias	Chapitre Chapter Capítulo	Page Page Página	Références References Referencias	Chapitre Chapter Capítulo	Page Page Página
J245211	XIII	40	J283100	XIII	58	J28350	XIII	65	J320026	XIII	69
J245212	XIII	40	J283101	XIII	58	J28360	XIII	65	J320028	XIII	69
J245213	XIII	40	J283102	XIII	58	J28370	XIII	65	J320030	XIII	69
J245220	XIII	39	J283103	XIII	58	J283790	XIII	60	J320032	XIII	69
J245301	XIII	39	J283104	XIII	58	J283791	XIII	60	J320034	XIII	69
J245302	XIII	39	J283105	XIII	58	J283792	XIII	60	J320036	XIII	69
J245303	XIII	39	J283106	XIII	58	J283800	XIII	60	J32010	XIII	70
J245304	XIII	39	J283107	XIII	58	J283801	XIII	60	J32020	XIII	70
J28005	XIII	55	J283108	XIII	58	J283802	XIII	60	J32030	XIII	70
J28010	XIII	55	J283110	XIII	58	J283803	XIII	60	J32040	XIII	70
J28020	XIII	55	J283120	XIII	58	J283810	XIII	61	J32050	XIII	70
J28030	XIII	55	J283200	XIII	62	J283811	XIII	61	J32060	XIII	70
J28040	XIII	55	J283201	XIII	62	J283812	XIII	61	J320613	XIII	68
J28050	XIII	55	J283202	XIII	62	J283813	XIII	61	J320614	XIII	68
J28060	XIII	55	J283203	XIII	62	J283814	XIII	61	J320615	XIII	68
J28070	XIII	55	J283204	XIII	62	J283820	XIII	61	J320616	XIII	68
J28080	XIII	55	J283205	XIII	62	J283821	XIII	61	J320617	XIII	68
J28090	XIII	55	J283206	XIII	62	J283822	XIII	61	J320623	XIII	68
J28110	XIII	55	J283207	XIII	62	J283823	XIII	61	J320624	XIII	68
J28130	XIII	55	J283208	XIII	62	J283830	XIII	61	J320625	XIII	68
J28150	XIII	55	J283210	XIII	62	J283831	XIII	61	J320626	XIII	68
J281507	XIII	55	J283211	XIII	62	J283832	XIII	61	J320627	XIII	68
J281508	XIII	55	J283212	XIII	62	J283833	XIII	61	J320634	XIII	68
J281509	XIII	55	J283213	XIII	62	J283840	XIII	64	J320636	XIII	68
J28151	XIII	55	J283214	XIII	62	J283841	XIII	64	J320644	XIII	71
J281515	XIII	55	J283215	XIII	62	J283842	XIII	64	J320646	XIII	71
J28152	XIII	55	J283216	XIII	62	J283850	XIII	64	J320648	XIII	71
J281525	XIII	55	J283217	XIII	62	J283851	XIII	64	J320650	XIII	71
J28153	XIII	55	J283218	XIII	62	J283852	XIII	64	J320652	XIII	71
J281535	XIII	55	J283220	XIII	62	J283860	XIII	64	J320654	XIII	71
J28155	XIII	55	J283221	XIII	62	J283861	XIII	64	J320670	XIII	71
J28156	XIII	55	J283222	XIII	62	J283862	XIII	64	J320671	XIII	71
J28157	XIII	55	J283223	XIII	62	J28400	XIII	65	J320672	XIII	71
J28158	XIII	55	J283224	XIII	62	J28402	XIII	52	J320673	XIII	71
J281620	XIII	56	J283225	XIII	62	J284030	XIII	52	J320674	XIII	71
J28163	XIII	56	J283226	XIII	62	J28404	XIII	52	J320675	XIII	71
J28170	XIII	56	J283227	XIII	62	J284050	XIII	52	J320676	XIII	71
J28180	XIII	56	J283228	XIII	62	J284060	XIII	52	J320680	XIII	71
J28190	XIII	56	J283233	XIII	63	J284070	XIII	52	J320681	XIII	71
J28200	XIII	56	J283234	XIII	63	J284080	XIII	52	J320682	XIII	71
J28210	XIII	56	J283235	XIII	63	J28412	XIII	52	J320683	XIII	71
J28220	XIII	56	J283300	XIII	63	J284130	XIII	52	J320684	XIII	71
J28230	XIII	56	J283310	XIII	63	J28414	XIII	52	J320685	XIII	71
J282310	XIII	56	J283320	XIII	63	J284150	XIII	52	J320686	XIII	71
J28232	XIII	56	J283400	XIII	59	J284160	XIII	52	J320710	XIII	74
J28234	XIII	56	J283401	XIII	59	J284170	XIII	52	J320715	XIII	74
J28236	XIII	56	J283402	XIII	59	J284180	XIII	52	J320720	XIII	74
J28240	XIII	56	J283403	XIII	59	J28420	XIII	52	J320725	XIII	74
J28250	XIII	56	J283404	XIII	59	J28425	XIII	52	J320730	XIII	74
J28260	XIII	56	J283405	XIII	59	J284260	XIII	53	J320735	XIII	74
J28270	XIII	56	J283406	XIII	59	J284274	XIII	53	J320740	XIII	74
J28280	XIII	56	J283407	XIII	59	J284275	XIII	53	J320762	XIII	74
J28290	XIII	56	J283408	XIII	59	J284276	XIII	53	J320766	XIII	74
J28300	XIII	56	J283410	XIII	59	J284279	XIII	53	J320768	XIII	74
J283001	XIII	57	J283411	XIII	59	J284280	XIII	53	J320800	XIII	75
J283002	XIII	57	J283412	XIII	59	J284281	XIII	53	J320802	XIII	75
J283003	XIII	57	J283413	XIII	59	J284290	XIII	53	J320803	XIII	75
J283004	XIII	57	J283414	XIII	59	J284300	XIII	54	J320804	XIII	75
J283005	XIII	57	J283415	XIII	59	J284310	XIII	54	J320805	XIII	75
J283006	XIII	57	J283416	XIII	59	J284320	XIII	54	J320810	XIII	75
J283007	XIII	57	J283417	XIII	59	J284330	XIII	54	J320812	XIII	75
J283008	XIII	57	J283418	XIII	59	J284340	XIII	54	J320813	XIII	75
J283009	XIII	57	J283420	XIII	59	J284350	XIII	54	J320814	XIII	75
J283010	XIII	57	J283421	XIII	59	J320004	XIII	69	J320815	XIII	75
J283021	XIII	57	J283422	XIII	59	J320006	XIII	69	J320990	XIII	75
J283022	XIII	57	J283423	XIII	59	J320008	XIII	69	J320991	XIII	75
J283023	XIII	57	J283424	XIII	59	J320010	XIII	69	J320992	XIII	75
J283024	XIII	57	J283425	XIII	59	J320012	XIII	69	J320993	XIII	75
J283025	XIII	57	J283426	XIII	59	J320014	XIII	69	J32100	XIII	75
J283026	XIII	57	J283427	XIII	59	J320016	XIII	69	J32110	XIII	75
J283027	XIII	57	J283428	XIII	59	J320024	XIII	69	J321101	XIII	75

## Index numérique - Numerical index - Índice numérico

Références References Referencias	Chapitre Chapter Capítulo	Page Page Página	Références References Referencias	Chapitre Chapter Capítulo	Page Page Página	Références References Referencias	Chapitre Chapter Capítulo	Page Page Página	Références References Referencias	Chapitre Chapter Capítulo	Page Page Página
J321102	XIII	75	J32580	XIII	66	J327225	XIII	72	J36270	XIII	72
J32140	XIII	75	J32590	XIII	66	J327230	XIII	72	J36280	XIII	72
J32150	XIII	75	J32600	XIII	66	J328006	XIII	75	J36290	XIII	72
J32160	XIII	75	J32610	XIII	66	J328008	XIII	75	J36300	XIII	72
J32170	XIII	75	J32620	XIII	66	J328010	XIII	75	J36310	XIII	72
J32190	XIII	75	J32621	XIII	67	J328012	XIII	75	J36320	XIII	72
J32200	XIII	75	J32622	XIII	67	J328015	XIII	75	J36330	XIII	72
J32210	XIII	75	J32623	XIII	67	J328020	XIII	75	J36335	XIII	77
J32220	XIII	75	J32624	XIII	67	J328025	XIII	75	J36340	XIII	77
J32235	XIII	73	J32625	XIII	67	J328030	XIII	75	J36345	XIII	77
J32240	XIII	72	J32627	XIII	76	J328904	XIII	80	J36350	XIII	76
J32250	XIII	72	J32628	XIII	76	J328906	XIII	80	J36360	XIII	76
J32260	XIII	72	J32629	XIII	76	J328908	XIII	80	J36370	XIII	76
J32270	XIII	72	J32630	XIII	76	J328910	XIII	80	J36380	XIII	76
J32280	XIII	72	J32640	XIII	76	J328912	XIII	80	J36390	XIII	76
J32290	XIII	72	J32650	XIII	76	J329005	XIII	80	J36400	XIII	76
J32300	XIII	72	J32660	XIII	76	J329007	XIII	80	J36410	XIII	76
J32310	XIII	72	J32665	XIII	76	J329010	XIII	80	J36420	XIII	76
J32320	XIII	72	J32675	XIII	65	J329015	XIII	80	J36430	XIII	76
J32330	XIII	72	J32678	XIII	67	J329020	XIII	80	J36440	XIII	76
J32340	XIII	72	J32682	XIII	67	J329025	XIII	80	J36450	XIII	76
J32350	XIII	72	J32684	XIII	67	J329030	XIII	80	J36460	XIII	76
J32360	XIII	72	J32686	XIII	67	J329120	XIII	81	J364714	XIII	78
J32370	XIII	72	J32688	XIII	67	J329130	XIII	81	J364716	XIII	78
J32380	XIII	72	J326890	XIII	73	J36020	XIII	77	J364718	XIII	78
J32390	XIII	72	J326891	XIII	73	J36030	XIII	77	J364720	XIII	78
J32400	XIII	70	J326892	XIII	73	J36040	XIII	77	J364814	XIII	78
J32410	XIII	70	J326893	XIII	73	J36042	XIII	77	J364816	XIII	78
J32420	XIII	70	J326894	XIII	73	J36044	XIII	77	J364818	XIII	78
J32430	XIII	74	J326895	XIII	73	J36060	XIII	77	J364820	XIII	78
J32440	XIII	74	J326896	XIII	73	J36070	XIII	77	J364914	XIII	78
J32450	XIII	74	J326897	XIII	73	J36080	XIII	77	J364916	XIII	78
J32460	XIII	74	J326898	XIII	73	J360904	XIII	69	J364918	XIII	78
J324621	XIII	66	J326899	XIII	73	J360906	XIII	69	J364920	XIII	78
J324622	XIII	66	J326900	XIII	73	J360908	XIII	69	J36560	XIII	75
J324623	XIII	66	J326901	XIII	73	J360910	XIII	69	J36570	XIII	75
J324624	XIII	66	J326902	XIII	73	J360912	XIII	69	J36580	XIII	75
J324625	XIII	66	J326903	XIII	73	J360914	XIII	69	J36590	XIII	75
J324626	XIII	66	J326904	XIII	73	J360916	XIII	69	J36600	XIII	76
J324627	XIII	66	J326905	XIII	73	J36100	XIII	70	J366170	XIII	79
J32465	XIII	66	J326906	XIII	73	J36110	XIII	70	J366180	XIII	79
J324658	XIII	66	J326907	XIII	73	J36120	XIII	70	J366190	XIII	79
J32470	XIII	66	J326908	XIII	73	J36130	XIII	70	J36620	XIII	79
J324750	XIII	66	J326909	XIII	73	J36140	XIII	70	J36625	XIII	79
J32480	XIII	66	J326910	XIII	72	J36150	XIII	70	J36635	XIII	79
J324850	XIII	66	J326912	XIII	72	J361513	XIII	68	J36650	XIII	65
J32490	XIII	66	J326915	XIII	72	J361514	XIII	68	J36700	XIII	79
J32500	XIII	66	J326920	XIII	72	J361515	XIII	68	J36705	XIII	79
J32510	XIII	66	J326925	XIII	72	J361516	XIII	68	J36710	XIII	79
J32520	XIII	66	J327006	XIII	72	J361517	XIII	68	J368904	XIII	80
J32530	XIII	66	J327008	XIII	72	J361523	XIII	68	J368906	XIII	80
J32540	XIII	66	J327010	XIII	72	J361524	XIII	68	J368908	XIII	80
J325418	XIII	66	J327012	XIII	72	J361525	XIII	68	J368910	XIII	80
J325420	XIII	66	J327015	XIII	72	J361526	XIII	68	J368912	XIII	80
J325421	XIII	66	J327020	XIII	72	J361527	XIII	68	J369005	XIII	80
J325422	XIII	66	J327025	XIII	72	J361534	XIII	68	J369007	XIII	80
J325423	XIII	66	J327030	XIII	72	J361536	XIII	68	J369010	XIII	80
J325424	XIII	66	J327106	XIII	72	J361546	XIII	71	J369015	XIII	80
J325425	XIII	66	J327108	XIII	72	J361548	XIII	71	J369020	XIII	80
J325426	XIII	66	J327110	XIII	72	J361550	XIII	71	J369025	XIII	80
J325427	XIII	66	J327112	XIII	72	J361552	XIII	71	J369030	XIII	80
J325428	XIII	66	J327115	XIII	72	J361554	XIII	71	J369105	XIII	81
J325429	XIII	66	J327120	XIII	72	J36180	XIII	72	J369110	XIII	81
J325430	XIII	66	J327125	XIII	72	J36190	XIII	72	J369205	XIII	81
J325450	XIII	66	J327130	XIII	72	J36200	XIII	72	J369210	XIII	81
J325455	XIII	66	J327206	XIII	72	J36210	XIII	72	J369215	XIII	81
J32550	XIII	66	J327208	XIII	72	J36220	XIII	72	J369305	XIII	81
J32555	XIII	66	J327210	XIII	72	J36230	XIII	72	J369310	XIII	81
J32560	XIII	66	J327212	XIII	72	J36240	XIII	72	J369315	XIII	81
J32565	XIII	66	J327215	XIII	72	J36250	XIII	72	J369406	XIII	82
J32570	XIII	66	J327220	XIII	72	J36260	XIII	72	J369408	XIII	82

## Index numérique - Numerical index - Índice numérico

Références References Referencias	Chapitre Chapter Capítulo	Page Page Página	Références References Referencias	Chapitre Chapter Capítulo	Page Page Página	Références References Referencias	Chapitre Chapter Capítulo	Page Page Página	Références References Referencias	Chapitre Chapter Capítulo	Page Page Página
J369411	XIII	82	J441114	XIII	92	J52170	VII	144	J644880	XIII	103
J369413	XIII	82	J441115	XIII	92	J521750	VII	144	J644885	XIII	103
J369416	XIII	82	J441115	XIII	91	J52180	VII	115	J644890	XIII	103
J369425	XIII	82	J441116	XIII	91	J521850	VII	108	J64490	XIII	103
J369429	XIII	82	J441117	XIII	91	J521860	VII	108	J644950	XIII	104
J369440	XIII	82	J441200	XIII	92	J52210	VII	142	J644960	XIII	104
J400010	XIII	84	J44121	XIII	93	J52220	VII	142	J644970	XIII	104
J400020	XIII	84	J44122	XIII	93	J52230	VII	142	J644980	XIII	104
J40010	XIII	84	J44123	XIII	93	J522400	VII	142	J644984	XIII	104
J40020	XIII	84	J442008	XIII	93	J56020	XIV	10	J644986	XIII	104
J40025	XIII	84	J442010	XIII	93	J560350	XIII	96	J644990	XIII	102
J40030	XIII	84	J442012	XIII	93	J56040	XIII	96	J644995	XIII	102
J40040	XIII	85	J48020	XIII	94	J56050	XIII	96	J644996	XIII	102
J40045	XIII	85	J48030	XIII	94	J56055	XIII	96	J645000	XIII	105
J40050	XIII	85	J48040	XIII	94	J56070	XIII	96	J645010	XIII	105
J40055	XIII	85	J48050	XIII	94	J561120	XIII	95	J645100	XIII	106
J40060	XIII	85	J520050	VII	141	J561130	XIII	95	J645110	XIII	105
J40070	XIII	85	J52010	VII	141	J561200	XIII	95	J645120	XIII	105
J40075	XIII	85	J52020	VII	141	J64020	XIII	97	J645200	XIII	102
J40080	XIII	85	J520230	VII	137	J64030	XIII	97	J645205	XIII	102
J40090	XIII	85	J520231	VII	137	J64040	XIII	97	J645210	XIII	105
J400950	XIII	86	J520240	VII	138	J64060	XIII	97	J645215	XIII	106
J401000	XIII	88	J520260	VII	138	J64070	XIII	97	J645220	XIII	107
J401180	XIII	89	J520280	VII	138	J64080	XIII	97	J645230	XIII	107
J401190	XIII	89	J52030	VII	138	J64090	XIII	97	J645235	XIII	108
J40120	XIII	89	J520320	VII	138	J64100	XIII	97	J645240	XIII	108
J401300	XIII	89	J520340	VII	138	J64120	XIII	97	J645245	XIII	108
J401301	XIII	89	J52040	VII	138	J64130	XIII	97	J645250	XIII	110
J401302	XIII	89	J520420	VII	138	J64150	XIII	98	J645251	XIII	110
J401303	XIII	89	J520440	VII	138	J64160	XIII	98	J645300	XIII	115
J401401	XIII	88	J520450	VII	138	J64190	XIII	106	J645310	XIII	115
J401405	XIII	88	J52050	VII	137	J64192	XIII	106	J645315	XIII	115
J401500	XIII	86	J52060	VII	137	J64200	XIII	111	J68010	XIII	118
J401600	XIII	86	J52070	VII	137	J64210	XIII	111	J68012	XIII	118
J401700	XIII	87	J52072	VII	131	J64220	XIII	111	J68015	XIII	118
J401710	XIII	87	J52074	VII	131	J64230	XIII	111	J68020	XIII	118
J401800	XIII	87	J52076	VII	132	J64240	XIII	111	J68022	XIII	116
J401810	XIII	87	J520770	VII	131	J64250	XIII	111	J68024	XIII	116
J44005	XIII	90	J52078	VII	132	J64254	XIII	113	J68026	XIII	116
J440070	XIII	90	J520785	VII	132	J64256	XIII	113	J68028	XIII	116
J440075	XIII	90	J52082	VII	132	J642570	XIII	113	J68030	XIII	116
J44010	XIII	90	J520830	VII	132	J64260	XIII	98	J68040	XIII	116
J44020	XIII	90	J52084	VII	133	J64270	XIII	100	J68050	XIII	116
J44032	XIII	90	J52086	VII	134	J64280	XIII	114	J68060	XIII	116
J44035	XIII	90	J52088	VII	134	J64290	XIII	99	J68062	XIII	116
J44040	XIII	90	J52092	VII	133	J64310	XIII	99	J68064	XIII	116
J44045	XIII	90	J520925	VII	135	J64330	XIII	99	J68066	XIII	116
J44050	XIII	90	J520926	VII	135	J64340	XIII	99	J68068	XIII	116
J44055	XIII	90	J520930	VII	135	J64350	XIII	99	J680700	XIII	117
J44060	XIII	90	J520935	VII	136	J64370	XIII	114	J680710	XIII	117
J44065	XIII	90	J520936	VII	136	J64380	XIII	99	J680715	XIII	117
J44066	XIII	90	J520938	VII	130	J643810	XIII	100	J680720	XIII	117
J44068	XIII	90	J52094	VII	130	J64384	XIII	109	J68090	XIII	119
J44070	XIII	90	J52096	VII	130	J643850	XIII	109	J68100	XIII	119
J44071	XIII	90	J52098	VII	130	J64386	XIII	109	J681090	XIII	120
J440723	XIII	92	J520990	VII	130	J64390	XIII	109	J68110	XIII	120
J440724	XIII	92	J521001	VII	139	J643950	XIII	109	J681190	XIII	119
J440725	XIII	92	J521002	VII	139	J64400	XIII	101	J68120	XIII	119
J440726	XIII	92	J521003	VII	139	J644005	XIII	101	J68130	XIII	121
J440728	XIII	92	J521004	VII	139	J644010	XIII	101	J68150	XIII	121
J440733	XIII	92	J521010	VII	139	J64410	XIII	109	J681600	XIII	124
J440734	XIII	92	J521015	VII	139	J64412	XIII	112	J681601	XIII	124
J440735	XIII	92	J521020	VII	139	J64414	XIII	112	J681605	XIII	122
J440736	XIII	92	J521030	VII	140	J64416	XIII	112	J681610	XIII	123
J440738	XIII	92	J521035	VII	140	J64418	XIII	112	J681615	XIII	123
J44075	XIII	91	J521040	VII	140	J64422	XIII	112	J681620	XIII	123
J44085	XIII	91	J52130	VII	143	J64480	XIII	109	J681630	XIII	123
J44100	XIII	91	J52150	VII	143	J644830	XIII	110	J68170	XIII	121
J44105	XIII	91	J521505	VII	143	J644850	XIII	110	J68180	XIII	121
J44110	XIII	91	J521600	VII	143	J644870	XIII	112	J681900	XIII	121
J441113	XIII	92	J521610	VII	143	J644875	XIII	103	J68210	XIII	122



## Index numérique - Numerical index - Índice numérico

Références References Referencias	Chapitre Chapter Capítulo	Page Page Página	Références References Referencias	Chapitre Chapter Capítulo	Page Page Página	Références References Referencias	Chapitre Chapter Capítulo	Page Page Página	Références References Referencias	Chapitre Chapter Capítulo	Page Page Página
J68220	XIII	122	J72575	XIII	126	J758426	XIV	35	J80435	XIII	155
J68230	XIII	122	J725800	XIII	126	J758430	XIV	26	J80440	XIII	155
J68240	XIII	122	J725810	XIII	126	J758431	XIV	26	J80445	XIII	155
J68250	XIII	125	J725850	XIII	126	J759030	XIV	27	J80450	XIII	155
J68260	XIII	125	J725860	XIII	136	J759040	XIV	27	J804510	XIII	143
J68270	XIII	125	J725870	XIII	136	J759041	XIV	27	J804520	XIII	143
J68275	XIII	118	J725880	XIII	136	J759042	XIV	27	J804530	XIII	143
J68280	XIII	118	J725885	XIII	136	J759050	XIV	27	J80455	XIII	155
J72010	XIII	127	J725890	XIII	136	J759060	XIV	28	J80460	XIII	143
J72020	XIII	132	J72590	XIII	128	J759061	XIV	28	J80470	XIII	143
J72030	XIII	132	J72595	XIII	128	J759062	XIV	28	J80480	XIII	143
J72040	XIII	132	J72600	XIII	128	J759063	XIV	28	J804850	XIII	143
J72050	XIII	132	J72605	XIII	128	J759100	XIV	28	J804860	XIII	143
J72060	XIII	132	J72610	XIII	128	J759105	XIV	28	J804870	XIII	143
J72070	XIII	132	J72612	XIII	128	J759110	XIV	28	J804880	XIII	143
J72090	XIII	139	J72615	XIII	128	J759115	XIV	28	J804885	XIII	143
J72100	XIII	138	J72620	XIII	128	J76020	XV	23	J80495	XIII	156
J721010	XIII	138	J72700	III	86	J760250	XV	23	J804960	XIII	156
J721020	XIII	138	J72705	XIII	141	J76030	XV	23	J804970	XIII	156
J72110	XIII	139	J727100	XIII	141	J760310	XV	23	J80500	XIII	155
J72120	XIII	135	J727110	XIII	141	J76050	XV	21	J805050	XIII	144
J72130	XIII	135	J727120	XIII	141	J76060	XV	21	J80510	XIII	144
J72140	XIII	135	J727500	XIII	140	J76070	XV	21	J80520	XIII	144
J72150	XIII	135	J727550	XIII	140	J76080	XV	24	J80530	XIII	144
J72160	XIII	135	J727560	XIII	140	J76090	XV	24	J805310	XIII	144
J72170	XIII	135	J727570	XIII	140	J76100	XV	24	J80540	XIII	144
J72180	XIII	137	J727580	XIII	140	J76110	XV	24	J80550	XIII	144
J721810	XIII	137	J727590	XIII	140	J76120	XV	24	J82010	XIII	146
J721820	XIII	137	J731100	XIV	29	J76128	XV	23	J82020	XIII	146
J72190	XIII	127	J731200	XIV	29	J76130	XV	23	J82030	XIII	147
J721901	XIII	127	J731300	XIV	29	J76140	III	85	J82040	XIII	147
J72195	XIII	141	J731400	XIV	29	J76140	XV	22	J82050	XIII	147
J72200	XIII	133	J732000	XIII	142	J761410	III	85	J821000	XIII	145
J72210	XIII	133	J732005	XIII	142	J761410	XV	22	J821010	XIII	145
J72220	XIII	133	J732010	XIII	142	J761450	XV	22	J821020	XIII	145
J72230	XIII	133	J732020	XIII	142	J761500	XV	22	J821030	XIII	145
J72240	XIII	133	J733000	XIII	142	J780000	XIII	161	J821040	XIII	145
J72250	XIII	133	J733050	XIII	142	J80010	XIII	150	J84010	XIII	148
J72260	XIII	133	J733060	XIII	142	J80015	XIII	150	J84020	XIII	148
J72270	XIII	133	J756900	XIV	25	J80020	XIII	150	J84030	XIII	148
J72280	XIII	133	J757410	XIV	27	J80030	XIII	150	J84040	XIII	148
J72310	XIII	134	J757490	XIV	31	J800400	XIII	150	J84070	XIII	149
J72320	XIII	134	J757500	XIV	31	J800405	XIII	150	J84110	XIII	149
J72330	XIII	134	J757506	XIV	30	J800500	XIII	150	J84120	XIII	149
J72340	XIII	134	J757508	XIV	30	J80075	XIII	151	J84130	XIII	149
J72350	XIII	127	J757510	XIV	30	J80080	XIII	151	J90030	XIII	157
J72355	XIII	129	J757520	XIV	30	J80090	XIII	151	J90040	XIII	157
J72360	XIII	129	J757900	XIV	26	J800950	XIII	151	J90050	XIII	157
J72370	XIII	129	J758000	XIV	26	J80100	XIII	151	J90060	XIII	158
J72380	XIII	129	J758010	XIV	32	J80110	XIII	151	J90065	XIII	158
J72390	XIII	129	J758050	XIV	32	J801110	XIII	151	J90070	XIII	158
J72400	XIII	127	J758060	XIV	32	J80120	XIII	152	J90080	XIII	157
J72405	XIII	129	J758070	XIV	32	J80130	XIII	152	J90090	XIII	157
J72410	XIII	129	J758080	XIV	32	J80140	XIII	152	J901010	XIII	157
J72420	XIII	129	J758200	XIV	31	J801450	XIII	153	J90110	XIII	159
J72430	XIII	129	J758300	XIV	31	J80150	XIII	153	J90120	XIII	159
J72440	XIII	129	J758400	XIV	33	J801550	XIII	153	J90130	XIII	159
J72460	XIII	130	J758401	XIV	34	J80170	III	86	J90140	XIII	159
J72470	XIII	130	J758402	XIV	34	J80200	XIII	154	J90150	XIII	159
J72480	XIII	130	J758403	XIV	33	J80210	XIII	148	J90220	XIII	160
J72490	XIII	130	J758404	XIV	36	J80220	XIII	156	J90230	XIII	160
J72510	XIII	130	J758405	XIV	36	J80230	XIII	156	J90240	XIII	160
J725200	XIII	131	J758406	XIV	35	J80270	XIII	155	J90250	XIII	160
J725201	XIII	131	J758407	XIV	35	J80280	XIII	155	J904000	XIII	161
J725202	XIII	131	J758410	XIV	33	J80290	XIII	155	J904010	XIII	161
J725203	XIII	131	J758416	XIV	35	J80300	XIII	155	J904020	XIII	161
J725204	XIII	131	J758420	XIV	33	J80305	XIII	155	J94020	XIV	40
J72540	XIII	134	J758421	XIV	34	J80370	XIII	154	J940250	XIV	7
J72550	XIII	139	J758423	XIV	33	J80390	XIII	154	J94030	XIV	8
J72560	XIII	139	J758424	XIV	36	J80420	XIII	154	J940310	XIV	8
J72570	XIII	139	J758425	XIV	36	J80430	XIII	155	J94035	XIV	9

## Index numérique - Numerical index - Índice numérico

Références References Referencias	Chapitre Chapter Capítulo	Page Page Página	Références References Referencias	Chapitre Chapter Capítulo	Page Page Página	Références References Referencias	Chapitre Chapter Capítulo	Page Page Página	Références References Referencias	Chapitre Chapter Capítulo	Page Page Página
J940400	XIV	8	M00472	XIV	6	M020230	XIV	41	M03210	XIV	42
J940410	XIV	8	M00473	XIV	6	M020231	XIV	41	M03211	XIV	42
J94050	XIV	9	M00474	XIV	6	M020232	XIV	41	M03212	XIV	42
J94055	XIV	9	M00475	XIV	6	M02030	XIV	43	M03213	XIV	42
J94150	XIV	37	M00476	XIV	6	M02040	XIV	43	M03220	XIV	43
J94160	XIV	37	M00477	XIV	6	M02050	XIV	43	M03240	XIV	39
J94170	XIV	37	M00478	XIV	6	M02070	XIV	45	M03241	XIV	39
J94180	XIV	37	M00490	XIV	10	M02071	XIV	45	M03250	XIV	39
J94190	XIV	37	M00491	XIV	10	M02072	XIV	45	M03260	XIV	39
J94210	XIV	9	M00492	XIV	10	M02080	XIV	44	M03290	XIV	39
M00200	XIV	38	M00493	XIV	10	M02090	XIV	44	M03291	XIV	39
M00201	XIV	38	M00510	XIV	10	M02091	XIV	44	M03320	XIV	44
M00202	XIV	38	M006050	XIV	37	M02092	XIV	44	M03321	XIV	44
M00203	XIV	38	M006055	XIV	37	M02100	XIV	50	M03340	XIV	48
M00204	XIV	38	M006080	XIV	37	M02110	XIV	50	M03350	XIV	48
M00205	XIV	38	M01000	XIV	42	M02120	XIV	50	M03355	XIV	48
M00206	XIV	38	M01040	XIV	23	M02122	XIV	51	M03356	XIV	48
M00207	XIV	38	M01050	XIV	20	M02124	XIV	51	M03357	XIV	48
M00208	XIV	38	M01051	XIV	20	M02126	XIV	51	M03360	XIV	49
M00209	XIV	38	M01052	XIV	20	M02130	XIV	17	M03361	XIV	49
M00210	XIV	38	M01060	XIV	49	M02140	XIV	17	M03362	XIV	49
M00211	XIV	38	M01070	XIV	49	M02150	XIV	19	M03380	XIV	14
M00212	XIV	38	M01080	XIV	49	M02170	XIV	40	M03381	XIV	14
M00213	XIV	38	M01110	XIV	7	M02190	XIV	17, 40	M03382	XIV	14
M00214	XIV	38	M01111	XIV	7	M02200	XIV	11	M03390	XIV	14
M002200	XIV	38	M01112	XIV	7	M02215	XIV	17	M03391	XIV	14
M00250	XIV	40	M01120	XIV	11	M02230	XIV	17	M03392	XIV	15
M00300	XIV	42	M01122	XIV	11	M02235	XIV	17	M03393	XIV	14
M00301	XIV	42	M01124	XIV	11	M02240	XIV	19	M03400	XIV	14
M00302	XIV	42	M01126	XIV	11	M02241	XIV	19	M034010	XIV	14
M00303	XIV	42	M01128	XIV	11	M02270	XIV	24	M03410	XIV	15
M00381	XIV	47	M01130	XIV	11	M02271	XIV	24	M03420	XIV	15
M00382	XIV	47	M01132	XIV	12	M02272	XIV	24	M03422	XIV	15
M00383	XIV	47	M01134	XIV	12	M02273	XIV	24	M03430	XIV	15
M003890	XIV	47	M01136	XIV	12	M02274	XIV	24	M03431	XIV	15
M00390	XIV	47	M01138	XIV	12	M02275	XIV	24	M03432	XIV	15
M00391	XIV	47	M01140	XIV	12	M022760	XIV	24	M03433	XIV	15
M00400	XIV	47	M01150	XIV	12	M022770	XIV	24	M03435	XIV	15
M004001	XIV	47	M01160	XIV	12	M022780	XIV	24	M03436	XIV	15
M00410	XIV	47	M01170	XIV	12	M022790	XIV	24	M03437	XIV	15
M00411	XIV	47	M01175	XIV	12	M03001	XIV	46	M03438	XIV	15
M004510	XIV	5	M01176	XIV	12	M03002	XIV	46	M03440	XIV	18
M004511	XIV	5	M01177	XIV	12	M030030	XIV	46	M03450	XIV	16
M004512	XIV	5	M01200	XIV	13	M03010	XIV	49	M03460	XIV	16
M004513	XIV	5	M01210	XIV	13	M03011	XIV	49	M03470	XIV	16
M004514	XIV	5	M01220	XIV	13	M03012	XIV	49	M03480	XIV	16
M004515	XIV	5	M01230	XIV	13	M03020	XIV	10	M03490	XIV	16
M004516	XIV	5	M01235	XIV	13	M03022	XIV	10	M03500	XIV	23
M004517	XIV	5	M01240	XIV	13	M03024	XIV	10	M03510	XIV	23
M004530	XIV	5	M01241	XIV	13	M03030	XIV	18	M035150	XIV	23
M004531	XIV	5	M01250	XIV	20	M03031	XIV	18	M035160	XIV	23
M004532	XIV	5	M01251	XIV	20	M03032	XIV	18	M03520	XIV	20
M004533	XIV	5	M01252	XIV	20	M03033	XIV	18	M03530	XIV	20
M004534	XIV	5	M01253	XIV	20	M03034	XIV	19	M03600	XIV	25
M004535	XIV	5	M01260	XIV	23	M03035	XIV	19	M036010	XIV	25
M004536	XIV	5	M01270	XIV	23	M03036	XIV	19	M03700	XIV	52
M004537	XIV	5	M012915	XIV	13	M03037	XIV	19	M03710	XIV	52
M004538	XIV	5	M012920	XIV	13	M03040	XIV	46	M03745	XIV	52
M004539	XIV	5	M012925	XIV	13	M03050	XIV	45	M03770	XIV	52
M004540	XIV	5	M012930	XIV	13	M03060	XIV	10	T90090	XV	25
M004541	XIV	5	M012940	XIV	13	M03110	XIV	21	T90095	XV	25
M004542	XIV	5	M012950	XIV	13	M03120	XIV	21	T90098	XV	25
M004543	XIV	5	M012960	XIV	13	M03125	XIV	21	T90100	XV	25
M00460	XIV	6	M02000	XIV	41	M03126	XIV	21	T90110	XV	25
M00461	XIV	6	M02001	XIV	41	M03130	XIV	22	T90120	XV	25
M00462	XIV	6	M02002	XIV	41	M03135	XIV	22	T90130	XV	25
M004625	XIV	6	M02003	XIV	41	M03170	XIV	25	T90140	XV	25
M00463	XIV	6	M02010	XIV	41	M03200	XIV	39	T90141	XV	25
M00464	XIV	6	M02020	XIV	41	M03201	XIV	39	T90143	XV	25
M00470	XIV	6	M02021	XIV	41	M03202	XIV	39	T90145	XV	25
M00471	XIV	6	M020220	XIV	41	M03203	XIV	39	V025650	XV	27

Références References Referencias	Chapitre Chapter Capítulo	Page Page Página
V02650	XV	28
V02660	XV	28
V028000	XV	27
V028001	XV	27
V029000	XV	29
V029001	XV	29
V029002	XV	29
V029003	XV	29
V029004	XV	29
V029005	XV	29
V029006	XV	29
V029100	XV	29
V029101	XV	29
V029102	XV	29
V029103	XV	29
V029200	XV	29
V029210	XV	29
V029300	XV	30
V029350	XV	30
V029400	XV	30
V029450	XV	29
V02570	XV	27
V02575	XV	27
V02580	XV	27
V02610	XV	28
V02620	XV	28
V02630	XV	28
V02640	XV	28
V029451	XV	29
V029452	XV	29
V029500	XV	30
V029550	XV	30
V036000	XV	28
V78070	XV	33
V78090	XV	32
V78100	XV	32
V78110	XV	32
V781150	XV	32
V78130	XV	32
V78170	XV	32
V782000	XV	32
V78300	XV	33
V78320	XV	33
V784000	XV	33



	Page	Chapitre
<b>AACHEN</b>	Spatule neurochirurgie	XI 5
<b>ABADIE</b>	Écarteur	VII 91
Abaisse langue		XV 6, 7
<b>ABOULKER</b>	Dilatateur ORL	XII 12
	Écarteur	VII 11
	Pince gouge	XIII 100
	Rugine et dissecteur	XIII 32
<b>ABRAHAM</b>	Couteau spatule ORL	XII 25
<b>ADLERKREUTZ</b>	Pince à dissection délicate	II 16
	Pince à dissection Prestige	II 50
<b>ADSON</b>	Crochet	XIII 24
	Écarteur	VII 122, 124
	Pince à dissection mors tungstène	II 47
	Pince gouge	XIII 104
	Pince hémostatique	IV 35
	Pince à dissection service	XV 17
	Porte-aiguilles	VI 10
	Rugine	XIII 38
	Pince à dissection délicate	II 22, 24
<b>ADSON-BIMER</b>	Pince à dissection délicate	II 24
<b>ADSON-BROWN</b>	Pince à dissection délicate	II 22
<b>ADSON-GRAEFE</b>	Pince à dissection délicate	II 24
Agraphe de Michel		VI 6
Aiguille à ligatures		VI 28 à 32
Aiguille à paracentèse		XII 22
Aiguille à sutures		VI 27
Aiguille pour rotule		XIII 156
<b>ALAN-PARKS</b>	Écarteur rectal	VIII 91
Alésior à main		XIV 40, 42
Alésior médullaire rigide		XIV 38
<b>ALEXANDER</b>	Ciseaux burins, ostéotome, gouges	XIII 71
	Rugine et dissecteur	XIII 29
<b>ALLAINE</b>	Ciseaux à dissection	III 25
	Passe-fils - Dissecteur	IV 53
<b>ALLAINE (BOYD)</b>	Ciseaux à dissection	III 26
<b>ALLAIRE</b>	Ciseaux délicats	III 15
<b>ALLEN</b>	Pince clamp intestinale et stomacale	IV 77
	Tournevis	XIV 13
<b>ALLIR-ADAIR</b>	Pince à préhension	IV 96
<b>ALLIS</b>	Pince à préhension	IV 94
<b>ALLISON</b>	Écarteur	VII 40
<b>ALM</b>	Écarteur	VII 109
Amnioscope		VIII 51
Amplificateur pour greffe de peau		I 10
Amygdalotome		XII 26
<b>ANDERSON-ADSON</b>	Ecarteurs neuro	VII 117
<b>ANDREW-PYNCHON</b>	Canule aspiratrice	XV 26
Anuscope		VIII 89
Arrache clou		XIV 41
<b>ARRUGA</b>	Pince capsulaire	X 16
<b>ASCH</b>	Cisaille ORL	XII 34
Atelle malléable		XV 25
<b>AUBERT (FINSTERER)</b>	Canule aspiratrice	XV 26
<b>AUBRY</b>	Écarteur ORL	XII 48
<b>AUFRICHT</b>	Écarteur et crochet ORL	XII 49
	Râpe ORL	XII 43
<b>AUSTIN</b>	Pince micro-tubaire	II 33
<b>AUVARD</b>	Valve vaginale	VIII 49
<b>AUVERT</b>	Écarteur complet	VII 86
	Pince à préhension	IV 92
	Valve	VII 86
<b>BABCOCK</b>	Pince à préhension	IV 100, 101
<b>BABINSKY</b>	Marteau à réflexes et caoutchouc	XV 5
<b>BABY KOCHER</b>	Pince clamp intestinale et stomacale	IV 70
<b>BABY SATINSKY</b>	Pince à préhension	IV 82
<b>BABY CRILE-WOOD</b>	Porte-aiguilles	VI 15
<b>BABY METZENBAUM</b>	Ciseaux Prestige	III 71
<b>BABY POOLE</b>	Canule aspiratrice	XV 26
<b>BABY ADSON</b>	Passe-fils - Dissecteur	IV 50
<b>BABY ALLIS</b>	Pince à préhension	IV 95
<b>BABY COLLIN</b>	Compas (écarteur)	VII 81
	Écarteur complet	VII 81
	Valve	VII 81
<b>BABY CRILE</b>	Pince hémostatique	IV 30
<b>BABY DOYEN</b>	Pince clamp intestinale et stomacale	IV 70
<b>BABY HAIGHT</b>	Écarteur pour nourrissons	VII 98
<b>BABY HARRINGTON</b>	Écarteur	VII 58
<b>BABY LEXER</b>	Ciseaux à dissection	III 21
<b>BABY MIKULICZ</b>	Pince hémostatique spéciale pour le péritoine	IV 48
<b>BABY MIXTER</b>	Passe-fils - Dissecteur	IV 58
<b>BABY OVERHOLT</b>	Passe-fils - Dissecteur	IV 58
<b>BABY ROUX</b>	Écarteur	VII 34
<b>BABY TISCHLER (MINI TOWNSEND)</b>	Pince à biopsie	VIII 64
<b>BACKHAUS</b>	Pince à champs	XV 20
		IV 104, 105



		Page	Chapitre
<b>BACON</b>	Pince gouge	XIII	108
Bague caoutchouc pour ligature		VIII	93
<b>BAILEY</b>	Écarteur	VII	107
<b>BAILEY BABY</b>	Rapprocheur de côtes	VII	107
<b>BAINBRIDGE</b>	Pince clamp atrauma	V	14
	Pince hémostatique spéciale	IV	44
<b>BAKES</b>	Dilatateur pour voies biliaires	IX	14
<b>BALFOUR</b>	Écarteur complet	VII	89, 90
	Valve	VII	89, 90
<b>BALFOUR USA MODEL</b>	Écarteur	VII	91
	Valve	VII	91
<b>BALFOUR BABY</b>	Écarteur complet	VII	89
	Valve	VII	89, 90
<b>BALLENGER</b>	Couteau à végétations	XII	24
	Gouge ORL	XII	40
<b>BALLENTINE</b>	Pince utérine	VIII	22
Bande		XV	31
<b>BANE HARTMANN</b>	Pince gouge	XIII	105
<b>BANKART</b>	Instrumentation pour épaupe	XIII	147
<b>BAR</b>	Pince à couper les clamps	VIII	60
<b>BARR</b>	Écarteur rectal	VIII	90
<b>BARRAQUER</b>	Micro porte-aiguilles	X	14
<b>BARRAYA</b>	Passe-fils - Dissecteur	IV	65
	Pince à dissection délicate	II	14
	Pince à dissection Prestige	II	50
<b>BARRE</b>	Pince à ailerons vésicaux	IX	11
<b>BARSKY</b>	Ecarteur, crochet	VII	9
<b>BECK</b>	Pince clamp atrauma	V	23, 34
<b>BECKMANN</b>	Couteau à végétations	XII	23
	Écarteur	VII	118 à 120
	Valve	VII	120
<b>BECKMANN (MOORE)</b>	Couteau à végétations	XII	24
<b>BECKMANN-CONE</b>	Écarteur	VII	118
<b>BECKMANN-ADSON</b>	Écarteur	VII	123
<b>BECKMANN-EATON</b>	Écarteur	VII	122
<b>BEEBE</b>	Ciseaux pour couper les fils	III	31
<b>BELLUCI</b>	Micro-ciseaux ORL	XII	33
<b>BENGOLEA</b>	Pince hémostatique longue	IV	39, 40
	Pince hémostatique Prestige	IV	115
<b>BENNET</b>	Écarteur	VII	141
<b>BENSAUDE</b>	Anuscopie	VIII	89
<b>BENSON</b>	Écarteur du pylore	IV	102
<b>BERGER</b>	Pince à biopsie	VIII	65
<b>BERGERET-TOUPET</b>	Porte-piquet	VII	72
<b>BERGMANN</b>	Ciseaux à pansements	III	30
	Ecarteur, crochet	VII	10
	Maillet	XIII	86
	Curette	XIII	52
<b>BESNIER</b>		XIII	122
<b>BETHUNE</b>	Costotome	XIII	122
<b>BEYER</b>	Pince gouge	XIII	106, 109
<b>BEYER-ZAUFAL</b>	Pince gouge	XIII	109
<b>BILLEAU</b>	Curette ORL	XII	56
<b>BIRCHER</b>	Instrumentation pour ménisque	XIII	150
<b>BIRCHER-GANSKE</b>	Instrumentation pour ménisque	XIII	153
<b>BIRKETT</b>	Pince hémostatique	IV	34
Bistouri coupe fils		I	7
Bistouri fixe		I	2
Bistouri PRIMA		I	7
Bistouri standard		I	7
Bistouri stérile		I	7
<b>BLAKE</b>	Curette utérine	VIII	76
	Pince pour calculs biliaires	IX	7
<b>BLONDIAU</b>	Maillet et curette ORL	XII	54
<b>BLOUNT</b>	Écarteur	VII	140
	Instrumentation pour ménisque	XIII	151
<b>BLUMENTHAL</b>	Pince gouge	XIII	102
<b>BOEHLER</b>	Étrier de traction	XIII	160
	Pince coupante	XIII	118
	Pince gouge	XIII	109
<b>BOETTCHER</b>	Ciseaux pour les amygdales	III	37
<b>BONN</b>	Ciseaux fins	III	39
<b>BONNAIRE</b>	Pince utérine	VIII	27
<b>BONNEY</b>	Pince à dissection spéciale	II	12
<b>BONNIOT</b>	Pince hémostatique	IV	24
<b>BORDIER-MEUNIER</b>	Trocart à biopsie osseuse	XV	28
<b>BOSE</b>	Speculum ORL	XII	17
<b>BOURGEOIS</b>	Pince à préhension ORL	XII	14
<b>BOWMAN (PALMER)</b>	Speculum ORL	XII	17
<b>BOYS-ALLIS</b>	Pince à préhension	IV	96
<b>BRAND</b>	Guide pour tendons	XIII	11
	Pince à saisir les tendons	XIII	14
<b>BRAUN</b>	Dépresseur utérin	VIII	79
	Pince utérine	VIII	25
<b>BRAUN-STADLER</b>	Ciseaux à épisiotomie	III	81
<b>BRIDGE</b>	Pince hémostatique longue	IV	37



		Page	Chapitre
<b>BRIESKY</b>	Pelvimètre	VIII	78
	Valve vaginale	VIII	43
<b>BRISTOW</b>	Écarteur	VII	139
Broche guide pour vis perforées		XIV	48
<b>BROCK</b>	Grattoir	XIII	52
<b>BROPHY</b>	Pince à dissection délicate	II	28
<b>BROPHY (SULLIVAN)</b>	Ciseaux longs et fins	III	49
<b>BROWN-RESANO</b>	Pince à dissection spéciale	II	18
<b>BRUENINGS</b>	Abaisse langue	XV	6
	Serre-noeuds ORL	XII	20
<b>BRUNETTI</b>	Instrument pour autopsie	XIII	23
<b>BRUNNER</b>	Aiguille à ligatures	VI	31
	Costotome	XIII	123
	Écarteur	VII	45
	Pince clamp intestinale et stomacale	IV	76
<b>BRUNS</b>	Ciseaux pour plâtres	XV	22
		III	85
	Curette	XIII	58, 62
<b>BUCK</b>	Curette ORL	XII	55
	Pince pour oreille	XII	32
<b>BUCK-GRAMCKO</b>	Leviers pour os du pied et de la main	VII	130
<b>BUELAU</b>	Trocart	XV	30
<b>BUNNEL</b>	Perforateur manuel	XIV	9
<b>BUNNELL</b>	Guide pour tendons	XIII	11
	Stripper à tendons	XIII	12
Burin		XIII	65
Burin ORL		XII	37, 38
Burin pour le crâne		XIII	22
<b>BUSCH (VEZIEN)</b>	Ciseaux pour le cordon ombilical	III	80
<b>BUSCHE</b>	Curette	XIII	63
Cadre (Écarteur)		VII	83
Cadre support instrument		XV	32
<b>CAIRNS</b>	Pince hémostatique	IV	36
<b>CAIRNS (CLOVIS-VINCENT)</b>	Rugine et dissecteur	XIII	37
<b>CANNY-RYALL</b>	Écarteur	VII	36
Canule à héparine		XV	27
Canule aspiratrice		XV	26
Canule aspiratrice ORL		XII	57, 58
Caoutchouc pour marteau à réflexes		XV	5
<b>CAPENER</b>	Ciseaux gouge	XIII	82
Capuchon pour écarteur		VII	82
<b>CAROLL</b>	Goniomètre	XIII	95
	Pince à saisir les tendons	XIII	13
<b>CARPENTER</b>	Rugine et dissecteur	XIII	28
<b>CARREL</b>	Clamp pour lymphographie	V	9
	Pince hémostatique	IV	16
<b>CASPAR</b>	Crochet	XIII	25
	Curette	XIII	64
	Écarteur	VII	46
	Écarteur neurochirurgie	XI	7
	Manche de bistouri	I	6
	Pincers rongeurs neurochirurgie	XI	12, 13
	Rugine	XIII	39
<b>CASTANEDA</b>	Pince clamp atrauma - Pédiatrie	V	39
<b>CASTROVIEJO</b>	Crochet ORL	XII	46
	Micro ciseaux	X	5, 8
	Micro porte-aiguilles	X	12
Cathéter		VIII	86
<b>CATLIN</b>	Couteau pour lobes	XIII	16
<b>CAUCHOIX</b>	Ciseaux ostéotomes, gouges	XIII	76
	Écarteur	VII	142
<b>CHADWICK</b>	Ciseaux fins	III	39
Chaîne pour écarteur		VII	82
Chaîne pour piquet		VII	72
<b>CHANDLER</b>	Écarteur	VII	139
	Écarteur complet	VII	104
	Valve	VII	104
<b>CHAPUT</b>	Pince à préhension	IV	93
<b>CHAPUT-MAYO</b>	Pince à préhension	IV	93
<b>CHARNLEY</b>	Cadre complet	XIII	142
	Curette	XIII	65
	Écarteur, main de plomb	XIII	142
	Valve	XIII	142
<b>CHARRIER</b>	Écarteur	VII	37
<b>CHARRIERE</b>	Instrument pour amputation	XIII	18, 19
Chasse-greffons		XIII	143, 144
<b>CHATELIER</b>	Pince à préhension ORL	XII	14
Chausse veine		VII	19
<b>CHEATLE</b>	Pince pour instruments	XV	32
<b>CHERON</b>	Pince à pansements	IV	119
<b>CHEVALIER-JACKSON</b>	Pince pour oesophagoscopie	XII	36
<b>CHEVRET</b>	Écarteur	VII	40
<b>CHRISTOPHE</b>	Pince hémostatique	IV	33
	Pince hémostatique Prestige	IV	117
<b>CHROBAK</b>	Pince utérine	VIII	24



		Page	Chapitre
<b>CINELLI</b>	Ostéotome	XII	39
<b>CIRCERON (MATHIEU)</b>	Pince pour stérilet	VIII	81
Cisaille ORL		XII	34
Ciseau à os		XIV	24
Ciseau conducteur pour plaques		XIV	17, 19
Ciseaux à cataracte		III	12, 57
Ciseaux à décapsuler		III	86
Ciseaux à dissection		III	16 à 26
Ciseaux à énucléation		III	13, 45
Ciseaux à épisiotomie		III	81, 82
Ciseaux à gencives		III	44
Ciseaux à incision		III	28
Ciseaux à iridectomie		XV	15
Ciseaux à ménisque		III	86
Ciseaux à ongles		III	88
		XV	15
Ciseaux à pansements		III	29, 30
Ciseaux à paramètres		III	68
Ciseaux à strabisme		III	12, 39
Ciseaux burins		XIII	68 à 75, 77, 81
Ciseaux chirurgicaux		III	9 à 11
Ciseaux coiffeur		III	53
Ciseaux colleur		III	53
Ciseaux coronaires		III	36
Ciseaux coupe ligatures		III	41, 42
		XV	15
Ciseaux couturière		III	54
Ciseaux dauphin pointu/mousse service		XV	16
Ciseaux délicats		III	11 à 15
Ciseaux divers		III	27, 37, 45, 50, 53 à 56, 87
Ciseaux en tungstène		III	57 à 69
Ciseaux enterotome		III	87
Ciseaux fins		III	14, 15, 38 à 40, 43, 44
Ciseaux gouge		XIII	65, 68 à 82
Ciseaux lingère		III	54
Ciseaux longs et fins		III	46 à 49
Ciseaux mousses service		XV	16
Ciseaux Nasaux		III	77 à 78, 83, 84
Ciseaux ORL		III	83, 84
Ciseaux ostéotomes		XIII	66, 67, 69, 71 à 74, 76, 80
Ciseaux pointu service		XV	16
Ciseaux pour cartilage		III	37
Ciseaux pour chirurgie osseuse		III	86
Ciseaux pour chirurgie vasculaire		III	32 à 36
Ciseaux pour coton		III	55
Ciseaux pour couper les fils		III	31
Ciseaux pour fistules		III	48, 57
Ciseaux pour intervention en profondeur		III	51, 52
Ciseaux pour le cordon ombilical		III	80
Ciseaux pour les amygdales		III	37
Ciseaux pour les nerfs		III	37
Ciseaux pour plâtres		XV	22
Ciseaux pour prostate		VIII	95
Ciseaux Prestige		III	70 à 79, 82
Ciseaux service		XV	15 à 17
Ciseaux vaginaux		III	82
<b>CITELLI</b>	Emporte pièces ORL	XII	27
Clamp bulldog		V	9 à 11
Clamp pour lymphographie		V	9
Clamp pour prostate		VIII	95
<b>CLAOUE</b>	Écarteur ORL	XII	48
Clé à cardan		XIV	23
Clé hexagonale		XIV	13
Clé mixte		XIV	23
Clé pour étrier		XIII	157
Clé pour manche de burin		XIV	24
Clé pour mandrin		XIV	7 à 9
Clé pour tendeur		XIV	23
<b>CLEVELAND</b>	Pince coupante	XIII	117
	Pince gouge	XIII	103
<b>CLOVIS-VINCENT</b>	Curette ORL	XII	56
	Perforateur neurochirurgie	XI	9
	Pince à dissection très fine	II	11
	Spatule neurochirurgie	XI	3
	Rugine	XIII	48
<b>CLOWARD</b>	Crochet	XIII	24
	Curette	XIII	59
<b>COAKLEY</b>	Curette ORL	XII	55
<b>COBB</b>	Ciseaux gouge	XIII	79
	Rugine	XIII	51
<b>COLLER-CRILE</b>	Pince hémostatique	IV	30
<b>COLLIN</b>	Compas (écarteur)	VII	79, 80
	Costotome	XIII	121
	Écarteur	VII	34, 79, 80
	Pince à préhension	IV	87, 90



		Page	Chapitre	
<b>COLLIN</b>	Pince hystérolable	VIII	52	
	Spéculum vaginal	VIII	31	
	Valve	VII	79, 80	
<b>COLLIN-POZZI</b>	Pince utérine	VIII	13	
<b>COLVER</b>	Pince à préhension ORL	XII	13	
Compas		XIII	145	
Compas (écarteur)		VII	67, 73, 74	
Compresseur de l'urètre		VIII	86	
Conducteur pour fil scie		XIII	20	
<b>CONVERSE</b>	Crochet ORL	XII	47	
	Porte-aiguilles	VI	14	
<b>COOLEY</b>	Dilatateur vasculaire et aortique	V	40	
	Écarteur	VII	101	
	Pince à dissection vasculaire	II	42	
	Pince clamp atrauma	V	33, 35, 36	
	Pince clamp atrauma - Pédiatrie	V	37, 38	
	Pince clamp cardiovasculaire atrauma - Anastomose	V	36, 37	
	Pince clamp cardiovasculaire atrauma - Coarctation	V	34, 36	
	Pince clamp cardiovasculaire atrauma - Ligature	V	36	
	Pince clamp cardiovasculaire atrauma - Usages multiples	V	34	
	Pince clamp cardiovasculaire atrauma - Anastomose	V	34	
<b>COOLEY-DERRA</b>	Écarteur	VII	53	
Costotome		XIII	121 à 125	
<b>COTT</b>	Compas (écarteur)	VII	77	
	Écarteur	VII	77	
	Pince utérine à lambeaux	VIII	24	
	Valve	VII	77	
<b>COTTLE</b>	Ciseaux Nasaux Prestige	III	79	
	Ciseaux ORL	III	84	
	Crochet ORL	XII	47	
	Ecarteur, crochet	VII	10	
	Maillet	XIII	88	
	Ostéotome	XII	37	
	Râpe ORL	XII	43	
	Rugine	XIII	43	
	Rugine et dissecteur	XIII	31	
	Speculum ORL	XII	18	
	<b>COTTLE (KILLIAN)</b>	Crochet ORL	XII	47
	<b>COTTLE-NEIVERT</b>	Écarteur	VII	129
	<b>COURTY</b>	Écarteur	VII	129
Couteau à cerveau		XIII	15	
Couteau à phalanges		XIII	16	
Couteau à végétations		XII	23, 24	
Couteau inter-osseux		XIII	16	
Couteau pour lobes		XIII	16	
Couteau spatule ORL		XII	25	
<b>CRAFOORD</b>	Ciseaux pour intervention en profondeur	III	51	
	Pince hémostatique longue	IV	43	
<b>CRAFOORD (SELLORS)</b>	Pince hémostatique spéciale	IV	45	
<b>CRAIG-DOMNICK</b>	Pince à préhension ORL	XII	15	
<b>CRAWFORD</b>	Écarteur	VII	36	
<b>CREED</b>	Rugine et dissecteur	XIII	28	
<b>CRILE</b>	Crochet	XIII	25	
<b>CRILE-MURRAY</b>	Écarteur	VII	33	
	Pince hémostatique	IV	28, 29	
	Pince hémostatique Prestige	IV	117	
	Porte-aiguilles	VI	11	
<b>CRILE-RANKIN</b>	Pince hémostatique	IV	29	
<b>CRILE-WOOD</b>	Porte-aiguille service	XV	18	
<b>CRILE-WOOD</b>	Porte-aiguilles	VI	11, 15	
	Crochet	VII	9, 10	
<b>CROCHET</b>		XIII	24, 94, 154	
	Crochet à tendons	XIII	12	
	Crochet d'extraction	XIV	41	
	Crochet ORL	XII	45 à 47, 49	
	Crochet pour muscles	XIII	22	
	Crochet pour tête de vis	XIV	11	
	Crochets à phlebectomie	V	7	
	Curette	XIII	52 à 65	
	Curette à biopsie	VIII	77	
	Curette ORL	XII	54 à 56	
	Curette pour voies biliaires	IX	12 à 13	
	Curette utérine	VIII	68 à 76	
	Curseur	VII	72, 92	
<b>CUSCHING-KOCHER</b>	Écarteur	VII	17	
<b>CUSCO</b>	Spéculum vaginal	VIII	33	
	Spéculum vaginal pour vierge	VIII	34	
<b>CUSHING</b>	Crochet	XIII	25	
	Écarteur	VII	13, 62	
	Micro crochet	X	20	
	Perforateur neurochirurgie	XI	10	
	Pince à dissection délicate	II	25	
	Pince à dissection mors tungstène	II	46	
	Pincettes rongeurs neurochirurgie	XI	11	
	Rugine	XIII	41, 42	
	Curette utérine	VIII	75	
	<b>CUZZI</b>	Curette utérine	VIII	75





		Page	Chapitre
<b>CZERNY</b>	Pince pour calculs biliaires	IX	7
	Pince utérine	VIII	25
	Spéculum rectal	VIII	88
<b>DALE</b>	Pince clamp atrauma - Périphérique	V	30
<b>DANDY</b>	Micro crochet	X	20
<b>DANIS</b>	Pince hémostatique	IV	26
	Écarteur et spatule pour épaule	XIII	148
	Instrumentation pour épaule	XIII	148
<b>DARGENT</b>	Passe fil	XIII	149
	Tendeur à fils	XIV	29
	Pince utérine	VIII	16
<b>DARTIGUES</b>	Valve vaginale	VIII	42
	Pince hystérolable	VIII	52
<b>DARTIGUES (LAPAROSTAT)</b>	Écarteur	VII	94
<b>DAUBENSPECK</b>	Curette	XIII	60
<b>DAUPHIN</b>	Ciseaux chirurgicaux	III	11
<b>DAUTREY</b>	Écarteur ORL	XII	48
<b>DAVID</b>	Pince gouge	XIII	114
Davier		XIII	126 à 141
<b>DAVIS</b>	Rugine et dissecteur	XIII	27
<b>DAVIS-BOYLE</b>	Ouvre-bouche	XII	10
<b>DE MARTEL</b>	Ciseaux pour chirurgie vasculaire	III	35
	Conducteur pour fil scie	XIII	20
	Pince pour cuir chevelu	IV	84
<b>DE MARTEL - WOLFSON</b>	Rugine et dissecteur	XIII	37
	Pince pour fermer les clamps et porte clamps	IV	80
	Ciseaux divers	III	45
<b>DEAN</b>			
<b>DEAVER</b>	Écarteur	VII	59, 60
<b>DEBAKEY</b>	Ciseaux fins	III	14
	Ciseaux tungstène	III	69
	Ciseaux pour chirurgie vasculaire	III	33, 36
	Clamp bulldog	V	10
	Clamp bulldog carotide	V	11
	Dilatateur vasculaire et aortique	V	40
	Écarteur	VII	102, 128
	Pince à dissection mors tungstène	II	44
	Pince à dissection vasculaire	II	41 à 43
	Pince clamp atrauma	V	13, 14, 22, 23, 27, 28, 32
	Pince clamp cardiovasculaire atrauma - Anévrisme de l'aorte	V	17
	Pince clamp cardiovasculaire atrauma - Aorte	V	20, 21
	Pince clamp cardiovasculaire atrauma - Artère rénale	V	15
	Pince clamp cardiovasculaire atrauma - Ligature	V	13, 20, 21
	Pince clamp cardiovasculaire atrauma - Usages multiples	V	24
	Porte-aiguilles vasculaire	VI	20
	Valve	VII	102
<b>DEBAKEY-BAHNSON</b>	Pince clamp cardiovasculaire atrauma - Anévrisme artère	V	25
<b>DEBAKEY-DIETRICH</b>	Pince à dissection vasculaire	II	43
<b>DEBAKEY-GERALD</b>	Pince à dissection vasculaire	II	43
<b>DEBAKEY-GLOVER</b>	Clamp bulldog	V	11
<b>DEBAKEY-MOSQUITO</b>	Pince clamp atrauma	V	27
<b>DEBAKEY-PEAN</b>	Pince clamp atrauma	V	26
<b>DEBAKEY-POTTS</b>		V	12
<b>DEBAKEY-RANKIN</b>	Pince clamp atrauma	V	27
<b>DEBAKEY-SATINSKY</b>	Clamp bulldog	V	11
<b>DEBAKEY-BECK</b>	Pince clamp atrauma	V	16
Décolleur à tendons		XIII	11
<b>DECOULX</b>	Écarteur	VII	121
<b>DELABARRE</b>	Ouvre-bouche	XII	7
<b>DELESTRE</b>	Ciseaux à épisiotomie	III	81
<b>DEMEL</b>	Tendeur à fils	XIV	32
<b>DEMELIN-SUZOR</b>	Forceps et spatule	VIII	54
<b>DEMOISELLE</b>	Chasse-greffons	XIII	143
<b>DENHART</b>	Ouvre-bouche	XII	7
<b>DENIS BROWN</b>	Cadre (Écarteur)	VII	84
	Valve	VII	84
Dépresseur double		VII	76
Dépresseur utérin		VIII	79
<b>DERF</b>	Porte-aiguilles	VI	8, 14
Dermatome à main		I	8, 9
<b>DERRA</b>	Pince clamp cardiovasculaire atrauma - Anastomose	V	29
<b>DESCHAMPS</b>	Aiguille à ligatures	VI	32
<b>DESCHAMPS-SCHAUTA</b>	Aiguille à ligatures	VI	31
<b>DESGOUTTES</b>	Pince à dissection spéciale	II	18
<b>DESJARDINS</b>	Curette pour voies biliaires	IX	12
	Drague pour voies biliaires	IX	12
	Explorateur pour voies biliaires	IX	12
	Pince à cystique	IX	11
	Pince pour calculs biliaires	IX	6
<b>DESMARET</b>	Écarteur	VII	70
<b>DESMARRES</b>	Écarteur	VII	11
Diapason ORL		XII	59, 60
<b>DIETRICH</b>	Pince clamp cardiovasculaire atrauma - Aorte	V	18
Dilatateur ORL		XII	12
Dilatateur pour voies biliaires		IX	14
Dilatateur utérin		VIII	82 à 84



	Page	Chapitre
Dilatateur vasculaire et aortique	V	40
<b>DINGMAN</b>	Écarteur	VII 66
<b>DINGMANN</b>	Davier	XIII 127
	Ouvre-bouche	XII 11
Disque pour maillet	XIII	87, 88
Dissecteur	V	8
	XIII	26 à 37, 44, 45
<b>DIXON-LOVELACE</b>	Pince hémostatique	IV 27
<b>DOCKHORN</b>	Écarteur pour chirurgie maxillo-faciale	VII 64
<b>DOUAY</b>	Pince à biopsie	VIII 65
<b>DOUGLAS</b>	Valve vaginale	VIII 41
Douille de centrage pour mèche	XIV	15
Douille protectrice pour vis perforées	XIV	48
<b>DOYEN</b>	Aiguille à ligatures	VI 28
	Ciseaux divers	III 27
	Costotome	XIII 125
	Écarteur	VII 61
	Ouvre-bouche	XII 8
	Perforateur initial	XI 9
	Perforateur neurochirurgie	XI 9
	Pince à champs	IV 103
	Pince à ovaire	VIII 27
	Pince clamp intestinale et stomacale	IV 69, 72
	Porte-aiguilles	VI 9
	Rugine et dissecteur	XIII 45
	Tracteur pour fibrome	VIII 81
	Valve vaginale	VIII 37, 46
	Perforateur neurochirurgie	XI 9
<b>DOYEN-ROCHARD</b>	Valve sus-pubienne	VII 69
Drague pour voies biliaires	IX	12
<b>DRYSSEN</b>	Écarteur	VII 105
<b>DUBOIS</b>	Ciseaux pour intervention en profondeur	III 51
<b>DUBOST</b>	Ciseaux à dissection	III 20
	Ciseaux tungstène	III 67
	Écarteur complet	VII 99
	Valve	VII 99
<b>DUBOST NOGENT</b>	Écarteur complet	VII 100
	Valve	VII 100
<b>DUFOURMONT</b>	Pince à dissection délicate	II 32
	Râpe ORL	XII 42
<b>DUMONT</b>	Pince d'horloger	II 35
<b>DUNHILL</b>	Pince hémostatique	IV 17
<b>DUPLAY</b>	Pince utérine	VIII 13
	Speculum ORL	XII 16
<b>DUPONT</b>	Ciseaux ostéotomes	XIII 67
<b>DURAND (PATTE DE VELOURS)</b>	Pince à dissection Prestige	II 50
	Pince à dissection spéciale	II 17
<b>DUVAL</b>	Pince à dissection spéciale	II 21
	Pince à préhension	IV 89 à 91
Écarteur	VII	9 à 144
Écarteur du pylore	IV	102
Écarteur neurochirurgie	VII	117
	XI	6 à 8
Écarteur ORL	XII	48, 49
Écarteur pour avant bras	VII	141
Écarteur pour chirurgie maxillo-faciale	VII	63 à 66
Écarteur pour épaule	XIII	146, 148
Écarteur pour goître	VII	129
Écarteur pour hémilaminectomie	VII	125
Écarteur pour prostate	VIII	96
	VII	60
Écarteur rectal	VIII	90, 91
Écarteur valves malléables	VII	41
Écarteur VK	VII	71
Écarteur, main de plomb	XIII	142
<b>ECHLIN</b>	Pince gouge	XIII 113
<b>EISELSBERG</b>	Ciseaux pour couper les fils	III 31
Élévateur ORL	XII	50, 51, 53
<b>EMMET</b>	Aiguille à ligatures	VI 29
Emporte pièces neurochirurgie	XI	16 à 22
Emporte pièces ORL	XII	27
Endartérectomie	V	6 à 8
Endospéculum	VIII	36
<b>ENGEL</b>	Instrument pour amputation	XIII 21
ENGLISH MODEL	Pince à dissection spéciale	II 12
Épingle à instruments	XV	32
<b>EPPENDORF</b>	Pince à biopsie	VIII 66
<b>ERRICO</b>	Perforateur	XI 10
<b>ESMARCH</b>	Bande	XV 31
	Ciseaux à pansements	III 30
Etalon d'angle pour plaques	XIV	18, 19
Étrier de traction	XIII	157 à 160
<b>EUFRATE</b>	Porte-aiguilles vasculaire	VI 22
<b>EVANS</b>	Pince à dissection mors tungstène	II 45
<b>EVES</b>	Serre-noeuds ORL	XII 20



	Page	Chapitre
Explorateur	XIII	154
Explorateur pour voies biliaires	IX	12
Extracteur	V	8, 45
Extracteur à agrafes	XIV	50
<b>FARABEUF</b>	Bistouri	I
	Ciseaux burins, gouges	XIII
	Davier	XIII
	Écarteur	VII
	Instrument pour amputation	XIII
	Rugine et dissecteur	XIII
	Écarteur	VII
<b>FARABEUF-CORTI</b>		
<b>FARKAS</b>	Pince à dissection spéciale	II
<b>FAVALORO</b>	Ciseaux pour chirurgie vasculaire	III
<b>FEILCHENFELD</b>	Pince à échardes	II
Fer à cintrer les clous	XIV	42
Fer à cintrer les plaques	XIV	20
Fer à cintrer les valves	VII	86
<b>FERGUSSON</b>	Canule aspiratrice ORL	XII
	Ciseaux à incision	III
	Davier	XIII
<b>FERRIS-SMITH-CUSHING</b>	Pincettes rongeurs neurochirurgie	XI
<b>FERRIS-SMITH-KERRISSON</b>	Empoigne pièces neurochirurgie	XI
<b>FICAT</b>	Poinçon et trépan	XIII
Filet pour la traction des doigts	XIII	161
<b>FINOCHIETTO</b>	Écarteur	VII
	Passe-fils - Dissecteur	IV
	Porte-aiguilles	VI
	Valve	VII
<b>FINOCHIETTO-BURFORD</b>	Écarteur complet	VII
	Valve	VII
<b>FINSEN</b>	Écarteur	VII
<b>FISH</b>	Crochet	XIII
	Crochet ORL	XII
	Stylets	XV
<b>FOMON</b>	Ciseaux Nasaux Prestige	III
	Ciseaux ORL	III
	Crochet ORL	XII
	Râpe ORL	XII
Forceps	VIII	53 à 59
Foret	XIV	5, 47
Foret pour perforateur	XIV	37
<b>FOUCAULT</b>	Écarteur VK	VII
<b>FRAZIER</b>	Canule aspiratrice ORL	XII
	Micro crochet	X
	Rugine et dissecteur	XIII
<b>FREER</b>	Burin et gouge ORL	XII
	Crochet ORL	XII
	Élévateur ORL	XII
	Gouge ORL	XII
	Rugine et dissecteur	XIII
	Rugine ORL	XII
<b>FREER-YASARGIL</b>	Rugine et dissecteur	XIII
<b>FRENCH</b>	Diapason ORL	XII
<b>FRIEDMANN DELIKAT</b>	Pince gouge	XIII
<b>FRICTSCH</b>	Écarteur	VII
<b>FRYKHOLM</b>	Pince gouge	XIII
<b>FUCHSIG</b>	Pince hémostatique	IV
<b>FUKUDA</b>	Écarteur	VII
Gabarit de cintrage pour plaques	XIV	20
Gabarit de forage pour plaques	XIV	17
<b>GALLAHER</b>	Râpe ORL	XII
<b>GELPI</b>	Écarteur	VII
<b>GEMINI</b>	Passe-fils - Dissecteur	IV
<b>GERALD</b>	Pince à dissection délicate	II
<b>GIERTZ-STILLE</b>	Costotome	XIII
<b>GIGLI</b>	Instrument pour amputation	XIII
<b>GILLIES</b>	Écarteur, crochet	VII
	Pince à dissection délicate	II
	Porte-aiguilles	VI
<b>GILLIES (WAUGH)</b>	Pince à dissection délicate	II
<b>GILLIES BABY</b>	Porte-aiguilles	VI
<b>GIL-VERNET</b>	Écarteur	VII
<b>GIL-VERNET (PAPIN)</b>	Écarteur	VII
<b>GINESTET</b>	Écarteur et crochet ORL	XII
<b>GLOVER</b>	Pince clamp atrauma	V
	Pince clamp cardiovasculaire atrauma - Ligature	V
<b>GLUCK</b>	Costotome	XIII
<b>GOELET</b>	Écarteur	VII
<b>GOLDMANN-FOX</b>	Ciseaux à gencives	III
	Ciseaux tungstène	III
Gomme de polissage	XV	33
Goniomètre	XIII	95
<b>GOOD</b>	Ciseaux divers	III
<b>GORNEY</b>	Ciseaux Prestige	III
<b>GOSSET</b>	Écarteur	VII



		Page	Chapitre
<b>GOSSET</b>	Valve	VII	88
Gouge ORL		XII	37, 38, 40
<b>GOUILLOUD</b>	Pince clamp	IV	47
<b>GOURDET</b>	Curette utérine	VIII	68
<b>GRAEFE</b>	Ciseaux fins	III	39
	Micro crochet	X	18
<b>GRAHAM</b>	Micro crochet	X	20
Grattoir		XIII	52
<b>GRAVE</b>	Spéculum vaginal	VIII	34
<b>GRAY</b>	Pince pour voies biliaires	IX	10
<b>GRAZIL</b>	Ciseaux délicats	III	13, 15
<b>GREEN</b>	Écarteur	VII	62
<b>GREEN-ARMYTAGE</b>		VIII	30
<b>GREGOIRE</b>	Pince à dissection spéciale	II	19
	Pince à préhension	IV	88
<b>GREGORY</b>	Pince clamp atrauma - Profondeur	V	31
	Clamp bulldog	V	10
<b>GROSS-MAYER</b>	Pince à pansements	IV	120
<b>GRUENWALD</b>	Pince à dissection mors tungstène	II	46
<b>GRUENWALD-HENKE</b>	Emporte pièces ORL	XII	28
<b>GUERRIER</b>	Écarteur et crochet ORL	XII	49
Guide et extracteur pour clous		XIV	42
Guide mèches		XIV	14 à 16, 23
Guide pour alésoirs		XIV	39
Guide pour taraud		XIV	15
Guide-clou		XIV	39, 41, 43
Guide-fil pour cerclage		XIV	52
<b>GUILLAUME</b>	Ciseaux burins, gouges	XIII	77
<b>GUNNAR-HEY</b>	Pince à traire les drains	IV	108
<b>GUTHRIE</b>	Micro crochet	X	19
<b>GUYON</b>	Cathéter	VIII	86
	Pince pour pédicules rénaux	IX	8
<b>GUYON-FREUDENBERG</b>	Mandrin	XV	31
<b>HABERER</b>	Écarteur	VII	38
<b>HAIGHT</b>	Écarteur	VII	101
<b>HAJEK</b>	Emporte pièces ORL	XII	28
	Maillet	XIII	86
<b>HAKANSSON</b>	Pince gouge	XIII	103
<b>HALLE</b>	Ciseaux Nasaux	III	83
	Curette	XIII	60
	Écarteur rectal	VIII	90
	Rugine et dissecteur	XIII	32
<b>HALSEY</b>	Porte-aiguilles	VI	8
<b>HALSEY (WEBSTER)</b>	Porte-aiguilles	VI	13
<b>HALSTEAD</b>	Pince hémostatique	IV	20
	Pince hémostatique Prestige	IV	113
	Pince service	XV	19
<b>HALSTEAD-MOSQUITO</b>	Pince hémostatique	IV	23
<b>HANK</b>	Dilatateur utérin	VIII	84
<b>HARKEN</b>	Pince à préhension	IV	83
	Pince clamp cardiovasculaire atrauma - Oreillette	V	18
<b>HARRINGTON</b>	Écarteur	VII	58
	Passe-fils - Dissecteur	IV	67
<b>HARRINGTON-PEMBERTON</b>	Écarteur	VII	58
<b>HARRIS</b>	Tendeur à fils	XIV	31
<b>HARTMANN</b>	Diapason ORL	XII	59, 60
	Écarteur	VII	36
	Emporte pièces ORL	XII	28
	Pince pour oreille	XII	31, 32
	Pince à polypes	XII	30
	Pince clamp intestinale et stomacale	IV	68
	Pince rongeur	XII	30
	Speculum ORL	XII	16
<b>HARTMANN-CITELLI</b>	Pince à polypes	XII	30
<b>HARTMANN-HALLE</b>	Speculum ORL	XII	18
<b>HARTMANN-WEINGARTNER</b>	Pince pour oreille	XII	31
<b>HARVEY</b>	Ciseaux pour couper les fils	III	31
<b>HAUTANT</b>	Burin et gouge ORL	XII	38
<b>HAUTEFEUILLE</b>	Piquet	VII	72
<b>HEANEY</b>	Curette utérine	VIII	75
	Écarteur	VII	37
	Pince utérine	VIII	19
	Porte-aiguilles	VI	10
<b>HEANEY-BALLENTINE</b>	Pince utérine	VIII	22
<b>HEATH</b>	Pince à retirer les agraphes	VI	7
<b>HEGAR</b>	Dilatateur utérin	VIII	82, 84
<b>HEGAR-BAUMGARTNER</b>	Porte-aiguilles	VI	11
<b>HEGAR-OLSEN</b>	Porte-aiguilles	VI	23
<b>HEGAR-OLSEN BABY</b>	Porte-aiguilles	VI	23
<b>HEGAR VASCULAR</b>	Porte-aiguilles vasculaire	VI	22
<b>HEGEMANN (DIETRICH)</b>	Ciseaux pour chirurgie vasculaire	III	34
<b>HEGENBARTH</b>	Pince à poser les agraphes	VI	5
<b>HEIFETZ</b>	Spatule neurochirurgie	XI	5
<b>HEISS</b>	Pince hémostatique longue	IV	38
<b>HEISS (HOLZEIMER)</b>	Écarteur	VII	109



		Page	Chapitre
<b>HEISTER</b>	Ouvre-bouche	XII	8
<b>HELFRICH-BIER</b>	Instrument pour amputation	XIII	19
<b>HENKE</b>	Élévateur ORL	XII	51
<b>HENLEY</b>	Écarteur complet	VII	114
	Valve	VII	114
<b>HENNING</b>	Pince pour plâtres	XV	24
<b>HERCULES</b>	Pince à couper les fils	XIV	33 à 36
	Pince d'extraction	XIV	26
<b>HERRICK</b>	Pince pour voies biliaires	IX	9
<b>HERTZLER</b>	Écarteur	VII	106
<b>HESS</b>	Écarteur neurochirurgie	XI	8
<b>HEY-GROVES</b>	Davier	XIII	136
<b>HEYMANN</b>	Ciseaux Nasaux	III	84
	Ciseaux Nasaux Prestige	III	79
<b>HEYWOOD-SMITH</b>	Pince hémorroïdale	VIII	94
	Pince utérine	VIII	28
<b>HIBBS</b>	Ciseaux burins, ostéotome, gouges	XIII	73
	Écarteur	VII	37
<b>HI-LEVEL KNOWLES</b>	Ciseaux à incision	III	28
<b>HOEN</b>	Rugine et dissecteur	XIII	34
<b>HOFFMAN</b>	Presse-tube	IV	110
<b>HOHMANN-ALDINGER</b>	Écarteur	VII	135
<b>HOLSHER</b>	Écarteur neurochirurgie	XI	8
<b>HOLZBACH</b>	Pince utérine	VIII	21
<b>HONTON</b>	Ciseaux gouge	XIII	78
<b>HORSLEY</b>	Rugine et dissecteur	XIII	36
<b>HÖSEL</b>	Écarteur	VII	46
<b>HOWARTH</b>	Rugine et dissecteur	XIII	27
<b>HRYNTSCHAK</b>	Écarteur complet	VII	92
	Valve	VII	92
<b>HUDSON</b>	Perforateur neurochirurgie	XI	10
<b>HUMBY</b>	Écarteur, crochet	VII	9
<b>HUNTER</b>	Pince à échardes	II	51
<b>HURD</b>	Élévateur ORL	XII	51
	Hystéromètre	VIII	85
	Hystéro-salpingographie	VIII	79, 80
<b>IMA</b>	Microchirurgie pince fine	X	17
	Impacteur à agrafes	XIV	50
	Impacteur extracteur pour clous	XIV	43
	Impacteur final	XIV	41
	Impacteur pour agrafes	XIV	51
	Impacteur pour clous	XIV	44, 45
	Impacteur pour plaques	XIV	17, 19
	Instrument pour amputation	XIII	15 à 21
	Instrument pour autopsie	XIII	22, 23
	Instrumentation pour genou	XIII	155, 156
	Instrumentation pour ménisque	XIII	150 à 154
	Instruments pour plâtres	III	85
<b>IOWA</b>	Pince pour la vésicule amniotique	VIII	10
<b>ISRAEL</b>	Écarteur	VII	29
<b>ISSELIN</b>	Poinçon	XIII	90
<b>IVG</b>	Manche pour canule IVG	VIII	81
<b>J.L. FAURE</b>	Pince à biopsie	VIII	62
	Pince à dissection spéciale	II	19
	Pince utérine	VIII	15, 17
<b>JACKSON</b>	Écarteur	VII	15
	Valve vaginale	VIII	44
<b>JACOBS</b>	Mandrin	XIV	7, 8
	Perforateur manuel	XIV	9
	Pince utérine	VIII	10
<b>JACOBSON</b>	Curette	XIII	53
	Micro porte-aiguilles	X	13
<b>JACOBSON-ADSON</b>	Pince à dissection délicate	II	23
	Passe-fils - Dissecteur	IV	56
<b>JACOBSON-HALSTEAD</b>	Pince hémostatique	IV	22
<b>JAMESON</b>	Ciseaux Prestige	III	73
	Ciseaux longs et fins	III	46 à 49
	Porte-aiguilles	VI	12
<b>JANSEN</b>	Curette	XIII	54
	Écarteur	VII	110
	Pince gouge	XIII	105, 108
	Rugine	XIII	41
<b>JANSEN (LUCAE)</b>	Pince à dissection O.R.L.	II	40
<b>JANSEN (MIDDLETON)</b>	Emporte pièces ORL	XII	29
<b>JANSEN-DEEP</b>	Écarteur	VII	110
	Jauge de longueur pour vis perforées	XIV	49
	Jauge de profondeur pour clous	XIV	46
	Jauge de profondeur pour vis	XIV	10
	Jauge pour alésoirs, clous et vis	XIV	46
	Jauge pour broches	XIV	46
<b>JAVID</b>	Pince clamp atrauma - Carotide	V	33
<b>JAYLE</b>	Spéculum vaginal	VIII	32
	Valve vaginale	VIII	48
<b>JEANNINGS</b>	Ouvre-bouche	XII	9
<b>JESCO</b>	Ciseaux divers	III	56



		Page	Chapitre
<b>JOHNS HOPKINS</b>	Clamp bulldog	V	9
<b>JOLL</b>	Écarteur pour goître	VII	129
<b>JONES</b>	Pince à champs	IV	103
<b>JOSEPH</b>	Ciseaux Prestige	III	76
	Instruments ORL	XII	52, 53
	Ciseaux ORL	III	83
<b>JOST</b>	Rugine et dissecteur	XIII	29
<b>JUDD-ALLIS</b>	Pince à préhension	IV	95
<b>JUDD-MASSON</b>	Écarteur	VII	93
<b>JUDET</b>	Ciseaux burins, ostéotome, gouges	XIII	74
	Écarteur	VII	138
	Maillet	XIII	89
<b>KADER</b>	Écarteur	VII	55
<b>KANTROWITZ</b>	Passe-fils - Dissecteur	IV	61
<b>KATZIN</b>	Micro ciseaux	X	7
<b>KATZIN-BARRAQUER</b>	Micro ciseaux	X	7
<b>KAYE</b>	Ciseaux Prestige	III	77
<b>KAZANJIAN</b>	Pince coupante	XIII	117
<b>KELLY</b>	Ciseaux tungstène	III	57
	Ciseaux pour fistules	III	48
	Écarteur	VII	50, 55
	Pince hémostatique	IV	31
	Pince hémostatique Prestige	IV	116
	Pince utérine	VIII	28
	Proctoscope	VIII	89
<b>KELLY-RANKIN</b>	Pince hémostatique	IV	32
<b>KERN</b>	Davier	XIII	134
<b>KERRISSON</b>	Emporte pièces ORL	XII	27
<b>KEVORKIAN</b>	Curette à biopsie	VIII	77
	Pince à biopsie	VIII	66, 67
<b>KEY</b>	Rugine	XIII	41
<b>KIELAND</b>	Forceps et spatule	VIII	55
<b>KIENNY</b>	Chausse veine	VII	19
<b>KILLIAN</b>	Élévateur ORL	XII	50
	Gouge ORL	XII	40
<b>KILNER</b>	Crochet ORL	XII	47
	Ecarteur, crochet	VII	10
	Porte-aiguilles	VI	13
<b>KILNER (RAGNELL)</b>	Ciseaux délicats	III	15
	Ciseaux tungstène	III	57
	Ouvre-bouche	XII	11
<b>KILNER-DOUGHTY</b>	Écarteur pour chirurgie maxillo-faciale	VII	64
<b>KIRSCH</b>	Cadre (Écarteur)	VII	83
<b>KIRSCHNER</b>	Étrier de traction	XIII	157, 158
	Instrument à ligatures	VI	34
	Valve	VII	83
	Étrier de traction	XIII	159
<b>KIRSCHNER (AMERICAN)</b>	Écarteur	VII	20
<b>KLAPP</b>	Ecarteur, crochet	VII	9
<b>KLEINERT-KUTZ</b>	Pince à saisir les tendons	XIII	13
<b>KLEINSCHMIDT</b>	Pince pour l'appendice	IV	77
<b>KLINKENBERG</b>	Ciseaux divers	III	50
	Ciseaux tungstène	III	67
<b>KNAPP</b>	Ciseaux fins	III	38
	Crochet ORL	XII	46
	Ciseaux à incision	III	28
<b>KNOWLES</b>	Couteau spatule ORL	XII	25
<b>KOCHER</b>	Écarteur	VII	27, 43, 47, 49
	Pince clamp intestinale et stomacale	IV	73, 74
	Pince hémostatique	IV	9 à 11
	Pince hémostatique Prestige	IV	116
	Pince service	XV	18
	Écarteur	VII	46
<b>KOCHER-WAGNER</b>	Écarteur	VII	42
<b>KOCHER-LANGENBECK</b>	Crochet	XIII	94
<b>KOENING</b>	Endospéculum	VIII	36
<b>KOGAN</b>	Compas et valve	XIII	145
<b>KÖLBEL</b>	Écarteur	VII	13
	Instrument à ligatures	VI	33
	Rugine et dissecteur	XIII	35
<b>KÖRTE</b>	Écarteur	VII	28, 29, 48
<b>KÖRTE-WAGNER</b>	Écarteur	VII	28
<b>KRAEMER</b>	Rugine	XIII	43
<b>KRAMER</b>	Rugine	XIII	41
<b>KRAUSE</b>	Serre-noeuds ORL	XII	21
	Trocart	XV	30
<b>KRAUSE-VOSS</b>	Serre-noeuds ORL	XII	21
<b>KRISTELLER</b>	Valve vaginale	VIII	44
<b>KRÖNLEIN</b>	Pince hémostatique	IV	17
<b>KÜMMEL</b>	Écarteur	VII	48
<b>LA GRANGE</b>	Ciseaux fins	III	38
<b>LABORDE</b>	Dilatateur ORL	XII	12
<b>LAGROT</b>	Dermatome à main	I	9
<b>LAHEY</b>	Écarteur	VII	27
	Pince à préhension ORL	XII	14



		Page	Chapitre
<b>LAHEY (SWEET)</b>	Passe-fils - Dissecteur	IV	60
<b>LAMBERT KAY</b>	Pince clamp cardiovasculaire atrauma - Anastomose	V	22
<b>LAMBOTTE</b>	Ciseaux ostéotomes	XIII	67
	Crochet	XIII	94
	Davier	XIII	133
	Écarteur	VII	143
	Pince porte-vis ou plaque	XIV	25
	Rugine	XIII	49
<b>LAMBOTTE (PAUWELLS)</b>	Ciseaux ostéotomes	XIII	66
Lame de burin		XIV	24
Lame ostéotome		XIV	24
Lames pour dermatome		I	8, 9
Lames U.U		I	4 à 6
<b>LANDANGER</b>	Davier	XIII	128
	Instrumentation pour ménisque	XIII	152
	Pince à biopsie	VIII	64
	Pince à pansements	IV	122
<b>LANDAU</b>	Trocart	XV	30
	Valve vaginale	VIII	43
<b>LANDOLT</b>	Ciseaux à énucléation	III	45
	Manche de bistouri	I	6
<b>LANE</b>	Davier	XIII	134
	Écarteur	VII	139
	Pince à dissection spéciale	II	13
	Pince clamp intestinale et stomacale	IV	79
<b>LANE (PAUCHET)</b>	Pince diverse	IV	109
<b>LANE-TRETHOWAN</b>	Écarteur	VII	139
<b>LANGÉ</b>	Instruments pour plâtres	III	85
<b>LANGÉ-HOHMANN</b>	Écarteur	VII	131 à 133, 135
<b>LANGENBECK</b>	Couteau pour lobes	XIII	16
	Davier	XIII	138
	Écarteur	VII	44
	Instrument pour amputation	XIII	17
	Porte-aiguilles	VI	26
	Rugine	XIII	42, 47
	Rugine et dissecteur	XIII	33
<b>LANGENBECK (LARREY)</b>	Instrument pour amputation	XIII	18
<b>LANGENBECK-GREEN</b>	Écarteur	VII	17, 20
<b>LARDENOIS</b>	Écarteur	VII	38, 39
<b>LAWRENCE</b>	Passe-fils - Dissecteur	IV	60
<b>LAZAR</b>	Microchirurgie pince fine	X	16
<b>LE MEE</b>	Speculum ORL	XII	16
<b>LEBEAU</b>	Gouge ORL	XII	40
	Rugine et dissecteur	XIII	34
<b>LEBSCHÉ</b>	Sternotome	XIII	125
<b>LECOUTEUR</b>	Abaisse langue	XV	7
<b>LEES</b>	Pince clamp cardiovasculaire atrauma - Bronches	V	19
<b>LEGUEU</b>	Écarteur	VII	60, 93
	Pince clamp	IV	46
<b>LEKSELL-STILLE</b>	Pince gouge	XIII	112
<b>LELIEVRE</b>	Burin ORL fin	XII	38
	Rugine	XIII	48
<b>LEMAIRE</b>	Instrumentation pour genou	XIII	155
<b>LEMPERT</b>	Curette	XIII	61
	Élévateur ORL	XII	51
	Pince gouge	XIII	106
<b>LEPAGE</b>	Pince à faux germes	VIII	26
<b>LERAT</b>	Pince à Capsule	XIII	141
<b>LERICHE</b>	Ecarteur, crochet	VII	10
	Pince hémostatique	IV	25
	Pince hémostatique Prestige	IV	114
	Pince service	XV	19
	Rugine et dissecteur	XIII	33
	Valve	VII	57
<b>LERICHE - BUGATTI</b>	Valve	VII	57
<b>LERMOYER</b>	Couteau à végétations	XII	23
<b>LETOURNEL</b>	Burin	XIII	65
	Ciseaux gouge	XIII	65
	Curette	XIII	65
Levier pour épaule		XIII	148
Levier pour os du pied et de la main		VII	130
<b>LEVRET</b>	Forceps et spatule	VIII	58
<b>LEWIN</b>	Davier	XIII	141
<b>LEWIS</b>	Râpe ORL	XII	43
<b>LEXER</b>	Ciseaux à dissection	III	21
	Ciseaux ostéotomes, gouges	XIII	80, 81
<b>LEXER-FINO</b>	Ciseaux à dissection	III	21
	Ciseaux tungstène	III	60, 61
<b>LICHTENBERG</b>	Porte-aiguilles	VI	26
<b>LICHTWITZ</b>	Trocart	XV	30
<b>LIEGE</b>	Pince à préhension	IV	99
<b>LIMA</b>	Maillet et curette ORL	XII	54
<b>LISTER</b>	Ciseaux à pansements	III	29
	Ciseaux tungstène	III	66
	Ciseaux service	XV	15



		Page	Chapitre
<b>LISTER EXCENTRIC</b>	Ciseaux à pansements	III	30
<b>LISTON</b>	Costotome	XIII	121
	Instrument pour amputation	XIII	15
	Pince coupante	XIII	116, 119
<b>LISTON-KEY (HORSLEY)</b>	Pince coupante	XIII	120
<b>LITTAUER</b>	Ciseaux coupe ligatures	III	42
<b>LITTAUER-LISTON</b>	Pince coupante	XIII	117
<b>LITTLER</b>	Ciseaux coupe ligatures	III	42
<b>LITTLEWOOD</b>	Pince à préhension	IV	99
<b>LOCHARD</b>	Pince ouvre-capsule	IV	110
<b>LOCKHART MUMMARY</b>	Sonde cannelée	XV	13
<b>LOCKLIN</b>	Ciseaux à gencives	III	44
<b>LOCKWOOD</b>	Pince à préhension	IV	90
<b>LOCKWOOD-ALLIS</b>	Pince à préhension	IV	97
<b>LOMBARD</b>	Maillet	XIII	88
	Pince gouge	XIII	98
<b>LORNA</b>	Pince à champs	IV	106
<b>LORTAT-JACOB</b>	Cadre support instrument	XV	32
<b>LOUTE</b>	Tendeur à fils	XIV	29
<b>LOVE</b>	Écarteur neurochirurgie	XI	6, 7
<b>LOVE (MORSE)</b>	Écarteur	VII	13
<b>LOVE-ADSON</b>	Rugine	XIII	38
<b>LOVE-GRUENWALD</b>	Pincers rongeurs neurochirurgie	XI	11
<b>LOVELACE</b>	Pince à poumons	IV	92
<b>LOWE</b>	Écarteur	VII	14
<b>LOWER</b>	Passe-fils - Dissecteur	IV	59
<b>LOWMAN</b>	Davier	XIII	140
<b>LOWMAN-HOGLUND</b>	Davier	XIII	140
<b>LUBET BARBON</b>	Pince à préhension ORL	XII	13
<b>LUC</b>	Pince à préhension ORL	XII	15
<b>LUCAE</b>	Crochet ORL	XII	45
	Diapason ORL	XII	60
	Maillet	XIII	86
	Pince à dissection O.R.L.	II	40
<b>LUCAE HARTMANN</b>	Diapason ORL	XII	59
<b>LUCAS</b>	Ciseaux burins, gouges	XIII	68
	Ciseaux burins, ostéotome, gouges	XIII	73
<b>LUCAS-CHAMPIONNIERE</b>	Perforateur	XIV	37
<b>LUER</b>	Écarteur	VII	33
	Pince gouge	XIII	103, 104
<b>LUER-KOERTE</b>	Curette pour voies biliaires	IX	13
<b>LUER LOCK</b>	Canule	XV	27
<b>LUER-FRIEDMANN</b>	Pince gouge	XIII	101
<b>LUKENS</b>	Écarteur	VII	15
<b>MAC DONALD</b>	Rugine et dissecteur	XIII	31
<b>MAC EVEN</b>	Ciseaux burins, ostéotome, gouges	XIII	74
	Maillet	XIII	85
<b>MAC GIVNEY</b>	Pince hémorroïdale	VIII	93, 94
<b>MAC INDOE</b>	Ciseaux divers	III	37
	Pince à dissection délicate	II	31
	Pince à dissection mors tungstène	II	47
	Pince coupante	XIII	118
<b>MAC KENTY</b>	Élévateur ORL	XII	50
	Rugine	XIII	39
<b>MAC KEE</b>	Écarteur	VII	115
<b>MAC KENZIE</b>	Perforateur neurochirurgie	XI	10
<b>MAC LEAN</b>	Forceps et spatule	VIII	55
<b>MAC PHERSON</b>	Microchirurgie pince fine	X	15
<b>MAGILL</b>	Pince à sondes	XV	9
	Maillet	XIII	84 à 89
	Maillet ORL	XII	54 à 56
	Mailon pour chaîne	VII	72
	Main de plomb	XIII	142
<b>MAINGOT</b>	Pince utérine	VIII	21
<b>MALTZ</b>	Râpe ORL	XII	42
	Manche de bistouris	I	3 à 6
	Manche pour canule IVG	VIII	81
	Mandrin	V	7, 9, 10, 49
	Mandrin de centrage pour clous	XV	32
		XIV	44
<b>MANGIAGALLI</b>	Valve vaginale	VIII	41
<b>MARKHAM-MEYERDING</b>	Écarteur	VII	126
<b>MARQUARDT</b>	Pince gouge	XIII	110
	Marteau à réflexes	XV	5
	Marteau diapason	XIV	17, 40
<b>MARTIN</b>	Écarteur	VII	51
	Pelvimètre	VIII	78
<b>MARTIN (SIMPSON)</b>	Hysteromètre	VIII	85
<b>MARTIN-CARTILAGE</b>	Ciseaux pour cartilage	III	37
<b>MARTINI</b>	Curette	XIII	53
<b>MASING</b>	Élévateur ORL	XII	50
<b>MASING (NEIVERT)</b>	Porte-aiguilles	VI	13
<b>MASING (SILVER)</b>	Ostéotome	XII	39
<b>MASSON</b>	Porte-aiguilles	VI	12, 17
<b>MATHEY</b>	Écarteur	VII	108





		Page	Chapitre
<b>MATHIEU</b>	Écarteur	VII	35
	Pince utérine à polypes	VIII	11
	Porte-aiguilles	VI	12, 25
	Spéculum rectal	VIII	87
	Valve vaginale	VIII	46
<b>MAURER</b>	Costotome	XIII	122
	Écarteur	VII	108, 144
	Rugine	XIII	50
<b>MAYFIELD</b>	Pince gouge	XIII	110
<b>MAYO</b>	Abaisse langue	XV	6
	Ciseaux à dissection	III	16
	Ciseaux tungstène	III	59
	Ciseaux Prestige	III	70
	Ciseaux service	XV	16
	Épingle à instruments	XV	32
	Pince à dissection spéciale	II	17
	Pince pour calculs biliaires	IX	7
	Pince clamp intestinale et stomacale	IV	71
	Écarteur	VII	81
<b>MAYO-ADAMS</b>	Écarteur	VII	81
<b>MAYO-ALSACE</b>	Ciseaux à dissection	III	18
<b>MAYO-HARRINGTON</b>	Ciseaux à dissection	III	19
<b>MAYO-HEGAR</b>	Porte-aiguilles	VI	11, 16 à 18
	Porte-aiguilles service	XV	18
<b>MAYO-LEGER</b>	Ciseaux à dissection	III	18
<b>MAYO-LEXER</b>	Ciseaux tungstène	III	60, 61
	Ciseaux Prestige	III	70
<b>MAYO-LYON</b>	Ciseaux à dissection	III	18
<b>MAYO-NOBLE</b>	Ciseaux à dissection	III	19
<b>MAYO-SANTY</b>	Ciseaux à dissection	III	19
<b>MAYO-STILLE</b>	Ciseaux à dissection	III	17
	Ciseaux tungstène	III	60, 61
	Ciseaux Prestige	III	70
<b>MEAD</b>	Disque pour maillet	XIII	87
	Maillet	XIII	87
	Pince gouge	XIII	102
<b>MEEKER</b>	Passe-fils - Dissecteur	IV	63
<b>MENTZENBAUM</b>	Ciseaux pour prostate	VIII	95
<b>MERCEDES</b>	Écarteur	VII	103
	Valve	VII	103
<b>MERIAM</b>	Pince à dissection délicate	II	29
<b>MERLE D'AUBIGNÉ</b>	Poinçon	XIII	91
	Écarteur	VII	137, 138
	Instrumentation pour épaule	XIII	147
	Rugine	XIII	49
	Écarteur pour épaule	XIII	146
<b>MERLE D'AUBIGNÉ (BANKART)</b>	Passe fil avec aiguille	XIII	146
	Ciseaux Prestige	III	75
<b>MERVEILLEUX</b>	Mesureur	XIII	96
<b>METZENBAUM</b>	Ciseaux à dissection	III	22, 23
	Ciseaux tungstène	III	62
	Ciseaux service	XV	17
	Ciseaux Prestige	III	71
	Ciseaux à dissection	III	24
<b>METZENBAUM-FINO</b>	Ciseaux tungstène	III	63 à 65
	Ciseaux Prestige	III	71
	Écarteur	VII	18, 49
<b>MEYERDING</b>	Agrafes	VI	6
	Pince à poser les agrafes	VI	5, 6
	Pince à retirer les agrafes	VI	7
	Pince double usage pour agrafes	VI	7
	Pince et agrafes	VI	6
	Tréphine pour enlever les vis cassées	XIV	37
	Pince clamp	IV	46
	Pince à dissection délicate	II	23
<b>MICHEL</b>	Micro ciseaux	X	3 à 11
	Micro ciseaux fins	III	38
	Micro crochet	X	18 à 20
	Micro pince à suture	II	33
	Micro porte-aiguilles	X	12 à 14
	Microchirurgie pince fine	X	15 à 17
	Micro ciseaux ORL	XII	33
	Micro extracteur	V	8
	Pince hémostatique	IV	20
	Pince hémostatique	IV	21
	Micro pince ORL	XII	33
	Porte-aiguilles vasculaire	VI	21
	Micro spatule	V	8
	Écarteur	VII	61, 62
	<b>MIDDELDORPF</b>	Écarteur	VII
Pince hémostatique spéciale pour le péritoine		IV	48, 49
Râpe ORL		XII	44
<b>MILLER</b>	Micro ciseaux	X	9
	Rugine et dissecteur	XIII	28
<b>MILLES</b>	Micro ciseaux	X	9
<b>MILLIGAN</b>	Rugine et dissecteur	XIII	28
<b>MILLIN</b>	Écarteur	VII	93
	Pince pour prostate	VIII	95



		Page	Chapitre
<b>MILLS</b>	Ciseaux pour chirurgie vasculaire	III	35
<b>MINI GEMINI</b>	Passe-fils - Dissecteur	IV	57
<b>MINI LEXER</b>	Ciseaux ostéotomes, gouges	XIII	80
<b>MINI TOWNSEND</b>	Pince à biopsie	VIII	67
<b>MINI FRIEDMANN</b>	Pince gouge	XIII	101
<b>MINI LANGENBECK</b>	Écarteur	VII	16
<b>MIRIZZI</b>	Pince pour calculs biliaires	IX	4, 5
Miroir laryngien		XV	8
<b>MITCHELL</b>	Rugine	XIII	42
<b>MIXTER</b>	Ciseaux fins	III	14
	Passe-fils - Dissecteur	IV	58, 59
<b>MIXTER-O'SHAUGNESSY</b>	Passe-fils - Dissecteur	IV	58
<b>MOHR</b>	Presse-tube	IV	110
<b>MOLISSON</b>	Écarteur	VII	116
<b>MOLT</b>	Rugine et dissecteur	XIII	27
<b>MÖLTGEN</b>	Goniomètre	XIII	95
<b>MONOD</b>	Trocart	XV	28
<b>MONESTRUC</b>	Écarteur	VII	87
	Valve	VII	87
<b>MOORE</b>	Cisaille ORL	XII	34
	Curette pour voies biliaires	IX	13
<b>MOORE-LAMBOTTE</b>	Écarteur	VII	143
<b>MOREL-FATIO</b>	Rugine et dissecteur	XIII	27
<b>MORRIS</b>	Écarteur	VII	52
<b>MORRIS-DEBAKEY</b>	Pince clamp cardiovasculaire atrauma - Aorte	V	24
Mors caoutchouc - Hercules		XIV	33, 35
Mors caoutchouc pour pince tire-langue		XV	9
Mors tungstène - Hercules		XIV	33 à 36
<b>MORSE-FAVALORO</b>	Écarteur	VII	103
<b>MOSQUITO</b>	Pince hémostatique	IV	19
<b>MOSQUITO-DANDY</b>	Pince hémostatique	IV	26
<b>MOYNIHAN</b>	Pince hémostatique	IV	36
	Pince hémostatique longue	IV	43
<b>MUHLING</b>	Rugine	XIII	40
<b>MULLER</b>	Crochets à phlebotomie	V	7
<b>MURPHY</b>	Écarteur	VII	23
	Instrumentation pour genou	XIII	155
	Pince à pansement	XV	20
	Pince presse-tubes	IV	112
<b>MUSEUX</b>	Davier	XIII	141
	Pince utérine	VIII	7, 8
<b>MUSEUX-PALMER</b>	Pince utérine	VIII	9
<b>MUSEUX-PALMER-CHERON</b>	Pince utérine	VIII	9
<b>MYERS</b>	Strippers	V	5
<b>MYRTLE</b>	Sonde cannelée	XV	13
<b>NABATOFF</b>	Strippers	V	5
<b>NAGELE</b>	Forceps et spatule	VIII	56
<b>NANCY</b>	Ciseaux burins, gouges	XIII	77
	Ciseaux divers	III	27
<b>NEFF</b>	Instrumentation pour ménisque	XIII	150
<b>NEGUS</b>	Pince clamp intestinale et stomacale	IV	69
<b>NEIVERT</b>	Porte-aiguilles	VI	14
<b>NELATON</b>	Bistouri	I	2
	Perforateur	XIV	37
	Sonde cannelée	XV	13
<b>NELSON</b>	Trocart	XV	29
Nettoyage et rénovation des instruments		XV	33
<b>NEW ORLEANS</b>	Porte-aiguilles	VI	17
<b>NICOLLET-KOCHER</b>	Instrumentation pour ménisque	XIII	152
<b>NICOLLET-MUSEUX</b>	Instrumentation pour ménisque	XIII	152
<b>NISSEN</b>	Pince pour voies biliaires	IX	11
	Pince hémostatique	IV	35
<b>NORFOLK-NORWICH</b>	Écarteur	VII	115
<b>NORTHFIELD</b>	Pince gouge	XIII	107
<b>NOTO</b>	Pince utérine	VIII	28
<b>NOTTER</b>	Perce membrane (amniotome)	VIII	60
<b>NOVACK</b>	Instruments pour hystéro-salpingographie	VIII	80
<b>NOYES</b>	Micro ciseaux	X	6
<b>NUBOER</b>	Canule aspiratrice	XV	26
<b>NUSSBAUM</b>	Pince clamp intestinale et stomacale	IV	78
<b>O'SHAUGNESSY</b>	Passe-fils - Dissecteur	IV	51 à 53
<b>OBWEGESER</b>	Ciseaux ostéotomes	XIII	67
	Écarteur pour chirurgie maxillo-faciale	VII	63, 65
<b>OCHSNER</b>	Pince clamp cardiovasculaire atrauma - Aorte	V	17
<b>OEHLER</b>	Pince à dissection mors tungstène	II	45
<b>OLIVECRONA</b>	Instrument pour amputation	XIII	20
	Rugine et dissecteur	XIII	26
	Spatule neurochirurgie	XI	4
	Pince gouge	XIII	106
<b>OLIVIER</b>	Écarteur complet	VII	82
<b>OLLIER</b>	Davier	XIII	135, 139
	Écarteur	VII	30
	Poinçon	XIII	156
	Rugine et dissecteur	XIII	44
<b>OMBREDANNE</b>	Ciseaux burins, gouges	XIII	70



		Page	Chapitre
<b>OMBREDANNE</b>	Maillet	XIII	84
	Pince à préhension	IV	98
	Poinçon	XIII	90
<b>OPEN COELIO</b>	Écarteur	VII	33
<b>OSCHNER</b>	Pince à ligature	II	33
<b>O'SHAUGNESSY</b>	Passe-fils pour prostate	VIII	95
Ostéotome		XII	37, 39
<b>O'SULIVAN - O'CONNOR</b>	Cadre (Écarteur)	VII	85
	Valve	VII	85
Ouvre-bouche		XII	7 à 11
<b>OVERHOLT-GEISSENDORFER</b>	Passe-fils - Dissecteur	IV	54
<b>OVERHOLT-MIXTER</b>	Passe-fils - Dissecteur	IV	61
<b>OVERHOLT-S</b>	Passe-fils - Dissecteur	IV	55
<b>OVERHOLT-SLIM</b>	Passe-fils - Dissecteur	IV	55
<b>PAJOT</b>	Forceps et spatule	VIII	55
<b>PALMER</b>	Dilatateur utérin	VIII	82
	Écarteur complet	VII	78
	Pince utérine à polypes	VIII	11
	Spéculum vaginal	VIII	31
	Valve	VII	78
<b>PARKER</b>	Écarteur	VII	35
<b>PARKER LANGENBECK (US ARMY)</b>	Écarteur	VII	35
<b>PARKER-MOTT</b>	Écarteur	VII	36
<b>PARTSCH</b>	Ciseaux burins, gouges	XIII	68
	Maillet	XIII	84
Passe-fil		XIII	149, 154
Passe-fil avec aiguille		XIII	146
Passe-fil pour tendons		XIII	11
Passe-fils - Dissecteur		IV	50 à 67
Passe-fils pour prostate		VIII	95
<b>PASSOW</b>	Chasse-greffons	XIII	143
<b>PATTERSON</b>	Pince à biopsie	VIII	66
<b>PAUCHET</b>	Pince à poser les agrafes	VI	5
<b>PAUCHET (Sabre)</b>	Aiguille à ligatures	VI	29
<b>PAYR</b>	Instrument à ligatures	VI	34
	Pince clamp intestinale et stomacale	IV	75
<b>PEAN</b>	Ciseaux service	XV	17
	Pince à pansements	IV	118
	Trocart	XV	30
<b>PEDERSON</b>	Spéculum vaginal	VIII	35
<b>PEERS</b>	Pince à champs	IV	105
<b>PEET</b>	Pince à échardes	II	52
<b>PELKMANN</b>	Pince à pansements	IV	127
Pelvimètre		VIII	78
<b>PENFIELD</b>	Rugine et dissecteur	XIII	30
<b>PENNINGTON</b>	Pince à préhension	IV	89
	Rugine ORL	XII	41
<b>PENNYBACKER</b>	Pince gouge	XIII	107
	Rugine	XIII	42
Perce membrane (amniotome)		VIII	60
<b>PERCY</b>	Instrument pour amputation	XIII	21
Perforateur		XIV	37
Perforateur initial		XIV	40
Perforateur manuel		XIV	9
Perforateur neurochirurgie		XI	9, 10
<b>PERRY</b>	Pince à dissection délicate	II	37
<b>PERTHES</b>	Poinçon	XIII	92
<b>PETIT DUTAILLY</b>	Rugine et dissecteur	XIII	37
<b>PHANEUF</b>	Pince utérine	VIII	22
Pied à coulisses inox		XIII	96
<b>PINARD</b>	Stéthoscope	XV	5
Pince pour oreille		XII	31, 32
Pince à ailerons vésicaux		IX	11
Pince à biopsie		VIII	62 à 67
Pince à biopsie rectale		VIII	92
Pince à champs		XV	20
		IV	103 à 107
Pince à couper les clamps		VIII	60
Pince à couper les fils		XIV	30 à 36
Pince à cystique		IX	11
Pince à dissection délicate		II	14 à 16, 22 à 33, 37
Pince à dissection fine		II	9, 10
Pince à dissection mors tungstène		II	44 à 47
Pince à dissection moyenne		II	7
Pince à dissection O.R.L.		II	38 à 40
Pince à dissection ophtalmologique		II	36
Pince à dissection Prestige		II	48 à 50
Pince à dissection service		XV	20
Pince à dissection spéciale		II	12, 13, 17 à 21, 34, 35
Pince à dissection standard		II	5, 6
Pince à dissection très fine		II	11
Pince à dissection vasculaire		II	41 à 43
Pince à échardes		II	51, 52
Pince à épiler		II	35
Pince à faux germes		VIII	26



	Page	Chapitre
Pince à fils métalliques	XIV	28 à 29
Pince à ligature	II	33
Pince à ongles	XV	10
Pince à ovaires	VIII	27
Pince à pansement	XV	20
	IV	118 à 127
Pince à polypes	XII	30
Pince à poser les agrafes	VI	5, 6
Pince à poser les clamps	V	10
Pince à poumons	IV	92
Pince à préhension	IV	81 à 102
Pince à préhension ORL	XII	13 à 15
Pince à retirer les agrafes	VI	7
Pince à saisir les tendons	XIII	13, 14
Pince à séquestre	XIII	139
Pince à sondes	XV	9
Pince à traire les drains	IV	108
Pince autoserrante	XIV	10
Pince capsulaire	X	16
Pince clamp	IV	46, 47
Pince clamp atrauma	V	12 à 36
Pince clamp atrauma - Carotide	V	33
Pince clamp atrauma - Pédiatrie	V	37 à 39
Pince clamp atrauma - Périphérique	V	30
Pince clamp atrauma - Profondeur	V	31
Pince clamp cardiovasculaire atrauma - Anastomose	V	12, 22, 29, 34, 36, 37
Pince clamp cardiovasculaire atrauma - Anévrisme artère	V	25
Pince clamp cardiovasculaire atrauma - Anévrisme de l'aorte	V	15, 16, 17
Pince clamp cardiovasculaire atrauma - Aorte	V	17, 18, 20, 21, 24, 31
Pince clamp cardiovasculaire atrauma - Artère rénale	V	15
Pince clamp cardiovasculaire atrauma - Bronches	V	19
Pince clamp cardiovasculaire atrauma - Coarctation	V	12, 25, 26, 34, 36
Pince clamp cardiovasculaire atrauma - Ligature	V	13, 20 à 21, 29, 36
Pince clamp cardiovasculaire atrauma - Occlusion tangentielle	V	22
Pince clamp cardiovasculaire atrauma - Oreillette	V	18
Pince clamp cardiovasculaire atrauma - Usages multiples	V	24, 34
Pince clamp intestinale et stomacale	IV	68 à 80
Pince clamps à bronches	IV	81
Pince coupante	XIII	116 à 120
Pince coupe câble	XIV	36
Pince d'extraction pour clous	XIV	45
Pince d'horloger	II	35
Pince double usage pour agrafes	VI	7
Pince gouge	XIII	97 à 115
Pince hémorroïdale	VIII	93, 94
	IV	102
	IV	9 à 36
Pince hémostatique	IV	37 à 43
Pince hémostatique longue	IV	113 à 117
Pince hémostatique Prestige	IV	44 à 49
Pince hémostatique spéciale	IV	48, 49
Pince hémostatique spéciale pour le péritoine	IV	52
Pince hystérolable	VIII	33
Pince micro-tubaire	II	27
Pince multiservices	XIV	34
Pince ORL	XII	35
Pince ORL à repositionner	XII	110
Pince ouvre-capsule	IV	25
Pince porte-vis ou plaque	XIV	25
Pince pour calculs biliaires	IX	4 à 7
Pince pour calculs rénaux	IX	3
Pince pour cintrer les clous	XIV	46
Pince pour cintrer les plaques	XIV	21, 22
Pince pour cuir chevelu	IV	84
Pince pour extraction du ciment	XIII	161
Pince pour fermer les clamps	IV	80
Pince pour instruments	XV	32
Pince pour la vésicule amniotique	VIII	10
Pince pour l'appendice	IV	77
Pince pour mini plaque	XIV	25
Pince pour oesophagoscopie	XII	36
Pince pour pédicules rénaux	IX	8
Pince pour plâtres	XV	23, 24
Pince pour prostate	VIII	95, 96
Pince pour stérilet	VIII	81
Pince pour voies biliaires	IX	9 à 11
Pince presse-tubes	IV	111, 112
Pince rongeur	XII	30
Pince service	XV	18, 19, 21
Pince tire-broches	XIV	26
Pince tire-langue	XV	9
Pince universelle	XIV	27
Pince utérine	VIII	7 à 30
Pince utérine à polypes	VIII	11
Pinces à Capsule	XIII	141
Pinces étai	XIV	27



		Page	Chapitre
Pincers rongeurs neurochirurgie		XI	11 à 15
<b>PIPER</b>	Forceps et spatule	VIII	58
Piquet		VII	72
<b>PIRON</b>	Curette utérine	VIII	75
Plaque repère pour ciseaux conducteurs		XIV	17
<b>PLESTER</b>	Canule aspiratrice ORL	XII	57
	Écarteur	VII	111
Poignée pour scie		XIII	20
Poinçon		XIII	90 à 93, 156
<b>POIRIER</b>	Ciseaux burins, gouges	XIII	70
<b>POLITZER</b>	Pince à dissection O.R.L.	II	39
<b>POLOSSON</b>	Écarteur	VII	56
<b>POOLE</b>	Canule aspiratrice	XV	26
Porte agrafes		XIV	50
Porte clamps		IV	80
Porte-aiguilles		VI	8 à 26
Porte-aiguilles vasculaire		VI	20 à 22
Porte-coton		XV	14
Porte-piquet		VII	72
<b>POSTEL</b>	Écarteur	VII	144
	Instrument pour amputation	XIII	18
<b>POTTS-DE MARTEL</b>	Ciseaux pour chirurgie vasculaire	III	35
<b>POTTS-SMITH</b>	Pince à dissection délicate	II	26
	Ciseaux divers	III	37
	Ciseaux pour chirurgie vasculaire	III	32
	Ciseaux Prestige	III	74
	Pince à dissection mors tungstène	II	46
	Ciseaux tungstène	III	69
	Ciseaux pour chirurgie vasculaire	III	36
Pousse clou		XIV	43
Pousse-nœuds		VI	34
<b>POZZI</b>	Curette utérine	VIII	76
	Instrumentation pour épaule	XIII	147
	Pince utérine	VIII	12
<b>POZZI-CHERON</b>	Instruments pour hystéro-salpingographie	VIII	80
<b>POZZI-PALMER</b>	Pince utérine	VIII	12
<b>PRATT</b>	Dilatateur utérin	VIII	84
	Pince hémorroïdale	IV	102
	Pince utérine	VIII	25
	Spéculum rectal	VIII	87
<b>PRECELLE</b>	Pince à dissection délicate	II	37
Presse pour cintrer les plaques		XIV	22
Presse-tube		XV	20
		IV	110
<b>PRICE THOMAS</b>	Pince clamps à bronches	IV	81
<b>PRINCE</b>	Ciseaux pour les amygdales	III	37
Proctoscope		VIII	89
Protecteur de peau		XIV	38
Protection translucide		XII	10
<b>PROVIDENCE</b>	Pince hémostatique	IV	26
<b>PUTTI</b>	Râpe	XIII	83
<b>QUENU</b>	Pince à dissection spéciale	II	20
	Pince clamp intestinale et stomacale	IV	68
<b>QUILICY FARISSE</b>	Passe-fils - Dissecteur	IV	62
<b>QUINBY</b>	Ciseaux divers	III	45
<b>QUIRE</b>	Pince pour oreille	XII	32
Raccord pour aspiration		VIII	77
Rachis <b>NOGENT</b>	Écarteur complet	VII	104
	Valve	VII	104
<b>RAGNEL (DAVIS)</b>	Écarteur	VII	19
<b>RALK</b>	Perforateur manuel	XIV	9
Rallonge pour écarteur		VII	67
Rallonge pour perforateur		XI	10
<b>RAMUS</b>	Écarteur pour chirurgie maxillo-faciale	VII	65
<b>RANDALL</b>	Pince pour calculs rénaux	IX	3
Râpe		XIII	83
Râpe ORL		XII	42 à 44
Rapprocheur de côtes		VII	107
<b>RECAMIER</b>	Curette utérine	VIII	74
<b>REDON</b>	Aiguille à ligatures	VI	30
	Passe-fils - Dissecteur	IV	50
Refouloir		XIII	149
Réglet inox		XIII	96
<b>REILL</b>	Davier	XIII	126
<b>RESANO</b>	Passe-fils - Dissecteur	IV	67
<b>REVERDIN</b>	Aiguille à sutures	VI	27
	Écarteur	VII	39
<b>REYNOLDS</b>	Ciseaux longs et fins	III	46
	Ciseaux Prestige	III	73
<b>RIBBON TYPE</b>	Ciseaux fins	III	43
<b>RICARD</b>	Compas (écarteur)	VII	73
	Écarteur complet	VII	75
	Valve	VII	73
<b>RICARD-BEGOIN</b>	Compas (écarteur)	VII	74
	Écarteur complet	VII	75



		Page	Chapitre
<b>RICARD-BEGOIN</b>	Valve	VII	74
<b>RICHARDSON</b>	Écarteur	VII	50
<b>RICHARDSON-EASTMAN</b>	Écarteur	VII	50
<b>RICHTER</b>	Ciseaux à incision	III	28
<b>RIZZUTI</b>	Rugine et dissecteur	XIII	26
<b>ROBB</b>	Rugine et dissecteur	XIII	29
<b>ROBERTS</b>	Pince hémostatique longue	IV	41
<b>ROBIN</b>	Burin et gouge ORL	XII	37
<b>ROCHARD</b>	Écarteur	VII	67, 68
	Pince utérine	VIII	26
<b>ROCHER</b>	Poinçon et trépan	XIII	93
<b>ROCHESTER-CARMALT</b>	Pince hémostatique	IV	14
<b>ROCHESTER-OSCHNER</b>	Pince hémostatique	IV	13
<b>ROCHESTER-PEAN</b>	Pince hémostatique	IV	12
<b>ROEDER</b>	Pince à champs	IV	107
<b>ROGERS</b>	Pince utérine	VIII	18
<b>RÖHM</b>	Mandrin	XIV	8
<b>ROLLET</b>	Crochet ORL	XII	46
<b>ROSE</b>	Écarteur	VII	15
<b>RÖTTGEN-RUSKIN</b>	Pince gouge	XIII	112
<b>ROUENNAIS</b>	Ciseaux divers	III	55
<b>ROUX</b>	Écarteur	VII	34
	Rugine	XIII	47
<b>ROWE</b>	Pince ORL à repositionner	XII	35
<b>RUAAULT</b>	Couteau spatule ORL	XII	25
<b>RUBIN</b>	Cisaille ORL	XII	34
<b>RUDD</b>	Pince hémorroïdale	VIII	93
	Rugine	XIII	26 à 51
	Rugine à tendons	XIII	12
	Rugine manche FERROZELL	XIII	46
	Rugine ORL	XII	41, 53
	Rugine pour ligament jaune	XIII	48
<b>RUMEL</b>	Passe-fils - Dissecteur	IV	63
<b>RUMEL-BELMONT</b>		V	7
<b>RUSKIN</b>	Pince gouge	XIII	110
<b>RUSKIN-LISTON</b>	Pince coupante	XIII	118
<b>RUSSIAN MODEL</b>	Pince à dissection spéciale	II	17
<b>RYDER</b>	Porte-aiguilles vasculaire	VI	21
<b>SACHS</b>	Rugine et dissecteur	XIII	36
<b>SAENGER</b>	Pince utérine	VIII	30
<b>SANTORINI</b>	Clamp pour prostate	VIII	95
<b>SANTULLI</b>		V	10
<b>SANTY</b>	Pince hémostatique longue	IV	42
	Canule aspiratrice	XV	26
<b>SANVENERO</b>	Ciseaux longs et fins	III	49
<b>SAROT</b>	Pince hémostatique longue	IV	41
	Porte-aiguilles vasculaire	VI	22
<b>SATINSKY</b>	Ciseaux divers	III	50
	Pince à préhension	IV	82
	Pince clamp cardiovasculaire atrauma - Occlusion tangentielle	V	22
<b>SATTERLEE</b>	Instrument pour amputation	XIII	18
<b>SAUERBRUCH</b>	Costotome	XIII	124
	Écarteur	VII	51, 53
	Pince gouge	XIII	114
<b>SAUERBRUCH-FREY</b>	Costotome	XIII	124
<b>SCHADEL</b>	Pince à champs	IV	103
<b>SCHEDE</b>	Curette	XIII	57
<b>SCHIBE</b>	Pince à préhension	IV	91
	Pince clamp intestinale et stomacale	IV	70
<b>SCHERBAK</b>	Valve vaginale	VIII	50
<b>SCHINK</b>	Dermatome à main	I	8
<b>SCHMID</b>	Endartérectomie	V	6
<b>SCHNIDT</b>	Passe-fils - Dissecteur	IV	56
<b>SCHOEMAKER-LOTH</b>	Ciseaux pour couper les fils	III	31
<b>SCHRÖDER</b>	Curette utérine	VIII	72
<b>SCHROEDER</b>	Pince utérine	VIII	13, 14
<b>SCHULTZE</b>	Instruments pour hystéro-salpingographie	VIII	79
<b>SCHUMACHER</b>	Ciseaux pour le cordon ombilical	III	80
	Écarteur	VII	136
	Pince à biopsie	VIII	63
<b>SCHUMACHER (WAGNER)</b>	Écarteur	VII	136
<b>SCHUMAKER</b>	Pince à biopsie	VIII	65
	Scie coupe-bague et lame	XV	11
<b>SCOVILLE</b>	Curette	XIII	63
<b>SCUDDER</b>	Pince clamp intestinale et stomacale	IV	78
<b>SEBILEAU</b>	Maillet et curette ORL	XII	54
	Rugine et dissecteur	XIII	34
	Rugine ORL	XII	41
<b>SEDILLOT</b>	Rugine	XIII	43
<b>SEGOND</b>	Écarteur	VII	55
	Pince utérine	VIII	19
<b>SEGOND-LANDAU</b>	Pince utérine	VIII	19
<b>SEGURA</b>	Maillet et curette ORL	XII	54
<b>SELLORS</b>	Écarteur	VII	107
<b>SEMB</b>	Davier	XIII	137



		Page	Chapitre
<b>SEMB</b>	Passe-fils - Dissecteur	IV	64
	Pince coupante	XIII	120
	Pince gouge	XIII	115
	Rugine	XIII	47
<b>SEMB-SAYLOR</b>	Passe-fils - Dissecteur	IV	64
<b>SEMKEN</b>	Pince à dissection délicate	II	32
	Pince à dissection mors tungstène	II	47
<b>SEMM</b>	Cadre (Écarteur)	VII	85
	Spéculum vaginal	VIII	35
	Valve	VII	85
<b>SENN-GREEN (CHIGOT)</b>	Écarteur	VII	16
<b>SENN-MILLER</b>	Écarteur	VII	19
<b>SENN-MILLER BABY</b>	Écarteur	VII	19
Serre-noeuds ORL		XII	20, 21
<b>SETTER</b>	Davier	XIII	136
<b>SEUTIN</b>	Ciseaux pour plâtres	XV	22
	Pince service	XV	21
<b>SEWALL</b>	Rugine et dissecteur	XIII	36
<b>SEYFFERT</b>	Spéculum vaginal	VIII	35
<b>SHUBERT</b>	Pince à biopsie	VIII	62
<b>SICARD</b>	Pince gouge	XIII	99
<b>SICART</b>	Rugine et dissecteur	XIII	37
<b>SIEBOLD</b>	Ciseaux divers	III	50
<b>SIMON</b>	Curette utérine	VIII	70, 72
	Écarteur	VII	51
<b>SIMPSON</b>	Forceps et spatule	VIII	57
<b>SIMPSON-BRAUN</b>	Forceps et spatule	VIII	58
<b>SIMPSON-LUIKART</b>	Forceps et spatule	VIII	59
<b>SIMS</b>	Ciseaux tungstène	III	68
	Ciseaux pour intervention en profondeur	III	52
	Ciseaux Prestige	III	76
	Curette utérine	VIII	73
	Hysteromètre	VIII	85
	Spéculum rectal	VIII	88
	Valve vaginale	VIII	45
	Bistouri	I	2
	Pince à pansements	IV	127
	<b>SIMS-MAIER</b>	Pince à dissection spéciale	II
<b>SINGLEY-TUTTLE</b>	Pince pour calculs biliaires	IX	6
<b>SISTERON</b>	Écarteur	VII	143
<b>SKID-MURPHY</b>	Amygdalotome	XII	26
<b>SLUDDER-BALLENGER</b>	Instrumentation pour ménisque	XIII	150, 151
<b>SMILLIE-TRILLAT</b>	Ciseaux divers	III	87
<b>SMITH</b>	Ciseaux burins, gouges	XIII	77
<b>SMITH-PETERSEN</b>	Ciseaux burins, ostéotome, gouges	XIII	71
	Pince gouge	XIII	112
	Curette ORL	XII	55
<b>SNELLEN</b>	Pince hystérolable	VIII	52
<b>SOMMER</b>	Sonde cannelée	XV	13
Sonde métallique		VIII	86
Spatule		VIII	53 à 59
Spatule à pommade		XV	31
Spatule neurochirurgie		XI	3 à 5
Spatule pour épaule		XIII	148
Speculum ORL		XII	16 à 19
Spéculum rectal		VIII	87, 88
Spéculum vaginal		VIII	31 à 35, 50
Spéculum vaginal pour vierge		VIII	33, 34
<b>SPENCER</b>	Ciseaux coupe ligatures	III	41
<b>SPENCER-WELLS</b>	Pince hémostatique	IV	15, 18
<b>SPENCER-FINO</b>	Ciseaux coupe ligatures	III	42
Sphinctéroscope		VIII	89
<b>SPINA-NASALIS</b>	Écarteur pour chirurgie maxillo-faciale	VII	65
Spray pour la lubrification		XV	33
Spray siliconé		XV	33
<b>SPURLING</b>	Pincers rongeurs neurochirurgie	XI	11
<b>ST MARKS</b>	Valve vaginale	VIII	47
<b>STAGNARA</b>	Ciseaux gouge	XIII	79
<b>STAMEY</b>	Aiguille à ligatures	VI	29
<b>STEINMANN</b>	Pince à saisir les tendons	XIII	13, 14
<b>STELLBRINK</b>	Pince gouge	XIII	105
<b>STERNBERG</b>	Ouvre-bouche	XII	8
Sternotome		XIII	125
Stéthoscope		XV	5
<b>STEVENS</b>	Ciseaux fins	III	43
	Ciseaux Prestige	III	73
	Pince à échardes	II	52
<b>STIEGLITZ</b>	Ciseaux burins, ostéotome, gouges	XIII	72
<b>STILLE</b>	Pince à dissection délicate	II	15
	Pince gouge	XIII	111
	Pince pour plâtres	XV	23
	Pince pour voies biliaires	IX	9
	Pince gouge	XIII	115
	Pince gouge	XIII	108
<b>STILLE-LUER</b>	Écarteur	VII	17
<b>STOOKEY</b>			
<b>STRANDELL-STILLE</b>			



		Page	Chapitre
<b>STRASBOURG</b>	Pince à dissection spéciale	II	13
<b>STRATT</b>	Porte-aiguilles	VI	19
<b>STRAUSS</b>	Compresseur de l'urètre	VIII	86
<b>STRELI</b>	Porte-aiguilles	VI	9
Stripper à tendons		XIII	12
Strippers		V	5
<b>STRULLY</b>	Ciseaux longs et fins	III	48
<b>STRUYCKEN</b>	Emporte pièces ORL	XII	28
Stylets		XV	12
<b>SUBRAMANIAN</b>	Pince clamp atrauma	V	31
	Pince clamp cardiovasculaire atrauma - Aorte	V	31
<b>SYME</b>	Rugine et dissecteur	XIII	29
<b>TAKAHASHI</b>	Emporte pièces ORL	XII	28
	Râpe ORL	XII	42
Taraud		XIV	6, 47
<b>TARNIER</b>	Forceps et spatule	VIII	53
<b>TAYLOR</b>	Écarteur neurochirurgie	XI	7
	Pince à dissection délicate	II	27
<b>TEALE</b>	Pince utérine	VIII	10
<b>TEISSIER</b>	Forceps et spatule	VIII	59
Tendeur à fils		XIV	29
Tendeur de fils pour cerclage		XIV	52
Tendeur de plaque		XIV	23
Tendeur pour étrier		XIII	157
<b>TENOTOME</b>	Bistouri	I	2
<b>TERRIER</b>	Ouvre-bouche	XII	7
	Pince hémostatique	IV	15, 16
<b>TESSIER</b>	Écarteur pour chirurgie maxillo-faciale	VII	66
<b>THERUM</b>	Pince pour stérilet	VIII	81
<b>THOMS-ALLIS</b>	Pince à préhension	IV	97
<b>THUDICHUM (GOLDSMITH)</b>	Speculum ORL	XII	17
<b>TIECK</b>	Speculum ORL	XII	19
Tige de nettoyage pour vis perforées		XIV	49
Tire-comédon		XIII	53
<b>TISCHLER</b>	Pince à biopsie	VIII	67
<b>TISCHLER-MORGAN</b>	Pince à biopsie	VIII	64
<b>TOENNIS</b>	Ciseaux longs et fins	III	46
	Rugine et dissecteur	XIII	31
<b>TOENNIS-ADSON</b>	Ciseaux tungstène	III	65
	Ciseaux longs et fins	III	47
<b>TOENNIS-ADSON-FINO (DEBAKEY)</b>	Ciseaux longs et fins	III	47
<b>TOHOKU</b>	Pince à champs	IV	106
Tord-broches		XIV	25
<b>TOUPET</b>	Dépresseur double	VII	76
	Pince clamp	IV	47
	Piquet	VII	72
	Valve	VII	73
<b>TOUPET (ENTEROSTAT)</b>	Écarteur	VII	76
Tournevis		XIV	11 à 13
Tournevis - Manche		XIV	13
Tournevis - Préhenseur		XIV	12
Tournevis pour vis perforées		XIV	49
Tourniquet vasculaire		V	7
<b>TOWNSEND</b>	Pince à biopsie	VIII	67
Tracteur pour fibrome		VIII	81
<b>TRAVERS</b>	Écarteur	VII	114
<b>TRELAT</b>	Spéculum rectal	VIII	87
Trépan		XIII	93
Tréphine pour enlever les vis cassées		XIV	37
<b>TREVES</b>	Pince à dissection spéciale	II	12
<b>TRILLAT</b>	Chasse-greffons	XIII	143
	Écarteur pour avant bras	VII	141
	Instrumentation pour épaule	XIII	148
	Instrumentation pour genou	XIII	155
	Instrumentation pour ménisque	XIII	154
Trocart		XV	28 à 30
Trocart à biopsie osseuse		XV	28
Trocart avec guide pour clous		XIV	44
<b>TROELTSCH</b>	Pince à dissection O.R.L.	II	38
<b>TROUSSEAU</b>	Dilatateur ORL	XII	12
<b>TROUTMAN</b>	Micro ciseaux	X	7
<b>TROUTMAN-BARRAQUÈRE</b>	Micro ciseaux	X	5
<b>TUBBS</b>	Dilatateur vasculaire et aortique	V	40
<b>TUBIANA</b>	Porte-aiguilles	VI	9
<b>TUFFIER</b>	Écarteur	VII	38, 49, 106
	Pince à préhension	IV	98
<b>TULIPE</b>	Endartérectomie	V	7
<b>UCKERMANN</b>	Dilatateur ORL	XII	12
<b>UFFENORDE</b>	Curette	XIII	58
<b>ULRICH</b>	Pince à pansements	IV	121
<b>UNNA</b>	Tire-comédon	XIII	53
<b>VACHER</b>	Serre-noeuds ORL	XII	20
	Speculum ORL	XII	16
<b>VALLEIX</b>	Hysteromètre	VIII	85
Valve		VII	





		Page	Chapitre
Valve à poumon		VII	40
Valve pour écarteur		VIII	91
Valve radio transparente		VII	68
Valve sus-pubienne		VII	68, 69
Valve vaginale		VIII	37 à 50
<b>VAN DOREN</b>	Pince à biopsie	VIII	63
<b>VANNAS</b>	Micro ciseaux	X	4, 9, 10
<b>VANNAS modifié TÜBINGEN</b>	Micro ciseaux	X	4
<b>VARADY</b>	Endartérectomie	V	8
<b>VELPEAU (TRICOISE)</b>	Costotome	XIII	125
Ventouse obstétricale et accessoires		VIII	61
<b>VERBRUGGE</b>	Davier	XIII	127 à 130
<b>VERBRUGGE-MULLER</b>	Écarteur	VII	134
<b>VERNON</b>	Marteau à réflexes et caoutchouc	XV	5
<b>VIDAL</b>	Grattoir	XIII	52
<b>VINCENT</b>	Pince à dissection Prestige	II	49
	Pince gouge	XIII	99
<b>VINCENT (SCHMIEDEN)</b>	Ciseaux pour chirurgie vasculaire	III	36
<b>VIRCHOW</b>	Couteau à cerveau	XIII	15
	Instrument pour amputation	XIII	17
<b>WISE</b>	Micro pince à suture	II	33
Viseur pour broche guide		XIV	48
<b>VOLKMANN</b>	Curette	XIII	54 à 57
	Curette utérine	VIII	71
	Écarteur	VII	22 à 26
<b>WACHENFELDT</b>	Pince à poser les agrafes	VI	5
<b>WAGNER</b>	Ciseaux fins	III	14
	Ciseaux Prestige	III	72
	Crochet ORL	XII	45
	Écarteur	VII	131
	Rugine	XIII	51
<b>WALDMANN</b>	Ciseaux à épisiotomie	III	82
<b>WALLICH</b>	Curette utérine	VIII	69
<b>WALSHAM</b>	Pince ORL à repositionner	XII	35
<b>WALTER-CARMALT</b>	Pince à échardes	II	51
<b>WALTER-DUVAL</b>	Pince à préhension	IV	86
<b>WALTON</b>	Ciseaux fins	III	40
	Écarteur pour hémilaminectomie	VII	125
<b>WANGENSTEEN</b>	Pince à dissection mors tungstène	II	45
	Porte-aiguilles	VI	17
<b>WATSON CHEYNE</b>	Rugine et dissecteur	XIII	31
	Stylets	XV	12
<b>WAUGH</b>	Pince à dissection délicate	II	31
<b>WEBER</b>	Pince clamp cardiovasculaire atrauma - Aorte	V	21
<b>WEBSTER</b>	Porte-aiguilles	VI	8
<b>WECKER</b>	Micro ciseaux	X	6
<b>WEIL-BLAKESLEY</b>	Pinces rongeurs neurochirurgie	XI	15
<b>WEISS</b>	Pince presse-tubes	IV	111
<b>WEITLANER</b>	Écarteur	VII	112, 113, 116
	Ecarteurs neuro	VII	117
<b>WEITLANER-WULLSTEIN</b>	Écarteur	VII	116
<b>WERTHEIM</b>	Ciseaux pour intervention en profondeur	III	52
	Pince utérine	VIII	16, 20
<b>WERTHEIM (BOZEMANN)</b>	Porte-aiguilles	VI	19
<b>WERTHEIM-CULLEN</b>	Pince utérine	VIII	23
<b>WERTHEIMER</b>	Canule aspiratrice ORL	XII	57
<b>WESTCOTT</b>	Micro ciseaux	X	3, 7
<b>WHITE</b>	Pince à préhension ORL	XII	13
<b>WHITEHEAD</b>	Ouvre-bouche	XII	9
<b>WICKSTROEM</b>	Passe-fils - Dissecteur	IV	59
<b>WIEN</b>	Speculum ORL	XII	19
<b>WILLIAMS</b>	Écarteur	VII	127
	Tournevis	XIV	12
<b>WILLIGER</b>	Curette	XIII	53
	Curette ORL	XII	56
	Rugine et dissecteur	XIII	35
<b>WILMER</b>	Ciseaux fins	III	39
<b>WINTER</b>	Pince utérine	VIII	29
<b>WOLF</b>	Pince pour plâtres	XV	23
<b>WOODSON</b>	Rugine et dissecteur	XIII	28
<b>WRIGLEY</b>	Forceps et spatule	VIII	57
<b>WYLIE</b>	Pince clamp cardiovasculaire atrauma - Anévrisme de l'aorte	V	16
<b>YANKAUER</b>	Rugine et dissecteur	XIII	34
	Canule aspiratrice	XV	26
<b>YASARGIL</b>	Micro ciseaux	X	11
	Micro porte-aiguilles	X	13
	Rugine et dissecteur	XIII	31
<b>YEOMAN</b>	Pince à biopsie rectale	VIII	92
<b>YOUNG</b>	Écarteur pour prostate	VIII	96
	Pince tire-langue	XV	9
<b>ZENKER</b>	Écarteur	VII	48
	Passe-fils - Dissecteur	IV	60
<b>ZIELKE</b>	Ciseaux gouge	XIII	82
<b>ZWEIFEL</b>	Porte-aiguilles	VI	26



		Chapter	Page
<b>AACHEN</b>	Spatula neurosurgery	XI	5
<b>ABADIE</b>	Retractor	VII	91
<b>ABOULKER</b>	Bone rongeur forceps	XIII	100
	ENT Dilator	XII	12
	Raspatory and elevator	XIII	32
	Retractor	VII	11
<b>ABRAHAM</b>	ENT Knife spatula	XII	25
Adenoids knives		XII	23, 24
<b>ADLERKREUTZ</b>	Delicate dissecting forceps	II	16
	Prestige dissecting forceps	II	50
<b>ADSON</b>	Bone rongeur forceps	XIII	104
	Dissecting forceps tungsten jaws	II	47
	Forceps (dissection) for services	XV	17
	Haemostatic forceps	IV	35
	Hook	XIII	24
	Needle holders	VI	10
	Raspatory	XIII	38
	Retractor	VII	122, 124
	Delicate dissecting forceps	II	22
<b>ADSON ATRAUMA</b>	Delicate dissecting forceps	II	24
<b>ADSON-BIMER</b>	Delicate dissecting forceps	II	24
<b>ADSON-BROWN</b>	Delicate dissecting forceps	II	22
<b>ADSON-GRAEFE</b>	Delicate dissecting forceps	II	24
<b>ALAN PARKS</b>	Rectal specula	VIII	91
<b>ALEXANDER</b>	Bone chisel, osteotome, gouges	XIII	71
	Raspatory and elevator	XIII	29
<b>ALLAINE</b>	Dissecting Scissors	III	25
	Ligature forceps - Dissector	IV	53
<b>ALLAINE (BOYD)</b>	Dissecting Scissors	III	26
<b>ALLAIRE</b>	Delicate scissors	III	15
<b>ALLEN</b>	Intestinal and stomach clamps forceps	IV	77
	Screw driver	XIV	13
<b>ALLIR-ADAIR</b>	Grasping forceps	IV	96
<b>ALLIS</b>	Grasping forceps	IV	94
<b>ALLISON</b>	Retractor	VII	40
<b>ALM</b>	Retractor	VII	109
Amnioscope		VIII	51
<b>ANDERSON-ADSON</b>	Neuro retractors	VII	117
<b>ANDREW-PYNCHON</b>	Suction tubes	XV	26
Anuscope		VIII	89
Aortic and vascular dilators		V	40
<b>ARRUGA</b>	Capsule forceps	X	16
<b>ASCH</b>	ENT Shear	XII	34
Atrauma cardiovascular forceps		V	12 to 36
Atrauma cardiovascular forceps - Anastomosis		V	12, 22, 29, 34, 36, 37
Atrauma cardiovascular forceps - Aorta		V	17, 18, 20, 21, 24, 31
Atrauma cardiovascular forceps - Aortic aneurysm		V	15, 16, 17
Atrauma cardiovascular forceps - Artery aneurysm		V	25
Atrauma cardiovascular forceps - Auricle		V	18
Atrauma cardiovascular forceps - Bronchus		V	19
Atrauma cardiovascular forceps - Carotid		V	33
Atrauma cardiovascular forceps - Coarctation		V	12, 25, 26, 34, 36
Atrauma cardiovascular forceps - Ligature		V	13, 20 to 21, 29, 36
Atrauma cardiovascular forceps - Multi purpose		V	24, 34
Atrauma cardiovascular forceps - Paediatrics		V	37 to 39
Atrauma cardiovascular forceps - Peripheral		V	30
Atrauma cardiovascular forceps - Profunda		V	31
Atrauma cardiovascular forceps - Renal artery		V	15
Atrauma cardiovascular forceps - Tangential Occlusion		V	22
<b>AUBERT (FINSTERER)</b>	Suction tubes	XV	26
<b>AUBRY</b>	ENT retractor	XII	48
<b>AUFRICHT</b>	ENT rasps	XII	43
	ENT Retractor and hook	XII	49
<b>AUSTIN</b>	Micro-tubal forceps	II	33
<b>AUVARD</b>	Vaginal blade	VIII	49
<b>AUVERT</b>	Blade	VII	86
	Grasping forceps	IV	92
	Retractor complete	VII	86
<b>BABCOCK</b>	Grasping forceps	IV	100, 101
<b>BABINSKY</b>	Percussion hammer and rubber	XV	5
<b>BABY KOCHER</b>	Intestinal and stomach clamps forceps	IV	70
<b>BABY SATINSKY</b>	Grasping forceps	IV	82
<b>BABY ADSON</b>	Ligature forceps - Dissector	IV	50
<b>BABY ALLIS</b>	Grasping forceps	IV	95
<b>BABY COLLIN</b>	Blade	VII	81
	Compass (retractor)	VII	81
	Retractor complete	VII	81
<b>BABY CRILE</b>	Haemostatic forceps	IV	30
<b>BABY CRILE-WOOD</b>	Needle holders	VI	15
<b>BABY DOYEN</b>	Intestinal and stomach clamps forceps	IV	70
<b>BABY HAIGHT</b>	Retractor for infants	VII	98
<b>BABY HARRINGTON</b>	Retractor	VII	58
<b>BABY LEXER</b>	Dissecting Scissors	III	21
<b>BABY METZENBAUM</b>	Prestige scissors	III	71
<b>BABY MIKULICZ</b>	Special haemostatic forceps for peritoneum	IV	48



		Chapter	Page
<b>BABY MIXTER</b>	Ligature forceps - Dissector	IV	58
<b>BABY OVERHOLT</b>	Ligature forceps - Dissector	IV	58
<b>BABY POOLE</b>	Suction tubes	XV	26
<b>BABY ROUX</b>	Retractor	VII	34
<b>BABY TISCHLER (MINI TOWNSEND)</b>	Biopsy forceps	VIII	64
<b>BACKHAUS</b>	Towel forceps	IV	104, 105
		XV	20
<b>BACON</b>	Bone rongeur forceps	XIII	108
<b>BAILEY</b>	Retractor	VII	107
<b>BAILEY BABY</b>	Rib contractor	VII	107
<b>BAINBRIDGE</b>	Atrauma cardiovascular forceps	V	14
	Special haemostatic forceps	IV	44
<b>BAKES</b>	Dilator for bile ducts	IX	14
<b>BALFOUR</b>	Blade	VII	89, 90
	Retractor complete	VII	89, 90
<b>BALFOUR (USA MODEL)</b>	Blade	VII	91
	Retractor	VII	91
<b>BALFOUR BABY</b>	Blade	VII	89, 90
	Retractor complete	VII	89
<b>BALLENGER</b>	Adenoids knives	XII	24
	ENT Gouge	XII	40
<b>BALLENTINE</b>	Uterine forceps	VIII	22
Bandage		XV	31
Bandage forceps		IV	118 to 127
Bandage scissors		III	29, 30, 85
<b>BANE HARTMANN</b>	Bone rongeur forceps	XIII	105
<b>BANKART</b>	Shoulder instrumentation	XIII	147
<b>BAR</b>	Forceps to cut the clamps	VIII	60
<b>BARR</b>	Rectal specula	VIII	90
<b>BARRAQUER</b>	Microsurgery needle-holder	X	14
<b>BARRAYA</b>	Delicate dissecting forceps	II	14
	Ligature forceps - Dissector	IV	65
	Prestige dissecting forceps	II	50
<b>BARRE</b>	Vesical forceps	IX	11
<b>BARSKY</b>	Retractor, hook	VII	9
<b>BECK</b>	Atrauma cardiovascular forceps	V	23, 34
<b>BECKMANN</b>	Adenoids knives	XII	23
	Blade	VII	120
	Retractor	VII	118 to 120
<b>BECKMANN (MOORE)</b>	Adenoids knives	XII	22
<b>BECKMANN-CONE</b>	Retractor	VII	118
<b>BECKMANN-ADSON</b>	Retractor	VII	123
<b>BECKMANN-EATON</b>	Retractor	VII	122
<b>BEEBE</b>	Wire cutting scissors	III	31
<b>BELLUCI</b>	ENT Micro-scissors	XII	31
Bending press for plates		XIV	22
Bending template for nails		XIV	46
<b>BENGOLEA</b>	Long haemostatic forceps	IV	39, 40
	Prestige haemostatic forceps	IV	115
<b>BENNET</b>	Retractor	VII	141
<b>BENSAUDE</b>	Anuscope	VIII	89
<b>BENSON</b>	Pylorus spreader	IV	102
<b>BERGER</b>	Biopsy forceps	VIII	65
<b>BERGERET-TOUPET</b>	Peg holder	VII	72
<b>BERGMANN</b>	Bandage scissors	III	30
	Mallet	XIII	86
	Retractor, hook	VII	10
	Curette	XIII	52
<b>BESNIER</b>			
<b>BETHUNE</b>	Costotome	XIII	122
<b>BEYER</b>	Bone rongeur forceps	XIII	106, 109
<b>BEYER-ZAUFAL</b>	Bone rongeur forceps	XIII	109
<b>BILLEAU</b>	ENT curettes	XII	56
Biopsy curette		VIII	77
Biopsy forceps		VIII	62 to 67
<b>BIRCHER</b>	Instrumentation for meniscus	XIII	150
<b>BIRCHER-GANSKE</b>	Instrumentation for meniscus	XIII	153
<b>BIRKETT</b>	Haemostatic forceps	IV	34
Blade		VII	
Blade bender		VII	86
Blade for lung		VII	40
Blades for dermatome		I	8, 9
<b>BLAKE</b>	Uterine curette	VIII	76
	Forceps gales stones	IX	7
Blind gut forceps		IV	77
<b>BLONDIAU</b>	ENT mallets and curettes	XII	56
<b>BLOUNT</b>	Instrumentation for meniscus	XIII	151
	Retractor	VII	140
<b>BLUMENTHAL</b>	Bone rongeur forceps	XIII	102
Blunt scissors for services		XV	16
<b>BOEHLER</b>	Bone cutting forceps	XIII	118
	Bone rongeur forceps	XIII	109
	Traction bows	XIII	160
<b>BOETTCHER</b>	Tonsil scissors	III	37
Bone chisel		XIII	65, 68 to 75, 77, 81
Bone chisel blade		XIV	24



	Chapter	Page
Bone cutting forceps	XIII	116 to 120
Bone drill neurosurgery	XI	9, 10
Bone forceps	XII	32
Bone hand drill	XIV	9
Bone holding forceps	XIII	126 to 141
Bone levers for foot and hand bones	VII	130
Bone rongeur forceps	XIII	97 to 115
Bone surgery scissors	III	86
<b>BONN</b>	Fine scissors	III
<b>BONNAIRE</b>	Uterine forceps	VIII
<b>BONNEY</b>	Special dissecting forceps	II
<b>BONNIOT</b>	Haemostatic forceps	IV
<b>BORDIER-MEUNIER</b>	Trocar in osseous biopsy	XV
<b>BOSE</b>	ENT Specula	XII
<b>BOURGEOIS</b>	ENT Grasping forceps	XII
<b>BOWMAN (PALMER)</b>	ENT Specula	XII
<b>BOYS-ALLIS</b>	Grasping forceps	IV
Brain knife	XIII	15
<b>BRAND</b>	Forceps to grasp tendons	XIII
	Guide for tendons	XIII
<b>BRAUN</b>	Uterin depressor	VIII
	Uterine forceps	VIII
<b>BRAUN-STADLER</b>	Episiotomy scissors	III
<b>BRIDGE</b>	Long haemostatic forceps	IV
<b>BRIESKY</b>	Pelvimeter	VIII
	Vaginal blade	VIII
<b>BRISTOW</b>	Retractor	VII
Bronchus clamps	IV	81
<b>BROCK</b>	Scraper	XIII
<b>BROPHY</b>	Delicate dissecting forceps	II
<b>BROPHY (SULLIVAN)</b>	Long and fine scissors	III
<b>BROWN-RESANO</b>	Special dissecting forceps	II
<b>BRUENINGS</b>	ENT Snare	XII
	Tongue depressor	XV
<b>BRUNETTI</b>	Instrument for autopsy	XIII
<b>BRUNNER</b>	Costotome	XIII
	Intestinal and stomach clamps forceps	IV
	Ligature needle	VI
	Retractor	VII
<b>BRUNS</b>	Curette	XIII
	Plaster scissors	III
		XV
<b>BUCK</b>	Ear forceps	XII
	ENT curettes	XII
<b>BUCK-GRAMCKO</b>	Bone levers for foot and hand bones	VII
<b>BUELAU</b>	Trocar	XV
Bulldog clamp	V	9 to 11
<b>BUNNEL</b>	Bone hand drill	XIV
<b>BUNNELL</b>	Guide for tendons	XIII
	Tendon stripper	XIII
<b>BUSCH (VEZIEN)</b>	Scissors for omilbilical cord	III
<b>BUSCHE</b>	Curette	XIII
Cable cut forceps	XIV	36
<b>CAIRNS</b>	Haemostatic forceps	IV
<b>CAIRNS (CLOVIS-VINCENT)</b>	Raspatory and elevator	XIII
Canal cleaner for cannulated screw	XIV	49
<b>CANNY-RYALL</b>	Retractor	VII
<b>CAPENER</b>	Gouges	XIII
Capsule forceps	X	16
		XIII
Capsule-opening forceps	IV	110
<b>CAROLL</b>	Forceps to grasp tendons	XIII
	Goniometer	XIII
<b>CARPENTER</b>	Raspatory and elevator	XIII
<b>CARREL</b>	Haemostatic forceps	IV
	Lymphographia clamp	V
Cartilage scissors	III	37
<b>CASPAR</b>	Curette	XIII
	Hook	XIII
	Laminectomy rongeurs neurosurgery	XI
	Raspatory	XIII
	Retractor	VII
	Retractor neurosurgery	XI
	Scalpel handle	I
<b>CASTANEDA</b>	Atrauma cardiovascular forceps - Paediatrics	V
<b>CASTROVIEJO</b>	ENT hook	XII
	Microsurgery needle-holder	X
	Microsurgery scissors	X
Catheter forceps	XV	9
<b>CATLIN</b>	Flap knife	XIII
<b>CAUCHOIX</b>	Osteotome, gouges	XIII
	Retractor	VII
Cement extraction forceps	XIII	161
Centering sleeve for nails	XIV	44
<b>CHADWICK</b>	Fine scissors	III



		Chapter	Page
Chain for peg		VII	72
Chain for retractor		VII	82
<b>CHANDLER</b>	Blade	VII	104
	Retractor	VII	139
	Retractor complete	VII	104
<b>CHAPUT</b>	Grasping forceps	IV	93
<b>CHAPUT-MAYO</b>	Grasping forceps	IV	93
<b>CHARNLEY</b>	Blade	XIII	142
	Complete frame	XIII	142
	Curette	XIII	65
	Retractor, lead hand	XIII	142
<b>CHARRIER</b>	Retractor	VII	37
<b>CHARRIERE</b>	Instrument for amputation	XIII	18, 19
<b>CHATELIER</b>	ENT Grasping forceps	XII	14
<b>CHEATLE</b>	Forceps for instruments	XV	32
<b>CHERON</b>	Bandage forceps	IV	119
<b>CHEVALIER-JACKSON</b>	Oesophagoscopy forceps	XII	36
<b>CHEVRET</b>	Retractor	VII	40
Chisel guide		XIV	17
<b>CHRISTOPHE</b>	Haemostatic forceps	IV	33
	Prestige haemostatic forceps	IV	117
<b>CHROBAK</b>	Uterine forceps	VIII	24
<b>CINELLI</b>	Osteotome	XII	39
<b>CIRCERON (MATHIEU)</b>	Forceps for coil	VIII	81
<b>CITELLI</b>	ENT Punch forceps	XII	29
Clamp closing forceps		IV	80
Clamp for prostate		VIII	95
Clamp forceps		IV	46, 47
Clamp holder		IV	80
Clamp Setting forceps		V	10
<b>CLAOUE</b>	ENT retractor	XII	48
Cleaning and renovation of instruments		XV	33
<b>CLEVELAND</b>	Bone cutting forceps	XIII	117
	Bone rongeur forceps	XIII	103
Clip applying and removing forceps		VI	7
Clip applying forceps		VI	5, 6
Clip removing forceps		VI	7
<b>CLOVIS-VINCENT</b>	Bone drill neurosurgery	XI	9
	ENT curettes	XII	58
	Spatula neurosurgery	XI	3
	Very Fine dissecting forceps	II	11
	Raspatory	XIII	48
<b>CLOWARD</b>	Curette	XIII	59
	Hook	XIII	24
<b>COAKLEY</b>	ENT curettes	XII	57
<b>COBB</b>	Gouges	XIII	79
	Raspatory	XIII	51
<b>COLLER-CRILE</b>	Haemostatic forceps	IV	30
<b>COLLIN</b>	Blade	VII	79, 80
	Compass (retractor)	VII	79, 80
	Costotome	XIII	121
	Grasping forceps	IV	87, 90
	Retractor	VII	34, 79, 80
	Uterine elevating forceps	VIII	52
	Vaginal specula	VIII	31
<b>COLLIN-POZZI</b>	Uterine forceps	VIII	13
<b>COLVER</b>	ENT Grasping forceps	XII	15
Comedone extractor		XIII	53
Compass		XIII	145
Compass (retractor)		VII	67, 73, 74
Conductor for wire saw		XIII	20
Connector for suction		VIII	77
<b>CONVERSE</b>	ENT hook	XII	47
	Needle holders	VI	14
<b>COOLEY</b>	Aortic and vascular dilators	V	40
	Atrauma cardiovascular forceps	V	33, 35, 36
	Atrauma cardiovascular forceps - Anastomosis	V	36, 37
	Atrauma cardiovascular forceps - Coarctation	V	34, 36
	Atrauma cardiovascular forceps - Ligature	V	36
	Atrauma cardiovascular forceps - Multi purpose	V	34
	Atrauma cardiovascular forceps - Paediatrics	V	37, 38
	Retractor	VII	101
	Vascular dissecting forceps	II	42
<b>COOLEY-DERRA</b>	Atrauma cardiovascular forceps - Anastomosis	V	34
Coronary scissors		III	36
<b>CORYLLOS</b>	Retractor	VII	53
Costotome		XIII	121 to 125
<b>COTT</b>	Blade	VII	77
	Compass (retractor)	VII	77
	Retractor	VII	77
	Uterine tatters forceps	VIII	24
<b>COTTLE</b>	ENT hook	XII	47
	ENT rasps	XII	43
	ENT scissors	III	84
	Mallet	XIII	88



		Chapter	Page	
<b>COTTLE</b>	Nasal scissors (Prestige)	III	79	
	Osteotome	XII	37	
	Raspatory	XIII	43	
	Raspatory and elevator	XIII	31	
	Retractor, hook	VII	10	
<b>COTTLE (KILLIAN)</b>	ENT Specula	XII	18	
<b>COTTLE-NEIVERT</b>	ENT hook	XII	47	
Cotton holder		XV	14	
Cotton scissors		III	55	
<b>COURTY</b>	Retractor	VII	129	
<b>CRAFOORD</b>	Long haemostatic forceps	IV	43	
<b>CRAFOORD (SELLORS)</b>	Scissors for deep operation	III	51	
	Special haemostatic forceps	IV	45	
<b>CRAIG-DOMNICK</b>	ENT Grasping forceps	XII	15	
<b>CRAWFORD</b>	Retractor	VII	36	
<b>CREED</b>	Raspatory and elevator	XIII	28	
<b>CRILE</b>	Haemostatic forceps	IV	28, 29	
	Hook	XIII	25	
	Prestige haemostatic forceps	IV	117	
	Retractor	VII	33	
<b>CRILE-MURRAY</b>	Needle holders	VI	11	
<b>CRILE-RANKIN</b>	Haemostatic forceps	IV	29	
<b>CRILE-WOOD</b>	Needle holder for services	XV	18	
	Needle holders	VI	11, 15	
Curette		XIII	52 to 65	
Curette for bile ducts		IX	12 to 13	
Cursor		VII	72, 92	
<b>CUSCHING-KOCHER</b>	Retractor	VII	17	
<b>CUSCO</b>	Vaginal specula	VIII	33	
	Virgin vaginal specula	VIII	34	
<b>CUSHING</b>	Bone drill neurosurgery	XI	10	
	Delicate dissecting forceps	II	25	
	Dissecting forceps tungsten jaws	II	46	
	Hook	XIII	25	
	Laminectomy rongeurs neurosurgery	XI	11	
	Microsurgery hook	X	20	
	Raspatory	XIII	41, 42	
	Retractor	VII	13, 62	
	Uterine curette	VIII	75	
	Cystic forceps	IX	11	
<b>CZERNY</b>	Forceps gales stones	IX	7	
	Rectal specula	VIII	88	
	Uterine forceps	VIII	25	
<b>DALE</b>	Atrauma cardiovascular forceps - Peripheral	V	30	
<b>DANDY</b>	Haemostatic forceps	IV	26	
	Microsurgery hook	X	20	
<b>DANIS</b>	Retractor and spatula for shoulder	XIII	148	
	Shoulder instrumentation	XIII	148	
	Wire guide	XIII	149	
	Wire tightener	XIV	29	
<b>DARGENT</b>	Uterine forceps	VIII	16	
	Vaginal blade	VIII	42	
<b>DARTIGUES</b>	Uterine elevating forceps	VIII	52	
<b>DARTIGUES (LAPAROSTAT)</b>	Retractor	VII	94	
<b>DAUBENSPECK</b>	Curette	XIII	60	
<b>DAUPHIN</b>	Surgical scissors	III	11	
<b>DAUTREY</b>	ENT retractor	XII	48	
<b>DAVID</b>	Bone rongeur forceps	XIII	114	
<b>DAVIS</b>	Raspatory and elevator	XIII	27	
<b>DAVIS-BOYLE</b>	Mouth gag	XII	10	
<b>DE MARTEL</b>	Conductor for wire saw	XIII	20	
	Raspatory and elevator	XIII	37	
	Scalp flap forceps	IV	84	
	Scissors for vascular surgery	III	35	
<b>DE MARTEL - WOLFSON</b>	Clamp closing forceps and clamp holder	IV	80	
<b>DEAN</b>	Various scissors	III	45	
<b>DEAVER</b>	Retractor	VII	59, 60	
	Fine scissors	III	14	
<b>DEBAKEY</b>	Aortic and vascular dilators	V	40	
	Atrauma cardiovascular forceps	V	13, 14, 22, 23, 27, 28, 32	
	Atrauma cardiovascular forceps - Aorta	V	20, 21	
	Atrauma cardiovascular forceps - Aortic aneurysm	V	17	
	Atrauma cardiovascular forceps - Ligature	V	13, 20, 21	
	Atrauma cardiovascular forceps - Multi purpose	V	24	
	Atrauma cardiovascular forceps - Renal artery	V	15	
	Blade	VII	102	
	Bulldog clamp	V	10	
	Bulldog clamp (carotid)	V	11	
	Dissecting forceps tungsten jaws	II	44	
	Retractor	VII	102, 128	
	Scissors for vascular surgery	III	3136	
	Tungsten scissors	III	69	
	Vascular dissecting forceps	II	41 to 43	
	Vascular needle holders	VI	20	
	<b>DEBAKEY-BAHNSON</b>	Atrauma cardiovascular forceps - Artery aneurysm	V	25



	Chapter	Page
<b>DEBAKEY-DIETRICH</b>	Vascular dissecting forceps	II 43
<b>DEBAKEY-GERALD</b>	Vascular dissecting forceps	II 43
<b>DEBAKEY-GLOVER</b>	Bulldog clamp	V 11
<b>DEBAKEY-MOSQUITO</b>	Atrauma cardiovascular forceps	V 27
<b>DEBAKEY-PEAN</b>	Atrauma cardiovascular forceps	V 26
<b>DEBAKEY-POTTS</b>	Atrauma cardiovascular forceps	V 12
<b>DEBAKEY-RANKIN</b>	Atrauma cardiovascular forceps	V 27
<b>DEBAKEY-SATINSKY</b>	Bulldog clamp	V 11
<b>DEBAKEY-BECK</b>	Atrauma cardiovascular forceps	V 16
<b>DECOULX</b>	Retractor	VII 121
<b>DELABARRE</b>	Mouth gag	XII 7
<b>DELESTRE</b>	Episiotomy scissors	III 81
Delicate dissecting forceps		II 11
Delicate scissors		III 12 to 15
<b>DEMEL</b>	Wire tightener	XIV 29
<b>DEMELIN-SUZOR</b>	Obstetrical forceps and spatula	VIII 54
<b>DEMOISELLE</b>	Grafts pusher	XIII 143
<b>DENHART</b>	Mouth gag	XII 7
<b>DENIS BROWN</b>	Blade	VII 84
	Frame (Retractor)	VII 84
Depth gauge for screw		XIV 10
<b>DERF</b>	Needle holders	VI 8, 14
<b>DERRA</b>	Atrauma cardiovascular forceps - Anastomosis	V 29
<b>DESCHAMPS</b>	Ligature needle	VI 32
<b>DESCHAMPS-SCHAUTA</b>	Ligature needle	VI 31
<b>DESOUTTES</b>	Special dissecting forceps	II 18
<b>DESJARDINS</b>	Curette for bile ducts	IX 12
	Cystic forceps	IX 11
	Probe for bile ducts	IX 12
	Scoop for bile ducts	IX 12
	Forceps gales stones	IX 6
<b>DESMARET</b>	Retractor	VII 70
<b>DESMARRES</b>	Retractor	VII 11
Detacher for tendons		XIII 11
<b>DIETRICH</b>	Atrauma cardiovascular forceps - Aorta	V 18
<b>DINGMANN</b>	Bone holding forceps	XIII 127
Dilating bougie		VIII 86
Dilator for bile ducts		IX 14
<b>DINGMAN</b>	Retractor	VII 66
<b>DINGMANN</b>	Bone holding forceps	XIII 127
	Mouth gag	XII 11
Disc for mallets		XIII 87, 88
Disposable blades		I 4 to 6
Dissecting forceps for services		XV 17
Dissecting forceps tungsten jaws		II 44 to 47
Dissecting Scissors		III 16 to 26
Dissector		V 8
<b>DIXON-LOVELACE</b>	Haemostatic forceps	IV 27
<b>DOCKHORN</b>	Retractor for maxillofacial surgery	VII 64
<b>DOUAY</b>	Biopsy forceps	VIII 65
Double depressor		VII 76
<b>DOUGLAS</b>	Vaginal blade	VIII 41
<b>DOYEN</b>	Bone drill neurosurgery	XI 9
	Costotome	XIII 125
	Initial drill	XI 9
	Intestinal and stomach clamps forceps	IV 69, 72
	Ligature needle	VI 28
	Mioma screw	VIII 81
	Mouth gag	XII 8
	Needle holders	VI 9
	Ovarian forceps	VIII 27
	Raspatory and elevator	XIII 45
	Retractor	VII 61
	Towel forceps	IV 103
	Vaginal blade	VIII 37, 46
	Various scissors	III 27
	Top pubic blade	VII 69
<b>DOYEN-ROCHARD</b>		VII 69
Drainage - tube drawing forceps		IV 108
Dressing forceps		XV 20
Dressmaker scissors		III 54
Drill		XIV 5 to 8
Drill guide angle for plates		XIV 17
Drills guide		XIV 14 to 17, 23
<b>DRYSSEN</b>	Retractor	VII 105
<b>DUBOIS</b>	Scissors for deep operation	III 51
<b>DUBOST</b>	Blade	VII 99
	Dissecting Scissors	III 20
	Retractor complete	VII 99
	Tungsten scissors	III 67
<b>DUBOST NOGENT</b>	Blade	VII 100
	Retractor complete	VII 100
<b>DUFOURMENTEL</b>	Delicate dissecting forceps	II 32
	ENT rasps	XII 42
<b>DUMONT</b>	Watch maker's forceps	II 35
<b>DUNHILL</b>	Haemostatic forceps	IV 17



		Chapter	Page
<b>DUPLAY</b>	ENT Specula	XII	16
	Uterine forceps	VIII	13
<b>DUPONT</b>	Osteotome	XIII	67
<b>DURAND (PATTE DE VELOURS)</b>	Prestige dissecting forceps	II	50
	Special dissecting forceps	II	17
<b>DUVAL</b>	Grasping forceps	IV	89 to 91
	Special dissecting forceps	II	21
<b>Ear forceps</b>		XII	31, 32
<b>ECHLIN</b>	Bone rongeur forceps	XIII	113
<b>EISELSBERG</b>	Wire cutting scissors	III	31
<b>Elevator</b>		XIII	26 to 37, 44, 45
<b>EMMET</b>	Ligature needle	VI	29
<b>Enderectomy</b>		V	6 to 8
<b>Endospecula</b>		VIII	36
<b>ENGEL</b>	Instrument for amputation	XIII	21
<b>ENGLISH MODEL</b>	Special dissecting forceps	II	12
<b>ENT Chisel</b>		XII	37, 38
<b>ENT curettes</b>		XII	54 to 56
<b>ENT Dilator</b>		XII	12
<b>ENT elevator</b>		XII	50 to 52
<b>ENT forceps</b>		XII	34
<b>ENT Gouge</b>		XII	37, 38, 40
<b>ENT Grasping forceps</b>		XII	13 to 15
<b>ENT hook</b>		XII	45 to 47, 49
<b>ENT Knife spatula</b>		XII	25
<b>ENT Mallets</b>		XII	54 to 56
<b>ENT Micro-forceps</b>		XII	33
<b>ENT Micro-scissors</b>		XII	33
<b>ENT Punch forceps</b>		XII	27
<b>ENT Raspatory</b>		XII	41, 53
<b>ENT rasps</b>		XII	42 to 44
<b>ENT reposition forceps</b>		XII	35
<b>ENT retractor</b>		XII	48, 49
<b>ENT scissors</b>		III	83, 84
<b>ENT Shear</b>		XII	34
<b>ENT Snare</b>		XII	20, 21
<b>ENT Specula</b>		XII	16 to 19
<b>ENT Suction tube</b>		XII	57, 58
<b>ENT tonsillotome</b>		XII	26
<b>ENT Tuning forks</b>		XII	59, 60
<b>Enterotome scissors</b>		III	87
<b>Eucleation scissors</b>		III	45
<b>Episiotomy scissors</b>		III	81, 82
<b>EPPENDORF</b>	Biopsy forceps	VIII	66
<b>ERRICO</b>	Drill	XI	10
<b>ESMARCH</b>	Bandage	XV	31
	Bandage scissors	III	30
<b>EUFRATE</b>	Vascular needle holders	VI	22
<b>EVANS</b>	Dissecting forceps tungsten jaws	II	45
<b>EVES</b>	ENT Snare	XII	20
<b>Extension piece for bone drill</b>		XI	10
<b>Extraction forceps for nails</b>		XIV	45
<b>Extraction hook</b>		XIV	41
<b>Extractor</b>		V	8
<b>FARABEUF</b>	Bone chisel, gouges	XIII	75
	Bone holding forceps	XIII	132
	Instrument for amputation	XIII	19
	Raspatory and elevator	XIII	44
	Retractor	VII	31, 32, 42
	Scalpel	I	2
<b>FARABEUF-CORTI</b>	Retractor	VII	33
<b>FARKAS</b>	Special dissecting forceps	II	20
<b>FAVALORO</b>	Scissors for vascular surgery	III	36
<b>FEILCHENFELD</b>	Splinters forceps	II	51
<b>FERGUSSON</b>	Bone holding forceps	XIII	138
	ENT Suction tube	XII	58
	Incision scissors	III	28
<b>FERRIS-SMITH-CUSHING</b>	Laminectomy rongeurs neurosurgery	XI	14
<b>FERRIS-SMITH-KERRISSON</b>	Punches neurosurgery	XI	16 to 22
<b>FICAT</b>	Punch and trephine	XIII	93
<b>Final impactor</b>		XIV	41
<b>Fine dissecting forceps</b>		II	9, 10
<b>Fine scissors</b>		III	14, 15, 38 to 40, 43, 44
<b>FINOCHIETTO</b>	Blade	VII	97
	Ligature forceps - Dissector	IV	66
	Needle holders	VI	10, 18
	Retractor	VII	95 to 98
<b>FINOCHIETTO-BURFORD</b>	Blade	VII	105
	Retractor complete	VII	105
<b>FINSEN</b>	Retractor	VII	109
<b>FISH</b>	Hook	XIII	24
	ENT hook	XII	45
		XV	12
<b>Flap knife</b>		XIII	16
<b>Fluted director</b>		XV	13





		Chapter	Page
<b>FOMON</b>	ENT hook	XII	46
	ENT rasps	XII	44
	ENT scissors	III	83, 84
	Nasal scissors (Prestige)	III	78
Forceps for bile ducts		IX	9 to 11
Forceps for coil		VIII	81
Forceps for epilation		II	35
Forceps for instruments		XV	32
Forceps for kidney pedicle		IX	8
Forceps for kidney stones		IX	3
Forceps for mini plates		XIV	25
Forceps for prostate		VIII	95, 96
Forceps for services		XV	18, 19
Forceps for the amnion bladder		VIII	10
Forceps gales stones		IX	4 to 7
Forceps to cut the clamps		VIII	60
Forceps to grasp tendons		XIII	13, 14
<b>FOUCAULT</b>	VK retractor	VII	71
Frame (Retractor)	Kirschner retractor	VII	83
<b>FRAZIER</b>	ENT Suction tube	XII	57, 58
	Microsurgery hook	X	19
	Raspatory and elevator	XIII	36
<b>FREER</b>	ENT Chisel and gouge	XII	37
	ENT elevator	XII	48
	ENT Gouge	XII	40
	ENT hook	XII	46
	ENT Raspatory	XII	41
	Raspatory and elevator	XIII	26
<b>FREER-YASARGIL</b>	Raspatory and elevator	XIII	26
<b>FRENCH</b>	ENT Tuning forks	XII	59
<b>FRIEDMANN DELIKAT</b>	Bone rongeur forceps	XIII	101
<b>FRITSCH</b>	Retractor	VII	61
<b>FRYKHOLM</b>	Bone rongeur forceps	XIII	113
<b>FUCHSIG</b>	Haemostatic forceps	IV	34
<b>FUKUDA</b>	Retractor	VII	140
<b>GALLAHER</b>	ENT rasps	XII	42
<b>GELPI</b>	Retractor	VII	128
<b>GEMINI</b>	Ligature forceps - Dissector	IV	57
<b>GERALD</b>	Delicate dissecting forceps	II	30
<b>GIERTZ-STILLE</b>	Costotome	XIII	123
<b>GIGLI</b>	Instrument for amputation	XIII	20
<b>GILLIES</b>	Delicate dissecting forceps	II	31
	Needle holders	VI	24
	Retractor, hook	VII	9
<b>GILLIES (WAUGH)</b>	Delicate dissecting forceps	II	31
<b>GILLIES-BABY</b>	Needle holders	VI	24
<b>GIL-VERNET</b>	Retractor	VII	12
<b>GIL-VERNET (PAPIN)</b>	Retractor	VII	12
<b>GINESTET</b>	ENT Retractor and hook	XII	49
Gingiva scissors		III	44
<b>GLOVER</b>	Atrauma cardiovascular forceps	V	28
	Atrauma cardiovascular forceps - Ligature	V	29
<b>GLUCK</b>	Costotome	XIII	123
Gluer scissors		III	53
<b>GOELET</b>	Retractor	VII	34
<b>GOLDMANN-FOX</b>	Gingiva scissors	III	44
	Tungsten scissors	III	66
Goniometer		XIII	95
<b>GOOD</b>	Various scissors	III	37
<b>GORNEY</b>	Prestige scissors	III	77
<b>GOSSET</b>	Blade	VII	88
	Retractor	VII	87, 88
Gouges		XIII	65, 68 to 82
<b>GOUILLOUD</b>	Clamp forceps	IV	47
<b>GOURDET</b>	Uterine curette	VIII	68
Graduated seating chisel for plates		XIV	17, 19
<b>GRAEFE</b>	Fine scissors	III	39
	Microsurgery hook	X	18
Graft skin amplifier		I	10
Grafts pusher		XIII	143, 144
<b>GRAHAM</b>	Microsurgery hook	X	20
Grasping forceps		IV	81 to 102
<b>GRAVE</b>	Vaginal specula	VIII	34
<b>GRAY</b>	Forceps for bile ducts	IX	10
<b>GRAZIL</b>	Delicate scissors	III	13, 15
<b>GREEN</b>	Retractor	VII	62
<b>GREEN-ARMYTAGE</b>		VIII	30
<b>GREGOIRE</b>	Grasping forceps	IV	88
	Special dissecting forceps	II	19
<b>GREGORY</b>	Atrauma cardiovascular forceps - Profunda	V	31
	Bulldog clamp Soft	V	10
<b>GROSS-MAYER</b>	Bandage forceps	IV	120
<b>GRUENWALD</b>	Dissecting forceps tungsten jaws	II	46
<b>GRUENWALD-HENKE</b>	ENT Punch forceps	XII	28
<b>GUERRIER</b>	ENT Retractor and hook	XII	49



	Chapter	Page
Guide for nails	XIV	39, 41, 43
Guide for reamers	XIV	39
Guide pin for cannulated screws	XIV	48
<b>GUILLAUME</b>	Bone chisel, gouges	XIII
		77
<b>GUNNAR-HEY</b>	Drainage - tube drawing forceps	IV
		108
<b>GUTHRIE</b>	Microsurgery hook	X
		19
<b>GUYON</b>	Dilating bougie	VIII
		86
	Forceps for kidney pedicle	IX
		8
<b>GUYON-FREUDENBERG</b>	Chuck	XV
		32
<b>HABERER</b>	Retractor	VII
		38
Haemorrhoidal clamp		IV
		102
Haemorrhoidal forceps		VIII
		93, 94
Haemostatic forceps		IV
		9 to 36
<b>HAIGHT</b>	Retractor	VII
		101
Hairdresser scissors		III
		53
<b>HAJEK</b>	ENT Punch forceps	XII
		28
	Mallet	XIII
		86
<b>HAKANSSON</b>	Bone rongeur forceps	XIII
		103
<b>HALLE</b>	Curette	XIII
		60
	Nasal scissors	III
		83
	Raspatory and elevator	XIII
		32
	Rectal specula	VIII
		90
<b>HALSEY</b>	Needle holders	VI
		8
<b>HALSEY (WEBSTER)</b>	Needle holders	VI
		13
<b>HALSTEAD</b>	Forceps for services	XV
		19
	Haemostatic forceps	IV
		20
	Prestige haemostatic forceps	IV
		113
<b>HALSTEAD-MOSQUITO</b>	Haemostatic forceps	IV
		23
Hand dermatome		I
		8, 9
Hand reamer		XIV
		40, 42
Handle for IVG cannula		VIII
		81
Handle for saw		XIII
		20
<b>HANK</b>	Uterine dilator	VIII
		84
<b>HARKEN</b>	Atrauma cardiovascular forceps - Auricle	V
		18
	Grasping forceps	IV
		83
<b>HARRINGTON</b>	Ligature forceps - Dissector	IV
		67
	Retractor	VII
		58
<b>HARRINGTON-PEMBERTON</b>	Retractor	VII
		58
<b>HARRIS</b>	Wire tightener	XIV
		29
<b>HARTMANN</b>	Ear forceps	XII
		31, 32
	ENT Punch forceps	XII
		28
	ENT Specula	XII
		16
	ENT Tuning forks	XII
		58, 59
	Intestinal and stomach clamps forceps	IV
		68
	Pince rongeur	XII
		30
	Polypus forceps	XII
		30
	Retractor	VII
		36
	Polypus forceps	XII
		30
<b>HARTMANN-CITELLI</b>	ENT Specula	XII
		18
<b>HARTMANN-HALLE</b>	Ear forceps	XII
		31
<b>HARTMANN-WEINGARTNER</b>	Wire cutting scissors	III
		31
<b>HARVEY</b>	ENT Chisel and gouge	XII
		38
<b>HAUTANT</b>	Peg	VII
		72
<b>HAUTEFEUILLE</b>	Needle holders	VI
		10
<b>HEANEY</b>	Retractor	VII
		37
	Uterine curette	VIII
		75
	Uterine forceps	VIII
		19
	Uterine forceps	VIII
		22
<b>HEANEY-BALLENTINE</b>	Clip removing forceps	VI
		7
<b>HEATH</b>	Uterine dilator	VIII
		82, 84
<b>HEGAR</b>	Needle holders	VI
		11
<b>HEGAR BAUMGARTNER</b>	Needle holders	VI
		23
<b>HEGAR-OLSEN</b>	Needle holders	VI
		23
<b>HEGAR-OLSEN BABY</b>	Needle holders	VI
		23
<b>HEGAR VASCULAR</b>	Vascular needle holders	VI
		22
<b>HEGEMANN (DIETRICH)</b>	Scissors for vascular surgery	III
		34
<b>HEGENBARTH</b>	Clip applying forceps	VI
		5
<b>HEIFETZ</b>	Spatula neurosurgery	XI
		5
<b>HEISS</b>	Long haemostatic forceps	IV
		38
<b>HEISS (HOLZEIMER)</b>	Retractor	VII
		109
<b>HEISTER</b>	Mouth gag	XII
		8
<b>HELFERICH-BIER</b>	Instrument for amputation	XIII
		19
<b>HENKE</b>	ENT elevator	XII
		51
<b>HENLEY</b>	Blade	VII
		114
	Retractor complete	VII
		114
<b>HENNING</b>	Plaster forceps	XV
		24
Heparin cannula		XV
		27
<b>HERCULES</b>	Extraction forceps	XIV
		26
	Wire cutting pliers	XIV
		33 to 36
<b>HERRICK</b>	Forceps for bile ducts	IX
		9
<b>HERTZLER</b>	Retractor	VII
		106
<b>HESS</b>	Retractor neurosurgery	XI
		8
Hexagonal keys		XIV
		13
<b>HEY-GROVES</b>	Bone holding forceps	XIII
		136
<b>HEYMANN</b>	Nasal scissors	III
		84
	Nasal scissors (Prestige)	III
		79



		Chapter	Page
<b>HEYWOOD-SMITH</b>	Haemorrhoidal forceps	VIII	94
	Uterine forceps	VIII	28
<b>HIBBS</b>	Bone chisel, osteotome, gouges	XIII	73
	Retractor	VII	37
<b>HI-LEVEL KNOWLES</b>	Incision scissors	III	28
<b>HOEN</b>	Raspatory and elevator	XIII	34
<b>HOFFMAN</b>	Pinchoc clamps	IV	110
<b>HOHMANN-ALDINGER</b>	Retractor	VII	135
<b>HOLSHER</b>	Retractor neurosurgery	XI	8
<b>HOLZBACH</b>	Uterine forceps	VIII	21
<b>HONTON</b>	Gouges	XIII	78
Hood for retractor		VII	82
Hook		XIII	24, 94, 154
		VII	9, 10
Hook for screw head		XIV	11
Hook for tendons		XIII	12
Hook probe		XIII	154
<b>HORSLEY</b>	Raspatory and elevator	XIII	36
<b>HÖSEL</b>	Retractor	VII	46
<b>HOWARTH</b>	Raspatory and elevator	XIII	27
<b>HRYNTSCHAK</b>	Blade	VII	92
	Retractor complete	VII	92
<b>HUDSON</b>	Bone drill neurosurgery	XI	10
<b>HUMBY</b>	Retractor, hook	VII	9
<b>HUNTER</b>	Splinters forceps	II	51
<b>HURD</b>	ENT elevator	XII	51
Hystero-salpingography		VIII	79, 80
<b>IMA</b>	Microsurgery fine forceps	X	17
Impactor extractor for nails		XIV	43
Impactor for plates		XIV	17, 19
Incision scissors	Incision scissors	III	28
Initial drill		XIV	40
Insert drill sleeve for drill		XIV	15
Instrument for amputation		XIII	15 to 21
Instrument for autopsy		XIII	22, 23
Instrumentation for knee		XIII	155, 156
Instrumentation for meniscus		XIII	150 to 154
Instruments holder frame		XV	32
Instruments pins		XV	32
Interosseous knife		XIII	16
Intestinal and stomach clamps forceps		IV	68 to 80
<b>IOWA</b>	Forceps for the amnion bladder	VIII	10
Iris scissors		XV	15
Iron for pins		XIV	25
<b>ISRAEL</b>	Retractor	VII	29
<b>ISSELIN</b>	Punch	XIII	90
<b>IVG</b>	Handle for IVG cannula	VIII	81
<b>J.L. FAURE</b>	Biopsy forceps	VIII	62
	Special dissecting forceps	II	19
	Uterine forceps	VIII	15, 17
<b>JACKSON</b>	Retractor	VII	15
	Vaginal blade	VIII	44
<b>JACOBS</b>	Bone hand drill	XIV	9
	Chuck	XIV	7, 8
	Uterine forceps	VIII	10
<b>JACOBSON</b>	Curette	XIII	53
	Microsurgery needle-holder	X	13
<b>JACOBSON-ADSON</b>	Delicate dissecting forceps	II	23
	Ligature forceps - Dissector	IV	56
<b>JACOBSON-HALSTEAD</b>	Haemostatic forceps	IV	22
<b>JAMESON</b>	Long and fine scissors	III	45
	Needle holders	VI	12
	Prestige scissors	III	73
<b>JANSEN</b>	Bone rongeur forceps	XIII	105, 108
	Curette	XIII	54
	Raspatory	XIII	41
	Retractor	VII	110
<b>JANSEN (LUCAE)</b>	ENT dissecting forceps	II	40
<b>JANSEN (MIDDLETON)</b>	ENT Punch forceps	XII	29
<b>JANSEN-DEEP</b>	Retractor	VII	110
<b>JAVID</b>	Atrauma cardiovascular forceps - Carotid	V	33
<b>JAYLE</b>	Vaginal blade	VIII	48
	Vaginal specula	VIII	32
<b>JEANNINGS</b>	Mouth gag	XII	9
<b>JESCO</b>	Various scissors	III	56
<b>JOHNS HOPKINS</b>	Bulldog clamp	V	9
<b>JOLL</b>	Retractor for goitre	VII	129
<b>JONES</b>	Towel forceps	IV	103
<b>JOSEPH</b>	ENT Joseph's instruments	XII	52, 53
	Prestige scissors	III	76
	ENT scissors	III	83
<b>JOST</b>	Raspatory and elevator	XIII	29
<b>JUDD-ALLIS</b>	Grasping forceps	IV	95
<b>JUDD-MASSON</b>	Retractor	VII	93
<b>JUDET</b>	Bone chisel, osteotome, gouges	XIII	74



		Chapter	Page
<b>JUDET</b>	Mallet	XIII	89
	Retractor	VII	138
<b>KADER</b>	Retractor	VII	55
<b>KANTROWITZ</b>	Ligature forceps - Dissector	IV	61
<b>KATZIN</b>	Microsurgery scissors	X	7
<b>KATZIN-BARRAQUER</b>	Microsurgery scissors	X	7
<b>KAYE</b>	Prestige scissors	III	77
<b>KAZANJIAN</b>	Bone cutting forceps	XIII	117
<b>KELLY</b>	Haemostatic forceps	IV	31
	Prestige haemostatic forceps	IV	116
	Proctoscope	VIII	89
	Retractor	VII	50, 55
	Scissors for fistula	III	48
	Tungsten scissors	III	57
	Uterine forceps	VIII	28
<b>KELLY-RANKIN</b>	Haemostatic forceps	IV	32
<b>KERN</b>	Bone holding forceps	XIII	134
<b>KERRISSON</b>	ENT Punch forceps	XII	27
<b>KEVORKIAN</b>	Biopsy curette	VIII	77
	Biopsy forceps	VIII	66, 67
<b>KEY</b>	Raspatory	XIII	41
Key for chuck		XIV	7 to 9
<b>KIELAND</b>	Obstetrical forceps and spatula	VIII	55
<b>KIENNY</b>	Vein holder	VII	19
<b>KILLIAN</b>	ENT elevator	XII	50
	ENT Gouge	XII	40
<b>KILNER</b>	ENT hook	XII	47
	Needle holders	VI	13
	Retractor, hook	VII	10
<b>KILNER (RAGNELL)</b>	Delicate scissors	III	15
	Tungsten scissors	III	57
<b>KILNER-DOUGHTY</b>	Mouth gag	XII	11
<b>KIRSCH</b>	Retractor for maxillofacial surgery	VII	64
<b>KIRSCHNER</b>	Blade	VII	83
	Frame (Retractor)	VII	83
	Ligature instrument	VI	34
	Traction bows	XIII	157, 158
<b>KIRSCHNER (AMERICAN)</b>	Traction bows	XIII	159
<b>KLAPP</b>	Retractor	VII	20
<b>KLEINERT-KUTZ</b>	Forceps to grasp tendons	XIII	13
	Retractor, hook	VII	9
<b>KLEINSCHMIDT</b>	Blind gut forceps	IV	77
<b>KLINKENBERG</b>	Tungsten scissors	III	67
	Various scissors	III	50
<b>KNAPP</b>	ENT hook	XII	46
	Fine scissors	III	38
Knot pusher		VI	34
<b>KNOWLES</b>	Incision scissors	III	28
<b>KOCHER</b>	ENT Knife spatula	XII	25
	Forceps for services	XV	18
	Haemostatic forceps	IV	9 to 11
	Intestinal and stomach clamps forceps	IV	73, 74
	Prestige haemostatic forceps	IV	116
	Retractor	VII	27, 43, 47, 49
<b>KOCHER-WAGNER</b>	Retractor	VII	46
<b>KOCHER-LANGENBECK</b>	Retractor	VII	42
<b>KOENING</b>	Hook	XIII	94
<b>KOGAN</b>	Endospecula	VIII	36
<b>KÖLBEL</b>	Compass and blade	XIII	145
<b>KÖNIG</b>	Ligature instrument	VI	33
	Raspatory and elevator	XIII	35
	Retractor	VII	13
<b>KÖRTE</b>	Retractor	VII	28, 29, 48
<b>KÖRTE-WAGNER</b>	Retractor	VII	28
<b>KRAEMER</b>	Raspatory	XIII	43
<b>KRAMER</b>	Raspatory	XIII	41
<b>KRAUSE</b>	ENT Snare	XII	21
	Trocar	XV	30
<b>KRAUSE-VOSS</b>	ENT Snare	XII	21
<b>KRISTELLER</b>	Vaginal blade	VIII	44
<b>KRÖNLEIN</b>	Haemostatic forceps	IV	17
<b>KÜMMEL</b>	Retractor	VII	48
<b>LA GRANGE</b>	Fine scissors	III	38
<b>LABORDE</b>	ENT Dilator	XII	12
<b>LAGROT</b>	Hand dermatome	I	9
<b>LAHEY</b>	ENT Grasping forceps	XII	14
	Retractor	VII	27
<b>LAHEY (SWEET)</b>	Ligature forceps - Dissector	IV	60
<b>LAMBERT KAY</b>	Atrauma cardiovascular forceps - Anastomosis	V	22
<b>LAMBOTTE</b>	Bone holding forceps	XIII	133
	Hook	XIII	94
	Osteotome	XIII	67
	Raspatory	XIII	49
	Retractor	VII	143
	Screw holder forceps	XIV	25



		Chapter	Page
<b>LAMBOTTE (PAUWELLS)</b>	Osteotome	XIII	66
Laminectomy rongeurs neurosurgery		XI	11 to 15
<b>LANDANGER</b>	Bandage forceps	IV	122
	Biopsy forceps	VIII	64
	Bone holding forceps	XIII	128
	Instrumentation pour ménisque - Instrumentation for meniscu	XIII	152
<b>LANDAU</b>	Trocar	XV	30
	Vaginal blade	VIII	43
<b>LANDOLT</b>	Enucleation scissors	III	45
	Scalpel handle	I	6
<b>LANE</b>	Bone holding forceps	XIII	134
	Intestinal and stomach clamps forceps	IV	79
	Retractor	VII	139
	Special dissecting forceps	II	13
<b>LANE (PAUCHET)</b>	Miscellaneous forceps	IV	109
<b>LANE-TRETHOWAN</b>	Retractor	VII	139
<b>LANGE</b>	Plaster instruments	III	85
<b>LANGE-HOHMANN</b>	Retractor	VII	131 to 133, 135
<b>LANGENBECK</b>	Bone holding forceps	XIII	138
	Flap knife	XIII	16
	Instrument for amputation	XIII	17
	Needle holders	VI	26
	Raspatory	XIII	42, 47
	Raspatory and elevator	XIII	33
	Retractor	VII	44
<b>LANGENBECK (LARREY)</b>	Instrument for amputation	XIII	18
<b>LANGENBECK-GREEN</b>	Retractor	VII	17, 20
<b>LARDENOIS</b>	Retractor	VII	38, 39
Laryngeal mirror		XV	8
<b>LAWRENCE</b>	Ligature forceps - Dissector	IV	60
<b>LAZAR</b>	Microsurgery fine forceps	X	16
<b>LE MEE</b>	ENT Specula	XII	16
Lead hands		XIII	142
<b>LEBEAU</b>	ENT Gouge	XII	40
	Raspatory and elevator	XIII	34
<b>LEBSCHÉ</b>	Sternum Chisel	XIII	125
<b>LECOUTEUR</b>	Tongue depressor	XV	7
<b>LEES</b>	Atrauma cardiovascular forceps - Bronchus	V	19
<b>LEGUEU</b>	Clamp forceps	IV	46
	Retractor	VII	60, 93
<b>LEKSELL-STILLE</b>	Bone rongeur forceps	XIII	112
<b>LELIEVRE</b>	ENT fine chisel	XII	38
	Raspatory	XIII	48
<b>LEMAIRE</b>	Instrumentation for knee	XIII	155
<b>LEMPERT</b>	Bone rongeur forceps	XIII	106
	Curette	XIII	61
	ENT elevator	XII	51
Length gauge for cannulated screw		XIV	49
<b>LEPAGE</b>	Ovum forceps	VIII	26
<b>LERAT</b>	Capsule Forceps	XIII	141
<b>LERICHE</b>	Blade	VII	57
	Forceps for services	XV	19
	Haemostatic forceps	IV	25
	Prestige haemostatic forceps	IV	114
	Raspatory and elevator	XIII	33
	Retractor, hook	VII	10
<b>LERICHE-BUGATTI</b>	Blade	VII	57
<b>LERMOYER</b>	Adenoids knives	XII	23
<b>LETOURNEL</b>	Bone chisel	XIII	65
	Curette	XIII	65
	Gouges	XIII	65
Levier for shoulder		XIII	148
<b>LEVRET</b>	Obstetrical forceps and spatula	VIII	58
<b>LEWIN</b>	Bone holding forceps	XIII	141
<b>LEWIS</b>	ENT rasps	XII	43
<b>LEXER</b>	Dissecting Scissors	III	21
	Osteotome, gouges	XIII	80, 81
<b>LEXER-FINO</b>	Dissecting Scissors	III	21
	Tungsten scissors	III	60, 61
<b>LICHTENBERG</b>	Needle holders	VI	26
<b>LICHTWITZ</b>	Trocar	XV	30
<b>LIEGE</b>	Grasping forceps	IV	99
Ligature cutting scissors		XV	15
		III	41, 42
Ligature forceps		II	33
Ligature forceps - Dissector		IV	50 to 67
Ligature needle		VI	28 to 32
Ligature rubber ring		VIII	93
<b>LIMA</b>	ENT mallets and currettes	XII	54
Lingere scissors		III	54
<b>LISTER</b>	Bandage scissors	III	29
	Scissors for services	XV	15
	Tungsten scissors	III	66
<b>LISTER EXCENTRIC</b>	Bandage scissors	III	30
<b>LISTON</b>	Bone cutting forceps	XIII	116, 119



		Chapter	Page
<b>LISTON</b>	Costotome	XIII	121
	Instrument for amputation	XIII	15
<b>LISTON-KEY (HORSLEY)</b>	Bone cutting forceps	XIII	120
<b>LITTAUER</b>	Ligature cutting scissors	III	42
<b>LITTAUER-LISTON</b>	Bone cutting forceps	XIII	117
<b>LITTLER</b>	Ligature cutting scissors	III	42
<b>LITTLEWOOD</b>	Grasping forceps	IV	99
<b>LOCHARD</b>	Capsule-opening forceps	IV	110
<b>LOCKHART-MUMMARY</b>	Fluted director	XV	13
<b>LOCKLIN</b>	Gingiva scissors	III	44
<b>LOCKWOOD</b>	Grasping forceps	IV	90
<b>LOCKWOOD-ALLIS</b>	Grasping forceps	IV	97
<b>LOMBARD</b>	Bone rongeur forceps	XIII	98
	Mallet	XIII	88
Long and fine scissors		III	46 à 49
Long haemostatic forceps		IV	37 to 43
<b>LORNA</b>	Towel forceps	IV	106
<b>LORTAT-JACOB</b>	Instruments holder frame	XV	32
<b>LOUTE</b>	Wire tightener	XIV	29
<b>LOVE</b>	Retractor neurosurgery	XI	6, 7
<b>LOVE (MORSE)</b>	Retractor	VII	13
<b>LOVE-ADSON</b>	Raspatory	XIII	38
<b>LOVE-GRUENWALD</b>	Laminectomy rongeurs neurosurgery	XI	11
<b>LOVELACE</b>	Lung forceps	IV	92
<b>LOWE</b>	Retractor	VII	14
<b>LOWER</b>	Ligature forceps - Dissector	IV	59
<b>LOWMAN</b>	Bone holding forceps	XIII	140
<b>LOWMAN-HOGLUND</b>	Bone holding forceps	XIII	140
<b>LUBET-BARBON</b>	ENT Grasping forceps	XII	13
<b>LUC</b>	ENT Grasping forceps	XII	15
<b>LUCAE</b>	ENT dissecting forceps	II	40
	ENT hook	XII	45
	ENT Tuning forks	XII	60
	Mallet	XIII	86
<b>LUCAE HARTMANN</b>	ENT Tuning forks	XII	59
<b>LUCAS</b>	Bone chisel, gouges	XIII	68
	Bone chisel, osteotome, gouges	XIII	73
<b>LUCAS-CHAMPIONNIERE</b>		XIV	37
<b>LUER</b>	Bone rongeur forceps	XIII	103, 104
	Retractor	VII	33
<b>LUER-KOERTE</b>	Curette for bile ducts	IX	13
<b>LUER-LOCK</b>	Cannula	XV	27
<b>LUER-FRIEDMANN</b>	Bone rongeur forceps	XIII	101
<b>LUKENS</b>	Retractor	VII	15
Lung forceps		IV	92
Lymphographia clamp		V	9
<b>MAC DONALD</b>	Raspatory and elevator	XIII	31
<b>MAC EVEN</b>	Bone chisel, osteotome, gouges	XIII	74
	Mallet	XIII	85
<b>MAC GIVNEY</b>	Haemorrhoidal forceps	VIII	93, 94
<b>MAC INDOE</b>	Bone cutting forceps	XIII	118
	Delicate dissecting forceps	II	31
	Dissecting forceps tungsten jaws	II	47
	Various scissors	III	37
<b>MAC KEE</b>	Retractor	VII	115
<b>MAC KENTY</b>	ENT elevator	XII	50
	Raspatory	XIII	39
<b>MAC KENZIE</b>	Bone drill neurosurgery	XI	10
<b>MAC LEAN</b>	Obstetrical forceps and spatula	VIII	55
<b>MAC PHERSON</b>	Microsurgery fine forceps	X	15
<b>MAGILL</b>	Catheter forceps	XV	9
<b>MAINGOT</b>	Uterine forceps	VIII	21
Malleable splints		XV	25
Mallet		XIII	84 to 89
<b>MALTZ</b>	ENT rasps	XII	42
<b>MANGIAGALLI</b>	Vaginal blade	VIII	41
<b>MARKHAM-MEYERDING</b>	Retractor	VII	126
<b>MARQUARDT</b>	Bone rongeur forceps	XIII	110
<b>MARTIN</b>	Pelvimeter	VIII	78
	Retractor	VII	51
<b>MARTIN (SIMPSON)</b>	Uterine sound	VIII	85
<b>MARTIN-CARTILAGE</b>	Cartilage scissors	III	37
<b>MARTINI</b>	Curette	XIII	53
<b>MASING</b>	ENT elevator	XII	50
<b>MASING (NEIVERT)</b>	Needle holders	VI	13
<b>MASING (SILVER)</b>	Osteotome	XII	39
<b>MASSON</b>	Needle holders	VI	12, 17
<b>MATHEY</b>	Retractor	VII	108
<b>MATHIEU</b>	Needle holders	VI	12, 25
	Rectal specula	VIII	87
	Retractor	VII	35
	Uterine polypus forceps	VIII	11
	Vaginal blade	VIII	46
<b>MAURER</b>	Costotome	XIII	122
	Raspatory	XIII	50



		Chapter	Page
<b>MAURER</b>	Retractor	VII	108, 144
<b>MAYFIELD</b>	Bone rongeur forceps	XIII	110
<b>MAYO</b>	Dissecting Scissors	III	16
	Instruments pins	XV	32
	Prestige scissors	III	70
	Scissors for services	XV	16
	Special dissecting forceps	II	17
	Tongue depressor	XV	6
	Tungsten scissors	III	59
<b>MAYO-BLAKE</b>	Forceps gales stones	IX	7
<b>MAYO-ROBSON</b>	Intestinal and stomach clamps forceps	IV	71
<b>MAYO-ADAMS</b>	Retractor	VII	81
<b>MAYO-ALSACE</b>	Dissecting Scissors	III	18
<b>MAYO-HARRINGTON</b>	Dissecting Scissors	III	19
<b>MAYO-HEGAR</b>	Needle holder for services	XV	18
	Needle holders	VI	11, 16 to 18
<b>MAYO-LEGER</b>	Dissecting Scissors	III	18
<b>MAYO-LEXER</b>	Prestige scissors	III	70
	Tungsten scissors	III	60, 61
<b>MAYO-LYON</b>	Dissecting Scissors	III	18
<b>MAYO-NOBLE</b>	Dissecting Scissors	III	19
<b>MAYO-SANTY</b>	Dissecting Scissors	III	19
<b>MAYO-STILLE</b>	Dissecting Scissors	III	17
	Tungsten scissors	III	60, 61
	Prestige scissors	III	70
<b>MEAD</b>	Bone rongeur forceps	XIII	102
	Disc for mallets	XIII	87
	Mallet	XIII	87
Measure		XIII	96
<b>MEEKER</b>	Ligature forceps - Dissector	IV	63
Membrane punch		VIII	60
Meniscus scissors		III	86
<b>MENTZENBAUM</b>	Scissors for prostate	VIII	95
<b>MERCEDES</b>	Blade	VII	103
	Retractor	VII	103
<b>MERIAM</b>	Delicate dissecting forceps	II	29
<b>MERLE D'AUBIGNÉ</b>	Punch	XIII	91
	Raspatory	XIII	49
	Retractor	VII	137, 138
	Shoulder instrumentation	XIII	147
<b>MERLE D'AUBIGNÉ (BANKART)</b>	Shoulder retractor	XIII	146
	Wire guide with needle	XIII	146
<b>MERVEILLEUX</b>	Prestige scissors	III	75
Metal catheter		VIII	86
<b>METZENBAUM</b>	Dissecting Scissors	III	22, 23
	Scissors for services	XV	17
	Tungsten scissors	III	62
	Prestige scissors	III	71
<b>METZENBAUM-FINO</b>	Dissecting Scissors	III	24
	Prestige scissors	III	71
	Tungsten scissors	III	63 to 65
<b>MEYERDING</b>	Retractor	VII	18, 49
<b>MICHEL</b>	Clip applying and removing forceps	VI	5 to 7
	Clip applying forceps	VI	5, 6
	Clip removing forceps	VI	7
	Forceps and clips	VI	6
Michel suture clips		VI	6
<b>MICHELE</b>	Trephine for removal broken screws	XIV	37
<b>MICHON</b>	Clamp forceps	IV	46
Micro dissecting forceps tungsten jaws		II	47
Micro fine scissors		III	38
<b>MICRO ADSON</b>	Delicate dissecting forceps	II	23
Micro-extractor		V	8
<b>MICRO-HALSTEAD</b>	Haemostatic forceps	IV	20
<b>MICRO-MOSQUITO</b>	Haemostatic forceps	IV	21
<b>MICRO-RYDER</b>	Vascular needle holders	VI	21
Micro-spatula		V	8
Microsurgery fine forceps		X	15 to 17
Microsurgery hook		X	18 to 20
Microsurgery needle-holder		X	12 to 14
Microsurgery scissors		X	3 to 11
Micro-tubal forceps		II	33
<b>MIDDELDORPF</b>	Retractor	VII	61, 62
<b>MIKULICZ</b>	Retractor	VII	54
	Special haemostatic forceps for peritoneum	IV	48, 49
<b>MILLER</b>	ENT rasps	XII	44
<b>MILLES</b>	Microsurgery scissors	X	9
<b>MILLIGAN</b>	Raspatory and elevator	XIII	28
<b>MILLIN</b>	Forceps for prostate	VIII	95
	Retractor	VII	93
<b>MILLS</b>	Scissors for vascular surgery	III	35
<b>MINI GEMINI</b>	Ligature forceps - Dissector	IV	57
<b>MINI LEXER</b>	Osteotome, gouges	XIII	80
<b>MINI TOWNSEND</b>	Biopsy forceps	VIII	67
<b>MINI FRIEDMANN</b>	Bone rongeur forceps	XIII	101



		Chapter	Page
<b>MINI LANGENBECK</b>	Retractor	VII	16
Mioma screw		VIII	81
<b>MIRIZZI</b>	Forceps gales stones	IX	4, 5
<b>MITCHELL</b>	Raspatory	XIII	42
<b>MIXTER</b>	Fine scissors	III	14
	Ligature forceps - Dissector	IV	58, 59
<b>MIXTER-O'SHAUGNESSY</b>	Ligature forceps - Dissector	IV	58
<b>MOHR</b>	Pinchoc clamps	IV	110
<b>MOLISSON</b>	Retractor	VII	116
<b>MOLT</b>	Raspatory and elevator	XIII	27
<b>MÖLTGEN</b>	Goniometer	XIII	95
<b>MONOD</b>	Trocar	XV	28
<b>MONESTRUC</b>	Blade	VII	87
	Retractor	VII	87
<b>MOORE</b>	Curette for bile ducts	IX	13
	ENT Shear	XII	34
<b>MOORE-LAMBOTTE</b>	Retractor	VII	143
<b>MOREL-FATIO</b>	Raspatory and elevator	XIII	27
<b>MORRIS</b>	Retractor	VII	52
<b>MORRIS-DEBAKEY</b>	Atrauma cardiovascular forceps - Aorta	V	24
<b>MORSE-FAVALORO</b>	Retractor	VII	103
<b>MOSQUITO</b>	Haemostatic forceps	IV	19
<b>MOSQUITO-DANDY</b>	Haemostatic forceps	IV	26
Mouth gag		XII	7 to 11
<b>MOYNIHAN</b>	Haemostatic forceps	IV	36
	Long haemostatic forceps	IV	43
<b>MUHLING</b>	Raspatory	XIII	40
<b>MULLER</b>	Phlebectomy hooks	V	7
MultiForceps for services		XIV	27
<b>MURPHY</b>	Dressing forceps	XV	20
	Instrumentation for knee	XIII	155
	Retractor	VII	23
	Tubing forceps	IV	112
Muscles Hook		XIII	22
<b>MUSEUX</b>	Bone holding forceps	XIII	141
	Uterine forceps	VIII	7, 8
<b>MUSEUX-PALMER</b>	Uterine forceps	VIII	9
<b>MUSEUX-PALMER-CHERON</b>	Uterine forceps	VIII	9
<b>MYERS</b>	Strippers	V	5
<b>MYRTLE</b>	Fluted director	XV	13
<b>NABATOFF</b>	Strippers	V	5
<b>NAGELE</b>	Obstetrical forceps and spatula	VIII	56
Nail cutter		XV	10
Nail depth gauge		XIV	46
Nail extractor		XIV	41
Nail inserter		XIV	43
Nails driver and extractor		XIV	42
Nails impactor		XIV	45
Nails scissors		XV	15
		III	88
<b>NANCY</b>	Bone chisel, gouges	XIII	77
	Variou scissors	III	27
Nasal scissors		III	77 to 78, 83, 84
Needle for kneecap		XIII	156
Needle holders		VI	8 to 26
<b>NEFF</b>	Instrumentation pour ménisque - Instrumentation for meniscus	XIII	150
<b>NEGUS</b>	Intestinal and stomach clamps forceps	IV	69
<b>NEIVERT</b>	Needle holders	VI	14
<b>NELATON</b>	Drill	XIV	37
	Fluted director	XV	13
	Scalpel	I	2
<b>NELSON</b>	Trocar	XV	29
Nerve dissecting scissors		III	37
Neuro retractor		VII	117
<b>NEW ORLEANS</b>	Needle holders	VI	17
<b>NICOLLET-KOCHER</b>	Instrumentation pour ménisque - Instrumentation for meniscus	XIII	152
<b>NICOLLET-MUSEUX</b>	Instrumentation pour ménisque - Instrumentation for meniscus	XIII	152
<b>NISSEN</b>	Forceps for bile ducts	IX	11
	Haemostatic forceps	IV	35
<b>NOGENT</b>	Blade (Spine)	VII	104
	Retractor complete	VII	104
<b>NORFOLK-NORWICH</b>	Retractor	VII	115
<b>NORTHFIELD</b>	Bone rongeur forceps	XIII	107
<b>NOTO</b>	Uterine forceps	VIII	28
<b>NOTTER</b>	Membrane punch	VIII	60
<b>NOVACK</b>	Instruments for hystero-salpingography	VIII	80
<b>NOYES</b>	Microsurgery scissors	X	6
<b>NUBOER</b>	Suction tubes	XV	26
<b>NUSSBAUM</b>	Intestinal and stomach clamps forceps	IV	78
<b>O'SHAUGNESSY</b>	Ligature forceps - Dissector	IV	51 to 53
Obstetric vaccum cup and accessories		VIII	61
Obstetrical forceps		VIII	53 to 59
<b>OBWEGESER</b>	Osteotome	XIII	67
	Retractor for maxillofacial surgery	VII	63, 65
<b>OCHSNER</b>	Atrauma cardiovascular forceps - Aorta	V	17





		Chapter	Page
<b>OEHLER</b>	Dissecting forceps tungsten jaws	II	45
Oesophagoscopy forceps		XII	36
Ointment spatula		XV	31
<b>OLIVECRONA</b>	Instrument for amputation	XIII	20
	Raspatory and elevator	XIII	26
	Spatula neurosurgery	XI	4
	Bone rongeur forceps	XIII	106
<b>OLIVIER</b>	Retractor complete	VII	82
<b>OLLIER</b>	Bone holding forceps	XIII	135, 139
	Punch	XIII	156
	Raspatory and elevator	XIII	44
	Retractor	VII	30
<b>OMBREDANNE</b>	Bone chisel, gouges	XIII	70
	Grasping forceps	IV	98
	Mallet	XIII	84
	Punch	XIII	90
One-piece scalpel		I	2
Open coelio	Retractor	VII	33
Open end wrench		XIV	23
Ophthalmologic dissecting forceps		II	36
<b>OSCHNER</b>	Ligature forceps	II	33
<b>O'SHAUGNESSY</b>	Suture passer for prostate	VIII	95
Osseous chisel		XIV	24
Osteotome		XII	37, 39
		XIII	66, 67, 69, 71 to 74, 76, 80
Osteotome blade		XIV	24
<b>O'SULIVAN - O'CONNOR</b>	Blade	VII	85
	Frame (Retractor)	VII	85
Ovarian forceps		VIII	27
<b>OVERHOLT-GEISSENDORFER</b>	Ligature forceps - Dissector	IV	54
<b>OVERHOLT-MIXTER</b>	Ligature forceps - Dissector	IV	61
<b>OVERHOLT-S</b>	Ligature forceps - Dissector	IV	55
<b>OVERHOLT-SLIM</b>	Ligature forceps - Dissector	IV	55
Ovum forceps		VIII	26
<b>Pad</b>		XV	32
		V	7, 9, 10, 49
<b>PAJOT</b>	Obstetrical forceps and spatula	VIII	55
<b>PALMER</b>	Blade	VII	78
	Retractor complete	VII	78
	Uterine dilator	VIII	82
	Uterine polypus forceps	VIII	11
	Vaginal specula	VIII	31
Paracentesis needle		XII	22
Parametrium scissors		III	68
<b>PARKER</b>	Retractor	VII	35
<b>PARKER LANGENBECK (US ARMY)</b>	Retractor	VII	35
<b>PARKER-MOTT</b>	Retractor	VII	36
<b>PARTSCH</b>	Bone chisel, gouges	XIII	68
	Mallet	XIII	84
<b>PASSOW</b>	Grafts pusher	XIII	143
<b>PATTERSON</b>	Biopsy forceps	VIII	66
<b>PAUCHET</b>	Clip applying forceps	VI	5
<b>PAUCHET (Sabre)</b>	Ligature needle	VI	29
<b>PAYR</b>	Intestinal and stomach clamps forceps	IV	75
	Ligature instrument	VI	34
<b>PEAN</b>	Bandage forceps	IV	118
	Scissors for services	XV	17
	Trocar	XV	30
<b>PEDERSON</b>	Vaginal specula	VIII	35
<b>PEERS</b>	Towel forceps	IV	105
<b>PEET</b>	Splinters forceps	II	52
Peg		VII	72
Peg holder		VII	72
<b>PELKMANN</b>	Bandage forceps	IV	127
Pelvimeter		VIII	78
<b>PENFIELD</b>	Raspatory and elevator	XIII	30
<b>PENNINGTON</b>	ENT Raspatory	XII	41
	Grasping forceps	IV	89
<b>PENNYBACKER</b>	Bone rongeur forceps	XIII	107
	Raspatory	XIII	42
Percussion hammer		XV	5
<b>PERCY</b>	Instrument for amputation	XIII	21
Perforator drill		XIV	37
<b>PERRY</b>	Delicate dissecting forceps	II	37
<b>PERTHES</b>	Punch	XIII	92
<b>PETIT DUTAIIY</b>	Raspatory and elevator	XIII	37
Phalangeal knife		XIII	16
<b>PHANEUF</b>	Uterine forceps	VIII	22
Phlebectomy hooks		V	7
Pin wrench for tension device		XIV	23
<b>PINARD</b>	Stethoscop	XV	5
Pincés à dissection O.R.L.		II	38 to 40
Pinchoc clamps		IV	110
		XV	20
Pins template		XIV	46



		Chapter	Page
<b>PIPER</b>	Obstetrical forceps and spatula	VIII	58
<b>PIRON</b>	Uterine curette	VIII	75
Plaster forceps		XV	23, 24
Plaster forceps (USA Model)	Plaster forceps	XV	23
Plaster instruments		III	85
Plaster scissors		XV	22
Plate bender for nails		XIV	42
Plate bender for plates		XIV	20
Plate bending pliers		XIV	21, 22
<b>PLESTER</b>	ENT Suction tube	XII	57
	Retractor	VII	111
<b>POIRIER</b>	Bone chisel, gouges	XIII	70
Polish rubber		XV	33
<b>POLITZER</b>	ENT dissecting forceps	II	39
<b>POLOSSON</b>	Retractor	VII	56
Polypus forceps		XII	30
<b>POOLE</b>	Suction tubes	XV	26
Positioning plate		XIV	18, 19
<b>POSTEL</b>	Instrument for amputation	XIII	18
	Retractor	VII	144
<b>POTTS-DE MARTEL</b>	Scissors for vascular surgery	III	35
<b>POTTS-SMITH</b>	Delicate dissecting forceps	II	26
	Dissecting forceps tungsten jaws	II	46
	Prestige scissors	III	74
	Scissors for vascular surgery	III	32
	Various scissors	III	37
	Tungsten scissors	III	69
	Scissors for vascular surgery	III	36
<b>POZZI</b>	Shoulder instrumentation	XIII	147
	Uterine curette	VIII	76
	Uterine forceps	VIII	12
<b>POZZI-CHERON</b>	Instruments for hystero-salpingography	VIII	80
<b>POZZI-PALMER</b>	Uterine forceps	VIII	12
<b>PRATT</b>	Haemorrhoidal clamp	IV	102
	Uterine dilator	VIII	84
	Uterine forceps	VIII	25
	Rectal specula	VIII	87
	Delicate dissecting forceps	II	37
<b>PRECELLE</b>			
Prestige dissecting forceps		II	48 to 50
Prestige haemostatic forceps		IV	113 to 117
Prestige scissors		III	70 to 79, 82
<b>PRICE THOMAS</b>	Brochus clamps	IV	81
PRIMA scalpel		I	7
<b>PRINCE</b>	Tonsil scissors	III	37
Probe for bile ducts		IX	12
Probes	Probes	XV	12
Proctoscope		VIII	89
Protection (translucent)		XII	10
<b>PROVIDENCE</b>	Haemostatic forceps	IV	26
Punch		XIII	90 to 93, 156
Punches neurosurgery		XI	16 to 22
<b>PUTTI</b>	Rasp	XIII	83
Pylorus spreader		IV	102
<b>QUENU</b>	Intestinal and stomach clamps forceps	IV	68
	Special dissecting forceps	II	20
<b>QUILICY FARISSE</b>	Ligature forceps - Dissector	IV	62
<b>QUINBY</b>	Various scissors	III	45
<b>QUIRE</b>	Ear forceps	XII	32
Radioluscent blade		VII	68
<b>RAGNEL (DAVIS)</b>	Retractor	VII	19
<b>RALK</b>	Bone hand drill	XIV	9
<b>RAMUS</b>	Retractor for maxillofacial surgery	VII	65
<b>RANDALL</b>	Forceps for kidney stones	IX	3
Rasp		XIII	83
Raspatory		XIII	26 to 51
Raspatory FERROZELL Handle		XIII	46
Raspatory for tendons		XIII	12
Raspatory for yellow ligament		XIII	48
Reamer, nails and screw template		XIV	46
<b>RECAMIER</b>	Uterine curette	VIII	74
Rectal biopsy forceps		VIII	92
Rectal specula		VIII	87, 88, 90, 91
<b>REDON</b>	Ligature forceps - Dissector	IV	50
	Ligature needle	VI	30
<b>REILL</b>	Bone holding forceps	XIII	126
<b>RESANO</b>	Ligature forceps - Dissector	IV	67
Retractor		VII	9 to 144
Retractor blade		VIII	91
Retractor extension		VII	67
Retractor for forearm		VII	141
Retractor for goitre		VII	129
Retractor for hemilaminectomy		VII	125
Retractor for maxillofacial surgery		VII	63 to 66
Retractor for prostate		VII	60
		VIII	96



		Chapter	Page
Retractor malleable blades		VII	41
Retractor neurosurgery		XI	6 to 8
Retractor, lead hand		XIII	142
<b>REVERDIN</b>	Retractor	VII	39
	Suture needle	VI	27
<b>REYNOLDS</b>	Long and fine scissors	III	46
	Prestige scissors	III	73
Rib contractor		VII	107
<b>RIBBON TYPE</b>	Fine scissors	III	43
<b>RICARD</b>	Blade	VII	73
	Compass (retractor)	VII	73
	Retractor complete	VII	75
<b>RICARD-BEGOIN</b>	Blade	VII	74
	Compass (retractor)	VII	74
	Retractor complete	VII	75
<b>RICHARDSON</b>	Retractor	VII	50
<b>RICHARDSON-EASTMAN</b>	Retractor	VII	50
<b>RICHTER</b>	Incision scissors	III	28
Rigid medulary reamer		XIV	38
Ring for chain		VII	72
<b>RIZZUTI</b>	Raspatory and elevator	XIII	26
<b>ROBB</b>	Raspatory and elevator	XIII	29
<b>ROBERTS</b>	Long haemostatic forceps	IV	41
<b>ROBIN</b>	ENT Chisel and gouge	XII	37
<b>ROCHARD</b>	Retractor	VII	67, 68
	Uterine forceps	VIII	26
<b>ROCHER</b>	Punch and trephine	XIII	93
<b>ROCHESTER-CARMALT</b>	Haemostatic forceps	IV	14
<b>ROCHESTER-OSCHNER</b>	Haemostatic forceps	IV	13
<b>ROCHESTER-PEAN</b>	Haemostatic forceps	IV	12
<b>ROEDER</b>	Towel forceps	IV	107
<b>ROGERS</b>	Uterine forceps	VIII	18
<b>RÖHM</b>	Chuck	XIV	8
<b>ROLLET</b>	ENT hook	XII	46
<b>ROSE</b>	Retractor	VII	15
<b>RÖTTGEN-RUSKIN</b>	Bone rongeur forceps	XIII	112
<b>ROUENNAIS</b>	Various scissors	III	55
<b>ROUX</b>	Raspatory	XIII	47
	Retractor	VII	34
<b>ROWE</b>	ENT reposition forceps	XII	35
<b>RUAULT</b>	ENT Knife spatula	XII	25
Rubber for percussion hammer		XV	5
Rubber jaw - Hercules		XIV	33, 35
Rubber jaw for tongue holding forceps		XV	9
<b>RUBIN</b>	ENT Shear	XII	34
<b>RUDD</b>	Haemorrhoidal forceps	VIII	93
<b>RUMEL</b>	Ligature forceps - Dissector	IV	63
<b>RUMEL-BELMONT</b>		V	7
<b>RUSKIN</b>	Bone rongeur forceps	XIII	110
<b>RUSKIN-LISTON</b>	Bone cutting forceps	XIII	118
<b>RUSSIAN MODEL</b>	Special dissecting forceps	II	17
<b>RYDER</b>	Vascular needle holders	VI	21
<b>SACHS</b>	Raspatory and elevator	XIII	36
<b>SAENGER</b>	Uterine forceps	VIII	30
<b>SANTORINI</b>	Clamp for prostate	VIII	95
<b>SANTULLI</b>		V	10
<b>SANTY</b>	Long haemostatic forceps	IV	42
	Suction tubes	XV	26
<b>SANVENERO</b>	Long and fine scissors	III	49
<b>SAROT</b>	Long haemostatic forceps	IV	41
	Vascular needle holders	VI	22
<b>SATINSKY</b>	Atrauma cardiovascular forceps - Tangential Occlusion	V	22
	Grasping forceps	IV	82
	Various scissors	III	50
<b>SATTERLEE</b>	Instrument for amputation	XIII	18
<b>SAUERBRUCH</b>	Bone rongeur forceps	XIII	114
	Costotome	XIII	124
	Retractor	VII	51, 53
<b>SAUERBRUCH-FREY</b>	Costotome	XIII	124
Saw to cut the ring and blade		XV	11
Scalp flap forceps		IV	84
Scalpel handle		I	3 to 6
<b>SCHADEL</b>	Towel forceps	IV	103
<b>SCHAEDE</b>	Curette	XIII	57
<b>SCHAEIBE</b>	Grasping forceps	IV	91
	Intestinal and stomach clamps forceps	IV	70
<b>SCHERBAK</b>	Vaginal blade	VIII	50
<b>SCHINK</b>	Hand dermatome	I	8
<b>SCHMID</b>	Endarterectomy	V	6
<b>SCHNIDT</b>	Ligature forceps - Dissector	IV	56
<b>SCHOEMAKER-LOTH</b>	Wire cutting scissors	III	31
<b>SCHRÖDER</b>	Uterine curette	VIII	72
<b>SCHROEDER</b>	Uterine forceps	VIII	13, 14
<b>SCHULTZE</b>	Instruments for hystero-salpingography	VIII	79
<b>SCHUMACHER</b>	Biopsy forceps	VIII	63



		Chapter	Page
<b>SCHUMACHER</b>	Retractor	VII	136
	Scissors for ombilical cord	III	80
<b>SCHUMACHER (WAGNER)</b>	Retractor	VII	136
<b>SCHUMAKER</b>	Biopsy forceps	VIII	65
Scissors for cataract		III	12, 57
Scissors for deep operation		III	51, 52
Scissors for enucleation		III	13
Scissors for fistula		III	48, 57
Scissors for ombilical cord		III	80
Scissors for prostate		VIII	95
Scissors for services		XV	15 to 17
Scissors for strabismus		III	12, 39
Scissors for vascular surgery		III	32 to 36
Scissors to uncap		III	86
Scoop for bile ducts		IX	12
<b>SCOVILLE</b>	Curette	XIII	63
Scraper		XIII	52
Screw driver		XIV	11 to 13
Screw driver - Handle		XIV	13
Screw driver - Holding sleeve		XIV	12
Screw driver for cannulated screw		XIV	49
Screw holder forceps		XIV	25
<b>SCUDDER</b>	Intestinal and stomach clamps forceps	IV	78
<b>SEBILEAU</b>	ENT mallets and curettes	XII	54
	ENT Raspatory	XII	41
	Raspatory and elevator	XIII	34
<b>SEDILLOT</b>	Raspatory	XIII	43
<b>SEGOND</b>	Retractor	VII	55
	Uterine forceps	VIII	19
<b>SEGOND-LANDAU</b>	Uterine forceps	VIII	19
<b>SEGURA</b>	ENT mallets and curettes	XII	54
Self holding forceps		XIV	10
<b>SELLORS</b>	Retractor	VII	107
<b>SEMB</b>	Bone cutting forceps	XIII	120
	Bone holding forceps	XIII	137
	Bone rongeur forceps	XIII	115
	Ligature forceps - Dissector	IV	64
	Raspatory	XIII	47
<b>SEMB-SAYLOR</b>	Ligature forceps - Dissector	IV	64
<b>SEMKEN</b>	Delicate dissecting forceps	II	32
	Dissecting forceps tungsten jaws	II	47
<b>SEMM</b>	Blade	VII	85
	Frame (Retractor)	VII	85
	Vaginal specula	VIII	35
<b>SENN-GREEN (CHIGOT)</b>	Retractor	VII	16
<b>SENN-MILLER</b>	Retractor	VII	19
<b>SENN-MILLER BABY</b>	Retractor	VII	19
Sequester Forceps		XIII	139
<b>SETTER</b>	Bone holding forceps	XIII	136
<b>SEUTIN</b>	Forceps for services	XV	21
	Plaster scissors	XV	22
<b>SEWALL</b>	Raspatory and elevator	XIII	36
<b>SEYFFERT</b>	Vaginal specula	VIII	35
Sharp scissors for services		XV	16
Sharp/blunt scissors for services		XV	16
Shoulder retractor		XIII	146, 148
<b>SHUBERT</b>	Biopsy forceps	VIII	62
<b>SICARD</b>	Bone rongeur forceps	XIII	99
<b>SICART</b>	Raspatory and elevator	XIII	37
<b>SIEBOLD</b>	Various scissors	III	50
Silicone spray		XV	33
<b>SIMON</b>	Retractor	VII	51
	Uterine curette	VIII	70, 72
<b>SIMPSON</b>	Obstetrical forceps and spatula	VIII	57
<b>SIMPSON-BRAUN</b>	Obstetrical forceps and spatula	VIII	58
<b>SIMPSON-LUIKART</b>	Obstetrical forceps and spatula	VIII	59
<b>SIMS</b>	Prestige scissors	III	76
	Rectal specula	VIII	88
	Scissors for deep operation	III	52
	Tungsten scissors	III	68
	Uterine curette	VIII	73
	Uterine sound	VIII	85
	Vaginal blade	VIII	45
	Scalpel	I	2
<b>SIMS-MAIER</b>	Bandage forceps	IV	127
<b>SINGLEY-TUTTLE</b>	Special dissecting forceps	II	21
<b>SISTERON</b>	Forceps gales stones	IX	6
<b>SKID MURPHY</b>	Retractor	VII	143
Skin protector		XIV	38
Skull breaker		XIII	22
Slotted hammer		XIV	17
		XIV	40
<b>SLUDDER-BALLENGER</b>	ENT tonsillotome	XII	26
<b>SMILLIE-TRILLAT</b>	Instrumentation pour ménisque - Instrumentation for meniscu	XIII	150, 151
<b>SMITH</b>	Various scissors	III	87



		Chapter	Page
<b>SMITH-PETERSEN</b>	Bone chisel, gouges	XIII	77
	Bone chisel, osteotome, gouges	XIII	71
	Bone rongeur forceps	XIII	112
<b>SNELLEN</b>	ENT curettes	XII	55
	Socket wrench	XIV	23
<b>SOMMER</b>	Uterine elevating forceps	VIII	52
Spatula		VIII	53 to 59
Spatula for shouler		XIII	148
Spatula neurosurgery		XI	3 to 5
Special dissecting forceps		II	12, 13, 17 to 21, 34, 35
Special haemostatic forceps		IV	44 to 49
Special haemostatic forceps for peritoneum		IV	48, 49
<b>SPENCER</b>	Ligature cutting scissors	III	41
<b>SPENCER-WELLS</b>	Haemostatic forceps	IV	15, 18
<b>SPENCER-FINO</b>	Ligature cutting scissors	III	42
Sphincteroscope		VIII	89
<b>SPINA-NASALIS</b>	Retractor for maxillofacial surgery	VII	65
Splinters forceps		II	51, 52
Spray for lubrication		XV	33
<b>SPURLING</b>	Laminectomy rongeurs neurosurgery	XI	11
<b>ST MARKS</b>	Vaginal blade	VIII	47
<b>STAGNARA</b>	Gouges	XIII	79
Stainless caliper		XIII	96
Stainless ruler		XIII	96
<b>STAMEY</b>	Ligature needle	VI	29
Standard dissecting forceps		II	5 to 8
Standard scalpel		I	7
Staples driver		XIV	50
Staples extractor		XIV	50
Staples impactor		XIV	51
Staples inserter		XIV	50
<b>STEINMANN</b>	Forceps to grasp tendons	XIII	13, 14
<b>STELLBRINK</b>	Bone rongeur forceps	XIII	105
Sterile scalpel		I	7
<b>STERNBERG</b>	Mouth gag	XII	8
Sternum Chisel		XIII	125
Stethoscop		XV	5
<b>STEVENS</b>	Fine scissors	III	43
	Prestige scissors	III	73
<b>STIEGLITZ</b>	Splinters forceps	II	52
	Bone chisel, osteotome, gouges	XIII	72
<b>STILLE</b>	Bone rongeur forceps	XIII	111
	Delicate dissecting forceps	II	15
	Plaster forceps	XV	23
	Forceps for bile ducts	IX	9
	Bone rongeur forceps	XIII	115
<b>STILLE-LUER</b>			
Stitch cutter scalpel		I	7
<b>STOOKEY</b>	Bone rongeur forceps	XIII	108
<b>STRANDELL-STILLE</b>	Retractor	VII	17
<b>STRASBOURG</b>	Special dissecting forceps	II	13
<b>STRATT</b>	Needle holders	VI	19
<b>STRAUSS</b>	Urethra compressor	VIII	86
<b>STRELI</b>	Needle holders	VI	9
Strippers		V	5
<b>STRULLY</b>	Long and fine scissors	III	48
<b>STRUYCKEN</b>	ENT Punch forceps	XII	28
<b>SUBRAMANIAN</b>	Atrauma cardiovascular forceps	V	31
	Atrauma cardiovascular forceps - Aorta	V	31
Suction tubes		XV	26
Surgical scissors		III	9 to 11
Suture micro forceps		II	33
Suture needle		VI	27
Suture passer for prostate		VIII	95
<b>SYME</b>	Raspatory and elevator	XIII	29
<b>TAKAHASHI</b>	ENT Punch forceps	XII	28
	ENT rasps	XII	42
Tamping tool		XIII	149
Tap guide		XIV	15
Taps		XIV	6, 47
Target device for guide pin		XIV	48
<b>TARNIER</b>	Obstetrical forceps and spatula	VIII	53
<b>TAYLOR</b>	Delicate dissecting forceps	II	27
	Retractor neurosurgery	XI	7
<b>TEALE</b>	Uterine forceps	VIII	10
<b>TEISSIER</b>	Obstetrical forceps and spatula	VIII	59
Template bending for plates		XIV	20
Tendon stripper		XIII	12
<b>TENOTOME</b>	Scalpel	I	2
Tension device for plate		XIV	23
Tensioner for bows		XIII	157
<b>TERRIER</b>	Haemostatic forceps	IV	15, 16
	Mouth gag	XII	7
<b>TESSIER</b>	Retractor for maxillofacial surgery	VII	66
<b>THERUM</b>	Forceps for coil	VIII	81
<b>THOMS-ALLIS</b>	Grasping forceps	IV	97



		Chapter	Page
<b>THUDICHUM (GOLDSMITH)</b>	ENT Specula	XII	17
<b>TIECK</b>	ENT Specula	XII	19
<b>TISCHLER</b>	Biopsy forceps	VIII	67
<b>TISCHLER-MORGAN</b>	Biopsy forceps	VIII	64
Tissue protector sleeve for cannulated screws		XIV	48
<b>TOENNIS</b>	Long and fine scissors	III	46
	Raspatory and elevator	XIII	31
<b>TOENNIS-ADSON</b>	Long and fine scissors	III	47
	Tungsten scissors	III	65
<b>TOENNIS-ADSON-FINO (DEBAKEY)</b>	Long and fine scissors	III	47
<b>TOHOKU</b>	Towel forceps	IV	106
Tongue depressor		XV	6, 7
Tongue holding forceps		XV	9
Tonsil scissors		III	37
Top pubic blade		VII	68, 69
<b>TOUPET</b>	Blade	VII	73
	Clamp forceps	IV	47
	Double depressor	VII	76
	Peg	VII	72
<b>TOUPET (ENTEROSTAT)</b>	Retractor	VII	76
Towel forceps		IV	103 to 107
		XV	20
<b>TOWNSEND</b>	Biopsy forceps	VIII	67
Traction bows		XIII	157 to 160
<b>TRAVERS</b>	Retractor	VII	114
<b>TRELAT</b>	Rectal specula	VIII	87
Trephine		XIII	93
Trephine for removal broken screws		XIV	37
<b>TREVES</b>	Special dissecting forceps	II	12
<b>TRILLAT</b>	Grafts pusher	XIII	143
	Instrumentation for knee	XIII	155
	Instrumentation pour ménisque - Instrumentation for meniscu	XIII	154
	Retractor for forearm	VII	141
	Shoulder instrumentation	XIII	148
Trocar		XV	28 to 30
Trocar in osseous biopsy		XV	28
Trocar with sleeve for nails		XIV	44
<b>TROELTSCH</b>	ENT dissecting forceps	II	38
<b>TROUSSEAU</b>	ENT Dilator	XII	12
<b>TROUTMAN</b>	Microsurgery scissors	X	7
<b>TROUTMAN-BARRAQUÈR</b>	Microsurgery scissors	X	5
<b>TUBBS</b>	Aortic and vascular dilators	V	40
<b>TUBIANA</b>	Needle holders	VI	9
Tubing forceps		IV	111, 112
<b>TUFFIER</b>	Grasping forceps	IV	98
	Retractor	VII	38, 49, 106
<b>TULIPE</b>	Enderectomy	V	7
Tungsten scissors		III	57 to 69
Tungstenn jaw - Hercules		XIV	33 to 36
<b>UCKERMANN</b>	ENT Dilator	XII	12
<b>UFFENORDE</b>	Curette	XIII	58
<b>ULRICH</b>	Bandage forceps	IV	121
<b>UNNA</b>	Comedone extractor	XIII	53
Urethra compressor		VIII	86
Uterin depressor		VIII	79
Uterine curette		VIII	68 to 76
Uterine dilator		VIII	82 to 84
Uterine elevating forceps		VIII	52
Uterine forceps		VIII	7 to 30
Uterine polypus forceps		VIII	11
Uterine sound		VIII	85
<b>VACHER</b>	ENT Snare	XII	20
	ENT Specula	XII	16
Vaginal blade		VIII	37 to 50
Vaginal scissors		III	82
Vaginal specula		VIII	31 to 35, 50
<b>VALLEIX</b>	Uterine sound	VIII	85
<b>VAN DOREN</b>	Biopsy forceps	VIII	63
<b>VANNAS</b>	Microsurgery scissors	X	4, 9, 10
<b>VANNAS modified TÜBINGEN</b>	Microsurgery scissors	X	4
<b>VARADY</b>	Enderectomy	V	8
Various scissors		III	27, 37, 45, 50, 53 to 56, 87
Vascular dissecting forceps	Vascular dissecting forceps	II	41 to 43
Vascular needle holders		VI	20 to 22
Vascular tourniquet		V	7
Vein holder		VII	19
<b>VELPEAU (TRICOISE)</b>	Costotome	XIII	125
<b>VERBRUGGE</b>	Bone holding forceps	XIII	127 to 130
<b>VERBRUGGE-MULLER</b>	Retractor	VII	134
<b>VERNON</b>	Percussion hammer and rubber	XV	5
Very Fine dissecting forceps		II	11
Vesical forceps		IX	11
<b>VIDAL</b>	Scraper	XIII	52
<b>VINCENT</b>	Bone rongeur forceps	XIII	99
	Prestige dissecting forceps	II	49



		Chapter	Page
<b>VINCENT (SCHMIEDEN)</b>	Scissors for vascular surgery	III	36
<b>VIRCHOW</b>	Brain knife	XIII	15
	Instrument for amputation	XIII	17
Virgin vaginal specula		VIII	33, 34
<b>WISE</b>	Suture micro forceps	II	33
Vise grip forceps		XIV	27
<b>VK retractor</b>		VII	71
<b>VOLKMANN</b>	Curette	XIII	54 to 57
	Retractor	VII	22 to 26
	Uterine curette	VIII	71
<b>WACHENFELDT</b>	Clip applying forceps	VI	5
<b>WAGNER</b>	ENT hook	XII	45
	Fine scissors	III	14
	Prestige scissors	III	72
	Raspatory	XIII	51
	Retractor	VII	131
<b>WALDMANN</b>	Episiotomy scissors	III	82
<b>WALLICH</b>	Uterine curette	VIII	69
<b>WALSHAM</b>	ENT reposition forceps	XII	35
<b>WALTER-CARMALT</b>	Splinters forceps	II	51
<b>WALTER-DUVAL</b>	Grasping forceps	IV	86
<b>WALTON</b>	Fine scissors	III	40
	Retractor for hemilaminectomy	VII	125
<b>WANGENSTEIN</b>	Dissecting forceps tungsten jaws	II	45
	Needle holders	VI	17
Watch maker's forceps		II	35
<b>WATSON (CHEYNE)</b>	Raspatory and elevator	XIII	31
	Probes	XV	12
<b>WAUGH</b>	Delicate dissecting forceps	II	31
<b>WEBER</b>	Atrauma cardiovascular forceps - Aorta	V	21
<b>WEBSTER</b>	Needle holders	VI	8
<b>WECKER</b>	Microsurgery scissors	X	6
<b>WEIL-BLAKESLEY</b>	Laminectomy rongeurs neurosurgery	XI	15
<b>WEISS</b>	Tubing forceps	IV	111
<b>WEITLANER</b>	Retractor	VII	112, 113, 116
	Neurosurgery retractors	VII	117
<b>WEITLANER-WULLSTEIN</b>	Retractor	VII	116
<b>WERTHEIM</b>	Scissors for deep operation	III	52
	Uterine forceps	VIII	16, 20
<b>WERTHEIM (BOZEMANN)</b>	Needle holders	VI	19
<b>WERTHEIMCULLEN</b>	Uterine forceps	VIII	23
<b>WERTHEIMER</b>	ENT Suction tube	XII	57
<b>WESTCOTT</b>	Microsurgery scissors	X	3, 7
<b>WHITE</b>	ENT Grasping forceps	XII	13
<b>WHITEHEAD</b>	Mouth gag	XII	9
<b>WICKSTROEM</b>	Ligature forceps - Dissector	IV	59
<b>WIEN</b>	ENT Specula	XII	19
<b>WILLIAMS</b>	Retractor	VII	127
	Screw driver	XIV	12
<b>WILLIGER</b>	Curette	XIII	53
	ENT currettes	XII	56
	Raspatory and elevator	XIII	35
<b>WILMER</b>	Fine scissors	III	39
<b>WINTER</b>	Uterine forceps	VIII	29
Wire cutting pliers		XIV	30 to 36
Wire cutting scissors		III	31
Wire guide		XIII	149, 154
Wire guide for tendons		XIII	11
Wire guide with needle		XIII	146
Wire mesh for traction of fingers		XIII	161
Wire passer for cerclage		XIV	52
Wire pliers		XIV	28, 29
Wire seizing forceps		XIV	26
Wire tightener		XIV	29
Wire tightener for cerclage		XIV	52
<b>WOLF</b>	Plaster forceps	XV	23
<b>WOODSON</b>	Raspatory and elevator	XIII	28
Wrench for bone chisel		XIV	24
Wrench for bow		XIII	157
<b>WRIGLEY</b>	Obstetrical forceps and spatula	VIII	57
<b>WYLIE</b>	Atrauma cardiovascular forceps - Aortic aneurysm	V	16
<b>YANKAUER</b>	Raspatory and elevator	XIII	34
	Suction tubes	XV	26
<b>YASARGIL</b>	Microsurgery needle-holder	X	13
	Microsurgery scissors	X	11
	Raspatory and elevator	XIII	31
<b>YEOMAN</b>	Rectal biopsy forceps	VIII	92
<b>YOUNG</b>	Retractor for prostate	VIII	96
	Tongue holding forceps	XV	9
<b>ZENKER</b>	Ligature forceps - Dissector	IV	60
	Retractor	VII	48
<b>ZIELKE</b>	Gouges	XIII	82
<b>ZWEIFEL</b>	Needle holders	VI	26



	Capítulo	Página
<b>AACHEN</b>	Espátula neurocirugía	XI 5
<b>ABADIE</b>	Separador	VII 91
<b>ABOULKER</b>	Dilatador ORL	XII 12
	Pinzas gubia	XIII 100
	Raspador y elevador	XIII 32
	Separador	VII 11
<b>ABRAHAM</b>	Bistouris espátula ORL	XII 25
Abre-boca		XII 7 a 11
Accesorio de succión		VIII 77
<b>ADLERKREUTZ</b>	Pinza par disección delicada	II 16
	Pinza para disección Prestige	II 50
<b>ADSON</b>	Gancho	XIII 24
	Pinza de servicio	XV 17
	Pinza hemostática	IV 35
	Pinza par disección boca de tungsteno	II 47
	Pinzas gubia	XIII 104
	Porta agujas	VI 10
	Raspador	XIII 38
	Separador	VII 122, 124
	Pinza par disección delicada	II 22
<b>ADSON ATRAUMA</b>	Pinza par disección delicada	II 24
<b>ADSON-BIMER</b>	Pinza par disección delicada	II 24
<b>ADSON-BROWN</b>	Pinza par disección delicada	II 22
<b>ADSON-GRAEFE</b>	Pinza par disección delicada	II 24
Aguja de sutura		VI 27
Aguja guía para tornillos canulados		XIV 48
Aguja para ligaduras		VI 28 a 32
Aguja para paracentesis		XII 22
Aguja para rotula		XIII 156
<b>ALAN-PARKS</b>	Separador rectal	VIII 91
<b>ALEXANDER</b>	Osea cincela, osteotomo, gubia	XIII 71
	Raspador y elevador	XIII 29
Alfileres de instrumentos		XV 32
Alicates para cortar alambre		XIV 30 a 36
Alicates para doblar placas		XIV 21, 22
<b>ALLAINE</b>	Disecador	IV 53
	Tijeras para disección	III 25
<b>ALLAINE (BOYD)</b>	Tijeras para disección	III 26
<b>ALLAIRE</b>	Tijeras delicadas	III 15
<b>ALLEN</b>	Destornillador	XIV 13
	Pinza clamp intestinal y estomacal	IV 77
<b>ALLIR-ADAIR</b>	Pinza a presión	IV 96
<b>ALLIS</b>	Pinza a presión	IV 94
<b>ALLISON</b>	Separador	VII 40
<b>ALM</b>	Separador	VII 109
Amnioscopio		VIII 51
Amplificador para injerto de piel		I 10
Amygdalotomo		XII 26
<b>ANDERSON-ADSON</b>	Separador neuro	VII 117
<b>ANDREW-PYNCHON</b>	Cánulas aspirantes	XV 26
Anillo para cadena		VII 72
Anuscopio		VIII 89
Arandelas de goma para ligadura		VIII 93
<b>ARRUGA</b>	Pinza capsular	X 16
<b>ASCH</b>	Pinza y cizalla ORL	XII 34
Atornillador para tornillos canulados		XIV 49
<b>AUBERT (FINSTERER)</b>	Cánulas aspirantes	XV 26
<b>AUBRY</b>	Separador ORL	XII 48
<b>AUFRICHT</b>	Raspa ORL	XII 43
	Separador y Gancho ORL	XII 49
<b>AUSTIN</b>	Pinza microtubarica	II 33
<b>AUVARD</b>	Valva vaginal	VIII 49
<b>AUVERT</b>	Pinza a presión	IV 92
	Separador completo	VII 86
	Valva	VII 86
<b>BABCOCK</b>	Pinza a presión	IV 100, 101
<b>BABINSKY</b>	Martillos a reflejos	XV 5
<b>BABY KOCHER</b>	Pinza clamp intestinal y estomacal	IV 70
<b>BABY SATINSKY</b>	Pinza a presión	IV 82
<b>BABY ADSON</b>	Disecador	IV 50
<b>BABY ALLIS</b>	Pinza a presión	IV 95
<b>BABY COLLIN</b>	Compas (separador)	VII 81
	Separador completo	VII 81
	Valva	VII 81
<b>BABY CRILE</b>	Pinza hemostática	IV 30
<b>BABY CRILE-WOOD</b>	Porta agujas	VI 15
<b>BABY DOYEN</b>	Pinza clamp intestinal y estomacal	IV 70
<b>BABY HAIGHT</b>	Separador para niños de pecho	VII 98
<b>BABY HARRINGTON</b>	Separador	VII 58
<b>BABY LEXER</b>	Tijeras para disección	III 21
<b>BABY METZENBAUM</b>	Tijeras Prestige	III 71
<b>BABY MIKULICZ</b>	Pinza hemostática especial para peritoneo	IV 48
<b>BABY MIXTER</b>	Disecador	IV 58
<b>BABY OVERHOLT</b>	Disecador	IV 58
<b>BABY POOLE</b>	Cánulas aspirantes	XV 26





		Capítulo	Página
<b>BABY ROUX</b>	Separador	VII	34
<b>BABY TISCHLER (MINI TOWNSEND)</b>	Pinza para biopsia	VIII	64
<b>BACKHAUS</b>	Pinza de compo	IV	104, 105
	Pinza para campos	XV	20
<b>BACON</b>	Pinzas gubia	XIII	108
<b>BAILEY</b>	Separador	VII	107
<b>BAILEY BABY</b>	Contractor de costillas	VII	107
<b>BAINBRIDGE</b>	Pinza clamp atrauma	V	14
	Pinza hemostática especial	IV	44
<b>BAKES</b>	Dilatador para vías biliares	IX	14
<b>BALFOUR</b>	Separador completo	VII	89, 90
	Valva	VII	89, 90
<b>BALFOUR (USA MODEL)</b>	Separador	VII	91
	Valva	VII	91
<b>BALFOUR BABY</b>	Separador completo	VII	89
	Valva	VII	89, 90
<b>BALLENGER</b>	Cuchillos para vegetaciones	XII	24
	Gubia ORL	XII	40
<b>BALLENTINE</b>	Pinza uterina	VIII	22
Banda		XV	31
<b>BANE HARTMANN</b>	Pinzas gubia	XIII	105
<b>BANKART</b>	Instrumentación para hombro	XIII	147
<b>BAR</b>	Pinza para cortar los clamps	VIII	60
<b>BARR</b>	Separador rectal	VIII	90
<b>BARRAQUER</b>	Microcirugía porta-agujas	X	14
<b>BARRAYA</b>	Disecador	IV	65
	Pinza par disección delicada	II	14
	Pinza para disección Prestige	II	50
<b>BARRE</b>	Pinza para alabes vesicales	IX	11
<b>BARSKY</b>	Separador, gancho	VII	9
<b>BECK</b>	Pinza clamp atrauma	V	23, 34
<b>BECKMANN</b>	Cuchillos para vegetaciones	XII	23
	Separador	VII	118 a 120
	Valva	VII	120
<b>BECKMANN (MOORE)</b>	Cuchillos para vegetaciones	XII	24
<b>BECKMANN-CONE</b>	Separador	VII	118
<b>BECKMANN-ADSON</b>	Separador	VII	123
<b>BECKMANN-EATON</b>	Separador	VII	122
<b>BEEBE</b>	Tijeras para cortar hilos	III	31
<b>BELLUCI</b>	Micro-tijeras ORL	XII	33
<b>BENGOLEA</b>	Pinza hemostática larga	IV	39, 40
	Pinza hemostática Prestige	IV	115
<b>BENNET</b>	Separador	VII	141
<b>BENSAUDE</b>	Anuscopio	VIII	89
<b>BENSON</b>	Separador para piloro	IV	102
<b>BERGER</b>	Pinza para biopsia	VIII	65
<b>BERGERET-TOUPET</b>	Porta estraca	VII	72
<b>BERGMANN</b>	Martillo	XIII	86
	Separador, gancho	VII	10
	Tijeras para vendajes	III	30
<b>BESNIER</b>	Cureta	XIII	52
<b>BETHUNE</b>	Costotomo	XIII	122
<b>BEYER</b>	Pinzas gubia	XIII	106, 109
<b>BEYER-ZAUFAL</b>	Pinzas gubia	XIII	109
<b>BILLEAU</b>	Cureta ORL	XII	56
<b>BIRCHER</b>	Instrumentación para menisco	XIII	150
<b>BIRCHER-GANSKE</b>	Instrumentación para menisco	XIII	153
<b>BIRKETT</b>	Pinza hemostática	IV	34
Bistouris espátula ORL		XII	25
Bisturí corta hilos		I	7
Bisturí esteril		I	7
Bisturí fijo		I	2
Bisturí PRIMA		I	7
Bisturís estándar		I	7
<b>BLAKE</b>	Cureta uterina	VIII	76
	Pinza para calculos biliares	IX	7
<b>BLONDIAU</b>	Mazo y cureta ORL	XII	54
<b>BLOUNT</b>	Instrumentación para menisco	XIII	151
	Separador	VII	140
<b>BLUMENTHAL</b>	Pinzas gubia	XIII	102
Boca caucho		XIV	33, 35
Boca de tungsteno		XIV	33 a 36
Bocas de goma para pinza para tirar la lengua		XV	9
<b>BOEHLER</b>	Estribo de tracción	XIII	160
	Pinza cortante	XIII	118
	Pinzas gubia	XIII	109
<b>BOETTCHER</b>	Tijeras para amígdalas	III	37
<b>BONN</b>	Tijeras finas	III	39
<b>BONNAIRE</b>	Pinza uterina	VIII	27
<b>BONNEY</b>	Pinza par disección especial	II	12
<b>BONNIOT</b>	Pinza hemostática	IV	24
<b>BORDIER-MEUNIER</b>	Trocar a biopsia ósea	XV	28
<b>BOSE</b>	Espéculo ORL	XII	17
<b>BOURGEOIS</b>	Pinza a presión ORL	XII	14
<b>BOWMAN (PALMER)</b>	Espéculo ORL	XII	17



		Capítulo	Página
<b>BOYS-ALLIS</b>	Pinza a presión	IV	96
<b>BRAND</b>	Guía para tendones	XIII	11
	Pinza para coger tendones	XIII	14
<b>BRAUN</b>	Depresor uterino	VIII	79
	Pinza uterina	VIII	25
<b>BRAUN-STADLER</b>	Tijeras para episiotomía	III	81
<b>BRIDGE</b>	Pinza hemostática larga	IV	37
<b>BRIESKY</b>	Pelvimetro	VIII	78
	Valva vaginal	VIII	43
<b>BRISTOW</b>	Separador	VII	139
Broca		XIV	5, 47
Broca a mano		XIV	40, 42
Broca para perforador		XIV	37
Broca rígida para la medula		XIV	38
<b>BROCK</b>	Raspador	XIII	52
<b>BROPHY</b>	Pinza par disección delicada	II	28
<b>BROPHY (SULLIVAN)</b>	Tijeras largas y finas	III	46 a 49
<b>BROWN-RESANO</b>	Pinza par disección especial	II	18
<b>BRUENINGS</b>	Cierra nudos ORL	XII	20
	Depresor lingual	XV	6
<b>BRUNETTI</b>	Instrumento para autopsia	XIII	23
<b>BRUNNER</b>	Aguja para ligaduras	VI	31
	Costotomo	XIII	123
	Pinza clamp intestinal y estomacal	IV	76
	Separador	VII	45
<b>BRUNS</b>	Cureta	XIII	58, 62
	Tijeras para escayolas	III	85
		XV	22
<b>BUCK</b>	Cureta ORL	XII	55
	Pinza para oreja	XII	32
<b>BUCK-GRAMCKO</b>	Elevador para huesos del pie y de la mano	VII	130
<b>BUELAU</b>	Trocar	XV	30
Bujía dilatador		VIII	86
<b>BUNNEL</b>	Perforador manual	XIV	9
<b>BUNNELL</b>	Enucleator de tendones	XIII	12
	Guía para tendones	XIII	11
<b>BUSCH (VEZIEN)</b>	Tijeras para el cordón umbelical	III	80
<b>BUSCHE</b>	Cureta	XIII	63
Cadena para estraca		VII	72
Cadena para separador		VII	82
<b>CAIRNS</b>	Pinza hemostática	IV	36
<b>CAIRNS (CLOVIS-VINCENT)</b>	Raspador y elevador	XIII	37
Calibre de medición		XIII	96
<b>CANNY-RYALL</b>	Separador	VII	36
Canula aspirante ORL		XII	57, 58
Cánula de heparina		XV	27
Cánulas aspirantes		XV	26
<b>CAPENER</b>	Gubia	XIII	82
Capucha para separador		VII	82
<b>CAROLL</b>	Goniometro	XIII	95
	Pinza para coger tendones	XIII	13
<b>CARPENTER</b>	Raspador y elevador	XIII	28
<b>CARREL</b>	Clamp para linfografía	V	9
	Pinza hemostática	IV	16
<b>CASPAR</b>	Cureta	XIII	64
	Gancho	XIII	25
	Mango de bisturí	I	6
	Pinzas para laminectomía neurocirugía	XI	12, 13
	Raspador	XIII	39
	Separador	VII	46
	Separador neurocirugía	XI	7
Casquillo de protección para tornillos canulados		XIV	48
Casquillo dentado para broca		XIV	15
<b>CASTANEDA</b>	Pinza clamp atrauma - Pediatría	V	39
<b>CASTROVIEJO</b>	Gancho ORL	XII	46
	Microcirugía porta-agujas	X	12
	Microcirugía tijeras	X	5, 8
<b>CATLIN</b>	Cuchillo para lóbulos	XIII	16
Caucho para martillos a reflejos		XV	5
<b>CAUCHOIX</b>	Osteotomo, gubia	XIII	76
	Separador	VII	142
<b>CHADWICK</b>	Tijeras finas	III	39
<b>CHANDLER</b>	Separador	VII	139
	Separador completo	VII	104
	Valva	VII	104
<b>CHAPUT</b>	Pinza a presión	IV	93
<b>CHAPUT-MAYO</b>	Pinza a presión	IV	93
<b>CHARNLEY</b>	Cuadro completo	XIII	142
	Cureta	XIII	65
	Separador, mano de plomo	XIII	142
	Valvula	XIII	142
	Separador	VII	37
<b>CHARRIER</b>	Instrumento para amputación	XIII	18, 19
<b>CHARRIERE</b>	Pinza a presión ORL	XII	14
<b>CHATELIER</b>	Pinza para instrumentos	XV	32



		Capítulo	Página
<b>CHERON</b>	Pinza para vendajes	IV	119
<b>CHEVALIER-JACKSON</b>	Pinza para esofagoscopia	XII	36
<b>CHEVRET</b>	Separador	VII	40
<b>CHRISTOPHE</b>	Pinza hemostática	IV	33
	Pinza hemostática Prestige	IV	117
<b>CHROBAK</b>	Pinza uterina	VIII	24
Cierra nudos ORL		XII	20, 21
Cierra tubos		IV	110
		XV	20
Cinzel		XIII	65
Cinzel ORL		XII	37, 38
Cinzel par esternón		XIII	125
Cinzel para huesos		XIV	24
Cinzel rompe-craneo		XIII	22
<b>CINELLI</b>	Ostetomo	XII	39
<b>CIRCIERON (MATHIEU)</b>	Pinza para espiral	VIII	81
<b>CITELLI</b>	Sacabocados ORL	XII	27
Cizalla ORL		XII	34
Clamp bulldog		V	9 a 11
Clamp para linfografía		V	9
Clamp para prostate		VIII	95
<b>CLAOUE</b>	Separador ORL	XII	48
<b>CLEVELAND</b>	Pinza cortante	XIII	117
	Pinzas gubia	XIII	103
<b>CLOVIS-VINCENT</b>	Cureta ORL	XII	56
	Espátula neurocirugía	XI	3
	Perforador neurocirugía	XI	9
	Pinza par disección muy fina	II	11
	Raspador	XIII	48
<b>CLOWARD</b>	Cureta	XIII	59
	Gancho	XIII	24
<b>COAKLEY</b>	Cureta ORL	XII	55
<b>COBB</b>	Gubia	XIII	79
	Raspador	XIII	51
<b>COLLER-CRILE</b>	Pinza hemostática	IV	30
<b>COLLIN</b>	Compas (separador)	VII	79, 80
	Costotomo	XIII	121
	Espéculo vaginal	VIII	31
	Pinza a presión	IV	87, 90
	Pinza para coger el útero	VIII	52
	Separador	VII	34, 79, 80
	Valva	VII	79, 80
<b>COLLIN-POZZI</b>	Pinza uterina	VIII	13
<b>COLVER</b>	Pinza a presión ORL	XII	13
Compas		XIII	145
Compas (separador)		VII	67, 73, 74
Compresor para uretra		VIII	86
Con ductor y extractor para clavos		XIV	42
Conductor para hilo sierra		XIII	20
Contractor de costillas		VII	107
Controlador de angulo		XIV	17
<b>CONVERSE</b>	Gancho ORL	XII	47
	Porta agujas	VI	14
<b>COOLEY</b>	Dilatador vascular y de aorta	V	40
	Pinza clamp atrauma	V	33, 35, 36
	Pinza clamp atrauma - Anastomosis	V	36, 37
	Pinza clamp atrauma - Coarctación	V	34, 36
	Pinza clamp atrauma - Ligadura	V	36
	Pinza clamp atrauma - Pediatría	V	37, 38
	Pinza clamp atrauma - Usos varios	V	34
	Pinza para disección vascular	II	42
	Separador	VII	101
<b>COOLEY-DERRA</b>	Pinza clamp atrauma - Anastomosis	V	34
<b>CORYLLOS</b>	Separador	VII	53
Costotomo		XIII	121 a 125
<b>COTT</b>	Compas (separador)	VII	77
	Pinza uterina	VIII	24
	Separador	VII	77
	Valva	VII	77
<b>COTTLE</b>	Gancho ORL	XII	47
	Martillo	XIII	88
	Ostetomo	XII	37
	Raspa ORL	XII	43
	Raspador	XIII	43
	Raspador y elevador	XIII	31
	Separador, gancho	VII	10
	Tijeras nasales Prestige	III	79
	Tijeras ORL	III	84
<b>COTTLE (KILLIAN)</b>	Espéculo ORL	XII	18
<b>COTTLE-NEIVERT</b>	Gancho ORL	XII	47
<b>COURTY</b>	Separador	VII	129
<b>CRAFOORD</b>	Pinza hemostática larga	IV	43
	Tijeras para intervención en profundidad	III	51
<b>CRAFOORD (SELLORS)</b>	Pinza hemostática especial	IV	45
<b>CRAIG-DOMNICK</b>	Pinza a presión ORL	XII	15



		Capítulo	Página
<b>CRAWFORD</b>	Separador	VII	36
<b>CREED</b>	Raspador y elevador	XIII	28
<b>CRILE</b>	Gancho	XIII	25
	Pinza hemostática	IV	28, 29
	Pinza hemostática Prestige	IV	117
	Separador	VII	33
<b>CRILE-MURRAY</b>	Porta agujas	VI	11
<b>CRILE-WOOD</b>	Porta agujas	VI	11
<b>CRILE-RANKIN</b>	Pinza hemostática	IV	29
<b>CRILE-WOOD</b>	Porta agujas	VI	15
	Porta agujas de servicio	XV	18
	Gancho para flebectomía	V	7
Cuadro (Separador)		VII	83
Cuadro soporte instrumentos		XV	32
Cuchillo interóseo		XIII	16
Cuchillo para cerebro		XIII	15
Cuchillo para falanges		XIII	16
Cuchillo para lóbulos		XIII	16
Cuchillos para vegetaciones		XII	23, 24
Cureta		XIII	52 a 65
Cureta para biopsia		VIII	77
Cureta para vías biliares		IX	12 a 13
Cureta uterina		VIII	68 a 76
Curetas ORL		XII	54 a 56
Cursor		VII	72, 92
<b>CUSCHING-KOCHER</b>	Separador	VII	17
<b>CUSCO</b>	Espéculo vaginal	VIII	33
	Espéculo vaginal para virgen	VIII	34
<b>CUSHING</b>	Gancho	XIII	25
	Microcirugía gancho	X	20
	Perfordor neurocirugía	XI	10
	Pinza par disección boca de tungsteno	II	46
	Pinza par disección delicada	II	25
	Pinzas para laminectomía neurocirugía	XI	11
	Raspador	XIII	41, 42
	Separador	VII	13, 62
<b>CUZZI</b>	Cureta uterina	VIII	75
<b>CZERNY</b>	Espéculo rectal	VIII	88
	Pinza para calculos biliares	IX	7
	Pinza uterina	VIII	25
<b>DALE</b>	Pinza clamp atrauma - Periférica	V	30
<b>DANDY</b>	Microcirugía gancho	X	20
	Pinza hemostática	IV	26
<b>DANIS</b>	Instrumentación para hombro	XIII	148
	Passe fil	XIII	149
	Separador y espátula apra hombro	XIII	148
	Tensor de alambre	XIV	30
<b>DARGENT</b>	Pinza uterina	VIII	16
	Valva vaginal	VIII	42
<b>DARTIGUES</b>	Pinza para coger el útero	VIII	52
<b>DARTIGUES (LAPAROSTAT)</b>	Separador	VII	94
<b>DAUBENSPECK</b>	Cureta	XIII	60
<b>DAUPHIN</b>	Tijeras quirúrgicas	III	11
<b>DAUTREY</b>	Separador ORL	XII	48
<b>DAVID</b>	Pinzas gubia	XIII	114
<b>DAVIS</b>	Raspador y elevador	XIII	27
<b>DAVIS-BOYLE</b>	Abre-boca	XII	10
<b>DE MARTEL</b>	Conductor para hilo sierra	XIII	20
	Pinza para pericraneio	IV	84
	Raspador y elevador	XIII	37
	Tijeras para cirugía vascular	III	35
<b>DE MARTEL-WOLFSON</b>	Pinza para cerrar clamps y porta clamps	IV	80
<b>DEAN</b>	Tijeras diversas	III	45
<b>DEAVER</b>	Separador	VII	59, 60
	Tijeras finas	III	14
<b>DEBAKEY</b>	Clamp bulldog	V	10
	Clamp bulldog (carotide)	V	11
	Dilatador vascular y de aorta	V	40
	Pinza clamp atrauma	V	13, 14, 22, 23, 27, 28, 32
	Pinza clamp atrauma - Aneurisma de la aorta	V	17
	Pinza clamp atrauma - Aorta	V	20, 21
	Pinza clamp atrauma - Arteria renal	V	15
	Pinza clamp atrauma - Ligadura	V	13, 20, 21
	Pinza clamp atrauma - Usos varios	V	24
	Pinza par disección boca de tungsteno	II	44
	Pinza para disección vascular	II	41 a 43
	Porta agujas vasculares	VI	20
	Separador	VII	102, 128
	Tijeras de tungsteno	III	69
	Tijeras para cirugía vascular	III	33, 36
	Valva	VII	102
<b>DEBAKEY-BAHNSON</b>	Pinza clamp atrauma - Aneurisma de la arteria	V	25
<b>DEBAKEY-DIETRICH</b>	Pinza para disección vascular	II	43
<b>DEBAKEY-GERALD</b>	Pinza para disección vascular	II	43
<b>DEBAKEY-GLOVER</b>	Clamp bulldog	V	11



		Capítulo	Página
<b>DEBAKEY-MOSQUITO</b>	Pinza clamp atrauma	V	27
<b>DEBAKEY-PEAN</b>	Pinza clamp atrauma	V	26
<b>DEBAKEY-POTTS</b>		V	12
<b>DEBAKEY-RANKIN</b>	Pinza clamp atrauma	V	27
<b>DEBAKEY-SATINSKY</b>	Clamp bulldog	V	11
<b>DEBAKEY-BECK</b>	Pinza clamp atrauma	V	16
<b>DECOULX</b>	Separador	VII	121
<b>DELABARRE</b>	Abre-boca	XII	7
<b>DELESTRE</b>	Tijeras para episiotomía	III	81
<b>DEMEL</b>	Tensor de alambre	XIV	32
<b>DEMELIN-SUZOR</b>	Forceps obstétrico y espátula	VIII	54
<b>DEMOISELLE</b>	Empujador de injertos	XIII	143
<b>DENHART</b>	Abre-boca	XII	7
<b>DENIS BROWN</b>	Cuadro (Separador)	VII	84
	Valva	VII	84
Depresor lingual		XV	6, 7
Depresor uterino		VIII	79
<b>DERF</b>	Porta agujas	VI	8, 14
Dermátomo de mano		I	8, 9
<b>DERRA</b>	Pinza clamp atrauma - Anastomosis	V	29
<b>DESCHAMPS</b>	Aguja para ligaduras	VI	32
<b>DESCHAMPS-SCHAUTA</b>	Aguja para ligaduras	VI	31
<b>DESGOUTTES</b>	Pinza par disección especial	II	18
<b>DESJARDINS</b>	Cureta para vías biliares	IX	12
	Draga para vías biliares	IX	12
	Explorador para vías biliares	IX	12
	Pinza para calculos biliares	IX	6
	Pinzas para cístico	IX	11
<b>DESMARET</b>	Separador	VII	70
<b>DESMARRES</b>	Separador	VII	11
Destornillador		XIV	11 a 13
Destornillador - Mango		XIV	13
Destornillador - Pinza de sujeción		XIV	12
Diapasón ORL		XII	59, 60
<b>DIETRICH</b>	Pinza clamp atrauma - Aorta	V	18
Dilatador ORL		XII	12
Dilatador para vías biliares		IX	14
Dilatador uterino		VIII	82 a 84
Dilatador vascular y de aorta		V	40
<b>DINGMAN</b>	Separador	VII	66
<b>DINGMANN</b>	Abre-boca	XII	11
	Pinza para huesos	XIII	127
Disco para martillos		XIII	87, 88
Disecador		IV	50 a 67
Disector		V	8
Disector a tendones		XIII	11
<b>DIXON-LOVELACE</b>	Pinza hemostática	IV	27
<b>DOCKHORN</b>	Separador para cirugía maxilo-facial	VII	64
<b>DOUAY</b>	Pinza para biopsia	VIII	65
<b>DOUGLAS</b>	Valva vaginal	VIII	41
<b>DOYEN</b>	Abre-boca	XII	8
	Aguja para ligaduras	VI	28
	Costotomo	XIII	125
	Perforador inicial	XI	9
	Perforador neurocirugía	XI	9
	Pinza clamp intestinal y estomacal	IV	69, 72
	Pinza de compo	IV	103
	Pinza para ovarios	VIII	27
	Porta agujas	VI	9
	Raspador y elevador	XIII	45
	Separador	VII	61
	Tijeras diversas	III	27
	Tirabuzone para fibroma	VIII	81
	Valva vaginal	VIII	37, 46
<b>DOYEN-ROCHARD</b>	Valva para abajo del pubis	VII	69
Draga para vías biliares		IX	12
<b>DRYSSEN</b>	Separador	VII	105
<b>DUBOIS</b>	Tijeras para intervención en profundidad	III	51
<b>DUBOST</b>	Separador completo	VII	99
	Tijeras de tungsteno	III	67
	Tijeras para disección	III	20
	Valva	VII	99
<b>DUBOST NOGENT</b>	Separador completo	VII	100
	Valva	VII	100
<b>DUFOURMENTEL</b>	Pinza par disección delicada	II	32
	Raspa ORL	XII	42
<b>DUMONT</b>	Pinza de relojero	II	35
<b>DUNHILL</b>	Pinza hemostática	IV	17
<b>DUPLAY</b>	Espéculo ORL	XII	16
	Pinza uterina	VIII	13
<b>DUPONT</b>	Osteotomo	XIII	67
<b>DURAND (PATTE DE VELOURS)</b>	Pinza par disección especial	II	17
	Pinza para disección Prestige	II	50
<b>DUVAL</b>	Pinza a prensión	IV	89 a 91
	Pinza par disección especial	II	21



		Capítulo	Página
<b>ECHLIN</b>	Pinzas gubia	XIII	113
<b>EISELSBERG</b>	Tijeras para cortar hilos	III	31
Elevador		XIII	26 a 37, 44, 45
Elevador ORL		XII	50, 51, 53
Elevador para hombro		XIII	148
Elevador para huesos del pie y de la mano		VII	130
<b>EMMET</b>	Aguja para ligaduras	VI	29
Empujador de injertos		XIII	143, 144
Empujador de nodos		VI	34
Enderectomia		V	6 a 8
Endoespeculo		VIII	36
<b>ENGEL</b>	Instrumento para amputación	XIII	21
ENGLISH MODEL	Pinza par disección especial	II	12
Enucleator de tendones		XIII	12
<b>EPPENDORF</b>	Pinza para biopsia	VIII	66
<b>ERRICO</b>	Perforador	XI	10
Escolplo guía graduado		XIV	17, 19
Esfinteroscopia		VIII	89
<b>ESMARCH</b>	Banda	XV	31
	Tijeras para vendajes	III	30
Espátula		VIII	53 a 59
Espátula de pomada		XV	31
Espátula neurocirugía		XI	3 a 5
Espátula para hombro		XIII	148
Espéculo ORL		XII	16 a 19
Espéculo rectal		VIII	87, 88
Espéculo vaginal		VIII	31 a 35, 50
Espéculo vaginal para virgen		VIII	33, 34
Espejo laringeo		XV	8
Estetoscopia		XV	5
Estiletes		XV	12
Estraca		VII	72
Estribo de tracción		XIII	157 a 160
<b>EUFRATE</b>	Porta agujas vasculares	VI	22
<b>EVANS</b>	Pinza par disección boca de tungsteno	II	45
<b>EVES</b>	Cierra nudos ORL	XII	20
Explorador		XIII	154
Explorador para vías biliares		IX	12
Extensión para separador		VII	67
Extractor		V	8, 45
Extractor de clavos		XIV	41
Extractor de grapas		XIV	50
<b>FARABEUF</b>	Bisturí	I	2
	Instrumento para amputación	XIII	19
	Osea cincela, gubia	XIII	75
	Pinza para huesos	XIII	132
	Raspador y elevador	XIII	44
	Separador	VII	31, 32, 42
<b>FARABEUF-CORTI</b>	Separador	VII	33
<b>FARKAS</b>	Pinza par disección especial	II	20
<b>FAVALORO</b>	Tijeras para cirugía vascular	III	36
<b>FEILCHENFELD</b>	Pinza para astillas	II	51
<b>FERGUSON</b>	Canula aspirante ORL	XII	58
	Pinza para huesos	XIII	138
	Tijeras para incisión	III	28
<b>FERRIS-SMITH-CUSHING</b>	Pinzas para laminectomía neurocirugía	XI	14
<b>FERRIS-SMITH-KERRISSON</b>	Sacabocados Neurocirugía	XI	16 a 22
<b>FICAT</b>	Punzón y trapanador	XIII	93
<b>FINOCHIETTO</b>	Disecador	IV	66
	Porta agujas	VI	10, 18
	Separador	VII	95 a 98
	Valva	VII	97
<b>FINOCHIETTO-BURFORD</b>	Separador completo	VII	105
	Valva	VII	105
<b>FINSEN</b>	Separador	VII	109
<b>FISH</b>	Gancho	XIII	24
	Gancho ORL	XII	45
	Estiletes	XV	12
<b>FOMON</b>	Gancho ORL	XII	46
	Raspa ORL	XII	44
	Tijeras nasales Prestige	III	78
	Tijeras ORL	III	83, 84
Forceps obstétrico		VIII	53 a 59
<b>FOUCAULT</b>	Separador VK	VII	71
<b>FRAZIER</b>	Canula aspirante ORL	XII	57, 58
	Microcirugía gancho	X	19
	Raspador y elevador	XIII	36
<b>FREER</b>	Cíncel y gubia ORL	XII	37
	Elevador ORL	XII	50
	Gancho ORL	XII	46
	Gubia ORL	XII	40
	Raspador ORL	XII	41
	Raspador y elevador	XIII	26
<b>FREER-YASARGIL</b>	Raspador y elevador	XIII	26
<b>FRENCH</b>	Diapasón ORL	XII	59



		Capítulo	Página
<b>FRIEDMANN DELIKAT</b>	Pinzas gubia	XIII	101
<b>FRITSCH</b>	Separador	VII	61
<b>FRYKHOLM</b>	Pinzas gubia	XIII	113
<b>FUCHSIG</b>	Pinza hemostática	IV	34
<b>FUKUDA</b>	Separador	VII	140
<b>GALLAHER</b>	Raspa ORL	XII	42
Gancho		VII	9, 10
		XIII	24, 94
Gancho de extracción		XIV	41
Gancho Muscular		XIII	22
Gancho ORL		XII	45 a 47, 49
Gancho para cabeza de tornillos		XIV	11
Gancho para tendones		XIII	12
Ganchura		XIII	154
<b>GELPI</b>	Separador	VII	128
<b>GEMINI</b>	Disecador	IV	57
<b>GERALD</b>	Pinza par disección delicada	II	30
<b>GIERTZ-STILLE</b>	Costotomo	XIII	123
<b>GIGLI</b>	Instrumento para amputación	XIII	20
<b>GILLIES</b>	Pinza par disección delicada	II	31
	Porta agujas	VI	24
	Separador, gancho	VII	9
<b>GILLIES (WAUGH)</b>	Pinza par disección delicada	II	31
<b>GILLIES BABY</b>	Porta agujas	VI	24
<b>GIL-VERNET</b>	Separador	VII	12
<b>GIL-VERNET (PAPIN)</b>	Separador	VII	12
<b>GINESTET</b>	Separador y Gancho ORL	XII	49
<b>GLOVER</b>	Pinza clamp atrauma	V	28
	Pinza clamp atrauma - Ligadura	V	29
<b>GLUCK</b>	Costotomo	XIII	123
<b>GOELET</b>	Separador	VII	34
<b>GOLDMANN-FOX</b>	Tijeras de tungsteno	III	66
	Tijeras para encía	III	44
Goma de pulimento		XV	33
Goniometro		XIII	95
<b>GOOD</b>	Tijeras diversas	III	37
<b>GORNEY</b>	Tijeras Prestige	III	77
<b>GOSSET</b>	Separador	VII	87, 88
	Valva	VII	88
<b>GOUILLOUD</b>	Pinza clamp	IV	47
<b>GOURDET</b>	Cureta uterina	VIII	68
<b>GRAEFE</b>	Microcirugía gancho	X	18
	Tijeras finas	III	39
<b>GRAHAM</b>	Microcirugía gancho	X	20
Grapas de Michel		VI	6
<b>GRAVE</b>	Espéculo vaginal	VIII	34
<b>GRAY</b>	Pinza para vías biliares	IX	10
<b>GRAZIL</b>	Tijeras delicadas	III	13, 15
<b>GREEN</b>	Separador	VII	62
<b>GREEN-ARMYTAGE</b>		VIII	30
<b>GREGOIRE</b>	Pinza a presión	IV	88
	Pinza par disección especial	II	19
<b>GREGORY</b>	Pinza clamp atrauma - Profundidad	V	31
	Clamp bulldog	V	10
<b>GROSS-MAYER</b>	Pinza para vendajes	IV	120
<b>GRUENWALD</b>	Pinza par disección boca de tungsteno	II	46
<b>GRUENWALD-HENKE</b>	Sacabocados ORL	XII	28
Gubia		XIII	65, 68 a 82
Gubia ORL		XII	37, 38, 40
<b>GUERRIER</b>	Separador y Gancho ORL	XII	49
Guía - hilo para tendones		XIII	11
Guía de broca para placas		XIV	17
Guía de brocas		XIV	14 a 16, 23
Guía de terraja		XIV	15
Guía hilo		XIII	154
Guía para brocas		XIV	39, 41, 43
Guía para clavos		XIV	39
<b>GUILLAUME</b>	Osea cincela, gubia	XIII	77
<b>GUNNAR-HEY</b>	Pinza para ordenar las canulas	IV	108
<b>GUTHRIE</b>	Microcirugía gancho	X	19
<b>GUYON</b>	Bujía dilatador	VIII	86
	Pinza para pedunculos renales	IX	8
<b>GUYON-FREUDENBERG</b>	Mandril	XV	31
<b>HABERER</b>	Separador	VII	38
<b>HAIGHT</b>	Separador	VII	101
<b>HAJEK</b>	Martillo	XIII	86
	Sacabocados ORL	XII	28
<b>HAKANSSON</b>	Pinzas gubia	XIII	103
<b>HALLE</b>	Cureta	XIII	60
	Raspador y elevador	XIII	32
	Separador rectal	VIII	90
	Tijeras nasales	III	83
<b>HALSEY</b>	Porta agujas	VI	8
<b>HALSEY (WEBSTER)</b>	Porta agujas	VI	13
<b>HALSTEAD</b>	Pinza de servicio	XV	19



		Capítulo	Página
<b>HALSTEAD</b>	Pinza hemostática	IV	20
	Pinza hemostática Prestige	IV	113
<b>HALSTEAD-MOSQUITO</b>	Pinza hemostática	IV	23
<b>HANK</b>	Dilatador uterino	VIII	84
<b>HARKEN</b>	Pinza a presión	IV	83
	Pinza clamp atrauma - Auriculares	V	18
<b>HARRINGTON</b>	Disecador	IV	67
	Separador	VII	58
<b>HARRINGTON-PEMBERTON</b>	Separador	VII	58
<b>HARRIS</b>	Tensor de alambre	XIV	31
<b>HARTMANN</b>	Diapasón ORL	XII	59, 60
	Espéculo ORL	XII	16
	Pinza clamp intestinal y estomacal	IV	68
	Pinza gubia	XII	30
	Pinza para oreja	XII	31, 32
	Pinza para pólipos	XII	30
	Sacabocados ORL	XII	28
	Separador	VII	36
	Pinza para pólipos	XII	30
<b>HARTMANN-CITELLI</b>	Espéculo ORL	XII	18
<b>HARTMANN-HALLE</b>	Pinza para oreja	XII	31
<b>HARTMANN-WEINGARTNER</b>	Tijeras para cortar hilos	III	31
<b>HARVEY</b>	Cíncel y gubia ORL	XII	38
<b>HAUTANT</b>	Estraca	VII	72
<b>HAUTEFEUILLE</b>	Cureta uterina	VIII	75
<b>HEANEY</b>	Pinza uterina	VIII	19
	Porta agujas	VI	10
	Separador	VII	37
	Pinza uterina	VIII	22
<b>HEANEY-BALLENTINE</b>	Pinza para retirar las grapas	VI	7
<b>HEATH</b>	Dilatador uterino	VIII	82, 84
<b>HEGAR</b>	Porta agujas	VI	11
<b>HEGAR-BAUMGARTNER</b>	Porta agujas	VI	23
<b>HEGAR-OLSEN</b>	Porta agujas	VI	23
<b>HEGAR-OLSEN BABY</b>	Porta agujas vasculares	VI	22
<b>HEGAR VASCULAR</b>	Tijeras para cirugía vascular	III	34
<b>HEGEMANN (DIETRICH)</b>	Pinza para poner las grapas	VI	5
<b>HEGENBARTH</b>	Espátula neurocirugía	XI	5
<b>HEIFETZ</b>	Pinza hemostática larga	IV	38
<b>HEISS</b>	Separador	VII	109
<b>HEISS (HOLZEIMER)</b>	Abre-boca	XII	8
<b>HEISTER</b>	Instrumento para amputación	XIII	19
<b>HELFERICH-BIER</b>	Elevador ORL	XII	51
<b>HENKE</b>	Separador completo	VII	114
<b>HENLEY</b>	Valva	VII	114
	Pinza para escayolas	XV	24
<b>HENNING</b>	Alicates para cortar alambre	XIV	33 a 36
<b>HERCULES</b>	Pinza para extracción	XIV	26
	Pinza para vías biliares	IX	9
<b>HERRICK</b>	Separador	VII	106
<b>HERTZLER</b>	Separador neurocirugía	XI	8
<b>HESS</b>	Pinza para huesos	XIII	136
<b>HEY-GROVES</b>	Tijeras nasales	III	84
<b>HEYMANN</b>	Tijeras nasales Prestige	III	79
	Pinza hemorroidal	VIII	94
<b>HEYWOOD-SMITH</b>	Pinza uterina	VIII	28
<b>HIBBS</b>	Osea cincela, osteotomo, gubia	XIII	73
	Separador	VII	37
	Tijeras para incisión	III	28
<b>HI-LEVEL KNOWLES</b>	Hilo para limpiar para tornillos canulados	XIV	49
	Histero-salpingografía	VIII	79, 80
<b>HOEN</b>	Raspador y elevador	XIII	34
<b>HOFFMAN</b>	Cierra tubos	IV	110
<b>HOHMANN-ALDINGER</b>	Separador	VII	135
	Hoja de cincel	XIV	24
	Hoja de osteotomo	XIV	24
	Hojas desechables	I	4 a 6
	Hojas para dermatomo	I	8, 9
<b>HOLSHER</b>	Separador neurocirugía	XI	8
<b>HOLZBACH</b>	Pinza uterina	VIII	21
<b>HONTON</b>	Gubia	XIII	78
<b>HORSLEY</b>	Raspador y elevador	XIII	36
<b>HÖSEL</b>	Separador	VII	46
<b>HOWARTH</b>	Raspador y elevador	XIII	27
<b>HRYNITSCHAK</b>	Separador completo	VII	92
	Valva	VII	92
<b>HUDSON</b>	Perfordor neurocirugía	XI	10
<b>HUMBY</b>	Separador, gancho	VII	9
<b>HUNTER</b>	Pinza para astillas	II	51
<b>HURD</b>	Elevador ORL	XII	51
	Hysterómetro	VIII	85
<b>IMA</b>	Microcirugía Pinza para disección	X	17
	Impactor	XIV	43
	Impactor de grapas	XIV	50
	Impactor extractor para clavos	XIV	43





		Capítulo	Página
Impactor final		XIV	41
Impactor para clavos		XIV	44, 45
Impactor para grapas		XIV	51
Impactor para placas		XIV	17, 19
Instrumentación para menisco		XIII	150 a 154
Instrumentación para rodilla		XIII	155, 156
Instrumento para amputación		XIII	15 a 21
Instrumento para autopsia		XIII	22, 23
Instrumentos para escayolas		III	85
<b>IOWA</b>	Pinza para la vesícula amniótica	VIII	10
<b>ISRAEL</b>	Separador	VII	29
<b>ISSELIN</b>	Punzón	XIII	90
<b>IVG</b>	Mango para canula IVG	VIII	81
<b>J.L. FAURE</b>	Pinza par disección especial	II	19
	Pinza para biopsia	VIII	62
	Pinza uterina	VIII	15, 17
<b>JACKSON</b>	Separador	VII	15
	Valva vaginal	VIII	44
<b>JACOBS</b>	Mandril	XIV	7, 8
	Perforador manual	XIV	9
	Pinza uterina	VIII	10
<b>JACOBSON</b>	Cureta	XIII	53
	Microcirugía porta-agujas	X	13
<b>JACOBSON-ADSON</b>	Pinza par disección delicada	II	23
	Disecador	IV	56
<b>JACOBSON-HALSTEAD</b>	Pinza hemostática	IV	22
<b>JAMESON</b>	Porta agujas	VI	12
	Tijeras largas y finas	III	45
	Tijeras Prestige	III	73
<b>JANSEN</b>	Cureta	XIII	54
	Pinzas gubia	XIII	105, 108
	Raspador	XIII	41
	Separador	VII	110
<b>JANSEN (LUCAE)</b>	Pinza para disección O.R.L.	II	40
<b>JANSEN (MIDDLETON)</b>	Sacabocados ORL	XII	29
<b>JANSEN-DEEP</b>	Separador	VII	110
<b>JAVID</b>	Pinza clamp atrauma - Carótida	V	33
<b>JAYLE</b>	Espéculo vaginal	VIII	32
	Valva vaginal	VIII	48
<b>JEANNINGS</b>	Abre-boca	XII	9
<b>JESCO</b>	Tijeras diversas	III	56
<b>JOHNS HOPKINS</b>	Clamp bulldog	V	9
<b>JOLL</b>	Separador para bocio	VII	129
<b>JONES</b>	Pinza de compo	IV	103
<b>JOSEPH</b>	Instrumentos ORL de Joseph	XII	52, 53
	Tijeras Prestige	III	76
	Tijeras ORL	III	83
<b>JOST</b>	Raspador y elevador	XIII	29
<b>JUDD-ALLIS</b>	Pinza a presión	IV	95
<b>JUDD-MASSON</b>	Separador	VII	93
<b>JUDET</b>	Martillo	XIII	89
	Osea cincela, osteotomo, gubia	XIII	74
	Separador	VII	138
<b>KADER</b>	Separador	VII	55
<b>KANTROWITZ</b>	Disecador	IV	61
<b>KATZIN</b>	Microcirugía tijeras	X	7
<b>KATZIN-BARRAQUER</b>	Microcirugía tijeras	X	7
<b>KAYE</b>	Tijeras Prestige	III	77
<b>KAZANJIAN</b>	Pinza cortante	XIII	117
<b>KELLY</b>	Pinza hemostática	IV	31
	Pinza hemostática Prestige	IV	116
	Pinza uterina	VIII	28
	Proctoscopio	VIII	89
	Separador	VII	50, 55
	Tijeras de tungsteno	III	57
	Tijeras para fistula	III	48
<b>KELLY-RANKIN</b>	Pinza hemostática	IV	32
<b>KERN</b>	Pinza para huesos	XIII	134
<b>KERRISSON</b>	Sacabocados ORL	XII	27
<b>KEVORKIAN</b>	Cureta para biopsia	VIII	77
	Pinza para biopsia	VIII	66, 67
<b>KEY</b>	Raspador	XIII	41
<b>KIELAND</b>	Forceps obstétrico y espátula	VIII	55
<b>KIENNY</b>	Porta veina	VII	19
<b>KILLIAN</b>	Elevador ORL	XII	50
	Gubia ORL	XII	40
<b>KILNER</b>	Gancho ORL	XII	47
	Porta agujas	VI	13
	Separador, gancho	VII	10
<b>KILNER (RAGNELL)</b>	Tijeras de tungsteno	III	57
	Tijeras delicadas	III	15
<b>KILNER-DOUGHTY</b>	Abre-boca	XII	11
<b>KIRSCH</b>	Separador para cirugía maxilo-facial	VII	64
<b>KIRSCHNER</b>	Cuadro (Separador)	VII	83
	Estribo de tracción	XIII	157, 158



		Capítulo	Página
<b>KIRSCHNER</b>	Instrumento para ligaduras	VI	34
	Valva	VII	83
<b>KIRSCHNER (AMERICAN)</b>	Estribo de tracción	XIII	159
<b>KLAPP</b>	Separador	VII	20
<b>KLEINERT-KUTZ</b>	Pinza para coger tendones	XIII	13
	Separador, gancho	VII	9
<b>KLEINSCHMIDT</b>	Pinza para apendice	IV	77
<b>KLINKENBERG</b>	Tijeras de tungsteno	III	67
	Tijeras diversas	III	50
<b>KNAPP</b>	Gancho ORL	XII	46
	Tijeras finas	III	38
<b>KNOWLES</b>	Tijeras para incisión	III	28
<b>KOCHER</b>	Bistouris espátula ORL	XII	25
	Pinza clamp intestinal y estomacal	IV	73, 74
	Pinza de servicio	XV	18
	Pinza hemostática	IV	9 a 11
	Pinza hemostática Prestige	IV	116
	Separador	VII	27, 43, 47, 49
	Separador	VII	46
<b>KOCHER-WAGNER</b>	Separador	VII	42
<b>KOCHER-LANGENBECK</b>	Gancho	XIII	94
<b>KOENING</b>	Endoespeculo	VIII	36
<b>KOGAN</b>	Compas y valvula	XIII	145
<b>KÖLBEL</b>	Instrumento para ligaduras	VI	33
<b>KÖNIG</b>	Raspador y elevador	XIII	35
	Separador	VII	13
	Separador	VII	28, 29, 48
<b>KÖRTE</b>	Separador	VII	28
<b>KÖRTE-WAGNER</b>	Raspador	XIII	43
<b>KRAEMER</b>	Raspador	XIII	41
<b>KRAMER</b>	Cierra nudos ORL	XII	21
<b>KRAUSE</b>	Trocar	XV	30
	Cierra nudos ORL	XII	21
<b>KRAUSE-VOSS</b>	Valva vaginal	VIII	44
<b>KRISTELLER</b>	Pinza hemostática	IV	17
<b>KRÖNLEIN</b>	Separador	VII	48
<b>KÜMMEL</b>	Tijeras finas	III	38
<b>LA GRANGE</b>	Dilatador ORL	XII	12
<b>LABORDE</b>	Dermátomo de mano	I	9
<b>LAGROT</b>	Pinza a presión ORL	XII	14
<b>LAHEY</b>	Separador	VII	27
	Disecador	IV	60
<b>LAHEY (SWEET)</b>	Pinza clamp atrauma - Anastomosis	V	22
<b>LAMBERT KAY</b>	Gancho	XIII	94
<b>LAMBOTTE</b>	Osteotomo	XIII	67
	Pinza para huesos	XIII	133
	Pinza porta-tornillos o placa	XIV	25
	Raspador	XIII	49
	Separador	VII	143
<b>LAMBOTTE (PAUWELLS)</b>	Osteotomo	XIII	66
<b>LANDANGER</b>	Instrumentación para menisco	XIII	152
	Pinza para biopsia	VIII	64
	Pinza para huesos	XIII	128
	Pinza para vendajes	IV	122
<b>LANDAU</b>	Trocar	XV	30
	Valva vaginal	VIII	43
<b>LANDOLT</b>	Mango de bisturí	I	6
	Tijeras para enucleación	III	45
<b>LANE</b>	Pinza clamp intestinal y estomacal	IV	79
	Pinza par disección especial	II	13
	Pinza para huesos	XIII	134
	Separador	VII	139
<b>LANE (PAUCHET)</b>	Pinza diversa	IV	109
<b>LANE-TRETHOWAN</b>	Separador	VII	139
<b>LANGE</b>	Instrumentos para escayolas	III	85
<b>LANGE-HOHMANN</b>	Separador	VII	131 a 133, 135
<b>LANGENBECK</b>	Cuchillo para lóbulos	XIII	16
	Instrumento para amputación	XIII	17
	Pinza para huesos	XIII	138
	Porta agujas	VI	26
	Raspador	XIII	42, 47
	Raspador y elevador	XIII	33
	Separador	VII	44
<b>LANGENBECK (LARREY)</b>	Instrumento para amputación	XIII	18
<b>LANGENBECK-GREEN</b>	Separador	VII	17, 20
<b>LARDENOIS</b>	Separador	VII	38, 39
<b>LAWRENCE</b>	Disecador	IV	60
<b>LAZAR</b>	Microcirugía pinza fina	X	16
<b>LE MEE</b>	Espéculo ORL	XII	16
<b>LEBEAU</b>	Gubia ORL	XII	40
	Raspador y elevador	XIII	34
<b>LEBSCHÉ</b>	Cinzel par esternón	XIII	125
<b>LECOUTEUR</b>	Depresor lingual	XV	7
<b>LEES</b>	Pinza clamp atrauma - Bronquios	V	19
<b>LEGUEU</b>	Pinza clamp	IV	46



		Capítulo	Página
<b>LEGUEU</b>	Separador	VII	60, 93
<b>LEKSELL-STILLE</b>	Pinzas gubia	XIII	112
<b>LELIEVRE</b>	Cinzel ORL fino	XII	38
	Raspador	XIII	48
<b>LEMAIRE</b>	Instrumentación para rodilla	XIII	155
<b>LEMPERT</b>	Cureta	XIII	61
	Elevador ORL	XII	51
	Pinzas gubia	XIII	106
<b>LEPAGE</b>	Pinza para aborto	VIII	26
<b>LERAT</b>	Pinza para Capsula	XIII	141
<b>LERICHE</b>	Pinza de servicio	XV	19
	Pinza hemostática	IV	25
	Pinza hemostática Prestige	IV	114
	Raspador y elevador	XIII	33
	Separador, gancho	VII	10
	Valva	VII	57
<b>LERICHE - BUGATTI</b>	Valva	VII	57
<b>LERMOYER</b>	Cuchillos para vegetaciones	XII	23
<b>LETOURNEL</b>	Cinzel	XIII	65
	Cureta	XIII	65
	Gubia	XIII	65
<b>LEVRET</b>	Forceps obstétrico y espátula	VIII	58
<b>LEWIN</b>	Pinza para huesos	XIII	141
<b>LEWIS</b>	Raspa ORL	XII	43
<b>LEXER</b>	Osteotomo, gubia	XIII	80, 81
	Tijeras para disección	III	21
<b>LEXER-FINO</b>	Tijeras de tungsteno	III	60, 61
	Tijeras para disección	III	21
<b>LICHTENBERG</b>	Porta agujas	VI	26
<b>LICHTWITZ</b>	Trocar	XV	30
<b>LIEGE</b>	Pinza a presión	IV	99
<b>LIMA</b>	Mazo y cureta ORL	XII	54
	Limpieza y renovación de los instrumentos	XV	33
<b>LISTER</b>	Tijeras de servicio	XV	15
	Tijeras de tungsteno	III	66
	Tijeras para vendajes	III	29
<b>LISTER EXCENTRIC</b>	Tijeras para vendajes	III	30
<b>LISTON</b>	Costotomo	XIII	121
	Instrument pour amputation - Instruments for amputation - In	XIII	15
	Pinza cortante	XIII	116, 119
<b>LISTON-KEY (HORSLEY)</b>	Pinza cortante	XIII	120
<b>LITTAUER</b>	Tijeras para cortar ligaduras	III	42
<b>LITTAUER-LISTON</b>	Pinza cortante	XIII	117
<b>LITTLER</b>	Tijeras para cortar ligaduras	III	42
<b>LITTLEWOOD</b>	Pinza a presión	IV	99
	Llave cardan	XIV	23
	Llave figa	XIV	23
	Llave hexagonale	XIV	13
	Llave para doblar clavos	XIV	42
	Llave para doblar placas	XIV	20
	Llave para estribo	XIII	157
	Llave para mandril	XIV	7 a 9, 24
	Llave para tensor	XIV	23
	Llave para valva	VII	86
<b>LOCHARD</b>	Pinza para abrir las capsulas	IV	110
<b>LOCKHART MUMMARY</b>	Sonda acanalada	XV	13
<b>LOCKLIN</b>	Tijeras para encía	III	44
<b>LOCKWOOD</b>	Pinza a presión	IV	90
<b>LOCKWOOD-ALLIS</b>	Pinza a presión	IV	97
<b>LOMBARD</b>	Martillo	XIII	88
	Pinzas gubia	XIII	98
<b>LORNA</b>	Pinza de compo	IV	106
<b>LORTAT-JACOB</b>	Cuadro soporte instrumentos	XV	32
<b>LOUTE</b>	Tensor de alambre	XIV	29
<b>LOVE</b>	Separador neurocirugía	XI	6, 7
<b>LOVE (MORSE)</b>	Separador	VII	13
<b>LOVE-ADSON</b>	Raspador	XIII	38
<b>LOVE-GRUENWALD</b>	Pinzas para laminectomia neurocirugía	XI	11
<b>LOVELACE</b>	Pinza pulmonar	IV	92
<b>LOWE</b>	Separador	VII	14
<b>LOWER</b>	Disecador	IV	59
<b>LOWMAN</b>	Pinza para huesos	XIII	140
<b>LOWMAN-HOGLUND</b>	Pinza para huesos	XIII	140
<b>LUBET BARBON</b>	Pinza a presión ORL	XII	13
<b>LUC</b>	Pinza a presión ORL	XII	15
<b>LUCAE</b>	Diapasón ORL	XII	60
	Gancho ORL	XII	45
	Martillo	XIII	86
	Pinza para disección O.R.L	II	40
<b>LUCAE HARTMANN</b>	Diapasón ORL	XII	59
<b>LUCAS</b>	Osea cincela, gubia	XIII	68
	Osea cincela, osteotomo, gubia	XIII	73
<b>LUCAS-CHAMPIONNIERE</b>	Perforador	XIV	37
<b>LUER</b>	Pinzas gubia	XIII	103, 104
	Separador	VII	33



		Capítulo	Página
<b>LUER-KOERTE</b>	Cureta para vías biliares	IX	13
<b>LUER LOCK</b>	Cánula	XV	27
<b>LUER-FRIEDMANN</b>	Pinzas gubia	XIII	101
<b>LUKENS</b>	Separador	VII	15
<b>MAC DONALD</b>	Raspador y elevador	XIII	31
<b>MAC EVEN</b>	Martillo	XIII	85
	Osea cincela, osteotomo, gubia	XIII	74
<b>MAC GIVNEY</b>	Pinza hemorroidal	VIII	93, 94
<b>MAC INDOE</b>	Pinza cortante	XIII	118
	Pinza par disección delicada	II	31
	Pinza par disección boca de tungsteno	II	47
	Tijeras diversas	III	37
<b>MAC KENTY</b>	Elevador ORL	XII	50
	Raspador	XIII	39
<b>MAC KENZIE</b>	Perfordor neurocirugía	XI	10
<b>MAC KEE</b>	Separador	VII	115
<b>MAC LEAN</b>	Forceps obstétrico y espátula	VIII	55
<b>MAC PHERSON</b>	Microcirugía pinza fina	X	15
<b>MAGILL</b>	Pinza para sondas	XV	9
<b>MAINGOT</b>	Pinza uterina	VIII	21
Malla de alambre para tracción de los dedos		XIII	161
<b>MALTZ</b>	Raspa ORL	XII	42
Mandril		V	7, 9, 10, 49
		XV	32
Mandril para centrar clavos		XIV	44
<b>MANGIAGALLI</b>	Valva vaginal	VIII	41
Mango de bisturí		I	3 a 6
Mango para canula IVG		VIII	81
Mano de plomo		XIII	142
<b>MARKHAM-MEYERDING</b>	Separador	VII	126
<b>MARQUARDT</b>	Pinzas gubia	XIII	110
Martillo		XIII	84 a 89
Martillo diapason		XIV	17, 40
Martillos a reflejos		XV	5
<b>MARTIN</b>	Pelvimetro	VIII	78
	Separador	VII	51
<b>MARTIN (SIMPSON)</b>	Hysterómetro	VIII	85
<b>MARTIN-CARTILAGE</b>	Tijeras para cartilago	III	37
<b>MARTINI</b>	Cureta	XIII	53
<b>MASING</b>	Elevador ORL	XII	50
<b>MASING (NEIVERT)</b>	Porta agujas	VI	13
<b>MASING (SILVER)</b>	Ostetomo	XII	39
<b>MASSON</b>	Porta agujas	VI	12, 17
<b>MATHEY</b>	Separador	VII	108
<b>MATHIEU</b>	Espéculo rectal	VIII	87
	Pinza uterina para polipos	VIII	11
	Porta agujas	VI	12, 25
	Separador	VII	35
	Valva vaginal	VIII	46
<b>MAURER</b>	Costotomo	XIII	122
	Raspador	XIII	50
	Separador	VII	108, 144
<b>MAYFIELD</b>	Pinzas gubia	XIII	110
<b>MAYO</b>	Alfileres de instrumentos	XV	32
	Depresor lingual	XV	6
	Pinza par disección especial	II	17
	Tijeras de servicio	XV	16
	Tijeras de tungsteno	III	59
	Tijeras para disección	III	16
	Tijeras Prestige	III	70
<b>MAYO-BLAKE</b>	Pinza para calculos biliares	IX	7
<b>MAYO-ROBSON</b>	Pinza clamp intestinal y estomacal	IV	71
<b>MAYO-ADAMS</b>	Separador	VII	81
<b>MAYO-ALSACE</b>	Tijeras para disección	III	18
<b>MAYO-HARRINGTON</b>	Tijeras para disección	III	19
<b>MAYO-HEGAR</b>	Porta agujas	VI	11, 16 a 18
	Porta agujas de servicio	XV	18
<b>MAYO-LEGER</b>	Tijeras para disección	III	18
	Tijeras de tungsteno	III	60, 61
	Tijeras Prestige	III	70
<b>MAYO-LYON</b>	Tijeras para disección	III	18
<b>MAYO-NOBLE</b>	Tijeras para disección	III	19
<b>MAYO-SANTY</b>	Tijeras para disección	III	19
<b>MAYO-STILLE</b>	Tijeras de tungsteno	III	60, 61
	Tijeras para disección	III	17
	Tijeras Prestige	III	70
Mazos ORL		XII	54 a 56
<b>MEAD</b>	Disco para martillos	XIII	87
	Martillo	XIII	87
	Pinzas gubia	XIII	102
Medidor		XIII	96
Medidor de largo para tornillos canulados		XIV	49
Medidor de profundidad para clavos		XIV	46
Medidor de profundidad para tornillos		XIV	10
Medidor para agujas		XIV	46



		Capítulo	Página
Medidor para brocas, clavos, tornillos		XIV	46
<b>MEEKER</b>	Disecador	IV	63
<b>MENTZENBAUM</b>	Tijeras para prostate	VIII	95
<b>MERCEDES</b>	Separador	VII	103
	Valva	VII	103
<b>MERIAM</b>	Pinza par disección delicada	II	29
<b>MERLE D'AUBIGNÉ</b>	Punzón	XIII	91
	Instrumentación para hombro	XIII	147
	Raspador	XIII	49
	Separador	VII	137, 138
<b>MERLE D'AUBIGNÉ (BANKART)</b>	Pasa hilo con aguja	XIII	146
	Separador para hombro	XIII	146
<b>MERVEILLEUX</b>	Tijeras Prestige	III	75
<b>METZENBAUM</b>	Tijeras de servicio	XV	17
	Tijeras de tungsteno	III	62
	Tijeras para disección	III	22, 23
	Tijeras Prestige	III	71
<b>METZENBAUM-FINO</b>	Tijeras de tungsteno	III	63 a 65
	Tijeras para disección	III	24
	Tijeras Prestige	III	71
<b>MEYERDING</b>	Separador	VII	18, 49
<b>MICHEL</b>	Pinza para poner las grapas	VI	5, 6
	Pinza para retirar las grapas	VI	7
	Pinza uso doble para grapas	VI	7
	Pinza y grapas	VI	6
<b>MICHELE</b>	Trephine para retirar los tornillos rotas	XIV	37
<b>MICHON</b>	Pinza clamp	IV	46
<b>MICRO ADSON</b>	Pinza par disección delicada	II	23
Micro pinza par disección boca de tungsteno		II	47
Micro pinza para sutura		II	33
Microcirugía gancho		X	18 a 20
Microcirugía pinza fina		X	15 a 17
Microcirugía porta-agujas		X	12 a 14
Microcirugía tijeras		X	3 a 11
Micro tijeras finas		III	38
Micro-espátula		V	8
Micro-extractor		V	8
<b>MICRO-HALSTEAD</b>	Pinza hemostática	IV	20
<b>MICRO-MOSQUITO</b>	Pinza hemostática	IV	21
Micro-pinza ORL		XII	33
<b>MICRO-RYDER</b>	Porta agujas vasculares	VI	21
Micro-tijeras ORL		XII	33
<b>MIDDELORPF</b>	Separador	VII	61, 62
<b>MIKULICZ</b>	Separador	VII	54
	Pinza hemostática especial para peritoneo	IV	48, 49
<b>MILLER</b>	Raspa ORL	XII	44
<b>MILLES</b>	Microcirugía tijeras	X	9
<b>MILLIGAN</b>	Raspador y elevador	XIII	28
<b>MILLIN</b>	Pinza para prostate	VIII	95
	Separador	VII	93
<b>MILLS</b>	Tijeras para cirugía vascular	III	35
<b>MINI GEMINI</b>	Disecador	IV	57
<b>MINI LEXER</b>	Osteotomo, gubia	XIII	80
<b>MINI TOWNSEND</b>	Pinza para biopsia	VIII	67
<b>MINI FRIEDMANN</b>	Pinzas gubia	XIII	101
<b>MINILANGENBECK</b>	Separador	VII	16
<b>MIRIZZI</b>	Pinza para calculos biliares	IX	4, 5
<b>MITCHELL</b>	Raspador	XIII	42
<b>MIXTER</b>	Disecador	IV	58, 59
	Tijeras finas	III	14
<b>MIXTER-O'SHAUGNESSY</b>	Disecador	IV	58
Modelo para doblar placas		XIV	20
<b>MOHR</b>	Cierra tubos	IV	110
<b>MOLISSON</b>	Separador	VII	116
<b>MOLT</b>	Raspador y elevador	XIII	27
<b>MÖLTGEN</b>	Goniometro	XIII	95
<b>MONOD</b>	Trocar	XV	28
<b>MONTESTRUC</b>	Separador	VII	87
	Valva	VII	87
<b>MOORE</b>	Cureta para vías biliares	IX	13
	Pinza y cizalla ORL	XII	34
<b>MOORE-LAMBOTTE</b>	Separador	VII	143
<b>MOREL-FATIO</b>	Raspador y elevador	XIII	27
<b>MORRIS</b>	Separador	VII	52
<b>MORRIS-DEBAKEY</b>	Pinza clamp atrauma - Aorta	V	24
<b>MORSE-FAVALORO</b>	Separador	VII	103
<b>MOSQUITO</b>	Pinza hemostática	IV	19
<b>MOSQUITO-DANDY</b>	Pinza hemostática	IV	26
<b>MOYNIHAN</b>	Pinza hemostática	IV	36
	Pinza hemostática larga	IV	43
<b>MUHLING</b>	Raspador	XIII	40
<b>MULLER</b>	Gancho para flebotomía	V	7
<b>MURPHY</b>	Instrumentación para rodilla	XIII	155
	Pinza para tubos	IV	112
	Pinza para vendajes	XV	20



		Capítulo	Página
<b>MURPHY</b>	Separador	VII	23
<b>MUSEUX</b>	Pinza para huesos	XIII	141
	Pinza uterina	VIII	7, 8
<b>MUSEUX-PALMER</b>	Pinza uterina	VIII	9
<b>MUSEUX-PALMER-CHERON</b>	Pinza uterina	VIII	9
<b>MYERS</b>	Sondas para varices	V	5
<b>MYRTLE</b>	Sonda acanalada	XV	13
<b>NABATOFF</b>	Sondas para varices	V	5
<b>NAGELE</b>	Forceps obstétrico y espátula	VIII	56
<b>NANCY</b>	Osea cincela, gubia	XIII	77
	Tijeras diversas	III	27
<b>NEFF</b>	Instrumentación para menisco	XIII	150
<b>NEGUS</b>	Pinza clamp intestinal y estomacal	IV	69
<b>NEIVERT</b>	Porta agujas	VI	14
<b>NELATON</b>	Bisturí	I	2
	Perforador	XIV	37
	Sonda acanalada	XV	13
<b>NELSON</b>	Trocar	XV	29
<b>NEW ORLEANS</b>	Porta agujas	VI	17
<b>NICOLLET-KOCHER</b>	Instrumentación para menisco	XIII	152
<b>NICOLLET-MUSEUX</b>	Instrumentación para menisco	XIII	152
<b>NISSSEN</b>	Pinza hemostática	IV	35
	Pinza para vías biliares	IX	11
<b>NORFOLK-NORWICH</b>	Separador	VII	115
<b>NORTHFIELD</b>	Pinzas gubia	XIII	107
<b>NOTO</b>	Pinza uterina	VIII	28
<b>NOTTER</b>	Perforador para la membrana	VIII	60
<b>NOVACK</b>	Instrumentos para histero-salpingografía	VIII	80
<b>NOYES</b>	Microcirugía tijeras	X	6
<b>NUBOER</b>	Cánulas aspirantes	XV	26
<b>NUSSBAUM</b>	Pinza clamp intestinal y estomacal	IV	78
<b>O'SHAUGNESSY</b>	Disecador	IV	51 a 53
<b>OBWEGESER</b>	Osteotomo	XIII	67
	Separador para cirugía maxilo-facial	VII	63, 65
<b>OCHSNER</b>	Pinza clamp atrauma - Aorta	V	17
<b>OEHLER</b>	Pinza par disección boca de tungsteno	II	45
<b>OLIVECRONA</b>	Espátula neurocirugía	XI	4
	Instrumento para amputación	XIII	20
	Raspador y elevador	XIII	26
	Pinzas gubia	XIII	106
<b>OLIVIER</b>	Separador completo	VII	82
<b>OLLIER</b>	Pinza para huesos	XIII	135, 139
	Punzón	XIII	156
	Raspador y elevador	XIII	44
	Separador	VII	30
<b>OMBREDANNE</b>	Martillo	XIII	84
	Osea cincela, gubia	XIII	70
	Pinza a presión	IV	98
	Punzón	XIII	90
<b>OPEN COELIO</b>	Separador	VII	33
<b>OSCHNER</b>	Pinza para hilo	II	33
Osea cincela		XIII	68 a 75, 77, 81
<b>O'SHAUGNESSY</b>	Pasa hilos para prostate	VIII	95
Osteotomo		XIII	66, 67, 69, 71 a 74, 76, 80
Ostetomo		XII	37, 39
<b>O'SULIVAN - O'CONNOR</b>	Cuadro (Separador)	VII	85
	Valva	VII	85
<b>OVERHOLT-GEISSENDORFER</b>	Disecador	IV	54
<b>OVERHOLT-MIXTER</b>	Disecador	IV	61
<b>OVERHOLT-S</b>	Disecador	IV	55
<b>OVERHOLT-SLIM</b>	Disecador	IV	55
<b>PAJOT</b>	Forceps obstétrico y espátula	VIII	55
<b>PALMER</b>	Dilatador uterino	VIII	82
	Espéculo vaginal	VIII	31
	Pinza uterina para polipas	VIII	11
	Separador completo	VII	78
	Valva	VII	78
<b>PARKER</b>	Separador	VII	35
<b>PARKER LANGENBECK (US ARMY)</b>	Separador	VII	35
<b>PARKER-MOTT</b>	Separador	VII	36
<b>PARTSCH</b>	Martillo	XIII	84
	Osea cincela, gubia	XIII	68
Pasa hilo		XIII	149
Pasa hilo con aguja		XIII	146
Pasa hilos para prostate		VIII	95
Pasahilos para cerclage		XIV	52
<b>PASSOW</b>	Empujador de injertos	XIII	143
Patrón de angulo para placas		XIV	18, 19
<b>PATTERSON</b>	Pinza para biopsia	VIII	66
<b>PAUCHET</b>	Pinza para poner las grapas	VI	5
<b>PAUCHET (Sabre)</b>	Aguja para ligaduras	VI	29
<b>PAYR</b>	Instrumento para ligaduras	VI	34
	Pinza clamp intestinal y estomacal	IV	75
<b>PEAN</b>	Pinza para vendajes	IV	118
	Tijeras de servicio	XV	17



	Capítulo	Página
<b>PEAN</b>	Trocar	XV 30
<b>PEDERSON</b>	Espéculo vaginal	VIII 35
<b>PEERS</b>	Pinza de compo	IV 105
<b>PEET</b>	Pinza para astillas	II 52
<b>PELKMANN</b>	Pinza para vendajes	IV 127
Pelvimetro		VIII 78
<b>PENFIELD</b>	Raspador y elevador	XIII 30
<b>PENNINGTON</b>	Pinza a presión	IV 89
	Raspador ORL	XII 41
<b>PENNYBACKER</b>	Pinzas gubia	XIII 107
	Raspador	XIII 42
<b>PERCY</b>	Instrumento para amputación	XIII 21
Perforador		XIV 37
Perforador inicial		XIV 40
Perforador manual		XIV 9
Perforador para la membrana		VIII 60
Perforador neurocirugía		XI 9, 10
<b>PERRY</b>	Pinza par disección delicada	II 37
<b>PERTHES</b>	Punzón	XIII 92
<b>PETIT DUTAILLY</b>	Raspador y elevador	XIII 37
<b>PHANEUF</b>	Pinza uterina	VIII 22
Pieza alargadera para perforador		XI 10
<b>PINARD</b>	Estetoscopio	XV 5
Pinza a presión		IV 81 a 102
Pinza a presión ORL		XII 13 a 15
Pinza autofijadora		XIV 10
Pinza capsular		X 16
Pinza clamp		IV 46, 47
Pinza clamp atrauma		V 12 a 36
Pinza clamp atrauma - Anastomosis		V 12, 22, 29, 34, 36, 37
Pinza clamp atrauma - Aneurisma de la aorta		V 15, 16, 17
Pinza clamp atrauma - Aneurisma de la arteria		V 25
Pinza clamp atrauma - Aorta		V 17, 18, 20, 21, 24, 31
Pinza clamp atrauma - Arteria renal		V 15
Pinza clamp atrauma - Auriculares		V 18
Pinza clamp atrauma - Bronquios		V 19
Pinza clamp atrauma - Carótida		V 33
Pinza clamp atrauma - Coarctación		V 12, 25, 26, 34, 36
Pinza clamp atrauma - Ligadura		V 13, 20 a 21, 29, 36
Pinza clamp atrauma - Oclusión tangencial		V 22
Pinza clamp atrauma - Pediatría		V 37 a 39
Pinza clamp atrauma - Periférica		V 30
Pinza clamp atrauma - Profundidad		V 31
Pinza clamp atrauma - Usos varios		V 24, 34
Pinza clamp intestinal y estomacal		IV 68 a 80
Pinza clamps para bronquios		IV 81
Pinza corta cables		XIV 36
Pinza cortante		XIII 116 a 120
Pinza de alambre		XIV 28 a 29
Pinza de compo		IV 103 a 107
Pinza de extracción de cemento		XIII 161
Pinza de extracción para clavos		XIV 45
Pinza de fijación		XIV 27
Pinza de relojero		II 35
Pinza de servicio		XV 18, 19
Pinza gubia		XII 30
Pinza hemorroidal		IV 102
		VIII 93, 94
Pinza hemostática		IV 9 a 36
Pinza hemostática especial		IV 44 a 49
Pinza hemostática especial para peritoneo		IV 48, 49
Pinza hemostática larga		IV 37 a 43
Pinza microtubarica		II 33
Pinza multiservicios		XIV 27
Pinza ORL		XII 34
Pinza ORL para reposicionar		XII 35
Pinza par disección boca de tungsteno		II 44 a 47
Pinza par disección delicada		II 14 a 16, 22 a 33, 37
Pinza par disección especial		II 12, 13, 17 a 21, 34, 35
Pinza par disección estándar		II 5, 6
Pinza par disección fina		II 9, 10
Pinza par disección media fina		II 7, 8
Pinza par disección muy fina		II 11
Pinza para aborto		VIII 26
Pinza para abrir las capsulas		IV 110
Pinza para alabes vesicales		IX 11
Pinza para apendice		IV 77
Pinza para astillas		II 51, 52
Pinza para biopsia		VIII 62 a 67
Pinza para biopsia rectal		VIII 92
Pinza para calculos biliares		IX 4 a 7
Pinza para calculos renales		IX 3
Pinza para campos		XV 20
Pinza para capsula		XIII 141
Pinza para cerrar clamps		IV 80



	Capítulo	Página	
Pinza para coger agujas	XIV	26	
Pinza para coger el útero	VIII	52	
Pinza para coger tendones	XIII	13, 14	
Pinza para colocar clamps	V	10	
Pinza para contornear los clavos	XIV	46	
Pinza para cortar los clamps	VIII	60	
Pinza para disección de servicio	XV	20	
Pinza para disección O.R.L.	II	38 a 40	
Pinza para disección oftalmológica	II	36	
Pinza para disección Prestige	II	48 a 50	
Pinza para disección vascular	II	41 a 43	
Pinza para epilación	II	35	
Pinza para escayolas	XV	23, 24	
Pinza para esofagoscopia	XII	36	
Pinza para espiral	VIII	81	
Pinza para hilo	II	33	
Pinza para huesos	XIII	126 a 141	
Pinza para instrumentos	XV	32	
Pinza para la vesícula amniótica	VIII	10	
Pinza para ordenar las canulas	IV	108	
Pinza para oreja	XII	31, 32	
Pinza para ovarios	VIII	27	
Pinza para pedunculos renales	IX	8	
Pinza para pericraneos	IV	84	
Pinza para placa mini	XIV	25	
Pinza para pólipos	XII	30	
Pinza para poner las grapas	VI	5, 6	
Pinza para prostate	VIII	95, 96	
Pinza para retirar las grapas	VI	7	
Pinza para secuestro	XIII	139	
Pinza para sondas	XV	9	
Pinza para tirar la lengua	XV	9	
Pinza para tubos	IV	111, 112	
Pinza para uñas	XV	10	
Pinza para vendajes	IV	118 a 127	
	XV	20	
Pinza para vías biliares	IX	9 a 11	
Pinza porta-tornillos o placa	XIV	25	
Pinza pulmonar	IV	92	
Pinza universal	XIV	27	
Pinza uso doble para grapas	VI	7	
Pinza uterina	VIII	7 a 30	
Pinza uterina para polipas	VIII	11	
Pinzas gubia	XIII	97 a 115	
Pinzas para cistico	IX	11	
Pinzas para laminectomía neurocirugía	XI	11 a 15	
<b>PIPER</b>	Forceps obstétrico y espátula	VIII	58
<b>PIRON</b>	Cureta uterina	VIII	75
<b>PLESTER</b>	Canula aspirante ORL	XII	57
	Separador	VII	111
<b>POIRIER</b>	Osea cincela, gubia	XIII	70
<b>POLITZER</b>	Pinza para disección O.R.L.	II	39
<b>POLOSSON</b>	Separador	VII	56
<b>POOLE</b>	Cánulas aspirantes	XV	26
Porta agujas	VI	8 a 26	
Porta agujas vasculares	VI	20 a 22	
Porta algodón	XV	14	
Porta clamps	IV	80	
Porta estraca	VII	72	
Porta grapas	XIV	50	
Porta veina	VII	19	
<b>POSTEL</b>	Instrumento para amputación	XIII	18
	Separador	VII	144
<b>POTTS-DE MARTEL</b>	Tijeras para cirugía vascular	III	35
<b>POTTS-SMITH</b>	Pinza par disección delicada	II	26
	Pinza par disección boca de tungsteno	II	46
	Tijeras diversas	III	37
	Tijeras para cirugía vascular	III	32
	Tijeras Prestige	III	74
	Tijeras de tungsteno	III	69
	Tijeras para cirugía vascular	III	36
<b>POZZI</b>	Cureta uterina	VIII	76
	Instrumentación para hombro	XIII	147
	Pinza uterina	VIII	12
<b>POZZI-CHERON</b>	Instrumentos para histero-salpingografía	VIII	80
<b>POZZI-PALMER</b>	Pinza uterina	VIII	12
<b>PRATT</b>	Dilatador uterino	VIII	84
	Pinza hemorroidal	IV	102
	Pinza uterina	VIII	25
	Espéculo rectal	VIII	87
<b>PRECELLE</b>	Pinza par disección delicada	II	37
Prensa para doblar placas	XIV	22	
<b>PRICE THOMAS</b>	Pinza clamps para bronquios	IV	81
<b>PRINCE</b>	Tijeras para amígdalas	III	37
Proctoscopia	VIII	89	





		Capítulo	Página
Protección translúcida		XII	10
Protector de piel		XIV	38
<b>PROVIDENCE</b>	Pinza hemostática	IV	26
Puñado para sierra		XIII	20
Punzón		XIII	90 a 21, 156
<b>PUTTI</b>	Raspa	XIII	83
<b>QUENU</b>	Pinza clamp intestinal y estomacal	IV	68
	Pinza par disección especial	II	20
<b>QUILICY FARISSE</b>	Disecador	IV	62
<b>QUINBY</b>	Tijeras diversas	III	45
<b>QUIRE</b>	Pinza para oreja	XII	32
<b>RACHIS NOGENT</b>	Separador completo	VII	104
	Valva	VII	104
<b>RAGNEL (DAVIS)</b>	Separador	VII	19
<b>RALK</b>	Perforador manual	XIV	9
<b>RAMUS</b>	Separador para cirugía maxilo-facial	VII	65
<b>RANDALL</b>	Pinza para calculos renales	IX	3
Raspa		XIII	83
Raspa ORL		XII	42 a 44
Raspador		XIII	52
Raspador mango FERROZELL		XIII	46
Raspador ORL		XII	41, 53
Raspador para ligamento amarillo		XIII	48
Raspador para tendones		XIII	12
Recalcador		XIII	149
<b>RECAMIER</b>	Cureta uterina	VIII	74
<b>REDON</b>	Aguja para ligaduras	VI	30
	Disecador	IV	50
Regla inoxidable		XIII	96
<b>REILL</b>	Pinza para huesos	XIII	126
<b>RESANO</b>	Disecador	IV	67
<b>REVERDIN</b>	Aguja de sutura	VI	27
	Separador	VII	39
<b>REYNOLDS</b>	Tijeras largas y finas	III	46
	Tijeras Prestige	III	73
<b>RIBBON TYPE</b>	Tijeras finas	III	43
<b>RICARD</b>	Compas (separador)	VII	73
	Separador completo	VII	75
	Valva	VII	73
<b>RICARD-BEGOIN</b>	Compas (separador)	VII	74
	Separador completo	VII	75
	Valva	VII	74
<b>RICHARDSON</b>	Separador	VII	50
<b>RICHARDSON-EASTMAN</b>	Separador	VII	50
<b>RICHTER</b>	Tijeras para incisión	III	28
<b>RIZZUTI</b>	Raspador y elevador	XIII	26
<b>ROBB</b>	Raspador y elevador	XIII	29
<b>ROBERTS</b>	Pinza hemostática larga	IV	41
<b>ROBIN</b>	Cinzel y gubia ORL	XII	37
<b>ROCHARD</b>	Pinza uterina	VIII	26
	Separador	VII	67, 68
<b>ROCHER</b>	Punzón y trapanador	XIII	93
<b>ROCHESTER-CARMALT</b>	Pinza hemostática	IV	14
<b>ROCHESTER-OSCHNER</b>	Pinza hemostática	IV	13
<b>ROCHESTER-PEAN</b>	Pinza hemostática	IV	12
<b>ROEDER</b>	Pinza de compo	IV	107
<b>ROGERS</b>	Pinza uterina	VIII	18
<b>RÖHM</b>	Mandril	XIV	8
<b>ROLLET</b>	Gancho ORL	XII	46
<b>ROSE</b>	Separador	VII	15
<b>RÖTTGEN-RUSKIN</b>	Pinzas gubia	XIII	112
<b>ROUENNAIS</b>	Tijeras diversas	III	55
<b>ROUX</b>	Raspador	XIII	47
	Separador	VII	34
<b>ROWE</b>	Pinza ORL para reposicionar	XII	35
<b>RUAULT</b>	Bistouris espátula ORL	XII	25
<b>RUBIN</b>	Pinza y cizalla ORL	XII	34
<b>RUDD</b>	Pinza hemorroidal	VIII	93
<b>RUMEL</b>	Disecador	IV	63
<b>RUMEL-BELMONT</b>		V	7
<b>RUSKIN</b>	Pinzas gubia	XIII	110
<b>RUSKIN-LISTON</b>	Pinza cortante	XIII	118
<b>RUSSIAN MODEL</b>	Pinza par disección especial	II	17
<b>RYDER</b>	Porta agujas vasculares	VI	21
Saca comedone		XIII	53
Sacabocados Neurocirugía		XI	16 a 22
Sacabocados ORL		XII	27
<b>SACHS</b>	Raspador y elevador	XIII	36
<b>SAENGER</b>	Pinza uterina	VIII	30
<b>SANTORINI</b>	Clamp para prostate	VIII	95
<b>SANTULLI</b>		V	10
<b>SANTY</b>	Pinza hemostática larga	IV	42
	Cánulas aspirantes	XV	26
<b>SANVENERO</b>	Tijeras largas y finas	III	49
<b>SAROT</b>	Pinza hemostática larga	IV	41



		Capítulo	Página
<b>SAROT</b>	Porta agujas vasculares	VI	22
<b>SATINSKY</b>	Pinza a presión	IV	82
	Pinza clamp atrauma - Oclusión tangencial	V	22
	Tijeras diversas	III	50
<b>SATTERLEE</b>	Instrumento para amputación	XIII	18
<b>SAUERBRUCH</b>	Costotomo	XIII	124
	Pinzas gubia	XIII	114
	Separador	VII	51,53
<b>SAUERBRUCH-FREY</b>	Costotomo	XIII	124
<b>SCHADEL</b>	Pinza de compo	IV	103
<b>SCHEDE</b>	Cureta	XIII	57
<b>SCHEIBE</b>	Pinza a presión	IV	91
	Pinza clamp intestinal y estomacal	IV	70
<b>SCHERBAK</b>	Valva vaginal	VIII	50
<b>SCHINK</b>	Dermátomo de mano	I	8
<b>SCHMID</b>	Endarterectomia	V	6
<b>SCHNIDT</b>	Disecador	IV	56
<b>SCHOEMAKER-LOTH</b>	Tijeras para cortar hilos	III	31
<b>SCHRÖDER</b>	Cureta uterina	VIII	72
<b>SCHROEDER</b>	Pinza uterina	VIII	13, 14
<b>SCHULTZE</b>	Instrumentos para histero-salpingografía	VIII	79
<b>SCHUMACHER</b>	Pinza para biopsia	VIII	63
	Separador	VII	136
	Tijeras para el cordón umbelical	III	80
<b>SCHUMACHER (WAGNER)</b>	Separador	VII	136
<b>SCHUMAKER</b>	Pinza para biopsia	VIII	65
<b>SCOVILLE</b>	Cureta	XIII	63
<b>SCUDDER</b>	Pinza clamp intestinal y estomacal	IV	78
<b>SEBILEAU</b>	Mazo y cureta ORL	XII	54
	Raspador ORL	XII	41
	Raspador y elevador	XIII	34
<b>SEDILLOT</b>	Raspador	XIII	43
<b>SEGOND</b>	Pinza uterina	VIII	19
	Separador	VII	55
<b>SEGOND-LANDAU</b>	Pinza uterina	VIII	19
<b>SEGURA</b>	Mazo y cureta ORL	XII	54
<b>SELLORS</b>	Separador	VII	107
<b>SEMB</b>	Disecador	IV	64
	Pinza cortante	XIII	120
	Pinza para huesos	XIII	137
	Pinzas gubia	XIII	115
	Raspador	XIII	47
<b>SEMB-SAYLOR</b>	Disecador	IV	64
<b>SEMKEN</b>	Pinza par disección boca de tungsteno	II	47
	Pinza par disección delicada	II	32
<b>SEMM</b>	Cuadro (Separador)	VII	85
	Espéculo vaginal	VIII	35
	Valva	VII	85
<b>SENN-GREEN (CHIGOT)</b>	Separador	VII	16
<b>SENN-MILLER</b>	Separador	VII	19
<b>SENN-MILLER BABY</b>	Separador	VII	19
	Separador	VII	9 a 144
	Separador neuro	VII	117
	Separador neurocirugía	XI	6 a 8
	Separador ORL	XII	48, 49
	Separador para antebrazo	VII	141
	Separador para bocio	VII	129
	Separador para cirugía maxilo-facial	VII	63 a 66
	Separador para hémilaminectomia	VII	125
	Separador para hombro	XIII	146, 148
	Separador para piloro	IV	102
	Separador para prostate	VII	60
		VIII	96
	Separador rectal	VIII	90, 91
	Separador valvas maleables	VII	41
	Separador VK	VII	71
	Separador, mano de plomo	XIII	142
<b>SETTER</b>	Pinza para huesos	XIII	136
<b>SEUTIN</b>	Pinza de servicio	XV	21
	Tijeras para escayolas	XV	22
<b>SEWALL</b>	Raspador y elevador	XIII	36
<b>SEYFFERT</b>	Espéculo vaginal	VIII	35
<b>SHUBERT</b>	Pinza para biopsia	VIII	62
<b>SICARD</b>	Pinzas gubia	XIII	99
<b>SICART</b>	Raspador y elevador	XIII	37
<b>SIEBOLD</b>	Tijeras diversas	III	50
	Sierra para cortar los anillos y hoja	XV	11
<b>SIMON</b>	Cureta uterina	VIII	70, 72
	Separador	VII	51
<b>SIMPSON</b>	Forceps obstétrico y espátula	VIII	57
<b>SIMPSON-BRAUN</b>	Forceps obstétrico y espátula	VIII	58
<b>SIMPSON-LUIKART</b>	Forceps obstétrico y espátula	VIII	59
<b>SIMS</b>	Bisturí	I	2
	Cureta uterina	VIII	73
	Espéculo rectal	VIII	88



		Capítulo	Página
<b>SIMS</b>	Hysterómetro	VIII	85
	Tijeras de tungsteno	III	68
	Tijeras para intervención en profundidad	III	52
	Tijeras Prestige	III	76
	Valva vaginal	VIII	45
<b>SIMS-MAIER</b>	Pinza para vendajes	IV	127
<b>SINGLEY-TUTTLE</b>	Pinza par disección especial	II	21
<b>SISTERON</b>	Pinza para calculos biliares	IX	6
<b>SKID-MURPHY</b>	Separador	VII	143
<b>SLUDDER-BALLENGER</b>	Amygdalotomo	XII	26
<b>SMILLIE-TRILLAT</b>	Instrumentación para menisco	XIII	150, 151
<b>SMITH</b>	Tijeras diversas	III	87
<b>SMITH-PETERSEN</b>	Osea cincela, gubia	XIII	77
	Osea cincela, osteotomo, gubia	XIII	71
	Pinzas gubia	XIII	112
<b>SNELLEN</b>	Cureta ORL	XII	55
<b>SOMMER</b>	Pinza para coger el útero	VIII	52
Sonda acanalada		XV	13
Sonda metálica		VIII	86
Sondas para varices		V	5
<b>SPENCER</b>	Tijeras para cortar ligaduras	III	41
<b>SPENCER-WELLS</b>	Pinza hemostática	IV	15, 18
<b>SPENCER-FINO</b>	Tijeras para cortar ligaduras	III	42
<b>SPINA-NASALIS</b>	Separador para cirugía maxilo-facial	VII	65
Spray de silicona		XV	33
Spray para lubricación		XV	33
<b>SPURLING</b>	Pinzas para laminectomía neurocirugía	XI	11
<b>ST MARKS</b>	Valva vaginal	VIII	47
<b>STAGNARA</b>	Gubia	XIII	79
<b>STAMEY</b>	Aguja para ligaduras	VI	29
<b>STEINMANN</b>	Pinza para coger tendones	XIII	13, 14
<b>STELLBRINK</b>	Pinzas gubia	XIII	105
<b>STERNBERG</b>	Abre-boca	XII	8
<b>STEVENS</b>	Tijeras finas	III	43
	Tijeras Prestige	III	73
<b>STIEGLITZ</b>	Pinza para astillas	II	52
<b>STILLE</b>	Osea cincela, osteotomo, gubia	XIII	72
	Pinza par disección delicada	II	15
	Pinza para escayolas	XV	23
	Pinzas gubia	XIII	111
	Pinza para vías biliares	IX	9
<b>STILLE-LUER</b>	Pinzas gubia	XIII	115
<b>STOOKEY</b>	Pinzas gubia	XIII	108
<b>STRANDELL-STILLE</b>	Separador	VII	17
<b>STRASBOURG</b>	Pinza par disección especial	II	13
<b>STRATT</b>	Porta agujas	VI	19
<b>STRAUSS</b>	Compresor para uretra	VIII	86
<b>STRELI</b>	Porta agujas	VI	9
<b>STRULLY</b>	Tijeras largas y finas	III	48
<b>STRUYCKEN</b>	Sacabocados ORL	XII	28
<b>SUBRAMANIAN</b>	Pinza clamp atrauma	V	31
	Pinza clamp atrauma - Aorta	V	31
<b>SYME</b>	Raspador y elevador	XIII	29
Tabillas maleables		XV	25
<b>TAKAHASHI</b>	Raspa ORL	XII	42
	Sacabocados ORL	XII	28
<b>TARNIER</b>	Forceps obstétrico y espátula	VIII	53
<b>TAYLOR</b>	Pinza par disección delicada	II	27
	Separador neurocirugía	XI	7
<b>TEALE</b>	Pinza uterina	VIII	10
<b>TEISSIER</b>	Forceps obstétrico y espátula	VIII	59
<b>TENOTOME</b>	Bisturí	I	2
Tensor de alambre		XIV	29
Tensor de alambre para cerclage		XIV	52
Tensor para estribo		XIII	157
Tensor para placas		XIV	23
Terraja		XIV	6, 47
<b>TERRIER</b>	Abre-boca	XII	7
	Pinza hemostática	IV	15, 16
<b>TESSIER</b>	Separador para cirugía maxilo-facial	VII	66
<b>THERUM</b>	Pinza para espiral	VIII	81
<b>THOMS-ALLIS</b>	Pinza a presión	IV	97
<b>THUDICHUM (GOLDSMITH)</b>	Espéculo ORL	XII	17
<b>TIECK</b>	Espéculo ORL	XII	19
Tijeras aguda de servicio		XV	16
Tijeras aguda/roma de servicio		XV	16
Tijeras apra parametrio		III	68
Tijeras de servicio		XV	15 a 17
Tijeras de tungsteno		III	57 a 69
Tijeras delicadas		III	11 a 15
Tijeras diversas		III	27, 37, 45, 50, 53 a 56, 87
Tijeras encolador		III	53
Tijeras enterotomo		III	87
Tijeras finas		III	14, 15, 38 a 40, 43, 44
Tijeras iridectomía		XV	15



	Capítulo	Página	
Tijeras largas y finas	III	45	
Tijeras lencera	III	54	
Tijeras modista	III	54	
Tijeras nasales	III	77 a 78, 83, 84	
Tijeras ORL	III	83, 84	
Tijeras par enucleación	III	13	
Tijeras para algodón	III	55	
Tijeras para amígdalas	III	37	
Tijeras para cartilago	III	37	
Tijeras para catarata	III	12, 57	
Tijeras para cirugía ósea	III	86	
Tijeras para cirugía vascular	III	32 a 36	
Tijeras para coronarias	III	36	
Tijeras para cortar hilos	III	31	
Tijeras para cortar ligaduras	III	41, 42	
	XV	15	
Tijeras para decapsular	III	86	
Tijeras para disección	III	16 a 26	
Tijeras para el cordón umbelical	III	80	
Tijeras para encía	III	44	
Tijeras para enucleación	III	45	
Tijeras para episiotomía	III	81, 82	
Tijeras para escayolas	XV	22	
Tijeras para estrabismo	III	12, 39	
Tijeras para fístula	III	48, 57	
Tijeras para incisión	III	28	
Tijeras para intervención en profundidad	III	51, 52	
Tijeras para manisco	III	86	
Tijeras para nervios	III	37	
Tijeras para prostate	VIII	95	
Tijeras para uñas	III	88	
	XV	15	
Tijeras para vendajes	III	29, 30, 85	
Tijeras Peluquero	III	53	
Tijeras Prestige	III	70 a 79, 82	
Tijeras quirúrgicas	III	9 a 11	
Tijeras roma de servicio	XV	16	
Tijeras vaginales	III	82	
Tirabuzone para fibroma	VIII	81	
<b>TISCHLER</b>	Pinza para biopsia	VIII	67
<b>TISCHLER-MORGAN</b>	Pinza para biopsia	VIII	64
<b>TOENNIS</b>	Raspador y elevador	XIII	31
	Tijeras largas y finas	III	46
<b>TOENNIS-ADSON</b>	Tijeras de tungsteno	III	65
	Tijeras largas y finas	III	47
<b>TOENNIS-ADSON-FINO (DEBAKEY)</b>	Tijeras largas y finas	III	47
<b>TOHOKU</b>	Pinza de compo	IV	106
<b>TOUPET</b>	Estraca	VII	72
	Pinza clamp	IV	47
	Valva	VII	73
	Valva doble	VII	76
<b>TOUPET (ENTEROSTAT)</b>	Separador	VII	76
Tourniquete vascular	V	7	
<b>TOWNSEND</b>	Pinza para biopsia	VIII	67
Trapanador	XIII	93	
<b>TRAVERS</b>	Separador	VII	114
<b>TRELAT</b>	Espéculo rectal	VIII	87
Trephine para retirar los tornillos rotos	XIV	37	
<b>TREVES</b>	Pinza par disección especial	II	12
<b>TRILLAT</b>	Empujador de injertos	XIII	143
	Instrumentación para hombro	XIII	148
	Instrumentación para menisco	XIII	154
	Instrumentación para rodilla	XIII	155
	Separador para antebrazo	VII	141
Trocar	XV	28 a 30	
Trocar a biopsia ósea	XV	28	
Trocar con mandril para clavos	XIV	44	
<b>TROELTSCH</b>	Pinza para disección O.R.L.	II	38
<b>TROUSSEAU</b>	Dilatador ORL	XII	12
<b>TROUTMAN</b>	Microcirugía tijeras	X	7
<b>TROUTMAN-BARRAQUÈR</b>	Microcirugía tijeras	X	5
<b>TUBBS</b>	Dilatador vascular y de aorta	V	40
<b>TUBIANA</b>	Porta agujas	VI	9
Tubo para curvar agujas	XIV	25	
<b>TUFFIER</b>	Pinza a presión	IV	98
	Separador	VII	38, 49, 106
<b>TULIPE</b>	Endarterectomia	V	7
<b>UCKERMANN</b>	Dilatador ORL	XII	12
<b>UFFENORDE</b>	Cureta	XIII	58
<b>ULRICH</b>	Pinza para vendajes	IV	121
<b>UNNA</b>	Saca comedone	XIII	53
<b>VACHER</b>	Cierra nudos ORL	XII	20
	Espéculo ORL	XII	16
<b>VALLEIX</b>	Hysterómetro	VIII	85
Valva	VII		



		Capítulo	Página
Valva doble		VII	76
Valva para abajo del pubis		VII	68, 69
Valva para pulmón		VII	40
Valva radio transparente		VII	68
Valva vaginal		VIII	37 a 50
Válvula		XIII	145
Válvula para separador		VIII	91
<b>VAN DOREN</b>	Pinza para biopsia	VIII	63
<b>VANNAS</b>	Microcirugía tijeras	X	4, 9, 10
<b>VANNAS modificado TUBINGEN</b>	Microcirugía tijeras	X	4
<b>VARADY</b>	Enderectomía	V	8
<b>VELPEAU (TRICOISE)</b>	Costotomo	XIII	125
Ventosa obstétrica y accesorios		VIII	61
<b>VERBRUGGE</b>	Pinza para huesos	XIII	127 a 130
<b>VERBRUGGE-MULLER</b>	Separador	VII	134
<b>VERNON</b>	Martillos a reflejos	XV	5
<b>VIDAL</b>	Raspador	XIII	52
<b>VINCENT</b>	Pinza para disección Prestige	II	49
	Pinzas gubia	XIII	99
<b>VINCENT (SCHMIEDEN)</b>	Tijeras para cirugía vascular	III	36
<b>VIRCHOW</b>	Cuchillo para cerebro	XIII	15
	Instrumento para amputación	XIII	17
<b>WISE</b>	Micro pinza para sutura	II	33
Visor para aguja guía		XIV	48
<b>VOLKMANN</b>	Cureta	XIII	54 a 57
	Cureta uterina	VIII	71
	Separador	VII	22 a 26
<b>WACHENFELDT</b>	Pinza para poner las grapas	VI	5
<b>WAGNER</b>	Gancho ORL	XII	45
	Raspador	XIII	51
	Separador	VII	131
	Tijeras finas	III	14
	Tijeras Prestige	III	72
<b>WALDMANN</b>	Tijeras para episiotomía	III	82
<b>WALLICH</b>	Cureta uterina	VIII	69
<b>WALSHAM</b>	Pinza ORL para reposicionar	XII	35
<b>WALTER-CARMALT</b>	Pinza para astillas	II	51
<b>WALTER-DUVAL</b>	Pinza a presión	IV	86
<b>WALTON</b>	Separador para hémilaminectomía	VII	125
	Tijeras finas	III	40
<b>WANGENSTEEN</b>	Pinza par disección boca de tungsteno	II	45
	Porta agujas	VI	17
<b>WATSON CHEYNE</b>	Raspador y elevador	XIII	31
	Estiletos	XV	12
<b>WAUGH</b>	Pinza par disección delicada	II	31
<b>WEBER</b>	Pinza clamp atrauma - Aorta	V	21
<b>WEBSTER</b>	Porta agujas	VI	8
<b>WECKER</b>	Microcirugía tijeras	X	6
<b>WEIL-BLAKESLEY</b>	Pinzas para laminectomía neurocirugía	XI	15
<b>WEISS</b>	Pinza para tubos	IV	111
<b>WEITLANER</b>	Separador	VII	112, 113, 116
	Separador neuro	VII	117
<b>WEITLANER-WULLSTEIN</b>	Separador	VII	116
<b>WERTHEIM</b>	Pinza uterina	VIII	16, 20
	Tijeras para intervención en profundidad	III	52
<b>WERTHEIM (BOZEMANN)</b>	Porta agujas	VI	19
<b>WERTHEIM-CULLEN</b>	Pinza uterina	VIII	23
<b>WERTHEIMER</b>	Canula aspirante ORL	XII	57
<b>WESTCOTT</b>	Microcirugía tijeras	X	3, 7
<b>WHITE</b>	Pinza a presión ORL	XII	13
<b>WHITEHEAD</b>	Abre-boca	XII	9
<b>WICKSTROEM</b>	Disecador	IV	59
<b>WIEN</b>	Espéculo ORL	XII	19
<b>WILLIAMS</b>	Destornillador	XIV	12
	Separador	VII	127
<b>WILLIGER</b>	Cureta	XIII	53
	Cureta ORL	XII	56
	Raspador y elevador	XIII	35
<b>WILMER</b>	Tijeras finas	III	39
<b>WINTER</b>	Pinza uterina	VIII	29
<b>WOLF</b>	Pinza para escayolas	XV	23
<b>WOODSON</b>	Raspador y elevador	XIII	28
<b>WRIGLEY</b>	Forceps obstétrico y espátula	VIII	57
<b>WYLIE</b>	Pinza clamp atrauma - Aneurisma de la aorta	V	16
<b>YANKAUER</b>	Raspador y elevador	XIII	34
	Cánulas aspirantes	XV	26
<b>YASARGIL</b>	Microcirugía porta-agujas	X	13
	Microcirugía tijeras	X	11
	Raspador y elevador	XIII	31
<b>YEOMAN</b>	Pinza para biopsia rectal	VIII	92
<b>YOUNG</b>	Pinza para tirar la lengua	XV	9
	Separador para prostate	VIII	96
<b>ZENKER</b>	Disecador	IV	60
	Separador	VII	48
<b>ZIELKE</b>	Gubia	XIII	82
<b>ZWEIFEL</b>	Porta agujas	VI	26





# LANDANGER

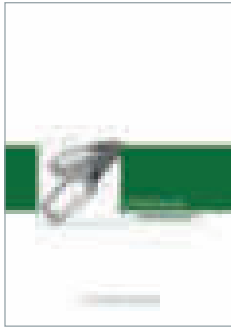

Arthroscopie  
Arthroscopy  
Artroscopia

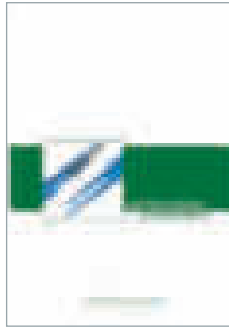

Electrochirurgie  
Electrosurgery  
Electrocirugía

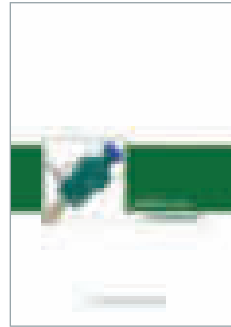

Laparoscopie  
Laparoscopy  
Laparoscopia

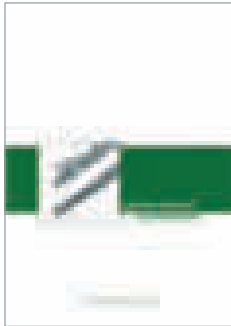

Neurochirurgie  
Neurosurgery  
Neurocirugía

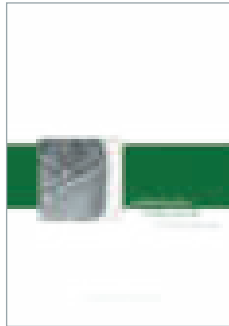

Stérilisation  
Sterilization  
Esterilización

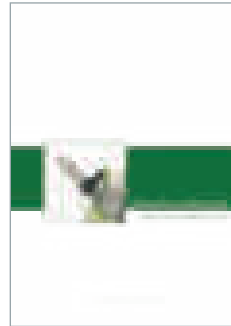

Urologie-Gynécologie  
Urology-Gynecology  
Urología-Ginecología

## Indications importantes

Le contenu de ce catalogue de vente (y compris les marques, les textes, les dessins, illustrations, présentations, etc.) est, sauf mention contraire, la propriété exclusive de la société LANDANGER. Toute reproduction, représentation, modification, adaptation, et/ou traduction de ce catalogue - qu'elle soit totale ou partielle, à titre gratuit ou onéreux - est interdite sans l'accord préalable écrit de la société LANDANGER.

Nous pouvons demander le retour du catalogue dans le cas où celui-ci n'est pas utilisé conformément à nos intérêts, pour la vente ou l'achat de nos produits. Dans ce cas nous nous réservons le droit de mener des actions juridiques.

Sous réserve des modifications techniques.

## Important notice

The content of this catalogue (including the trademarks, the texts, the drawings, illustrations, layouts, etc.) is, unless otherwise specified, the exclusive property of LANDANGER. It is not allowed to reproduce, represent, display, modify, adapt an/or translate - whether in part or in whole and whether for free or for financial consideration - the catalogue and/or any material composing the catalogue, without the prior and written consent of LANDANGER.

We can at any time recall the catalogue, in case that it has been not used according to our interests, i.e. sale or purchase of our products. We preserve the right for further steps in that case.

Patterns are subject to change.

## Indicaciones importantes

El contenido de este catálogo (marcas, textos, dibujos, ilustraciones, presentaciones incluidos, etc.) es, excepto mención contraria, exclusiva propiedad de la empresa LANDANGER. Toda reproducción, representación, modificación, adaptación, y/o traducción de este catálogo - que sea total o parcial, gratuitamente o pagando - esta prohibida sin el acuerdo escrito de la empresa LANDANGER.

Podemos pedir el retorno del catálogo en caso de que este no sea usado conforme a nuestro interés, para la venta o la compra de nuestros productos. En aquel caso, nos reservamos el derecho de dirigir acciones jurídicas.

Bajo reserva de modificaciones técnicas.

## Version 2015-09 - Catalogue de vente - ZA-CAT-LDG-15

Conception et design - Concept and design - Concepto y diseño : Copyright©LANDANGER - 1947 - 2015.

Tous droits réservés - All rights reserved - Todos derechos reservados.

Photos et illustrations non contractuelles - The photos and pictures are not contractual - Fotos e ilustraciones no contractuales.





L A N D A N G E R

1947

*Services clients - Contactez-nous - Contactez-nous*

**Nos bureaux et Lines Landanger - 5295 Chasseraut - FRANCE -**  
Tél. : +33 (0)3 29 02 10 10 / Fax : +33 (0) 29 02 10 20 / Email : [contact@landanger.com](mailto:contact@landanger.com)

*Agence - Agence officielle - Total*

**18 avenue de la République - 75011 Paris - FRANCE**