

Dissection Needles

without suction channel, insulated sheath,
with connector pin for unipolar coagulation

Size 3.5 mm

Operating instruments, **length 36 cm**,
for use **with trocars size 3.5 mm**

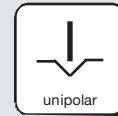

26167 NNL



26167 NNL
NEW

KOH Ultramicro High Frequency Electrode, for splitting and coagulation, insulated, retractable, with connector pin for unipolar coagulation, size 3.5 mm, length 36 cm

26167 NNX

Spare Needle Electrode, autoclavable, size 3.5 mm, length 36 cm, package of 5, for use with KOH Ultramicro High Frequency Electrode 26167 NNL

Size 5 mm

Operating instruments, **length 31 cm**,
for use **with trocars size 6 mm**

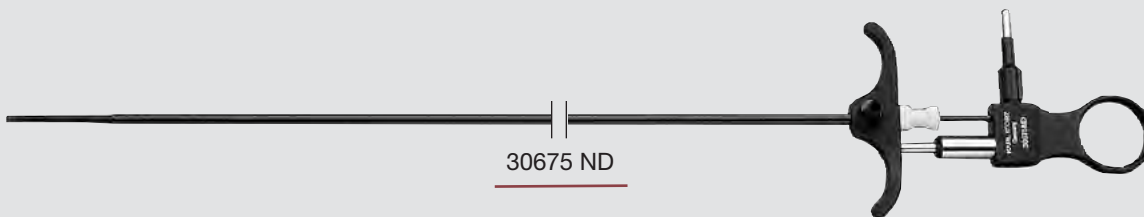

30675 ND



30675 ND

High Frequency Needle, for splitting and coagulation, insulated, retractable, with connector pin for unipolar coagulation, size 5 mm, length 31 cm



26175 NE

Spare Needle Electrode, autoclavable, diameter 0.7 mm, length 31 cm, for use with High Frequency Needle 30675 ND

26175 NL

Spare Needle Electrode, autoclavable, package of 1, diameter 1.1 mm, length 31 cm, for use with High Frequency Needle 30675 ND

26175 NS

Same, diameter 0.5 mm

Units for use with Dissection Needles see chapter 20, UNITS

Coagulation and Dissection Electrodes

without suction channel, insulated sheath,
with connector pin for unipolar coagulation

Size 5 mm

Operating instruments, **lengths 30 and 36 cm**,
for use with **trocars size 6 mm**

Operating instruments, **length 43 cm**,
for use with telescopes with inbuilt
working channel and trocars size 6 mm



Length	Instrument
30 cm	
<u>36 cm</u>	
43 cm	

Distal Tip	Instrument
	26772 UF <u>26775 UF</u> 26778 UF Coagulation and Dissection Electrode, L-shaped
	26775 UE 26778 UE Coagulation and Dissection Electrode, spatula-shaped, blunt
	26775 S Coagulation and Dissection Electrode, knife-shaped
	26775 R MANGESHIKAR Coagulation Electrode, with ball end

Special Features:

- The hook electrode is suitable for resection, insulating structures as well as dissection and coagulation.
- The distal tip is semicircular: The thick outer curvature enables safe dissection.
- The thin inner curvature enables fast work with minimal coagulation.
- The striated handle allows easier gripping.
- The hook length enables ergonomic work.

Length	Instrument
36 cm	
43 cm	

Distal Tip	Instrument
	26775 C 26775 CL CADIERE Coagulation and Dissection Electrode, L-shaped, with cm-marking, distal tip tapered

Units for use with Coagulation and Dissection Electrodes see chapter 20, UNITS

Dissecting and Grasping Forceps

CLICK*line* – rotating, dismantling, insulated,
with connector pin for unipolar coagulation

Size 5 mm

Operating instruments, lengths 30 and 36 cm,
for use with trocars size 6 mm

Operating instruments, length 43 cm,
for use with telescopes with inbuilt
working channel and trocars size 6 mm

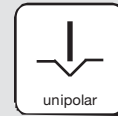

5 mm

Length	Handle						
	33151	33152	33153	33156	33121	33125	33149
30 cm							
36 cm							
43 cm							

Double action jaws

Working Insert	Complete Instrument						
33210 AF	33251 AF	33252 AF	33253 AF	33256 AF	33221 AF	33225 AF	33249 AF
33310 AF	33351 AF	33352 AF	33353 AF	<u>33356 AF</u>	33321 AF	33325 AF	33349 AF
33410 AF	33451 AF	33452 AF	33453 AF	33456 AF	33421 AF	33425 AF	33449 AF

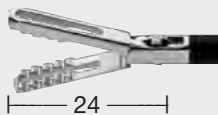

CLICK*line* Grasping Forceps, atraumatic, fenestrated

33310 OD	33351 OD	33352 OD	33353 OD	33356 OD	33321 OD	33325 OD	33349 OD
----------	----------	----------	----------	----------	----------	----------	----------

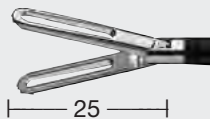

CLICK*line* Grasping Forceps, fenestrated,
with especially fine atraumatic serration

33310 FG	33351 FG	33352 FG	33353 FG	33356 FG	33321 FG	33325 FG	33349 FG
33410 FG	33451 FG	33452 FG	33453 FG	33456 FG	33421 FG	33425 FG	33449 FG



CLICK*line* Grasping Forceps, atraumatic

33210 D	33251 D	33252 D	33253 D	33256 D	33221 D	33225 D	33249 D
33310 D	33351 D	33352 D	33353 D	33356 D	33321 D	33325 D	33349 D



CLICK*line* Grasping Forceps, atraumatic, spoon-shaped, with multiple teeth

33310 K	33351 K	33352 K	33353 K	33356 K	33321 K	33325 K	33349 K
---------	---------	---------	---------	---------	---------	---------	---------



CLICK*line* Grasping Forceps, atraumatic, fenestrated

7-111

Scissors and Cutting-Coagulation Forceps

CLICK*linē* – rotating, dismantling,
with and without connector pin for unipolar coagulation

Size 5 mm

Operating instruments, lengths 30, 36 and 43 cm,
for use with trocars size 6 mm

Operating instruments, length 43 cm,
for use with telescopes with inbuilt
working channel and trocars size 6 mm

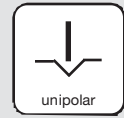

Length	Handle						
	33151	33121	33125	33149	33161	33131	33147
30 cm							
36 cm							
43 cm							

5 mm

Double action jaws

Working Insert	Complete Instrument						
34310 SA	34351 SA	34321 SA	34325 SA	34349 SA	34361 SA	34331 SA	34347 SA
	CLICK <i>linē</i> SHAWKI Duo, cutting-coagulation forceps, "dolphin nose"						

34310 SO	34351 SO	34321 SO	34325 SO	34349 SO	34361 SO	34331 SO	34347 SO
	CLICK <i>linē</i> SHAWKI Duo, cutting-coagulation forceps, right-angled jaws						

Single action jaws

34310 MT	34351 MT	34321 MT	34325 MT	34349 MT	34361 MT	34331 MT	34347 MT
	CLICK <i>linē</i> Scissors, serrated						

34210 EH	34251 EH	34221 EH	34225 EH	34249 EH	34261 EH	34231 EH	34247 EH
34310 EH	34351 EH	34321 EH	34325 EH	34349 EH	34361 EH	34331 EH	34347 EH
34410 EH	34451 EH	34421 EH	34425 EH	34449 EH	34461 EH	34431 EH	34447 EH

	CLICK <i>linē</i> Hook Scissors						
--	---------------------------------	--	--	--	--	--	--

34210 EK	34251 EK	34221 EK	34225 EK	34249 EK	34261 EK	34231 EK	34247 EK
34310 EK	34351 EK	34321 EK	34325 EK	34349 EK	34361 EK	34331 EK	34347 EK
34410 EK	34451 EK	34421 EK	34425 EK	34449 EK	34461 EK	34431 EK	34447 EK

	CLICK <i>linē</i> Hook Scissors, jaws not crossing						
--	--	--	--	--	--	--	--

2-012

Scissors

CLICK*line* – rotating, dismantling,
with and without connector pin for unipolar coagulation

Size 5 mm

Operating instruments, lengths 30, 36 and 43 cm,
for use with trocars size 6 mm

Operating instruments, length 43 cm,
for use with telescopes with inbuilt
working channel and trocars size 6 mm

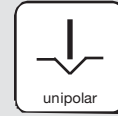

5 mm

Length	Handle						
	33151	33121	33125	33149	33161	33131	33147
30 cm							
36 cm							
43 cm							

Double action jaws

Working Insert	Complete Instrument						
34210 MS	34251 MS	34221 MS	34225 MS	34249 MS	34261 MS	34231 MS	34247 MS
34310 MS	34351 MS	34321 MS	34325 MS	34349 MS	34361 MS	34331 MS	34347 MS
34410 MS	34451 MS	34421 MS	34425 MS	34449 MS	34461 MS	34431 MS	34447 MS

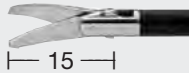

CLICK*line* METZENBAUM Scissors, curved

34210 MA	34251 MA	34221 MA	34225 MA	34249 MA	34261 MA	34231 MA	34247 MA
34310 MA	34351 MA	34321 MA	34325 MA	34349 MA	34361 MA	34331 MA	34347 MA
34410 MA	34451 MA	34421 MA	34425 MA	34449 MA	34461 MA	34431 MA	34447 MA



CLICK*line* Scissors, serrated blades, spoon-shaped, curved

34210 MW	34251 MW	34221 MW	34225 MW	34249 MW	34261 MW	34231 MW	34247 MW
34310 MW	34351 MW	34321 MW	34325 MW	34349 MW	34361 MW	34331 MW	34347 MW
34410 MW	34451 MW	34421 MW	34425 MW	34449 MW	34461 MW	34431 MW	34447 MW



CLICK*line* Scissors, serrated, curved, conical

34210 MD	34251 MD	34221 MD	34225 MD	34249 MD	34261 MD	34231 MD	34247 MD
34310 MD	34351 MD	34321 MD	34325 MD	34349 MD	34361 MD	34331 MD	34347 MD

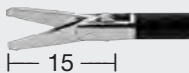

CLICK*line* Scissors, straight

Dissecting and Grasping Forceps

CLICK*line* – rotating, dismantling, insulated,
with connector pin for unipolar coagulation

Size 5 mm

Operating instruments, lengths 30 and 36 cm,
for use with trocars size 6 mm

Operating instruments, length 43 cm,
for use with telescopes with inbuilt
working channel and trocars size 6 mm

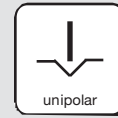

5 mm

Length	Handle						
	33151	33152	33153	33156	33121	33125	33149
30 cm							
36 cm							
43 cm							

Double action jaws

Working Insert	Complete Instrument						
33210 AF	33251 AF	33252 AF	33253 AF	33256 AF	33221 AF	33225 AF	33249 AF
33310 AF	33351 AF	33352 AF	33353 AF	33356 AF	33321 AF	33325 AF	33349 AF
33410 AF	33451 AF	33452 AF	33453 AF	33456 AF	33421 AF	33425 AF	33449 AF



CLICK*line* Grasping Forceps, atraumatic, fenestrated

33310 OD	33351 OD	33352 OD	33353 OD	33356 OD	33321 OD	33325 OD	33349 OD
----------	----------	----------	----------	----------	----------	----------	----------

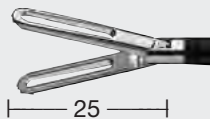

CLICK*line* Grasping Forceps, fenestrated,
with especially fine atraumatic serration

33310 FG	33351 FG	33352 FG	33353 FG	33356 FG	33321 FG	33325 FG	33349 FG
33410 FG	33451 FG	33452 FG	33453 FG	33456 FG	33421 FG	33425 FG	33449 FG



CLICK*line* Grasping Forceps, atraumatic

33210 D	33251 D	33252 D	33253 D	33256 D	33221 D	33225 D	33249 D
33310 D	33351 D	33352 D	33353 D	33356 D	33321 D	33325 D	33349 D



CLICK*line* Grasping Forceps, atraumatic, spoon-shaped, with multiple teeth

33310 K	33351 K	33352 K	33353 K	33356 K	33321 K	33325 K	33349 K
---------	---------	---------	---------	---------	---------	---------	---------



CLICK*line* Grasping Forceps, atraumatic, fenestrated

7-111

Dissecting and Grasping Forceps

CLICK*line* – rotating, dismantling, insulated, with connector pin for unipolar coagulation

Size 5 mm

Operating instruments, lengths 30 and 36 cm, for use with trocars size 6 mm

Operating instruments, length 43 cm, for use with telescopes with inbuilt working channel and trocars size 6 mm

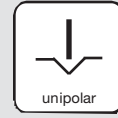

5 mm

Length	Handle						
	33151	33152	33153	33156	33121	33125	33149
30 cm							
36 cm							
43 cm							

Single action jaws

Working Insert	Complete Instrument						
33310 M	33351 M	33352 M	33353 M	33356 M	33321 M	33325 M	33349 M
 —14—	CLICK<i>line</i> Grasping Forceps , with multiple teeth, width of jaws 3 mm, for atraumatic and accurate grasping						
33310 FM	33351 FM	33352 FM	33353 FM	33356 FM	33321 FM	33325 FM	33349 FM
33410 FM	33451 FM	33452 FM	33453 FM	33456 FM	33421 FM	33425 FM	33449 FM
 —26—	CLICK<i>line</i> Claw Forceps , 2 x 3 teeth						
33210 ME	33251 ME	33252 ME	33253 ME	33256 ME	33221 ME	33225 ME	33249 ME
33310 ME	33351 ME	33352 ME	33353 ME	33356 ME	33321 ME	33325 ME	33349 ME
33410 ME	33451 ME	33452 ME	33453 ME	33456 ME	33421 ME	33425 ME	33449 ME
 —14—	CLICK<i>line</i> Grasping Forceps , with multiple teeth, width of jaws 4.8 mm, for atraumatic and accurate grasping						
33210 MG	33251 MG	33252 MG	33253 MG	33256 MG	33221 MG	33225 MG	33249 MG
33310 MG	33351 MG	33352 MG	33353 MG	33356 MG	33321 MG	33325 MG	33349 MG
33410 MG	33451 MG	33452 MG	33453 MG	33456 MG	33421 MG	33425 MG	33449 MG
 —14—	CLICK<i>line</i> Grasping Forceps , “tiger jaws”, 2 x 4 teeth, for grasping and removal of solid organs, in particular during adhesiolyses						

ROBI® Bipolar Grasping Forceps ^{NEW}

rotating, dismantling, with connector pin for bipolar coagulation, CLERMONT-FERRAND model

Size 5 mm



Operating instruments, **length 36 cm**, for use **with trocars size 6 mm**

Operating instruments, **length 43 cm**, for use with telescopes with inbuilt working channel and trocars size 6 mm

Outer Sheath	Handle
	38151
Length 36 cm	
Length 43 cm	

Double action jaws

Working insert	Complete Instrument
38610 ON	<u>38651 ON</u>
38710 ON	38751 ON
<p>18</p>	<p>ROBI® Grasping Forceps, CLERMONT-FERRAND model, fenestrated, with especially fine atraumatic serration</p>
38610 WA	38651 WA
<p>19</p>	<p>ROBI® WATTIEZ Grasping Forceps, with multiple teeth, for atraumatic and accurate grasping</p>
38610 MD	38651 MD
38710 MD	38751 MD
<p>19</p>	<p>ROBI® KELLY Dissecting and Grasping Forceps, CLERMONT-FERRAND model, especially suitable for dissection</p>
38610 ML	38651 ML
<p>24</p>	<p>ROBI® KELLY Dissecting and Grasping Forceps, CLERMONT-FERRAND model, especially suitable for dissection</p>
38610 MA	38651 MA
<p>24</p>	<p>ROBI® MALZONI Dissecting and Grasping Forceps, especially suitable for dissection</p>

5 mm

Please note:

For the instrument only the **individual component parts** are numbered. The catalog number for the **complete instrument** is not on the instrument. Please take this number from the numbers indicated in the **red** background of the table above. The color **green** indicates the working inserts.

Bipolar High Frequency Cords see accessories page 158

Uterine Manipulator

CLERMONT-FERRAND Model

For mobilization of the uterus, identification of the vaginal fornices and sealing of the vagina during hysterectomy

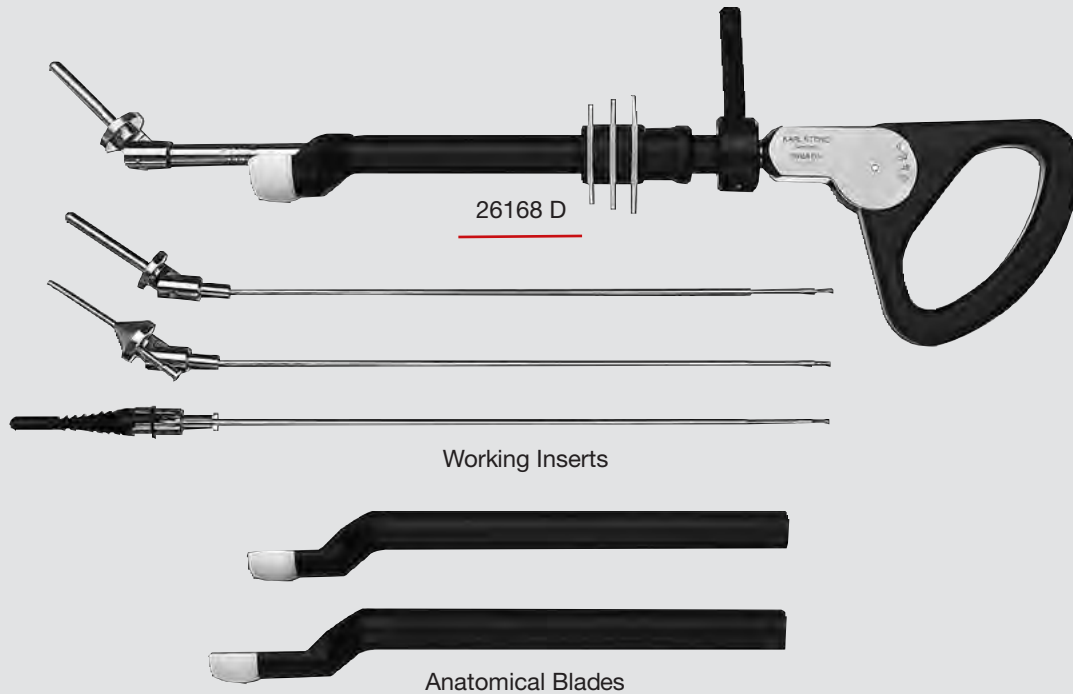

- 26168 D **Uterine Manipulator**, CLERMONT-FERRAND model including:
- Handle**, with fixation screw
 - Manipulator Rod**
 - Sealing Cylinder**
 - Silicone Seal**, package of 3 (3 sizes)
 - Sheath**
 - Working Insert**, conical, with thread, medium
 - Working Insert**, atraumatic, diameter 7 mm, length 50 mm
 - Working Insert**, with connector for chromopertubation, atraumatic, diameter 4 mm, length 40 mm
 - Anatomical Blade**, short, diameter 36 mm, length 48 mm
 - Cleaning Adaptor**

Recommended Accessories

- | | | |
|------------|----------|---|
| | 26168 DF | Working Insert , conical, with thread, short |
| | 26168 DH | Same , long |
| NEW | 26168 DO | Working Insert , atraumatic, diameter 7 mm, length 60 mm |
| NEW | 26168 DQ | Working Insert , with connector for chromopertubation, atraumatic, diameter 4 mm, length 60 mm |
| NEW | 26168 DJ | Attachment with Cap , diameter 28 mm, length 43 mm |
| | 26168 DM | Anatomical Blade , medium, diameter 36 mm, length 58 mm |
| | 26168 DL | Anatomical Blade , long, diameter 36 mm, length 68 mm |

Components/Spare Parts see chapter 21

Accessories for Maintenance and Cleaning



27652



27650 A – G



27651 AL – UB

Order No.	Flat	Round/rigid	Round/flexible	Length	Outer diameter	Channel diameter	Notes
27652	●	-	-	-	-	-	cleaning of jaws
27648 A	-	●	-	55 cm	16 mm	4 – 14 mm	
27650 A	-	●	-	35 cm	11 mm	3 – 9 mm	
27650 B	-	●	-	35 cm	7 mm	2.5 – 5 mm	
27650 C	-	●	-	35 cm	2.5 mm	2 – 2.4 mm	
27650 D	-	●	-	50 cm	11 mm	3 – 9 mm	
27650 E	-	●	-	50 cm	7 mm	2.5 – 5 mm	
27650 F	-	●	-	50 cm	2.5 mm	2 – 2.4 mm	
27650 G	-	●	-	50 cm	2.5 mm	-	for CLICKline® and ROBI®
27651 AL	-	-	●	150 cm	2 mm	1.2 – 1.8 mm	
27651 B	-	-	●	100 cm	3 mm	1.8 – 2.6 mm	
27651 UA	-	-	●	60 cm	2 mm	1.4 – 1.8 mm	
27651 UB	-	-	●	60 cm	2.2 mm	0.8 – 2 mm	



27657

27657

Special Lubricant, for stopcocks

For further information see catalog HYGIENE

Trocars

Size 6 mm

For use with telescopes and instruments size 5 mm

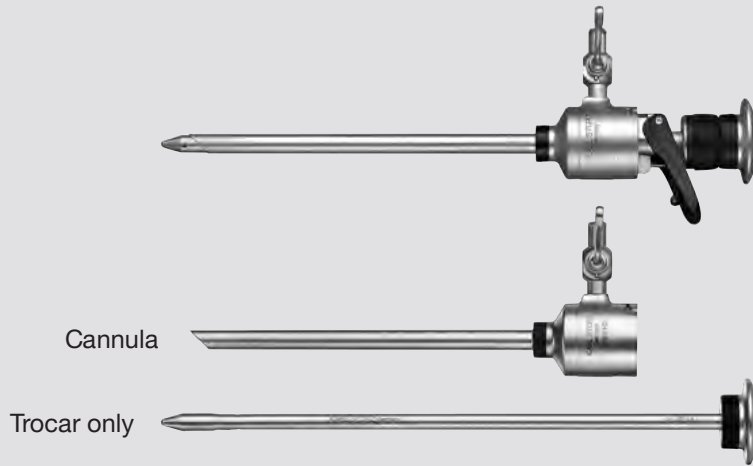





Multifunctional Valve



Automatic Valve



Size:		6 mm			
Working length:		8.5 cm	10.5 cm	8.5 cm	10.5 cm
Color code:		black-white	black	black-white	black
		Multifunctional Valve		Automatic Valve	
	Trocar, with conical tip including: Cannula Trocar only Valve	30160 WY <u>30160 H1</u> 30160 Y 30160 M1	30160 MC 30160 H2 <u>30160 C</u> <u>30160 M1</u>	30160 FY 30160 H1 30160 Y 30160 A1	30160 AC 30160 H2 30160 C 30160 A1
	Trocar, with pyramidal tip including: Cannula Trocar only Valve	30160 WZ 30160 H1 30160 Z 30160 M1	30160 MP 30160 H2 30160 P 30160 M1	30160 FZ 30160 H1 30160 Z 30160 A1	30160 AP 30160 H2 30160 P 30160 A1
	Trocar, with blunt tip including: Cannula Trocar only Valve	30160 WX 30160 H1 30160 X 30160 M1	30160 MA 30160 H2 30160 A 30160 M1	30160 FX 30160 H1 30160 X 30160 A1	30160 AA 30160 H2 30160 A 30160 A1
	Trocar including: Cannula Trocar only Valve	–	30160 MB 30160 H2 30160 B 30160 M1	–	30160 AB 30160 H2 30160 B 30160 A1

Telescopes for use with trocars size 6 mm see page 33
HEINKEL-SEMM Dilatation Set see page 78, Accessories for Trocars see pages 76-77

Accessories

Reducer, Thread Sleeves and Distance Holders

Reducer, for use with trocars with valve seals



30141 RS

30141 RS **Reducer**, 13.5/5 mm and 11/5 mm

Thread Sleeves



30160 S

30160 S **Thread Sleeve**, for trocars size 6 mm,
color code: black

30103 S **Thread Sleeve**, for trocars size 11 mm,
color code: green

NEW 30108 S **Thread Sleeve**, for trocars size 13.5 mm,
color code: blue

Distance Holders, to limit the depth of puncture



30103 D

30160 D **Distance Holder**, for trocars size 6 mm,
color code: black

30103 D **Distance Holder**, for trocars size 11 mm,
color code: green

Trocars

Size 11 mm



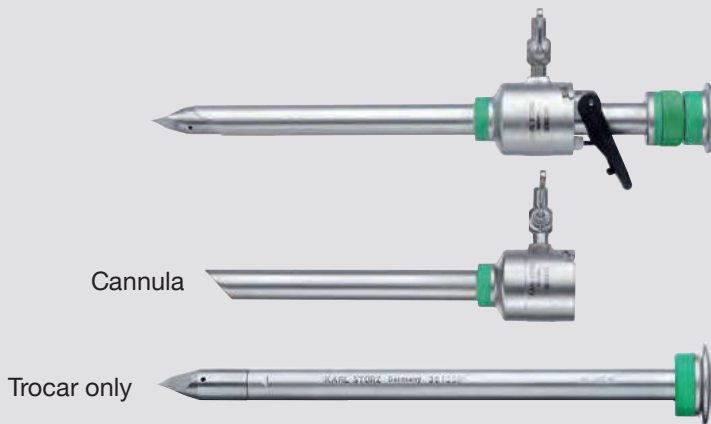

For use with telescopes and instruments size 11 mm



Multifunctional Valve



Automatic Valve

Size:		11 mm			
Working length:		8.5 cm	10.5 cm	8.5 cm	10.5 cm
Color code:		green-white	green	green-white	green
		Multifunctional Valve		Automatic Valve	
	Trocar , with conical tip including: Cannula Trocar only Valve	30103 WY <u>30103 H1</u> 30103 Y <u>30103 M1</u>	30103 MC 30103 H2 <u>30103 C</u> 30103 M1	30103 FY 30103 H1 30103 Y 30103 A1	30103 AC 30103 H2 30103 C 30103 A1
	Trocar , with pyramidal tip including: Cannula Trocar only Valve	30103 WZ 30103 H1 30103 Z 30103 M1	30103 MP 30103 H2 30103 P 30103 M1	30103 FZ 30103 H1 30103 Z 30103 A1	30103 AP 30103 H2 30103 P 30103 A1
	Trocar , with blunt tip including: Cannula Trocar only Valve	30103 WX 30103 H1 30103 X 30103 M1	30103 MA 30103 H2 30103 A 30103 M1	30103 FX 30103 H1 30103 X 30103 A1	30103 AA 30103 H2 30103 A 30103 A1
	MOTSON Trocar , with conical, blunt tip, including: Cannula Trocar only Valve	–	30103 MMO 30103 H2 30103 MO 30103 M1	–	30103 AMO 30103 H2 30103 MO 30103 A1
	Trocar including: Cannula Trocar only Valve	–	30103 WSB 30103 H2 30103 SB 30103 M1	–	30103 FSB 30103 H2 30103 SB 30103 A1



Telescopes for use with trocars size 11 mm see pages 31, 35, 38-40
HEINKEL-SEMM Dilatation Set see page 78, Accessories for Trocars see pages 76-77

Trocars for Adipose Patients

Size 6, 11 and 13.5 mm

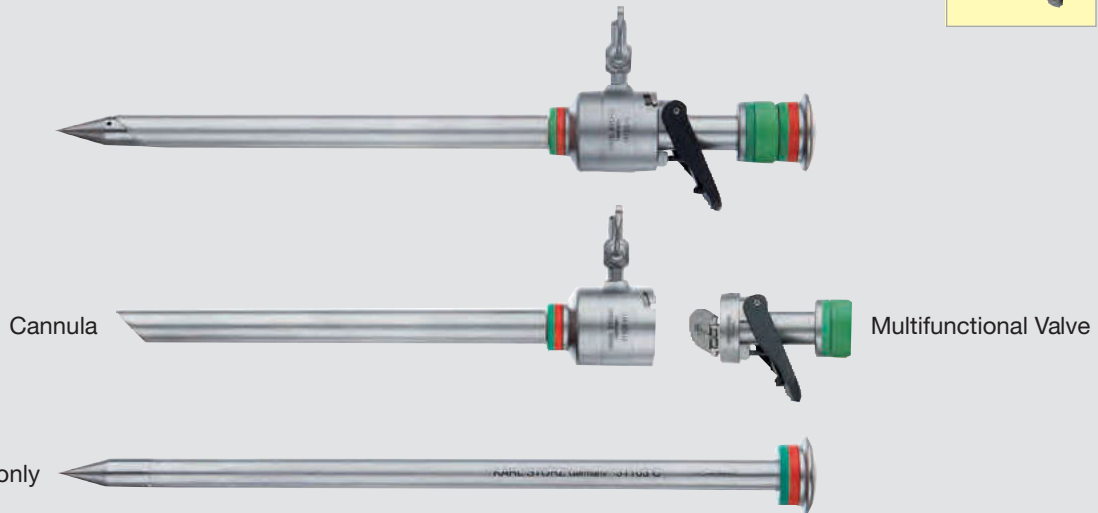
XL



Size:	6 mm	11 mm	13.5 mm
Working length:	15 cm	15 cm	15 cm
Color code:	black-red	green-red	blue-red
	Trocar, with conical tip including: Cannula Trocar only Multifunctional Valve 31160 MC <u>31160 H1</u> <u>31160 C</u> <u>30160 M1</u>	31103 MC 31103 H1 31103 C 30103 M1	–
	Trocar, with pyramidal tip including: Cannula Trocar only Multifunctional Valve 31160 MP 31160 H1 31160 P 30160 M1	31103 MP 31103 H1 31103 P 30103 M1	31108 MP 31108 H1 31108 P 30108 M1
	Trocar, with blunt tip including: Cannula Trocar only Multifunctional Valve 31160 MA 31160 H1 31160 A 30160 M1	31103 MA 31103 H1 31103 A 30103 M1	–

Telescopes for use with trocars size 6 mm see page 33
 Telescopes for use with trocars size 11 mm see pages 31, 35, 38-40
 HEINKEL-SEMM Dilatation Set see page 78, Accessories for Trocars see pages 76-77