

CORONARY VASCULAR AND RENAL DENERVATION PRODUCT CATALOGUE

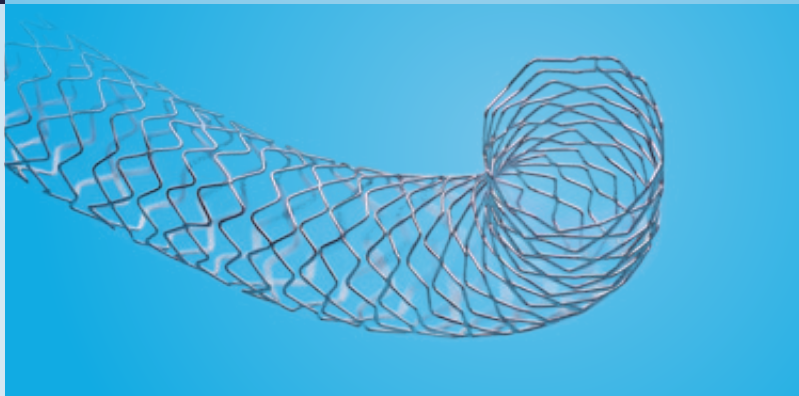

Medtronic
Further, Together



INTRODUCTION

GOING "FURTHER, TOGETHER"

As a global leader in medical technology, services and solutions, Medtronic improves the health and lives of millions of people each year. We believe our deep clinical, therapeutic, and economic expertise can help address the complex challenges — such as rising costs, aging populations, and the burden of chronic disease — faced by families and healthcare systems today. But no one can do it alone. That's why we're committed to partnering in new ways and developing powerful solutions that deliver better patient outcomes.

We call this new approach "**Further,Together.**" "Further," because we will continue to drive progress in innovation, and devise powerful solutions with proven clinical and economic value as the basis of our offerings and value proposition. And "Together," because we will forge new, different, and stronger partnerships to help our customers achieve their goal of delivering more seamless, integrated care across the healthcare continuum.

The main tenets of "Further, Together." focus on developing **meaningful innovations** at the therapy, procedural, and system levels; leveraging our capabilities and expertise to align value among the various stakeholders in the healthcare system; and expanding global access to healthcare — all while developing new partnerships with those who are committed to transforming healthcare.

Founded in 1949 as a medical repair company, we're now among the world's largest medical technology, services and solutions companies, employing more than 85,000 people worldwide, serving physicians, hospitals and patients in more than 155 countries. Join us in our commitment to take healthcare Further, Together. Learn more at Medtronic.com.

CONTENTS

1. DRUG ELUTING STENTS

- a. Resolute™
- b. Resolute Integrity™
- c. Resolute Onyx™

2. BARE METAL STENTS

- a. Integrity™

3. BALLOON DILATATION CATHETERS

Euphora Family

- a. Euphora™
- b. NC Euphora™

Sprinter Family

- a. Sprinter Legend™ RX
- b. Sprinter Legend™ OTW
- c. Sprinter™ OTW
- d. NC Sprinter™

6. INTERVENTIONAL GUIDEWIRES

- a. Guidewire Family overview
- b. Zinger™ stainless steel workhorse wire
- c. Intuition™ advanced workhorse guidewire
- d. Cougar™ nitinol workhorse wire
- e. ProVia™ crossing guidewire
- f. Thunder™ extra-support guidewire

7. ASPIRATION CATHETERS

- a. Export Advance™ Aspiration Catheter
- b. Export™ AP Aspiration Catheter
- c. Export™ 7 F

9. INTRODUCERS

Radial introducers

- a. InTRakit™

Femoral introducers

- a. Input™ TS
- b. Input™ PS
- c. Input™ Accessories
- d. Transseptal Introducers

10. INTERVENTIONAL ACCESSORIES

- a. TRAcelet™ hemostasis device
- b. Everest™ inflation device and survival kit
- c. Piton™ disposable PTCA Y-Adaptor and Y-Adaptor kits
- d. Stretch™ insertion tool
- e. Steering handle
- f. Pulmonary Wedge Pressure Catheter (PWP) for hemodynamic monitoring

4. DRUG ELUTING BALLOONS

- a. In.Pact Falcon™

5. GUIDE CATHETER FAMILY

- a. Guide catheter family overview
- b. Launcher™
- c. Sherpa NX™ Active
- d. Sherpa NX™ Balanced
- e. Zuma 2™
- f. Zuma™

8. ANGIOGRAPHIC CATHETERS AND WIRES

- a. DxTerty™
- b. Sones™ Woven Coronary Catheters
- c. Woven Coronary Catheters High-Volume
- d. Woven Coronary Catheters General Purpose and Transvalvular
- e. PTFE-Coated Guidewires: Fixed Core
- f. PTFE-Coated Guidewires: Movable Core
- g. Support and Exchange wires
- h. Specialty Guidewires

11. PEDIATRIC AND TRANSSEPTAL PRODUCTS

Pediatric Products

- a. Pediatric Woven Coronary Catheters
- b. Pediatric Woven NIH Catheters
- c. Pediatric Rashkind™ Septostomy Balloon Catheters
- d. Pediatric Mullins™ Transseptal Introducer Sheath

Transseptal Products

- a. Transseptal Catheter Introducer Sheaths

12. RENAL DENERVATION

- a. Symplicity Spyral™ Multi-Electrode Renal Denervation Catheter

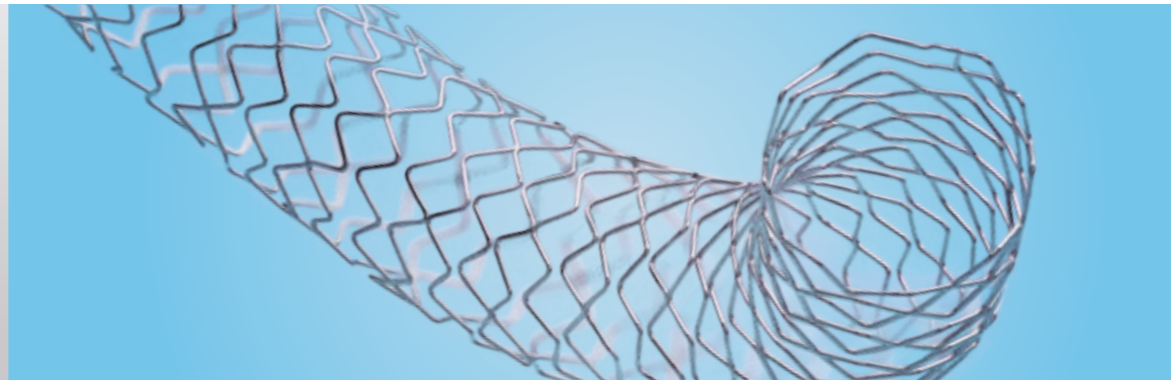

DRUG ELUTING STENTS

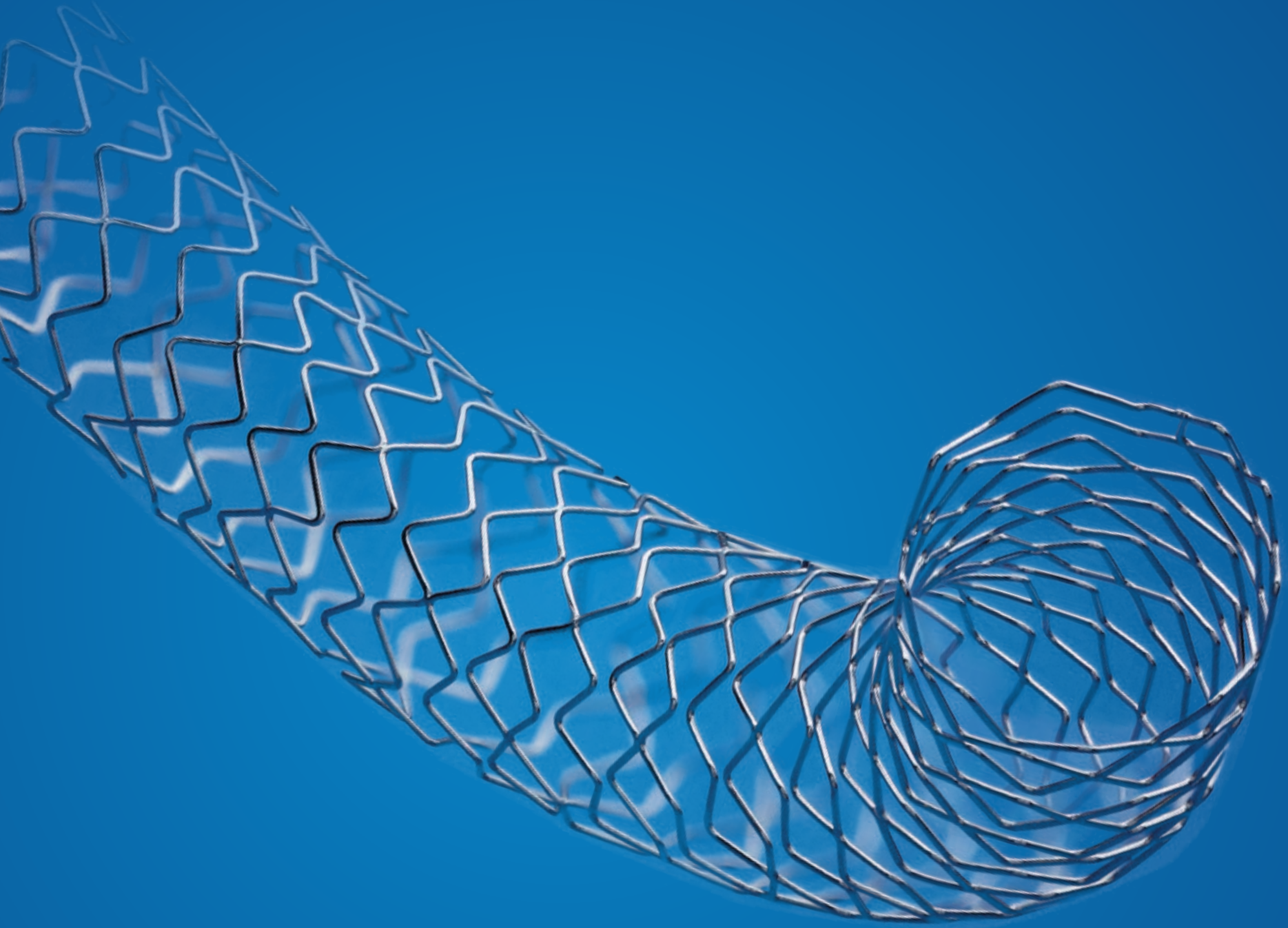

CORONARY STENTS

Resolute™
Drug-Eluting Stent System. Proven Value

GENERAL CHARACTERISTICS

• Supplied sterile. • Items per box: 1 • Label color: White

PRODUCT DESCRIPTION

The Resolute zotarolimus-eluting rapid exchange coronary stent system offers safe long-term drug elution with the BioLinx polymer specifically designed for DES.

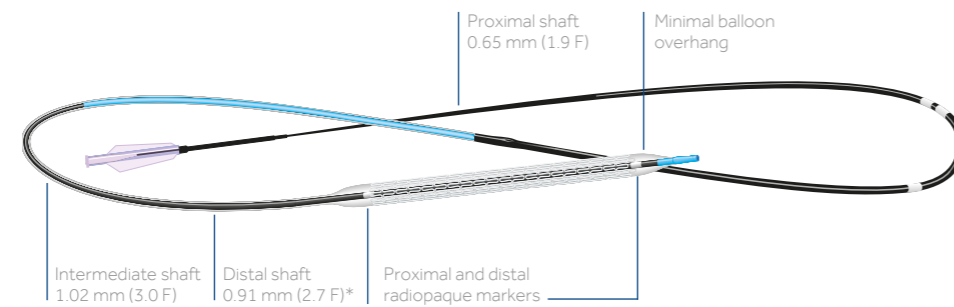

*1.02 mm (3.0F) for all 4.00 mm stent sizes

00643169265455
Crossing Profile: 2.25–4.00 mm stents = 1.01–1.22 mm (0.040–0.048 in.)

RESOLUTE DRUG-ELUTING STENT SYSTEM

PRODUCT CODE	STENT DIAMETER (MM)	STENT LENGTH (MM)
ERES22508X	2.25	8
ERES25008X	2.50	8
ERES27508X	2.75	8
ERES30009X	3.00	9
ERES35009X	3.50	9
ERES40009X	4.00	9
ERES22512X	2.25	12
ERES25012X	2.50	12
ERES27512X	2.75	12
ERES30012X	3.00	12
ERES35012X	3.50	12
ERES40012X	4.00	12
ERES22514X	2.25	14
ERES25014X	2.50	14
ERES27514X	2.75	14
ERES30015X	3.00	15
ERES35015X	3.50	15
ERES40015X	4.00	15
ERES22518X	2.25	18
ERES25018X	2.50	18

PRODUCT CODE	STENT DIAMETER (MM)	STENT LENGTH (MM)
ERES27518X	2.75	18
ERES30018X	3.00	18
ERES35018X	3.50	18
ERES40018X	4.00	18
ERES22524X	2.25	24
ERES25024X	2.50	24
ERES27524X	2.75	24
ERES30024X	3.00	24
ERES35024X	3.50	24
ERES40024X	4.00	24
ERES22530X	2.25	30
ERES25030X	2.50	30
ERES27530X	2.75	30
ERES30030X	3.00	30
ERES35030X	3.50	30
ERES40030X	4.00	30
ERES30038X	3.00	38
ERES35038X	3.50	38
ERES40038X	4.00	38

CORONARY STENTS

Resolute™
Drug-Eluting Stent System. Proven Value

COMPLIANCE DATA

PRESSURE (ATM)	DIAMETER (MM)					
	2.25	2.50	2.75	3.00	3.50	4.00
7 (709 kPa)	2.20	2.48	2.67	2.90	3.32	3.82
8 (811 kPa)	2.24	2.53	2.73	2.96	3.40	3.90
9 (912 kPa)	2.28	2.58	2.80	3.02	3.49	3.96
10 (1013 kPa)	2.32	2.62	2.85	3.06	3.53	4.01
11 (1115 kPa)	2.36	2.66	2.89	3.10	3.57	4.07
12 (1216 kPa)	2.40	2.70	2.93	3.15	3.63	4.11
13 (1317 kPa)	2.44	2.73	2.97	3.19	3.68	4.16
14 (1418 kPa)	2.48	2.77	3.02	3.24	3.73	4.20
15 (1520 kPa)	2.52	2.81	3.07	3.29	3.78	4.25
16 (1621 kPa)	2.56	2.85	3.11	3.34	3.84	4.29
17 (1722 kPa)	2.60	2.89	3.16	3.38	3.89	4.34
18 (1824 kPa)	2.65	–	3.20	3.44	3.94	4.38
MSID	3.50	3.50	3.50	4.75	4.75	4.75

Nominal pressure	Rated burst pressure ¹	Maximum Stent I.D. ²
------------------	-----------------------------------	---------------------------------

- Do not exceed rated burst pressure.
- Do not expand to a diameter beyond 0.5 mm of its nominal diameter.

CORONARY STENTS

Resolute Integrity™ Drug-Eluting Stent System. Everyday Performance

GENERAL CHARACTERISTICS

• Supplied sterile. • Items per box: 1 • Label color: White

PRODUCT DESCRIPTION

The Resolute Integrity zotarolimus-eluting rapid exchange coronary stent system effectively combines the superior deliverability¹ of the Integrity stent platform utilizing continuous sinusoid technology and offers key performance attributes with the proven long-term safety and efficacy of Resolute DES.²

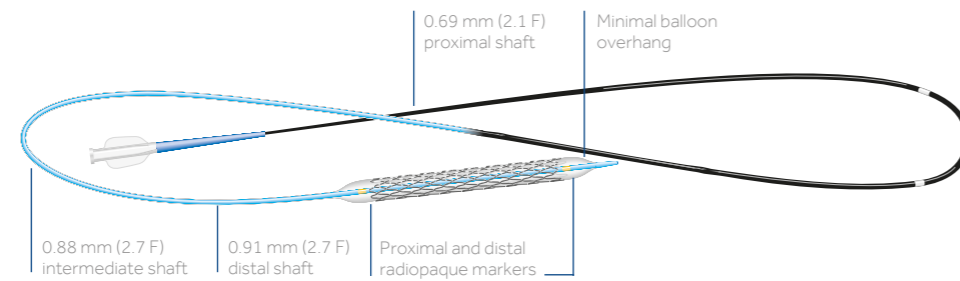

RESOLUTE INTEGRITY DRUG-ELUTING STENT SYSTEM

PRODUCT CODE	STENT DIAMETER (MM)	STENT LENGTH (MM)	PRODUCT CODE	STENT DIAMETER (MM)	STENT LENGTH (MM)
RSINT22508X	2.25	8	RSINT30018X	3.00	18
RSINT22512X	2.25	12	RSINT30022X	3.00	22
RSINT22514X	2.25	14	RSINT30026X	3.00	26
RSINT22518X	2.25	18	RSINT30030X	3.00	30
RSINT22522X	2.25	22	RSINT30034X	3.00	34
RSINT22526X	2.25	26	RSINT30038X	3.00	38
RSINT22530X	2.25	30	RSINT35009X	3.50	9
RSINT25008X	2.50	8	RSINT35012X	3.50	12
RSINT25012X	2.50	12	RSINT35015X	3.50	15
RSINT25014X	2.50	14	RSINT35018X	3.50	18
RSINT25018X	2.50	18	RSINT35022X	3.50	22
RSINT25022X	2.50	22	RSINT35026X	3.50	26
RSINT25026X	2.50	26	RSINT35030X	3.50	30
RSINT25030X	2.50	30	RSINT35034X	3.50	34
RSINT27508X	2.75	8	RSINT35038X	3.50	38
RSINT27512X	2.75	12	RSINT40009X	4.00	9
RSINT27514X	2.75	14	RSINT40012X	4.00	12
RSINT27518X	2.75	18	RSINT40015X	4.00	15
RSINT27522X	2.75	22	RSINT40018X	4.00	18
RSINT27526X	2.75	26	RSINT40022X	4.00	22
RSINT27530X	2.75	30	RSINT40026X	4.00	26
RSINT30009X	3.00	9	RSINT40030X	4.00	30
RSINT30012X	3.00	12	RSINT40034X	4.00	34
RSINT30015X	3.00	15	RSINT40038X	4.00	38

CORONARY STENTS

Resolute Integrity™ Drug-Eluting Stent System. Everyday Performance

COMPLIANCE DATA

PRESSURE (ATM)	DIAMETER (MM)					
	2.25	2.50	2.75	3.00	3.50	4.00
6 (608 kPa)	2.20	2.45	2.70	2.90	3.30	3.75
7 (709 kPa)	2.20	2.45	2.70	2.95	3.35	3.80
8 (811 kPa)	2.25	2.50	2.75	3.00	3.40	3.90
9 (912 kPa)	2.30	2.55	2.80	3.05	3.50	3.95
10 (1013 kPa)	2.30	2.60	2.85	3.10	3.55	4.05
11 (1115 kPa)	2.35	2.60	2.90	3.15	3.60	4.10
12 (1216 kPa)	2.40	2.65	2.95	3.20	3.65	4.15
13 (1317 kPa)	2.40	2.70	3.00	3.20	3.70	4.20
14 (1419 kPa)	2.45	2.70	3.05	3.25	3.75	4.25
15 (1520 kPa)	2.50	2.75	3.10	3.30	3.80	4.30
16 (1621 kPa)	2.55	2.80	3.15	3.35	3.85	4.35
17 (1723 kPa)	2.60	2.80	3.20	3.40	3.90	4.40
18 (1824 kPa)	2.60	2.85	3.25	3.45	3.95	4.45
19 (1925 kPa)	—	2.90	3.30	3.50	4.00	4.50
20 (2027 kPa)	—	2.95	3.40	3.55	4.05	—
MSID	3.50	3.50	3.50	4.75	4.75	4.75

Nominal pressure	Rated burst pressure ¹	Maximum Stent I.D. ²
------------------	-----------------------------------	---------------------------------

- Do not exceed rated burst pressure.
- Do not postdilate the 2.25–2.75-mm stents to greater than 3.50 mm. Do not postdilate the 3.00–4.00-mm stents to greater than 4.75 mm.

1. Bench test data vs. Abbott Xience Prime and Boston Scientific Promus Element on file at Medtronic, Inc.
 2. RESOLUTE All Comers 12-month data. RESOLUTE All Comers evaluated the Resolute stent.
 3. Internal bench test data on file at Medtronic, Inc.

Technical Information:
 5F Minimum guide catheter I.D. 1.4 mm (0.056 in.)
 Crossing Profiles:³
 2.25–2.75 mm: 1.01–1.10 mm (0.040–0.043 in.)
 3.0–4.0 mm: 1.10–1.31 mm (0.043–0.052 in.)

CORONARY STENTS

Resolute Onyx™ Drug-Eluting Stent System. Advanced Workhorse

GENERAL CHARACTERISTICS

• Supplied sterile. • Items per box: 1 • Label color: White

PRODUCT DESCRIPTION

Resolute Onyx zotarolimus-eluting coronary stent builds on the Integrity™ platform's acute procedural success¹ utilizing Continuous Sinusoid Technology and introduces Core Wire Technology for increased radiopacity, deliverability² and performance, the broadest size matrix to optimize treatment of complex clinical scenarios and the proven long-term safety and efficacy shown in the Global RESOLUTE Program

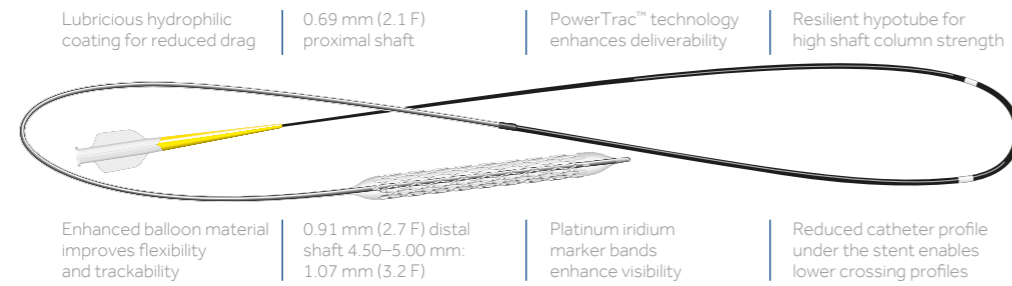

RESOLUTE INTEGRITY DRUG-ELUTING STENT SYSTEM

PRODUCT CODE	STENT DIAMETER (MM)	STENT LENGTH (MM)
RONYX20008X	2.00	8
RONYX20012X	2.00	12
RONYX20015X	2.00	15
RONYX20018X	2.00	18
RONYX20022X	2.00	22
RONYX20026X	2.00	26
RONYX20030X	2.00	30
RONYX22508X	2.25	8
RONYX22512X	2.25	12
RONYX22515X	2.25	15
RONYX22518X	2.25	18
RONYX22522X	2.25	22
RONYX22526X	2.25	26
RONYX22530X	2.25	30
RONYX22534X	2.25	34
RONYX22538X	2.25	38
RONYX25008X	2.50	8
RONYX25012X	2.50	12
RONYX25015X	2.50	15
RONYX25018X	2.50	18
RONYX25022X	2.50	22
RONYX25026X	2.50	26
RONYX25030X	2.50	30
RONYX25034X	2.50	34
RONYX25038X	2.50	38
RONYX27508X	2.75	8
RONYX27512X	2.75	12
RONYX27515X	2.75	15
RONYX27518X	2.75	18
RONYX27522X	2.75	22
RONYX27526X	2.75	26
RONYX27530X	2.75	30
RONYX27534X	2.75	34
RONYX27538X	2.75	38
RONYX30008X	3.00	8
RONYX30012X	3.00	12
RONYX30015X	3.00	15

PRODUCT CODE	STENT DIAMETER (MM)	STENT LENGTH (MM)
RONYX30018X	3.00	18
RONYX30022X	3.00	22
RONYX30026X	3.00	26
RONYX30030X	3.00	30
RONYX30034X	3.00	34
RONYX30038X	3.00	38
RONYX35008X	3.50	8
RONYX35012X	3.50	12
RONYX35015X	3.50	15
RONYX35018X	3.50	18
RONYX35022X	3.50	22
RONYX35026X	3.50	26
RONYX35030X	3.50	30
RONYX35034X	3.50	34
RONYX35038X	3.50	38
RONYX40008X	4.00	8
RONYX40012X	4.00	12
RONYX40015X	4.00	15
RONYX40018X	4.00	18
RONYX40022X	4.00	22
RONYX40026X	4.00	26
RONYX40030X	4.00	30
RONYX40034X	4.00	34
RONYX40038X	4.00	38
RONYX45012X	4.50	12
RONYX45015X	4.50	15
RONYX45018X	4.50	18
RONYX45022X	4.50	22
RONYX45026X	4.50	26
RONYX45030X	4.50	30
RONYX50012X	5.00	12
RONYX50015X	5.00	15
RONYX50018X	5.00	18
RONYX50022X	5.00	22
RONYX50026X	5.00	26
RONYX50030X	5.00	30

CORONARY STENTS

Resolute Onyx™ Drug-Eluting Stent System. Advanced Workhorse

COMPLIANCE DATA

PRESSURE (ATM)	STENT DIAMETER, DEPLOYED STENT I.D. (MM)									
	2.00	2.25	2.50	2.75	3.00	3.50	4.00	4.50	5.00	
7 (709 kPa)	1.85	2.05	2.25	2.45	2.75	3.05	3.60	4.10	4.55	
8 (811 kPa)	1.90	2.10	2.30	2.55	2.80	3.15	3.70	4.20	4.65	
9 (912 kPa)	1.90	2.15	2.35	2.60	2.90	3.25	3.80	4.30	4.80	
10 (1013 kPa)	1.95	2.20	2.45	2.65	2.95	3.35	3.85	4.40	4.90	
11 (1115 kPa)	2.00	2.25	2.50	2.70	3.00	3.40	3.95	4.45	4.95	
12 (1216 kPa)	2.05	2.30	2.55	2.75	3.05	3.45	4.00	4.50	5.05	
13 (1317 kPa)	2.05	2.35	2.55	2.80	3.10	3.50	4.05	4.55	5.10	
14 (1419 kPa)	2.10	2.35	2.60	2.80	3.10	3.55	4.05	4.60	5.15	
15 (1520 kPa)	2.10	2.35	2.60	2.85	3.15	3.55	4.10	4.65	5.20	
16 (1621 kPa)	2.15	2.40	2.65	2.90	3.20	3.60	4.15	4.70	5.25	
17 (1723 kPa)	2.15	2.40	2.70	2.90	3.20	3.65	4.20	4.80	5.30	
18 (1824 kPa)	2.20	2.45	2.70	2.95	3.25	3.70	4.25	4.85	5.35	
19 (1925 kPa)	2.20	2.45	2.75	3.00	3.30	3.75	4.30	–	–	
20 (2027 kPa)	2.25	2.50	2.75	3.00	3.35	3.80	4.35	–	–	
21 (2128 kPa)	2.25	2.50	2.80	3.05	3.40	3.80	4.40	–	–	
MSID	3.25	3.25	3.25	3.75	3.75	4.75	4.75	5.75	5.75	

Nominal pressure	Rated burst pressure ¹	Maximum Stent I.D. ²
------------------	-----------------------------------	---------------------------------

1. Do not exceed rated burst pressure.
2. Do not postdilate greater than listed value.

1. DELIVER study
2. Based on bench test data vs. Promus Premier™ DES, Synergy™ II DES, Xience Xpedition™ DES, Xience Alpine™ DES, BioMatrix NeoFlex™ DES, Orsiro™ DES Ultimaster™ DES and Resolute Integrity™ DES.

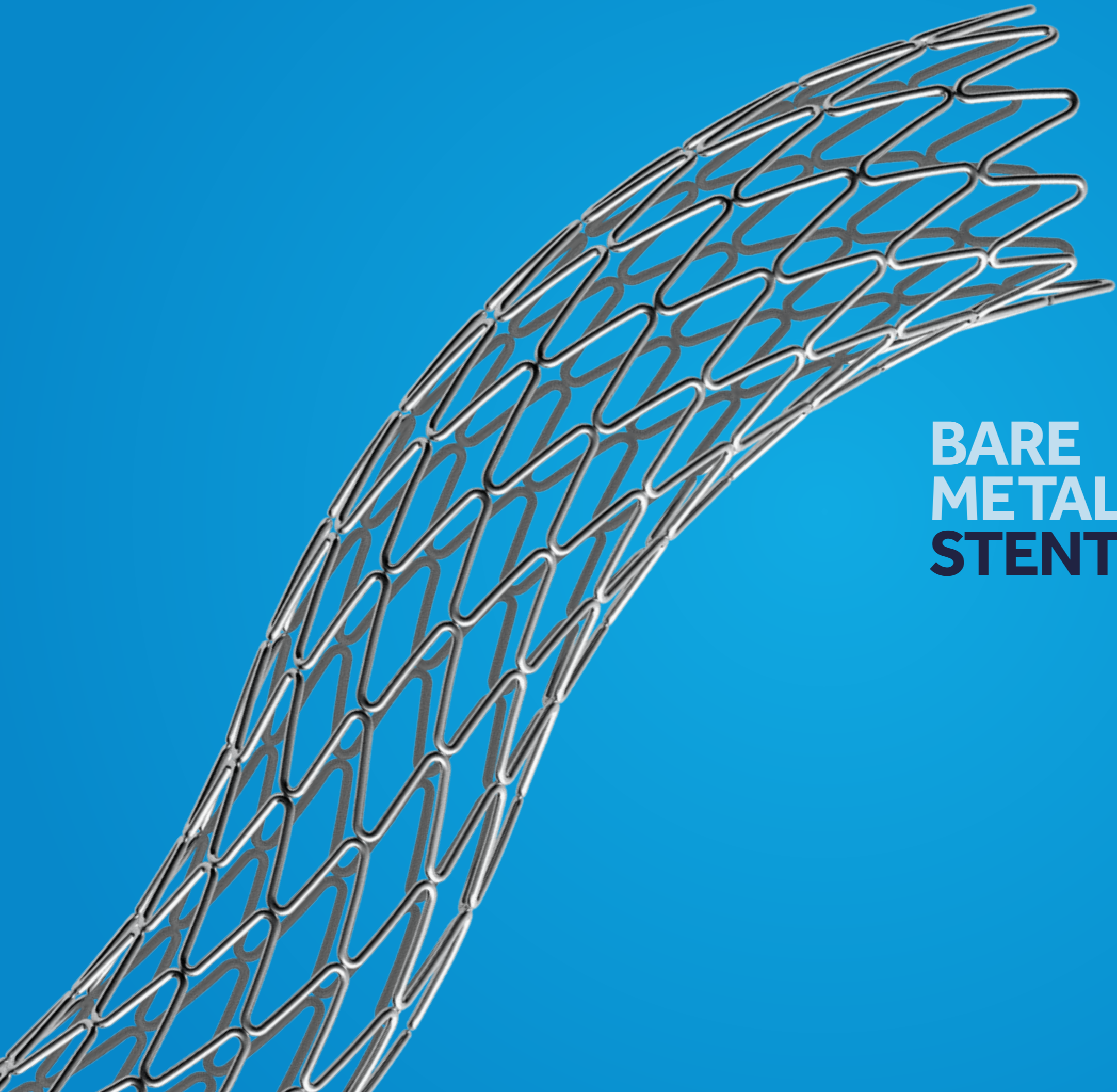

BARE METAL STENTS

CORONARY STENTS

Integrity™ Bare-Metal Rapid Exchange Coronary Stent System

GENERAL CHARACTERISTICS

* Supplied sterile • Items per box: 1

PRODUCT DESCRIPTION

The Integrity™ Bare-Metal Rapid Exchange Coronary Stent System is a low-profile advanced cobalt alloy stent manufactured using Continuous Sinusoid Technology and mounted on the extended-pressure, semi-compliant, rapid exchange MicroTrac delivery system with a low-profile exchange joint for 6 F KBT and 7 F KST* compatibility and an enhanced tip design.

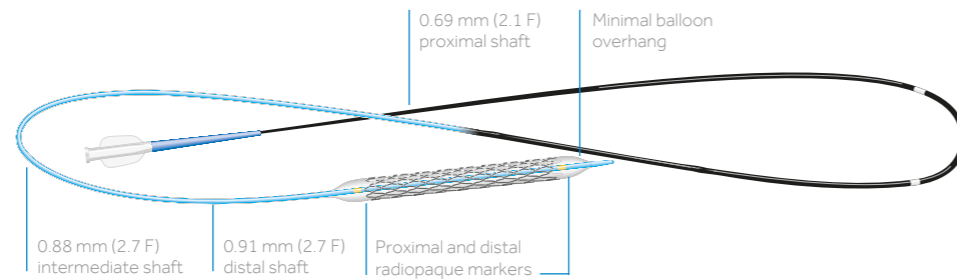

INTEGRITY RAPID EXCHANGE CORONARY STENT SYSTEM

PRODUCT CODE	STENT DIAMETER (MM)	STENT LENGTH (MM)	PRODUCT CODE	STENT DIAMETER (MM)	STENT LENGTH (MM)
INT22508X	2.25	8	INT30009X	3.00	9
INT22512X	2.25	12	INT30012X	3.00	12
INT22514X	2.25	14	INT30015X	3.00	15
INT22518X	2.25	18	INT30018X	3.00	18
INT22522X	2.25	22	INT30022X	3.00	22
INT22526X	2.25	26	INT30026X	3.00	26
INT22530X	2.25	30	INT30030X	3.00	30
INT25008X	2.50	8	INT35009X	3.50	9
INT25012X	2.50	12	INT35012X	3.50	12
INT25014X	2.50	14	INT35015X	3.50	15
INT25018X	2.50	18	INT35018X	3.50	18
INT25022X	2.50	22	INT35022X	3.50	22
INT25026X	2.50	26	INT35026X	3.50	26
INT25030X	2.50	30	INT35030X	3.50	30
INT27508X	2.75	8	INT40009X	4.00	9
INT27512X	2.75	12	INT40012X	4.00	12
INT27514X	2.75	14	INT40015X	4.00	15
INT27518X	2.75	18	INT40018X	4.00	18
INT27522X	2.75	22	INT40022X	4.00	22
INT27526X	2.75	26	INT40026X	4.00	26
INT27530X	2.75	30	INT40030X	4.00	30

CORONARY STENTS

Integrity™ Bare-Metal Rapid Exchange Coronary Stent System

COMPLIANCE DATA

PRESSURE KPA (ATM)	DEPLOYED STENT I.D. (MM)					
	2.25	2.50	2.75	3.00	3.50	4.00
608 (6)	2.25	2.50	2.75	2.95	3.35	3.80
709 (7)	2.25	2.50	2.80	3.00	3.40	3.85
811 (8)	2.30	2.55	2.85	3.05	3.45	3.95
912 (9)	2.35	2.60	2.85	3.10	3.50	4.00
1013 (10)	2.35	2.65	2.90	3.15	3.60	4.05
1115 (11)	2.40	2.70	2.95	3.20	3.65	4.15
1216 (12)	2.45	2.70	3.00	3.25	3.65	4.20
1317 (13)	2.50	2.75	3.05	3.30	3.70	4.20
1419 (14)	2.50	2.80	3.10	3.30	3.75	4.25
1520 (15)	2.55	2.80	3.10	3.35	3.80	4.30
1621 (16)	2.60	2.85	3.15	3.40	3.85	4.35
1723 (17)	2.65	2.90	3.20	3.45	3.90	4.40
1824 (18)	2.70	2.95	3.25	3.50	3.90	4.45
1925 (19)	2.75	3.00	3.30	3.55	3.95	4.50
2027 (20)	2.80	3.05	3.40	3.60	4.00	—
MSID	3.50*	3.50*	3.50*	4.75*	4.75*	4.75*

Nominal pressure	Rated burst pressure ¹	Maximum Stent I.D. ²
------------------	-----------------------------------	---------------------------------

1. Do not exceed rated burst pressure.
 2. Do not dilate the 2.25–2.75-mm stents to greater than 3.50 mm.
 Do not dilate the 3.00–4.00-mm stents to greater than 4.75 mm.

BALLOON DILATATION CATHETERS



- CONTENTS
- 1. DRUG ELUTING STENTS
- 2. METAL STENTS
- 3. BALLOON DILATATION CATHETERS**
- 4. DRUG ELUTING BALLOONS
- 5. GUIDE CATHETER FAMILY
- 6. INTERVENTIONAL GUIDEWIRES
- 7. ASPIRATION CATHETERS
- 8. ANGIOGRAPHIC CATHETERS AND WIRES
- 9. INTRODUCERS
- 10. INTERVENTIONAL ACCESSORIES
- 11. PEDIATRIC AND TRANSCATHETER PRODUCTS
- 12. RENAL DENERVATION

BALLOON DILATATION CATHETERS

Euphora™ Semicompliant Balloon Dilatation Catheter

GENERAL CHARACTERISTICS

• Supplied sterile • Items per box: 1

PRODUCT DESCRIPTION

From materials to design, every Euphora™ balloon component was developed to provide superior deliverability¹ with unmatched crossability¹ and pushability

FEATURES

- Ultra-slim balloon material
- Optimised miniwrap
- Low profile marker bands
- Tapered shaft
- PowerTrac™ shaft technology
- Low-profile inner/outer shaft

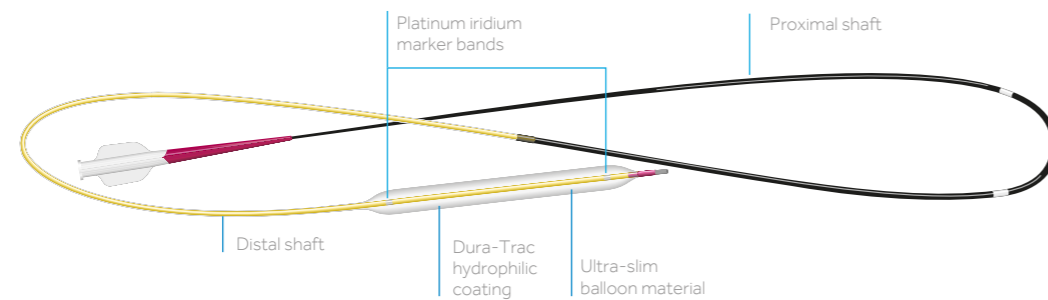

PRODUCT CODE

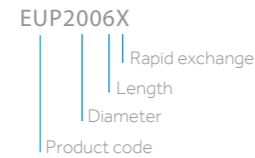

SIZE MATRIX

BALLOON DIAMETER (MM)	BALLOON LENGTH (MM)						
	06	10	12	15	20	25	30
1.50	EUP1506X	EUP1510X	EUP1512X	EUP1515X	EUP1520X	—	—
2.00	EUP2006X	EUP2010X	EUP2012X	EUP2015X	EUP2020X	EUP2025X	EUP2030X
2.25	EUP22506X	EUP22510X	EUP22512X	EUP22515X	EUP22520X	EUP22525X	—
2.50	EUP2506X	EUP2510X	EUP2512X	EUP2515X	EUP2520X	EUP2525X	EUP2530X
2.75	EUP27506X	EUP27510X	EUP27512X	EUP27515X	EUP27520X	EUP27525X	—
3.00	EUP3006X	EUP3010X	EUP3012X	EUP3015X	EUP3020X	EUP3025X	EUP3030X
3.25	EUP32506X	EUP32510X	EUP32512X	EUP32515X	EUP32520X	EUP32525X	—
3.50	EUP3506X	EUP3510X	EUP3512X	EUP3515X	EUP3520X	EUP3525X	EUP3530X
3.75	EUP37506X	EUP37510X	EUP37512X	EUP37515X	EUP37520X	EUP37525X	—
4.00	EUP4006X	EUP4010X	EUP4012X	EUP4015X	EUP4020X	EUP4025X	EUP4030X

BALLOON DILATATION CATHETERS

Euphora™ Semicompliant Balloon Dilatation Catheter

COMPLIANCE DATA

PRESSURE KPA (ATM)	AVERAGE BALLOON DIAMETER (MM)									
	1.50	2.00	2.25	2.50	2.75	3.00	3.25	3.50	3.75	4.00
608 (6)	1.49	2.03	2.27	2.50	2.70	2.92	3.17	3.39	3.66	3.88
709 (7)	1.51	2.05	2.30	2.52	2.73	2.95	3.21	3.43	3.70	3.93
811 (8)	1.52	2.07	2.32	2.55	2.77	2.99	3.25	3.48	3.75	3.99
912 (9)	1.54	2.09	2.35	2.58	2.80	3.03	3.30	3.53	3.80	4.04
1013 (10)	1.55	2.12	2.38	2.61	2.84	3.06	3.34	3.58	3.85	4.10
1115 (11)	1.57	2.14	2.41	2.64	2.87	3.10	3.38	3.62	3.90	4.14
1216 (12)	1.58	2.17	2.43	2.67	2.91	3.14	3.42	3.67	3.95	4.19
1317 (13)	1.60	2.19	2.46	2.70	2.94	3.17	3.46	3.71	4.00	4.23
1419 (14)	1.61	2.22	2.49	2.73	2.98	3.21	3.51	3.76	4.05	4.28
1520 (15)	1.62	2.25	2.52	2.76	3.02	3.25	3.56	3.81	4.10	4.33
1621 (16)	1.64	2.28	2.56	2.79	3.06	3.29	3.61	3.86	4.16	4.38
1723 (17)	1.65	—	2.60	2.83	3.11	3.34	3.66	3.91	4.22	4.43

Nominal pressure¹ Rated burst pressure²

1. Nominal pressure: the pressure at which the balloon approximates its labeled diameter
 2. Rated burst pressure: the maximum pressure to which a balloon is designed to be inflated – do not exceed.

TECHNICAL INFORMATION

Catheter length	142 cm	
Platinum iridium marker bands	1.50 mm 2.00–4.00 mm	Single Double
Coating	Selective Dura-Trac	
Balloon material	Ultra-Slim	
MiniWrap	1.50 mm 2.00–3.50 mm 3.75–4.00 mm	2 folds 3 folds 5 folds
Shaft dimensions: 1.50–3.50 mm	Proximal Distal	0.69 mm (2.1 F) 0.84 mm (2.5 F)
Shaft dimensions: 3.75–4.00 mm	Proximal Distal	0.69 mm (2.1 F) 0.91 mm (2.7 F)
MGCID	For 1.50–4.00 mm balloon	1.42 mm/0.056 in.
Nominal pressure, atm	8	
Rated burst pressure (RBP), atm	14	
Cycles to RBP	10	
Lesion entry profile	0.016 in.	

1. Competitive testing vs. NC Trek and NC Quantum Apex™ balloons on file at Medtronic.
 2. Rated burst pressure—do not exceed.

BALLOON DILATATION CATHETERS

NC Euphora™ Noncompliant Balloon Dilatation Catheter

GENERAL CHARACTERISTICS

• Supplied sterile • Items per box: 1

PRODUCT DESCRIPTION

From material to design every NC Euphora™ balloon component was developed to provide superior growth profile and deliverability, excellent recross and high-pressure capability

FEATURES

- Strong, durable and flexible LIGHT™ (Low Inflation Growth, High Track) balloon material
- Low profile platinum iridium marker bands
- Optimized tapered tip
- PowerTrac™ shaft technology
- Low-profile inner/outer shaft

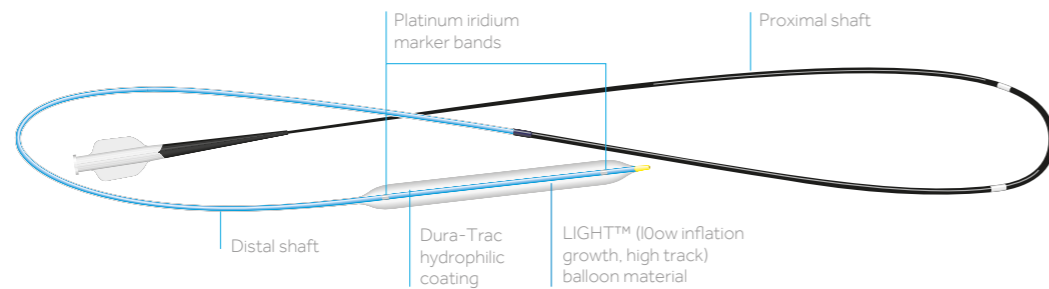

PRODUCT CODE

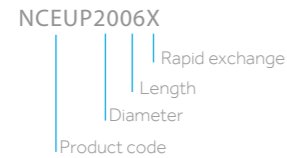

SIZE MATRIX

BALLOON DIAMETER (MM)	BALLOON LENGTH (MM)					
	06	08	12	15	20	27
2.00	NCEUP2006X	NCEUP2008X	NCEUP2012X	NCEUP2015X	NCEUP2020X	—
2.25	NCEUP22506X	NCEUP22508X	NCEUP22512X	NCEUP22515X	NCEUP22520X	—
2.50	NCEUP2506X	NCEUP2508X	NCEUP2512X	NCEUP2515X	NCEUP2520X	NCEUP2527X
2.75	NCEUP27506X	NCEUP27508X	NCEUP27512X	NCEUP27515X	NCEUP27520X	NCEUP27527X
3.00	NCEUP3006X	NCEUP3008X	NCEUP3012X	NCEUP3015X	NCEUP3020X	NCEUP3027X
3.25	NCEUP32506X	NCEUP32508X	NCEUP32512X	NCEUP32515X	NCEUP32520X	NCEUP32527X
3.50	NCEUP3506X	NCEUP3508X	NCEUP3512X	NCEUP3515X	NCEUP3520X	NCEUP3527X
3.75	NCEUP37506X	NCEUP37508X	NCEUP37512X	NCEUP37515X	NCEUP37520X	NCEUP37527X
4.00	NCEUP4006X	NCEUP4008X	NCEUP4012X	NCEUP4015X	NCEUP4020X	NCEUP4027X
4.50	—	NCEUP4508X	NCEUP4512X	NCEUP4515X	NCEUP4520X	—
5.00	—	NCEUP5008X	NCEUP5012X	NCEUP5015X	—	—

BALLOON DILATATION CATHETERS

NC Euphora™ Noncompliant Balloon Dilatation Catheter

COMPLIANCE DATA

PRESSURE KPA (ATM)	AVERAGE BALLOON DIAMETER (MM)										
	2.00	2.25	2.50	2.75	3.00	3.25	3.50	3.75	4.00	4.50	5.00
608 (6)	1.89	2.12	2.35	2.54	2.77	2.94	3.13	3.43	3.67	4.09	4.64
709 (7)	1.91	2.15	2.37	2.57	2.80	2.97	3.17	3.47	3.72	4.14	4.71
811 (8)	1.93	2.17	2.40	2.60	2.84	3.01	3.22	3.51	3.78	4.19	4.79
912 (9)	1.95	2.19	2.43	2.63	2.87	3.06	3.27	3.56	3.84	4.25	4.86
1013 (10)	1.97	2.21	2.46	2.66	2.91	3.10	3.32	3.61	3.90	4.31	4.92
1115 (11)	1.98	2.23	2.48	2.69	2.94	3.14	3.37	3.66	3.95	4.37	4.95
1216 (12)	1.99	2.25	2.50	2.71	2.97	3.18	3.41	3.70	3.99	4.42	5.00
1317 (13)	2.00	2.26	2.51	2.73	2.99	3.21	3.44	3.73	4.03	4.47	5.04
1419 (14)	2.02	2.28	2.53	2.75	3.01	3.23	3.47	3.76	4.07	4.51	5.08
1520 (15)	2.03	2.29	2.54	2.77	3.03	3.26	3.50	3.78	4.10	4.54	5.12
1621 (16)	2.04	2.30	2.56	2.78	3.05	3.28	3.52	3.81	4.13	4.58	5.15
1723 (17)	2.05	2.31	2.58	2.80	3.07	3.30	3.55	3.83	4.15	4.60	5.19
1824 (18)	2.06	2.33	2.59	2.81	3.09	3.33	3.57	3.86	4.18	4.63	5.23
1925 (19)	2.07	2.34	2.61	2.83	3.11	3.35	3.59	3.88	4.21	4.66	5.27
2027 (20)	2.09	2.36	2.63	2.84	3.13	3.37	3.62	3.91	4.24	4.69	5.30
2128 (21)	2.10	2.37	2.65	2.86	3.15	3.39	3.64	3.93	4.28	4.72	5.35
2229 (22)	2.12	2.39	2.66	2.88	3.17	3.41	3.66	3.96	4.31	4.75	5.39
2330 (23)	2.14	2.40	2.68	2.90	3.20	3.43	3.69	3.99	4.34	4.78	—
2432 (24)	2.15	2.42	2.71	2.92	3.22	—	3.71	—	—	4.81	—
2533 (25)	—	2.44	—	2.94	3.25	—	3.74	—	—	4.84	—

Nominal pressure¹ Rated burst pressure²

1. Nominal pressure: the pressure at which the balloon approximates its labeled diameter
 2. Rated burst pressure: the maximum pressure to which a balloon is designed to be inflated – do not exceed.

TECHNICAL INFORMATION

Catheter length	142 cm	
Platinum iridium marker bands	2.00 – 5.00 mm	Double
Coating	Selective Dura-Trac	
Balloon material	LIGHT (Low Inflation Growth, High Track)	
MiniWrap	2.00 – 3.75 mm 4.00 – 5.00 mm	3 folds 5 folds
Shaft dimensions For 2.00 – 3.75 mm	Proximal Distal	0.69 mm (2.1 F) 0.84 mm (2.5 F)
Shaft dimensions For 4.00 – 5.00 mm	Proximal Distal	0.69 mm (2.1 F) 0.91 mm (2.7 F)
MGCID	For 2.00 - 4.00 mm balloon For 4.50 - 5.00 mm balloon	1.42 mm/0.056 in. 1.68 mm/0.066 in.
Nominal pressure, atm	12	
Rated burst pressure (RBP), atm	20	
Cycles to RBP	20	
Lesion entry profile	0.015 in.	

BALLOON DILATATION CATHETERS

Sprinter Legend™ RX 1.25 mm Semicompliant Rapid Exchange Balloon Dilatation Catheter

GENERAL CHARACTERISTICS

- Supplied sterile • Items per box: 1

PRODUCT DESCRIPTION

The Sprinter Legend™ RX 1.25 mm semicompliant rapid exchange balloon dilatation catheter, with its SuperCROSSER Zerofold Technology, (no balloon wrap or shoulders) helps provide your best chance at crossing even the most difficult lesions

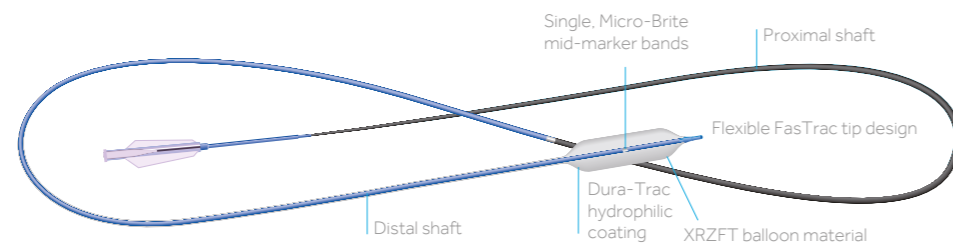

FEATURES

- Lesion entry profile: 0.41 mm (0.016")
- Crossing profile: 0.5 mm (0.020")
- Profile over mid-marker: 0.6 mm (0.024")
- No wrapped material allows for ultra-low catheter profile. Expands from a straight tube into a balloon
- No balloon shoulders,¹ Facilitates balloon passage through the lesion

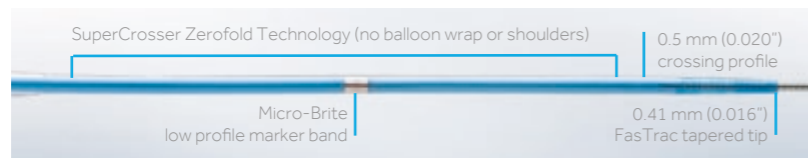
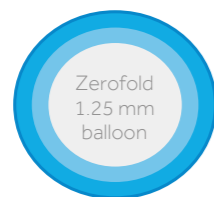

COMPLIANCE DATA

PRESSURE KPA (ATM)	BALLOON DIAMETER 1.25
405 (4)	0.60
507 (5)	0.60
608 (6)	0.63
709 (7)	0.67
811 (8)	0.75
912 (9)	0.86
1013 (10)	0.99
1115 (11)	1.11
1216 (12)	1.20
1317 (13)	1.28
1419 (14)	1.35
1520 (15)	1.40
Nominal pressure & Rated burst pressure	

ORDERING INFORMATION

BALLOON DIAMETER (MM)	BALLOON LENGTH (MM)				
	6	10	12	15	20
1.25	SPL12506X	SPL12510X	SPL12512X	SPL12515X	SPL12520X

BALLOON DILATATION CATHETERS

Sprinter Legend™ RX Semicompliant Rapid Exchange Balloon Dilatation Catheter

GENERAL CHARACTERISTICS

- Supplied sterile • Items per box: 1

PRODUCT DESCRIPTION

A high-performing semicompliant balloon available in a wide range of diameters and lengths, designed to meet a comprehensive spectrum of interventional needs and maximise your success in treating patients

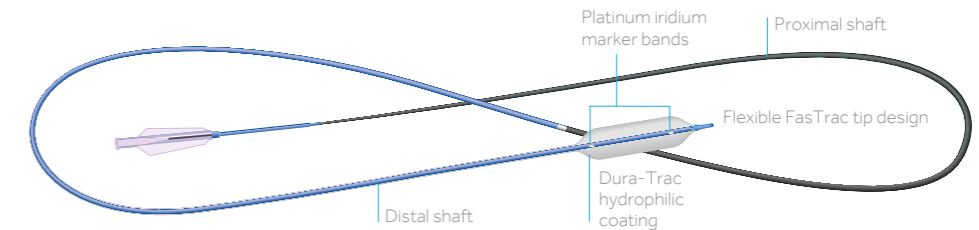

PRODUCT CODE

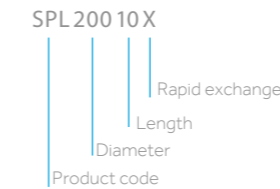

ORDERING INFORMATION

BALLOON DIAMETER (MM)	BALLOON LENGTH (MM)						
	6	10	12	15	20	25	30
1.25	SPL12506X	SPL12510X	SPL12512X	SPL12515X	SPL12520X	—	—
1.50	SPL15006X	SPL15010X	SPL15012X	SPL15015X	SPL15020X	—	—
2.00	SPL20006X	SPL20010X	SPL20012X	SPL20015X	SPL20020X	SPL20025X	SPL20030X
2.25	SPL22506X	SPL22510X	SPL22512X	SPL22515X	SPL22520X	SPL22525X	—
2.50	SPL25006X	SPL25010X	SPL25012X	SPL25015X	SPL25020X	SPL25025X	SPL25030X
2.75	SPL27506X	—	SPL27512X	SPL27515X	SPL27520X	SPL27525X	—
3.00	SPL30006X	SPL30010X	SPL30012X	SPL30015X	SPL30020X	SPL30025X	SPL30030X
3.25	—	—	SPL32512X	SPL32515X	SPL32520X	—	—
3.50	SPL35006X	SPL35010X	SPL35012X	SPL35015X	SPL35020X	SPL35025X	SPL35030X
3.75	—	—	SPL37512X	SPL37515X	SPL37520X	—	—
4.00	SPL40006X	SPL40010X	SPL40012X	SPL40015X	SPL40020X	SPL40025X	SPL40030X

1. Test data on file at Medtronic, Inc. Best-in-class profiles based on distal balloon shoulder outer diameter vs. key competitors. Bench test data may not be indicative of clinical results.

Test data on file at Medtronic, Inc. Bench testing not necessarily indicative of clinical performance.

Nominal pressure: the pressure at which the balloon reaches its labeled diameter. Rated burst pressure: the maximum pressure to which a balloon is designed to be inflated (95% confidence that 99.9% will not fail below rated burst pressure).

BALLOON DILATATION CATHETERS

Sprinter Legend™ RX Semicompliant Rapid Exchange Balloon Dilatation Catheter

GENERAL CHARACTERISTICS

• Supplied sterile • Items per box: 1

COMPLIANCE DATA

	PRESSURE KPA (ATM)	BALLOON DIAMETER (MM)										
		1.25	1.50	2.00	2.25	2.50	2.75	3.00	3.25	3.50	3.75	4.00
405 (4)	0.60	1.36	—	—	—	—	—	—	—	—	—	—
507 (5)	0.60	1.41	—	—	—	—	—	—	—	—	—	—
608 (6)	0.63	1.47	1.91	2.23	2.34	2.60	2.81	3.14	3.32	3.61	3.85	—
709 (7)	0.67	1.53	1.95	2.29	2.41	2.67	2.89	3.22	3.42	3.70	3.96	—
811 (8)	0.75	1.58	2.00	2.33	2.47	2.74	2.97	3.29	3.50	3.79	4.05	—
912 (9)	0.86	1.61	2.03	2.38	2.53	2.79	3.04	3.35	3.57	3.86	4.12	—
1013 (10)	0.99	1.64	2.06	2.41	2.57	2.84	3.09	3.40	3.63	3.93	4.18	—
1115 (11)	1.11	1.67	2.09	2.44	2.61	2.89	3.14	3.44	3.68	3.98	4.23	—
1216 (12)	1.20	1.70	2.12	2.47	2.64	2.93	3.18	3.48	3.73	4.02	4.29	—
1317 (13)	1.28	1.73	2.14	2.51	2.67	2.96	3.22	3.52	3.77	4.07	4.35	—
1419 (14)	1.35	1.75	2.16	2.54	2.70	3.00	3.25	3.56	3.82	4.12	4.40	—
1520 (15)	1.40	1.78	2.19	2.58	2.73	3.03	3.29	3.59	3.87	4.16	4.45	—
1621 (16)	—	—	2.21	2.61	2.76	3.07	3.33	3.64	3.92	4.21	4.50	—

Nominal pressure ¹	Rated burst pressure ²	Nominal pressure & rated burst pressure
-------------------------------	-----------------------------------	---

1. Nominal pressure: the pressure at which the balloon approximates its labeled diameter
2. Rated burst pressure: the maximum pressure to which a balloon is designed to be inflated – do not exceed.

TECHNICAL INFORMATION

Catheter length (cm)	142
Distal shaft length (cm)	21
Platinum iridium marker bands	
1.25-1.50 mm	Single
2.00-4.00 mm	Double
Coating	Selective Dura-Trac
MiniWrap	
1.25 mm	Zero Fold
1.50 mm	2 folds
2.00 mm-3.75mm	3 folds
4.00 mm	5 folds
Shaft dimensions for 1.25-3.5mm	
Proximal	1.9F
Distal	2.4F/2.6F
Shaft dimensions for 3.75-4.00 mm	
Proximal	1.9F
Distal	2.5F/2.7F
MGCID	1.4 mm/0.056" (1.25-3.50)



*Compatible with 6 F kissing balloon technique.

*Any combination of two Sprinter Legend rapid exchange balloon models (1.25 - 3.50 mm) can be used for the Kissing Balloon Technique within a 6 F (MGCID 0.070") guide catheter. Test data on file at Medtronic, Inc.

BALLOON DILATATION CATHETERS

Sprinter Legend™ 1.25 OTW Semi-compliant Balloon Dilatation Catheter

GENERAL CHARACTERISTICS

• Supplied sterile • Items per box: 1

PRODUCT DESCRIPTION

Sprinter Legend™ 1.25 OTW semicompliant balloon is designed to maximise your chances for a successful outcome on highly complex, challenging and tightly occluded lesions.

FEATURES

- Superb push and track—for easier lesion access
- Excellent postinflation profile—for smooth recross
- Ultralow crossing profiles—for advanced lesion crossing
- 152-cm catheter length—to facilitate extended vasculature

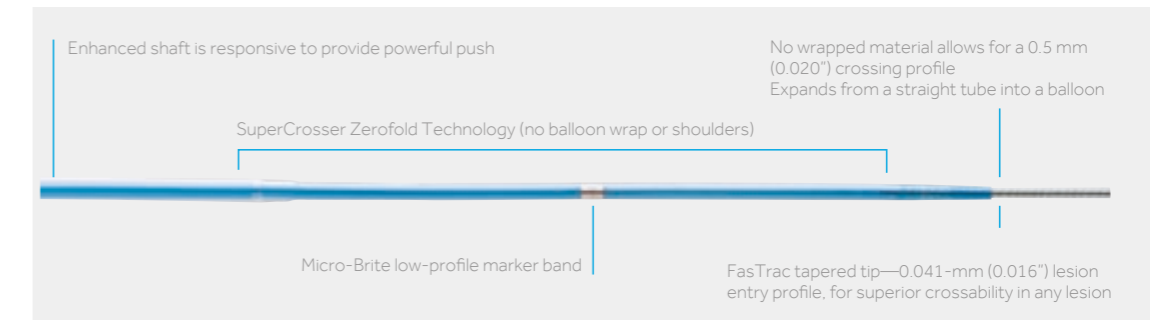

PRODUCT CODE

SPL 125 10 WL
Over the wire
Length
Diameter
Product code

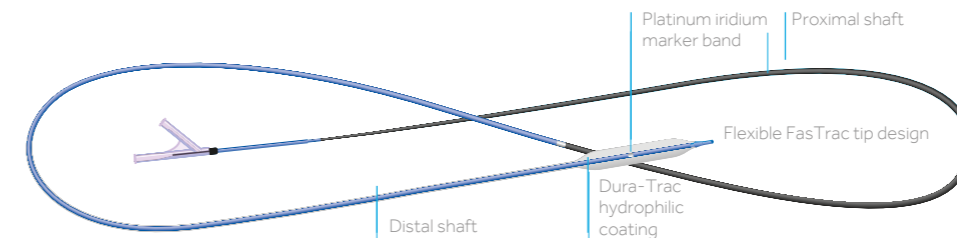

TECHNICAL INFORMATION

Catheter length (cm)	152
Distal shaft length (cm)	22.5
Platinum iridium marker band	1.25mm single
Coating	Selective Dura-Trac
SuperCROSSER Zerofold technology	
Shaft dimensions	
Proximal	3.2F
Distal	2.4F/2.6F
MGCID	1.42 mm/0.056"
Crossing profile	1.25 MM 0.5 mm (0.020 in)

ORDERING INFORMATION

BALLOON DIAMETER (MM)	BALLOON LENGTH (MM)	6	10	15	20
1.25	SPL12506WL	SPL12510WL	SPL12515WL	SPL12520WL	

COMPLIANCE DATA

PRESSURE KPA (ATM)	BALLOON DIAMETER 1.25
405 (4)	0.60
507 (5)	0.60
608 (6)	0.63
709 (7)	0.67
811 (8)	0.75
912 (9)	0.86
1013 (10)	0.99
1115 (11)	1.11
1216 (12)	1.20
1317 (13)	1.28
1419 (14)	1.35
1520 (15)	1.40
1621 (16)	
Nominal pressure & rated burst pressure	

BALLOON DILATATION CATHETERS

Sprinter™ OTW Semi-compliant Over-the-Wire Balloon Dilatation Catheter

GENERAL CHARACTERISTICS

• Supplied sterile • Items per box: 1

PRODUCT DESCRIPTION

A high-performing semicompliant balloon available in a wide range of diameters and lengths, designed to meet a comprehensive spectrum of interventional needs and maximise your success in treating patients.

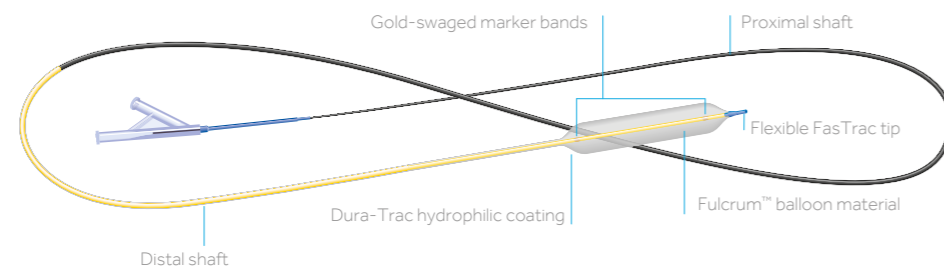

PRODUCT CODE

SPL 200 10 W
 W = Over-the-Wire
 Length
 Diameter
 Product code

ORDERING INFORMATION

BALLOON DIAMETER (MM)	BALLOON LENGTH (MM)						
	6	10	12	15	20	25	30
1.50	SPR15006W	SPR15010W	SPR15012W	SPR15015W	SPR15020W	—	—
2.00	SPR20006W	SPR20010W	SPR20012W	SPR20015W	SPR20020W	SPR2025W	SPR2030W
2.25	SPR22506W	SPR22510W	SPR22512W	SPR22515W	SPR22520W	—	—
2.50	SPR25006W	SPR25010W	SPR25012W	SPR25015W	SPR25020W	SPR2525W	SPR2530W
2.75	SPR27506W	—	SPR27512W	SPR27515W	SPR27520W	—	—
3.00	SPR30006W	SPR30010W	SPR30012W	SPR30015W	SPR30020W	SPR3025W	SPR3030W
3.25	—	—	SPR32512W	SPR32515W	SPR32520W	—	—
3.50	SPR35006W	SPR35010W	SPR35012W	SPR35015W	SPR35020W	SPR3525W	SPR3530W
3.75	—	—	SPR37512W	SPR37515W	SPR37520W	—	—
4.00	SPR40006W	SPR40010W	SPR40012W	SPR40015W	SPR40020W	SPR4025W	SPR4030W

BALLOON DILATATION CATHETERS

Sprinter™ OTW Semi-compliant Over-the-Wire Balloon Dilatation Catheter

COMPLIANCE DATA

PRESSURE KPA (ATM)	BALLOON DIAMETER (MM)									
	1.50	2.00	2.25	2.50	2.75	3.00	3.25	3.50	3.75	4.00
405 (4)	1.37	1.77	2.00	2.22	2.40	2.62	2.87	3.01	3.35	3.48
507 (5)	1.42	1.83	2.07	2.29	2.49	2.71	2.98	3.14	3.48	3.64
608 (6)	1.47	1.88	2.14	2.37	2.57	2.81	3.08	3.25	3.60	3.78
709 (7)	1.52	1.93	2.20	2.44	2.66	2.90	3.18	3.37	3.70	3.91
811 (8)	1.55	1.97	2.25	2.50	2.73	2.98	3.25	3.47	3.80	4.02
912 (9)	1.58	2.01	2.30	2.55	2.80	3.05	3.32	3.55	3.87	4.11
1013 (10)	1.60	2.04	2.33	2.59	2.85	3.10	3.38	3.62	3.93	4.19
1115 (11)	1.63	2.07	2.37	2.63	2.89	3.14	3.42	3.68	3.98	4.25
1216 (12)	1.65	2.10	2.40	2.66	2.93	3.18	3.46	3.72	4.03	4.31
1317 (13)	1.67	2.12	2.43	2.69	2.97	3.22	3.51	3.77	4.08	4.37
1419 (14)	1.69	2.15	2.46	2.72	3.00	3.26	3.55	3.82	4.13	4.42
1520 (15)	1.72	2.17	2.49	2.76	3.04	3.29	3.59	3.87	4.19	4.48
1621 (16)	-	2.19	2.53	2.79	3.08	3.33	3.64	3.92	4.24	4.54
1723 (17)	-	2.21	2.56	2.82	3.11	3.37	3.69	3.97	4.30	4.60
1824 (18)	-	2.24	2.59	2.86	3.15	3.42	3.73	4.02	4.38	4.67

Nominal pressure¹ Rated burst pressure²

1. Nominal pressure: the pressure at which the balloon approximates its labeled diameter
 2. Rated burst pressure: the maximum pressure to which a balloon is designed to be inflated – do not exceed.

TECHNICAL INFORMATION

Catheter length	138 cm
Gold-swaged marker bands	
1.5mm	Single
2.00 – 4.00mm	Double
Coating	Dura-Trac selective
Balloon material	Falcrum™
MiniWrap	
1.5mm	2 folds
2.00 – 3.75mm	3 folds
4.00 – 5.00mm	5 folds
Shaft dimensions for 1.5 – 3.5mm	
Proximal	3.2 F
Distal	2.4 F / 2.6 F
Shaft dimensions for 3.75 – 4.0mm	
Proximal	3.2 F
Distal	2.5 F
MGCID	1.42 mm/0.056"

BALLOON DILATATION CATHETERS

NC Sprinter™ Noncompliant Rapid Exchange Balloon Dilatation Catheter

GENERAL CHARACTERISTICS

• Supplied sterile • Items per box: 1

PRODUCT DESCRIPTION

The NC Sprinter™ noncompliant rapid exchange balloon dilatation catheter combines proven Sprinter technology with the high-pressure capability and controlled expansion of a noncompliant balloon-performance for optimal stenting results.

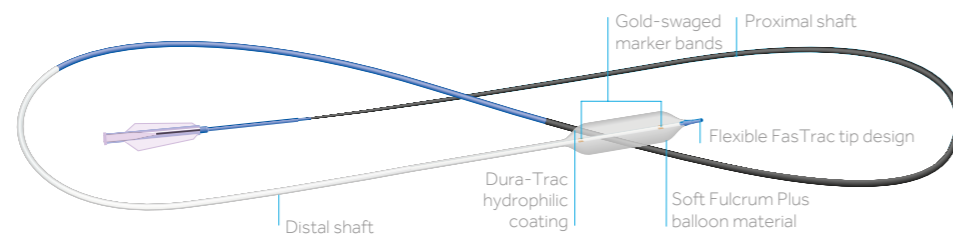

PRODUCT CODE

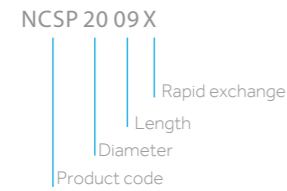

ORDERING INFORMATION

BALLOON DIAMETER (MM)	BALLOON LENGTH (MM)					
	6	9	12	15	21	27
2.00	NCSP2006X	NCSP2009X	NCSP2012X	NCSP2015X	NCSP2021X	—
2.25	NCSP22506X	—	NCSP22512X	—	NCSP22521X	—
2.50	NCSP2506X	NCSP2509X	NCSP2512X	NCSP2515X	NCSP2521X	NCSP2527X
2.75	NCSP27506X	NCSP27509X	NCSP27512X	NCSP27515X	NCSP27521X	—
3.00	NCSP3006X	NCSP3009X	NCSP3012X	NCSP3015X	NCSP3021X	NCSP3027X
3.25	NCSP32506X	NCSP32509X	NCSP32512X	NCSP32515X	NCSP32521X	—
3.50	NCSP3506X	NCSP3509X	NCSP3512X	NCSP3515X	NCSP3521X	NCSP3527X
3.75	NCSP37506X	NCSP37509X	NCSP37512X	NCSP37515X	NCSP37521X	—
4.00	NCSP4006X	NCSP4009X	NCSP4012X	NCSP4015X	NCSP4021X	NCSP4027X
4.50	—	—	—	NCSP4515X	NCSP4521X	—
5.00	—	—	—	NCSP5015X	—	—

BALLOON DILATATION CATHETERS

NC Sprinter™ Noncompliant Rapid Exchange Balloon Dilatation Catheter

COMPLIANCE DATA

PRESSURE KPA (ATM)	BALLOON DIAMETER (MM)										
	2.00	2.25	2.50	2.75	3.00	3.25	3.50	3.75	4.00	4.50	5.00
811 (8)	1.98	2.17	2.45	2.70	2.97	3.09	3.36	3.62	3.87	4.27	4.75
912 (9)	2.00	2.20	2.49	2.74	3.01	3.15	3.42	3.68	3.93	4.34	4.84
1013 (10)	2.02	2.23	2.51	2.77	3.04	3.18	3.45	3.72	3.97	4.39	4.91
1115 (11)	2.03	2.24	2.53	2.80	3.07	3.22	3.49	3.76	4.01	4.44	4.97
1216 (12)	2.05	2.26	2.55	2.82	3.10	3.25	3.52	3.79	4.05	4.48	5.01
1317 (13)	2.07	2.28	2.57	2.84	3.13	3.28	3.55	3.82	4.08	4.51	5.06
1419 (14)	2.08	2.30	2.58	2.87	3.15	3.31	3.58	3.85	4.11	4.55	5.10
1520 (15)	2.10	2.32	2.60	2.89	3.18	3.33	3.61	3.88	4.15	4.58	5.14
1621 (16)	2.12	2.33	2.62	2.91	3.20	3.36	3.63	3.90	4.18	4.61	5.18
1723 (17)	2.13	2.36	2.63	2.93	3.23	3.39	3.65	3.93	4.22	4.65	5.22
1824 (18)	2.15	2.38	2.65	2.95	3.26	3.41	3.68	3.96	4.25	4.68	5.26
1925 (19)	2.17	2.40	2.66	2.98	3.29	3.44	3.71	3.99	4.29	4.72	5.30
2026 (20)	2.19	2.42	2.68	3.00	—	3.47	3.73	4.02	—	4.76	—
2128 (21)	2.21	2.44	2.70	3.03	—	3.50	3.77	4.05	—	4.80	—
2229 (22)	2.23	2.46	2.72	3.05	—	3.53	—	4.08	—	4.84	—

Nominal pressure¹ Rated burst pressure²

1. Nominal pressure: the pressure at which the balloon approximates its labeled diameter
2. Rated burst pressure: the maximum pressure to which a balloon is designed to be inflated – do not exceed.

TECHNICAL INFORMATION

Catheter length	142 cm
Gold-swaged marker bands 2.00 - 5.00mm	Double
Coating	Selective Dura-Trac
Balloon material	Soft Fulcrum Plus
MiniWrap 2.00mm - 3.75mm 4.00mm - 5.00mm	3 folds 5 folds
Shaft dimensions for 2.00 - 3.75mm Proximal Distal	0.65 mm (1.9F) 0.81 mm/0.86 mm (2.4F/2.6F)
Shaft dimensions for 4.00 - 5.00mm Proximal Distal	0.65 mm (1.9F) 1.02 mm (3.0F)
MGCID 2.00mm - 4.00mm 4.50mm - 5.00mm	1.42 mm/.056" 1.68 mm/.066"

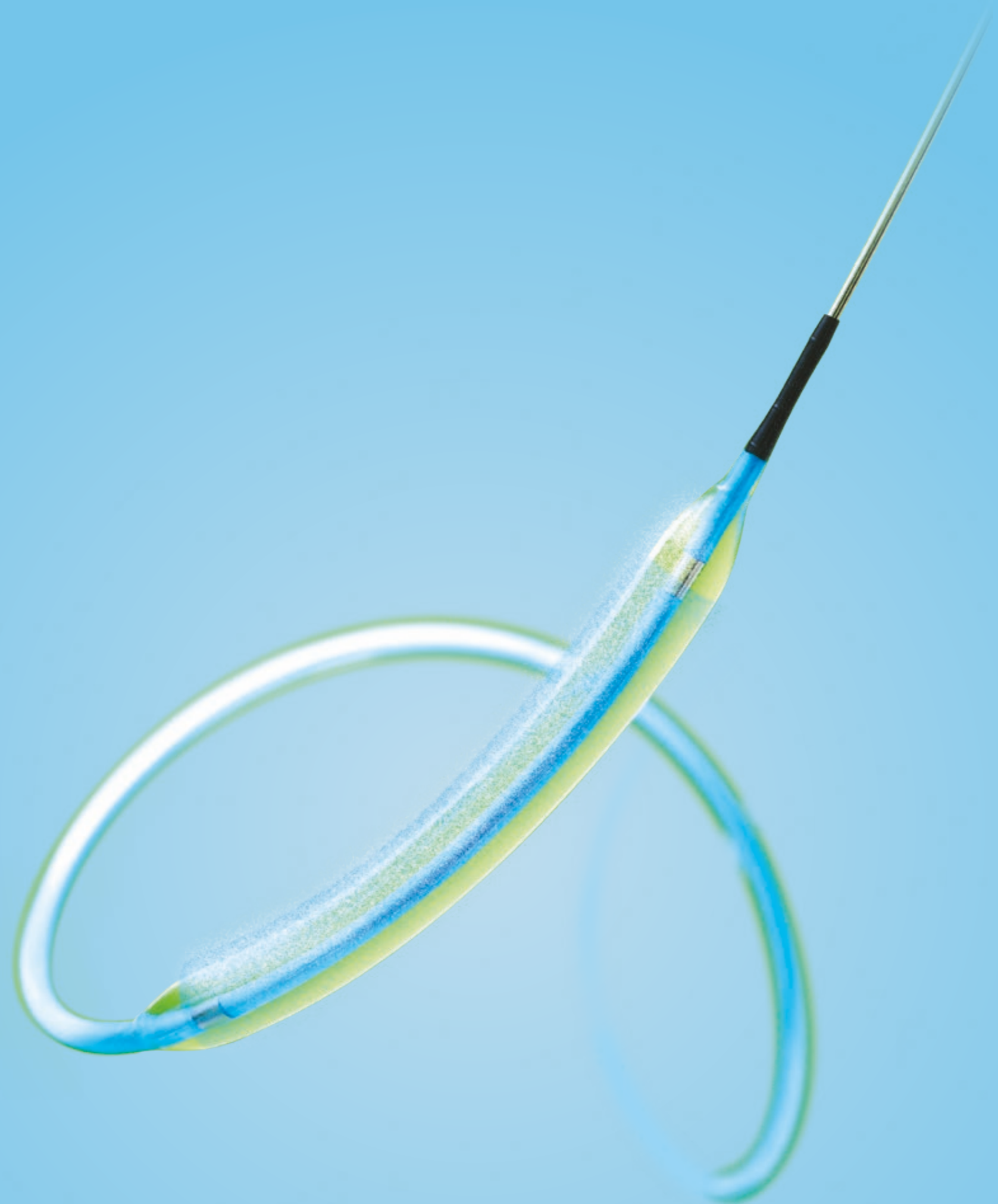

DRUG ELUTING BALLOONS

DRUG ELUTING BALLOONS

In.Pact Falcon™ Paclitaxel-Eluting Coronary Balloon Catheter

GENERAL CHARACTERISTICS

- Supplied sterile; items per box: 1

PRODUCT DESCRIPTION

The balloon's unique FreePac coating combines urea and paclitaxel molecules into a compound that provides increased drug solubility and optimal diffusion into the vessel wall, short-term drug delivery and continued antirestenotic protection.

FEATURES

- Paclitaxel drug
- Urea drug carrier
- Falcon™ Bravo semi-compliant balloon

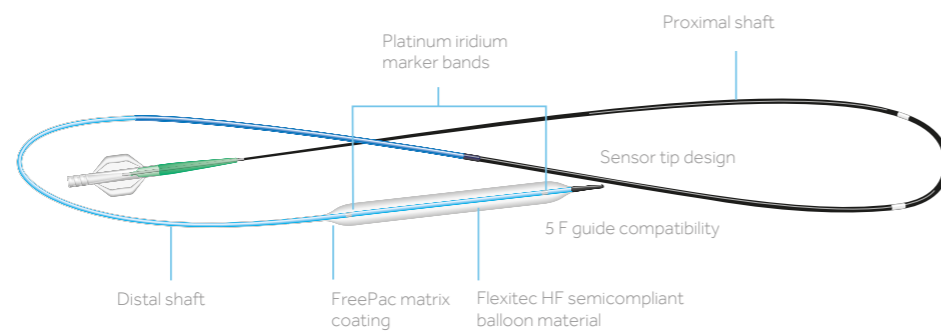

PRODUCT CODE

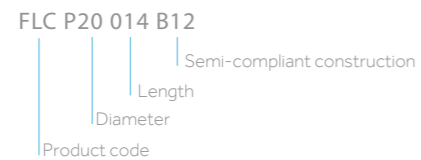

ORDERING INFORMATION

BALLOON DIAMETER (MM)	BALLOON LENGTH (MM)			
	14	20	30	40
2.00	FLC P20 014 B12	FLC P20 020 B12	FLC P20 030 B12	—
2.25	FLC P22 014 B12	FLC P22 020 B12	FLC P22 030 B12	—
2.50	FLC P25 014 B12	FLC P25 020 B12	FLC P25 030 B12	FLC P25 040 B12
2.75	FLC P27 014 B12	FLC P27 020 B12	FLC P27 030 B12	—
3.00	FLC P30 014 B12	FLC P30 020 B12	FLC P30 030 B12	FLC P30 040 B12
3.25	FLC P32 014 B12	FLC P32 020 B12	FLC P32 030 B12	—
3.50	FLC P35 014 B12	FLC P35 020 B12	FLC P35 030 B12	FLC P35 040 B12
3.75	FLC P37 014 B12	FLC P37 020 B12	FLC P37 030 B12	—
4.00	FLC P40 014 B12	FLC P40 020 B12	—	—

DRUG ELUTING BALLOONS

In.Pact Falcon™ Paclitaxel-Eluting Coronary Balloon Catheter

COMPLIANCE DATA

PRESSURE KPA (ATM)	BALLOON LENGTH (MM)								
	2.00	2.25	2.50	2.75	3.00	3.25	3.50	3.75	4.00
507 (5)	1.90	2.15	2.40	2.65	2.90	3.15	3.40	3.65	3.90
608 (6)	1.95	2.20	2.45	2.70	2.95	3.20	3.45	3.70	3.95
709 (7)	2.00	2.25	2.50	2.75	3.00	3.25	3.50	3.75	4.35
811 (8)	2.02	2.27	2.52	2.78	3.03	3.28	3.54	3.80	4.05
912 (9)	2.04	2.29	2.54	2.82	3.07	3.32	3.58	3.85	4.10
1013 (10)	2.06	2.31	2.57	2.86	3.11	3.36	3.62	3.90	4.15
1115 (11)	2.08	2.34	2.60	2.90	3.15	3.40	3.66	3.95	4.20
1216 (12)	2.11	2.37	2.63	2.94	3.19	3.45	3.70	4.00	4.25
1317 (13)	2.14	2.40	2.67	2.98	3.23	3.50	3.75	4.05	4.30
1419 (14)	2.17	2.43	2.71	3.02	3.27	3.55	3.80	4.10	4.35
1520 (15)	2.20	2.46	2.75	3.06	3.31	3.60	3.85	4.15	4.40
1621 (16)	2.23	2.50	2.80	—	—	—	—	—	—
1723 (17)	2.26	—	—	—	—	—	—	—	—

Nominal pressure	Rated burst pressure ¹
7	17

1. Do not exceed rated burst pressure. Test data on file at Medtronic, Inc.

TECHNICAL INFORMATION

Catheter length, cm	142
Platinum iridium marker bands 2.00 – 4.00 mm	Double
Coating	FreePac matrix
Balloon material	Flexitec HF
Guide compatibility	5F
Nominal pressure, atm	7
Rated burst pressure (RBP), atm	2.00 mm 17 2.25 - 2.50 mm 16 2.75 - 4.00 mm 15



GUIDE CATHETERS

- CONTENTS
- 1. DRUG-ELUTING STENTS
- 2. DRUG-METAL STENTS
- 3. BALLON DILATION CATHETERS
- 4. DRUG-ELUTING BALLOONS
- 5. GUIDE CATHETER FAMILY
- 6. INTERVENTIONAL GUIDEWIRES
- 7. ASPIRATION CATHETERS
- 8. ANGIOGRAPHIC CATHETERS AND WIRES
- 9. INTRODUCERS
- 10. INTERVENTIONAL ACCESSORIES
- 11. PEDIATRIC AND TRANSDERMAL PRODUCTS
- 12. RENAL DENERVATION

CORONARY GUIDE CATHETER FAMILY

LAUNCHER™

- Balanced guide for stable and consistent performance
- Workhorse construction suitable for a variety of anatomies and takeoffs
- Flexible distal segment for manipulation if case requires
- Large 6F I.D. (0.071"). allows for increased contrast flow for enhanced visualization
- Multiple guide catheter platforms provide options for guide engagement



SHERPA NX™ ACTIVE

- Soft distal segment for active engagement with soft tip and advanced material liner for consistent low-friction device passage
- Distal segment allows for manipulation of the catheter to obtain stable position
- Distal segment can reshape in anatomy
- Large I.D. allows for enhanced contrast flow and better visualization



SHERPA NX™ BALANCED

- Balanced guide for stable consistent performance with soft tip and advanced HDPE liner for smooth, low-friction device passage
- Workhorse construction suitable for a variety of anatomies and takeoffs
- Flexible distal segment for manipulation if case requires
- Supportive secondary curve for increased backup support and curve retention
- Large ID for maximum contrast flow and absolute visualization



CORONARY GUIDE CATHETER FAMILY

ZUMA 2™

- Soft, flexible distal segment for atraumatic engagement
- Soft tip polymer construction to minimize vessel trauma



ZUMA™

- Supportive stiff guide for passive use
- Available sizes: 6F - 9F



UNIQUE FULL WALL TECHNOLOGY

- Encapsulated flat wire braid enables thinner, robust walls without compromising support or retention
- Designed for large lumens and enhanced flexibility without loss of support



1. SH available on all curves. 2. Custom built curves also available.

The curve recommendations on this sheet are not intended to replace patient specific clinical judgement.

Caution: Federal (USA) law restricts these devices to sale by or on the order of a licensed healthcare practitioner.

CORONARY GUIDE CATHETER FAMILY

Curve Selection Femoral approach

COMMON ANATOMIES

Three Types of Ostial Takeoffs (Can occur in right or left arteries)



Three Types of Aortic Roots



LEFT CURVES

Normal Left Takeoffs

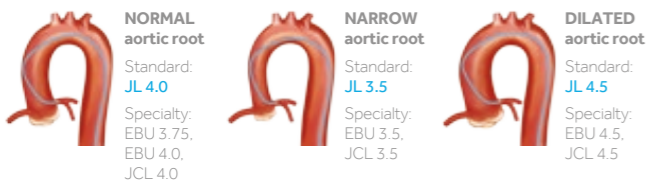

Superior Left Takeoffs



Inferior Left Takeoffs



Normal Takeoffs and Short Left Mains

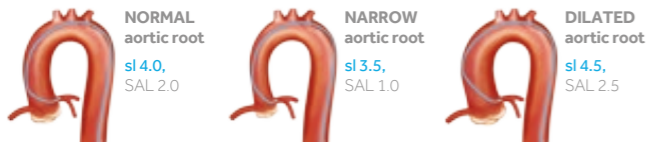

BYPASS GRAFTS



RIGHT CURVES

Normal Right Takeoffs

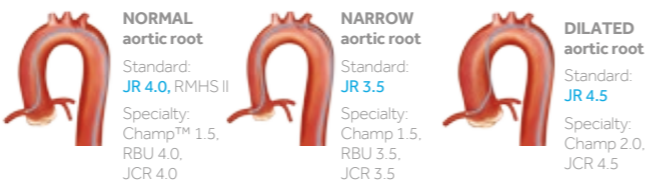

Superior Shepherd's Crook Right Takeoffs



Inferior Right Takeoffs

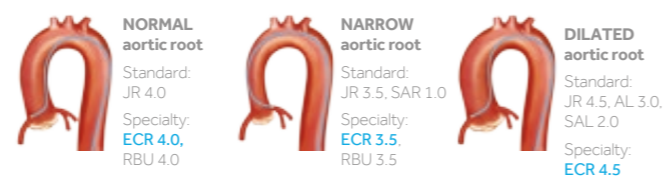

Normal Takeoffs and Proximal Lesions in the RCA



CORONARY GUIDE CATHETER FAMILY

Curve Selection Transradial approach

 EBU EXTRA BACKUP Patented curve design for left coronary arteries Sizing: JL35 = EBU35 JL40 = EBU35 JL50 = EBU40	 JR Standard right coronary artery curve Sizing: Same as femoral approach	 JL Standard left coronary artery curve with open primary curve Sizing: Downsize the curve by 0.5 mm from what is used for femoral approach	 AL Left coronary artery curve designed for maximum backup support with secondary curve seated firmly in aortic root Sizing: Same as femoral
 AR (AMPLATZ RIGHT) Right coronary artery curve providing maximum backup support with secondary curve seated firmly in aortic root Sizing: Same as femoral	 AL20 Designed for left coronary artery. Provides backup support with secondary curve seated firmly in aortic root Sizing: Same as femoral approach	 MULTIPURPOSE-MB1/MP2 Gentle curve design provides ease of engagement for lateral to inferior-oriented arteries Sizing: One size fits all	 MRADIAL Designed for left and right coronary artery engagement. Provides excellent support from contralateral wall and aortic root leverage Sizing: One size fits all
 MAC Multi-aortic curve for left or right coronary artery Sizing: Lateral takeoff and small root-MAC30. Superior takeoff and small root-MAC35/40. Superior takeoff and large root-MAC40. Lateral and large root-MAC35/40	 MAC3030 Universal guide for left and right coronary artery engagement Sizing: One size fits all	 ERADL Delivers excellent backup support and easy engagement Sizing: Easy Radial Left for standard size aorta. Easy Radial Left Long Tip for enlarged aorta. Easy Radial Left Short. Tip for narrowed aorta	 ERADR Excellent backup support and easy engagement Sizing: Easy Radial Right for standard size aorta. Easy Radial Short Tip for narrowed aorta
 RRAD Designed for both lateral and superior-oriented right coronary arteries. Modification of the MRADIAL curve. Provides good support from contralateral wall Sizing: One size fits all	 LARA Provides excellent support from aortic root leverage and contralateral wall Sizing: One size fits all with Judkins-like engagement	 ALR12 Designed for right coronary artery. Provides maximum backup support with secondary curve seated firmly in aortic root Sizing: One size fits all	 MRESS Designed for right coronary artery. Provides excellent support from contralateral wall and aortic root leverage Sizing: One size fits all
 HOCKEY STICK Multipurpose curve is easy to engage for right coronary artery. Gentle primary curve and long distal tip for device delivery Sizing: Available in HSI for <3.5 cm aortic roots and HSIII for 3.5–4.0 cm aortic roots RMHSII (Relaxed Modified HSI) has a relaxed primary curve	 PAPA Designed for left and right coronary arteries with contralateral wall support, and also available in PAPA 1, which has an angled tip Sizing: One size fits all	MULTIPURPOSE SHORT TIP Standard curve for right coronary artery and may be helpful for inferior takeoffs Engagement Recommendations: Use a gentle clockwise rotation technique similar to the Judkins Right coronary approach and the MAC Pullback may be required to carefully engage the artery Sizing: Same as femoral approach	

CURVE ABBREVIATION KEY

ERAD = Easy Radial
 EBU = Extra Backup
 HS = Hockey Stick
 LCB = Left Coronary Bypass
 MAC = Multi-aortic Curve
 NOTO = No Torque Right
 RBU = Right Backup
 RCB = Right Coronary Bypass
 RMHS = Relaxed Modified Hockey Stick
 SAL = Short Amplatz Left
 SL = Short Left
 NOTE: Curves in **BLUE** text indicate type of curve used in illustration.

CORONARY GUIDE CATHETERS

Launcher™ Guide Catheter Left Coronary Curve

GENERAL CHARACTERISTICS

- Supplied sterile Items per box: 1 • Label colour: 5F: Grey, 6F: Green, 7F: Orange, 8F: Blue
- Lumen inner diameter: 5F = 0.058", 6F = 0.071", 7F = 0.081", 8F = 0.090"

PRODUCT DESCRIPTION

Full-Wall Technology construction provides kink resistance and stable torque control; large ID allows for increased contrast flow for enhanced visualization. Vest-Tech Nylon outer jacket provides excellent hub to tip radiopacity.

FEATURES

- Custom lengths and custom curve program available
- Over 230 specialty curves available
- SH available on all curves

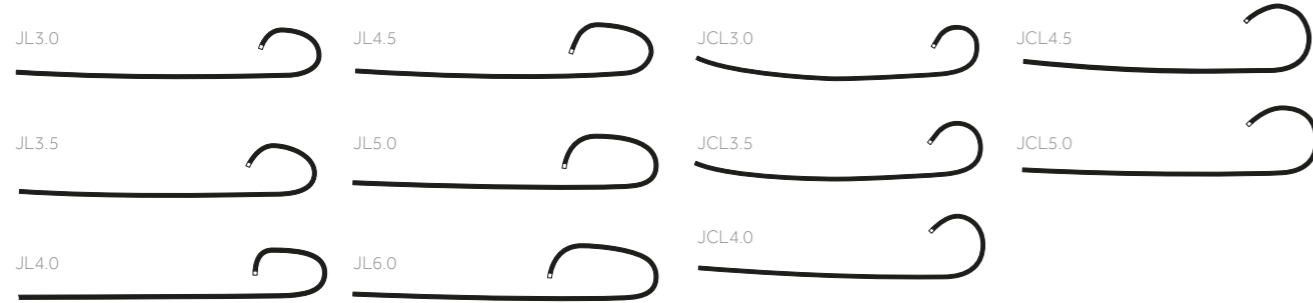

LEFT STANDARD

PRODUCT CODE	5F (I.D. 0.058 IN.)	6F (I.D. 0.071 IN.)	7F (I.D. 0.081 IN.)	8F (I.D. 0.090 IN.)
JL3.0	LA5JL30	LA6JL30	LA7JL30	LA8JL30
JL3.5	LA5JL35	LA6JL35	LA7JL35	LA8JL35
JL4.0	LA5JL40	LA6JL40	LA7JL40	LA8JL40
JL4.5	LA5JL45	LA6JL45	LA7JL45	LA8JL45
JL5.0	LA5JL50	LA6JL50	LA7JL50	LA8JL50
JL6.0	LA5JL60	LA6JL60	LA7JL60	LA8JL60
JCL3.0	LA5JCL30	LA6JCL30	LA7JCL30	LA8JCL30
JCL3.5	LA5JCL35	LA6JCL35	LA7JCL35	LA8JCL35
JCL4.0	LA5JCL40	LA6JCL40	LA7JCL40	LA8JCL40
JCL4.5	LA5JCL45	LA6JCL45	LA7JCL45	LA8JCL45
JCL5.0	LA5JCL50	LA6JCL50	LA7JCL50	LA8JCL50

CORONARY GUIDE CATHETERS

Launcher™ Guide Catheter Short Left Coronary Curve

GENERAL CHARACTERISTICS

- Supplied sterile Items per box: 1 • Label colour: 5F: Grey, 6F: Green, 7F: Orange, 8F: Blue
- Lumen inner diameter: 5F = 0.058", 6F = 0.071", 7F = 0.081", 8F = 0.090"

PRODUCT DESCRIPTION

Full-Wall Technology construction provides kink resistance and stable torque control; large ID allows for increased contrast flow for enhanced visualization. Vest-Tech Nylon outer jacket provides excellent hub to tip radiopacity.

FEATURES

- Custom lengths and custom curve program available
- Over 230 specialty curves available
- SH available on all curves

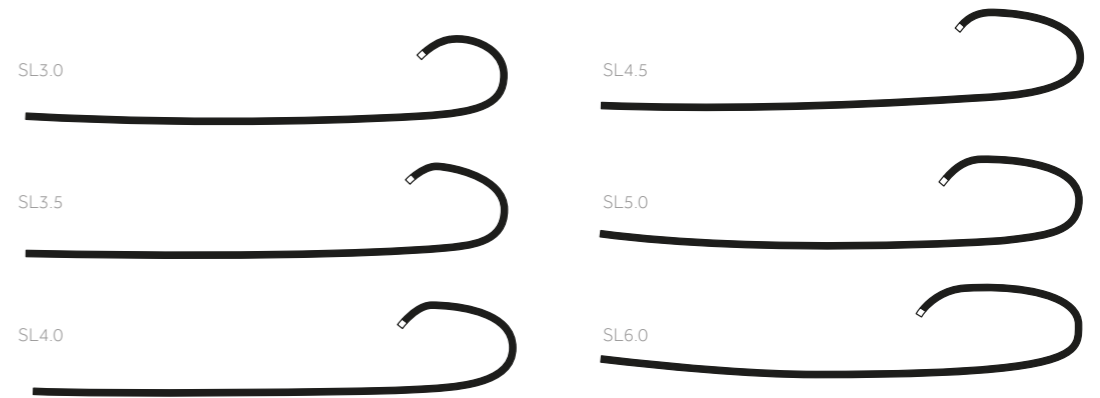

SHORT LEFT

PRODUCT CODE	5F (I.D. 0.058 IN.)	6F (I.D. 0.071 IN.)	7F (I.D. 0.081 IN.)	8F (I.D. 0.090 IN.)
SL3.0	LA5SL30	LA6SL30	LA7SL30	LA8SL30
SL3.5	LA5SL35	LA6SL35	LA7SL35	LA8SL35
SL4.0	LA5SL40	LA6SL40	LA7SL40	LA8SL40
SL4.5	LA5SL45	LA6SL45	LA7SL45	LA8SL45
SL5.0	LA5SL50	LA6SL50	LA7SL50	LA8SL50
SL6.0	LA5SL60	LA6SL60	LA7SL60	LA8SL60

CORONARY GUIDE CATHETERS

Launcher™ Guide Catheter Amplatz Left Coronary Curve

GENERAL CHARACTERISTICS

- Supplied sterile Items per box: 1 • Label colour: 5F: Grey, 6F: Green, 7F: Orange, 8F: Blue
- Lumen inner diameter: 5F = 0.058", 6F = 0.071", 7F = 0.081", 8F = 0.090"

PRODUCT DESCRIPTION

Full-Wall Technology construction provides kink resistance and stable torque control; large ID allows for increased contrast flow for enhanced visualization. Vest-Tech Nylon outer jacket provides excellent hub to tip radiopacity.

FEATURES

- Custom lengths and custom curve program available
- Over 230 specialty curves available
- SH available on all curves

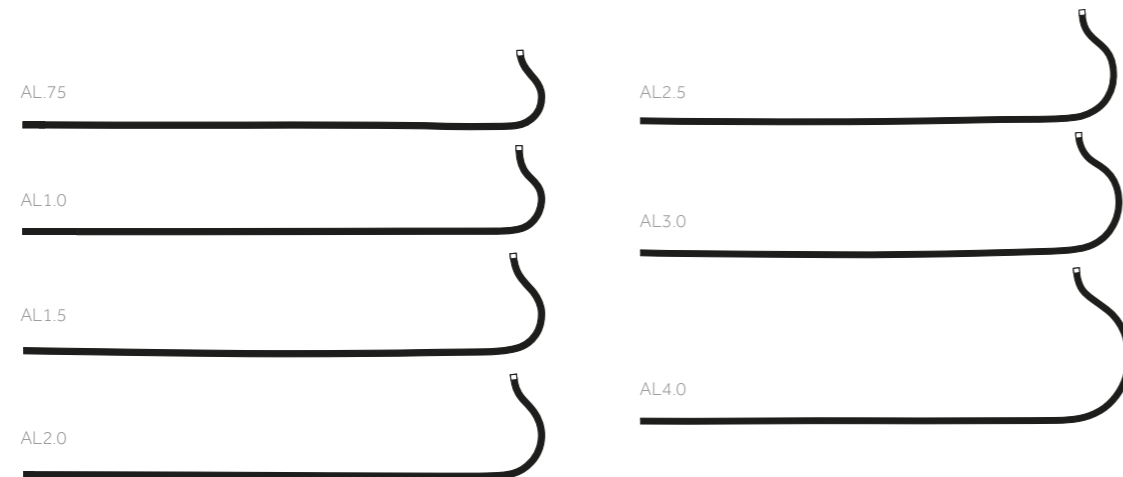

AMPLATZ LEFT

PRODUCT CODE	5F (I.D. 0.058 IN.)	6F (I.D. 0.071 IN.)	7F (I.D. 0.081 IN.)	8F (I.D. 0.090 IN.)
AL75	LA5AL75	LA6AL75	LA7AL75	LA8AL75
AL1.0	LA5AL10	LA6AL10	LA7AL10	LA8AL10
AL1.5	LA5AL15	LA6AL15	LA7AL15	LA8AL15
AL2.0	LA5AL20	LA6AL20	LA7AL20	LA8AL20
AL2.5	LA5AL25	LA6AL25	LA7AL25	LA8AL25
AL3.0	LA5AL30	LA6AL30	LA7AL30	LA8AL30
AL4.0	LA5AL40	LA6AL40	LA7AL40	LA8AL40

CORONARY GUIDE CATHETERS

Launcher™ Guide Catheter Short Amplatz Left Coronary Curve

GENERAL CHARACTERISTICS

- Supplied sterile Items per box: 1 • Label colour: 5F: Grey, 6F: Green, 7F: Orange, 8F: Blue
- Lumen inner diameter: 5F = 0.058", 6F = 0.071", 7F = 0.081", 8F = 0.090"

PRODUCT DESCRIPTION

Full-Wall Technology construction provides kink resistance and stable torque control; large ID allows for increased contrast flow for enhanced visualization. Vest-Tech Nylon outer jacket provides excellent hub to tip radiopacity.

FEATURES

- Custom lengths and custom curve program available
- Over 230 specialty curves available
- SH available on all curves

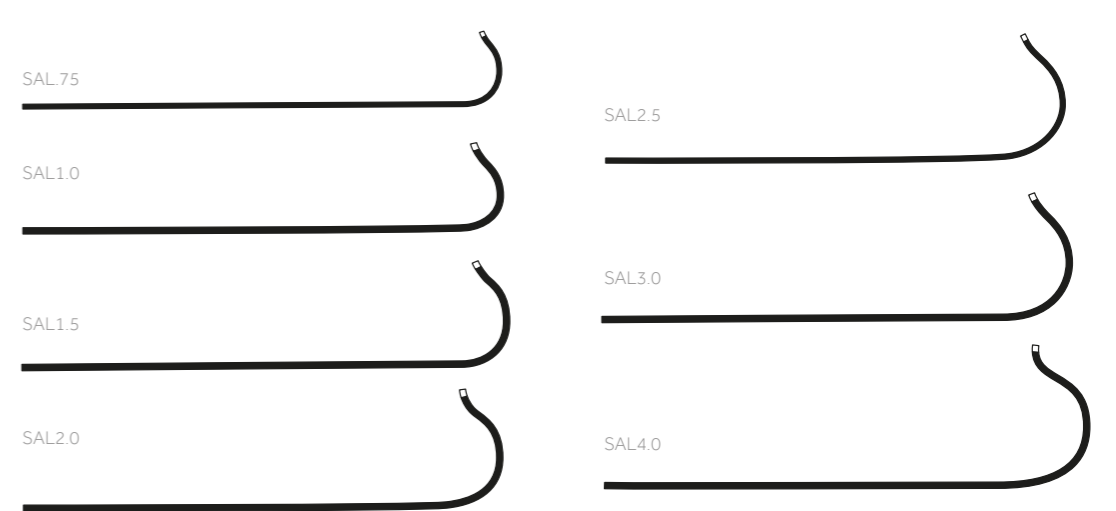

SHORT AMPLATZ LEFT

PRODUCT CODE	5F (I.D. 0.058 IN.)	6F (I.D. 0.071 IN.)	7F (I.D. 0.081 IN.)	8F (I.D. 0.090 IN.)
SAL75	LA5SAL75	LA6SAL75	LA7SAL75	LA8SAL75
SAL1.0	LA5SAL10	LA6SAL10	LA7SAL10	LA8SAL10
SAL1.5	LA5SAL15	LA6SAL15	LA7SAL15	LA8SAL15
SAL2.0	LA5SAL20	LA6SAL20	LA7SAL20	LA8SAL20
SAL2.5	LA5SAL25	LA6SAL25	LA7SAL25	LA8SAL25
SAL3.0	LA5SAL30	LA6SAL30	LA7SAL30	LA8SAL30
SAL4.0	LA5SAL40	LA6SAL40	LA7SAL40	LA8SAL40

CORONARY GUIDE CATHETERS

Launcher™ Guide Catheter Left Coronary Backup Support

GENERAL CHARACTERISTICS

- Supplied sterile Items per box: 1 • Label colour: 5F: Grey, 6F: Green, 7F: Orange, 8F: Blue
- Lumen inner diameter: 5F = 0.058", 6F = 0.071", 7F = 0.081", 8F = 0.090"

PRODUCT DESCRIPTION

Full-Wall Technology construction provides kink resistance and stable torque control; large ID allows for increased contrast flow for enhanced visualization. Vest-Tech Nylon outer jacket provides excellent hub to tip radiopacity.

FEATURES

- Custom lengths and custom curve program available
- Over 230 specialty curves available
- SH available on all curves

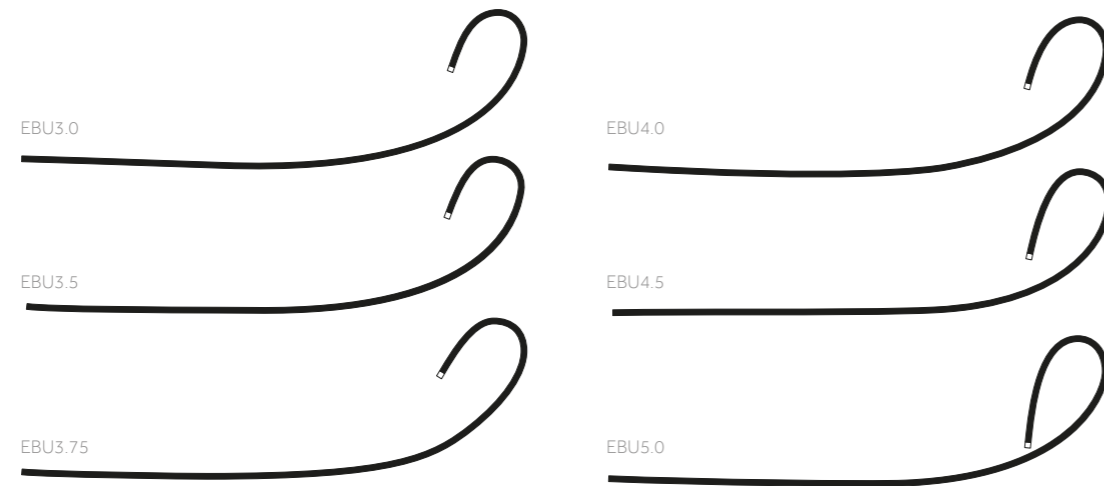

EBU (EXTRA BACKUP)

PRODUCT CODE	5F I.D. 0.058 IN.)	6F (I.D. 0.071 IN.)	7F (I.D. 0.081 IN.)	8F (I.D. 0.090 IN.)
EBU3.0	LA5EBU30	LA6EBU30	LA7EBU30	LA8EBU30
EBU3.5	LA5EBU35	LA6EBU35	LA7EBU35	LA8EBU35
EBU3.75	LA5EBU375	LA6EBU375	LA7EBU375	LA8EBU375
EBU4.0	LA5EBU40	LA6EBU40	LA7EBU40	LA8EBU40
EBU4.5	LA5EBU45	LA6EBU45	LA7EBU45	LA8EBU45
EBU5.0	LA5EBU50	LA6EBU50	LA7EBU50	LA8EBU50

CORONARY GUIDE CATHETERS

Launcher™ Guide Catheter Right Coronary Curve

GENERAL CHARACTERISTICS

- Supplied sterile Items per box: 1 • Label colour: 5F: Grey, 6F: Green, 7F: Orange, 8F: Blue
- Lumen inner diameter: 5F = 0.058", 6F = 0.071", 7F = 0.081", 8F = 0.090"

PRODUCT DESCRIPTION

Full-Wall Technology construction provides kink resistance and stable torque control; large ID allows for increased contrast flow for enhanced visualization. Vest-Tech Nylon outer jacket provides excellent hub to tip radiopacity.

FEATURES

- Custom lengths and custom curve program available
- Over 230 specialty curves available
- SH available on all curves

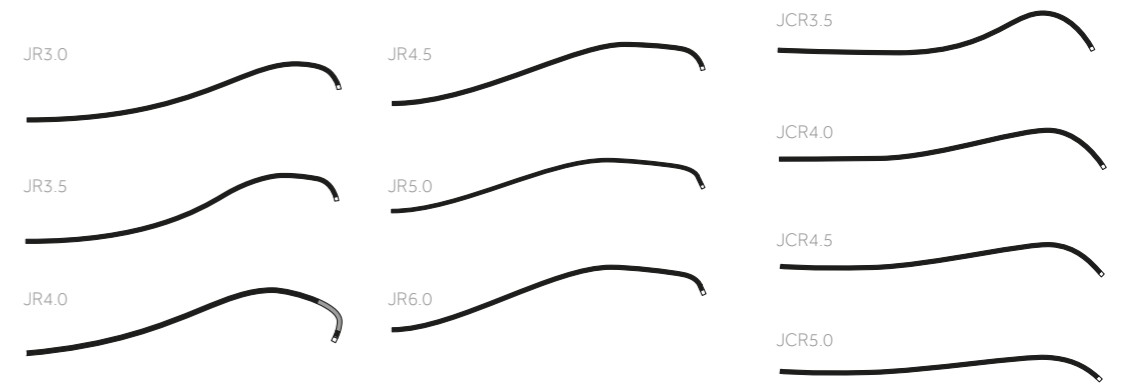

RIGHT STANDARD

PRODUCT CODE	5F (I.D. 0.058 IN.)	6F (I.D. 0.071 IN.)	7F (I.D. 0.081 IN.)	8F (I.D. 0.090 IN.)
JR3.0	LA5JR30	LA6JR30	LA7JR30	LA8JR30
JR3.5	LA5JR35	LA6JR35	LA7JR35	LA8JR35
JR4.0	LA5JR40	LA6JR40	LA7JR40	LA8JR40
JR4.5	LA5JR45	LA6JR45	LA7JR45	LA8JR45
JR5.0	LA5JR50	LA6JR50	LA7JR50	LA8JR50
JR6.0	LA5JR60	LA6JR60	LA7JR60	LA8JR60
JCR3.5	LA5JCR35	LA6JCR35	LA7JCR35	LA8JCR35
JCR4.0	LA5JCR40	LA6JCR40	LA7JCR40	LA8JCR40
JCR4.5	LA5JCR45	LA6JCR45	LA7JCR45	LA8JCR45
JCR5.0	LA5JCR50	LA6JCR50	LA7JCR50	LA8JCR50

CORONARY GUIDE CATHETERS

Launcher™ Guide Catheter Short Right Coronary Curve

GENERAL CHARACTERISTICS

- Supplied sterile Items per box: 1 • Label colour: 5F: Grey, 6F: Green, 7F: Orange, 8F: Blue
- Lumen inner diameter: 5F = 0.058", 6F = 0.071", 7F = 0.081", 8F = 0.090"

PRODUCT DESCRIPTION

Full-Wall Technology construction provides kink resistance and stable torque control; large ID allows for increased contrast flow for enhanced visualization. Vest-Tech Nylon outer jacket provides excellent hub to tip radiopacity.

FEATURES

- Custom lengths and custom curve program available
- Over 230 specialty curves available
- SH available on all curves

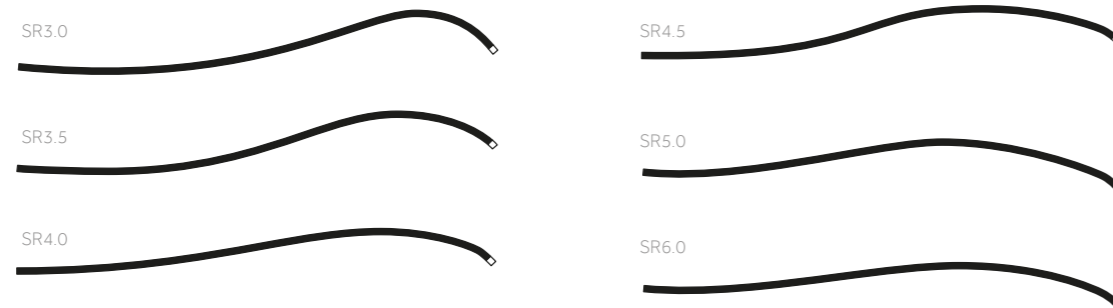

SHORT RIGHT

PRODUCT CODE	5F (I.D. 0.058 IN.)	6F (I.D. 0.071 IN.)	7F (I.D. 0.081 IN.)	8F (I.D. 0.090 IN.)
SR3.0	LA5SR30	LA6SR30	LA7SR30	LA8SR30
SR3.5	LA5SR35	LA6SR35	LA7SR35	LA8SR35
SR4.0	LA5SR40	LA6SR40	LA7SR40	LA8SR40
SR4.5	LA5SR45	LA6SR45	LA7SR45	LA8SR45
SR5.0	LA5SR50	LA6SR50	LA7SR50	LA8SR50
SR6.0	LA5SR60	LA6SR60	LA7SR60	LA8SR60

CORONARY GUIDE CATHETERS

Launcher™ Guide Catheter Amplatz Right Coronary Curve

GENERAL CHARACTERISTICS

- Supplied sterile Items per box: 1 • Label colour: 5F: Grey, 6F: Green, 7F: Orange, 8F: Blue
- Lumen inner diameter: 5F = 0.058", 6F = 0.071", 7F = 0.081", 8F = 0.090"

PRODUCT DESCRIPTION

Full-Wall Technology construction provides kink resistance and stable torque control; large ID allows for increased contrast flow for enhanced visualization. Vest-Tech Nylon outer jacket provides excellent hub to tip radiopacity.

FEATURES

- Custom lengths and custom curve program available
- Over 230 specialty curves available
- SH available on all curves



AMPLATZ RIGHT

PRODUCT CODE	5F (I.D. 0.058 IN.)	6F (I.D. 0.071 IN.)	7F (I.D. 0.081 IN.)	8F (I.D. 0.090 IN.)
AR1.0	LA5AR10	LA6AR10	LA7AR10	LA8AR10
AR2.0	LA5AR20	LA6AR20	LA7AR20	LA8AR20
ALR1-2	LA5ALR12	LA6ALR12	LA7ALR12	LA8ALR12

CORONARY GUIDE CATHETERS

Launcher™ Guide Catheter Short Amplatz Right Coronary Curve

GENERAL CHARACTERISTICS

- Supplied sterile Items per box: 1 • Label colour: 5F: Grey, 6F: Green, 7F: Orange, 8F: Blue
- Lumen inner diameter: 5F = 0.058", 6F = 0.071", 7F = 0.081", 8F = 0.090"

PRODUCT DESCRIPTION

Full-Wall Technology construction provides kink resistance and stable torque control; large ID allows for increased contrast flow for enhanced visualization. Vest-Tech Nylon outer jacket provides excellent hub to tip radiopacity.

FEATURES

- Custom lengths and custom curve program available
- Over 230 specialty curves available
- SH available on all curves

SAR1.0



SAR2.0



SHORT AMPLATZ RIGHT

PRODUCT CODE	5F (I.D. 0.058 IN.)	6F (I.D. 0.071 IN.)	7F (I.D. 0.081 IN.)	8F (I.D. 0.090 IN.)
SAR1.0	LA5SAR10	LA6SAR10	LA7SAR10	LA8SAR10
SAR2.0	LA5SAR20	LA6SAR20	LA7SAR20	LA8SAR20

CORONARY GUIDE CATHETERS

Launcher™ Guide Catheter Shepherd's Crook Coronary Curve

GENERAL CHARACTERISTICS

- Supplied sterile Items per box: 1 • Label colour: 5F: Grey, 6F: Green, 7F: Orange, 8F: Blue
- Lumen inner diameter: 5F = 0.058", 6F = 0.071", 7F = 0.081", 8F = 0.090"

PRODUCT DESCRIPTION

Full-Wall Technology construction provides kink resistance and stable torque control; large ID allows for increased contrast flow for enhanced visualization. Vest-Tech Nylon outer jacket provides excellent hub to tip radiopacity.

FEATURES

- Custom lengths and custom curve program available
- Over 230 specialty curves available
- SH available on all curves

SCR3.5



SCR4.0



SCR5.0



SHEPHERD'S CROOK RIGHT

PRODUCT CODE	5F (I.D. 0.058 IN.)	6F (I.D. 0.071 IN.)	7F (I.D. 0.081 IN.)	8F (I.D. 0.090 IN.)
SCR3.5	LA5SCR35	LA6SCR35	LA7SCR35	LA8SCR35
SCR4.0	LA5SCR40	LA6SCR40	LA7SCR40	LA8SCR40
SCR5.0	LA5SCR50	LA6SCR50	LA7SCR50	LA8SCR50

CORONARY GUIDE CATHETERS

Launcher™ Guide Catheter Right Coronary Backup Support

GENERAL CHARACTERISTICS

- Supplied sterile Items per box: 1 • Label colour: 5F: Grey, 6F: Green, 7F: Orange, 8F: Blue
- Lumen inner diameter: 5F = 0.058", 6F = 0.071", 7F = 0.081", 8F = 0.090"

PRODUCT DESCRIPTION

Full-Wall Technology construction provides kink resistance and stable torque control; large ID allows for increased contrast flow for enhanced visualization. Vest-Tech Nylon outer jacket provides excellent hub to tip radiopacity.

FEATURES

- Custom lengths and custom curve program available
- Over 230 specialty curves available
- SH available on all curves

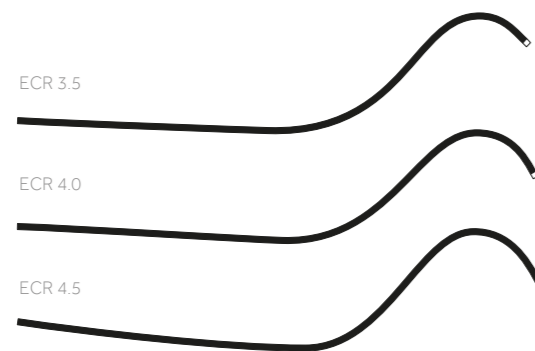

ECR CURVES

PRODUCT CODE	5F (I.D. 0.058 IN.)	6F (I.D. 0.071 IN.)	7F (I.D. 0.081 IN.)	8F (I.D. 0.090 IN.)
ECR 3.5	LA5ECR35	LA6ECR35	LA7ECR35	LA8ECR35
ECR 4.0	LA5ECR40	LA6ECR40	LA7ECR40	LA8ECR40
ECR 4.5	LA5ECR45	LA6ECR45	LA7ECR45	LA8ECR45

CORONARY GUIDE CATHETERS

Launcher™ Guide Catheter Right Coronary Backup Support

GENERAL CHARACTERISTICS

- Supplied sterile Items per box: 1 • Label colour: 5F: Grey, 6F: Green, 7F: Orange, 8F: Blue
- Lumen inner diameter: 5F = 0.058", 6F = 0.071", 7F = 0.081", 8F = 0.090"

PRODUCT DESCRIPTION

Full-Wall Technology construction provides kink resistance and stable torque control; large ID allows for increased contrast flow for enhanced visualization. Vest-Tech Nylon outer jacket provides excellent hub to tip radiopacity.

FEATURES

- Custom lengths and custom curve program available
- Over 230 specialty curves available
- SH available on all curves

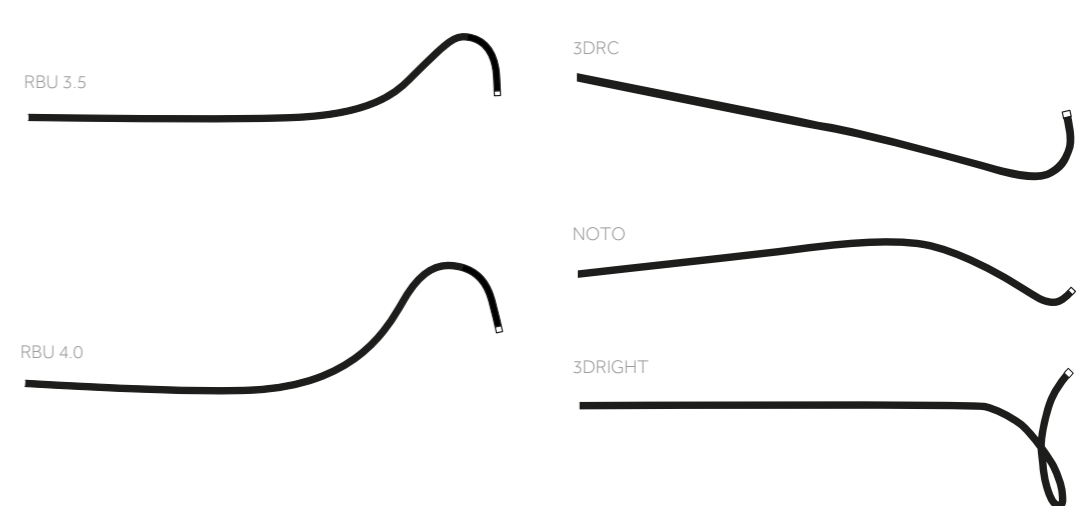

RBU CURVES

PRODUCT CODE	5F (I.D. 0.058 IN.)	6F (I.D. 0.071 IN.)	7F (I.D. 0.081 IN.)	8F (I.D. 0.090 IN.)
RBU 3.5	LA5RBU35	LA6RBU35	LA7RBU35	LA8RBU35
RBU 4.0	LA5RBU40	LA6RBU40	LA7RBU40	LA8RBU40
3DRC		LA63DRC	LA73DRC	LA83DRC
3DRIGHT	LA53DRIGHT	LA63DRIGHT	LA73DRIGHT	
NOTO	LA5NOTO	LA6NOTO	LA7NOTO	LA8NOTO

CORONARY GUIDE CATHETERS

Launcher™ Guide Catheter Multipurpose Curves

GENERAL CHARACTERISTICS

- Supplied sterile items per box: 1 • Label colour: 5F: Grey, 6F: Green, 7F: Orange, 8F: Blue
- Lumen inner diameter: 5F = 0.058", 6F = 0.071", 7F = 0.081", 8F = 0.090"

PRODUCT DESCRIPTION

Full-Wall Technology construction provides kink resistance and stable torque control; large ID allows for increased contrast flow for enhanced visualization. Vest-Tech Nylon outer jacket provides excellent hub to tip radiopacity.

FEATURES

- Custom lengths and custom curve program available
- Over 230 specialty curves available
- SH available on all curves

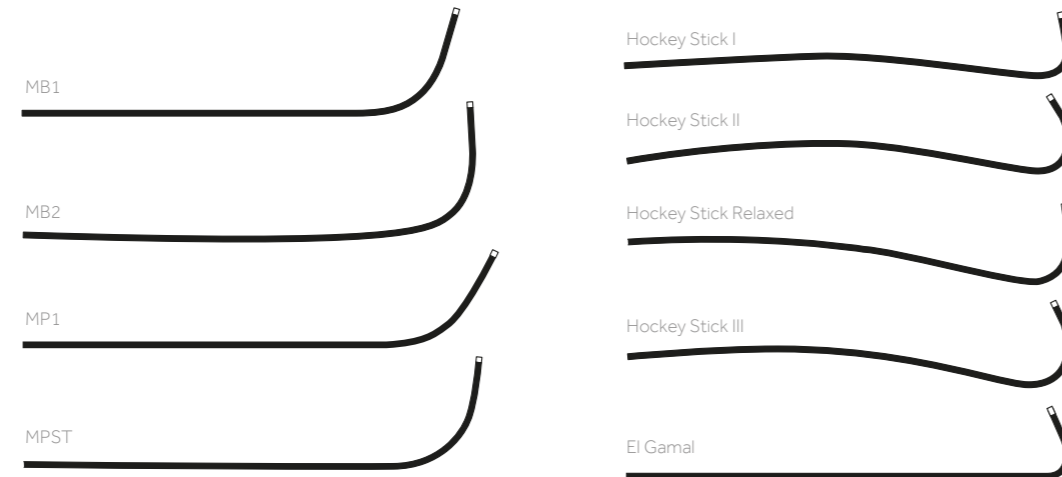

MULTIPURPOSE

PRODUCT CODE	5F (I.D. 0.058 IN.)	6F (I.D. 0.071 IN.)	7F (I.D. 0.081 IN.)	8F (I.D. 0.090 IN.)
MB1	LA5MB1	LA6MB1	LA7MB1	LA8MB1
MB2	LA5MB2	LA6MB2	LA7MB2	LA8MB2
MP1	LA5MP1	LA6MP1	LA7MP1	LA8MP1
MP2		LA6MP2		
MB Short Tip	LA5MPST	LA6MPST	LA7MPST	LA8MPST
Hockey Stick I	LA5HSI	LA6HSI	LA7HSI	LA8HSI
Hockey Stick II	LA5HSII	LA6HSII	LA7HSII	LA8HSII
HS II Relaxed	LA5HSREL	LA6RMHSII	LA7RMHSII	LA8RMHSII
Hockey Stick III	LA5HSIII	LA6HSIII	LA7HSIII	LA8HSIII
El Gamal	LA5ELGAMAL	LA6ELGAMAL	LA7ELGAMAL	LA8ELGAMAL

CORONARY GUIDE CATHETERS

Launcher™ Guide Catheter Other Curves

GENERAL CHARACTERISTICS

- Supplied sterile items per box: 1 • Label colour: 5F: Grey, 6F: Green, 7F: Orange, 8F: Blue
- Lumen inner diameter: 5F = 0.058", 6F = 0.071", 7F = 0.081", 8F = 0.090"

PRODUCT DESCRIPTION

Full-Wall Technology construction provides kink resistance and stable torque control; large ID allows for increased contrast flow for enhanced visualization. Vest-Tech Nylon outer jacket provides excellent hub to tip radiopacity.

FEATURES

- Custom lengths and custom curve program available
- Over 230 specialty curves available
- SH available on all curves



MAC (MULTI-AORTIC CURVES)

PRODUCT CODE	5F (I.D. 0.058 IN.)	6F (I.D. 0.071 IN.)	7F (I.D. 0.081 IN.)	8F (I.D. 0.090 IN.)
MAC3.0	LA5MAC30	LA6MAC30	LA7MAC30	LA8MAC30
MAC3.5	LA5MAC35	LA6MAC35	LA7MAC35	LA8MAC35
MAC3.75	LA5MAC375	LA6MAC375	LA7MAC375	LA8MAC375
MAC4.0	LA5MAC40	LA6MAC40	LA7MAC40	LA8MAC40
MAC4.5	LA5MAC45	LA6MAC45	LA7MAC45	LA8MAC45
MAC5.0	LA5MAC50	LA6MAC50	LA7MAC50	LA8MAC50

CORONARY GUIDE CATHETERS

Launcher™ Guide Catheter Bypass Curves

GENERAL CHARACTERISTICS

- Supplied sterile Items per box: 1 • Label colour: 5F: Grey, 6F: Green, 7F: Orange, 8F: Blue
- Lumen inner diameter: 5F = 0.058", 6F = 0.071", 7F = 0.081", 8F = 0.090"

PRODUCT DESCRIPTION

Full-Wall Technology construction provides kink resistance and stable torque control; large ID allows for increased contrast flow for enhanced visualization. Vest-Tech Nylon outer jacket provides excellent hub to tip radiopacity.

FEATURES

- Custom lengths and custom curve program available
- Over 230 specialty curves available
- SH available on all curves

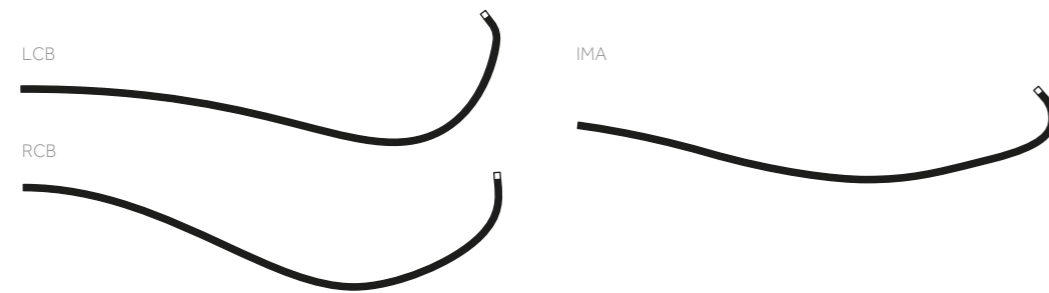

BYPASS GRAFTS

PRODUCT CODE	5F (I.D. 0.058 IN.)	6F (I.D. 0.071 IN.)	7F (I.D. 0.081 IN.)	8F (I.D. 0.090 IN.)
LCB	LA5LCB	LA6LCB	LA7LCB	LA8LCB
LCB Relaxed	-	LA6RELAXLCB	-	-
RCB	LA5RCB	LA6RCB	LA7RCB	LA8RCB
RCB (90 cm)	LA5RCBD	LA6RCBD	LA7RCBD	LA8RCBD
IMA	LA5IMA	LA6IMA	LA7IMA	LA8IMA
IMA (90 cm)	LA5IMAD	LA6IMAD	LA7IMAD	LA8IMAD

CORONARY GUIDE CATHETERS

Launcher™ Guide Catheter Other Curves

GENERAL CHARACTERISTICS

- Supplied sterile Items per box: 1 • Label colour: 5F: Grey, 6F: Green, 7F: Orange, 8F: Blue
- Lumen inner diameter: 5F = 0.058", 6F = 0.071", 7F = 0.081", 8F = 0.090"

PRODUCT DESCRIPTION

Full-Wall Technology construction provides kink resistance and stable torque control; large ID allows for increased contrast flow for enhanced visualization. Vest-Tech Nylon outer jacket provides excellent hub to tip radiopacity.

FEATURES

- Custom lengths and custom curve program available
- Over 230 specialty curves available
- SH available on all curves

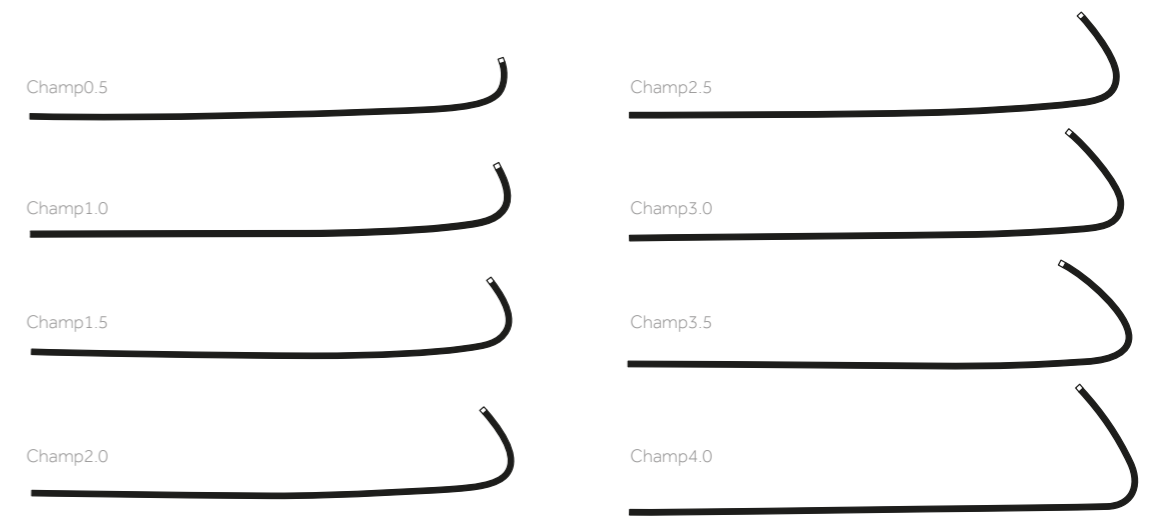

CHAMP

PRODUCT CODE	5F (I.D. 0.058 IN.)	6F (I.D. 0.071 IN.)	7F (I.D. 0.081 IN.)	8F (I.D. 0.090 IN.)
CHAMP 0.5	LA5CHAMP05	LA6CHAMP05	LA7CHAMP05	LA8CHAMP05
CHAMP 10	LA5CHAMP10	LA6CHAMP10	LA7CHAMP10	LA8CHAMP10
CHAMP 15	LA5CHAMP15	LA6CHAMP15	LA7CHAMP15	LA8CHAMP15
CHAMP 20	LA5CHAMP20	LA6CHAMP20	LA7CHAMP20	LA8CHAMP20
CHAMP 25	LA5CHAMP25	LA6CHAMP25	LA7CHAMP25	LA8CHAMP25
CHAMP 30	LA5CHAMP30	LA6CHAMP30	LA7CHAMP30	LA8CHAMP30
CHAMP 35	LA5CHAMP35	LA6CHAMP35	LA7CHAMP35	LA8CHAMP35
CHAMP 40	LA5CHAMP40	LA6CHAMP40	LA7CHAMP40	LA8CHAMP40

CORONARY GUIDE CATHETERS

Launcher™ Guide Catheter Radial Curves

GENERAL CHARACTERISTICS

- Supplied sterile Items per box: 1 • Label colour: 5F: Grey, 6F: Green, 7F: Orange, 8F: Blue
- Lumen inner diameter: 5F = 0.058", 6F = 0.071", 7F = 0.081", 8F = 0.090"

PRODUCT DESCRIPTION

Full-Wall Technology construction provides kink resistance and stable torque control; large ID allows for increased contrast flow for enhanced visualization. Vest-Tech Nylon outer jacket provides excellent hub to tip radiopacity.

FEATURES

- Custom lengths and custom curve program available
- Over 230 specialty curves available
- SH available on all curves

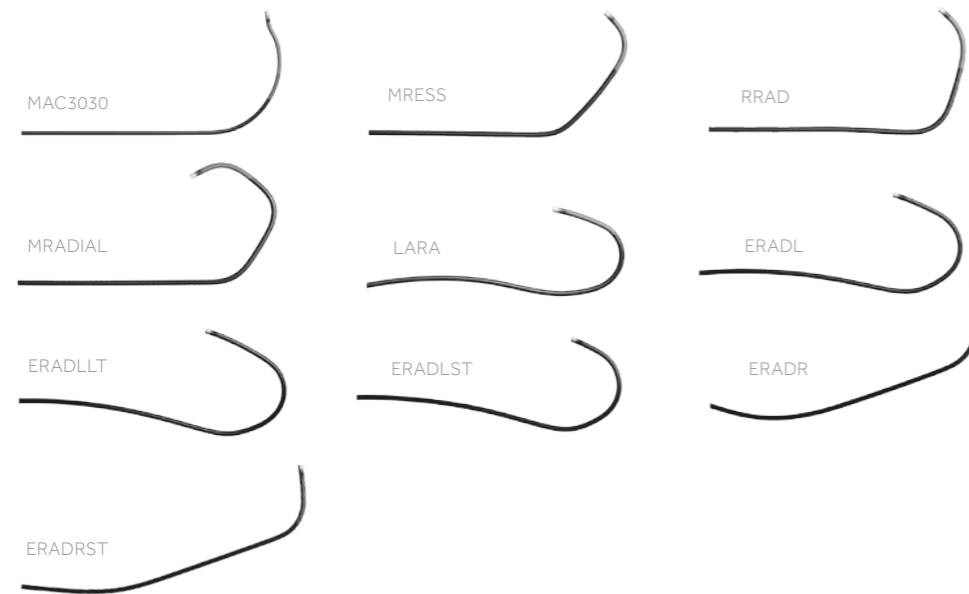

ADDITIONAL RADIAL CURVES

PRODUCT CODE	5F I.D. 0.058 IN.)	6F (I.D. 0.071 IN.)	7F (I.D. 0.081 IN.)	8F (I.D. 0.090 IN.)
MRADIAL	LA5MRADIAL	LA6MRADIAL	-	-
MRESS	LA5MRESS	LA6MRESS	-	-
RIGHT RADIAL	LA5RRAD	LA6RRAD	-	-
ERADL	LA5ERADL	LA6ERADL	-	-
ERADLLT	LA5ERADLLT	LA6ERADLLT	-	-
ERADLST	LA5ERADLST	LA6ERADLST	-	-
ERADR	LA5ERADR	LA6ERADR	-	-
ERADRST	LA5ERADRST	LA6ERADRST	-	-
LARA	LA5LARA	LA6LARA	-	-
MAC3030	LA5MAC3030	LA6MAC3030	-	-

CORONARY GUIDE CATHETERS

Sherpa NX™ Active Left Coronary Curve

GENERAL CHARACTERISTICS

- Supplied sterile, Items per box: 1
- Label colour: 5F = Grey, 6F = Green
- Lumen inner diameter: 5F = 0.058", 6F 0.070"

PRODUCT DESCRIPTION

Soft tip and distal sleeve to facilitate ease of engagement. Advanced HDPE liner for smooth, low friction device passage

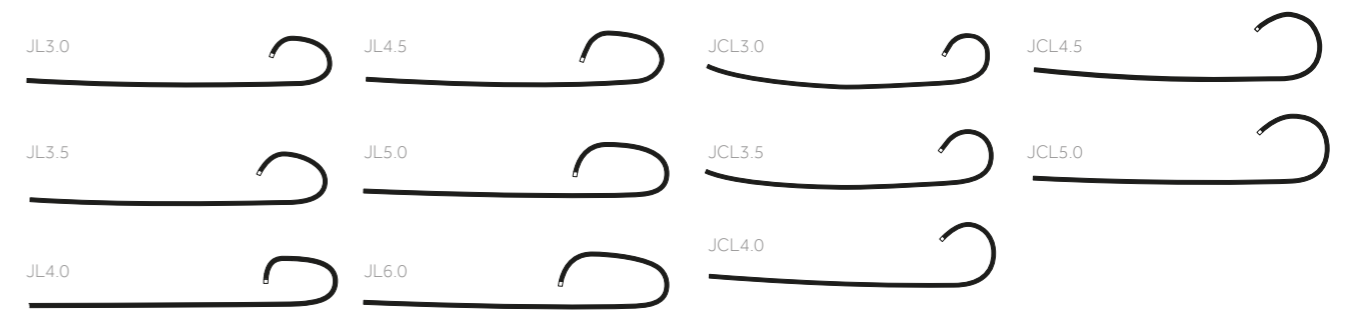

LEFT STANDARD

	5F ACTIVE CODE	6F ACTIVE CODE
JL3.0	SA5JL30	SA6JL30
JL3.5	SA5JL35	SA6JL35
JL4.0	SA5JL40	SA6JL40
JL4.5	SA5JL45	SA6JL45
JL5.0	SA5JL50	SA6JL50
JL6.0	SA5JL60	SA6JL60
JCL3.0	SA5JCL30	SA6JCL30
JCL3.5	SA5JCL35	SA6JCL35
JCL4.0	SA5JCL40	SA6JCL40
JCL4.5	SA5JCL45	SA6JCL45
JCL5.0	SA5JCL50	SA6JCL50

CORONARY GUIDE CATHETERS

Sherpa NX™ Active Short Left Coronary Curve

GENERAL CHARACTERISTICS

- Supplied sterile, Items per box: 1
- Label colour: 5F = Grey, 6F = Green
- Lumen inner diameter: 5F = 0.058", 6F 0.070"

PRODUCT DESCRIPTION

Soft tip and distal sleeve to facilitate ease of engagement. Advanced HDPE liner for smooth, low friction device passage

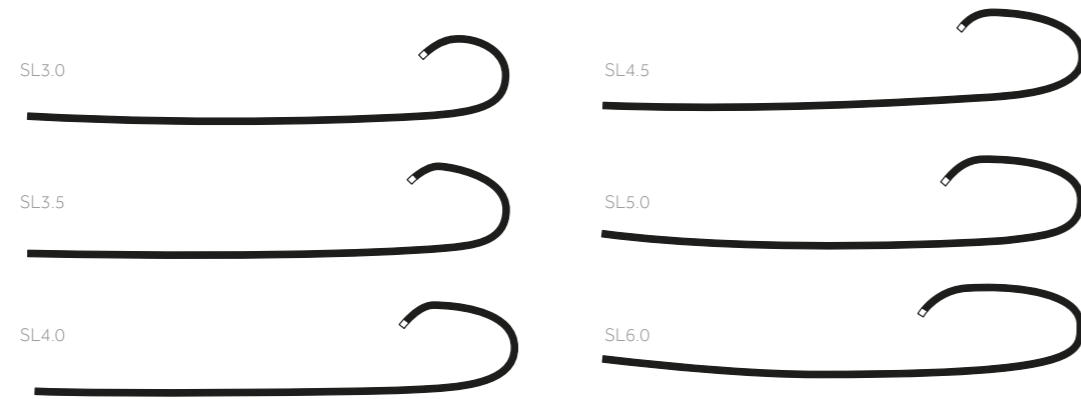

SHORT LEFT

	5F ACTIVE CODE	6F ACTIVE CODE
SL3.0	SA5SL30	SA6SL30
SL3.5	SA5SL35	SA6SL35
SL4.0	SA5SL40	SA6SL40
SL4.5	SA5SL45	SA6SL45
SL5.0	SA5SL50	SA6SL50
SL6.0	SA5SL60	SA6SL60

CORONARY GUIDE CATHETERS

Sherpa NX™ Active Amplatz Left Coronary Curve

GENERAL CHARACTERISTICS

- Supplied sterile, Items per box: 1
- Label colour: 5F = Grey, 6F = Green
- Lumen inner diameter: 5F = 0.058", 6F 0.070"

PRODUCT DESCRIPTION

Soft tip and distal sleeve to facilitate ease of engagement. Advanced HDPE liner for smooth, low friction device passage

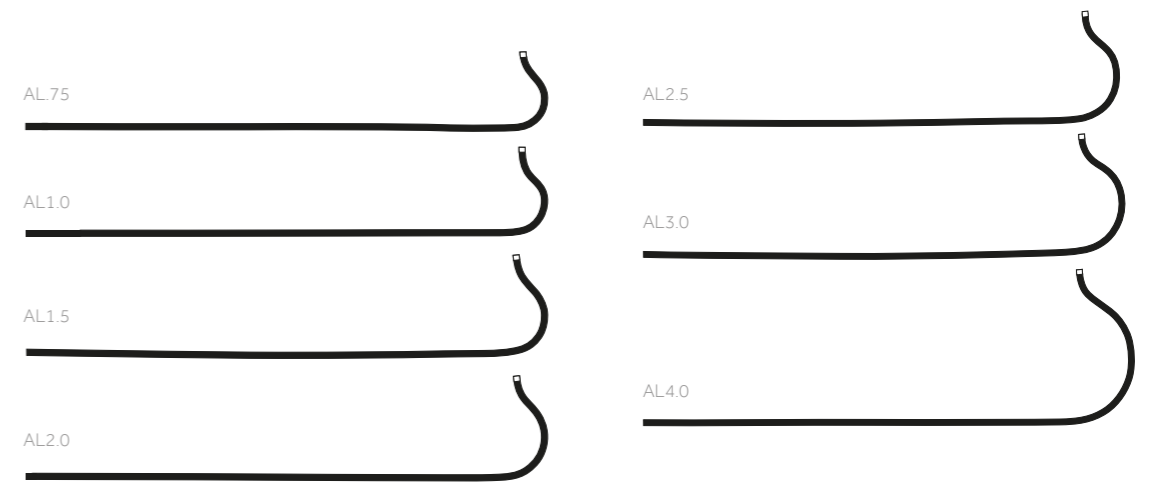

AMPLATZ LEFT

	5F ACTIVE CODE	6F ACTIVE CODE
AL75	SA5AL75	SA6AL75
AL1.0	SA5AL10	SA6AL10
AL1.5	SA5AL15	SA6AL15
AL2.0	SA5AL20	SA6AL20
AL2.5	SA5AL25	SA6AL25
AL3.0	SA5AL30	SA6AL30
AL4.0	SA5AL40	SA6AL40

CORONARY GUIDE CATHETERS

Sherpa NX™ Active Short Amplatz Left Coronary Curve

GENERAL CHARACTERISTICS

- Supplied sterile, Items per box: 1
- Label colour: 5F = Grey, 6F = Green
- Lumen inner diameter: 5F = 0.058", 6F 0.070"

PRODUCT DESCRIPTION

Soft tip and distal sleeve to facilitate ease of engagement. Advanced HDPE liner for smooth, low friction device passage



SHORT AMPLATZ LEFT

	5F ACTIVE CODE	6F ACTIVE CODE
SAL75	SA5SAL75	SA6SAL75
SAL1.0	SA5SAL10	SA6SAL10
SAL1.5	SA5SAL15	SA6SAL15
SAL2.0	SA5SAL20	SA6SAL20
SAL2.5	SA5SAL25	SA6SAL25
SAL3.0	SA5SAL30	SA6SAL30
SAL4.0	SA5SAL40	SA6SAL40

CORONARY GUIDE CATHETERS

Sherpa NX™ Active Left Coronary Backup Support

GENERAL CHARACTERISTICS

- Supplied sterile, Items per box: 1
- Label colour: 5F = Grey, 6F = Green
- Lumen inner diameter: 5F = 0.058", 6F 0.070"

PRODUCT DESCRIPTION

Soft tip and distal sleeve to facilitate ease of engagement. Advanced HDPE liner for smooth, low friction device passage

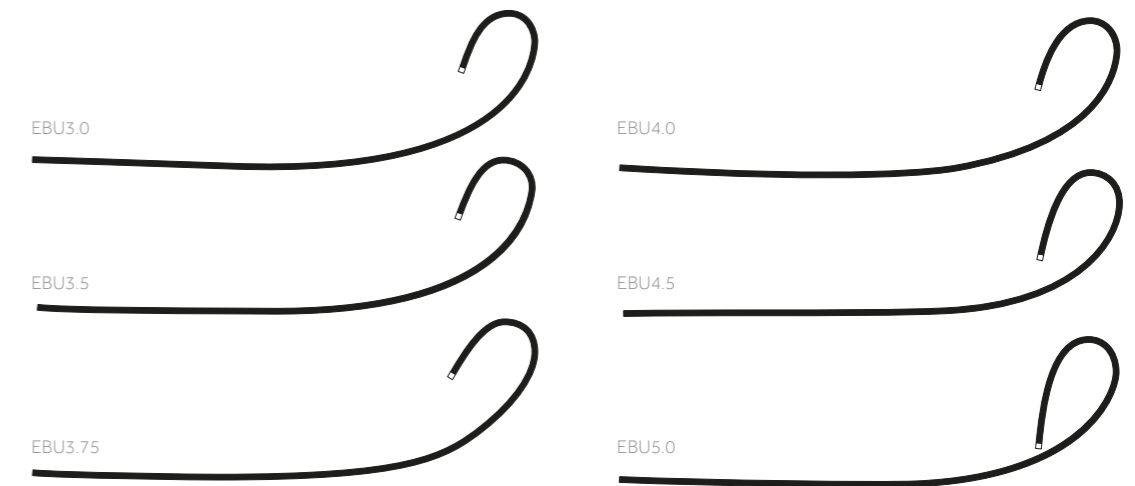

EBU (EXTRA BACKUP)

	5F ACTIVE CODE	6F ACTIVE CODE
EBU3.0	SA5EBU30	SA6EBU30
EBU3.5	SA5EBU35	SA6EBU35
EBU3.75	SA5EBU375	SA6EBU375
EBU4.0	SA5EBU40	SA6EBU40
EBU4.5	SA5EBU45	SA6EBU45
EBU5.0	SA5EBU50	SA6EBU50

CORONARY GUIDE CATHETERS

Sherpa NX™ Active Right Coronary Curve

GENERAL CHARACTERISTICS

- Supplied sterile, Items per box: 1
- Label colour: 5F = Grey, 6F = Green
- Lumen inner diameter: 5F = 0.058", 6F 0.070"

PRODUCT DESCRIPTION

Soft tip and distal sleeve to facilitate ease of engagement. Advanced HDPE liner for smooth, low friction device passage

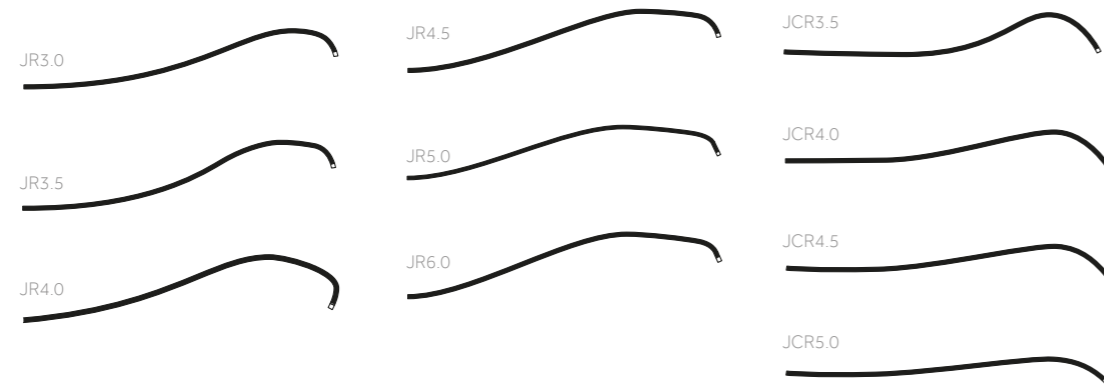

RIGHT STANDARD

	5F ACTIVE CODE	6F ACTIVE CODE
JR3.0	SA5JR30	SA6JR30
JR3.5	SA5JR35	SA6JR35
JR4.0	SA5JR40	SA6JR40
JR4.5	SA5JR45	SA6JR45
JR5.0	SA5JR50	SA6JR50
JR6.0	SA5JR60	SA6JR60
JCR3.5	SA5JCR35	SA6JCR35
JCR4.0	SA5JCR40	SA6JCR40
JCR4.5	SA5JCR45	SA6JCR45
JCR5.0	SA5JCR50	SA6JCR50

CORONARY GUIDE CATHETERS

Sherpa NX™ Active Short Right Coronary Curve

GENERAL CHARACTERISTICS

- Supplied sterile, Items per box: 1
- Label colour: 5F = Grey, 6F = Green
- Lumen inner diameter: 5F = 0.058", 6F 0.070"

PRODUCT DESCRIPTION

Soft tip and distal sleeve to facilitate ease of engagement. Advanced HDPE liner for smooth, low friction device passage

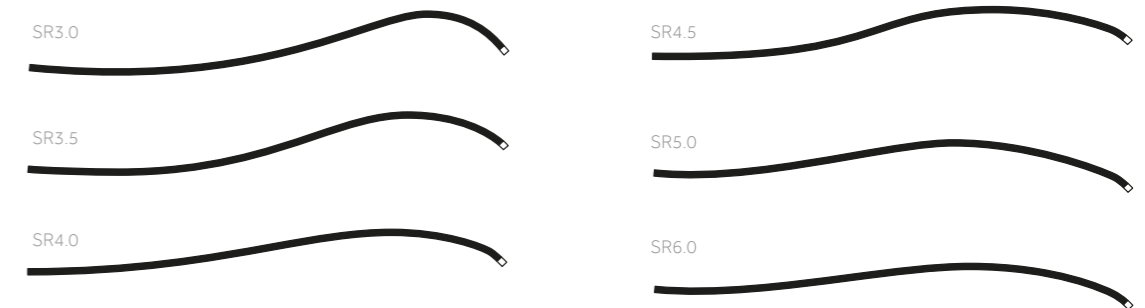

SHORT RIGHT

	5F ACTIVE CODE	6F ACTIVE CODE
SR3.0	SA5SR30	SA6SR30
SR3.5	SA5SR35	SA6SR35
SR4.0	SA5SR40	SA6SR40
SR4.5	SA5SR45	SA6SR45
SR5.0	SA5SR50	SA6SR50
SR6.0	SA5SR60	SA6SR60

CORONARY GUIDE CATHETERS

Sherpa NX™ Active Amplatz Right Coronary Curve

GENERAL CHARACTERISTICS

- Supplied sterile, Items per box: 1
- Label colour: 5F = Grey, 6F = Green
- Lumen inner diameter: 5F = 0.058", 6F 0.070"

PRODUCT DESCRIPTION

Soft tip and distal sleeve to facilitate ease of engagement. Advanced HDPE liner for smooth, low friction device passage

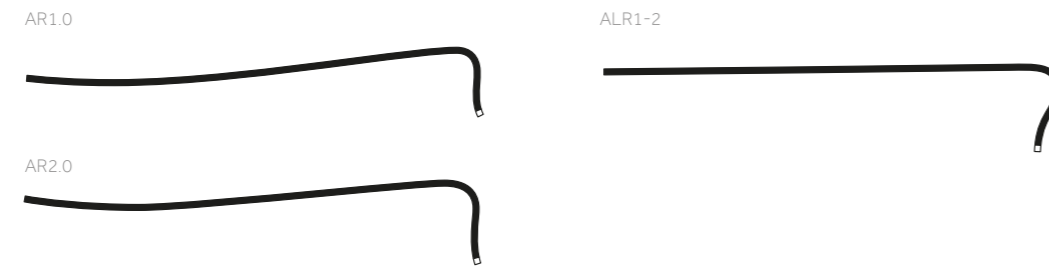

AMPLATZ RIGHT

	5F ACTIVE CODE	6F ACTIVE CODE
AR1.0	SA5AR10	SA6AR10
AR2.0	SA5AR20	SA6AR20
ALR1-2	SA5ALR12	SA6ALR12

CORONARY GUIDE CATHETERS

Sherpa NX™ Active Short Amplatz Right Coronary Curve

GENERAL CHARACTERISTICS

- Supplied sterile, Items per box: 1
- Label colour: 5F = Grey, 6F = Green
- Lumen inner diameter: 5F = 0.058", 6F 0.070"

PRODUCT DESCRIPTION

Soft tip and distal sleeve to facilitate ease of engagement. Advanced HDPE liner for smooth, low friction device passage



SHORT AMPLATZ RIGHT

	5F ACTIVE CODE	6F ACTIVE CODE
SAR1.0	SA5SAR10	SA6SAR10
SAR2.0	SA5SAR20	SA6SAR20

CORONARY GUIDE CATHETERS

Sherpa NX™ Active Shepherd's Crook Right Coronary Curve

GENERAL CHARACTERISTICS

- Supplied sterile, Items per box: 1
- Label colour: 5F = Grey, 6F = Green
- Lumen inner diameter: 5F = 0.058", 6F 0.070"

PRODUCT DESCRIPTION

Soft tip and distal sleeve to facilitate ease of engagement. Advanced HDPE liner for smooth, low friction device passage

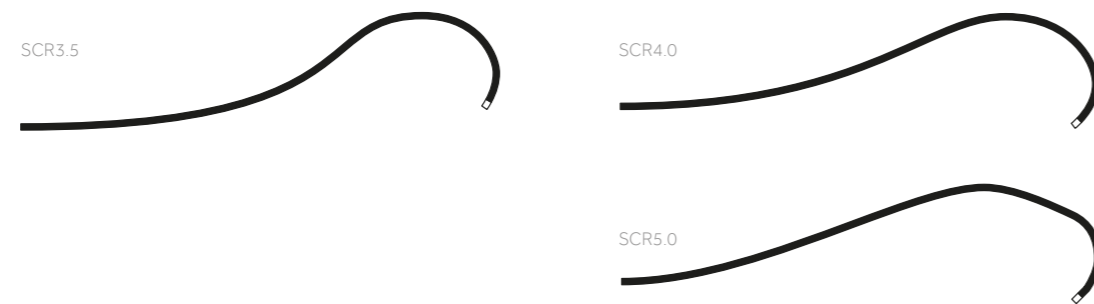

SHEPHERD'S CROOK RIGHT

	5F ACTIVE CODE	6F ACTIVE CODE
SCR3.5	SA5SCR35	SA6SCR35
SCR4.0	SA5SCR40	SA6SCR40
SCR5.0	SA5SCR50	SA6SCR50

CORONARY GUIDE CATHETERS

Sherpa NX™ Active Right Coronary Backup Support

GENERAL CHARACTERISTICS

- Supplied sterile, Items per box: 1
- Label colour: 5F = Grey, 6F = Green
- Lumen inner diameter: 5F = 0.058", 6F 0.070"

PRODUCT DESCRIPTION

Soft tip and distal sleeve to facilitate ease of engagement. Advanced HDPE liner for smooth, low friction device passage

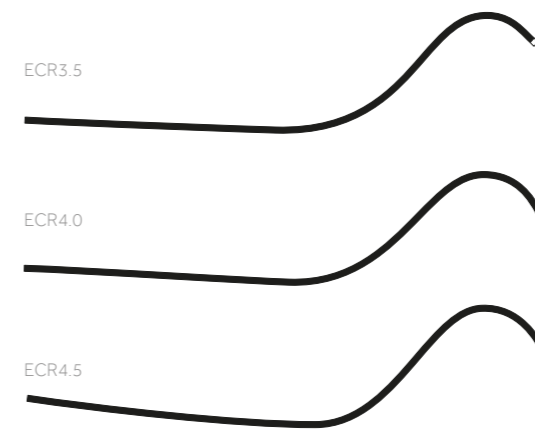

ECR CURVES

	5F ACTIVE CODE	6F ACTIVE CODE
ECR 3.5	SA5ECR35	SA6ECR35
ECR 4.0	SA5ECR40	SA6ECR40
ECR 4.5	SA5ECR45	SA6ECR45

CORONARY GUIDE CATHETERS

Sherpa NX™ Active Right Coronary Backup Support

GENERAL CHARACTERISTICS

- Supplied sterile, Items per box: 1
- Label colour: 5F = Grey, 6F = Green
- Lumen inner diameter: 5F = 0.058", 6F 0.070"

PRODUCT DESCRIPTION

Soft tip and distal sleeve to facilitate ease of engagement. Advanced HDPE liner for smooth, low friction device passage

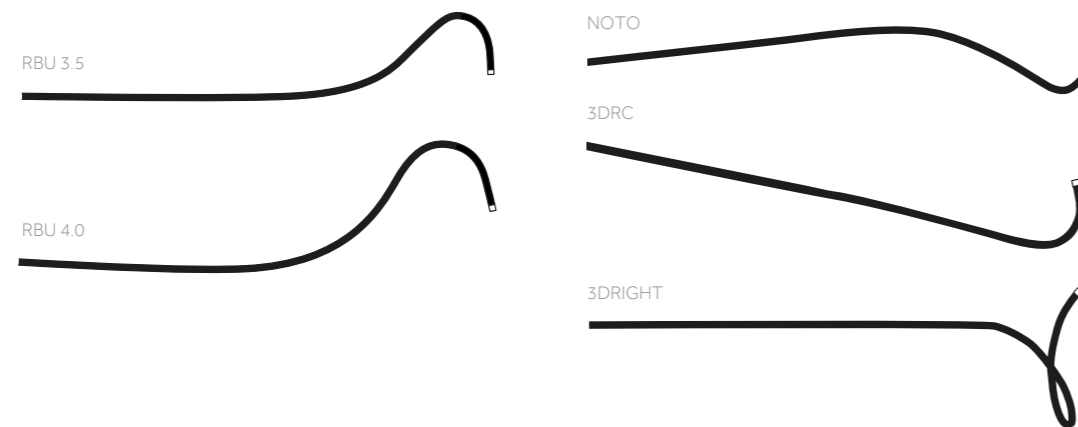

BACKUP SUPPORT CURVES

	5F ACTIVE CODE	6F ACTIVE CODE
RBU 3.5	SA5RBU35	SA6RBU35
RBU 4.0	SA5RBU40	SA6RBU40
3DRC		SA63DRC
3DRIGHT	SA53DRIGHT	SA63DRIGHT
NOTO	LA5NOTO	LA6NOTO

CORONARY GUIDE CATHETERS

Sherpa NX™ Active Multipurpose Curves

GENERAL CHARACTERISTICS

- Supplied sterile, Items per box: 1
- Label colour: 5F = Grey, 6F = Green
- Lumen inner diameter: 5F = 0.058", 6F 0.070"

PRODUCT DESCRIPTION

Soft tip and distal sleeve to facilitate ease of engagement. Advanced HDPE liner for smooth, low friction device passage

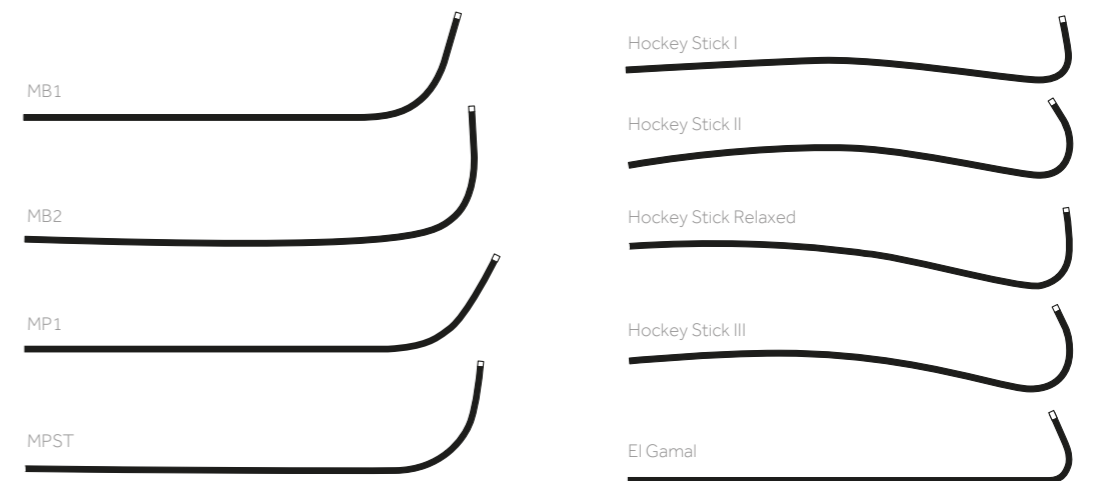

MULTIPURPOSE

	5F ACTIVE CODE	6F ACTIVE CODE
MB1	SA5MB1	SA6MB1
MB2	SA5MB2	SA6MB2
MB Short Tip	SA5MPST	SA6MPST
MP1	SA5MP1	SA6MP1
MP2	SA5MP2	SA6MP2
Hockey Stick I	SA5HSI	SA6HSI
Hockey Stick II	SA5HSII	SA6HSII
HS II Relaxed	SA5RMHSII	SA6RMHSII
Hockey Stick III	SA5HSIII	SA6HSIII
El Gamal	SA5ELGAMAL	SA6ELGAMAL

CORONARY GUIDE CATHETERS

Sherpa NX™ Active Other Curves

GENERAL CHARACTERISTICS

- Supplied sterile, Items per box: 1
- Label colour: 5F = Grey, 6F = Green
- Lumen inner diameter: 5F = 0.058", 6F 0.070"

PRODUCT DESCRIPTION

Soft tip and distal sleeve to facilitate ease of engagement. Advanced HDPE liner for smooth, low friction device passage

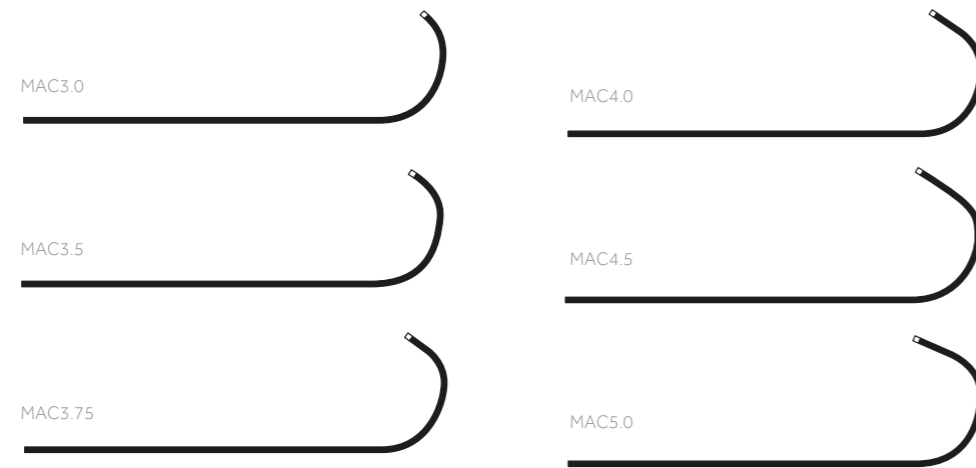

MAC (MULTI- AORTIC CURVES)

	5F ACTIVE CODE	6F ACTIVE CODE
MAC3.0	SA5MAC30	SA6MAC30
MAC3.5	SA5MAC35	SA6MAC35
MAC3.75	SA5MAC375	SA6MAC375
MAC4.0	SA5MAC40	SA6MAC40
MAC4.5	SA5MAC45	SA6MAC45
MAC5.0	SA5MAC50	SA6MAC50

CORONARY GUIDE CATHETERS

Sherpa NX™ Active Bypass Curves

GENERAL CHARACTERISTICS

- Supplied sterile, Items per box: 1
- Label colour: 5F = Grey, 6F = Green
- Lumen inner diameter: 5F = 0.058", 6F 0.070"

PRODUCT DESCRIPTION

Soft tip and distal sleeve to facilitate ease of engagement. Advanced HDPE liner for smooth, low friction device passage

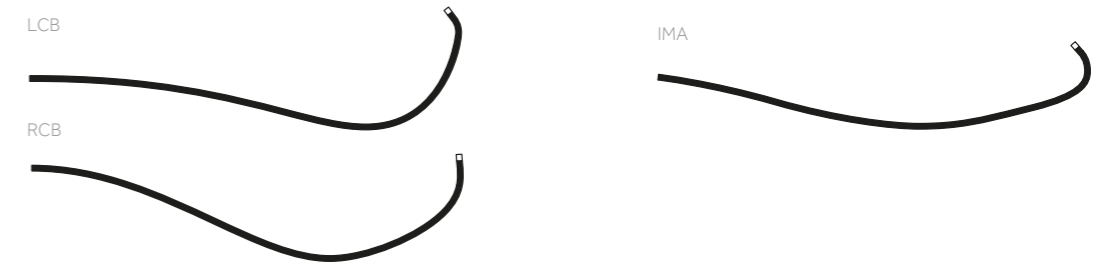

BYPASS CURVES

	5F ACTIVE CODE	6F ACTIVE CODE
LCB	SA5LCB	SA6LCB
LCB (90 cm)	SA5LCBD	SA6LCBD
RCB	SA5RCB	SA6RCB
RCB (90 cm)	SA5RCBD	SA6RCBD
IMA	SA5IMA	SA6IMA
IMA (90 cm)	SA5IMAD	SA6IMAD

CORONARY GUIDE CATHETERS

Sherpa NX™ Active Other Curves

GENERAL CHARACTERISTICS

- Supplied sterile, Items per box: 1
- Label colour: 5F = Grey, 6F = Green
- Lumen inner diameter: 5F = 0.058", 6F 0.070"

PRODUCT DESCRIPTION

Soft tip and distal sleeve to facilitate ease of engagement. Advanced HDPE liner for smooth, low friction device passage

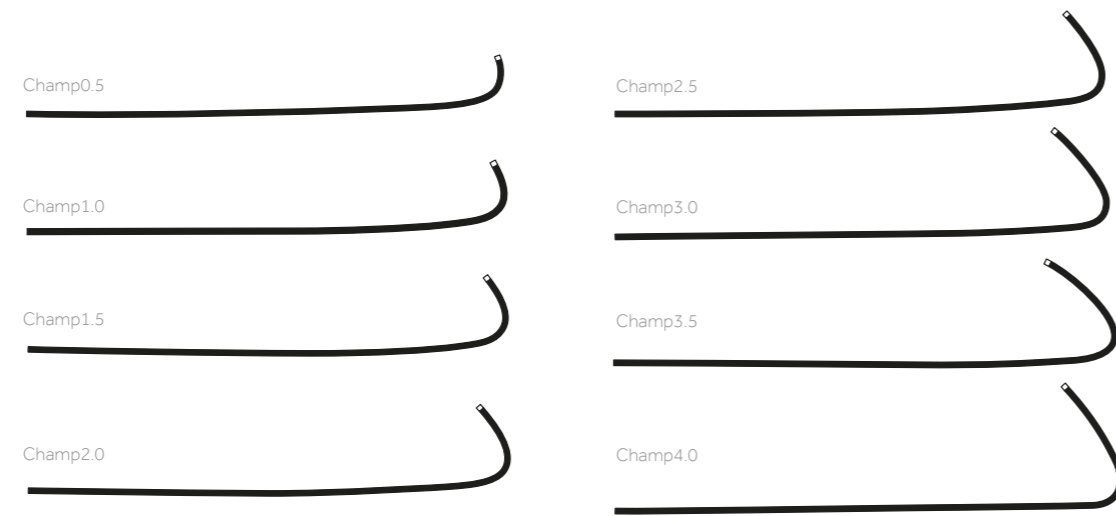

CHAMP

	5F ACTIVE CODE	6F ACTIVE CODE
CHAMP 0.5	SA5CHAMP05	SA6CHAMP05
CHAMP 10	SA5CHAMP10	SA6CHAMP10
CHAMP 15	SA5CHAMP15	SA6CHAMP15
CHAMP 20	SA5CHAMP20	SA6CHAMP20
CHAMP 25	SA5CHAMP25	SA6CHAMP25
CHAMP 30	SA5CHAMP30	SA6CHAMP30
CHAMP 35	SA5CHAMP35	SA6CHAMP35
CHAMP 40	SA5CHAMP40	SA6CHAMP40

CORONARY GUIDE CATHETERS

Sherpa NX™ Active Radial Curves

GENERAL CHARACTERISTICS

- Supplied sterile, Items per box: 1
- Label colour: 5F = Grey, 6F = Green
- Lumen inner diameter: 5F = 0.058", 6F 0.070"

PRODUCT DESCRIPTION

Soft tip and distal sleeve to facilitate ease of engagement. Advanced HDPE liner for smooth, low friction device passage

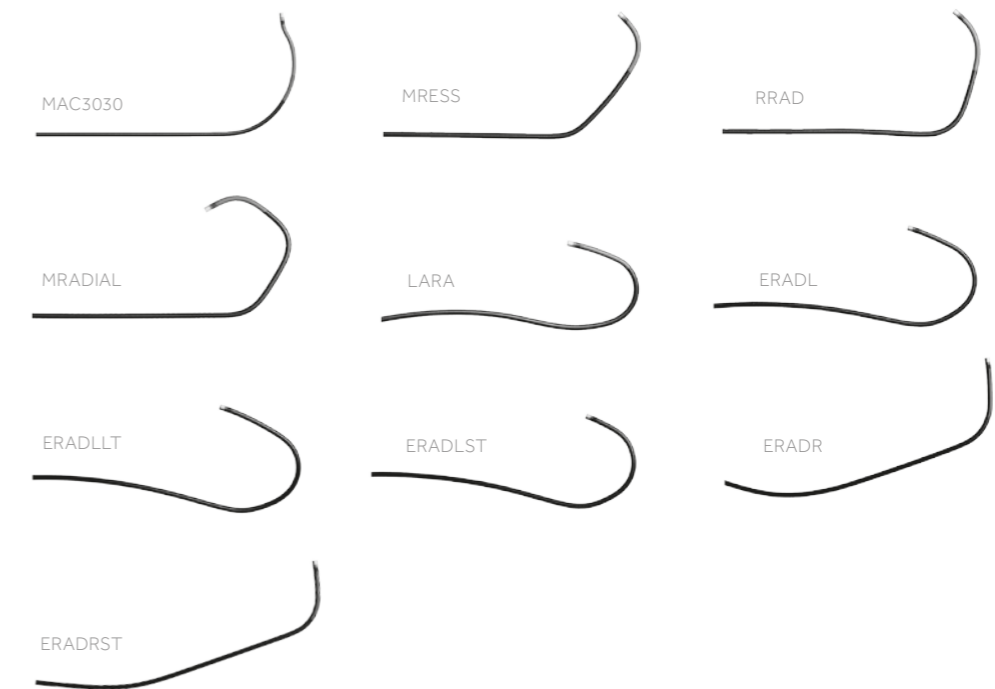

RADIAL CURVES

	5F ACTIVE CODE	6F ACTIVE CODE
MRADIAL	SA5MRADIAL	SA6MRADIAL
MRESS	SA5MRESS	SA6MRESS
RIGHT RADIAL	SA5RRAD	SA6RRAD
ERADL	SA5ERADL	SA6ERADL
ERADLLT	SA5ERADLLT	SA6ERADLLT
ERADLST	SA5ERADLST	SA6ERADLST
ERADR	SA5ERADR	SA6ERADR
ERADRST	SA5ERADRST	SA6ERADRST
MAC3030	SA5MAC30303	SA6MAC30303

CORONARY GUIDE CATHETERS

Sherpa NX™ Balanced Left Coronary Curve

GENERAL CHARACTERISTICS

- Supplied sterile, Items per box: 1
- Label colour: 6F = Green, 7F = Orange, 8F = Blue
- Lumen inner diameter: 6F = 0.070", 7F = 0.080", 8F = 0.088"

PRODUCT DESCRIPTION

Soft tip and distal sleeve to facilitate ease of engagement. Advanced HDPE liner for smooth, low friction device passage

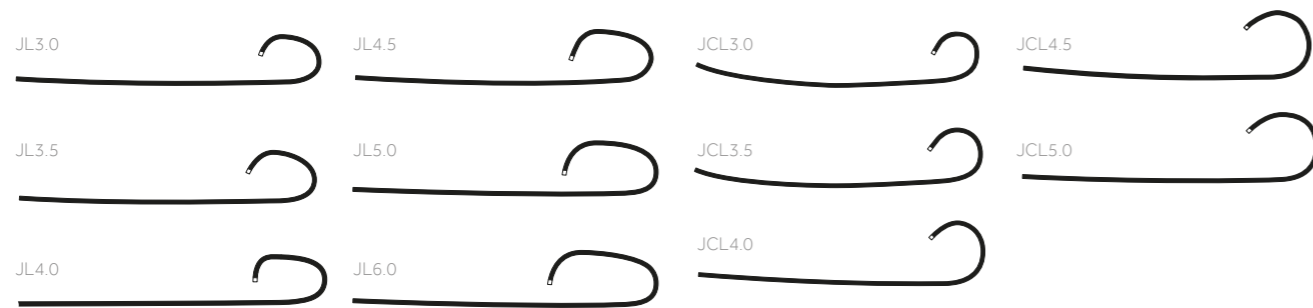

LEFT STANDARD

	6F BALANCED CODE	7F BALANCED CODE	8F BALANCED CODE
JL3.0	SB6JL30	SB7JL30	SB8JL30
JL3.5	SB6JL35	SB7JL35	SB8JL35
JL4.0	SB6JL40	SB7JL40	SB8JL40
JL4.5	SB6JL45	SB7JL45	SB8JL45
JL5.0	SB6JL50	SB7JL50	SB8JL50
JL6.0	SB6JL60	SB7JL70	SB8JL70
JCL3.0	SB6JCL30	SB7JCL30	SB8JCL30
JCL3.5	SB6JCL35	SB7JCL35	SB8JCL35
JCL4.0	SB6JCL40	SB7JCL40	SB8JCL40
JCL4.5	SB6JCL45	SB7JCL45	SB8JCL45
JCL5.0	SB6JCL50	SB7JCL50	SB8JCL50

CORONARY GUIDE CATHETERS

Sherpa NX™ Balanced Short Left Coronary Curve

GENERAL CHARACTERISTICS

- Supplied sterile, Items per box: 1
- Label colour: 6F = Green, 7F = Orange, 8F = Blue
- Lumen inner diameter: 6F = 0.070", 7F = 0.080", 8F = 0.088"

PRODUCT DESCRIPTION

Soft tip and distal sleeve to facilitate ease of engagement. Advanced HDPE liner for smooth, low friction device passage

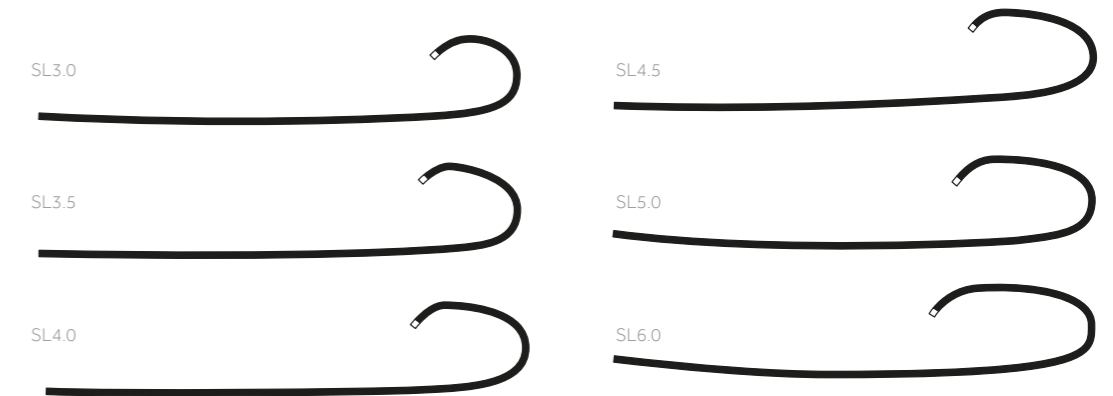

SHORT LEFT

	6F BALANCED CODE	7F BALANCED CODE	8F BALANCED CODE
SL3.0	SB6SL30	SB7SL30	SB8SL30
SL3.5	SB6SL35	SB7SL35	SB8SL35
SL4.0	SB6SL40	SB7SL40	SB8SL40
SL4.5	SB6SL45	SB7SL45	SB8SL45
SL5.0	SB6SL50	SB7SL50	SB8SL50
SL6.0	SB6SL60	SB7SL70	SB8SL70

CORONARY GUIDE CATHETERS

Sherpa NX™ Balanced Amplatz Left Coronary Curve

GENERAL CHARACTERISTICS

- Supplied sterile, Items per box: 1
- Label colour: 6F = Green, 7F = Orange, 8F = Blue
- Lumen inner diameter: 6F = 0.070", 7F = 0.080", 8F = 0.088"

PRODUCT DESCRIPTION

Soft tip and distal sleeve to facilitate ease of engagement. Advanced HDPE liner for smooth, low friction device passage

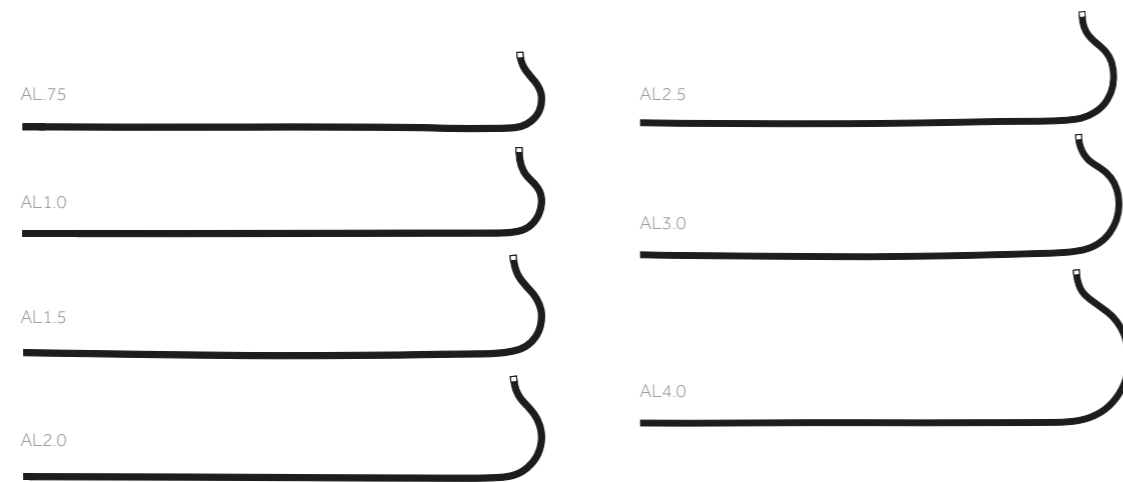

AMPLATZ LEFT

	6F BALANCED CODE	7F BALANCED CODE	8F BALANCED CODE
AL.75	SB6AL75	SB7AL75	SB8AL75
AL1.0	SB6AL10	SB7AL10	SB8AL10
AL1.5	SB6AL15	SB7AL15	SB8AL15
AL2.0	SB6AL20	SB7AL20	SB8AL20
AL2.5	SB6AL25	SB7AL25	SB8AL25
AL3.0	SB6AL30	SB7AL30	SB8AL30
AL4.0	SB6AL40	SB7AL40	SB8AL40

CORONARY GUIDE CATHETERS

Sherpa NX™ Balanced Short Amplatz Left Coronary Curve

GENERAL CHARACTERISTICS

- Supplied sterile, Items per box: 1
- Label colour: 6F = Green, 7F = Orange, 8F = Blue
- Lumen inner diameter: 6F = 0.070", 7F = 0.080", 8F = 0.088"

PRODUCT DESCRIPTION

Soft tip and distal sleeve to facilitate ease of engagement. Advanced HDPE liner for smooth, low friction device passage

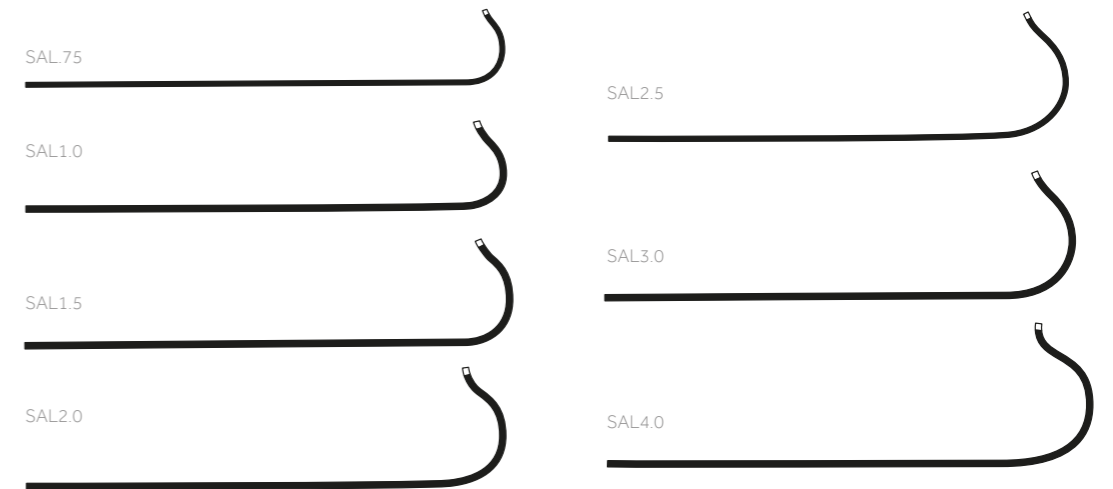

SHORT AMPLATZ LEFT

	6F BALANCED CODE	7F BALANCED CODE	8F BALANCED CODE
SAL.75	SB6SAL75	SB7SAL75	SB8SAL75
SAL1.0	SB6SAL10	SB7SAL10	SB8SAL10
SAL1.5	SB6SAL15	SB7SAL15	SB8SAL15
SAL2.0	SB6SAL20	SB7SAL20	SB8SAL20
SAL2.5	SB6SAL25	SB7SAL25	SB8SAL25
SAL3.0	SB6SAL30	SB7SAL30	SB8SAL30
SAL4.0	SB6SAL40	SB7SAL40	SB8SAL40

CORONARY GUIDE CATHETERS

Sherpa NX™ Balanced Left Coronary Backup Support

GENERAL CHARACTERISTICS

- Supplied sterile, Items per box: 1
- Label colour: 6F = Green, 7F = Orange, 8F = Blue
- Lumen inner diameter: 6F = 0.070", 7F = 0.080", 8F = 0.088"

PRODUCT DESCRIPTION

Soft tip and distal sleeve to facilitate ease of engagement. Advanced HDPE liner for smooth, low friction device passage

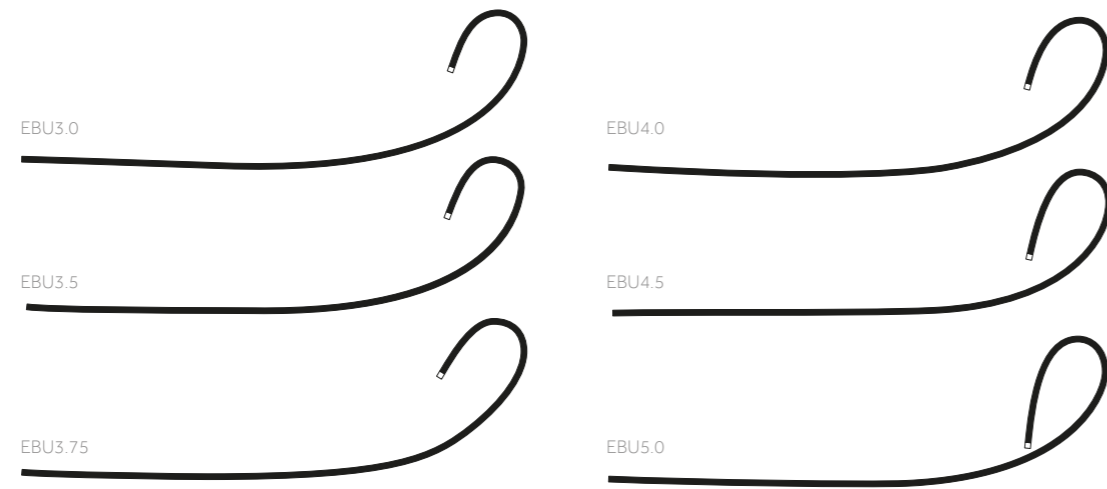

EBU (EXTRA BACKUP)

	6F BALANCED CODE	7F BALANCED CODE	8F BALANCED CODE
EBU3.0	SB6EBU30	SB7EBU30	SB8EBU30
EBU3.5	SB6EBU35	SB7EBU35	SB8EBU35
EBU3.75	SB6EBU375	SB7EBU375	SB8EBU375
EBU4.0	SB6EBU40	SB7EBU40	SB8EBU40
EBU4.5	SB6EBU45	SB7EBU45	SB8EBU45
EBU5.0	SB6EBU50	SB7EBU50	SB8EBU50

CORONARY GUIDE CATHETERS

Sherpa NX™ Balanced Right Coronary Curve

GENERAL CHARACTERISTICS

- Supplied sterile, Items per box: 1
- Label colour: 6F = Green, 7F = Orange, 8F = Blue
- Lumen inner diameter: 6F = 0.070", 7F = 0.080", 8F = 0.088"

PRODUCT DESCRIPTION

Soft tip and distal sleeve to facilitate ease of engagement. Advanced HDPE liner for smooth, low friction device passage

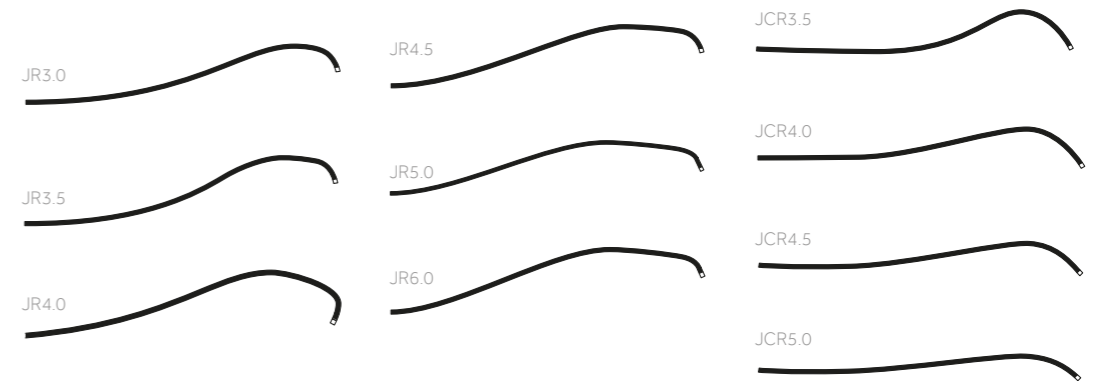

RIGHT STANDARD

	6F BALANCED CODE	7F BALANCED CODE	8F BALANCED CODE
JR3.0	SB6JR30	SB7JR30	SB8JR30
JR3.5	SB6JR35	SB7JR35	SB8JR35
JR4.0	SB6JR40	SB7JR40	SB8JR40
JR4.5	SB6JR45	SB7JR45	SB8JR45
JR5.0	SB6JR50	SB7JR50	SB8JR50
JR6.0	SB6JR60	SB7JR70	SB8JR70
JCR3.5	SB6JCR35	SB7JCR35	SB8JCR35
JCR4.0	SB6JCR40	SB7JCR40	SB8JCR40
JCR4.5	SB6JCR45	SB7JCR45	SB8JCR45
JCR5.0	SB6JCR50	SB7JCR50	SB8JCR50

CORONARY GUIDE CATHETERS

Sherpa NX™ Balanced Short Right Coronary Curve

GENERAL CHARACTERISTICS

- Supplied sterile, Items per box: 1
- Label colour: 6F = Green, 7F = Orange, 8F = Blue
- Lumen inner diameter: 6F = 0.070", 7F = 0.080", 8F = 0.088"

PRODUCT DESCRIPTION

Soft tip and distal sleeve to facilitate ease of engagement. Advanced HDPE liner for smooth, low friction device passage

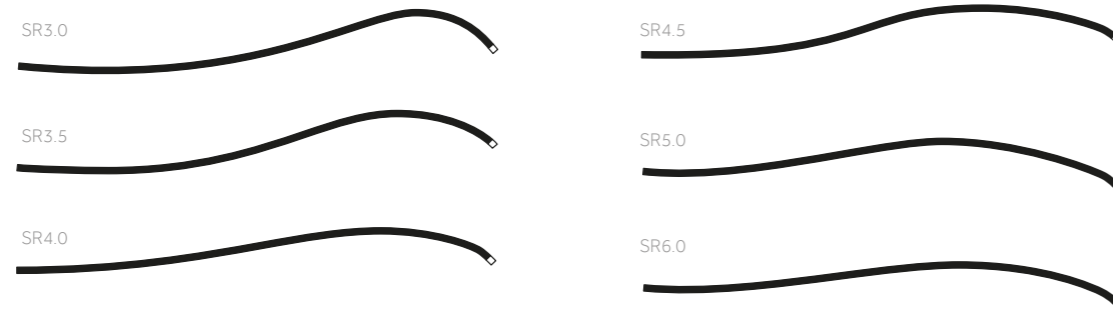

SHORT RIGHT

	6F BALANCED CODE	7F BALANCED CODE	8F BALANCED CODE
SR3.0	SB6SR30	SB7SR30	SB8SR30
SR3.5	SB6SR35	SB7SR35	SB8SR35
SR4.0	SB6SR40	SB7SR40	SB8SR40
SR4.5	SB6SR45	SB7SR45	SB8SR45
SR5.0	SB6SR50	SB7SR50	SB8SR50
SR6.0	SB6SR60	SB7SR70	SB8SR70

CORONARY GUIDE CATHETERS

Sherpa NX™ Balanced Amplatz Right Coronary Curve

GENERAL CHARACTERISTICS

- Supplied sterile, Items per box: 1
- Label colour: 6F = Green, 7F = Orange, 8F = Blue
- Lumen inner diameter: 6F = 0.070", 7F = 0.080", 8F = 0.088"

PRODUCT DESCRIPTION

Soft tip and distal sleeve to facilitate ease of engagement. Advanced HDPE liner for smooth, low friction device passage

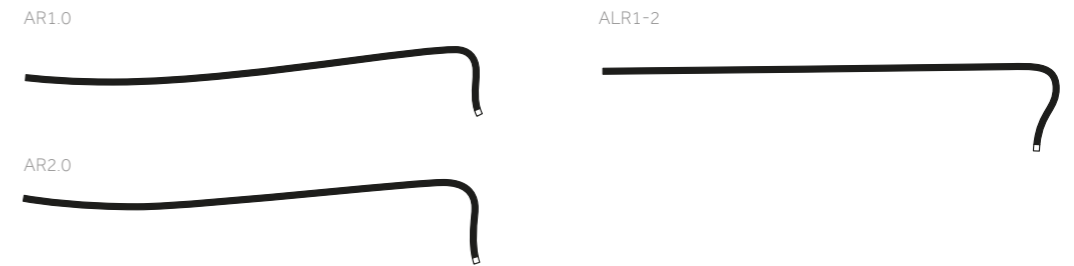

AMPLATZ RIGHT

	6F BALANCED CODE	7F BALANCED CODE	8F BALANCED CODE
AR1.0	SB6AR10	SB7AR10	SB8AR10
AR2.0	SB6AR20	SB7AR20	SB8AR20
ALR1-2	SB6ALR12	SB7ALR12	SB8ALR12

CORONARY GUIDE CATHETERS

Sherpa NX™ Balanced Short Amplatz Right Coronary Curve

GENERAL CHARACTERISTICS

- Supplied sterile, Items per box: 1
- Label colour: 6F = Green, 7F = Orange, 8F = Blue
- Lumen inner diameter: 6F = 0.070", 7F = 0.080", 8F = 0.088"

PRODUCT DESCRIPTION

Soft tip and distal sleeve to facilitate ease of engagement. Advanced HDPE liner for smooth, low friction device passage

SAR1.0



SAR2.0



SHORT AMPLATZ RIGHT

	6F BALANCED CODE	7F BALANCED CODE	8F BALANCED CODE
SAR1.0	SB6SAR10	SB7SAR10	SB8SAR10
SAR2.0	SB6SAR20	SB7SAR20	SB8SAR20

CORONARY GUIDE CATHETERS

Sherpa NX™ Balanced Shepherd's Crook Right Coronary Curve

GENERAL CHARACTERISTICS

- Supplied sterile, Items per box: 1
- Label colour: 6F = Green, 7F = Orange, 8F = Blue
- Lumen inner diameter: 6F = 0.070", 7F = 0.080", 8F = 0.088"

PRODUCT DESCRIPTION

Soft tip and distal sleeve to facilitate ease of engagement. Advanced HDPE liner for smooth, low friction device passage

SCR3.5



SCR4.0



SCR5.0



SHEPHERD'S CROOK RIGHT

	6F BALANCED CODE	7F BALANCED CODE	8F BALANCED CODE
SCR3.5	SB6SCR35	SB7SCR35	SB8SCR35
SCR4.0	SB6SCR40	SB7SCR40	SB8SCR40
SCR5.0	SB6SCR50	SB7SCR50	SB8SCR50

CORONARY GUIDE CATHETERS

Sherpa NX™ Balanced Right Coronary Backup Support

GENERAL CHARACTERISTICS

- Supplied sterile, Items per box: 1
- Label colour: 6F = Green, 7F = Orange, 8F = Blue
- Lumen inner diameter: 6F = 0.070", 7F = 0.080", 8F = 0.088"

PRODUCT DESCRIPTION

Soft tip and distal sleeve to facilitate ease of engagement. Advanced HDPE liner for smooth, low friction device passage

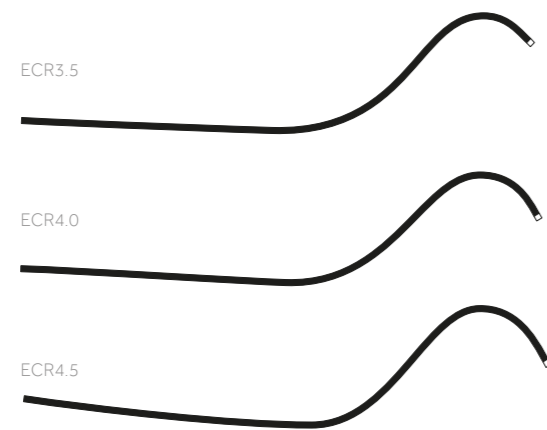

ECR CURVES

	6F BALANCED CODE	7F BALANCED CODE	8F BALANCED CODE
ECR 3.5	SB6ECR35	SB7ECR35	SB8ECR35
ECR 4.0	SB6ECR40	SB7ECR40	SB8ECR40
ECR 4.5	SB6ECR45	SB7ECR45	SB8ECR45

CORONARY GUIDE CATHETERS

Sherpa NX™ Balanced Right Coronary Backup Support

GENERAL CHARACTERISTICS

- Supplied sterile, Items per box: 1
- Label colour: 6F = Green, 7F = Orange, 8F = Blue
- Lumen inner diameter: 6F = 0.070", 7F = 0.080", 8F = 0.088"

PRODUCT DESCRIPTION

Soft tip and distal sleeve to facilitate ease of engagement. Advanced HDPE liner for smooth, low friction device passage

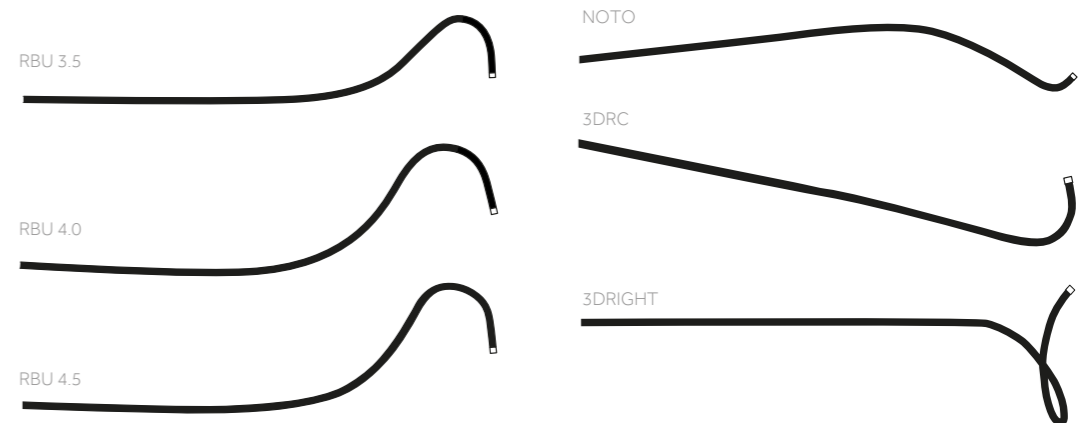

BACKUP SUPPORT CURVES

	6F BALANCED CODE	7F BALANCED CODE	8F BALANCED CODE
RBU 3.5	SB6RBU35	SB7RBU35	SB8RBU35
RBU 4.0	SB6RBU40	SB7RBU40	SB8RBU40
RBU 4.5	SB6RBU45	SB7RBU45	SB8RBU45
3DRC	SB63DRC	SB73DRC	SB83DRC
3DRIGHT	SB63DRIGHT	SB73DRIGHT	SB83DRIGHT
NO TORQUE Right	SB6NOTO	SB7NOTO	

CORONARY GUIDE CATHETERS

Sherpa NX™ Balanced Multipurpose Curves

GENERAL CHARACTERISTICS

- Supplied sterile, Items per box: 1
- Label colour: 6F = Green, 7F = Orange, 8F = Blue
- Lumen inner diameter: 6F = 0.070", 7F = 0.080", 8F = 0.088"

PRODUCT DESCRIPTION

Soft tip and distal sleeve to facilitate ease of engagement. Advanced HDPE liner for smooth, low friction device passage

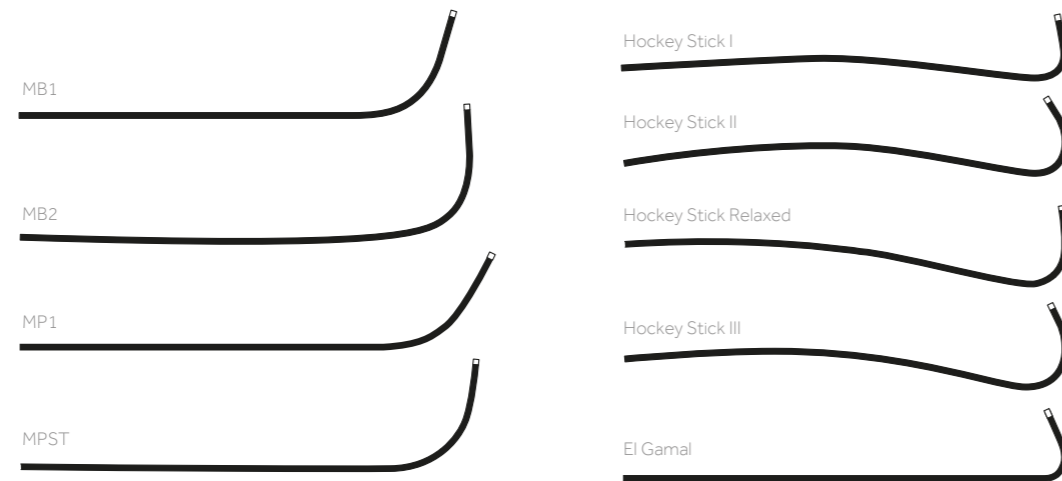

MULTIPURPOSE

	6F BALANCED CODE	7F BALANCED CODE	8F BALANCED CODE
MB1	SB6MB1	SB7MB1	SB8MB1
MB2	SB6MB2	SB7MB2	SB8MB2
MB Short Tip	SB6MPST	SB7MPST	SB8MPST
MP1	SB6MP1	SB7MP1	SB8MP1
MP2	SB6MP2	SB7MP2	SB8MP2
Hockey Stick I	SB6HSI	SB7HSI	SB8HSI
Hockey Stick II	SB6HSII	SB7HSII	SB8HSII
HS II Relaxed	SB6RMHSII	SB7RMHSII	SB8RMHSII
Hockey Stick III	SB6HSIII	SB7HSIII	SB8HSIII
El Gamal	SB6ELGAMAL	SB7ELGAMAL	SB8ELGAMAL

CORONARY GUIDE CATHETERS

Sherpa NX™ Balanced Other Curves

GENERAL CHARACTERISTICS

- Supplied sterile, Items per box: 1
- Label colour: 6F = Green, 7F = Orange, 8F = Blue
- Lumen inner diameter: 6F = 0.070", 7F = 0.080", 8F = 0.088"

PRODUCT DESCRIPTION

Soft tip and distal sleeve to facilitate ease of engagement. Advanced HDPE liner for smooth, low friction device passage

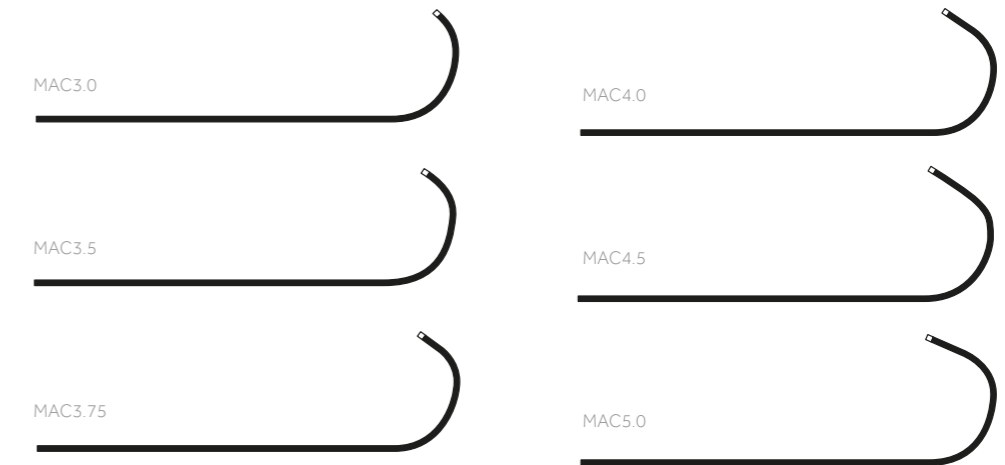

MAC (MULTI-AORTIC CURVES)

	6F BALANCED CODE	7F BALANCED CODE	8F BALANCED CODE
MAC3.0	SB6MAC30	SB7MAC30	SB8MAC30
MAC3.5	SB6MAC35	SB7MAC35	SB8MAC35
MAC3.75	SB6MAC375	SB7MAC375	SB8MAC375
MAC4.0	SB6MAC40	SB7MAC40	SB8MAC40
MAC4.5	SB6MAC45	SB7MAC45	SB8MAC45
MAC5.0	SB6MAC50	SB7MAC50	SB8MAC50

CORONARY GUIDE CATHETERS

Sherpa NX™ Balanced Bypass Curves

GENERAL CHARACTERISTICS

- Supplied sterile, Items per box: 1
- Label colour: 6F = Green, 7F = Orange, 8F = Blue
- Lumen inner diameter: 6F = 0.070", 7F = 0.080", 8F = 0.088"

PRODUCT DESCRIPTION

Soft tip and distal sleeve to facilitate ease of engagement. Advanced HDPE liner for smooth, low friction device passage

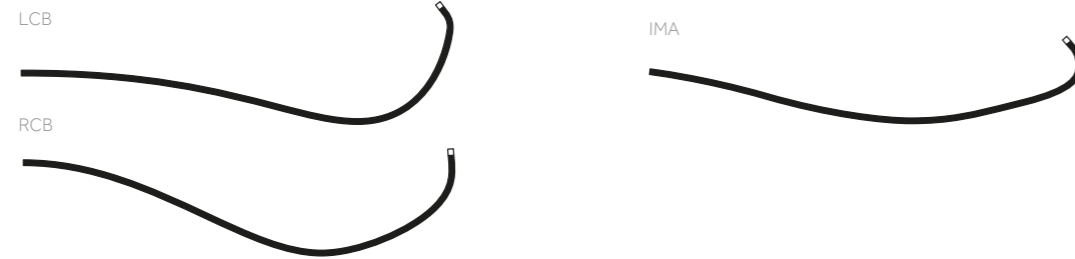

BYPASS CURVES

	6F BALANCED CODE	7F BALANCED CODE	8F BALANCED CODE
LCB	SB6LCB	SB7LCB	SB8LCB
LCB (90 cm)	SB6LCBD	SB7LCBD	SB8LCBD
RCB	SB6RCB	SB7RCB	SB8RCB
RCB (90 cm)	SB6RCBD	SB7RCBD	SB8RCBD
IMA	SB6IMA	SB7IMA	SB8IMA
IMA (90 cm)	SB6IMAD	SB7IMAD	SB8IMAD

CORONARY GUIDE CATHETERS

Sherpa NX™ Balanced Other Curves

GENERAL CHARACTERISTICS

- Supplied sterile, Items per box: 1
- Label colour: 6F = Green, 7F = Orange, 8F = Blue
- Lumen inner diameter: 6F = 0.070", 7F = 0.080", 8F = 0.088"

PRODUCT DESCRIPTION

Soft tip and distal sleeve to facilitate ease of engagement. Advanced HDPE liner for smooth, low friction device passage

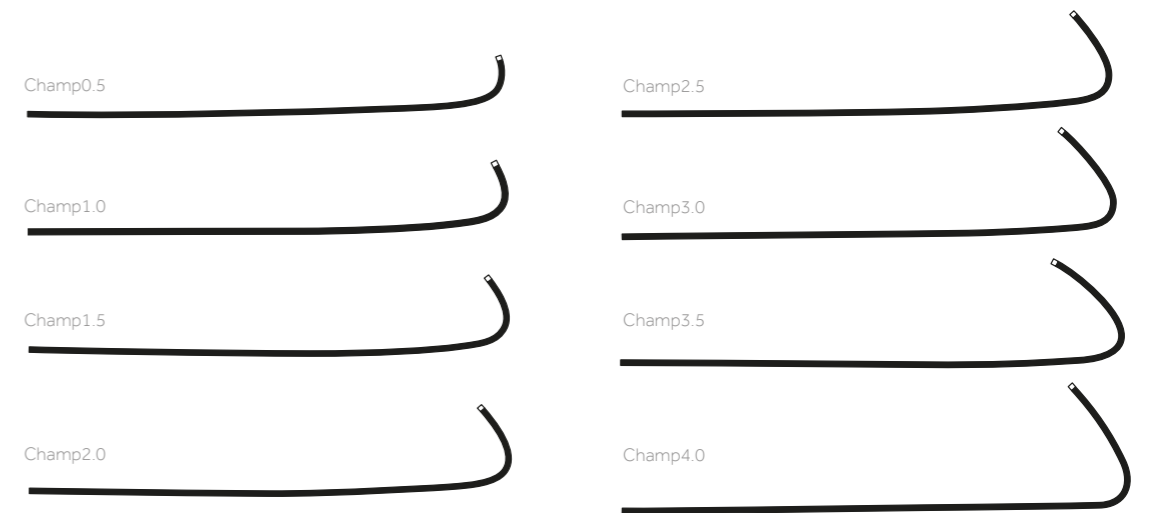

CHAMP

	6F BALANCED CODE	7F BALANCED CODE	8F BALANCED CODE
CHAMP 0.5	SB6CHAMP05	SB7CHAMP05	SB8CHAMP05
CHAMP 10	SB6CHAMP10	SB7CHAMP10	SB8CHAMP10
CHAMP 15	SB6CHAMP15	SB7CHAMP15	SB8CHAMP15
CHAMP 20	SB6CHAMP20	SB7CHAMP20	SB8CHAMP20
CHAMP 25	SB6CHAMP25	SB7CHAMP25	SB8CHAMP25
CHAMP 30	SB6CHAMP30	SB7CHAMP30	SB8CHAMP30
CHAMP 35	SB6CHAMP35	SB7CHAMP35	SB8CHAMP35
CHAMP 40	SB6CHAMP40	SB7CHAMP40	SB8CHAMP40

CORONARY GUIDE CATHETERS

Sherpa NX™ Balanced Radial Curves

GENERAL CHARACTERISTICS

- Supplied sterile, Items per box: 1
- Label colour: 6F = Green, 7F = Orange, 8F = Blue
- Lumen inner diameter: 6F = 0.070", 7F = 0.080", 8F = 0.088"

PRODUCT DESCRIPTION

Soft tip and distal sleeve to facilitate ease of engagement. Advanced HDPE liner for smooth, low friction device passage

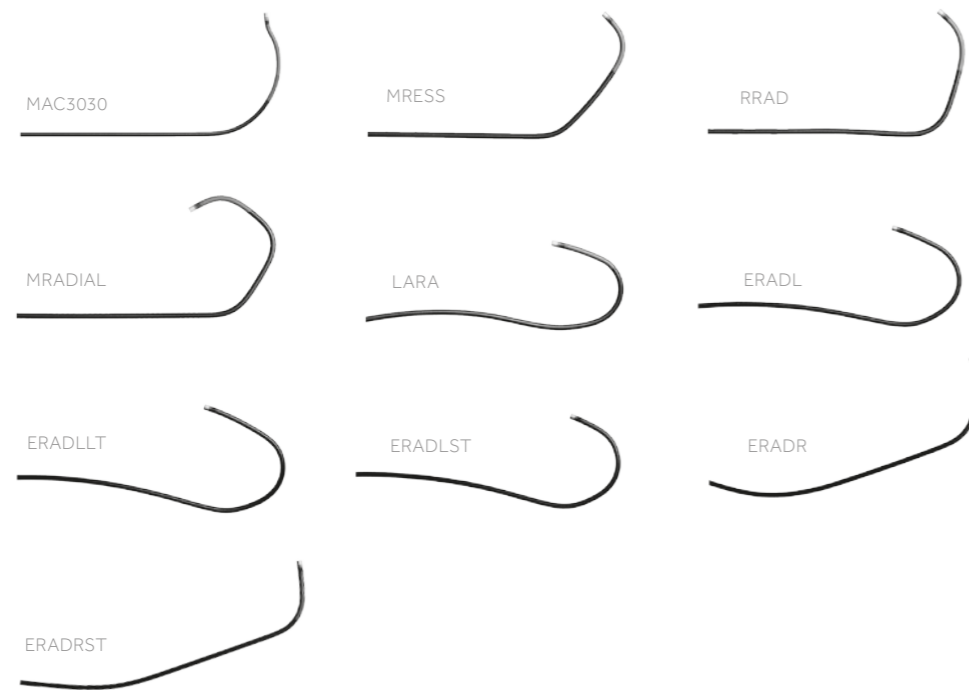

RADIAL CURVES

	6F BALANCED CODE	7F BALANCED CODE
MRADIAL	SB6MRADIAL	SB7MRADIAL
MRESS	SB6MRESS	SB7MRESS
RIGHT RADIAL	SB6RRAD	SB7RRAD
ERADL	SB6ERADL	
ERADLLT	SB6ERADLLT	
ERADLST	SB6ERADLST	
ERADR	SB6ERADR	
ERADRST	SB6ERADRST	

CORONARY GUIDE CATHETERS

Zuma2™ Left Coronary Curve

GENERAL CHARACTERISTICS

- Supplied sterile Items per box: 1
- Label colour: 5F = Grey, 6F = Green, 7F = Orange, 8F = Blue
- Lumen inner diameter: 5F = 0.058", 6F = 0.070", 7F = 0.081", 8F = 0.091"

PRODUCT DESCRIPTION

Soft, flexible distal segment for atraumatic engagement. Soft tip polymer construction to minimize vessel trauma.

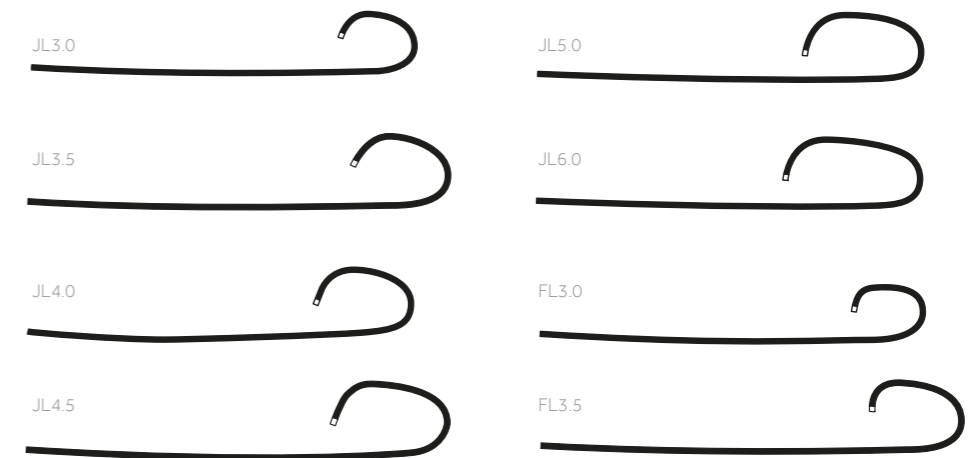

LEFT CORONARY

	5F CODE	6F CODE	7F CODE	8F CODE
JL3.0	ZM5JL30	Z26JL30	Z27JL30	Z28JL30
JL3.5	ZM5JL35	Z26JL35	Z27JL35	Z28JL35
JL4.0	ZM5JL40	Z26JL40	Z27JL40	Z28JL40
JL4.5	ZM5JL45	Z26JL45	Z27JL45	Z28JL45
JL5.0	ZM5JL50	Z26JL50	Z27JL50	Z28JL50
JL6.0	ZM5JL60	Z26JL60	Z27JL60	Z28JL60
FL3.0	ZM5FL30	Z26FL30	Z27FL30	Z28FL30
FL3.5	ZM5FL35	Z26FL35	Z27FL35	Z28FL35

CORONARY GUIDE CATHETERS

Zuma2™ Left Coronary Curve

GENERAL CHARACTERISTICS

- Supplied sterile Items per box: 1
- Label colour: 5F = Grey, 6F = Green, 7F = Orange, 8F = Blue
- Lumen inner diameter: 5F = 0.058", 6F = 0.070", 7F = 0.081", 8F = 0.091"

PRODUCT DESCRIPTION

Soft, flexible distal segment for atraumatic engagement. Soft tip polymer construction to minimize vessel trauma.

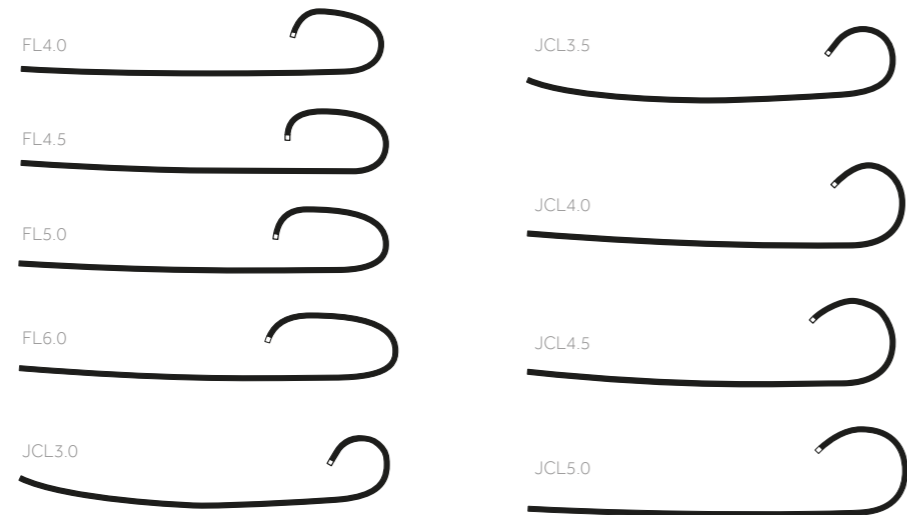

LEFT CORONARY

	5F CODE	6F CODE	7F CODE	8F CODE
FL4.0	ZM5FL40	Z26FL40	Z27FL40	Z28FL40
FL4.5	ZM5FL45	Z26FL45	Z27FL45	Z28FL45
FL5.0	ZM5FL50	Z26FL50	Z27FL50	Z28FL50
FL6.0	ZM5FL60	Z26FL60	Z27FL60	Z28FL60
JCL3.0	ZM5JCL30	Z26JCL30	Z27JCL30	Z28JCL30
JCL3.5	ZM5JCL35	Z26JCL35	Z27JCL35	Z28JCL35
JCL4.0	ZM5JCL40	Z26JCL40	Z27JCL40	Z28JCL40
JCL4.5	ZM5JCL45	Z26JCL45	Z27JCL45	Z28JCL45
JCL5.0	ZM5JCL50	Z26JCL50	Z27JCL50	Z28JCL50

CORONARY GUIDE CATHETERS

Zuma2™ Short Left Coronary Curve

GENERAL CHARACTERISTICS

- Supplied sterile Items per box: 1
- Label colour: 5F = Grey, 6F = Green, 7F = Orange, 8F = Blue
- Lumen inner diameter: 5F = 0.058", 6F = 0.070", 7F = 0.081", 8F = 0.091"

PRODUCT DESCRIPTION

Soft, flexible distal segment for atraumatic engagement. Soft tip polymer construction to minimize vessel trauma.

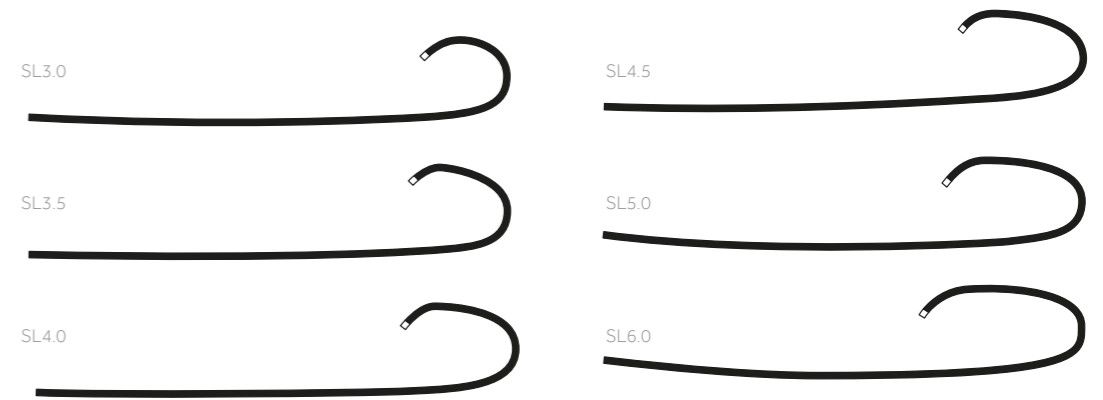

SHORT TIP LEFT CORONARY

	5F CODE	6F CODE	7F CODE	8F CODE
SL3.0	ZM5SL30	Z26SL30	Z27SL30	Z28SL30
SL3.5	ZM5SL35	Z26SL35	Z27SL35	Z28SL35
SL4.0	ZM5SL40	Z26SL40	Z27SL40	Z28SL40
SL4.5	ZM5SL45	Z26SL45	Z27SL45	Z28SL45
SL5.0	ZM5SL50	Z26SL50	Z27SL50	Z28SL50
SL6.0	ZM5SL60	Z26SL60	Z27SL60	Z28SL60

CORONARY GUIDE CATHETERS

Zuma2™ Amplatz Left Coronary Curve

GENERAL CHARACTERISTICS

- Supplied sterile Items per box: 1
- Label colour: 5F = Grey, 6F = Green, 7F = Orange, 8F = Blue
- Lumen inner diameter: 5F = 0.058", 6F = 0.070", 7F = 0.081", 8F = 0.091"

PRODUCT DESCRIPTION

Soft, flexible distal segment for atraumatic engagement. Soft tip polymer construction to minimize vessel trauma.

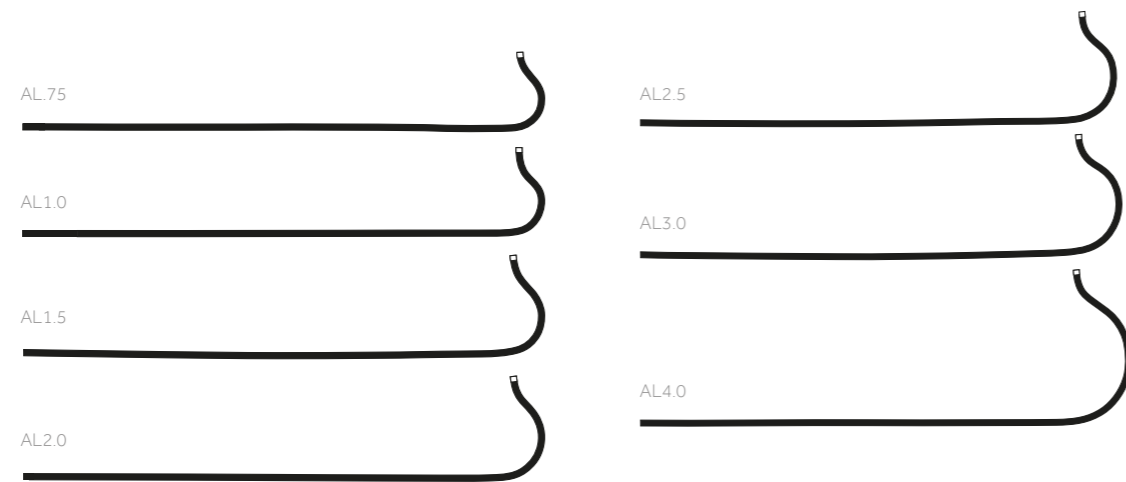

AMPLATZ LEFT

	5F CODE	6F CODE	7F CODE	8F CODE
AL.75	ZM5AL75	Z26AL75	Z27AL75	Z28AL75
AL.1.0	ZM5AL10	Z26AL10	Z27AL10	Z28AL10
AL.1.5	ZM5AL15	Z26AL15	Z27AL15	Z28AL15
AL.2.0	ZM5AL20	Z26AL20	Z27AL20	Z28AL20
AL.2.5	ZM5AL25	Z26AL25	Z27AL25	Z28AL25
AL.3.0	ZM5AL30	Z26AL30	Z27AL30	Z28AL30
AL.4.0	ZM5AL40	Z26AL40	Z27AL40	Z28AL40

CORONARY GUIDE CATHETERS

Zuma2™ Short Amplatz Left Coronary Curve

GENERAL CHARACTERISTICS

- Supplied sterile Items per box: 1
- Label colour: 5F = Grey, 6F = Green, 7F = Orange, 8F = Blue
- Lumen inner diameter: 5F = 0.058", 6F = 0.070", 7F = 0.081", 8F = 0.091"

PRODUCT DESCRIPTION

Soft, flexible distal segment for atraumatic engagement. Soft tip polymer construction to minimize vessel trauma.

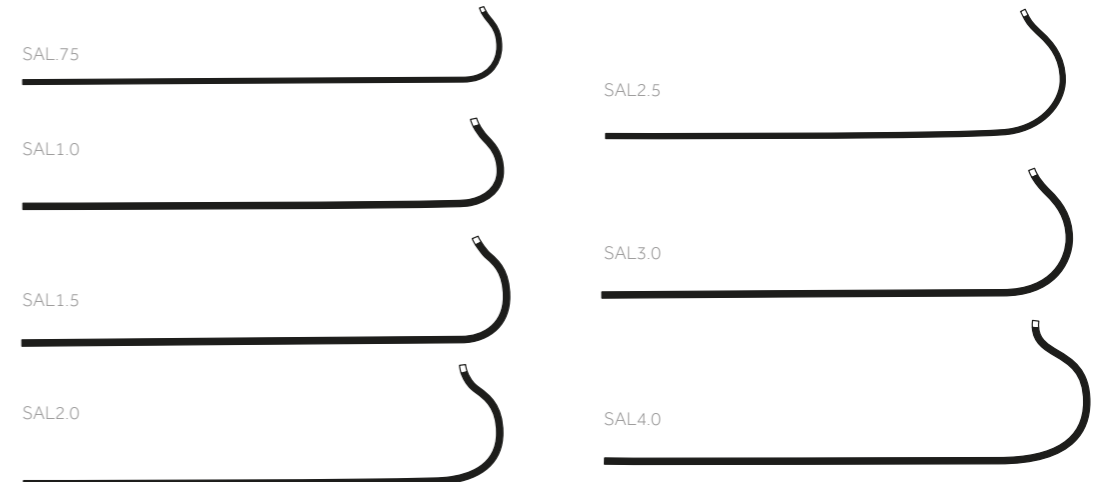

SHORT TIP AMPLATZ LEFT

	5F CODE	6F CODE	7F CODE	8F CODE
SAL.75	ZM5SAL75	Z26SAL75	Z27SAL75	Z28SAL75
SAL.1.0	ZM5SAL10	Z26SAL10	Z27SAL10	Z28SAL10
SAL.1.5	ZM5SAL15	Z26SAL15	Z27SAL15	Z28SAL15
SAL.2.0	ZM5SAL20	Z26SAL20	Z27SAL20	Z28SAL20
SAL.2.5	ZM5SAL25	Z26SAL25	Z27SAL25	Z28SAL25
SAL.3.0	ZM5SAL30	Z26SAL30	Z27SAL30	Z28SAL30
SAL.4.0	ZM5SAL40	Z26SAL40	Z27SAL40	Z28SAL40

CORONARY GUIDE CATHETERS

Zuma2™ Left Coronary Backup Support

GENERAL CHARACTERISTICS

- Supplied sterile Items per box: 1
- Label colour: 5F = Grey, 6F = Green, 7F = Orange, 8F = Blue
- Lumen inner diameter: 5F = 0.058", 6F = 0.070", 7F = 0.081", 8F = 0.091"

PRODUCT DESCRIPTION

Soft, flexible distal segment for atraumatic engagement. Soft tip polymer construction to minimize vessel trauma.

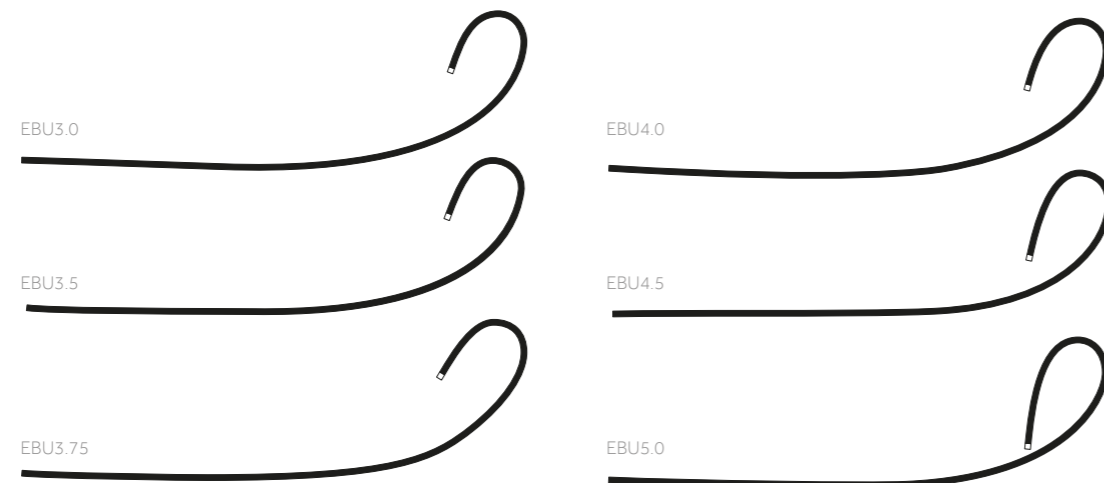

EBU (EXTRA BACKUP)

	5F CODE	6F CODE	7F CODE	8F CODE
EBU3.0	ZM5EBU30	Z26EBU30	Z27EBU30	Z28EBU30
EBU3.5	ZM5EBU35	Z26EBU35	Z27EBU35	Z28EBU35
EBU3.75	ZM5EBU375	Z26EBU375	Z27EBU375	Z28EBU375
EBU4.0	ZM5EBU40	Z26EBU40	Z27EBU40	Z28EBU40
EBU4.5	ZM5EBU45	Z26EBU45	Z27EBU45	Z28EBU45
EBU5.0	ZM5EBU50	Z26EBU50	Z27EBU50	Z28EBU50

CORONARY GUIDE CATHETERS

Zuma2™ Right Coronary Curve

GENERAL CHARACTERISTICS

- Supplied sterile Items per box: 1
- Label colour: 5F = Grey, 6F = Green, 7F = Orange, 8F = Blue
- Lumen inner diameter: 5F = 0.058", 6F = 0.070", 7F = 0.081", 8F = 0.091"

PRODUCT DESCRIPTION

Soft, flexible distal segment for atraumatic engagement. Soft tip polymer construction to minimize vessel trauma.

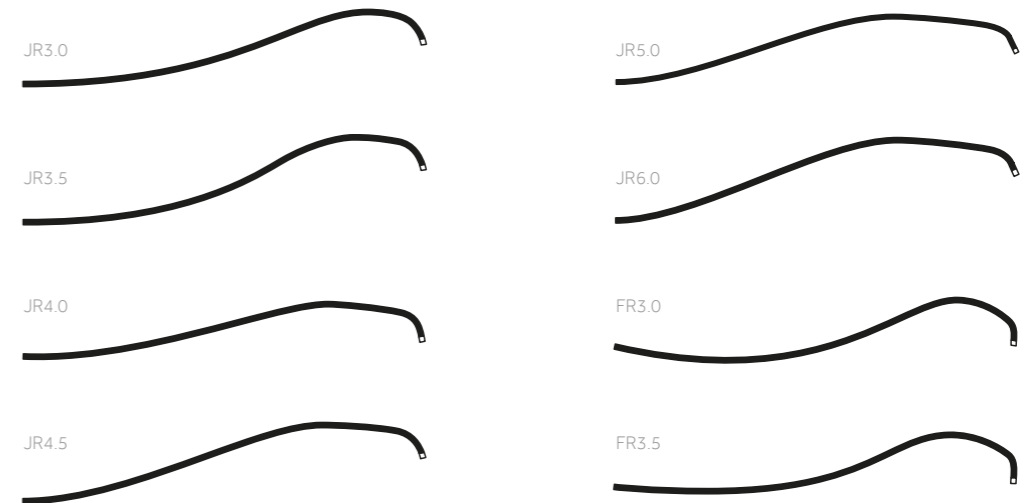

RIGHT CORONARY CURVE

	5F CODE	6F CODE	7F CODE	8F CODE
JR3.0	ZM5JR30	Z26JR30	Z27JR30	Z28JR30
JR3.5	ZM5JR35	Z26JR35	Z27JR35	Z28JR35
JR4.0	ZM5JR40	Z26JR40	Z27JR40	Z28JR40
JR4.5	ZM5JR45	Z26JR45	Z27JR45	Z28JR45
JR5.0	ZM5JR50	Z26JR50	Z27JR50	Z28JR50
JR6.0	ZM5JR60	Z26JR60	Z27JR60	Z28JR60
FR3.0	ZM5FR30	Z26FR30	Z27FR30	Z28FR30
FR3.5	ZM5FR35	Z26FR35	Z27FR35	Z28FR35

CORONARY GUIDE CATHETERS

Zuma2™ Right Coronary Curve

GENERAL CHARACTERISTICS

- Supplied sterile Items per box: 1
- Label colour: 5F = Grey, 6F = Green, 7F = Orange, 8F = Blue
- Lumen inner diameter: 5F = 0.058", 6F = 0.070", 7F = 0.081", 8F = 0.091"

PRODUCT DESCRIPTION

Soft, flexible distal segment for atraumatic engagement. Soft tip polymer construction to minimize vessel trauma.

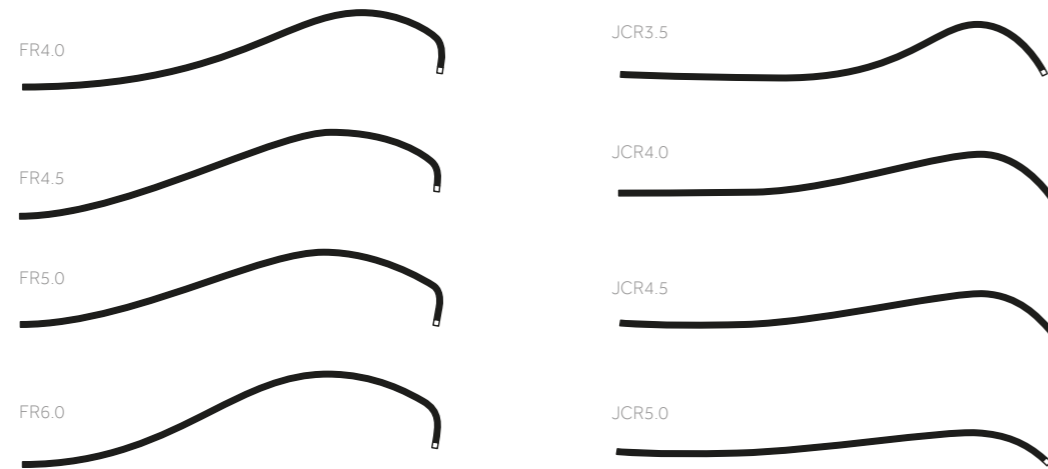

RIGHT CORONARY CURVE

	5F CODE	6F CODE	7F CODE	8F CODE
FR4.0	ZM5FR40	Z26FR40	Z27FR40	Z28FR40
FR4.5	ZM5FR45	Z26FR45	Z27FR45	Z28FR45
FR5.0	ZM5FR50	Z26FR50	Z27FR50	Z28FR50
FR6.0	ZM5FR60	Z26FR60	Z27FR60	Z28FR60
JCR3.5	ZM5JCR35	Z26JCR35	Z27JCR35	Z28JCR35
JCR4.0	ZM5JCR40	Z26JCR40	Z27JCR40	Z28JCR40
JCR4.5	ZM5JCR45	Z26JCR45	Z27JCR45	Z28JCR45
JCR5.0	ZM5JCR50	Z26JCR50	Z27JCR50	Z28JCR50

CORONARY GUIDE CATHETERS

Zuma2™ Short Right Coronary Curve

GENERAL CHARACTERISTICS

- Supplied sterile Items per box: 1
- Label colour: 5F = Grey, 6F = Green, 7F = Orange, 8F = Blue
- Lumen inner diameter: 5F = 0.058", 6F = 0.070", 7F = 0.081", 8F = 0.091"

PRODUCT DESCRIPTION

Soft, flexible distal segment for atraumatic engagement. Soft tip polymer construction to minimize vessel trauma.

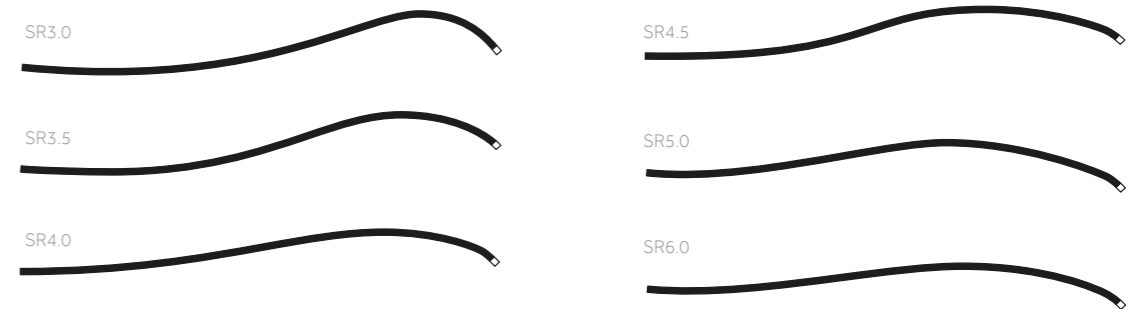

SHORT TIP RIGHT CORONARY

	5F CODE	6F CODE	7F CODE	8F CODE
SR3.0	ZM5SR30	Z26SR30	Z27SR30	Z28SR30
SR3.5	ZM5SR35	Z26SR35	Z27SR35	Z28SR35
SR4.0	ZM5SR40	Z26SR40	Z27SR40	Z28SR40
SR4.5	ZM5SR45	Z26SR45	Z27SR45	Z28SR45
SR5.0	ZM5SR50	Z26SR50	Z27SR50	Z28SR50
SR6.0	ZM5SR60	Z26SR60	Z27SR60	Z28SR60

CORONARY GUIDE CATHETERS

Zuma2™ Amplatz Right Coronary Curve

GENERAL CHARACTERISTICS

- Supplied sterile Items per box: 1
- Label colour: 5F = Grey, 6F = Green, 7F = Orange, 8F = Blue
- Lumen inner diameter: 5F = 0.058", 6F = 0.070", 7F = 0.081", 8F = 0.091"

PRODUCT DESCRIPTION

Soft, flexible distal segment for atraumatic engagement. Soft tip polymer construction to minimize vessel trauma.



AMPLATZ RIGHT

	5F CODE	6F CODE	7F CODE	8F CODE
AR1.0	ZM5AR10	Z26AR10	Z27AR10	Z28AR10
AR2.0	ZM5AR20	Z26AR20	Z27AR20	Z28AR20
ALR1-2	ZM5ALR12	Z26ALR12	Z27ALR12	Z28ALR12

CORONARY GUIDE CATHETERS

Zuma2™ Short Amplatz Right Coronary Curve

GENERAL CHARACTERISTICS

- Supplied sterile Items per box: 1
- Label colour: 5F = Grey, 6F = Green, 7F = Orange, 8F = Blue
- Lumen inner diameter: 5F = 0.058", 6F = 0.070", 7F = 0.081", 8F = 0.091"

PRODUCT DESCRIPTION

Soft, flexible distal segment for atraumatic engagement. Soft tip polymer construction to minimize vessel trauma.

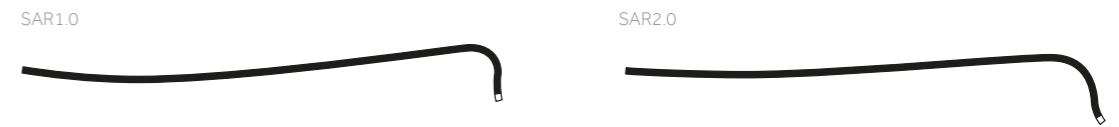

SHORT TIP AMPLATZ RIGHT

	5F CODE	6F CODE	7F CODE	8F CODE
SAR1.0	ZM5SAR10	Z26SAR10	Z27SAR10	Z28SAR10
SAR2.0	ZM5SAR20	Z26SAR20	Z27SAR20	Z28SAR20

CORONARY GUIDE CATHETERS

Zuma2™ Shepherd's Crook Right Coronary Curve

GENERAL CHARACTERISTICS

- Supplied sterile Items per box: 1
- Label colour: 5F = Grey, 6F = Green, 7F = Orange, 8F = Blue
- Lumen inner diameter: 5F = 0.058", 6F = 0.070", 7F = 0.081", 8F = 0.091"

PRODUCT DESCRIPTION

Soft, flexible distal segment for atraumatic engagement. Soft tip polymer construction to minimize vessel trauma.

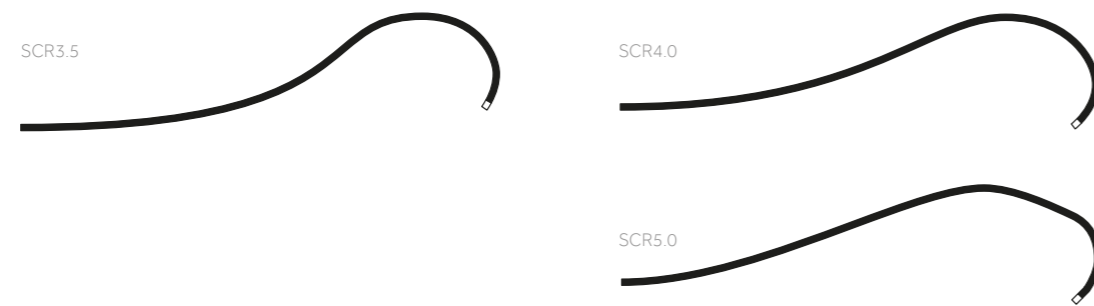

SHEPHERD'S CROOK RIGHT

	5F CODE	6F CODE	7F CODE	8F CODE
SCR3.5	ZM5SCR35	Z26SCR35	Z27SCR35	Z28SCR35
SCR4.0	ZM5SCR40	Z26SCR40	Z27SCR40	Z28SCR40
SCR5.0	ZM5SCR50	Z26SCR50	Z27SCR50	Z28SCR50

CORONARY GUIDE CATHETERS

Zuma2™ Right Coronary Backup Support

GENERAL CHARACTERISTICS

- Supplied sterile Items per box: 1
- Label colour: 5F = Grey, 6F = Green, 7F = Orange, 8F = Blue
- Lumen inner diameter: 5F = 0.058", 6F = 0.070", 7F = 0.081", 8F = 0.091"

PRODUCT DESCRIPTION

Soft, flexible distal segment for atraumatic engagement. Soft tip polymer construction to minimize vessel trauma.

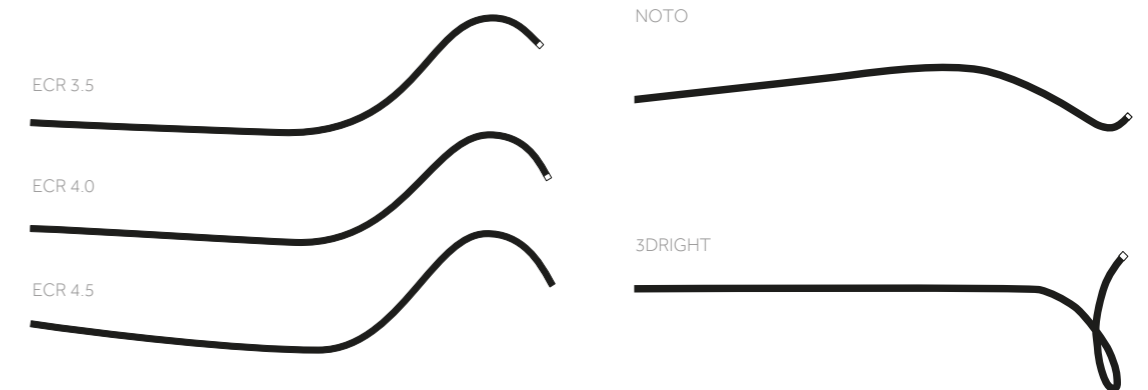

ECR CURVES

	5F CODE	6F CODE	7F CODE	8F CODE
ECR 3.5		Z26ECR35	Z27ECR35	Z28ECR35
ECR 4.0		Z26ECR40	Z27ECR40	Z28ECR40
ECR 4.5		Z26ECR45	Z27ECR45	Z28ECR45
3D RIGHT	-	Z263DRIGHT		
NO TORQUE Right	ZM5NOTO	Z26NOTO	Z27NOTO	Z28NOTO

CORONARY GUIDE CATHETERS

Zuma2™ Multipurpose Curves

GENERAL CHARACTERISTICS

- Supplied sterile Items per box: 1
- Label colour: 5F = Grey, 6F = Green, 7F = Orange, 8F = Blue
- Lumen inner diameter: 5F = 0.058", 6F = 0.070", 7F = 0.081", 8F = 0.091"

PRODUCT DESCRIPTION

Soft, flexible distal segment for atraumatic engagement. Soft tip polymer construction to minimize vessel trauma.

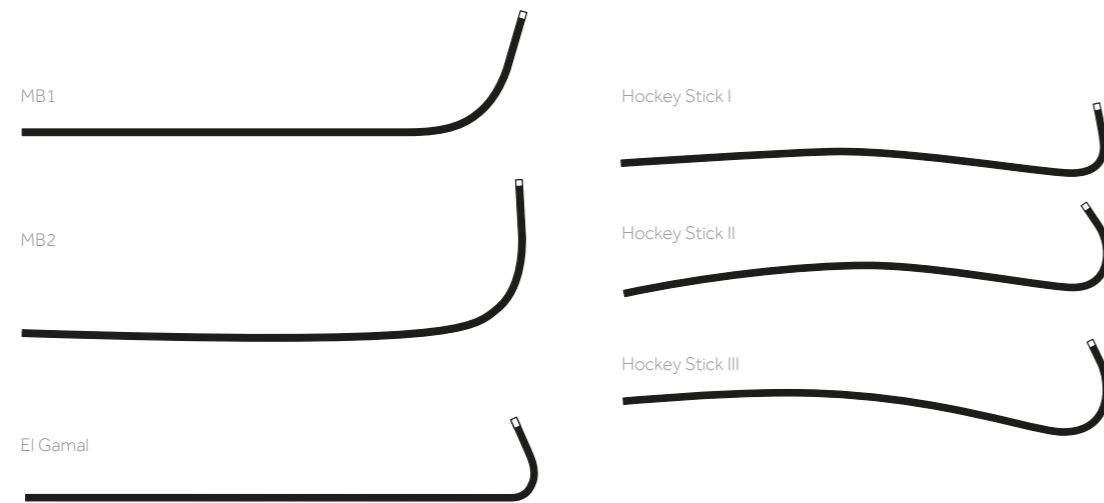

MULTIPURPOSE

	5F CODE	6F CODE	7F CODE	8F CODE
MB1	ZM5MB1	Z26MB1	Z27MB1	Z28MB1
MB2	ZM5MB2	Z26MB2	Z27MB2	Z28MB2
Hockey Stick I	ZM5HSI	Z26HSI	Z27HSI	Z28HSI
Hockey Stick II	ZM5HSII	Z26HSII	Z27HSII	Z28HSII
Hockey Stick III	ZM5HSIII	Z26HSIII	Z27HSIII	Z28HSIII
El Gamal	ZM5ELGAMAL	Z26ELGAMAL	Z27ELGAMAL	Z28ELGAMAL

CORONARY GUIDE CATHETERS

Zuma2™ Other Curves

GENERAL CHARACTERISTICS

- Supplied sterile Items per box: 1
- Label colour: 5F = Grey, 6F = Green, 7F = Orange, 8F = Blue
- Lumen inner diameter: 5F = 0.058", 6F = 0.070", 7F = 0.081", 8F = 0.091"

PRODUCT DESCRIPTION

Soft, flexible distal segment for atraumatic engagement. Soft tip polymer construction to minimize vessel trauma.

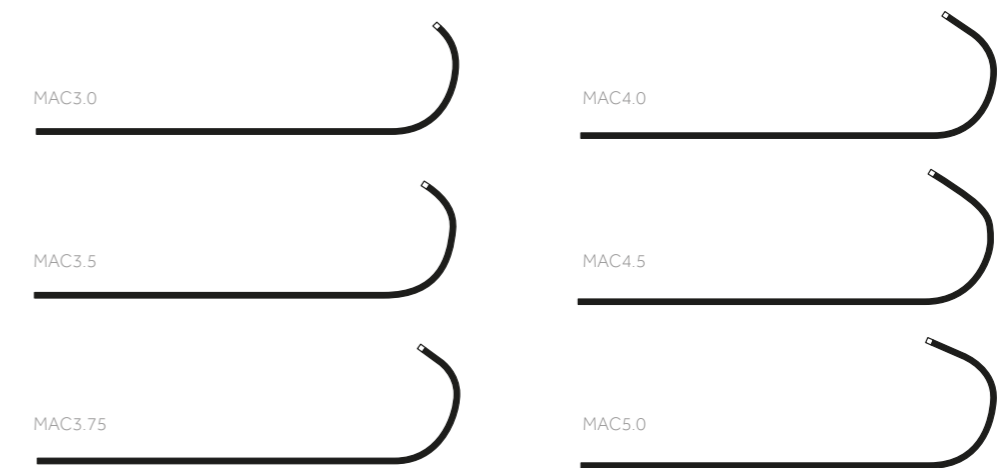

MAC (MULTI- AORTIC CURVES)

	5F CODE	6F CODE	7F CODE	8F CODE
MAC3.0	ZM5MAC30	Z26MAC30	Z27MAC30	Z28MAC30
MAC3.5	ZM5MAC35	Z26MAC35	Z27MAC35	Z28MAC35
MAC3.75	ZM5MAC375	Z26MAC375	Z27MAC375	Z28MAC375
MAC4.0	ZM5MAC40	Z26MAC40	Z27MAC40	Z28MAC40
MAC4.5	ZM5MAC45	Z26MAC45	Z27MAC45	Z28MAC45
MAC5.0	ZM5MAC50	Z26MAC50	Z27MAC50	Z28MAC50

CORONARY GUIDE CATHETERS

Zuma2™ Bypass Curves

GENERAL CHARACTERISTICS

- Supplied sterile Items per box: 1
- Label colour: 5F = Grey, 6F = Green, 7F = Orange, 8F = Blue
- Lumen inner diameter: 5F = 0.058", 6F = 0.070", 7F = 0.081", 8F = 0.091"

PRODUCT DESCRIPTION

Soft, flexible distal segment for atraumatic engagement. Soft tip polymer construction to minimize vessel trauma.

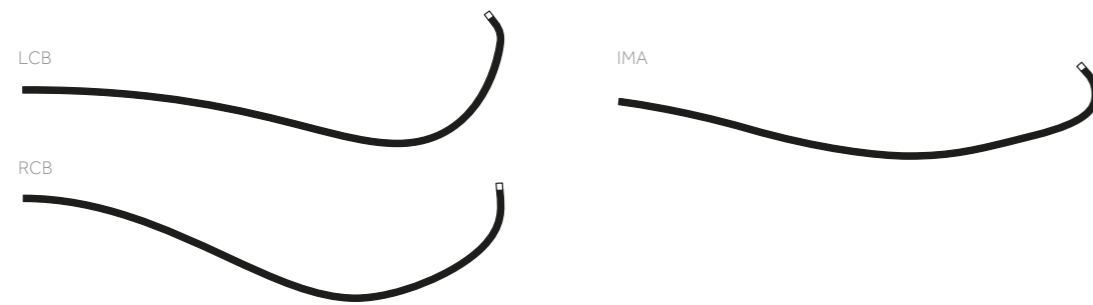

BYPASS GRAFTS

	5F CODE	6F CODE	7F CODE	8F CODE
LCB	ZM5LCB	Z26LCB	Z27LCB	Z28LCB
RCB	ZM5RCB	Z26RCB	Z27RCB	Z28RCB
RCB (90 cm)	ZM5RCBD	Z26RCBD	Z27RCBD	Z28RCBD
IMA	ZM5IMA	Z26IMA	Z27IMA	Z28IMA
IMA (90 cm)	ZM5IMAD	Z26IMAD	Z27IMAD	Z28IMAD

CORONARY GUIDE CATHETERS

Zuma2™ Other Curves

GENERAL CHARACTERISTICS

- Supplied sterile Items per box: 1
- Label colour: 5F = Grey, 6F = Green, 7F = Orange, 8F = Blue
- Lumen inner diameter: 5F = 0.058", 6F = 0.070", 7F = 0.081", 8F = 0.091"

PRODUCT DESCRIPTION

Soft, flexible distal segment for atraumatic engagement. Soft tip polymer construction to minimize vessel trauma.

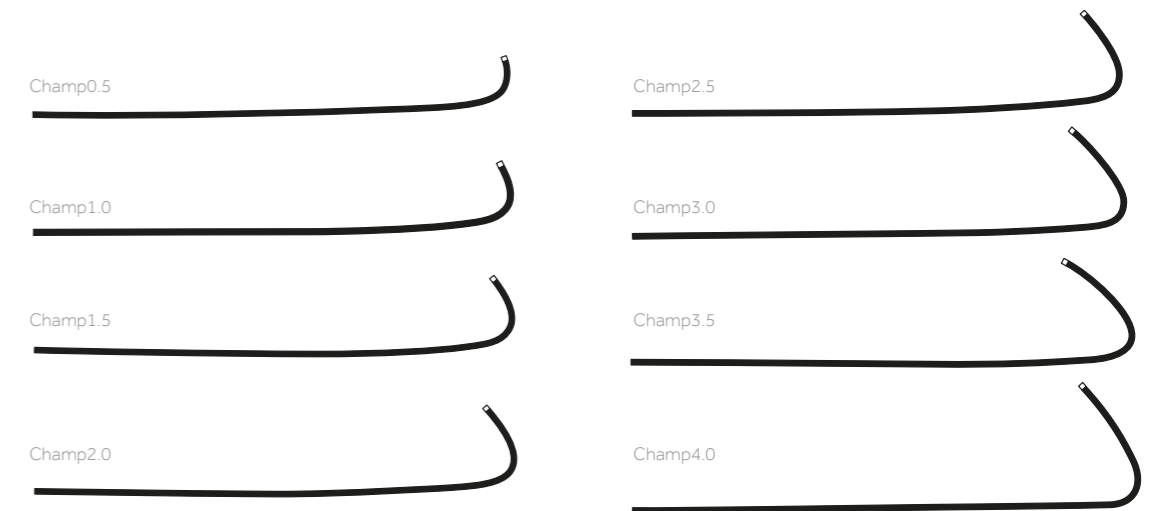

CHAMP

	5F CODE	6F CODE	7F CODE	8F CODE
CHAMP 0.5	ZM5CHAMP05	Z26CHAMP05	Z27CHAMP05	Z28CHAMP05
CHAMP 10	ZM5CHAMP10	Z26CHAMP10	Z27CHAMP10	Z28CHAMP10
CHAMP 15	ZM5CHAMP15	Z26CHAMP15	Z27CHAMP15	Z28CHAMP15
CHAMP 20	ZM5CHAMP20	Z26CHAMP20	Z27CHAMP20	Z28CHAMP20
CHAMP 25	ZM5CHAMP25	Z26CHAMP25	Z27CHAMP25	Z28CHAMP25
CHAMP 30	ZM5CHAMP30	Z26CHAMP30	Z27CHAMP30	Z28CHAMP30
CHAMP 35	ZM5CHAMP35	Z26CHAMP35	Z27CHAMP35	Z28CHAMP35
CHAMP 40	ZM5CHAMP40	Z26CHAMP40	Z27CHAMP40	Z28CHAMP40

CORONARY GUIDE CATHETERS

Zuma™
Left Coronary Curve

GENERAL CHARACTERISTICS

- Supplied sterile Items per box: 1
- Label colour: 6F = Green, 7F = Orange, 8F = Blue, 9F = Grey.
- Lumen inner diameter: 6F = 0.068", 7F = 0.081", 8F = 0.091", 9F = 0.103"

PRODUCT DESCRIPTION

Supportive stiff guide for passive use

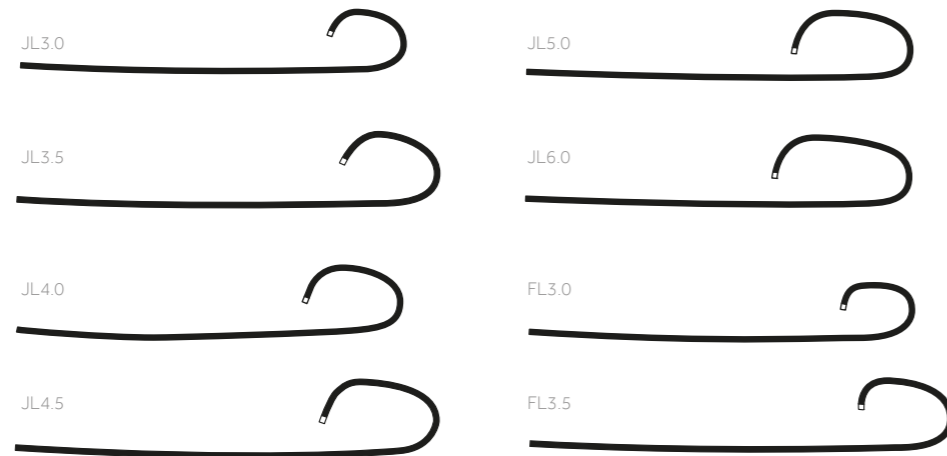

LEFT CORONARY

	6F CODE	7F CODE	8F CODE	9F CODE
JL3.0	ZM6JL30	ZT7JL30	ZS8JL30	ZM9JL30
JL3.5	ZM6JL35	ZT7JL35	ZS8JL35	ZM9JL35
JL4.0	ZM6JL40	ZT7JL40	ZS8JL40	ZM9JL40
JL4.5	ZM6JL45	ZT7JL45	ZS8JL45	ZM9JL45
JL5.0	ZM6JL50	ZT7JL50	ZS8JL50	ZM9JL50
JL6.0	ZM6JL60	ZT7JL60	ZS8JL60	ZM9JL60
FL3.0	ZM6FL30	ZT7FL30	ZS8FL30	ZM9FL30
FL3.5	ZM6FL35	ZT7FL35	ZS8FL35	ZM9FL35

CORONARY GUIDE CATHETERS

Zuma™
Left Coronary Curve

GENERAL CHARACTERISTICS

- Supplied sterile Items per box: 1
- Label colour: 6F = Green, 7F = Orange, 8F = Blue, 9F = Grey.
- Lumen inner diameter: 6F = 0.068", 7F = 0.081", 8F = 0.091", 9F = 0.103"

PRODUCT DESCRIPTION

Supportive stiff guide for passive use

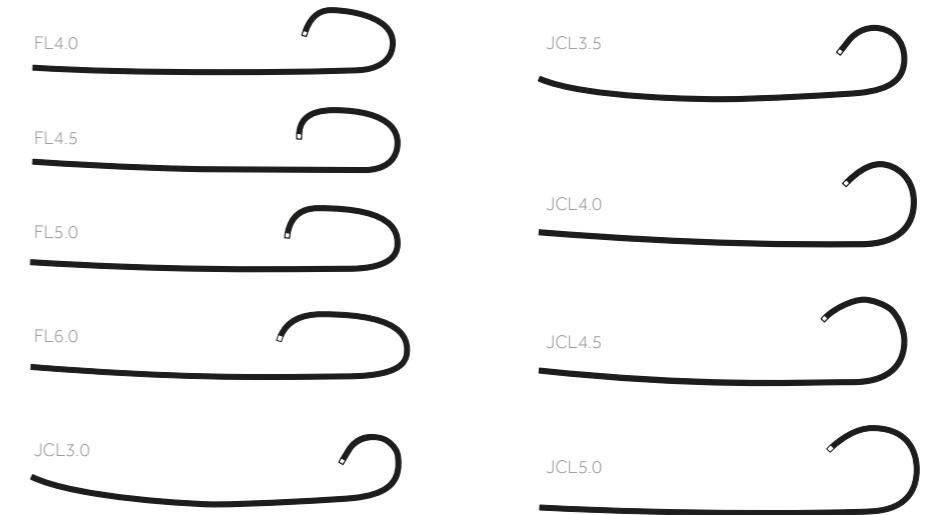

LEFT CORONARY

	6F CODE	7F CODE	8F CODE	9F CODE
FL4.0	ZM6FL40	ZT7FL40	ZS8FL40	ZM9FL40
FL4.5	ZM6FL45	ZT7FL45	ZS8FL45	ZM9FL45
FL5.0	ZM6FL50	ZT7FL50	ZS8FL50	ZM9FL50
FL6.0	ZM6FL60	ZT7FL60	ZS8FL60	ZM9FL60
JCL3.0	ZM6JCL30	ZT7JCL30	ZS8JCL30	ZM9JCL30
JCL3.5	ZM6JCL35	ZT7JCL35	ZS8JCL35	ZM9JCL35
JCL4.0	ZM6JCL40	ZT7JCL40	ZS8JCL40	ZM9JCL40
JCL4.5	ZM6JCL45	ZT7JCL45	ZS8JCL45	ZM9JCL45
JCL5.0	ZM6JCL50	ZT7JCL50	ZS8JCL50	ZM9JCL50

CORONARY GUIDE CATHETERS

Zuma™ Short Left Coronary Curve

GENERAL CHARACTERISTICS

- Supplied sterile Items per box: 1
- Label colour: 6F = Green, 7F = Orange, 8F = Blue, 9F = Grey,
- Lumen inner diameter: 6F = 0.068", 7F = 0.081", 8F = 0.091", 9F = 0.103"

PRODUCT DESCRIPTION

Supportive stiff guide for passive use

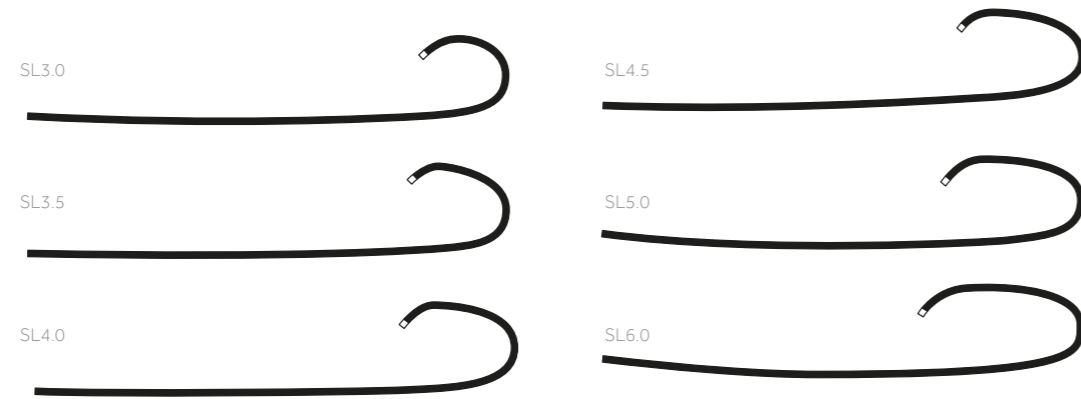

SHORT TIP LEFT CORONARY

	6F CODE	7F CODE	8F CODE	9F CODE
SL3.0	ZM6SL30	ZT7SL30	ZS8SL30	ZM9SL30
SL3.5	ZM6SL35	ZT7SL35	ZS8SL35	ZM9SL35
SL4.0	ZM6SL40	ZT7SL40	ZS8SL40	ZM9SL40
SL4.5	ZM6SL45	ZT7SL45	ZS8SL45	ZM9SL45
SL5.0	ZM6SL50	ZT7SL50	ZS8SL50	ZM9SL50
SL6.0	ZM6SL60	ZT7SL60	ZS8SL60	ZM9SL60

CORONARY GUIDE CATHETERS

Zuma™ Amplatz Left Coronary Curve

GENERAL CHARACTERISTICS

- Supplied sterile Items per box: 1
- Label colour: 6F = Green, 7F = Orange, 8F = Blue, 9F = Grey,
- Lumen inner diameter: 6F = 0.068", 7F = 0.081", 8F = 0.091", 9F = 0.103"

PRODUCT DESCRIPTION

Supportive stiff guide for passive use

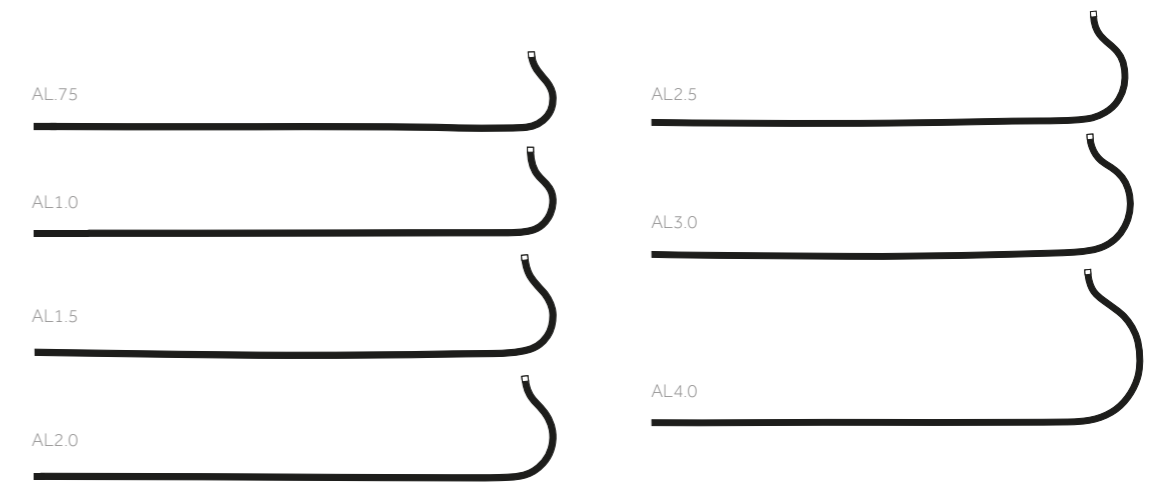

AMPLATZ LEFT

	6F CODE	7F CODE	8F CODE	9F CODE
AL75	ZM6AL75	ZT7AL75	ZS8AL75	ZM9AL75
AL1.0	ZM6AL10	ZT7AL10	ZS8AL10	ZM9AL10
AL1.5	ZM6AL15	ZT7AL15	ZS8AL15	ZM9AL15
AL2.0	ZM6AL20	ZT7AL20	ZS8AL20	ZM9AL20
AL2.5	ZM6AL25	ZT7AL25	ZS8AL25	ZM9AL25
AL3.0	ZM6AL30	ZT7AL30	ZS8AL30	ZM9AL30
AL4.0	ZM6AL40	ZT7AL40	ZS8AL40	ZM9AL40

CORONARY GUIDE CATHETERS

Zuma™ Short Amplatz Left Coronary Curve

GENERAL CHARACTERISTICS

- Supplied sterile Items per box: 1
- Label colour: 6F = Green, 7F = Orange, 8F = Blue, 9F = Grey,
- Lumen inner diameter: 6F = 0.068", 7F = 0.081", 8F = 0.091", 9F = 0.103"

PRODUCT DESCRIPTION

Supportive stiff guide for passive use



SHORT TIP AMPLATZ LEFT

	6F CODE	7F CODE	8F CODE	9F CODE
SAL75	ZM6SAL75	ZT7SAL75	ZS8SAL75	ZM9SAL75
SAL1.0	ZM6SAL10	ZT7SAL10	ZS8SAL10	ZM9SAL10
SAL1.5	ZM6SAL15	ZT7SAL15	ZS8SAL15	ZM9SAL15
SAL2.0	ZM6SAL20	ZT7SAL20	ZS8SAL20	ZM9SAL20
SAL2.5	ZM6SAL25	ZT7SAL25	ZS8SAL25	ZM9SAL25
SAL3.0	ZM6SAL30	ZT7SAL30	ZS8SAL30	ZM9SAL30
SAL4.0	ZM6SAL40	ZT7SAL40	ZS8SAL40	ZM9SAL40

CORONARY GUIDE CATHETERS

Zuma™ Left Coronary Backup Support

GENERAL CHARACTERISTICS

- Supplied sterile Items per box: 1
- Label colour: 6F = Green, 7F = Orange, 8F = Blue, 9F = Grey,
- Lumen inner diameter: 6F = 0.068", 7F = 0.081", 8F = 0.091", 9F = 0.103"

PRODUCT DESCRIPTION

Supportive stiff guide for passive use

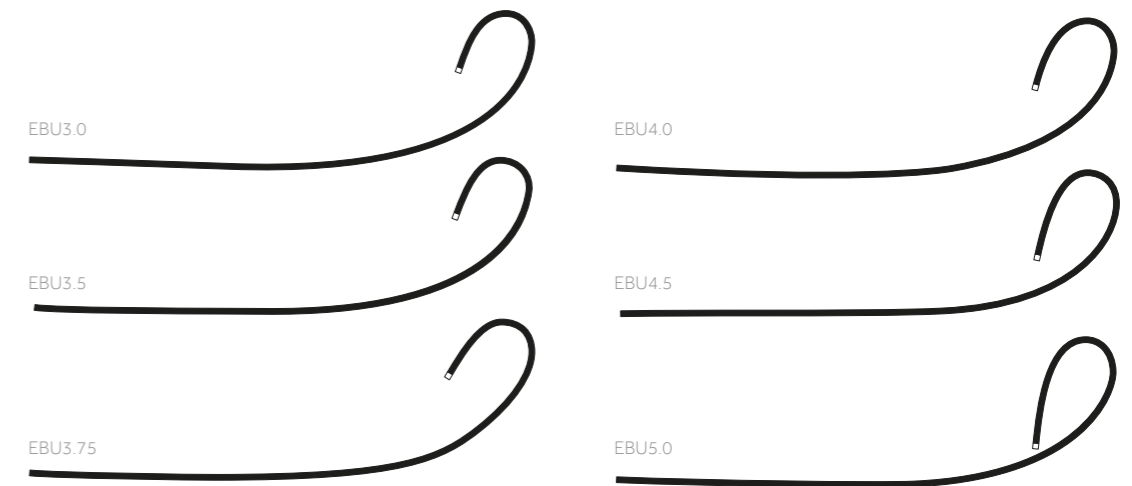

EBU (EXTRA BACKUP)

	6F CODE	7F CODE	8F CODE	9F CODE
EBU3.0	ZM6EBU30	ZT7EBU30	ZS8EBU30	ZM9EBU30
EBU3.5	ZM6EBU35	ZT7EBU35	ZS8EBU35	ZM9EBU35
EBU3.75	ZM6EBU375	ZT7EBU375	ZS8EBU375	ZM9EBU375
EBU4.0	ZM6EBU40	ZT7EBU40	ZS8EBU40	ZM9EBU40
EBU4.5	ZM6EBU45	ZT7EBU45	ZS8EBU45	ZM9EBU45
EBU5.0	ZM6EBU50	ZT7EBU50	ZS8EBU50	ZM9EBU50

CORONARY GUIDE CATHETERS

Zuma™ Right Coronary Curve

GENERAL CHARACTERISTICS

- Supplied sterile Items per box: 1
- Label colour: 6F = Green, 7F = Orange, 8F = Blue, 9F = Grey,
- Lumen inner diameter: 6F = 0.068", 7F = 0.081", 8F = 0.091", 9F = 0.103"

PRODUCT DESCRIPTION

Supportive stiff guide for passive use

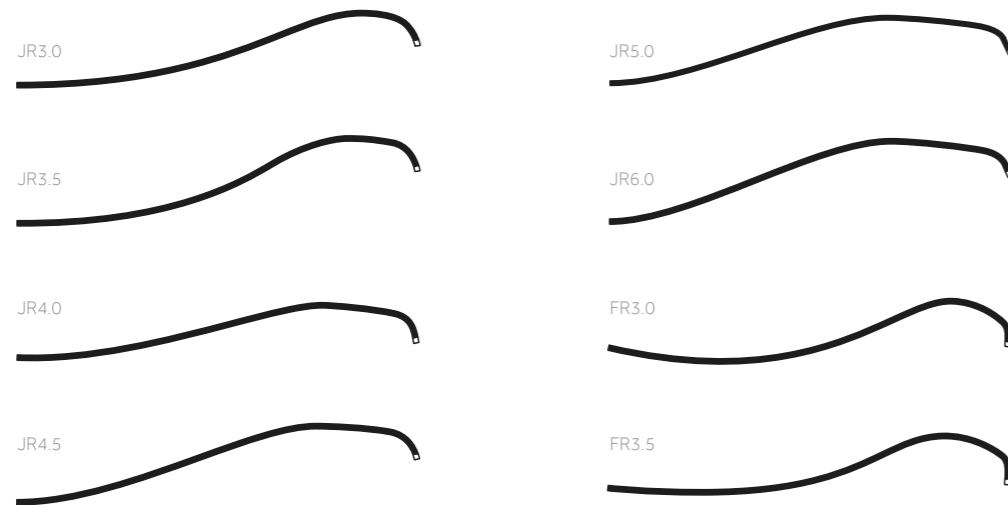

RIGHT CORONARY CURVE

	6F CODE	7F CODE	8F CODE	9F CODE
JR3.0	ZM6JR30	ZT7JR30	ZS8JR30	ZM9JR30
JR3.5	ZM6JR35	ZT7JR35	ZS8JR35	ZM9JR35
JR4.0	ZM6JR40	ZT7JR40	ZS8JR40	ZM9JR40
JR4.5	ZM6JR45	ZT7JR45	ZS8JR45	ZM9JR45
JR5.0	ZM6JR50	ZT7JR50	ZS8JR50	ZM9JR50
JR6.0	ZM6JR60	ZT7JR60	ZS8JR60	ZM9JR60
FR3.0	ZM6FR30	ZT7FR30	ZS8FR30	ZM9FR30
FR3.5	ZM6FR35	ZT7FR35	ZS8FR35	ZM9FR35

CORONARY GUIDE CATHETERS

Zuma™ Right Coronary Curve

GENERAL CHARACTERISTICS

- Supplied sterile Items per box: 1
- Label colour: 6F = Green, 7F = Orange, 8F = Blue, 9F = Grey,
- Lumen inner diameter: 6F = 0.068", 7F = 0.081", 8F = 0.091", 9F = 0.103"

PRODUCT DESCRIPTION

Supportive stiff guide for passive use

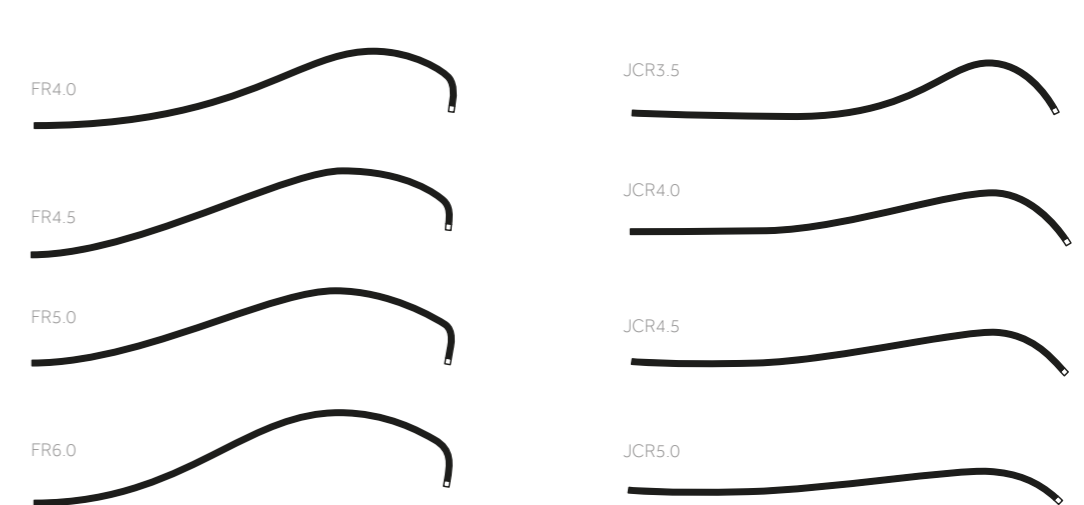

RIGHT CORONARY CURVE

	6F CODE	7F CODE	8F CODE	9F CODE
FR4.0	ZM6FR40	ZT7FR40	ZS8FR40	ZM9FR40
FR4.5	ZM6FR45	ZT7FR45	ZS8FR45	ZM9FR45
FR5.0	ZM6FR50	ZT7FR50	ZS8FR50	ZM9FR50
FR6.0	ZM6FR60	ZT7FR60	ZS8FR60	ZM9FR60
JCR3.5	ZM6JCR35	ZT7JCR35	ZS8JCR35	ZM9JCR35
JCR4.0	ZM6JCR40	ZT7JCR40	ZS8JCR40	ZM9JCR40
JCR4.5	ZM6JCR45	ZT7JCR45	ZS8JCR45	ZM9JCR45
JCR5.0	ZM6JCR50	ZT7JCR50	ZS8JCR50	ZM9JCR50

CORONARY GUIDE CATHETERS

Zuma™ Short Right Coronary Curve

GENERAL CHARACTERISTICS

- Supplied sterile Items per box: 1
- Label colour: 6F = Green, 7F = Orange, 8F = Blue, 9F = Grey,
- Lumen inner diameter: 6F = 0.068", 7F = 0.081", 8F = 0.091", 9F = 0.103"

PRODUCT DESCRIPTION

Supportive stiff guide for passive use



SHORT TIP RIGHT CORONARY

	6F CODE	7F CODE	8F CODE	9F CODE
SR3.0	ZM6SR30	ZT7SR30	ZS8SR30	ZM9SR30
SR3.5	ZM6SR35	ZT7SR35	ZS8SR35	ZM9SR35
SR4.0	ZM6SR40	ZT7SR40	ZS8SR40	ZM9SR40
SR4.5	ZM6SR45	ZT7SR45	ZS8SR45	ZM9SR45
SR5.0	ZM6SR50	ZT7SR50	ZS8SR50	ZM9SR50
SR6.0	ZM6SR60	ZT7SR60	ZS8SR60	ZM9SR60

CORONARY GUIDE CATHETERS

Zuma™ Amplatz Right Coronary Curve

GENERAL CHARACTERISTICS

- Supplied sterile Items per box: 1
- Label colour: 6F = Green, 7F = Orange, 8F = Blue, 9F = Grey,
- Lumen inner diameter: 6F = 0.068", 7F = 0.081", 8F = 0.091", 9F = 0.103"

PRODUCT DESCRIPTION

Supportive stiff guide for passive use

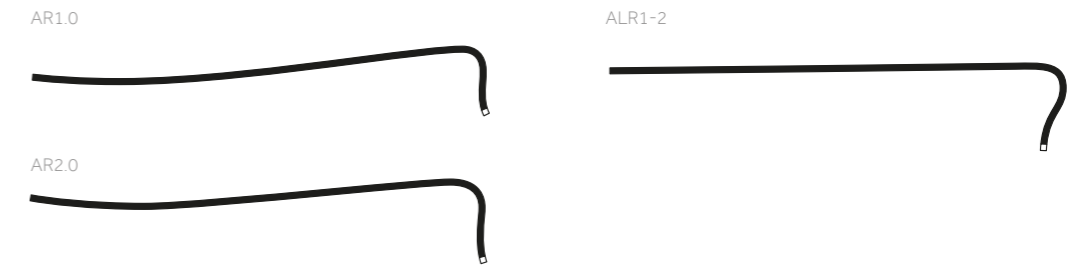

AMPLATZ RIGHT

	6F CODE	7F CODE	8F CODE	9F CODE
AR1.0	ZM6AR10	ZT7AR10	ZS8AR10	ZM9AR10
AR2.0	ZM6AR20	ZT7AR20	ZS8AR20	ZM9AR20
ALR1-2	ZM6ALR12	ZT7ALR12	ZS8ALR12	ZM9ALR12

CORONARY GUIDE CATHETERS

Zuma™ Short Amplatz Right Coronary Curve

GENERAL CHARACTERISTICS

- Supplied sterile Items per box: 1
- Label colour: 6F = Green, 7F = Orange, 8F = Blue, 9F = Grey,
- Lumen inner diameter: 6F = 0.068", 7F = 0.081", 8F = 0.091", 9F = 0.103"

PRODUCT DESCRIPTION

Supportive stiff guide for passive use

SAR1.0



SAR2.0



SHORT TIP AMPLATZ RIGHT

	6F CODE	7F CODE	8F CODE	9F CODE
SAR1.0	ZM6SAR10	ZT7SAR10	ZS8SAR10	ZM9SAR10
SAR2.0	ZM6SAR20	ZT7SAR20	ZS8SAR20	ZM9SAR20

CORONARY GUIDE CATHETERS

Zuma™ Shepherd's Crook Right Coronary Curve

GENERAL CHARACTERISTICS

- Supplied sterile Items per box: 1
- Label colour: 6F = Green, 7F = Orange, 8F = Blue, 9F = Grey,
- Lumen inner diameter: 6F = 0.068", 7F = 0.081", 8F = 0.091", 9F = 0.103"

PRODUCT DESCRIPTION

Supportive stiff guide for passive use

SCR3.5



SCR4.0



SCR5.0



SHEPHERD'S CROOK RIGHT

	6F CODE	7F CODE	8F CODE	9F CODE
SCR3.5	ZM6SCR35	ZT7SCR35	ZS8SCR35	ZM9SCR35
SCR4.0	ZM6SCR40	ZT7SCR40	ZS8SCR40	ZM9SCR40
SCR5.0	ZM6SCR50	ZT7SCR50	ZS8SCR50	ZM9SCR50

CORONARY GUIDE CATHETERS

Zuma™ Right Coronary Backup Support

GENERAL CHARACTERISTICS

- Supplied sterile Items per box: 1
- Label colour: 6F = Green, 7F = Orange, 8F = Blue, 9F = Grey,
- Lumen inner diameter: 6F = 0.068", 7F = 0.081", 8F = 0.091", 9F = 0.103"

PRODUCT DESCRIPTION

Supportive stiff guide for passive use



LEFT CORONARY

	6F CODE	7F CODE	8F CODE	9F CODE
NO TORQUE Right	ZM6NOTO	ZT7NOTO	ZS8NOTO	ZM9NOTO

CORONARY GUIDE CATHETERS

Zuma™ Multipurpose Curves

GENERAL CHARACTERISTICS

- Supplied sterile Items per box: 1
- Label colour: 6F = Green, 7F = Orange, 8F = Blue, 9F = Grey,
- Lumen inner diameter: 6F = 0.068", 7F = 0.081", 8F = 0.091", 9F = 0.103"

PRODUCT DESCRIPTION

Supportive stiff guide for passive use

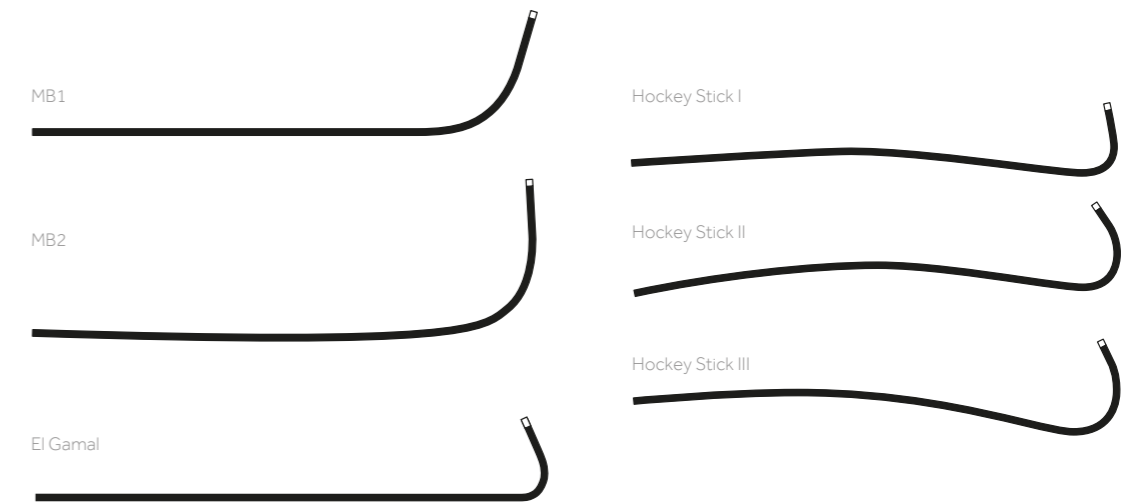

MULTIPURPOSE

	6F CODE	7F CODE	8F CODE	9F CODE
MB1	ZM6MB10	ZT7MB1	ZS8MB1	ZM9MB1
MB2	ZM6MB2	ZT7MB2	ZS8MB2	ZM9MB2
Hockey Stick I	ZM6HSI	ZT7HSI	ZS8HSI	ZM9HSI
Hockey Stick II	ZM6HSII	ZT7HSII	ZS8HSII	ZM9HSII
Hockey Stick III	ZM6HSIII	ZT7HSIII	ZS8HSIII	ZM9HSIII
El Gamal	ZM6ELGAMAL	ZT7ELGAMAL	ZS8ELGAMAL	ZM9ELGAMAL

CORONARY GUIDE CATHETERS

Zuma™ Other Curves

GENERAL CHARACTERISTICS

- Supplied sterile Items per box: 1
- Label colour: 6F = Green, 7F = Orange, 8F = Blue, 9F = Grey,
- Lumen inner diameter: 6F = 0.068", 7F = 0.081", 8F = 0.091", 9F = 0.103"

PRODUCT DESCRIPTION

Supportive stiff guide for passive use

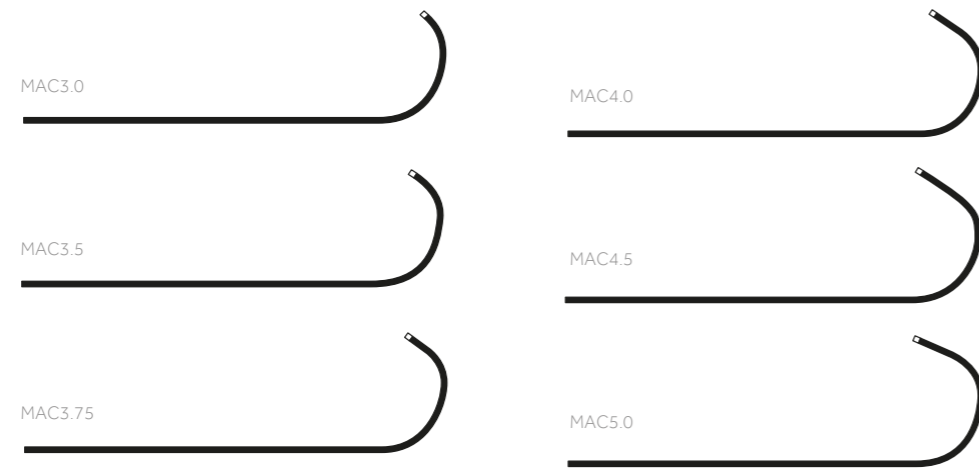

MAC (MULTI- AORTIC CURVES)

	6F CODE	7F CODE	8F CODE	9F CODE
MAC3.0	ZM6MAC30	ZT7MAC30	ZS8MAC30	ZM9MAC30
MAC3.5	ZM6MAC35	ZT7MAC35	ZS8MAC35	ZM9MAC35
MAC3.75	ZM6MAC375	ZT7MAC375	ZS8MAC375	ZM9MAC375
MAC4.0	ZM6MAC40	ZT7MAC40	ZS8MAC40	ZM9MAC40
MAC4.5	ZM6MAC45	ZT7MAC45	ZS8MAC45	ZM9MAC45
MAC5.0	ZM6MAC50	ZT7MAC50	ZS8MAC50	ZM9MAC50

CORONARY GUIDE CATHETERS

Zuma™ Bypass Curves

GENERAL CHARACTERISTICS

- Supplied sterile Items per box: 1
- Label colour: 6F = Green, 7F = Orange, 8F = Blue, 9F = Grey,
- Lumen inner diameter: 6F = 0.068", 7F = 0.081", 8F = 0.091", 9F = 0.103"

PRODUCT DESCRIPTION

Supportive stiff guide for passive use

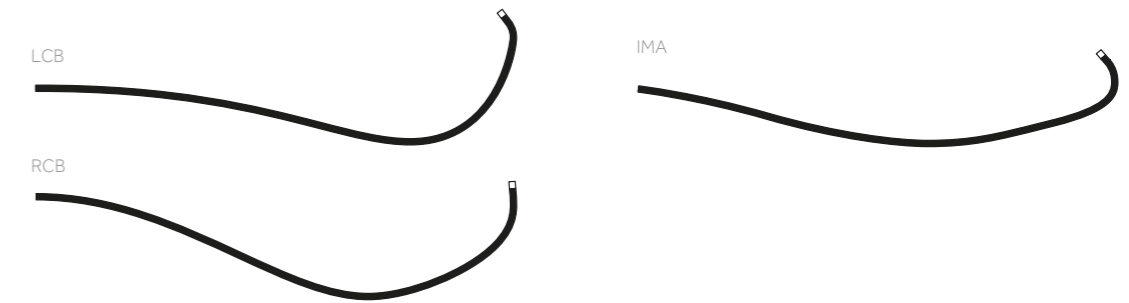

BYPASS GRAFTS

	6F CODE	7F CODE	8F CODE	9F CODE
LCB	ZM6LCB	ZT7LCB	ZS8LCB	ZM9LCB
RCB	ZM6RCB	ZT7RCB	ZS8RCB	ZM9RCB
RCB (90 cm)	ZM6RCBD	ZT7RCBD	ZS8RCBD	ZM9RCBD
IMA	ZM6IMA	ZT7IMA	ZS8IMA	ZM9IMA
IMA (90 cm)	ZM6IMAD	ZT7IMAD	ZS8IMAD	ZM9IMAD

CORONARY GUIDE CATHETERS

Zuma™
Other Curves

GENERAL CHARACTERISTICS

- Supplied sterile Items per box: 1
- Label colour: 6F = Green, 7F = Orange, 8F = Blue, 9F = Grey.
- Lumen inner diameter: 6F = 0.068", 7F = 0.081", 8F = 0.091", 9F = 0.103"

PRODUCT DESCRIPTION

Supportive stiff guide for passive use

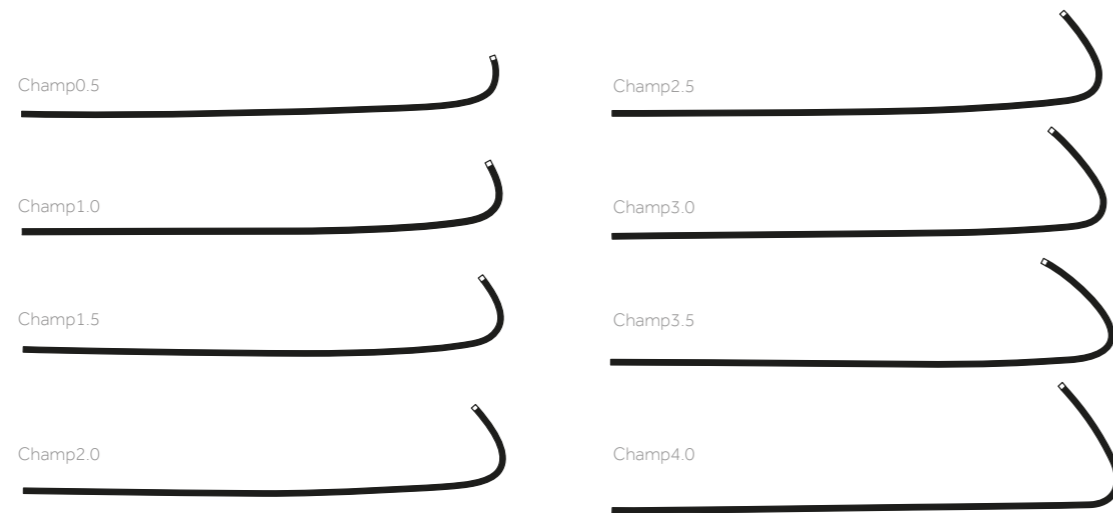

CHAMP

	6F CODE	7F CODE	8F CODE	9F CODE
CHAMP 0.5	Z26CHAMP05	ZT7CHAMP05	ZS8CHAMP05	ZM9CHAMP05
CHAMP 10	Z26CHAMP10	ZT7CHAMP10	ZS8CHAMP10	ZM9CHAMP10
CHAMP 15	Z26CHAMP15	ZT7CHAMP15	ZS8CHAMP15	ZM9CHAMP15
CHAMP 20	Z26CHAMP20	ZT7CHAMP20	ZS8CHAMP20	ZM9CHAMP20
CHAMP 25	Z26CHAMP25	ZT7CHAMP25	ZS8CHAMP25	ZM9CHAMP25
CHAMP 30	Z26CHAMP30	ZT7CHAMP30	ZS8CHAMP30	—
CHAMP 35	Z26CHAMP35	ZT7CHAMP35	ZS8CHAMP35	ZM9CHAMP35
CHAMP 40	Z26CHAMP40	ZT7CHAMP40	ZS8CHAMP40	ZM9CHAMP40

INTERVENTIONAL GUIDEWIRES

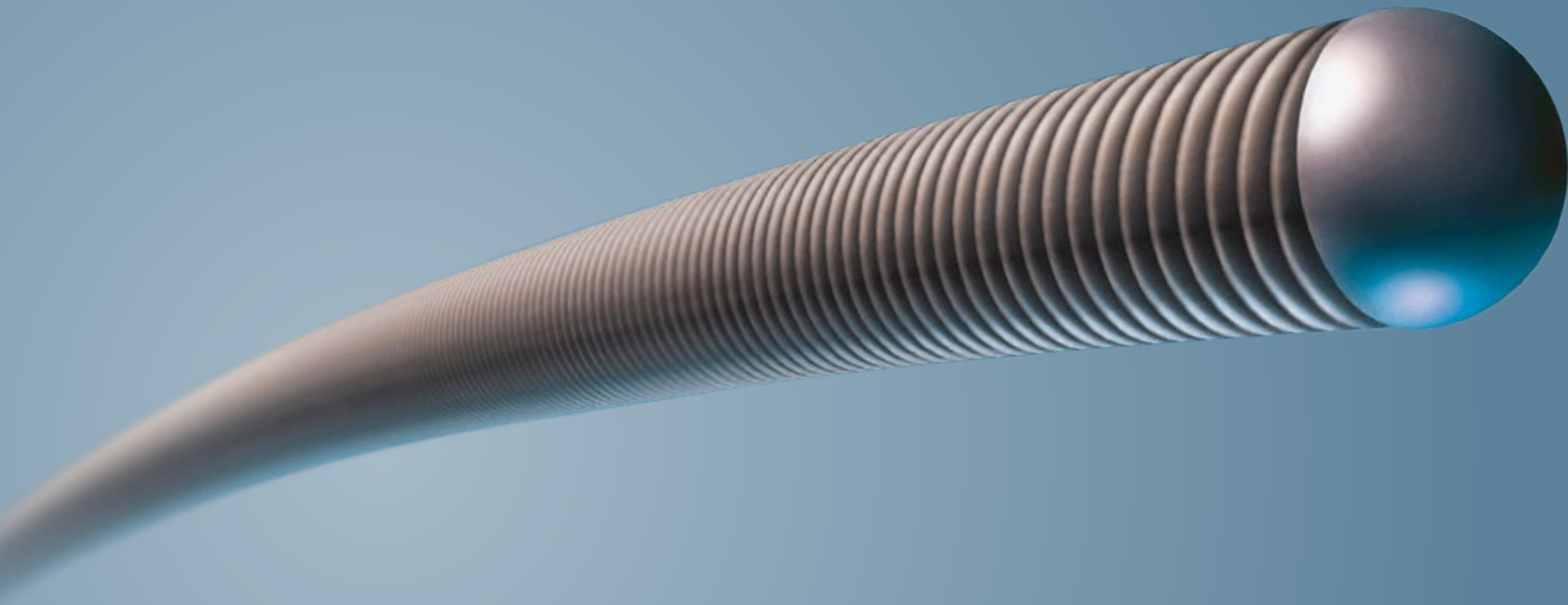

GUIDEWIRE FAMILY

Medtronic offers a wide array of guidewires to support different clinical needs

ZINGER™ Stainless steel workhorse guidewire

- When you need steerability and torque control
- Stainless steel core wire provides torque transmission for advanced steerability and control. Available in a range of support levels for a variety of clinical situations: light, marker, medium and support.

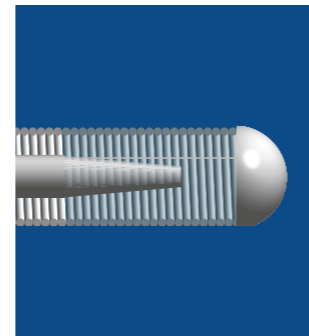

INTUITION™ Advanced workhorse guidewire

- Confidently cross your more challenging workhorse cases
- Torque performance and one-gram tip weight give you precision and confidence during your more difficult workhorse cases. Accu-Core Technology provides torque and improved crossability.

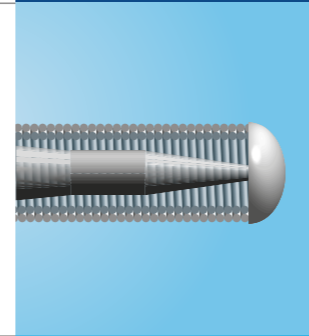

COUGAR™ Nitinol workhorse guidewire

- When you need trackability for distal and tortuous access
- Nitinol core wire provides steerability and support through tortuous anatomy and for multivessel treatment. Double coil tip is soft and atraumatic for shape retention.

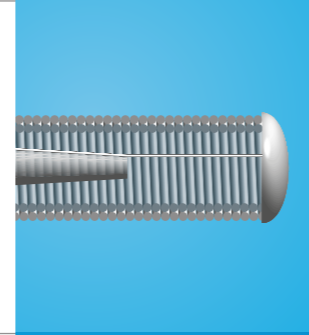

PROVIA™ Crossing guidewire

- Designed to cross your most demanding lesions
- Available in a wide range of weights and lengths. Accu-Core Technology offers torque performance, tactile feel, improved lesion penetration and a 1-mm nonhydrophilic tip.

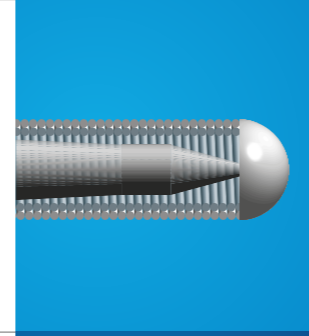

THUNDER™ Extra-support guidewire

- When you need extra support
- Stainless steel, core-to-tip design provides torque, tip control and steering for situations requiring extra support.

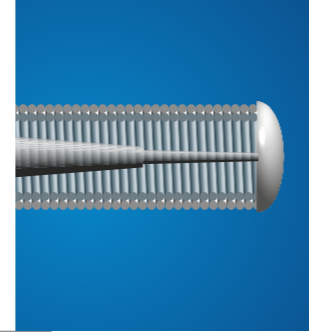

INTERVENTIONAL GUIDEWIRES

Zinger™ Light Stainless steel workhorse guidewire

GENERAL CHARACTERISTICS

• Supplied sterile • Items per box: 5

PRODUCT DESCRIPTION

The Zinger™ line of guidewires is the latest advancement in highly trackable guidewires with excellent torque control.

- Available with Pro/Pel™ silicone coating or Hydro-Track™ hydrophilic coating for more treatment strategies.
- Zinger™ is available in various support levels as well as a marker version to meet your preference and clinical challenge.
- 2-cm radiopaque tip for visibility.
- Zinger™ Light is a highly trackable light support guidewire with floppy tip for tortuous anatomy.

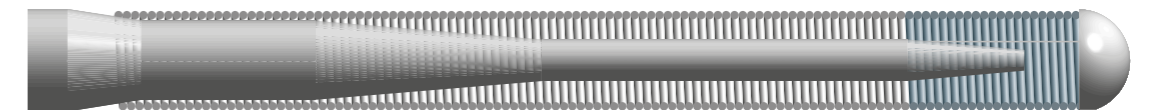

ORDERING INFORMATION

PRODUCT	PRODUCT CODE	LENGTH (CM)	COATING	TIP
ZINGER LS	ZNGRLS180HS	180	Hydro-Track	Straight tip
ZINGER LS	ZNGRLS180S	180	Pro/Pel	Straight tip
ZINGER LS	ZNGRLS180HJ	180	Hydro-Track	J-tip
ZINGER LS	ZNGRLS180J	180	Pro/Pel	J-tip
ZINGER LS	ZNGRLS300HS	300	Hydro-Track	Straight tip
ZINGER LS	ZNGRLS300S	300	Pro/Pel	Straight tip
ZINGER LS	ZNGRLS300HJ	300	Hydro-Track	J-tip
ZINGER LS	ZNGRLS300J	300	Pro/Pel	J-tip

Tip style: Forming ribbon

Outer coating: Hydro-Track or Pro/Pel

Tip Stiffness Support



INTERVENTIONAL GUIDEWIRES

Zinger™ Marker Stainless steel workhorse guidewire

GENERAL CHARACTERISTICS

- Supplied sterile • Items per box: 5

PRODUCT DESCRIPTION

The Zinger™ line of guidewires is the latest advancement in highly trackable guidewires with excellent torque control.

- The Hydro-track hydrophilic coating offers optimal lubricity and durability.
- Zinger™ is available in various support levels as well as a marker version to meet your preference and clinical challenge.
- Zinger™ Marker is a light support guidewire with two radiopaque markers for reference measure of vessels and lesions.

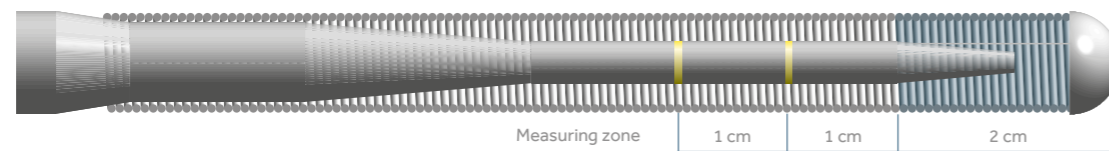

ORDERING INFORMATION

PRODUCT	PRODUCT CODE	LENGTH (CM)	COATING	TIP
ZINGER MK	ZNGRMK180HS	180	Hydro-Track	Straight tip
ZINGER MK	ZNGRMK180S	180	Pro/Pel	Straight tip
ZINGER MK	ZNGRMK180HJ	180	Hydro-Track	J-tip
ZINGER MK	ZNGRMK180J	180	Pro/Pel	J-tip
ZINGER MK	ZNGRMK300HS	300	Hydro-Track	Straight tip
ZINGER MK	ZNGRMK300S	300	Pro/Pel	Straight tip
ZINGER MK	ZNGRMK300HJ	300	Hydro-Track	J-tip
ZINGER MK	ZNGRMK300J	300	Pro/Pel	J-tip

Tip style: Forming ribbon
Outer coating: Hydro-Track or Pro/Pel

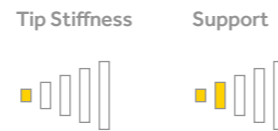

INTERVENTIONAL GUIDEWIRES

Zinger™ Medium Stainless steel workhorse guidewire

GENERAL CHARACTERISTICS

- Supplied sterile • Items per box: 5

PRODUCT DESCRIPTION

The Zinger™ line of guidewires is the latest advancement in highly trackable guidewires with excellent torque control.

- The Hydro-track hydrophilic coating offers optimal lubricity and durability.
- Zinger™ is available in various support levels as well as a marker version to meet your preference and clinical challenge.
- Zinger™ Medium is a medium weight "workhorse" wire, ideal for general use in varied anatomy.

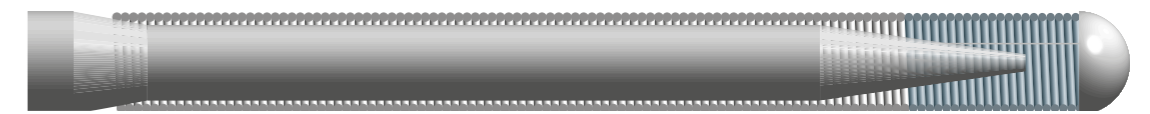

ORDERING INFORMATION

PRODUCT	PRODUCT CODE	LENGTH (CM)	COATING	TIP
ZINGER MS	ZNGRMS180HS	180	Hydro-Track	Straight tip
ZINGER MS	ZNGRMS180S	180	Pro/Pel	Straight tip
ZINGER MS	ZNGRMS180HJ	180	Hydro-Track	J-tip
ZINGER MS	ZNGRMS180J	180	Pro/Pel	J-tip
ZINGER MS	ZNGRMS300HS	300	Hydro-Track	Straight tip
ZINGER MS	ZNGRMS300S	300	Pro/Pel	Straight tip
ZINGER MS	ZNGRMS300HJ	300	Hydro-Track	J-tip
ZINGER MS	ZNGRMS300J	300	Pro/Pel	J-tip

Tip style: Core-to-tip
Outer coating: Hydro-Track or Pro/Pel

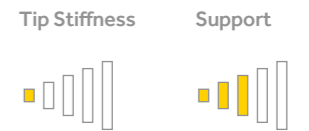

INTERVENTIONAL GUIDEWIRES

Zinger™ Support Stainless steel workhorse guidewire

GENERAL CHARACTERISTICS

• Supplied sterile • Items per box: 5

PRODUCT DESCRIPTION

The Zinger™ line of guidewires is the latest advancement in highly trackable guidewires with excellent torque control.

- The Hydro-track hydrophilic coating offers optimal lubricity and durability.
- Zinger™ is available in various support levels as well as a marker version to meet your preference and clinical challenge.
- Zinger™ Support is designed with added support for stent placement, yet trackable.

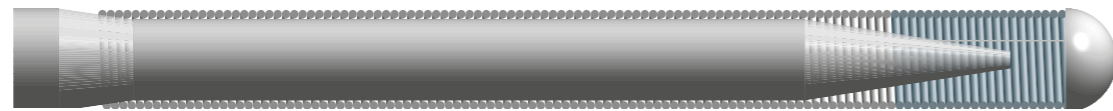

ORDERING INFORMATION

PRODUCT	PRODUCT CODE	LENGTH (CM)	COATING	TIP
ZINGER S	ZNGRS180HS	180	Hydro-Track	Straight tip
ZINGER S	ZNGRS180S	180	Pro/Pel	Straight tip
ZINGER S	ZNGRS180HJ	180	Hydro-Track	J-tip
ZINGER S	ZNGRS180J	180	Pro/Pel	J-tip
ZINGER S	ZNGRS300HS	300	Hydro-Track	Straight tip
ZINGER S	ZNGRS300S	300	Pro/Pel	Straight tip
ZINGER S	ZNGRS300HJ	300	Hydro-Track	J-tip
ZINGER S	ZNGRS300J	300	Pro/Pel	J-tip

Tip style: Forming ribbon

Outer coating: Hydro-Track or Pro/Pel

Tip Stiffness Support



INTERVENTIONAL GUIDEWIRES

Intuition™ Advanced workhorse guidewire

GENERAL CHARACTERISTICS

• Supplied sterile • Items per box: 5

PRODUCT DESCRIPTION

The Intuition™ guidewire offers torque performance and one-gram tip weight to give precision and confidence during more difficult workhorse cases.

- Rounded tip and body provide control.
- Accu-Core technology provides torque performance to control and direct the wire.
- Femoral (proximal) markers on wire, 90 cm and 100 cm from distal tip.
- Available with Pro/Pel™ silicone coating or Hydro-Track™ hydrophilic coating for more treatment strategies.
- 3-cm radiopaque tip for visibility.

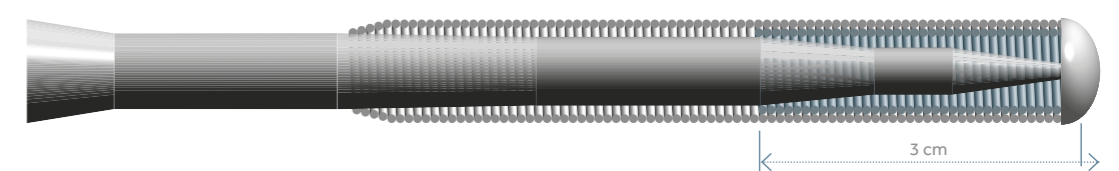

ORDERING INFORMATION

PRODUCT	PRODUCT CODE	LENGTH (CM)	COATING	TIP
Intuition	INTU180HS	180	Hydro-Track	Straight tip
Intuition	INTU180SS	180	Pro/Pel	Straight tip
Intuition	INTU300HS	300	Hydro-Track	Straight tip
Intuition	INTU300SS	300	Pro/Pel	Straight tip

Tip style: Core-to-tip

Outer coating: Hydro-Track or Pro/Pel

Tip Stiffness Support



INTERVENTIONAL GUIDEWIRES

Cougar™ LS Nitinol workhorse guidewire

GENERAL CHARACTERISTICS

- Supplied sterile • Items per box: 5

PRODUCT DESCRIPTION

The Cougar™ Steerable Guidewire offers the performance and support required for workhorse cases.

- Nitinol core wire
- Double coil tip design offers a soft tip with outstanding tip shape retention.
- Available in Hydro-Track™ hydrophilic or Pro/Pel™ silicone coating. The Hydro-Track hydrophilic coating offers optimal lubricity and durability.
- The Pro/Pel silicone coating offers traditional performance for situations that require reduced lubricity.
- 3-cm radiopaque tip for visibility.

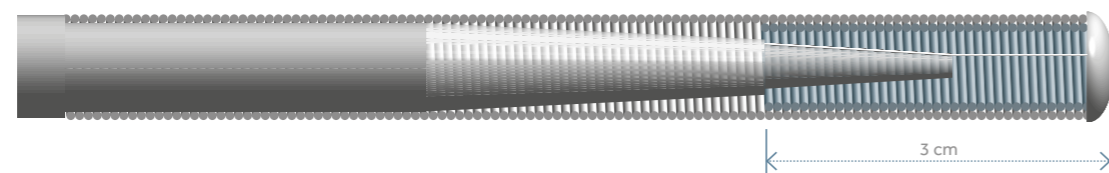

ORDERING INFORMATION

PRODUCT	PRODUCT CODE	LENGTH (CM)	COATING	TIP
Cougar LS	CGRLS190HS	190 cm	Hydro-Track	Straight tip
Cougar LS	CGRLS190S	190 cm	Pro/Pel	Straight tip
Cougar LS	CGRLS190HJ	190 cm	Hydro-Track	J-tip
Cougar LS	CGRLS190J	190 cm	Pro/Pel	J-tip
Cougar LS	CGRLS300HS	300 cm	Hydro-Track	Straight tip
Cougar LS	CGRLS300S	300 cm	Pro/Pel	Straight tip
Cougar LS	CGRLS300HJ	300 cm	Hydro-Track	J-tip
Cougar LS	CGRLS300J	300 cm	Pro/Pel	J-tip

Tip style: Forming ribbon

Outer coating: Hydro-Track or Pro/Pel

Tip Stiffness **Support**



INTERVENTIONAL GUIDEWIRES

Cougar™ XT Nitinol workhorse guidewire

GENERAL CHARACTERISTICS

- Supplied sterile • Items per box: 5

PRODUCT DESCRIPTION

The Cougar™ Steerable Guidewire offers the performance and support required for workhorse cases.

- Nitinol core wire
- Double coil tip design offers a soft tip with outstanding tip shape retention.
- Available in Hydro-Track™ hydrophilic or Pro/Pel™ silicone coating. The Hydro-Track hydrophilic coating offers optimal lubricity and durability.
- The Pro/Pel silicone coating offers traditional performance for situations that require reduced lubricity.
- 3-cm radiopaque tip for visibility.

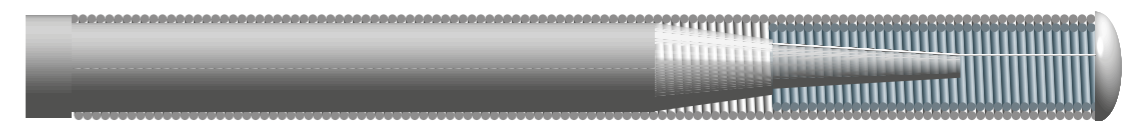

ORDERING INFORMATION

PRODUCT	PRODUCT CODE	LENGTH (CM)	COATING	TIP
Cougar XT	CGRXT190HS	190 cm	Hydro-Track	Straight tip
Cougar XT	CGRXT190S	190 cm	Pro/Pel	Straight tip
Cougar XT	CGRXT190HJ	190 cm	Hydro-Track	J-tip
Cougar XT	CGRXT190J	190 cm	Pro/Pel	J-tip
Cougar XT	CGRXT300HS	300 cm	Hydro-Track	Straight tip
Cougar XT	CGRXT300S	300 cm	Pro/Pel	Straight tip
Cougar XT	CGRXT300HJ	300 cm	Hydro-Track	J-tip
Cougar XT	CGRXT300J	300 cm	Pro/Pel	J-tip

Tip style: Forming ribbon

Outer coating: Hydro-Track or Pro/Pel

Tip Stiffness **Support**



INTERVENTIONAL GUIDEWIRES

ProVia™ Crossing guidewire

GENERAL CHARACTERISTICS

- Supplied sterile • Items per box: 5

PRODUCT DESCRIPTION

- The ProVia™ Crossing Guidewire is designed to cross demanding lesions.
- Accu-Core wire technology is designed to provide torque performance to control and direct the wire.
 - Rounded tip and body provide control.
 - Tapered tip on ProVia™ 9 and 12 wires.
 - 1-mm noncoated tip on the hydrophilic version.
 - Femoral (proximal) markers on wire, 90 cm and 100 cm from distal tip.
 - Available in Hydro-Track™ hydrophilic or Pro/Pel™ silicone coating. The Hydro-Track hydrophilic coating offers optimal lubricity and durability.
 - The Pro/Pel silicone coating offers traditional performance for situations that require reduced lubricity.
 - 3-cm radiopaque tip for visibility

ProVia™ 3

Straight tip (0.014 in.)

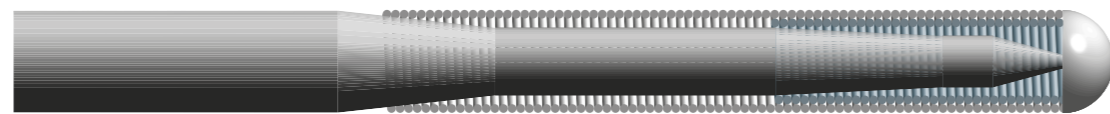

ORDERING INFORMATION

PRODUCT	PRODUCT CODE	SIZE (G)	LENGTH (CM)	COATING	TIP
ProVia 3	3PROV180HS	3	180	Hydro-Track	Straight tip
ProVia 3	3PROV180SS	3	180	Pro/Pel	Straight tip
ProVia 3	3PROV300HS	3	300	Hydro-Track	Straight tip
ProVia 3	3PROV300SS	3	300	Pro/Pel	Straight tip

Tip style: Core-to-tip

Outer coating: Hydro-Track or Pro/Pel

Tip Stiffness



Support



ProVia™ 6

Straight tip (0.014 in.)

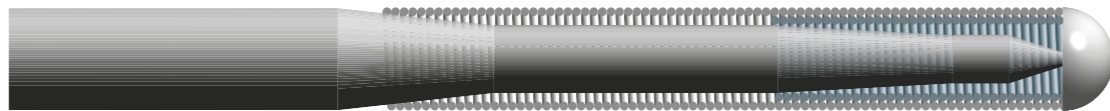

ORDERING INFORMATION

PRODUCT	PRODUCT CODE	SIZE (G)	LENGTH (CM)	COATING	TIP
ProVia 6	6PROV180HS	6	180	Hydro-Track	Straight tip
ProVia 6	6PROV180SS	6	180	Pro/Pel	Straight tip
ProVia 6	6PROV300HS	6	300	Hydro-Track	Straight tip
ProVia 6	6PROV300SS	6	300	Pro/Pel	Straight tip

Tip style: Core-to-tip

Outer coating: Hydro-Track or Pro/Pel

Tip Stiffness



Support



INTERVENTIONAL GUIDEWIRES

ProVia™ Crossing guidewire

GENERAL CHARACTERISTICS

- Supplied sterile • Items per box: 5

PRODUCT DESCRIPTION

- The ProVia™ Crossing Guidewire is designed to cross demanding lesions.
- Accu-Core wire technology is designed to provide torque performance to control and direct the wire.
 - Rounded tip and body provide control.
 - Tapered tip on ProVia™ 9 and 12 wires.
 - 1-mm noncoated tip on the hydrophilic version.
 - Femoral (proximal) markers on wire, 90 cm and 100 cm from distal tip.
 - Available in Hydro-Track™ hydrophilic or Pro/Pel™ silicone coating. The Hydro-Track hydrophilic coating offers optimal lubricity and durability.
 - The Pro/Pel silicone coating offers traditional performance for situations that require reduced lubricity.
 - 3-cm radiopaque tip for visibility

ProVia™ 9

Tapered tip (0.009 in.)

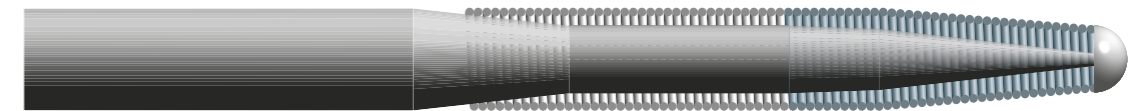

ORDERING INFORMATION

PRODUCT	PRODUCT CODE	SIZE (G)	LENGTH (CM)	COATING	TIP
ProVia 9	9PROV180HS	9	180	Hydro-Track	Tapered tip
ProVia 9	9PROV180SS	9	180	Pro/Pel	Tapered tip
ProVia 9	9PROV300HS	9	300	Hydro-Track	Tapered tip
ProVia 9	9PROV300SS	9	300	Pro/Pel	Tapered tip

Tip style: Core-to-tip

Outer coating: Hydro-Track or Pro/Pel

Tip Stiffness



Support



ProVia™ 12

Tapered tip (0.009 in.)

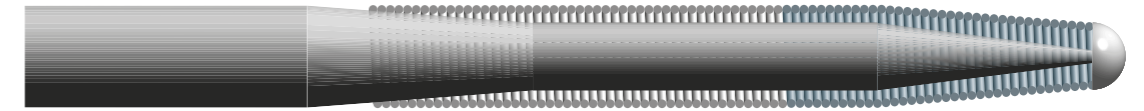

ORDERING INFORMATION

PRODUCT	PRODUCT CODE	SIZE (G)	LENGTH (CM)	COATING	TIP
ProVia 12	12PROV180HS	12	180	Hydro-Track	Tapered tip
ProVia 12	12PROV180SS	12	180	Pro/Pel	Tapered tip
ProVia 12	12PROV300HS	12	300	Hydro-Track	Tapered tip
ProVia 12	12PROV300SS	12	300	Pro/Pel	Tapered tip

Tip style: Core-to-tip

Outer coating: Hydro-Track or Pro/Pel

Tip Stiffness



Support



INTERVENTIONAL GUIDEWIRES

ProVia™ Crossing guidewire

GENERAL CHARACTERISTICS

• Supplied sterile • Items per box: 5

PRODUCT DESCRIPTION

- The ProVia™ Crossing Guidewire is designed to cross demanding lesions.
- Accu-Core wire technology is designed to provide torque performance to control and direct the wire.
 - Rounded tip and body provide control.
 - Tapered tip on ProVia™ 9 and 12 wires.
 - 1-mm noncoated tip on the hydrophilic version.
 - Femoral (proximal) markers on wire, 90 cm and 100 cm from distal tip.
 - Available in Hydro-Track™ hydrophilic or Pro/Pel™ silicone coating. The Hydro-Track hydrophilic coating offers optimal lubricity and durability.
 - The Pro/Pel silicone coating offers traditional performance for situations that require reduced lubricity.
 - 3-cm radiopaque tip for visibility

ProVia™ 15 Tapered tip (0.009 in.)

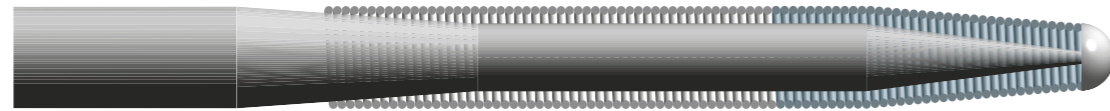

ORDERING INFORMATION

PRODUCT	PRODUCT CODE	SIZE (G)	LENGTH (CM)	COATING	TIP
ProVia 15	15PROV180HS	15	180	Hydro-Track	Tapered tip
ProVia 15	15PROV180SS	15	180	Pro/Pel	Tapered tip
ProVia 15	15PROV300HS	15	300	Hydro-Track	Tapered tip
ProVia 15	15PROV300SS	15	300	Pro/Pel	Tapered tip

Tip style:	Core-to-tip
Outer coating:	Hydro-Track or Pro/Pel



INTERVENTIONAL GUIDEWIRES

Thunder™ Extra-Support guidewire

GENERAL CHARACTERISTICS

• Supplied sterile • Items per box: 5 • Label color: Silver

PRODUCT DESCRIPTION

The Thunder™ Guidewire has a stainless steel core-to-tip design which provides enhanced support and stability while maintaining excellent torque characteristics with precise tip control and steering.

- 11 cm transition zone (rail) which provides support for accurate device placement
- Available in Pro/Pel Silicone coating for track ability and smooth device delivery
- 3 cm Radiopaque Tip for visibility

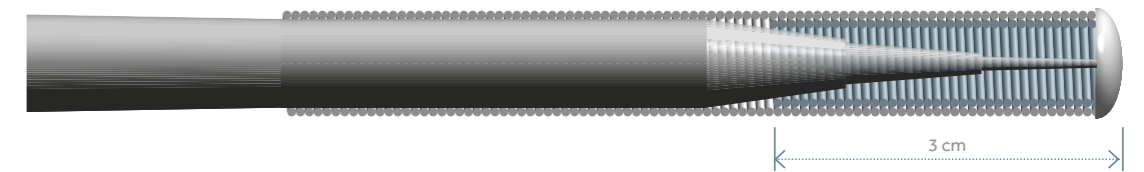

ORDERING INFORMATION

PRODUCT	PRODUCT CODE	LENGTH (CM)	COATING	TIP
THUNDER	THNDR190S	190	Pro/Pel	Straight tip
THUNDER	THNDR190J	190	Pro/Pel	J-tip
THUNDER	THNDR300S	300	Pro/Pel	Straight tip
THUNDER	THNDR300J	300	Pro/Pel	J-tip

Tip style:	Core-to-tip
Outer coating:	Pro/Pel



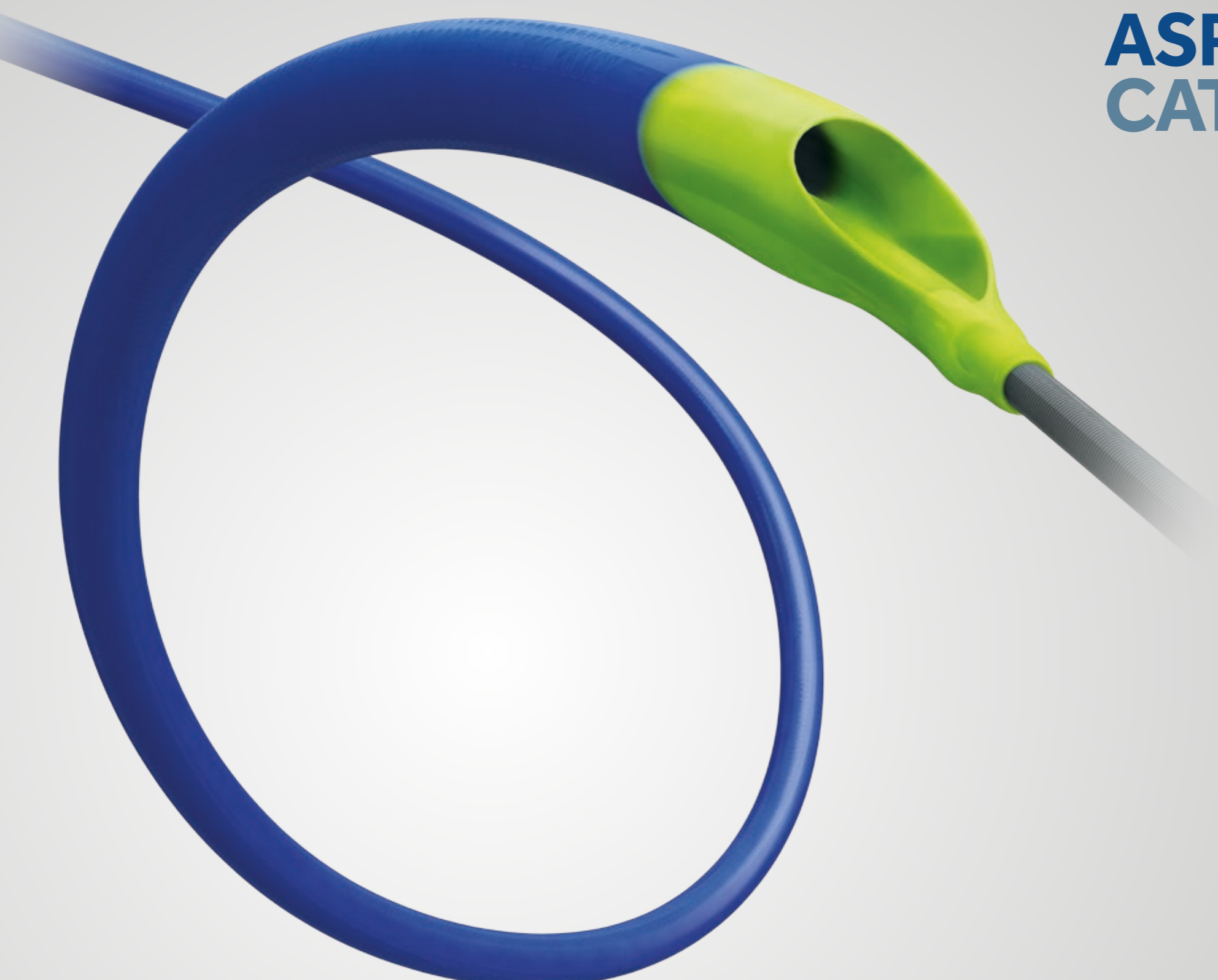

ASPIRATION CATHETERS

CONTENTS

- 1. DRUG-ELUTING STENTS
- 2. BARE-METAL STENTS
- 3. BALLON DILATION CATHETERS
- 4. DRUG-ELUTING BALLOONS
- 5. GUIDE CATHETER FAMILY
- 6. INTERVENTIONAL GUIDEWIRES
- 7. ASPIRATION CATHETERS
- 8. ANGIOGRAPHIC CATHETERS AND WIRES
- 9. INTRODUCERS
- 10. INTERVENTIONAL ACCESSORIES
- 11. PEDIATRIC AND TRANSCATHETER PRODUCTS
- 12. RENAL DENERVATION

ASPIRATION CATHETERS

Export Advance™

GENERAL CHARACTERISTICS

- Supplied sterile
- Items per box: 1
- Includes two syringes, one filter cup and extension line with stopcock.

PRODUCT DESCRIPTION

The Export Advance™ aspiration catheter features a preloaded stylet and manual locking syringe to remove embolic material throughout the arterial system.

FEATURES

- Full Wall Variable Braiding Technology shaft construction
- Preloaded stylet
- Buddy wire compatibility
- Large extraction lumen (0.044" proximal; 0.043" distal)
- Soft, short, forward-facing tip

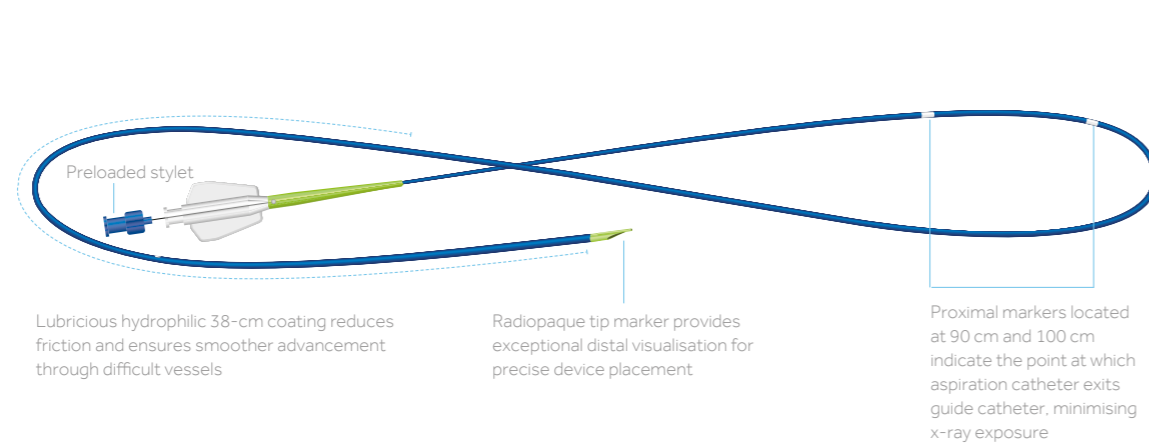

TECHNICAL INFORMATION

Distal O.D. (in.)	0.067
Lumen I.D. (in.)	0.043 (distal), 0.044 (proximal)
Length (cm)	140
Braiding	Variable, hub to tip
Tip design	Soft, short, beveled tip
Coating	Hydrophilic (38 cm)
Syringe (cc)	2 x 30
Product code	ADVANCECE

ASPIRATION CATHETERS

Export™ AP

GENERAL CHARACTERISTICS

- Supplied sterile
- Items per box: 1
- Includes two syringes, one filter cup and extension line with stopcock.

PRODUCT DESCRIPTION

The Export™ AP aspiration catheter uses a manual locking syringe to remove embolic material throughout the arterial system.

FEATURES

- Full Wall Variable Braiding Technology shaft construction
- Extended hydrophilic coating (40 cm)
- Forward-facing atraumatic tip

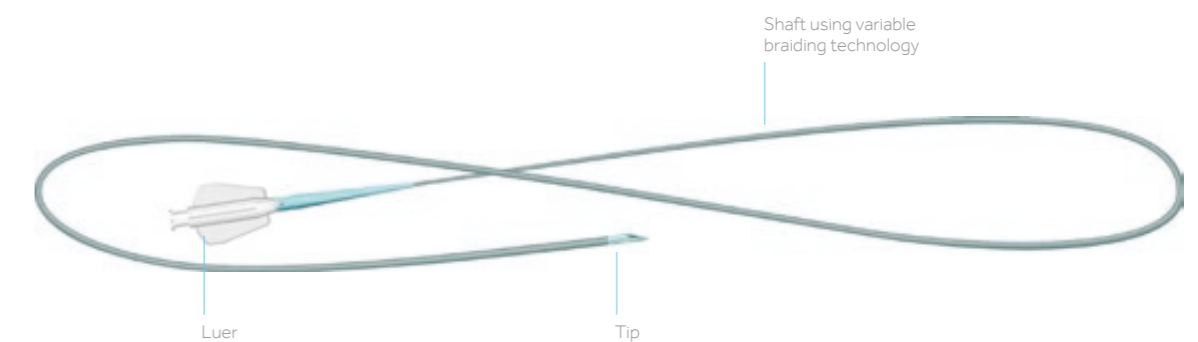

TECHNICAL INFORMATION

Lumen I.D. (in.)	0.043
Lumen O.D. (in.)	0.068
Guide catheter compatibility (in.)	6F (min ID 0.070)
Guide wire compatibility (in.)	0.014
Delivery System	Rapid Exchange
Length (cm)	140
Radio-opaque marker	1.5 mm from distal tip
Product code	EXPORTAPCE

ASPIRATION CATHETERS

Export™ 7 F

GENERAL CHARACTERISTICS

• Supplied sterile. • Includes two syringes and two filters.

PRODUCT DESCRIPTION

The Export™ Aspiration Catheter uses a manual locking syringe to remove embolic material throughout the arterial system. Export™ 7 French delivers double the aspiration power.

FEATURES

- Distal lumen (in.) 0.050
- Lumen O.D. (in) 0.078
- Guide catheter compatibility (in.) 7F (min ID 0.080)

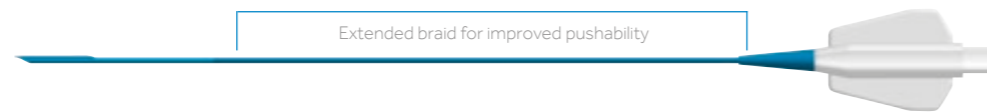

TECHNICAL INFORMATION

PRODUCT CODE	GUIDE COMPATIBILITY (IN.)	WIRE COMPATIBILITY (IN.)	LENGTH (CM)
GEZ62007B	7F min. guide I.D. 0.080	0.014	145

ANGIOGRAPHIC CATHETERS AND WIRES

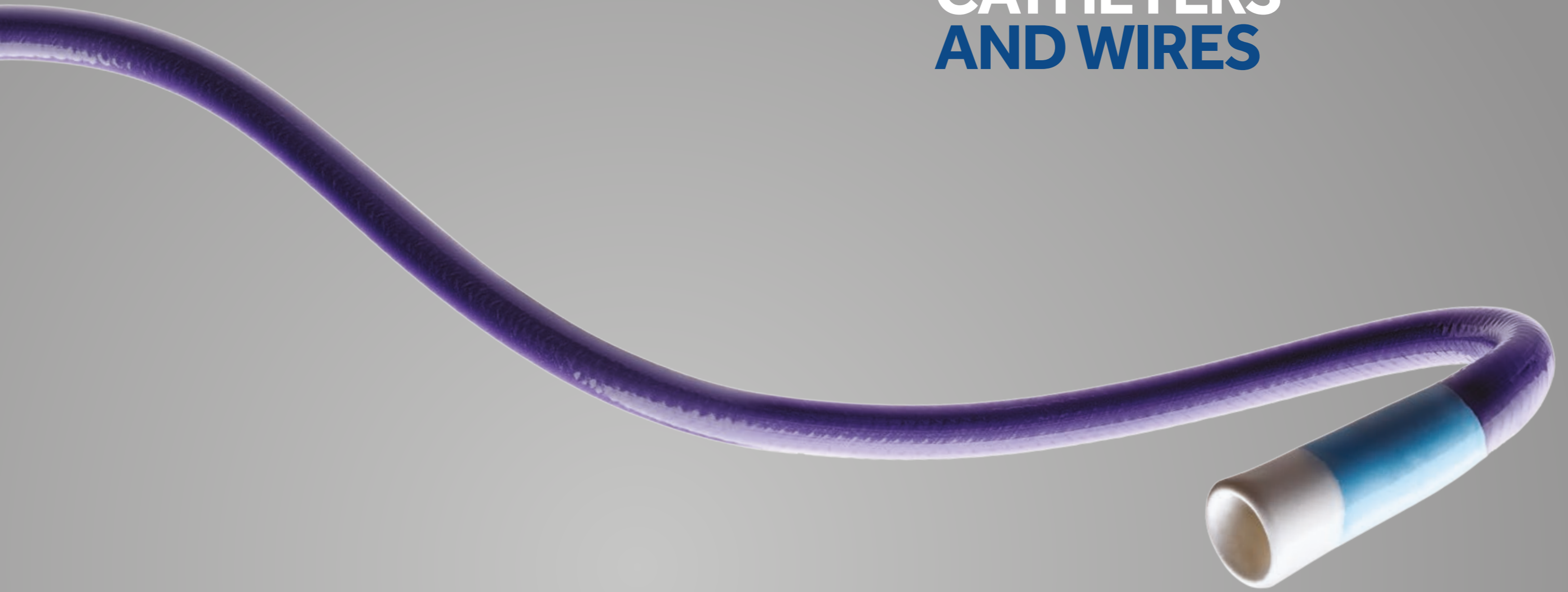

- CONTENTS
- 1. DRUG-ELUTING STENTS
- 2. BARE-METAL STENTS
- 3. BALLOON DILATION CATHETERS
- 4. DRUG-ELUTING BALLOONS
- 5. GUIDE CATHETER FAMILY
- 6. INTERVENTIONAL GUIDEWIRES
- 7. ASPIRATION CATHETERS
- 8. ANGIOGRAPHIC CATHETERS AND WIRES
- 9. INTRODUCERS
- 10. INTERVENTIONAL ACCESSORIES
- 11. PEDIATRIC AND TRANSCATHETER PRODUCTS
- 12. RENAL DENERVATION

CORONARY DIAGNOSTIC CATHETERS

DxTerity™

PRODUCT DESCRIPTION

Features Full-Wall Technology: a proprietary extrusion process that melts layers together to form a solid shaft. This construction process is applied from hub to tip, providing the DxTerity diagnostic catheter with superior torque and lubricity for precise manipulation and enhanced deliverability.

PRODUCT FEATURES

- Enhanced deliverability:**
- InSlide™ polymer additive for superior lubricity to reduce friction and enhance deliverability
- Precise manipulation:**
- Unique, ergonomic, winged hub design for easy manipulation
 - Double-braid wire applied from hub to tip enhances strength, torque and kink resistance
- Excellent image quality:**
- Soft, atraumatic radiopaque tip allows for increased visibility
 - Large lumen enables high flow of contrast media to increase visualization
- Broad catheter portfolio:**
- Optimized for both radial and femoral procedures
 - Wide range of shapes and sizes
 - Includes expanded offerings of long (125 cm) lengths

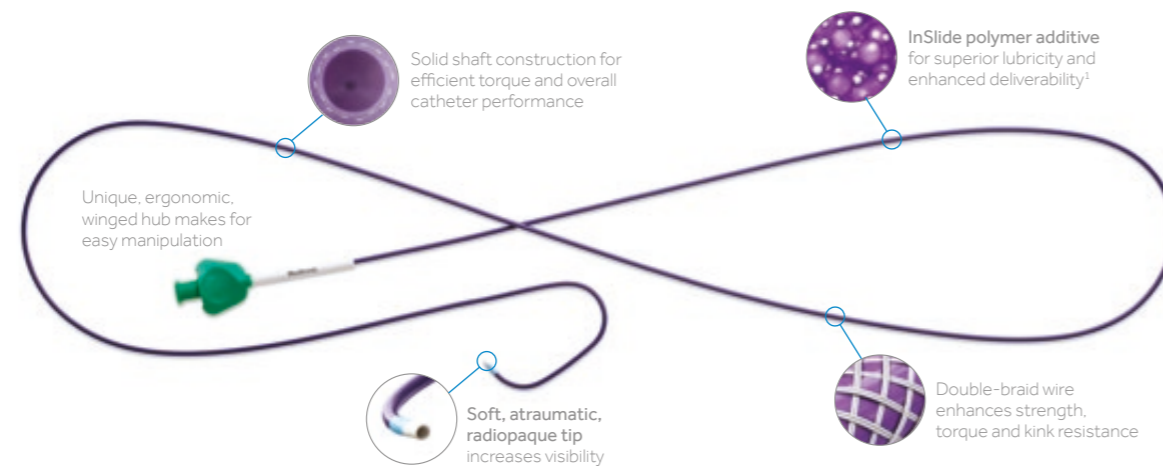

TECHNICAL SPECIFICATIONS

	5F		6F	
Catheter O.D. (in)	0.066		0.079	
Lumen I.D. (in)	0.047		0.056	
Braiding	Hub to tip		Hub to tip	
Dye flow rate at:	600 psi	1200 psi	600 psi	1200 psi
(mL/sec)	19	27	28	40

CORONARY DIAGNOSTIC CATHETERS

DxTerity™
Standard Curve Selection

LEFT CURVES

Judkins Left

Available in: 3.5, 4.0, 4.5, 5.0, 6.0



Amplatz Left

Available in: 1.0, 2.0, 3.0



RIGHT CURVES

Judkins Right

Available in: 3.5, 4.0, 4.0 ST, 4.0 MOD, 5.0, 6.0

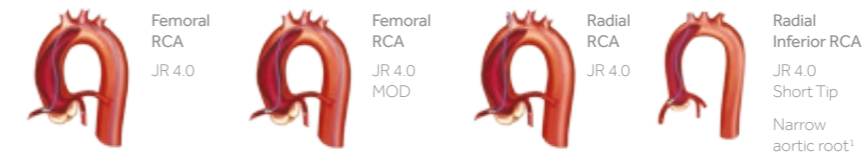

3DRC

One size

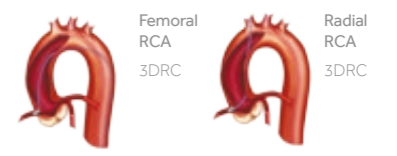

Amplatz Right

Available in: 1.0, 2.0, MOD

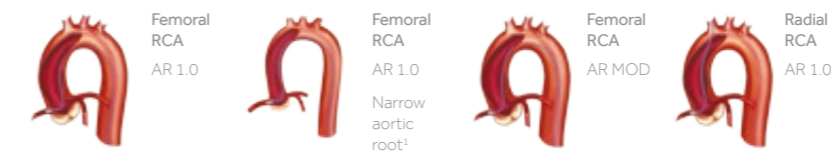

NOTO

One size

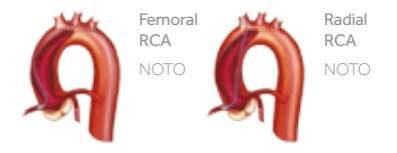

MULTIPURPOSE CURVES

MPA

One size fits all



MPB

One size fits all



Normal anatomy is shown unless otherwise indicated.

1. In porcine models. Based on preclinical data on file at Medtronic.

1. Based on bench test data comparing leading competitors. Bench test data may not be indicative of clinical performance.

CORONARY DIAGNOSTIC CATHETERS

DxTerity™
Standard Curve Selection

BYPASS CURVES

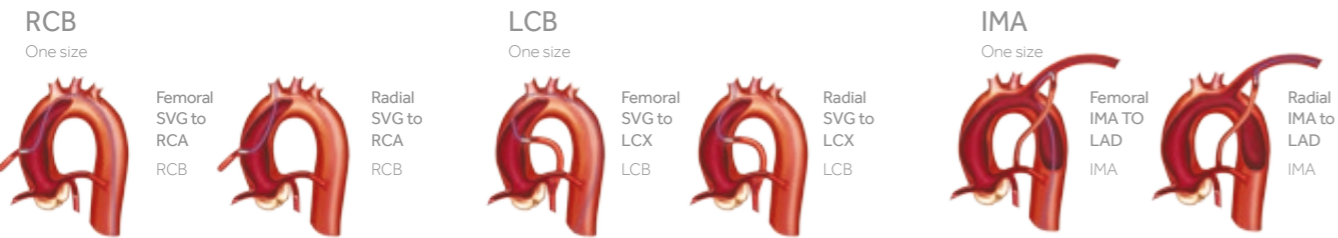

PIGTAIL CURVES

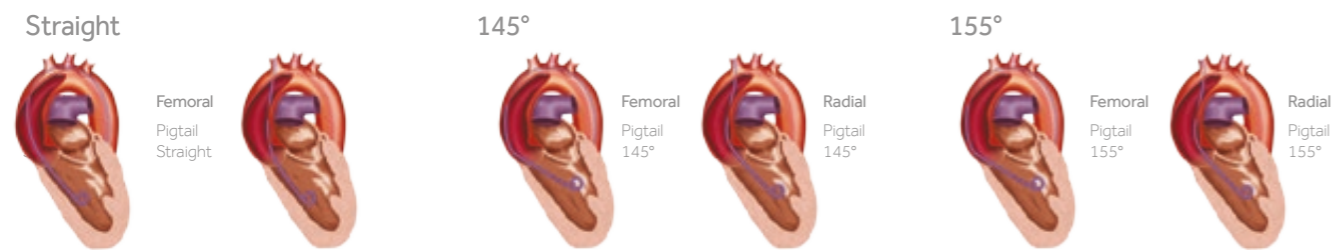

CORONARY DIAGNOSTIC CATHETERS

DxTerity™
Universal Radial Curve Selection

UNIVERSAL RADIAL CURVES

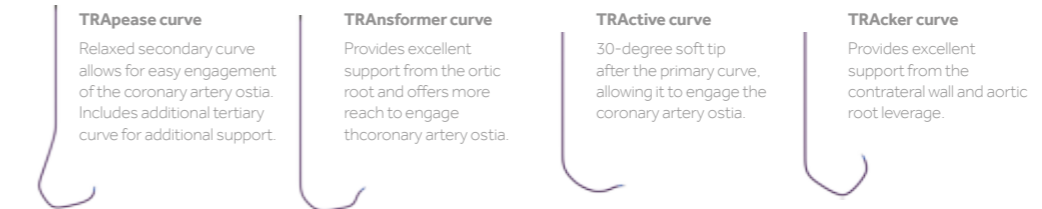

TRapease Curve

Available in: 3.5, 4.0, 4.5



TRAnformer Curve

Available in: 3.5, 4.0, 4.5

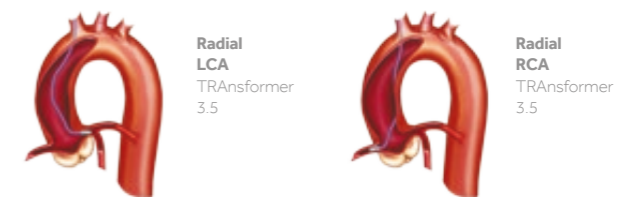

TRActive Curve

One size fits all

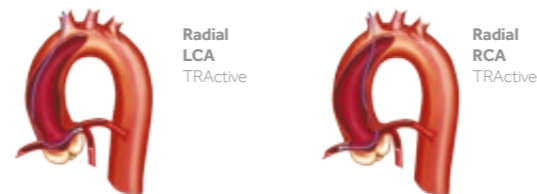

TRAcke Curve

One size fits all



1. Normal aortic root, 3.5–4.0 cm; narrow aortic root, <3.5 cm; dilated aortic root > 4.0 cm.

CORONARY DIAGNOSTIC CATHETERS

DxTerity™ Standard Curves

GENERAL CHARACTERISTICS

- 5 catheters per box • Supplied sterile • Color-coded hub and packaging
- Maximum guidewire: 5F = 0.038"; 6 F = 0.038"

PRODUCT DESCRIPTION

Features Full-Wall Technology: a proprietary extrusion process that melts layers together to form a solid shaft. This construction process is applied from hub to tip, providing the DxTerity diagnostic catheter with superior torque and lubricity for precise manipulation and enhanced deliverability.

PRODUCT CODE

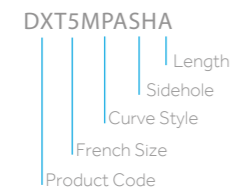

ORDERING INFORMATION

CURVE STYLE	CURVE SIZE	LENGTH (CM)	5F PRODUCT CODE	6F PRODUCT CODE	SIDEHOLES
Judkins Left	JL3.5	100	DXT5JL35	DXT6JL35	0
	JL4.0	100	DXT5JL40	DXT6JL40	0
	JL4.0	125	DXT5JL40X	DXT6JL40X	0
	JL4.5	100	DXT5JL45	DXT6JL45	0
	JL4.5	125	DXT5JL45X	DXT6JL45X	0
	JL5.0	100	DXT5JL50	DXT6JL50	0
Judkins Right	JL5.0	125	DXT5JL50X	DXT6JL50X	0
	JL6.0	100	DXT5JL60	DXT6JL60	0
	JR3.5	100	DXT5JR35	DXT6JR35	0
	JR3.5	125	DXT5JR35X	DXT6JR35X	0
	JR4.0	100	DXT5JR40	DXT6JR40	0
	JR4.0	125	DXT5JR40X	DXT6JR40X	0
Amplatz Left	JR4.0 MOD	100	DXT5JR4M	DXT6JR4M	0
	JR4.0 ST	100	DXT5JR4ST	DXT6JR4ST	0
	JR5.0	100	DXT5JR50	DXT6JR50	0
	JR5.0	125	DXT5JR50X	DXT6JR50X	0
	JR6.0	100	DXT5JR60	DXT6JR60	0
	Amplatz Right	AL1.0	100	DXT5AL10	DXT6AL10
AL2.0		100	DXT5AL20	DXT6AL20	0
AL3.0		100	DXT5AL30	DXT6AL30	0
Multipurpose	AR1.0	100	DXT5AR10	DXT6AR10	0
	AR2.0	100	DXT5AR20	DXT6AR20	0
	AR MOD	100	DXT5ARM	DXT6ARM	0
Specialty	MPA	100	DXT5MPA	DXT6MPA	0
	MPA	110	DXT5MPAA	DXT6MPAA	0
	MPA	100	DXT5MPASH	DXT6MPASH	2
	MPA	110	DXT5MPASHA	DXT6MPASHA	2
	MPB	100	DXT5MPB	DXT6MPB	0
	MPB	110	DXT5MPBA	DXT6MPBA	0
Pigtails	MPB	100	DXT5MPBSH	DXT6MPBSH	2
	MPB	110	DXT5MPBSHA	DXT6MPBSHA	2
	NOTO	100	DXT5NOTO	DXT6NOTO	0
	3DRC	100	DXT53DRC	DXT63DRC	0
	RCB	100	DXT5RCB	DXT6RCB	0
	LCB	100	DXT5LCB	DXT6LCB	0
Pigtails	IMA	100	DXT5IMA	DXT6IMA	0
	PIG STR	110CM	DXT5PIGSTA	DXT6PIGSTA	6
	PIG STR	125CM	DXT5PIGSTX	DXT6PIGSTX	6
	PIG 145	110CM	DXT5PIG45A	DXT6PIG45A	6
	PIG 155	110CM	DXT5PIG55A	DXT6PIG55A	6

CORONARY DIAGNOSTIC CATHETERS

Packaging options for DxTerity™ Angio-kits Standard curve

GENERAL CHARACTERISTICS

- 5 catheters per box • Supplied sterile • Maximum guidewire: 5F = 0.038"; 6 F = 0.038"

PRODUCT DESCRIPTION

Angio-kit contains:

- One Judkins Left 4.0 catheter (JL4.0)
- One Judkins Right 4.0 catheter (JR 4.0)
- One Straight or Angled Pigtail catheter

ORDERING INFORMATION

PRODUCT CODE	CURVES	LENGTH (CM)	SIZE
AKSTAN501	Judkins Left 4.0	100	5F
	Judkins Right 4.0	100	5F
	Straight Pigtail	110	5F
AKSTAN502	Judkins Left 4.0	100	5F
	Judkins Right 4.0	100	5F
	145 Pigtail	110	5F
AKSTAN601	Judkins Left 4.0	100	6F
	Judkins Right 4.0	100	6F
	Straight Pigtail	110	6F
AKSTAN602	Judkins Left 4.0	100	6F
	Judkins Right 4.0	100	6F
	145 Pigtail	110	6F

CORONARY DIAGNOSTIC CATHETERS

DxTerity™ Universal Radial Curves

GENERAL CHARACTERISTICS

• 5 catheters per box • Supplied sterile • Color-coded hub and packaging • Maximum guidewire: 5F = 0.038"; 6 F = 0.038"

PRODUCT DESCRIPTION

Features Full-Wall Technology: a proprietary extrusion process that melts layers together to form a solid shaft. This construction process is applied from hub to tip, providing the DxTerity diagnostic catheter with superior torque and lubricity for precise manipulation and enhanced deliverability.

DxTerity™ TRA diagnostic catheters are specifically adapted for radial use, offering four universal radial curve shapes to engage both coronaries without catheter exchange.

PRODUCT CODE

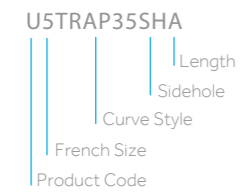

ORDERING INFORMATION

CURVE STYLE	CURVE SIZE	LENGTH (CM)	5F PRODUCT CODE	6F PRODUCT CODE	SIDEHOLES
TRapease	TRAP 3.5	100	U5TRAP35	U6TRAP35	0
	TRAP 3.5	100	U5TRAP35SH	U6TRAP35SH	2
	TRAP 3.5	110	U5TRAP35SHA	U6TRAP35SHA	2
	TRAP 4.0	100	U5TRAP40	U6TRAP40	0
	TRAP 4.0	100	U5TRAP40SH	U6TRAP40SH	2
	TRAP 4.0	110	U5TRAP40SHA	U6TRAP40SHA	2
	TRAP 4.5	100	U5TRAP45	U6TRAP45	0
	TRAP 4.5	100	U5TRAP45SH	U6TRAP45SH	2
	TRAP 4.5	110	U5TRAP45SHA	U6TRAP45SHA	2
	TRAnformer	TRAN 3.5	100	U5TRAN35	U6TRAN35
TRAN 3.5		100	U5TRAN35SH	U6TRAN35SH	2
TRAN 3.5		110	U5TRAN35SHA	U6TRAN35SHA	2
TRAN 4.0		100	U5TRAN40	U6TRAN40	0
TRAN 4.0		100	U5TRAN40SH	U6TRAN40SH	2
TRAN 4.0		110	U5TRAN40SHA	U6TRAN40SHA	2
TRAN 4.5		100	U5TRAN45	U6TRAN45	0
TRAN 4.5		100	U5TRAN45SH	U6TRAN45SH	2
TRAN 4.5		110	U5TRAN45SHA	U6TRAN45SHA	2
TRAcker		TRACK	100	U5TRACK	U6TRACK
	TRACK	100	U5TRACKSH	U6TRACKSH	2
	TRACK	110	U5TRACKSHA	U6TRACKSHA	2
TRActive	TRACT	100	U5TRACT	U6TRACT	0
	TRACT	100	U5TRACTSH	U6TRACTSH	2
	TRACT	110	U5TRACTSHA	U6TRACTSHA	2

CORONARY DIAGNOSTIC CATHETERS

Packaging options for DxTerity™ Angio-kits Universal Radial Curves

GENERAL CHARACTERISTICS

• 5 catheters per box • Supplied sterile • Maximum guidewire: 5F = 0.038"; 6 F = 0.038"

PRODUCT DESCRIPTION

Angio-kit contains:

- One Universal Radial Curve with sideholes (TRAP4.0 o TRAN3.5)
- One Straight or Angled Pigtail catheter

ORDERING INFORMATION

PRODUCT CODE	CURVES	LENGTH (CM)	SIZE
AKUNIV501	TRapease 4.0 SH	100	5F
	Straight Pigtail	110	5F
AKUNIV502	TRapease 4.0 SH	100	5F
	145 Pigtail	110	5F
AKUNIV503	TRAnformer 3.5 SH	100	5F
	Straight Pigtail	110	5F
AKUNIV504	TRAnformer 3.5 SH	100	5F
	145 Pigtail	110	5F
AKUNIV601	TRapease 4.0 SH	100	6F
	Straight Pigtail	110	6F
AKUNIV602	TRapease 4.0 SH	100	6F
	145 Pigtail	110	6F
AKUNIV603	TRAnformer 3.5 SH	100	6F
	Straight Pigtail	110	6F
AKUNIV604	TRAnformer 3.5 SH	100	6F
	145 Pigtail	110	6F

ANGIOGRAPHIC CATHETERS

Sones™ Woven Coronary Catheters Curve Style A Standard

GENERAL CHARACTERISTICS

- Supplied sterile • Maximum guidewire: 7F, 7.5F and 8F standard: 0.035" 7F and 8 F Hi-Flow: 0.038"
- Items per box: 10

PRODUCT DESCRIPTION

The Sones™ coronary catheter was developed with F. Mason Sones, MD, to meet the evolving clinical needs of the brachial angiographer.

Two Unique Design Features:

- The woven core provides excellent torque control.
- The tapered tip easily adapts to anatomical variations.

Medtronic supplies a variety of catheter constructions and curve style tips as illustrated.

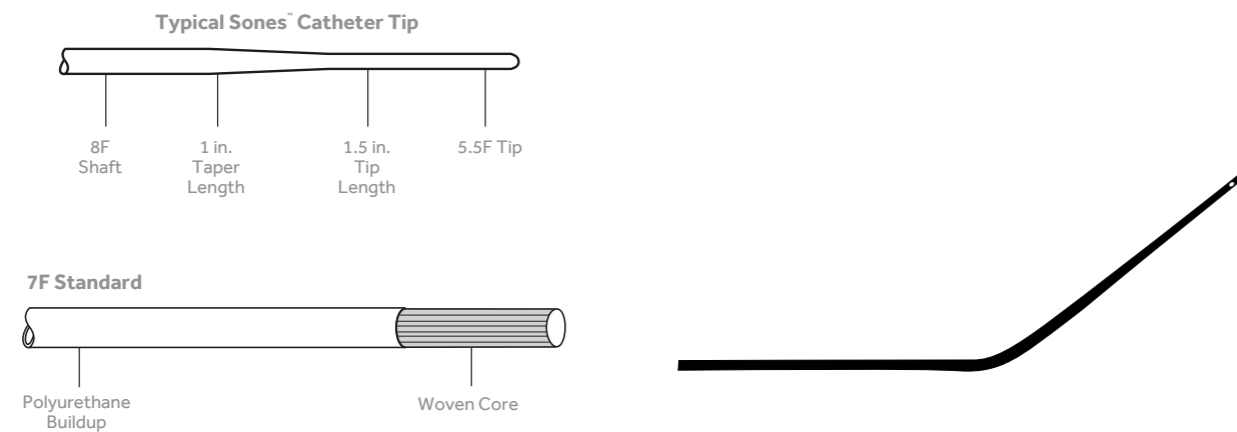

CURVE STYLE A STANDARD

PRODUCT CODE	FRENCH SIZE	LENGTH (CM)	TIP LENGTH (IN.)	MINIMUM TIP I.D. (IN.)	COMMENTS
007764	7	80	1.5	0.036	Extra stiffness—tip & shaft
007536	7	100	1.5	0.036	

ANGIOGRAPHIC CATHETERS

Sones™ Woven Coronary Catheters Curve Style A Hi-Flow

GENERAL CHARACTERISTICS

- Supplied sterile • Maximum guidewire: 7F, 7.5F & 8F Standard: 0.035"; 7F & 8F Hi-Flow: 0.038"
- Items per box: 10 • All tips taper to 5.5F

PRODUCT DESCRIPTION

The Sones™ coronary catheter was developed with F. Mason Sones, MD, to meet the evolving clinical needs of the brachial angiographer.

Two Unique Design Features:

- The woven core provides excellent torque control.
- The tapered tip easily adapts to anatomical variations.

Medtronic supplies a variety of catheter constructions and curve style tips as illustrated.

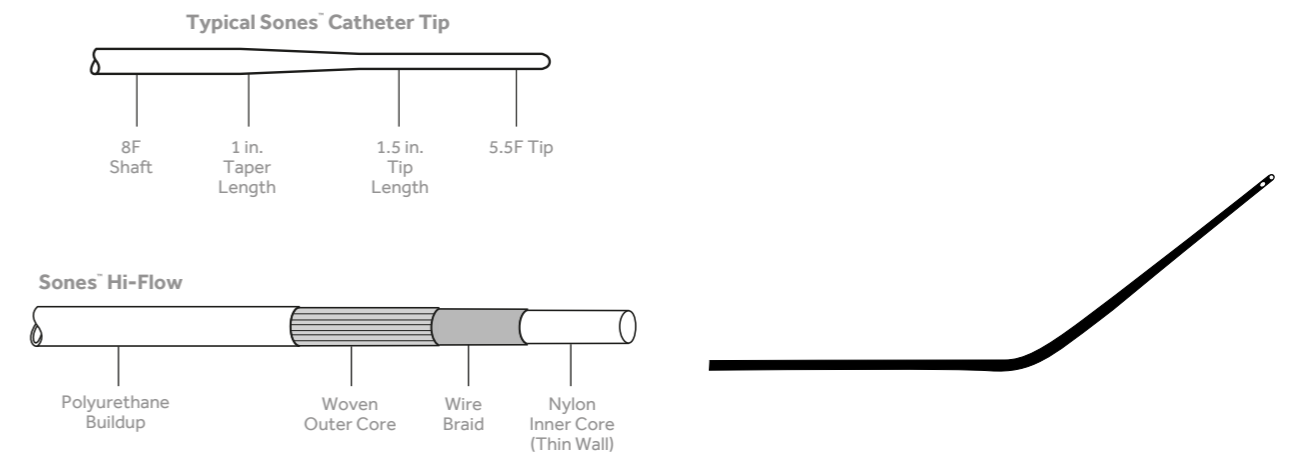

CURVE STYLE A HI-FLOW

PRODUCT CODE	FRENCH SIZE	LENGTH (CM)	TIP LENGTH (IN.)	MINIMUM TIP I.D. (IN.)	COMMENTS
008976	7	80	1.5	0.040	
008977	7	100	1.5	0.040	
008718	8	80	1.5	0.040	
008971	8	100	1.5	0.040	

ANGIOGRAPHIC CATHETERS

Sones™ Woven Coronary Catheters Curve Style A Standard Nylon Core

GENERAL CHARACTERISTICS

- Supplied sterile. • Maximum guidewire: 7F, 7.5F & 8F Standard: 0.035"; 7F & 8F Hi-Flow: 0.038"
- Items per box: 10 • All tips taper to 5.5F

PRODUCT DESCRIPTION

The Sones™ coronary catheter was developed with F. Mason Sones, MD, to meet the evolving clinical needs of the brachial angiographer.

Two Unique Design Features:

- The woven core provides excellent torque control.
- The tapered tip easily adapts to anatomical variations.

Medtronic supplies a variety of catheter constructions and curve style tips as illustrated.

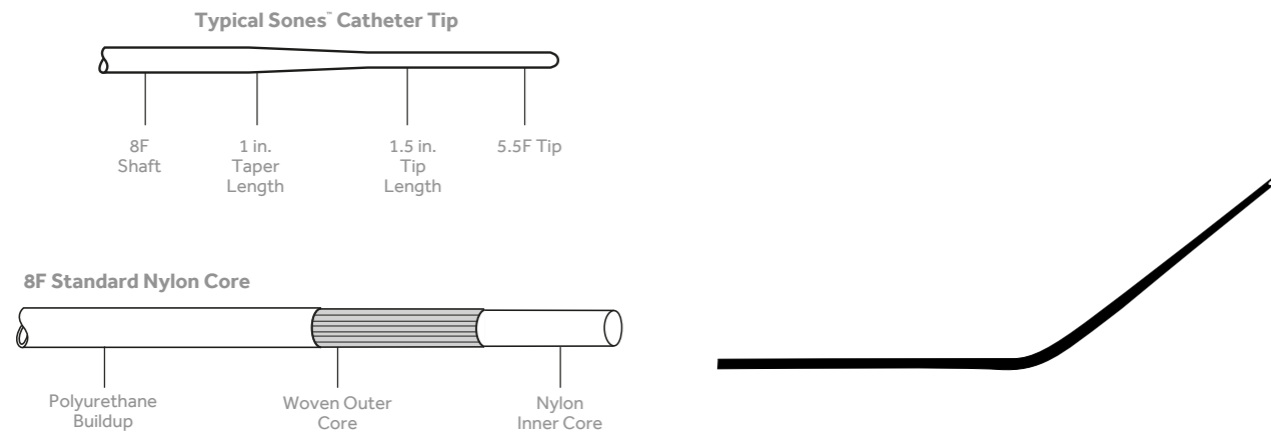

CURVE STYLE A STANDARD NYLON CORE

PRODUCT CODE	FRENCH SIZE	LENGTH (CM)	TIP LENGTH (IN.)	MINIMUM TIP I.D. (IN.)	COMMENTS
007538	8	80	1.5	0.036	
007539	8	100	1.5	0.036	
007766	8	80	1.5	0.036	Extra stiffness—tip & shaft
007540	8	125	1.5	0.036	

ANGIOGRAPHIC CATHETERS

Sones™ Woven Coronary Catheters Curve Style A Positrol™ Nylon Core

GENERAL CHARACTERISTICS

- Supplied sterile. • Maximum guidewire: 7F, 7.5F & 8F Standard: 0.035"; 7F & 8F Hi-Flow: 0.038"
- Items per box: 10 • All tips taper to 5.5F

PRODUCT DESCRIPTION

The Sones™ coronary catheter was developed with F. Mason Sones, MD, to meet the evolving clinical needs of the brachial angiographer.

Two Unique Design Features:

- The woven core provides excellent torque control.
- The tapered tip easily adapts to anatomical variations.

Medtronic supplies a variety of catheter constructions and curve style tips as illustrated.

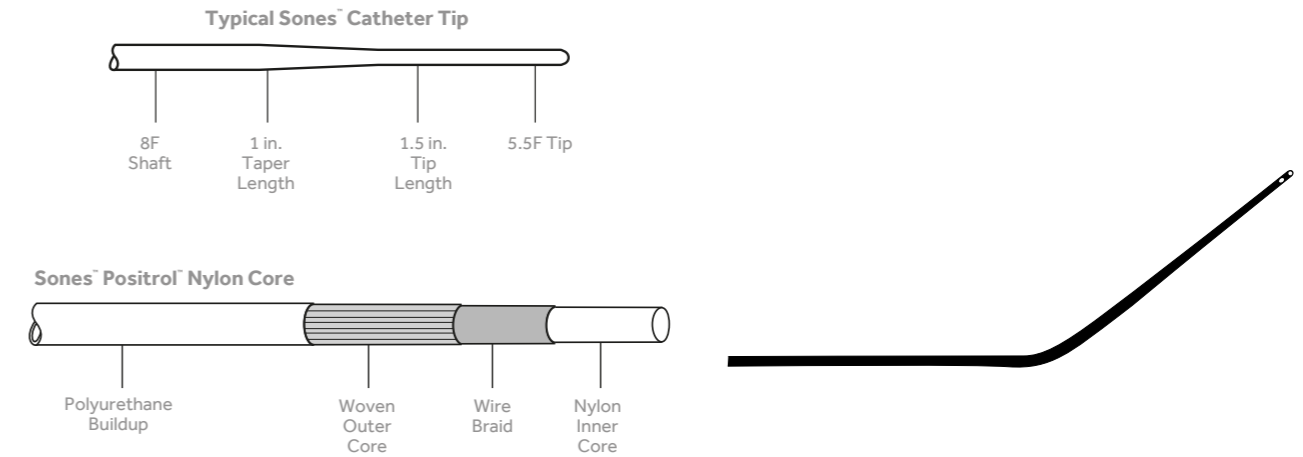

CURVE STYLE A POSITROL™ NYLON CORE

PRODUCT CODE	FRENCH SIZE	LENGTH (CM)	TIP LENGTH (IN.)	MINIMUM TIP I.D. (IN.)	COMMENTS
008541	7.5	100	1.5	0.036	Extra stiffness—shaft

ANGIOGRAPHIC CATHETERS

Sones™ Woven Coronary Catheters Curve Style B Standard

GENERAL CHARACTERISTICS

- Supplied sterile. • Maximum guidewire: 7F, 7.5F & 8F Standard: 0.035"; 7F & 8F Hi-Flow: 0.038"
- Items per box: 10 • All tips taper to 5.5F

PRODUCT DESCRIPTION

The Sones™ coronary catheter was developed with F. Mason Sones, MD, to meet the evolving clinical needs of the brachial angiographer.

Two Unique Design Features:

- The woven core provides excellent torque control.
- The tapered tip easily adapts to anatomical variations.

Medtronic supplies a variety of catheter constructions and curve style tips as illustrated.

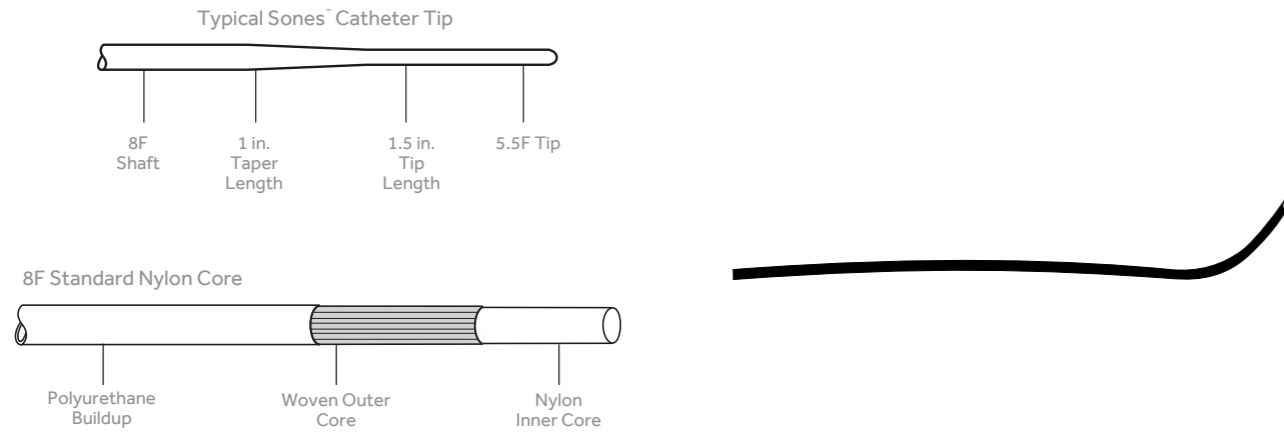

CURVE STYLE B STANDARD

PRODUCT CODE	FRENCH SIZE	LENGTH (CM)	TIP LENGTH (IN.)	MINIMUM TIP I.D. (IN.)	COMMENTS
007548	7	100	1.5	0.036	

ANGIOGRAPHIC CATHETERS

Sones™ Woven Coronary Catheters Curve Style B Hi-Flow

GENERAL CHARACTERISTICS

- Supplied sterile. • Maximum guidewire: 7F, 7.5F & 8F Standard: 0.035"; 7F & 8F Hi-Flow: 0.038"
- Items per box: 10 • All tips taper to 5.5F

PRODUCT DESCRIPTION

The Sones™ coronary catheter was developed with F. Mason Sones, MD, to meet the evolving clinical needs of the brachial angiographer.

Two Unique Design Features:

- The woven core provides excellent torque control.
- The tapered tip easily adapts to anatomical variations.

Medtronic supplies a variety of catheter constructions and curve style tips as illustrated.

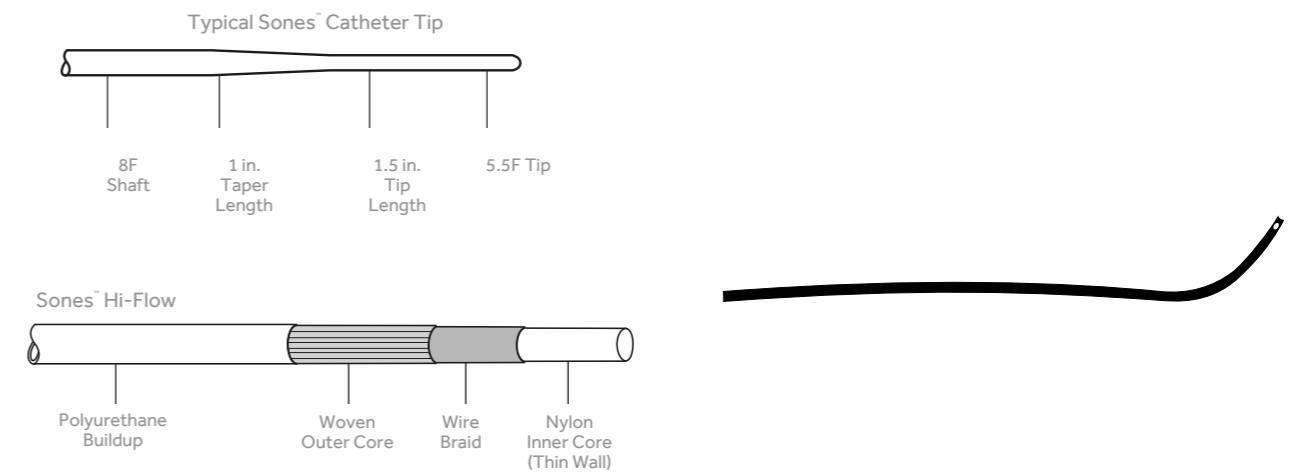

CURVE STYLE B HI-FLOW

PRODUCT CODE	FRENCH SIZE	LENGTH (CM)	TIP LENGTH (IN.)	MINIMUM TIP I.D. (IN.)	COMMENTS
008978	7	80	1.5	0.040	
008979	7	100	1.5	0.040	
008719	8	80	1.5	0.040	

ANGIOGRAPHIC CATHETERS

Sones™ Woven Coronary Catheters Curve Style B Standard Nylon Core

GENERAL CHARACTERISTICS

- Supplied sterile. • Maximum guidewire: 7F, 7.5F & 8F Standard: 0.035"; 7F & 8F Hi-Flow: 0.038"
- Items per box: 10 • All tips taper to 5.5F

PRODUCT DESCRIPTION

The Sones™ coronary catheter was developed with F. Mason Sones, MD, to meet the evolving clinical needs of the brachial angiographer.

Two Unique Design Features:

- The woven core provides excellent torque control.
- The tapered tip easily adapts to anatomical variations.

Medtronic supplies a variety of catheter constructions and curve style tips as illustrated.

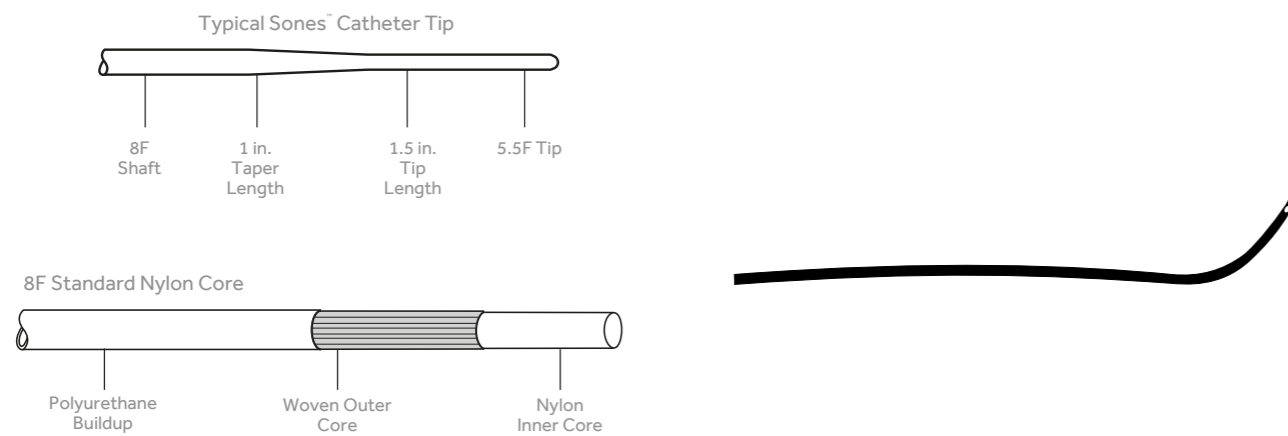

CURVE STYLE B STANDARD NYLON CORE

PRODUCT CODE	FRENCH SIZE	LENGTH (CM)	TIP LENGTH (IN.)	MINIMUM TIP I.D. (IN.)	COMMENTS
007550	8	80	1.5	0.036	
007551	8	100	1.5	0.036	

ANGIOGRAPHIC CATHETERS

Sones™ Woven Coronary Catheters Curve Style B Positrol™ Woven Core

GENERAL CHARACTERISTICS

- Supplied sterile. • Maximum guidewire: 7F, 7.5F & 8F Standard: 0.035"; 7F & 8F Hi-Flow: 0.038"
- Items per box: 10 • All tips taper to 5.5F

PRODUCT DESCRIPTION

The Sones™ coronary catheter was developed with F. Mason Sones, MD, to meet the evolving clinical needs of the brachial angiographer.

Two Unique Design Features:

- The woven core provides excellent torque control.
- The tapered tip easily adapts to anatomical variations.

Medtronic supplies a variety of catheter constructions and curve style tips as illustrated.

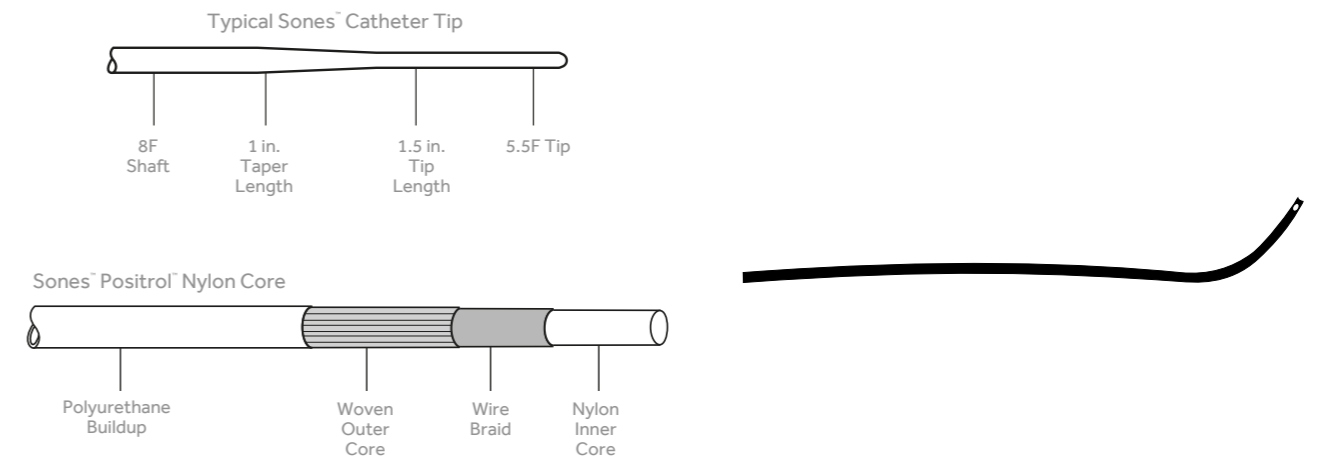

CURVE STYLE B POSITROL™ WOVEN CORE

PRODUCT CODE	FRENCH SIZE	LENGTH (CM)	TIP LENGTH (IN.)	MINIMUM TIP I.D. (IN.)	COMMENTS
007561	7.5	80	1.5	0.036	Wire-reinforced
007562	7.5	100	1.5	0.036	Wire-reinforced

ANGIOGRAPHIC CATHETERS

Sones™ Woven Coronary Catheters Curve Style B Positrol™ Nylon Core

GENERAL CHARACTERISTICS

- Supplied sterile. • Maximum guidewire: 7F, 7.5F & 8F Standard: 0.035"; 7F & 8F Hi-Flow: 0.038"
- Items per box: 10 • All tips taper to 5.5F

PRODUCT DESCRIPTION

The Sones™ coronary catheter was developed with F. Mason Sones, MD, to meet the evolving clinical needs of the brachial angiographer.

Two Unique Design Features:

- The woven core provides excellent torque control.
- The tapered tip easily adapts to anatomical variations.

Medtronic supplies a variety of catheter constructions and curve style tips as illustrated.

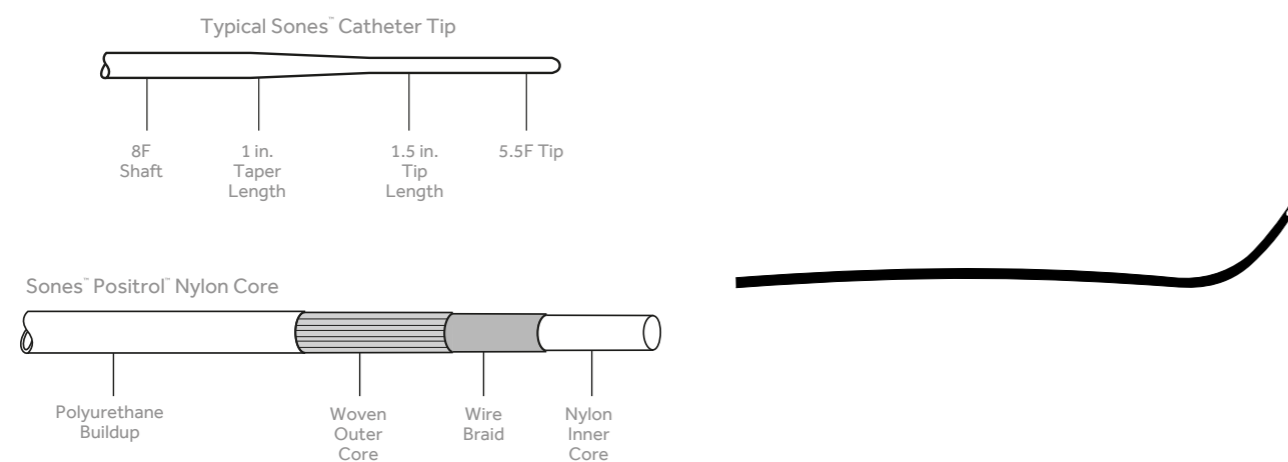

CURVE STYLE B POSITROL™ NYLON CORE

PRODUCT CODE	FRENCH SIZE	LENGTH (CM)	TIP LENGTH (IN.)	MINIMUM TIP I.D. (IN.)	COMMENTS
008554	7.5	100	1.5	0.036	Extra stiffness—shaft

ANGIOGRAPHIC CATHETERS

Sones™ Woven Coronary Catheters Curve Style C Hi-Flow

GENERAL CHARACTERISTICS

- Supplied sterile. • Maximum guidewire: 7F, 7.5F & 8F Standard: 0.035"; 7F & 8F Hi-Flow: 0.038"
- Items per box: 10 • All tips taper to 5.5F

PRODUCT DESCRIPTION

The Sones™ coronary catheter was developed with F. Mason Sones, MD, to meet the evolving clinical needs of the brachial angiographer.

Two Unique Design Features:

- The woven core provides excellent torque control.
- The tapered tip easily adapts to anatomical variations.

Medtronic supplies a variety of catheter constructions and curve style tips as illustrated.

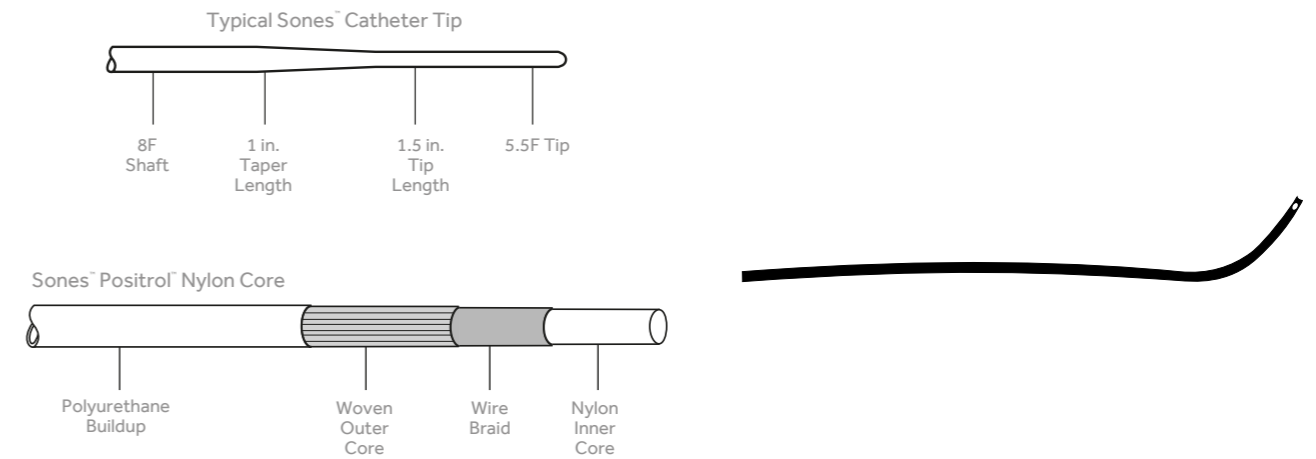

CURVE STYLE C HI-FLOW

PRODUCT CODE	FRENCH SIZE	LENGTH (CM)	TIP LENGTH (IN.)	MINIMUM TIP I.D. (IN.)	COMMENTS
008980	7	80	1.5	0.040	
008981	7	100	1.5	0.040	
008720	8	80	1.5	0.040	

ANGIOGRAPHIC CATHETERS

Sones™ Woven Coronary Catheters Curve Style C Positrol™ Nylon Core

GENERAL CHARACTERISTICS

- Supplied sterile. • Maximum guidewire: 7F, 7.5F & 8F Standard: 0.035"; 7F & 8F Hi-Flow: 0.038"
- Items per box: 10 • All tips taper to 5.5F

PRODUCT DESCRIPTION

The Sones™ coronary catheter was developed with F. Mason Sones, MD, to meet the evolving clinical needs of the brachial angiographer.

Two Unique Design Features:

- The woven core provides excellent torque control.
- The tapered tip easily adapts to anatomical variations.

Medtronic supplies a variety of catheter constructions and curve style tips as illustrated.

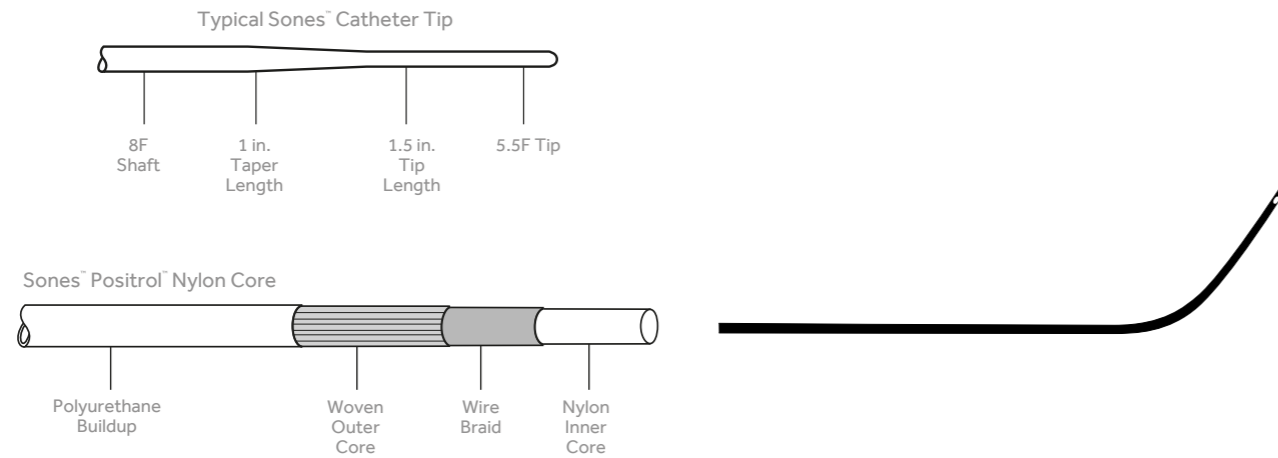

CURVE STYLE C POSITROL™ NYLON CORE

PRODUCT CODE	FRENCH SIZE	LENGTH (CM)	TIP LENGTH (IN.)	MINIMUM TIP I.D. (IN.)	COMMENTS
008538	7.5	80	1.5	0.036	
008539	7.5	100	1.5	0.036	
008356	8	80	1.5	0.036	Standard nylon core

ANGIOGRAPHIC CATHETERS

Sones™ Woven Coronary Catheters Brachial LTX-S

GENERAL CHARACTERISTICS

- Supplied sterile. • Maximum guidewire: 7F, 7.5F & 8F Standard: 0.035"; 7F & 8F Hi-Flow: 0.038"
- Items per box: 10 • All tips taper to 5.5F

PRODUCT DESCRIPTION

The Sones™ coronary catheter was developed with F. Mason Sones, MD, to meet the evolving clinical needs of the brachial angiographer.

Two Unique Design Features:

- The woven core provides excellent torque control.
- The tapered tip easily adapts to anatomical variations.

Medtronic supplies a variety of catheter constructions and curve style tips as illustrated.

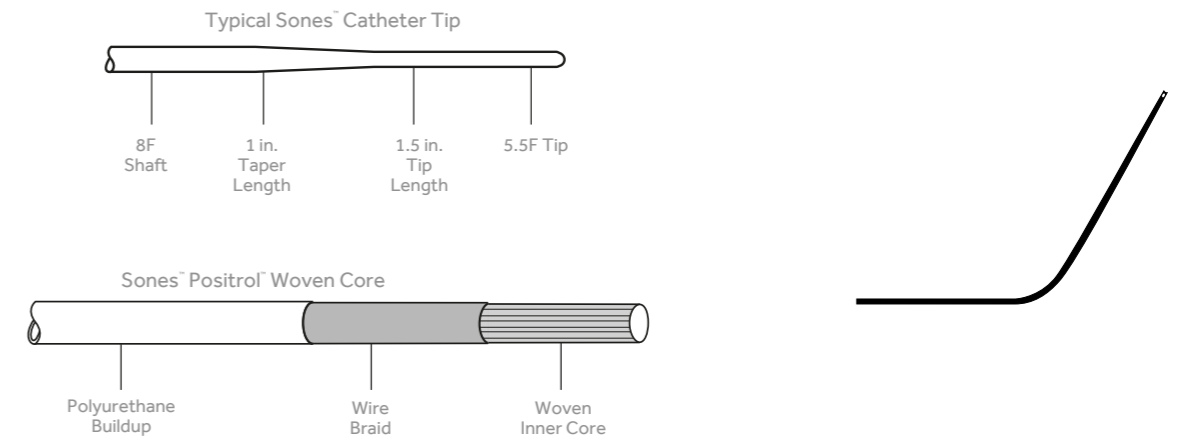

BRACHIAL LTX-S

PRODUCT CODE	FRENCH SIZE	LENGTH (CM)	TIP LENGTH (IN.)	MINIMUM TIP I.D. (IN.)	COMMENTS
007770	8	80	Long tip	0.036	
007771	8	100	Long tip	0.036	

ANGIOGRAPHIC CATHETERS

Sones™ Woven Coronary Catheters Standard Nylon Core

GENERAL CHARACTERISTICS

- Supplied sterile. • Maximum guidewire: 7F, 7.5F & 8F Standard: 0.035"; 7F & 8F Hi-Flow: 0.038"
- Items per box: 10 • All tips taper to 5.5F

PRODUCT DESCRIPTION

The Sones™ coronary catheter was developed with F. Mason Sones, MD, to meet the evolving clinical needs of the brachial angiographer.

Two Unique Design Features:

- The woven core provides excellent torque control.
- The tapered tip easily adapts to anatomical variations.

Medtronic supplies a variety of catheter constructions and curve style tips as illustrated.

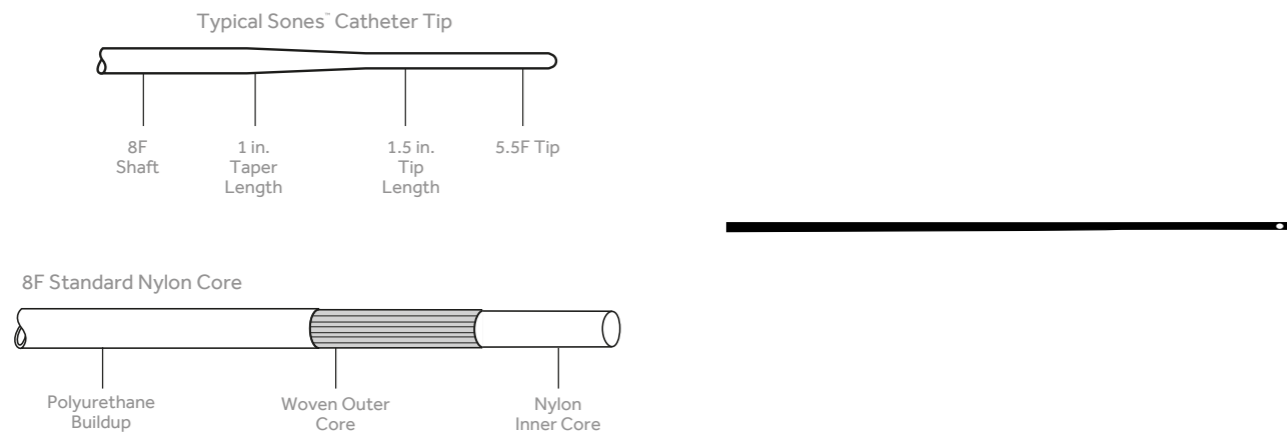

STANDARD NYLON CORE

PRODUCT CODE	FRENCH SIZE	LENGTH (CM)	TIP LENGTH (IN.)	MINIMUM TIP I.D. (IN.)	COMMENTS
008358	8	80	1.5	0.036	Straight tip
008359	8	100	1.5	0.036	Straight tip

ANGIOGRAPHIC CATHETERS

NIH Woven Coronary catheters High-Volume

GENERAL CHARACTERISTICS

- Supplied sterile. • Items per box: 10 • Nylon core • Closed end • Six sideholes • Thin-wall construction

PRODUCT DESCRIPTION

The NIH catheter is designed with a thin wall and nylon core construction to provide maximum flow rates and catheter stability.

The flexible tip makes positioning in the cardiopulmonary system easier. This catheter is used to visualize the aorta, ventricles, pulmonary vasculature and the great veins.



NIH

PRODUCT CODE	FRENCH SIZE	DESIGN STYLE	LENGTH (CM)
001348 †	5	Thin wall	50
001353 †	6	Thin wall	80

† Pediatric item

ANGIOGRAPHIC CATHETERS

Pediatric NIH Woven Coronary catheters High-Volume

GENERAL CHARACTERISTICS

• Supplied sterile. • Items per box: 10 • Closed end • Six sideholes (4F catheter has four sideholes) • Thin-wall construction

PRODUCT DESCRIPTION

This thin-walled catheter is designed to provide maximum flow and flexibility.
The catheter can be used for aortic, ventricular, pulmonary and large-vein contrast studies.



PEDIATRIC NIH

PRODUCT CODE	FRENCH SIZE	DESIGN STYLE	SIDEHOLES	LENGTH (CM)
001375 †	4	Thin wall	4	50
001377 †	5	Thin wall	6	50
001378 †	5	Thin wall	6	80
001380 †	6	Thin wall	6	50
001381 †	6	Thin wall	6	80
001382 †	6	Thin wall	6	100

† Pediatric item

ANGIOGRAPHIC CATHETERS

Pediatric NIH with Cardio-Marker Image Bands Woven Coronary catheters High-Volume

GENERAL CHARACTERISTICS

• Supplied sterile. • Items per box: 5 • Closed end • Six sideholes • Thin-wall construction • Band width: 1mm

PRODUCT DESCRIPTION

This thin-walled catheter is designed to provide maximum flow and flexibility. The catheter can be used for aortic, ventricular, pulmonary and large-vein contrast studies.
Bandwidth: 1 mm; two marker bands 1 cm apart \pm 0.5 mm (leading edge to leading edge)



PEDIATRIC NIH WITH CARDIO-MARKER IMAGE BANDS

PRODUCT CODE	FRENCH SIZE	DESIGN STYLE	LENGTH (CM)
010010 †	5	Thin wall	010010 - 65
010011 †	6	Thin wall	010011 - 80
010012 †	7	Thin wall	010012 - 80

† Pediatric item

ANGIOGRAPHIC CATHETERS

Pediatric Curved NIH Woven Coronary catheters High-Volume

GENERAL CHARACTERISTICS

• Supplied sterile. • Items per box: 10 • Closed end • Six sideholes • Thin-wall construction

PRODUCT DESCRIPTION

This thin-walled catheter is designed to provide maximum flow and flexibility. The catheter can be used for aortic, ventricular, pulmonary and large-vein contrast studies.



PEDIATRIC CURVED NIH

PRODUCT CODE	FRENCH SIZE	DESIGN STYLE	LENGTH (CM)
008761 †	5	Thin wall	65
008762 †	6	Thin wall	65
008763 †	7	Thin wall	80

† Pediatric item

ANGIOGRAPHIC CATHETERS

Lehman™ Ventriculography Woven Coronary catheters High-Volume

GENERAL CHARACTERISTICS

• Supplied sterile. • Items per box: 10 • Closed end • Four sideholes • Thin-wall construction

PRODUCT DESCRIPTION

J.S. Lehman, MD, developed the Lehman™ ventriculography catheter. This catheter is specifically designed to be placed easily into the left ventricle via the aorta. The flexible, tapered distal tip is slightly curved to assist passage through the aortic valve and to sit freely in the contour of the left ventricle.

The location of the four sideholes enables the angiographer to record proximal aortic pressures without removing the tip from the aortic valve. This catheter provides excellent flow rates and catheter stability due to its thin-wall construction.



LEHMAN™ VENTRICULOGRAPHY

PRODUCT CODE	FRENCH SIZE	DESIGN STYLE	LENGTH (CM)	COMMENTS
001415	7	Thin wall	100	Closed end

ANGIOGRAPHIC CATHETERS

Gensini™ Catheter Woven Coronary Catheters High-Volume

GENERAL CHARACTERISTICS

• Supplied sterile. • Items per box: 10 • Open end • Six sideholes • Thin-wall construction

PRODUCT DESCRIPTION

Goffredo G. Gensini, MD, is responsible for the first designed catheter with an open end hole. This catheter has a tapered tip that fits securely over a guidewire for percutaneous introduction.

The six sideholes and thin-wall construction provide maximum flow rates. The catheter is used for aortic, ventricular, pulmonary, and large-venous contrast studies.



GENSINI™ PERCUTANEOUS

PRODUCT CODE	FRENCH SIZE	DESIGN STYLE	MINIMUM TIP I.D. (IN.)	LENGTH (CM)	COMMENTS
001323 †	5	Thin wall	0.026	100	Use with 0.025 in. guidewire
001339 †	6	Thin wall	0.036	80	Use with 0.035 in. guidewire
† Pediatric item					

ANGIOGRAPHIC CATHETERS

Gensini™ Catheter Woven Coronary catheters General Purpose and Transvalvular

GENERAL CHARACTERISTICS

• Supplied sterile. • Items per box: 10 • Open end • No sideholes • Standard wall construction

PRODUCT DESCRIPTION

Designed by Andre Cournand, MD, in 1939, the Cournand™ Catheter was the first to be manufactured specifically for use in the heart. The gradually curved tip facilitates easy access to the right heart. The Cournand™ catheter is used for blood sampling and pressure measurements.

The general construction of these catheters consists of a woven outer core and a high-density polyurethane coating.



COURNAND™ CATHETER

PRODUCT CODE	FRENCH SIZE	DESIGN STYLE	MINIMUM TIP I.D. (IN.)	LENGTH (CM)
001433	6	Standard wall	0.036	100
001434	6	Standard wall	0.036	125
007455	7	Standard wall	0.046	100
007456	7	Standard wall	0.046	125

ANGIOGRAPHIC CATHETERS

Lehman™ Catheter Woven Coronary catheters General Purpose and Transvalvular

GENERAL CHARACTERISTICS

- Supplied sterile. • Items per box: 10 • Open end • No sideholes • Thin-wall construction

PRODUCT DESCRIPTION

J.S. Lehman, MD, designed a catheter for right heart studies similar to the Cournand™ catheter. However, the Lehman™ catheter has a thin-wall construction that maximizes catheter flexibility and flow rates.

The general construction of these catheters consists of a woven outer core and a high-density polyurethane coating.



LEHMAN™ CATHETER

PRODUCT CODE	FRENCH SIZE	DESIGN STYLE	MINIMUM TIP I.D. (IN.)	LENGTH (CM)
001253 †	5	Thin wall	0.032	50
001254 †	5	Thin wall	0.032	80
001263	7	Thin wall	0.055	100
001264	7	Thin wall	0.055	125

† Pediatric item

ANGIOGRAPHIC CATHETERS

Goodale-Lubin™ Catheter Woven Coronary catheters General Purpose and Transvalvular

GENERAL CHARACTERISTICS

- Supplied sterile. • Items per box: 10 • Open end • Two laterally opposed sideholes. • Thin-wall or standard-wall construction.

PRODUCT DESCRIPTION

The general construction of these catheters consists of a woven outer core and a high-density polyurethane coating.

Walter T. Goodale, MD, and Martin Lubin, MD, developed standard-wall and thin-wall catheters similar to the Cournand™ and Lehman™ catheters in construction and tip curve.

The additional feature of the Goodale-Lubin™ catheter is the two laterally opposed sideholes just proximal to the tip for improved disbursement of contrast during right heart angiography.



Thin Wall



Standard Wall

GOODALE-LUBIN™ CATHETER

PRODUCT CODE	FRENCH SIZE	DESIGN STYLE	MINIMUM TIP I.D. (IN.)	LENGTH (CM)
001279 †	5	Thin wall	0.032	80
001453 †	5	Standard wall	0.026	50
001284	6	Thin wall	0.043	100
001288	7	Thin wall	0.055	100
007459	7	Standard wall	0.046	100
007460	7	Standard wall	0.046	125

† Pediatric item

ANGIOGRAPHIC WIRES

PTFE-Coated Guidewires: Fixed Core Straight Tip

GENERAL CHARACTERISTICS

- Supplied sterile. • Packaged in coiled hoops. • Items per box: 10

PRODUCT DESCRIPTION

This design has a gradually tapered core that minimizes trauma to the vessel. Angiography guidewires come with a PTFE coating applied over the entire core, enabling free movement and a smooth sliding action.

A unique 'J' tip configuration is available on the fixed core wires. This 'J' tip can be "fingertip-straightened" from virtually any point of the wire shaft. This built-in convenience eliminates the need for a 'J' straightening tool for wire loading.

Medtronic offers a variety of tip configurations, sizes and styles. The two most common tip configurations are straight and 'J'. Medtronic guidewires are available in a range of diameters and are compatible with the minimal needle sizes noted in the table.

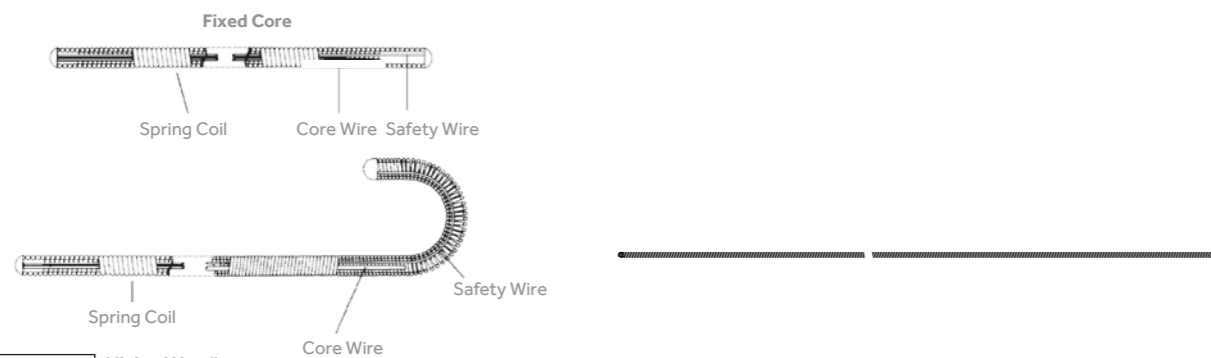

Guidewire Diameter in./mm	Minimum Needle Size	Minimal Needle Size Compatibility
0.025/0.6	19 gauge	
0.032/0.8	18 gauge	
0.035/0.9	18 gauge	
0.038/1.0	18 gauge	
0.045/1.1	16 gauge	

STRAIGHT TIP

PRODUCT CODE	SIZE IN./MM	LENGTH (CM)	COMMENTS
007468	0.035/0.9	145	Extra long taper core 15 cm
007643	0.038/1.0	145	Extra long taper core 15 cm
007467	0.035/0.9	145	Long taper core 10 cm
007642	0.038/1.0	145	Long taper core 10 cm
007641	0.025/0.6	120	Standard taper core 6 cm
010387	0.025/0.6	145	Standard taper core 6 cm
007644	0.032/0.8	120	Standard taper core 6 cm
007645	0.032/0.8	145	Standard taper core 6 cm
007045	0.035/0.9	120	Standard taper core 6 cm
007046	0.035/0.9	145	Standard taper core 6 cm
008629	0.035/0.9	175	Standard taper core 6 cm
007048	0.038/1.0	145	Standard taper core 6 cm

ANGIOGRAPHIC WIRES

PTFE-Coated Guidewires: Fixed Core 1.5-mm 'J' Tip

GENERAL CHARACTERISTICS

- Supplied sterile. • Packaged in coiled hoops. • Items per box: 10

PRODUCT DESCRIPTION

This design has a gradually tapered core that minimizes trauma to the vessel. Angiography guidewires come with a PTFE coating applied over the entire core, enabling free movement and a smooth sliding action.

A unique 'J' tip configuration is available on the fixed core wires. This 'J' tip can be "fingertip-straightened" from virtually any point of the wire shaft. This built-in convenience eliminates the need for a 'J' straightening tool for wire loading.

Medtronic offers a variety of tip configurations, sizes and styles. The two most common tip configurations are straight and 'J'. Medtronic guidewires are available in a range of diameters and are compatible with the minimal needle sizes noted in the table.

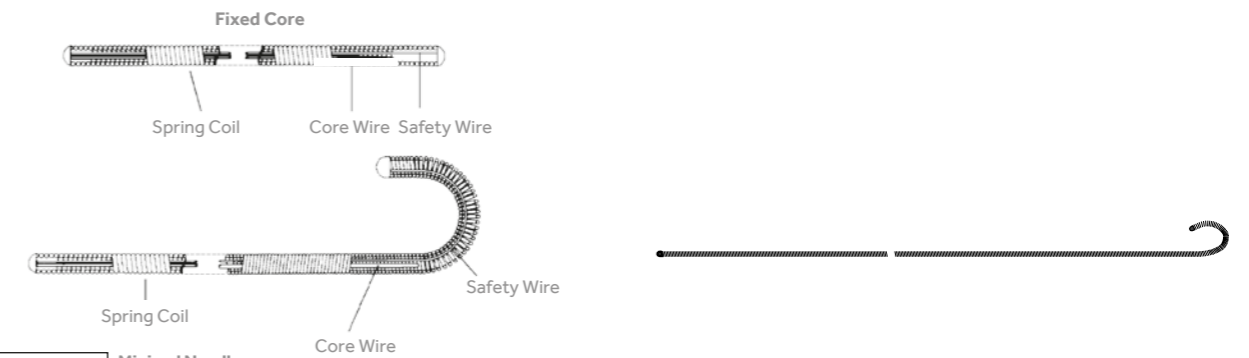

Guidewire Diameter in./mm	Minimum Needle Size	Minimal Needle Size Compatibility
0.025/0.6	19 gauge	
0.032/0.8	18 gauge	
0.035/0.9	18 gauge	
0.038/1.0	18 gauge	
0.045/1.1	16 gauge	

1.5-MM 'J' TIP

PRODUCT CODE	SIZE IN./MM	LENGTH (CM)	COMMENTS
008944	0.035/0.9	175	Rosen guidewire
008945	0.038/1.0	175	Rosen guidewire

ANGIOGRAPHIC WIRES

PTFE-Coated Guidewires: Fixed Core 3-mm 'J' Tip

GENERAL CHARACTERISTICS

- Supplied sterile. • Packaged in coiled hoops. • Items per box: 10

PRODUCT DESCRIPTION

This design has a gradually tapered core that minimizes trauma to the vessel. Angiography guidewires come with a PTFE coating applied over the entire core, enabling free movement and a smooth sliding action.

A unique 'J' tip configuration is available on the fixed core wires. This 'J' tip can be "fingertip-straightened" from virtually any point of the wire shaft. This built-in convenience eliminates the need for a 'J' straightening tool for wire loading.

Medtronic offers a variety of tip configurations, sizes and styles. The two most common tip configurations are straight and 'J'. Medtronic guidewires are available in a range of diameters and are compatible with the minimal needle sizes noted in the table.

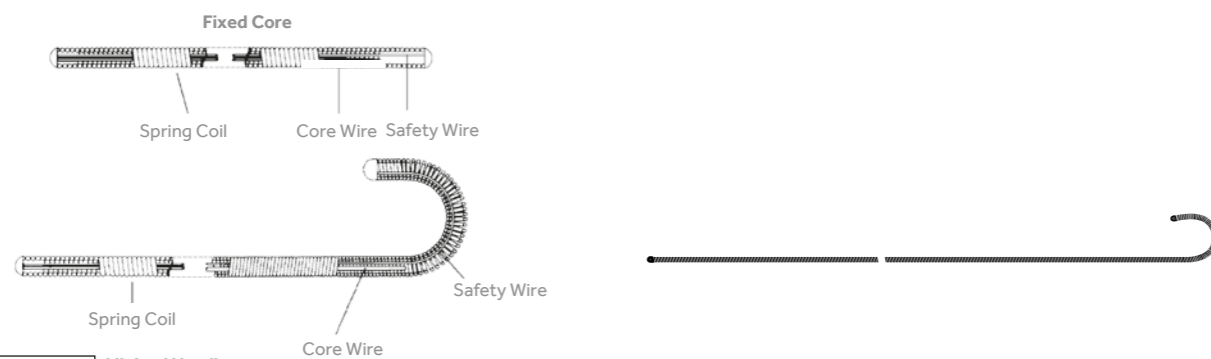

Guidewire Diameter in./mm	Minimum Needle Size	Minimal Needle Size Compatibility
0.025/0.6	19 gauge	
0.032/0.8	18 gauge	
0.035/0.9	18 gauge	
0.038/1.0	18 gauge	
0.045/1.1	16 gauge	

3-MM 'J' TIP

PRODUCT CODE	SIZE IN./MM	LENGTH (CM)	COMMENTS
010388	0.025/0.6	145	Standard taper core 6 cm
008952	0.028/0.7	145	Standard taper core 6 cm
008953	0.032/0.8	145	Standard taper core 6 cm
007041	0.035/0.9	120	Standard taper core 6 cm
007042	0.035/0.9	145	Standard taper core 6 cm
008627	0.035/0.9	175	Standard taper core 6 cm
007044	0.038/1.0	145	Standard taper core 6 cm
008628	0.038/1.0	175	Standard taper core 6 cm
010003	0.035/0.9	145	Long taper core 10 cm
010004	0.038/1.0	145	Long taper core 10 cm

ANGIOGRAPHIC WIRES

PTFE-Coated Guidewires: Fixed Core 6-mm 'J' Tip

GENERAL CHARACTERISTICS

- Supplied sterile. • Packaged in coiled hoops. • Items per box: 10

PRODUCT DESCRIPTION

This design has a gradually tapered core that minimizes trauma to the vessel. Angiography guidewires come with a PTFE coating applied over the entire core, enabling free movement and a smooth sliding action.

A unique 'J' tip configuration is available on the fixed core wires. This 'J' tip can be "fingertip-straightened" from virtually any point of the wire shaft. This built-in convenience eliminates the need for a 'J' straightening tool for wire loading.

Medtronic offers a variety of tip configurations, sizes and styles. The two most common tip configurations are straight and 'J'. Medtronic guidewires are available in a range of diameters and are compatible with the minimal needle sizes noted in the table.

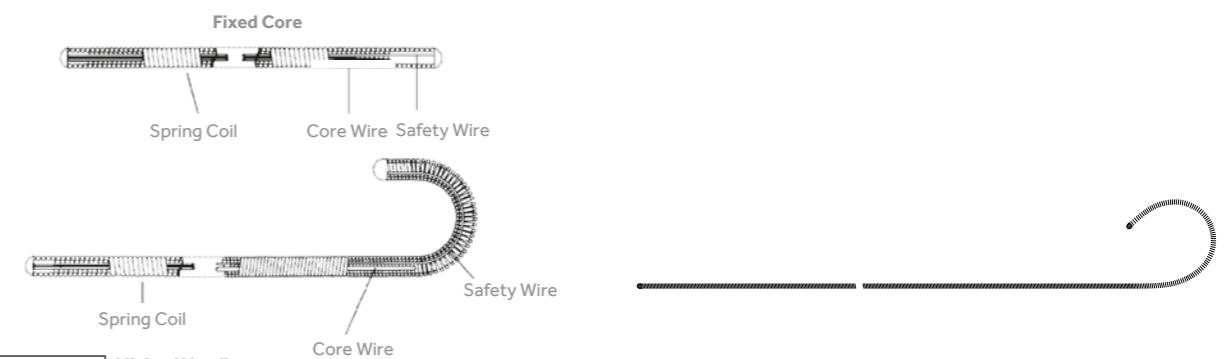

Guidewire Diameter in./mm	Minimum Needle Size	Minimal Needle Size Compatibility
0.025/0.6	19 gauge	
0.032/0.8	18 gauge	
0.035/0.9	18 gauge	
0.038/1.0	18 gauge	
0.045/1.1	16 gauge	

6-MM 'J' TIP

PRODUCT CODE	SIZE IN./MM	LENGTH (CM)	COMMENTS
007441	0.035/0.9	145	Standard taper core 6 cm
007443	0.038/1.0	145	Standard taper core 6 cm

ANGIOGRAPHIC WIRES

PTFE-Coated Guidewires: Fixed Core 15-mm 'J' Tip

GENERAL CHARACTERISTICS

- Supplied sterile. • Packaged in coiled hoops. • Items per box: 10

PRODUCT DESCRIPTION

This design has a gradually tapered core that minimizes trauma to the vessel. Angiography guidewires come with a PTFE coating applied over the entire core, enabling free movement and a smooth sliding action.

A unique 'J' tip configuration is available on the fixed core wires. This 'J' tip can be "fingertip-straightened" from virtually any point of the wire shaft. This built-in convenience eliminates the need for a 'J' straightening tool for wire loading.

Medtronic offers a variety of tip configurations, sizes and styles. The two most common tip configurations are straight and 'J'. Medtronic guidewires are available in a range of diameters and are compatible with the minimal needle sizes noted in the table.

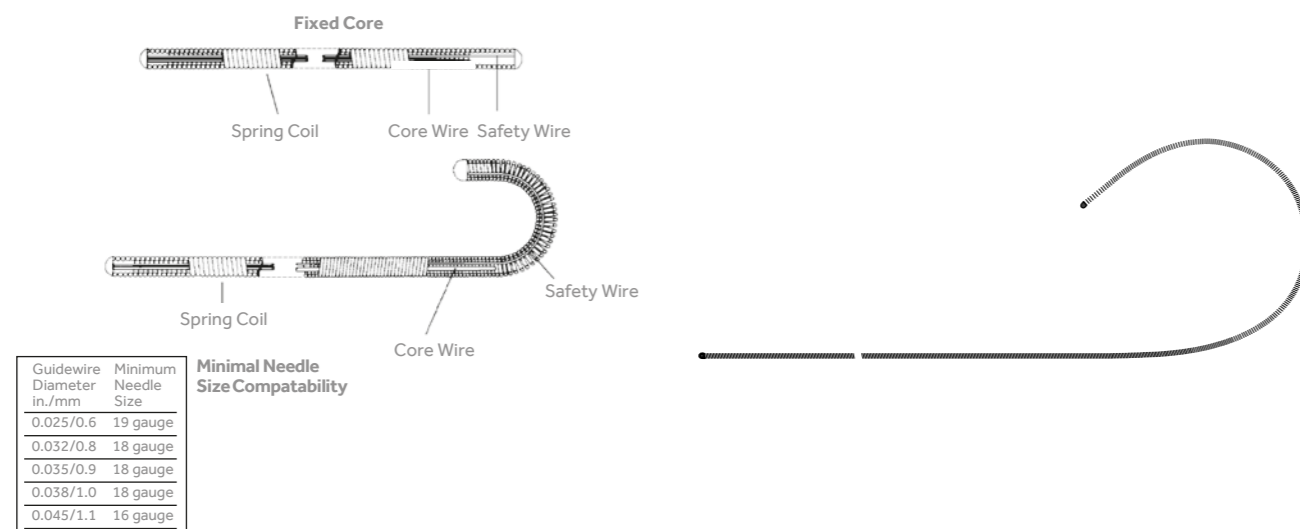

15-MM 'J' TIP

PRODUCT CODE	FRENCH SIZE	LENGTH (CM)	COMMENTS
007471	0.035/0.9	145	Standard taper core 6 cm
007472	0.038/1.0	145	Standard taper core 6 cm

ANGIOGRAPHIC WIRES

PTFE-Coated Guidewires: Movable Core Straight Tip

GENERAL CHARACTERISTICS

- Supplied sterile. • Packaged in coiled hoops. • Variable stiffness. • Items per box: 10

PRODUCT DESCRIPTION

This design allows the wire softness to be adjusted manually by moving the core wire back and forth, allowing the operator to lengthen or shorten at will.

Angiography guidewires come with a PTFE coating applied over the entire core, enabling free movement and a smooth sliding action.

A unique 'J' tip configuration is available on the movable core wires. This 'J' tip can be "fingertipstraightened" from virtually any point of the wire shaft.

This built-in convenience eliminates the need for a 'J' straightening tool for wire loading. Medtronic offers a variety of tip configurations, sizes and styles. The two most common tip configurations are straight and 'J'. Medtronic guidewires are available in a range of diameters and are compatible with the minimal needle sizes noted in the table.

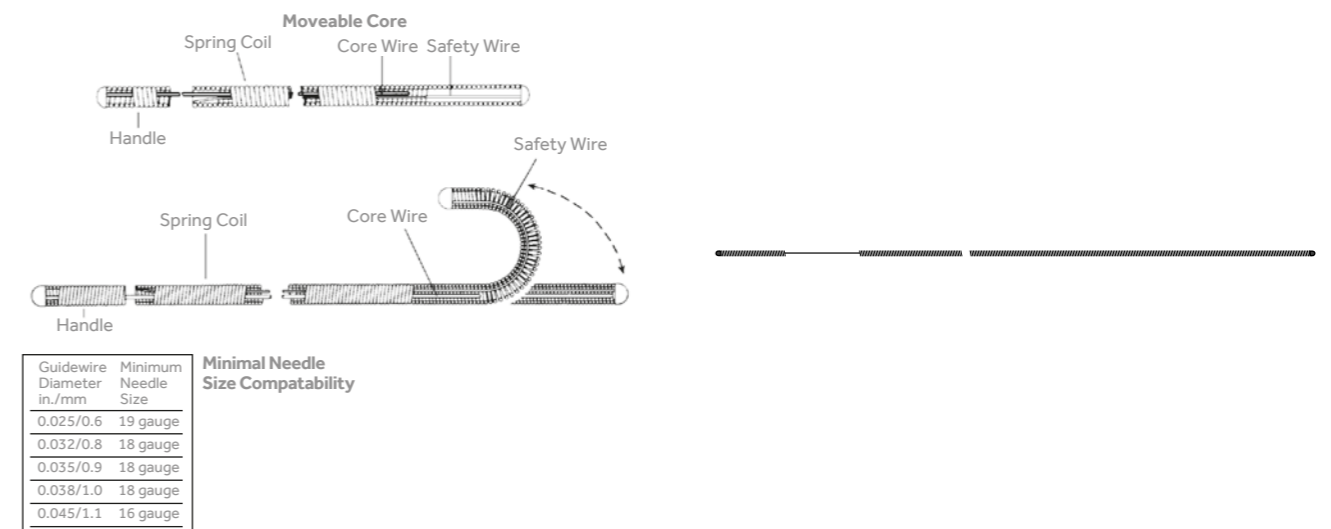

STRAIGHT TIP

PRODUCT CODE	SIZE IN./MM	LENGTH (CM)
007647	0.032/0.8	145
007051	0.035/0.9	145
007053	0.038/1.0	145

ANGIOGRAPHIC WIRES

PTFE-Coated Guidewires: Movable Core 3-mm 'J' Tip

GENERAL CHARACTERISTICS

- Supplied sterile. • Packaged in coiled hoops. • Variable stiffness. • Items per box: 10

PRODUCT DESCRIPTION

This design allows the wire softness to be adjusted manually by moving the core wire back and forth, allowing the operator to lengthen or shorten at will.

Angiography guidewires come with a PTFE coating applied over the entire core, enabling free movement and a smooth sliding action.

A unique 'J' tip configuration is available on the movable core wires. This 'J' tip can be "fingertipstraightened" from virtually any point of the wire shaft.

This built-in convenience eliminates the need for a 'J' straightening tool for wire loading. Medtronic offers a variety of tip configurations, sizes and styles. The two most common tip configurations are straight and 'J'. Medtronic guidewires are available in a range of diameters and are compatible with the minimal needle sizes noted in the table.

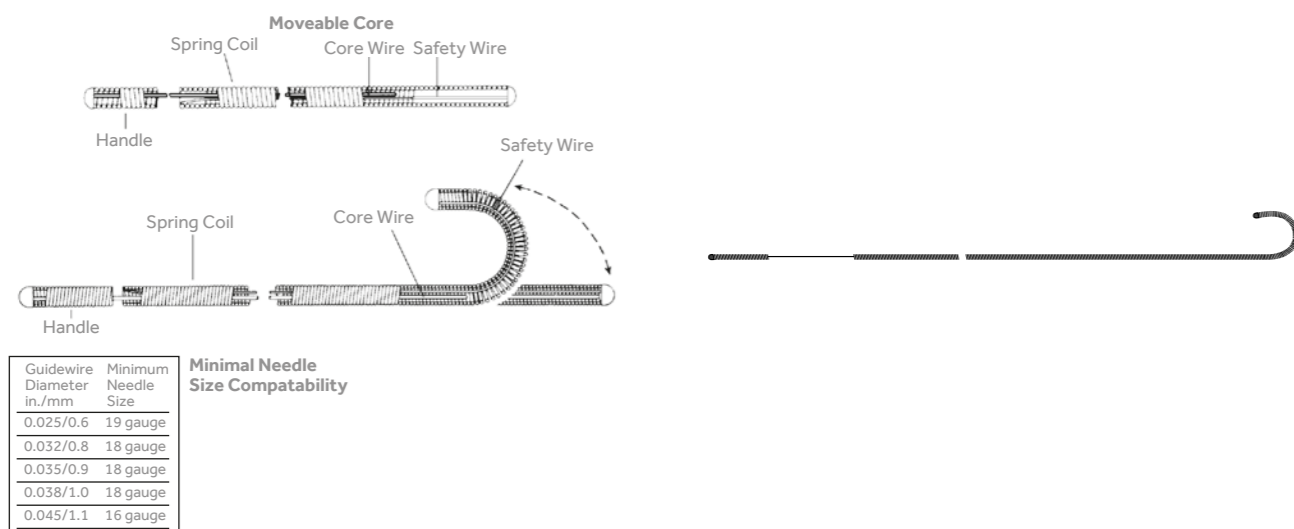

3-MM 'J' TIP

PRODUCT CODE	SIZE IN./MM	LENGTH (CM)
007648	0.032/0.8	120
007649	0.032/0.8	145
007446	0.035/0.9	120
007447	0.035/0.9	145
007054	0.038/1.0	145

ANGIOGRAPHIC WIRES

PTFE-Coated Guidewires: Movable Core 6-mm 'J' Tip

GENERAL CHARACTERISTICS

- Supplied sterile. • Packaged in coiled hoops. • Variable stiffness. • Items per box: 10

PRODUCT DESCRIPTION

This design allows the wire softness to be adjusted manually by moving the core wire back and forth, allowing the operator to lengthen or shorten at will.

Angiography guidewires come with a PTFE coating applied over the entire core, enabling free movement and a smooth sliding action.

A unique 'J' tip configuration is available on the movable core wires. This 'J' tip can be "fingertipstraightened" from virtually any point of the wire shaft.

This built-in convenience eliminates the need for a 'J' straightening tool for wire loading. Medtronic offers a variety of tip configurations, sizes and styles. The two most common tip configurations are straight and 'J'. Medtronic guidewires are available in a range of diameters and are compatible with the minimal needle sizes noted in the table.

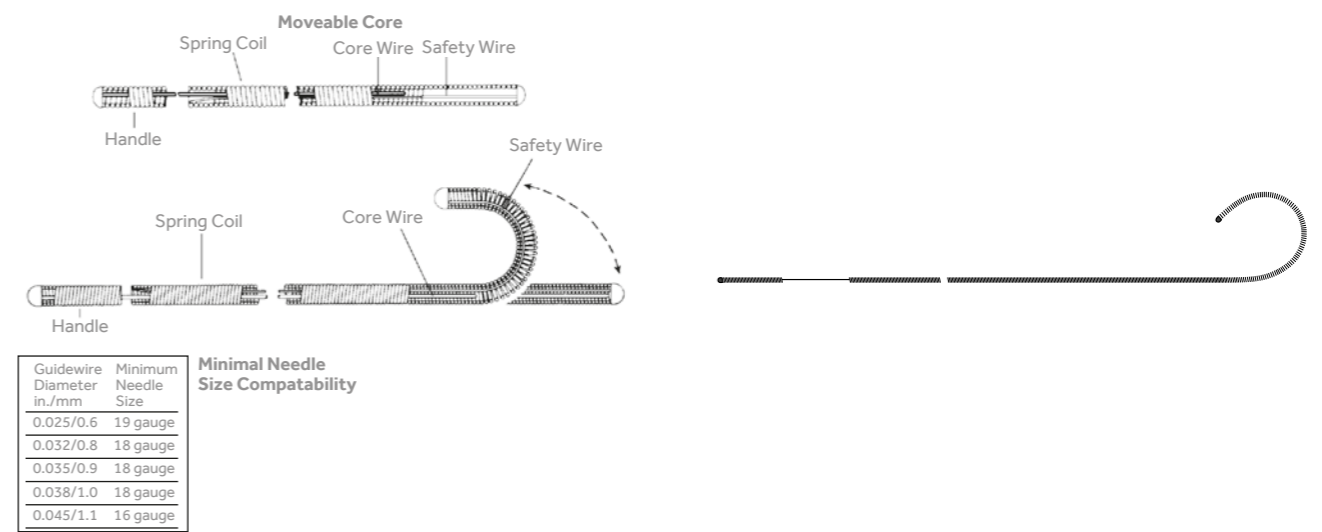

6-MM 'J' TIP

PRODUCT CODE	SIZE IN./MM	LENGTH (CM)
007445	0.035/0.9	145

ANGIOGRAPHIC WIRES

Support and Exchange wires 3-mm 'J' Tip Exchange Wire: Fixed Core

GENERAL CHARACTERISTICS

• Supplied sterile. • Packaged in coiled hoops. • PTFE coated. • Items per box: 10

PRODUCT DESCRIPTION

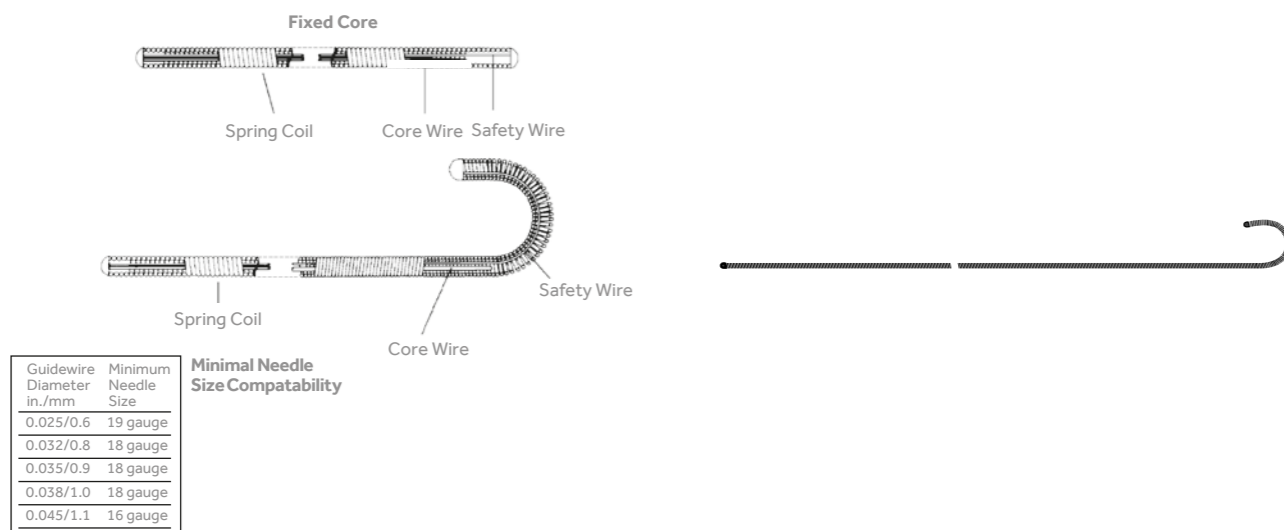

3-MM 'J' TIP EXCHANGE WIRE: FIXED CORE

PRODUCT CODE	SIZE IN./MM	LENGTH (CM)	COMMENTS
008631	0.035/0.9	260	Standard taper core 6 cm
008634	0.038/1.0	260	Standard taper core 6 cm

ANGIOGRAPHIC WIRES

Support and Exchange wires Straight Tip Exchange Wire: Fixed Core

GENERAL CHARACTERISTICS

• Supplied sterile. • Packaged in coiled hoops. • PTFE coated. • Items per box: 10

PRODUCT DESCRIPTION

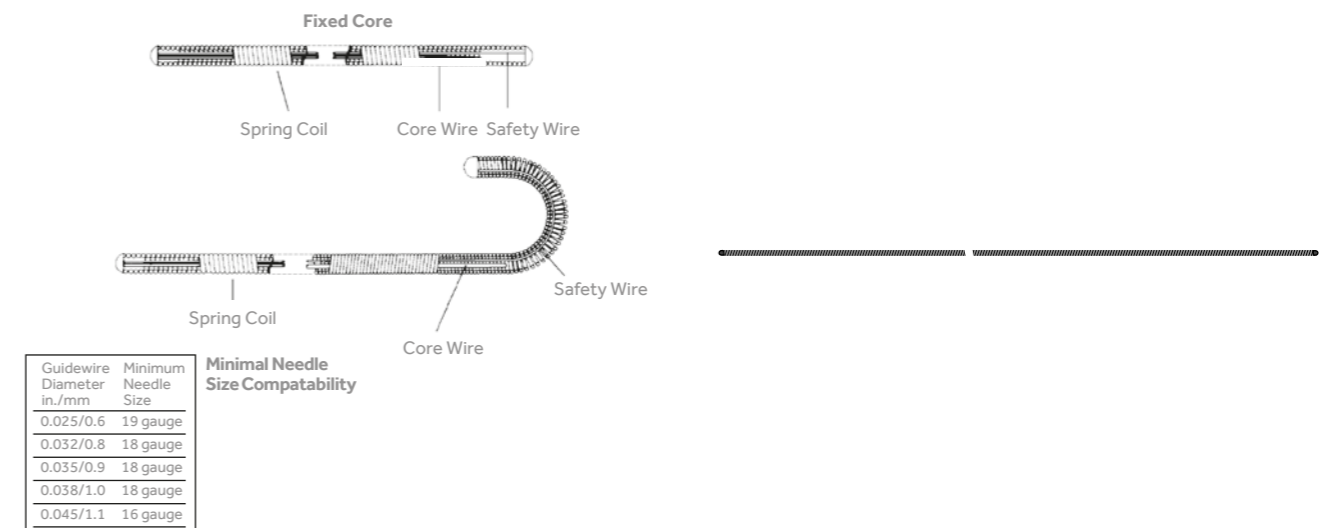

STRAIGHT TIP EXCHANGE WIRE: FIXED CORE

PRODUCT CODE	SIZE IN./MM	LENGTH (CM)	COMMENTS
008633	0.035/0.9	260	Standard taper core 6 cm
008632	0.038/1.0	260	Standard taper core 6 cm

ANGIOGRAPHIC WIRES

Support and Exchange wires PTFE-Coated 0.063" Guidewire

GENERAL CHARACTERISTICS

• Supplied sterile. • Packaged in coiled hoops. • PTFE coated. • Items per box: 10

PRODUCT DESCRIPTION

For placement of guiding catheter (flexible distal tip, fixed core)

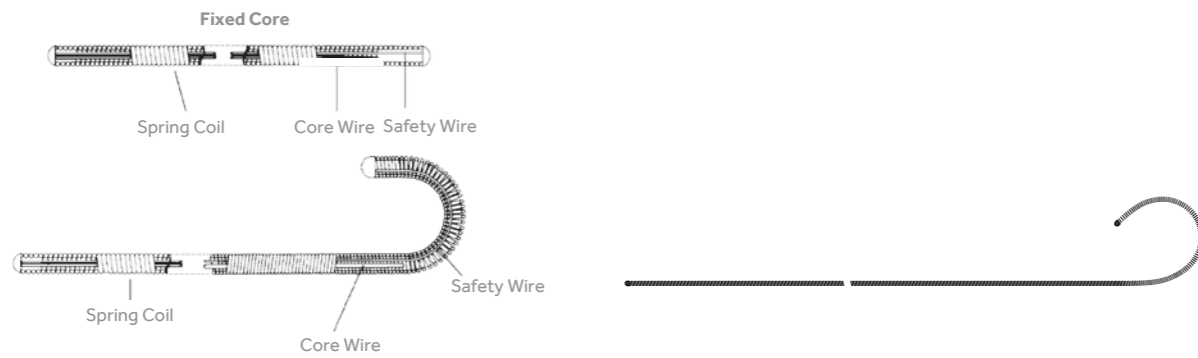

PTFE-COATED 0.063" GUIDEWIRE

PRODUCT CODE	TIP	DIAMETER (IN.)	LENGTH (CM)
008418	6-mm 'J'	0.063	160

ANGIOGRAPHIC WIRES

Specialty Guidewires Sos Open-Ended Guidewire

GENERAL CHARACTERISTICS

• Supplied sterile. • Packaged in coiled hoops. • Items per box: 10

PRODUCT DESCRIPTION

Movable/removable core wire is packaged with removable luer lock hub, product code 006210

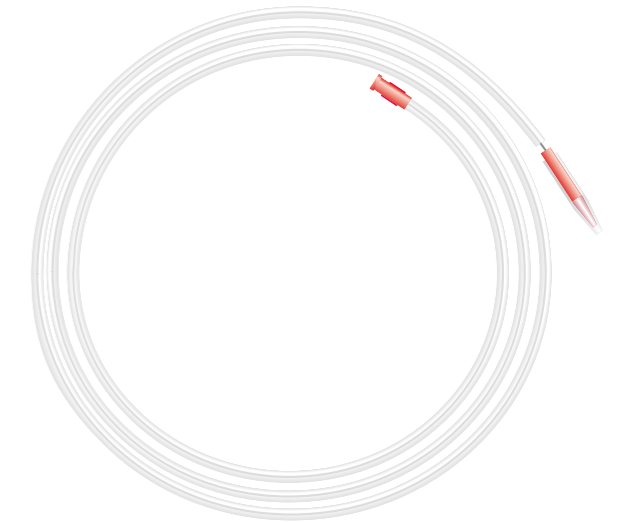
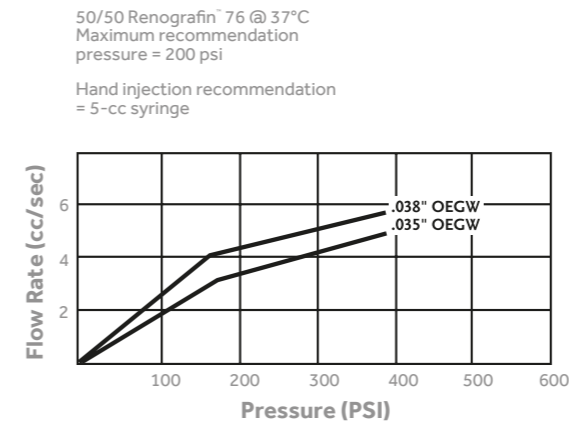

SOS OPEN-ENDED GUIDEWIRE

PRODUCT CODE	SIZE IN./MM	LENGTH (CM)	COMMENTS
006203	0.035/0.9	145	Standard taper core 6 cm
006200	0.038/1.0	145	Standard taper core 6 cm
006204	0.035/0.9	145	Long taper core 10 cm
006201	0.038/1.0	145	Long taper core 10 cm

Renografin[®] is a registered trademark of Olin Mathieson Chemical Corporation.

ANGIOGRAPHIC WIRES

Specialty Guidewires Removable Luer Lock Hub

GENERAL CHARACTERISTICS

- Supplied sterile. • Items per box: 10

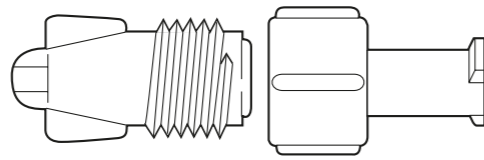

REMOVABLE LUER LOCK HUB

PRODUCT CODE	SIZE IN./MM	FOR USE WITH
006210	Fits all sizes	Sos Open-Ended Guidewire

ANGIOGRAPHIC WIRES

Specialty Guidewires Steerable Guidewire with Steering Handle

GENERAL CHARACTERISTICS

- Supplied sterile. • Packaged in coiled hoops. • PTFE coated. • Items per box: 5

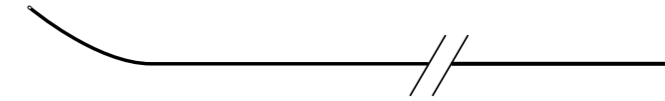

STEERABLE GUIDEWIRE WITH STEERING HANDLE

PRODUCT CODE	SIZE IN./MM	LENGTH (CM)	COMMENTS
010037	0.035/0.9	145	3 cm flexible tip
010038	0.038/1.0	145	3 cm flexible tip

ANGIOGRAPHIC WIRES

Specialty Guidewires Softwire

GENERAL CHARACTERISTICS

- Supplied sterile.
- Packaged in coiled hoops.
- PTFE coated.
- Items per box: 10



SOFTWARE

PRODUCT CODE	SIZE IN./MM	LENGTH (CM)	COMMENTS
006305	0.035/0.9	145	Extra long taper core 15 cm
006307	0.038/1.0	145	Extra long taper core 15 cm

INTRODUCERS

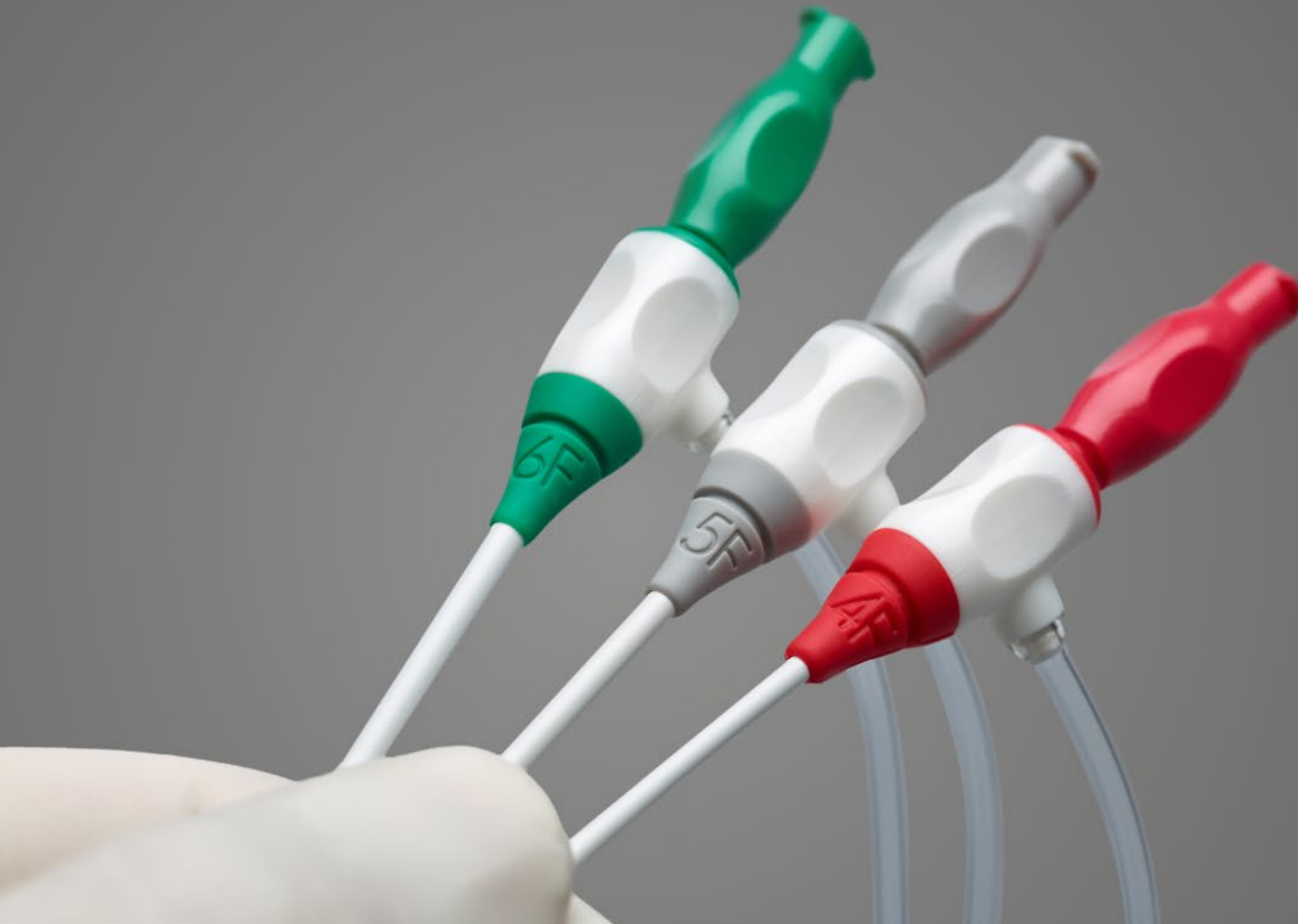

- CONTENTS
- 1. DRUG ELUTING STENTS
- 2. DRUG METAL STENTS
- 3. BALLOON DILATION CATHETERS
- 4. DRUG ELUTING BALLOONS
- 5. GUIDE CATHETER FAMILY
- 6. INTERVENTIONAL GUIDEWIRES
- 7. ASPIRATION CATHETERS
- 8. ANGIOGRAPHIC CATHETERS AND WIRES
- 9. INTRODUCERS
- 10. INTERVENTIONAL ACCESSORIES
- 11. PEDIATRIC AND TRANSDERMAL PRODUCTS
- 12. RENAL DENERVATION

RADIAL INTRODUCERS

InTRAKit™ Access Kit

GENERAL CHARACTERISTICS

*Items per box: 5 • Supplied sterile

PRODUCT DESCRIPTION

InTRAKit™ access kit delivers excellent components for the transradial approach:

- IV catheter and micropuncture needles feature sharp tips for easy insertion
- Needle hubs offer excellent flashback visualization and excellent grip
- Mini-guidewire options include stainless steel, nitinol, or plastic-jacketed — all with atraumatic tips
- Tapered design ensures a smooth dilator-to-sheath transition
- Hydrophilic coating for enhanced lubricity
- Sheath provides excellent kink resistance

PRODUCT CODE

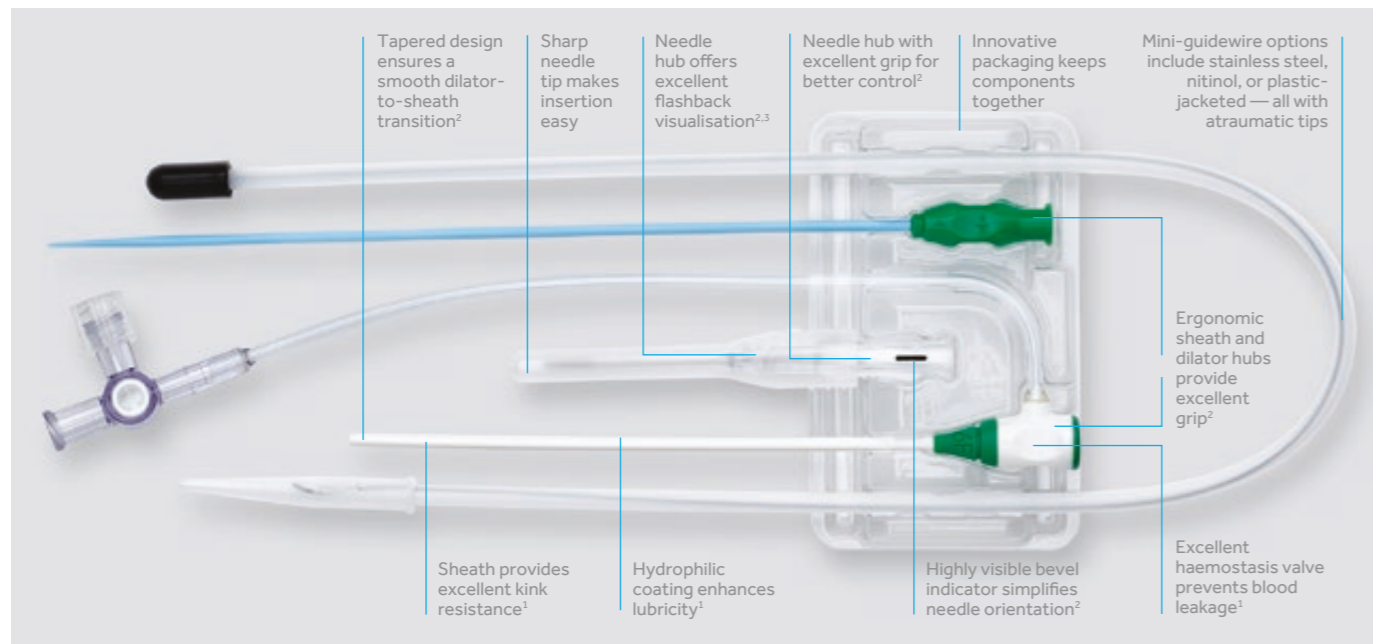
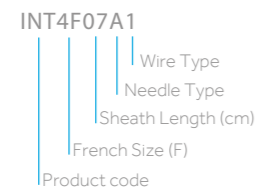

ORDERING INFORMATION

SHEATH THICKNESS	FRENCH SIZE (F)	SHEATH LENGTH (CM)	NEEDLE TYPE	WIRE TYPE
Standard	4)	07	A: IV Cath 22G	1: Stainless steel 45 cm
	5	11	B: IV Cath 20G	2: Nitinol 45 cm
	6	23	C: Micropuncture 21 G	3: Plastic-jacketed 45 cm
			D: Micropuncture 18 G	4: Stainless steel 80 cm

1. Bench test data on file at Medtronic. Bench test data may not be indicative of clinical results.

2. Based on physician feedback during preclinical study and compared to participants' current clinical experience; data on file at Medtronic.

3. Preclinical studies on file at Medtronic. Preclinical data may not be indicative of clinical performance.

RADIAL INTRODUCERS

InTRAKit™ Access Kit

ORDERING INFORMATION

4 FRENCH ORDER CODES (CFN)

CFN	Sheath Length	Needle Size	Needle Type	Wire Type	Wire Length
INT4F07B1	7 cm	20 G	IV Catheter	Stainless steel	45 cm
INT4F07B3	7 cm	20 G	IV Catheter	Plastic-jacketed	45 cm
INT4F07C1	7 cm	21 G	Micropuncture	Stainless steel	45 cm
INT4F11A3	11 cm	22 G	IV Catheter	Plastic-jacketed	45 cm
INT4F11B1	11 cm	20 G	IV Catheter	Stainless steel	45 cm
INT4F11B3	11 cm	20 G	IV Catheter	Plastic-jacketed	45 cm
INT4F11C1	11 cm	21 G	Micropuncture	Stainless steel	45 cm
INT4F11C2	11 cm	21 G	Micropuncture	Nitinol	45 cm
INT4F23B4	23 cm	20 G	IV Catheter	Stainless steel	80 cm
INT4F23C4	23 cm	21 G	Micropuncture	Stainless steel	80 cm

5 FRENCH ORDER CODES (CFN)

CFN	Sheath Length	Needle Size	Needle Type	Wire Type	Wire Length
INT5F07B1	7 cm	20 G	IV Catheter	Stainless steel	45 cm
INT5F07B2	7 cm	20 G	IV Catheter	Nitinol	45 cm
INT5F07B3	7 cm	20 G	IV Catheter	Plastic-jacketed	45 cm
INT5F07C1	7 cm	21 G	Micropuncture	Stainless steel	45 cm
INT5F07C2	7 cm	21 G	Micropuncture	Nitinol	45 cm
INT5F07D1	7 cm	18 G	Micropuncture	Stainless steel	45 cm
INT5F07D2	7 cm	18 G	Micropuncture	Nitinol	45 cm
INT5F11A3	11 cm	22 G	IV Catheter	Plastic-jacketed	45 cm
INT5F11B1	11 cm	20 G	IV Catheter	Stainless steel	45 cm
INT5F11B2	11 cm	20 G	IV Catheter	Nitinol	45 cm
INT5F11B3	11 cm	20 G	IV Catheter	Plastic-jacketed	45 cm
INT5F11C1	11 cm	21 G	Micropuncture	Stainless steel	45 cm
INT5F11C2	11 cm	21 G	Micropuncture	Nitinol	45 cm
INT5F11D1	11 cm	18 G	Micropuncture	Stainless steel	45 cm
INT5F11D2	11 cm	18 G	Micropuncture	Nitinol	45 cm
INT5F23B4	23 cm	20 G	IV Catheter	Stainless steel	80 cm
INT5F23C4	23 cm	21 G	Micropuncture	Stainless steel	80 cm
INT5F23D4	23 cm	18 G	Micropuncture	Stainless steel	80 cm

6 FRENCH ORDER CODES (CFN)

CFN	Sheath Length	Needle Size	Needle Type	Wire Type	Wire Length
INT6F07B1	7 cm	20 G	IV Catheter	Stainless steel	45 cm
INT6F07B2	7 cm	20 G	IV Catheter	Nitinol	45 cm
INT6F07B3	7 cm	20 G	IV Catheter	Plastic-jacketed	45 cm
INT6F07C1	7 cm	21 G	Micropuncture	Stainless steel	45 cm
INT6F07C2	7 cm	21 G	Micropuncture	Nitinol	45 cm
INT6F07D1	7 cm	18 G	Micropuncture	Stainless steel	45 cm
INT6F11A3	11 cm	22 G	IV Catheter	Plastic-jacketed	45 cm
INT6F11B1	11 cm	20 G	IV Catheter	Stainless steel	45 cm
INT6F11B2	11 cm	20 G	IV Catheter	Nitinol	45 cm
INT6F11B3	11 cm	20 G	IV Catheter	Plastic-jacketed	45 cm
INT6F11C1	11 cm	21 G	Micropuncture	Stainless steel	45 cm
INT6F11C2	11 cm	21 G	Micropuncture	Nitinol	45 cm
INT6F11D1	11 cm	18 G	Micropuncture	Stainless steel	45 cm
INT6F23B4	23 cm	20 G	IV Catheter	Stainless steel	80 cm
INT6F23C4	23 cm	21 G	Micropuncture	Stainless steel	80 cm
INT6F23D4	23 cm	18 G	Micropuncture	Stainless steel	80 cm

FEMORAL INTRODUCERS

Input™ TS Introducer Sheath

GENERAL CHARACTERISTICS

• Supplied sterile. • Maximum guidewire: 0.038" • Items per box: 5

PRODUCT DESCRIPTION

- FEP sheath with silicone coating.
- Silicone hemostasis valve.
- Polyethylene dilator with silicone coating.
- Double distal 'J' stainless steel guidewire (included in 7-cm and 11-cm sheaths only).
- See obturators, dilators and sterile sleeves.



Input TS Introducer Sheath Dilator

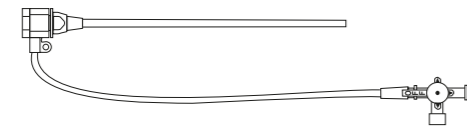

Input TS Introducer Sheath

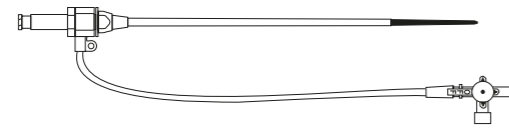

Input TS Introducer Sheath with Dilator

INPUT™ TS INTRODUCER SHEATH

PRODUCT CODE	FRENCH SIZE	OBTURATOR INCLUDED	COLOR CODE	LENGTH (CM)	DILATOR LENGTH (CM)	WIRE STYLE (IN.)
040028A	5	No	Gray	7	13	0.038 DDJ
040031A	6	No	Green	7	13	0.038 DDJ
040035A	7	No	Orange	7	13	0.038 DDJ
051101A	5	No	Gray	11	17	0.038 DDJ
061101A	6	No	Green	11	17	0.038 DDJ
071101A	7	No	Orange	11	17	0.038 DDJ
081101A	8	No	Blue	11	17	0.038 DDJ
091101A	9	No	Gray	11	17	0.038 DDJ
010101A	10	No	Dk Blue	11	17	0.038 DDJ
011101A	11	No	Red	11	17	0.038 DDJ
060037A	6	Yes	Green	23	29	N/A
070037A	7	Yes	Orange	23	29	N/A
080037A	8	Yes	Blue	23	29	N/A
090037A	9	Yes	Gray	23	29	N/A

FEMORAL INTRODUCERS

Input™ TS Introducer Sheath with Needle and Guidewire

GENERAL CHARACTERISTICS

• Supplied sterile. • Maximum guidewire: 0.038" • Items per box: 5

PRODUCT DESCRIPTION

- FEP sheath with silicone coating.
- Silicone hemostasis valve.
- Polyethylene dilator with silicone coating.
- Double distal 'J' stainless steel guidewire (included in 7-cm and 11-cm sheaths only).
- See obturators, dilators and sterile sleeves.



Input TS Introducer Sheath Dilator

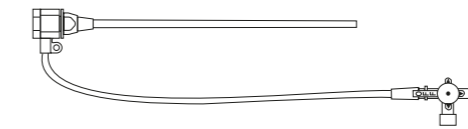

Input TS Introducer Sheath

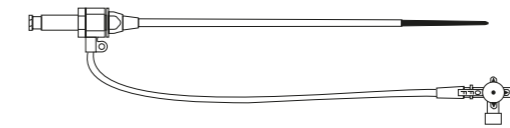

Input TS Introducer Sheath with Dilator

INPUT™ TS INTRODUCER SHEATH WITH NEEDLE AND GUIDEWIRE

PRODUCT CODE	FRENCH SIZE	SHEATH LENGTH (CM)	NEEDLE LENGTH (CM)	NEEDLE GAUGE
051102A	5	11	7	18
061102A	6	11	7	18
071102A	7	11	7	18
081102A	8	11	7	18
091102A	9	11	7	18

FEMORAL INTRODUCERS

Input™ PS Introducer Sheath

GENERAL CHARACTERISTICS

• Supplied sterile. • Maximum guidewire: 0.038" • Items per box: 5

PRODUCT DESCRIPTION

- Pebax™ sheath.
- Silicone hemostasis valve.
- Polyethylene dilator.
- Double distal 'J' stainless steel guidewire (included in 11-cm sheaths only).
- Hydro/Pel™ hydrophilic coating: water-activated, super-lubricious coating on the distal portions of the sheath assembly allows for easy insertion.
- See obturators, dilators, sterile sleeves.

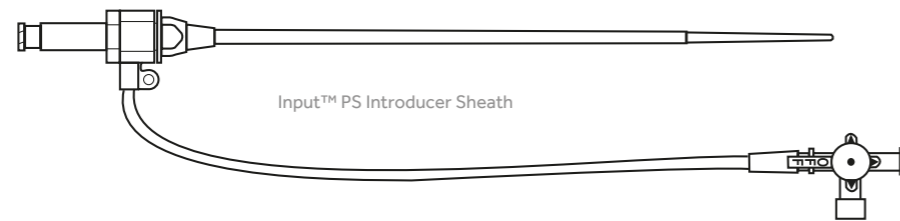

INPUT™ PS INTRODUCER SHEATH

PRODUCT CODE	FRENCH SIZE	OBTURATOR INCLUDED	COLOR CODE	SHEATH LENGTH (CM)	DILATOR LENGTH (CM)	WIRE STYLE (IN.)
050011	5	No	Gray	11	17	0.038 DDJ
060011	6	No	Green	11	17	0.038 DDJ
070011	7	No	Orange	11	17	0.038 DDJ
080011	8	No	Blue	11	17	0.038 DDJ
060023	6	Yes	Green	23	31	N/A
070023	7	Yes	Orange	23	39	N/A
080023	8	Yes	Blue	23	39	N/A
863311	6	No	Green	11	17	N/A
873311	7	No	Orange	11	17	N/A
883311	8	No	Blue	11	17	N/A

Pebax™ is a registered trademark of Atofina Corporation France.

FEMORAL INTRODUCERS

Input™ PS Introducer Sheath with Needle and Guidewire

GENERAL CHARACTERISTICS

• Supplied sterile. • Maximum guidewire diameter: 0.038" • Items per box: 5 • Color code: see chart below

PRODUCT DESCRIPTION

- Pebax™ sheath.
- Silicone hemostasis valve.
- Polyethylene dilator.
- Double distal "J" stainless steel guidewire (included in 11-cm sheaths only).
- Hydro/Pel™ hydrophilic coating: water-activated, super-lubricious coating on the distal portions of the sheath assembly allows for easy insertion.
- See obturators, dilators, sterile sleeves.

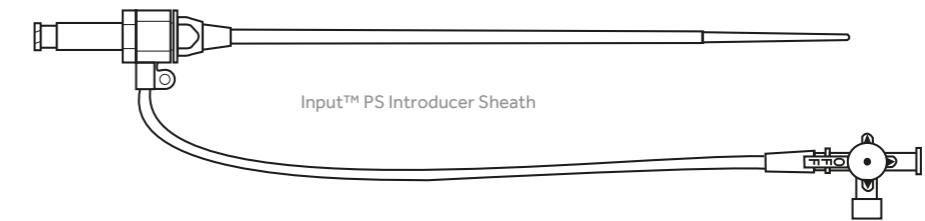

INPUT™ PS INTRODUCER SHEATH WITH NEEDLE AND GUIDEWIRE

PRODUCT CODE	FRENCH SIZE (F)	SHEATH LENGTH (CM)	NEEDLE LENGTH (CM)	NEEDLE GAUGE	COLOUR CODE
553311	5	11	7	18	Gray
563311	6	11	7	18	Green
573311	7	11	7	18	Orange
583311	8	11	7	18	Blue

Pebax™ is a registered trademark of Atofina Corporation France.

FEMORAL INTRODUCERS

Input™ Accessories Obturator

GENERAL CHARACTERISTICS

- Supplied sterile. • Color-coded for easy identification of compatible sheath. • Items per box: 10

PRODUCT DESCRIPTION

- Helps maintain sheath patency and protects from outside contamination.
- Twist 'N Shut locking system locks obturator in place to prevent backout from sheath.
- Inserted into the introducer sheath when placement of the transvenous temporary pacing electrode or intravascular catheter is delayed or removed.

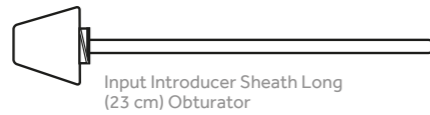
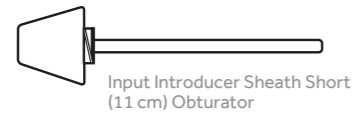

INPUT™ PS INTRODUCER SHEATH OBTURATOR

PRODUCT CODE	USE WITH INTRODUCER	COLOR CODE	OBTURATOR I.D. (F)	OBTURATOR O.D. (F)	OBTURATOR LENGTH (CM)
205211	050011	Gray	5	4	11
206211	060011	Green	6	5	11
207211	070011	Orange	7	6	11
209223	090023	Gray	9	8	23

FEMORAL INTRODUCERS

Input™ Accessories Obturator

GENERAL CHARACTERISTICS

- Supplied sterile. • Color-coded for easy identification of compatible sheath. • Items per box: 10

PRODUCT DESCRIPTION

- Helps maintain sheath patency and protects from outside contamination.
- Twist 'N Shut locking system locks obturator in place to prevent backout from sheath.
- Inserted into the introducer sheath when placement of the transvenous temporary pacing electrode or intravascular catheter is delayed or removed.

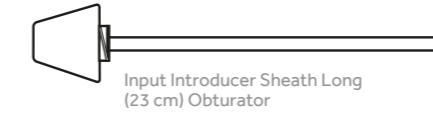
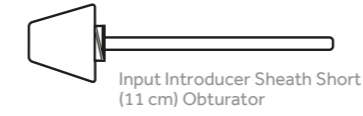

INPUT™ TS INTRODUCER SHEATH OBTURATOR

PRODUCT CODE	USE WITH INTRODUCER	COLOR CODE	OBTURATOR I.D. (F)	OBTURATOR O.D. (F)	OBTURATOR LENGTH (CM)
206211A	061101A	Green	6	6	11
207211A	071101A	Orange	7	7	11
209223A	090037A	Gray	9	9	23

FEMORAL INTRODUCERS

Input™ Accessories Vessel Dilator

GENERAL CHARACTERISTICS

- Supplied sterile. • Items per box: 10

PRODUCT DESCRIPTION

- For use in arterial or venous applications.
- Polyethylene dilator.



Input Introducer Sheath Vessel Dilator

INPUT™ PS INTRODUCER SHEATH VESSEL DILATOR

PRODUCT CODE	FRENCH SIZE	COLOR CODE	MAXIMUM WIRE SIZE (IN.)	DILATOR LENGTH (CM)
653311	5	Gray	0.038	17
673311	7	Orange	0.038	17
673323	7	Orange	0.038	Double 39

FEMORAL INTRODUCERS

Input™ Accessories Vessel Dilator

GENERAL CHARACTERISTICS

- Supplied sterile. • Items per box: 10

PRODUCT DESCRIPTION

- For use in arterial or venous applications.
- Polyethylene dilator.



Input Introducer Sheath Vessel Dilator

INPUT™ TS INTRODUCER SHEATH VESSEL DILATOR

PRODUCT CODE	FRENCH SIZE	COLOR CODE	MAXIMUM WIRE SIZE (IN.)	DILATOR LENGTH (CM)
040037A	5	Gray	0.038	17
040042A	6	Green	0.038	17
040044A	7	Orange	0.038	17
040049A	9	Gray	0.038	17

FEMORAL INTRODUCERS

Input™ Accessories Sterile Sleeve

GENERAL CHARACTERISTICS

- Supplied sterile. • Items per box: 10

PRODUCT DESCRIPTION

- Maintains sterility of indwelling catheter shaft proximal to the introducer hub.
- Twist 'N Shut locking system locks sleeve into input hub.



Input Introducer Sheath Sterile Sleeve

INPUT™ INTRODUCER SHEATH STERILE SLEEVE

PRODUCT CODE	LENGTH (CM)	FOR USE WITH
026000	26	Input™ Introducer Sheaths
060000	60	Input™ Introducer Sheaths

FEMORAL INTRODUCERS

Mullins Transseptal Catheter Introducer Sheath

GENERAL CHARACTERISTICS

- Supplied sterile. • Items per box: 1

PRODUCT DESCRIPTION

Sets include one sheath and one dilator. Used with Brockenbrough™ needle, except where noted.



Mullins Transseptal Catheter Introducer Sheath

MULLINS TRANSSEPTAL CATHETER INTRODUCER SHEATH

PRODUCT CODE	FRENCH SIZE	MAXIMUM WIRE SIZE (IN.)	SHEATH LENGTH (CM)	DILATOR LENGTH (CM)
008550	6	0.032	59	67
008551	7	0.032	59	67
008552	8	0.032	59	67

FEMORAL INTRODUCERS

Pediatric Mullins Transseptal Catheter Introducer Sheath

GENERAL CHARACTERISTICS

• Supplied sterile. • Items per box: 1

PRODUCT DESCRIPTION

Sets include one sheath and one dilator. Used with Brockenbrough™ needle, except where noted.



Mullins Transseptal Catheter Introducer Sheath

MULLINS TRANSEPTAL CATHETER INTRODUCER SHEATH

PRODUCT CODE	FRENCH SIZE	MAXIMUM WIRE SIZE (IN.)	SHEATH LENGTH (CM)	DILATOR LENGTH (CM)
008530 †	6	0.025	44	52
008531 †	7	0.025	44	52
008532 †	8	0.025	44	52

† Pediatric item

FEMORAL INTRODUCERS

Mullins Transseptal Catheter Introducer Sheath with Hemostasis Valve

GENERAL CHARACTERISTICS

• Supplied sterile. • Items per box: 1

PRODUCT DESCRIPTION

Sets include one sheath and one dilator. Used with Brockenbrough™ needle.

Transseptal catheter introducer sheath has attached sidearm with stopcock and hemostasis valve.

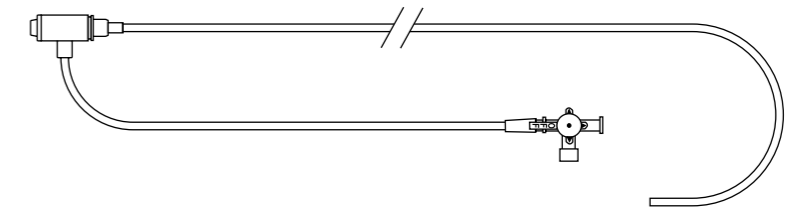

Transseptal Catheter Introducer Sheath with Hemostasis Valve

TRANSEPTAL CATHETER INTRODUCER SHEATH WITH HEMOSTASIS VALVE

PRODUCT CODE	FRENCH SIZE	MAXIMUM WIRE SIZE (IN.)	SHEATH LENGTH (CM)	DILATOR LENGTH (CM)
008591	8	0.032	59	67

INTERVENTIONAL ACCESSORIES



CONTENTS

- 1. DRUG ELUTING STENTS
- 2. DRUG METAL STENTS
- 3. BALLOON DILATION CATHETERS
- 4. DRUG ELUTING BALLOONS
- 5. GUIDE CATHETER FAMILY
- 6. INTERVENTIONAL GUIDEWIRES
- 7. ASPIRATION CATHETERS
- 8. ANGIOGRAPHIC CATHETERS AND WIRES
- 9. INTRODUCERS
- 10. INTERVENTIONAL ACCESSORIES
- 11. PEDIATRIC AND TRANSDERMAL PRODUCTS
- 12. RENAL DENERVATION

INTERVENTIONAL ACCESSORIES

TRAcelet™ Hemostasis Device

GENERAL CHARACTERISTICS

- Items per box: 5 • Supplied sterile

PRODUCT DESCRIPTION

- The TRAcelet™ compression device is an innovative solution for simplified pressure control.
- Its dual-compression balloon system uniformly delivers pressure to the access site to stop bleeding, while maintaining radial artery patency.
- In the cath lab: use the syringe provided with the TRAcelet™ compression device for pressure optimization.
- In the recovery area: use the dial-based system for controlled pressure adjustments without the need for a syringe.

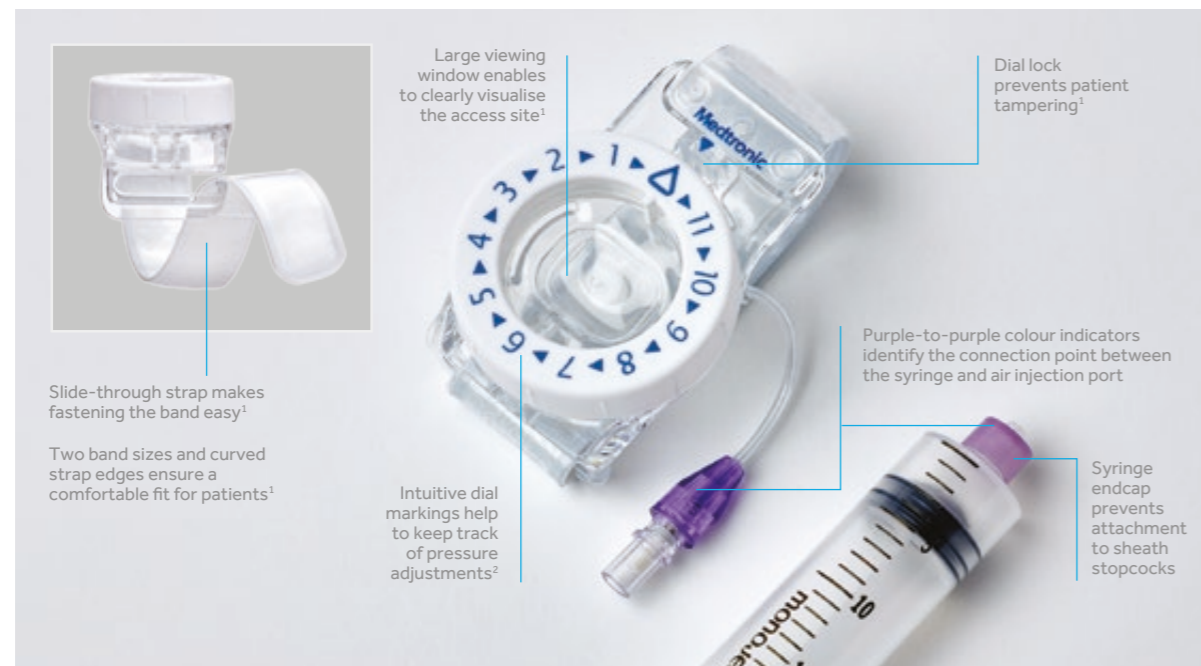

TECHNICAL SPECIFICATIONS

INFLATION VOLUME NUMBERS (CC)		STRAP LENGTHS (CM)		CFN	STRAP LENGTHS (CM)
Nominal	13	Regular	19.2	TRACR	Regular
Maximum	18	Large	25.2	TRACL	Large

1. Data on file at Medtronic.
2. Bench test data on file at Medtronic.

INTERVENTIONAL ACCESSORIES

Everest™ Disposable Inflation Device and Accessories

GENERAL CHARACTERISTICS

- Supplied sterile. • Items per box: 1 • Kits per box: 1

PRODUCT DESCRIPTION

- Available with a 3-way stopcock.
- The pistol-grip fits comfortably in either hand and its trigger mechanism is easy to use for all operators.
- A 20-cc syringe capacity provides rapid negative pressures to speed deflation times.
- The 20 atm/bar and 30 atm/bar luminescent gauges are easy to read under low light conditions. Accurate readings within +/- 3% of gauge full scale.

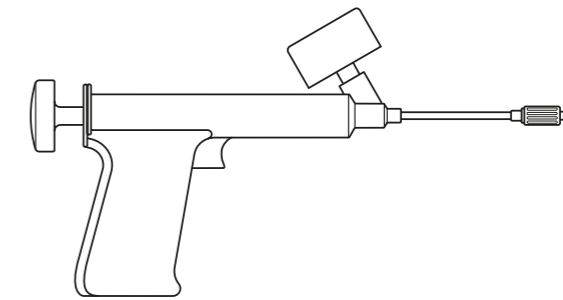

EVEREST INFLATION DEVICE

PRODUCT CODE	DESCRIPTION	PACKAGED WITH
AC2200	Everest20 Inflation Device	1 three-way stopcock
AC3200	Everest30 Inflation Device	1 three-way stopcock
AC2205P	Everest20 Survival Kit	1 Everest20 atm inflation device, 1 three-way stopcock, Piton™ Y-adapter, guidewire insertion tool, and torque handle
AC3205P	Everest30 Survival Kit	1 Everest30 atm inflation device, 1 three-way stopcock, Piton™ Y-adapter, guidewire insertion tool, and torque handle

INTERVENTIONAL ACCESSORIES

Piton™ Disposable PTCA Y-Adaptor and Y-Adaptor Kits

GENERAL CHARACTERISTICS

- Supplied sterile. • Items per box: 5

PRODUCT DESCRIPTION

- Designed for today's smaller shafted balloon catheters.
- Large, ridged cap and extra length simplify handling.
- Cap won't fall off.
- Lubricious gasket allows better maneuverability.

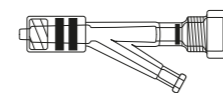

Piton™ Y-Adaptor



Insertion Tool

PITON™ Y-ADAPTOR

PRODUCT CODE	COLOR	LUMEN I.D. (IN.)	PACKAGED WITH
AC4001M	Clear/Blue	0.110	1 Piton™ Y-Adaptor, 1 insertion tool

INTERVENTIONAL ACCESSORIES

Piton™ Disposable PTCA Y-Adaptor and Y-Adaptor Kits

GENERAL CHARACTERISTICS

- Supplied sterile. • Items per box: 5

PRODUCT DESCRIPTION

- Designed for today's smaller shafted balloon catheters.
- Large, ridged cap and extra length simplify handling.
- Cap won't fall off.
- Lubricious gasket allows better maneuverability.

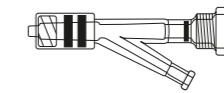

Piton™ Y-Adaptor



Insertion Tool



Torque Handle

PITON™ Y-ADAPTOR KIT

PRODUCT CODE	LUMEN I.D. (IN.)	PACKAGED WITH
AC4003M	0.110	1 Piton™ Y-Adaptor, 1 insertion tool, 1 torque handle

INTERVENTIONAL ACCESSORIES

Piton™ Disposable PTCA Y-Adaptor and Y-Adaptor Kits

GENERAL CHARACTERISTICS

• Supplied sterile. • Items per box: 5

PRODUCT DESCRIPTION

- Designed for today's smaller shafted balloon catheters.
- Large, ridged cap and extra length simplify handling.
- Cap won't fall off.
- Lubricious gasket allows better maneuverability.

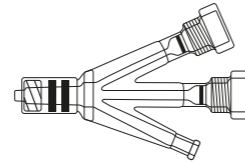

Piton™ Tri-Adaptor



Insertion Tool

PITON™ TRI-ADAPTORS

PRODUCT CODE	LUMEN I.D. (IN.)	PACKAGED WITH
AC4002M	0.110	1 Piton™ Tri-Adaptor, 1 insertion tool

INTERVENTIONAL ACCESSORIES

Metal guidewire insertion tool

GENERAL CHARACTERISTICS

• Supplied sterile. • Items per box: 5

PRODUCT DESCRIPTION

For use with Piton™ Y-Adaptors and Tri-Adaptors.



Stretch Insertion Tool

STRETCH INSERTION TOOL

PRODUCT CODE	DESCRIPTION
006073	Stretch insertion tool

INTERVENTIONAL ACCESSORIES

Steering Handle

GENERAL CHARACTERISTICS

- Supplied sterile. • Items per box: 5

PRODUCT DESCRIPTION

For use with PTCA guidewires.
Plastic nut with metal jaws.

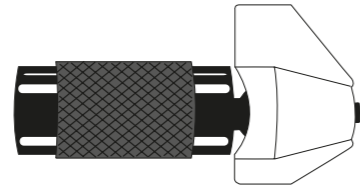

STEERING HANDLE

PRODUCT CODE

008958

HEMODYNAMIC MONITORING CATHETERS

Pulmonary Wedge Pressure (PWP) Catheter

GENERAL CHARACTERISTICS

- Supplied sterile. • For single use. • Maximum guidewire: 0.038" • Items per box: 5
- Packaged with balloon inflation syringe.

PRODUCT DESCRIPTION

- Provides rapid and accurate placement for hemodynamic pressure readings.
- Large lumen for blood sampling and excellent pressure tracings.



PULMONARY WEDGE PRESSURE (PWP) CATHETER

PRODUCT CODE	FRENCH SIZE	LENGTH (CM)
150075	7	110



PEDIATRIC AND TRANSSEPTAL PRODUCTS

CONTENTS

1. DRUG ELUTING
STENTS

2. TRANSSEPTAL
STENTS

3. BALLOON
DILATION
CATHETERS

4. DRUG ELUTING
BALLOONS

5. GUIDE
CATHETER
FAMILY

6. INTERVENTIONAL
GUIDEWIRES

7. ASPIRATION
CATHETERS

8. ANGIOGRAPHIC
CATHETERS
AND WIRES

9. INTRODUCERS

10. INTERVENTIONAL
ACCESSORIES

11. PEDIATRIC AND
TRANSSEPTAL
PRODUCTS

12. RENAL
DENOVATION

PEDIATRIC PRODUCTS

Lehman™ Catheter Pediatric Woven Coronary Catheters

GENERAL CHARACTERISTICS

- Supplied sterile. • Items per box: 10 • Maximum guidewire equals minimum tip I.D. • Closed end.
- Thin-wall construction.

PRODUCT DESCRIPTION

J.S. Lehman, MD, developed the Lehman™ ventriculography catheter. This catheter is specifically designed to be placed easily into the left ventricle via the aorta. The flexible, tapered distal tip is slightly curved to assist passage through the aortic valve and to sit freely in the contour of the left ventricle. This catheter provides excellent flow rates and catheter stability due to its thin-wall construction.



LEHMAN™ CATHETER

PRODUCT CODE	FRENCH SIZE	DESIGN STYLE	MINIMUM TIP I.D. (IN.)	LENGTH (CM)	COMMENTS
001253	5	Thin wall	0.032	50	No sideholes
001254	5	Thin wall	0.032	80	No sideholes
Pediatric item					

PEDIATRIC PRODUCTS

Goodale-Lubin™ Catheter Pediatric Woven Coronary Catheters

GENERAL CHARACTERISTICS

- Supplied sterile. • Items per box: 10 • Maximum guidewire equals minimum tip I.D. • Open end.
- Two laterally opposed sideholes. • Thin-wall or standard-wall construction.

PRODUCT DESCRIPTION

Walter T. Goodale, MD, and Martin Lubin, MD, developed standard-wall and thin-wall catheters similar to the Courmand™ and Lehman™ catheters in construction and tip curve.

The additional feature of the Goodale-Lubin™ catheter is the two laterally opposed sideholes just proximal to the tip for improved disbursement of contrast during right heart angiography.

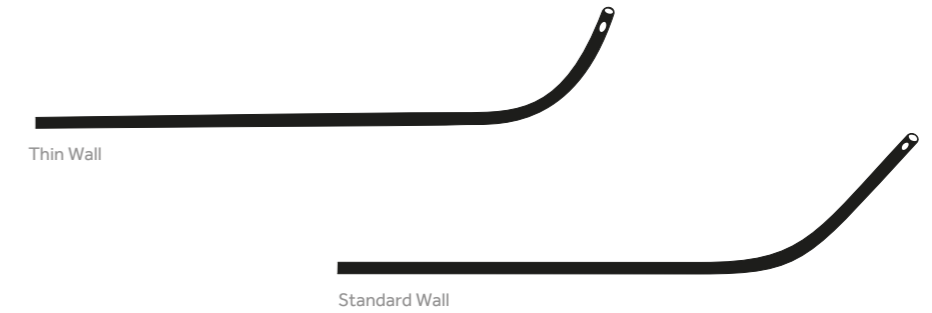

GOODALE-LUBIN™ CATHETER

PRODUCT CODE	FRENCH SIZE	DESIGN STYLE	MINIMUM TIP I.D. (IN.)	SIDEHOLES	LENGTH (CM)
001279	5	Thin wall	0.032	2	80
001453	5	Standard wall	0.026	2	50
Pediatric item					

PEDIATRIC PRODUCTS

Gensini™ Percutaneous Catheter Pediatric Woven Coronary Catheters

GENERAL CHARACTERISTICS

- Supplied sterile. • Items per box: 10 • Maximum guidewire equals minimum tip I.D. • Open end.
- Six sideholes. • Thin-wall construction.

PRODUCT DESCRIPTION

Goffredo G. Gensini, MD, is responsible for the first designed catheter with an open end hole. This catheter has a tapered tip that fits securely over a guidewire for percutaneous introduction.

The six sideholes and thin-wall construction provide maximum flow rates. The catheter is used for aortic, ventricular, pulmonary and large-venous contrast studies.



GENSINI™ PERCUTANEOUS CATHETER

PRODUCT CODE	FRENCH SIZE	DESIGN STYLE	MINIMUM TIP I.D. (IN.)	LENGTH (CM)	COMMENTS
001323 †	5	Thin wall	0.026	100	Use with 0.025 in. guidewire
001339 †	6	Thin wall	0.036	80	Use with 0.035 in. guidewire

† Pediatric item

PEDIATRIC PRODUCTS

NIH Pediatric Woven NIH Catheters

GENERAL CHARACTERISTICS

- Supplied sterile. • Items per box: 10 • Maximum guidewire equals minimum tip I.D. • Nylon core.
- Closed end. • Six sideholes. • Thin-wall construction.

PRODUCT DESCRIPTION

The NIH (National Institutes of Health) catheter is designed with a thin wall and nylon core construction to provide maximum flow rates and catheter stability.

The flexible tip makes positioning in the cardiopulmonary system easier. This catheter is used to visualize the aorta, ventricles, pulmonary vasculature and the great veins.

The flexible tip makes positioning in the cardiopulmonary system easier. This catheter is used to visualize the aorta, ventricle, pulmonary vasculature and the great veins.



NIH

PRODUCT CODE	FRENCH SIZE	DESIGN STYLE	SIDEHOLES	LENGTH (CM)
001348 †	5	Thin wall	6	50
001353 †	6	Thin wall	6	80

† Pediatric item

PEDIATRIC PRODUCTS

Pediatric NIH Pediatric Woven NIH Catheters

GENERAL CHARACTERISTICS

- Supplied sterile. • Items per box: 10 • Maximum guidewire equals minimum tip I.D. • Nylon core.
- Closed end. • Six sideholes (4F Catheter has four sideholes). • Thin-wall construction.

PRODUCT DESCRIPTION

This thin-walled catheter is designed to provide maximum flow and flexibility. The catheter can be used for aortic, ventricular, pulmonary and large-vein contrast studies.

The flexible tip makes positioning in the cardiopulmonary system easier. This catheter is used to visualize the aorta, ventricle, pulmonary vasculature and the great veins.



PEDIATRIC NIH

PRODUCT CODE	FRENCH SIZE	DESIGN STYLE	SIDEHOLES	LENGTH (CM)
001375 †	4	Thin wall	4	50
001377 †	5	Thin wall	6	50
001378 †	5	Thin wall	6	80
001380 †	6	Thin wall	6	50
001381 †	6	Thin wall	6	80
001382 †	6	Thin wall	6	100
† Pediatric item				

PEDIATRIC PRODUCTS

Pediatric Curved NIH Pediatric Woven NIH Catheters

GENERAL CHARACTERISTICS

- Supplied sterile. • Items per box: 10 • Maximum guidewire equals minimum tip I.D. • Nylon core.
- Closed end. • Six sideholes. • Thin-wall construction.

PRODUCT DESCRIPTION

This thin-walled catheter is designed to provide maximum flow and flexibility. The catheter can be used for aortic, ventricular, pulmonary and large-vein contrast studies.

The flexible tip makes positioning in the cardiopulmonary system easier. This catheter is used to visualize the aorta, ventricle, pulmonary vasculature and the great veins.



PEDIATRIC CURVED NIH

PRODUCT CODE	FRENCH SIZE	DESIGN STYLE	LENGTH (CM)
008761 †	5	Thin wall	65
008762 †	6	Thin wall	65
008763 †	7	Thin wall	80
† Pediatric item			

PEDIATRIC PRODUCTS

Pediatric NIH with Cardio-Marker Image Bands Pediatric Woven NIH Catheters

GENERAL CHARACTERISTICS

- Supplied sterile. • Items per box: 5 • Maximum guidewire equals minimum tip I.D. • Closed end.
- Six sideholes • Thin-wall construction.

PRODUCT DESCRIPTION

This thin-walled catheter is designed to provide maximum flow and flexibility. The catheter can be used for aortic, ventricular, pulmonary and large-vein contrast studies.

Band width: 1 mm.

Two marker bands 1 cm apart +/- 1/2 mm (leading edge to leading edge).



PEDIATRIC NIH WITH CARDIO-MARKER IMAGE BANDS

PRODUCT CODE	FRENCH SIZE	DESIGN STYLE	SIDEHOLES	LENGTH (CM)
010010	5	Thin wall	6	65
010011	6	Thin wall	6	80
010012	7	Thin wall	6	80

Pediatric item

PEDIATRIC PRODUCTS

Rashkind™ Recessed Balloon Catheter Pediatric Septostomy Balloon Catheters

GENERAL CHARACTERISTICS

- Supplied sterile. • Items per box: 1

PRODUCT DESCRIPTION

- Woven shaft design

- Shaft length: 50 cm



RASHKIND™ RECESSED BALLOON CATHETER

PRODUCT CODE	SHAFT SIZE (F)	RECOMMENDED INFLATED BALLOON DIAMETER (MM)	RECOMMENDED INTRODUCER (F)	COMMENTS
008764	6	14	6	Single lumen

Pediatric item

Rashkind™ is a registered trademark of William J. Rashkind, M.D.

PEDIATRIC PRODUCTS

Rashkind™ Balloon Catheter Single Lumen Pediatric Septostomy Balloon Catheters

GENERAL CHARACTERISTICS



• Supplied sterile. • Items per box: 1

PRODUCT DESCRIPTION

• Woven shaft design
• Shaft length: 50 cm



RASHKIND™ BALLOON CATHETER SINGLE LUMEN

PRODUCT CODE	SHAFT SIZE (F)	RECOMMENDED INFLATED BALLOON DIAMETER (MM)	RECOMMENDED INTRODUCER (F)	COMMENTS
007161 	4	11	7	Single lumen
007160 	5	12	8	Single lumen

 Pediatric item

Rashkind® is a registered trademark of William J. Rashkind, M.D.

PEDIATRIC PRODUCTS

Rashkind™ Balloon Catheter Double Lumen Pediatric Septostomy Balloon Catheters

GENERAL CHARACTERISTICS

• Supplied sterile. • Items per box: 1

PRODUCT DESCRIPTION

• Woven shaft design
• Shaft length: 50 cm



RASHKIND™ BALLOON CATHETER DOUBLE LUMEN

PRODUCT CODE	SHAFT FRENCH SIZE	RECOMMENDED INFLATED BALLOON DIAMETER (MM)	RECOMMENDED INTRODUCER (F)	COMMENTS
007158	5.5	14	9	Double lumen

 Pediatric item

PEDIATRIC PRODUCTS

Pediatric Mullins Transseptal Catheter Introducer Sheath

GENERAL CHARACTERISTICS

• Supplied sterile. • Maximum guidewire: 0.025" • Items per box: 1

PRODUCT DESCRIPTION

• Sets include one sheath and one dilator.
• For use with Pediatric Brockenbrough™ Needle.



Mullins Transseptal Catheter Introducer Sheath

PEDIATRIC MULLINS TRANSEPTAL INTRODUCER SHEATH

PRODUCT CODE	FRENCH SIZE	MAXIMUM WIRE SIZE (IN.)	SHEATH LENGTH (CM)	DILATOR LENGTH (CM)
008530 †	6	0.025	44	52
008531 †	7	0.025	44	52
008532 †	8	0.025	44	52

† Pediatric item

TRANSEPTAL PRODUCTS & ACCESSORIES

Mullins Transseptal Catheter Introducer Sheath

GENERAL CHARACTERISTICS

• Not supplied sterile. • Single-use device. • Items per box: 1

PRODUCT DESCRIPTION

Sets include one sheath and one dilator. Used with Brockenbrough™ needle, except where noted.
For use with Brockenbrough™ Needle.



Mullins Transseptal Catheter Introducer Sheath

MULLINS TRANSEPTAL CATHETER INTRODUCER SHEATH

PRODUCT CODE	FRENCH SIZE	MAXIMUM WIRE SIZE (IN.)	SHEATH LENGTH (CM)	DILATOR LENGTH (CM)
008550	6	0.032	59	67
008551	7	0.032	59	67
008552	8	0.032	59	67

For use with Brockenbrough™ Needle.

RENAL DENERVATION CATHETERS

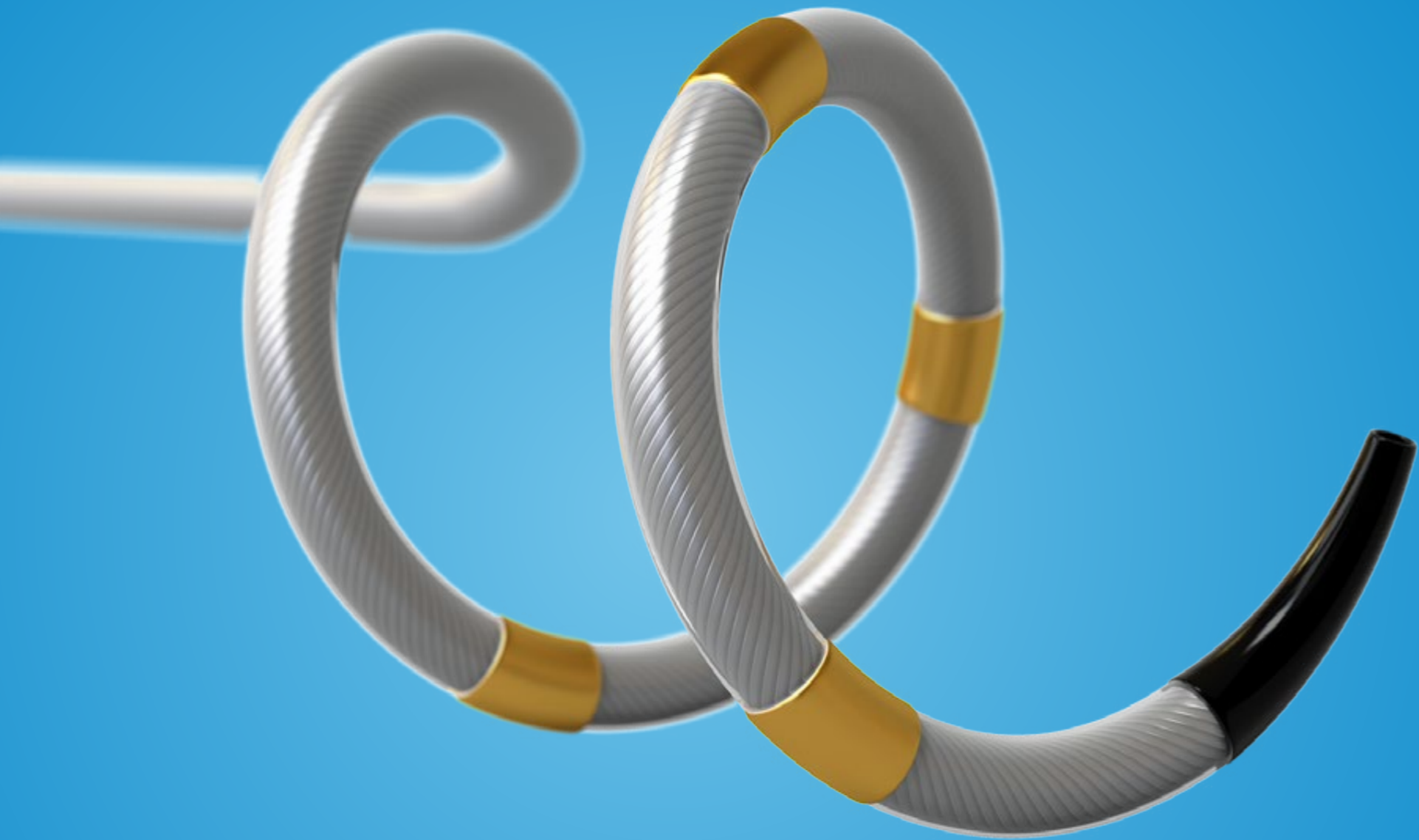

RENAL DENERVATION

Symplicity Spyral™ Multi-Electrode Renal Denervation Catheter

GENERAL CHARACTERISTICS

• Supplied sterile • Items per box: 1 • Label color: Orange.

PRODUCT DESCRIPTION

The Symplicity Spyral™ Multi-Electrode Catheter offers an improved renal denervation procedure. Consistent four-quadrant ablation pattern, self-expanding helical design conforms to a wide range of artery shapes and sizes (3-8mm) and a low 6F guide catheter compatibility, delivered over a standard 0.014" guidewire with rapid exchange system.



ORDERING CHART

CATALOG NUMBER	PRODUCT
RDN016	Symplicity Spyral™ Catheter
RDN017	Symplicity G3™ Generator, supplied standard with remote control
RDN019	Cart, Symplicity G3™ Generator Component
RDN012	Replacement foot switch
PRT075-XX	Replacement power cable (country-specific) (Contact Medtronic representative for catalog number)

Medtronic

Europe

Medtronic International Trading Sàrl.
Route du Molliau 31
Case postale
CH-1131 Tolochenaz
Tel: +41 (0)21 802 70 00
Fax: +41 (0)21 802 79 00

United Kingdom/Ireland

Medtronic UK Ltd.
Building 9
Croxley Park
Watford
Hertfordshire WD18 8WW
UK
www.medtronic.co.uk
Tel: +44 (0)1923 212213
Fax: +44 (0)1923 241004

UC201804901EE © 2017 Medtronic. All rights reserved.
Printed in Europe. Not for distribution in France.