

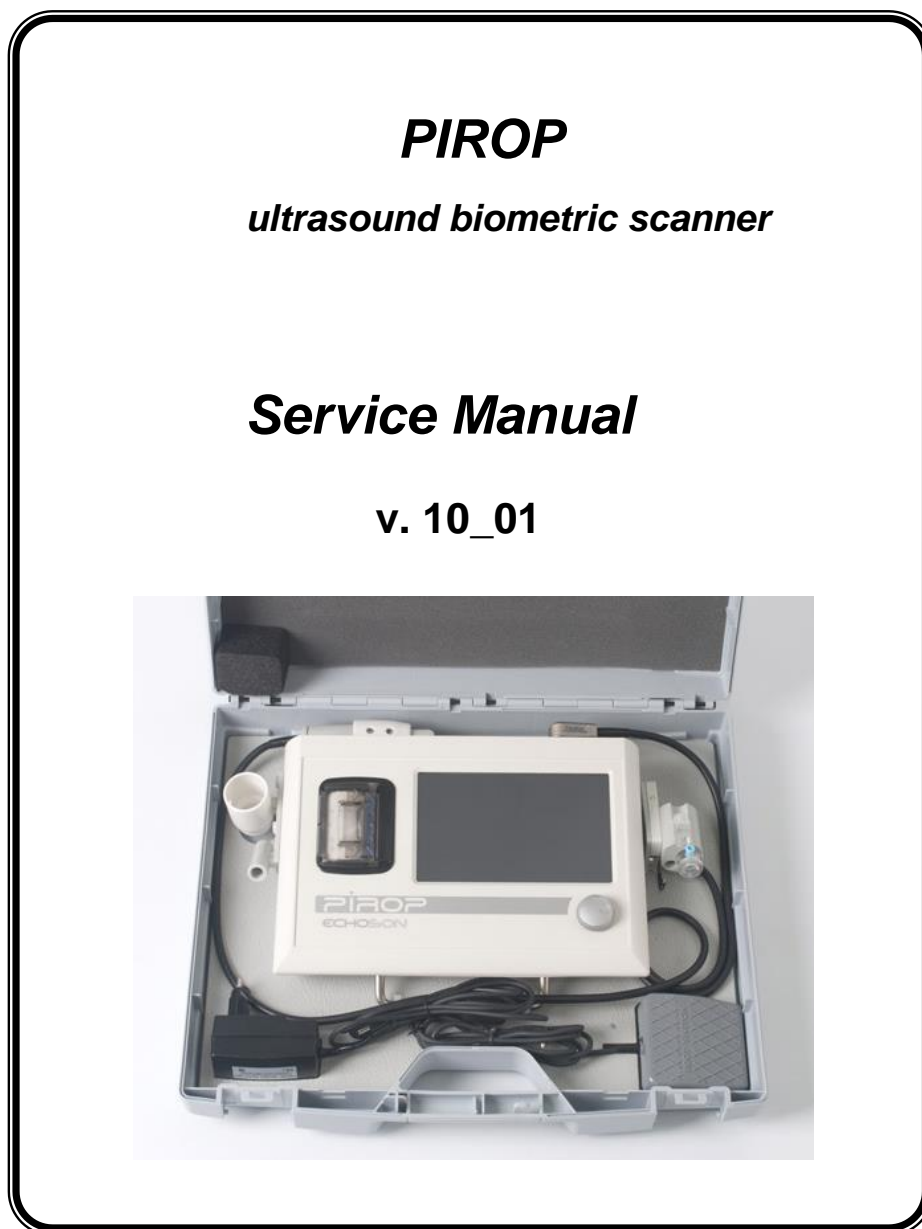

<b>SERVICE MANUAL</b>		File Service manual PIROP v.10_01. doc / pdf
 ul. Krancowa 5 24-100 Pulawy Poland tel. 0-48-81- 886 3613	Device <b>Ultrasound biometric scanner PIROP</b>	Version v.10_01
	Title	Date <b>16.05.2017</b>
		Page 1/40



Written by: J.Masiak	Checked by: R.Szpakowski	18-06-11	-1-
----------------------	--------------------------	----------	-----

<b>SERVICE MANUAL</b>		File Service manual PIROP v.10_01.doc / pdf
 ul. Krancowa 5 24-100 Pulawy Poland tel. 0-48-81- 886 3613	Device <b>Ultrasound biometric scanner PIROP</b>	Version v.10_01
	Title	Date <b>16.05.2017</b>
		Page 2/40

### **Manufacturer :**

ECHO - SON S.A.  
 ul. Krancowa 5  
 24-100 PUŁAWY  
 POLAND

### **Phone / Fax :**

0 - 48 - 81 - 8863613

### **E-mail :**

info@echoson.com.pl

### **WWW :**

[www.echoson.com.pl](http://www.echoson.com.pl)

Written by: J.Masiak	Checked by: R.Szpakowski	18-06-11	-2-
----------------------	--------------------------	----------	-----

<b>SERVICE MANUAL</b>		File Service manual PIROP v.10_01. doc / pdf
 ul. Krancowa 5 24-100 Pulawy Poland tel. 0-48-81- 886 3613	Device <b>Ultrasound biometric scanner PIROP</b>	Version v.10_01
	Title	Date <b>16.05.2017</b>
		Page 3/40

## CONTENTS :

<b>1. INTRODUCTION .....</b>	<b>5</b>
1.1. General .....	5
1.2. Configurations of PIROP system (optional).....	5
1.3. Optional equipment of PIROP system .....	5
1.4. System components .....	5
1.5. Ultrasound probes.....	6
1.6. Specification of PIROP system .....	7
<b>2. SAFETY .....</b>	<b>13</b>
2.1. General Safety Precautions.....	13
2.2. Acoustic Safety.....	14
2.3. Labels and Icons .....	15
2.4. How to handle the ultrasound probes .....	16
<b>3. THE "PIROP" SYSTEM OVERVIEW .....</b>	<b>20</b>
3.1. System configuration.....	20
3.2. Main unit block diagram .....	21
3.3. Probe interface .....	22
3.4. Tx/Rx board.....	22
3.5. CPU board.....	23
3.6. LCD interface board .....	24
3.7. Power supply board .....	24
3.8. Ultrasound probe.....	24
<b>4. THE "PIROP" SYSTEM MODULES AND CONNECTIONS.....</b>	<b>26</b>
4.1. List of PIROP internal modules .....	26
4.2. Internal modules arrangements .....	27
4.3. Internal modules connections.....	28
<b>5. SOFTWARE UPDATE (v.20) .....</b>	<b>29</b>
5.1. General note: .....	29
5.2. Update files:.....	29
5.3. USB memory preparation: .....	29
5.4. Procedure of the software update.....	29
5.5. Procedure of the software update - EMERGENCY MODE.....	30
<b>6. TABLE OF SPARE PARTS.....</b>	<b>32</b>
<b>7. REPLACEMENT PROCEDURES .....</b>	<b>33</b>
7.1. DISASSEMBLING PROCEDURE.....	33
7.2. THE LCD SCREEN REPLACEMENT PROCEDURE .....	35
7.3. REPLACING THE PRINTER PAPER .....	36
<b>8. SYSTEM TESTING.....</b>	<b>37</b>
8.1. General system checkout .....	37
8.2. TEST – pachymeter testing .....	37
8.3. CALIBRATION – testing the scanner in the A-scan mode .....	38

Written by: J.Masiak	Checked by: R.Szpakowski	18-06-11	-3-
----------------------	--------------------------	----------	-----

<b>SERVICE MANUAL</b>		File Service manual PIROP v.10_01.doc / pdf
 ul. Krancowa 5 24-100 Pulawy Poland tel. 0-48-81- 886 3613	Device <b>Ultrasound biometric scanner PIROP</b>	Version v.10_01
	Title	Date <b>16.05.2017</b>
		Page 4/40

**9. TROUBLESHOOTING..... 40**

Written by: J.Masiak	Checked by: R.Szpakowski	18-06-11	-4-
----------------------	--------------------------	----------	-----

<b>SERVICE MANUAL</b>		File Service manual PIROP v.10_01.doc / pdf
 ul. Krancowa 5 24-100 Pulawy Poland tel. 0-48-81- 886 3613	Device <b>Ultrasound biometric scanner PIROP</b>	Version v.10_01
	Title	Date <b>16.05.2017</b>
		Page 5/40

# 1. INTRODUCTION

- This service manual applies to **PIROP** ultrasound biometric scanner
- Please read this instruction before any service procedures
- This service manual is intended for persons trained by manufacturer.

## 1.1. General

The **PIROP** in ophthalmology application - state-of-the-art ophthalmic ultrasonic device for Pachymetry and Ocular Biometry.

**PACHYETER - Ocular Cornea biometrics** Modern, ultrasonic pachymeter (cornea thickness biometrics) that uses a very high sampling frequency - 400 MHz - a significant increase in measurement accuracy.

**A-SCAN - Ocular Lens biometrics** Modern digital 'A-scan' tool for ophthalmology, biometry and lens power calculation for intra-ocular implants.

## 1.2. Configurations of PIROP system (optional)

- PIROP can works with two probes :
  - a) Pachymeter – probe OP-20
  - b) A-scan – probe OA-12
  - c) B-scan – probe OB-12

## 1.3. Optional equipment of PIROP system

- USB memory (Pen drive)

## 1.4. System components

The system **PIROP** comprise the following components :

1. main unit „PIROP” with 7" VGA and "touch-screen"
2. ultrasound probe OP-20
3. external power supply adapter ( 100...230V AC / 12 V DC , 2A )
4. transport suitcase
5. user guide
6. pointer

Written by: J.Masiak	Checked by: R.Szpakowski	18-06-11	-5-
----------------------	--------------------------	----------	-----

<b>SERVICE MANUAL</b>		File Service manual PIROP v.10_01.doc / pdf
 ul. Krancowa 5 24-100 Pulawy Poland tel. 0-48-81- 886 3613	Device <b>Ultrasound biometric scanner PIROP</b>	Version v.10_01
	Title	Date <b>16.05.2017</b>
		Page 6/40

**The PIROP system :**



## **1.5. Ultrasound probes**

The PIROP works with probes :

Item	Probe type	Probe operating frequency	Probe code
1	pachymeter	20 MHz	OP-20
2	A-scan	12MHz	OA-12
3	B-scan	12 MHz	OB-12

Written by: J.Masiak	Checked by: R.Szpakowski	18-06-11	-6-
----------------------	--------------------------	----------	-----

<b>SERVICE MANUAL</b>		File Service manual PIROP v.10_01.doc / pdf
 ul. Krancowa 5 24-100 Pulawy Poland tel. 0-48-81- 886 3613	Device <b>Ultrasound biometric scanner PIROP</b>	Version v.10_01
	Title	Date <b>16.05.2017</b>
		Page 7/40

## 1.6. Specification of PIROP system

### General properties:

- **PIROP - State-of-the-art ultrasonic Ophthalmic scanner for Pachymetry and Ocular Biometry (A+ P+ B scan).**
- Three operation modes:
  1. **A-SCAN - Ocular Lens biometrics.** Digital 'A-scan' tool for ophthalmology, biometry and lens power calculation for intra-ocular implants.
  2. **B-SCAN - Digital 'B-scan'** tool for ophthalmology, imaging of interior of an eyeball, retina, optical nerve ..
  3. **P-scan - PACHYETER - Ocular Cornea Thickness Biometrics.** Ultrasonic pachymeter (cornea thickness biometrics) that uses a very high sampling frequency - 400 MHz - a significant increase in measurement accuracy.
- Easy and intuitive operation via **touch screen** – modern, user friendly Graphical Interface
- Quick Start (about 3 sec)
- Ergonomically and lightweight design: compact casing with Color LCD, Touch Screen and built-in Printer
- Colour LCD panoramic 16:9 screen, size 7", 800 x 480 pixels
- Probe operating frequency: 12 /15/ 20 MHz
- Composite-video output PAL (option) - external optional video monitor 10" - 32" (or more)
- Probe holders
- Run/Freeze: Foot Switch or touch screen activated
- Adjusting the monitor brightness
- Built-in internal calendar & clock (date and time)
- Composite-video output PAL (option)
- Entering a patient and operator data using the touch screen keyboard
- Internal patient's database
- Ability to choose up to 10 different user profiles (operators)
- Integrated internal memory for archive
- Storing measurement results and ultrasound images on internal memory and on USB memory stick (Pen drive).
- The possibility of printing the results of measurement on the built-in small thermal printer
- The possibility to print on the supplied printer the measurement results of the images from the archive (USB memory)
- Footswitch
- Ready to use also in transport suitcase
- Trolley – option
- Easy firmware software upgrade via a USB memory
- Possibility of introducing changes according to specific user diagnosis requirements .

### Application A-scan:

- Complete and quick biometry :
  - eye axial length /AXL/,
  - anterior chamber depth /AC/,

Written by: J.Masiak	Checked by: R.Szapkowski	18-06-11	-7-
----------------------	--------------------------	----------	-----

<b>SERVICE MANUAL</b>		File Service manual PIROP v.10_01.doc / pdf
 ul. Krancowa 5 24-100 Pulawy Poland tel. 0-48-81- 886 3613	Device <b>Ultrasound biometric scanner PIROP</b>	Version v.10_01
	Title	Date <b>16.05.2017</b>
		Page 8/40

- lens thickness /LENS/,
- vitreous length /VITR/
- Calculation of the arithmetic mean of AXL, AC, LENS, VITR measurements
- Calculation of the standard deviation for AXL measurements
- Two Automatic modes of work, each with 10 measurements
- Measurements using individual zone velocities
- Adjustable velocities for each segment and pseudophakic materials
- Automatic control of measurement scatters (with manual correction)
- Measurement Range:
  - AXL: 15 mm to 35 mm
  - AC: 1,8 mm to 6 mm
  - LENS: 1,5 mm to 6,5 mm
- Measurements of all eye types:
  - Normal,
  - Cataract,
  - Dense Cataract,
  - Silicone Oil Vitreous,
  - Aphakic,
  - Pseudoaphakic /PMMA,
  - Pseudoaphakic / Acrylate,
  - Pseudoaphakic / Silicone
- IOL six formulas:
  - SRK II,
  - SRK T,
  - Holladay,
  - Hoffer-Q,
  - Binkhorst II,
  - Haggis
- Post refractive formulas :
  - Double-K SRKT,
  - Latkany / Flat-K SRKT/,
  - Latkany /avg-K SRKT/,
  - Masket
- Contact and immersion methods
- Immersion shell for probe OA12
- Probe frequency – 12 MHz
- Probe with central light beam for correct eye positioning
- Memory of 20 scans with measurements for further analysis
- Easy review and sort post-operative results
- Entering parameters of artificial lenses – 10 types for each user
- Lens Database
- Automatically or Manually optimize Lens Constants for formulas.
- Customizable for 10 users, 10 profiles for each.
- Automatic TGC adjustment, GAIN adjustment (up to 110 dB)
- Range of scan 40 mm
- Clinical resolution 0.1 mm
- Electronic resolution –/+ 0.01 mm
- Adjusting and test via attached calibrator

Written by: J.Masiak	Checked by: R.Szpakowski	18-06-11	-8-
----------------------	--------------------------	----------	-----



<b>SERVICE MANUAL</b>		File Service manual PIROP v.10_01.doc / pdf
 ul. Krancowa 5 24-100 Pulawy Poland tel. 0-48-81- 886 3613	Device <b>Ultrasound biometric scanner PIROP</b>	Version v.10_01
	Title	Date <b>16.05.2017</b>
		Page 9/40

### **Application B-scan:**

- Display modes :
  - B,
  - B+A, (B-Scan with simultaneous selectable vector A-Scan)
  - B+B
- Probe frequency - 12 MHz /15 MHz ; focused transducer
- Clinical resolution (axial) 0.12 mm
- Clinical resolution (lateral) 0.3 mm
- Scanning method: Sector
- Scanning angle 55°
- Scan depth: 20 - 60 mm (5 steps)
- Scan refresh rate - 12 frame / sec
- CV vector in Run and Freeze modes
- Automatic TGC adjustment
- Gain/dynamics up to 110dB
- 256 Levels Gray scale
- Dynamic Range Correction
- Image processing (sharp, smooth, brightness etc.)
- Four image memory B (cache memory) independent for right and left eyes
- Cache memory markers
- Measurements/calculations and annotations on snapshot playback
- Zoom function (x2) in Run and Freeze modes
- Controlling position the Zoom ROI
- Digital Gain Correction in Freeze mode
- Cine memory - Cineloop function ( about 6 second) independent for left/right eyes
- 2 distances measurements with ultrasound velocity correction
- Axial distance measurement with ultrasound velocity correction
- Area measurement- draw method
- Comments entered by the user (4 text comment lines)
- Pointers (arrows)
- Sound velocity correction (adjustment range from 1400 to 2000 m/s)
- User setup for B-mode ( Gain, CV on/off, Range, Display mode)
- Self test in B-mode for checking the probe and software algorithm
- Composite video output for video printer - option

### **Application Pachymeter P-scan:**

- Quick measurements of thickness for all corneal types
- Measurement of thickness at arbitrarily selected points of the corneal surface
- Automatic and manual measurements
- Calculation of the mean; standard deviation of the measured thickness
- Ability for rejecting uncorrected measurements
- Sophisticated algorithms for the accuracy improvement
- Very high frequency for measuring purpose- 400 MHz sampling rate
- High averaging ratio - 512 automatic measurements cycles.
- Intra-ocular pressure (IOP) calculations with measuring and/or manual correction
- Five IOP correction formulas : (Kohlhas/Shah, Herndon/ Doughty, Whitacre et al., Ehlers et al., custom - own)
- BIAS percentage deviation of the measured thickness from 60% to 130%

Written by: J.Masiak	Checked by: R.Szpakowski	18-06-11	-9-
----------------------	--------------------------	----------	-----

<b>SERVICE MANUAL</b>		File Service manual PIROP v.10_01.doc / pdf
 ul. Krancowa 5 24-100 Pulawy Poland tel. 0-48-81- 886 3613	Device <b>Ultrasound biometric scanner PIROP</b>	Version v.10_01
	Title	Date <b>16.05.2017</b>
		Page 10/40

- 20 MHz operating frequency of the probe
- Direct contact probe
- Digital receiver 12 bit
- Default sound velocity - 1640 m/s (adjustment range from 1400 to 2000 m/s)
- Measurement range from 220 µm to 1100 µm
- Measuring accuracy < ± 2 µm
- Resolution 1 µm
- Nine maps of corneal thickness with the number of points: 1, 5, 9, 13, 21, 25, 1 MULTI, 5 MULTI, 9 MULTI
- Test Function for automatic checking the correctness of operation (without using external phantoms or patterns)

#### **Archiwe:**

- Build-in thermal printer to print measurement results in P and A application
- External video printer (print in gray scale)
- Printed values: screenshot, results of measurements, patient name, operator name, date and time.
- Images and measurements can be stored in build-in Internal memory (screenshot).
- Patients folders
- Apart from the image itself archive file contains full information of the measurement, image parameters, patient data etc.
- Internal memory to save images and measurements in all applications
  - Image file: BMP (24bit) formats 800 x 480 resolution (up to 8000 images)
  - Possibility to display images from internal memory
  - Possibility to delete selected image in internal memory
  - Possibility to export data from internal to external USB memory to display saved images on any PC computer
  - Possibility to print report from saved images on supplied thermal printer
  - Possibility to erase all internal memory

#### **Ultrasound probes:**

- Dedicated sector probe, scanning angle 55° for B-scan application
- Probe operating frequency :
- A-Scan : 12MHz
- B-Scan: 12/15 MHz
- P-scan: 20 MHz

#### **Dimensions and weight:**

- Dimensions: 290 x 205 x 85 mm
- Weight (with built-in printer): 1.4 kg
- Overall weight (with transport suitcase) : ~ 2.6 kg

Written by: J.Masiak	Checked by: R.Szpakowski	18-06-11	-10-
----------------------	--------------------------	----------	------

<b>SERVICE MANUAL</b>		File Service manual PIROP v.10_01.doc / pdf
 ul. Krancowa 5 24-100 Pulawy Poland tel. 0-48-81- 886 3613	Device <b>Ultrasound biometric scanner PIROP</b>	Version v.10_01
	Title	Date <b>16.05.2017</b>
		Page 11/40

### Supply :

- External AC/DC adaptor : input : 100 - 230 V AC  
output : +12V DC ( 2 A)
- Power consumption : about 11 W

### Enviromental conditions :

- Temperature : 10°- 40 °C
- Relative humidity : 30% - 85%

### Electrical safety standards :

- Medical device class IIa comply with Medical Devic Directive 93/42 EEC
- Scanner complies with requirements for Class II devices of EN/IEC 60601-1
- Medical Device Directive 93/42 EEC
- EMC Directive 89/336/EEC
- Electromagnetic Compatibility EN 60601-1-2
- Electrical Safety EN 60601

### Approvals :

- CE marking

### Acoustic safety standards :

- Acoustic safety : EN 60601-2-37 : 2007  
All the probes foreseen to be used with Echo-Son systems PIROP meet the requirements of the Thermal Index TI and the Mechanical Index MI published by the Food and Drug Administration - USA and the International Electro-technical Commission IEC – International Standard 1157.

### Liquid Ingress Protection:

- Scanner, printer, charger :  
**IPX0** - (ordinary equipment without protection against ingress of water)
- Probes ( position of the probe during the patient's examination):  
✓ OA 12 (A-Scan) - **IPX1** – dripping water (vertically falling drops) shall have no harmful effect

Written by: J.Masiak	Checked by: R.Szapkowski	18-06-11	-11-
----------------------	--------------------------	----------	------

<b>SERVICE MANUAL</b>		File Service manual PIROP v.10_01.doc / pdf
 ul. Krancowa 5 24-100 Pulawy Poland tel. 0-48-81- 886 3613	Device <b>Ultrasound biometric scanner PIROP</b>	Version v.10_01
	Title	Date <b>16.05.2017</b>
		Page 12/40

- ✓ OB 12 (B-Scan) - **IPX1** – dripping water (vertically falling drops) shall have no harmful effect
- ✓ OP 20 (P -scan) - **IPX3** – water falling as a spray at any angle up to 60° from the vertical shall have no harmful effect.

- Position of the cleaning and disinfection of the probe.:  
**IPX1** – do not submerge the probe in any liquid deeper than shown in Fig - *permissible level of submersion*



Written by: J.Masiak	Checked by: R.Szpakowski	18-06-11	-12-
----------------------	--------------------------	----------	------

<b>SERVICE MANUAL</b>		File Service manual PIROP v.10_01.doc / pdf
 ul. Krancowa 5 24-100 Pulawy Poland tel. 0-48-81- 886 3613	Device <b>Ultrasound biometric scanner PIROP</b>	Version v.10_01
	Title	Date <b>16.05.2017</b>
		Page 13/40

## 2. SAFETY

**WARNING** - describes precautions necessary to prevent injury or loss of life

**CAUTION** - describes precautions necessary to protect the products

### 2.1. General Safety Precautions

The bladder volume scanner PIROP is specified as Class II equipment under standards of EN 60601-1 (Safety and Medical Equipment).



#### **WARNINGS:**

- The equipment has no waterproof features. Do not use this equipment in any place with the possibility of water ingress. There is a risk of electric shock if any water is sprayed on or into the equipment.
- To avoid the risk of electrical shock, all plugs, and power cord must always be completely dry and not damaged.
- This equipment is forseen for medical diagnostics only. It must be operated by qualified personel.
- To avoid the risk of electrical shock, before using the probes, inspect the probes faces, housings and cables. Do not use the probe, if the probe or cable have vissible damages.
- Do not operate the system in the presence of flammable gasses or anesthetics.
- If you have experienced any trouble with the equipment, switch it off immediately and contact ECHO-SON S.A. technical service.
- Assembling/disassembling is allowed only by qualified personnel (technical service)
- **It is forbidden to carry out any repairs or modifications of the equipment, probes and accessories by unauthorized persons. Echo-Son S.A do not take responsibility for any claims on its products, repaired or serviced by others as the manufacturer or authorized by him personel**

Written by: J.Masiak	Checked by: R.Szpakowski	18-06-11	-13-
----------------------	--------------------------	----------	------

<b>SERVICE MANUAL</b>		File Service manual PIROP v.10_01.doc / pdf
 ul. Krancowa 5 24-100 Pulawy Poland tel. 0-48-81- 886 3613	Device <b>Ultrasound biometric scanner PIROP</b>	Version v.10_01
	Title	Date <b>16.05.2017</b>
		Page 14/40

**CAUTIONS :**

- The ultrasound main unit and the probe must be kept and used in environment with temperature between 10°C and 40°C. Humidity should be between 30% and 85%.
- The probe can be plugged in, only when the equipment is switched off or in „FREEZE” mode.
- Do not try to use probes from other manufacturers
- Both, the main unit and the probe must be kept clean - especially all remains of the contact gel must be removed. Keep the main unit clean, using simple detergents ( i.e: the same as for washing dishes ). About cleaning probes read point 2.4.
- Do not place any objects on the LCD screen.
- Always keep the equipment dry. Avoid transporting it quickly from a cold place to a warm place, otherwise condensation of water drops may cause short circuits. In such a necessity do not plug in the system, until the temperatures of the system and the environment will be equal.
- Although ultrasound system has been manufactured in compliance with existing EMI/EMC requirements, use of the system in the presence of an electromagnetic field can cause degradation of the ultrasound image. If this occurs often, ECHO-SON S.A. suggests to identify and remove the possible sources of the disturbances or move your system to an other place.

## **2.2. Acoustic Safety**

The PIROP scanner is not able to exceed value 1.0 for Mechanical Index (MI) and for Thermal Index (TIS) .

There is no need to display index values MI and TIS.

Written by: J.Masiak	Checked by: R.Szpakowski	18-06-11	-14-
----------------------	--------------------------	----------	------

<b>SERVICE MANUAL</b>		File Service manual PIROP v.10_01.doc / pdf
 ul. Krancowa 5 24-100 Pulawy Poland tel. 0-48-81- 886 3613	Device <b>Ultrasound biometric scanner PIROP</b>	Version v.10_01
	Title	Date <b>16.05.2017</b>
		Page 15/40

### 2.3. Labels and Icons



- Danger Voltage. Caution: To reduce the risk of electric shock, do not remove cover. Refer servicing to qualified service personnel



- see User Manual



- Mains power ON



- Mains power OFF



- Do not throw the weared ot device to the home waste



- BF - type equipment – probe



- Class II insulation



- USB connector

Written by: J.Masiak	Checked by: R.Szpakowski	18-06-11	-15-
----------------------	--------------------------	----------	------

<b>SERVICE MANUAL</b>		File Service manual PIROP v.10_01.doc / pdf
 ul. Krancowa 5 24-100 Pulawy Poland tel. 0-48-81- 886 3613	Device <b>Ultrasound biometric scanner PIROP</b>	Version v.10_01
	Title	Date <b>16.05.2017</b>
		Page 16/40

## 2.4. How to handle the ultrasound probes

### **AUTOMATIC SERVO SYSTEM FOR SECTOR PROBES :**

The unit is equipped with automatic servo system for mechanical convex probes. This system set up optimal frame rate for each scan depth.

Important notice: when new or not used in long time probe is connected to the unit, the servo system need a some time (several seconds) to set up optimal frame rate.

In this case, when the image is "unstable" the user should wait about 30 seconds until servo system set up the optimal frame rate.

During normal operation the servo system works in background, and it is invisible for the user.

### **CARE AND USE OF PROBES**



#### **WARNINGS :**

- To avoid the risk of electrical shock, before using the probes, inspect the probes face, housing and cable.  
**Never use damaged or faulty probes.**
- To maintain the required safety of the transducer, its plug must be always completely dry.
- The ultrasound probes may be damaged or even destroyed when are improperly handled.

#### **CAUTIONS :**

To avoid damage or destruction of the very delicate equipment, the following rules must be strictly followed:

- Do not expose the probes to shocks or strokes
- **Always keep the probes in special holders attached to the scanner**
- Especially protect the front part of the probe against any damage
- Do not twist or stretch the probe cable
- Do not expose the probes to temperatures exceeding +50 degrees Centigrade and below minus 20 degrees. If ultrasound probes were cooled below 0°C, keep them in the room temperature (about 20°C) approximately 2 hours before use. Noncompliance of foregoing notice may damage the probe.
- Do not expose the probes to the pressure different from atmospheric pressure
- Before each usage of the probe check if it's free from visible damages on the part which is in contact with patient's body, on the cover or cable

Written by: J.Masiak	Checked by: R.Szapkowski	18-06-11	-16-
----------------------	--------------------------	----------	------



<b>SERVICE MANUAL</b>		File Service manual PIROP v.10_01.doc / pdf
 ul. Krancowa 5 24-100 Pulawy Poland tel. 0-48-81- 886 3613	Device <b>Ultrasound biometric scanner PIROP</b>	Version v.10_01
	Title	Date <b>16.05.2017</b>
		Page 17/40

- Do not submerge the probe in any liquid deeper than shown in Fig. 1 presenting the permissible level of probe submerging (Fig. 1).

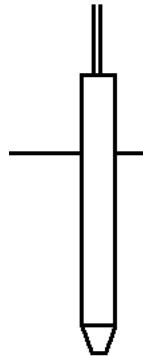

Fig. 1  
Permissible level of submersion

- Do not allow for contact with inadequate gels or cleaning agents
- Do not wet or submerge the probe with liquids containing alcohol, ammonia, perhydrol, e.t.c.
- Avoid the contact of the probe with solutions and gels containing mineral oil, olive oil, lanoline, polyethylene glykol, dimethylene silikon, derivatives of ethyl and methyl
- The use of inadequate gel e.g. EKG gel may result in deterioration of examination results or malfunction of the probe
- Use only ultrasound gels, having necessary certificates
- Avoid leaving gel on the probe. Wipe off the gel after each usage of the probe.

#### PROBE CLEANING :

**Careful cleaning and disinfecting of the used probes prevents spreading of diseases.**

**The User is responsible for the recommended anti infection procedures .**

1. Remove gel from the probe after each use using soft cloth or a towel and by rinsing carefully with water
2. **The probe body and the cable should be washed with the solution of soft soap using soft brush, sponge or cloth**
3. Do not use detergents or aggressive cleaning agents
4. After washing wipe the probe with soft cloth moistened in clean possibly demineralised water

Written by: J.Masiak	Checked by: R.Szpakowski	18-06-11	-17-
----------------------	--------------------------	----------	------

<b>SERVICE MANUAL</b>		File Service manual PIROP v.10_01.doc / pdf
 ul. Krancowa 5 24-100 Pulawy Poland tel. 0-48-81- 886 3613	Device <b>Ultrasound biometric scanner PIROP</b>	Version v.10_01
	Title	Date <b>16.05.2017</b>
		Page 18/40

5. Dry the probe with air or soft cloth



**WARNING :**

- Be sure to keep the probe plug dry all the times

**DISINFECTION OF THE PROBES**

After cleaning procedures as described above, it is possible to carry out the disinfection of the probe by submerging it as shown on Fig. 1 in 2% solution of glutaren aldehyde or by sprinkling it with this solution

-CIDEX , CIDEZYME – manufacturer: Johnson&Johnson,

-LYSOFORMIN 3000 – manufacturer: Lysoformin,

-SEKUSEPT , SEKUCID – manufacturer: Henkel Ekolab.



**WARNING :**

The remains of bactericidal agent rinse with clean, possibly distilled water

**GAS STERILISATION - CAUTION: It is not recommended to use gas sterilization**

The correct way of winding the probe cable



Written by: J.Masiak	Checked by: R.Szpakowski	18-06-11	-18-
----------------------	--------------------------	----------	------

<b>SERVICE MANUAL</b>		File Service manual PIROP v.10_01.doc / pdf
<b>ECHOSON</b> ul. Krancowa 5 24-100 Pulawy Poland tel. 0-48-81- 886 3613	Device <b>Ultrasound biometric scanner PIROP</b>	Version v.10_01
	Title	Date <b>16.05.2017</b>
		Page 19/40

Permissible level of submersion



#### EMISSION OF ULTRASOUND WAVES

Even if it is known, that ultrasound waves do not cause significantly changes in the mammal tissues, the user of the ultrasound device has to consider eventual possibilities of incidental biological effects, which can appear. Therefore, you should limit the time of examination to a minimum.

Written by: J.Masiak	Checked by: R.Szapkowski	18-06-11	-19-
----------------------	--------------------------	----------	------

<b>SERVICE MANUAL</b>		File Service manual PIROP v.10_01.doc / pdf
 ul. Krancowa 5 24-100 Pulawy Poland tel. 0-48-81- 886 3613	Device <b>Ultrasound biometric scanner PIROP</b>	Version v.10_01
	Title	Date <b>16.05.2017</b>
		Page 20/40

### 3. THE "PIROP" SYSTEM OVERVIEW

#### 3.1. System configuration

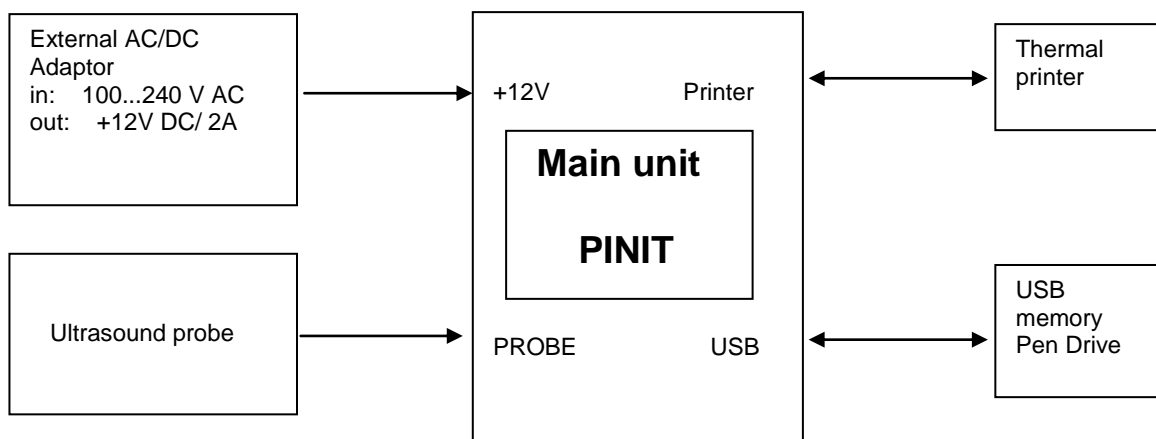

- External AC/DC Adaptor : use only GS25E12-P1J type supplied by manufacturer ECHO-SON , do not repair , contact with ECHO-SON if needed

Adaptor parameters:      - input : 100...240 V / 0.7A  
                                      - output : 12V / 2A (max. 25W)

- Thermal Printer : use only CUSTOM My Printer , model PCMY-U88

- Ultrasound probe : type OP-20, OA-12 , OB-12, supplied by manufacturer ECHO-SON , do not repair , contact with ECHO-SON S.A. if needed

- USB memory : Kingston pen-drives recommended

Written by: J.Masiak	Checked by: R.Szpakowski	18-06-11	-20-
----------------------	--------------------------	----------	------

<b>SERVICE MANUAL</b>		File Service manual PIROP v.10_01.doc / pdf
 ul. Krancowa 5 24-100 Pulawy Poland tel. 0-48-81- 886 3613	Device <b>Ultrasound biometric scanner PIROP</b>	Version v.10_01
	Title	Date <b>16.05.2017</b>
		Page 21/40

### 3.2. Main unit block diagram

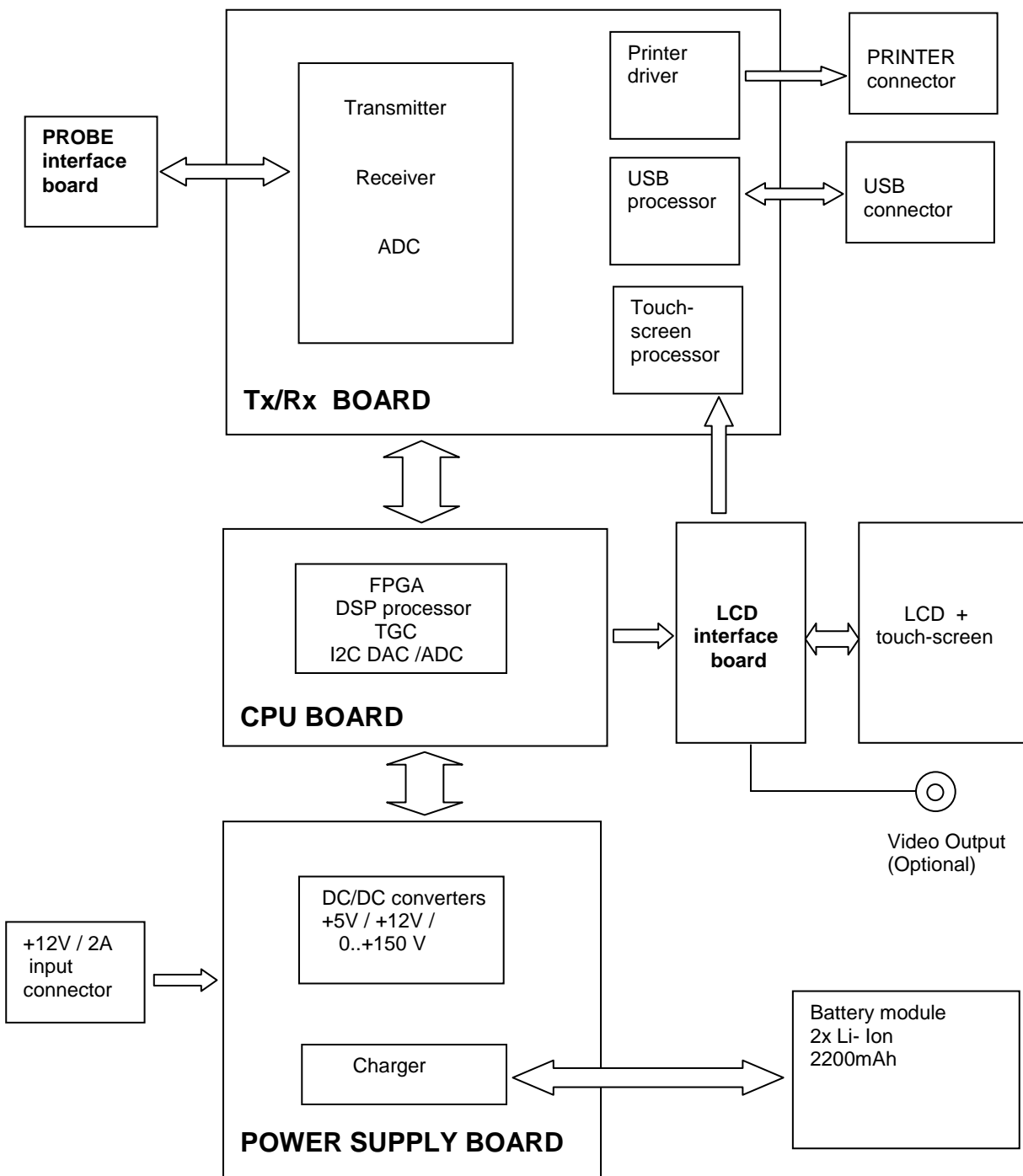

Written by: J.Masiak	Checked by: R.Szpakowski	18-06-11	-21-
----------------------	--------------------------	----------	------

<b>SERVICE MANUAL</b>		File Service manual PIROP v.10_01.doc / pdf
 ul. Krancowa 5 24-100 Pulawy Poland tel. 0-48-81- 886 3613	Device <b>Ultrasound biometric scanner PIROP</b>	Version v.10_01
	Title	Date <b>16.05.2017</b>
		Page 22/40

### **3.3. Probe interface**

The probe interface board allow to connect different signals from ultrasound probe to the system. The board include protection elements which protect system against ESD shocks.

### **3.4. Tx/Rx board**

#### **3.4.1. Transmitter**

The transmitter circuit transmitt short ultrasound pulse to ultrasound probe . The probe contains ultrasoud transducer , which convert electrical pulse to acoustic wave .

Pulse amplitude , frequency and number of transmitted periods depends on CPU settin gs.

#### **3.4.2. Receiver**

Acoustic signal reflected in the body is converted to electrical in the same ultrasound transducer which is used to pulse transmission. The receiver circuit amplifies and filters signal to desirable level . The same circuit (VGA) makes TGC compensation. The signal after VGA amplifier goes to the high-speed ADC converter.

#### **3.4.3. ADC converter**

ADC high-speed 12-bits converter changes analog signal to digital. This conversion is make in RF domain . Digital signal goes to FPGA chip on the CPU board to further processing.

#### **3.4.4. Printer driver**

The printer driver (MAX3232E) changes the voltage level of signals from LV-TTL to RS-232 , and protect the system against ESD shocks.

#### **3.4.5. USB processor**

The USB processor (Vinculum I) allows to connect USB Pen-Drive memory to CPU . CPU exchanges data with USB processor via fast paralell interface.

#### **3.4.6. Touch screen processor**

Touch screen processor (ATmega8) process the position signals from touch-screen and allow to read touch point coordinatates by CPU processor via serial interface.

Written by: J.Masiak	Checked by: R.Szpakowski	18-06-11	-22-
----------------------	--------------------------	----------	------

<b>SERVICE MANUAL</b>		File Service manual PIROP v.10_01.doc / pdf
 ul. Krancowa 5 24-100 Pulawy Poland tel. 0-48-81- 886 3613	Device <b>Ultrasound biometric scanner PIROP</b>	Version v.10_01
	Title	Date <b>16.05.2017</b>
		Page 23/40

## **3.5. CPU board**

### **3.5.1. FPGA chip**

The main function of FPGA chip (ALTERA , Cyclone II series) is make an connections between different components in the system and digital signal processing for ultrasound signal .

Signal processing is make in RF domain (radio frequency) and contains :

- digital band-pass filtering
- digital I/Q demodulation
- digital envelope detection
- digital LOG function

### **3.5.2. DSP processor**

The DSP processor performs the following functions :

- system control , read a touch-point positions from touch-screen processor , support buttons and display appropriate menu on the screen
- continuous service of LCD display in background
- control motor voltage for ultrasound probe
- makes an advanced measurements and calculations (i.e. bladder volume algorithms)
- receives processed ultrasound data from FGPA
- makes a scan conversion from rectangular to polar coordinates
- display processed ultrasound data on the LCD

### **3.5.3. TGC**

The main function of the TGC signal is dynamic compensation of attenuation in the human body.

TGC circuits contain : 2-channel high-speed DAC converter , active low-pass TGC filter

### **3.5.4. I2C ADC/DAC (ADT7519)**

I2C chip contains : 4 ADC converters , 4 DAC converters and temperature sensor

The ADC converters support :

- channel A : feedback for Motor Control Voltage
- channel B : Battery voltage measurement
- channel C : +5V system voltage measurement
- channel D : +12V system voltage measurement

Written by: J.Masiak	Checked by: R.Szpakowski	18-06-11	-23-
----------------------	--------------------------	----------	------

<b>SERVICE MANUAL</b>		File Service manual PIROP v.10_01.doc / pdf
 ul. Krancowa 5 24-100 Pulawy Poland tel. 0-48-81- 886 3613	Device <b>Ultrasound biometric scanner PIROP</b>	Version v.10_01
	Title	Date <b>16.05.2017</b>
		Page 24/40

The DAC converters support :

- channel A : POWER , level of high voltage for transmitter
- channel B : MOTOR , voltage for motor driver circuit
- channel C : BRIGHT , voltage for LCD brightness control
- channel D : not used

I2C ADC/DAC chip is controlled via I2C serial bus.

### **3.6. LCD interface board**

LCD interface board connect CPU board with LCD screen and make separation for touch-screen position signals (X- , X+ , Y- , Y+). These signals go through connector to Tx/Rx board to further processing .

### **3.7. Power supply board**

Power supply board include :

- DC/DC converters . They convert input +12V dc voltage to :
  - 1) +5V (main digital supply for CPU and Tx/Rx boards)
  - 2) +12V (analog circuits supply )
  - 3) 0...+150V (voltage controled output) , for transmitter driver
- charger circuit for battery charging. Charging current  $I_c = 1.33 \text{ A}$  .

Charger state is monitored by CPU with use of 3 signals [P2 P1 P0] :

- [P1] External Adapter Connected (yes / no)
- [P2][P0] Charger state (charge in progress / charge suspend / charge done)

### **3.8. Ultrasound probe**

#### **3.8.1. Probe description.**

The PIROP system works together with specialistic ultrasound probe which has got possibility to work in two perpendicular scanning planes . The scanning plane is chosen under CPU control.

The ultrasound transducer is stimulated by high-voltage pulse. The frequency , number of pulses and pulse amplitude depend on CPU settings.

The probe contains following elements :

- ultrasound transducer

Written by: J.Masiak	Checked by: R.Szpakowski	18-06-11	-24-
----------------------	--------------------------	----------	------



<b>SERVICE MANUAL</b>		File Service manual PIROP v.10_01.doc / pdf
 ul. Krancowa 5 24-100 Pulawy Poland tel. 0-48-81- 886 3613	Device <b>Ultrasound biometric scanner PIROP</b>	Version v.10_01
	Title	Date <b>16.05.2017</b>
		Page 25/40

- connector board
- the probe cable with probe connector
- the probe housing

### 3.9.2. Probe connector

The placement of signals on the probe connector ( at the probe cable) ,  
view from the back of the probe connector :

Probe connector type: Fisher 101, TYCO TRIAD 01

Written by: J.Masiak	Checked by: R.Szpakowski	18-06-11	-25-
----------------------	--------------------------	----------	------

<b>SERVICE MANUAL</b>		File Service manual PIROP v.10_01.doc / pdf
 ul. Krancowa 5 24-100 Pulawy Poland tel. 0-48-81- 886 3613	Device <b>Ultrasound biometric scanner PIROP</b>	Version v.10_01
	Title	Date <b>16.05.2017</b>
		Page 26/40

## 4. THE "PIROP" SYSTEM MODULES AND CONNECTIONS

### 4.1. List of PIROP internal modules

	Module	Name
1	Probe Interface board	INT 1_51
2	Tx/Rx board	PIROP C_04_2
3	LCD Interface board	LCD_3_5
4	LCD Screen with touch-screen	KWH070KQ13-F02
5	Power supply board	ZAS PI 1_91

Written by: J.Masiak	Checked by: R.Szpakowski	18-06-11	-26-
----------------------	--------------------------	----------	------

<b>SERVICE MANUAL</b>		File Service manual PIROP v.10_01.doc / pdf
 ul. Krancowa 5 24-100 Pulawy Poland tel. 0-48-81- 886 3613	Device <b>Ultrasound biometric scanner PIROP</b>	Version v.10_01
	Title	Date <b>16.05.2017</b>
		Page 27/40

## 4.2. Internal modules arrangements

### VIEW FROM THE TOP :

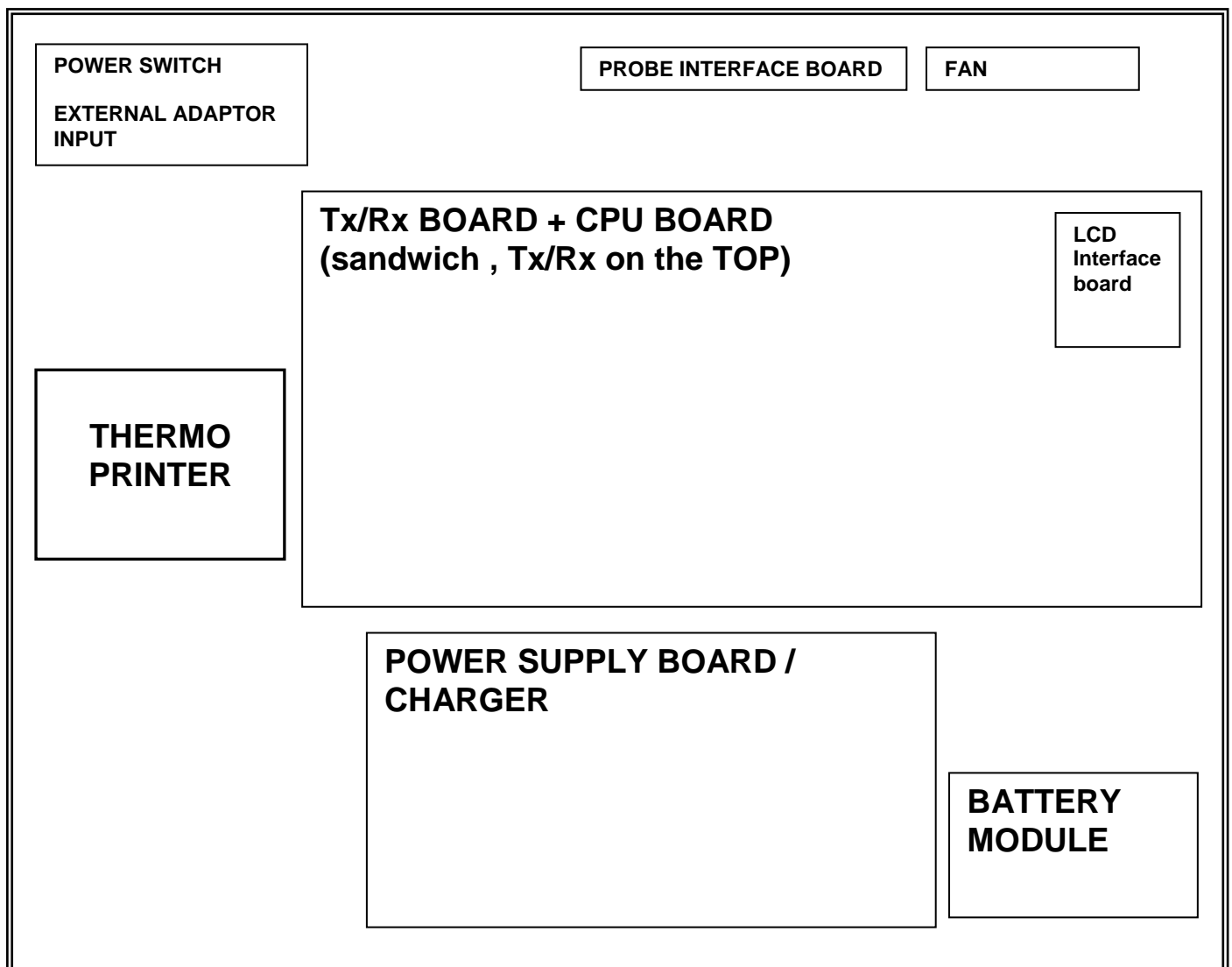

Written by: J.Masiak	Checked by: R.Szpakowski	18-06-11	-27-
----------------------	--------------------------	----------	------

<b>SERVICE MANUAL</b>		File Service manual PIROP v.10_01.doc / pdf
 ul. Krancowa 5 24-100 Pulawy Poland tel. 0-48-81- 886 3613	Device <b>Ultrasound biometric scanner PIROP</b>	Version v.10_01
	Title	Date <b>16.05.2017</b>
		Page 28/40

### 4.3. Internal modules connections

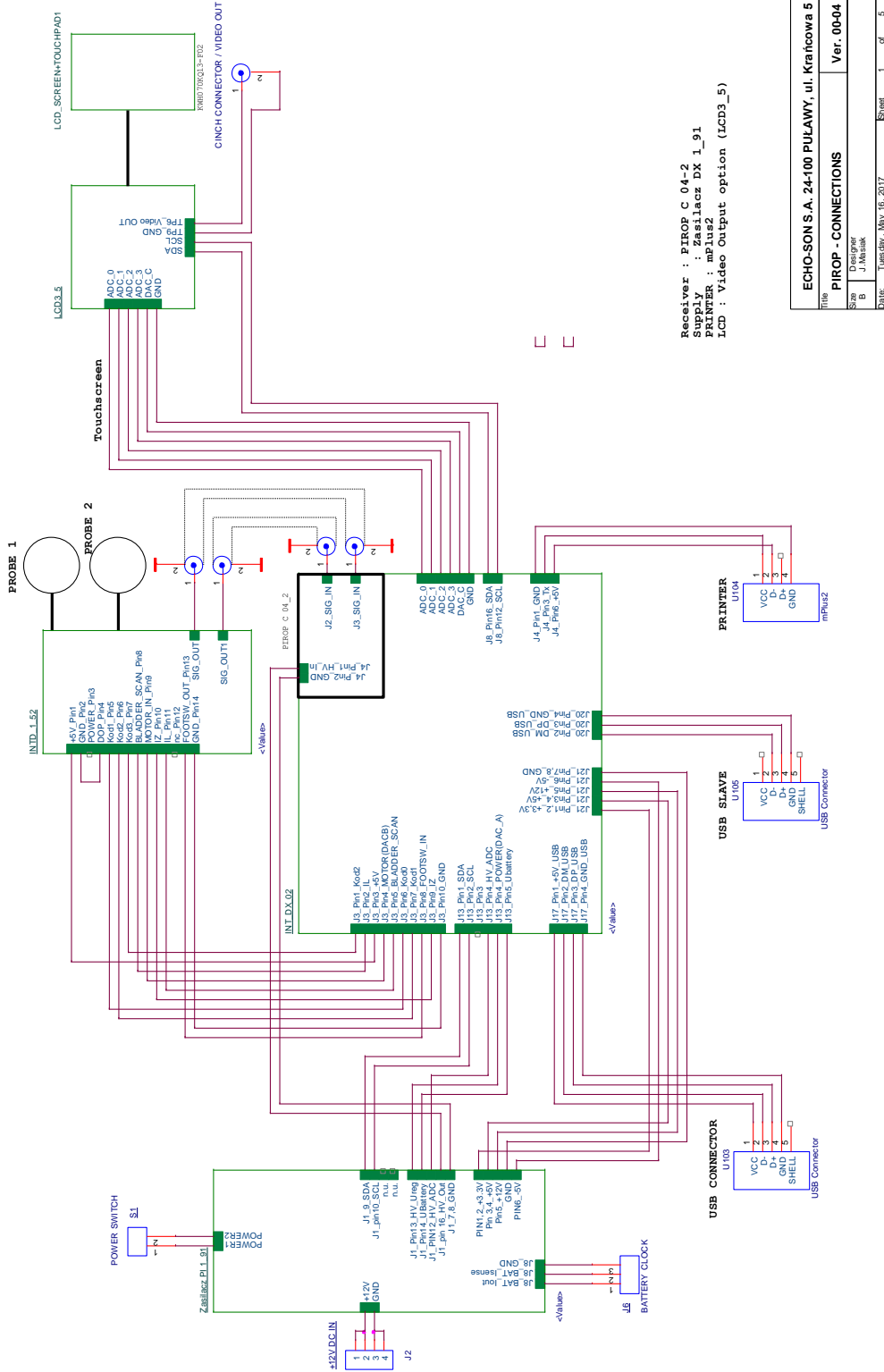

Written by: J.Masiak	Checked by: R.Szpakowski	18-06-11	-28-
----------------------	--------------------------	----------	------

<b>SERVICE MANUAL</b>		File Service manual PIROP v.10_01.doc / pdf
 ul. Krancowa 5 24-100 Pulawy Poland tel. 0-48-81- 886 3613	Device <b>Ultrasound biometric scanner PIROP</b>	Version v.10_01
	Title	Date <b>16.05.2017</b>
		Page 29/40

## 5. SOFTWARE UPDATE (v.20)

### 5.1. General note:

- Installed program version is displayed in left upper corner of the Start Screen.

### 5.2. Update files:

The PINIT program version :	greater or equal 01.50
Destination folder for update files :	
Files for update (4 files) :	
	Prg_xxxx.pr2
	Prg_xxxx.sfv (checksum file)
xxxx - version number	Alt_xxxx.al2
	Alt_xxxx.sfv (checksum file)

### 5.3. USB memory preparation:

Software update procedure in PINIT scanner is performed through USB port with use of USB memory (Pen Drive).

**Operating system: Windows (XP/7/8/10), USB memory file system : FAT (12/16/32).**

5.3.1. New software is distributed as Update PINIT.zip packet. Extract this packet on your computer.

5.3.2. Copy folder **PINIT2** ( including subfolder **Update2** ) to the root of the USB memory.

5.3.3. Check if files: Prg\_xxxx.pr2 , Prg\_xxxx.sfv , Alt\_xxxx.al2 , Alt\_xxxx.sfv exist in subfolder **Update2** .

*Note : if older versions of update files exist on the pen drive , replace these files by new ones.*

*Only newest versions of update files should exist in subfolder **Update2** !!!*

### 5.4. Procedure of the software update

5.4.1. Turn power on the PINIT scanner .

5.4.2. Insert the USB memory (Pen Drive) with update files to the USB socket . Ensure that USB indicator appears on the screen .

Written by: J.Masiak	Checked by: R.Szpakowski	18-06-11	-29-
----------------------	--------------------------	----------	------

<b>SERVICE MANUAL</b>		File Service manual PIROP v.10_01.doc / pdf
 ul. Krancowa 5 24-100 Pulawy Poland tel. 0-48-81- 886 3613	Device <b>Ultrasound biometric scanner PIROP</b>	Version v.10_01
	Title	Date <b>16.05.2017</b>
		Page 30/40

5.4.3. Press **Menu** button - the Menu screen should appear.

5.4.4. Press **Service** button - the Service screen should appear .

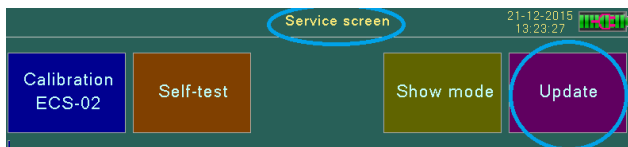

5.4.5. Press **Update** button - the *Update screen* should appear .

5.4.6. Press **Start** button to start update process .

5.4.7. The update process should start . For each file , the progress indicator will be visible on the screen.

The message "*Update is in progress , please wait ...* " should be visible.

5.4.8. Wait until all files will be programmed.

**Note : DO NOT TURN OFF POWER SUPPLY AND DO NOT REMOVE USB MEMORY WHEN UPDATE IS IN PROGRESS !!!!**

5.4.9. When the update is finished , the "*Update successfull !!!*" message should appear on the screen.

5.4.10. Wait few seconds until the system will be started with new software.

(The screen will be turned off until the system will be started ).

*Note : If the system does not start in about 1 minute : turn power off , wait few seconds , turn power on .*

*The system should start in Emergency Mode. See p.1.5 "Procedure of the software update - Emergency Mode".*

5.4.11. After restart, check if new software is installed properly.

Method to checking software version :

- 1) press successively : **Menu** and **Info** buttons
- 2) check if Program version is according to delivered program version
- 3) check if Altera version is according to delivered altera version

## **5.5. Procedure of the software update - EMERGENCY MODE**

The system PINIT can enter in **EMERGENCY MODE** in situations like below:

- if during software update power supply has been turned off
- if during software update pen drive has been removed
- if some from update files are damaged (i.e. through errors in file transfer )
- if unexpected error appears during software update

If after turning power on the PINIT scanner starts in EMERGENCY MODE (**red screen**) follow the procedure below :

Written by: J.Masiak	Checked by: R.Szpakowski	18-06-11	-30-
----------------------	--------------------------	----------	------

<b>SERVICE MANUAL</b>		File Service manual PIROP v.10_01.doc / pdf
 ul. Krancowa 5 24-100 Pulawy Poland tel. 0-48-81- 886 3613	Device <b>Ultrasound biometric scanner PIROP</b>	Version v.10_01
	Title	Date <b>16.05.2017</b>
		Page 31/40

- 5.5.1. Turn power off the PINIT scanner.
- 5.5.2. Ensure that you have good update files on the USB memory (Pen Drive). *Note : see p.5.3.3*
- 5.5.3. Turn power on the PINIT scanner.
- 5.5.4. The PINIT scanner should start in the SERVICE / EMERGENCY MODE (red screen)
- 5.5.5. Insert the USB memory (Pen Drive) with update files to the USB socket . Ensure that USB inscription appears on the screen (in the right upper corner)
- 5.5.6. Press **Update by USB memory** button - the Update screen should appear.
- 5.5.7. Press **Start** button to start update process .
- 5.5.8. The update process should start . For each file , the progress indicator will be visible on the screen.  
The message "Update is in progress , please wait ... " should be visible.
- 5.5.9. Wait until all files will be programmed.

***Note : DO NOT TURN OFF POWER SUPPLY AND DO NOT REMOVE USB MEMORY  
WHEN UPDATE IS IN PROGRESS !!!!***

- 5.5.10. When the update is finished , the "Update successfull !!! " message should appear on the screen.
- 5.5.11. Wait few seconds until the system will be started with new software.  
(The screen will be turned off until the system will be started ).
- 5.5.12. After restart, check if new software is installed properly according to p. 5.4.11.

**NOTICE !!!**

If from any reason **Update by USB memory** option doesn't work , try to use **System recovery** option.  
This option recovers the system to the factory default software version. Pay attention that the factory default software doesn't have to be newest software version !!!

Written by: J.Masiak	Checked by: R.Szpakowski	18-06-11	-31-
----------------------	--------------------------	----------	------

<b>SERVICE MANUAL</b>		File Service manual PIROP v.10_01.doc / pdf
 ul. Krancowa 5 24-100 Pulawy Poland tel. 0-48-81- 886 3613	Device <b>Ultrasound biometric scanner PIROP</b>	Version v.10_01
	Title	Date <b>16.05.2017</b>
		Page 32/40

## 6. TABLE OF SPARE PARTS

### PIROP - SPARE PARTS

Nr.	Name	Description	Catalog number
1	Printer- mPlus2	The printer	AB01/PINDR11
2	Paper to Printer – mPlus2	1 x roll of paper	AB03/PINBP11
3	Probe OA-12	Ultrasound probe	AP04/OA12
5	Probe OB-20	Ultrasound probe	AP06/OB20
5	Probe OP-20	Ultrasound probe	AP05/OP20
6	Supply adaptor GE24I12-P1J	Supply adaptor with all plug-ins	AB06
7	Probe holder		AP07
8	Scriber		AP08
9	USB memory		AB09
10	Trolley base	Trolley base together with wheels	AB10
11	Trolley - the column		AB11
12	Trolley - the basket	The basket together with mounting clamps	AB12
13	The PIROP bracket	The bracket to mounting PIROP on the trolley	AB13
14	Trolley wheel		AB14
15	Transport suitcase		AB15

Written by: J.Masiak	Checked by: R.Szpakowski	18-06-11	-32-
----------------------	--------------------------	----------	------



<b>SERVICE MANUAL</b>		File Service manual PIROP v.10_01.doc / pdf
 ul. Krancowa 5 24-100 Pulawy Poland tel. 0-48-81- 886 3613	Device <b>Ultrasound biometric scanner PIROP</b>	Version v.10_01
	Title	Date <b>16.05.2017</b>
		Page 33/40

## 7. REPLACEMENT PROCEDURES



### **WARNING:**

- To avoid the risk of electrical shock always disconnect external adaptor from mains (230 V ac) before disassembling !!!!
- To avoid the risk of electrical shock always turn off the system before disassembling !!!!

### **7.1. DISASSEMBLING PROCEDURE**

1) Unscrew 2 housing screws



2) Carefully pick up upper part of housing



3) Carefully put the upper part of housing on the top side

Written by: J.Masiak	Checked by: R.Szpakowski	18-06-11	-33-
----------------------	--------------------------	----------	------

<b>SERVICE MANUAL</b>		File Service manual PIROP v.10_01.doc / pdf
 ul. Krancowa 5 24-100 Pulawy Poland tel. 0-48-81- 886 3613	Device <b>Ultrasound biometric scanner PIROP</b>	Version v.10_01
	Title	Date <b>16.05.2017</b>
		Page 34/40

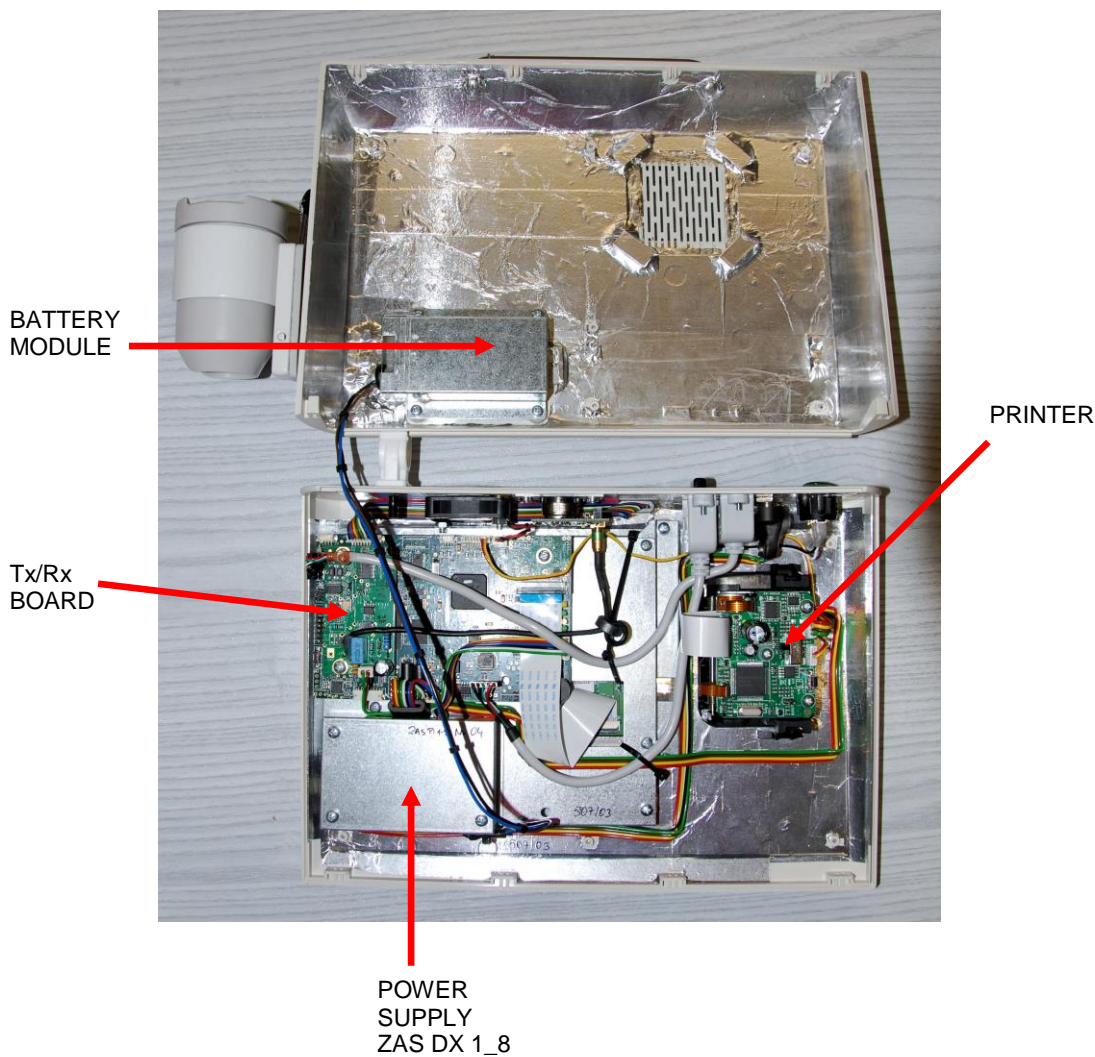

Written by: J.Masiak	Checked by: R.Szapkowski	18-06-11	-34-
----------------------	--------------------------	----------	------

<b>SERVICE MANUAL</b>		File Service manual PIROP v.10_01.doc / pdf
 ul. Krancowa 5 24-100 Pulawy Poland tel. 0-48-81- 886 3613	Device <b>Ultrasound biometric scanner PIROP</b>	Version v.10_01
	Title	Date <b>16.05.2017</b>
		Page 35/40

## 7.2. THE LCD SCREEN REPLACEMENT PROCEDURE

- 1) Disassemble the system (see p.7.1) , rotate the upper part of housing and put on the system like on the photo below
- 2) On the LCD CONNECTOR unlock the protection bar (pick up the black bar) and carefully disconnect LCD tape
- 3) Unscrew 4 screen screws

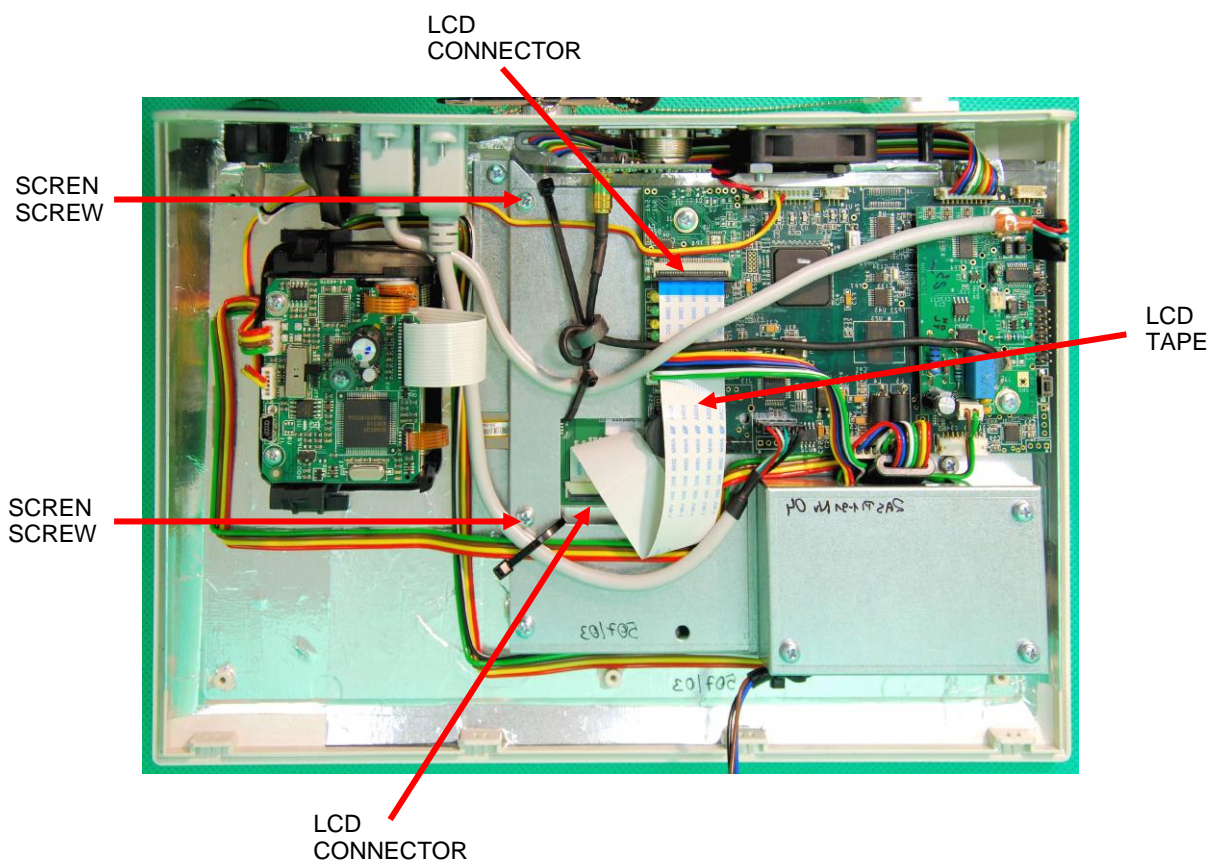

- 4) Remove the screen and replace it by new one
- 5) Tighten the screen screws
- 6) Install the LCD tape in LCD CONNECTOR and lock the protection bar (pick down the black bar)
- 7) Calibrate the touchscreen (see p.8)

Written by: J.Masiak	Checked by: R.Szapkowski	18-06-11	-35-
----------------------	--------------------------	----------	------

<b>SERVICE MANUAL</b>		File Service manual PIROP v.10_01.doc / pdf
 ul. Krancowa 5 24-100 Pulawy Poland tel. 0-48-81- 886 3613	Device <b>Ultrasound biometric scanner PIROP</b>	Version v.10_01
	Title	Date <b>16.05.2017</b>
		Page 36/40

### 7.3. REPLACING THE PRINTER PAPER

Printer prints on 2"- wide heat-sensitive paper with the diameter of a new roll of max. 33 cm. To install a new roll of paper, open the lid of the paper container (1) - place finger underneath indentation located at the top of the lid covering the printer, and gently lift up. If the previous roll has been used up, remove the remaining reel and throw it away. Place the new roll (2) in a way that the paper rolls out from the bottom to the centre of the printer. Then pull the end of paper sheet above the printer housing and close the lid, pushing down until it snaps (3). The paper should protrude from the gap.

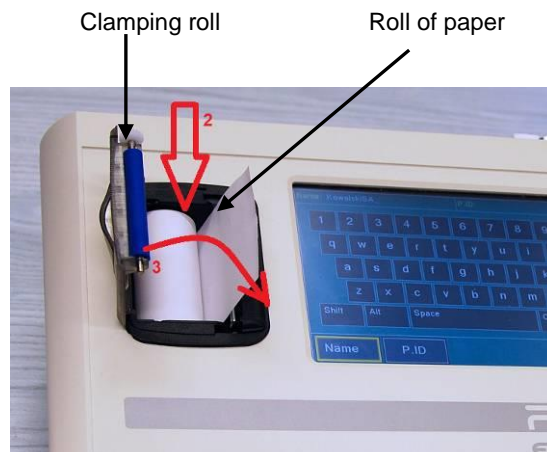
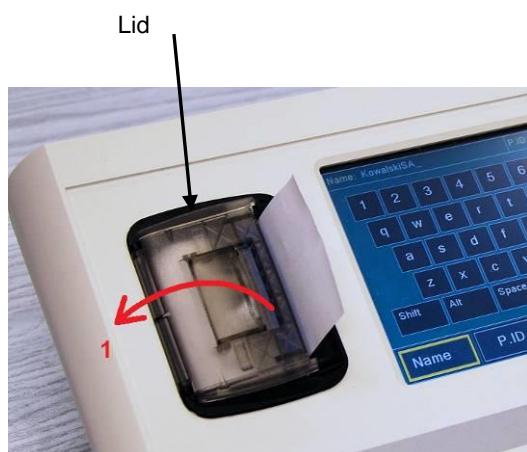

If there is any irregularity caused by jammed paper, do out; open the lid, take the paper out, cut the crumpled clamping roll and install the paper properly.



not use any tools to take it end off, possibly clean the

#### **Detailed specification of paper by the printer's manufacturer:**

Type of paper: Roll of thermal paper (heat-sensitive surface on the outside of the roll)  
 Recommended type: 55 g/m<sup>2</sup> – 60 g/m<sup>2</sup> (KANZAN KF50 or MITSUBISHI PG5075)  
 Thickness of paper: 61 µm  
 Width of paper roll: 57 mm (± 0.5) = 2"  
 Maximum diameter of roll: Ø 33 mm  
 End of paper: not attached to the reel  
 Inner diameter of the reel: Ø 12 mm (± 1)  
 Reel structure: cardboard or plastic

Written by: J.Masiak	Checked by: R.Szpakowski	18-06-11	-36-
----------------------	--------------------------	----------	------

<b>SERVICE MANUAL</b>		File Service manual PIROP v.10_01.doc / pdf
 ul. Krancowa 5 24-100 Pulawy Poland tel. 0-48-81- 886 3613	Device <b>Ultrasound biometric scanner PIROP</b>	Version v.10_01
	Title	Date <b>16.05.2017</b>
		Page 37/40

## 8. SYSTEM TESTING

### 8.1. General system checkout

Press successively : MAIN=>PACHYMETER => PATIENT => USER=>SHIFT=>SHIFT=>TEST check :

- 1) version of CPU software
- 2) version of Altera software
- 3) version of touch-screen processor software
- 4) version of USB processor software
- 5) system temperature
- 6) probe code
- 7) system configuration
- 8) actual LCD screen brightness

### 8.2. TEST – pachymeter testing

 **NOTE:** The tests ought to be performed each time the scanner is switched on.

The tests are performed to control the performance of the scanner and the probe.

Two function tests are performed automatically:

**SENSITIVITY** – the sensitivity of the probe is tested. When the test is performed, the probe ought to be dry and clean and ought not to touch any object.

The message “OK” is displayed when the test result is positive.

If the probe is disconnected, the message “No Probe!” is displayed. (No Probe!)

Written by: J.Masiak	Checked by: R.Szpakowski	18-06-11	-37-
----------------------	--------------------------	----------	------



<b>SERVICE MANUAL</b>		File Service manual PIROP v.10_01.doc / pdf
 ul. Krancowa 5 24-100 Pulawy Poland tel. 0-48-81- 886 3613	Device <b>Ultrasound biometric scanner PIROP</b>	Version v.10_01
	Title	Date <b>16.05.2017</b>
		Page 38/40

The message “Weak Probe!” is displayed when the test result is negative. (Weak Probe!). Make sure the probe is clean. If the probe is clean and the repeated sensitivity tests give the same result, it means the probe has lost its sensitivity and the manufacturer’s service should be contacted.

ACCURACY – the internal test of the measurement accuracy is performed. Echo signals artificially created and independent of the measurement system are measured at an interval corresponding to the thickness of 502 µm (the probe is not used in this test). The positive result (the measurement result are within the tolerance limits) indicates good performance of the scanner and the message “OK” is displayed.

The message “Bad Accuracy” is displayed when the result is negative. Several repeated accuracy tests ought to be performed by pressing the TEST button. If the negative result occurs again, the manufacturer’s service should be contacted.

### **8.3. CALIBRATION – testing the scanner in the A-scan mode**

Pressing the A-SCAN button on the main page opens the page for testing the scanner and probe A. A user can skip the testing procedure by pressing the EXIT button. After it is pressed, the page with the main A-scan menu opens.

 **NOTE!**

**The tests ought to be performed each time the scanner is switched on.**

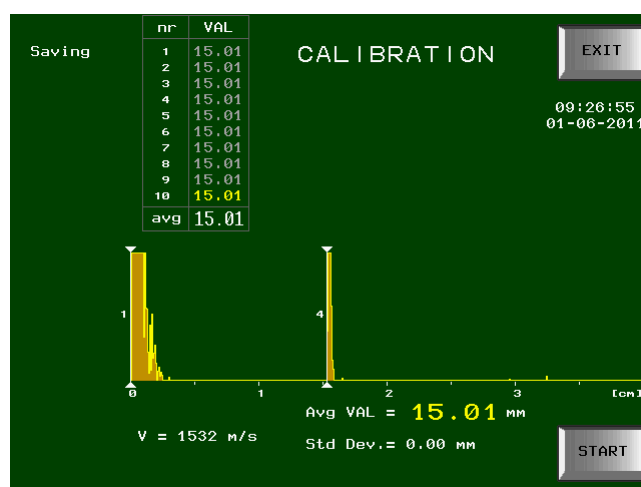

Written by: J.Masiak	Checked by: R.Szapkowski	18-06-11	-38-
----------------------	--------------------------	----------	------

<b>SERVICE MANUAL</b>		File Service manual PIROP v.10_01.doc / pdf
 ul. Krancowa 5 24-100 Pulawy Poland tel. 0-48-81- 886 3613	Device <b>Ultrasound biometric scanner PIROP</b>	Version v.10_01
	Title	Date <b>16.05.2017</b>
		Page 39/40

Calibration is performed to control the performance of the scanner and the probe.

**Calibration procedure:**

1. Inspect the head of the calibration standard and the tip of the probe visually (cleanness)
2. make sure the velocity is displayed properly, i.e. 1523 m/s in the bottom left corner of the screen
3. Place the probe **perpendicularly** to the standard using a small amount of gel or water for contact and press the START button or the foot button.
4. The scanner will automatically perform 10 measurements displaying the result of 15 mm  $\pm$  0.15 mm.
5. If a measurement is outside the aforementioned tolerance limits, the measurement should be repeated after a slight correction of the vertical alignment of the probe - until the proper result is obtained (A higher result indicates that the probe is not aligned perpendicularly to the head of the standard).
6. After calibration is completed, the standard and the probe head should be wiped gently.

**NOTE!**

*If you cannot obtain the proper result during calibration, you should contact the manufacturer.*

A user can always perform calibration during tests by pressing the CALIBRATION button in the main menu.

**NOTE!**

*We can start the examination of the patient only when we leave the calibration process by pressing the EXIT button.*

Written by: J.Masiak	Checked by: R.Szpakowski	18-06-11	-39-
----------------------	--------------------------	----------	------

<b>SERVICE MANUAL</b>		File Service manual PIROP v.10_01.doc / pdf
 ul. Krancowa 5 24-100 Pulawy Poland tel. 0-48-81- 886 3613	Device <b>Ultrasound biometric scanner PIROP</b>	Version v.10_01
	Title	Date <b>16.05.2017</b>
		Page 40/40

## 9. TROUBLESHOOTING

<b>Symptoms</b>	<b>Proposed solution</b>
The system doesn't turn on	<ol style="list-style-type: none"> <li>1. Connect the power adapter. Check the connection . Turn on the system and charge the internal battery.</li> <li>2. Set the power switch to "off" (O position), wait 15 seconds and turn it back on (I position).</li> </ol>
No Print	<ol style="list-style-type: none"> <li>1. Check the printer connection</li> <li>2. Check the printer status (see Chapter 8 in User Manual): battery charge status, the presence of the paper, the correctness of the configuration</li> </ol>
Bad image quality	<ol style="list-style-type: none"> <li>1. Adjust Gain</li> <li>2. Check the brightness of the LCD (4.5.3 in User Manual)</li> <li>3. Adjust the main unit angle in terms of good-looking view of the screen. Image quality is strong depend on the angle of screen view</li> </ol>
Probe doesn't work , no ultrasound image on the screen	<ol style="list-style-type: none"> <li>1. Check the status of the probe connection</li> <li>2. Check the status of probe head, the housing and cables. It is prohibited to use a damaged or defective probe!</li> </ol>
Probe is not recognized by system	<ol style="list-style-type: none"> <li>1. Check the status of the probe connection</li> <li>2. Turn off and turn on the system.</li> </ol>
The unit is suspended	<ol style="list-style-type: none"> <li>1. Set the power switch to "off" (O position), wait 15 seconds and turn the unit again ( I position). .</li> </ol>
In Archive mode the system not recognized USB memory	<ol style="list-style-type: none"> <li>1. Connect USB Pen-drive memory</li> <li>2. Exit from Archive and then press Archive once again</li> <li>3. Exit from Archive . Disconnect the USB Pen-Drive, wait a few seconds, and then connect Pen-drive again. Wait a few seconds before pressing Archive button.</li> <li>4. Check the operation for another USB memory</li> </ol>

Written by: J.Masiak	Checked by: R.Szpakowski	18-06-11	-40-
----------------------	--------------------------	----------	------