

EDAN Agile PLM Electronic Signature Information

--Signatures related to this document and performed in EDAN Agile PLM.

文件名称(Document Name) : iX10 iX12 iX15 系列说明书_英文 CE

文件编号(Number) : 01.54.458899

版本(Version) : 1.4

产品型号(Product Model) : iX10;iX12;iX15

项目编码(Project Code) : 00033I001

签批信息(Signature):

作者(Originator) : 洪 珊艳 (hongshanyan) 2023-09-07 14:32:46

审核人(Reviewers) : 程 亮 (chengliang) 2023-09-07 20:35:40

审核人(Reviewers) : 夏 欢欢 (xiahuanhuan) 2023-09-11 10:32:34

审核人(Reviewers) : 刘 烜辰 (liuxuanchen) 2023-09-07 16:51:38

审核人(Reviewers) : 陈 浩杰 (chenhaojie) 2023-09-07 16:59:21

审核人(Reviewers) : 陈 勇强 (chenyongqiang) 2023-09-07 19:45:28

审核人(Reviewers) : 欧阳 亮 (ouyangliang) 2023-09-13 17:47:11

批准人(Approvers) : 韦 华彪 (weihuabiao) 2023-09-16 10:47:12

批准人(Approvers) : 兰 雪峰 (lanxuefeng) 2023-09-15 09:05:02

iX10/iX12/iX15 Series
Patient Monitor
Version 1.4

User Manual

CE₀₁₂₃



About this Manual

P/N: 01.54.458899

MPN: 01.54.458899014

Release Date: September 2023

© Copyright EDAN INSTRUMENTS, INC. 2021-2023. All rights reserved.

Statement

This manual will help you understand the operation and maintenance of the product better. It is reminded that the product shall be used strictly complying with this manual. User's operation failing to comply with this manual may result in malfunction or accident for which EDAN INSTRUMENTS, INC. (hereinafter called EDAN) cannot be held liable.

EDAN owns the copyrights of this manual. Without prior written consent of EDAN, any materials contained in this manual shall not be photocopied, reproduced or translated into other languages.

Materials protected by the copyright law, including but not limited to confidential information such as technical information and patent information are contained in this manual, the user shall not disclose such information to any irrelevant third party.

The user shall understand that nothing in this manual grants him, expressly or implicitly, any right or license to use any of the intellectual properties of EDAN.

EDAN holds the rights to modify, update, and ultimately explain this manual.

Responsibility of the Manufacturer

EDAN only considers itself responsible for any effect on safety, reliability and performance of the equipment if:

Assembly operations, extensions, re-adjustments, modifications or repairs are carried out by persons authorized by EDAN, and

The electrical installation of the relevant room complies with national standards, and

The instrument is used in accordance with the instructions for use.

Terms Used in this Manual

This guide is designed to give key concepts on safety precautions.

WARNING

A **WARNING** describes serious adverse reactions and potential safety hazards, limitations in use imposed by them, and steps that should be taken if they occur.

PRECAUTION

A **PRECAUTION** includes information regarding any special care to be exercised by the practitioner and/or patient for the safe and effective use of the device.

CONTRAINDICATION

A **CONTRAINDICATION** describes situations in which the device should not be used because the risk of use clearly outweighs any possible benefit.

NOTE

A **NOTE** provides useful information regarding a function or a procedure.

Table of Contents

Chapter 1 Intended Use and Safety Guidance	1
1.1 Intended Purpose	1
1.2 Intended Population	1
1.3 Intended User	1
1.4 Intended Use/Indications for Use	1
1.5 Contraindication	1
1.6 Safety Guidance	1
1.7 Symbols	8
Chapter 2 Installation	14
2.1 Initial Inspection	14
2.2 Mounting the Monitor	14
2.3 Connecting the Power Cord	15
2.4 Checking the Monitor	15
2.5 Checking the Recorder	15
2.6 Setting Date and Time	16
2.7 Handing Over the Monitor	16
2.8 FCC Statement	16
2.9 FCC RF Radiation Exposure Statement	17
Chapter 3 Basic Operation	18
3.1 System Components	18
3.1.1 Front View	18
3.1.2 Rear View	20
3.1.3 Side View	22
3.1.4 Applied Parts	24
3.2 Operating and Navigating	24
3.2.1 Using Keys	26
3.2.2 Using the Touch Screen	27
3.2.3 Using the On-Screen Keyboard	28
3.3 Operating Mode	28
3.3.1 Demo Mode	28
3.3.2 Standby Mode	29
3.3.3 Night Mode	29
3.3.4 Privacy Mode	30
3.3.5 NFC Mode*	30
3.4 Changing Monitor Settings	31
3.4.1 Adjusting Screen Brightness	31
3.4.2 Changing Date and Time	31
3.5 Adjusting Volume	31

3.5.1 Adjusting Key Volume	31
3.5.2 Adjusting Alarm Volume	32
3.5.3 Adjusting QRS Volume	32
3.6 Setting Languages	32
3.7 Setting Keyboard Languages	32
3.8 Setting Parameter Unit	33
3.9 Using the Barcode Scanner	33
3.10 Checking Your Monitor Version	33
3.11 Checking Software License	34
Chapter 4 Networked Monitoring	35
4.1 Cybersecurity Measures	35
4.1.1 Personal Information Safety	35
4.1.2 Network Security	37
4.1.3 Login Management	37
4.2 Configuring the Network	38
4.2.1 Selecting a Network Type	38
4.2.2 Setting the Wired Network	38
4.2.3 Setting the Wireless Network	38
4.3 Managing Certificates	40
4.3.1 Importing Certificates	40
4.3.2 Certificate Management	41
4.3.3 Setting the Server	41
4.4 Connecting the Monitor to Central Monitoring System	42
4.5 Connecting the EMR System	43
Chapter 5 Alarms	44
5.1 Alarm Category	44
5.1.1 Physiological Alarms	44
5.1.2 Technical Alarms	44
5.1.3 Prompts	44
5.2 Alarm Setup	45
5.2.1 Selecting Alarm Tone Type	45
5.3 Alarm Levels	45
5.3.1 Changing Technical Alarm Priority Settings	46
5.4 Controlling Alarm	47
5.4.1 Setting Parameter Alarm	47
5.4.2 Audio Alarm Paused	47
5.4.3 Audio Alarm off	48
5.4.4 Alarm Reset	49
5.4.5 Setting Alarm Light Status for Alarm Reset	49
5.5 Latching Alarms	50

5.6 Intubation Mode	50
5.7 Testing Alarms	50
Chapter 6 Alarm Information	52
6.1 Physiological Alarm Information	52
6.2 Technical Alarm Information	62
6.3 Prompts	81
6.4 Adjustable Range of Alarm Limits	85
Chapter 7 Managing Patients	89
7.1 Confirming a Patient	89
7.2 Discharging a Patient	89
7.3 Admitting a Patient	89
7.3.1 Patient Category and Pace Status	91
7.4 Quick Admit	91
7.5 Barcode Admit	91
7.6 Managing Patient Information	92
7.6.1 Editing Patient Information	92
Chapter 8 Managing Profiles	93
8.1 Changing Institutional Default Profile	93
8.2 Resetting to Factory Default Profile	93
8.3 Setting User Profile	93
8.4 Transferring Profile	94
Chapter 9 User Interface	95
9.1 Switching On or Off a Parameter	95
9.2 Changing Screen Layout	95
9.3 Standard Screen	96
9.4 Large Font Screen	96
9.5 Trend Screen	96
9.6 OxyCRG Screen	96
9.7 ECG Screen	96
9.8 Changing Parameter and Waveform Colors	97
9.9 Changing Waveform Lines	97
Chapter 10 Monitoring ECG	98
10.1 Overview	98
10.2 ECG Safety Information	98
10.3 ECG Display	100
10.4 Monitoring Procedure	101
10.4.1 Preparation	101
10.4.2 Connecting ECG Cables	101
10.4.3 Selecting Electrode Type	101
10.4.4 Installing Electrodes	102

10.5 ECG Setup.....	107
10.5.1 Setting Analysis Mode.....	107
10.5.2 Selecting Calculation Lead.....	108
10.5.3 Selecting the Primary and Secondary Leads.....	108
10.5.4 Setting Alarm Source.....	109
10.5.5 Setting QRS Tone Source.....	109
10.5.6 Setting ECG SQI.....	109
10.5.7 Smart Lead Off.....	110
10.5.8 Setting Pace Status.....	110
10.5.9 Enabling Pace Pulse Rejection.....	111
10.5.10 ECG Calibration.....	111
10.5.11 ECG Waveform Setup.....	111
10.6 12-Lead ECG Monitoring.....	113
10.6.1 Activating 12-Lead ECG Monitoring.....	113
10.6.2 Analysis Function.....	113
10.6.3 Waveform Durations and Isoelectric Segments.....	114
10.7 ST Segment Monitoring.....	114
10.7.1 ST Display.....	116
10.7.2 About ST Measurement Points.....	116
10.7.3 Adjusting ST and ISO Measurement Points.....	116
10.7.4 ST VIEW.....	117
10.7.5 ST Histogram.....	117
10.8 Arrhythmia Monitoring.....	117
10.8.1 Arrhythmia Analysis.....	117
10.8.2 Arrhythmia Analysis Menu.....	122
10.9 QT Analysis.....	124
10.9.1 Measurement Limitations.....	124
10.9.2 Enabling QT Analysis.....	125
10.9.3 QT Display.....	125
10.9.4 Selecting QT Analysis Lead.....	125
10.9.5 Selecting QTc Formula.....	125
10.9.6 QT VIEW.....	126
Chapter 11 Monitoring RESP.....	127
11.1 Overview.....	127
11.2 RESP Safety Information.....	127
11.3 Electrode Placement for Monitoring RESP.....	128
11.4 Cardiac Overlay.....	129
11.5 Chest Expansion.....	129
11.6 Abdominal Breathing.....	129
11.7 Setting RR Source.....	130

11.8 Selecting RESP Lead.....	130
11.9 Changing Hold Type.....	130
11.10 Setting the Respiration Wave.....	130
11.11 Changing the No Breath Detected Alarm Time.....	130
Chapter 12 Monitoring SpO₂.....	131
12.1 Overview.....	131
12.2 SpO ₂ Safety Information.....	131
12.3 Selecting SpO ₂ Label*.....	132
12.4 Measuring SpO ₂	133
12.5 Measurement Limitations.....	135
12.6 Assessing the Validity of a SpO ₂ Reading.....	136
12.7 SpO ₂ Alarm Delay.....	137
12.8 Perfusion Indicator (Blip Bar).....	138
12.9 PI (Perfusion Index)*.....	138
12.10 SI (Signal Intensity)*.....	138
12.11 SpO ₂ Setup.....	138
12.11.1 Setting the Response Mode*.....	138
12.11.2 Setting Sensor Light Intensity Display*.....	139
12.11.3 Setting NIBP Simul.....	139
12.11.4 Setting Pitch Tone.....	139
12.11.5 Setting Sensitivity*.....	139
12.11.6 Setting Waveform Speed.....	139
12.12 SatSeconds Alarm Management*.....	140
12.12.1 Describing SatSeconds.....	140
12.12.2 SatSeconds “Safety Net”.....	141
12.12.3 Setting SatSeconds Duration.....	141
12.13 SpO ₂ Relevant Data for Reference.....	142
Chapter 13 Monitoring PR.....	146
13.1 Overview.....	146
13.2 Setting PR Source.....	146
13.3 Pleth SQL.....	146
13.4 Selecting PR Alarm Source.....	146
Chapter 14 Monitoring NIBP.....	147
14.1 Overview.....	147
14.2 NIBP Safety Information.....	147
14.3 Measurement Limitations.....	149
14.4 Measurement Modes.....	149
14.5 Measurement Procedures.....	150
14.5.1 Starting and Stopping NIBP Measurements.....	152
14.6 NIBP Setup.....	152

14.6.1 Setting Alarm Limit Display	153
14.6.2 Setting Inflation Value	153
14.6.3 Displaying/Hiding PR	153
14.6.4 Setting NIBP End Tone	153
14.6.5 Setting NIBP Trigger Recording	153
14.7 Selecting NIBP Algorithm	153
14.8 Manometer Mode	154
14.9 Resetting NIBP	154
14.10 Calibrating NIBP	154
14.11 Leakage Test	155
Chapter 15 Monitoring CNBP	156
15.1 Overview	156
15.2 CNBP Calibration	156
15.3 CNBP Monitoring	157
Chapter 16 Monitoring TEMP	158
16.1 Overview	158
16.2 TEMP Safety Information	158
16.3 Making a TEMP Measurement	158
16.4 Selecting TEMP Sensor Type	160
16.5 Selecting a Temperature for Monitoring	160
16.6 Calculating Temp Difference	160
Chapter 17 Monitoring iTEMP	161
17.1 Overview	161
17.2 Tympanic TEMP Safety Information	162
17.3 Measuring Procedure	163
Chapter 18 Monitoring IBP	165
18.1 Overview	165
18.2 IBP Safety Information	165
18.3 Monitoring Procedures	166
18.3.1 Zeroing the Pressure Transducer	166
18.3.2 Troubleshooting the Pressure Zeroing (Taking Art for Example)	167
18.3.3 IBP Calibration	167
18.4 IBP Setup	167
18.4.1 Selecting the Pressure Label	168
18.4.2 Setting Alarm Limit Display	168
18.4.3 Setting IBP Filter	169
18.4.4 Setting the IBP Waveform Speed	169
18.4.5 Changing the IBP Waveform Scale	169
18.5 Calculating CPP	169
18.6 Calculating PPV	169

18.7 Calculating SVV	170
Chapter 19 Monitoring CO₂	171
19.1 Overview	171
19.2 CO ₂ Safety Information	171
19.3 Monitoring Procedures	173
19.3.1 Zeroing	173
19.3.2 Hiding the Invalid Display after Zeroing the CO ₂ Module	174
19.3.3 Sidestream CO ₂ Module	174
19.3.4 Mainstream CO ₂ Module	183
19.4 Setting the Gas Compensation	185
19.5 Setting No Breath Detected Alarm Time	186
19.6 CO ₂ Setup	186
Chapter 20 Monitoring C.O.	187
20.1 Overview	187
20.2 C.O. Safety Information	187
20.3 C.O. Monitoring	188
20.4 Blood Temperature Monitoring	190
Chapter 21 Monitoring AG	192
21.1 Overview	192
21.2 Safety Information	192
21.2.1 Safety Information for G7 Module	192
21.2.2 Safety Information for Masimo ISA Analyzer	193
21.2.3 Safety Information for Masimo IRMA Module	196
21.3 Monitoring Steps	197
21.3.1 Monitoring Steps for G7 Module	197
21.3.2 Monitoring Steps for Masimo ISA Module	199
21.3.3 Monitoring Steps for Masimo IRMA Module	202
21.4 MAC Calculation	205
21.5 Hiding the Invalid Display after Zeroing the AG Module	207
21.6 Setting No Breath Detected Alarm Time	207
21.7 AG Setup	207
21.8 O ₂ Compensations	207
21.9 Effects of Humidity*	208
Chapter 22 Freeze	209
22.1 Entering/Exiting Freeze Status	209
22.2 Setting Freeze Duration	209
22.3 Reviewing Frozen Waveform	210
Chapter 23 Review	211
23.1 Trend Graph Review	211
23.2 Trend Table Review	212

23.3 Alarm Review	213
23.4 Discharged Patients Review	213
Chapter 24 Calculation	214
24.1 Drug Calculation	214
24.1.1 Calculation Procedures	214
24.1.2 Calculation Unit	215
24.1.3 Titration Table	216
24.2 Hemodynamic Calculation	216
24.2.1 Calculation Procedure	216
24.2.2 Input Parameters	216
24.2.3 Output Parameters	217
24.3 Oxygenation Calculation	218
24.3.1 Calculation Procedure	218
24.3.2 Input Parameters	218
24.3.3 Output Parameters	219
24.4 Ventilation Calculation	220
24.4.1 Calculation Procedure	220
24.4.2 Input Parameters	220
24.4.3 Output Parameters	220
24.5 Renal Function Calculation	221
24.5.1 Calculation Procedure	221
24.5.2 Input Parameters	221
24.5.3 Output Parameters	222
Chapter 25 Clinical Assistive Applications (CAA)	223
25.1 Early Warning Score	223
25.1.1 Accessing/Exiting Score Interface	223
25.1.2 Performing Warning Score	223
25.1.3 Warning Score Trend	224
25.2 Glasgow Coma Scale (GCS)	224
25.3 24h NIBP Summary	224
25.4 24h ECG Summary	225
25.5 HRV Analysis	225
25.6 CCHD Screening	226
25.6.1 CCHD Screening Process	227
25.6.2 Accessing CCHD Screening Interface	227
25.6.3 Performing CCHD Screening	228
Chapter 26 Recording	230
26.1 Performance of the Recorder	230
26.2 Starting and Stopping Recording	231
26.3 Parameter Alarm Trigger Recording	232

26.4 Recorder Operations and Status Messages	232
26.4.1 Record Paper Requirement	232
26.4.2 Proper Operation	232
26.4.3 Paper Out	233
26.4.4 Replacing Paper	233
26.4.5 Removing Paper Jam	233
Chapter 27 Other Functions	234
27.1 Nurse Call	234
27.2 Analog Output and Defibrillator Synchronization	235
Chapter 28 Using Battery	236
28.1 Battery Safety Information	236
28.2 Battery Power Indicator	237
28.3 Battery Status on the Main Screen	237
28.4 Charging the Battery	238
28.5 Maintaining the Battery	238
28.6 Storing the Battery	239
28.7 Checking Battery Performance	239
28.8 Replacing the Battery	239
28.9 Recycling the Battery	240
Chapter 29 Care and Cleaning	241
29.1 Safety Instructions	241
29.2 General Points	241
29.3 Cleaning	242
29.3.1 Cleaning the Monitor	243
29.3.2 Cleaning the Reusable Accessories	243
29.4 Disinfection	246
29.4.1 Disinfecting the Monitor	248
29.4.2 Disinfecting the Reusable Accessories	249
29.5 Cleaning and Disinfecting Other Accessories	251
29.6 After Reprocessing	251
29.7 Storage and Transport	252
Chapter 30 Maintenance	253
30.1 Inspecting	253
30.2 Maintenance Task and Test Schedule	253
Chapter 31 Warranty and Service	255
31.1 Warranty	255
31.2 Contact Information	255
Chapter 32 Accessories	256
32.1 ECG Accessories	256
32.2 SpO ₂ Accessories	258

32.3 NIBP Accessories	259
32.4 TEMP Accessories	260
32.5 IBP Accessories	261
32.6 C.O. Accessories	261
32.7 CO ₂ Accessories	262
32.8 AG Accessories*	264
32.9 Other Accessories	265
A Product Specification	266
A.1 Classification	266
A.2 Physical Specifications	266
A.2.1 Size and Weight	266
A.2.2 Function Configuration	266
A.2.3 Environment Specification	267
A.2.4 Power Supply Specifications	270
A.2.5 Battery Specification	271
A.2.6 Display	272
A.2.7 Recorder	272
A.2.8 Data Storage	272
A.3 Wi-Fi	273
A.3.1 Wi-Fi Technical Specifications	273
A.3.2 Wi-Fi Performance Specifications	273
A.4 ECG	275
A.5 RESP	281
A.6 NIBP	282
A.7 CNBP	283
A.8 SpO ₂	284
A.9 PR	285
A.10 TEMP	286
A.11 IBP	287
A.12 CO ₂	288
A.13 C.O.	300
A.14 AG	301
A.14.1 Sidestream	301
A.14.2 Mainstream	309
A.15 Interfaces	314
A.15.1 Analog Output	314
A.15.2 Defibrillator Synchronization	315
A.15.3 Nurse Call	316
A 15.4 USB Interfaces	316
A.15.5 Video Output Interface	316

A.15.6 RS232 Interface	316
A.15.7 Wired Network Interface	317
A.15.8 Power Adapter Interface	317
B EMC Information	318
B.1 Electromagnetic Emissions	318
B.2 Electromagnetic Immunity	319
B.3 Electromagnetic Immunity	321
B.4 Recommended Separation Distances	325
C Default Settings	326
C.1 Patient Information Default Settings	326
C.2 Alarm Default Settings	326
C.3 ECG Default Settings	326
C.4 RESP Default Settings	329
C.5 SpO ₂ Default Settings	330
C.6 PR Default Settings	330
C.7 NIBP Default Settings	331
C.8 CNBP Default Settings	331
C.9 TEMP Default Settings	332
C.10 IBP Default Settings	332
C.11 CO ₂ Default Settings	333
C.12 C.O. Default Settings	334
C.13 AG Default Settings	334
D Abbreviations	336

Chapter 1 Intended Use and Safety Guidance

1.1 Intended Purpose

The patient monitor is intended for monitoring, displaying, reviewing, storing, alarming, and transferring of multiple physiological parameters.

1.2 Intended Population

The patient monitor is applicable to adult, pediatric, and neonatal usage in hospital environments.

1.3 Intended User

Users of the patient monitor must be trained and experienced medical professionals.

1.4 Intended Use/Indications for Use

The monitors are intended to be used for monitoring, storing, recording, and reviewing of, and to generate alarms for, multiple physiological parameters of adults and pediatrics (including neonates). The monitors are intended for use by trained healthcare professionals in hospital environments.

The monitored physiological parameters include: ECG, respiration (RESP), temperature (TEMP), oxygen saturation of arterial blood (SpO₂), pulse rate (PR), non-invasive blood pressure (NIBP), continuous non-invasive blood pressure (CNBP), invasive blood pressure (IBP), carbon dioxide (CO₂), cardiac output (C.O.), and Anaesthesia gas (AG).

The arrhythmia detection and ST Segment analysis are intended for adult patients.

The monitors are not intended for MRI environments.

The cardiac output (C.O.) is only intended for adult patients.

1.5 Contraindication

None known.

1.6 Safety Guidance

Federal (U.S.) law restricts this device from being sold by or on the order of a physician.

WARNING

- 1 Any use of the medical device requires full understanding and strict observation of all sections of these instructions for use. The medical device must only be used for the purpose specified under "Intended Use". Strictly observe all **WARNING** and **PRECAUTION** statements throughout these instructions for use and all statements on medical device labels. Failure to observe these safety information statements constitutes a use of the medical device that is inconsistent with its intended use.
 - 2 Do not use any monitoring system, sensor, cable, connector, or screen that appears damaged. Remove any damaged equipment from service for inspection by a qualified service technician.
 - 3 **EXPLOSION HAZARD**-Do not use the device in a flammable atmosphere where concentrations of flammable anesthetics or other materials may occur.
 - 4 **SHOCK HAZARD**-To avoid the **RISK** of electric shock, this equipment must only be connected to a **SUPPLY MAINS** with protective earth. Never adapt the three-prong plug from the monitor to fit a two-slot outlet.
 - 5 Do not come into contact with the patient, table, or the monitor during defibrillation.
 - 6 The simultaneous use of a cardiac pacemaker or other electrical stimulators may cause safety hazard.
 - 7 Magnetic and electrical fields are capable of interfering with the proper performance of the device. For this reason, make sure that all external devices operated in the vicinity of the monitor comply with the relevant EMC requirements. X-ray equipment or MRI devices are a possible source of interference as they may emit higher levels of electromagnetic radiation.
 - 8 Extreme care must be exercised when applying medical electrical equipment. Many parts of the human/machine circuit are conductive, such as the patient, connectors, electrodes, transducers. It is very important that these conductive parts do not come into contact with other grounded, conductive parts when connected to the isolated patient input of the device. Such contact would bridge the patient's isolation and cancel the protection provided by the isolated input. In particular, there must be no contact of the neutral electrode and ground.
-
-

WARNING

- 9 Route all cables carefully to avoid possible entanglement, strangulation, or electrical interference.**
 - 10 Devices connecting with monitor should be equipotential.**
 - 11 If the protective grounding (protective earth) system is doubtful, the monitor must be supplied by internal power only.**
 - 12 Do not rely exclusively on the auditory alarm system for patient monitoring. Adjustment of alarm volume to a low level or off during patient monitoring may result in a hazard to the patient. Remember that the most reliable method of patient monitoring combines close personal surveillance with correct operation of monitoring equipment.**
 - 13 Accessory equipment connected to the analog and digital interfaces must be certified according to the respective IEC/EN standards (e.g. IEC/EN 60950 for data processing equipment and IEC/EN 60601-1 for medical equipment). Furthermore, all configurations shall comply with the valid version of the standard IEC/EN 60601-1. Therefore, anybody who connects additional equipment to the signal input or output connector to configure a medical system must make sure that it complies with the requirements of the valid version of the system standard IEC/EN 60601-1. If in doubt, consult our technical service department or your local distributor.**
 - 14 The monitor is equipped with wireless AP/Wi-Fi to receive RF electromagnetic energy. Therefore, any other equipment complying with CISPR radiation requirements may also interfere with the wireless communication and make it interrupted.**
 - 15 Only patient cable and other accessories supplied by EDAN can be used. The performance and electric shock protection cannot be guaranteed, and the patient may be injured otherwise. Prior to use, check if the casing of a disposable or sterilized accessory is intact. Do not use it if its casing is damaged.**
 - 16 When interfacing with other equipment, a test for leakage current must be performed by qualified biomedical engineering personnel before using with patients.**
 - 17 If several items of medical equipment are interconnected, pay attention to the sum of the leakage currents; otherwise, it may cause shock hazard. Consult your service personnel.**
-
-

WARNING

- 18 Keep away from fire immediately when leakage or foul odor is detected.**
 - 19 Wireless LAN equipment contains an intentional RF radiator that has the potential of interfering with other medical equipment, including patient implanted devices. Be sure to perform the electromagnetic compatibility test before installation and any time new medical equipment is added to the Wireless LAN coverage area.**
 - 20 Clinical decision making based on the output of the device is left to the discretion of the provider. The equipment should not be used as the sole basis for medical decisions. It must be used in conjunction with clinical signs and symptom. If uncertain about the accuracy of any measurement, first check the patient's vital signs by alternate means, and then make sure the monitor is functioning correctly.**
 - 21 This equipment is not intended for home use.**
 - 22 Do not perform service or maintenance on the device or any accessory while it is in use.**
 - 23 The appliance coupler or mains plug is used as an isolation means from supply mains. Position the monitor in a location where the operator can easily access the disconnection device.**
 - 24 Assembly of the monitor and modifications during actual service life shall be evaluated based on the requirements of IEC60601-1.**
 - 25 The monitors are not intended for use in an MRI environment.**
 - 26 Only recommended batteries shall be used for the monitor.**
 - 27 Additional multiple socket-outlets or extension cords cannot be connected to the system.**
 - 28 Only items that have been specified as part of the system or specified as being compatible with the system can be connected to the system.**
 - 29 All the accessories connected to system must be installed outside the patient vicinity if they do not meet the requirement of IEC/EN 60601-1.**
 - 30 The medical electrical equipment needs to be installed and put into service according to the EMC Information provided in this user manual.**
 - 31 Portable and mobile RF communications equipment can affect medical electrical equipment. Refer to the recommended separation distances provided in this user manual.**
-
-

WARNING

- 32 Connecting any accessory or other device (such as the computer) to this monitor makes the monitor and connected devices a medical system. In that case, additional safety measures should be taken during installation of the system, and the system shall provide:**
- a) Within the patient environment, a level of safety comparable to that provided by medical electrical equipment complying with IEC/EN 60601-1, and**
 - b) Outside the patient environment, the level of safety appropriate for non-medical electrical equipment complying with other IEC or ISO safety standards.**
- 33 Using accessories other than those specified may result in increased electromagnetic emission or decreased electromagnetic immunity of the monitoring equipment.**
- 34 The monitor should not be used adjacent to or stacked with other equipment. If adjacent or stacked use is necessary, the monitor shall be observed to verify normal operation in the configuration in which it will be used.**
- 35 Do not touch accessible parts of medical or non-medical electrical equipment in the patient environment and the patient simultaneously. Such parts include a USB connector, VGA connector or other signal input/output connectors.**
- 36 SHOCK HAZARD - Do not connect electrical equipment, which has not been supplied as a part of the system, to the multiple portable socket-outlet supplying the system.**
- 37 SHOCK HAZARD - Do not connect electrical equipment that were supplied as a part of the system directly to the wall outlet when the non-medical equipment is intended to be supplied by a multiple portable socket-outlet with an isolation transformer.**
- 38 Operation of the equipment exceeding specified physiological signal or the operational specification may cause inaccurate results.**
- 39 The equipment can provide protective means to prevent the patient from being burned when used with HF SURGICAL EQUIPMENT. The equipment can protect against the effects of the discharge of a defibrillator. Use only EDAN-approved accessories.**
- 40 When the monitor is used with HF surgical equipment, the transducer and the cables must be avoided from conductive connection to the HF equipment. This is to protect against burns to the patient.**
-
-

WARNING

- 41 To protect the monitor from damage during defibrillation, to use for accurate measurement information, and to protect against noise and other interference, use only accessories specified by EDAN.**
 - 42 Always remove non-defibrillation-proof accessories during defibrillation.**
 - 43 No modification of this equipment is allowed without authorization of the manufacturer.**
 - 44 Portable RF communications equipment (including peripherals such as antenna cables and external antennas) should be used no closer than 30 cm (12 inches) to any part of the monitor, including cables specified by the manufacturer. Otherwise, degradation of the performance of this equipment could result.**
 - 45 The monitor is suitable for use in the presence of electrosurgery. When the monitor is used with HF surgical equipment, the user (doctor or nurse) should be cautious about patient safety.**
 - 46 Make sure networking function is used in a secure network environment.**
 - 47 Do not touch the system components. Otherwise patient injury may result.**
 - 48 If the accessory is accidentally disconnected, it shall be reconnected by a trained healthcare professional.**
-
-

PRECAUTION

- 1 The packaging is to be disposed of according to local or institutional regulations in order to avoid environmental contamination. Store the packaging out of reach of children.**
 - 2 The device and accessories are to be disposed of according to local regulations. Alternatively, it can be returned to the dealer or the manufacturer for recycling or proper disposal.**
 - 3 Batteries are hazardous waste. Do NOT dispose it together with the household garbage. At the end of their life, hand the batteries over to the applicable collection points for the recycling of waste batteries. For more detailed information about recycling of this product or battery, please contact your local Civic Office or the shop where you purchased the product.**
 - 4 Some settings are password protected. Password should only be changed by authorized personnel. Contact the relevant personnel of the medical institution for password to these features.**
-
-

PRECAUTION











- 5 Ensure that the monitor is supplied with continuous electric power during operation from the main source power or batteries. Sudden power failure may cause failure to monitor parameters.
 - 6 Electromagnetic Interference - Ensure that the environment in which the patient monitor is installed is not subject to any sources of strong electromagnetic interference, such as radio transmitters, mobile telephones, microwaves, etc.
 - 7 Keep the environment clean. Avoid vibration. Keep it far away from corrosive medicine, dusty areas, high temperatures and humid environments.
 - 8 Do not use autoclave or gas to sterilize the monitor, recorder or any accessories.
 - 9 The Ingress Protection of the monitor is IP22. Do not spray, pour, or spill any liquid on the monitor, its accessories, connectors, switches, or openings, since this may cause damage to the monitor. If liquid gets on or in the monitor, please contact the service personnel of the manufacturer.
 - 10 To ensure patient safety, use only parts and accessories manufactured or recommended by EDAN.
 - 11 Before connecting the monitor to the AC power, make sure the voltage and the power frequency are consistent with the requirements indicated on the device label or in this user manual.
 - 12 Protect the device against mechanical damage resulting from falls, impacts, and vibration.
 - 13 Do not touch the touch screen with a sharp object.
 - 14 The device must be connected to the ground to avoid signal interferences.
 - 15 Poor contact might be caused by frequently plugging and unplugging the power cord. Check the power cord regularly and replace it as needed.
 - 16 To protect eyes from damage, do not look directly into barcode scanner's light for long periods of time.
-
-















NOTE:



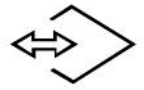







- 1 In case of a temporary power interruption, if the power is restored, monitoring will resume with all active settings unchanged.
- 2 Position the device in a location where the operator can easily see the screen and access the operating controls.













- 3 The monitor can only be used on one patient at a time.
- 4 The pictures and interfaces in this manual are for reference only.
- 5 Regular preventive maintenance should be carried out every two years. You are responsible for any requirements specific to your country.
- 6 When there is measurement beyond range, an invalid measurement or no measurement value, a -?- will be displayed.
- 7 In normal use, the operator shall stand in front of the monitor.



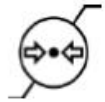







1.7 Symbols





1		DEFIBRILLATION-PROOF TYPE CF APPLIED PART
2		Caution
3		MR Unsafe - Keep away from magnetic resonance imaging (MRI) equipment
4		Equipotentiality
5		Alternating Current
6		Direct Current
7		Both direct and alternating
8		Battery check
9		Power-on indication
10		Power Supply switch
11		Serial Number

12		Network port
13		USB (Universal Serial Bus) Connection
14		Temporarily/permanently silence audible alarms
15		NIBP measurement
16		Alarm reset
17		Screen locked
18		Menu
19		Video output
20		RS-232 port
21		Defibrillator synchronization/Signal output port
22		Output
23		CE marking
24		Authorized representative in the European Community
25		Date of manufacture
26		Manufacturer

27	P/N	Part Number
28		General symbol for recovery/recyclable
29		The products marked with this symbol apply to the European WEEE directive. This symbol indicates this equipment contains electrical or electronic components that must not be disposed of as unsorted municipal waste, but collected separately. Contact an authorized representative of the manufacturer for information for the decommissioning of your equipment.
30		Operating instructions
31		Refer to instruction manual/booklet (Background: Blue; Symbol: White)
32		Warning (Background: Yellow; Symbol & outline: black)
33		Anti-theft lock
34		Gas inlet
35		Gas outlet (evac)
36		ISA equipped to measure CO ₂ only.
37		ISA equipped to measure multiple gases.
38	IP22	Ingress Protection IP22 (Protected against access to hazardous parts with a finger; Protected against solid foreign objects of 12.5 mm Ø and greater; Protected against vertically falling water drops when enclosure tilted up to 15°)

39	Rx Only	Caution: Federal (U.S.) Law restricts this device to sale by or on the order of a physician.
40	 (Optional)	Non-ionizing electromagnetic radiation
41	Contains FCC ID	Federal Communications Commission: Contains FCC ID: SMQ9113EDAN
42		DO NOT RE-USE
43		Catalog number/model number) (for Masimo module)
44		Lot code (for Masimo module)
45		Not made with natural rubber latex (for Masimo module)
46		Use by date [YYYY-MM] (for Masimo module)
47		Storage temperature range (for Masimo module)
48		Atmospheric pressure limitation (for Masimo module)
49		Storage humidity limitation (for Masimo module)
50		Do not use if package is damaged (for Masimo module)
51		Biohazardous waste (for Masimo module)
52		Patient body weight range (for Masimo module)
53		Number of units (for Masimo module)

54		CE marking (for Masimo module)
55		ETL Intertek certification (for Masimo module)
56	IPX4	Protection against water splashed from all directions (for Masimo AG sidestream module)
57	IP34	Protection from ingress of particulates ≥ 2.5 mm and against splashing water from all directions (for Masimo CO ₂ sidestream module)
58	IP44	IP classification indicating degree of protection against ingress of solid foreign objects and water (for Masimo mainstream module)
59		Class II Equipment (for Masimo module)
60		China Restriction of Hazardous Substances (for Masimo module)
61		Instructions/Directions for Use/Manuals are available in electronic format @ http://www.Masimo.com/TechDocs Note: eIFU is not available in all countries. (for Masimo module)
62		This way up
63		Fragile, handle with care
64		Keep dry
65		Stacking limit by number
66		Handle with care

67		Do not step on
68		Use-by date
69		Medical Device
70		Unique Device Identifier
71		Protective earth (ground)

NOTE:

The user manual is printed in black and white.

Chapter 2 Installation

WARNING

The installation, including a correct protective earth connection, must only be carried out by qualified service personnel.

PRECAUTION

A ventilated environment is required for monitor installation. Do not block the ventilation grille at the back of the device.

NOTE:

The monitor settings must be configured by the authorized hospital personnel.

2.1 Initial Inspection

Before unpacking, check the packaging and check that there are no signs of mishandling or damage. If the shipping cartons are damaged, contact the carrier for compensation and package them again.

Open the package carefully and remove the monitor and accessories. Check that all correct options and accessories are included.

If you have any question, please contact your local supplier.

2.2 Mounting the Monitor

Place the monitor on a flat, level surface, hang it on the bed rail, on a trolley, or mount it on a wall. For detailed information about how to install the mount adapter, refer to the *Wall Mounting Bracket Assembly Instruction*.

WARNING

- 1 The wall mounting bracket can be fixed only on a concrete wall. For the device mounted over the patient, sufficient precautionary measures should be taken to prevent it from falling on the patient.**
 - 2 The safe loads of the wall mounting bracket and the trolley are 7.5 kg and 7.7 kg respectively. Exceeding the safe load may cause bracket to fail and the device to fall.**
-
-

NOTE:

Introduce regular checks of the mounting integrity depending on the local environment.

2.3 Connecting the Power Cord

1. Make sure the AC power supply complies with the following specifications: 100 V-240 V~, 50 Hz/60 Hz.
2. Connect the power cord provided with the monitor to the power input of the monitor. Connect the other end of the power cord to a grounded 3-pin power output.

NOTE:

- 1 Connect the power cord to the socket specialized for hospital use.**
- 2 Only use the power cord recommended by EDAN.**

2.4 Checking the Monitor

Make sure there is no damage to the accessories and cables. Turn on the monitor and verify that the monitor starts normally. Make sure all alarm lamps light up and the alarm sound is heard when turning on the monitor. Refer to chapter *Testing Alarms*.

WARNING

Do not use the device if any damage is detected or if the monitor displays error messages. Contact the hospital technical personnel or the Service Representative immediately.

NOTE:

- 1 Check that all monitor functions are operating correctly.**
- 2 If rechargeable batteries are provided, charge them each time before using the device to ensure adequate power.**
- 3 After an extended period of continuous use, restart the monitor to ensure the steady performance and prolong the lifespan of monitor and battery.**

2.5 Checking the Recorder

If your monitor is equipped with a recorder, open the recorder's door to check if paper is properly installed in the slot. If no paper exists, refer to Chapter *Recording* for details.

2.6 Setting Date and Time

To set the date and time:

1. Select **Menu > System > System Time**.
2. Adjust the **Time Zone, Date Format, Clock Format** and **Display Seconds** as desired.
3. Set the correct time of year, month, day, hour, min and sec.

Select **Nighttime from** and **Nighttime to** to define the beginning and end of Nighttime in ECG summary and NIBP summary.

To synchronize the system time with the server, set **Time Synchronization** to On and configure the NTP server address or domain.

NOTE:

- 1 **After the monitor is connected with the MFM-CMS, the system time shall not be changed.**
- 2 **After a prolong duration of the device out service, the system time setting may need to be readjusted.**
- 3 **If the system time cannot be saved and reverts back to the default value after restart, contact the service department of EDAN.**
- 4 **The default clock format is 24 hours. Select AM or PM as needed when Clock Format is set to 12 Hours.**

2.7 Handing Over the Monitor

The users must be adequately trained to use the monitor before monitoring a patient. To achieve this, the users should be provided with the following materials:

- Operational Manual - for full operating instructions.
- Quick Guide - for quick reminders during use.

2.8 FCC Statement

This equipment has been tested and found to comply with the limits for a Class B digital device, pursuant to part 15 of FCC Rules. These limits are designed to provide reasonable protection against harmful interference in a residential installation.

NOTE:

“Harmful interference” is defined in 47 CFR §2.1 by the FCC as follows: Interference which endangers the functioning of a radio navigation service or of other safety services or seriously degrades, obstructs, or repeatedly interrupts a

radio communication service operating in accordance with the [ITU] Radio Regulations.

This equipment generates and can radiate radio frequency energy and, if not installed and used in accordance with the instructions, may cause harmful interference to radio communications. However, there is no guarantee that interference will not occur in a particular installation. If this equipment does cause harmful interference to radio or television reception, which can be determined by turning the equipment off and on, the user is encouraged to try to correct the interference by one or more of the following measures:

1. Reorient or relocate the receiving antenna.
2. Increase the separation between the equipment and receiver.
3. Connect the equipment into an outlet on a circuit different from that to which the receiver is connected.
4. Consult the dealer or an experienced radio/TV technician for help.

This device complies with Part 15 of FCC Rules.

Operation is subject to the following two conditions:

1. This device may not cause harmful interference, and
2. This device must accept any interference received, including interference that may cause undesired operation.

NOTE:

The manufacturer is not responsible for any radio or TV interference caused by unauthorized modifications to this equipment. Such modifications could void the user's authority to operate this equipment.

2.9 FCC RF Radiation Exposure Statement

This equipment complies with FCC RF radiation exposure limits set forth for an uncontrolled environment. This equipment should be installed and operated with a minimum distance of 20 centimeters between the radiator and your body.

Chapter 3 Basic Operation

This manual is intended for healthcare providers using the iX10/iX12/iX15 Series patient monitors. Unless otherwise specified, the information here is valid for all the above products.

This user manual describes all features and options. Your monitor may not have all of them; they are not all available in all geographies. Your monitor is highly configurable. What you see on the screen, how the menus appear and so forth, depend on the way it has been tailored for your hospital and may not be exactly as shown here.

You may frequently use the following functions:

- ◆ ECG monitoring (Refer to *Monitoring ECG* for more information.)
- ◆ SpO₂ monitoring (Refer to *Monitoring SpO₂* for more information.)
- ◆ PR monitoring (Refer to *Monitoring PR* for more information.)
- ◆ NIBP monitoring (Refer to *Monitoring NIBP* for more information.)
- ◆ Alarm (Refer to *Alarms* for more information.)

3.1 System Components

3.1.1 Front View

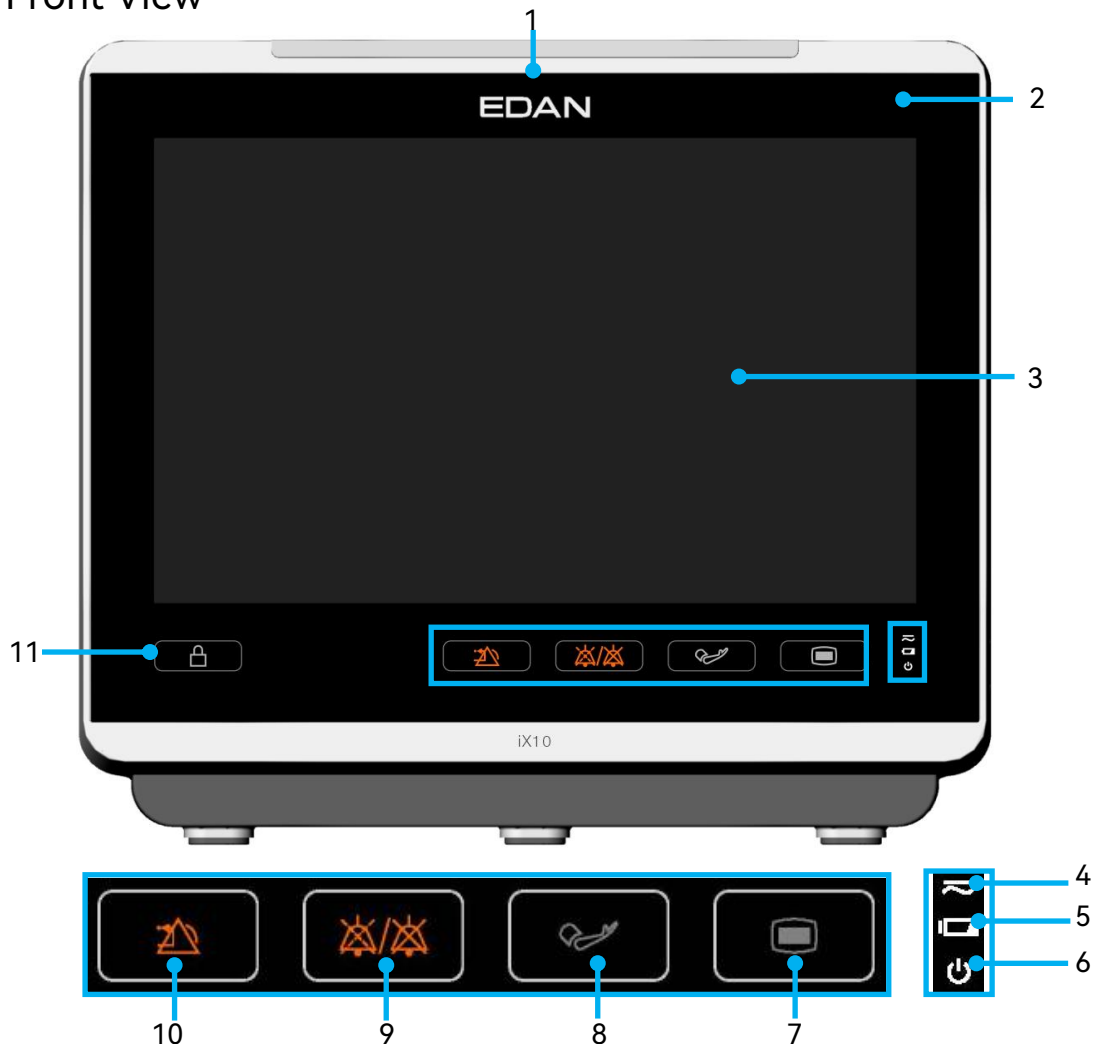

1	<p>Alarm indicator</p> <p>When a physiological alarm or technical alarm occurs, this indicator lights and flashes corresponding based on the alarm priority: High-level alarm: flashes red; Medium-level alarm: flashes yellow; Low-level alarm: constantly cyan.</p>
2	Light sensor —Senses ambient light as functional input.
3	Display
4	<p>AC/DC power indicator</p> <p>On: when AC/DC power is connected.</p> <p>Off: when AC/DC power is not connected.</p>
5	Battery indicator — Refer to Section <i>Battery Power Indicator</i> for details.
6	<p>Power-on indicator</p> <p>On: the monitor is in working condition.</p> <p>Off: the monitor is not in working condition.</p>
7	Main menu
8	Start/Stop NIBP measurement — Press this button to inflate the cuff and start blood pressure measurement. During the measurement, press the button to stop the measurement.
9	Mute — Press it to suspend the output of all audible alarm signals. Upon the configuration, pressing this button to pause or permanently turn off the audio alarm. Further information can be found in the section <i>Audio Alarm Paused</i> and section <i>Audio Alarm Off</i> .
10	Alarm reset — Press it to reset the alarm system.
11	Lock screen —Press it to lock the keys and touch screen. Press and hold it for one second to unlock the keys and touch screen.

3.1.2 Rear View

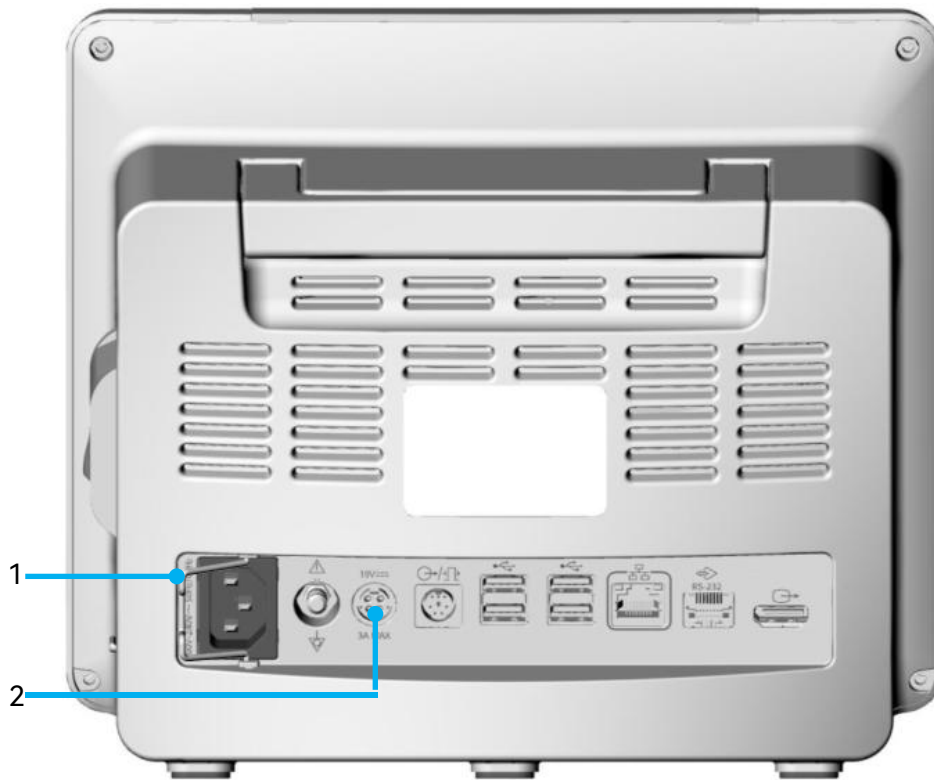

iX10 Series

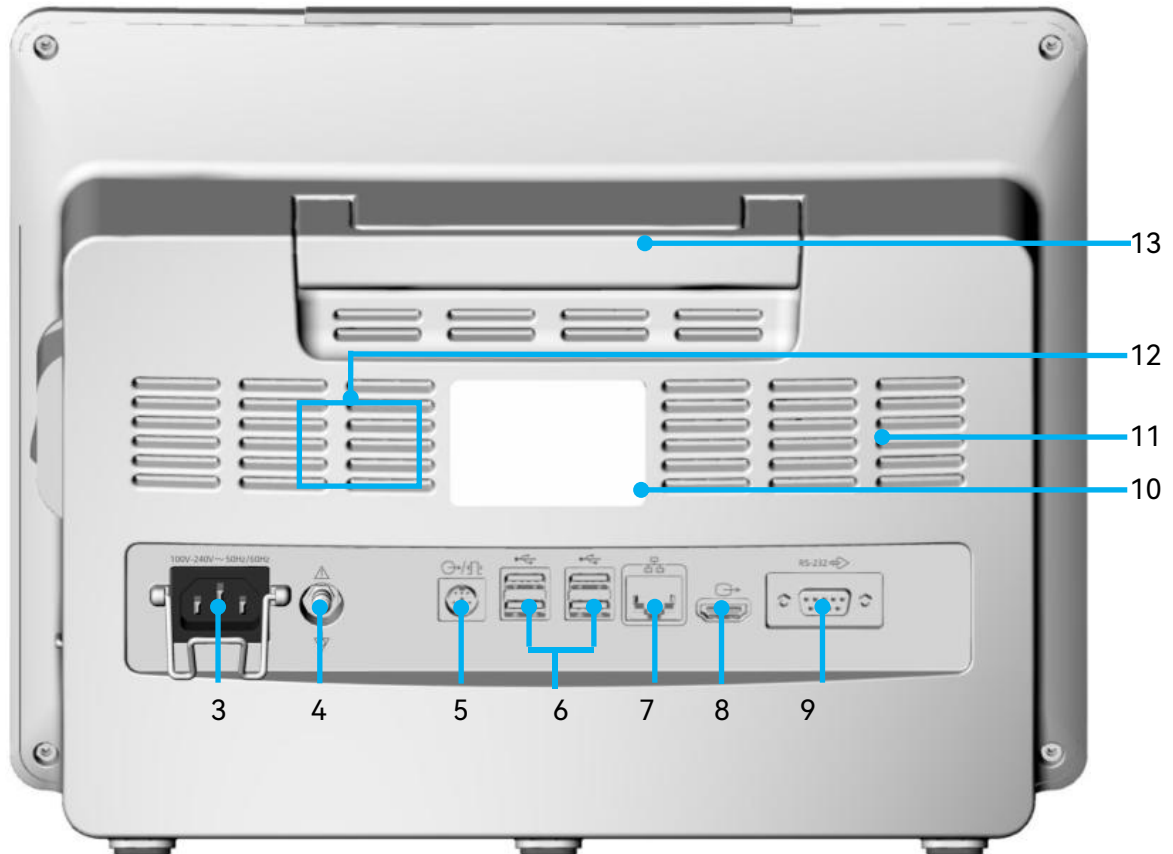

iX12/iX15 Series

1	Power cable safety latch: Used to prevent the power cord from loosening or falling.
2	Power adapter socket (for iX10 series only): Used to connect the power adapter.
3	Power supply interface: Used for connecting AC power cord and providing power to the monitor.
4	Equipotential grounding terminal. If the monitor or other processing units are used in internal examinations on the heart, ensure that the room provides an equipotential grounding system to which the monitor and other processing units can be connected.
5	<p>Multifunctional port: Nurse call port/analog output/defibrillator synchronization.</p> <p>Nurse call port: Connects the monitor to the hospital's nurse call system. Alarms alerts communicated through the nurse call system if configured accordingly.</p> <p>Analog output: Used for the monitor to communicate waveform outputs through the port.</p> <p>Defibrillator synchronization: The monitor outputs the defibrillator synchronization signal through the port.</p>
6	USB interface: Supports USB 2.0 output. It enables communication of the monitor to approved USB devices, for example, USB flash disk, barcode scanner, mouse and keyboard.
7	Network interface: Enables software upgrades and connects the monitor to the central monitoring system (also named as MFM-CMS) via standard network cable, which enables MFM-CMS to achieve bidirectional communication with the monitor.
8	Video output interface: Enables video output.
9	RS232 interface: Enables serial communication to other devices.
10	Label
11	Heat sink: This monitor adopts a No-fan design which is dust-free, low noise and low consumption.
12	Speaker: Used to play the alarm tone, pulse tone, etc.
13	Handle: Used for lifting or moving the monitor.

3.1.3 Side View

3.1.3.1 Left Side



The parameter configuration of each model is slightly different. Take two of them as examples:



1	NIBP cuff port: enables the NIBP parameter measurement.
2	SpO ₂ sensor port: enables the SpO ₂ parameter measurement.

3	CO ₂ cable port: enables the CO ₂ parameter measurement.
4	IBP cable port: enables the IBP parameter measurement.
5	C.O. cable port: enables the C.O. parameter measurement.
6	TEMP probe port: enables the TEMP parameter measurement.
7	ECG cable port: enables the ECG parameter measurement

3.1.3.2 Right Side



1	On/Off power switch — When the monitor is connected to the power supply, press the key to turn the monitor on. When the monitor is turned on, press and hold the key to turn the monitor off. To completely disconnect the AC power supply, unplug the power cord.
2	Battery door — For access to and replacing battery.
3	Recorder — Refer to Section <i>Recording</i> for details.

NOTE:

- 1** In some special cases, if the monitor crashes, the system will provide a prompt tone to inform the user, and then the monitor will restart automatically.

2 When mains power is disconnected, and no battery is installed or battery power is low, a prompt tone will sound. The tone can be silenced by pressing the On/Off power switch.

3.1.4 Applied Parts

The applied parts of the monitor are: ECG cable and electrode, SpO₂ sensor, NIBP cuff, TEMP probe, IBP transducer, C.O. sensor, CO₂ sampling line/sampling cannula, CO₂ airway adapter, AG sampling line, water trap, and AG airway adapter.

3.2 Operating and Navigating



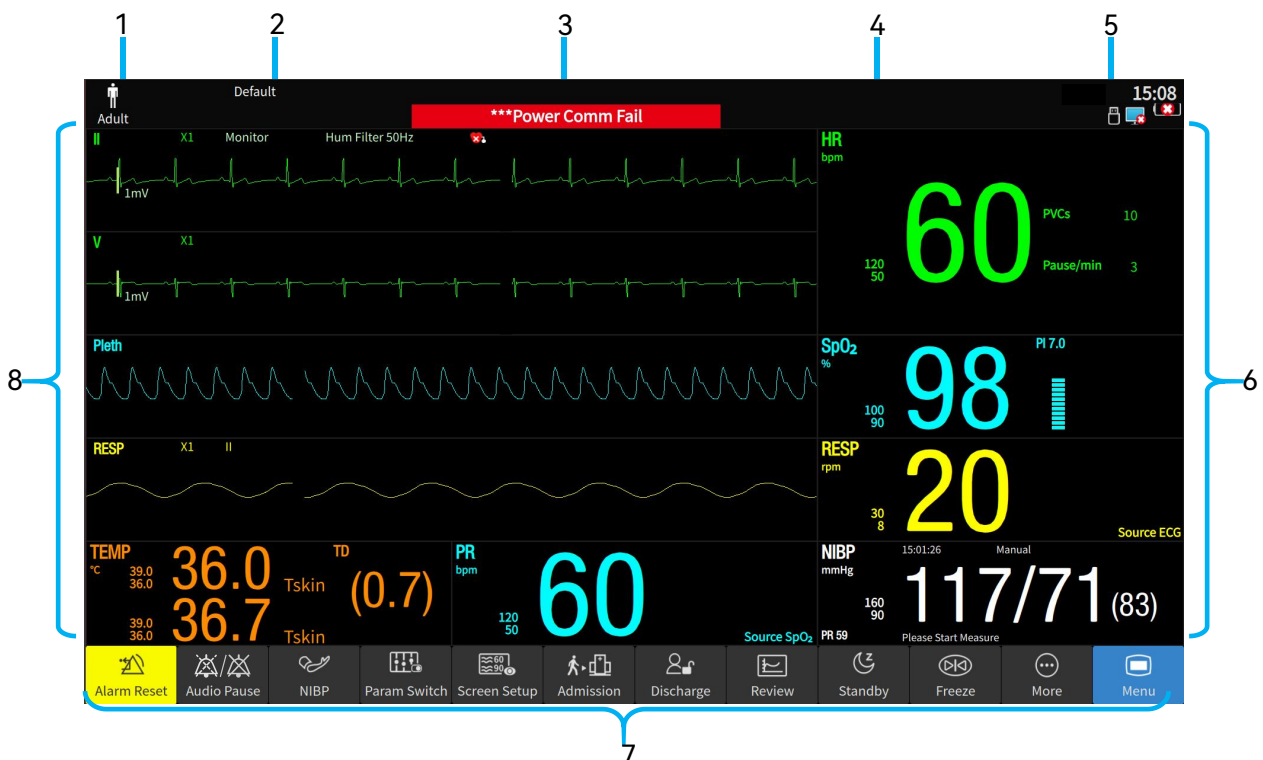













Everything you need to operate the monitor is available on the screen. Every element on the screen is interactive. Screen elements include measurement data, waveforms, screen keys, information fields, alarms fields and menus. The configurability of the monitor means that often you can access the same element in different ways. For example, you might be able to access an item through its on-screen setup menu, via a hard key, or via a shortcut key. The User Manual always describes how to access items via an on-screen menu. You may use whichever way you find most convenient.







1	Patient information area
2	Current profile

3	Technical alarm and prompt information area: displays prompt information at the top; displays technical alarm information at the bottom. Click this area to enter the technical alarm list.
4	Physiological alarm information area: displays high-level physiological alarms at the top; displays medium-level and low-level physiological alarms at the bottom. Click this area to enter the physiological alarm list.
5	System information area: displays system time, battery status, screen brightness, volume, etc. For more information, refer to <i>On-screen Symbols</i> . Click this area to unfold the system information area.
6	Parameter measurement values: click this area to enter the corresponding parameter setup interface.
7	Shortcut key area
8	Parameter area/waveform area: click this area to enter the corresponding parameter setup interface.

On-screen Symbols

Symbol	Description	Symbol	Description
	Patient type: Adult		Patient type: Pediatric
	Patient type: Neonate		Battery status
	Screen brightness		Alarm volume
	QRS volume		Calendar
	Key volume		High-level alarm
	Medium-level/low-level alarm		Tympanic TEMP
	Parameter alarm is turned off.		USB flash disk is ready
	Alarm reset		USB flash disk is inserted in

	Audio alarm paused		NFC mode
	Audio alarm off		Wired network connection status
	Wireless network signal strength		

3.2.1 Using Keys

The monitor has four different types of keys. If the key volume is enabled, the monitor gives a normal key tone when the operation is valid.

3.2.1.1 Permanent Keys

A permanent key is a graphical key that remains on the screen all the time to give you fast access to functions.



Main menu - enters the main setup menu.



Alarm reset - confirms ongoing alarms and resets the alarm system.



Alarm mute - pauses or permanently turns off the alarm tone.



More - shows more shortcut keys.

3.2.1.2 Shortcut Keys

A shortcut key is a configurable graphical key, located at the bottom of the main screen. It gives you fast access to functions. The selection of shortcut keys available on your monitor depends on your monitor configuration and on the options purchased. You can select the shortcut keys to be displayed on the main screen through **Menu > Screen > Shortcut Keys** (password protected). Adjust the shortcut key sequence as needed. Refer to Section *Changing Screen Layout* for details.



Quickly admit a patient



Enter **Alarm Setup** interface



Discharge a patient



Start or stop NIBP measurement



Enter the **Review** interface

















Start NIBP STAT measurement



Parameters setup



Stop all NIBP measurements

	Screen setup		Zero the IBP sensor
	Freeze or unfreeze waveforms		Enter the C.O. measurement interface
	Enter the configuration management interface		Start or stop real-time recording
	Enter the Standby mode		Enter the Night mode
	Enter the score interface (not applicable in neonate mode)		Enter the CCHD screening interface (only applicable in neonate mode)
	Enter 24h ECG Summary interface		Enter 24h NIBP Summary interface
	Enter the Intubation mode		Enter the privacy mode

3.2.1.3 Hardkeys

A hardkey is a physical key on a monitoring device, such as the On/Off power switch key on the right side.

3.2.1.4 Pop-up Keys



Pop-up keys are task-related graphical keys that appear automatically on the screen when required. For example, the **Confirm** pop-up key appears only when you need to confirm a change.

3.2.2 Using the Touch Screen

3.2.2.1 Gesture Control

- Click the touch screen:
 - ◆ Select the options in the menu or the list.
 - ◆ Enter the setup menu of the corresponding parameter area or waveform area.
- Swipe with fingers:
 - ◆ Swipe the menu or list up and down to show more options.
 - ◆ Swipe the touch screen left or right to switch the screen layout.



3.2.2.2 Disabling the Touch Screen

To avoid misuse, the user can disable touch screen operation by pressing the virtual key  on the front panel. The virtual key  illuminates if the screen is disabled.

To enable the touch screen operation, hold and press the virtual key  on the front panel for one second.

3.2.3 Using the On-Screen Keyboard

The on-screen keyboard enables you to enter information:

- Enter the information by selecting one character after another.
- Select  to delete single character or select  to clear the entire entry.
- Select  to access uppercase letters.
- Select **OK** to confirm the entry and exit the on-screen keyboard.

3.3 Operating Mode

3.3.1 Demo Mode

To change from operating mode to demo mode:

Select **Menu > System > Demo > Demo Mode** and input the required password.

After entering the **Demo Mode**, the monitor will perform the following:

- Stores demonstration data and clears previously stored data from memory.
- All real-time data and historical data are simulated rather than actual patient data.

To exit **Demo Mode**, select **Menu > System > Demo > Exit Demo Mode** or restart the monitor.

The default initial password of DEMO mode is demo3045. Select **Modify Demo Password** to change the password. Contact the service personal to reset the password if needed.

WARNING

Demo Mode is for demonstration purposes only. Demo mode shall not be used during patient monitoring. In Demo Mode, all stored trend information is deleted from the monitor's memory.

3.3.2 Standby Mode

Normally, enter the standby mode for the patient who must temporarily leave the monitor.

To enter the monitor into standby mode,

- Select the shortcut key  on the screen directly, the monitor will ask the user to confirm the operation. If the user selects **Confirm**, the monitor enters into standby mode.
- Select **Standby after Discharge** in the **Discharge Patient** dialog.

In standby mode:

- The monitor stops monitoring patients and stores previously monitored data.
- The monitor will not respond to alarms and prompts.

To exit the standby mode, choose any of the following ways:

- Select **Current Patient** to exit the standby mode and resume monitoring the current patient.
- Select **New Patient** to exit the standby mode and admit a new patient.

3.3.3 Night Mode

To switch to night mode, you may:

- Select the shortcut key  on the main screen, or
- Select **Menu > Screen > Display Setup > Night Mode**.

To exit the Night Mode, select the the shortcut key  or **Display Setup > Quit Night Mode**.

NOTE:

In night mode, the key volume, QRS volume, pitch tone and NIBP end tone is muted; the alarm volume and screen brightness are down to their minimum; the settings including key volume, QRS volume, pitch tone, alarm volume, screen brightness and NIBP end tone are unavailable.

PRECAUTION

Verify settings including screen brightness, alarm volume, QRS volume and key volume after entering Night mode. Pay attention to the potential risk if the setting value is low.

3.3.4 Privacy Mode

Only if the monitor is connected and admitted by MFM-CMS, the privacy mode can be activated. Press the shortcut key  or select **Menu > Screen > Display Setup > Privacy Mode**, the monitor enters into privacy mode after confirmation.

In privacy mode:

1. The screen displays message: **Privacy mode and Patient monitored without audio and visual alarms. Please click on screen or hard key to exit.**
2. Monitoring data, alarm information, stored data and monitor status are transmitted to MFM-CMS.
3. No visual alarm indication and alarm sound are issued.

The monitor exits privacy mode under any of the conditions:

1. Click anywhere on the screen or any virtual key on the front panel.
2. Battery Low alarm or Data Disconnected alarm occurs.
3. The monitor is disconnected with MFM-CMS.

3.3.5 NFC Mode*

* NFC has nothing to do with "Near Field Communication".

NFC mode is designed to constantly observe the HR physiological alarm. In NFC mode, the HR physiological alarm cannot be deactivated. To configure NFC mode, select **Menu > System > User Maintain > Alarm Setup** and choose **NFC Mode** which can be set to On or Off. NFC mode is off by default.

In NFC mode:

1. The HR physiological alarms are always on and cannot be set to off.
2. Audio alarm cannot be turned off permanently.
3. The audio alarm off status will be finished and the monitor enters normal alarm response status. **Pause Time** will automatically switch to **120 s**, which can be set to

60 s, 120 s, or 180 s manually.

4. The audio alarm paused status is not affected by entering NFC mode.
5. Symbol **NFC** is displayed in the HR parameter area.

After exiting NFC mode:

1. The HR physiological alarms are still on and can be set to off.
2. **Pause Time** keeps no change and can be set to **Permanent**.
3. Symbol **NFC** disappears.

3.4 Changing Monitor Settings

3.4.1 Adjusting Screen Brightness

To change the screen brightness:

1. Click the system information area and adjust .
2. Or select **Menu > Screen > Display Setup**. If the monitor is AC powered, set the screen **Brightness**. When it is set to **Auto**, the monitor will automatically adjust the screen brightness according to the ambient light. If the monitor is battery powered, set the **Brightness on Battery**.

3.4.2 Changing Date and Time

To change the date and time, refer to Section *Setting Date and Time*.

PRECAUTION

Change to date and time will influence the storage of trend data and may result in loss of data.

3.5 Adjusting Volume

3.5.1 Adjusting Key Volume

The key volume is audible when you select any field on the monitor screen. To adjust the key volume:

1. Select  in the system information area.
2. Select the appropriate setting for the key volume. The volume ranges from 0 to 10. If it is set to 0, the key volume will be off.

3.5.2 Adjusting Alarm Volume

To change the alarm volume:

1. Select  in the system information area, or select **Menu > Alarm > Alarm Setup > Alarm Volume**.
2. Select the appropriate setting for the alarm volume. The volume ranges from 1 to 10.

3.5.3 Adjusting QRS Volume

QRS volume is from HR or PR, depending on your setting of the QRS tone source. To change the QRS volume:

1. Select  in the system information area, or select **QRS Volume** in ECG Setup or PR setup menu.
2. Select the appropriate setting for the QRS volume. The volume ranges from 0 to 10. If it is set to 0, the QRS volume will be off. QRS frequency has positive correlation with measurement value.

NOTE:

Changing the QRS volume in the system information area also changes the QRS volume in the ECG Setup and PR Setup menus.

3.6 Setting Languages

To change the language, please:

1. Select **Menu > System > User Maintain > Other Setups**.
2. Select **Language** and choose the desired language from the list. The setting will take effect immediately.

3.7 Setting Keyboard Languages

The monitor is equipped with Chinese keyboard and English keyboard. To change the keyboard language, select **Menu > System > User Maintain > Other Setups > Keyboard Language**, then select the desired language from the list.

NOTE:

The keyboard language will restore to the default language when the system language changes. The default keyboard language varies in different system language. The keyboard language can be changed if necessary.

3.8 Setting Parameter Unit

To set parameter unit, please:

1. Select **Menu > System > User Maintain > Unit Settings**.
2. Set unit for each parameter.

NOTE:

The unit % for CO₂ and AG gases indicates vol%.

3.9 Using the Barcode Scanner

The monitor supports both a linear (1D) barcode scanner and two-dimensional (2D) barcode scanner (Honeywell Xenon 1900, Zebra Symbol DS2208/DS2278).

Prior to first use, properly set the barcode scanner according to the user manual of the scanner:

- Program the scanner for USB HID barcode scanner. Take Honeywell Xenon 1900 barcode scanner as an example, it's required the user to scan the following barcode before connecting the barcode scanner to the monitor.



- Program a carriage return.
 1. Connect the barcode scanner to the monitor's USB port.
 2. If the scanner is connected for the first time, enter the required password and the monitor will pop up a confirmation message to ask user whether the new USB device is added as scanner. Choose **Scanner** to add the barcode scanner to the scanner management list and to enable the barcode scanning.
 3. Select **Menu > System > User Maintain** and enter the required password to define the barcode in **Scanner > Barcode Setup**. Set the start and end codes before using scanner to update patient according to the hospital's data format, thus the barcode can be read correctly. After setting start and end codes, user should also set male code and female code to distinguish the gender.
 4. Refer to Section *Barcode Admit* for admitting patients by barcode scanner.

In addition, check relevant scanner information or delete specific barcode scanner in **Scanner > Scanner Management**.

3.10 Checking Your Monitor Version

To check the monitor version, please select **Menu > System > About** to check the software revision of the monitor.

3.11 Checking Software License

Software license is required to run specific functions in the monitor. To check the software license, please select **Menu > System > License**.

Chapter 4 Networked Monitoring

The monitor can connect to both the hospital wired network and a wireless network. When the monitor is networked, a network symbol is displayed on the screen.

NOTE:

Be aware that some network-based functions may be limited for monitors on wireless networks in comparison to those on wired networks.

4.1 Cybersecurity Measures

4.1.1 Personal Information Safety

Protecting personal health information is a major component of security strategy. To protect the personal information and ensure the proper device performance, the user should take necessary precautions in accordance with local laws and regulations and institution's policies. EDAN recommends health care organizations or medical institutions to implement a comprehensive and multifaceted strategy to protect the information and systems from internal and external security threats.

To ensure the patients' safety and protect their personal health information, the user should implement security practices or measures that include:

1. Physical safeguards - physical safety measures to ensure that unauthorized personnel do not have access to the monitor.
2. Operational safeguards - safety measures during operation.
3. Administrative safeguards - safety measures in management.
4. Technical safeguards - safety measures in technical field.

PRECAUTION

- 1 The access/operation of the monitor is restricted to authorized personnel only. Assign only staff with a specific role the right to use the monitor.**
 - 2 Ensure that all device components maintaining personal information (other than removable media) are physically secure (i.e. cannot remove without tools).**
 - 3 After patient discharge, ensure the patient data is archived according to the hospital protocol (when applicable), before it is deleted from the monitor memory.**
-

PRECAUTION

- 4 Ensure that the monitor is connected only to a device authorized/approved by EDAN. Users should operate all EDAN deployed and supported monitors within EDAN authorized specifications, including EDAN approved software, software configuration, security configuration, etc.
- 5 Protect all the passwords to prevent unauthorized changes. Only the manufacturer's service personnel is allowed to modify the Factory Maintain settings.
- 6 Anti-virus measures such as USB device virus scanning should be carried out prior to using USB flash drive.
- 7 Firewalls and/or other security devices should be in place between the medical system and any externally accessible systems. It's recommended to use Windows defender firewall or any other firewall that can defend against DoS and DDoS attacks, and keep it up to date.
- 8 DoS and DDoS protection of the router or switch must be turned on for defending against attacks.
- 9 Prior of sending the monitor back to the manufacturer, ensure all patient data is removed from the monitor.
- 10 When building the networking environment: 1) If a wireless router is used, please turn on the MAC address filtering function of the wireless router and add the MAC address of the monitor to the rule list. The wireless router only allows devices in the rule list to access the wireless network. 2) It is suggested to build a VLAN, assign the LAN ports where the approved switch port, monitor and MFM-CMS are into the same VLAN, and isolate it from other VLANs.
- 11 Protect the personal information and data displayed and stored in the monitor.
- 12 To avoid malicious tampering and theft of data transmitted by the network, it is recommended to switch on the encryption function. After the encryption function is turned on (it is set to on by default), the monitor will authenticate the accessed MFM-CMS devices and encrypt the transmitted data to ensure the security.

NOTE:

Log files generated by the monitor are used for system troubleshooting and do not contain protected medical data.

4.1.2 Network Security

For more security operations, select **Menu > System > User Maintain** and input user maintenance password > **Network Setup > Network Security**. In this menu:

- Set **Firewall** to On to protect against hacker attacking.
- Click **Firewall Rules** to check rule details.
- Enable the **Packets Limit Switch** and set **Packets Limit** value for traffic monitoring. If the data traffic per minute exceeds the preset threshold, the monitor will trigger the alarm “**Network Traffic Abnormity**” to remind the user, and at the same time, the network will disconnect for 5 minutes. After 5 minutes, the network will be re-connected and alarm disappears.
- For **Certificate Management**, refer to Section *Managing Certificates* for further information.

4.1.3 Login Management

Select **Menu > System > User Maintain** and input user maintenance password > **Login Management**. In this menu:

- Set **Auto Login** to On/Off.
When it is set to On (default), the user can directly enter the main interface; otherwise, the user needs to enter a password for identity authentication.
- Select **User login Timeout** to set the login timeout period. If no operation after accessing the working interface within the configured time, the screen will be locked. The password shall be re-entered after the timeout period. If the password is forgotten, reset the user maintenance password by inputting the factory maintenance password. When set to **Never**, there is no need to re-enter the password after the successful login. The setting is **Never** by default.
- Select **Modify User Password**, the user can change the password according to the prompts. For safety considerations, change the password periodically, and a combination of words and numbers is recommended. If **Old Password** is forgotten, contact service personal for help.

NOTE:

- 1 **When accessing the monitor for the first time, modify the User Maintain password according to the prompts.**
- 2 **When any password is input incorrectly for more than 5 times consecutively, the monitor will display the information: More than 5 consecutive password errors.**

4.2 Configuring the Network

The user can connect the monitor to the central monitoring system through wired LAN or wireless LAN.

4.2.1 Selecting a Network Type

To select a network type, follow these steps:

1. Select **Menu > System > User Maintain**, and input the password.
2. Select **Network Setup > Connections**. Set **Connection Type** to **Wired** or **WLAN**.

4.2.2 Setting the Wired Network

To set the wired network, follow these steps:

1. Select **Menu > System > User Maintain**, and input the password.
2. Select **Network Setup > Connections**. Set **Connection Type** to **Wired**.
3. Select **Config** and set **Mode** to **Manual** or **Auto**.
 - ◆ **Auto**: the monitor automatically gets the IP address.
 - ◆ **Manual**: the user needs to input **Local IP address**, **Subnet Mask** and **Gateway**.
4. Set the **DNS** address if needed.

4.2.3 Setting the Wireless Network





The monitor can optionally be equipped with the Wi-Fi module (Wi-Fi4). To configure the settings on the monitor following the steps below before connecting the monitor to a wireless network:

1. Select **Menu > System > User Maintain**, and input the password.
2. Select **Network Setup > Connections**. Set **Connection Type** to **WLAN**.
3. Select **WLAN** and set **Frequency Band** to **2.4GHz**, **5GHz** or **Auto**. Restart the monitor and the available networks will be listed in **WLAN** window. Choose a network from the window, in which the user can check the network's encryption information. The user will be prompted to enter the password of that network if a password is required. After entering the password, click **Connect**.
4. Or, select **Other** and input the information as needed. Click **Connect**.
 - ◆ For WPA2-PSK, input the network name and password.
 - ◆ For WPA2-EAP, input the network name, EAP method (TLS/TTLS/PEAP), inner authentication (EAP-MSCHAPV2/any), domain, username and password as



required. When the EAP method is set to TLS (Compatible with V1.1, V1.2 and V1.3), import the certificate according to Section *Managing Certificates* and then select the corresponding certificate from the **Certificate List**.

5. Select **Config** to set **Mode**, **Local IP address**, **Subnet Mask** and **Gateway**.

If the monitor is successfully connected to the selected network, it will be indicated by the icon  in the system information area, and the Wi-Fi currently in use will be displayed at the top of the **WLAN** window. The meanings of the networking state symbols are explained below:

	Wi-Fi signal intensity: Level 4
	Wi-Fi signal intensity: Level 3
	Wi-Fi signal intensity: Level 2
	Wi-Fi signal intensity: Level 1



Click  to review the historically connected network. After choosing certain network, the user can select **Delete** or **Join**.

If the encryption information of the currently connected network is modified, the network will automatically disconnect and attempt to reconnect. At this time, click  first to ignore this network and then connect manually. For an unconnected network, if the encryption information or SSID is modified and the user attempts to connect it, the user needs to disconnect the currently connected network and click  to select the updated network.

Select **Disconnection Statistics** to view details of the network disconnection and click **Export** to export the statistics data to the specified USB drive.

In **Wi-Fi Maintain** menu, enable the **Background Scan Switch** and select **Background Scan Channel** to search for better WLAN in specified channels. Roaming threshold and lag can also be viewed.

The following symbols may appear when configuring Wi-Fi:

Symbol	Description
	View historically connected network
	Refresh network list
	The network is password protected.

NOTE:

- 1 The obstacles such as the presence of the main walls and their number may interfere with data transmission and even cause data loss.

- 2 When signal intensity is level 2 or less, signal may be unstable and quality of the signal transmission may be degraded.
- 3 When the monitor is connected to MFM-CMS via the wireless network, the user should set the router to a secure encryption/authentication and use a high complexity, non-dictionary password.

WARNING

- 1 Before monitoring patient, Connection Type (Wired or WLAN) should be selected and is not allowed to switch during monitoring. Otherwise, the data may not be transmitted to the central monitoring system.
 - 2 If Wi-Fi is unavailable, please restart WLAN to restore Wi-Fi function under the precondition of ensuring the patient safety.
-
-

4.3 Managing Certificates

The monitor provides built-in CA certificates and supports importing a new CA and certificate.

4.3.1 Importing Certificates

The monitor supports the import of the monitor certificate and CA (Certificate Authority) from the USB flash disk.

Prepare

Create a “cert” folder in the root directory of the USB flash disk and place the certificates to be imported in the directory.

Interface

Select **Menu > System > User Maintain** and input user maintenance password > **Network Setup > Network Security**.

Before importing the certificate, you need import the CA that assigned the certificate at first, in order to make the monitor trust this CA. When importing the certificate, you need select the CA which assigned this certificate, because the monitor would make verification to ensure that the imported certificate is a valid one.

Import CA

1. Select **CA Certificate** to show CA list of the monitor.
2. Click the specific certificate to show the details.
3. Click **Import Certificate > CA** to import the desired CA to the monitor.

4.3.2 Certificate Management

Select **Certificate Management** and a list of monitor certificates is displayed. Click the specific certificate to show the details.

Import Certificate

Click **Import Certificate**:

- Select the USB flash disk where the certificate is located.
- **CA**: Select the CA which assigned this certificate.
- **Certificate**: Select the certificate from the USB flash disk.
- Select the Private Key and input the password as required.

Select **Import Certificate** button to import the certificate to the monitor.

Select Certificate

Click **Select Certificate** to choose the certificate currently used by the monitor, and then restart to retain the settings change you have just made.

NOTE:

The monitor supports CA and certificate suffixed with ‘.cer’, ‘.crt’, ‘.pem’ and ‘.key’.

4.3.3 Setting the Server

To set the server information, follow these steps:

1. Select **Menu > System > User Maintain** and input user maintenance password > **Network Setup > Connections**.
2. Enable **Server Connection**. When it is disabled, the monitor disconnects from the server.
3. Enable **Server Encryption** to encrypt the data.
4. Select **Server Address** to input the IP address of the server or domain.
5. Select **Server Port** to input the port of the server.
6. Select **Server Name** to input the name of the server (Server Name is the CN field of the server certificate).
7. Select **Certificate** to choose the certificate currently used by the monitor. The setting in **Network Security > Certificate Management > Select Certificate** also changes accordingly.

4.4 Connecting the Monitor to Central Monitoring System

The monitor can be connected to the central monitoring system. Through the network:

1. The monitor sends patient information, real-time monitoring or measurement data to the central monitoring system.
2. The real-time monitoring information is displayed on the central monitoring system as the same to the monitor, and the central monitoring system can perform some bilateral control. To set the remote control switch, select **Menu > System > User Maintain** and input user maintenance password > **Network Setup > Connections**. Enable **Remote Control Switch**. When it is disabled, the monitor will not respond to the control of the central monitoring system.

WARNING

Due to the delay of network transmission, data viewed at the MFM-CMS has a delay of less than 10 seconds compared with data generated at the corresponding monitoring device. To avoid potential patient injury, do not rely exclusively on the system when it comes to time-critical observations.

NOTE:

- 1 **Due to ESU interference, while using the monitor in an Operating Room environment, the monitor should be connected via a wired connection instead of wireless networking.**
- 2 **When deploying the network of the monitor and central monitoring system, it is recommended to isolate the network and the Intranet system of the hospital by using VLAN so as to ensure the network security. Only trusted devices are allowed to join the VLAN network.**

The central monitoring system network is as shown below.

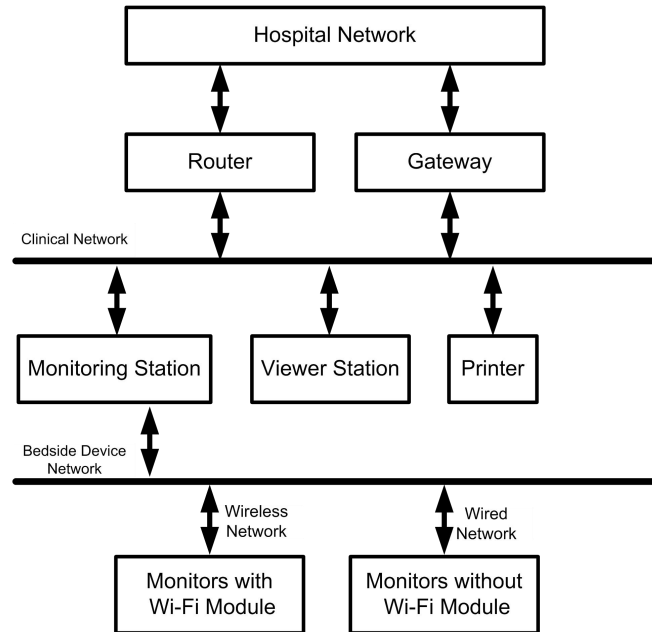

4.5 Connecting the EMR System

The monitor supports HL7 protocol (HL7 V2) to upload data to the EMR system. To connect the EMR system, select **Menu > System > User Maintain** and input user maintenance password > **Network Setup > HL7 Setup**. In this menu:

- Set **Transfer Switch** to On.
- Set **Encryption Switch** to On/Off. When it is set to On, the user needs to import the CA of the server. Refer to Section *Importing Certificates* for details.
- Switch on or off **Send Alarms, Send Alarms Periodically (ORU_R01)** and **Send Alarms Periodically (ORU_R40)**.
- Set **Parameter Period** to 30 s, 60 s or 5 min.
- Select **Server Address** to set the IP address or domain for the server receiving the data.
- Set the server **Port**.

For more information about HL7 communication, refer to *HL7 Communication Protocol Specifications*.

Chapter 5 Alarms

WARNING

A potential hazard can exist if different alarm presets are used for the same or similar equipment in any single area, e.g. an intensive care unit or cardiac operating room.

NOTE:

- 1 The delay time from onset of ALARM CONDITION to the point where representation of ALARM CONDITION leaves the SIGNAL OUTPUT PART is less than 1 second.**
- 2 The sum of the mean alarm condition delay plus the mean alarm signal generation delay is less than 10 s.**

5.1 Alarm Category

The monitor provides physiological alarms, technical alarms and prompts.

5.1.1 Physiological Alarms

If one or more physiological parameters of the currently monitored patient exceed the predefined alarm limit, the monitor will give an alarm, and this type of alarm is called physiological alarms. About the detailed alarm information, please refer to the Section *Physiological Alarm Information*.

5.1.2 Technical Alarms

If one or more technical status of the device is in abnormal status, the monitor will give an alarm. And this type of alarm is called technical alarms. Technical alarms cannot be disabled. About the detailed alarm information, please refer to Section *Technical Alarm Information*.

5.1.3 Prompts

The monitor can give the character indication of monitoring process or other functions. And this character is called prompts. About the detailed alarm information, please refer to Section *Prompts*.

5.2 Alarm Setup

5.2.1 Selecting Alarm Tone Type

The user can select the alarm tone type as desired.

1. Select **Menu > System > User Maintain**, and enter the required password.
2. If configured, select **Alarm Setup**, and set **Alarm Tone** to **Standard**.
 - ◆ **Standard**: Standard alarm sound according to IEC 60601-1-8.

5.3 Alarm Levels

In terms of severity, the device's alarm levels can be classified into three categories: high-level alarms, medium-level alarms and low-level alarms.

1. High-level alarms

A high-level alarm intensively warns the operator of a high priority alarm condition which requires immediate operator response. Failure to respond to the cause of the alarm condition is likely to result in death or irreversible injury of the patient.

2. Medium-level alarms

A medium-level alarm warns the operator of a medium priority alarm condition which requires prompt operator response. Failure to respond to the cause of the alarm condition is likely to result in reversible injury of the patient.

3. Low-level alarms

A low-level alarm reminds the operator of a low priority alarm condition which requires response. And the response time for a low priority alarm condition can be greater than that for a medium priority alarm condition. Failure to respond to the cause of the alarm condition is likely to result in discomfort or reversible minor injury of the patient.

The high/medium/low-level alarms are indicated by the system in following different ways:

Standard



Alarm level	Prompt
High	Mode is "DO-DO-DO-----DO-DO, DO-DO-DO-----DO-DO", which is triggered once every 10 seconds. The alarm indicator flashes in red, with frequency of 1.4 Hz ~ 2.8 Hz. The alarm message flashes with red background, and the symbol *** is displayed in the alarm area.

Alarm level	Prompt
Medium	Mode is “DO-DO-DO”, which is triggered once every 25 seconds. The alarm indicator flashes in yellow, with frequency of 0.4 Hz ~ 0.8 Hz. The alarm message flashes with yellow background, and the symbol ** is displayed in the alarm area.
Low	Mode is “DO-”, which is triggered once every 30 seconds. The alarm indicator is constantly cyan. For physiological alarm, the alarm message flashes with yellow background; For technical alarm, the alarm message flashes with blue background, and the symbol * is displayed in the alarm area.

The sound pressure range for standard audible alarm signals is from 45 dBA to 85 dBA, with the measurement radius of 1 meter.

The parameter area has two flash methods to prompt alarms: background flash and text flash. User can select one method from **Menu > Alarm > Alarm Setup > Visual Effect:**

1. **Text Flash:** text flashes with frequency of 1 Hz.
2. **Background Flash:** background flashes with frequency of 1 Hz. When the alarm is reset, the background stops flashing.

Meanwhile, the alarm level icon is displayed in the parameter area.  stands for medium or low-level alarm and  for high-level alarm.

WARNING

- 1 **Do not rely exclusively on the audible alarm system for patient monitoring. Adjustment of alarm volume to a low level or off during patient monitoring may result in patient danger. Remember that the most reliable method of patient monitoring combines close personal surveillance with correct operation of monitoring equipment.**
- 2 **Ensure the volume is properly set up. When the sound pressure of audible alarm is below or equivalent to the ambient noise, it may be difficult for the operator to distinguish the audio alarm.**

5.3.1 Changing Technical Alarm Priority Settings

To set the priority of the SpO₂ Sensor Off alarm and SpO₂ No Sensor alarm, select **Menu > System > User Maintain** and input user maintenance password > **Parameter Maintain > SpO₂ > SpO₂ Sensor Off Alarm Level** or **SpO₂ No Sensor Alarm Level**.

5.4 Controlling Alarm

5.4.1 Setting Parameter Alarm

Parameter alarm settings including alarm switch, alarm record, alarm level and alarm limit are available on the respective alarm setup menu for each parameter. To access the menu for parameter alarm settings, use the shortcut key  or select **Menu > Alarm > Alarm Limit**. Also, you can access this menu via the respective parameter setup menu.

The user can switch on/off alarms only when **Alarm Switch Setup** is enabled. To enable the authority,



1. Select **Menu > Maintenance > User Maintain**, and enter the required password.
2. Select **Alarm Setup** and set **Alarm Switch Setup** to **Enable**.

When the parameter alarm switch is off, the parameter alarm off icon  will be displayed in the corresponding parameter area.

WARNING

- 1 **When the alarm is set to Off, the monitor will not give an alarm prompt even if an alarm occurs. In order to avoid endangering the patient life, the user should use this function cautiously.**
- 2 **Prior to monitoring, verify that the alarm limit settings are appropriate for the patient being monitored. Always make sure that necessary alarm limits are active and set according to the patient's clinical condition.**
- 3 **Setting alarm limits to extreme values may cause the alarm system to become ineffective. It is recommended to use the default settings.**



5.4.2 Audio Alarm Paused



You can temporarily pause alarm sound by pressing the virtual key  on the front panel or pressing shortcut key  on the screen.

You can set the alarm pause time as desired. The default alarm pause time is 120 s.

1. Select **Menu > System > User Maintain**, and enter the required password.
2. Select **Alarm Setup**, and set **Pause Time** to **60 s**, **120 s**, or **180 s**.

When alarms are paused,



- The audio alarm is turned off, and alarm sound is not issued.
- The visual alarm indications are still displayed.
- The monitor displays the audio alarm paused icon  in the system information area.
- The monitor displays the remaining pause time in seconds with red background.
- The backlight of virtual key  constantly illuminates and the shortcut key  is displayed with red background.

When the alarm pause time expires, the audio alarm paused status will be terminated and alarm sound is reactivated. You can also terminate the alarm paused status by pressing the hardkey  on the front panel or pressing shortcut key  on the screen.



NOTE:

If a new alarm occurs during the audio alarm paused period, the new alarm will not sound.



5.4.3 Audio Alarm off

Set **Pause Time** to **Permanent**, press hardkey  or shortcut key , the monitor displays information: **please confirm whether to activate audio alarm off function?** Click **Confirm**, the monitor will enter into audio alarm off status. Click **Cancel**, the monitor will keep current status.

During the audio alarm off status,

- The audio alarm is turned off, and alarm sound is not issued.
- The visual alarm indications are still displayed.
- The backlight of virtual key  constantly illuminates and the shortcut key  is displayed with red background.

Remind signal: Audio alarm off symbol  is displayed in the system information area and **Audio Pause** on a red colored background are displayed during the audio alarm off status.

Pressing the hardkey  or shortcut key  again can resume the audio alarm.

NOTE:



If a new alarm occurs during the audio alarm off period, the new alarm will not sound.

5.4.4 Alarm Reset



Alarm reset function can be activated in either of the following ways:

- Press the hardkey  on the front panel.
- Select the shortcut key  on the screen directly.

Alarm reset can be password protected. To set the authority,

1. Select **Menu > Maintenance > User Maintain**, and enter the required password.
2. Select **Alarm Setup** and set **Alarm Reset Authority** to **On**. Press the hardkey  or the shortcut key  and enter the required password to activate the function.

When the alarm is reset,

- The alarm reset icon  displays in the system information area.
- Alarm sound is not issued until a new alarm occurs. Symbol  is displayed before the alarm information, indicating that the alarm is confirmed.
- All latching alarms are cleared.

NOTE:

If a new alarm occurs after the alarm is reset, the new alarm will sound and the alarm reset icon in the system information area will disappear.

5.4.5 Setting Alarm Light Status for Alarm Reset

When the alarm is reset, the alarm light illuminates by default, which can be switched off as needed. To change the alarm light setting, follow these steps:

1. Select **Menu > System > User Maintain**, and enter the required password.
2. Set **Alarm Light**.
 - ◆ **On When Reset:** When the alarm is reset, the audio alarm indications of the current alarms are switched off, but the alarm light remains flashing.
 - ◆ **Off When Reset:** When the alarm is reset, both the audio alarm indications and alarm light are switched off.

5.5 Latching Alarms

To configure the alarm latching setting, select **Menu > System > User Maintain > Alarm Setup** and choose **Alarm Latch** which can be set to On or Off. When it is set to Off, alarm indications end when the alarm condition ends. When it is set to On, the visual and audio alarm indication are still active after the alarm condition ends; meanwhile, the alarm time is also displayed for the latched alarm for your reference. The indication lasts until you confirm the alarm.

You can use the permanent key  on the screen to confirm the latched alarm.

5.6 Intubation Mode

Intubation mode is suitable for RESP monitoring, CO₂ monitoring and AG monitoring. During general anesthesia, the monitor can be set to intubation mode to eliminate unnecessary alarms. In intubation mode, RESP/CO₂/AG-related physiological alarms (including **RESP/CO₂/AG No Breath Detected**) will be turned off, and the user is unable to enter the RESP/CO₂/AG setup interface for related settings.

To enter intubation mode, follow these steps:

1. Select the shortcut key  or click **Menu > Alarm > Alarm Setup**;
2. Set **Intubation Mode Period** to **3 min** or **5 min**. The default setting is **3 min**.
3. Click **Intubation** to start the intubation mode. During the intubation mode, the monitor will display the intubation mode and remaining time.

Choose either of the following ways to exit the intubation mode:

1. When countdown expires.
2. Click **Exit Intubation Mode**.

3. Select the shortcut key .

After exiting the intubation mode, the monitor will respond the RESP/CO₂/AG -related physiological alarms.

5.7 Testing Alarms

When you switch the monitor on, the monitor will prompt a “DO-” tone that means the audio in selftest is normal. Meantime, you must check that the alarm indicator lights are normal (alarm indicator illuminates in red, yellow and cyan in turn). This indicates that the visible and auditory alarm indicators are functioning correctly. For further testing of individual measurement alarms, perform the measurement on

yourself or use a simulator. If necessary, adjust alarm limits and check that appropriate alarm behavior is observed.

Chapter 6 Alarm Information

6.1 Physiological Alarm Information

WARNING

The physiological alarms including **Asystole, Sustain VT, RESP No Breath Detected, SpO₂ No Pulse, SpO₂ Desat, CO₂ No Breath Detected, AG FiO₂ Low, and AG No Breath Detected** cannot be turned off. Switching off parameter alarms is password protected. For further information, refer to Section *Setting Parameter Alarm*.

Message	Cause	Alarm level
ECG		
HR High	HR measuring value is above the upper alarm limit.	User-selectable
HR Low	HR measuring value is below the lower alarm limit.	User-selectable
ST-X High	ST measuring value is above the upper alarm limit. (X stands for I, II, III, aVR, aVL, aVF, V, V1, V2, V3, V4, V5 or V6)	User-selectable
ST-X Low	ST measuring value is below the lower alarm limit.(X stands for I, II, III, aVR, aVL, aVF, V, V1, V2, V3, V4, V5 or V6)	User-selectable
QTc High	QTc measuring value is above upper alarm limit.	User-selectable
ΔQTc High	ΔQTc measuring value is above upper alarm limit.	User-selectable
Asystole	No QRS is detected for 4 consecutive seconds	High
V-Fib/V-Tach	4 consecutive seconds' fibrillation wave occurs; Or 5 consecutive ventricular beats, and ventricular HR ≥100 bpm.	High
Couplet	2 consecutive PVCs	User-selectable
Run PVCs	3 ≤ the number of consecutive PVCs < 5	User-selectable
PVC Bigeminy	A dominant rhythm of N, V, N, V (N = supraventricular beat, V = ventricular beat) was detected.	User-selectable

Message	Cause	Alarm level
PVC Trigeminy	A dominant rhythm of N, N, V, N, N,V	User-selectable
R on T	A type of single PVC under the condition that HR < 100, R-R interval is less than 1/3 the average interval, followed by a compensating pause of 1.25X the average R-R interval (the next R wave advances onto the previous T wave).	User-selectable
PVC	Single PVC detected in normal heartbeats, and the number of consecutive single PVC ≥ 4 within 30 s.	User-selectable
Tachy	Adult: RR interval for 5 consecutive QRS complex ≤ 0.5 s. Pediatric/neonatal: RR interval for 5 consecutive QRS complex ≤ 0.375 s.	User-selectable
Brady	Adult: RR interval for 5 consecutive QRS complex ≥ 1.5 s. Pediatric/neonatal: RR interval for 5 consecutive QRS complex ≥ 1 s.	User-selectable
Missed Beat	If HR < 120 bpm, no beats are detected for 1.75 times average RR interval; or if HR ≥ 120 bpm, no beats are detected for one second.	User-selectable
Irr Rhythm	Consistently irregular heart rhythm	User-selectable
Pacer not Capture	No QRS complex detected in 300ms after a pace pulse.	User-selectable
Pacer not Pacing	No pace pulse detected in 1.75 times RR interval after a QRS complex.	User-selectable
Vent Brady	5 consecutive ventricular beats, and ventricular HR < 20 bpm.	High
Vent Rhythm	5 consecutive ventricular beats, and $20 \text{ bpm} \leq$ ventricular HR < 40 bpm.	User-selectable
Sustain VT	The duration of ventricular tachycardia rhythm > the threshold value that has been set.	High
ExtremeTachy	HR > Extreme Tachycardia threshold value that has been set.	High

Message	Cause	Alarm level
ExtremeBrady	HR < Extreme Bradycardia threshold value that has been set.	High
V-Tach	5 consecutive ventricular beats and ventricular HR \geq 100 bpm.	High
Wide QRS Tachy	Meet tachycardia conditions, and QRS wave width \geq 160 ms.	User-selectable
Non-Sustain VT	$3 \leq$ The number of consecutive ventricular beats < 5, and ventricular HR \geq 100 bpm.	User-selectable
Afib	Atrial fibrillation alarm should meet below two conditions for 1 minute: the RR interval of normal beats must be irregular, and it can be seen that the obvious f or P waves do not exist.	User-selectable
Acc. Vent Rhythm	5 consecutive ventricular beats, and $40 \text{ bpm} \leq$ ventricular HR < 100 bpm.	User-selectable
Pause	No QRS is detected within the heartbeat pause threshold value that has been set.	User-selectable
Pauses/min High	The measurement value of Pause/min is greater than high alarm limit that has been set.	User-selectable
PVCs High	The measurement value of PVCs is greater than high alarm limit that has been set.	User-selectable
VEB	The delayed ventricular beats detected in normal heartbeats occur more than or equal to 2 times within 30 s.	User-selectable
Multiform PVCs	Different forms of ventricular premature beats are detected in 15 beats.	User-selectable
IPVC	The single ventricular premature beat between 2 sinus beats with normal interval occurs more than or equal to 3 times within 30 s.	User-selectable
PAC Bigeminy	The dominant rhythm of N, A, N, A, N, A, and the rhythm number exceeds the number of threshold value that has been set (N = supraventricular beat, A = atrial beat).	User-selectable

Message	Cause	Alarm level
PAC Trigeminy	The dominant rhythm of N, N, A, N, N, A, N, N, A, and the rhythm number exceeds the number of threshold value that has been set.	User-selectable
Low Voltage(Limb)	None of the signal amplitudes of I, II and III leads exceeds that of the alarm threshold that has been set. PS: this alarm is available for 5 or 12 leads only, not available for 3 leads.	User-selectable
RESP		
RESP No Breath Detected	RESP waveform cannot be detected within the configured No Breath Detected delay time.	High
RR High	RR measuring value is above upper alarm limit.	User-selectable
RR Low	RR measuring value is below lower alarm limit.	User-selectable
SpO₂		
SpO₂ High	SpO ₂ measuring value is above upper alarm limit.	User-selectable
SpO₂ Low	SpO ₂ measuring value is below lower alarm limit.	User-selectable
SpO₂ No Pulse	The signal of the measurement site is too weak due to insufficient blood supply and environmental factors, so the monitor cannot detect the pulse signal.	High
SpO₂ Desat	SpO ₂ measuring value is below the SpO ₂ Desat Limit.	High
EDAN two-channel SpO₂		
SpO₂/SpO_{2b} High	SpO ₂ /SpO _{2b} measuring value is above upper alarm limit.	User-selectable
SpO₂/SpO_{2b} Low	SpO ₂ /SpO _{2b} measuring value is below lower alarm limit.	User-selectable

Message	Cause	Alarm level
SpO₂/SpO_{2b} No Pulse	The signal of the measurement site is too weak due to insufficient blood supply and environmental factors, so the monitor can't detect the pulse signal.	High
SpO₂/SpO_{2b} Desat	SpO ₂ /SpO _{2b} measuring value is below the SpO ₂ /SpO _{2b} Desat Limit.	High
PR		
PR High	Measuring value is above upper alarm limit.	User-selectable
PR Low	Measuring value is below lower alarm limit.	User-selectable
iTEMP		
iTEMP High	Measuring value is above upper alarm limit.	User-selectable
iTEMP Low	Measuring value is below lower alarm limit.	User-selectable
TEMP		
T1 High	Measuring value of T1 channel is above upper alarm limit.	User-selectable
T1 Low	Measuring value of T1 channel is below lower alarm limit.	User-selectable
T2 High	Measuring value of T2 channel is above upper alarm limit.	User-selectable
T2 Low	Measuring value of T2 channel is below lower alarm limit.	User-selectable
TD High	Measuring value of TD channel is above upper alarm limit.	User-selectable
NIBP		
SYS High	SYS measuring value is above upper alarm limit.	User-selectable
SYS Low	SYS measuring value is below lower alarm limit.	User-selectable
DIA High	DIA measuring value is above upper alarm limit.	User-selectable
DIA Low	DIA measuring value is below lower alarm limit.	User-selectable
MAP High	MAP measuring value is above upper alarm limit.	User-selectable

Message	Cause	Alarm level
MAP Low	MAP measuring value is below lower alarm limit.	User-selectable
CNBP		
CNBP (SYS) High	CNBP (SYS) measuring value is above upper alarm limit.	User-selectable
CNBP (SYS) Low	CNBP (SYS) measuring value is below lower alarm limit.	User-selectable
CNBP (DIA) High	CNBP (DIA) measuring value is above upper alarm limit.	User-selectable
CNBP (DIA) Low	CNBP (DIA) measuring value is below lower alarm limit.	User-selectable
IBP		
YY SYS High (YY stands for the IBP label name: ART, Ao, UAP , BAP, FAP, LV, P1-P4)	YY SYS measuring value is above upper alarm limit.	User-selectable
YY SYS Low (YY stands for the IBP label name: ART, Ao, UAP , BAP, FAP, LV, P1-P4)	YY SYS measuring value is below lower alarm limit.	User-selectable
YY DIA High (YY stands for the IBP label name: ART, Ao, UAP , BAP, FAP, LV, P1-P4)	YY DIA measuring value is above upper alarm limit.	User-selectable

Message	Cause	Alarm level
YY DIA Low (YY stands for the IBP label name: ART, Ao, UAP , BAP, FAP, LV, P1-P4)	YY DIA measuring value is below lower alarm limit.	User-selectable
YY MAP High (YY stands for the IBP label name: ART, Ao, UAP , BAP, FAP, LV, P1-P4)	YY MAP measuring value is above upper alarm limit.	User-selectable
YY MAP Low (YY stands for the IBP label name: ART, Ao, UAP , BAP, FAP, LV, P1-P4)	YY MAP measuring value is below lower alarm limit.	User-selectable
PA SYS High	PA SYS measuring value is above upper alarm limit.	User-selectable
PA SYS Low	PA SYS measuring value is below lower alarm limit.	User-selectable
PA DIA High	PA DIA measuring value is above upper alarm limit.	User-selectable
PA DIA Low	PA DIA measuring value is below lower alarm limit.	User-selectable
PA MAP High	PA MAP measuring value is above upper alarm limit.	User-selectable
PA MAP Low	PA MAP measuring value is below lower alarm limit.	User-selectable

Message	Cause	Alarm level
YY MAP High (YY stands for the IBP label name: CVP, ICP, LAP, RAP, UVP, P1-P4)	YY MAP measuring value is above upper alarm limit.	User-selectable
YY MAP Low (YY stands for the IBP label name: CVP, ICP, LAP, RAP, UVP, P1-P4)	YY MAP measuring value is below lower alarm limit.	User-selectable
CO₂		
etCO₂ High	etCO ₂ measuring value is above upper alarm limit.	User-selectable
etCO₂ Low	etCO ₂ measuring value is below lower alarm limit.	User-selectable
FiCO₂ High	FiCO ₂ measuring value is above alarm limits.	User-selectable
CO₂ No Breath Detected	Within the configured No Breath Detected alarm delay time interval, no RESP can be detected using CO ₂ module.	High
AwRR High	AwRR measuring value is above upper alarm limit.	User-selectable
AwRR Low	AwRR measuring value is below lower alarm limit.	User-selectable
AG		
etCO₂ (AG) High	etCO ₂ (AG) measuring value is above upper alarm limit.	User-selectable
etCO₂ (AG) Low	etCO ₂ (AG) measuring value is below lower alarm limit.	User-selectable
FiCO₂ (AG) High	FiCO ₂ (AG) measuring value is above alarm limits.	User-selectable

Message	Cause	Alarm level
AwRR (AG) High	AwRR (AG) measuring value is above upper alarm limit.	User-selectable
AwRR (AG) Low	AwRR (AG) measuring value is below lower alarm limit.	User-selectable
etO₂ High	etO ₂ measuring value is above upper alarm limit.	User-selectable
etO₂ Low	etO ₂ measuring value is below lower alarm limit.	User-selectable
FiO₂ High	FiO ₂ measuring value is above upper alarm limit.	User-selectable
FiO₂ Low	FiO ₂ measuring value is below lower alarm limit.	User-selectable
etN₂O High	etN ₂ O measuring value is above upper alarm limit.	User-selectable
etN₂O Low	etN ₂ O measuring value is below lower alarm limit.	User-selectable
FiN₂O High	FiN ₂ O measuring value is above upper alarm limit.	User-selectable
FiN₂O Low	FiN ₂ O measuring value is below lower alarm limit.	User-selectable
etHAL High	etHAL measuring value is above upper alarm limit.	User-selectable
etHAL Low	etHAL measuring value is below lower alarm limit.	User-selectable
FiHAL High	FiHAL measuring value is above upper alarm limit.	User-selectable
FiHAL Low	FiHAL measuring value is below lower alarm limit.	User-selectable
etENF High	etENF measuring value is above upper alarm limit.	User-selectable
etENF Low	etENF measuring value is below lower alarm limit.	User-selectable
FiENF High	FiENF measuring value is above upper alarm limit.	User-selectable
FiENF Low	FiENF measuring value is below lower alarm limit.	User-selectable

Message	Cause	Alarm level
etISO High	etISO measuring value is above upper alarm limit.	User-selectable
etISO Low	etISO measuring value is below lower alarm limit.	User-selectable
FiISO High	FiISO measuring value is above upper alarm limit.	User-selectable
FiISO Low	FiISO measuring value is below lower alarm limit.	User-selectable
etSEV High	etSEV measuring value is above upper alarm limit.	User-selectable
etSEV Low	etSEV measuring value is below lower alarm limit.	User-selectable
FiSEV High	FiSEV measuring value is above upper alarm limit.	User-selectable
FiSEV Low	FiSEV measuring value is below lower alarm limit.	User-selectable
etDES High	etDES measuring value is above upper alarm limit.	User-selectable
etDES Low	etDES measuring value is below lower alarm limit.	User-selectable
FiDES High	FiDES measuring value is above upper alarm limit.	User-selectable
FiDES Low	FiDES measuring value is below lower alarm limit.	User-selectable
AG FiO₂ Low	FiO ₂ measure value is extremely low.	High
AG No Breath Detected	Within the configured No Breath Detected alarm delay time interval, no breath can be detected using AG module.	High
C.O.		
TB High	TB measuring value is above upper alarm.	User-selectable
TB Low	TB measuring value is below lower alarm.	User-selectable

6.2 Technical Alarm Information

NOTE:

The ECG alarm information listed in the below table describes the electrode names in America. For the corresponding electrode names in Europe, please refer to the section *Installing Electrodes*.

Message	Cause	Alarm Level	Action Taken
ECG			
ECG Lead Off	1) The drive electrode or more than one ECG limb electrode falls off the skin; 2) ECG cables fall off the monitor.	Low	Make sure that all electrodes, leads and patient cables are properly connected.
ECG LL Lead Off	ECG electrode LL falls off the skin or the ECG cable LL falls off the monitor.	Low	
ECG LA Lead Off	ECG electrode LA falls off the skin or the ECG cable LA falls off the monitor.	Low	
ECG RA Lead Off	ECG electrode RA falls off the skin or the ECG cable RA falls off the monitor.	Low	
ECG RL Lead Off	When electrode type is AUTO, ECG electrode RL falls off the skin or the ECG cable RL falls off the monitor, 5/6/10 electrodes switches to 3 electrodes.	Low	
ECG V Lead Off	ECG electrode V falls off the skin or the ECG cable V falls off the monitor.	Low	

Message	Cause	Alarm Level	Action Taken
ECG V1 Lead Off	ECG electrode V1 falls off the skin or the ECG cable V1 falls off.	Low	Make sure that all electrodes, leads and patient cables are properly connected.
ECG V2 Lead Off	ECG electrode V2 falls off the skin or the ECG cable V2 falls off.	Low	
ECG V3 Lead Off	ECG electrode V3 falls off the skin or the ECG cable V3 falls off.	Low	
ECG V4 Lead Off	ECG electrode V4 falls off the skin or the ECG cable V4 falls off.	Low	
ECG V5 Lead Off	ECG electrode V5 falls off the skin or the ECG cable V5 falls off.	Low	
ECG V6 Lead Off	ECG electrode V6 falls off the skin or the ECG cable V6 falls off.	Low	Make sure that all electrodes, leads and patient cables are properly connected.
ECG Signal Exceeded	ECG measuring signal is beyond measuring range.	Low	Check lead connection and patient condition.
ECG Comm Fail	ECG module failure or communication failure	High	Stop measuring function of ECG module, and notify biomedical engineer or manufacturer's service staff.
ECG Noise	ECG measuring signal is greatly interrupted.	Low	Check lead connection and patient condition.

Message	Cause	Alarm Level	Action Taken
RESP			
RESP Comm Fail	RESP module failure or communication failure	High	Stop measuring function of RESP module, and notify biomedical engineer or the manufacturer's service staff.
RESP Cardiac Artifact	No RESP waveform can be detected due to apnea or shallow breathing of the patient.	High	Check whether the patient is breathing normally. Take measures to help the patient breathe normally when necessary. If the patient is breathing normally, try to adjust the electrode position on the patient in order to reduce the interference of cardiogenic artifact.
RESP Noise	RR cannot be measured due to patient movement.	Low	Check whether the RESP leads are well connected. Keep the patient calm for better monitoring.

Message	Cause	Alarm Level	Action Taken
RR Exceed	RR measuring value is out of the measure range.	Medium	Check whether interference to the respiratory signal exists. And check whether the patient is breathing normally; breathing too rapidly or too slowly may endanger the patient life.
SpO₂			
SpO₂ Sensor Off SpO₂b Sensor Off	SpO ₂ sensor may be disconnected from the patient measuring site.	User-selectable	Make sure the sensor is well connected to the patient's finger or other parts. Make sure the monitor and cables are well connected.
SpO₂ Comm Fail SpO₂b Comm Fail	SpO ₂ module failure or communication failure	High	Stop using measuring function of SpO ₂ module, and notify biomedical engineer or manufacturer's service staff.
SpO₂ Sensor Err SpO₂b Sensor Err	Malfunction in the SpO ₂ sensor or in the extension cable.	Low	Replace the SpO ₂ sensor or the extension cable.

Message	Cause	Alarm Level	Action Taken
SpO₂ No Sensor SpO₂b No Sensor	No SpO ₂ sensor was connected to the monitor.	User-selectable	Make sure the monitor and sensor are well connected, reconnect the sensor.
SpO₂ Low Perfusion SpO₂b Low Perfusion (EDAN SpO ₂ module)	The pulse signal is too weak or the perfusion of the measurement site is too low. The SpO ₂ value and PR value might be inaccurate then.	Low	Reconnect the SpO ₂ sensor and change the measurement site. If problem exists, please notify biomedical engineer or manufacturer's service staff.
SpO₂ Noisy Signal SpO₂b Noisy Signal (EDAN SpO ₂ module)	There is interference with SpO ₂ measurement signals due to patient movement, ambient light, electrical interference or else.	Low	Check the condition of patient and avoid patient movement; make sure the cable is well connected.
SpO₂ Light Interference SpO₂b Light Interference (EDAN SpO ₂ module)	Ambient light around the sensor is too strong.	Low	Reduce interference of the ambient light and avoid sensor's exposure to strong light.

Message	Cause	Alarm Level	Action Taken
NIBP			
NIBP Comm Fail	NIBP module failure or communication failure	High	Stop using measuring function of NIBP module, and notify biomedical engineer or manufacturer's service staff.
NIBP Leak	NIBP pump, valve, cuff or tube has a leakage.	Low	Check the connections and the wrapped cuff to see whether they are all prepared well. If failure persists, please notify biomedical engineer or manufacturer's service staff.
NIBP Pressure Over	Pressure has exceeded the specified upper safety limit.	Low	Measure again, if failure persists, stop measuring function of NIBP module and notify biomedical engineer or manufacturer's service staff.
NIBP Init Pressure High	The initial pressure is too high during measuring	Low	
NIBP Aux Excessive Pressure	Pressure has exceeded the second safety limit as specified.	High	Notify biomedical engineer or manufacturer's service staff.

Message	Cause	Alarm Level	Action Taken
NIBP Time Out	Measuring time has exceeded the specified time.	Low	Measure again or use other measuring method.
NIBP Self Test Error	Sensor or other hardware errors.	High	Measure again, if failure persists, stop using measuring function of NIBP module and notify biomedical engineer or manufacturer's service staff.
NIBP Cuff Type Error	The cuff type used isn't consistent with the patient type.	Low	Confirm the patient type and change the cuff.
NIBP Airway Pressure Abnormality	Atmospheric pressure or system pressure is abnormal. The valve is occluded so that deflation is failed.	Low	Check whether the airway is occluded or pressure sensor works properly. If the problem still exists, contact your service personnel.
NIBP System Failure	NIBP is not calibrated.	High	Contact your service personnel.
NIBP Weak Signal	Cuff is too loose or patient pulse is too weak.	Low	Use other methods to measure blood pressure.

Message	Cause	Alarm Level	Action Taken
NIBP Range Exceeded	All of the SYS, DIA and MAP value are beyond the measurement range.	High	Use other methods to measure blood pressure.
SYS(NIBP) Overrange	SYS (NIBP) value is beyond the measurement range.	High	Use other methods to measure blood pressure.
DIA(NIBP) Overrange	DIA (NIBP) value is beyond the measurement range.	High	
MAP(NIBP) Overrange	MAP (NIBP) value is beyond the measurement range.	High	
NIBP Loose Cuff	Cuff is not properly wrapped or no cuff is connected.	Low	Properly wrap the cuff.
NIBP Interference	Signal noise is too large or pulse rate is not regular due to the patient movement.	Low	Make sure that the patient under monitoring is motionless.
NIBP Leak Test Error	Fail to deflate normally during the leak test, so NIBP leak test cannot be finished.	Low	Test again. If the problem still exists, contact your service personnel.
Unable to analyze CNBP	<ol style="list-style-type: none"> ECG or SpO₂ accessories fall off and there's no ECG/SpO₂ signal. Excessive signal interference during CNBP analysis. 	High	<ol style="list-style-type: none"> Ensure ECG and SpO₂ accessories are well connected. If the problem still exists, contact your service personnel.

Message	Cause	Alarm Level	Action Taken
TEMP			
iTemp TEMP Overrange	The Tympanic TEMP value is beyond the range of +33 °C ~ +42 °C.	High	Check sensor connection and patient condition.
TEMP T1 Sensor Off	Temperature cable of TEMP channe1 may be disconnected from the monitor.	Low	Make sure that the cable is properly connected.
TEMP T2 Sensor Off	Temperature cable of TEMP channe2 may be disconnected from the monitor.	Low	Make sure that the cable is properly connected.
Excessive T1	TEMP1 measuring value is beyond measuring range.	High	Check sensor connection and patient condition.
Excessive T2	TEMP2 measuring value is beyond measuring range.	High	Check sensor connection and patient condition.
TEMP Comm Fail	TEMP module failure or communication failure.	High	Stop measuring function of TEMP module, and notify biomedical engineer or Manufacturer's service staff.
T1 Calibration Failed	T1 calibration failed.	High	Please check whether the module works properly.
T2 Calibration Failed	T2 calibration failed	High	Please check whether the module works properly.

Message	Cause	Alarm Level	Action Taken
IBP			
YY Sensor Off (YY stands for the IBP label name: ART, Ao, UAP, BAP, FAP, LV, P1-P4, CVP, ICP, LAP, RAP, UVP, PA)	IBP sensor falls off.	Medium	Check the sensor connection and reconnect the sensor.
YY Catheter Off (YY stands for the IBP label name: ART, Ao, UAP, BAP, FAP, LV, P1-P4, PA)	IBP catheter falls off due to patient movement.	High	Check the catheter connection and reconnect it.
YY Sensor Err (YY stands for the IBP label name: ART, Ao, UAP, BAP, FAP, LV, P1-P4, CVP, ICP, LAP, RAP, UVP, PA)	Malfunction in the IBP sensor or in the extension cable.	Medium	Replace the IBP sensor or the extension cable.
YY Comm Fail (YY stands for the IBP label name: ART, Ao, UAP, BAP, FAP, LV, P1-P4, CVP, ICP, LAP, RAP, UVP, PA)	IBP module failure or communication failure	High	Stop measuring function of IBP module, and notify biomedical engineer or Manufacturer's service staff.
Abnormal YY Power (YY stands for the IBP label name: ART, Ao, UAP, BAP, FAP, LV, P1-P4, CVP, ICP, LAP, RAP, UVP, PA)	Malfunction in the IBP power	Medium	Stop measuring function of IBP module, and notify biomedical engineer or Manufacturer's service staff.

Message	Cause	Alarm Level	Action Taken
C.O.			
C.O. Comm Fail	C.O. module failure or communication failure	High	Stop measuring of C.O. module, or notify biomedical engineer or Manufacturer's service staff.
C.O. TI Sensor Off	C.O. TI sensor not connected	Low	Insert injective temperature sensor.
C.O. TB Sensor Off	C.O. TB sensor not connected	Low	Insert TB sensor.
TI TEMP Out Of Range	TI measuring value is beyond measuring range.	High	Please check TI sensor.
TB TEMP Out Of Range	TB measuring value is beyond measuring range.	High	Please check TB sensor.
AG			
AG Comm Fail	AG module failure or communication failure.	High	Stop measuring function of AG module, and notify biomedical engineer or Manufacturer's service staff.
CO₂ Out Of Range	The CO ₂ concentration exceeds the accuracy range of AG module.	High	
N₂O Out Of Range	The N ₂ O concentration exceeds the accuracy range of AG module.	High	
AA Out Of Range	The anesthesia gas concentration exceeds the accuracy range of AG module.	High	

Message	Cause	Alarm Level	Action Taken
O₂ Out Of Range	The O ₂ concentration exceeds the accuracy range of AG module.	High	
AG Pressure Overrange	The barometric pressure exceeds the specified working barometric pressure range.	High	Make sure the AG module is used within the specified barometric pressure range.
AG Mixed Agents MAC<3	Anesthetics gas mixture (HAL, ISO, ENF, SEV, DES) is detected, and MAC of 2 anesthetics + MAC(N ₂ O) < 3.	Low	Adjust the concentration of the anesthetic agents if necessary.
AG Mixed Agents MAC≥3	Anesthetics gas mixture (HAL, ISO, ENF, SEV, DES) is detected, and MAC of 2 anesthetics + MAC(N ₂ O) ≥ 3.	Medium	Adjust the concentration of the anesthetic agents if necessary.
AG AA Id Unreliable	<p>1) Mainstream: The airway adapter was replaced without a zeroing.</p> <p>2) More than 2 anesthetic agents are present in the breathing circuit.</p> <p>3) High concentrations of solvents, cleaning agents or other interfering gases are present in the breathing circuit.</p>	<p>High (EDAN AG module)</p> <p>Medium (Masimo AG module)</p>	<p>1) Perform a zeroing after replacing the adapter.</p> <p>2) Reduce the number of anesthetic agent types.</p> <p>3) Replace the sampling tube or reduce the interfering gases.</p>

Message	Cause	Alarm Level	Action Taken
AG Zero Required (Masimo AG module)	Zeroing of AG module is required.	Medium	Perform zero calibration.
AG Replace O₂ Sensor (Masimo AG module)	Replacement of the O ₂ sensor is required.	Medium	Stop measuring function of AG module, and notify biomedical engineer or Manufacturer's service staff.
AG Motor Error (Masimo AG module)	Malfunction in the AG motor.	High	
O₂ Cali Required (Masimo AG module)	O ₂ sensor requires calibration.	Medium	
AG Software Error	Malfunction in the AG software.	High	
AG Hardware Error	Malfunction in the AG hardware.	High	
AG Uncalibrated (Masimo AG module)	AG module calibration is not completed.	High	
AG Calibration Failed (Masimo AG module)	Calibration of the sidestream AG module fails.	Medium	
AG Replace Adapter (Masimo AG module)	Replacement of the adapter is required.	Medium	Replace the adapter.

Message	Cause	Alarm Level	Action Taken
AG TEMP Out Of Range	The temperature of the AG module exceeds the specified working temperature range.	High	Make sure the AG module is used within the specified temperature range.
Sample Line Occluded	The sampling tube is occluded.	Medium	Replace the sampling tube.
O₂ Sensor Error (Masimo AG module)	Malfunction in the O ₂ sensor inside the sidestream AG module.	High	Stop measuring function of AG module, and notify biomedical engineer or Manufacturer's service staff.
AG No Adapter (Masimo AG module)	No adapter is connected.	Medium	Connect the adapter correctly.
No Sample Line (Masimo AG module)	No sampling tube is connected.	Medium	Connect the sampling tube correctly.
AG Occluded	AG module sample line occluded	Medium	Replace the sampling line.
Watertrap will be full (EDAN AG module)	Watertrap will be full.	Medium	Replace the watertrap.
O₂ Port Clogged (Masimo AG module)	O ₂ inlet of the AG module is occluded.	Medium	Check that the sampling line is blocked, if not blocked, return it to the manufacturer.

Message	Cause	Alarm Level	Action Taken
AG Module Fault (EDAN AG module)	AG module has malfunction.	High	Stop measuring function, and notify biomedical engineer or Manufacturer's service staff.
AG Watertrap Not Connected (EDAN AG module)	No water trap is connected to the AG module.	Medium	Check that the water trap is properly connected.
O₂ Module Error (EDAN AG module)	O ₂ is not in place or cannot communicate properly.	High	Stop measuring function, and notify biomedical engineer or Manufacturer's service staff.
CO₂			
CO₂ Comm Fail	CO ₂ module failure or communication failure	High	Check if the water tray has been fixed.
CO₂ Zero Required	Zero calibration failure	Low	Disconnect the sampling cannula or adapter from the airway; initiate the zeroing before making sure that no expired air is inside the sampling cannula and adapter.

Message	Cause	Alarm Level	Action Taken
CO₂ Check Adapter	<p>1) For the Respironics CO₂ module: The cannula is off or disconnected.</p> <p>2) For the EDAN CO₂ module: The water trap is disconnected or not properly connected.</p>	Low	<p>1) For the Respironics CO₂ module: Check whether the adapter is properly connected or replace the adapter.</p> <p>2) For the EDAN CO₂ module: Properly connect the water trap.</p>
CO₂ Sensor Over Temp	CO ₂ sensor temperature exceeds +40 °C.	High	Stop using measuring function of CO ₂ module, notify biomedical engineer.
CO₂ Out Of Range	The CO ₂ concentration exceeds the accuracy range of CO ₂ module.	High	Reduce CO ₂ concentration.
etCO₂ Overrange	The etCO ₂ concentration exceeds the measurement range.	High	Please check the monitor or patient status and adjust the gas concentration accordingly.
FiCO₂ Overrange	The FiCO ₂ concentration exceeds the measurement range.	High	
CO₂ Sensor Faulty	CO ₂ module failure	High	Stop measuring function of CO ₂ module, notify biomedical engineer.

Message	Cause	Alarm Level	Action Taken
CO₂ Occlude	Water trap of SideStream is occluded.	High	Make sure the gas exhaust works well
CO₂ Replace Adapter	Replacement of the adapter is required.	Medium	Replace the adapter.
CO₂ Hardware Error	Hardware error of CO ₂ module	High	Stop measuring function of CO ₂ module, and notify biomedical engineer or Manufacturer's service staff.
CO₂ Software Error	Software error of CO ₂ module	Medium	
CO₂ Motor Error	Malfunction in the CO ₂ motor.	High	
CO₂ Factory Calibration Data Lost	Ex-factory calibration data of CO ₂ module is lost.	Medium	
CO₂ Air Pressure Overrange	The barometric pressure exceeds the specified working barometric pressure range.	High	Make sure the CO ₂ module is used within the specified barometric pressure range.
CO₂ No Sample Line	No sampling tube is connected.	Medium	Connect the sampling tube correctly.
CO₂ No Adapter	No adapter connected	Medium	Connect the adapter correctly.
CO₂ Occlusion	CO ₂ module sample line occluded.	High	Replace the sampling line.

Message	Cause	Alarm Level	Action Taken
CO₂ Noisy Signal (EDAN CO ₂ module)	The CO ₂ signal is interfered by ambient or electromagnetic interference	Low	Check interference sources around the device.
Others			
Battery Low	Battery power lower than 2%, and the monitor will shut down automatically after 5 minutes.	High	Please change the battery or charge the battery.
	Battery power lower than 25%	Medium	
Battery1 Error	Malfunction in Battery 1	Low	Replace the battery and restart the monitor. If the problem persists, notify the manufacturer's service staff.
Battery2 Error	Malfunction in Battery 2	Low	
Battery1 Voltage Too High	Battery 1: over-voltage during charging	Low	Stop using the battery and notify the manufacturer's service staff.
Battery2 Voltage Too High	Battery 2: over-voltage during charging	Low	
Recorder Out Of Paper	Recorder Out Of Paper	Low	Please install the paper
Recorder Probe Overheated	The probe of recorder is overheated.	Low	Stop recording and retry after the probe cools.
Recorder Voltage Low	The battery capacity of the monitor is too low, thus the record function is unavailable.	Low	Please change the battery or charge the battery.

Message	Cause	Alarm Level	Action Taken
Audio Failed	Audio circuit connection is abnormal, or loudspeaker falls off.	High	Stop using the monitor and notify the manufacturer's service staff.
Network Traffic Abnormity	Abnormal network traffic has been detected. The data traffic exceeds the limit.	High	Disconnect the network to make the monitor work properly, and then contact the professionals authorized by manufacturer to check the network problem.
Server Disconnected	The monitor's network is disconnected.	Medium	<ol style="list-style-type: none"> 1) Check if the network cable is well connected or Wi-Fi is connected. 2) Check if the central monitoring system is turned on. 3) Check if the IP of bedside monitor and central monitoring system are on the same network segment.
Data Disconnected	The system client is disconnected from the internal data service.	High	Restart the monitor.

6.3 Prompts

Message	Cause
ARR Relearning	The QRS template building required for Arr. Analysis is in process.
Unable to analyze ST	The ST algorithm cannot produce valid ST value, which may be caused by the large change in the measured value of connected cardiogram ST or ventricular pacing.
Unable to analyze QT	QT algorithm cannot generate valid QT for more than 10 minutes (or 1 minute during startup).
QT Baseline Overrange	After modifying the calculation formula, the QTc parameter value exceeds the range.
Unable to analyze ECG	The arrhythmia algorithm cannot analyze ECG data reliably.
V-Fib/V-Tach Off	V-Fib/V-Tach alarm is set to Off .
ExtremeTachy Off	Extreme Tachycardia alarm is set to Off .
ExtremeBrady Off	Extreme Bradycardia alarm is set to Off .
V-Tach Off	V-Tach alarm is set to Off .
Vent Brady Off	Vent Brady alarm is set to Off .
Check if the patient has a pacemaker	When Pace is set to Unknown and pace pulse is detected.
Electrodes Contact Poor	The electrode has bad contact with patient's body.
SpO₂ Searching Pulse SpO₂b Searching Pulse	SpO ₂ module is analyzing the patient signal and searching for the pulse to compute the saturation, when sensor is connected with patient.
Please Start Measure	NIBP module is in idle status.
Measuring	The NIBP measurement is in process.
Done	NIBP measurement is completed.
Measurem. Canceled	Press the "Start/stop NIBP measurement" button or shortcut key  to stop the measurement.

Message	Cause
Calibrating	Monitor is currently calibrating.
Calibration Cancelled	Calibration is cancelled.
Main Sensor Calibration Done	Main sensor calibration is completed.
OPU Calibration Done	OPU (Overpressure protection unit) calibration is completed.
Leak. Test Running	The leakage test is in process.
Leak. Test Canceled	Pneumatic test over.
Leakage Test Ok	There is no leak.
Manometer Mode	Calibrate in this mode.
Resetting	NIBP module in resetting.
STAT Aborted	STAT measurement ends.
STAT Completed	STAT is completed.
CO₂ Standby	Turn from measuring mode to standby mode, making the module in energy-saving status.
CO₂ Sensor Warms Up	The CO ₂ module is in warm-up state.
CO₂ Zeroing...	The zeroing of CO ₂ module is in progress.
CO₂ Zero Success	CO ₂ module completes zero calibration.
CO₂ Zero Failed	CO ₂ module failed to complete the zero calibration.
CO₂ Calibration OK	CO ₂ module completes calibration.
CO₂ Calibration Failed	CO ₂ module failed to complete the calibration.
IBP Zero Success	IBP completes zeroing.
IBP Zero Failed	During the zero, the IBP transducer falls off or the pressure exceeds the range.
Pressure Pulsating, Unable to Zero	During the zeroing process, pressure fluctuation is excessive.
Pressure Overrange, Unable to Zero	During the zeroing process, pressure value is beyond the zeroing range.
Sensor Off, Unable to Zero	Perform zeroing when the sensor is off.
Invalid Time, Zero Failed.	Time is not set up prior zeroing.

Message	Cause
Unable to Zero in Demo Mode	Perform zeroing in Demo Mode.
IBP Zeroing...	Zeroing is in progress.
IBP Calibration OK	IBP Calibration is completed.
Pressure Pulsating, Unable to Calibrate	During the Calibration process, pressure fluctuation is excessive.
Pressure Overrange, Unable to Calibrate	During the Calibration process, pressure value is beyond the Calibration range.
Not Zeroed, Unable to Calibrate	Zeroing is not performed prior calibration.
Sensor Off, Unable to Calibrate	Perform calibration when the sensor is off.
Invalid Time, Calibration Failed.	Time is not set up prior calibration.
Unable to Calibrate in Demo Mode	Perform calibration in Demo Mode.
IBP Alias Conflict	The same IBP label appears.
C.O. Lack Param	Parameter is not configured for C.O. measurement.
C.O. TI No Sensor	C.O. TI sensor not connected
C.O. TB No Sensor	C.O. TB sensor not connected
AG Self-Testing..... (Masimo AG module)	AG module is performing a power-on self-test.
AG Span Calib In Progress (Masimo AG module)	The calibration of AG module is in progress.
AG Standby	Switch from measuring mode to standby mode, making the module in energy-saving status.
AG Zeroing...	The zeroing of AG module is in progress.
AG Sensor Warms Up	The AG module is in warm-up state.
CO₂/AG Auto-zero Suppression	CO ₂ /AG module auto zeroing is suppressed.
CO₂/AG Zero Recovering	The CO ₂ /AG module is in zero recovery status.

Message	Cause
Lack of parameter, unable to score	In Warning-Score System interface, parameters are not completely input.
SpO₂ Noisy Signal (Nellcor SpO ₂ module)	There is interference with SpO ₂ measurement signals due to patient movement, ambient light, electrical interference or else.
NIBP Simul	NIBP Simul function is turned on.
SpO₂/NIBP Simul SpO₂b/NIBP Simul	NIBP Simul function is turned on for SpO ₂ channel or SpO ₂ b channel.
More than 5 consecutive password errors	Continuously enter the wrong password for more than 5 times.
Hand Measurement in Progress	Select the hand as the measurement site and start the measurement.
Foot Measurement in Progress	Select the foot as the measurement site and start the measurement.
Dual-Channel SpO₂ Measurement in Progress	Switch on the dual-channel SpO ₂ measurement and start the measurement.
Hand Measurement Completed	45 seconds trend curve and the valid SpO ₂ measurement value of the hand are displayed.
Foot Measurement Completed	45 seconds trend curve and the valid SpO ₂ measurement value of the foot are displayed.
Current Measurements Completed	45 seconds trend curve and the valid SpO ₂ measurement value are displayed.
Countdown to Next Measurement	Suspect positive. Start one hour countdown.
Remeasure	Remeasure the SpO ₂ values. Click the  button.
SpO₂ measurement interference, please remeasure	SpO ₂ measurement has interference, please remeasure the SpO ₂ values.
CCHD measurement timeout	No measurement was started within 10 min after the countdown expires.
Export Failed	Failed to export the trend table data to the USB flash disk.

Message	Cause
Export Success	The trend table data export is completed.
Space Limited, circular storage will start	The storage space is less than 260 M. The circular storage is about to start.
Deleting data during circular storage	The storage space is less than 250 M. The circular storage is in progress and earlier data will be replaced by later one.

6.4 Adjustable Range of Alarm Limits

ECG alarm limits are listed as follows: unit (bpm)

Parameter	Patient Type	Adjustable Range
HR	ADU	15~300
	PED/NEO	15~350

ST analysis alarm limits are listed as follows: unit (mV)

Parameter	Adjustable Range
ST	-2.00~2.00

QTc and Δ QTc alarm limits are listed as follows: unit (ms)

Parameter	Adjustable Range
QTc	200~800
Δ QTc	30~200

RESP alarm limits are listed as follows: unit (rpm)

Parameter	Adjustable Range
RR	2~150

SpO₂ alarm limits are listed as follows: unit (%)

Parameter	Adjustable Range
SpO ₂	20~100

SpO₂ Desat Limits are listed as follows: unit (%)

	Adjustable Range
SpO ₂ Desat Limit	20~99

NOTE:

User can set the range through User Maintain > Alarm Setup > SpO₂ Desat Limit, SpO₂ Desat Limit should be less than or equal to SpO₂ alarm low limit.

PR alarm limits are listed as follows: unit (bpm)

Parameter	Adjustable Range
PR	30~300

NIBP alarm limits are listed as follows: unit (mmHg)

Patient Type	Parameter	Adjustable Range
ADU	SYS	25~290
	DIA	10~250
	MAP	15~260
PED	SYS	25~240
	DIA	10~200
	MAP	15~215
NEO	SYS	25~140
	DIA	10~115
	MAP	15~125

CNBP alarm limits are listed as follows: unit (mmHg)

Patient Type	Parameter	Adjustable Range
ADU	CNBP (SYS)	25~290
	CNBP (DIA)	10~250
PED	CNBP (SYS)	25~240
	CNBP (DIA)	10~200

TEMP alarm limits are listed as follows:

Parameter	Adjustable Range
T1	0 °C (32 °F)~50 °C (122 °F)
T2	0 °C (32 °F)~50 °C (122 °F)
TD	High limit: 0.1 °C (0.2 °F)~50 °C (90 °F)

iTEMP alarm limit is listed as follows:

Parameter	Adjustable Range
iTEMP	33 °C (91.4 °F)~42 °C (107.6 °F)

IBP alarm limits are listed as follows: unit (mmHg)

Parameter	Adjustable Range
ART, Ao, UAP, BAP, FAP, LV, P1-P4	-50~400
CVP, ICP, LAP, RAP, UVP	-10~40
PA	-6~120

CO₂ alarm limits are listed as follows:

Parameter	Adjustable Range
etCO ₂	0 mmHg~150 mmHg
FiCO ₂	High limit: 3 mmHg~50 mmHg (Masimo Sidestream) 0 mmHg~50 mmHg (EDAN, Respirationics, Masimo Mainstream)
AwRR	Sidestream: 2 rpm~150 rpm (EDAN, Respirationics) 0 rpm~150 rpm (Masimo) Mainstream: 0 rpm~150 rpm

C.O. alarm limits are listed as follows:

Parameter	Adjustable Range
TB	23 °C (73.4 °F)~43 °C (109.4 °F)

AG alarm limits are listed as follows:

EDAN Module

Parameter	Adjustable Range
etCO ₂	0.0%~15.0%
FiCO ₂	0.1%~15.0%
etO ₂ /etN ₂ O/FiN ₂ O	0.0%~100.0%
FiO ₂	18.0%~100.0%
etHAL/etENF/etISO/FiHAL/FiENF/FiISO	0.0%~8.0%
etSEV/FiSEV	0.0%~10.0%
etDES/FiDES	0.0%~22.0%
AwRR	2 rpm~150 rpm
No Breath Detected Alarm Time	20 s~40 s

Masimo Module

Parameter	Adjustable Range
FiCO ₂	0.1%~25.0%
etCO ₂	0.0%~25.0%
FiO ₂	18.0%~100.0%
etO ₂	0.0%~100.0%
FiN ₂ O/etN ₂ O	0.0%~82.0%
etDES/FiDES	0.0%~18.0%
etISO/FiISO/etHAL/FiHAL/etENF/FiENF	0.0%~5.0%
etSEV/FiSEV	0.0%~8.0%
AwRR	0 rpm~150 rpm
No Breath Detected Alarm Time	20 s~40 s

Chapter 7 Managing Patients

7.1 Confirming a Patient

If the patient is not discharged before the monitor is shut down, on the following time the monitor is turned on, the following message will be presented to the user: “**Continue monitoring the current patient or admit a new patient?**”. Select **Current Patient** to use the current configuration; Select **New Patient** to admit new patient.

NOTE:

If the user does not make a selection within 1 minute, Current Patient is selected by default.

7.2 Discharging a Patient

Always discharge the previous patient before monitoring a new patient. Failure to do so can lead to data being attributed to the wrong patient.

To discharge a patient, use any of the following methods to access the Discharge Patient page:

- Select the shortcut key .
- Select **Menu > Patient Setup > Patient Info > Discharge**.
- Select the patient information area and click **Discharge**.

Select an option in the Discharge Patient dialog:

- **Standby after Discharge:** After discharging the patient, the monitor enters into standby mode.
- **New Patient:** After discharging the current patient, the monitor displays the patient admitting interface.
- **Cancel:** Cancel the patient discharging.

After discharging the patient, all patient data, including patient information, trend data and physiological alarm information, will be cleared and the technical alarm status will be reset.

7.3 Admitting a Patient

The monitor displays physiological data and stores it in the trends as soon as a patient is connected. This allows you to monitor a patient who is not yet admitted. It is however important to admit patients properly so that you can identify your patient on recordings, reports, and networked devices.

During admission you enter data that the monitor needs for safe and accurate operation. For example, the patient category setting determines the algorithm the monitor uses to process and calculate some measurements, the safety limits that are applied for some measurements, and the alarm limit ranges.

To admit a patient, please:

1. Click patient information area, or select **Menu > Patient Setup > Patient Info** to enter the patient information page.
2. Enter the patient information:
 - **Patient ID:** Enter the patient's medical record number.
 - **Last Name:** Enter the patient's last name (family name).
 - **First Name:** Enter the patient's first name.
 - **Bed Label:** Supports up to 20 characters. Chinese, English, numbers and special characters can be input.
 - **Department:** Enter the patient's department.
 - **Doctor:** Enter the attending doctor for the patient.
 - **Nurse:** Enter the nurse in charge for the patient.
 - **Gender:** **Male**, **Female** and **N/A**.
 - **Type:** Choose the patient type, either **Adult**, **Pediat**, or **Neonat**.
 - **BloodType:** **N/A**, **A**, **B**, **AB** and **O**.
 - **Pace:** Choose **On**, **Off** or **Unknown** (You must select **On** if your patient has a pacemaker).
 - **Date of Birth:** Enter the patient's date of birth.
 - **Date of Admission:** Enter the patient's date of admission.
 - **Age:** Enter the patient's age.
 - **Height:** Enter the patient's height, with unit: **cm** or **inch**.
 - **Weight:** Enter the patient's weight, with unit: **kg** or **lb**.
 - **BMI:** The system calculates the BMI automatically based on the input height and weight.
 - **TEMP:** Enter the patient's temperature.

The user can set the patient information items to be displayed in **Menu > System > User Maintain > Patient Setup**. The Patient ID, Bed Label, name, patient type and pace are fixed display items and cannot be hidden.

3. Click **Confirm** to admit the patient.

NOTE:

- 1 **Creating new patient and updating patient will clear the history data in the monitor associated with the patient.**
- 2 **For Bed Label, user can select English or Chinese through switching keyboard language, and select special characters through .**

7.3.1 Patient Category and Pace Status

The patient category setting determines the algorithm which the monitor uses to process and calculate some measurements, the safety limits that are applied for some measurements, and the alarm limit ranges.

The pace setting determines whether the monitor shows pace pulse marker or not.

WARNING

- 1 **Changing the patient category may change the arrhythmia and NIBP alarm limits. Always check alarm limits to make sure that they are appropriate for your patient.**
- 2 **For paced patients, you must set Pace to On. If it is incorrectly set to Off, the monitor could mistake a pace pulse for a QRS and fail to give an alarm during asystole.**

7.4 Quick Admit

If you do not have the time or information to fully admit a patient, you can use Quick Admit to quickly admit a patient and complete the rest of the patient information later. To quickly admit a patient, please:

1. Select the shortcut key  on the screen directly.
2. Configure **Type** and **Pace** to the correct setting and click **Confirm** to finish the quick patient admission operation. If you want to quit the operation, click **Cancel**.

7.5 Barcode Admit

Barcode scanner can recognize patient information directly and quickly, which can provide convenience and reduce mistakes for users.

Scan the barcode/QR code of the patient with the scanner.

- If the patient ID is consistent with the current one, **Patient Info** screen pops up and the patient information will be updated according to the identified barcode information. Click **Confirm** to retain the change.
- If the patient ID is different from the current one, **Admission** screen pops up and the patient information will be updated according to the identified barcode information. Check and edit the patient information if required. Click **Confirm** to admit the patient.

Barcode scanned information will be parsed into patient information according to the barcode setup and patient information will always be transferred in HL7 protocol. The monitor transfers the patient information change event to the EMR system once patient information has been changed.

7.6 Managing Patient Information

7.6.1 Editing Patient Information

To edit the patient information after a patient has been admitted, select **Menu > Patient Setup > Patient Info**, make the required changes on the popup interface, and click **Confirm**. If a barcode scanner is configured with your monitor, scan the patient's barcode to enter patient information.

NOTE:

When changing the patient type, the patient will be re-admitted as a new patient after user's confirmation.

Chapter 8 Managing Profiles

Profiles are predefined monitor configurations, by which you can change the configuration of the monitor to adapt it to different monitoring situations. Different sets of profiles can be configured to accommodate various patient types and departments.

8.1 Changing Institutional Default Profile

The monitor will load the pre-set institutional default profile in the following cases:

- A patient is admitted.
- Patient type is changed.

To change the institutional default profile, follow these steps:

1. Select **Menu > Profile > Institutional Defaults**.
2. Choose a profile from the pop-up list and input the required password to confirm the selection. This profile can be either factory default profile or a saved user profile.

8.2 Resetting to Factory Default Profile

To set factory default profile, select **Menu > Profile > Profile Management** and choose a factory profile (adult, pediatric or neonate) based on the patient category.

8.3 Setting User Profile

25 pieces of user profile can be saved in the monitor. The one labeled with  is the current profile. To set the user profile, follow these steps:

Select the shortcut key  or select **Menu > Profile > Profile Management > User Profile**:

- **Apply**: Apply the currently selected profile.
- **Save and Apply**: Input the required password and profile name. Click **Confirm** to save and apply the current settings.
- **Delete**: Input the required password to delete the currently selected profile.

NOTE:

The profile currently in use cannot be deleted.

8.4 Transferring Profile

When installing several monitors with identical user profiles, it is not necessary to set each monitor separately. Use a USB flash disk to transfer the profile from monitor to monitor.

To export the current monitor's profile, follow these steps:

1. Connect the USB flash disk to the monitor's USB port.
2. Select **Menu > Profile > Transfer Profile** and input the required password.
3. Choose the removable device and click **Export** to enter the preview interface. Select a profile from the profile list and click **Confirm**.

To import the configuration from the USB flash disk to the monitor, follow these steps:

1. Connect the USB flash disk to the monitor's USB port.
2. Select **Menu > Profile > Transfer Profile** and input the required password.
3. Choose the removable device and click **Import** to enter the preview interface. Select the profile from the profile list and click **Confirm**.

Chapter 9 User Interface

9.1 Switching On or Off a Parameter

The user can switch on or off a parameter based on the requirement.







1. Select the shortcut key  on the screen directly, or
2. Select **Menu > Parameter > Param Switch**.
3. Enable or disable desired parameters. Select **Param Setup** to access the setup menu of the specific enabled parameter.

NOTE:

When a parameter is manually switched off, the corresponding parameter module stops working, you cannot set the parameter to be displayed in the main interface.

9.2 Changing Screen Layout

Select **Menu > Screen** to open the setup menu on which you can:

- Select the desired screen based on the clinical needs in **Screen Setup**. The user can also select the shortcut key  to change the screen layout.
- Configure the parameter layout in **Screen Layout** page:
 - ◆ Select **Add Row/Add Column** or **Remove Row/Remove Column** to set the quantity of rows and columns.
 - ◆ Select a specified parameter area or waveform area, and then choose the elements to be displayed in this area from the popup dialog. The user can also enable **All Parameters** to show all the parameters on the screen. Click  to clear the parameter selection.
 - ◆ Merge or split the parameter area by clicking  or .
 - ◆ Exchange the parameter/waveform area by clicking  or .
- Select the required shortcut keys and adjust the sequence by dragging any key **Shortcut Keys** page (password protected).
- Set the screen brightness in **Display Setup** page. Refer to Section *Adjusting Screen Brightness* for details.
- Select Night mode in **Display Setup** page. Refer to Section *Night Mode* for details.

9.3 Standard Screen

The standard screen is most frequently used for patient monitoring. To enter the standard screen, select **Menu > Screen > Screen Setup > Standard**. Refer to Section *Operating and Navigating* for the layout of standard screen.

9.4 Large Font Screen

The large font screen displays parameter values in big font size. To enter the large font screen, select **Menu > Screen > Screen Setup > Large Font**. Select **Menu > Screen > Parameter Layout** to choose the elements to be displayed in this area.

9.5 Trend Screen

The trend screen shows the recent graphic trends of parameters. To enter the trend screen, select **Menu > Screen > Screen Setup > Trend Screen**.

Select short trend to open **Short Trend Setup** menu on which you can set **Time Interval** for the trend.

9.6 OxyCRG Screen

The OxyCRG screen is always used in NICU because the SpO₂, HR and Resp of the neonate are different from those of adults. OxyCRG is in the bottom half part of wave area; it consists of HR trend, SpO₂ trend and RR trend or RESP compressed waveform. To enter the OxyCRG screen, select **Menu > Screen > Screen Setup > OxyCRG**.

Select OxyCRG waveform to open **OxyCRG Setup** menu on which you can set:

1. **Time Interval**: set the time for the trend and compressed waveform.
2. **RESP Display**: select **RR** for RR trend, or **RESP** for RESP compressed waveform.

9.7 ECG Screen

When **Electrode Type** is **5 Electrodes** or **6 Electrodes**, **Screen Setup** can be set to **Full-Screen** and **Half-Screen**; When **Electrode Type** is **10 Electrodes**, **Screen Setup** can be set to **Full-Screen**.

■ Full-Screen:

- ◆ For 5 electrodes, display seven ECG waveforms which occupy the area of seven waveforms on the main screen;
- ◆ For 6 electrodes, display eight ECG waveforms which occupy the area of eight waveforms on the main screen;

- ◆ For 10 electrodes, display 12 ECG waveforms which occupy the area of six waveforms on the main screen.

■ **Half-Screen:**

- ◆ For 5 electrodes, display seven ECG waveforms which occupy the area of four waveforms on the main screen;
- ◆ For 6 electrodes, display eight ECG waveforms which occupy the area of four waveforms on the main screen.

9.8 Changing Parameter and Waveform Colors

The user can set the display colors of parameter and waveform as desired. To change the display color, please select **Menu > Screen > Color Setup > Current or All** to make color changes on parameter and waveform.

9.9 Changing Waveform Lines

To change the thickness of waveform lines, select **Menu > System > User Maintain** and input user maintenance password > **Other Setups > Wave Line. Thick, Medium** and **Thin** are optional.

Chapter 10 Monitoring ECG

10.1 Overview

The electrocardiogram (ECG) measures the electrical activity of the heart and displays it on the monitor as a waveform and a numeric.

10.2 ECG Safety Information

WARNING

- 1 Only use the ECG leads supplied by the manufacturer when using the monitor for ECG monitoring.**
 - 2 When connecting the cables and electrodes, make sure no conductive part is in contact with the ground. Verify that all ECG electrodes, including neutral electrodes, are securely attached to the patient but not the conductive part or ground.**
 - 3 Place the electrode carefully and ensure a good contact. Check every day whether there is skin irritation resulted from the ECG electrodes. If yes, replace electrodes every 24 hours or change their sites.**
 - 4 Store the electrodes in room temperature. Open the electrode package immediately prior to use. Never mix electrode types or brands. This may lead to problem due to impedance difference. When applying the electrodes, avoid bones close to skin, obvious layers of fat and major muscles. Muscle movement can result in electrical interference. Applying electrodes on major muscles, for example on muscles of thorax, may lead to erroneous arrhythmia alarm due to excessive muscle movement.**
 - 5 Check if the lead connection is correct before monitoring. If you unplug the ECG cable from the socket, the screen will display the error message “ECG LEAD OFF” and the audible alarm is activated.**
 - 6 If the ECG signal exceeds the measuring range, the monitor will indicate it by a message “ECG Signal Exceeded”.**
 - 7 In order to avoid burning, please keep the electrodes far away from the radio knife while using electrosurgical equipment.**
 - 8 When using Electrosurgery (ES) equipment, do not place an electrode near the grounding plate of the Electrosurgery device; otherwise, there will be a great deal of interference with the ECG signal.**
 - 9 The electrodes should be made of the same metal materials.**
-

WARNING

- 10 ECG cables can be damaged when connected to a patient during defibrillation or using other high frequency equipment. Check cables for functionality before using them again. It is recommended to use defibrillator-proof ECG lead to avoid burn.**
 - 11 According to AAMI specifications the peak of the synchronized defibrillator discharge should be delivered within 60 ms of the peak of the R wave. The synchronization pulse output on the patient monitors is delayed by a maximum of 35 ms from the R wave peak. Your biomedical engineer should verify that your ECG/Defibrillator combination does not exceed the recommended maximum delay of 60 ms.**
 - 12 Before outputting signals with defibrillator synchronization or ECG, check if the output is functioning normally.**
 - 13 ECG accessories are not suitable for DIRECT CARDIAC APPLICATION. (Refer to IEC60601-1 for more information about the definition of DIRECT CARDIAC APPLICATION.)**
 - 14 Line isolation monitor transients may resemble actual cardiac waveforms and thus inhibit heart rate alarms. When the electrode or lead is loose or fallen, the monitor is easily affected by the transient response of certain types of insulation monitors. The transient monitor signal produced by poor insulation of the line may be very similar to the actual heart waveform, which will prevent the monitor from prompting a heart rate alarm. In order to avoid this, user should check the lead wires for damage and ensure good skin contact prior to and during use. Always use fresh electrodes and follow proper skin preparation techniques.**
 - 15 The monitor can only be used on one patient at a time. Monitoring more than one patient simultaneously may result in hazards to the patient.**
 - 16 Pacemaker Failure: During a complete cardiac block or when pacemaker is unable to pacing/capture, high P-wave (greater than 1/5 of the average height of the R-wave) may be incorrectly counted by the monitor, which leads to a missing asystole.**
-
-

NOTE:

- 1 Interference from a non-grounded instrument near the patient and ESU interference can cause inaccuracy of the waveform.**

- 2 IEC/EN60601-1-2 (protection against radiation is 3 v/m) specifies that the electrical field density exceeding 3 v/m may cause measurement error in various frequencies. It is accordingly suggested that do not use equipment generating electrical radiation near ECG/RESP monitoring devices.
- 3 If the pacemaker signals are beyond the claimed range, the heart rate may be calculated incorrectly.
- 4 In the default settings of the monitor, the ECG waveforms are the first two waveforms from top in the waveform area.
- 5 For measurements in or near the heart, we recommend connecting the monitor to the potential equalization system.
- 6 For protecting environment, the used electrodes must be recycled or disposed of properly.

10.3 ECG Display

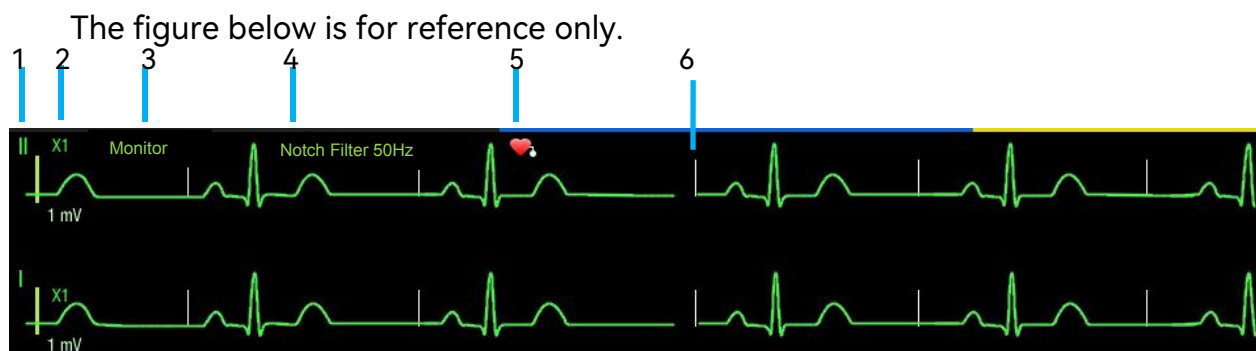

1: indicates lead name of displayed waveform: there are several options, such as **I**, **II**, **III**, **aVR**, **aVF**, **aVL**, **V** (for 5 Electrodes). Refer to section *Selecting Calculation Lead* for details.

2: indicates waveform gain: there are several options, such as **X0.125**, **X0.25**, **X0.5**, **X1**, **X2**, **X4** and **Auto**. Refer to section *Changing the Size of the ECG Wave* for details.

3: indicates Filter mode, there are six options: **Monitor**, **Surgery**, **Diagnosis**, **Enhanced**, **Diagnosis1**, and **Customized**. Refer to section *Changing the ECG Filter Setting* for details.

4: indicates notch filter status. **Off**, **50 Hz**, and **60 Hz** are optional. Refer to section *Setting Notch Filter* for details.

5: indicates pace status. Refer to section *Setting Pace Status* for details.

6: indicates pace pulse marker. Refer to *Setting Pace Status* for details.

10.4 Monitoring Procedure

10.4.1 Preparation

The skin is a poor conductor of electricity; therefore, preparation of the patient's skin is important to facilitate good electrode contact to skin.

- Select sites with intact skin, without impairment of any kind.
- Shave hair from sites, if necessary.
- Wash sites thoroughly with soap and water. (Never use ether or pure alcohol, because this increases skin impedance).
- Rub the skin briskly to increase capillary blood flow in the tissues and remove skin scurf and grease.

10.4.2 Connecting ECG Cables

1. Attach clip or snap to electrodes prior to placement.
2. Put the electrodes on the patient. Before attaching, apply some conductive jelly on the electrodes if the electrodes are not electrolyte self-supplied.
3. Connect the ECG electrode to the ECG cable.
4. Plug the ECG cable into the ECG connector on the monitor.

PRECAUTION

To protect the monitor from damage during defibrillation, for accurate ECG information and to protect against noise and other interference, use only ECG electrodes and cables specified by EDAN.

10.4.3 Selecting Electrode Type

To change the electrode type, please:

1. Select the ECG parameter area to access the ECG Setup menu;
2. Set **Electrode Type** to **3 Electrodes**, **5 Electrodes**, **6 Electrodes**, **10 Electrodes** or **Auto** based on the lead used.

NOTE:

If Electrode Type is set to Auto and if you remove the electrodes, the monitor will automatically recognize the new Electrode Type and issue the ECG lead off alarm. Click Update Lead Setup button to clear the ECG lead off alarm.

10.4.4 Installing Electrodes

To select the ECG standard according to the lead in use, please:

1. Select **Menu > System > User Maintain** and input user maintenance password;
2. Select **Parameter Maintain > ECG > ECG Standard**. AHA and IEC are optional.

NOTE:

The following table gives the corresponding electrode names used in Europe and America respectively. (Electrode names are represented by R, L, F, N, C, C1-C6 in Europe, whose corresponding electrode names in America are RA, LA, LL, RL, V, V1-V6.)

AHA (American Standard)		IEC (Europe Standard)	
Electrode Labels	Color	Electrode Labels	Color
RA	White	R	Red
LA	Black	L	Yellow
LL	Red	F	Green
RL	Green	N	Black
V	Brown	C	White
V1	Brown/ Red	C1	White/ Red
V2	Brown/ Yellow	C2	White/ Yellow
V3	Brown/ Green	C3	White/ Green
V4	Brown/Blue	C4	White/ Brown
V5	Brown/Orange	C5	White/ Black
V6	Brown/Purple	C6	White/ Purple

3 Electrodes Placement

Take the American standard for example, see the following figure:

- RA placement - directly below the clavicle and near the right shoulder.
- LA placement: directly below the clavicle and near the left shoulder.
- LL placement - on the left hypogastrium.

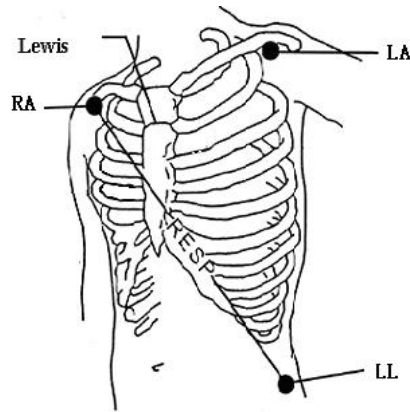

3 Electrodes Placement

5 Electrodes Placement

Take the American standard for example, see the following figure:

- RA placement: directly below the clavicle and near the right shoulder.
- LA placement: directly below the clavicle and near the left shoulder.
- RL placement: on the right hypogastrium.
- LL placement: on the left hypogastrium.
- V placement: on the chest, the position depends on your required electrode selection.

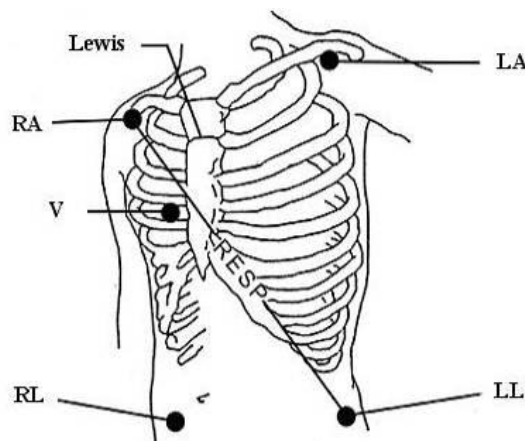

5 Electrodes Placement

NOTE:

To ensure the patient safety, all electrodes must be attached to the patient.

- For 5 electrodes, attach the V electrode to one of the indicated positions as below:
 - V1 On the 4th intercostal space at the right sterna margin.
 - V2 On the 4th intercostal space at the left sterna margin.

- V3 Midway between V2 and V4 electrodes.
- V4 On the 5th intercostal space at the left clavicular line.
- V5 On the left anterior axillary line, horizontal with V4 electrode.
- V6 On the left middle axillary line, horizontal with V4 electrode.
- V3R-V6R On the right side of the chest in positions corresponding to those on the left.
- VE Over the xiphoid position.
- V7 On the 5th intercostal space at the left posterior axillary line of back.
- V7R On the 5th intercostal space at the right posterior axillary line of back.

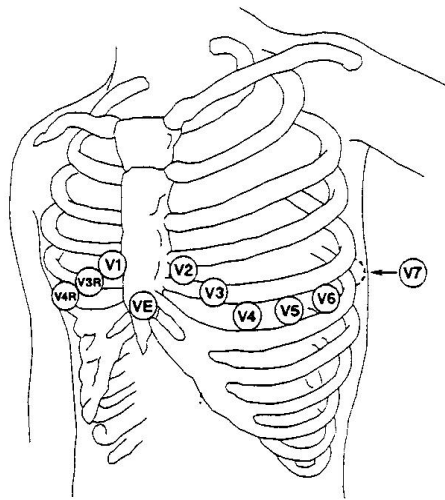

V-Electrode Placement for 5 Electrodes

6 Electrodes Placement

For the placement of 6 electrodes, please use the position of 5 electrodes in the schematic diagram to remove the two thoracic leads. The two thoracic leads Va and Vb can be placed at any two positions from V1 to V6, as shown in the following thoracic leads. To ensure that the label is correct, the selected Va and Vb placements must be set simultaneously in ECG Setup.

- V1 On the 4th intercostal space at the right sterna margin.
- V2 On the 4th intercostal space at the left sterna margin.
- V3 Midway between V2 and V4 electrodes.
- V4 On the 5th intercostal space at the left clavicular line.
- V5 On the left anterior axillary line, horizontal with V4 electrode.

- V6 On the left middle axillary line, horizontal with V4 electrode.

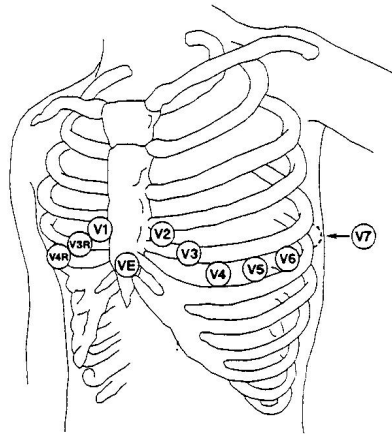

V-Electrode Placement for 6 Electrodes

10 Electrodes Placement

In 12-Lead ECG monitoring, the 10 electrodes are placed on the patient's four limbs and chest. The limb electrodes should be placed on the soft skin according to the physician's preference. The picture below shows the conventional 10 electrodes placement.

Take the American standard for example; the 10 electrodes should be placed as follows:

Limb electrodes:

- RA and LA: Place arm electrodes on the inside of each arm, between the wrist and the elbow.
- RL and LL: Place leg electrodes inside of each calf, between the knee and the ankle.

Chest electrodes:

- V1: On the 4th intercostal space at the right sterna margin.
- V2: On the 4th intercostal space at the left sterna margin.
- V3: Midway between V2 and V4 electrodes.
- V4: On the 5th intercostal space at the left clavicular line.
- V5: On the left anterior axillary line, horizontal with V4 electrode.
- V6: On the left middle axillary line, horizontal with V4 electrode.

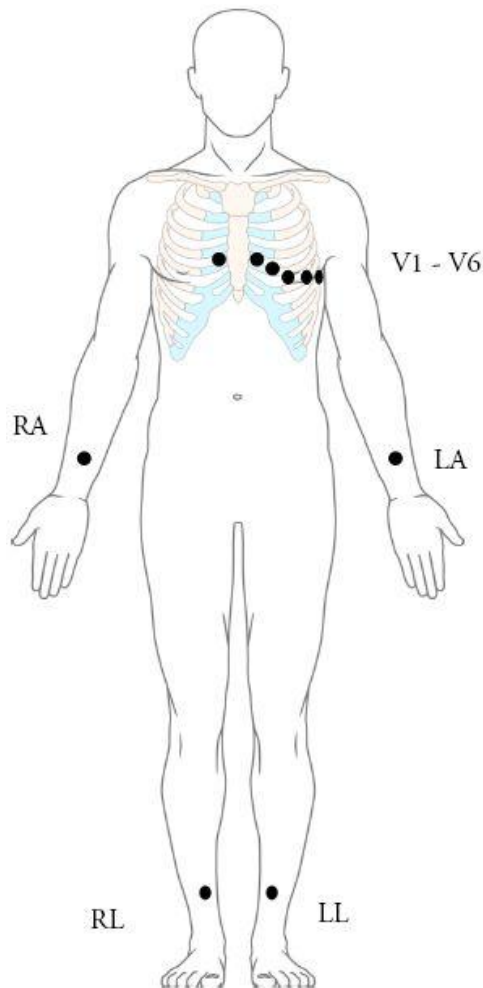

10 Electrodes Placement

Recommended ECG Electrode Placement for Surgical Patients

WARNING

When using Electrosurgery (ES) equipment, leads should be placed in a position in equal distance from Electrosurgery electrotome and the ES grounding plate to avoid cautery. Electrosurgery equipment wire and ECG cable must not be tangled up.

Monitoring ECG leads are mainly used for monitoring the patient's vital signs. When using the patient monitor with other electrosurgery equipment, it is advised to use the counteracting defibrillation ECG lead.

The placement of the ECG leads will depend on the type of surgery that is being performed. For example, in an open chest surgery the electrodes may be placed laterally on the chest or on the back. In the operating room, artifacts may affect the

ECG waveform due to the use of ES (Electrosurgery) equipment. To help reduce this you can place the electrodes on the right and left shoulders, the right and left sides near the abdomen, and the chest lead on the left side at mid-chest. Avoid placing the electrodes on the upper arms. Otherwise, the ECG waveform will be too small.

WARNING

ECG cables can be damaged when connected to a patient during defibrillation or using other high frequency equipment. Check cables for functionality before using them again. It is recommended to use defibrillator-proof ECG lead to avoid burn.

NOTE:

- 1 If an ECG waveform is not accurate, while the electrodes are tightly attached, try to change the leads displayed on the screen.**
- 2 Interference from a non-grounded instrument near the patient and ESU interference can cause inaccuracy of the waveform.**

10.5 ECG Setup

Select the ECG parameter area or waveform area to enter the **ECG** dialog. Select the **Setup** tab to access the ECG Setup menu.

10.5.1 Setting Analysis Mode

Multiple-leads analysis improves the detection sensitivity and reduces the false alarm, but when most leads are disturbed and have low amplitude, it is recommended to select the most suitable lead for single-lead analysis.

Select **Analysis Mode** in ECG Setup menu, and choose an appropriate setting from the pop-up list:

- **Single-Lead:** Refer to Section *Selecting Calculation Lead* to set the analysis lead.
- **Multiple-Leads:** Refer to Section *Selecting the Primary and Secondary Leads* to set the analysis leads.

NOTE:

When Electrode Type is set to 3 Electrodes, the analysis mode function is not available and the monitor always adopts the single-lead analysis mode.

10.5.2 Selecting Calculation Lead

In the single-lead analysis mode, set the **Calc. Lead** in ECG Setup menu. The default calculation lead is II.

- For 3 Electrodes, I, II, and III are optional.
- For 5 Electrodes, I, II, III, aVR, aVL, aVF, and V are optional.
- For 6 Electrodes, I, II, III, aVR, aVL, aVF and leads corresponding to Va and Vb are optional.
- For 10 Electrodes, I, II, III, aVR, aVL, aVF, V1, V2, V3, V4, V5, and V6 are optional.

The user can also set the waveform displayed on the main interface in addition to the calculation lead. Set the second waveform to be displayed in ECG Setup > **Second Wave** menu. The second ECG waveform of the main interface should not be the same with the waveform of the calculation lead.

10.5.3 Selecting the Primary and Secondary Leads

In the multiple-leads analysis mode, select **Primary Lead** or **Secondary Lead** in ECG Setup menu, and then select the appropriate lead. The monitor uses the primary and secondary leads to compute HR and to analyze and detect cardiac arrhythmias.

- For 5 Electrodes, I, II, III, aVR, aVL, aVF, and V are optional. By default, the primary lead is II, and the secondary lead is V.
- For 6 Electrodes, I, II, III, aVR, aVL, aVF and leads corresponding to Va and Vb are optional. By default, the primary lead is II, and the secondary lead is Va.
- For 10 Electrodes, I, II, III, aVR, aVL, aVF, V1, V2, V3, V4, V5, and V6 are optional. By default, the primary lead is II, and the secondary lead is V1.

The secondary and primary leads should not be the same lead. Choose a lead as primary or secondary lead that has the following characteristics:

- The normal QRS should be either completely above or below the baseline and it should not be biphasic. For paced patients, the QRS complexes should be at least twice the height of pace pulses.
- The QRS should be tall and narrow.
- The P-waves and the T-waves should be less than 0.2 mV.

NOTE:

Make sure you have selected the best lead with the best waveform amplitude and highest signal-to-noise ratio. Choosing the best lead is important for heart beat test, heart beat classification and ventricular fibrillation detection.

10.5.4 Setting Alarm Source

To change the alarm source, please select either ECG Setup > **Alarm Source** or PR Setup > **Alarm Source**, then a pop-up list is displayed:

HR: the monitor considers the HR as HR/PR alarm source;

PR: the monitor considers the PR as HR/PR alarm source;

Auto: If the alarm source is set to **Auto**, the monitor will use the heart rate from the ECG measurement as the alarm source whenever the ECG measurement is switched on and valid HR values are available. The monitor will automatically switch to PR as the alarm source if:

- valid HR values can no longer be measured and
- a PR source is switched on and available.

The monitor then uses the pulse rate from the measurement currently active as system pulse. If valid HR values become available again, the monitor automatically uses HR as alarm source.

10.5.5 Setting QRS Tone Source

To change the QRS tone source, select either ECG Setup > **QRS Volume Source** or PR Setup > **QRS Volume Source**. Select from the following options:

HR: HR is HR/PR QRS tone source;

PR: PR is HR/PR QRS tone source;

Auto: If the **QRS Volume Source** is set to **Auto**, the monitor will use HR as the QRS tone source whenever the ECG measurement is switched on, and valid HR values are available. The monitor will automatically switch to PR as the QRS tone source if:

- valid HR values can no longer be measured and
- a PR source is switched on and available.

If valid HR values become available again, the monitor automatically uses HR as QRS tone source and the monitor gives a “Di” tone when one heartbeat is detected. While a pulse is detected, the monitor gives a “Da” tone.

10.5.6 Setting ECG SQI

The ECG SQI indicates the signal quality of the ECG analysis leads. In the ECG Setup menu, enable **ECG SQI**. The default setting is off. When it is enabled, the ECG SQI icon will be displayed in the ECG parameter area to indicate 10 different levels of HR signal intensity.

10.5.7 Smart Lead Off

When **Electrode Type** is **5 Electrodes**, **6 Electrodes** or **10 Electrodes** and **Smart Lead Off** is set to on, if the selected ECG waveform cannot be measured because of lead-off or other reasons, it will automatically switch to another available lead channel via which a waveform can be measured. When the detached ECG lead is re-connected, the monitor automatically switches back to the original lead.

NOTE:

When Electrode Type is set to Auto, the smart lead off function will be automatically turned on and cannot be turned off.

10.5.8 Setting Pace Status

It is important to set the paced status correctly when you start monitoring ECG. To change the paced status in the ECG Setup menu, select **Pace** to toggle between **On**, **Off** or **Unknown**. When **Pace** is set to **On**:

– Pace pulse marker is displayed as ^l on the ECG waveform.

When monitoring a patient with a pacemaker, set **Pace** to **On**. If monitoring a patient without a pacemaker, set **Pace** to **Off**.

When **Pace** is set to **Unknown**, the monitor will continuously monitor the pace status and prompt the information when the pace signal is detected. Meanwhile,  will be displayed in the ECG waveform area, in order to prompt the user to turn on the pace analysis.

WARNING

- 1 Some pace pulses can be difficult to reject. When this happens, the pulses are counted as a QRS complex, and could result in an incorrect HR and failure to detect cardiac arrest or some arrhythmias. Be sure to check the paced symbol on the display screen has correctly detected the pacing pulse. Keep pacemaker patients under close observation.**
 - 2 For patients with pacemakers, the pace must be switched ON. Otherwise, the pacing impulse may be counted as regular QRS complexes, which could prevent an asystole event from being detected. When changing settings and admitting patients, please make sure the pace mode is always correct.**
 - 3 External pacing electrodes: When using pacemakers with external pacing electrodes on the patient, the quality of arrhythmia is severely degraded due to the high energy level in the pacemaker pulse. This can cause arrhythmia algorithms cannot detect the pacemaker without capturing or asystole.**
-

10.5.9 Enabling Pace Pulse Rejection

To enable the pace pulse rejection function, switch on **Pace Pulse Rejection** in ECG Setup menu. When it is enabled, pacemaker pulses are rejected and will not be displayed on the ECG waveform.

NOTE:

- 1 The pace pulse rejection can be adjusted only when Pace is set to On.
- 2 The display of pace pulse marker ¹ is not affected by the pace pulse rejection setting.

10.5.10 ECG Calibration

Select **Menu > System > User Maintain** and input user maintenance password > **Parameter Maintain > ECG > Start Calibration** to calibrate ECG waveform. When you select this item again, the ECG waveform calibration ends.

NOTE:

The patients cannot be monitored during the ECG calibration.

10.5.11 ECG Waveform Setup

10.5.11.1 Changing the Size of the ECG Wave

If any of the displayed ECG waveform is too small or clipped, you can change the size of it on the screen. First select **Waveform Gain** in ECG Setup menu, and then select an appropriate factor from the pop-up list to adjust the ECG waveform. If it is set to **Auto**, the monitor automatically adjusts the size of all the ECG waveforms.

NOTE:

The effect of ECG wave gain is subject to the size of the wave area. Whichever wave gain is chosen, the ECG wave has to be displayed within the wave area, the exceeded part is clipped.

10.5.11.2 Setting the Speed of the ECG Wave

To change the speed, select **Speed** in ECG Setup menu, and then select an appropriate setting from the pop-up list. The bigger the value is, the wider the waveform is.

10.5.11.3 Setting Va and Vb Labels

If **6 Electrodes** is selected in the ECG Setup menu, Va and Vb can be respectively set to either Lead V1 ~ V6, but cannot be set to the same lead. Va is Lead V1 by default

and Vb is Lead V2 by default.

NOTE:

If Auto is selected in the ECG Setup menu, Va and Vb cannot be set. Va is fixed as V1 and Vb is fixed as V2.

10.5.11.4 Changing the ECG Filter Settings

The ECG filter setting defines how ECG waves are smoothed.

To change the filter setting, in the ECG Setup menu, select **Filter** and then select the appropriate setting.

- **Monitor:** Use this mode under normal measurement conditions.
- **Surgery:** The filter reduces interference to the signal. It should be used if the signal is distorted by high frequency or low frequency interference. High frequency interference usually results in large amplitude spikes making the ECG signal look irregular. Low frequency interference usually leads to a wandering or rough baseline. In the operating room, the Filter reduces artifacts and interference from electro-surgical units. Under normal measurement conditions, selecting **Surgery** may suppress the QRS complexes too much and thus interfere with the clinical evaluation of the ECG displayed on the monitor.
- **Diagnosis:** Use this mode when undistorted quality is required and its own characteristics can be maintained. The waveform filtered by the bandwidth of 0.05 Hz~150 Hz is displayed so that the actual changes such as R-wave notching or discrete elevation or depression of the ST segments are visible.
- **Enhanced:** It should be used if the signal is distorted by strong interference from high frequency or low frequency. If there is still obviously interference in the signals when select surgery filter mode, it is recommended to choose the enhanced mode. In this mode, QRS wave rhythm information is emphasized, its shape information cannot be considered as diagnostic criteria. Under normal measurement conditions, the selection of this mode may inhibit QRS wave group and interfere ECG analysis.
- **Diagnosis1:** To meet the filtering requirements of ST analysis, it is used when ST analysis is turned on or when ST analysis results are concerned.
- **Customized:** User can set **High-pass Filter** and **Low-pass Filter** as needed. Cutoff frequency of **High-pass Filter** can be selected as: **0.01 Hz, 0.05 Hz, 0.15 Hz, 0.25 Hz, 0.32 Hz, 0.5 Hz** and **0.67 Hz**. Cutoff frequency of **Low-pass Filter** can be selected as: **25 Hz, 35 Hz, 45 Hz, 75 Hz, 100 Hz, and 150 Hz**. After **High-pass filter** and **Low-pass Filter** are set, the bandwidth range of high – pass bandwidth to low – pass bandwidth can be formed.

10.5.11.5 Setting Notch Filter

The notch filter can screen out 50 Hz/60 Hz power frequency interference. Select **Notch Filter** in ECG Setup menu, and then select an appropriate setting from the pop-up list. **Off**, **50 Hz** and **60 Hz** are optional. The default setting is **50 Hz**.

10.6 12-Lead ECG Monitoring

In 12-lead display mode, 12 ECG waveforms and one rhythm lead waveform will be shown in the waveform area on the screen. The rhythm lead is for ECG calculation before entering 12-lead display mode. Also, in this mode, the filter mode is set to **Diagnosis** and the pace pulse rejection is enabled, which cannot be changed.

NOTE:

- 1 **The 12-lead analysis results are for reference only and the analysis significance must be determined by the physician.**
- 2 **If the ECG signal is too weak, the 12-lead analysis results might be affected.**
- 3 **SEMIP algorithm is a 12-lead ECG automatic measurement and analysis algorithm. Regarding to the standards' instructions for ECG measurement and analysis of the monitor, please refer to *Smart ECG Measurement and Interpretation Programs User Manual_EDAN2*.**

10.6.1 Activating 12-Lead ECG Monitoring

Select **Menu > Maintenance > User Maintain > Parameter Maintain > ECG > Activate 12 Leads** in order to get the SN number which is supposed to be supplied to EDAN for a corresponding password. Enter the password on the above-mentioned interface and restart the monitor, and the 12-lead ECG monitoring function will be activated.

NOTE:

If the 12-lead ECG monitoring fails to be activated, users can reenter the password and try to activate this function again.

10.6.2 Analysis Function

If your monitor is configured with the 12-lead ECG monitoring function, the monitor can perform automatic analysis function. To perform 12-lead analysis:

1. In the ECG Setup menu, set **Electrode Type** to **10 Electrodes**.
2. Set **Screen Setup** to **Full-Screen**.

- Click the **Start 12-Lead Analysis** button in the main interface. The analysis results will be provided in the **12-Lead Analysis** window.

The measurement function provides the automatic measurement of the common parameters, such as heart rate, PR interval, QRS duration, QT/QTc interval, P/QRS/T axis, RV5/SV1 amplitude and RV5+SV1 amplitude. The interpretation function provides the automatic analysis of hundreds of abnormal cases, such as arrhythmia, AV block, IVCD (Intraventricular Conduction Block), myocardial infarction, ventricular hypertrophy and atrial enlargement, ST-T abnormality and electrical axis deviation.

10.6.3 Waveform Durations and Isoelectric Segments

Between the global onset and offset of the QRS-complex, signal parts with a duration of more than 6 ms and amplitude not exceeding 20 μV should be defined as isoelectric segments.

Because the duration of the Q-, R- or S-wave of 12 leads is respectively detected by the ECG algorithm, isoelectric parts (I-waves) after global QRS-onset or before global QRS-offset (K-wave) are excluded in the measurement duration of the respective adjacent waveform.

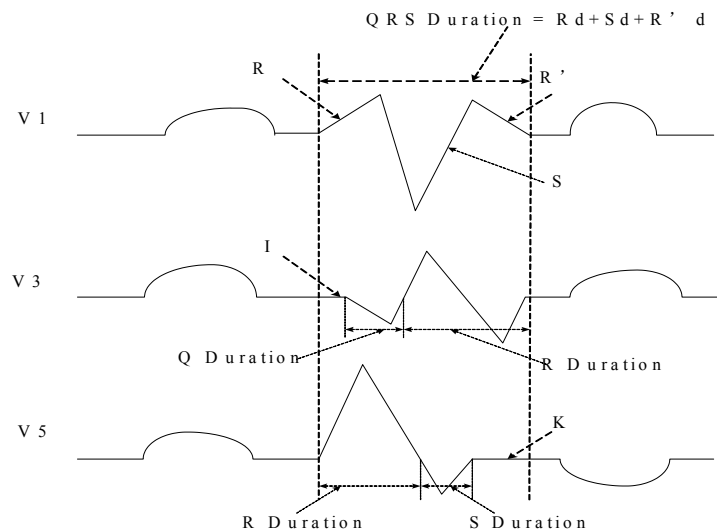

10.7 ST Segment Monitoring

The monitor performs ST segment analysis on normal and atrial beats and calculates ST segment elevations and depressions. This information can be displayed in the form of ST numerics and ST templates on the monitor.

ST segment monitoring function is disabled by default. You enable **ST Analysis** when necessary.

To switch on ST analysis, follow these steps:

1. Select the ECG parameter area or waveform area to enter the **ECG** dialog.
2. Select the **ST** tab > **Setup** tab. Enable **ST Analysis**.

NOTE:

- 1 **ST-segment analysis is intended for use with adult patients only and is not clinically validated for use with neonatal and pediatric patients. For this reason, the recommended and default setting for ST analysis in neonatal and pediatric modes is Off.**
- 2 **In ST analysis, the obtained ST value and ST template are all unaffected by the selected filter mode. ST algorithm itself uses a dedicated linear filter to ensure the signal is not distorted, and to better ensure the consistent and accurate measurement value and ST template can be obtained in different filter modes. If the doctor wants to observe the waveform to evaluate ST segment result, it is recommended to use the ST template for observation, as it is not affected by the filter mode. If the real-time waveform displayed on the interface is used to evaluate ST segment result, it is recommended to select Diagnosis/Diagnosis1 mode.**
- 3 **Reliable ST monitoring may be influenced in following situations:**
 - You are unable to get a lead with low noise.
 - If there is arrhythmia such as atrial fibrillation/flutter, the ECG baseline may be irregular.
 - The patient is continually performing ventricular paced.
 - The dominant template cannot be obtained for a long time.
 - The patient has left bundle branch block.

When any of above situations happens, ST monitoring should be switched off.

- 4 **The ST algorithm has been tested for accuracy of the ST segment data. The significance of the ST segment changes need to be determined by a clinician.**
- 5 **If you use ST analysis, you must adjust the ST measurement point when you start the monitor. If the patient's heart rate or ECG waveform changes significantly, so the ST point must be placed. If the equipotential or ST points are not set correctly, the ST fragments of the artifacts may be depressed or raised. Always ensure that the ST measurement point is suitable for your patient.**
- 6 **ST values may be affected by such factors as some drugs or metabolic and**

conduction disturbances.

- 7 **ST is calculated with a fixed delay from the R position. Changes in heart rate or the width of QRS may affect ST.**
- 8 **If the algorithm triggers self-learning (either manually or automatically), the calculation of ST segment will be reinitialized.**

10.7.1 ST Display

Your monitor screen may be configured to look slightly different from the illustrations.

ST I	0.08	aVR	-0.09	V	0.04
II	0.10	aVL	0.03		
III	0.02	aVF	0.06		

10.7.2 About ST Measurement Points

The ST value for each QRS complex is the vertical difference between the ISO point and the ST point, as shown in the diagram below. The isoelectric (ISO) point provides the baseline, and the ST point is at the midpoint of the ST segment. The J point is where the QRS complex changes its slope; as it is a fixed distance away from the ST point, it can be useful to help you position the ST point correctly.

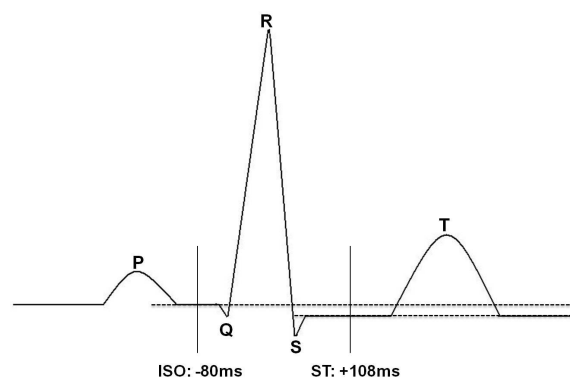

DEF POINT

The ST and ISO measurement points need to be adjusted when you start monitoring, and if the patient's heart rate or ECG morphology changes significantly. Always ensure that ST measurement points are appropriate for your patient. Abnormal QRS complex is not considered in ST segment analysis.

10.7.3 Adjusting ST and ISO Measurement Points

To adjust the ST measurement points, follow these steps:

1. Select **Analysis Point Setup** in ST Setup menu.

2. Input the appropriate value to move the cursor line left or right.

10.7.4 ST VIEW

The ST View displays a complete QRS segment for each ST lead. The color of current ST segment and ST value are consistent with the color of HR. The color of baseline and ST value are yellow. To enter ST view, select **ST VIEW** in ST Setup menu.

In the ST View interface, the user can save ST baseline by clicking **Save Baseline** when ST values gets stable. If no ST baseline is saved, the monitor automatically saves the baseline when the first valid and complete ST waveform appears.

In the ST View interface, the user can also perform the following operations:

- Display or hide ST baseline by selecting **Show Baseline** or **Hide Baseline**.
- Display or hide ST points by selecting **Show Points** or **Hide Points**.

10.7.5 ST Histogram

The monitor can derive a ST Histogram from the ST analysis to help you detect changes in ST values. To enter ST Histogram, select **ST Histogram** in ST Setup menu. The horizontal axis shows the lead name while the vertical axis shows the ST value. The bar graph displays the ST value of corresponding ST lead. The color of the bar graph indicates ST status: cyan indicates that corresponding ST value is within normal range; yellow and orange indicate that the ST value is out of normal range. The ST histogram refreshes with ST View synchronously.

10.8 Arrhythmia Monitoring

10.8.1 Arrhythmia Analysis

The arrhythmia algorithm is used to monitor ECG of adult patients in clinics, detect the changes of heart rate and ventricular rhythm, save arrhythmia events, and generate alarm information. Arrhythmia algorithm can monitor paced and non-paced patients. Qualified personnel can use arrhythmia analysis to evaluate patient's condition (such as heart rate, PVCs frequency, rhythm and ectopic beat) and decide the treatment. Besides detecting change of ECG, arrhythmia algorithm can also monitor patients and give proper alarm for arrhythmia.

NOTE:

The measured PVCs and Pause/min will be displayed in main interface.

Arrhy Alarms	Occurring Condition
Asystole	No QRS is detected for 4 consecutive seconds.

Arrhy Alarms	Occurring Condition
V-Fib/V-Tach	4 consecutive seconds' fibrillation wave occurs; Or 5 consecutive ventricular beats, and ventricular HR \geq 100 bpm.
Couplet	2 consecutive PVCs.
Run PVCs	$3 \leq$ the number of consecutive PVCs < 5 .
PVC Bigeminy	A dominant rhythm of N, V, N, V (N = supraventricular beat, V = ventricular beat) was detected.
PVC Trigeminy	A dominant rhythm of N, N, V, N, N, V.
R on T	A type of single PVC under the condition that HR < 100 , R-R interval is less than 1/3 the average interval, followed by a compensating pause of 1.25X the average R-R interval (the next R wave advances onto the previous T wave).
PVC	Single PVC detected in normal heartbeats, and the number of consecutive single PVC ≥ 4 within 30 s.
Tachy	Adult: RR interval for 5 consecutive QRS complex ≤ 0.5 s. Pediatric/neonatal: RR interval for 5 consecutive QRS complex ≤ 0.375 s.
Brady	Adult: RR interval for 5 consecutive QRS complex ≥ 1.5 s. Pediatric/neonatal: RR interval for 5 consecutive QRS complex ≥ 1 s.
Missed Beat	If HR < 120 bpm, no beats are detected for 1.75 times average RR interval; or if HR ≥ 120 bpm, no beats are detected for one second.
Irr Rhythm	Consistently irregular heart rhythm.
Pacer not Capture	No QRS complex detected in 300 ms after a pace pulse.
Pacer not Pacing	No pace pulse detected in 1.75 times RR interval after a QRS complex.
Vent Brady	5 consecutive ventricular beats, and ventricular HR < 20 bpm.
Vent Rhythm	5 consecutive ventricular beats, and $20 \text{ bpm} \leq$ ventricular HR < 40 bpm.
PVCs High	The measurement value of PVCs is greater than high alarm limit that has been set.

Arrhy Alarms	Occurring Condition
Sustain VT	The duration of ventricular tachycardia rhythm > the threshold value that has been set.
ExtremeTachy	HR > Extreme Tachycardia threshold value that has been set.
ExtremeBrady	HR < Extreme Bradycardia threshold value that has been set.
V-Tach	5 consecutive ventricular beats and ventricular HR \geq 100 bpm.
Wide QRS Tachy	Meet tachycardia conditions, and QRS wave width \geq 160 ms.
Non-Sustain VT	$3 \leq$ The number of consecutive ventricular beats < 5, and ventricular HR \geq 100 bpm.
Afib	Atrial fibrillation alarm should meet below two conditions for 1 minute: the RR interval of normal beats must be irregular, and it can be seen that the obvious f or P waves do not exist.
Acc. Vent Rhythm	5 consecutive ventricular beats, and $40 \text{ bpm} \leq$ ventricular HR < 100 bpm.
Pause	No QRS is detected within the heartbeat pause threshold value that has been set.
Pauses/min High	The measurement value of Pause/min is greater than high alarm limit that has been set.
VEB	The delayed ventricular beats detected in normal heartbeats occur more than or equal to 2 times within 30 s.
Multiform PVCs	Different forms of ventricular premature beats are detected in 15 beats.
IPVC	The single ventricular premature beat between 2 sinus beats with normal interval occurs more than or equal to 3 times within 30 s.
PAC Bigeminy	The dominant rhythm of N, A, N, A, N, A, and the rhythm number exceeds the number of threshold value that has been set (N = supraventricular beat, A = atrial beat).
PAC Trigeminy	The dominant rhythm of N, N, A, N, N, A, N, N, A, and the rhythm number exceeds the number of threshold value that has been set.

Arrhy Alarms	Occurring Condition
Low Voltage(Limb)	<p>The signal amplitudes of I, II and III leads shall not exceed alarm threshold value that has been set.</p> <p>PS: this alarm is available for 5 or 12 leads only, not available for 3 leads.</p>
<p>NOTE: Arrhythmia monitoring is intended for use with adult patients only and is not clinically validated for use with neonatal and pediatric patients. For this reason, the recommended setting for arrhythmia monitoring in neonatal and pediatric modes is Off.</p>	

Selecting an ECG lead for Arrhythmia:

In arrhythmia monitoring, it is important to select the appropriate lead.

For non-paced patients, the guidelines are:

- QRS should be tall and narrow (recommended amplitude > 0.5 mV)
- R wave should be above or below the baseline (but not biphasic)
- T wave should be smaller than 1/3 of the R wave height
- P wave should be smaller than 1/5 of the R wave height.

For paced patients, in addition to above guidelines, the pacemaker signal should also:

- not wider than normal QRS
- The QRS complexes should be at least twice the height of the pacing pulse
- large enough to be detected, without repolarization signal

According to Standard IEC 60601-2-27, the minimum detection level of the QRS complex is set to 0.15 mV, to prevent the detection of P-wave or baseline noise as QRS complexes. Adjusting ECG displayed waveform size (gain adjustment) will not influence ECG signals which are used for arrhythmia analysis. If the ECG signal is too small, a false asystole alarm may occur.

Aberrantly-Conducted Beats:

As P waves are not analyzed, it is difficult for the monitor to distinguish between an aberrantly-conducted beat and a ventricular beat. If the aberrantly-conducted beat is similar to ventricular tachycardia, it may be classified as ventricular. Always select a lead where the aberrantly-conducted beats have an R wave that is as narrow as possible to minimize incorrect calls. The ventricular should have a different appearance from "normal heartbeat". Physicians should be more alert to these patients.

Intermittent bundle branch block: bundle branch block or other bundle obstruction phenomenon is a challenge for the arrhythmia algorithm. If the QRS wave during the block has a considerable change in morphology compared to the normal QRS of learning, the blocked heartbeat may be misclassified as ventricular tachycardia, resulting in an incorrect chamber alarm. Make sure to select such a lead, which blocks the heartbeat of the R wave as narrow as possible to minimize the wrong classification. Ventricular heartbeat should have a different appearance from “normal heartbeat”. Physicians should be more alert to these patients.

NOTE:

- 1 Heart rate reading may be affected by cardiac arrhythmias. Do not rely entirely on heart rate alarms when monitoring patients with arrhythmia. Always keep these patients under close surveillance.**
- 2 Since the arrhythmia detection algorithm sensitivity and specificity is less than 100%, there may be some false arrhythmias detected; some true arrhythmia events may not be detected. This is especially true when the signal is noisy.**
- 3 The ventricular HR mentioned above refers to: when the consecutive PVCs number ≥ 3 , the algorithm calculates ventricular HR with the average of 2-8 RR intervals. The methods are different from the HR Averaging Method of the monitor. Therefore, the ventricular HR values calculated by Arrhythmia algorithm may be different from the HR values calculated by HR Averaging Method. The ventricular HR is for judging arrhythmias and is not exactly equal to the HR displayed on the interface.**
- 4 The Arrhythmia analysis results and HR values obtained during Arrhythmia analysis and HR calculation are not affected by the selected filter mode. The algorithm itself has independent data-flow processing, which can better ensure the consistent and accurate results in different filter modes.**
- 5 Atrial fibrillation alarm should meet below two conditions for 1 minute:**
 - The RR interval of normal beats must be irregular,
 - It can be seen that the obvious f or P waves do not exist.
- 6 Atrial fibrillation analysis is only applicable to adult patients and should not be performed for PVC or pacing fluctuations.**
- 7 Atrial flutter cannot be detected by the atrial fibrillation algorithm because most of their RR intervals are regular.**
- 8 In following situations, atrial fibrillation alarm detection error may occur:**
 - Sinus arrhythmia
 - Atrioventricular block

- **Frequent ventricular premature beats**
- **Myoelectric interference**
- **Electrode motion artifact**

10.8.2 Arrhythmia Analysis Menu

10.8.2.1 Enabling Arrhythmia Analysis

To switch on Arrhythmia analysis, follow these steps:

1. Select the ECG parameter area or waveform area to enter the **ECG** dialog.
2. Select the **Arrhythmia** tab > **Setup** tab.
3. Enable **ARR Analysis**.

10.8.2.2 Arrhythmia Alarm Setup

Asystole and **Sustain VT** alarms are key Arrhy alarms and they are preset to be on and cannot be turned off.

The user can switch on/off Arrhy alarms only when **Alarm Switch Setup** is enabled. To enable the authority,

1. Select **Menu** > **Maintenance** > **User Maintain**, and enter the required password.
2. Select **Alarm Setup** and set **Alarm Switch Setup** to **Enable**. If any of key Arrhy alarms is switched off, the monitor will give prompts.

Select **Arrhythmia** tab > **Alarm** tab to change the following arrhythmia alarm settings:

- Separately switch on or off each arrhythmia alarm and set the alarm level/record.
- Select **All Alarms On/All Alarms Off** to switch on or off all arrhythmia alarms except **Asystole** and **Sustain VT** alarms.
- Set the threshold of certain arrhythmia alarms. When an arrhythmia exceeds its threshold, an alarm will be triggered.

Confirm the changes to make the settings effective.

WARNING

When the arrhythmia alarm is set to Off, the monitor will not give an alarm prompt even if an alarm occurs. In order to avoid endangering the patient life, this function should be used cautiously.

NOTE:

Pacer not Capture and Pacer not Pacing alarms are available only when Pace is set to On.

10.8.2.3 Adjustable Range of Arrhythmia Alarm Threshold

Arrhythmia Alarm	Range
PVCs High	1/min to 99/min
Pauses/min High	1/min to 20/min
Pause	2 s, 2.5 s, 3 s
Sustain VT	15 s to 45 s
ExtremeTachy	Adult: 120 bpm to 300 bpm; Pediatric/neonatal: 120 bpm to 350 bpm
ExtremeBrady	15 bpm to 60 bpm
PAC Bigeminy PAC Trigeminy	3/min to 50/min
Low Voltage(Limb)	0.3 mV to 0.8 mV

10.8.2.4 Arrhythmia Relearning

Pick this item **Start ARR Relearning** to start a learning procedure, and **ARR Relearning** is displayed on the screen.

The Arrhythmia relearning will start automatically in the following status:

- Switching the Arrhythmia Analysis from Off to On;
- Changing patient type or electrode type;
- Connecting or switching calculation leads/primary lead/secondary lead;
- Changing pacemaker status;
- Exiting Standby mode;
- Admitting a patient;
- Switching calibration mode into normal measurement mode;
- Switching the ECG parameter on;
- Switching the analysis mode.

NOTE:

- 1 **During the relearning phase of the algorithm, arrhythmia detection may not be available. So you should closely monitor the patient condition during and for several minutes after the learning phase to allow the algorithm to reach optimal detection performance.**

- 2 Take care to initiate Arrhythmia relearning only during periods of predominantly normal rhythm and when ECG signal is relatively noise-free. If Arrhythmia relearning takes place during arrhythmia, the ectopics may be incorrectly learned as normal QRS complex. This may result in missed detection of subsequent events of arrhythmia.**
- 3 If Arrhythmia relearning is performed during ventricular rhythm, ventricular heartbeats may be erroneously identified as normal QRS complexes. This may lead to missed ventricular tachycardia and ventricular fibrillation events.**

Due to this reason, you should:

- 1) Take care that Arrhythmia relearning may start automatically;**
- 2) Response to lead off information;**
- 3) Always check the correctness of arrhythmia alarm.**

10.9 QT Analysis

The QT interval is the time from the beginning of Q wave to the end of T wave. It measured the total duration of the depolarization (QRS duration) and repolarization (ST-T) phases of ventricular action potential. QT analysis can help detect extended QT interval syndrome.

10.9.1 Measurement Limitations

The following clinical status of the patient may affect the QT analysis, and the inaccurate measurement may but is not limited to the following reasons:

- The T-wave is very flat;
- Atrial flutter and atrial fibrillation make T wave is difficult to define;
- The end of the T-wave is difficult to define because of the presence of U-waves;
- A high heart rate causes the P-wave to encroach on the end of the previous T-wave;
- Noise or the QRS wave variation is too big.

In these cases, the user should choose a lead with good T wave amplitude and no visible oscillations, and without a dominant U wave or P wave.

In some conditions, such as left or right bundle branch block or cardiac hypertrophy causes broaden QRS complex. If long QTc is observed, verify it to ensure that it is not caused by QRS broadening.

Since normal beats followed by ventricular beats are not included in the analysis, QT measurement could not be carried out when there was bigeminy rhythm.

When the heart rate changes, it may take several minutes for the QT interval to stabilize. In order to obtain reliable QTc calculations, it is important to avoid areas where the heart rate changes.

NOTE:

QT/QTc measurements should always be validated by a qualified clinician.

10.9.2 Enabling QT Analysis

To switch on QT analysis, follow these steps:

1. Select the ECG numeric area or waveform area to enter the **ECG** dialog.
2. Select the **QT** tab > **Setup** tab.
3. Enable **QT Analysis**.

10.9.3 QT Display

The following figure is QT display for your reference only. The graphics on your monitor may be slightly different.



10.9.4 Selecting QT Analysis Lead

To adjust the QT analysis lead, select **QT Leads** in QT Setup menu.

There are two modes for selection:

ALL: Use all available leads (except the pressurized limb lead) to produce an overall QT measurement.

Single lead: Select a single lead from all available leads to perform QT measurement (except the pressurized limb lead).

10.9.5 Selecting QTc Formula

The monitor uses Bazett formula to correct QT values by default. To adjust the QTc formula, select **QTc Formula** in QT Setup menu. There are four alternative formulas:

Bazett, Fridericia, Framingham and Hodges.

$$\text{Hodges: } QTc = QT + 1.75 \times (HR - 60)$$

$$\text{Bazett: } QTc = QT \times \left(\frac{HR}{60} \right)^{\frac{1}{2}}$$

$$\text{Fridericia: } QT_c = QT \times \left(\frac{HR}{60}\right)^{\frac{1}{3}}$$

$$\text{Framingham: } QT_c = QT + 154 \times \left(1 - \frac{60}{HR}\right)$$

10.9.6 QT VIEW

QT View shows the current and baseline QT parameter values and waveforms.

To enter QT view, select **QT VIEW** in QT Setup menu.

Users can select different leads for QT view. It varies depending on the **QT Leads**.

To quantitatively express the QTc values change, the user can set a QT baseline. The baseline is used for calculating ΔQT_c value. If no baseline has been set for this patient within the first five minutes after getting valid QT values, the monitor will automatically set a baseline.

To save the current values as baseline, select **Save Baseline**, and the monitor displays **Baseline Saved at:** (Time). If a new baseline is set, the previous baseline is discarded. Because ΔQT_c alarm is based on the difference of the baseline with the current values, inappropriate baseline settings may lead that no ΔQT_c alarm is generated. Select **Display Baseline** or **Hide Baseline** to show or hide the QT baseline waveforms.

Chapter 11 Monitoring RESP

11.1 Overview

The monitor measures respiration from the amount of thoracic impedance between two ECG electrodes. The change of impedance between the two electrodes, (due to the thoracic movement), produces a respiratory waveform on the screen.

Respiration may also be measured by CO₂ module. Refer to Section *Monitoring CO₂* for respiration information.

11.2 RESP Safety Information

WARNING

- 1 If you do not set the Hold High and Hold Low for the respiration correctly in manual detection mode, it may not be possible for the monitor to detect apnea. If you set the Hold High and Hold Low too low, the monitor is more likely to detect cardiac activity, and to falsely interpret cardiac activity as respiratory activity in the case of apnea.**
 - 2 Respiration measurements cannot detect all underexposure sudden events, nor can they distinguish between central, obstructive and mixed respiratory asphyxial events. It only prompts alarm in a predetermined time if the last breath is detected and the next breath is not detected, so it cannot be used for diagnostic purposes.**
 - 3 If operating under conditions according to the EMC Standard EN 60601-1-2 (Radiated Immunity 3 V/m), field strengths above 3 V/m may cause erroneous measurements at various frequencies. Therefore, it is recommended to avoid the use of electrically radiating equipment in close proximity to the respiration measurement unit.**
 - 4 Cardiogenic artifact in impedance respiration monitoring may make it difficult to detect breaths or may otherwise be counted as breaths. In some instances, the breath rate may also correspond to the heart rate making it difficult to determine if the signal is due to breathing or the cardiac cycle. Do not rely on RESP monitoring as the sole method for detecting cessation of breathing. Follow hospital guidelines and best clinical practices for apnea detection including monitoring additional parameters that indicate the patient's oxygenation status, such as etCO₂ and SpO₂.**
 - 5 For the diagnosis of apnea, especially in premature infants and infants, the safety and effectiveness of respiration measurements have not been validated.**
-

WARNING

- 6 To monitor the respiration, only non-ESU-proof accessories can be used. This is because the internal impedance of the ESU-proof accessories required to be used for electrosurgical operation is too large.**
 - 7 Some implantable pacemakers can adjust their triggering frequency according to the "minute ventilation rate." Impedance respiration measurements may cause these pacemakers to react incorrectly. To prevent this, turn off the respiration measurement.**
 - 8 In manual detection mode, after changing the gain of the respiration wave, be sure to check the setting of hold high and hold low.**
 - 9 When ECG electrode is placed on patient's limb, the impedance respiration may be unreliable.**
 - 10 Respiration measurement cannot be performed when ESU is used.**
 - 11 RESP No Breath Detected alarm is based on inadequate thoracic impedance change.**
 - 12 RESP No Breath Detected alarm should not be used or relied upon while the patient is unattended.**
-
-

NOTE:

The RESP monitoring is not recommended to be used on patients who are very active, as this can cause false alarms.

11.3 Electrode Placement for Monitoring RESP

Correct patient skin preparation for electrode placement is important for RESP measurement. Refer to the chapter on ECG for more information.

The RESP signal is always measured between two of the ECG electrodes. There are two standard ECG leads for selection: I lead (RA and LA) and II lead (RA and LL).

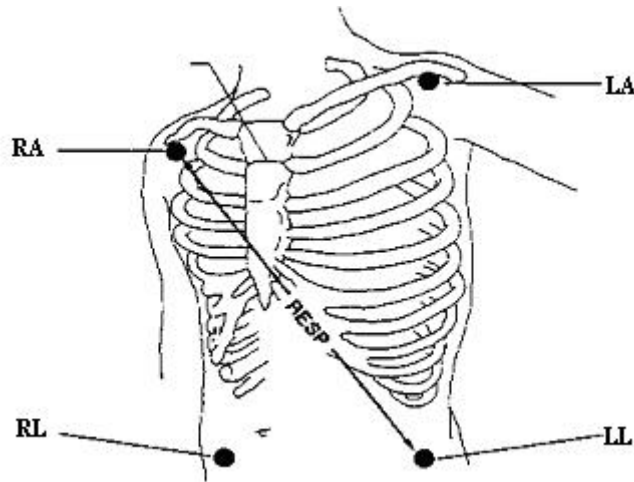

Electrodes Placement for 5 Electrodes

11.4 Cardiac Overlay

Cardiac activity that affects the RESP waveform is called cardiac overlay. This occurs when the RESP electrodes detect impedance changes caused by the rhythmic blood flow. Correct electrode placement can reduce cardiac overlay: avoid the liver area and the ventricles of the heart in the line between the respiratory electrodes. This is particularly important for neonates.

11.5 Chest Expansion

Some patients, especially neonates, expand their chests laterally. In these cases it is best to place the two respiratory electrodes in the right midaxillary and left lateral chest areas at the patient's maximum point of breathing movement to optimize the respiratory wave.

11.6 Abdominal Breathing

Some patients with restricted chest movement breathe mainly abdominally. In these cases, you may need to place the left leg electrode on the left abdomen at the point of maximum abdominal expansion to optimize the respiratory wave.

NOTE:

Place the red and green electrodes diagonally to optimize the respiration waveform. Avoid the liver area and the ventricles of the heart in the line between the RESP electrodes so as to avoid cardiac overlay or artifacts from pulsating blood flow. This is particularly important for neonates.

11.7 Setting RR Source

Set **RR Source** to **CO₂**, **ECG** or **Auto** in RESP Setup menu. The RR source is displayed in the RESP parameter area.

When it is set to **Auto**, the monitor automatically selects the RR source with the following priority: CO₂ > ECG.

11.8 Selecting RESP Lead

To set the respiration lead to II or I to obtain the best respiratory waveform, select **RESP Lead** in RESP Setup menu.

11.9 Changing Hold Type

Change the calculation mode in the RESP Setup menu, set **Hold Type** to **Manual** or **Auto**. When it is set to the **Auto** mode, **Hold High** and **Hold Low** are unavailable, and the monitor can calculate the respiration rate automatically. When it is set to the **Manual** mode, you can adjust the detection threshold of the respiration wave.

11.10 Setting the Respiration Wave

In the RESP Setup menu:

- Select **Scale** and choose an appropriate value. The bigger the value is, the higher the waveform amplitude will be.
- Select **Speed** and select an appropriate setting from the pop-up list. The bigger the value is, the wider the waveform will be.

11.11 Changing the No Breath Detected Alarm Time

The No Breath Detected alarm is a high priority red alarm used to detect apneas. The No Breath Detected alarm delay time defines the time period between the point where the monitor cannot detect any respiration activity and the indication of the No Breath Detected alarm. Users should set it cautiously.

1. In the RESP Setup menu, select **No Breath Detected**.
2. Select the appropriate setting from the pop-up list.

Chapter 12 Monitoring SpO₂

12.1 Overview

SpO₂ is used to measure arterial blood oxygen saturation, which is the percentage of oxyhemoglobin in the arterial blood. SpO₂ parameter can also provide pulse rate (PR) and a plethysmogram wave (Pleth).

The monitor can be configured with EDAN or Nellcor SpO₂ module. EDAN SpO₂ module supports single-channel SpO₂ and two-channel SpO₂.

12.2 SpO₂ Safety Information

WARNING

- 1 Do not use the SpO₂ sensors if the packaging or the sensor is damaged and return them to the vendor.**
 - 2 If the SpO₂ sensor cannot work properly, please reconnect the sensor or change a new one.**
 - 3 Correct and proper sensor application: if the sensor is too loose, it might compromise the optical alignment, and even cause the sensor to fall off. If the sensor is too tight, (such as the application site is too large or becomes too large due to edema), excessive pressure and local tissue ischemia, hypoxia and lack of nutrition may occur on the application site. Prolonged and continuous monitoring may increase the risk of skin irritations or lacerations. To avoid these damages, users should periodically check surrounding skin of application site according to the patient's condition and pressure sensor, inspect the if there is sign of stress-related damage in surrounding tissue, and regularly change the application site. For the patients whose fluid is easy to transfer and/or the patients with systemic or localized edema, users should inspect the skin and change application site more frequently.**
 - 4 Use only EDAN permitted sensors and extension cables with the monitor. Other sensors or extension cables may cause improper monitor performance and/or minor personal injury.**
 - 5 High oxygen levels may predispose a premature infant to retrolental fibroplasia. If this is a consideration do NOT set the high alarm limit to 100%, which is equivalent to switching the high limit alarm off.**
 - 6 When serious arrhythmia is present, the SpO₂ pulse rate may differ from ECG heart rate but this does not indicate an inaccurate PR (SpO₂) value.**
-
-

WARNING

- 7 Misapplied sensor or sensor that becomes partially dislodged may cause either over or under reading of actual arterial oxygen saturation.
 - 8 Pulse oximetry readings and pulse signal can be affected by certain ambient environmental conditions, sensor application errors, and patient conditions.
-
-

NOTE:

- 1 Avoid placing the sensor on extremities with an arterial catheter, or intravascular venous infusion line, or inflated NIBP cuff. When measuring SpO₂ on the limb with inflated NIBP cuff, please turn on the NIBP Simul function.
- 2 When a trend toward patient deoxygenation is indicated, analyze the blood samples with a laboratory co-oximeter to completely understand the patient's condition.
- 3 SpO₂ waveform is not directly proportional to the pulse volume.
- 4 The device is calibrated to display functional oxygen saturation.
- 5 A Functional tester or simulator cannot be used to assess the SpO₂ accuracy. However, it can be used to demonstrate that a particular monitor reproduces a calibration curve that has been independently demonstrated to meet a particular accuracy.
- 6 If the surrounding temperature increases, the operator should pay attention to the site of poor perfusion, and increase the frequency of checking the skin and changing the measurement site to prevent burns. If the initial skin temperature is less than 35°C, the temperature of all the listed sensors on the skin will not exceed 41°C during working.
- 7 The cumulative use time for the SpO₂ sensor in a single patient should be less than 30 days.

12.3 Selecting SpO₂ Label*

* Only applicable to the EDAN SpO₂ module.

Select the SpO₂ label according to the measurement site of the corresponding channel.

Switch on **SpO₂** or **SpO₂b** in **Menu > Parameter > Param Switch**. Each channel can be switched on/off separately. By default, the label of SpO₂ channel 1 is SpO₂ and the label of SpO₂ channel 2 is SpO₂b. After selecting the label, set the SpO₂ for each channel separately. For details, refer to Section *SpO₂ Setup*.

12.4 Measuring SpO₂

1. Select the correct patient category setting (Adult/Pediatric and Neonate), as this is used to optimize the calculation of the SpO₂ and pulse numerics.
2. During measurement, ensure that the application site:
 - has a pulsatile flow, ideally with a good circulation perfusion.
 - has not changed in its thickness, causing an improper fit of the sensor.

Measurement Procedure

1. Switch on the monitor.
2. Attach the sensor to the appropriate site of the patient.

Before Applying the Sensor:

Be sure to understand all warnings listed in the previous section before applying any sensor to a patient. Also, check the sensor as follows:

- ♦ Check the sensor outside and inside. To inspect the inside, gently open the sensor cavity and check splits on or next to the transparent silicone that covers the optical elements.
- ♦ Any sensor showing signs of damage or alteration must not be used for further patient monitoring; instead, dispose of it using proper disposal procedures.

Applying Finger/Soft-tip Sensors:

- ♦ Nip the clamp, and choose a site that is well perfused and restricts a conscious patient's movements least. The ring finger of the non-dominant hand is preferred. Alternatively, the other fingers on the non-dominant hand may be used.
- ♦ The big toe or long toe (next to the big toe) may be used on restrained patients or patients whose hands are unavailable.
- ♦ Place the finger into the sensor according to the direction of the symbol on the sensor. Adjust the finger to ensure that the pad of the finger completely covers the sensor detection window.
- ♦ Orient the sensor so that the cable will be running towards the top of the patient's hand.
- ♦ Connect the sensor with the monitor (or with the extension cable if needed).

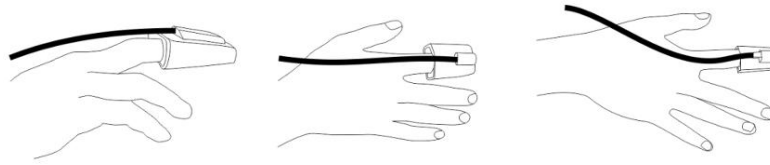

Applying Neonatal Finger (or Toe) Wrap Sensors:

- ◆ When you perform the measurement, position the sensor over the hand or foot with optical components opposite each other.
- ◆ Hold the sensor, and insert stretched strap into slot, hold it there while threading end through latch. If strap is too long, thread it through second latch.
- ◆ Connect the sensor with the monitor (or with the extension cable if needed).

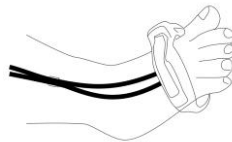

Applying Adult/Pediatric Ear Clip Sensor:

- ◆ When you perform the measurement, clip the plastic fixing part on top of the ear; reinforce it to prevent falling off or getting loose.
- ◆ Clip the probe onto fleshy part of the lobe with optical components opposite to each other.
- ◆ Connect the sensor with the monitor (or with the extension cable if needed).



3. Plug the connector of the sensor extension cable into the SpO₂ socket.

WARNING

- 1 Inspect the application site every two to three hours to ensure skin quality and correct optical alignment. If the skin quality changes, move the sensor to another site. Change the application site at least every four hours (or more often, if indicated by circulatory status and/or skin integrity).**
- 2 For neonate, change the measuring site every 20 minutes.**

NOTE:

- 1 Injected dyes such as methylene blue or intravascular dyshemoglobins such as methemoglobin and carboxyhemoglobin may lead to inaccurate measurements.**
- 2 Inspect the sensor to ensure that the light emitter and receiver are aligned with each other and there is no gap between the sensor and the finger. All the light emitted by the light emitter must pass through the patient's tissue. Refer to Directions for Use for the application of each sensor.**
- 3 Clean and remove any substances such as nail polish from the application site. Periodically check to ensure that the sensor remains properly positioned on the patient.**

12.5 Measurement Limitations

Certain patient conditions can affect the measurements or cause the loss of the pulse signal.

Inaccurate measurements can be caused but not limited by:

- incorrect sensor application
- high levels of ambient light sources, such as surgical lights (especially those with a xenon light source), bilirubin lamps, fluorescent lights, infrared heating lamps, and direct sunlight
- failure to cover the sensor with opaque material in high levels of ambient light conditions
- dysfunctional hemoglobins
- low peripheral perfusion
- excessive or violent patient movement
- venous pulsations
- intravascular dyes, such as indocyanine green or methylene blue
- externally applied coloring agents (nail polish, dye, pigmented cream)
- defibrillation
- placement of the sensor on an extremity with a blood pressure cuff, arterial catheter, or intravascular line
- electromagnetic interference

Loss of pulse signal can occur for the following reasons:

- the sensor is applied too tightly
- a blood pressure cuff is inflated on the same extremity as the one with the sensor attached
- there is arterial occlusion proximal to the sensor
- low peripheral perfusion

NOTE:

- 1 To prevent interference from ambient light, ensure that the sensor is properly applied, and cover the sensor site with opaque material.**
- 2 Adjacent SpO₂ sensors may interfere with each other (eg, multiple SpO₂ measurements in the same patient). Be sure to cover the sensor with opaque material to reduce cross-interference.**
- 3 Move the sensor to a less active site.**
- 4 For Nellcor SpO₂ module, the algorithm automatically extends the amount of data required for measuring SpO₂ and PR depending on the measurement conditions. During normal measurement conditions the averaging time is 5 to 7 seconds. During conditions such as those caused by low perfusion, interference (e.g., external interference such as ambient light or patient movement), or a combination of these, the algorithm automatically extends the amount of data required beyond 7 seconds. If the resulting dynamic averaging time exceeds 20 seconds, the screen will display prompt message “SpO₂ Search Pulse” and SpO₂ and PR will continue to be updated every second. As these conditions extend, the amount of data required continues to increase. If the dynamic averaging time reaches 40 seconds, the screen will display high-level alarm message “SpO₂ No Pulse” indicating a loss-of-pulse condition.**

12.6 Assessing the Validity of a SpO₂ Reading

You can check the quality of the pleth wave and the stability of the SpO₂ values to assess whether the sensor functions properly and whether the SpO₂ readings are valid. Always use these two indications simultaneously to assess the validity of a SpO₂ reading.

Generally, the quality of the SpO₂ pleth wave reflects the quality of the light signals obtained by the sensor. A wave of poor-quality manifests a decline of the signal validity. On the other hand, the stability of the SpO₂ values also reflects the signal quality. Different from varying SpO₂ readings caused by physiological factors,

unstable SpO₂ readings are resulted from the sensor's receiving signals with interference. The problems mentioned above may be caused by patient movement, wrong sensor placement or sensor malfunction. To obtain valid SpO₂ readings, try to limit patient movement, check the placement of the sensor, measure another site or replace the sensor.

NOTE:

- 1 The SpO₂ accuracy has been validated in controlled human studies against arterial blood sample reference measured with a CO-oximeter. SpO₂ measurements are statistically distributed, only about two-thirds of the measurements can be expected to fall within the specified accuracy compared to CO-oximeter measurements. The volunteer population in the studies are composed of healthy men and women from age 18 to 50, with various skin pigmentations. Note that the study population was healthy adults and not in the actual intended use population.**
- 2 The pulse rate accuracy is obtained by comparison to the pulse rate generated with an arterial oxygen simulator (also an electronic pulse simulator).**
- 3 During monitoring, if the monitor's reading differs significantly from the patient's physiological condition, it indicates that the signal may be disturbed, resulting in an inaccurate reading. In this case, the artifact can disguise as a similar reading, causing the monitor to fail to send an alarm. In order to ensure reliable monitoring, it is necessary to regularly check whether the sensor is wearing properly and the signal quality is good.**

12.7 SpO₂ Alarm Delay

There is a delay between a physiological event at the measurement site and the corresponding alarm at the monitor. This delay has two components:

1. The time between the occurrence of the physiological event and when this event is represented by the displayed numerical values. This delay depends on the algorithmic processing time and the sensitivity setting. The lower the sensitivity configured, the longer the time needed until the numerical values reflect the physiological event.
2. The time between the displayed numerical values exceeding an alarm limit and the alarm indication on the monitor. This delay is the combination of the configured alarm delay time plus the general system delay time.

12.8 Perfusion Indicator (Blip Bar)

The Blip Bar indicates pulse beat and the relative (non-normalized) pulse amplitude. As the detected pulse becomes stronger, more bars light with each pulse.

12.9 PI (Perfusion Index)*

* Only applicable to the EDAN SpO₂ module.

PI (Perfusion Index) gives a percentage for the pulsatile signal to the non-pulsatile signal at the monitoring site. PI reflects the perfusion level at the monitoring site, which can also indicate arterial pulse signal strength. PI is indicated by a percentage ranging from 0 to 20%. PI below 0.1% indicates the low perfusion at the monitoring site. Reposition the sensor or find a better site.

12.10 SI (Signal Intensity)*

* Only applicable to the Nellcor SpO₂ module.

SI is a numeric value indicating the arterial pulse signal intensity, which can be used to assess the SpO₂ signal intensity. SI is indicated by a value ranging from 0 to 25.5. The bigger the value is, the better the signal quality will be. The signal quality is at its maximum when the value reaches 25.5. When SI is below 0.3, it indicates the poor signal quality at the monitoring site; you need to reposition the sensor or find a better site.

NOTE:

Poor placement (attachment) of sensor on the patient can negatively affect the measurement of pulse strength.

12.11 SpO₂ Setup

Select the SpO₂ parameter area or waveform area to enter the **SpO₂** dialog. Select the **Setup** tab to access the SpO₂ Setup menu.

12.11.1 Setting the Response Mode*

* Only applicable to the Nellcor SpO₂ module.

The response mode establishes the frequency the monitor uses to calculate and display SpO₂ saturation levels, but does not affect the calculation of pulse rate. To change the response mode, in the SpO₂ Setup menu, select **Work Mode** and then select the appropriate setting.

- **Normal:** Default response mode responds to changes in blood oxygen saturation in five- to seven-seconds when calculating %SpO₂.

- **Fast:** Fast mode responds to changes in blood oxygen saturation levels in two- to four-seconds when calculating %SpO₂. This can be particularly helpful for situations that require close monitoring. This setting is often used in the L&D and Sleep Labs where a fast response by the pulse oximeter is desired.

12.11.2 Setting Sensor Light Intensity Display*

* Only applicable to the EDAN SpO₂ module.

In the **SpO₂ Setup** menu, select **Sensor Light Intensity** to toggle between On and Off. The default setting is Off. When it is set to enabled, the sensor light intensity icon  will be displayed in the SpO₂ parameter area to indicate five different levels of intensity.

12.11.3 Setting NIBP Simul

While measuring SpO₂ and NIBP on the same limb simultaneously, the user can set **NIBP Simul** to enabled in **SpO₂ Setup** or **SpO₂b Setup** menu to lock the SpO₂ alarm status until the NIBP measurement ends. If **NIBP Simul** is disabled, low perfusion caused by NIBP measurement may lead to inaccurate SpO₂ readings and therefore cause false physiological alarms.

12.11.4 Setting Pitch Tone

In **SpO₂ Setup** or **SpO₂b Setup** menu,

- Select **Pitch Tone** to toggle between On and Off. If tone modulation is on, the PR sound lowers when the SpO₂ level drops.

12.11.5 Setting Sensitivity*

* Only applicable to the EDAN SpO₂ module.

The different sensitivity indicates different refresh frequency. **High** indicates the refresh frequency of SpO₂ value is the most frequent. To change the sensitivity, please follow the steps:

1. Select the **SpO₂ Setup** or **SpO₂b Setup** menu;
2. Select **Sensitivity** on the interface and select the desired sensitivity from the pop-up list.

12.11.6 Setting Waveform Speed

To set the speed of Pleth waveforms, follow these steps:

1. Select the **SpO₂ Setup** or **SpO₂b Setup** menu;
2. Choose **Speed** and select a suitable setting from the pop-up list. The bigger the value is, the wider the waveform will be.

12.12 SatSeconds Alarm Management*

* Only applicable to the Nellcor SpO₂ module.

12.12.1 Describing SatSeconds

With traditional alarm management, upper and lower alarm limits are set for monitoring oxygen saturation. During monitoring, as soon as an alarm limit is violated by as little as one percentage point, an alarm is immediately triggered. When the SpO₂ level fluctuates near an alarm limit, the alarm is triggered each time the limit is violated. Such frequent alarms can be distracting.

With the SatSeconds technique, upper and lower SpO₂ alarm limits are set in the same way as traditional alarm management. However, you can also set a SatSeconds limit that allows monitoring of SpO₂ below the selected lower alarm limit and above the selected upper alarm limit for a period of time before an alarm is triggered.

The method of calculation is as follows:

The number of percentage points that the SpO₂ falls outside the alarm limit is multiplied by the number of seconds that the SpO₂ level remains outside that limit. This can be stated as an equation:

$$\text{Points} \times \text{Seconds} = \text{SatSeconds}$$

Where:

Points = SpO₂ percentage points outside of the limit

Seconds = number of seconds that SpO₂ remains at that point outside of the limit

The alarm response time, assuming a SatSeconds limit set at 50 and a lower alarm limit set at 90, is described and illustrated below.

In this example, the SpO₂ level drops to 88 (2 points below the limit) and remains there for a period of 2 seconds (2 points × 2 seconds = 4 SatSeconds). The SpO₂ then drops to 86 for 3 seconds and then to 84 for 6 seconds. The resulting SatSeconds values are shown below:

SpO ₂		Seconds		SatSeconds
2	×	2	=	4
4	×	3	=	12
6	×	6	=	36
Total SatSeconds			=	52

After approximately 10.7 seconds, a SatSeconds alarm will be triggered, because the limit of 50 SatSeconds has been exceeded. See arrow (↑) in the following figure.

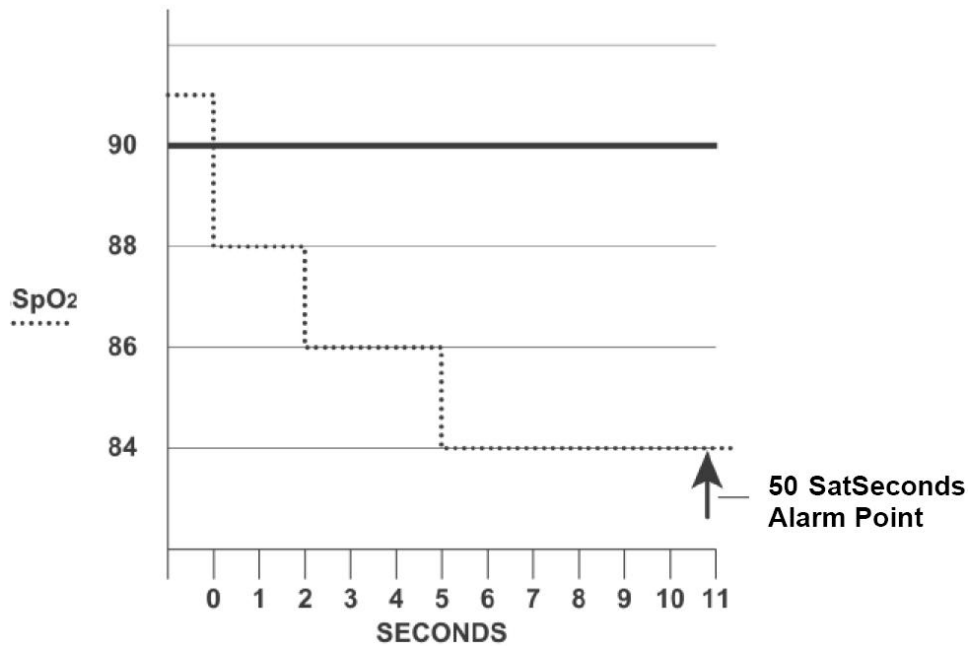

Alarm Response with SatSeconds

Saturation levels may fluctuate rather than remaining steady for a period of several seconds. Often, the patient SpO₂ may fluctuate above and below the alarm limit, re-entering the non-alarm range several times. During such fluctuation, the monitor integrates the number of SpO₂ points, both positive and negative, until either the SatSeconds limit is reached, or the patient SpO₂ returns within a normal range and remains there.

12.12.2 SatSeconds “Safety Net”

The SatSeconds “Safety Net” is for patients whose saturation makes frequent excursions below or above the SpO₂ limit but does not remain in violation long enough for the SatSeconds limit to be reached. If three or more SpO₂ alarm limit violations occur within a 60-second period, an alarm will be triggered even if the SatSeconds limit has not been reached.

12.12.3 Setting SatSeconds Duration

You can set **SatSeconds** to **Off** or to the duration among **10**, **25**, **50** and **100**. To configure the SatSeconds settings, enter the **SpO₂ Setup** menu and select the desired SatSeconds setting from the **SatSeconds Setup** list.

When the Nellcor™ SatSeconds technology detects an SpO₂ value outside the alarm limit, the SatSeconds circle icon begins to “fill” clockwise. When the SpO₂ value is within the set limits, the SatSeconds icon empties counterclockwise. When the SatSeconds icon completely fills (red: high-level alarm; yellow: medium/low-level alarm), indicating the threshold has been reached, an audible alarm sounds and the displayed SpO₂ value flashes.

12.13 SpO₂ Relevant Data for Reference

1. The table below shows Arms values measured using SH series sensors and ear clip sensor with iX Series in a clinical study.

SaO ₂ Range	Arms					
	With SH1	With SH3	With SH4	With SH5	With SHD-A	With Ear Clip
90%-100%	1.01	1.07	1.29	1.10	1.15	1.03
80%-90%	2.01	2.30	2.17	2.13	2.08	1.78
70%-80%	2.01	2.65	2.29	2.57	2.67	2.93
70%-100%	1.68	1.99	1.89	1.90	1.92	1.86

2. The figures below show the Bland-Altman Plot of SaO₂ vs SpO₂ measured using SH series sensor and ear clip sensor. In the plots, the upper and lower dotted lines represent the upper and inferior limits of the 95% consistency, and the middle dotted line represents the average of the bias.

Bland-Altman plot for comparator's SaO₂ and SpO₂ of investigational device with SH1 sensor

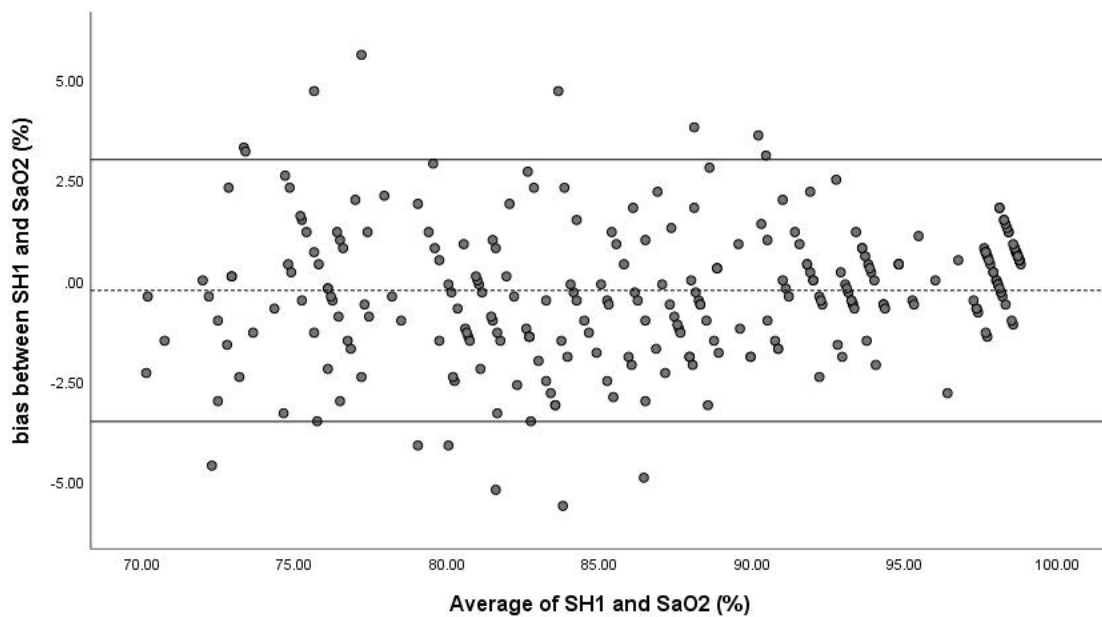

Bland-Altman plot for comparator's SaO₂ and SpO₂ of investigational device with SH3 sensor

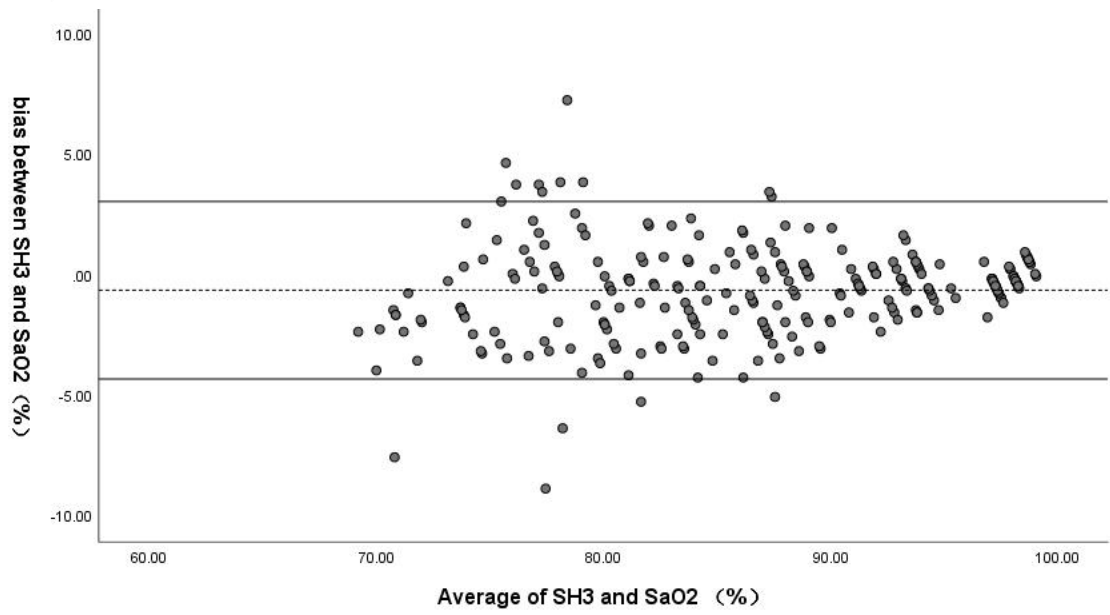

Bland-Altman plot for comparator's SaO₂ and SpO₂ of investigational device with SH4 sensor

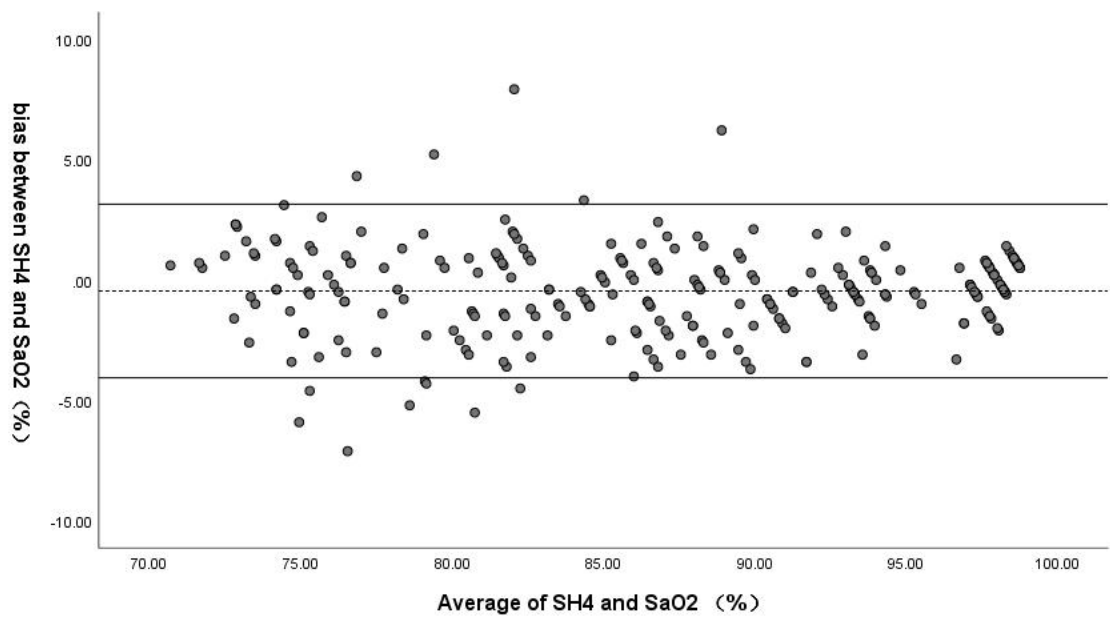

Bland-Altman plot for comparator's SaO₂ and SpO₂ of investigational device with SH5 sensor

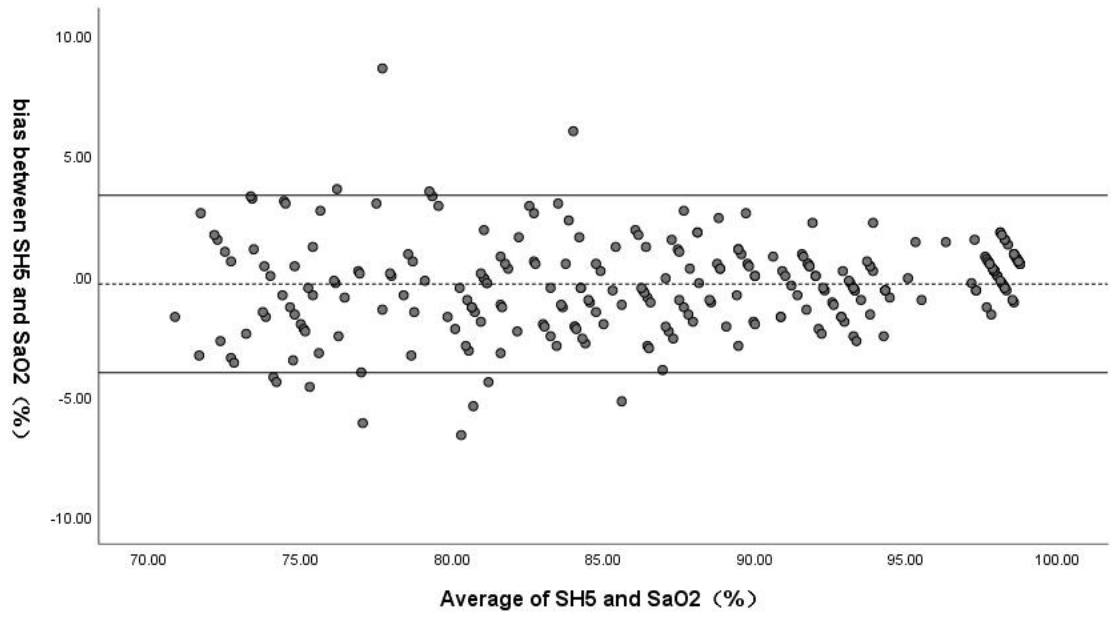

Bland-Altman plot for comparator's SaO₂ and SpO₂ of investigational device with SHD-A sensor

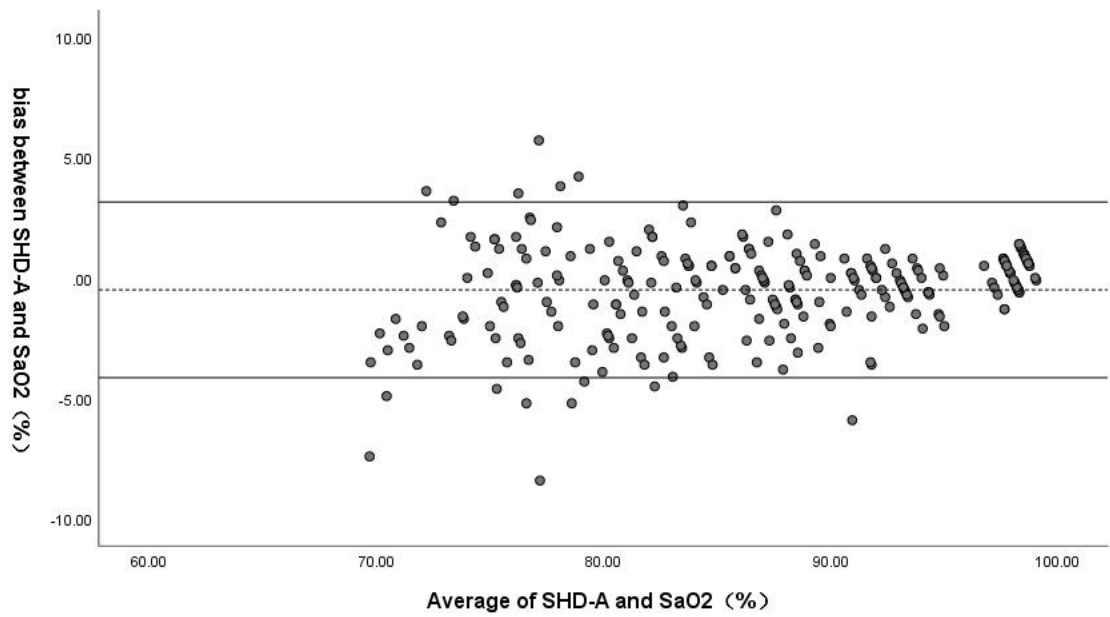

Bland-Altman plot for comparator's SaO₂ and SpO₂ of investigational device with ear clip sensor

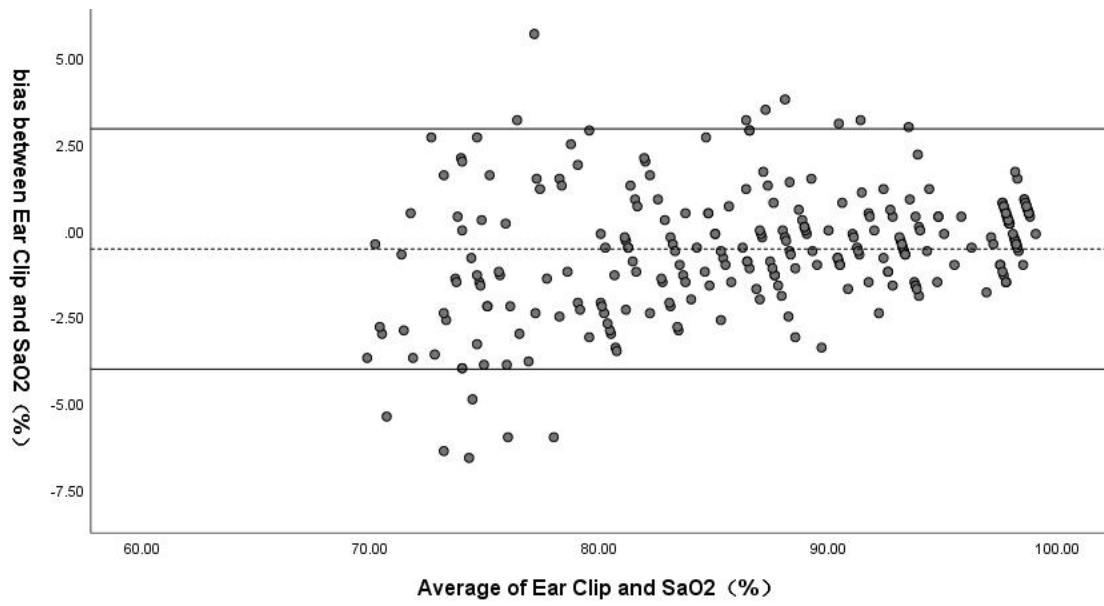

Chapter 13 Monitoring PR

13.1 Overview

The pulse numeric counts the arterial pulsations that result from the mechanical activity of the heart in beats per minute (bpm). You can obtain a pulse from any measured SpO₂ or any arterial pressure.

13.2 Setting PR Source

The monitor provides PR source options. Current pulse source is displayed in the PR parameter area. You can select SpO₂ (SpO₂-pr, SpO₂-po), IBP (PA, ART, Ao, UAP, BAP, FAP, LV, P1-P4) or Auto as the PR source in the PR Setup > **PR Source** menu.

The **PR Source** menu displays the currently valid PR sources. When it is set to **Auto**, the monitor will automatically select the PR source by priority.

13.3 Pleth SQI

Pleth SQI refers to the credibility of the current PR value. The accuracy of the PR depends on the original signal for PR calculation. The better the signal quality, the higher the Pleth SQI. Pleth SQI is rated 1-10.

When **PR source** is SpO₂, the Pleth SQI icon can be displayed in the interface.

13.4 Selecting PR Alarm Source

In most cases, the HR and PR numerics are identical. In order to avoid simultaneous alarms on HR and PR, the monitor uses either HR or PR as its active alarm source. To change the alarm source, select either ECG Setup > **Alarm Source** or PR Setup > **Alarm Source**, then select:

- **HR**: if you want HR to be the active alarm source.
- **PR**: if you select PR as the active alarm source. Be aware that if you select PR as the alarm source, ECG HR alarms are inactivated.
- **Auto**: If the alarm source is set to Auto, the monitor will use the heart rate from the ECG measurement as the alarm source whenever the ECG measurement is switched on and valid HR values are available. The monitor will automatically switch to PR for the alarm source if:
 - valid HR values can no longer be measured and
 - a PR source is switched on and available.

The monitor uses the pulse rate from the currently active measurement as system pulse. If valid HR values become available again, the monitor automatically uses HR as alarm source.

Chapter 14 Monitoring NIBP

14.1 Overview

This monitor uses the oscillometric method for measuring NIBP. It can be used for adult, pediatric and neonatal patients. It is also intended for use with pregnant, including pre-eclamptic patients.

iCUPS algorithm: Oscillometric devices measure the amplitude of pressure changes in the occluding cuff as the cuff deflates from above systolic pressure. The amplitude suddenly increases as the pulse breaks through the occlusion in the artery. As the cuff pressure decreases further, the pulsations increase in amplitude, reach a maximum (which approximates to the mean pressure), and then diminish. The oscillometric method measures the mean pressure and determines the systolic and diastolic pressures.

iFAST algorithm: During the cuff inflation, oscillometric devices detect the change of pulsation amplitude due to the cuff pressure change. The pulsations increase in amplitude and reach a maximum (which approximates to the mean pressure). The oscillometric method measures the mean pressure and determines the systolic and diastolic pressures. Oscillometric devices terminate the NIBP measurement and deflate quickly once the systolic pressure is determined.

The blood pressure measurements determined with this device comply with the American National Standard for Electronic or Automated Sphygmomanometers (ISO 81060-2) in relation to mean error and standard deviation. In a clinical investigation method with a reference sphygmomanometer, the fifth Korotkoff sound was used to determine adult diastolic pressure, and the fourth Korotkoff sound was used to determine pediatric diastolic pressure. The invasive blood pressure is used to determine the neonate pressure in clinical investigation, and the arterial reference sites include umbilical artery, arteria cruralis, axillary artery, brachial artery, dorsalis pedis, and radial artery.

When selecting the patient type on the patient admitting interface, it is recommended to choose **Adult** for patients greater than 21 years of age, **Pediat** for patients greater than 3 through 21 years of age and **Neonat** for patients from birth through 3 years of age.

14.2 NIBP Safety Information

WARNING

- 1 Do not measure NIBP on patients with sickle-cell disease or any condition where skin damage has occurred or is expected.**
 - 2 Do not measure NIBP on the arm of the same side with a mastectomy or lymph node clearance.**
-
-

WARNING

- 3 Use clinical judgement to decide whether to perform frequent blood pressure measurements on patients with severe blood clotting disorders because of the risk of hematoma in the limb fitted with the cuff.**
 - 4 Do not apply the cuff to a limb that has an intravenous infusion or catheter in place. This could cause tissue damage around the catheter when infusion is slowed or blocked during cuff inflation.**
 - 5 Do not apply the cuff to a limb where intravascular access or therapy, or an arterio-venous (A-V) shunt is present, otherwise, it may result in injury to the patient.**
 - 6 Ensure that the correct patient type is selected before performing measurements. Do not apply the higher adult inflation, overpressure limits and measurement duration for neonatal patients. Not using the neonate mode on a neonatal patient can block the blood flow, potentially causing harm to the patient.**
 - 7 Make sure that the air conduit connecting the blood pressure cuff and the monitor is neither blocked nor tangled.**
 - 8 Measuring of blood pressure can temporarily cause malfunctioning of other medical monitoring devices on the same limb.**
 - 9 NIBP readings can be affected by the measurement site, the position of the patient, exercise, or the patient's physiologic conditions.**
 - 10 Continuous cuff pressure due to connection tubing kinking can block the blood flow and may result in injury to the patient.**
 - 11 Verifying the calibration is only applicable for adults, and it cannot be operated in automatic measuring interval. Continuous measuring cannot be operated in automatic measuring interval either.**
-
-

NOTE:

- 1 It is suggested that the user should not start NIBP measuring when the low battery displays, or the monitor may be turned off automatically.**
- 2 If you spill liquid onto the equipment or accessories, particularly if there is a chance that it can get inside the tubing or the measurement device, contact your service personnel.**
- 3 Continuous use of the automatic measuring mode for short intervals may lead to the discomfort of patient. Continuous measuring and automatic measuring in neonatal or pediatric mode may result in tissue damage or ischemia to the patient.**

- 4 **NIBP measurement can be affected by extremes of temperature, humidity and altitude.**
- 5 **NIBP measurement value should be explained by qualified professionals.**
- 6 **The pulse rate based on the NIBP measurement may differ from the heart rate based on the ECG waveform. NIBP measures the number of peripheral pulse pulsations, and the heart rate is measured by the electrical signal of the heart. When the electrical signals of the heart occasionally fail to cause the peripheral blood vessels to pulse or the patient's peripheral perfusion is poor, the difference happens.**
- 7 **The cumulative use time for the NIBP cuff in a single patient should be less than 30 days.**

14.3 Measurement Limitations

Measurements are impossible with pulse rate extremes of less than 40 bpm or greater than 240 bpm, or if the patient is on a heart-lung machine.

The measurement may be inaccurate or impossible in the following situations:

- A regular arterial pressure pulse is hard to detect.
- Patients with cardiac arrhythmias.
- Patients with excessive and continuous movement such as shivering or convulsions.
- Patients with rapid blood pressure changes.
- Patients with severe shock or hypothermia that reduces blood flow to the peripheries.
- Patients with obesity, where a thick layer of fat surrounding a limb dampens the oscillations coming from the artery.
- Patients on an edematous extremity.

14.4 Measurement Modes

There are four NIBP measurement modes:

- **Manual** - measurement on demand.
- **Auto** - continually repeated measurements (between 1 and 480 minute adjustable interval). The interval can be user defined, and the default user defined interval is 25 minutes. After the first measurement starts manually, the monitor will automatically measure NIBP as preset interval. When **Clock** is turned on and the measurement interval is set to 5 min, 10 min, 15 min, 30 min, 60 min, 90 min, 120

min, 180 min, 240 min, 360 min and 480 min, the system will automatically adjust the next measurement time. For instance, if the measurement interval is set to 10 min, and NIBP auto measurement is started at 12:02, the next measurement will be taken at 12:10, and then at 12:20, 12:30, 12:40 and so on.

- **STAT** - the measurement will run consecutively at an interval of 5 s in five minutes, then the monitor enters manual mode.
- **Sequence** - after the first measurement starts manually, NIBP measurements run automatically according to the preset times and interval. NIBP sequence measurement can have up to six phases. The measurement times and interval of each phase can be set individually. The measurement times can be set to **Off**, **1 to 30**, and **Continuous**. When it is set to **Off**, sequence measurement will terminate in current phase, and no subsequent measurement phase will be performed. When it is set to **Continuous**, sequence measurement will continue in current phase, but no more subsequent measurement phase. The measurement interval can be set to 1–480 minutes.

WARNING

Prolonged non-invasive blood pressure measurements in Auto, Continuous, or Sequence mode may be associated with purpura, ischemia and neuropathy in the limb wearing the cuff. When monitoring a patient, examine the extremities of the limb frequently for normal color, warmth and sensitivity. If any abnormality is observed, stop the blood pressure measurements.

14.5 Measurement Procedures

To obtain accurate measurements, the following operating steps need to be observed:

1. Ensure the patient position in normal use, including
 - ◆ Comfortably seated or lie flat, legs uncrossed;
 - ◆ Feet flat on the floor;
 - ◆ Back, elbow and forearm supported;
 - ◆ Relax as much as possible, neither talking nor applying external pressure against the cuff. Rest for five minutes in a quiet environment.
2. Connect the cuff to the air tubing. Plug the air tubing to the NIBP connector on the monitor.



Apply the blood pressure cuff to the patient's arm or leg and follow the instructions below.

-Ensure that the cuff is completely deflated.

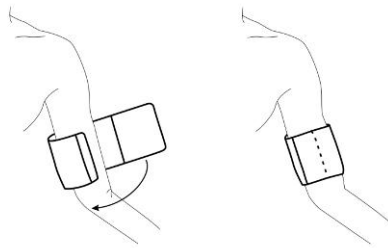
-Apply the appropriate size cuff to the patient (About the cuff size selection, please refer to Section *NIBP accessories*), and make sure that the symbol "Φ" is over the artery. The cuff shall be applied on the bare arm and there shall be no arm compression proximal to the cuff. Ensure that the middle of the cuff is at the level of the right atrium of the heart and the cuff is not wrapped too tightly around the limb. Excessive tightness may cause discoloration and eventual ischemia of the extremity.



Cuff Usage

3. Select the correct patient type setting for your patient in the **Patient Info.** menu.
4. Select a measurement mode in the NIBP Setup menu. Refer to Section *Starting and Stopping NIBP Measurements* for details.
5. Press the  button on the front panel or shortcut key  on the main screen to start a measurement.
6. Wait until the first reading is taken.

NOTE:

- 1 **The width of the cuff is either approximately 40% of the limb circumference or 2/3 of the upper arm length. The inflatable part of the cuff should be long enough to encircle 80%-100% of the limb. The wrong size of cuff can cause erroneous readings. If the cuff size is in question, use another cuff with suitable size to avoid errors.**
- 2 **If an NIBP measurement is suspect, repeat the measurement. If you are still uncertain about the reading, use another method to measure the blood pressure.**
- 3 **Please make sure the cuff is well connected. A leak of air may cause measurement error.**
- 4 **Please select the cuff with the suitable size. An unsuitable cuff may cause incorrect measurements.**
- 5 **Avoid incursion of liquid into the cuff. If this happens, please desiccate the cuff**



completely.

- 6 During the blood pressure measurement, if the user changes the patient type or updates the patient, the monitor will immediately terminate all measurements and clear the display of blood pressure parameters.**



14.5.1 Starting and Stopping NIBP Measurements

Start and stop NIBP measurement by selecting the virtual key on the front panel, shortcut key, or from the NIBP setup menu.

1. Manual measurement

Access the NIBP Setup menu and set the **Measure Mode** item to **Manual**. Then press the  button on the front panel or shortcut key  on the main screen to start a manual measurement.



2. Automatical Measurement

Access the NIBP Setup menu and set the **Measure Mode** item to **Auto**, select time interval as need, then press the  button on the front panel or shortcut key  on the main screen.



3. STAT measurement

Select the shortcut key  or access the NIBP Setup menu and pick the **Continuous** item to start a continuous measurement. The STAT measurement will last 5 minutes.

4. Sequence measurement

Access the NIBP Setup menu and set the **Measure Mode** item to **Sequence**. Access the **Sequence Measure Set** dialog to set the **Phase**, **Times** and **Interval**. Then press the  button on the front panel or shortcut key  on the main screen to start the measurement.

5. Stopping the measurement

During the measurement, press the  button on the front panel or shortcut key ,  on the main screen at any time to stop measurement.

14.6 NIBP Setup

Select the NIBP parameter area to enter the **NIBP** dialog. Select the **Setup** tab to

access the NIBP Setup menu.

14.6.1 Setting Alarm Limit Display

Select NIBP Setup > **Alarm Limit Display Format** to set whether to display the alarm limits of diastolic NIBP and mean NIBP. SYS and SYS&DIA&MAP are optional. The default setting is SYS.

14.6.2 Setting Inflation Value

To change the inflation value:

1. Select **Inflation Value** in NIBP Setup menu;
2. Choose the appropriate setting from the pull-down list.
 - ◆ If **Auto** is chosen, the default value will be adopted as the inflation value when measuring blood pressure.

14.6.3 Displaying/Hiding PR

The user can set whether to display the PR value in the NIBP parameter area.

To display PR, enable **Display PR** in the NIBP Setup menu.

14.6.4 Setting NIBP End Tone

The monitor can issue a reminder tone at the completion of NIBP measurement.

To set the NIBP end tone, in the NIBP Setup menu, select the appropriate volume for the **NIBP End Tone**. The volume ranges from 0 to 10. If it is set to 0, the NIBP end tone will be off.

14.6.5 Setting NIBP Trigger Recording

To set the NIBP to trigger recording, enable **NIBP Trigger Recording** in the NIBP Setup menu. The monitor triggers recording at the completion of NIBP measurement.

14.7 Selecting NIBP Algorithm

The EDAN NIBP module supports two measurement algorithms: iCUFS and iFAST. iCUFS measurement is applicable to adults, pediatrics and neonates. iFAST measurement shortens the blood pressure measurement time and rapidly outputs values, which is applicable to adults and pediatrics.

To set the NIBP algorithm, select **Menu > System > User Maintain > Parameter Maintain > NIBP** and set **NIBP Algorithm** to **iCUFS** or **iFAST**.

14.8 Manometer Mode

Manometer mode verifies accuracy of the NIBP system.

NOTE:

The manometer test is for checking the measurement accuracy only and will not affect the measurement results.

Tools required: stopcock, NIBP extension tubes, cylinder (200 ml), manometer (measurement range should be within 0 to 300 mmHg; accuracy should be within ± 0.3 mmHg.)

Procedure:

1. To conduct the NIBP accuracy test, access the User Maintain menu through the following sequence: **Menu > System > User Maintain > Parameter Maintain > NIBP.**
2. Connect the equipment as shown below.

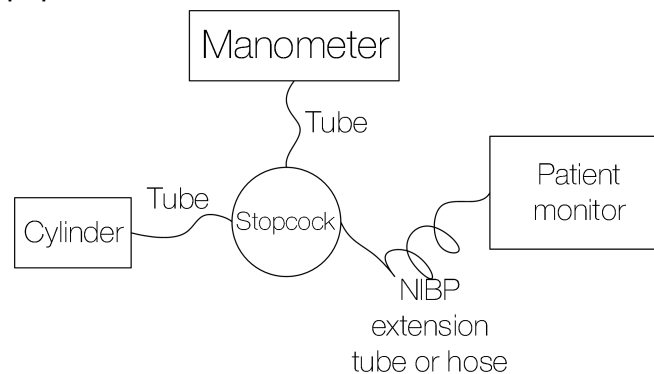

3. Select **Manometer Mode.**
4. Apply a fixed static pressure on the monitor with the help of a manometer.
5. Wait 10 seconds until the pressure stabilizes. Verify the displayed values on the monitor against the manometer setting.
6. A tolerance of ± 3 mmHg is reasonable.

14.9 Resetting NIBP

When the pressure does not work properly and the system fails to give a message for the problem, pick **Reset** in the **Menu > System > User Maintain > Parameter Maintain > NIBP** menu to activate self-test procedure, and thus restore the system from abnormal performance.

14.10 Calibrating NIBP

NIBP is not user-calibrated. Cuff-pressure transducers must be verified and calibrated, if necessary, at least once every two years by a qualified service professional. See the Service Manual for details.

14.11 Leakage Test

Leakage test is used to detect the air tightness of the NIBP pump, valve, and trachea. If not, the system will display NIBP leakage. NIBP leak detection should be performed at least once every two years or when you think the measurement is inaccurate.

WARNING

This leakage test other than being specified in the ISO 81060-1 standard is to be used by the user to simply determine whether there are air leaks in the NIBP airway. If at the end of the test the system gives the prompt that the NIBP airway has air leaks, please contact the manufacturer for repair.

Procedure of Leakage Test

1. Connect the cuff securely with the socket for NIBP air hole.
2. Wrap the cuff around the cylinder of an appropriate size, do not wrap the cuff around limbs.
3. Make sure the patient type has been set to **Adult**.
4. Access **Menu > System > User Maintain > Parameter Maintain > NIBP > Leakage Test**.
5. Select **Start**. Then the prompt **Leak. Test Running** will appear indicating that the system has started the leakage test.

The system will automatically inflate the pneumatic system to about 180 mmHg. After 20 seconds to 40 seconds, if system leakage has detected, the system will automatically open the deflating valve to stop the leak test and indicates **NIBP Leak**. If no system leakage is detected when the pneumatic system is inflated to 180 mmHg, the system will perform a deflation to an approximate value of 40 mmHg and subsequently perform the second phase leak test. After 20 seconds to 40 seconds, the system will automatically open the deflating valve and provide corresponding indication based on the test result.

6. If the alarm information **NIBP Leak** appears, it indicates that the airway may have air leaks. In this case, the user should check for loose connection. After confirming secure connections, the user should re-perform the leakage test. If the failure prompt still appears, please contact the manufacturer for repair.

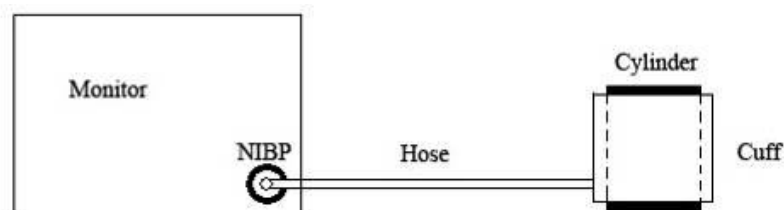

Diagram of NIBP Air Leakage Test

Chapter 15 Monitoring CNBP

15.1 Overview

PTT is the pulse wave transmission time, the time that the pulse wave travels from one point to another point in the human artery tree, which is associated with the arterial blood pressure. The arterial blood pressure value corresponding to the cardiac cycle can be obtained by calculating the PTT in each cardiac cycle, and the continuous monitoring of non-invasive blood pressure can be realized (CNBP). CNBP monitoring is applicable for adults and pediatrics (≥ 1 year of age).

15.2 CNBP Calibration

The monitor can only be used for continuous blood pressure monitoring after CNBP calibration. CNBP calibration must be performed if:

- Perform CNBP for the first time after each boot.
- Change the patient type or update patient.

CNBP calibration is recommended when continuous monitoring is not calibrated for more than 24 hours.

To perform the CNBP calibration, follow these steps:

1. Get the parameter values for calibration.
 - ◆ Blood pressure reference value: manually input or automatically obtain the monitor measurement value.
2. Ensure the SpO₂ sensor and the ECG electrodes are applied correctly.
3. Click **Start Calibration**. When the calibration is successful, the system will prompt the CNBP successfully calibrated and display the CNBP parameter values in real time in the corresponding parameter area.

CNBP calibration is required to improve the accuracy of blood pressure predictive values. The user can use the NIBP periodical measurement function of the monitor to trigger the CNBP periodical calibration.

NOTE:

- 1 The acquisition of blood pressure reference values is critical for CNBP monitoring results. Incorrect blood pressure reference values may result in inaccurate CNBP results or calibration failure.**
- 2 Calibration may fail in patients with arrhythmia, low perfusion or high physiological state fluctuations. If the calibration fails, wait for the patient to stabilize and try to calibrate again. If the calibration still fails, other methods**

are recommended to detect blood pressure.

- 3 For measuring CNBP, the recommended SpO₂ sensor application site is finger.
- 4 If CNBP calibration is not carried out for a long time, the monitor can still measure the values, but the accuracy of the measurement may not be ideal.
- 5 When measuring SpO₂ on the limb with inflated NIBP cuff, the CNBP values may be affected during the NIBP measurement, ensure to turn on the NIBP Simul function to deactivate CNBP temporarily.

15.3 CNBP Monitoring

When the calibration is successful, the system will display the following parameters in the CNBP parameter area of the main interface: CNBP (SYS), CNBP (DIA), and BPVI (Blood Pressure Variability Index).

NOTE:

- 1 If you doubt the CNBP measurements, measure the patient's blood pressure by alternative means.
- 2 If the state of the patient in CNBP monitoring (position, drugs taken, SpO₂ sensor application site, etc.) differs from that in calibration, the output results may be different. Perform CNBP recalibration after the adjustment.

Chapter 16 Monitoring TEMP

16.1 Overview

Body temperature is measured by means of a thermistor probe (a semiconductor whose resistance changes with temperature) that is applied to the skin, oral cavity or to the rectum.

Two TEMP probes can be used simultaneously to measure two TEMP values and get the temperature difference. T1 or T2 can be switched on/off separately and will not be affected by each other.

16.2 TEMP Safety Information

WARNING

- 1 Verify probe cables fault detection before the beginning of monitoring phase. Unplug the temperature probe cable of the channel1 from the socket, and then the screen will display the error message TEMP T1 Sensor Off and the auditory alarm is activated. It is the same to the other channel.**
 - 2 Take the TEMP probe and cable carefully. When they are not in use, you should coil up the probe and cable into a loose circle. If the wire inside the cable is tensely pulled, it may cause mechanical damage to the probe and the cable.**
 - 3 Temperature probes do not need any probe covers; Please remember to disinfect the probe after each use on a patient.**
-
-

NOTE:

- 1 The reference body site temperature is the same as the temperature of the measuring site.**
- 2 The cumulative use time for the oral or rectal temperature probe in a single patient should be less than 24 hours.**

16.3 Making a TEMP Measurement

1. Select an appropriate probe for your patient.
2. Plug the probe to the temperature connector.
3. Attach the probe to the patient.
 - ◆ For skin temperature probe: Dry skin completely in area of intended probe placement. Fasten the probe with medical tape and place the sensor over dry skin.
 - ◆ For oral temperature probe: Place the probe tip under patient's tongue on

either side of the mouth to reach the sublingual pocket. Close the patient's lips and allow breathing from the nose.

- ◆ For rectal temperature probe: Ensure that the patient is in lateral position, prone position, or dorsal recumbent position, and expose the temperature measurement site. Lubricate the temperature probe prior to insertion, and place the probe in accordance with currently acceptable medical procedures.
4. Select TEMP sensor type and label before measuring if necessary.
 5. Check that the alarm settings are appropriate.
 6. It takes 5 minutes for the temperature measurement to stabilize.
 7. During surgical procedures which employ electro-cautery, use currently acceptable procedures to minimize conditions of the thermistor and a lead wire functioning as an alternate path for radio-frequency current to return to ground, causing localized tissue burns. Procedures which may minimize risk of electro-surgical burns are:
 - ◆ Keep both active and ground electrodes of the electro-cautery system in close proximity so that the skin temperature sensor is outside of the radio-frequency current field.
 - ◆ Keep the monitor with its associated cables separated from electrocautery systems.
 - ◆ Unusual, fast variations in temperature reading may occur with concomitant applications of electro-cautery systems.

PRECAUTION

- 1 Sweat will lead to increased heat dissipation, affecting the measurement accuracy. Dry the skin thoroughly. Shave hair from sites, if necessary.**
 - 2 Do not measure rectal temperature on patients with rectal or anal surgery, or diarrhea.**
 - 3 Patients with myocardial infarction should not have their temperature measured rectally to avoid stimulating the anus and causing the vasovagal reflex, leading to bradycardia.**
 - 4 For long-term monitoring, periodically check surrounding skin of application site according to the patient's condition and change the application site if required.**
-

NOTE:

- 1 Choose a medical tape which is coated with medical grade hypoallergenic adhesive suitable for skin application according to the patient needs.**

- 2 **Do not measure axillary temperature on patients with skin damage, surgery, inflammation, excessive sweat in the axilla, and shoulder joint injury.**
- 3 **Before use, clean and disinfect temperature probes.**
- 4 **When using these probes, follow standard application practices recommended by your medical facility.**
- 5 **To avoid patient injury:**
 - ◆ **Do not apply these temperature probes to patients who are undergoing Magnetic Resonance Imaging (MRI) procedures.**
 - ◆ **Always use caution when applying, inserting, or removing a temperature probe from a patient.**
 - ◆ **Assure that probe and connector cable are not positioned where they could become entangled around patient, or cause choking, strangulation, or inhibit circulation in extremities.**
 - ◆ **Assure that probe and connector cable are not positioned where they could become entangled around IV tubes and restrict IV flow.**

16.4 Selecting TEMP Sensor Type

The user can choose the TEMP sensor type as the temperature signal source.

To configure the TEMP sensor type, select **Menu > System > User Maintain > Parameter Maintain > Other Parameters**, and set **Probe Type** to **YSI-10K** or **YSI-2.252K**.

16.5 Selecting a Temperature for Monitoring

Select the temperature label according to the measurement site. The label is a unique identifier for each type of temperature.

To select the label,

1. Click the TEMP parameter area to enter TEMP Setup menu.
2. Select the appropriate label from the list for **T1** and **T2**.

Label	Description
Tskin	Skin temperature
Trect	Rectal/Oral temperature

16.6 Calculating Temp Difference

The monitor can calculate and display the difference between two temperature values by subtracting the second value from the first. The difference is labeled TD.

Chapter 17 Monitoring iTEMP

17.1 Overview

Covidien Genius 3 infrared tympanic thermometer can be connected to the monitor. The tympanic thermometer measured the ear (tympanic) temperature by infrared technique. The measurement result iTEMP will be displayed on the tympanic thermometer screen and transmitted to the monitor.

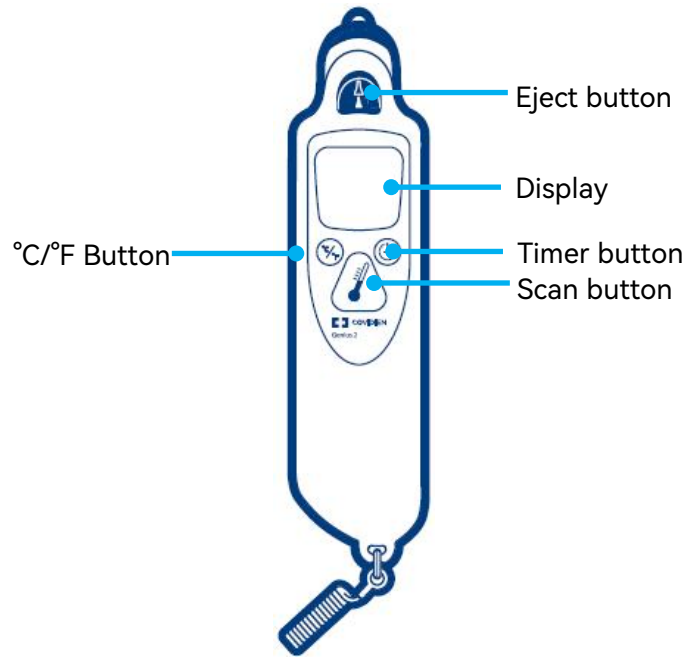

	Eject button	Eject the probe cover by pressing the eject button.
	°C/°F Button	Press and hold the °C/°F button to toggle between degrees Celsius and degrees Fahrenheit.
	Scan button	Press the scan button to measure tympanic temperature.
	Timer button	Press and hold the timer button to enter Timer mode. Press again to start the timer. The thermometer will issue a single beep at 15 seconds, a dual beep at 30 seconds, a triple beep at 45 seconds, and four beeps at 60 seconds.

17.2 Tympanic TEMP Safety Information

WARNING

- 1 The Genius 3 Tympanic Thermometer and Base is a precision optical instrument. For reliable and trouble free operation, handle carefully and do not drop.
 - 2 Read the operator's manual thoroughly before using the Genius 3 Tympanic Thermometer and Base.
 - 3 Prior to use, ensure that the probe tip is clean and clear of any material. If the thermometer tip becomes soiled, gently clean with a lens wipe or lint free swab. The tip should appear shiny and free of fingerprints and/or debris. For further cleaning instructions refer to *Genius 3 Tympanic Thermometer Operating Manual*.
 - 4 Always install a new probe cover prior to taking a temperature. The probe cover membrane should be smooth with no holes, tears, or wrinkles.
 - 5 Always use a single-patient probe cover to prevent patient cross-contamination.
 - 6 Use of probe covers manufactured by any company other than Covidien llc may result in erroneous readings.
 - 7 Ensure that the probe tip seals the ear canal prior to taking a temperature. Failing to seal the ear canal will result in a loss of accuracy.
 - 8 When not in use, the Genius 3 Tympanic Thermometer and Base should be placed in the thermometer base unit.
 - 9 The Genius 3 Tympanic Thermometer and Base should not be used on patients with ear drainage, blood, cerebrospinal fluid, vernix, ear wax plugs, or foreign bodies in the ear canal.
 - 10 Patients with removable hearing aids should remove the device at least 10 minutes prior to ear temperature assessment. Implanted devices generally do not affect ear temperature.
 - 11 Pressure equalization (PE) or tympanostomy tubes will not adversely affect accuracy. For patient comfort, wait one week after surgery before using Genius 3 Tympanic Thermometer and Base.
 - 12 When assessing patient temperatures during cold weather conditions, allow the patient to equilibrate to room temperature before use.
 - 13 Excessive eardrum scarring may cause lowered temperature readings.
 - 14 Under normal conditions, ear wax does not affect accuracy. However, cerumen plugs or impactions containing debris can lower the temperature measurement by several tenths of a degree.
 - 15 Always wait at least two minutes before taking another measurement in the same ear.
 - 16 Lithium or alkaline batteries must be disposed of in accordance with local environmental and institutional policies.
-
-

WARNING

- 17 Used probe covers must be treated as infectious biological waste and disposed of in accordance with current medical practices and local regulations. Removal of batteries is recommended if the unit is not going to be used for an extended period of time.**
 - 18 Expired or old equipment must be disposed of in accordance with institutional policy.**
 - 19 Fluid ingress may cause a reduction in battery life and interfere with unit functionality. Cleaning guidelines should be followed as per *Genius 3 Tympanic Thermometer Operating Manual* to prevent fluid entering the unit.**
 - 20 Do not use this device near flammable anesthetics. Not suitable for use in the presence of flammable anesthetic mixture with air, oxygen, or nitrous oxide.**
 - 21 Slowly insert the probe to avoid damage to the ear canal and tympanic.**
-
-







17.3 Measuring Procedure

1. Make sure to connect the base to the monitor interface by using the correct cable.
2. Visually inspect the patient's ear canal. Remove the Genius 3 Tympanic Thermometer from the base.
3. Inspect the probe lens. If any debris is present, clean the probe tip per the directions in *Genius 3 Tympanic Thermometer Operating Manual*. If the probe tip is clean, proceed to step 4.
4. Press the scan button to verify functionality and mode selection on the LCD screen. Take a new probe cover from the container of the base. Install a probe cover by firmly inserting the probe tip into a probe cover. After the probe cover is installed, the thermometer will perform a system reset. The thermometer will then display dashes, the equivalence mode, and the thermometer icon.
5. Inspect the probe cover to make sure it is fully seated (no space between cover and tip base) and no holes, tears, or wrinkles are present in the plastic film.
6. Check whether the monitor correctly displays the corresponding temperature label of the measurement site, or whether the corresponding icon is displayed.
7. Place the probe in the ear canal and seal the opening with the probe tip. For consistent results, ensure that the probe shaft is aligned with the ear canal.
8. Once positioned lightly in the ear canal press and release the scan button.
9. Wait for the triple beep before removing the thermometer. The patient temperature will be displayed on both the thermometer and the monitor.

10. Press the eject button to eject the probe cover into a suitable waste receptacle.

11. Always return the thermometer to base for storage.

The Genius 3 Tympanic Thermometer and Base enters sleep mode after 30-40 seconds of non-use. To wake up the thermometer, eject the attached probe cover and/or install a new probe cover.

Icon	Description
	Patient temperature above specified range
	Patient temperature below specified range
	Ambient Temperature above specified range
	Ambient Temperature below specified range
	Low Battery
	Battery depleted. The batteries must be changed.

Chapter 18 Monitoring IBP

18.1 Overview

IBP is measured by means of a catheter inserted directly into the circulatory system. A pressure transducer connected to the catheter converts the mechanical force exerted by the blood into an electrical signal, which is displayed graphically as pressure versus time on a monitor screen or numerically on digital display.

The monitor measures direct blood pressure of one selected blood vessel through two channels or four channels, and displays waveforms and pressure of measured direct blood pressure (SYS, DIA and MAP).

18.2 IBP Safety Information

WARNING

- 1 The operator should avoid contact with the conductive parts of the appurtenance when it is connected or applied.**
 - 2 When the monitor is used with HF surgical equipment, the transducer and the cables must be avoided from conductive connection to the HF equipment. This is to protect against burns to the patient.**
 - 3 Disposable IBP transducer or domes should not be reused.**
 - 4 If any kind of liquid, other than solution to be infused in pressure line or transducer, is splashed on the equipment or its accessories, or enters the transducer or the monitor, contact the Hospital Service Center immediately.**
 - 5 All invasive procedures have risks to the patient. Use aseptic technique and follow catheter manufacturer's instructions.**
 - 6 Mechanical shock to the invasive blood pressure transducer may cause severe shifts in zero and calibration, and then cause erroneous readings.**
 - 7 The longest duration of IBP arterial catheterization is 7 days.**
-
-

NOTE:

- 1 Use only the pressure transducer listed in the IBP Accessories.**
- 2 If measuring intracranial pressure (ICP) on a sitting patient, adjust the transducer on the same level with the top of the patient's ear. Incorrect leveling may lead incorrect values.**

- 3 **Confirm you set correct alarm limit for labels, the alarm limit you set are stored for its label only. Changing label may change the alarm limit.**
- 4 **Don't perform IBP calibration when a patient is being monitored.**
- 5 **When using high frequency ventilation, make sure that the ventilator catheter is not connected to or indirectly connected to the arterial catheter at zero pressure. This can lead to less pressure variations, thus interfere the zeroing process.**
- 6 **Please use the accessory of the same model from the same manufacturer.**
- 7 **Zeroing or and calibration are required after replacing the transducer or cable.**

18.3 Monitoring Procedures

Preparatory steps for IBP measurement:

1. Plug the pressure cable into the IBP socket and switch on the monitor.
2. Prepare the flush solution.
3. Flush through the system, exhaust all air from the tube, and ensure that the transducer and stopcocks are free of air bubbles.
4. Connect the patient catheter to the pressure line, making sure that there is no air present in the catheter or pressure line.
5. Position the transducer so that it is at the same level with the patient's heart, approximately mid-axillary line.
6. For the label name selection, please refer to *Selecting the Pressure Label*.
7. To zero the transducer, please refer to *Zeroing the Pressure Transducer*.

WARNING

If there are air bubbles in the tube system, you should flush the system with the solution again. The bubbles may cause erroneous pressure readings.

18.3.1 Zeroing the Pressure Transducer

To avoid inaccurate pressure readings, the monitor requires a valid zero. Zero the transducer in accordance with your hospital policy (at least once per day). You must perform a zero:

- When you use a new transducer or tubing;
- Every time you reconnect the transducer cable to the monitor;

- If you think the monitor's pressure readings are not correct.

When using a pressure module, the zero information is stored in the module.

The zeroing procedure is listed as below:

1. Turn off the stopcock to the patient.
2. Vent the transducer to atmospheric pressure, to compensate for the static and atmospheric pressure exerted on the transducer.
3. Select the shortcut key  or the IBP Setup menu, select **Zero > Zero XX** or **Zero All**. (**XX** stands for the IBP label name). After confirmation, the user can zero the pressure of certain channel or pressure of all channels. After zeroing, the interface displays the result and last calibration time.
4. When you see the message **Zero Ok**, please close the stopcock to atmospheric pressure, and open the stopcock to the patient.

18.3.2 Troubleshooting the Pressure Zeroing (Taking Art for Example)

Message	Corrective Action
Sensor Off, Unable to Zero	Make sure that transducer is not off, and then proceed zeroing.
Unable to Zero in Demo Mode	Make sure that the monitor is not in DEMO mode. Contact service technician if necessary.
Pressure Overrange, Unable to Zero	Make sure that the stopcock is vented to atmosphere. If the problem persists, please contact service technician.
Pressure Pulsating, Unable to Zero	Make sure that the transducer is vented to air, not connected to a patient, and try again.

18.3.3 IBP Calibration

IBP is not user-calibrated. Calibration should be performed by a qualified service professional as frequently as dictated by your Hospital Procedures Policy.

18.4 IBP Setup

Select the parameter area or waveform area of any pressure to access the corresponding menu. Select the **Setup** tab to access the IBP Setup menu.

18.4.1 Selecting the Pressure Label

Tell the monitor which pressure you want to monitor by selecting its pressure label. The label is a unique identifier for each type of pressure. When you choose a label, the monitor uses that label's stored settings, for example color, wave scale and alarm settings. The label also determines which algorithm is used to process the pressure signal, so an incorrect label can lead to incorrect pressure values. To select the label:

1. Select **Alias** in the IBP Setup menu.
2. Select the appropriate pressure label from the list.

Label	Description	Label	Description
Art	Arterial blood pressure	ICP	Intracranial pressure
Ao	Aortic pressure	LAP	Left atrial pressure
PA	Pulmonary artery pressure	RAP	Right atrial pressure
BAP	Brachial arterial pressure	LV	Left ventricular pressure
UAP	Umbilical arterial pressure	UVP	Umbilical venous pressure
FAP	Femoral arterial pressure	P1-P4	Alternative non-specific pressure labels
CVP	Central venous pressure	CPP	Cerebral perfusion pressure

If the current pressure is non-specific pressure (P1, P2, P3 or P4), set the **Pressure Type** to **Artery** or **Vein** in the IBP Setup menu. The default setting is **Artery**.

For the arterial pressure, its corresponding parameter area displays systolic pressure, diastolic pressure and mean pressure; for the venous pressure, its corresponding parameter area only displays the mean pressure.

NOTE:

The pressure type option is only valid when the label is P1-P4 and does not take effect under other labels.

18.4.2 Setting Alarm Limit Display

Set the **Alarm Limit Display Format** in the IBP Setup menu.

- If the current pressure is arterial pressure, the display format of the alarm limits can be set to SYS or SYS&DIA&MAP. The default setting is SYS.
- If the current pressure is venous pressure, the display format of the alarm limits is fixed to MAP and cannot be set.

18.4.3 Setting IBP Filter

1. Access **Menu > System > User Maintain > Parameter Maintain > Other Parameters**.
2. Set the **IBP Filter** to 12.5 Hz or 40 Hz. The default setting is 12.5 Hz.

18.4.4 Setting the IBP Waveform Speed

To change the speed, choose **Speed** and select a suitable setting from the pop-up list. The bigger the value is, the wider the waveform will be.

18.4.5 Changing the IBP Waveform Scale

The top and bottom rulers are available for each channel of IBP waveform. Choose **Scale** and select a suitable setting from the pop-up list. If **Customized** is selected, adjust the top and bottom rulers manually.

18.5 Calculating CPP

CPP is calculated by subtracting MAP and ICP, it means: $CPP = MAP - ICP$.

To select an arterial pressure as CPP source:

1. Click the ICP parameter area to enter into ICP Setup interface.
2. Select **CPP Source**; CPP source can be selected as **Auto, Art, Ao, FAP, LV, UAP, BAP, P1, P2, P3** or **P4**.

Only when P1, P2, P3 and P4 are arterial pressure can they be selected as CPP source

18.6 Calculating PPV

Pulse Pressure Variation (PPV) is calculated from the specific arterial pressure values, which reflects the variation between the maximal pulse pressure and the minimum pulse pressure in 30 seconds. Pulse pressure is affected by left ventricular-stroke volume, arterial resistance and arterial compliance.

WARNING

- 1 **The clinical value of the derived PPV information must be determined by a physician. According to recent scientific literature, the PPV information is restricted to sedated patients who receive controlled mechanical ventilation and without arrhythmia. Whether the calculation results in other situations are clinically significant, applicable and reliable must be determined by a physician.**
-

WARNING

2 In below situations, the calculated PPV value may be inaccurate:

- the respiration rate is lower than 8 rpm
- the tidal volume during ventilation is lower than 8 ml/kg
- patients have acute right ventricular functional disorder (pulmonary heart disease)

3 PPV measurement has been validated only for adult patients.

PPV is calculated according to the following equation:

$$\text{PPV} = (\text{PPmax} - \text{PPmin}) / (\text{PPmax} + \text{PPmin}) / 2 * 100\%$$

To select an arterial pressure as PPV source:

1. Click the PPV parameter area to enter PPV Setup menu.
2. Select **PPV Source**; PPV source can be selected as **Auto, Art, Ao, FAP, LV, UAP, BAP, P1, P2, P3** or **P4**.

Only when P1, P2, P3 and P4 are arterial pressure can they be selected as PPV source.

18.7 Calculating SVV

Stroke Volume Variation (SVV) is the percentage of the difference between maximum stroke volume and minimum stroke volume and the ratio of average stroke volume in the specified time. The main principle is the effect of respiratory movement on cardiac pump blood. SVV is only applicable in patients on controlled mechanical ventilation.

SVV is calculated according to the following equation:

$$\text{SVV} = (\text{SVmax} - \text{SVmin}) / \text{SVmean} * 100\%$$

To select an arterial pressure as SVV source:

1. Click the SVV parameter area to enter SVV Setup menu.
2. Select **SVV Source**; SVV source can be selected as **Auto, Art, Ao, FAP, LV, UAP, BAP, P1, P2, P3** or **P4**.

Only when P1, P2, P3 and P4 are arterial pressure can they be selected as SVV source.

Chapter 19 Monitoring CO₂

19.1 Overview

The monitor provides the sidestream and mainstream methods for CO₂ monitoring. EDAN etCO₂ module, Masimo Sidestream CO₂ module and Respirationics Sidestream CO₂ module are used for sidestream measuring; Masimo Mainstream CO₂ module and Respirationics Mainstream CO₂ module are used for mainstream measuring.

The principle of CO₂ measurement is primarily based on the fact that CO₂ molecule can absorb 4.3µm infrared ray. Absorption intensity is proportional to CO₂ concentration of patient sample, the CO₂ concentration will compute according to the detecting CO₂ absorption intensity of patient sample.

- Sidestream measurement takes a sample of the respiratory gas with a constant sample flow from the patient's airway and analyzes it with a CO₂ sensor. You can measure Sidestream CO₂ using the monitor's built-in CO₂ measurement. Respiration rate is calculated by measuring the time interval between detected breaths.
- Mainstream measurement uses a CO₂ sensor attached to an airway adapter directly inserted into the patient's breathing system.

19.2 CO₂ Safety Information

WARNING

- 1 Do not use the device in the environment with flammable anesthetic gas.**
 - 2 The device should be used by trained and qualified medical personnel authorized by EDAN.**
 - 3 Nitrous oxide, elevated levels of oxygen, helium, xenon, halogenated hydrocarbons, and barometric pressure can influence the CO₂ measurement.**
 - 4 The monitor will be damaged if any pipeline from the CO₂ module's air tube /the air inlet /the air outlet is plugged by water or other materials.**
 - 5 The accuracy of the CO₂ measurement will be affected by the following reasons: the airway was highly obstructed; the leakage of air way connection or quick variation of environment temperature.**
 - 6 Follow precautions for electrostatic discharge (ESD) and electromagnetic interference (EMI) to and from other equipment.**
 - 7 Do not place the sensor cables or tubing in any manner that may cause entanglement or strangulation.**
-
-

WARNING

- 8** When using mechanical ventilation, gas compensation should be well set. Inappropriate setting may cause incorrect measurement result.
 - 9** Respironics module is not equipped with automatic air pressure compensation, before you start the CO₂ measurement for the first time, you must set the correct altitude. Incorrect altitude settings can cause incorrect CO₂ readings. EDAN etCO₂ module is equipped with automatic air pressure compensation, and manual setting is not required.
 - 10** Leakage in the respiratory system or sampling system may result in a significant low display of the etCO₂ value. Always keep all components connected firmly and check for leaks according to standard clinical procedures.
 - 11** The etCO₂ reading is not always closely related to the paCO₂ value, especially in neonatal patients, and patients with pulmonary disease, with pulmonary embolism or inappropriate ventilation.
 - 12** Do not measure CO₂ while nebulized medications are being delivered.
 - 13** The CO₂ module temporally stops measuring during zeroing.
 - 14** Do not use the etCO₂ monitor for diagnostic purpose.
 - 15** CO₂ No Breath Detected alarm is based on detection of breaths within a configured time frame.
 - 16** CO₂ No Breath Detected alarm should not be used or relied upon while the patient is unattended.
-
-

NOTE:

- 1** After the low battery alarm appears, please do not start the CO₂ measurement, or the monitor may turn off for the low capacity of battery.
- 2** For disposal of hospital waste such as accumulated fluids, calibration gases, sampled gases, where not otherwise specified, follow local regulations regarding disposal of hospital waste.
- 3** If the measurement or sensor fails, stop measurement before the qualified service personnel solves the problem.
- 4** The cumulative use time for the sampling line in a single patient should be less than 30 days.

19.3 Monitoring Procedures

19.3.1 Zeroing

For the EDAN etCO₂ module:

EDAN etCO₂ module itself has automatic zero function, only when the measurement is abnormal or measurement results are doubtful, the user can perform manual zero as following steps:

1. Wait until the monitor's warm-up message disappears; keep the monitor away from CO₂ source.
2. In the CO₂ Setup menu, set **Work Mode** to **Measure**.
3. Select **Zero Calibration** in CO₂ Setup menu.
4. After the zeroing calibration is completed, the zeroing message disappears, and the CO₂ monitoring can be performed.

NOTE:

The Auto Zero shall be suppressed for 5 min when physiological/technical alarms related to EDAN etCO₂ module are active.

For the Respironics Sidestream CO₂ Module:

1. Connect the sample line to the module correctly, wait until the monitor's warm-up message disappears, keep the inlet of sample line away from CO₂ source.
2. In the CO₂ Setup menu, set **Work Mode** to **Measure**.
3. Select **Zero Calibration** in CO₂ Setup menu.
4. After the zeroing calibration is completed, the zeroing message disappears, and the CO₂ monitoring can be performed. If the monitor displays **Breath Detected** or **Zero Required**, zeroing has failed. Zero calibration must be performed again.

For the Masimo Sidestream CO₂ module:

The highly stable Masimo Sidestream CO₂ module requires no regular zeroing. A room air reference measurement is performed when the NomoLine is disconnected from the gas inlet, provided that CO₂ measurements are stable. This zeroing procedure is indicated by the blinking green.

For the Respironics Mainstream CO₂ Module:

1. Wait until the monitor's warm-up message disappears; correctly install the mainstream CO₂ sensor to airway adaptor and remove it from breathing circuit, keep the monitor away from CO₂ source.

2. In the CO₂ Setup menu, set **Work Mode** to **Measure**.
3. Select **Zero Calibration** in CO₂ Setup menu.
4. After the zeroing calibration is completed, the zeroing message disappears, and the CO₂ monitoring can be performed. If the monitor displays **Breath Detected** or **Zero Required**, zeroing has failed. Zero calibration must be performed again.

Note: CO₂ source includes ventilator, patient's and operator's breath.

For Masimo Mainstream CO₂ Module:

The user can click **Zero** button in CO₂ Setup, during the zeroing progress, the monitor displays prompt information of "**Zeroing**".

Zeroing needs to be performed only when an offset in gas value is observed, or when an unspecified accuracy message is displayed.

19.3.2 Hiding the Invalid Display after Zeroing the CO₂ Module

Within 30 s after the zero calibration starts, the monitor displays **Zero Recovering** and invalid CO₂ value. Valid data will reappear 30 seconds after the zero calibration is started. The user can hide the display of **Zero Recovering** and show CO₂ values. To hide the display of **Zero Recovering**, follow these steps:

1. Select **Menu > System > User Maintain**, and input the password;
2. Select **Parameters Maintain > Other Parameters** and switch off **Zero Recovery**.

NOTE:

CO₂ values displayed within 30 s after the zero calibration is started should be interpreted cautiously.

19.3.3 Sidestream CO₂ Module

19.3.3.1 Measurement Steps

For the EDAN etCO₂ Module:

1. Fix the water trap to the water trap holder on the left side of the monitor, confirm it is well fixed.
2. Connect the sampling cannula or the sampling line to the water trap.
3. Set **Work Mode** to **Measure**.
4. For intubated patients, an airway adapter is required. For non-intubated patients, place the nasal cannula or the sampling mask onto the patient.

PRECAUTION

- 1 The water trap collects water drops condensed in the sampling line and therefore prevents them from entering the module. If the water trap is nearly filled, you should replace it to avoid blocking the airway.**
 - 2 When replacing the water trap or suspecting the measurement value, please check if the O-rings of the water trap holder are normal and well installed. If the O-rings get damaged or loose, contact EDAN's service staff.**
 - 3 To prevent the module from abnormal work, please ensure the water trap detection button is not mistakenly touched.**
 - 4 Based on a sample gas temperature of 37 °C, a room temperature of 23 °C and sample relative humidity of 100%, the water trap will be filled after approximately 90 hours with the flowrate of 100 ml/min, approximately 130 hours with the flowrate of 70 ml/min, and approximately 180 hours with the flowrate of 50 ml/min. In clinical practice, the water trap can be used for a longer time before it is filled. It is recommended to replace the water trap once every month.**
 - 5 Please replace and discard the water trap when blocking. Do not reuse it, otherwise the reading is not accurate and even the device may be damaged.**
-
-

NOTE:

- 1 Disconnect the water trap from the holder or set Work Mode to Standby when the module is not in use. Setting path: CO₂ Setup > Work Mode > Standby.**
- 2 To avoid patient cross infection, do not connect the exhaust tube to the ventilator circuit. If the sampled gas is returned to the breathing system, always use the bacterial filter of the sample gas return kit.**

For the Respironics Sidestream Module:

1. Plug the sensor cable into the monitor's CO₂ input connector. Allow the sensor two minutes for warm-up.
2. Appropriately connect the cannula, airway adapter or sample line to the sensor. It will click into place when seated correctly.
3. To zero the sensor, please refer to *Zeroing*.
4. For intubated patients, an airway adapter is required;

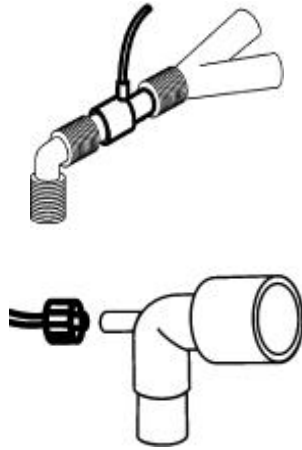

Air adapter

For non-intubated patients: Place the nasal cannula onto the patient.



Place the nasal cannula

NOTE:

- 1 You must perform a zero calibration as described in this procedure each time the ambient temperature changes more than 10°C (for example during transport).**
- 2 Always connect the airway adapter to the sensor before inserting the airway adapter into the breathing circuit. In reverse, always remove the airway adapter from the breathing circuit before removing the sensor.**
- 3 Always disconnect the cannula, airway adapter or sample line from the sensor when the sensor is not in use.**
- 4 To extend the lifetime of the module, set Work Mode to Standby when the module is not in use.**
- 5 The sidestream CO₂ module continuously extracts a quantity of gas from the patient's airway per minute. Please do not use this module in any patient who will be affected by this sampling rate.**
- 6 If the catheter falls off during the measurement, it is necessary to re-zero after the catheter is well connected, and then measurement can be performed.**

For Masimo Sidestream Module:

WARNING

- 1 To avoid water condensation inside the module and the connecting tubings, ensure that the surrounding temperature of the module and the connecting tubings does not fall below the ambient temperature of the Sampling line.
 - 2 The fulfillment of the EMC requirement is the responsibility of the integrator.
 - 3 The Masimo sidestream CO₂ module's exhaust gas is not intended to be returned to the patient circuit.
 - 4 The host power supply shall employ current limiting, whereby current is reduced or cut-off under overload conditions.
 - 5 The host power supply shall provide 2 MOPP of isolation to Mains according to IEC 60601-1.
 - 6 Alarm messages corresponding to each bit in the status summary field of the software interface protocol must be implemented in the host equipment.
 - 7 The host equipment shall be equipped with appropriate alarm systems to alert the user of situations which could lead to death or severe deterioration of the patient's state of health.
 - 8 Make sure that Masimo sidestream CO₂ module is used in the electromagnetic environment specified in this manual.
 - 9 Portable and mobile RF communications equipment (including peripherals such as antenna cables and external antennas) should be used no closer than 30 cm (12 inches) to any part of Masimo sidestream CO₂ module, including the cable. Otherwise, degradation of the performance of the Masimo sidestream CO₂ module could result.
 - 10 Use of this equipment adjacent to or stacked with other equipment should be avoided because it could result in improper operation. If such use is necessary, this equipment and the other equipment should be observed to verify that they are operating properly.
 - 11 Use of accessories and cables other than those specified or provided could result in increased electromagnetic emissions or decreased electromagnetic immunity of this equipment and result in improper operation.
 - 12 Do not use the module if it appears or is suspected to be damaged. Damage to the device can result in exposed electrical circuits that may cause patient harm.
-
-

WARNING

- 13 Do not adjust, repair, open, disassemble, or modify the module. Damage to the device may result in degraded performance and/or patient injury.**
 - 14 Do not start or operate the module unless the setup was verified to be correct. Improper set-up of this device may result in degraded performance and/or patient injury.**
 - 15 Do not place the module or accessories in any position that might cause it to fall on the patient.**
 - 16 Only use Masimo authorized devices with the module. Using unauthorized devices with the module may result in damage to the device and/or patient injury.**
 - 17 Carefully route the sampling line to reduce the risk of patient entanglement or strangulation.**
 - 18 Do not lift the module by the NomoLine capnography sampling line as it could disconnect from the module, causing the device to fall on the patient.**
 - 19 Do not use the module during magnetic resonance imaging (MRI) or in an MRI environment.**
 - 20 Only use sample lines intended for anesthetic agents if N₂O and/or anesthetic agents are being used.**
 - 21 Do not re-use disposable single-patient use NomoLine Family sampling lines due to the risk of cross contamination.**
 - 22 Do not use the NomoLine Infant/Neonate Airway Adapter Sets for adults/pediatrics as they may cause excessive flow resistance (0,7 ml dead space).**
 - 23 Do not use the NomoLine Adult/Pediatric Airway Adapter Sets for infants/neonates as the airway adapter adds 6 ml dead space.**
 - 24 Do not apply negative pressure to remove condensed water from the NomoLine Family sampling line.**
 - 25 The module is not intended to be used for returning exhaust gases to the patient circuit. Exhaust gases should be returned to a scavenging system.**
 - 26 Disconnect the device from AC mains by removing the device cable connection from the host device.**
 - 27 The module should not be used as the sole basis for medical decisions. It must be used in conjunction with clinical signs and symptoms.**
-
-

WARNING

- 28 Use of high-frequency electrosurgical equipment in the vicinity of the module may produce interference and cause incorrect measurements.**
 - 29 Do not use the module with metered-dose inhalers or nebulized medications as this may clog the bacteria filter.**
 - 30 Properly apply sampling lines according to the sampling lines directions for use. Misapplied sampling lines that become partially dislodged may cause no or incorrect readings.**
 - 31 Replace the sampling line if the sampling line input connector starts flashing red, or host device displays a check sampling line type of message.**
 - 32 Too strong positive or negative pressure in the patient circuit might affect the sample flow.**
 - 33 Strong scavenging suction pressure might affect the sample flow.**
 - 34 To avoid electric shock, always physically disconnect the module and all patient connections before cleaning.**
 - 35 Do not attempt to remanufacture, recondition or recycle the module as these processes may damage the electrical components, potentially leading to patient harm.**
-
-

PRECAUTION

- 1 Masimo sidestream CO₂ module does not contain any user-serviceable parts.**
 - 2 Anyone not properly trained and certified must not attempt to perform any service or maintenance of the Masimo product.**
 - 3 Only use existing mounting holes. Drilling additional holes will void the warranty.**
 - 4 Do not operate the module outside of the specific operating environment.**
 - 5 The module should be mounted securely to avoid risk of damage.**
-
-

NOTE:

Use and store the module in accordance with specifications. See the Specifications section in this manual.

NomoLine Sampling Lines

Masimo Sidestream CO₂ module samples gas from the respiratory circuit through the NomoLine Family sampling line at a rate of 50 sml/min, making measurements of CO₂ possible for adult, pediatric, infant and neonatal patients. The NomoLine Family of sampling lines are designed for optimal performance and measurement fidelity when used with the Masimo Sidestream CO₂ module.

NomoLine sampling lines include nasal and nasal/oral cannulas for non-intubated patients with and without supplementary oxygen delivery and airway adapter sets for intubated patients.



As long as no sampling line is connected, the Masimo Sidestream CO₂ module remains in a low-power sleep mode. Once the sampling line is connected, the Masimo Sidestream CO₂ module switches to measuring mode and starts delivering gas data.

For ordering information about NomoLine sampling lines, cannulas, and related consumables, visit www.masimo.com.

Sampling Line Replacement

NomoLine sampling lines should be replaced between each patient or when the sampling line becomes occluded. Occlusion occurs when water, secretions etc. are aspirated from the respiratory circuit to such an extent that NomoLine capnography cannot maintain the normal 50 ml/min sample flow. This is indicated by a red flashing LEGI indicator and an alarm message; replace the sampling line and wait until the LEGI indicator switches to green, indicating that the Masimo Sidestream CO₂ module is again ready for use.

For ordering information about NomoLine sampling lines and related consumables, visit www.masimo.com.

Setting up

1. Remove the temporary plug from the NomoLine Capnography input connector.
2. Securely mount the Masimo sidestream CO₂ module.

Note: A bracket designed to mount the module is available, visit www.masimo.com.

3. Connect the gas sample exhaust port on the rear of the module to a scavenging system if intended to be used in combination with N₂O and/or anesthetic agents.
4. Connect the module cable to the connection port of the monitor.
5. Connect a NomoLine sampling line to the module input connector.
6. Check that the monitor is powered up and correctly configured.
7. Set **Work Mode** to **Measure**.
8. Check that the gas inlet indicator shows a steady green light, indicating that the Masimo sidestream CO₂ module is ready for use.

Note: Without a sampling line connected, the gas inlet indicator does not illuminate.

9. Attach a NomoLine sampling line to the patient for monitoring. Refer to the NomoLine sampling line Directions for Use.
10. Following connection of the NomoLine sampling line, check that CO₂ values appear on the monitor screen.

Operation

The information in this section assumes that Masimo sidestream CO₂ module is set up and ready for use. This section provides necessary information for proper operation of the device. Do not operate Masimo sidestream CO₂ module without completely reading and understanding these instructions.

The Light Emitting Gas Inlet (LEGI) Indicator provides visual indications of capnography status. The LEGI Indicator (3) is located around the capnography connector on the front of the device.

The LEGI indicator illuminates in different colors depending on the state of the device as described in the table:

LEGI Indicator	Status
Steady green light	Capnography monitoring in operation and OK
Blinking green light	Zeroing in progress. Refer to <i>Zeroing</i>
Steady red light	Sensor error
Blinking red light	Check the sampling line (possible occlusion)

Note: Without a NomoLine sampling line connected, the LEGI Indicator does not illuminate.

With no sampling line connected, the Masimo sidestream CO₂ module stays in a low-power, sleep mode. Once a sampling line is connected, the Masimo sidestream CO₂ module switches to measuring mode and starts delivering gas data.

Capnography Display

Parameters and measurements display on the screen of the monitor that the Masimo Sidestream CO₂ module is connected to.

Cleaning

Cleaning of the Masimo sidestream CO₂ module should be performed at regular intervals or in accordance with hospital, as well as local and governmental regulations.

WARNING

To avoid electric shock, always physically disconnect the modules and all patient connections before cleaning.

PRECAUTION

To avoid permanent damage to the module, do not use undiluted bleach (5% - 5.25% sodium hypochlorite) or any other cleaning solution not recommended.

NOTE:

To prevent cleaning liquids and dust from entering the NomoLine capnography gas analyzer through its sampling gas inlet connector, keep the sampling line fitted while cleaning the module.

The surfaces of the module may be cleaned with the following solution(s):

- 70% ethyl alcohol
- 70% isopropyl alcohol
- Glutaraldehyde Solution
- Quaternary Ammonium Chloride Wipe
- 0.5% Sodium Hypochlorite/Water Solution
- Accelerated Hydrogen Peroxide

Maintenance

Once every year it is recommended to perform maintenance on the module. A NomoLine ISA CO₂ Maintenance Kit containing all required components and instructions to perform maintenance procedures is available through www.masimo.com.

19.3.3.2 Removing Exhaust Gases from the System

WARNING

Do not connect the exhaust tube to the ventilator circuit, connect the outlet to a scavenging system, cross infection can occur if sampling gas is returned to the breathing system. When using the sidestream CO₂ measurement on patients who are receiving or have recently received anesthetics, please avoid exposing medical staff to anesthetics.

Use an exhaust tube to remove the sample gas to a scavenging system. Attach it to the sidestream sensor at the outlet connector.

19.3.4 Mainstream CO₂ Module

For Respironics Module:

NOTE:

You must perform a zero calibration as described in this procedure each time you use a new airway adapter.

19.3.4.1 Measurement Steps

- 1 Attach the sensor connector to the CO₂ connector on the monitor.
- 2 Wait two minutes, allowing the sensor to reach its operating temperature and a stable thermal condition.
- 3 Choose the appropriate airway adapter and connect it to the sensor head. The airway adapter clicks into place when seated correctly.

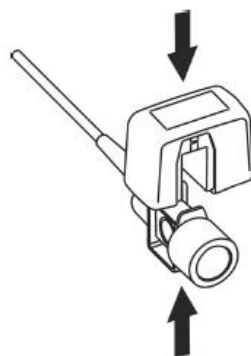

Connecting Sensor

- 4 To zero the sensor, please refer to *Zeroing*.
- 5 Install the airway adapter at the proximal end of the circuit between the elbow and the ventilator Y-section.

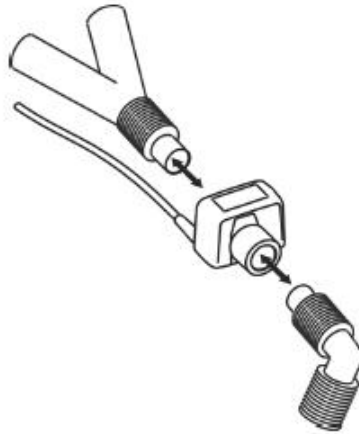

Connecting Airway Adapter

WARNING

- 1 No routine user calibration is required.**
 - 2 Accuracy is affected by temperature and barometric pressure.**
-

NOTE:

- 1 If the catheter falls off during the measurement, it is necessary to re-zero after the catheter is well connected, and then measurement can be performed.**
- 2 Replace the airway adapter, if excessive moisture or secretions are observed in the tubing or if the CO₂ waveform changes unexpectedly without a change in patient status.**
- 3 To avoid cross infection, use only sterilized, disinfected or disposable airway adapters.**
- 4 Inspect the airway adapters prior to use. Do not use it if airway adapter appears damaged or broken. Observe airway adapter color coding for patient population.**
- 5 Periodically check the flow sensor and tubing for excessive moisture or secretion buildup.**
- 6 Always connect the airway adapter to the sensor before inserting the airway adapter into the breathing circuit. In reverse, always remove the airway adapter from the breathing circuit before removing the sensor.**
- 7 To avoid dead space, place the sensor as close to the patient as possible.**

For Masimo Mainstream Module:**WARNING**

- 1 The connection circuit in the host device shall be separated from live parts with double or reinforced insulation.
- 2 The host power supply shall employ current limiting, whereby current is reduced or cut-off under overload conditions.
- 3 The host equipment shall be equipped with appropriate alarm system to alert the user of situations which could lead to death or severe deterioration of the patient's state of health.
- 4 Alarm message corresponding to each bit in the status summary field must be implemented in the host equipment.
- 5 Incorrect probe zeroing will result in false gas readings.
- 6 Measurements can be affected by mobile and portable RF communications equipment. It should be assured that the probe is used in the electromagnetic environment specified in this manual.

For the monitoring procedures, please refer to Section *Monitoring Steps for IRMA Module*.

19.4 Setting the Gas Compensation

Temperature, water vapor in the patient's breath, barometric pressure, and the proportions of O₂, N₂O and Helium in the mixture all influence CO₂ absorption. If values seem inaccurately high or low, check that the monitor is using the appropriate corrections.

For the EDAN sidestream module, the following items are available in the **Compensation Setting** menu: **N₂O Compens.**, **O₂ Compens.**, **Anest. Agent**, **Vapor Compens.** and **Pump Rate**. The concentration of compensated gas should be set based on the current gas concentration which is supplied for patient. As for O₂ and N₂O, make the supplied gas concentration multiply to its volume to get the concentration. For instance, supply 100% O₂, and its volume is 60%, then O₂ compensation is: $100\% \times 60\% = 60\%$. AG concentration is decided by anaesthesia apparatus.

For the Respironics CO₂ modules, there are **Baro Press**, **O₂ Compens**, **Anes Agent** and **Balance Gas** in the **Compensation Setting** menu. The concentration of compensated gas (including O₂ and AG) should be set based on the current gas concentration which is supplied for patient. The selection of balance gas depends on actual situation. For instance, N₂O should be selected as balance gas if the real balance gas is N₂O.

For the Masimo CO₂ modules, there are **N₂O Compens** and **O₂ Compens** in the **Compensation Setting** menu. The **N₂O Compens** includes two options: low and high, default is **Low**. **Low** refers to N₂O concentration is 0~30%, and **High** refers to N₂O concentration is 30%~70%. **O₂ Compens** includes three options: low, medium and high, default is **Low**. **Low** refers to O₂ concentration is 0~30%, **Medium** refers to O₂ concentration is 30%~70%, and **High** refers to O₂ concentration is 70%~100%.

After settings, confirm the changes to make the settings effective.

NOTE:

Make sure compensation value is correctly set, otherwise the measurement accuracy may be affected.

19.5 Setting No Breath Detected Alarm Time

This determines the time limit after which the monitor gives an alarm if the patient stops breathing.

1. Select the **CO₂** tab > **No Breath Detected**;
2. Choose the No Breath Detected alarm time from the pop-up list.

WARNING

Safety and effectiveness of the respiration measurement method in the detection of No Breath Detected, particularly the apnea of prematurity and apnea of infancy, has not been established.

19.6 CO₂ Setup

Select the CO₂ parameter area or waveform area to enter the **CO₂** dialog. Select the **Setup** tab to access the CO₂ Setup menu.

- Choose **Mode** and set it to **Curve** or **Filled** from the pop-up list;
- Choose **Speed** and select a suitable setting from the pop-up list. The bigger the value is, the wider the waveform will be.
- Choose **Scale** and select the appropriate setting from the pop-up list.

Chapter 20 Monitoring C.O.

20.1 Overview

The cardiac output (C.O.) measurement invasively measures cardiac output and other hemodynamic parameters by using the Thermodilution method. The Thermodilution method is to inject a cold solution into the blood circulation system and measure the temperature changes caused by the cold solution through the thermistor of the pulmonary artery floating catheter, and the C.O. value is calculated by using the temperature dilution curve.

20.2 C.O. Safety Information

WARNING

- 1 Make sure that appurtenance applied is in conformity with relevant Medical Device Safety Requirements.**
 - 2 Appurtenance should be avoided from contact with conductive metal body when being connected or applied.**
 - 3 All invasive procedures involve risks to the patient. Use aseptic technique and follow catheter manufacturer's instructions.**
 - 4 The C.O. measurement results may be incorrect during electrosurgery.**
 - 5 C.O. floating catheter shall be removed or reinserted after 3 days.**
-
-

NOTE:

- 1 To replace the catheter thermistor, please enter the catheter computation coefficient into the Constant item according to the instruction.**
- 2 Please set injection switch well. The calculation of the cardiac output is based on the state of the injection switch at the end of the measurement. Therefore, after the selection of the injection switch is completed, do not change until the measurement is completed.**
- 3 Please start C.O. measurement after blood temperature is stable, otherwise the measurement may fail.**

20.3 C.O. Monitoring

Preparing Measurement

1. Plug the C.O. cable into the C.O. socket and turn on the monitor.
2. Attach the injective probe connector and catheter thermistor connector to the appropriate parts of the cardiac output interface cable.

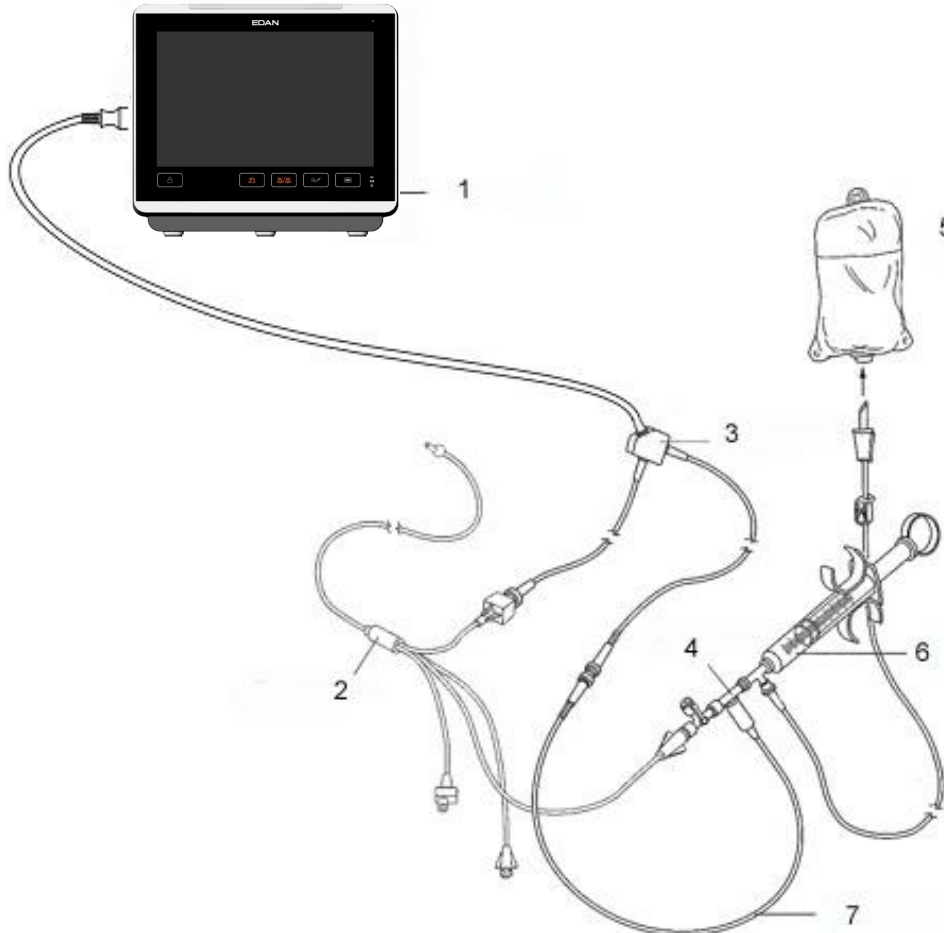

- 1: Monitor; 2: Thermodilution Catheter; 3: Cardiac Output Cable; 4: Injectate Sensor Housing; 5: Injectate; 6: Delivery System; 7: In-line injectate Temperature probe.

C.O. Sensor Connection

3. Open the patient information window to confirm the patients' height and weight.
4. Select **Menu > System > User Maintain** and input user maintenance password > **Parameter Maintain > Other Parameters**. Check that the correct computation constant is entered.
 - The computation constant is associated with catheter and injectate volume. When the catheter is changed, please adjust **Constant** based on product description provided by the manufacturer. After user's confirmation, the setup takes effect.

Select the C.O. parameter area to enter the **C.O.** dialog. Select the **Setup** tab to access the C.O. Setup menu. In C.O. Setup menu, set:

- **Inj. Temp Source:** Select **Auto** or **Manual** from the list, when set as **Manual**, the system directly displays the injectate temperature from INJ. TEMP. Ensure INJ. TEMP is correct, otherwise the C.O. measurement may be affected. When set as **Auto**, the system obtains the injectate temperature through sampling.

Performing C.O. Measurement

1. Select the shortcut key  or pick the **Measure** item in the **C.O.** dialog. The C.O. Measure menu displays as below:

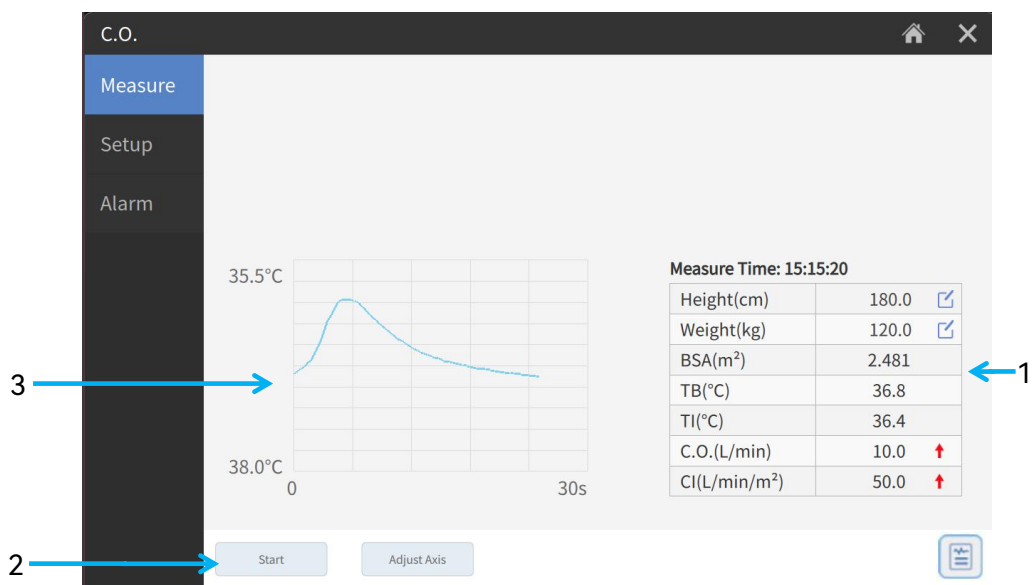

- 1 Current measurement values
- 2 Functional keys
- 3 Current measurement curves

The functional keys on the C.O. measure window are explained in the following table:

Start Start a measurement

Cancel Cancel the processing measurement or cancel the result after measurement.



Print out the measurement result through the recorder.

2. Measurement should be taken when the message “**Ready for new measurement**” appears on the screen. Press the **Start** button, and then start injection. The thermodilution curve, current blood temperature and the injective temperature are displayed during the measurement. Curve drawing will stop automatically when the measurement finishes, and the C.O. and CI will be calculated and displayed on the screen.

To ensure the accuracy of the measurement, it is suggested that a reasonable interval should take place between two consecutive measurements. The length of the interval can be set in the C.O. Setup menu (Time unit: second). The interval time counter is displayed on the screen. The next measurement cannot be performed until the time reduces to zero and a message **Ready for new measurement** appears. The adjustable range of **Interval** is: 5 to 300 seconds.

WARNING

- 1 Make sure that the computational constant for the measurement is appropriate to the catheter used.**
 - 2 Before a C.O. measurement is initiated, check the accuracy of patient setup. The calculation of C.O. is related to the patient height, weight, and catheter computation coefficient; therefore, incorrect input will lead to error in calculation.**
-

NOTE:

- 1 The blood temperature alarm will not function during C.O. measurement. It will resume automatically when the measurement is over.**
- 2 It is strongly recommended that the user must push the injector within four seconds after pressing the Start button.**
- 3 It is strongly recommended that you wait at least one minute (or longer depending on the patient's clinical condition) before starting the next measurement.**

20.4 Blood Temperature Monitoring

Blood temperature monitoring can function when C.O. measurement is not taken. The blood temperature is measured by the thermistor situated in the distal end of the flotation catheter in the pulmonary artery.

The blood temperature alarm function will not work during the C.O. measurement. When the measurement ends, the function will automatically resume.

The current blood temperature is displayed in the C.O. parameter area.

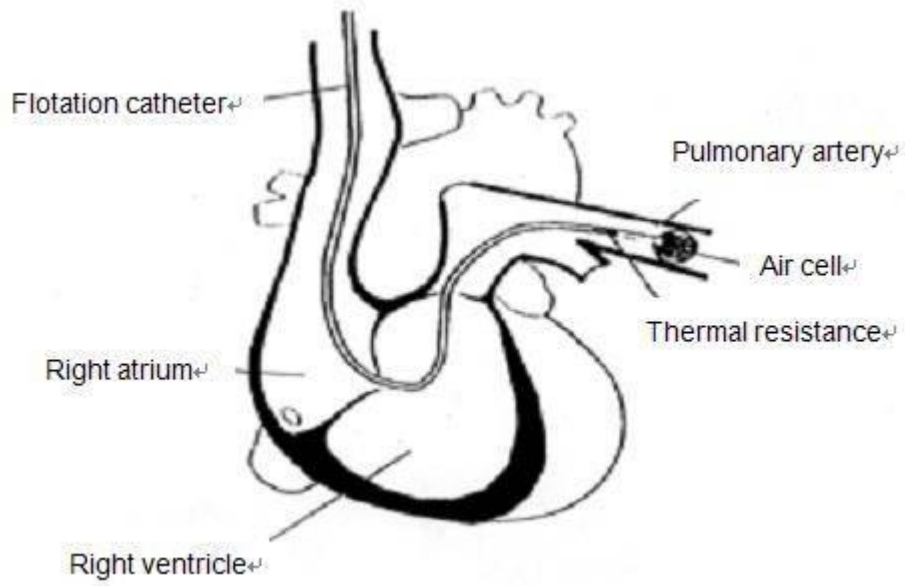

Thermodilution Catheter Site

Chapter 21 Monitoring AG

21.1 Overview

The monitor uses ISA sidestream gas analyzer (hereinafter called ISA analyzer), EDAN G7 sidestream (hereinafter called G7 Module) and IRMA mainstream module (hereinafter called IRMA module) to monitor the anesthetic gas which can be used to measure the gases of adult, pediatric and neonatal patients during anesthesia, recovery and respiratory care. And the anesthetic gas includes Halothane (HAL), Isoflurane (ISO), Enflurane (ENF), Sevoflurane (SEV), Desflurane (DES), N₂O, and O₂ (Optional).

21.2 Safety Information

21.2.1 Safety Information for G7 Module

WARNING

- 1 G7 Module is not designed for MRI environments.**
 - 2 Do not use the device in the environment with flammable anesthetic gas.**
 - 3 The device should be used by trained and qualified medical personnel authorized by EDAN.**
 - 4 Nitrous oxide, elevated levels of oxygen, helium, xenon, halogenated hydrocarbons, and barometric pressure can influence the AG measurement.**
 - 5 The monitor will be damaged if any pipeline from the AG module's air tube /the air inlet /the air outlet is plugged by water or other materials.**
 - 6 The accuracy of the AG measurement will be affected by the following reasons: the airway was highly obstructed; the leakage of air way connection or quick variation of environment temperature.**
 - 7 Follow precautions for electrostatic discharge (ESD) and electromagnetic interference (EMI) to and from other equipment.**
 - 8 The use of authentic EDAN anesthesia sample lines is strongly recommended, as other sample lines with an incorrect length and/or diameter may lead to erroneous agent concentration readings.**
 - 9 Since a successful zeroing requires the presence of ambient air (21% O₂ and 0% CO₂), ensure that the module is placed in a well-ventilated place. Avoid breathing near the module before or during the zeroing procedure.**
 - 10 The module is intended only as an adjunct in patient assessment. It must be used in conjunction with other assessments of clinical signs and symptoms.**
-
-

WARNING

- 11 Exhaust gases should be returned to the patient circuit or a scavenging system.
 - 12 Too strong positive or negative pressure in the patient circuit might affect the sample flow.
 - 13 When the monitor is working, do not insert or unplug G7 module (with O₂) to prevent inaccurate O₂ measurement.
 - 14 Do not place the module in any position that might cause it to fall on the patient.
 - 15 Do not immerse sampling lines in liquid.
 - 16 It is recommended to use two agents maximally at the same time.
-
-

PRECAUTION

- 1 Do not operate the module outside the specified operating temperature environment.
 - 2 The sidestream AG module with O₂ is fragile and should be handled with care.
 - 3 The module should be securely mounted in order to avoid the risk of damage to the module. The module should be handle with care and it cannot be fallen or thrown.
-
-

21.2.2 Safety Information for Masimo ISA Analyzer

WARNING

- 1 The ISA sidestream gas analyzer is intended for use by authorized healthcare professionals only.
 - 2 Carefully route the sampling line to reduce the risk of patient entanglement or strangulation.
 - 3 Do not lift the ISA sidestream gas analyzer by the sampling line as it could disconnect from the ISA, causing the ISA sidestream gas analyzer to fall on the patient.
 - 4 Dispose Nomoline Family sampling lines in accordance with local regulations for biohazardous waste.
-
-

WARNING

- 5 Use only airway T-adapters with the sampling point in the center of the adapter.
 - 6 Do only use sample lines intended for anesthetic agents if N₂O and/or anesthetic agents are being used.
 - 7 Do not use the T-adapter with infants or neonates, as this adds 7 ml dead space to the patient circuit.
 - 8 Do not use the ISA gas analyzer with metered-dose inhalers or nebulized medications as this may clog the bacteria filter.
 - 9 Since a successful zeroing requires the presence of ambient air (21% O₂ and 0% CO₂), ensure that the ISA is placed in a well ventilated place. Avoid breathing near the ISA sidestream gas analyzer before or during the zeroing procedure.
 - 10 Never sterilize or immerse the ISA sidestream gas analyzer in liquid.
 - 11 The ISA sidestream gas analyzer is intended only as an adjunct in patient assessment. It must be used in conjunction with other assessments of clinical signs and symptoms.
 - 12 Measurements can be affected by mobile and portable RF communications equipment. Make sure that the ISA sidestream gas analyzer is used in the electromagnetic environment specified in this manual.
 - 13 Replace the sampling line if the sampling line input connector starts flashing red, or the monitor displays “Sample Line Occluded” message.
 - 14 No modification of this equipment is allowed without authorization of the manufacturer. If this equipment is modified, appropriate inspection and testing must be conducted to ensure continued safe operation.
 - 15 The ISA sidestream gas analyzers are not designed for MRI environments.
 - 16 During MRI scanning, ISA must be placed outside the MRI suite.
 - 17 Use of high frequency electrosurgical equipment in the vicinity of the monitor may produce interference and cause incorrect measurements.
 - 18 Do not apply negative pressure to remove condensed water from the Nomoline Family sampling line.
 - 19 Too strong positive or negative pressure in the patient circuit might affect the sample flow.
-
-

WARNING

- 20 Strong scavenging suction pressure might affect the sample flow.**
 - 21 Exhaust gases should be returned to the patient circuit or a scavenging system.**
 - 22 Due to the risk of patient cross-infection, always use a bacteria filter on the exhaust port side if sampled gas is intended to be re-breathed.**
 - 23 Do not place the ISA gas analyzer in any position that might cause it to fall on the patient.**
 - 24 Do not re-use disposable single-patient use Nomoline Family sampling lines due to the risk of cross contamination.**
 - 25 Do not sterilize or immerse Nomoline Family sampling lines in liquid.**
 - 26 Do not operate the ISA sidestream gas analyzer if the enclosure is damaged.**
 - 27 Do not use the NomoLine Adult/Pediatric Airway Adapter Sets for infants/neonates as the adult/pediatric airway adapter adds 6 ml dead space.**
 - 28 Do not use the NomoLine Infant/Neonate Airway Adapter Sets for adults/pediatrics, as they may cause excessive flow resistance (0.7 ml dead space).**
 - 29 Disconnect the module from the gas inlet or set Work Mode to Standby when the module is not in use. Setting path: AG Setup > Work Mode > Standby.**
-
-

PRECAUTION

- 1 The ISA analyzers should be securely mounted in order to avoid the risk of damage to the ISA.**
 - 2 Do not operate the ISA sidestream gas analyzer outside the specified operating environment.**
 - 3 (US Only) Caution: Federal law restricts this device to sale by or on the order of a physician. For professional use. See instructions for use for full prescribing information, including indications, contraindications, warnings, precautions and adverse events.**
-
-

21.2.3 Safety Information for Masimo IRMA Module

WARNING

- 1 The IRMA probe is intended for use by qualified medical personnel only.**
 - 2 The IRMA probe is intended only as an adjunct in patient assessment. It must be used in conjunction with other assessment of clinical signs and symptoms.**
 - 3 Disposable IRMA airway adapters shall not be reused. Reuse of the single use adapter can cause cross infection.**
 - 4 Used airway adapters shall be disposed of in accordance with local regulations for biohazardous waste.**
 - 5 Do not use the IRMA Adult/Pediatric adapter with infants as the adapter adds 6 ml dead space to the patient circuit.**
 - 6 Do not use the IRMA Infant airway adapter with adults/pediatrics as this may cause excessive flow resistance.**
 - 7 Use of high frequency electrosurgical equipment in the vicinity of IRMA may produce interference and cause incorrect measurements.**
 - 8 The IRMA probe is not designed for MRI-environments.**
 - 9 Do not place the IRMA Airway Adapter between the endotracheal tube and an elbow as this may allow patient secretions to block the adapter windows and result in incorrect operation.**
 - 10 To keep secretions and moisture from pooling on the windows, always position the IRMA probe in a vertical position with the LED pointing upwards.**
 - 11 Do not use the IRMA Airway Adapter with metered dose inhalers or nebulized medications as this may affect the light transmission of the airway adapter windows.**
 - 12 Incorrect probe zeroing will result in false gas readings.**
 - 13 Replace the airway adapter if rainout/condensation occurs inside the airway adapter.**
 - 14 Use only Masimo manufactured IRMA Airway Adapters.**
 - 15 The IRMA probe is not intended to be in patient contact.**
 - 16 If, for whatever the reason, the IRMA probe is in direct contact with any parts of the infant's body an insulation material shall be placed between the IRMA probe and the body.**
-

WARNING

- 17 No modification of this equipment is allowed.**
 - 18 Measurements can be affected by mobile and RF communications equipment. It should be assured that the IRMA probe is used in the electromagnetic environment specified in this manual.**
 - 19 Disconnect the module from the airway adapter or set Work Mode to Standby when the module is not in use. Setting path: AG Setup > Work Mode > Standby.**
-
-

PRECAUTION

- 1 Never sterilize or immerse the IRMA probe in liquid.**
 - 2 The IRMA airway adapters are non-sterile devices. Do not autoclave the devices as this will damage them.**
 - 3 Do not apply tension to the probe cable.**
 - 4 Do not operate the IRMA probe outside the specified operating temperature environment.**
 - 5 (US Only) Caution: Federal law restricts this device to sale by or on the order of a physician. For professional use. See instructions for use for full prescribing information, including indications, contraindications, warnings, precautions and adverse events.**
-
-

NOTE:

For disposal of hospital waste such as accumulated fluids, calibration gases, sampled gases, where not otherwise specified, follow local regulations regarding disposal of hospital waste.

21.3 Monitoring Steps

21.3.1 Monitoring Steps for G7 Module

21.3.1.1 Zeroing

EDAN G7 module itself has automatic zero function, only when the measurement is abnormal or measurement results are doubtful, the user can perform manual zero as following steps:

- 1. Wait until the monitor's warm-up message disappears; keep the monitor away from AG source.

2. In the AG **General Settings** menu, set **Work Mode** to **Measure**.
3. Select **Zero** in the AG **General Settings** menu.

NOTE:

The Auto Zero shall be suppressed for 5 min when physiological/technical alarms related to EDAN G7 module are active.

21.3.1.2 Measurement Steps

1. Fix the water trap to the water trap holder on the left side of the monitor, confirm it is well fixed.
2. Connect the sampling cannula or the sampling line to the water trap.
3. Set **Work Mode** to **Measure**.
4. For intubated patients, an airway adapter is required. For non-intubated patients, place the nasal cannula or the sampling mask onto the patient.

PRECAUTION

- 1 **The water trap collects water drops condensed in the sampling line and therefore prevents them from entering the module. If the water trap is nearly filled, you should replace it to avoid blocking the airway.**
 - 2 **When replacing the water trap or suspecting the measurement value, please check if the O-rings of the water trap holder are normal and well installed. If the O-rings get damaged or loose, contact EDAN's service staff.**
 - 3 **To prevent the module from abnormal work, please ensure the water trap detection button is not mistakenly touched.**
 - 4 **Based on a sample gas temperature of 37 °C, a room temperature of 23 °C and sample relative humidity of 100%, the water trap will be filled after approximately 60 hours with the flowrate of 150 ml/min. In clinical practice, the water trap can be used for a longer time before it is filled. It is recommended to replace the water trap once every month.**
 - 5 **Please replace and discard the water trap when blocking. Don't reuse it, otherwise the reading is not accurate and even the device may be damaged.**
-
-

NOTE:

To avoid patient cross infection, do not connect the exhaust tube to the ventilator circuit. If the sampled gas is returned to the breathing system, always use the bacterial filter of the sample gas return kit.

21.3.2 Monitoring Steps for Masimo ISA Module

NomoLine Sampling Lines

Masimo Sidestream CO₂ module samples gas from the respiratory circuit through the NomoLine Family sampling line at a rate of 50 sml/min, making measurements of CO₂ possible for adult, pediatric, infant and neonatal patients. The NomoLine Family of sampling lines are designed for optimal performance and measurement fidelity when used with the Masimo Sidestream CO₂ module.

NomoLine sampling lines include nasal and nasal/oral cannulas for non-intubated patients with and without supplementary oxygen delivery and airway adapter sets for intubated patients.



As long as no sampling line is connected, the Masimo Sidestream CO₂ module remains in a low-power sleep mode. Once the sampling line is connected, the Masimo Sidestream CO₂ module switches to measuring mode and starts delivering gas data.

For ordering information about NomoLine sampling lines, cannulas, and related consumables, visit www.masimo.com.

Working Status of ISA analyzer

Working status of the ISA analyzer can be indicated by the indicator. For the detailed information, please refer to the following table.

Indication	Status
Steady green light	System OK
Blinking green light	Zeroing in progress
Steady blue light	Anesthetic agent present
Steady red light	Sensor error
Blinking red light	Check sampling line

Remark: the blue light is applicable to ISA AX+ and ISA OR+.

21.3.2.1 Performing a Pre-use Check

Before connecting the Nomoline sampling line to the breathing circuit, do the following:

1. Connect the sampling line to the ISA gas inlet connector (LEGI).
2. Check that the LEGI shows a steady green light (indicating that the system is OK).
3. For ISA OR+ and ISA AX+ module with O₂ option fitted: Check that the O₂ reading on the monitor is correct (21%).
4. Breathe into the sampling line and check that valid CO₂ waveforms and values are displayed on the monitor.
5. Occlude the sampling line with a fingertip and wait for 10 seconds.
6. Check that an occlusion alarm is displayed and that the LEGI shows a flashing red light.
7. If applicable: Perform a tightness check of the patient circuit with the sampling line attached.

21.3.2.2 Leakage Check

1. Connect a new Nomoline sampling line with male luer lock to the ISA LEGI and check that the LEGI shows a steady green light.
2. Connect a short silicon tubing with an inner diameter of 3/32" (2.4 mm) to the Nomoline male luer.
3. Exhale a long breath into the silicon tubing until the CO₂ concentration is greater than 4.5 vol% or 34 mmHg.
4. Quickly connect the silicon tubing tightly to the exhaust port.
5. Wait 1 minute until the CO₂ concentration has stabilized. Note the value.
6. Wait 1 minute and check that the CO₂ concentration has not decreased more than 0.4 vol% or 3 mmHg. If it has decreased more there is a major leakage in the ISA unit or in the Nomoline. Do not operate the ISA if there is a major leakage in the unit.

21.3.2.3 System Setup for Analyzer

If your system is using the plug-in and measure ISA analyzer, please follow the setup instructions below:

1. Connect the ISA analyzer interface cable to the monitor.
2. Connect a Nomoline sampling line to the ISA analyzer input connector.

3. Connect the gas sample exhaust port to a scavenging system or return the gas to the patient circuit.
4. Power up the monitor.
5. A green LED indicates that the ISA analyzer is ready for use.
6. Perform a pre-use check as described in section Perform a pre-use Check.

21.3.2.4 Zeroing

The infrared module needs to establish a zero reference level for the CO₂, N₂O and anesthetic agent gas measurement. This zero calibration is here referred to as "zeroing".

ISA analyzer performs zeroing automatically by switching the gas sampling from the respiratory circuit to ambient air. The automatic zeroing is performed every 8 hours, and takes less than 10 seconds for ISA analyzer.

If the ISA analyzer is fitted with an oxygen sensor, the automatic zeroing will also include room air calibration of the oxygen sensor.

NOTE:

The Auto Zero shall be suppressed for 5 min when physiological/technical alarms related to ISA module are active.

WARNING

Since a successful zeroing requires the presence of ambient air (21% O₂ and 0% CO₂), ensure that the ISA analyzer is placed in a well ventilated place. Avoid breathing near the ISA analyzer before or during the zeroing procedure.

21.3.2.5 Cleaning

The ISA sidestream gas analyzers and Nomoline Adapter can be cleaned using a cloth moistened (not wet) with max 70% ethanol or isopropyl alcohol.

To prevent cleaning liquids and dust from entering the ISA gas analyzer through its LEGI connector, keep the Nomoline Family sampling line connected while cleaning the analyzer.

PRECAUTION

Never immerse the ISA sidestream gas analyzer in liquid.

21.3.2.6 Maintenance

Once every year, or whenever gas readings are questionable, perform a leakage check according to section *Leakage Check* and verify gas readings with a reference instrument or with calibration gas.

WARNING

The Nomoline sampling lines are non-sterile devices. To avoid damage, do not autoclave any parts of the sampling line.

21.3.2.7 Replacement of Consumables

The Nomoline and Nomoline Airway Adapter Set are single-patient use products.

The Nomoline Adapter is a multiple-patient use product.

The T-adapter and Nomo Extension are single-patient use products.

Nomoline Family sampling lines and all consumables mentioned above should be replaced according to good clinical practice or when the sampling line gets occluded. Occlusion occurs when water, secretion etc. is aspirated from the respiratory circuit to such extent that ISA cannot maintain the normal 50 ml/min sample flow. This situation is indicated by a red flashing gas inlet connector and an alarm message; Replace the Nomoline and wait until the gas inlet connector switches to green indicating that the ISA gas analyzer is ready for use.

21.3.3 Monitoring Steps for Masimo IRMA Module

1. Plug the IRMA connector into the IRMA input and switch the power on.
2. Snap the IRMA sensor head on the top of the IRMA airway adapter. It will click into place when properly seated.

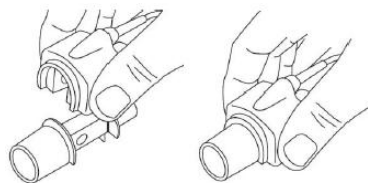

3. A green LED indicates that the IRMA probe is ready for use.
4. Connect IRMA /airway adapter 15mm male connector to the breathing circuit Y-piece.

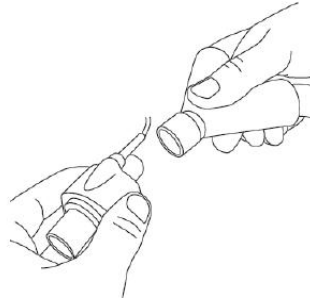

5. Connect the IRMA /airway adapter 15mm female connector to the patient's endotracheal tube.



Alternatively, connect an HME (Heat Moisture Exchanger) between the patient's endotracheal tube and the IRMA probe. Placing an HME in front of the IRMA probe protects the airway adapter from secretions and effects of water vapor and eliminates the need of changing the adapter. It allows free positioning of the IRMA probe as well.

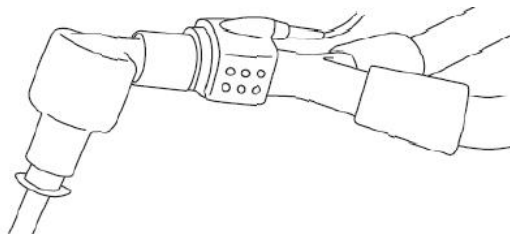

6. Unless the IRMA probe is protected with an HME always position the IRMA probe with the status LED pointing upwards.

Working Status of IRMA Module

The working status of the IRMA module can be transmitted by the IRMA probe. For the detailed information, please refer to the following table.

Indication	Status
Steady green light	System OK
Blinking green light	Zeroing in progress
Steady blue light	Anesthetic agent present
Steady red light	Sensor error

Indication	Status
Blinking red light	Check adapter

Remark: the blue light is applicable to IRMA AX+ only.

21.3.3.1 Placement of IRMA Probe

When connecting IRMA probe to an infant patient circuit, it is important to avoid a direct contact between the IRMA probe and the infant's body. If, for whatever the reason, the IRMA probe is in direct contact with any parts of the infant's body, an insulation material shall be placed between the IRMA probe and the body.

WARNING

The IRMA probe is not intended to be in long term skin contact.

21.3.3.2 Performing a Pre-use Check

Prior to connecting the IRMA airway adapter to the breathing circuit, verify gas readings and waveforms on the monitor before connecting the airway adapter to the patient circuit.

Perform the tightness check of the patient circuit with the IRMA probe snapped on the IRMA airway adapter.

21.3.3.3 Zeroing

WARNING

Incorrect probe zeroing will result in false gas readings.

In order to secure high precision of the IRMA probe measurements the following zeroing recommendations should be followed.

Zeroing is performed by snapping a new IRMA airway adapter onto the IRMA probe, without connecting the airway adapter to the patient circuit, and then using the host instrument to transmit a zero reference command to the IRMA probe.

Special care should be taken to avoid breathing near the airway adapter before or during the zeroing procedure. The presence of ambient air (21% O₂ and 0% CO₂) in the IRMA airway adapter is of crucial importance for a successful zeroing. If a **“Zero Required”** appears directly after a zeroing procedure, the procedure has to be repeated.

Always perform a pre-use check after zeroing the probe.

Zeroing for IRMA AX+ probes:

Zeroing should be performed every time the IRMA airway adapter is replaced, or whenever an offset in gas values or an unspecified gas accuracy message is displayed.

Allow 30 seconds for warm up of the IRMA AX+ probes after power on and after changing the IRMA airway adapter before proceeding with the Zeroing Procedure. The green LED on the probe will be blinking for approximately 5 seconds while zeroing is in progress.

NOTE:

The Auto Zero shall be suppressed for 5 min when physiological/technical alarms related to IRMA module are active.

21.3.3.4 Cleaning

The IRMA probe can be cleaned using a cloth moistened with maximum 70% ethanol or maximum 70% isopropyl alcohol.

Remove the disposable IRMA airway adapter prior to cleaning the IRMA probe.

PRECAUTION

- 1 The IRMA airway adapters are non-sterile devices. Do not autoclave the devices as this will damage them.**
 - 2 Never immerse the IRMA probe in liquid.**
-
-

21.3.3.5 Maintenance

Gas readings should be verified at regular intervals with a reference instrument or by conducting the gas check. The suggested interval is once every year.

21.4 MAC Calculation

NOTE:

When monitoring AG, access the AG Setup menu to determine if Standard or Age-based is displayed.

The minimum alveolar concentration (MAC) value of the agent is a simple navigation aid for anesthetic agent delivery.

Standard MAC values

1 standard MAC is equal to the alveolar anesthetic concentration at one atmosphere (760 mmHg) at which 50 % of all patients no longer respond to noxious stimuli. The

integrated MAC algorithm is based on the MAC values shown in the following table. The values specified in the table apply to a patient age of 40 years and are guiding values only.

	MAC _{standard}
HAL	0.77%
ENF	1.7%
ISO	1.15%
DES	6.0%
SEV	2.1%
N ₂ O	105%

The formula to calculate the MAC value is as follows:

$$\text{MAC} = \frac{\text{EtAA1}}{\text{MAC}_{\text{standard1}}} + \frac{\text{EtAA2}}{\text{MAC}_{\text{standard2}}} + \frac{\text{EtN2O}}{\text{MAC}_{\text{standardN2O}}}$$

EtAA1 is the concentration of the end-tidal main anesthetic gas.

EtAA2 is the concentration of the end-tidal secondary anesthetic gas.

etN₂O is the concentration of the end-tidal N₂O.

MAC_{standard1} is the MAC_{standard} value of the main anesthetic gas.

MAC_{standard2} is the MAC_{standard} value of the secondary anesthetic gas.

MAC_{standardN2O} is the MAC_{standard} value of N₂O.

NOTE:

Age and other factors are not taken into account for standard MAC value calculation.

Age-corrected MAC values

The age-corrected MAC values are calculated using an equation developed by W.W. Mapleson (British Journal of Anaesthesia 1996, pp. 179-185). The equation applies to patients older than 1 year.

$$\text{MAC}_{\text{age corrected}} = \text{standard MAC} \times 10^{(-0.00269 \times (\text{age} - 40))}$$

PRECAUTION

1. **The patient's age is derived from the birth date entered in the Patient Info menu. Incorrect settings can lead to inappropriate MAC values and therefore to inappropriate anesthetic gas delivery. Always set patient age correctly.**
2. **Age-based MAC values only apply if the patient's age is ≥ 1 year. An aged-based MAC of 1 year is used if the patient's age is < 1 year.**

21.5 Hiding the Invalid Display after Zeroing the AG Module

Within 30 s after the zero calibration starts, the monitor displays **Zero Recovering** and invalid AG value. Valid data will reappear 30 seconds after the zero calibration is started. The user can hide the display of **Zero Recovering** and show AG values. To hide the display of **Zero Recovering**, follow these steps:

1. Select **Menu > Maintenance > User Maintain**, and input the password;
2. Select **Other Parameters** and switch off **Zero Recovery**.

NOTE:

AG values displayed within 30 s after the zero calibration is started should be interpreted cautiously.

21.6 Setting No Breath Detected Alarm Time

This determines the time limit after which the monitor gives an alarm if the patient stops breathing.

1. Select the **CO₂** tab > **No Breath Detected**;
2. Choose the No Breath Detected alarm time from the pull-down list.

21.7 AG Setup

Select the AG parameter area or waveform area to enter the **AG** dialog.

- Select the **General Settings** tab to set **Work Mode, Pump Rate, Compensation Setting** and perform zeroing,
- Select the **CO₂** tab > **Waveform Display**, set it to **Curve** or **Filled**.
- Select the **CO₂/O₂/N₂O/AA** tab > **Speed** and select a suitable setting from the pop-up list. The bigger the value is, the wider the waveform will be.
- Select the **CO₂/O₂/N₂O/AA** tab and manually adjust a suitable ruler for **TopRuler** or **BotRuler**.

21.8 O₂ Compensations

The following models need O₂ compensation: IRMA AX+, ISA AX+, G7, G7+, G7S and G7S+. For the compensation details, please refer to the following.

For the Masimo AG modules, the following table is for your reference:

O ₂ Range	Set O ₂ Range
0 to 30 vol%	Low

O ₂ Range	Set O ₂ Range
30 to 70 vol%	Med.
70 to 100 vol%	High

For G7 module, the following items are available in the **General Settings > Compensation Setting** menu: **O₂ Compens.** and **Humidity Compen.** The concentration of compensated gas should be set based on the current gas concentration which is supplied for patient. As for O₂, Make the supplied gas concentration multiply to its volume to get the concentration. For instance, supply 100% O₂, and its volume is 60%, then O₂ compensation is: 100%*60% = 60%. AG concentration is decided by anaesthesia apparatus. For G7 with O₂ module (G7+ and G7S+), the O₂ compensation is automatic; for G7 without O₂ module (G7 and G7S), the O₂ compensation is manual. After settings, confirm the changes to make the settings effective.

21.9 Effects of Humidity*

* Only applicable to the Masimo AG module.

The partial pressure and the volume percentage of CO₂, N₂O, O₂ and anesthetic agents depend on the amount of water vapor in the measured gas. The O₂ measurement will be calibrated to show 20.8 vol% at actual ambient temperature and humidity level, instead of showing actual partial pressure. 20.8 vol% O₂ corresponds to the actual O₂ concentration in room air with 0.7 vol% H₂O concentration (at 1013 hPa this equals for example 25°C and 23% RH). The measurement of CO₂, N₂O, and anesthetic agents (e.g. all gases measured by the IR-bench) will always show the actual partial pressure at the current humidity level.

In the alveoli of the patient, the breathing gas is saturated with water vapor at body temperature (BTPS).

When the breathing gas flows through the sampling line, the gas temperature will adapt to ambient before reaching the gas analyzer. As the NOMO section removes all condensed water, no water will reach the ISA gas analyzer. The relative humidity of the sampled gas will be about 95%.

If CO₂ values at BTPS are required, the following equation can be used:

$$EtCO_2(BTPS) = EtCO_2 * \left(1 - \left(\frac{3.8}{P_{amb}} \right) \right)$$

where:

etCO₂ = etCO₂ value sent from ISA [vol %]

P_{amb} = Ambient pressure sent from ISA [kPa]

3.8 = Typical partial pressure of water vapor condensed between patient circuit and ISA [kPa]

etCO₂ (BTPS) = etCO₂ gas concentration at BTPS [vol%]



O₂ is assumed to be room air calibrated at a humidity level of 0.7 vol% H₂O.

Chapter 22 Freeze

When monitoring a patient, the user may freeze the waveforms so that you can have a close examination of the patient's status. Generally, the user can review a frozen waveform of a maximum of 120 seconds. The freeze function of this monitor has the following features:

- Freeze status can be activated on any operating screen.
- Once entering the Freeze status, the system exits all other operating menus. Besides, the system freezes all waveforms in the Waveform area of the Basic Screen, and also freezes Full Lead ECG waveforms and extra waveforms on the Full Lead ECG interface (if any). Nevertheless the Parameter area refreshes normally.
- The frozen waveforms can be reviewed and recorded.

22.1 Entering/Exiting Freeze Status

Select the shortcut key  to access the freeze status and the popup **Freeze** menu is displayed. In Freeze status, all waveforms are frozen and will no longer be refreshed. Click  to exit the freeze status.

After exiting Freeze status, the system will clear screen waveforms and resume displaying real-time waveforms. In the Screen Refresh mode, the system will sweep the waveforms from left to right in the Waveform Area.

NOTE:

Select the shortcut key  repeatedly over a short period of time may result in discontinuous waveforms on the screen.

22.2 Setting Freeze Duration

By setting the freeze duration, the monitor can exit freeze status automatically after certain period. To set the freeze duration:

1. On the **Freeze** menu, select **Duration**.
2. Select the desired setting from the pop-up list. Permanent/1/2/3/4/5/10/15/20/30/60 min are optional. When **Permanent** is selected, exit freeze status manually based on the actual situation.

22.3 Reviewing Frozen Waveform

By moving the frozen waveform, you may review a waveform of 120 seconds before it is frozen. For a waveform of less than 120 seconds, the remaining part is displayed as a straight line. Select **Time** on the **Freeze** menu and use the left/right arrow keys to move the frozen waves so that you can review the other parts of the frozen waves not displayed on the current screen.

Chapter 23 Review

Users can view the trend data and alarm events through the review interface to understand the development and changes of the patient's condition.

Select the shortcut key  on the main screen to enter the review interface.

23.1 Trend Graph Review

To review the trend graph, select **Menu > Review > Trend Graph**.



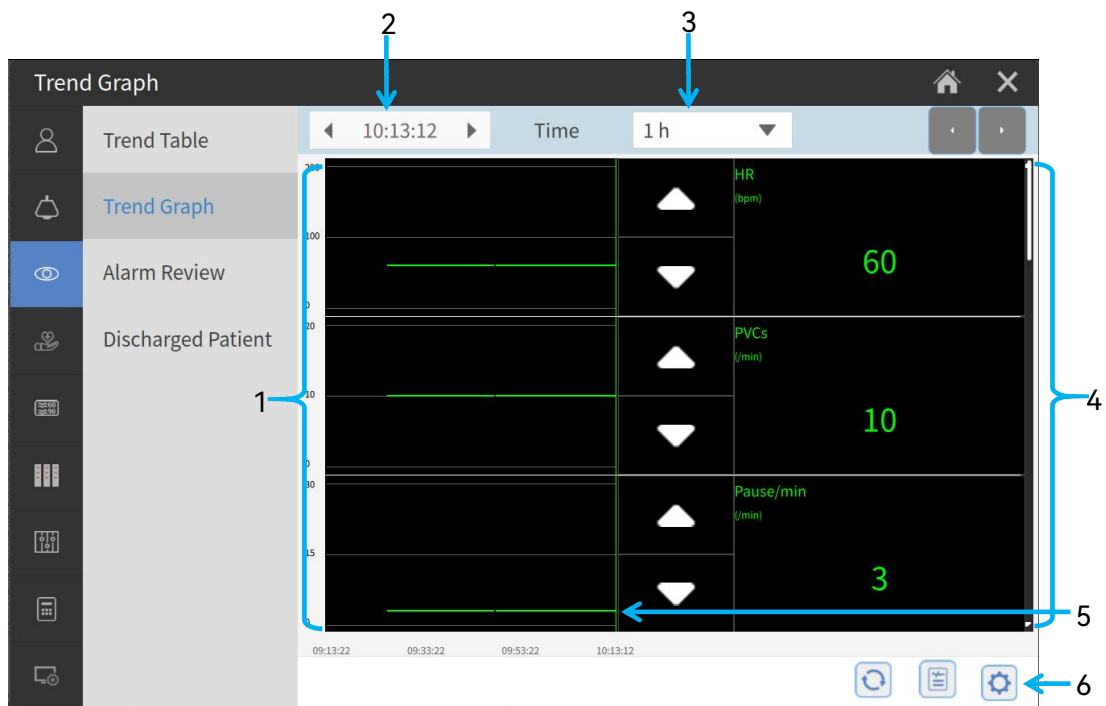



In the trend graph, the y-axis stands for the measurement value and x-axis stands for the time. With the exception of NIBBP, other trends are displayed as continuous curves.



- 1 Trend curve area
- 2 Cursor time
- 3 Time
- 4 Trend data: displays measurement values at the cursor indicated time.
- 5 Cursor
- 6 Functional keys

In the trend graph review window:







- Select  and you can choose the required parameters to be displayed in the trend graph.

- Click  or  to adjust the trend scale.
- Select **Time** to change the length of trend data displayed on the current screen. **6 min, 12 min, 30 min, 1 h, 2 h, 4 h, 6 h, 12 h, 24 h, 36 h** and **48 h** are optional.
- Click different locations to adjust the cursor.
- Click  or  to browse more trends.
- Select  to refresh and obtain the latest data.
- Select  to print out the currently displayed trends through the recorder.

23.2 Trend Table Review

To review the trend table, select **Menu > Review > Trend Table**.

In the trend table review window:

- Select  and you can choose the required parameters to be displayed in the trend table. The parameter selection in the trend table is synchronized with that in the trend graph.
- Select **Interval** to change the interval of the trend data. **1 s, 5 s, 30 s, 1 min, 3 min, 5 min, 10 min, 15 min, 30 min, 60 min, NIBP** and **C.O.** are optional. Select **NIBP** or **C.O.** to view the trend data according to the NIBP or C.O. measurement time.
- Click  or  to view more trends.
- Select  to refresh and obtain the latest data.
- Select  to print out the currently displayed trends through the recorder.
- Select **Data Export** to pop up the trend table data exporting interface after the user authentication.
 - ◆ Set start and end time of trend table review. Click  to refresh the start time to the monitoring start time of the current patient and end time to the current system time.
 - ◆ Select the USB flash disk on which you want to store the data.
 - ◆ Click **Export** to export the trend table data of the current patient. The trend table data is available in CSV format only.

23.3 Alarm Review

The monitor stores events in real time, including physiological alarm events and Arrhythmia events. When an event occurs, all the measurement numerics and the event-related waveforms 4/8/16 seconds before and after the event are stored.

To review the alarm event, select **Menu > Review > Alarm Review**.

In the alarm review window:

- View the alarm events: *** indicates high-level alarm, ** for medium-level alarm and * for low-level alarm.
- Set **Sort** to filter events by alarm level or time.
- View the parameter values and alarm thresholds.
- Click a specific event to view waveforms and parameter values at the event time. Select **Back** to return back to the alarm review list. Select **Alarm Wave** to set the time length to be displayed in the current window.
- Swipe the screen to browse more alarm events.
- Select  to access Alarm Review Setup menu:
 - ◆ Select **Alarm Type** to choose the required parameter to be reviewed.

NOTE:

- 1 **When the alarm system is powered down, the log is maintained. The time of powering down will not be recorded in the system log.**
- 2 **A total loss of power has no impact on the stored log.**
- 3 **As soon as the alarm event storage is full, the earliest alarm event will be replaced by the latest one.**

23.4 Discharged Patients Review

Select **Menu > Review > Discharged Patient** to review the selected patient data.

In the **Discharged Patient** window:

- Select a specific patient from the list. Check the detailed data by selecting **Trend Graph, Trend Table** or **Alarm Review**.
- Click **Effective Date** to sort the patients by time.
- Click  to delete the selected discharged patient data.

Chapter 24 Calculation

The monitor provides calculation function and titration table. Calculations are patient data that are not directly measured but calculated by the monitor.

Select **Menu > Calculation** to enter the calculation interface. The monitor can perform drug calculation, hemodynamic calculation, oxygenation calculation, ventilation calculation and renal function calculation.

NOTE:

The calculation function is independent of other monitoring functions and can therefore be used for patients being monitored by other monitors. Any operation in a calculation dialog does not affect the patient monitored by the current monitor.

PRECAUTION

The calculation results are for reference only and the calculation significance must be determined by the physician.

WARNING

The correctness of the input parameters and the suitability of the calculated results should be carefully verified. The manufacturer is not liable for any consequences arising from input or operation errors.

24.1 Drug Calculation

24.1.1 Calculation Procedures

1. Select **Menu > Calculation > Drug Dose**.
2. Select the right pull-down box of the **Drug** option and select the required drug name among the 15 drugs which are listed as follows. And the drug name of **Drug A, Drug B, Drug C, Drug D** and **Drug E** can be defined by the user. Select the unit of the total amount and dose according to the selected drug.
 - Drug A, Drug B, Drug C, Drug D and Drug E
 - Aminophylline
 - Dobutamine

- Dopamine
 - Epinephrine
 - Heparin
 - Isuprel
 - Lidocaine
 - Nipride
 - Nitroglycerin
 - Pitocin
3. The system generates values that cannot be treated the calculation results. The user must enter the correct parameter value based on the doctor's instruction.
 4. Manually enter the value of patient weight or directly obtain the value from the monitor by selecting **Reset**.
 5. Enter the correct parameter value.
 6. Confirm whether the calculation result is correct.

The following formulas are applied to dose calculation:

Concentration = Amount / Volume

Inf. Rate = Dose / Concentration

Duration = Amount / Dose

Dose= Inf. Rate × Concentration

Dose (weight based) = Inf. Rate × Concentration / Weight

Drip Rate (GTT/min) = Inf. Rate (ml/hr) / 60 × Drop Factor (GTT/ml)

24.1.2 Calculation Unit

Each drug has the fixed unit or unit series to calculate. Among the same unit series, the unit binary varies with the entered parameter value.

The calculation units of the drugs are listed as follows:

Drug	Unit
Drug A, Drug B, Drug C, Aminophylline, Dobutamine, Dopamine, Epinephrine, Isuprel, Lidocaine, Nipride, Nitroglycerin	mg, mcg
Drug D, Pitocin, Heparin	Ku, Unit
Drug E	meq

When defining a drug, select Drug A, Drug B, Drug C, Drug D, and Drug E based on the unit series.

NOTE:

Drip Rate and Drop Factor are unavailable in the neonatal mode.

24.1.3 Titration Table

After completing the drug calculation, the user can open the **Titration** on the **Drug Dose** interface.

The user can change the following items in the titration table:

- Basic
- Step

The data in the titration table will vary with the changes above. And the user can swipe the screen to observe more data.

24.2 Hemodynamic Calculation

24.2.1 Calculation Procedure

1. Select **Menu > Calculation > Hemodynamics**.
2. Manually enter the values required on this interface. You can also directly obtain the values of HR, patient height and patient weight, if they are available from the monitor by selecting **Reset**.
3. Select **Calculate** to output parameter value.

24.2.2 Input Parameters

Items	Unit	English Full Name/Description
PAWP	mmHg	Pulmonary artery wedge pressure
CVP	mmHg	Central venous pressure
C.O.	L/min	Cardiac output
HR	bpm	Heart rate
EDV	ml	End-diastolic volume
AP MAP	mmHg	Mean Artery Pressure
PA MAP	mmHg	Pulmonary artery mean pressure

Items	Unit	English Full Name/Description
Height	cm	/
Weight	kg	/

24.2.3 Output Parameters

Items	Unit	English Full Name/Description	Formula
CI	L/min/m ²	Cardiac index	$CI (L/min/m^2) = C.O. (L/min)/BSA (m^2)$
BSA	m ²	Body surface area	$BSA (m^2) = Weight^{0.425} (kg) \times Height^{0.725} (cm) \times 0.007184$
SV	ml	Stroke volume	$SV (ml) = C.O. (L/min)/HR (bpm) \times 1000$
SVI	ml/m ²	Stroke volume index	$SVI (ml/m^2) = SV (ml)/BSA (m^2)$
SVR	DS/cm ⁵	Systemic vascular resistance	$SVR (DS/cm^5) = 80 \times [AP \text{ MAP} (mmHg) - CVP (mmHg)]/C.O. (L/min)$
SVRI	DS·m ² /cm ⁵	Systemic vascular resistance index	$SVRI (DS \cdot m^2/cm^5) = SVR (DS/cm^5) \times BSA (m^2)$
PVR	DS/cm ⁵	Pulmonary vascular resistance	$PVR (DS/cm^5) = 80 \times [PA \text{ MAP} (mmHg) - PAWP (mmHg)]/C.O. (L/min)$
PVRI	DS·m ² /cm ⁵	Pulmonary vascular resistance index	$PVRI (DS \cdot m^2/cm^5) = PVR (DS/cm^5) \times BSA (m^2)$
LCW	kg·m	Left cardiac work	$LCW (kg \cdot m) = 0.0136 \times [AP \text{ MAP} (mmHg) - PAWP (mmHg)] \times C.O. (L/min)$
LCWI	kg·m/m ²	Left cardiac work index	$LCWI (kg \cdot m/m^2) = LCW (kg \cdot m)/BSA (m^2)$
RCW	kg·m	Right cardiac work	$RCW (kg \cdot m) = 0.0136 \times [PA \text{ MAP} (mmHg) - CVP (mmHg)] \times C.O. (L/min)$
RCWI	kg·m/m ²	Right cardiac work index	$RCWI (kg \cdot m/m^2) = RCW (kg \cdot m)/BSA (m^2)$

Items	Unit	English Full Name/Description	Formula
LVSW	g · m	Left ventricular stroke work	$LVSW (g \cdot m) = 0.0136 \times [AP \text{ MAP (mmHg)} - PAWP \text{ (mmHg)}] \times SV \text{ (ml)}$
LVSWI	g · m/m ²	Left ventricular stroke work index	$LVSWI (g \cdot m/m^2) = LVSW (g \cdot m)/BSA (m^2)$
RVSW	g · m	Right ventricular stroke work	$RVSW (g \cdot m) = 0.0136 \times [PA \text{ MAP (mmHg)} - CVP \text{ (mmHg)}] \times SV \text{ (ml)}$
RVSWI	g · m/m ²	Right ventricular stroke work index	$RVSWI (g \cdot m/m^2) = RVSW (g \cdot m)/BSA (m^2)$
EF	%	Ejection fraction	$EF (\%) = SV \text{ (ml)}/EDV \text{ (ml)} \times 100$

24.3 Oxygenation Calculation

24.3.1 Calculation Procedure

1. Select **Menu > Calculation > Oxygenation**.
2. Manually enter the values required on this interface. You can also directly obtain the values of patient height and patient weight if they are available from the monitor by selecting **Reset**.
3. Select **Calculate** to output parameter value.

24.3.2 Input Parameters

Items	Unit	English Full Name/Description
FiO ₂	%	Percentage fraction of inspired oxygen
PaO ₂	mmHg	Partial pressure of oxygen in the arteries
PaCO ₂	mmHg	Partial pressure of carbon dioxide in the arteries
SaO ₂	%	Arterial oxygen saturation
PvO ₂	mmHg	Partial pressure of oxygen in venous blood
SvO ₂	%	Venous oxygen saturation
Hb	g/L	Hemoglobin
RQ	/	Respiratory quotient
ATMP	mmHg	Atmospheric pressure

Items	Unit	English Full Name/Description
C.O.	L/min	Cardiac output
Height	cm	/
Weight	kg	/

24.3.3 Output Parameters

Items	Unit	English Full Name/Description	Formula
BSA	m ²	Body surface area	$BSA (m^2) = Weight^{0.425} (kg) \times Height^{0.725} (cm) \times 0.007184$
VO ₂	ml/min	Oxygen consumption	$VO_2 (ml/min) = Ca-vO_2 (ml/L) \times C.O. (L/min)$
Ca-vO ₂	ml/L	Arteriovenous oxygen content difference	$Ca-vO_2 (ml/L) = CaO_2 (ml/L) - CvO_2 (ml/L)$
O ₂ ER	%	Oxygen extraction ratio	$O_2ER (\%) = VO_2 (ml/min)/DO_2 (ml/min) \times 100$
DO ₂	ml/min	Oxygen transport	$DO_2 (ml/min) = CaO_2 (ml/L) \times C.O. (L/min)$
PAO ₂	mmHg	Partial pressure of oxygen in the alveoli	$PAO_2 (mmHg) = [ATMP (mmHg) - 47 mmHg] \times FiO_2 (\%)/100 - PaCO_2 (mmHg) \times [FiO_2 (\%)/100 + (1 - FiO_2 (\%)/100)/RQ]$
AaDO ₂	mmHg	Alveolar-arterial oxygen difference	$AaDO_2 (mmHg) = PAO_2 (mmHg) - PaO_2 (mmHg)$
CcO ₂	ml/L	Capillary oxygen content	$CcO_2 (ml/L) = Hb (g/L) \times 1.34 + 0.031 \times PAO_2 (mmHg)$
Qs/Qt	%	Venous admixture	$Qs/Qt (\%) = [CcO_2 (ml/L) - CaO_2 (ml/L)]/[CcO_2 (ml/L) - CvO_2 (ml/L)] \times 100$
AaDO ₂ /PaO ₂	/	AaDO ₂ /PaO ₂	$AaDO_2/PaO_2 = [PAO_2 (mmHg) - PaO_2 (mmHg)]/PaO_2 (mmHg)$
DO ₂ l	ml/min/m ²	Oxygen delivery index	$DO_2l (ml/min/m^2) = DO_2 (ml/min)/BSA (m^2)$
VO ₂ l	ml/min/m ²	Oxygen consumption index	$VO_2l (ml/min/m^2) = VO_2 (ml/min)/BSA (m^2)$

Items	Unit	English Full Name/Description	Formula
CaO ₂	ml/L	Arterial oxygen content	$CaO_2 \text{ (ml/L)} = 100 \times 1.34 \times Hb \text{ (g/L)} \times SaO_2 \text{ (\%)/100} + 0.031 \times PaO_2 \text{ (mmHg)}$
CvO ₂	ml/L	Venous oxygen content	$CvO_2 \text{ (ml/L)} = 100 \times 1.34 \times Hb \text{ (g/L)} \times SvO_2 \text{ (\%)/100} + 0.031 \times PvO_2 \text{ (mmHg)}$

24.4 Ventilation Calculation

24.4.1 Calculation Procedure

1. Select **Menu > Calculation > Ventilation**.
2. Manually enter the values required on this interface. You can also directly obtain the available values from the monitor by selecting **Reset**.
3. Select **Calculate** to output parameter value.

24.4.2 Input Parameters

Items	Unit	English Full Name/Description
FiO ₂	%	Percentage fraction of inspired oxygen
RR	rpm	Respiration rate
VT	ml	Tidal volume
PaCO ₂	mmHg	Partial pressure of carbon dioxide in the arteries
PaO ₂	mmHg	Partial pressure of oxygen in the arteries
RQ	/	Respiratory quotient
PeCO ₂	mmHg	Partial pressure of mixed expiratory CO ₂
ATMP	mmHg	Atmospheric pressure

24.4.3 Output Parameters

Items	Unit	English Full Name/Description	Formula
PAO ₂	mmHg	Partial pressure of oxygen in the alveoli	$PAO_2 \text{ (mmHg)} = [ATMP \text{ (mmHg)} - 47 \text{ mmHg}] \times FiO_2 \text{ (\%)/100} - PaCO_2 \text{ (mmHg)} \times [FiO_2 \text{ (\%)/100} + (1 - FiO_2 \text{ (\%)/100})/RQ]$

Items	Unit	English Full Name/Description	Formula
AaDO ₂	mmHg	Alveolar-arterial oxygen difference	$AaDO_2 \text{ (mmHg)} = PAO_2 \text{ (mmHg)} - PaO_2 \text{ (mmHg)}$
AaDO ₂ /PaO ₂	/	AaDO ₂ /PaO ₂	$AaDO_2/PaO_2 = [PAO_2 \text{ (mmHg)} - PaO_2 \text{ (mmHg)}]/PaO_2 \text{ (mmHg)}$
MV	L/min	Minute volume	$MV \text{ (L/min)} = VT \text{ (ml)} \times RR \text{ (rpm)}/1000$
VD	ml	Volume of physiological dead space	$VD \text{ (ml)} = [(PaCO_2 \text{ (mmHg)} - PeCO_2 \text{ (mmHg)}) \times VT \text{ (ml)}]/PaCO_2 \text{ (mmHg)}$
VD/VT	%	Physiological dead space in percent of tidal volume	$VD/VT \text{ (%) } = [(PaCO_2 \text{ (mmHg)} - PeCO_2 \text{ (mmHg)})/PaCO_2 \text{ (mmHg)}] \times 100$
VA	L/min	Alveolar volume	$VA \text{ (L/min)} = [VT \text{ (ml)} - VD \text{ (ml)}] \times RR \text{ (rpm)}/1000$

24.5 Renal Function Calculation

24.5.1 Calculation Procedure

1. Select **Menu > Calculation > Renal Function**.
2. Manually enter the values required on this interface.
3. Select **Calculate** to output parameter value.

24.5.2 Input Parameters

Items	Unit	English Full Name/Description
URK	mmol/L	Urine potassium
URNa	mmol/L	Urinary sodium
Urine	ml/24h	Urine
Posm	mOsm/kgH ₂ O	Plasm osmolality
Uosm	mOsm/kgH ₂ O	Urine osmolality
SerNa	mmol/L	Serum sodium
SCr	umol/L	Serum creatinine
UCr	umol/L	Urine creatinine
BUN	mmol/L	Blood urea nitrogen
UUN	mmol/L	Urine urea nitrogen

24.5.3 Output Parameters

Items	Unit	English Full Name/Description	Formula
URNaEx	mmol/24h	Urine sodium excretion	$URNaEx \text{ (mmol/24h)} = URNa \text{ (mmol/L)} \times \text{Urine (ml/24h)}/1000$
URKEx	mmol/24h	Urine potassium excretion	$URKEx \text{ (mmol/24h)} = URK \text{ (mmol/L)} \times \text{Urine (ml/24h)}/1000$
Na/K	%	Sodium potassium ratio	$Na/K \text{ (%) = URNa (mmol/L)}/URK \text{ (mmol/L)} \times 100$
CNa	ml/24h	Clearance of sodium	$CNa \text{ (ml/24h)} = URNa \text{ (mmol/L)} \times \text{Urine (ml/24h)}/SerNa \text{ (mmol/L)}$
CCr	ml/min	Creatinine clearance rate	$CCr \text{ (ml/min)} = UCr \text{ (}\mu\text{mol/L)} \times \text{Urine (ml/24h)}/[SCr \text{ (}\mu\text{mol/L)} \times 24 \times 60]$
CUUN	ml/min	Urine urea nitrogen clearance rate	$CUUN \text{ (ml/min)} = UUN \text{ (mmol/L)} \times \text{Urine (ml/24h)}/[BUN \text{ (mmol/L)} \times 24 \times 60]$
FENa	%	Fractional excretion of sodium	$FENa \text{ (%) = } [URNa \text{ (mmol/L)} \times SCr \text{ (}\mu\text{mol/L)}]/[UCr \text{ (}\mu\text{mol/L)} \times SerNa \text{ (mmol/L)}] \times 100$
FEUr	%	Fractional Excretion of Urea	$FEUr \text{ (%) = } [SCr \text{ (}\mu\text{mol/L)} \times UUN \text{ (mmol/L)}]/[UCr \text{ (}\mu\text{mol/L)} \times BUN \text{ (mmol/L)}] \times 100$
Cosm	ml/min	Osmolar clearance	$Cosm \text{ (ml/min)} = [Uosm \text{ (mOsm/kgH}_2\text{O)} \times \text{Urine (ml/24h)}]/[Posm \text{ (mOsm/kgH}_2\text{O)} \times 24 \times 60]$
CH ₂ O	ml/24h	Free water clearance	$CH_2O \text{ (ml/24h)} = \text{Urine (ml/24h)} - Uosm \text{ (mOsm/kgH}_2\text{O)} \times \text{Urine (ml/24h)}/Posm \text{ (mOsm/kgH}_2\text{O)}$
U/P osm	/	Urine to plasma osmolality ratio	$U/P \text{ osm} = Uosm \text{ (mOsm/kgH}_2\text{O)}/Posm \text{ (mOsm/kgH}_2\text{O)}$
BUN/SCr	/	Blood urea nitrogen creatinine ratio	$BUN/SCr = [BUN \text{ (mmol/L)}/SCr \text{ (}\mu\text{mol/L)}] \times 1000$
U/SCr	/	Urine-serum creatinine ratio	$U/SCr = UCr \text{ (}\mu\text{mol/L)}/SCr \text{ (}\mu\text{mol/L)}$

Chapter 25 Clinical Assistive Applications (CAA)

25.1 Early Warning Score

User can use early warning score system to get an early warning score based on measurement value or input value of each vital sign. Depending on the score calculated, appropriate recommendations are displayed.

Early warning score system includes MEWS (Modified Early Warning Score), NEWS (National Early Warning Score), NEWS2 (National Early Warning Score 2), and PEWS (Pediatric Early Warning Score). Click **Menu** > **System** > **User Maintain** > **Other Setups** > **Score** to select the desired score system. Only one score system can be selected and the default score system is MEWS.

MEWS, NEWS and NEWS2 are intended for adult patients only. PEWS is intended for pediatric patients only.

NOTE:

The score results are for reference only and the score significance must be determined by the physician.

25.1.1 Accessing/Exiting Score Interface

Access the score interface in any of the following ways:

- Click **Score** shortcut key ;
- Select **Menu** > **CAA** > **Score**.

To exit the interface: Click  button on the top right of the interface.

25.1.2 Performing Warning Score

To perform warning score, follow these steps:

Manual scoring: Select **Reset** to clear the previous score and re-obtain the data from the monitor. Manually input the other parameter values. Click **Start** to perform scoring.

For NEWS2, set the **SpO₂ Scale** in NEWS2 interface:

- ◆ **Scale 1:** for patients without hypercapnic respiratory failure.
- ◆ **Scale 2:** for patients with a prescribed oxygen saturation requirement of 88–92%, for instance, COPD (Chronic Obstructive Pulmonary Disease) patients.

NOTE:

If any of above information is missing, the monitor will inform the user that the parameter input is incomplete, unable to score.

25.1.3 Warning Score Trend

Trend table provides the monitored patient's scores during a period of time; it includes score time, score parameters and score. Click **Trend Table** or **Trend Graph** button in Warning Score interface to review the trend. Earlier trends will be replaced by later ones if the storage capacity is reached.

25.2 Glasgow Coma Scale (GCS)

Select **Menu > CAA > Score > GCS** to enter the GCS score interface. GCS is used for coma patients with various causes and objectively reflects patient's level of consciousness. GCS scores include eye opening reaction, speech reaction and motor reaction. Three aspects of behavior are independently measured: eye opening, verbal response, and motor response. The addition of the three scores is the coma scale.

GCS is intended for adults and pediatric patients.



PRECAUTION

GCS is for reference only. It must be used in conjunction with clinical signs and symptoms of the patient.

To perform GCS scoring, follow these steps:

1. Respectively select an appropriate item that represents the patient's status for eye opening, verbal response, and motor response.
2. Click **Start** to perform scoring. Click **Reset** to clear the previous score and time. Click **Trend Table** or **Trend Graph** button in Warning Score interface to review the trend.



25.3 24h NIBP Summary

24h NIBP summary provides NIBP statistics of the current patient over the time scale. It allows the user to know the patient's condition over the last 24 hours. Select the shortcut key  on the main screen, or select **Menu > CAA > NIBP Summary** to enter the interface. Select  to refresh and obtain the latest data.

24h NIBP summary interface provides the following information:

- ◆ NIBP data throughout the whole day/daytime/nighttime (average SYS/DIA/MAP, maximum SYS/DIA/MAP, minimum SYS/DIA/MAP, and measurement time).
- ◆ The percentage of SYS and DIA within the normal range, below the normal range, and above the normal range throughout the whole day.
- ◆ The night time duration. The night time can be set according to 24 hours format or 12 hours format. The minimum period can be set to 30 minutes. The default start time of night time is 20:00 (PM) and the default end time of night time is 06:00 (AM).

25.4 24h ECG Summary

24h ECG summary provides ECG statistics of the current patient within the last 24 hours. Select the shortcut key  on the main screen, or select **Menu > CAA > ECG Summary** to enter the interface. Select  to refresh and obtain the latest data.

24h ECG summary interface provides the following information:

- HR statistics
- QT/QTc measurement statistics
- Maximum and minimum ST corresponding to each lead
- Arrhythmia event statistics

NOTE:

1. **The 24h ECG Summary is intended for the current patient, not for discharged patients.**
2. **Patient data is saved, collected and displayed together in the 24h ECG Summary, which is not recalculated.**

25.5 HRV Analysis

HRV (Heart Rate Variability) analysis provides a variation in the successive heartbeat cycle differences of the current patient. Select **Menu > CAA > HRV** to enter the interface.

In **HRV** analysis interface:

- Set **Analysis Duration**. 24 hours and 5 minutes are optional. The default setting is 24 hours.
- View the HRV analysis result:

- ◆ RR interval histogram.
- ◆ Time-domain analysis parameters: SDNN, RMSSD, SDDSD, NN50, PNN50 and HRVt.

25.6 CCHD Screening

If configured, the monitor provides CCHD screening function when the patient type is neonate. CCHD screening is performed by measuring the SpO₂ values in the right hand and any foot of the neonate, as well as comparing the differences in SpO₂ values (Δ SpO₂).

A working group consisting of selected members of the Secretary's Advisory Committee on Heritable Disorders in Newborns and Children (SACHDNC), the American Academy of Pediatrics (AAP), the American College of Cardiology Foundation (ACCF) and the American Heart Association (AHA) recommended screening for critical congenital heart disease (CCHD) within 24 hours to 48 hours after birth, and less than 24 hours after birth but requiring early discharge should be screened as soon as possible before discharge.

25.6.1 CCHD Screening Process

CCHD screening process of the monitor comes from the neonatal screening process recommended by the working group. The flow chart is as follows:

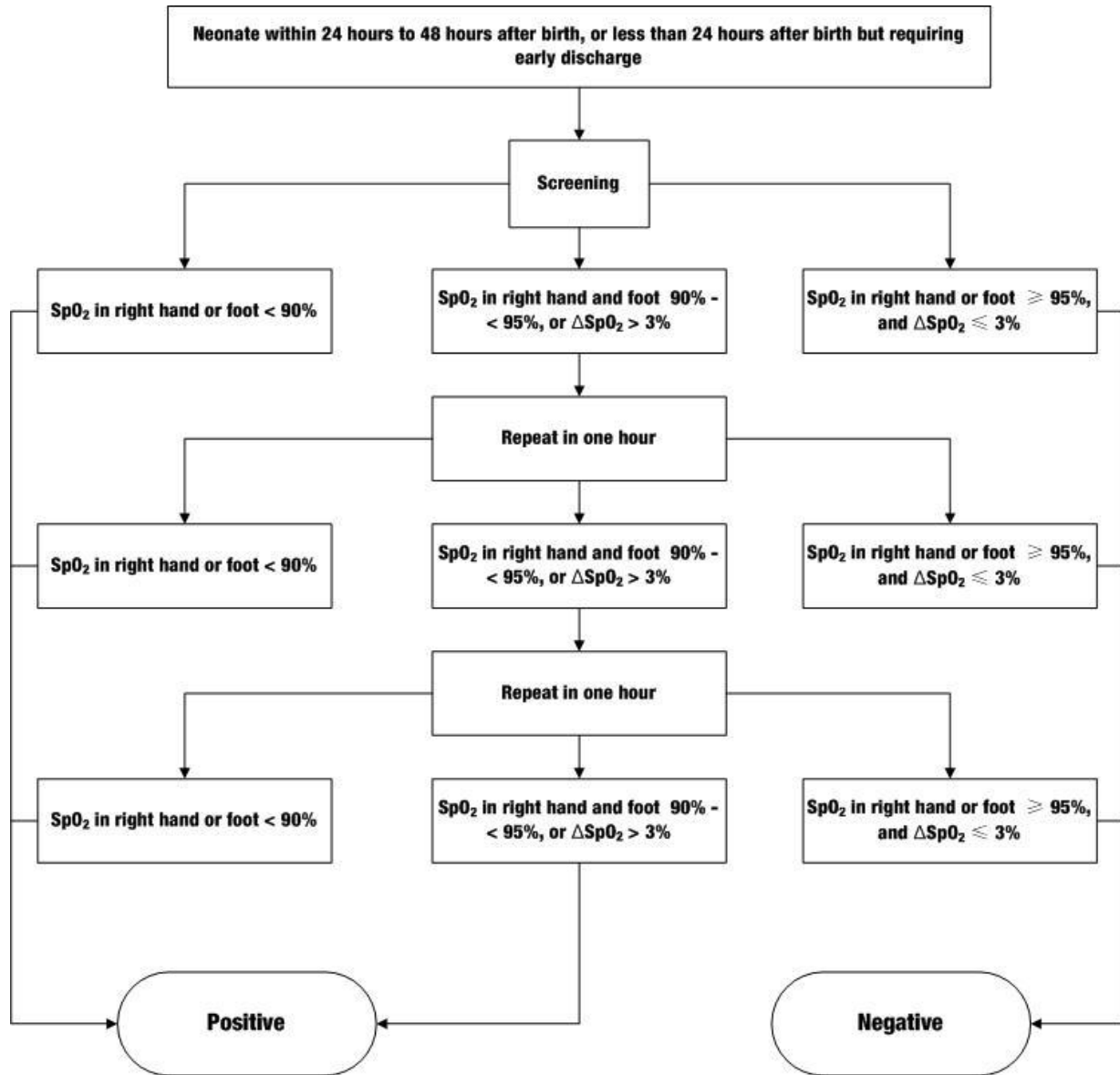

25.6.2 Accessing CCHD Screening Interface

Access the CCHD screening interface in any of the following ways:

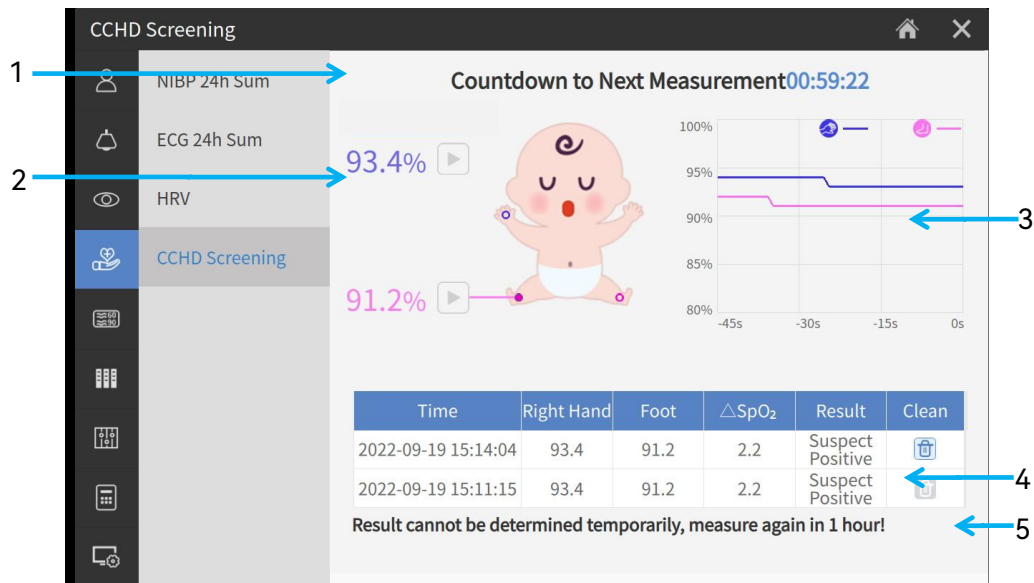

- Select the shortcut key  on the main screen;
- Select **Menu > CAA > CCHD Screening**.





- 1 Prompt information area
- 2 Parameter measurement area: Click measurement startup key  to measure SpO₂.
- 3 Trend area
- 4 Measurement result area
- 5 Screening conclusion area

25.6.3 Performing CCHD Screening

CCHD screening was completed by measuring SpO₂ in the right hand and any foot of the neonate.

1. For single-channel SpO₂: After entering the CCHD screening interface, select the hand as the first measurement site and click the measurement key  to complete the first set of SpO₂ measurement; select any foot and click the measurement key  to complete the second set of SpO₂ measurement. The screening results are displayed after the second set of SpO₂ measurement is completed.
2. For two-channel SpO₂: After entering the CCHD screening interface, click the measurement key . The screening results are displayed after the SpO₂ measurement is completed.
 - ◆ **Negative:** Screening ended.
 - ◆ **Positive:** CCHD screening is not passed. Echocardiography is recommended.
 - ◆ **The result cannot be determined temporarily, please measure again in 1 hour!:** It is unable to determine whether the screening results are negative or

positive. The monitor starts the countdown and the user needs to wait an hour before remeasuring. Alternatively, the user can click  or  to cancel the countdown and restart the measurement.

After starting the CCHD screening function, the system will provide 45 seconds of SpO₂ parameter values in the trend area.

When in doubt about the current screening results, re-perform the CCHD screening:

1. Click the  button to delete the current set of measurement data and screening results in the list of measurement results.
2. Repeat the measurement steps.

NOTE:

- 1 The measurement history results cannot be deleted.**
- 2 The monitor can store up to 20 sets of measurements. When exceeding 20 sets, the system deletes the earliest measured data.**

Chapter 26 Recording

A thermal dot matrix recorder is used for the monitor and can support many recording types and output patient information, measurement data, review data waveform and so forth.



1	Recording indicator. On: the recorder works correctly
2	Paper feeding key: press this key to start or stop feeding recording paper without outputting anything on the paper
3	Paper outlet
4	Recorder door

NOTE:

If the blank recording paper is insufficient after recording is stopped, the user can press the paper feeding key on the recorder to feed more paper.

26.1 Performance of the Recorder







- Waveform record is printed at the rate of 12.5 mm/s, 25 mm/s or 50 mm/s.
- 48 mm record width and 50 mm record paper width.
- It can record up to three waveforms.
- User-selectable real-time recording time and waveform.
- Auto recording interval is set by the user, and the waveform is in accordance with the real time recording.



NOTE:

It is suggested that the user should not use the recorder when the low battery displays, or the monitor may be turned off automatically.

26.2 Starting and Stopping Recording

The monitor provides several types of stripe recording. You can start recording following the procedure below:

Recording Type	Description/ Procedure
Continual recording real-time	Select at least one Rec waveform in Report Setup (A maximum of three waveforms can be selected), select Continual in Recording Duration . Select shortcut key  to start the recording. Press the button again to stop recording.
8-second recording/20-second real-time recording real-time	Select at least one Rec waveform in Report Setup (A maximum of three waveforms can be selected), select 8 s or 20 s in Recording Duration , set Record Interval as needed, select shortcut key  to start the recording. Select shortcut key  again to stop recording or when recording duration ends, the monitor stops recording automatically. The runtime for each wave is 8 seconds or 20 seconds. The record Interval can be set as: Off, 10 min, 20 min, 30 min, 40 min, 50 min, 1 h, 2 h, 3 h, 4 h . The default recording time is 8 s .
Trend graph recording	Select Menu > Review > Trend Graph , click  to start recording.
Trend table recording	Select Menu > Review > Trend Table , click  to start recording.
C.O. recording measurement	Select C.O. Option > C.O. Measure , click  to start recording.

Recording Type	Description/ Procedure
NIBP trigger recording	The monitor triggers recording at the completion of NIBP measurement.
ST VIEW recording	In the ST VIEW window, click  to start recording.
QT VIEW recording	In the QT VIEW window, click  to start recording.

To manually stop recording, click  again in the related windows.

The recorder will stop recording in the following situations:

- The recording task is finished.
- No paper in the recorder.
- Malfunction stops the recorder from running properly.
- The monitor enters into standby mode.

NOTE:

You can also select shortcut key  to manually start or stop recording.

26.3 Parameter Alarm Trigger Recording

Select **Menu > Alarm > Alarm Setup** and set **Alarm Rec. Time**.

When the physiological alarm occurs and the alarm recording function is turned on, the monitor automatically records the output. The output waveform is the waveform of N/2 seconds before and after the alarm time. N is the preset waveform length of alarm recording. 8 seconds, 16 seconds and 32 seconds are optional. The default setting is 8 seconds.

26.4 Recorder Operations and Status Messages

26.4.1 Record Paper Requirement

Only standard thermosensitive record paper can be used: otherwise the recorder may not function, the recording quality may be poor, and the thermosensitive print head may be damaged.

26.4.2 Proper Operation

- When the recorder is working, the record paper goes out steadily. Do not pull the paper outward with force: otherwise the recorder may be damaged.

- Do not operate the recorder without record paper.

26.4.3 Paper Out

When the **Recorder Out Of Paper** alarm is displayed, the recorder cannot start. Please insert record paper properly.

26.4.4 Replacing Paper

1. Pull outwards the upper arc part of the recorder door to release the casing, shown in the following figure.



2. Insert a new roll of paper into the paper cassette, printing side facing upwards.
3. Ensure proper position and tidy margin.
4. Pull some paper out from the top of the roller, and close the recorder door.

NOTE:

Be careful when inserting papers. Avoid damaging the thermo-sensitive print head. Unless when inserting papers or shooting troubles, do not leave the recorder door open.

26.4.5 Removing Paper Jam

When the recorder functions or sounds improperly, you should open the recorder casing to check for a paper jam. Remove the paper jam in the following way:

1. Open the recorder door as shown above.
2. Cut the record paper from the feeding edge.
3. Reload the paper and close the recorder door.

NOTE:

- 1 **If the monitor is not configured with the recorder function, it will indicate Recorder Setup Needed after the Record button is pressed.**
- 2 **Do not touch the thermo-sensitive print head when performing continuous recording.**

Chapter 27 Other Functions

27.1 Nurse Call

The monitor provides a dedicated nurse call port to output a nurse call signal when a user-defined alarm occurs. To establish communication between the nurse call system and the monitor, use the dedicated nurse call cable to connect the hospital's nurse call system to the monitor's nurse call port.

Alarms are sent to the nurse call system given the following conditions are met:

- The nurse call system is enabled.
- A user-defined alarm occurs.
- Alarms are not paused or reset.

The nurse call function can be set through the following steps:

1. Select **Menu > System > User Maintain**, input the password.
2. Select **Other Setups** and enable **Nurse Call**.
3. Select **Signal Type**:
 - ◆ **Continuous**: the nurse call signal lasts until the alarm ends, which means the duration of a nurse call signal is equal to that of the alarm condition.
 - ◆ **Pulse**: the nurse call signal is a pulse signal, and the duration of each pulse is user-defined. When multiple alarms occur simultaneously, only one pulse signal is produced. If an alarm occurs but the previous one is not cleared, a new pulse signal will also be produced. Set **Pulse Width** to 1 s, 2 s, or 3 s, as desired.
4. Select **Contact Type** to set the work mode of the nurse call relay.
5. Select **Alarm Level** to set the priority of alarms sent to the nurse call system.
6. Select **Alarm Type** to set the type of alarms sent to the nurse call system.

NOTE:

1. **Before using nurse call function, please ensure its proper operation.**
2. **If you need to connect the monitor to the nurse call system, a dedicated nurse call cable is required. For more information, contact the service personnel for assistance.**
3. **Do not rely exclusively on the nurse call system for alarm notifications. Remember that the most reliable alarm notification combines audible and visual alarm indications with the patient's clinical condition.**

27.2 Analog Output and Defibrillator Synchronization

The monitor provides analog output signals to accessory equipment. Also, if a defibrillator is connected to the monitor, a defibrillator synchronization pulse can be output. You should activate the function following the steps below:

1. Select **Menu > System > User Maintain**, and input the password;
2. Select **Other Setups > Auxiliary Function**;
3. Choose **Analog Output, Defibrillation** or **Off**.

Chapter 28 Using Battery

This monitor can run on battery power, which ensures its uninterrupted operation even when AC power supply is interrupted. The battery recharges whenever the monitor is connected to the AC power source. During monitoring, if the AC power is interrupted, the monitor will take power from the internal battery. If the monitor is powered by battery, the monitor will switch off automatically before the battery is completely depleted.

28.1 Battery Safety Information

WARNING

- 1 Before using the rechargeable lithium-ion battery (hereinafter called lithium battery), be sure to read the user manual and safety precautions thoroughly.**
 - 2 The lithium battery can only be used for this device.**
 - 3 The lithium battery can only be charged in this device.**
 - 4 Do not reverse the lithium battery polarity.**
 - 5 Do not connect the positive (+) and negative (-) terminals with metal objects such as lead wire, which can result in short circuits.**
 - 6 The cycle life of the lithium battery is 300 charge. The service life of the lithium battery may shorten if it is used inappropriately. It is recommended to replace the lithium battery after 300 charge-discharge cycles, or it may cause safety risks such as heat and liquid leakage, and risks such as failure or decline of performance.**
 - 7 Do not heat or throw the lithium battery into a fire.**
 - 8 Do not immerse, throw, or wet the lithium battery in water, beverages or other liquids.**
 - 9 Do not use or leave lithium battery at high temperature (charging >45 °C, discharging >60 °C, such as in direct sunlight or in a very hot car), otherwise it may cause overheat, fire, malfunction to the lithium battery, shorten the service life of the lithium battery, or damage the lithium battery.**
 - 10 Do not place the lithium battery near microwave equipment or other cooking devices. If the lithium battery is heated or subjected to strong electromagnetic radiation, liquid leakage, heat, smoke, fire, etc. may occur.**
 - 11 Do not hit with a hammer, step on, throw or drop to cause strong shock.**
 - 12 Do not weld the lithium battery directly.**
-
-

WARNING









- 13 Do not use a lithium battery of other specifications.**
 - 14 Do not use a lithium battery with serious scratch or deformation.**
 - 15 Keep lithium batteries out of the reach of children.**
 - 16 Power off the device, remove and stop using the battery if abnormal heat, odor, discoloration, deformation or abnormal condition is detected during use, charge, or storage, or it may cause safety accidents such as heat, smoke, and fire.**
 - 17 Do not touch a leaking lithium battery. If the liquid leaked from the lithium battery gets into eyes, do not rub the eyes. Wash them well with clean water and see a doctor immediately.**
 - 18 When the device is running on lithium battery power, do not replace the lithium battery during operation of the device.**
 - 19 High internal temperature may also cause the lithium battery unable to be charged. Keep the device at room temperature and move it away from heat sources or out of direct sunlight. The lithium battery will resume charging when the temperature is within range again.**
 - 20 Lithium batteries should be charged, used and stored in places far away from static electricity.**
 - 21 Lithium batteries are hazardous waste. Do NOT dispose them together with house-hold garbage. At the end of their life hand the batteries over to the applicable collection points for the recycling of waste batteries. For more detailed information about recycling of this product or lithium batteries, please contact your local Civic Office, or the shop where you purchased the product.**
-
-

28.2 Battery Power Indicator

The indicator labeled Battery on the front panel of the monitor illuminates in green when the monitor is battery powered and illuminates in yellow when battery is being charged. The indicator is not illuminated when the monitor is not powered or when AC power is applied.

28.3 Battery Status on the Main Screen

Battery status symbols show the status of each battery detected and the combined battery power remaining.

	Remaining battery power: 76%~100%.
	Remaining battery power: 51%~75%
	Remaining battery power: 26%~50%
	Remaining battery power: 2%~25%
	Batteries are almost depleted (0~2%) and need to recharge immediately.
	Batteries are depleted.
	Batteries are in charging.
	No battery is installed.
	Battery malfunction

28.4 Charging the Battery

To charge the battery, please follow the procedure:

1. Load the battery into the device and connect the device to the main source power. The battery indicator illuminates in yellow when battery is being charged.
2. Charge the battery until it is full, the battery indicator is off, and the battery power indicator is filled.

NOTE:

It is recommended to charge the battery when the device is switched off to help improve the charging efficiency and save charging time.

28.5 Maintaining the Battery

The performance of rechargeable batteries may deteriorate over time. It is recommended to check and maintain the batteries regularly every 3 months.

1. Disconnect the patient from the device and stop all measurement.
2. Switch off the device, connect it to main source power, install the battery and fully charge it.
3. Disconnect the device from main source power, switch on the device and let the device run until there is no battery power left and the device shuts off.
4. Reconnect the device to main source power and charge the battery until it is full for use or charge to 40%~60% for storage.

NOTE:

- 1 **Do not use the device on a patient during the battery maintenance.**

2 Do not interrupt the battery maintenance process.

28.6 Storing the Battery

Remove the lithium battery and store it at a cool and dry environment if the lithium battery or the device is not used for a long time. Charge the batteries to 40%–60% for storage. Check and maintain the batteries regularly every 3 months. For more information, please refer to Section *Maintaining the Battery*.

NOTE:

- 1 **When storing batteries, make sure that the battery terminals do not come into contact with metallic objects.**
- 2 **The service life of the battery will be shortened if it is stored at high temperature for a long time. Storing batteries in a cool place can slow down the aging process. The ideal storage temperature is 15 °C.**

28.7 Checking Battery Performance

The performance of rechargeable batteries may deteriorate over time. If you suspect that the battery may have failed, check the battery performance.

Refer to Step 1~Step 3 in Section *Maintaining the Battery* and record the running time of the battery which reflects the battery performance directly. If the running time is obviously less than the specified time in the specification, the battery may have reached its service life or malfunctioned, please change the battery or contact the service personnel. If the running time meets the specification, then the battery can continue to be used normally.

28.8 Replacing the Battery

To install or replace the battery, please follow the procedure:



1. Open the battery door as indicated above.
2. Pull the plastic retainer until the battery can be removed.
3. Insert the new battery into the battery compartment.
4. Pull the metal retainer downward to fix the battery and close the battery door.

28.9 Recycling the Battery

When the battery no longer holds a charge, it should be replaced. Remove the old battery from the monitor and recycle it properly.

WARNING

Do not disassemble batteries, put them into fire or cause them to short circuit. They may ignite, explode or leak, causing personal injury.

Chapter 29 Care and Cleaning

Use only the EDAN-approved substances and methods listed in this chapter to clean or disinfect your equipment. Warranty does not cover damage caused by using unapproved substances or methods.

EDAN Instruments has validated the cleaning and disinfection instructions included in this User Manual. It is the responsibility of the healthcare professional to ensure that the instructions are followed to ensure adequate cleaning and disinfection.

29.1 Safety Instructions

Reusable products

Reusable products must be reprocessed, otherwise there is an increased risk of infection.

- ▶ Follow the infection prevention policies and reprocessing regulations of the health-care facility.
- ▶ Follow the national infection prevention policies and reprocessing regulations.
- ▶ Use validated procedures for reprocessing.
- ▶ Reprocess reusable products after every use.
- ▶ Follow the manufacturer's instructions for cleaning agents, disinfectants, and reprocessing devices. Signs of wear, e.g., cracks, deformation, discoloration, or peeling, may occur with reprocessed products.
- ▶ Check the products for signs of wear and replace them if necessary.

Disposable products

Disposable products have been designed, tested, and manufactured exclusively for single use. Reuse, reprocessing, or sterilization can result in failure of the accessory, incorrect measurements, and injury to the patient.

- ▶ Do not reuse disposable products.
- ▶ Do not reprocess disposable products.
- ▶ Do not use any disinfectants.

29.2 General Points

Keep your monitor, cables and accessories free of dust and dirt. To prevent the device from damage, please follow the procedure:

- Use only recommended cleaning substances and disinfectants listed in this manual. Others may cause damage (not covered by warranty), reduce product

lifetime or cause safety hazards.

- Always dilute according to the manufacturer's instructions.
- Unless otherwise specified, do not immerse any part of the equipment or any accessories in liquid.
- Do not pour liquid onto the system.
- Do not allow liquid to enter the case.
- Never use abrasive material (such as steel wool or silver polish).
- Inspect the monitor and reusable accessories after they are cleaned and disinfected.

PRECAUTION

If you spill liquid on the equipment, battery, or accessories, or they are accidentally immersed in liquid, contact your service personnel or EDAN service engineer.

NOTE:

- 1 Automated cleaning/disinfection to the equipment and accessories are prohibited.**
- 2 To avoid blocking and affecting NIBP measurement, the user should clean the battery compartment periodically by opening the door and dust the vent. Do not use wet cotton swab to clean the vent. If NIBP measurement is still affected after cleaning, contact the service personnel of the manufacturer.**

29.3 Cleaning

If the device or accessory has been in contact with the patient, then cleaning and disinfection is required after every use. If there has been no patient contact and there is no visible contamination then daily cleaning and disinfection is appropriate.

The validated cleaning agents for cleaning the monitor and reusable accessories are:

- Mild near neutral detergent
- Ethanol (75%)
- Isopropanol (70%)

Cleaning agents should be applied and removed by using a clean cotton swab or a clean, soft, non-abrasive cloth or paper towel each time. Refer to the cleaning agent manufacturer's instruction for use with reference to concentration, temperature and contact time.

29.3.1 Cleaning the Monitor

WARNING

Before cleaning the monitor, make sure that the monitor is switched off and disconnected from the power line.

To surface-clean the monitor, follow these steps:

1. Switch off the monitor and disconnect it from the power line.
2. Remove all residual foreign matters from the surface of the monitor using sterile cloth or paper towel immediately after examination until the surface is visually clean.
3. Use a clean cotton swab dampened with the cleaning solution to wipe the surface apertures of the equipment until no visible contaminants remain.
4. Use a soft clean cloth dampened with the cleaning solution to wipe the entire exterior surface of the equipment until no visible contaminants remain.
5. After cleaning, wipe off the cleaning solution with a fresh cloth or towel dampened with tap water until no visible cleaning agent remains.
6. Dry the monitor in a ventilated and cool place.
7. If the monitor is not visually clean after cleaning, please repeat the cleaning steps through step 3 to step 6.
8. Inspect the monitor to ensure that there is no damage.

29.3.2 Cleaning the Reusable Accessories

29.3.2.1 Cleaning the Cable

1. Remove cable from the monitor.
2. Remove all residual foreign matters from the surface of the cable using sterile cloth or paper towel immediately after examination until the surface is visually clean.
3. Wipe the cable with a soft cloth dampened with the cleaning solution until no visible contaminants remain.
4. After cleaning, wipe off the cleaning solution with a fresh cloth or towel dampened with tap water until no visible cleaning agent remains.
5. Wipe off residual moisture with a dry cloth.

6. Leave the cable to air dry.
7. If the cable is not visually clean after cleaning, please repeat the cleaning steps through step 3 to step 6.
8. Inspect the cable to ensure that there is no damage.

29.3.2.2 Cleaning the Electrode

1. Remove the electrode from the monitor.
2. Remove all residual foreign matters from the surface of the electrode using sterile cloth or paper towel immediately after examination until the surface is visually clean.
3. Wipe the electrode with a soft cloth dampened with the cleaning solution until no visible contaminants remain.
4. After cleaning, wipe off the cleaning solution with a fresh cloth or towel dampened with tap water until no visible cleaning agent remains.
5. Wipe off residual moisture with a dry cloth.
6. Leave the electrode to air dry.
7. If the electrode is not visually clean after cleaning, please repeat the cleaning steps through step 3 to step 6.
8. Inspect the electrode to ensure that there is no damage.

29.3.2.3 Cleaning the Blood Pressure Cuff

Cleaning the Cuff:

1. Remove NIBP Cuff from the monitor, and take out the air bladder.
2. Remove all residual foreign matters from the surface of cuff and air bladder using sterile cloth or paper towel immediately after examination until the surface is visually clean.
3. Hand wash the cuff with the cleaning solution; clean the air bladder with a soft cloth dampened with the cleaning solution. Clean the surface of the cuff and the air bladder thoroughly until no visible contaminants remain.
4. Rinse the cuff and after cleaning, wipe off the cleaning solution with a fresh cloth or towel dampened with tap water until no visible cleaning agent remains.
5. Wipe off residual moisture with a dry cloth.
6. Air dry the cuff thoroughly after cleaning.
7. If the cuff and the air bladder are not visually clean after cleaning, please repeat

the cleaning steps through step 3 to step 6.

8. Inspect the cuff and the air bladder to ensure that there is no damage.

Replacing the Air Bladder:

After cleaning, replace the air bladder into the cuff following the steps below:

1. Roll the bladder lengthwise and insert it into the cuff from the large opening at one end of the cuff.
2. Thread the hose from within the cuff and out through the small hole at the top of the cuff.
3. Adjust the bladder until it is in position.

29.3.2.4 Cleaning the SpO₂ Sensor

1. Remove SpO₂ sensors from the monitor.
2. Remove all residual foreign matters from the surface of SpO₂ sensors, including cables, using sterile cloth or paper towel immediately after examination until the surface is visually clean.
3. Wipe the surfaces of the sensor and cable using a soft cloth dampened with the cleaning solution until no visible contaminants remain.
4. Wipe the patient contact area of the sensor with the cotton swab dampened with the cleaning solution until no visible contaminants remain.
5. After cleaning, wipe off the cleaning solution with a fresh cloth or towel dampened with tap water until no visible cleaning agent remains.
6. Wipe off residual moisture with a dry cloth.
7. Leave the sensor to air dry.
8. If the SpO₂ sensors, including cables, are not visually clean after cleaning, please repeat the cleaning steps through step 3 to step 7.
9. Inspect the SpO₂ sensors, including cables, to ensure that there is no damage.

29.3.2.5 Cleaning the TEMP Sensor

1. Remove TEMP sensors from the monitor.
2. Remove all residual foreign matters from the surface of TEMP sensors using sterile cloth or paper towel immediately after examination until the surface is visually clean.
3. Wipe the sensor with a soft cloth dampened with the cleaning solution until no visible contaminants remain.

4. After cleaning, wipe off the cleaning solution with a fresh cloth or towel dampened with tap water until no visible cleaning agent remains.
5. Wipe off residual moisture with a dry cloth.
6. Leave the sensor to air dry.
7. If the TEMP sensors are not visually clean after cleaning, please repeat the cleaning steps through step 3 to step 6.
8. Inspect the TEMP sensors to ensure that there is no damage.

29.4 Disinfection

For devices or accessories that have been in contact mucosal surface, High-Level disinfection must occur, for all other accessories, low-level disinfection is appropriate. Clean the monitor and reusable accessories before they are disinfected.

The validated disinfectants for disinfecting the monitor are:

- Ethanol (75%)
- Ethanol (70%)
- Isopropanol (70%)
- Hydrogen Peroxide solution 0.5-1% concentration
- PDI Sani-Cloth Bleach Germicidal Disposable Wipes. (Composition: 0.63% Sodium Hypochlorite.)
- PDI Super Sani-Cloth Germicidal Disposable Wipes. (Composition: 55% Isopropyl alcohol, 0.25% Alkyl dimethyl benzyl ammonium chlorides, 0.25% Alkyl ethylbenzyl ammonium chloride.)
- Diversey Oxivir 1 Wipes. (Composition: 0.5% Hydrogen Peroxide)
- Diversey Oxivir Tb Wipes. (Composition: 0.5% Hydrogen Peroxide)
- Sodium Hypochlorite solution 6500 ppm (household bleach diluted ~1:10)
- Health Essence Disinfecting Effervescent Tablets. (Composition: active chlorine, trichloroisocyanuric acid 500~1000mg/L)
- Clinell Sporicidal Wipes. (Composition: peracetic acid)
- Dian Erkang II Wipes. (Composition: 1.8g/L~2.2g/L Quaternary Ammonium, 14%~17% Isopropyl Alcohol, 36%-44% Ethanol)
- Mikrozyd Sensitive Wipes. (Composition: 100 g solution contains the following active substances: 0.26 g Alkyl Dimethylbenzyl Ammonium Chloride, 0.26 g Didecyldimethylammonium Chloride, 0.26 g Alkyl Ethylbenzylammonium Chloride)

- Clorox Dispatch Hospital. (Composition: Sodium Hypochlorite 0.65%)
- Dismozon plus. (Composition: Magnesium Monoperoxyphthalate Hexahydrate 958 mg/g)
- Descosept AF wipes. (Composition: 100 g solution contains the following active substances: 42 g Ethanol and 0.05 g Didecyl Dimethyl Ammonium Chloride)
- Incidin Oxywipes. (Composition: Hydrogen Peroxide 1.5%)
- Terralin Liquid. (Composition: 100 g solution contains the following active substances: 42 g Ethanol and 35 g Propyl Alcohol)
- Mikrozyd universal. (Composition: 100 g solution contains the following active substances: 17.4 g Propane and 12.6 g Ethanol)
- Dian Erkang Surface Wipes. (Composition: Didecyl dimethyl ammonium Chloride, Dodecyl Dimethyl Benzyl Ammonium Chloride, Isopropyl Alcohol)
- Hydrogen Peroxide 3%.
- Clinell Universal Wipes. (Composition: RO pure water, surfactant, Double-Chain Quaternary Ammonium Salt Compound (w/w) 0.765%–0.935%)
- 0.5% sodium hypochlorite.
- 2% glutaraldehyde.
- 50% N-propanol.
- Clorox Bleach Gemicidal Wipes. (Composition: 0.55% Sodium Hypochlorite).
- Clorox disinfecting wipes. (Composition: 0.368% Chlorine Quaternary Ammonium Salt).
- Cleanisept wipes. (Composition: 100 g solution contains the following active substances: 0.5 g Alkyl Dimethylbenzyl Ammonium Chloride and 0.25 g Didecyl dimethyl ammonium Chloride)
- Mikrozyd AF wipes. (Composition: Ethanol, Isopropanol)
- Mikrozyd PAA Wipes. (Composition: 100 g solution contains the following active substances: 0.06 g Peracetic Acid, Hydrogen Peroxide and Acetic Acid)
- Clorox Healthcare Hydrogen Peroxide Cleaner Disinfectant Wipes. (Composition: Hydrogen Peroxide 1.4%)

Final dilution shall be determined according to the chlorine concentration in the specific household bleach solution, bought from market.

The validated disinfectants for disinfecting the reusable accessories are:

- Ethanol (75%)

- Isopropanol (70%)
- Cidex OPA (High-level disinfection of intracavitary temperature probe only)

Disinfecting agents should be applied and removed by using a clean cotton swab or a clean, soft, non-abrasive cloth or paper towel each time. Refer to the disinfecting agent manufacturer's instruction for use with reference to concentration, temperature and contact time.

PRECAUTION

- 1 Do not use any disinfectant containing additional active ingredients other than those listed, such as disinfectant didecyl dimethyl ammonium bromide which contains quaternary ammonium salt.**
 - 2 Although the monitor is chemically resistant to most common hospital cleaners, disinfectants and non-caustic detergents, unvalidated cleaners or disinfectants are not recommended and may stain the monitor, such as disinfectant didecyl dimethyl ammonium bromide which contains quaternary ammonium salt.**
 - 3 Do not use phenol disinfectants because vinyl absorbs them. Do not use strong aromatic, chlorinated, ketone, ether or ester solvents. Do not immerse the cables for any prolonged period in alcohol, mild organic solvents, or highly alkaline solutions. Never boil or autoclave the cable. Vinyl withstands temperatures up to 100 °C but begins to soften at around 90 °C. Handle gently when hot and wipe away from the tip toward the cable.**
-
-

WARNING

The monitor and reusable accessories shall be disinfected to avoid patient cross contamination.

29.4.1 Disinfecting the Monitor

WARNING

Before disinfecting the monitor, make sure that the monitor is switched off and disconnected from the power line.

To disinfect the monitor, follow these steps:

1. Switch off the monitor and disconnect it from the power line.

2. Clean and dry the monitor according to the methods in section *Cleaning the Monitor* prior to disinfection.
3. Prepare the disinfectant solution.
4. Use a clean cotton swab dampened with the disinfectant solution to wipe the surface apertures of the equipment. Follow the disinfectant manufacture's recommended contact time and mode.
5. Use a soft clean cloth dampened with the disinfectant solution to wipe the entire exterior surface of the equipment. Follow the disinfectant manufacture's recommended contact time and mode.
6. After disinfection, wipe off the disinfecting agent with a new sterile cloth dampened with sterile water.
7. Dry the monitor for at least 30 minutes in a ventilated and cool place.
8. Inspect the monitor to ensure that there is no damage.

29.4.2 Disinfecting the Reusable Accessories

29.4.2.1 Disinfecting the Cable

1. Remove the cable from the monitor.
2. Clean and dry the cable according to the methods in section *Cleaning the Cable* prior to disinfection.
3. Prepare the disinfectant solution.
4. Wipe the cable assembly with a soft cloth dampened with the disinfectant solution.
5. Wipe off the disinfectant solution with a dry cloth after disinfection.
6. Leave the cable assembly to air dry for at least 30 minutes.
7. Inspect the cable to ensure that there is no damage.

29.4.2.2 Disinfecting the Electrode

1. Remove the electrode from the monitor.
2. Clean and dry the electrode according to the methods in section *Cleaning the Electrode* prior to disinfection.
3. Prepare the disinfectant solution.
4. Wipe the electrode with a soft cloth dampened with the disinfectant solution.
5. Wipe off the disinfectant solution with a dry cloth after disinfection.

6. Leave the electrode to air dry for at least 30 minutes.
7. Inspect the electrode to ensure that there is no damage.

29.4.2.3 Disinfecting the Blood Pressure Cuff

Disinfecting the Cuff:

1. Remove NIBP Cuff from the monitor, and take out the air bladder.
2. Clean and dry the NIBP Cuff and air bladder according to the methods in section *Cleaning the Blood Pressure Cuff* prior to disinfection.
3. Prepare the disinfectant solution.
4. Wipe the cuff and the air bladder with a soft cloth dampened with the disinfectant solution.
5. Leave the cuff and air bladder to air dry for at least 30 minutes.
6. Inspect the cuff and the air bladder to ensure that there is no damage.

Replacing the Air Bladder:

After disinfection, replace the air bladder into the cuff. Refer to Section *Cleaning the Blood Pressure Cuff* for more information.

NOTE:

Prolonged use of disinfectant may cause discoloration of the cuff.

29.4.2.4 Disinfecting the SpO₂ Sensor

1. Remove SpO₂ sensors from the monitor.
2. Clean and dry the SpO₂ sensor according to the methods in section *Cleaning the SpO₂ Sensor* prior to disinfection.
3. Prepare the disinfectant solution.
4. Wipe the surfaces of the sensor and cable using a soft cloth dampened with the disinfection solution.
5. Wipe the patient contact area of the sensor with the cotton swab dampened with the disinfection solution.
6. Wipe off the disinfection solution with a dry cloth after disinfection.
7. Leave the sensor to air dry for at least 30 minutes.
8. Inspect the SpO₂ sensors, including cables, to ensure that there is no damage.

29.4.2.5 Disinfecting the TEMP Sensor

The intracavitary TEMP sensors should be reprocessed by high-level disinfection before and after use on each new patient. Cidex OPA is the validated agent for high level disinfection. Refer to the instructions of the disinfectant for the methods of disinfection. High-level disinfection has been validated with a 12 minute soak. Rinse and dry according to the labeled instructions of Cidex OPA. Do not dampen the sensor connector.

For the skin TEMP sensors, disinfect them as follows using ethanol or isopropanol only:

1. Remove TEMP sensors from the monitor.
2. Clean and dry the TEMP Sensor according to the methods in section *Cleaning the TEMP Sensor* prior to disinfection.
3. Prepare the disinfectant solution.
4. Wipe the sensor with a soft cloth dampened with the disinfectant solution (ethanol or isopropanol).
5. Wipe off the disinfectant solution with a dry cloth after disinfection.
6. Leave the sensor to air dry.
7. Inspect the TEMP sensors to ensure that there is no damage.

29.5 Cleaning and Disinfecting Other Accessories

For cleaning and disinfecting other accessories, refer to the instructions delivered with the accessories. If the accessories are not accompanied by instructions, refer to this manual for the methods of cleaning and disinfecting the monitor.

29.6 After Reprocessing

- After reprocessing, the equipment, cables, cuffs, sensors and other accessories should be checked to ensure there are no signs of aging, wear, cracks, deformation, discoloration or peeling, etc. Replacement should be taken or contact the service personal of the manufacturer if necessary.
- Assembling and attaching device-specific components

Prerequisite:

All components have been reprocessed and are dry.

- Preparation before next use of device

Assembling and fitting patient-specific accessories and consumables, i.e. SpO₂

sensors and NIBP Cuffs.

The device can be reused only if it is reconditioned under the responsibility of the manufacturer to comply with the general safety and performance requirements.

29.7 Storage and Transport

After reprocessing, there are no special requirements for storage and transport of the product. However, the following must be observed:

- Store dry and free of dust
- Avoid recontamination and damage during transport

All further information on storage and transport included in the accompanying documents must be observed.

Chapter 30 Maintenance

WARNING

- 1 Failure on the part of the responsible individual hospital or institution employing the use of this equipment to implement a satisfactory maintenance schedule may cause undue equipment failure and possible health hazards.**
- 2 If you discover a problem with any of the equipment, contact your service personnel, or your authorized supplier.**
- 3 The maintenance operations like software upgrade of the device can only be completed by EDAN-qualified service professionals.**
- 4 Any serious incident that has occurred in relation to the device should be reported to the manufacturer and the competent authority of the Member State in which the user and/or patient is established.**

30.1 Inspecting

The overall check of the monitor, including the safety check, should be performed only by qualified personnel every 24 months, and each time after fix up.

The following items should be checked:

- If the environment condition and power supply meet requirement.
- If the power supply cord has damage and insulation meets requirement.
- If the device and accessories have damage.
- Specified accessories.
- If the alarm system can work properly.
- If the recorder can work properly and the paper meets the requirement.
- Battery performance
- If all monitoring functions are in good conditions.
- If the grounding resistance and leakage current meet requirement.

If any damage or abnormality is found, please do not use the monitor and contact local Customer Service Center.

30.2 Maintenance Task and Test Schedule

Maintenance shall be carried out at least once every two years, or as specified by local regulations. The following tasks are for EDAN-qualified service professionals only. Contact an EDAN-qualified service provider if your monitor needs a safety or

performance test. Clean and disinfect equipment to decontaminate it before testing or maintaining it.

Maintenance and Test Schedule	Frequency
Safety checks. Selected tests on the basis of IEC60601-1	At least once every two years, or as needed, after any repairs where the power supply is removed or replaced, or if the monitor has been dropped.
Check all monitoring functions and measuring functions	At least once every two years, or as needed.

Chapter 31 Warranty and Service

31.1 Warranty

EDAN warrants that EDAN's products meet the labeled specifications of the products and will be free from defects in materials and workmanship that occur within warranty period.

The warranty is void in cases of:

- a) damage caused by mishandling during shipping.
- b) subsequent damage caused by improper use or maintenance.
- c) damage caused by alteration or repair by anyone not authorized by EDAN.
- d) damage caused by accidents.
- e) replacement or removal of serial number label and manufacture label.

If a product covered by this warranty is determined to be defective because of defective materials, components, or workmanship, and the warranty claim is made within the warranty period, EDAN will, at its discretion, repair or replace the defective part(s) free of charge. EDAN will not provide a substitute product for use when the defective product is being repaired.

NOTE:



The products marked with this symbol apply to the European WEEE directive. This symbol indicates this equipment contains electrical or electronic components that must not be disposed of as unsorted municipal waste, but collected separately. Contact an authorized representative of the manufacturer for information for the decommissioning of your equipment.

31.2 Contact Information

If you have any question about maintenance, technical specifications or malfunctions of devices, contact your local distributor.

Alternatively, you can send an email to EDAN service department at: support@edan.com.

Chapter 32 Accessories

You can order accessories from EDAN supplies at www.edan.com or consult your local EDAN representative for details.

WARNING

- 1 Never reuse disposable transducers, sensors, accessories and so forth that are intended for single use, or single patient use only. Reuse may compromise device functionality and system performance and cause a potential hazard.**
- 2 Use only EDAN-approved accessories. Using non-EDAN-approved accessories may compromise device functionality and system performance and cause a potential hazard. It is not recommended to use accessories supplied by EDAN with patient monitors by other manufacturers.**
- 3 IBP and C.O. sterilized accessories are already sterilized, refer to the package labeling for detailed method. Do not use a sterilized accessory if its packaging is damaged.**

NOTE:

Transducers and sensors have a limited shelf life. Refer to the package labeling.

The materials with which the patient or any other person can come into contact conform to the standard of EN ISO 10993-1.

The following cables may not all be available in all countries. Please check availability with your local EDAN supplier.

32.1 ECG Accessories

Part Number	Accessories
ECG Cable	
01.57.471380	3-lead, 12-pin, Defib-proof, AHA, Snap
01.57.471388	3-lead, 12-pin, ESU-proof, AHA, Snap
01.57.471378	3-lead, 12-pin, Defib-proof, AHA, Clip
01.57.471386	3-lead, 12-pin, ESU-proof, AHA, Clip
01.57.471379	3-lead, 12-pin, Defib-proof, IEC, Snap
01.57.471387	3-lead, 12-pin, ESU-proof, IEC, Snap
01.57.471377	3-lead, 12-pin, Defib-proof, IEC, Clip

Part Number	Accessories
01.57.471385	3-lead, 12-pin, ESU-proof, IEC, Clip
01.57.471226	5-lead, 12-pin, ESU-proof, Adult/pediatric
01.57.471227	ECG trunk cable, 5-lead, 12-pin, ESU-proof, AHA/IEC, 5.0 m, reusable
01.57.471228	5-lead, 12-pin, Defib-proof, Adult/pediatric
01.57.471229	5-lead, 12-pin, Defib-proof, Adult/pediatric, Extended
01.13.036620	5-lead, Clip, AHA, Adult/pediatric, Extended
01.13.036621	5-lead, Clip, AHA, Adult/pediatric
01.13.036622	5-lead, Snap, AHA, Adult/pediatric, Extended
01.13.036623	5-lead, Snap, AHA, Adult/pediatric
01.13.036624	5-lead, Clip, IEC, Adult/pediatric, Extended
01.13.036625	5-lead, Clip, IEC, Adult/pediatric
01.13.036626	5-lead, Snap, IEC, Adult/pediatric, Extended
01.13.036627	5-lead, Snap, IEC, Adult/pediatric
01.57.471979	6-lead, 12-pin, Defib-proof, Adult/pediatric
01.57.471980	6-lead, Clip, AHA, Adult/pediatric
01.57.471981	6-lead, Snap, AHA, Adult/pediatric
01.57.471982	6-lead, Clip, IEC, Adult/pediatric
01.57.471983	6-lead, Snap, IEC, Adult/pediatric
01.57.040203	12-lead, Snap, IEC, Adult/pediatric
01.57.471163	12-lead, Clip, IEC, Adult/pediatric
01.57.109101	12-lead, Snap, AHA, Adult/pediatric
01.57.471169	12-lead, Clip, AHA, Adult/pediatric
01.57.471072	12-lead, 12-pin, Defib-proof, AHA, Adult/pediatric
01.57.471168	12-lead, 12-pin, Defib-proof, IEC, Adult/pediatric
01.57.471461	3-lead, Clip, IEC, 1.0 m, Reusable
01.57.471462	ECG limb wires, 3-lead, snap, IEC, 1.0 m, reusable
01.57.471463	3-lead, Clip, AHA, 1.0 m, Reusable
01.57.471464	ECG limb wires, 3-lead, snap, AHA, 1.0 m, reusable
01.57.471465	5-lead, 12-pin, Defib-proof, Clip, IEC, 3.4 m, Reusable
01.57.471466	5-lead, 12-pin, Defib-proof, Clip, AHA, 3.4 m, Reusable
01.57.471467	5-lead, 12-pin, Defib-proof, Snap, IEC, 3.4 m, Reusable

Part Number	Accessories
01.57.471468	5-lead, 12-pin, Defib-proof, Snap, AHA, 3.4 m, Reusable
01.57.471473	5-lead, 12-pin, ESU-proof, Clip, IEC, 3.4 m, Reusable
01.57.471474	5-Lead, 12-pin, ESU-proof, Clip, AHA, 3.4 m, Reusable
01.57.471475	5-Lead, 12-pin, ESU-proof, Snap, IEC, 3.4 m, Reusable
01.57.471476	5-lead, 12-pin, ESU-proof, Snap, AHA, 3.4 m, Reusable
01.57.471481	3-lead, 12-pin, ESU-proof, AHA/IEC, 2.7 m, Reusable
01.57.471482	3-lead, 12-pin, ESU-proof, AHA/IEC, 5.0 m, Reusable
01.57.471483	3-lead, 12-pin, Defib-proof, AHA/IEC, 2.7 m, Reusable
01.57.471484	3-lead, 12-pin, Defib-proof, AHA/IEC, 5.0 m, Reusable
01.57.471196	3-lead, Snap, AHA, Neonate
01.57.471198	3-lead, Clip, AHA, Neonate
01.57.471195	3-lead, Snap, IEC, Neonate
01.57.471197	3-lead, Clip, IEC, Neonate
01.57.471194	3-lead, 12-pin, Defib-proof, Neonate
ECG Electrode	
01.57.471861	Disposable ECG Electrodes
01.57.471858	Disposable ECG Electrodes
01.57.471862	Disposable ECG Electrodes
01.57.471859	Disposable ECG Electrodes
01.57.471897	Disposable ECG Electrodes
01.57.471898	Disposable ECG Electrodes
01.57.472011	Disposable ECG Electrodes
01.57.472012	Disposable ECG Electrodes
01.57.472013	Disposable ECG Electrodes
01.57.472014	Disposable ECG Electrodes

32.2 SpO₂ Accessories

Part Number	Accessories
EDAN Module	
SpO ₂ Sensor	
02.57.225029	7-pin SH1 Adult Reusable SpO ₂ Sensor /adult, 2.5 m

Part Number	Accessories
02.01.210120	SH1 Adult Reusable SpO ₂ Sensor (DB9)
02.01.210673	SH3 Neonate Wrap SpO ₂ Sensor
02.01.210122	SH4 Adult Silicone Soft-tip SpO ₂ Sensor
02.01.210121	SH5 pediatric Silicone Soft-tip SpO ₂ Sensor
02.57.225000	SpO ₂ Sensor, Ear Clip, Adult/Pediatric, 1 m, reusable
01.57.471235	SHD-A SpO ₂ Sensor, adult, disposable
01.57.471236	SHD-P SpO ₂ Sensor, pediatric, disposable
01.57.471237	SHD-I SpO ₂ Sensor, Infant, disposable
01.57.471238	SHD-N SpO ₂ Sensor, Neonate, disposable
SpO ₂ Extension Cable	
01.57.471068	SpO ₂ Extension cable, 2 m
01.57.471789	7-pin SpO ₂ adapter cable/SpO ₂ Extension cable, 4.0 m
Nellcor Module	
01.15.30043	Nellcor Reusable Adult SpO ₂ Sensor (DS-100A OxiMax)
01.15.40096	Nellcor Reusable Adult/Neonate SpO ₂ Sensor (OXI-A/N OxiMax)
01.57.471069	Nellcor SpO ₂ Extension cable (Compatible with Nellcor OXI-Max SpO ₂ module and Nellcor sensor)
01.57.040436	Nellcor forehead sensor, Adult/Pediatric, > 10 kg, MAX-FAST
01.57.040437	Nellcor strip winding sensor, Pediatric/Infant, 3 kg-40 kg, hand/foot, OXI-P/I
01.57.040438	Nellcor multisite sensor, > 1 kg, hand, D-YS
01.57.040440	Nellcor sticking sensor, Adult, > 30 kg, hand, MAX-A/MAX-AL
01.57.040441	Nellcor sticking sensor, Neonatal/Adult < 3kg or > 40 kg, foot, MAX-N
01.57.040442	Nellcor sticking sensor, Infant, 3 kg-20 kg, foot, MAX-I
01.57.040445	Nellcor sticking sensor, Pediatric, 10 kg-50 kg, hand, MAX-P

32.3 NIBP Accessories

Part Number	Accessories
NIBP Cuff	
01.57.471326	NIBP Cuff, E5, Infant,10-15cm, reusable
01.57.471327	NIBP Cuff, E6, Small child,13-17cm, reusable

Part Number	Accessories
01.57.471328	NIBP Cuff, E7, Child,16–21.5cm, reusable
01.57.471329	NIBP Cuff, E8, Small adult,20.5–28cm, reusable
01.57.471330	NIBP Cuff, E9, Adult,27–35cm, reusable
01.57.471331	NIBP Cuff, E10, Large adult,34–43cm, reusable
01.57.471323	NIBP Cuff, Neonate, 10cm–15cm, reusable
01.57.471324	NIBP Cuff, Neonate, 6cm–11cm, reusable
01.57.471157	NIBP Cuff, neonatal #1, 3–6cm,disposable
01.57.471158	NIBP Cuff, neonatal #2, 4–8cm,disposable
01.57.471159	NIBP Cuff, neonatal #3, 6–11cm,disposable
01.57.471160	NIBP Cuff, neonatal #4, 7–13cm,disposable
01.57.471161	NIBP Cuff, neonatal #5, 8–15cm,disposable
NIBP Tube	
01.59.473007	NIBP Hose/3.0 m,Φ7.2 mm*Φ3.6 mm, TPU 85A, gray

32.4 TEMP Accessories

Part Number	Accessories
EDAN TEMP	
Temperature Probe	
01.15.040225	Temperature Probe/Skin, adult, 3 m, reusable
01.15.040226	Temperature Probe/Skin, adult, 3 m, reusable
01.15.040227	Temperature Probe/rectal/oral, adult, 3 m, reusable
01.15.040228	Temperature Probe, rectal/oral, adult, 3 m, reusable
01.15.040253	Temperature Probe/Skin, neonatal/Infant, 3 m, reusable
01.15.040254	Temperature Probe/rectal/oral, neonatal/Infant, 3 m, reusable
01.15.040255	Temperature Probe/Skin, neonatal/Infant, 3 m, reusable
01.15.040256	Temperature Probe/rectal/oral, neonatal/Infant, 3 m, reusable
Covidien Genius 3 Tympanic Thermometer	
01.48.099351	Genius 3 Tympanic Thermometer module
01.57.472254	Genius 3 TEMP probe cover

32.5 IBP Accessories

Part Number	Accessories
IBP Transducer	
01.57.40121	DTX Enhanced SPU Transducer/BD DT-4812
01.57.471664	Disposable Pressure Transducer/PT161103
01.57.471665	Disposable Pressure Transducer/PT151103
01.57.471666	Disposable Pressure Transducer/PT141103
01.57.471880	Reusable Pressure Transducer/RT2000
01.57.471881	Disposable Dome/DD6012
IBP Cable	
01.57.471971	12 pin, dual channel, IBP cable (BD)
01.57.471972	12 pin, dual channel, IBP cable (EDWARD)
01.57.471973	12 pin, dual channel, IBP cable (HOSPIRA)
01.57.471974	12 pin, dual channel, IBP cable (UTAH)
01.57.471975	12 pin, dual channel, IBP cable (B.Braun)
01.57.471070	IBP Pressure transducer interface cable/Interface model BD
01.57.471172	IBP Pressure transducer interface cable/EDWARD type interface
01.57.471173	IBP Pressure transducer interface cable/Hospira type interface
01.57.471166	IBP Pressure transducer interface cable/the UTAH type interface
01.57.471836	IBP Pressure transducer interface cable/12 pin,B.Braun type interface

32.6 C.O. Accessories

Part Number	Accessories
01.57.471071	Cardiac output cable
01.13.40119	In-line Injection temperature probe (BD 684056-SP4042)
01.57.40120	In-line Injection temperature probe housing (BD 680006-SP5045)
01.57.40121	IDTX Enhanced SPU Transducer/BD DT-4812
01.57.100175	Control Syringe (Medex MX387)

NOTE:

The Thermodilution Catheter is required when measuring C.O.. Swan-Ganz catheter (Type 131HF7 and 741HF7), manufactured by Edwards Lifesciences Corporation, has been validated to be compatible with the monitor. Refer to Edwards for more details.

32.7 CO₂ Accessories

Part Number	Accessories
EDAN Module	
02.01.210520	Dewatering Cup(Single Patient Use, Adult/Pediatric 10 ml)
01.57.471275	CO ₂ Sampling Line with Male Luer Lock, 2.0 m
01.57.471282	All Purpose Sampling Cannula without filter (Non Sterile). Size: Adult
01.57.471283	All Purpose Sampling Cannula without filter (Non Sterile). Size: Infant
01.57.471284	All Purpose Sampling Cannula without filter (Non Sterile). Size: Neonate
01.57.471285	Duo Flow O ₂ +CO ₂ Sampling Cannula (Non Sterile). Size: Adult
01.57.471286	Duo Flow O ₂ +CO ₂ Sampling Cannula (Non Sterile). Size: Child
01.57.471287	Capnomask O ₂ +CO ₂ Sampling Cannula (Non Sterile). Size: Adult
01.57.471288	Capnomask O ₂ +CO ₂ Sampling Cannula (Non Sterile). Size: Child
Respironics Module	
01.57.471085	CO ₂ Module Extension cable
01.57.078139	Disposable CO ₂ Nasal Cannula - Adult (Respironics 3468ADU-00)
01.57.078151	Adult/Pediatric Airway adapter kit with dehumidification tubing (Respironics 3473ADU-00)
01.57.078154	Disposable Sampling Line Kit with Dehumidification Tubing (Respironics 3475-00)
01.57.471020	Reusable Neonate/Infant Airway Adapter (7053-01)
01.59.078155	CO ₂ Airway Adapter, Adult, disposable (6063-00)
01.59.078156	CO ₂ Airway Adapter, Neonatal (infant/pediatric) (6312-00)
01.57.078142	Adult Nasal CO ₂ with O ₂ delivery sampling cannula (Respironics 3469ADU-00)
01.57.078143	Pediatric Nasal CO ₂ with O ₂ delivery sampling cannula (Respironics 3469PED-00)
01.57.078144	Infant Nasal CO ₂ with O ₂ delivery sampling cannula (Respironics 3469INF-00)
01.57.101019	Adult Nasal/Oral CO ₂ sampling cannula (Respironics 3470ADU-00)

Part Number	Accessories
01.57.101020	Pediatric Nasal/Oral CO ₂ sampling cannula (Respironics 3470PED-00)
01.57.101021	Adult Nasal/Oral CO ₂ with O ₂ delivery sampling cannula (Respironics 3471ADU-00)
01.12.031598	Adult/Pediatric Airway adapter kit (Respironics 3472ADU-00)
01.57.078140	Disposable CO ₂ Nasal Cannula - Pediatric (Respironics 3468PED-00)
01.57.078141	Disposable CO ₂ Nasal Cannula - Infant (Respironics 3468INF-00)
01.57.078152	Pediatric/Infant Airway adapter kit with dehumidification tubing (Respironics 3473INF-00)
01.57.078158	Pediatric mask/mainstream 9960PED-00
01.57.078159	Adult standard mask /mainstream 9960STD-00
01.57.078160	Adult large mask /mainstream 9960LGE-00
01.57.078161	Band/mainstream 8751-00
01.12.078162	Card Slot /Mainstream 6934-00
01.15.040143	Respironics CAPNOSTAT 5 etCO ₂ (Main-stream) Module 1015928
02.08.078137	Sidestream CO ₂ Module 1022054
Masimo Module	
01.57.471086	GAS Module Extension cable, 0.3 m
01.57.472058	CO ₂ mainstream module
01.57.472071	CO ₂ sidestream module
02.08.208216	Nomoline IRMA CO ₂ , DB9, 200101
02.08.208217	Nomoline ISA CO ₂ , DB9, 4410
01.51.412962	Masimo CO ₂ mounting bracket
01.57.471042	IRMA Airway Adapter, Adult/Pediatric, Box of 25, CAT.NO. 106220
01.57.472072	NomoLine LH Adult/Pediatric Airway Adapter Set, 25/box 3814 2 m
01.57.472076	NomoLine HH Adult/Pediatric Airway Adapter Set, 25/box 3827 2 m
01.57.472077	NomoLine HH Adult/Pediatric Airway Adapter Set, 25/box 3828 3 m
01.57.472079	NomoLine HH Infant/Neonatal, Airway Adapter Set, 25/box 4367 2 m
01.57.472080	NomoLine LH Adult Nasal CO ₂ Cannula with O ₂ , 25/box 3820 2 m
01.57.472081	NomoLine LH Pediatric Nasal CO ₂ Cannula with O ₂ , 25/box 3821 2 m
01.57.472082	NomoLine LH Adult Nasal/Oral CO ₂ Cannula with O ₂ , 25/box 3824 2 m

Part Number	Accessories
01.57.472083	NomoLine LH Pediatric Nasal/Oral CO ₂ Cannula with O ₂ , 25/box 3825 2 m
01.57.472084	NomoLine HH Adult Nasal CO ₂ Cannula with O ₂ , 25/box 3833 2 m
01.57.472085	NomoLine HH Pediatric Nasal CO ₂ Cannula with O ₂ , 25/box 3834 2 m
01.57.472086	NomoLine HH Adult Nasal/Oral CO ₂ Cannula with O ₂ , 25/box 3837 2 m
01.57.472087	NomoLine HH Pediatric Nasal/Oral CO ₂ Cannula with O ₂ , 25/box 3838 2m
01.57.472088	NomoLine LH Adult Nasal CO ₂ Cannula, 25/box 3817 2 m
01.57.472089	NomoLine LH Pediatric Nasal CO ₂ Cannula, 25/box 3818 2 m
01.57.472090	NomoLine LH Infant Nasal CO ₂ Cannula, 25/box 3819 2 m
01.57.472091	NomoLine LH Adult Nasal/Oral CO ₂ Cannula, 25/box 3822 2 m
01.57.472092	NomoLine LH Pediatric Nasal/Oral CO ₂ Cannula, 25/box 3823 2 m
01.57.472093	NomoLine LH Adult Single Nasal Prong CO ₂ Cannula, 25/box 3826 2 m
01.57.472094	NomoLine HH Adult Nasal CO ₂ Cannula, 25/box 3830 2 m
01.57.472096	NomoLine HH Infant Nasal CO ₂ Cannula, 25/box 3832 2 m
01.57.472099	NomoLine HH Adult Single Nasal Prong CO ₂ Cannula, 25/box 3839 2 m

32.8 AG Accessories*

Part Number	Accessories
EDAN G7 Module	
02.01.210520	Water Trap (Single Patient Use, Adult/Pediatric 10 ml)
01.57.472055	Anaesthetic gas sampling line
Masimo Module	
01.57.471042	IRMA Airway Adapter, Adult/Pediatric, Box of 25, CAT.NO. 106220
02.08.208005	ISA™ Sidestream Analyzers, ISA AX+, CAT.NO.800601 (CO ₂ , N ₂ O, 5AA, AAID)
02.08.208006	IRMA™ Mainstream Analyzers, IRMA AX+,CAT.NO.200601 (CO ₂ , N ₂ O, 5AA, AAID)
02.08.208007	ISA™ Sidestream Analyzers, ISAOR+, CAT.NO.800401 (CO ₂ , O ₂ , N ₂ O, 5AA, AAID)
01.13.113617	Extension cable for Masimo GAS module

32.9 Other Accessories

Part Number	Accessories
01.13.036638	Power cable, length 1.8 m, VDE
01.13.037122	Power cable, length 1.8 m, American standard, medical grade
01.13.114214	Potential Equalization Conductor
01.21.064142	Rechargeable Lithium-ion Battery/TWSLB-002, 14.8 V, 2500 mAh
01.21.064143	Rechargeable Lithium-ion Battery/TWSLB-003, 14.8 V, 5000 mAh
01.57.078035	Recorder paper
01.23.068023	Linear Barcode Scanner
02.04.241690	Patient monitor mounting arm assembly kit
02.04.241688	Patient monitor mounting arm assembly kit
02.04.241699	Patient monitor mounting arm assembly kit
02.04.243472	Patient monitor mounting arm assembly kit
02.01.211226	Patient monitor mounting arm assembly kit
02.01.211225	Patient monitor mounting arm assembly kit
02.04.241697	Patient monitor mounting arm assembly kit
02.04.243469	Patient monitor mounting arm assembly kit
83.60.262072	MT-206 (S) Trolley (iX10 series)
83.60.262073	MT-206 (S) Trolley (iX12, iX15 series)
83.60.262076	MT-206 Trolley (Metal wheels, iX10 series)
83.60.262078	MT-206 Trolley (Metal wheels, iX12, iX15 series)
83.60.262081	MT-206 Trolley (Plastic wheels, iX10 series)
83.60.262083	MT-206 Trolley (plastic wheels, iX12, iX15 series)
02.04.101976	Rolling Stand Basket (in the bottom)
02.04.101984	M3 Trolley Adaptor Kit
02.01.211227	Trolley adapter assembly kit
01.18.052245	Netac USB flash disk (U208, 4G, USB2.0)
01.17.102659	SD Memory Card (32 GB, Class 10)
02.01.210633	Unicode recorder, Serial/parallel port

NOTE:

The part name may vary depending on context, but the part number is constant.

A Product Specification

NOTE:

The performance of the equipment with ☆ mark is determined to be essential performance.

A.1 Classification

Anti-electroshock type	iX12/iX15 Series: Class I equipment and internal powered equipment iX10 series with AC power supply: Class I equipment iX10 series with DC power supply: Class II equipment
Anti-electroshock degree	CF
Ingress Protection	IP22
Disinfection/sterilization method	Refer to Chapter <i>Care and Cleaning</i> for details.
Working system	Continuous operation equipment
Compliant with Standards	IEC 60601-1; IEC 60601-1-2; EN 60601-1; EN 60601-1-2; IEC 80601-2-49

A.2 Physical Specifications

A.2.1 Size and Weight

Product	Size	Weight*
iX10 Series	260 mm (W) × 227 mm (H) × 155 mm (D)	< 3.2 kg
iX12 Series	334 mm (W) × 264 mm (H) × 162 mm (D)	< 3.8 kg
iX15 Series	385 mm (W) × 286 mm (H) × 162 mm (D)	< 4.9 kg

* Standard configuration, excluding battery, accessories, and recorder.

A.2.2 Function Configuration

Product	Parameter Configuration
iX10 Series	ECG, RESP, TEMP (EDAN), iTEMP (COVIDIEN Genius 3), SpO ₂ (EDAN), two-channel SpO ₂ (EDAN), SpO ₂ (Nellcor), NIBP (EDAN), CNBP (EDAN), IBP (two-channel), C.O., CO ₂ (EDAN), CO ₂ (Respironics), CO ₂ (Masimo)

Product	Parameter Configuration
iX12 Series	ECG, RESP, TEMP (EDAN), SpO ₂ (EDAN), two-channel SpO ₂ (EDAN), SpO ₂ (Nellcor), NIBP (EDAN), CNBP (EDAN), IBP (two-channel), C.O., CO ₂ (EDAN), CO ₂ (Respironics), CO ₂ (Masimo), AG (Masimo), AG (EDAN)
iX15 Series	ECG, RESP, TEMP (EDAN), SpO ₂ (EDAN), SpO ₂ (Nellcor), NIBP (EDAN), CNBP (EDAN), IBP (four-channel), C.O., CO ₂ (EDAN), CO ₂ (Respironics), CO ₂ (Masimo), AG (Masimo), AG (EDAN)

A.2.3 Environment Specification

The monitor may not meet the performance specifications given here if stored or used outside the specified temperature and humidity ranges.

When the monitor and related products have differing environmental specifications, the effective range for the combined products is that range which is common to the specifications for all products.

Component	Main unit
Temperature	
Working	0 °C to 40 °C (32 °F to 104 °F)
Transport and Storage	iX10 Series: -30 °C to 70 °C (-22 °F to 158 °F) iX12/iX15 Series: -20 °C to 60 °C (-4 °F to 140 °F)
Relative Humidity	
Working	15%RH to 95%RH (non-condensing)
Transport and Storage	10%RH to 95%RH (non-condensing)
Barometric Pressure	
Working	57 kPa to 107.4 kPa
Transport and Storage	16 kPa to 107.4 kPa

Component	Main unit (configured with Nellcor SpO ₂ module)
Temperature	
Working	0 °C to 40 °C (32 °F to 104 °F)
Transport and Storage	iX10 Series: -30 °C to 70 °C (-22 °F to 158 °F)

Storage	iX12/iX15 Series: -20 °C to 60 °C (-4 °F to 140 °F)
Relative Humidity	
Working	15%RH to 95%RH (non-condensing)
Transport and Storage	15%RH to 95%RH (non-condensing)
Barometric Pressure	
Working	70.7 kPa to 105 kPa
Transport and Storage	47.1 kPa to 105 kPa

Component	Covidien Genius 3 module
Temperature	
Working	16 °C to 33 °C (60.8 °F to 91.4 °F)
Transport and Storage	-20 °C to 55 °C (-4 °F to 131 °F)
Relative Humidity	
Working	15%RH to 90%RH (non-condensing)
Transport and Storage	10%RH to 90%RH (non-condensing)
Barometric Pressure	
Working	70 kPa to 106 kPa
Transport and Storage	70 kPa to 106 kPa

Component	EDAN AG module
Temperature	
Working	5 °C to 40 °C (41 °F to 104 °F)
Storage	-20 °C to 60 °C (-4 °F to 140 °F)
Relative Humidity	
Working	15%RH to 95%RH (non-condensing)
Storage	10%RH to 95%RH (non-condensing)

Barometric Pressure	
Working	65 kPa to 107.4 kPa
Storage	57 kPa to 107.4 kPa

Component	Respironics CO ₂ module
Temperature	
Working	0 °C to 40 °C (32 °F to 104 °F)
Storage	-20 °C to 60 °C (-4 °F to 140 °F)
Relative Humidity	
Working	15%RH to 90%RH (non-condensing)
Storage	10%RH to 90%RH (non-condensing)
Barometric Pressure	
Working	57 kPa to 106.6 kPa
Storage	53 kPa to 106.6 kPa

Component	Masimo CO ₂ modules
Temperature	
Working	0 °C to 40 °C (32 °F to 104 °F)
Storage	-20 °C to 60 °C (-4 °F to 140 °F)
Relative Humidity	
Working	15%RH to 95%RH (non-condensing)
Storage	10%RH to 95%RH (non-condensing)
Barometric Pressure	
Working	57 kPa to 107.4 kPa
Storage	50 kPa to 107.4 kPa

Component	Masimo mainstream AG module
Temperature	
Working	10 °C to 40 °C (50 °F to 104 °F)
Storage	-20 °C to 60 °C (-4 °F to 140 °F)

Relative Humidity	
Working	15%RH to 95%RH (non-condensing)
Storage	10%RH to 95%RH (non-condensing)
Barometric Pressure	
Working	57 kPa to 107.4 kPa
Storage	50 kPa to 107.4 kPa

Component	Masimo sidestream AG module
Temperature	
Working	5 °C to 40 °C (41 °F to 104 °F)
Storage	-20 °C to 60 °C (-4 °F to 140 °F)
Relative Humidity	
Working	15%RH to 95%RH (non-condensing)
Storage	10%RH to 95%RH (non-condensing)
Barometric Pressure	
Working	57 kPa to 107.4 kPa
Storage	50 kPa to 107.4 kPa

A.2.4 Power Supply Specifications

AC Voltage	100 V to 240 V~
Input Current	1.6 A to 0.8 A
Frequency	50 Hz/60 Hz
Over Current Fuse Protection	Support

DC Voltage	12/24 V	Only applicable to iX10 Series.
Input Current	< 3.5 A	

A.2.5 Battery Specification

Operating Time	iX10 Series	One battery (2500 mAh)	≥ 3.5 h	
		One battery (5000 mAh)	≥ 7 h	
	iX12 Series	Two batteries (2×2500 mAh)	≥ 6 h	
		Two batteries (2×5000 mAh)	≥ 12 h	
	iX15 Series	Two batteries (2×2500 mAh)	≥ 5 h	
		Two batteries (2×5000 mAh)	≥ 10 h	
Condition	At 25±5 ° C, with (a) new fully charged battery/batteries, NIBP automatic measurement mode at interval of 15 minutes, SpO ₂ sensor and 5-lead ECG cable connected, screen brightness set to “1”.			
Charge Time	iX10 Series	One battery (2500 mAh)	≤ 2.5 h (monitor is off) ≤ 5 h (monitor is running or in standby mode)	
		One battery (5000 mAh)	≤ 5 h (monitor is off) ≤ 10 h (monitor is running or in standby mode)	
	iX12/iX15 Series	Two batteries (2×2500 mAh)	≤ 5 h (monitor is off) ≤ 10 h (monitor is running or in standby mode)	
		Two batteries (2×5000 mAh)	≤ 10 h (monitor is off) ≤ 20 h (monitor is running or in standby mode)	
	Condition	Environment temperature: 20 to 30 °C. ≥ 90% charged.		
	Charge/Discharge Cycle	300 times		

A.2.6 Display

Product	Display	Messages
iX10 Series	Display screen: 10.1-inch color TFT, supporting touch screen Resolution: 1280×800	A maximum of 8 waveforms One power LED One AC power LED Two alarm LED One battery LED
iX12 Series	Display screen: 13.3-inch color TFT, supporting touch screen Resolution: 1920×1080	A maximum of 10 waveforms One power LED One AC power LED Two alarm LED One battery LED
iX15 Series	Display screen: 15.6-inch color TFT, supporting touch screen Resolution: 1920×1080	A maximum of 12 waveforms One power LED One AC power LED Two alarm LED One battery LED

A.2.7 Recorder

Record Width	48 mm
Record Paper Width	50 mm
Paper Speed	12.5 mm/s, 25 mm/s, 50 mm/s
Number of waveform channels	A maximum of 3

A.2.8 Data Storage

Trend Data	2400 hours @ 1 second
NIBP Measurement	1200 sets
Alarm Events	1000 sets

A.3 Wi-Fi

A.3.1 Wi-Fi Technical Specifications

IEEE	802.11a/b/g/n
Frequency Band	2.4 GHz ISM band & 5 G ISM band
Modulation	OFDM with BPSK, QPSK, 16-QAM, and 64-QAM 802.11b with CCK and DSSS
Maximum Typical Transmit Power (± 2 dBm)	2.4 G: 17 dBm for 802.11b DSSS 17 dBm for 802.11b CCK 17 dBm for 802.11g OFDM 16 dBm for 802.11n OFDM 5 G: 10 dBm for 802.11a OFDM 9 dBm for 802.11n OFDM

A.3.2 Wi-Fi Performance Specifications

System Capacity and Resistance to Wireless Interference	<p>When the following conditions are present,</p> <ul style="list-style-type: none"> ■ Quantity of the monitors supported by a single AP: ≤ 8. ■ Each monitor can communicate with MFM-CMS. ■ The AP signal strength of the monitor should be stronger than -65 dBm. ■ When the distance between the interfering devices and the monitor is more than 30 cm, and there are a co-channel interference Wi-Fi network (at least -85 dBm weaker than the monitor's network) and an adjacent-channel Wi-Fi network (at least -50 dBm weaker than the monitor's network) at the same time. Note: Excluding the Wi-Fi devices, the interfering devices include but are not limited to:
---	--

	<ul style="list-style-type: none"> ◆ 2.4 G or 5G wireless devices (excluding Wi-Fi devices) ◆ Cellular mobile communication networks ◆ Microwave ovens ◆ Interphones ◆ Mobile phones ◆ ESU equipment <p>The wireless network function of all monitors works normally and meets the following requirements:</p> <ul style="list-style-type: none"> ■ Total delay time for data transmission from the monitors to MFM-CMS: ≤ 2 s. ■ Total delay time of data transmission from one monitor to other monitors: ≤ 2 seconds. ■ Effective time of alarm reset configured on another monitor ≤ 2 s. ■ Effective time for monitor-related settings configured on the MFM-CMS: ≤ 2 s. ■ No communication loss between all the monitors.
<p>Wi-Fi Network Stability</p>	<p>When the following conditions are present,</p> <ul style="list-style-type: none"> ■ Quantity of the monitors supported by a single AP: ≤ 8. ■ Each monitor can communicate with MFM-CMS. ■ The AP signal strength of the monitor should be stronger than -65 dBm. <p>The following requirements must be met:</p> <ul style="list-style-type: none"> ■ Within 24 hours, the time percentage of failing to transmit data from any monitor to the MFM-CMS does not exceed 0.1%. When the connected 8 monitors roam for 30 times, the time percentage of failing to transmit data from any monitor to the MFM-CMS does not exceed 0.1%.

Distinct Vision Distance	The distinct vision distance between the monitor and the AP: ≥ 50 meters.
--------------------------	--

A.4 ECG

Complies with IEC 60601-2-25, IEC 60601-2-27.

Lead Mode	<p>3 Electrodes: I, II, III</p> <p>5 Electrodes: I, II, III, aVR, aVL, aVF, V</p> <p>6 Electrodes: I, II, III, aVR, aVL, aVF, and leads corresponding to Va Vb.</p> <p>10 Electrodes: I, II, III, aVR, aVL, aVF, V1, V2, V3, V4, V5, V6</p>
Electrode Standard	AHA, IEC
☆Display Sensitivity (Gain Selection)	1.25 mm/mV ($\times 0.125$), 2.5 mm/mV ($\times 0.25$), 5 mm/mV ($\times 0.5$), 10 mm/mV ($\times 1$), 20 mm/mV ($\times 2$), , 40 mm/mV ($\times 4$), AUTO gain
☆Sweep	6.25 mm/s, 12.5 mm/s, 25 mm/s, 50 mm/s
Bandwidth (-3dB) (Output amplitude relative to that for a 5 Hz sinusoidal input signal)	<p>Diagnosis: 0.05 Hz to 150 Hz</p> <p>Diagnosis 1: 0.05 Hz to 40 Hz</p> <p>Monitor: 0.5 Hz to 40 Hz</p> <p>Surgery: 1 Hz to 20 Hz</p> <p>Enhanced: 2 Hz ~18 Hz</p> <p>Customized: High-pass Filter and Low-pass Filter (Refer to <i>Changing the ECG Filter Settings</i>)</p>
☆CMRR (Common Mode Rejection Ratio)	<p>Diagnosis: > 95 dB</p> <p>Diagnosis 1: > 105 dB (when Notch is turned on)</p> <p>Monitor: > 105 dB</p> <p>Surgery: > 105 dB</p> <p>Enhanced: > 105 dB</p> <p>Customized: > 105 dB (Low-pass Filter < 40 Hz) > 95 dB (Low-pass Filter > 40 Hz)</p>
Hum Filter	In diagnosis, Diagnosis 1, monitor, surgery, enhanced and customized modes: 50 Hz/60 Hz (Hum Filter can be turned on or off manually)

☆Differential Input Impedance	> 5 MΩ
☆Input Signal Range	±10 mV PP
☆Accuracy of Signal Reproduction	An error of $\leq \pm 20\%$ of the nominal value of the output or $\pm 100 \mu\text{V}$, whichever is greater. The total error and frequency response comply with IEC 60601-2-27: 2011, Sect. 201.12.1.101.1.
☆Electrode Offset Potential Tolerance	±800 mV
Auxiliary Current (Leads off detection)	Active electrode: < 100 nA Reference electrode: < 900 nA
☆Recovery Time After Defibrillation	< 5 s (measured without electrodes as IEC60601-2-27:2011, Sect. 201.8.5.5.1 requires.)
Leakage Current of Patient	< 10 μA
Scale Signal	1 mV PP, accuracy is $\pm 5\%$
☆System Noise	< 30 $\mu\text{Vp-p}$
☆Multichannel Crosstalk	$\leq 5\%$ of the input signal Complied with IEC 60601-2-27: 2011, Sect. 201.12.1.101.5.
☆Frequency and Impulse Response	Frequency response: Input a 5 Hz, 1 mV sine wave signal, and the output signal amplitude remains within the range of 71 % to 110 % at 0.67 Hz and 40 Hz. Input a 1 Hz, 1.5 mV 200 ms triangular wave input signal, and the output shall be within 11.25 mm~15 mm. Impulse response: Displacement value: $\leq 0.1 \text{ mV}$ Slope: $\leq 0.3 \text{ mV/s}$ following the end of the pulse. Complied with IEC 60601-2-27: 2011, Sect. 201.12.1.101.8.
Sampling Frequency	1000 Hz

Sampling Channel Switch Time	< 80 μ S
A/D Precision	24 Bits (Minimum resolution: 0.077uV/LSB)
☆ESU Protection	Cut mode: 300 W Coagulation mode: 100 W Restore time: \leq 10 s
Electrosurgical Interference Suppression	Test according to ANSI/AAMI EC13:2002, Sect. 5.2.9.14. Complied with ANSI/AAMI EC13:2002, Sect. 4.2.9.14.
Minimum Input Slew Rate (Lead II)	> 2.5 V/s
☆Baseline Reset Time	< 3 s
Pace Pulse without Overshoot	
☆Pulse Indicator	Pulse is marked if the requirements of IEC 60601-2-27: 2011, Sect. 201.12.1.101.12 are met: Amplitude: \pm 2 mV to \pm 700 mV Width: 0.1 ms to 2.0 ms Ascending time: 10 μ s to 100 μ s
☆Pulse Rejection	Pulse is rejected if the requirements of IEC 60601-2-27: 2011, Sect. 201.12.1.101.13 are met: Amplitude: \pm 2 mV to \pm 700 mV Width: 0.1 ms to 2.0 ms Ascending time: 10 μ s to 100 μ s
Pace Pulse Detecting Lead: one among I, II, III, aVR, aVL, aVF, V1, V2, V3, V4, V5, V6	
Heart Rate	
HR Calculation	
☆Range	ADU: 15 bpm to 300 bpm PED/NEO: 15 bpm to 350 bpm
☆Accuracy	\pm 1% or 1 bpm, whichever is greater

Resolution	1 bpm
Sensitivity	≥ 300 μVPP
☆QRS Detection Range	<p>The detection range has exceeded the requirement described in the standard:</p> <p>Width: 70 ms~120 ms for adult, 40 ms~120 ms for Pediatric/neonate.</p> <p>Amplitude: 0.5 mv~5 mv</p> <p>In adult mode, these two signals are not responded:</p> <ol style="list-style-type: none"> 1. when QRS amplitude of 0.15 mV or less is applied; 2. when QRS duration of 10 ms and QRS amplitude of 1 mV or less is applied. <p>Complied with IEC 60601-2-27: 2011, Sect. 201.12.1.101.15.</p>
PVC	
Range	<p>ADU: (0 to 300) PVCs/ min</p> <p>PED/NEO: (0 to 350) PVCs/ min</p>
Resolution	1 PVCs/min
Pause/min	
Range	ADU/PED/NEO: (0 to 30) pauses/min
Resolution	1 pause/min
ST value	
Range	-2.0 mV to +2.0 mV
Accuracy	-0.8 mV to +0.8 mV: ±0.02 mV or 10%, whichever is greater. Beyond this range: not specified.
Resolution	0.01 mV
QT measurement	
Range	200 ms ~ 800 ms
Resolution	4 ms
Accuracy	± 30 ms

QTc measurement	
Range	200ms ~ 800 ms
Resolution	1 ms
Δ QTc measurement	
Range	-600 ms ~ 600 ms
Resolution	1 ms
HR Averaging Method	
Method 1	Heart rate is computed by excluding the minimum and maximum values from the 12 most recent RR intervals and averaging the residual 10 RR intervals.
Method 2	If each of three consecutive RR intervals is greater than 1200 ms, then the four most recent RR intervals are averaged to compute the HR.
Range of Sinus and SV Rhythm	
Tachy	Adult: RR interval for 5 consecutive QRS complex ≤ 0.5 s. Pediatric/neonatal: RR interval for 5 consecutive QRS complex ≤ 0.375 s.
Normal	Adult: 0.5 s < RR interval for 5 consecutive QRS complex < 1.5 s. Pediatric/neonatal: 0.375 s < RR interval for 5 consecutive QRS complex < 1 s.
Brady	Adult: RR interval for 5 consecutive QRS complex ≥ 1.5 s. Pediatric/neonatal: RR interval for 5 consecutive QRS complex ≥ 1 s.
Range of Ventricular Rhythm	
V-Tach	5 consecutive ventricular beats and ventricular HR ≥ 100 bpm.
Vent Rhythm	5 consecutive ventricular beats, and 20 bpm \leq ventricular HR < 40 bpm.
Vent Brady	5 consecutive ventricular beats, and ventricular HR < 20 bpm.
Acc. Vent Rhythm	5 consecutive ventricular beats, and 40 bpm \leq ventricular HR < 100 bpm.

Maximum Start-up Alarm Time for Tachycardia			
V-Tach (Ventricular Tachycardia) 1 mV 206 bpm	Gain 0.5: 10 s Gain 1.0: 10 s Gain 2.0: 10 s		
V-Tach (Ventricular Tachycardia) 2 mV 195 bpm	Gain 0.5: 10 s Gain 1.0: 10 s Gain 2.0: 10 s		
Response Time of Heart Rate Meter to Change in HR	HR range: 80 bpm to 120 bpm Range : Within 11 s HR range: 80 bpm to 40 bpm Range : Within 11 s		
☆Tall T-wave Rejection	Complied with IEC 60601-2-27: 2011, Sect. 201.12.1.101.17 minimum recommended 1.2 mV T-Wave amplitude		
Accuracy of Heart Rate Meter and Response to Irregular Rhythm	Complied with IEC 60601-2-27: 2011, Sect. 201.7.9.2.9.101 b) 4), the HR value after 20 seconds of stabilization is displayed as follows: Ventricular bigeminy: 80 bpm±1 bpm Slow alternating ventricular bigeminy: 60 bpm±1 bpm Rapid alternating ventricular bigeminy: 120 bpm±1 bpm Bidirectional systoles: 91 bpm±1 bpm		
Time to Alarm for Heart Rate alarm conditions	Asystole alarm: ≤ 10 s HR low alarm: ≤ 10 s HR high alarm: ≤ 10 s		
Arrhythmia analysis	Asystole	V-Fib/V-Tach	Couplet
	Vent Rhythm	PVC Bigeminy	PVC Trigeminy
	Tachy	R on T	PVC
	Irr Rhythm	Brady	Missed Beat

	Pacer not Pacing	Vent Brady	Pacer not Capture
	VEB	Run PVCs	Acc. Vent Rhythm
	IPVC	Non-Sustain VT	Multiform PVCs
	Pauses/min High	Pause	Afib
	PAC Bigeminy	PVCs High	Low Voltage(Limb)
	ExtremeBrady	PAC Trigeminy	Wide QRS Tachy
	Sustain VT	ExtremeTachy	V-Tach
12-Lead ECG Synchronization Analysis	Average parameters of heart beat		
	Heart rate (bpm)		
	Time limit of P wave (ms)		
	PR interval (ms)		
	QRS interval (ms)		
	QT/QTc (ms)		
	P-QRS-T AXIS		

A.5 RESP

Method	Impedance between RA-LL, RA-LA
Measurement lead	Options are lead I and II. The default is lead II.
Calculation Type	Manual, Automatic
Baseline Impedance Range	200 Ω to 2500 Ω (with ECG cables of 1 K Ω resistance)
Measuring Sensitivity	Within the baseline impedance range: 0.3 Ω
Waveform Bandwidth	0.2 Hz to 3.3 Hz (-3 dB)
Respiration Waveform Excitation	Sinusoid, 45.6 kHz ($\pm 10\%$), < 350 μ A
☆Gain Selection	$\times 0.25$, $\times 0.5$, $\times 1$, $\times 2$, $\times 3$, $\times 4$, $\times 5$
☆Sweep	6.25 mm/s, 12.5 mm/s, 25 mm/s, 50 mm/s

☆No Breath Detected Alarm Time Setup	10 s, 15 s, 20 s, 25 s, 30 s, 35 s, 40 s; default value is 20 s.
☆RR Measuring Range	0 rpm to 200 rpm
Resolution	1 rpm
☆Accuracy	6 rpm to 200 rpm: ± 2 rpm 0 rpm to 5 rpm: not specified

A.6 NIBP

Complies with IEC 80601-2-30.

Technique	Oscillometry
Mode	Manual, Auto, Continuous, Sequence
Measuring Interval in AUTO Mode (unit: minute)	1/2/2.5/3/4/5/10/15/30/60/90/120/180/240/360/480 and User Define
Continuous	5 min, interval is 5 s
Measuring Parameter	SYS, DIA, MAP, PR
Pressure Unit	kPa, mmHg, cmH ₂ O
☆Measuring Range	
☆Adult Mode	SYS: 25 mmHg to 290 mmHg DIA: 10 mmHg to 250 mmHg MAP: 15 mmHg to 260 mmHg
☆Pediatric Mode	SYS: 25 mmHg to 240 mmHg DIA: 10 mmHg to 200 mmHg MAP: 15 mmHg to 215 mmHg
☆Neonatal Mode	SYS: 25 mmHg to 140 mmHg DIA: 10 mmHg to 115 mmHg MAP: 15 mmHg to 125 mmHg
☆Alarm Type	SYS, DIA, MAP
☆Cuff Pressure Measuring Range	0 mmHg to 300 mmHg

Pressure Resolution	1 mmHg
☆Maximum Mean Error	±5 mmHg
☆Maximum Standard Deviation	8 mmHg
Maximum Measuring Period	
Adult/Pediatric	120 s
Neonate	90 s
Typical Measuring Period	iCUFFS measurement: 20 s to 35 s (depend on HR/motion disturbance) (measured with E9 cuff, default inflation value, PR is set as 80 bpm and systolic pressure within 100~120 mmHg) iFAST measurement: 15 s (depend on SYS, arm circumference and HR/motion disturbance) (measured with E8 cuff, PR is set as 80 bpm and systolic pressure within 100~120 mmHg)
Dual Independent Channel Overpressure Protection	
Adult	(297±3) mmHg
Pediatric	(245±3) mmHg
Neonatal	(147±3) mmHg
Pre-inflation Pressure	
Adult	80/100/120/140/150/160/180/200/220/240 mmHg
Pediatric	80/100/120/140/150/160/180/200 mmHg
Neonatal	60/70/80/100/120 mmHg

A.7 CNBP

☆CNBP Measuring Range	
Adult	SYS: 25 mmHg to 290 mmHg
	DIA: 10 mmHg to 250 mmHg
Pediatric	SYS: 25 mmHg to 240 mmHg
	DIA: 10 mmHg to 200 mmHg

☆Alarm Type	SYS, DIA
☆Pressure Resolution	1 mmHg
☆Maximum Mean Error	±5 mmHg
☆Maximum Standard Deviation	8 mmHg
BPVI	
Measuring Range	0~100%
Resolution	1%
Update Frequency	5 s

A.8 SpO₂

Complies with ISO 80601-2-61.

EDAN Module

Measuring Range	0% to 100%
Resolution	1%
☆Data Update Period	1 s
☆Accuracy	
☆Adult /Pediatric	±2% (70% to 100% SpO ₂)
	Undefined (0% to 69% SpO ₂)
☆Neonate	±3% (70% to 100% SpO ₂)
	Undefined (0% to 69% SpO ₂)
Sensor	
Red Light	(660±3) nm
Infrared Light	(905±10) nm
Emitted Light Energy	< 15 mW
PI	
Measuring Range	0 to 20%, invalid PI value is -?-.

Resolution	1% (10% to 20%) 0.1% (1.0% to 9.9%) 0.01% (0.00% to 0.99%)
------------	--

Nellcor Module

Measuring Range	1% to 100%	
Resolution	1%	
☆Data Update Period	1 s	
☆Accuracy	DS-100A, OXI-A/N(Adult) D-YS (Adult and Pediatric) OXI-P/I (Pediatric)	± 3% (70% to 100% SpO ₂)
	MAX-A, MAX-AL, MAX-N, MAX-P, MAX-I, MAX-FAST (Adult and Pediatric)	±2% (70% to 100% SpO ₂)
	MAX-A, MAX-AL, MAX-N, MAX-P, MAX-I, MAX-FAST (Adult and Pediatric)	±3% (60% to 80% SpO ₂)
	If sensor is used for neonate as recommended, the accuracy will be larger than adult by ±1.	
Sensor	Wave length: approximately 660 nm and 900 nm	
	Emitted light energy: < 15 mW	
SI	0-25.5	

NOTE:

The information about wavelength range can be especially useful to clinicians (for instance, when photodynamic therapy is performed).

A.9 PR

		Measuring range	Accuracy	Resolution
☆PR (SpO ₂)	EDAN	25 bpm to 300 bpm	±2 bpm	1 bpm

		Measuring range	Accuracy	Resolution
	Nellcor	20 bpm to 300 bpm	± 3 bpm (20 bpm to 250 bpm)	1 bpm
☆PR (NIBP)	EDAN	40 bpm to 240 bpm	± 3 bpm or 3.5%, whichever is greater	1 bpm
☆PR (IBP)	EDAN	20 bpm to 300 bpm	30 bpm to 300 bpm: ± 2 bpm or $\pm 2\%$, whichever is greater; 20 bpm to 29 bpm: undefined	1 bpm

A.10 TEMP

Complies with ISO 80601-2-56.

EDAN Module

Technique	Thermal resistance
Position	Skin, oral cavity, rectum
Measure Parameter	T1, T2, TD (the absolute value of T2 minus T1)
Channel	2
Sensor Type	YSI-10K and YSI-2.252K
Unit	$^{\circ}\text{C}$, $^{\circ}\text{F}$
Measuring Range	0 $^{\circ}\text{C}$ to 50 $^{\circ}\text{C}$ (32 $^{\circ}\text{F}$ to 122 $^{\circ}\text{F}$)
Resolution	0.1 $^{\circ}\text{C}$ (0.1 $^{\circ}\text{F}$)
☆Accuracy ¹	± 0.3 $^{\circ}\text{C}$ (± 0.1 $^{\circ}\text{C}$ exclude sensor error)
Refresh Time	Every 1 s to 2 s
Temperature Calibration	At an interval of 5 to 10 minutes
Measuring Mode	Direct Mode
Transient Response Time	≤ 30 s

Covidien Genius 3 Tympanic Thermometer

Only applicable to iX10 Series.

☆Measuring Range	33.0 °C to 42.0 °C (91.4 °F to 107.6 °F)
☆Accuracy	Ambient Temperature: 16 °C to 33 °C, when measuring 33 °C to 42 °C, the accuracy is ±0.3 °C.
Resolution	0.1 °C/0.1 °F
Measurement Response Time	< 2 s
Storage Temperature	-25 °C to 55 °C (-13 °F to 131 °F)
Measuring Mode	Adjusted Mode

A.11 IBP

Complies with IEC 60601-2-34.

Technique		Direct invasive measurement	
Channel		iX15 Series: 4 channels iX10/iX12 Series: 2 channels	
IBP Measure	☆Measuring Range	ART, Ao, UAP, BAP, FAP, LV, P1-P4	(-50 to +400) mmHg
		PA	(-6 to +120) mmHg
		CVP, ICP, LAP, RAP, UVP	(-10 to +40) mmHg
	Resolution	1 mmHg	
	☆Accuracy (not including sensor)	± 2 % or ± 1 mmHg, whichever is greater ICP: 0 mmHg to 40 mmHg: ± 2 % or ± 1 mmHg, whichever is greater; -10 mmHg to -1 mmHg: undefined	
Pressure Unit		kPa, mmHg, cmH ₂ O	
Pressure sensor			

Sensitivity		5 $\mu\text{V/V/mmHg}$
Impedance Range		300 Ω to 3000 Ω
Filter		DC~ 12.5 Hz; DC~ 40 Hz
Zero		Range: ± 200 mmHg
Pressure Calibration Range	IBP (excluding ICP)	80 mmHg to 300 mmHg
	ICP	10 mmHg to 40 mmHg
Volume Displacement		7.4×10^4 mm ³ /100mmHg

A.12 CO₂

Complies with ISO 80601-2-55.

EDAN G2 Sidestream Module

Intended Patient	Adult, pediatric, neonatal		
Measure Parameters	etCO ₂ , FiCO ₂ , AwRR		
Unit	mmHg, %, kPa		
☆ Measuring Range	etCO ₂	0 mmHg to 150 mmHg (0 % to 20%)	
	FiCO ₂	0 mmHg to 50 mmHg	
	AwRR	0 rpm to 150 rpm	
Resolution	etCO ₂	1 mmHg	
	FiCO ₂	1 mmHg	
	AwRR	1 rpm	
☆ Accuracy	etCO ₂	± 2 mmHg, 0 mmHg to 40 mmHg	Typical conditions: Ambient temperature: (25 \pm 3) °C Barometric pressure: (760 \pm 10) mmHg Balance gas: N ₂ Sample gas flowrate: 100 ml/min
		$\pm 5\%$ of reading, 41 mmHg to 70 mmHg	
		$\pm 8\%$ of reading, 71 mmHg to 100 mmHg	
		$\pm 10\%$ of reading, 101 mmHg to 150 mmHg	
	$\pm 12\%$ of reading or ± 4 mmHg, whichever is greater	All conditions	

	AwRR	± 1 rpm
Drift of Measure Accuracy	Meets the requirements of the measure accuracy	
Sample Gas Flowrate	50 ml/min, 70 ml/min or 100 ml/min (optional), accuracy: ± 15 ml/min	
Warm-up Time	Display reading within 20 s; reach to the designed accuracy within 2 minutes.	
Rise Time	< 400 ms (with 2 m gas sampling tube, sample gas flowrate: 100 ml/min)	
	< 500 ms (with 2 m gas sampling tube, sample gas flowrate: 70 ml/min)	
	< 1000 ms (with 2 m gas sampling tube, sample gas flowrate: 50 ml/min)	
Response Time	< 4 s (with 2 m gas sampling tube, sample gas flowrate: 100 ml/min & 70 ml/min)	
	< 5.5 s (with 2 m gas sampling tube, sample gas flowrate: 50 ml/min)	
Work Mode	Standby (default), measure	
O ₂ Compensation	Range: 0% to 100% Resolution: 1% Default: 16%	
N ₂ O Compensation	Range: 0% to 100% Resolution: 1% Default: 0%	
AG Compensation	Range: 0% to 20% Resolution: 0.1% Default: 0%	
Humidity Compensation Method	ATPD (default), BTPS	
Barometric Pressure Compensation	Automatic (The change of barometric pressure will not add additional errors to the measurement values.)	
Zero Calibration	Support	
Calibration	Support (It is recommend to be operated by trained personal.)	

☆Alarm	etCO ₂ , FiCO ₂ , AwRR	
☆No Breath Detected Alarm Delay	10 s, 15 s, 20 s, 25 s, 30 s, 35 s, 40 s; default value is 20 s.	
Data Sample Rate	100 Hz	
etCO ₂ Change ¹	AwRR ≤ 80rpm, meet the accuracy mentioned above; AwRR > 80 rpm, etCO ₂ descends 8%; AwRR > 120 rpm, etCO ₂ descends 10%	with 2 m gas sampling tube, sample gas flowrate: 100 ml/min)
	AwRR ≤ 60rpm, meet the accuracy mentioned above; AwRR > 60 rpm, etCO ₂ descends 8%; AwRR > 90 rpm, etCO ₂ descends 10%; AwRR > 120rpm, etCO ₂ descends 15%;	with 2 m gas sampling tube, sample gas flowrate: 70 ml/min)
	AwRR ≤ 20 rpm, meet the accuracy mentioned above; AwRR > 20 rpm, etCO ₂ descends 8%; AwRR > 40 rpm, not applicable;	with 2 m gas sampling tube, sample gas flowrate: 50 ml/min)

Note 1: Use a test device equivalent to EN ISO 80601-2-55 fig 201.101 to measure at 1:2 I/E ratio. Respiration rate accuracy is determined by frequency of device, and end-tidal reading change refers to the nominal value.

Interfering Gas Effects:

Gas	Gas Level (%)	Quantitative Effect/Comments
Nitrous oxide	60%	None
Halothane	4%	None
Enflurane	5%	None
Isoflurane	5%	None
Sevoflurane	5%	None
Xenon	Not applicable	Not applicable
Helium	Not applicable	Not applicable
Metered dose inhaler	Not applicable	Not applicable

propellants		
Desflurane	15%	None
Ethanol	0.1%	None
Isopropanol	0.1%	None
Acetone	0.1%	None
Methane	1%	None

Respironics Sidestream and Mainstream Modules

Applicable Patient Type	Adult, pediatric and neonatal patients	
Technique	Infra-red Absorption Technique	
Measure Parameters	etCO ₂ , FiCO ₂ , AwRR	
Unit	mmHg, %, Kpa	
☆Measuring Range		
☆etCO ₂	0 mmHg to 150 mmHg	
☆FiCO ₂	3 mmHg to 50 mmHg	
☆AwRR	0 rpm to 150 rpm (Mainstream) 2 rpm to 150 rpm (Sidestream)	
Resolution	etCO ₂	1 mmHg
	FiCO ₂	1 mmHg
	AwRR	1 rpm
☆etCO ₂ Accuracy	± 2 mmHg, 0 mmHg to 40 mmHg	
	± 5 % of reading, 41 mmHg to 70 mmHg	
	± 8 % of reading, 71 mmHg to 100 mmHg	
	± 10 % of reading, 101 mmHg to 150 mmHg	
	± 12% of reading, RR is over 80 rpm (sidestream) There will be no degradation in performance due to Respiration Rate. (mainstream)	
☆AwRR Accuracy	± 1 rpm	
Operation Mode	Measure, standby	

Sample Gas Flowrate (sidestream)	(50 ±10) ml/min
O ₂ Compensation	
Range	0% to 100%
Resolution	1%
Default	16%
Barometric Compensation Pressure	User setup
Anesthetic Gas Compensation	
Range	0% to 20%
Resolution	0.1%
Default	0.0%
Balance Gas Compensation	Room air, N ₂ O, helium
Stability	
Short Term Drift	Drift over 4 hours < 0.8 mmHg
Long Term Drift	120 hours
Zero Calibration	Support
☆Alarm Type	etCO ₂ , FiCO ₂ , AwRR
☆No Breath Detected Alarm Delay	10 s, 15 s, 20 s, 25 s, 30 s, 35 s, 40 s; default value is 20 s.
Data Sample Rate	100 Hz
CO ₂ Rise Time/Response Time (mainstream)	Less than 60 ms
Sensor Response Time (sidestream)	< 3 seconds, including transport time and rise time

Interfering Gas and Vapor Effects on etCO₂ Measurement Values:

Gas or Vapor	Gas Level (%)	Quantitative Effect/Comments
Nitrous oxide	60	Dry and Saturated Gas

Halothane	4	(0 – 40) mmHg: ± 1 mmHg additional error
Enflurane	5	(41 – 70) mmHg: ± 2.5% additional error
Isoflurane	5	(71 – 100) mmHg: ± 4% additional error
Sevoflurane	5	(101 – 150) mmHg: ± 5% additional error
Xenon	80	<p>*Additional worst case error when compensation for P_B, O₂, N₂O, anesthetic agents, or helium is correctly selected for the actual fractional gas constituents present.</p> <p>Desflurane: The presence of desflurane in the exhaled breath at concentrations greater than 5% will positively bias Carbon Dioxide values by up to an additional 3 mmHg at 38 mmHg.</p> <p>Xenon: The presence of Xenon in the exhaled breath will negatively bias Carbon Dioxide values by up to an additional 5 mmHg at 38 mmHg.</p>
Helium	50	
Desflurane	15	

Barometric Pressure on etCO₂ Measurement Values:

Quantitative Effect
<p>Ambient Barometric, Operational</p> <p>(0 – 40) mmHg: ± 1 mmHg additional error</p> <p>(41 – 70) mmHg: ± 2.5% additional error</p> <p>(71 – 100) mmHg: ± 4% additional error</p> <p>(101 – 150) mmHg: ± 5% additional error</p> <p>*Additional worst case error when compensation for P_B, O₂, N₂O, anesthetic agents, or helium is correctly selected for the actual fractional gas constituents present.</p>

NOTE:

Respiration Rate accuracy was verified by using a solenoid test setup to deliver a square wave of known CO₂ concentration to the device. 5% and 10% CO₂ concentrations were used. Respiration rate was varied over the range of the device. Pass/Fail criteria was comparison of the respiratory rate output from the sensor to the frequency of the square wave.

Masimo Sidestream Module

Dimensions	91 mm × 60 mm × 37 mm (3.6 × 2.4 × 1.4), excluding cable, tubing and Nomoline.
------------	--

Weight	≤ 98 g, excluding cable, tubing and Nomoline.
According to the degree of protection against harmful ingress of water	IP34
Transient operating Temperature	The device operates according to specification when exposed to -20 °C to 0 °C (-4 °F to 32 °F) for 20 minutes.
Warm up time after storage at -40 °C	A warm up period of 10 minutes is required for the NomoLine ISA CO ₂ module to fulfill the accuracy specification if immediately put into use after being stored at -40 °C (A power on reset is required if a hardware error is generated during the warm up period after being stored at -40 °C).
Ambient CO ₂	≤ 800 ppm (0.08 vol%)
Mechanical robustness	Meets the shock and vibration requirements for transport of EN ISO 80601-2-55:2018 clause 201.15.3.5.101.2 and EN 60601-1-12: 2015 clause 10.1.3
Recovery time after defibrillator test	Unaffected
Drift of measurement accuracy	No drift
Water handling	NomoLine Family sampling lines with proprietary water removal tubing.
Sampling flow rate	(50 ± 10) sml/min Note: 1. Volumetric flow rate of air corrected to standardized conditions of temperature and pressure. 2. Flow accuracy specification for the extended temperature range (-20 to 0 °C) is +15/-10 sml/min.
Breath detection	Adaptive threshold, minimum 1 vol% change in CO ₂ concentration.
Respiration rate	0 to 150 ± 1 breaths/min. (Measured at I/E ratio 1:1 using breath simulator according to EN ISO 80601-2-55 fig. 201.101.)
Fi and ET	FiCO ₂ and etCO ₂ are displayed after one breath and have a continuously updated breath average. The following method is used to calculate end-tidal (ET) values:

	<p>- The highest concentration of CO₂ during one breathing cycle with a weight function applied to favor values closer to the end of the cycle.</p> <p>etCO₂ will typically decrease below nominal value (ET_{nom}) when respiration rate (RR) exceeds the RR threshold (RR_{th}) according to the following formula:</p> $Et = Et_{nom} \times \sqrt{95/RR} \text{ for } RR > 95$ <p>(with NomoLine HH Adult/Pediatric Airway Adapter Set - REF 3827)</p> <p>Measured according to EN ISO 80601-2-55.</p>		
Sensor head	Dual channel NDIR type gas analyzer measuring at 3.5 to 4.5 μm. Data acquisition rate 10 kHz (sample rate 20 Hz / channel).		
Compensations	Automatic compensation for pressure and temperature. Manual compensation for broadening effects on CO ₂ .		
Calibration	No span calibration is required.		
Warm-up time	< 10 seconds (Concentrations reported and full accuracy)		
CO ₂ rise time at 50sml/min sample flow	≤ 200 ms (Measured according to EN ISO 80601-2-55.)		
NomoLine ISA CO ₂ system response time	< 3 seconds		
☆No Breath Detected Alarm Delay	15 s, 20 s, 25 s, 30 s, 35 s, 40 s; default value is 20 s.		
☆AwRR	0 rpm to 150 rpm		
☆AwRR Accuracy	± 1 rpm		
☆CO ₂ Measurement Range	0 to 25 vol%		
☆Accuracy- Standard Conditions	Gas	Range	Accuracy
	CO ₂	(0 to 15) vol%	±(0.2 vol% + 2% of reading)
(15 to 25) vol%		Unspecified	
The accuracy specifications above are valid for dry single gases at 22 ± 5 °C and 1013 ± 40 hPa.			
☆Accuracy- All Conditions	CO ₂	±(0.3 kPa + 4% of reading)	
The accuracy specification above is valid for all specified environmental conditions			

except for interference specified in Section *Effects From Water Vapor Partial Pressure On Gas Readings* and Section *Interfering Gas Effects*.

Effects from Water Vapor Partial Pressure on Gas Readings:

When the breathing gas flows through the sampling line, the gas temperature will adapt to the ambient temperature before reaching the gas analyzer. The CO₂ measurement will always show the actual partial pressure at the current humidity level in the gas sample. As the NomoLine sampling line removes all condensed water, no water will reach NomoLine ISA CO₂ system. However at an ambient temperature of 37 °C and a breathing gas with a relative humidity of 95% the CO₂ reading will typically be 6% lower than corresponding partial pressure after removal of all water.

Interfering Gas Effects:

Gas	Gas Level	Effect on CO ₂
N ₂ O ¹⁾	60 vol%	- ²⁾
HAL ¹⁾	4 vol%	- ³⁾
ENF, ISO, SEV ¹⁾	5 vol%	+8% of reading ⁴⁾
DES ¹⁾	15 vol%	+12% of reading ⁴⁾
Xe (Xenon) ¹⁾	80 vol%	-10% of reading ⁴⁾
He (Helium) ¹⁾	50 vol%	-6% of reading ⁴⁾
Metered dose inhaler propellants ¹⁾	Not for use with metered dose inhaler propellants	
C ₂ H ₅ OH (Ethanol) ¹⁾	0.3 vol%	- ³⁾
C ₃ H ₇ OH (Isopropanol) ¹⁾	0.5 vol%	- ³⁾
CH ₃ COCH ₃ (Acetone) ¹⁾	1 vol%	- ³⁾
CH ₄ (Methane) ¹⁾	3 vol%	- ³⁾
CO (Carbon monoxide) ⁵⁾	1 vol%	- ³⁾
NO (Nitrogen monoxide) ⁵⁾	0.02 vol%	- ³⁾
O ₂ ⁵⁾	100 vol%	- ²⁾

Note 1: According to the EN ISO 80601-2-55:2018 standard.

Note 2: Negligible interference with N₂O / O₂ concentrations correctly set, effect included in the specification “Accuracy, all conditions” above.

Note 3: Negligible interference, effect included in the specification “Accuracy, all

conditions” above.

Note 4: Interference at indicated gas level. For example, 50 vol% Helium typically decreases the CO₂ readings by 6%. This means that if measuring on a mixture containing 5.0 vol% CO₂ and 50 vol% Helium, the actual measured CO₂ concentration will typically be $(1-0.06) * 5.0 \text{ vol\%} = 4.7 \text{ vol\% CO}_2$.

Note 5: In addition to the EN ISO 80601-2-55:2018 standard.

Masimo Mainstream Module

Dimensions (W × D × H)	38 mm × 37 mm × 34 mm (1.49” × 1.45” × 1.34”)
Weight	≤ 25 g (cable excluded)
According to the degree of protection against harmful ingress of water	IP44
Mechanical robustness	Withstand repeated 1.8 m drops on a hard surface. Complies with requirements for shock and vibration for professional transportation according to EN ISO 80601-2-55:2018 and requirements for road ambulances according to EN1789:2007 (clause 6.4).
Recovery time after defibrillator test	Unaffected
Drift of measurement accuracy	No drift
Surface temperature (at ambient temp. 23 °C)	Max 39 °C / 102 °F
Airway adapters	Disposable adult/pediatric: <ul style="list-style-type: none"> - Adds less than 6 ml deadspace - Pressure drop less than 0.3 cm H₂O @ 30 LPM Disposable infant: <ul style="list-style-type: none"> - Adds less than 1 ml deadspace - Pressure drop less than 1.3 cm H₂O @ 10 LPM (Infant Airway Adapter recommended for Tracheal Tube ID size ≤ 4 mm)
Breath detection	Adaptive threshold, minimum 1 vol% change in CO ₂ concentration.

Respiration rate	0 to 150 ± 1 bpm. The respiration rate I displayed after three breaths and the average value is updated every breath. (Measured at I/E ratio 1:1 using breath simulator according to EN ISO 80601-2-55 fig. 201.101.)		
Fi and ET	FiCO ₂ and etCO ₂ are displayed after one breath and have a continuously updated breath average. The following method is used to calculate end-tidal (ET) values: - The highest concentration of CO ₂ during one breathing cycle with a weight function applied to favor values closer to the end of the cycle. etCO ₂ will be within specification for all respiration rates up to 150 bpm. (Measured at I/E ratio 1:1 using breath simulator according to EN ISO 80601-2-55 fig. 201.101.)		
Probe	2-9 channel NDIR type gas analyzer measuring at 4-10 µm. Data acquisition rate 10 kHz (sample rate 20 Hz / channel). Pressure, temperature and full spectral interference correction.		
Calibration	No span calibration required for the IR bench.		
Warm-up Time	< 10 seconds (full accuracy)		
Rise time (@ 10 l/min)	≤ 90 ms (measured @10 l/min with gas concentration steps corresponding to 30% of total measuring range for each gas)		
Total system response time	< 1 second (Measured according to EN ISO 80601-2-55)		
☆No Breath Detected Alarm Delay	15 s, 20 s, 25 s, 30 s, 35 s, 40 s; default value is 20 s.		
☆AwRR	0 rpm to 150 rpm		
☆AwRR Accuracy	± 1 rpm		
☆CO ₂ Measurement Range	0 to 25 vol%		
☆Accuracy- Conditions	Gas	Range	Accuracy
	CO ₂	(0 to 15) vol%	±(0.2 vol% + 2% of reading)
		(15 to 25) vol%	Unspecified

The accuracy specifications above are valid for dry single gases at 22 ± 5 °C and 1013 ± 40 hPa.		
☆Accuracy- All Conditions	CO ₂	$\pm(0.3 \text{ kPa} + 4\% \text{ of reading})$
The accuracy specification above is valid for all specified environmental conditions except for interference specified in Section <i>Effects From Water Vapor Partial Pressure On Gas Readings</i> and Section <i>Interfering Gas Effects</i> .		

Interfering Gas Effects:

Gas	Gas Level	CO ₂	Agents	N ₂ O
N ₂ O ⁴⁾	60 vol%	- ^{1&2)}	- ¹⁾	- ¹⁾
HAL ⁴⁾	4 vol%	- ¹⁾	- ¹⁾	- ¹⁾
ENF, ISO, SEV ⁴⁾	5 vol%	+8% of reading- ³⁾	- ¹⁾	- ¹⁾
DES ⁴⁾	15 vol%	+12% of reading ³⁾	- ¹⁾	- ¹⁾
Xe (Xenon) ⁴⁾	80 vol%	-10% of reading ³⁾	- ¹⁾	- ¹⁾
He (Helium) ⁴⁾	50 vol%	-6% of reading ³⁾	- ¹⁾	- ¹⁾
Metered Dose Inhaler Propellants ⁴⁾	Not for use with metered dose inhaler propellants			
C ₂ H ₅ OH (Ethanol) ⁴⁾	0.3 vol%	- ¹⁾	- ¹⁾	- ¹⁾
C ₃ H ₇ OH (Isopropanol) ⁴⁾	0.5 vol%	- ¹⁾	- ¹⁾	- ¹⁾
CH ₃ COCH ₃ (Acetone) ⁴⁾	1 vol%	- ¹⁾	- ¹⁾	- ¹⁾
CH ₄ (Methane) ⁴⁾	3 vol%	- ¹⁾	- ¹⁾	- ¹⁾
CO (Carbon monoxide) ⁵⁾	1 vol%	- ¹⁾	- ¹⁾	- ¹⁾
NO (Nitrogen monoxide) ⁵⁾	0.02 vol%	- ¹⁾	- ¹⁾	- ¹⁾
O ₂ ⁵⁾	100 vol%	- ^{1&2)}	- ¹⁾	- ¹⁾

Note 1: Negligible interference, effect included in the specification “Accuracy, all conditions” above.

Note 2: For probes not measuring N₂O and/or O₂ the concentrations shall be set

from host according to the instructions. (IRMA CO₂ measures neither N₂O nor O₂.)

Note 3: Interference at indicated gas level. For example, 50 vol% Helium typically decreases the CO₂ readings by 6%. This means that if measuring on a mixture containing 5.0 vol% CO₂ and 50 vol% Helium, the measured CO₂ concentration will typically be $(1-0.06) * 5.0 \text{ vol\%} = 4.7 \text{ vol\% CO}_2$.

Note 4: According to the EN ISO 80601-2-55:2018 standard.

Note 5: In addition to the EN ISO 80601-2-55:2018 standard.

A.13 C.O.

Technique	Thermodilution Technique
Measure Parameters	C.O., TB, TI
Measuring Range	
C.O.	0.1 L/min to 20 L/min
TB	23 °C to 43 °C(73.4 °F to 109.4 °F)
TI	-1 °C to 27 °C(30.2 °F to 80.6 °F)
Resolution	
C.O.	0.1 L/min
TB, TI	+0.1 °C (+0.1 °F)
Accuracy	
C.O.	±5% or ± 0.2 L/min, whichever is greater
TB	±0.1 °C (±0.18 °F) (not including sensor)
TI	±0.1 °C (±0.18 °F) (not including sensor)

NOTE:

At least 90% of the C.O. data should reside inside the bounded region, and the lower 95% confidence interval should not exceed 85%.

A.14 AG

Complies with ISO 80601-2-55.

Only applicable to iX12 and iX15 Series.

A.14.1 Sidestream

EDAN G7 Module

Intended Patient	Adult, pediatric, neonatal		
Measure Parameters	Halothane (HAL), Isoflurane (ISO), Enflurane (ENF), Sevoflurane (SEV), Desflurane (DES), CO ₂ , O ₂ , N ₂ O, AwRR, and MAC		
Unit	HAL, ISO, ENF, SEV, DES, N ₂ O: %; CO ₂ , O ₂ : mmHg, %, kPa, default is %; AwRR: rpm;		
☆Measuring Range	CO ₂	0~15 vol%	
	N ₂ O	0~100 vol%	
	Halothane/ Enflurane/ Isoflurane	0~8 vol%	
	Sevoflurane	0~10 vol%	
	Desflurane	0~22 vol%	
	O ₂ ¹	0~100%	
Resolution	N ₂ O, O ₂ ¹	1%	
	CO ₂ , AG	0.1%	
AwRR	Measurement range	2 ~ 150 rpm	
	Measuring accuracy	±1 rpm (120 rpm and below), Not specified (120 rpm above)	
	Resolution	1 rpm	
☆Accuracy	CO ₂	±(0.2vol% + 2% of reading)	Typical conditions: Ambient temperature: (25 ± 3) °C Barometric pressure: (760 ± 10) mmHg Balance gas: N ₂ Sample gas flowrate:
	N ₂ O	±(2vol% + 2% of reading)	
	HAL, ENF, ISO, SEV, DES	±(0.15vol% + 5% of reading)	

	O ₂ ¹	±(1vol% + 2% of reading)	100 ml/min
	CO ₂	±(0.3vol% + 4% of reading)	Claimed working environment
	N ₂ O	±(2vol% + 5% of reading)	
	HAL, ENF, ISO, SEV, DES	±(0.2vol% + 10% of reading)	
	O ₂ ¹	±(2vol% + 2% of reading)	
Anesthetic gas identification method	Manually set anesthetic gas ¹ Automatic identification of an anesthetic gas ² Automatic identification of two anesthetic gases ³		
Anesthetic gas identification concentration	1 st gas identification concentration ²	> 0.2vol%	
	2 nd gas identification concentration ³	> 0.3vol% When the concentration of DES in the mixed gas is greater than 3%, the identification concentration of the second anesthetic gas should be greater than 10% of the DES concentration.	
Sample Gas Flowrate	150 ml/min, accuracy ±15 ml/min		
Warm-up Time	Display reading within 20 s; reach to the designed accuracy within 2 minutes.		
Rise Time	CO ₂ / N ₂ O/ DES/ SEV/ ISO/ ENF	< 400ms	with 2 m gas sampling tube, sample gas flowrate: 150 ml/min
	HAL/ O ₂	< 500 ms	
Response Time	< 4 s (with 2 m gas sampling tube, sample gas flowrate: 150 ml/min)		
Work Mode	Standby, measure		

O ₂ Compensation	Manual: without O ₂ module Range: 0% to 100% Resolution: 1% Default: 16% Auto: with O ₂ module
Humidity Compensation Method	ATPD (default), BTPS
Zero Calibration	Auto, Manual
☆Alarm	etCO ₂ , FiCO ₂ , AwRR, etAA, FiAA, etO ₂ , FiO ₂ , etN ₂ O, FiN ₂ O
☆No Breath Detected Alarm Delay	20 s, 25 s, 30 s, 35 s, 40 s; default value is 20 s.
Data Sample Rate	100 Hz
Drift of Measure Accuracy	Meets the requirements of the measure accuracy
Barometric Pressure Compensation	Automatic (The change of barometric pressure will not add additional errors to the measurement values.)

Note 1: This function is available in O₂ module.

Note 2: This function is available in G7, G7+ modules.

Note 3: This function is available in G7A, G7A+, G7S, and G7S+ modules.

Note 4: This function is available in G7S and G7S+ modules.

Interfering Gas Effects:

Gas	Gas Level (%)	Quantitative Effect/Comments
Xenon/Helium/Metered dose inhaler propellants	Not applicable	Not applicable
Ethanol/Isopropanol/Acetone	0.1%	None
Methane	1%	None

Masimo ISA analyzer

Module Type	ISA AX+	Displaying the concentration of CO ₂ , N ₂ O, and two anaesthesia agent and identifying the anaesthesia agent automatically (built-in module)
	ISA OR+	Displaying the concentration of CO ₂ , O ₂ , N ₂ O, and two anaesthesia agent and identifying the anaesthesia agent automatically (built-in module)
Measurement Parameters	CO ₂ , N ₂ O , O ₂ , Halothane (HAL), Isoflurane (ISO), Enflurane (ENF), Sevoflurane (SEV) , Desflurane (DES), AwRR, MAC	
Measurement Principle	CO ₂ , N ₂ O, Anaesthesia Agent: infra-red absorption characteristic; O ₂ : Paramagnetic method	
Dimensions (W × D × H)	ISA AX+: 33 mm × 78 mm × 49 mm (1.3" × 3.1" × 1.9") ISA OR+: 49 mm × 90 mm × 100 mm (1.9" × 3.5" × 3.9") Excluding cable, tubing and NomoLine.	
Weight	ISA AX+: < 130 g (cable included) ISA OR+: < 420 g (cable included)	
According to the degree of protection against harmful ingress of water	IPX4	
Ambient CO ₂	≤ 800 ppm (0.08 vol%)	
Mechanical robustness	Meets the shock and vibration requirements EN ISO 80601-2-55:2018 clause 201.15.3.5.101.1	
Recovery time after defibrillator test	Unaffected	
Drift of measurement accuracy	No drift	
Water handling	NomoLine Family sampling lines with proprietary water removal tubing.	

Sampling flow rate	(50 ± 10) sml/min Note: Volumetric flow rate of air corrected to standardized conditions of temperature and pressure.
Breath detection	Adaptive threshold, minimum 1 vol% change in CO ₂ concentration.
Respiration rate	0 to 150 ± 1 breaths/min. (Measured at I/E ratio 1:1 using breath simulator according to EN ISO 80601-2-55 fig. 201.101.)
Fi and ET	<p>Fi and ET are displayed after one breath and have a continuously updated breath average.</p> <p>The following methods are used to calculate end-tidal (ET) values:</p> <ul style="list-style-type: none"> - CO₂: The highest concentration of CO₂ during one breathing cycle with a weight function applied to favor values closer to the end of the cycle. - O₂: The highest/lowest concentration of O₂ during the expiratory phase (depending on whether etO₂ is higher or lower than FiO₂). - N₂O and anesthetic agents: The momentary gas concentration at the time point where etCO₂ is detected. <p>ET will typically decrease below nominal value (ET_{nom}) when respiration rate (RR) exceeds the RR threshold (RR_{th}) according to the following formulas:</p> <p>CO₂ $ET = ET_{nom} \times \sqrt{(70/RR)}$ for RR_{th} > 70</p> <p>N₂O, O₂, DES, ENF, ISO, SEV $ET = ET_{nom} \times \sqrt{(50/RR)}$ for RR_{th} > 50</p> <p>HAL $ET = ET_{nom} \times \sqrt{(35/RR)}$ for RR_{th} > 35</p> <p>NOTE: Measured at I/E ratio 1:1 using breath simulator according to EN ISO 80601-2-55 fig. 201.101</p>
Automatic agent identification	Primary and secondary agents
Sensor head	2 to 9 channel NDIR type gas analyzer measuring at 4 to 10 μm. Data acquisition rate 10 kHz (sample rate 20 Hz / channel). O ₂ measurements by Servomex's paramagnetic sensor.
Compensations	Automatic compensation for pressure, temperature and broadening effects on CO ₂ .
Calibration	No span calibration is required for the IR bench. An automatic Zeroing is performed typically 1 to 3 times per day.

Warm-up Time	< 20 seconds (Concentrations reported, automatic agent identification enabled and full accuracy)		
Rise time (@ 50 sml/min sample flow)	CO ₂ ≤ 300 ms N ₂ O, O ₂ , ENF, ISO, SEV, DES ≤ 400 ms HAL ≤ 500 ms (Measured according to EN ISO 80601-2-55)		
Primary Agent Threshold	0.15 vol%. When an agent is identified, concentrations will be reported even below 0.15 vol% as long as apnea is not detected.		
Secondary Agent Threshold	0.2 vol% + 10% of total agent concentration		
Agent Identification Time	< 20 seconds (typically < 10 seconds)		
Total system response time	< 4 seconds (with 2 m Nomoline Airway Adapter Set sampling line)		
Work Mode	Measure		
Data Update Period	1 s		
Measurement Range	CO ₂ : 0 to 25 vol% O ₂ : 0 to 100 vol% N ₂ O: 0 to 100 vol% HAL, ENF, ISO, SEV, DES: 0 to 25 vol% AwRR: 0 rpm to 150 rpm		
Resolution	CO ₂ : 0.1% HAL, ENF, ISO, SEV, DES: 0.1% N ₂ O: 1% O ₂ : 1% AwRR: 1 rpm		
☆Accuracy - Standard Conditions	Gas	Range	Accuracy
	CO ₂	0 to 15 vol% 15 to 25 vol%	±(0.2 vol% + 2% of reading) Unspecified

	N ₂ O	0 to 100 vol%	±(2 vol% + 2% of reading)
	HAL, ENF, ISO	0 to 8 vol % 8 to 25 vol %	±(0.15 vol% + 5% of reading) Unspecified
	SEV	0 to 10 vol % 10 to 25 vol %	±(0.15 vol% + 5% of reading) Unspecified
	DES	0 to 22 vol % 22 to 25 vol %	±(0.15 vol% + 5% of reading) Unspecified
	O ₂	0 to 100 vol %	±(1 vol% + 2% of reading)
The accuracy specifications above are valid for dry single gases at 22 ± 5 °C and 1013 ± 40 hPa.			
☆Accuracy - All Conditions	Gas	Accuracy	
	CO ₂	±(0.3 kPa + 4% of reading)	
	N ₂ O	±(2 kPa + 5% of reading)	
	Agents	±(0.2 kPa + 10% of reading) (The accuracy specification is not valid if more than two agents are present in the gas mixture. If more than two agents are present, an alarm will be set)	
	O ₂	±(2 kPa + 2% of reading)	
The accuracy specification above is valid for all specified environmental conditions except for interference specified in Section <i>Effects From Water Vapor Partial Pressure On Gas Readings</i> and Section <i>Interfering Gas Effects</i> .			
☆AwRR Accuracy	±1 rpm		
☆No Breath Detected Alarm Delay	20 s, 25 s, 30 s, 35 s, 40 s; default value is 20 s.		
☆Alarm	Providing alarms of etCO ₂ , FiCO ₂ , etO ₂ , FiO ₂ , etN ₂ O, FiN ₂ O, etAA, FiAA, AwRR		
Exhaust Emission	Interface for exhaust collection is available		

Support:

- ◆ Zero calibration
- ◆ O₂ compensation
- ◆ N₂O compensation

Effects from Water Vapor Partial Pressure on Gas Readings:

When the breathing gas flows through the sampling line, the gas temperature will adapt to the ambient temperature before reaching the gas analyzer. The measurement of all gases will always show the actual partial pressure at the current humidity level in the gas sample. As the NOMO section removes all condensed water, no water will reach the ISA gas analyzer. However at an ambient temperature of 37 °C and a breathing gas with a relative humidity of 95% the gas reading will typically be 6% lower than corresponding partial pressure after removal of all water.

Interfering Gas Effects:

Gas	Gas Level	CO ₂	Agents	N ₂ O
		ISA AX+ ISA OR+		
N ₂ O ⁴⁾	60 vol%	- ¹⁾	- ¹⁾	- ¹⁾
HAL ⁴⁾	4 vol%	- ¹⁾	- ¹⁾	- ¹⁾
ENF, ISO, SEV ⁴⁾	5 vol%	- ¹⁾	- ¹⁾	- ¹⁾
DES ⁴⁾	15 vol%	- ¹⁾	- ¹⁾	- ¹⁾
Xe (Xenon) ⁴⁾	80 vol%	-10% of reading ³⁾	- ¹⁾	- ¹⁾
He (Helium) ⁴⁾	50 vol%	-6% of reading ³⁾	- ¹⁾	- ¹⁾
Metered Dose Inhaler Propellants ⁴⁾	Not for use with metered dose inhaler propellants			
C ₂ H ₅ OH (Ethanol) ⁴⁾	0.3 vol%	- ¹⁾	- ¹⁾	- ¹⁾
C ₃ H ₇ OH (Isopropanol) ⁴⁾	0.5 vol%	- ¹⁾	- ¹⁾	- ¹⁾
CH ₃ COCH ₃ (Acetone) ⁴⁾	1 vol%	- ¹⁾	- ¹⁾	- ¹⁾
CH ₄ (Methane) ⁴⁾	3 vol%	- ¹⁾	- ¹⁾	- ¹⁾

CO (Carbon monoxide) ⁵⁾	1 vol%	- ¹⁾	- ¹⁾	- ¹⁾
NO (Nitrogen monoxide) ⁵⁾	0.02 vol%	- ¹⁾	- ¹⁾	- ¹⁾
O ₂ ⁵⁾	100 vol%	- ²⁾	- ¹⁾	- ¹⁾

Note 1: Negligible interference, effect included in the specification “Accuracy, all conditions” above.

Note 2: Negligible interference with N₂O / O₂ concentrations correctly set, effect included in the specification “Accuracy, all conditions” above.

Note 3: Interference at indicated gas level. For example, 50 vol% Helium typically decreases the CO₂ readings by 6%. This means that if measuring on a mixture containing 5.0vol% CO₂ and 50vol% Helium, the actual measured CO₂ concentration will typically be $(1-0.06) * 5.0\text{vol}\% = 4.7\text{vol}\% \text{CO}_2$.

Note 4: According to the EN ISO 80601-2-55:2018 standard.

Note 5: In addition to the EN ISO 80601-2-55:2018 standard.

A.14.2 Mainstream

Masimo IRMA module

Module Type	IRMA AX+	Displaying the concentration of CO ₂ , N ₂ O and two anaesthesia agent and identifying two anaesthesia agent
Measurement Parameters	CO ₂ , N ₂ O, HAL, Isoflurane (ISO), Enflurane (ENF), Sevoflurane (SEV), Desflurane (DES), AwRR, MAC	
Measurement Principle	CO ₂ , N ₂ O, anaesthesia agent: infra-red absorption characteristic	
Dimensions (W × D × H)	38 mm × 37 mm × 34 mm (1.49” × 1.45” × 1.34”)	
Weight	≤ 25 g (cable excluded)	

According to the degree of protection against harmful ingress of water	IP44
Mechanical robustness	Withstand repeated 1.8 m drops on a hard surface. Complies with requirements for shock and vibration for professional transportation according to EN ISO 80601-2-55:2018 and requirements for road ambulances according to EN1789:2007 (clause 6.4).
Recovery time after defibrillator test	Unaffected
Drift of measurement accuracy	No drift
Surface temperature (at ambient temp. 23 °C)	Max 46 °C / 115 °F
Airway adapters	Disposable adult/pediatric: <ul style="list-style-type: none"> - Adds less than 6 ml deadspace - Pressure drop less than 0.3 cm H₂O @ 30 LPM Disposable infant: <ul style="list-style-type: none"> - Adds less than 1 ml deadspace - Pressure drop less than 1.3 cm H₂O @ 10 LPM (Infant Airway Adapter recommended for Tracheal Tube ID size ≤ 4 mm)
Breath detection	Adaptive threshold, minimum 1 vol% change in CO ₂ concentration.
Respiration rate	0 to 150 ± 1 bpm. The respiration rate is displayed after three breaths and the average value is updated every breath. (Measured at I/E ratio 1:1 using breath simulator according to EN ISO 80601-2-55 fig. 201.101.)

Fi and ET	<p>IRMA AX+: CO₂, N₂O, primary and secondary agents (HAL, ENF, ISO, SEV, DES)</p> <p>Fi and ET are displayed after one breath and have a continually updated breath average.</p> <p>The following method is used to calculate end-tidal (ET) values:</p> <ul style="list-style-type: none"> - CO₂: The highest concentration of CO₂ during one breathing cycle with a weight function applied to favor values closer to the end of the cycle. - N₂O and anesthetic agents: The momentary gas concentration at the time point where etCO₂ is detected. <p>ET-values for anathesthetic agents and N₂O (IRMA AX+) will typically decrease below nominal value when respiration rate exceeds 80 bpm. The maximum decrease is described by the formula $ET = 80 * ET_{nom} / RR$.</p> <p>etCO₂ will be within specification for all respiration rates up to 150 bpm. (Measured at I/E ratio 1:1 using breath simulator according to EN ISO 80601-2-55 fig. 201.101.)</p>
Automatic agent identification	Primary and secondary agents
Probe	<p>2-9 channel NDIR type gas analyzer measuring at 4-10 μm. Data acquisition rate 10 kHz (sample rate 20 Hz / channel). Pressure, temperature and full spectral interference correction.</p>
Calibration	Zeroing recommended when changing Airway adapter. No span calibration required for the IR bench.
Warm-up Time	< 20 seconds (agent identification enabled and full accuracy)
Rise Time (@ 10 l/min)	<p>CO₂ ≤ 90 ms</p> <p>N₂O ≤ 300 ms</p> <p>HAL, ISO, ENF, SEV, DES ≤ 300 ms</p> <p>(Measured @ 10 l/min with gas concentration steps corresponding to 30% of total measuring range for each gas.)</p>
Primary Agent Threshold	0.15 vol%. When an agent is identified, concentrations will be reported even below 0.15 vol% as long as apnea is not detected.

Secondary Agent Threshold	0.2 vol% + 10% of total agent concentration		
Agent Identification Time	< 20 seconds (typically < 10 seconds)		
Total System Response Time	< 1 second (Measured according to EN ISO 80601-2-55.)		
Barometric Pressure Compensation	Automatic		
Data Update Period	1 s		
Measurement Range	CO ₂ : 0 to 25 vol% N ₂ O: 0 to 100 vol% HAL, ENF, ISO, SEV, DES: 0 to 25 vol% AwRR: 0 to 150 rpm		
Resolution	CO ₂ : 0.1% HAL, ENF, ISO, SEV, DES: 0.1% N ₂ O: 1% AwRR: 1 rpm		
☆Accuracy- Standard Conditions	Gas	Range	Accuracy
	CO ₂	0 to 15 vol%	±(0.2 vol% + 2% of reading)
	N ₂ O	0 to 100 vol%	±(2 vol% + 2% of reading)
	HAL	0 to 8 vol%	±(0.15 vol% + 5% of reading)
	ISO		
	ENF		
	SEV	0 to 10 vol%	±(0.15 vol% + 5% of reading)
DES	0 to 22 vol%	±(0.15 vol% + 5% of reading)	
The accuracy specifications above are valid for dry single gases at 22 ± 5 °C and 1013 ± 40 hPa.			
☆Accuracy- All Conditions	Gas	Accuracy	
	CO ₂	±(0.3 kPa + 4% of reading)	
	N ₂ O	±(2 kPa + 5% of reading)	

	Agents	$\pm(0.2 \text{ kPa} + 10\% \text{ of reading})$ (The accuracy specification for IRMA AX+ is not valid if more than two agents are present in the gas mixture)
The accuracy specification above is valid for all specified environmental conditions except for interference specified in Section <i>Effects From Water Vapor Partial Pressure On Gas Readings</i> and Section <i>Interfering Gas Effects</i> .		
☆AwRR Accuracy	$\pm 1 \text{ rpm}$	
☆No Breath Detected Alarm Delay	20 s, 25 s, 30 s, 35 s, 40 s; default value is 20 s.	
Work Mode	Measure	
☆Alarm	Providing alarms of etCO ₂ , FiCO ₂ , etN ₂ O, FiN ₂ O, etAA, FiAA, AwRR	
Support:		
<ul style="list-style-type: none"> ◆ Real-time gas concentration monitoring ◆ Zero calibration 		

Interfering Gas Effects:

Gas	Gas Level	CO ₂	Agents	N ₂ O
		IRMA AX+		
N ₂ O ⁴⁾	60 vol%	-1&2)	-1)	-1)
HAL ⁴⁾	4 vol%	-1)	-1)	-1)
ENF, ISO, SEV ⁴⁾	5 vol%	-1)	-1)	-1)
DES ⁴⁾	15 vol%	-1)	-1)	-1)
Xe (Xenon) ⁴⁾	80 vol%	-10% of reading ³⁾	-1)	-1)
He (Helium) ⁴⁾	50 vol%	-6% of reading ³⁾	-1)	-1)
Metered Dose Inhaler Propellants ⁴⁾	Not for use with metered dose inhaler propellants			
C ₂ H ₅ OH (Ethanol) ⁴⁾	0.3 vol%	-1)	-1)	-1)

C ₃ H ₇ OH (Isopropanol) ⁴⁾	0.5 vol%	- ¹⁾	- ¹⁾	- ¹⁾
CH ₃ COCH ₃ (Acetone) ⁴⁾	1 vol%	- ¹⁾	- ¹⁾	- ¹⁾
CH ₄ (Methane) ⁴⁾	3 vol%	- ¹⁾	- ¹⁾	- ¹⁾
CO (Carbon monoxide) ⁵⁾	1 vol%	- ¹⁾	- ¹⁾	- ¹⁾
NO (Nitrogen monoxide) ⁵⁾	0.02 vol%	- ¹⁾	- ¹⁾	- ¹⁾
O ₂ ⁵⁾	100 vol%	- ^{1&2)}	- ¹⁾	- ¹⁾

Note 1: Negligible interference, effect included in the specification “Accuracy, all conditions” above.

Note 2: For probes not measuring N₂O and/or O₂ the concentrations shall be set from host according to the instructions. (IRMA AX+ does not measure O₂)

Note 3: Interference at indicated gas level. For example, 50 vol% Helium typically decreases the CO₂ readings by 6%. This means that if measuring on a mixture containing 5.0 vol% CO₂ and 50 vol% Helium, the measured CO₂ concentration will typically be $(1-0.06) * 5.0 \text{ vol\%} = 4.7 \text{ vol\% CO}_2$.

Note 4: According to the EN ISO 80601-2-55:2018 standard.

Note 5: In addition to the EN ISO 80601-2-55:2018 standard.

A.15 Interfaces

A.15.1 Analog Output

Bandwidth (-3 dB; reference frequency: 10 Hz)	Monitor: 0.5 Hz to 40 Hz Diagnosis: 0.5 Hz to 40 Hz Diagnosis 1: 0.05 Hz to 40 Hz Surgery: 1 Hz to 20 Hz Enhanced: 2 Hz ~18 Hz Customized: When Low-pass Filter < 40 Hz, Bandwidth is High-pass Filter ~ Low-pass Filter; When Low-pass Filter > 40 Hz, Bandwidth is High-pass ~40 Hz.
Maximum Transmission Delay (Diagnosis Mode)	500 ms

Sensitivity	1 V/1 mV \pm 10%
PACE Rejection/ Enhancement	No PACE rejection or enhancement
Waveform Display	Consistent with the calculation leads.
Compliant with Standard and Directive	Complies with the requirements in terms of short circuit protection and leakage current in EN60601-1.
Output Impedance	< 500 Ω
Interface Type	PS2 connector

NOTE:

While using analog output, set the calculation lead as following:

- 1) In 3 Electrodes mode, set to Lead I, Lead II, or Lead III.**
- 2) In 5 Electrodes mode, set to Lead I, Lead II, Lead III or Lead V.**
- 3) In 6 Electrodes mode, set to I, II, III, and leads corresponding to Va, Vb.**
- 4) In 10 Electrodes mode, set to Lead I, Lead II, Lead III or Lead V1~V6.**

A.15.2 Defibrillator Synchronization

Output Impedance	< 500 Ω
Maximum Time Delay	35 ms (R-wave peak to leading edge of pulse)
Waveform	Rectangular wave
Amplitude	High level: 3.5 V to 5.5 V, providing a maximum of 1 mA output current; Low level: < 0.5 V, receiving a maximum of 5 mA input current
Minimum Required R-wave Amplitude	0.3 mV
Pulse Width	100 ms \pm 10%
Limited Current	15 mA rating
Rising and Falling Time	< 1 ms
Interface Type	PS2 connector

A.15.3 Nurse Call

Drive Mode	Voltage output
Power Supply	≤ 12.6 VDC, 200 mA Max.
Interface Signal	12 V power supply and PWM waveform
Interface Type	PS2 connector

PS2 connector Definition for Analog Output/Defibrillator Synchronization/Nurse Call

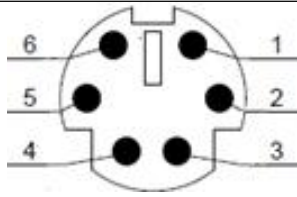
	PIN.NO.	Signal name	Signal Description
	1	ANALOG_OUT	Analog out signal
	2	GND	Ground
	3	SYS_OUT	Defibrillator Synchronization signal
	4	+12V	Nurse call power
	5	GND	Ground
	6	NURSE_OUT	Nurse call control signal

A 15.4 USB Interfaces

Number of USB Interfaces	Standard: 4
Drive Mode	HOST interface, USB1.0/2.0 protocol
Power Supply	5 VDC±5%, 500 mA Max.
Interface Type	USB A-type port

A.15.5 Video Output Interface

Interface Type	HDMI A-type port
----------------	------------------

A.15.6 RS232 Interface

Level	RS232
Interface Type	iX10 Series: RJ-45 interface iX12/iX15 Series: DB-9 female receptacle

A.15.7 Wired Network Interface

Specification	100-Base TX (IEEE802.3)
Interface Type	Standard RJ-45 network interface

A.15.8 Power Adapter Interface

Only applicable to iX10 Series.

Specification	DC 20V Input (Max)
Interface Type	DC Power Jack interface

B EMC Information

- Guidance and Manufacture's Declaration

B.1 Electromagnetic Emissions

Guidance and manufacture's declaration – electromagnetic emission		
iX10/iX12/iX15 Series are intended for use in the electromagnetic environment specified below. The customer or the user of iX10/iX12/iX15 Series should assure that they are used in such an environment.		
Emission test	Compliance	Electromagnetic environment – guidance
RF emissions CISPR 11	Group 1	iX10/iX12/iX15 Series use RF energy only for their internal function. Therefore, their RF emissions are very low and are not likely to cause any interference in nearby electronic equipment.
RF emission CISPR 11	Class A	iX10/iX12/iX15 Series are suitable for use in all establishments, other than domestic establishments and those directly connected to the public low-voltage power supply network that supplies buildings used for domestic purposes.
Harmonic emissions IEC/EN 61000-3-2	Class A	
Voltage fluctuations/ flicker emissions IEC/EN 61000-3-3	Complies	

NOTE:

The EMISSIONS characteristics of iX10/iX12/iX15 Series make it suitable for use in industrial areas and hospitals (CISPR 11 class A). If it is used in a residential environment (for which CISPR 11 class B is normally required) iX10/iX12/iX15 Series might not offer adequate protection to radio-frequency communication services. The user might need to take mitigation measures, such as relocating or re-orienting the equipment.

B.2 Electromagnetic Immunity

Guidance and manufacture's declaration – electromagnetic immunity			
iX10/iX12/iX15 Series are intended for use in the electromagnetic environment specified below. The customer or the user of iX10/iX12/iX15 Series should assure that they are used in such an environment.			
Immunity test	IEC/EN 60601 test level	Compliance level	Electromagnetic environment – guidance
Electrostatic discharge (ESD) IEC/EN 61000-4-2	± 8 kV contact ± 2 kV, ± 4 kV, ± 8 kV, ± 15 kV air	± 8 kV contact ± 2 kV, ± 4 kV, ± 8 kV, ± 15 kV air	Floors should be wood, concrete or ceramic tile. If floor are covered with synthetic material, the relative humidity should be at least 30%.
Electrical fast transient/burst IEC/EN 61000-4-4	± 2 kV for power supply lines	± 2 kV for power supply lines	Mains power quality should be that of a typical commercial or hospital environment.
Surge IEC/EN 61000-4-5	± 1 kV for line to line ± 2 kV for line to ground	± 1 kV for line to line ± 2 kV for line to ground	Mains power quality should be that of a typical commercial or hospital environment.
Power frequency (50/60Hz) magnetic field IEC/EN 61000-4-8	30 A/m	30 A/m	Power frequency magnetic fields should be at levels characteristic of a typical location in a typical commercial or hospital environment.

<p>Voltage dips, short interruptions and voltage variations on power supply input lines</p> <p>IEC/EN 61000-4-11</p>	<p>0 % U_T; 0.5 cycle</p> <p>At 0°, 45°, 90°, 135°, 180°, 225°, 270° and 315°</p> <p>0 % U_T; 1 cycle</p> <p>and</p> <p>70 % U_T; 25/30 cycles)</p> <p>Single phase: at 0°</p> <p>0 % U_T; 250/300 cycle</p>	<p>0 % U_T; 0.5 cycle</p> <p>At 0°, 45°, 90°, 135°, 180°, 225°, 270° and 315°</p> <p>0 % U_T; 1 cycle</p> <p>and</p> <p>70 % U_T; 25/30 cycles)</p> <p>Single phase: at 0°</p> <p>0 % U_T; 250/300 cycle</p>	<p>Mains power quality should be that of a typical commercial or hospital environment. If the user of iX10/iX12/iX15 Series requires continued operation during power mains interruptions, it is recommended that iX10/iX12/iX15 Series be powered from an uninterruptible power supply or a battery.</p>
<p>IMMUNITY to proximity magnetic fields</p>	<p>Test frequency: 30 KHz;</p> <p>65 A/m,</p> <p>Modulation: Pulse modulation, 2.1 KHz</p> <p>Test frequency:134.2 KHz;</p> <p>7.5 A/m,</p> <p>Modulation: Pulse modulation, 50 KHz</p> <p>Test frequency: 13.56 MHz</p>	<p>Test frequency: 30KHz;</p> <p>65 A/m,</p> <p>Modulation: Pulse modulation, 2.1 KHz</p> <p>Test frequency:134.2 KHz;</p> <p>7.5 A/m,</p> <p>Modulation: Pulse modulation, 50 KHz</p> <p>Test frequency: 13.56 MHz</p>	<p>--</p>
<p>NOTE U_T is the a.c. mains voltage prior to application of the test level.</p>			

Test Levels

RFID Specification	Frequency	Test level (RMS)	Result
ISO 14223	134.2 kHz	65 A/m	Complies
ISO/IEC 14443-3 (Type A)	13.56 MHz	7.5 A/m	Complies
ISO/IEC 14443-4 (Type B)	13.56 MHz	7.5 A/m	Complies
ISO/IEC 15693 (ISO 18000-3 Mode 1)	13.56 MHz	5 A/m	Complies
ISO 18000-3 Mode 3	13.56 MHz	12 A/m	Complies
ISO/IEC 18000-7	433 MHz	3 V/m	Complies
ISO/IEC 18000-63 Type C ^a	860-960 MHz	54 V/m	Complies
ISO/IEC 18000-4 Mode 1	2.45 GHz	54 V/m	Complies

NOTE:

Keep RFID readers away from the device.

B.3 Electromagnetic Immunity

Guidance and manufacture's declaration – electromagnetic immunity			
iX10/iX12/iX15 Series are intended for use in the electromagnetic environment specified below. The customer or the user of iX10/iX12/iX15 Series should assure that they are used in such an environment.			
Immunity test	IEC/EN 60601 test level	Compliance level	Electromagnetic environment - guidance
			<p>Portable and mobile RF communications equipment should be used no closer to any part of iX10/iX12/iX15 Series, including cables, than the recommended separation distance calculated from the equation applicable to the frequency of the transmitter.</p> <p>Recommended separation distance</p>

<p>Conducted RF IEC/EN 61000-4-6 Radiated RF IEC/EN 61000-4-3</p>	<p>$3 V_{rms}$ 150 kHz to 80 MHz $6V_{rms}^c$ in ISM bands between 0.15 MHz and 80 MHz $3 V/m$ 80 MHz to 2.7 GHz See Table 1</p>	<p>$3 V_{rms}$ 150 kHz to 80 MHz $6V_{rms}^c$ in ISM bands between 0.15 MHz and 80 MHz $3 V/m$ 80 MHz to 2.7 GHz Comply with Table 1</p>	<p>$d = 1.2\sqrt{P}$ 150KHz to 80MHz $d = 1.2\sqrt{P}$ 80 MHz to 800 MHz $d = 2.3\sqrt{P}$ 800 MHz to 2.7 GHz $d = 6\sqrt{P} / E$ at RF wireless communications equipment bands (Portable RF communications equipment (including peripherals such as antenna cables and external antennas) should be used no closer than 30 cm (12 inches) to any part of the monitor, including cables specified by the manufacturer).</p> <p>Where P is the maximum output power rating of the transmitter in watts (W) according to the transmitter manufacturer and d is the recommended separation distance in meters (m).</p> <p>Field strengths from fixed RF transmitters, as determined by an electromagnetic site survey,^a should be less than the compliance level in each frequency range.^b</p> <p>Interference may occur in the vicinity of equipment marked with the following symbol: </p>
---	--	--	--

NOTE 1 At 80 MHz and 800 MHz, the higher frequency range applies.

NOTE 2 These guidelines may not apply in all situations. Electromagnetic propagation is affected by absorption and reflection from structures, objects and people.

^a Field strengths from fixed transmitters, such as base stations for radio (cellular/cordless) telephones and land mobile radios, amateur radio, AM and FM radio broadcast and TV broadcast cannot be predicted theoretically with accuracy. To assess the electromagnetic environment due to fixed RF transmitters, an electromagnetic site survey should be considered. If the measured field strength in the location in which iX10/iX12/iX15 Series are used exceeds the applicable RF compliance level above, iX10/iX12/iX15 Series should be observed to verify normal operation. If abnormal performance is observed, additional measures may be necessary, such as reorienting or relocating iX10/iX12/iX15 Series.

^b Over the frequency range 150kHz to 80MHz, field strengths should be less than 3V/m.

^c The ISM (industrial, scientific and medical) bands between 0.15 MHz and 80 MHz are 6.765 MHz to 6.795 MHz; 13.553 MHz to 13.567 MHz; 26.957 MHz to 27.283 MHz; and 40.66 MHz to 40.70 MHz. The amateur radio bands between 0.15 MHz and 80 MHz are 1.8 MHz to 2.0 MHz, 3.5 MHz to 4.0 MHz, 5.3 MHz to 5.4 MHz, 7 MHz to 7.3 MHz, 10.1 MHz to 10.15 MHz, 14 MHz to 14.2 MHz, 18.07 MHz to 18.17 MHz, 21.0 MHz to 21.4 MHz, 24.89 MHz to 24.99 MHz, 28.0 MHz to 29.7 MHz and 50.0 MHz to 54.0 MHz.

Table 1 Test specifications for ENCLOSURE PORT IMMUNITY to RF wireless communications equipment

Test frequency (MHz)	Band ^{a)} (MHz)	Service ^{a)}	Modulation ^{b)}	Maximum power (W)	Distance (m)	Immunity test level (V/m)
385	380-390	TETRA 400	Pulse modulation ^{b)} 18 Hz	1.8	0.3	27
450	430-470	GMRS 460, FRS 460	FM ^{c)} ± 5 kHz deviation 1 kHz sine	2	0.3	28

Test frequency (MHz)	Band ^{a)} (MHz)	Service ^{a)}	Modulation ^{b)}	Maximum power (W)	Distance (m)	Immunity test level (V/m)
710	704-787	LTE Band 13, 17	Pulse modulation ^{b)} 217 Hz	0.2	0.3	9
745						
780						
810	800-960	GSM 800/900, TETRA 800, iDEN 820, CDMA 850, LTE Band 5	Pulse modulation ^{b)} 18 Hz	2	0.3	28
870						
930						
1720	1700-1990	GSM 1800; CDMA 1900; GSM 1900; DECT; LTE Band 1, 3, 4, 25; UMTS	Pulse modulation ^{b)} 217 Hz	2	0.3	28
1845						
1970						
2450	2400-2570	Bluetooth, WLAN, 802.11 b/g/n, RFID 2450, LTE Band 7	Pulse modulation ^{b)} 217 Hz	2	0.3	28
5240	5100-5800	WLAN 802.11 a/n	Pulse modulation ^{b)} 217 Hz	0.2	0.3	9
5500						
5785						

NOTE If necessary to achieve the IMMUNITY TEST LEVEL, the distance between the transmitting antenna and the ME EQUIPMENT or ME SYSTEM may be reduced to 1 m. The 1 m test distance is permitted by IEC 61000-4-3.

a) For some services, only the uplink frequencies are included.

b) The carrier shall be modulated using a 50 % duty cycle square wave signal.

c) As an alternative to FM modulation, 50 % pulse modulation at 18 Hz may be used because while it does not represent actual modulation, it would be worst case.

B.4 Recommended Separation Distances

Recommended separation distances between portable and mobile RF communications equipment and iX10/iX12/iX15 Series			
iX10/iX12/iX15 Series are intended for use in an electromagnetic environment in which radiated RF disturbances are controlled. The customer or the user of iX10/iX12/iX15 Series can help prevent electromagnetic interference by maintaining a minimum distance between portable and mobile RF communications equipment (transmitters) and iX10/iX12/iX15 Series as recommended below, according to the maximum output power of the communications equipment.			
Rated maximum output power of transmitter (W)	Separation distance according to frequency of transmitter(m)		
	150 kHz to 80 MHz $d = 1.2\sqrt{P}$	80 MHz to 800 MHz $d = 1.2\sqrt{P}$	800 MHz to 2.7 GHz $d = 2.3\sqrt{P}$
0.01	0.12	0.12	0.23
0.1	0.38	0.38	0.73
1	1.2	1.2	2.3
10	3.8	3.8	7.3
100	12	12	23
For transmitters rated at a maximum output power not listed above, the recommended separation distance d in meters (m) can be estimated using the equation applicable to the frequency of the transmitter, where P is the maximum output power rating of the transmitter in watts (W) according to the transmitter manufacturer.			
NOTE 1 At 80 MHz and 800 MHz, the separation distance for the higher frequency range applies.			
NOTE 2 These guidelines may not apply in all situations. Electromagnetic propagation is affected by absorption and reflection from structures, objects and people.			

C Default Settings

This appendix documents the most important default settings of your monitor as it is delivered from the factory.

NOTE:

If your monitor has been preconfigured according to your requirements, the settings at delivery will be different from the default settings listed here.

C.1 Patient Information Default Settings

Patient Information Settings	
Patient Type	Adult
Pace	Unknown

C.2 Alarm Default Settings

Alarm Settings	
Pause Time	120 s
Alarm Latch	Off
Alarm Light	On When Reset
Alarm Switch Setup	Enable
Alarm Reset Authority	Off

C.3 ECG Default Settings

ECG Settings	Adult	Pediatric	Neonate
Alarm Switch	On		
Alarm Record	Off		
Alarm Level	Medium		
Alarm High Limit	120	160	200
Alarm Low Limit	50	75	100
Arrhythmia Analysis Threshold Value			
Low	0.5 mV		

Voltage(Limb)			
Pause	3 s		
Sustain VT	30 s		
PAC Bigeminy	8/min		
Pauses/min High	8/min		
PVCs High	10/min		
PAC Trigeminy	16/min		
ExtremeTachy	160	180	200
Extreme Brady	30	50	60
Pace	Off		
Electrode Type	Auto		
Filter	Monitor		
Smart Lead Off	On		
QRS Volume	2		
ST Analysis	Off		
Alarm Switch	On		
Alarm Level	Medium		
Alarm Record	Off		
Alarm High Limit (ST-X)	0.2		
Alarm Low Limit (ST-X)	-0.2		
QT Analysis	Off		
QTc	500	480	460
Δ QTc	60		
X stands for I, II, III, aVR, aVL, aVF, V, V1, V2, V3, V4, V5 or V6.			
	Adult	Pediatric	Neonate
Arrhythmia Analysis	On	Off	Off

Arrhythmia Alarm Settings	Alarm Switch	Alarm Level	Alarm Record
Asystole	On (non-adjustable)	High (non-adjustable)	Off
V-Fib/V-Tach	On	High (non-adjustable)	Off
R on T	On	Medium	Off
PVC	On	Low	Off
Couplet	On	Low	Off
Run PVCs	On	Low	Off
PVC Bigeminy	On	Low	Off
PVC Trigeminy	On	Low	Off
Tachy	On	Medium	Off
Brady	On	Medium	Off
Missed Beat	On	Low	Off
Irr Rhythm	On	Low	Off
Pacer not Capture	On	Medium	Off
Pacer not Pacing	On	Medium	Off
Vent Brady	On	High (non-adjustable)	Off
Vent Rhythm	On	Medium	Off
Sustain VT	On (non-adjustable)	High (non-adjustable)	Off
ExtremeTachy	On	High (non-adjustable)	Off
ExtremeBrady	On	High (non-adjustable)	Off
V-Tach	On	High (non-adjustable)	Off

Wide QRS Tachy	On	Medium	Off
Non-Sustain VT	On	Medium	Off
Afib	On	Medium	Off
Acc. Vent Rhythm	On	Low	Off
Pause	On	Medium	Off
Pauses/min High	On	Medium	Off
PVCs High	On	Medium	Off
VEB	On	Low	Off
Multiform PVCs	On	Low	Off
IPVC	On	Low	Off
PAC Bigeminy	On	Low	Off
PAC Trigeminy	On	Low	Off
Low Voltage(Limb)	On	Low	Off

C.4 RESP Default Settings

RESP Settings	Adult	Pediatric	Neonate
Alarm Switch	On		
Alarm Record	Off		
Alarm Level	Medium		
Alarm High Limit	30	30	100
Alarm Low Limit	8	8	30
No Breath Detected Alarm Time	20 s		
Hold Type	Auto		
RR Source	CO ₂		
Resp Lead	II		
Sweep	12.5 mm/s		
Scale	×1		

C.5 SpO₂ Default Settings

SpO ₂ Settings	Adult	Pediatric	Neonate
Alarm Switch	On		
Alarm Record	Off		
Alarm Level	Medium		
Alarm High Limit	100	100	98
Alarm Low Limit	90	90	88
Pitch Tone	Off		
Sensitivity (EDAN Module)	Medium		
Response Mode (Nellcor Module)	Normal		
NIBP Simul	Off		
SatSeconds (Nellcor Module)	100	100	Off
Sweep	12.5 mm/s		
SpO ₂ Desat Limit	80%		
Sensor Light Intensity(EDAN Module)	Off		

C.6 PR Default Settings

PR Settings	Adult	Pediatric	Neonate
PR Source	SpO ₂		
Alarm Switch	On		
Alarm Record	Off		
Alarm Level	Medium		
Alarm High Limit	120	160	200
Alarm Low Limit	50	75	100
QRS Volume	2		
Alarm Source	Auto		

C.7 NIBP Default Settings

NIBP Settings	Adult	Pediatric	Neonate
Alarm Switch	On		
Alarm Record	Off		
Alarm Level	Medium		
Alarm High Limit (SYS)	160	120	90
Alarm Low Limit (SYS)	90	70	40
Alarm High Limit (Map)	110	90	70
Alarm Low Limit (Map)	60	50	30
Alarm High Limit (Dia)	90	70	60
Alarm Low Limit (Dia)	50	40	20
Inflation value	160	140	100
Unit	mmHg		
Measure Mode	Manual		
NIBP Algorithm	iCUFS		

C.8 CNBP Default Settings

CNBP Settings	Adult	Pediatric
Alarm Switch	On	
Alarm Record	Off	
Alarm Level	Medium	
Alarm High Limit (SYS)	160	120
Alarm Low Limit (SYS)	90	70
Alarm High Limit (Dia)	90	70
Alarm Low Limit (Dia)	50	40

C.9 TEMP Default Settings

TEMP Settings	Adult	Pediatric	Neonate
Alarm Switch	On		
Alarm Record	Off		
Alarm Level	Medium		
Alarm High Limit (T1)	39.0	39.0	39.0
Alarm Low Limit (T1)	36.0	36.0	36.0
Alarm High Limit (T2)	39.0	39.0	39.0
Alarm Low Limit (T2)	36.0	36.0	36.0
Alarm High Limit (TD)	2.0	2.0	2.0
Unit	°C		
Measurement Site	Skin		

C.10 IBP Default Settings

IBP Settings	Adult	Pediatric	Neonate
Alarm Switch	On		
Alarm Record	Off		
Alarm Level	Medium		
Unit	mmHg		
Filter	12.5 Hz		
	SYS, DIA, MAP	SYS, DIA, MAP	SYS, DIA, MAP
Alarm High Limit (ART, Ao, UAP, BAP, FAP, LV, P1-P4)	160, 90, 110	120, 70, 90	90, 60, 70
Alarm Low Limit (ART, Ao, UAP, BAP, FAP, LV, P1-P4)	90, 50, 70	70, 40, 50	50, 20, 35
Alarm High Limit (PA)	30, 16, 20	60, 4, 26	60, 4, 26
Alarm Low Limit (PA)	10, 0, 0	24, -4, 12	24, -4, 12
	MAP	MAP	MAP

IBP Settings	Adult	Pediatric	Neonate
Alarm High Limit (CVP, ICP, LAP, RAP, UVP)	10	4	4
Alarm Low Limit (CVP, ICP, LAP, RAP, UVP)	0	0	0

C.11 CO₂ Default Settings

CO ₂ Settings	Adult	Pediatric	Neonate
Alarm Switch	On		
Alarm Record	Off		
Alarm Level	Medium		
Work Mode	Standby		
Unit	mmHg		
No Breath Detected Alarm Time	20 s		
O ₂ Compensation	16% (EDAN G2 Module and Respirationics Module) Low (Masimo Module)		
N ₂ O Compensation	0% (EDAN G2 Module and Respirationics Module) Low (Masimo Module)		
Anes Agent	0%		
Alarm High Limit (etCO ₂)	50	50	45
Alarm Low Limit (etCO ₂)	25	25	30
Alarm High Limit (FiCO ₂)	4	4	4
Alarm High Limit (AwRR)	30	30	100
Alarm Low Limit (AwRR)	8	8	30
Sweep	6.25 mm/s		
Amplitude	Low		

C.12 C.O. Default Settings

C.O. Settings	Adult	Pediatric	Neonate
Alarm Switch	On		
Alarm Record	Off		
Alarm Level	Medium		
Alarm High Limit (TB)	40	40	40
Alarm Low Limit (TB)	30	30	30
Injective Temperature Source	Auto		
Temperature Unit	°C		
Interval	70		
Constant	0.542		

C.13 AG Default Settings

AG Settings	Adult	Pediatric	Neonate
Alarm Switch	On		
Alarm Record	Off		
Alarm Level	Medium		
Work Mode	Measure		
No Breath Detected Alarm Time	20s		
Unit	%		
O ₂ Compensation	16% (EDAN G7 Module) Low (Masimo Module)		
Humidity Compensation	Low		
Anes Agent	HAL		
Alarm High Limit (etCO ₂ AG)	6.6	6.6	5.9
Alarm Low Limit (etCO ₂ AG)	3.3	3.3	3.9
Alarm Low Limit (FiCO ₂ AG)	0.5	0.5	0.5

AG Settings	Adult	Pediatric	Neonate
Alarm High Limit (AwRR AG)	30	30	100
Alarm Low Limit (AwRR AG)	8	8	30
Alarm High Limit (etO ₂)	100	100	100
Alarm Low Limit (etO ₂)	0	0	0
Alarm High Limit (FiO ₂)	100	100	100
Alarm Low Limit (FiO ₂)	18	18	18
Alarm High Limit (etN ₂ O)	55	55	55
Alarm Low Limit (etN ₂ O)	0	0	0
Alarm High Limit (FiN ₂ O)	53	53	53
Alarm Low Limit (FiN ₂ O)	0	0	0
Alarm High Limit (etHAL, etENF, etISO)	3	3	3
Alarm Low Limit (etHAL, etENF, etISO)	0	0	0
Alarm High Limit (FiHAL, FiENF, FiISO)	2	2	2
Alarm Low Limit (FiHAL, FiENF, FiISO)	0	0	0
Alarm High Limit (etSEV)	6	6	6
Alarm Low Limit (etSEV)	0	0	0
Alarm High Limit (FiSEV)	5	5	5
Alarm Low Limit (FiSEV)	0	0	0
Alarm High Limit (etDES)	8	8	8
Alarm Low Limit (etDES)	0	0	0
Alarm High Limit (FiDES)	6	6	6
Alarm Low Limit (FiDES)	0	0	0
Sweep	6.25 mm/s		
Amplitude	2		

D Abbreviations

Abbr	English Full Name/Description
AC	Alternating Current
Acc. Vent Rhythm	Accelerated Idioventricular Rhythm
Adu	Adult
Afib	Atrial Fibrillation
AG	Anaesthesia Gas
Art	Arterial
aVF	Left Foot Augmented Lead
aVL	Left Arm Augmented Lead
aVR	Right Arm Augmented Lead
AwRR	Airway Respiration Rate
BP	Blood Pressure
Brady	Bradycardia
BTPS	Body temperature and pressure, saturated
CI	Cardiac Index
C.O.	Cardiac Output
CISPR	International Special Committee on Radio Interference
CMS	Central Monitoring System
CO ₂	Carbon Dioxide
COHb	Carboxyhemoglobin
Couplet	Ventricular Couplets
CVP	Central Venous Pressure
DC	Direct Current
DDoS	Distributed Denial of Service
Des	Desflurane
Dia	Diastolic
DoS	Denial of Service
ECG	Electrocardiogram

Abbr	English Full Name/Description
EEC	European Economic Community
EMC	Electromagnetic Compatibility
EMI	Electromagnetic Interference
Enf	Enflurane
ESU	Electrosurgical Unit
Et	End-tidal
etCO ₂	End-tidal Carbon Dioxide
etN ₂ O	End-tidal Nitrous Oxide
Eto	Ethylene Oxide
etO ₂	End-tidal Oxygen
ExtremeTachy	Extreme Tachycardia
ExtremeBrady	Extreme Bradycardia
Fi	Fraction of Inspired
FiCO ₂	Fraction of Inspired Carbon Dioxide
FiN ₂ O	Fraction of Inspired Nitrous Oxide
FiO ₂	Fraction of Inspired Oxygen
Hal	Halothane
Hb	Hemoglobin
Hb-CO	Carbon Mono-xide Hemoglobin
HR	Heart Rate
IBP	Invasive Blood Pressure
ICP	Intracranial Pressure
ICU	Intensive Care Unit
ID	Identification
IEC	International Electrotechnical Commission
IEEE	Institute of Electrical and Electronic Engineers
IPVC	Inserted Premature Ventricular Contraction
Irr Rhythm	Irregular Rhythm

Abbr	English Full Name/Description
Iso	Isoflurane
LA	Left Arm
LAP	Left Atrial Pressure
LCD	Liquid Crystal Display
LED	Light Emitting Diode
LL	Left Leg
Low Voltage(Limb)	Low QRS Voltage
MAP	Mean Arterial Pressure
MDD	Medical Device Directive
MetHb	Methemoglobin
MRI	Magnetic Resonance Imaging
Multiform PVCs	Multiformed Premature Ventricular Contractions
N/A	Not Applied
N ₂	Nitrogen
N ₂ O	Nitrous Oxide
Neo	Neonate
NIBP	Non-invasive Blood Pressure
Non-Sustain VT	Nonsustained Ventricular Tachycardia
O ₂	Oxygen
oxyCRG	Oxygen Cardio-respirogram
PA	Pulmonary Artery
PAC Bigeminy	Premature Atrial Contraction (PAC) Bigeminy
PAC Trigeminy	Premature Atrial Contraction (PAC) Trigeminy
PAWP	Pulmonary Artery Wedge Pressure
Ped	Pediatric
Pleth	Plethysmogram
PR	Pulse Rate
PVC	Premature Ventricular Contraction

Abbr	English Full Name/Description
PVC Bigeminy	Premature Ventricular Contraction Bigeminy
PVC Trigeminy	Premature Ventricular Contraction Trigeminy
R	Right
RA	Right Arm
RAP	Right Atrial Pressure
Resp	Respiration
RHb	Reduced Hemoglobin
RL	Right Leg
RR	Respiration Rate
Run PVCs	Run premature Ventricular Contractions
Sev	Sevoflurane
SpO ₂	Pulse Oxygen Saturation
Sustain VT	Sustained Ventricular Tachycardia
SYS	Systolic Pressure
Tachy	Tachycardia
TB	Blood Temperature
TD	Temperature Difference
TEMP	Temperature
USB	Universal Serial Bus
VEB	Ventricular Escape Beat
Vent Brady	Ventricular Bradycardia
Vent Rhythm	Ventricular Rhythm
V-Fib/V-Tach	Ventricular Fibrillation/Ventricular Tachycardia
V-Tach	Ventricular Tachycardia
Wide QRS Tachy	Wide QRS Tachycardia

P/N: 01.54.458899

MPN: 01.54.458899014



EDAN INSTRUMENTS, INC.

#15 Jinhui Road, Jinsha Community, Kengzi Sub-District

Pingshan District, 518122 Shenzhen, P.R.China

Email: info@edan.com

TEL: +86-755-2689 8326 FAX: +86-755-2689 8330

Website: www.edan.com



EC REPRESENTATIVE

Shanghai International Holding Corp. GmbH

Eiffestrasse 80, 20537 Hamburg Germany

TEL: +49-40-2513175

E-mail: shholding@hotmail.com