



MANUAL
OPERATION



RECESS
OPTION



HOTEL
TRACK

FOREST CS[®] *Contract System*

Heavy duty hand drawn curtain track system for medium and heavy draperies.

FOREST CS[®]
FOREST CS[®] Recess

THE WORLD
BEHIND
YOUR
CURTAINS



FOREST CS®



PRODUCT INFORMATION

- Heavy duty hand drawn system for medium and heavy draperies.
- Bendable; it can be bent and reverse bent using a 20 cm (8") radius or continuous curve.
- Heavy duty clickable carriers - 10 carriers on a breakaway strip - UV protected. Can also be used with ball bearing carriers.
- Ideal for use with overlap masters and batons which can be mounted behind or in front of draperies.
- Can also be used for the Forest Wave System (FES) and accordiafold drapery systems.
- Maximum fabric weight: CS: 15 kg p/m, CS Recess: 10 kg p/m.
- Colours available: white, black and grey.
- Track finish: High quality aluminium, powder coated with a factory applied patented dry lubricant.
- Available lengths: 3.66 m (12'), 4.27 m (14'), 4.88 m (16'), 6.10 m (20')
- Warranty: 10 years

- 1 CS Track
- 2 Carrier
- 3 Master Carrier R/L Overlap
- 4 Master Carrier R/L Underlap
- 5 Ball bearing carrier
- 6 Endcap with screw

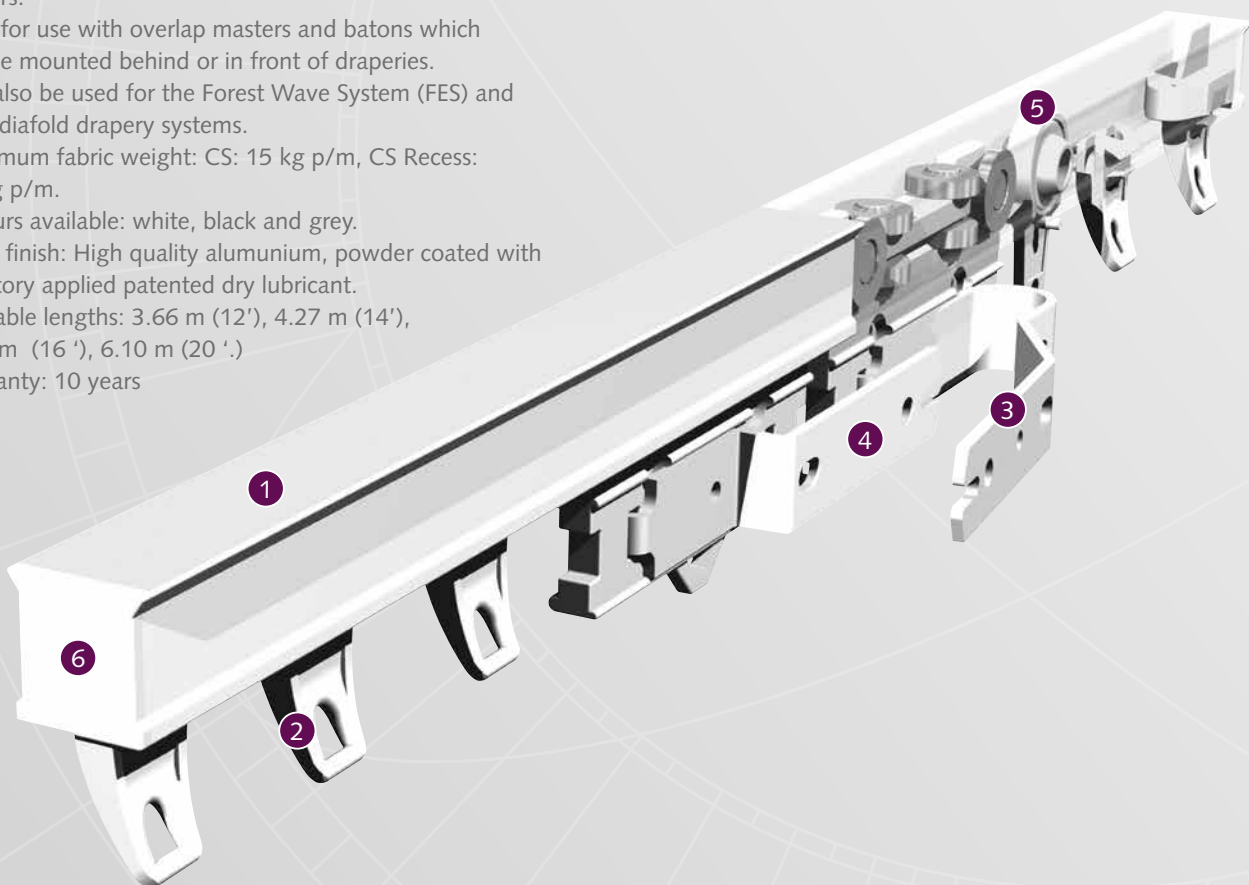



CS RECESS

Our CS® is now also offered as the CS® Recess model. Special care and attention have been given to the track joining method and endcaps. The CS® Recess brings a touch of luxury to any space with its seamless ceiling integration, providing a refined and graceful finish. Equipped with the innovative silent roller glider, it ensures ultra-smooth and whisper-quiet curtain operation. Available in matt white and matt black.

BENDING / CURVING

The CS® and CS® Recess can be bent and reverse bent using a 20 cm (8") radius. Continuous curving is also possible with the electrical bending tool (only possible with CS rail).

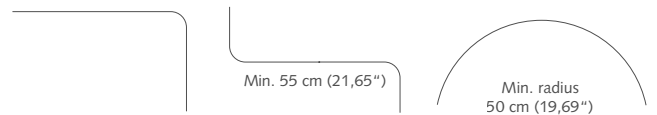

PROFILE

CS:

- Weight: 235 gr/mtr (2.53 ounce - ft)
- 20 mm x 20 mm (0,8" x 0,8")
- Aluminium Extrusion

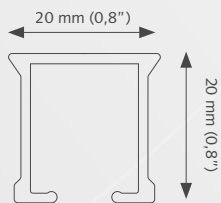

CS Recess:

- Weight: 385 gr/mtr (4.14 ounce - ft)
- 23 x 23 mm (0,9" x 0,9")
- Pre-drilled: holes every 25 cm

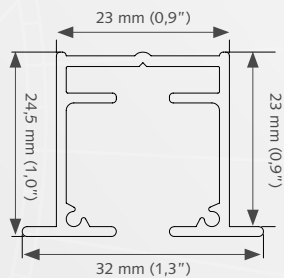

FOR USE IN

Hotels - Motels - offices - schools - healthcare residential or at any location where a heavy duty hand drawn system is required.



Easy installation
click - position - tighten

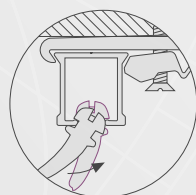

clickable carrier

38 mm (1,5")

APPLICATIONS

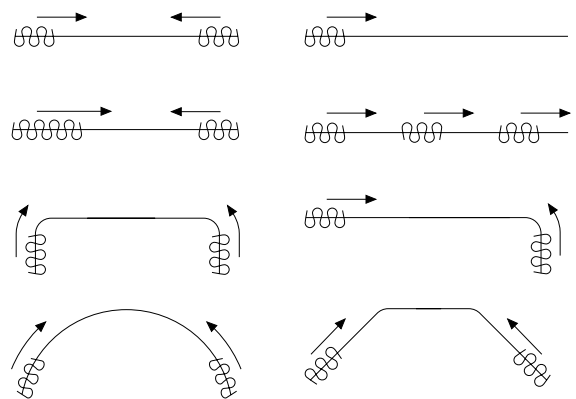

CLICK-ON STIFFENER

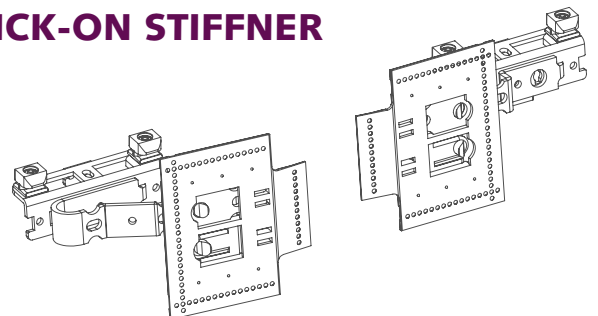

For applications where the curtains are treated very roughly, the stiffener is a sustainable solution. The stiffener makes curtains more robust and ensures that curtains last longer. Especially useful for hotels.

MOUNTING BRACKETS

Smart Klick Ceiling bracket

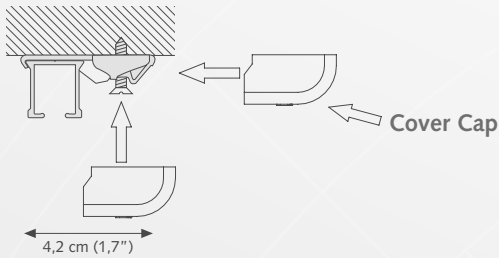

A) Min. 7,5 cm (2,9")



A) Min. 15 cm (5,9")

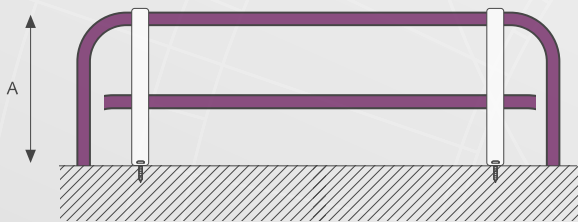

Other brackets are available. Brackets need to be placed every 60 cm (24").

SK Aluminium Wall bracket single

- A) 7,5 cm (3") B) 6,3 cm (2,5")
 A) 10 cm (4") B) 8,8 cm (3,5")

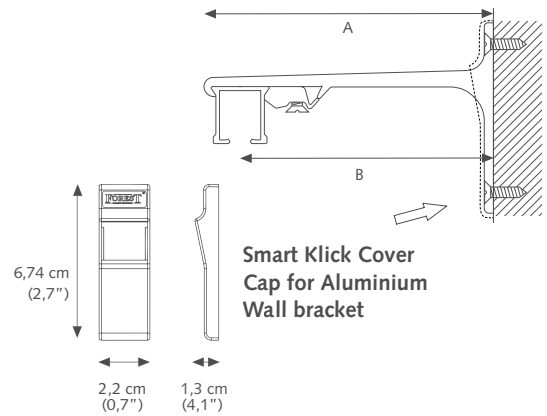

SK Aluminium Wall bracket double

- A) 15 cm (6") B) 9,2 cm (3,6") C) 4,5 cm (1,8")
 A) 20 cm (8") B) 9,2 cm (3,6") C) 9,5 cm (3,7")

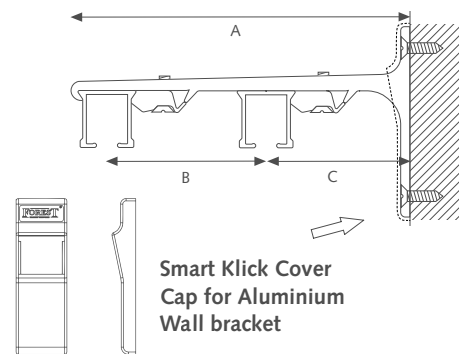





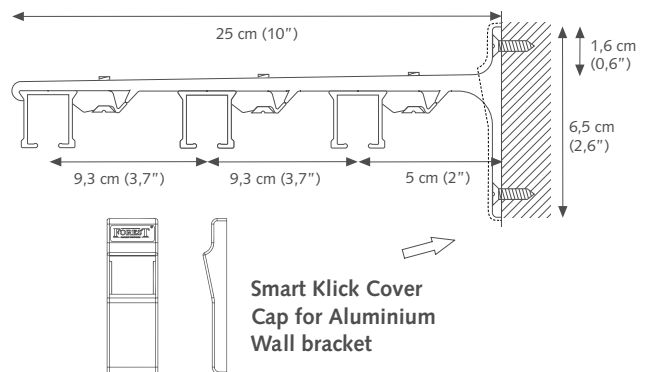



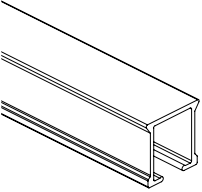
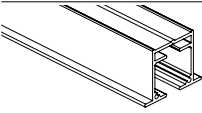
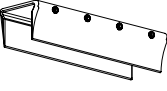
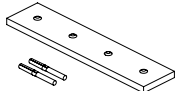
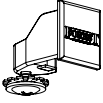
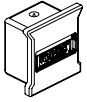
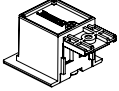
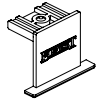

SK Aluminium Wall bracket triple

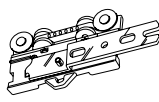
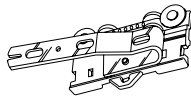

- A) 25 cm (10")

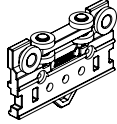
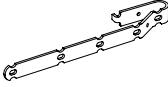
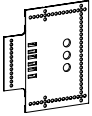

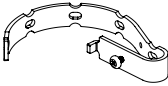

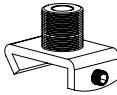
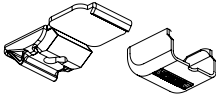
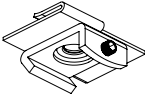
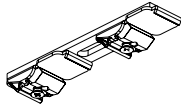
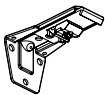
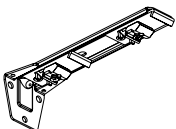

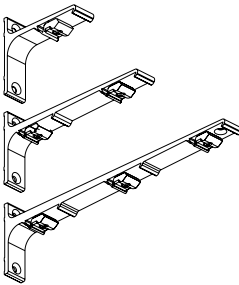
Brackets need to be placed every 50 - 60 cm (20"-24"), depending on fabric weight.

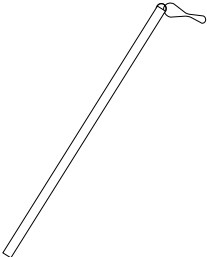
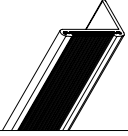
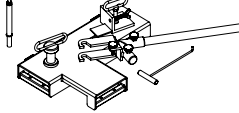
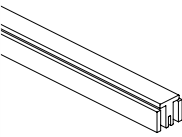
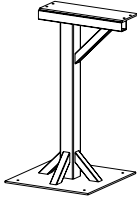
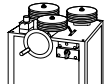
CS	CS RECESS	ARTICLE	PACKING UNIT		ART.NR	
●			CS TRACK WHITE Extruded aluminium, powder coating, factory lubricated.	10/bundle	3,66 meter (12') 4,27 meter (14') 4,88 meter (16') 6,10 meter (20')	2501001366 2501001427 2501001488 2501001610
			CS TRACK GREY Extruded aluminium, powder coating, factory lubricated	10/bundle	6,10 meter (20')	2501003610
			CS TRACK BLACK Extruded aluminium, powder coating, factory lubricated.	10/bundle	6,10 meter (20')	2501006610
	●		CS INBOUW RAIL 6 mtr	10/bundel	mat wit mat zwart	2531011600-MAT 2531016600-MAT
●			CS/CCS/FMS TRACK CONNECTOR Used to make a solid connection between two pieces of track.	10/box	white matt white grey black matt black	2518401000-A 2518401000-A-M 2518403000-A 2518406000-A 2518406000-A-M
	●		CS RECESS TRACK CONNECTOR GALVANISED SET	1/bag		2530401000
●			CS ENDCAP UNIVERSAL LONG WITH SCREW	100/box	white silver black	2516400000 2516403000 2516406000
●			CS ENDCAP UNIVERSAL SHORT WITH SCREW	100/box	white grey black	2516401001 2516403001 2516406001
	●		CS RECESS END CAP LONG Metal, powder coated	1/ doos	mat wit mat zwart	2536401000-MAT 2536406000-MAT
	●		CS RECESS END CAP SHORT Metal, powder coated	1/ doos	mat wit mat zwart	2536401001-MAT 2536406001-MAT
●			CS / CS RECESS / CCS AS CARRIER Clickable, offset, constructed of UV-resistant plastic. 10 Carriers on a break-away strip. Can be clicked in after.	250/box	white grey black	2510101000 2510103000 2510106000
●			CS STOPCARRIER Clickable	100/box	white	2510201000
●			CS / CCS CARRIER AS WITH HOOK Clickable	100/box	white	2510501000
●			CS ECONOMY SLIDE Can turn in the track.	500/box 500/box	white black	2510601000 2510606000
●			CS BALL BEARING CARRIER 16MM SMALL	100/box	white black	2512000016 2512006016
●			CONTRACT ROLLER CARRIER For a silent and smoothly operation with heavier curtains, also for CS Recess. Designed for use with butterfly pleats.	100/box	white black	4831001000 4831006000
●			CS UNDERLAP CARRIER R/L	25/box	white	2514600000
●			CS OVERLAP CARRIER R/L	25/box	white	2514700000

CS	CS RECESS	ARTICLE	PACKING UNIT	ART.NR
●		 CS MASTER CARRIER BASE R/L WHITE	25/box	white 4814500000
●		 PROLONGED OVERLAP ARM 150MM R/L for click-on stiffener	15/box	white 9500001010
●		 STIFFNER "CLICK-ON"	15/box	5116001001
●		 Z-ARM UNIVERSAL 175MM R/L Ideal for blackout	15/box	white black 9500001030 9500006030
●		 FMS EASYFLEX CURVED ARM R/L WHITE	15/box	white black 5135901020 5135906020
●		 MTS SUSPENSION CEILING BRACKET Length: 10 cm (4") - 100 cm (40") Complete with MTS Insert Screw and MTS Top Piece	1/each	white 4518201000
		MTS SUSPENSION CEILING BRACKET 1,50 MTR WHITE Length: 100 cm (40") - 150 cm (59") Complete with MTS insert screw and MTS Top Piece	1/each	white black 4518201500 4518206150
		MTS SUSPENSION CEILING BRACKET 2,00 MTR WHITE Length: 200 cm (78") Complete with MTS insert screw and MTS Top Piece	1/each	white 4518202000
●		 SUSPENSION BRACKET CLIP FOR KS For CS, to be used in combination with the MTS Suspension Ceiling Bracket.	50/box	white black 1016901000 1016906000
●		 SMART KLICK CEILING BRACKET INCL COVER CAP "Klicks" onto track, powder coated.	100/box	white grey black 1018201001 1018203001 1018206001
●		 FALSE CEILING BRACKET (METAL) For installation on to a suspended ceiling. The track can be fixed in any angle.	25/box	white black 4519001000 4519006000
●		 SMART KLICK CEILING BRACKET DOUBLE LONG Distance between two tracks: 90 mm (3,5")	30/box	white black 1018601000 1018606000
		SMART KLICK CEILING BRACKET DOUBLE SHORT		1018611000
●		 KS ADJUSTABLE WALL BRACKET, SINGLE 7,5 - 11,5 cm	100/box	white grey 1020801115 1020803115
●		 KS ADJUSTABLE WALL BRACKET, DOUBLE 6,5 - 19,5 cm	50/box	white 1020801195

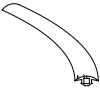
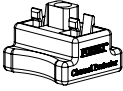
CS	CS RECESS	ARTICLE	PACKING UNIT		ART.NR	
●			ALUMINIUM WALL BRACKET 7.5 cm single (3') Maximum load: 25 kg/mtr.	20/box	white grey black	1020301075 1020303075 1020306075
			ALUMINIUM WALL BRACKET 10 cm single (4') Maximum load: 20 kg/mtr.	20/box	white grey black	1020301100 1020303100 1020306100
			ALUMINIUM WALL BRACKET 15 cm double (6') Maximum load: 13 kg/mtr.	15/box	white grey black	1020301150 1020303150 1020306150
			ALUMINIUM WALL BRACKET 20 cm double (8') Maximum load: 9 kg/mtr.	15/box	white grey black	1020301200 1020303200 1020306200
			ALUMINIUM WALL BRACKET 25 cm triple (10') Maximum load: 5 kg/mtr.	15/box	white grey black	1020301250 1020303250 1020306250
●			COVER CAP FOR SMART KLICK ALUMINIUM WALL BRACKET	50/box	white grey black	1021301000 1021303000 1021306000
●			FLICKSTICK FIBERGLASS	50/box	92 cm 122 cm 152 cm	1065101092 1065101122 1065101152
			FLICKSTICK TRANSPARENT	50/box	92 cm 122 cm 152 cm	1065102092 1065102122 1065102152
			FLICKSTICK WHITE ALUMINIUM	50/box	92 cm 122 cm 152 cm 202 cm	1065111092 1065111122 1065111152 1065111202
			FLICKSTICK SILVER ALUMINIUM	50/box	92 cm 122 cm 152 cm	1065113092 1065113122 1065113152
			FLICKSTICK BLACK ALUMINIUM	50/box	92 cm 122 cm 152 cm	1065116092 1065116122 1065116152
			FLICKSTICK ANTIQUE ALUMINIUM	50/box	92 cm 122 cm 152 cm	1065119092 1065119122 1065119152
●			VELCRO HOTEL PROFILE Inside frame fix, to reduce light leakage in combination with Looptape	120 mtr/bundle		3581601600
			LOOPTAPE	25 mtr/roll		
●			CONTRACT BENDING TOOL BASIC (without bending wheel)	1/each		2560000000
			CS/CCS/FMS BENDING WHEEL	1/each		
●			CS/FMS BENDING STRIPS For CS track, length: 90 cm (35,4")	1/set		8500000001
			CS/FMS BENDING STRIP FOR ELECTRIC POWERED BENDER Length 7 meter (23')	1/piece		
●			BENDING STAND Stand for contract bending tool	1/each		2560800000
●			ELECTRIC POWERED BENDER Available in 230V or 115V To create continuous curves and arches minimum radius 50 cm (20")	1/each		1060500000

CS	CS RECESS	ARTICLE	PACKING UNIT	ART.NR	
●		 <p>CS/CCS BENDING WHEELS For Electric Powered Bender. Complete set of 3 wheels.</p>	1/set	2560700000	
●		<p>voorbeeld-afbeelding</p>  <p>ELECTRIC POWERED RAILCUTTER 230 Volt EU</p>	1/each	1061100000	
		<p>BLADE FOREST CUTTER NEW MODEL</p>	1/each	1061200001	
●		 <p>FOREST LUBRICANT To lubricate components during assembly.</p>	1/each	5109010000	
●		 <p>MTS FLEXIBLE DUST STRIP To seal the curtain track opening of the ks recess track during finishing phase.</p>	50 mtr/roll	4518501000	
●		 <p>CHANNEL PROTECTOR with bit</p>	1/set	purple	1070600000
●		 <p>SCREW M3 X 25MM FOR KS RECESS PROFILE STAINLESS STEEL</p>	250/box		Forest073

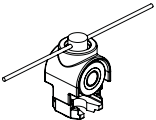
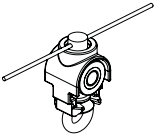
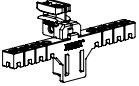
CS	CS RECESS	GENERAL WAVE COMPONENTS	ARTICLE	PACKING UNIT	ART.NR	
●	●		<p>CONTRACT EASYFOLD BASE ROLLER 60% 80MM For a silent and smoothly operation on CS, CS Recess, FMS Dual and CRS 28mm</p>	500/roll	white black	4833001060 4833006060
			<p>CONTRACT EASYFOLD BASE ROLLER 80% 60MM For a silent and smoothly operation on CS, CS Recess, FMS Dual and CRS 28mm</p>		white black	4833001080 4833006080
●	●		<p>CONTRACT EASYWAVE ROLLER 60% 80MM For a silent and smoothly operation on CS, CS Recess, FMS Dual and CRS 28mm</p>	500/roll	white black	4832001060 4832006060
			<p>CONTRACT EASYWAVE ROLLER 80% 60MM For a silent and smoothly operation on CS, CS Recess, FMS Dual and CRS 28mm</p>		white black	4832001080 4832006080
●	●		<p>WAVE ADJUSTABLE MASTER CARRIER For use with wave pleat curtains (Easyflex)</p>	25/box	white black	4813001050 4813006050
●	●		<p>WAVE ADJUSTABLE ENDSTOP For use with wave pleat curtains (FES). Height adjustable and blocks detachable for the correct wave pleat depth</p>	25/box	white black	4816001001 4816006001