

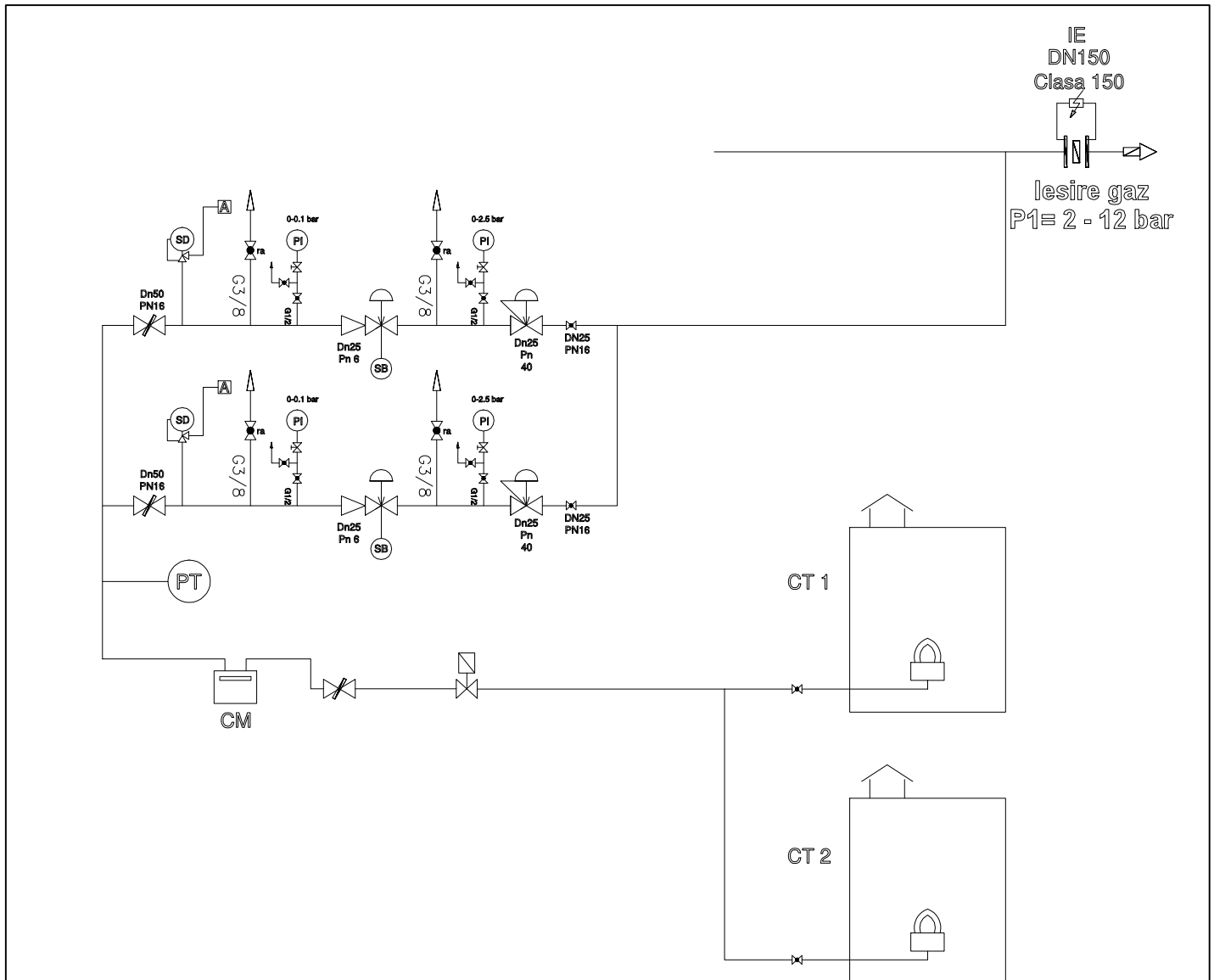













Schema tehnologică de bază centralei termice.

Anexa №3.1



LEGENDA

- | | |
|---|---|
|  RRM - Robinet Regulator actionat manual |  SB - Supapa de blocare |
|  Robinet fluture |  RG - Regulator cu actionare directa |
|  Aerisire |  Electroventil |
|  Reductie |  IE - Imbinare electroizolanta |
|  Robinet cu sfera |  SD - Supapa de descarcare |
|  PI - Manometru indicator | |
|  PT - Traductor de presiune | |
|  CM - Contor cu membrana | |
|  R - Robinet actionat manual | |