

FVW/VH 53

FAN COIL UNITS WITH CABINET AND 3-SPEED RADIAL FANS



floyd®



The picture and the descriptions are only a sample of the selected unit. The real unit configuration can change depending on versions and or accessories selected.

TECHNICAL FEATURES

General description.

Fan coil units with radial fan for floor installation. Vertical unit with front inlet and vertical delivery.

Frame.

Made from heavy galvanized sheet and protected by a prepainted sheet covering cabinet and ABS details, easily removed for possible maintenance and repair operations, complete with heat/sound insulation, regenerating filter, heat-resistant ABS polymer grills adjustable in 4 different directions and natural discharge condensation tray.

Fan.

Radial type directly coupled to a 6-speed single-phase electric motor, with 3 speeds connected in the standard configuration.

Heat exchange coil.

Made up of finned coil with copper pipes and aluminium fins with air vent on the headers.

TECHNICAL DATASHEET



FVW/VH 53

TECHNICAL DATA

Series		FVW
Version		VH
Model		FVW/VH 53
Static Pressure	Pa	0
Rows		3
Water connection		1/2 "G
Drain diameter		22 mm

Cooling conditions

Air side

Air flow	m ³ /h	690.0
Speed		5

Inlet

Dry bulb air temperature	°C	27.0
Wet bulb air temperature	°C	19.0
Relative humidity	%	47

Outlet

Dry bulb air temperature	°C	15.6
Wet bulb air temperature	°C	14.1
Relative humidity	%	86

Water side

Fluid		Water
Inlet fluid temperature	°C	7.0
Outlet fluid temperature	°C	12.0
Fluid flow	l/h	693.2
Pressure drop	kPa	26.0

Cooling performances

Total cooling capacity	kW	4.04
Sensible cooling capacity	kW	3.12
Dehumidification	kg/h	0.80

TECHNICAL DATASHEET



FVW/VH 53

Heating conditions

Air side

Air flow	m ³ /h	690.0
Speed		5

Inlet

Dry bulb air temperature	°C	20.0
Wet bulb air temperature	°C	19.0
Relative humidity	%	60

Outlet

Dry bulb air temperature	°C	55.5
Wet bulb air temperature	°C	25.4
Relative humidity	%	9

Water side

Fluid		Water
Inlet fluid temperature	°C	70.0
Outlet fluid temperature	°C	60.0
Fluid flow	l/h	713.8
Pressure drop	kPa	20.0

Heating performances

Heating capacity	kW	9.01
Rows		3

Sound data

Sound power levels	dB(A)	57.0
Sound pressure levels	dB(A)	46.0

Dimensions

Length	mm	1430
Height	mm	500
Depth	mm	210

Weight

Transport weight	kg	33
Operating weight	kg	31

FVW/VH 53

Electrical data

Power supply	V/Hz/Ph	230/1/50
Absorbed power	W	80.00
Absorbed current	A	0.36

Fan

Speed		5
Static Pressure	Pa	0
Air flow	m ³ /h	690.0

Notes

(1) Sound pressure measured at a distance of 1 meter and with reverberation time of 0,5 s.

TECHNICAL DATASHEET



FVW/VH 53

DIMENSIONAL DRAWING

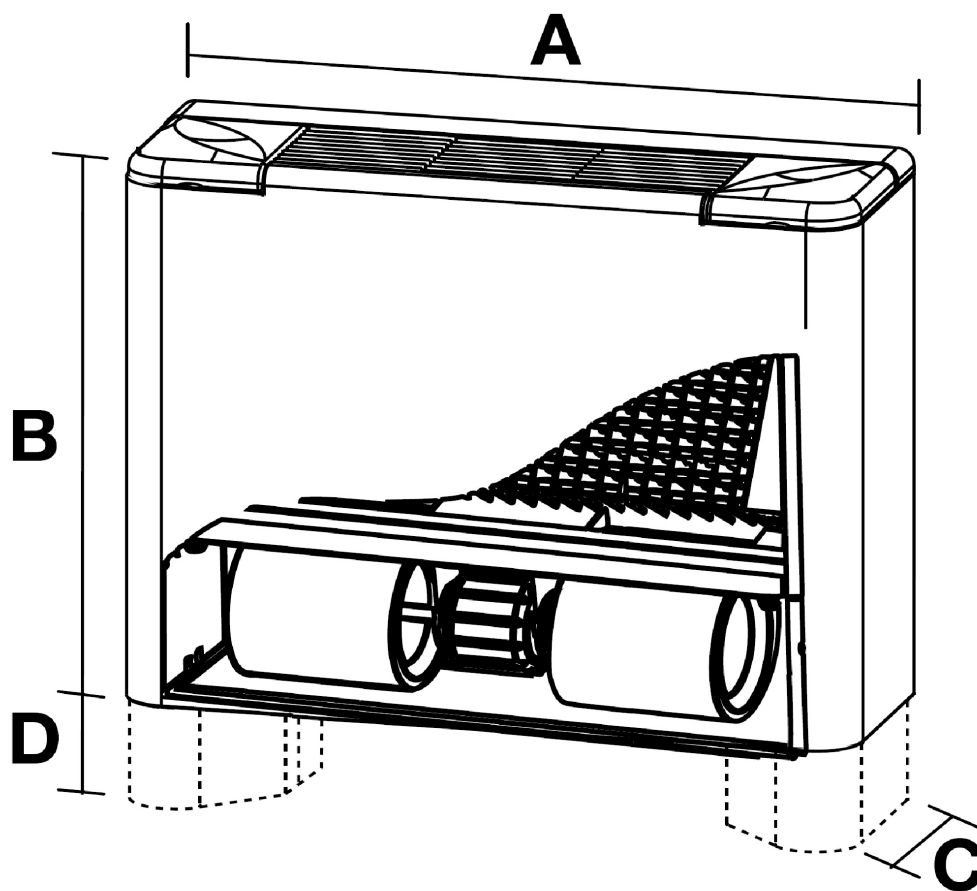

Dimensions

A	mm	1430
B	mm	500
C	mm	210