

EcoFit[®]

hip stem system





TABLE OF CONTENTS

INDICATIONS/CONTRAINDICATIONS.....	4
PREOPERATIVE PLANNING.....	5
DESIGN CHARACTERISTICS.....	6
SURGICAL TECHNIQUE.....	7
IMPLANTS.....	14
INSTRUMENTS.....	18

Nota Bene: The author of this technique has outlined the procedure for the uncomplicated surgical scenario. Ultimately however it is the operating surgeon who is best placed to assess and address the individual needs of each patient.

Copyright Information: EcoFit®, implaFix®, implavit®, implatan® and implacross® are registered trademarks of implantcast GmbH. The use and/or copying of the content of this brochure, be it wholly or in part, is only allowed with the prior written permission of implantcast GmbH. BIOLOX® is a brand name of CeramTec AG.

INDICATIONS/CONTRAINDICATIONS

Indications

The decision for replacement of the joint should be based on careful evaluation. The indication for this type of surgery should only be made when all other conservative or surgical alternatives are less promising.

Danger of post-operative complications can be limited by careful evaluation of the individual anatomical and load conditions, the condition of the soft tissues and the condition of the bone bed for the implants.

The provision of prostheses is generally indicated only in patients whose skeleton is fully grown.

Before intervention, preoperative examinations should be performed. The examinations depend on the patient's history.

Under consideration of these conditions the hip joint replacement applies to the following indications:

- Non-inflammatory degenerative joint disease including osteoarthritis and avascular necrosis,
- Post-traumatic osteoarthritis,
- Fractures,
- Rheumatoid arthritis.

The surgeon decides which version of prosthesis for the individual patient is used. This decision depends on several factors, such as the age and the patient's weight, bone quality, shape of the bone and deformation of the joint.

Contraindications

The longevity of an orthopaedic joint replacement device can be reduced by biological aspects, material characteristics and biomechanical factors. Patient selection and indication should be carefully monitored especially in patients who are overweight, patients with high physical activity levels and patients younger than 60 years of age.

An absolute contraindication is a known allergy to any of the implant materials used. The label on the secondary packaging of each component specifies the material used. Indication for testing, it is strongly recommended to perform an allergy test.

Further absolute contraindications are infection and osteomyelitis.

The relative contraindications include:

1. Anatomic conditions, which preclude or are not expected to maintain an adequate bony support of the implant or do not allow the implantation of a sufficiently large prosthesis.
 - Insufficient quantity and quality of bone stock, e.g. as a result of osteoporosis or osteomalacia
 - Vascular disease of the affected limb
2. Metabolic disorders that can affect a stable anchorage of the implant
3. Bone tumors in the implant fixation area
4. Neuromuscular diseases that can impair the affected limb
5. Lack of patient compliance
6. Mental or neurological conditions that affect the ability or willingness of patients to comply with medical instructions, especially during the healing phase
7. Obesity.

Risk factors

The following risk factors may affect the success of joint replacement:

- Nicotine and/or drug abuse
- Alcoholism
- Muscle insufficiency
- Severe deformities, which lead to an impairment of the anchorage, the exact positioning or function of the implant
- Excessive loading of the operated joint by strong physical work and/or inappropriate sports
- Therapies that may affect bone quality.

Post-operative Instructions

Post-operative patient care, patient instructions and warnings are of the utmost importance.

The use of an external support of the operated limb for a limited period is recommended.

Active and passive movements of the patient should be monitored.

The post-operative regime should be aimed at the prevention of overloading of the joint and stimulation of the healing process.

Regular monitoring of the position and condition of the prosthetic components and the surrounding bone is recommended.

For more information, please refer to the instructions for use.

Item Number: 09300029GB „Cemented Femoral HipStems“

Item Number: 09300028GB „Cementless Femoral HipStems“

PREOPERATIVE PLANNING

Preoperative planning and precise surgical techniques are mandatory for optimal results. The instructions and the procedure given in the surgical technique to the system must be adhered to. Familiarity with the recommended surgical technique and its careful application is essential to achieve the best possible outcome.

Before surgery a surgical planning with regard to the dimensions of the prosthetic model and the positioning of the implant components in the bone has to be carried out by the surgeon.

For this purpose, x-ray templates are available:

Digital templates: Digital templates are included in the data base of the common planning systems. For missing templates, please contact the provider of the planning software and request for these templates.

Radiographic templates: Alternatively radiographic templates are available in various scale factors, which can be obtained from your local representative.

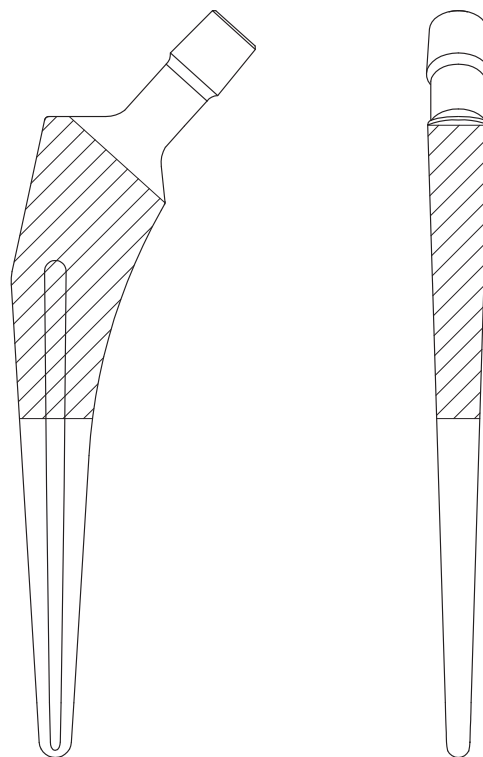

view A/P and M/L

EcoFit® hip stem cementless cpTi std.

Further prior to surgery the following should be ensured:

- all needed components are available during surgery. An adequate number of various implant components should be available for surgery. It should be determined whether the implantation should be done with or without the use of bone cement.
- all instruments for the implantation are present and are matching the corresponding implants. The insertion instruments must be adapted to the implant. The implants may only be used with the instruments provided by implantcast GmbH. An exception are exclusively the standardized instruments used during surgery.

The correct sized instruments are used during surgery to prevent damage to the implants.

DESIGN CHARACTERISTICS



standard and lateralised version



postoperative X-Ray EcoFit® stem

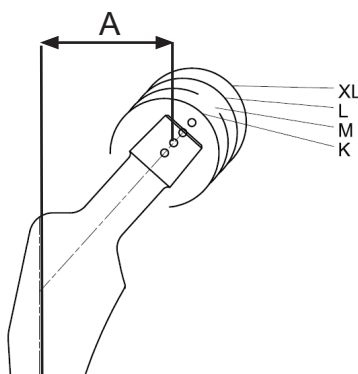

Offset measurement (A) EcoFit® stem in mm

size	6,25	7,5	8,75	10	11,25	12,5	13,75	15	17,5	20
standard	34,5	35,2	35,8	36,5	37,1	37,7	38,3	39	40,2	41,5
lateral	42,3	43	43,6	44,3	44,9	45,5	46,1	46,8	48	49,3

The EcoFit®-total hip system includes a complete variety of cementless and cemented hip stems for the primary treatment of the hip joint.

Aside from the standard stem, lateralised stems are also available (CCD-angle: 138°). The modular instrumentation allows the adaptation to the patients' anatomy and enables the surgeon to customize the treatment to the patient needs. The system includes 10 sizes of cementless and 6 sizes of cemented stems.

The cementless stems are available with implaFix® cpTi coating as well as implaFix® HA coating (hydroxyapatite). The cemented stems are available in matt and highly polished version.

The choice of the material for each version is based on the scientific outcome of actual hip arthroplasty. Due to this the cementless stems are made of implatan® TiAl₆V₄, the cemented stems are made of implavit® CoCrMo. Economical aspects were considered when the variety, modularity and the pricing were concerned.

SURGICAL TECHNIQUE

Femoral neck osteotomy

Due to the preoperative planning the neck of the femur is resected (Fig.1).

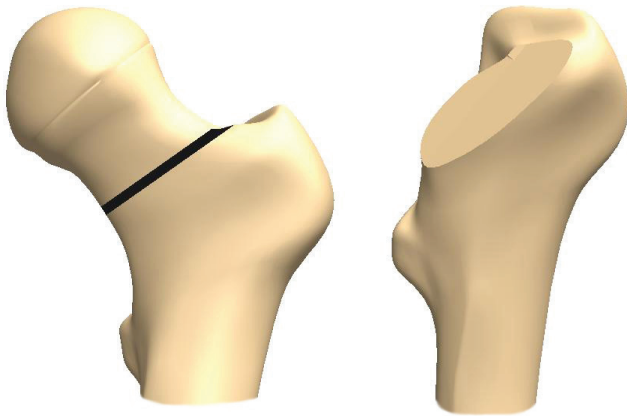

Figure 1

Preparation of the acetabular bone

If the preparation of the acetabular bone is necessary, please consider the surgical technique provided in conjunction with the preferred implant.

Opening of the femoral canal

Please use the special awl to open the intramedullary canal (Fig. 2a).



Figure 2a

Notice:

Start to use the straight awl to open the canal laterally, so the canal is prepared in the length axis of the femur. Alternatively the special box chisel can be used (Fig. 2b).

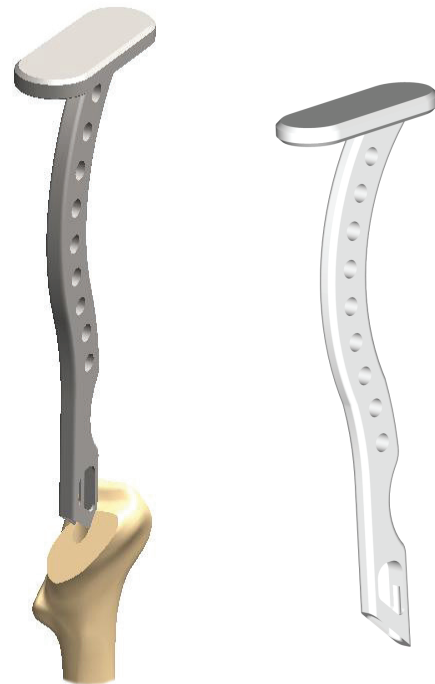

Figure 2b

SURGICAL TECHNIQUE

Broaching of the femoral canal

Begin with the smallest broach to prepare the intramedullary bone. If a large sized stem has been planned please begin with a broach which is 3 to 4 sizes smaller than the implant size. Enlarge the bone preparation with the broaches of increasing sizes until you reach the preoperatively chosen stem size (Fig. 3a).

Notice:

The broaches should be impacted until the depth marking on the handle corresponds to the rotational centre of the hip joint (regularly the marking corresponds to the tip of the greater trochanter) (Fig. 3b).

If the mark reaches the tip of the greater trochanter a head of the neck length medium will meet the centre of rotation.

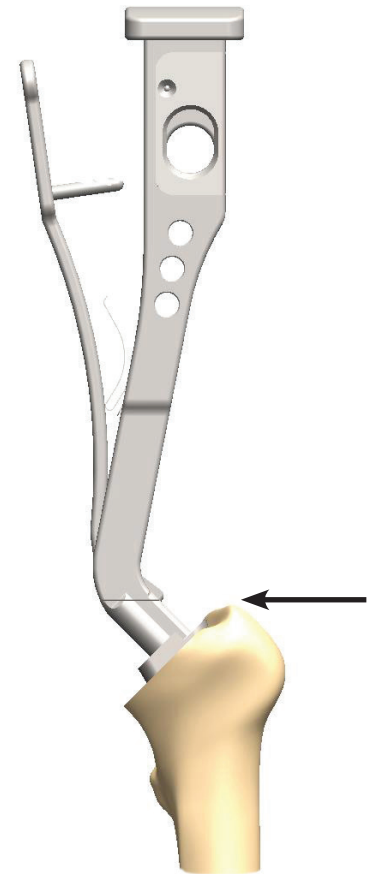
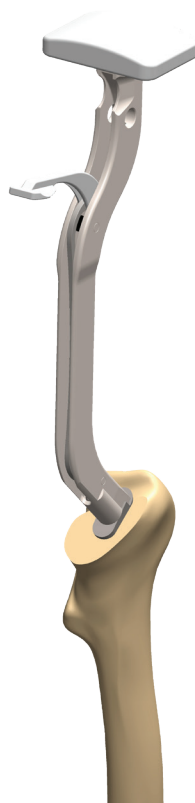

Figure 3b



Figure 3a

Old design



New design

SURGICAL TECHNIQUE

Trial reduction

Remove the broach handle (fig. 4a). Attach the trial neck 'standard' (Fig. 4b) and the trial head (28 mm or 32 mm) of the length 'medium' (Fig. 4c).

Reduce the joint and check the range of motion as well as the stability of the joint.

If necessary replace the trial neck by the trial neck 'lateralised' or a head of a different neck length and check again the range of motion.

If sufficient stabilization is achieved, remove all instruments and trial components (Fig. 4d).



Figure 4a



Figure 4b



Figure 4c



Figure 4d

SURGICAL TECHNIQUE

Implantation of the EcoFit® stem

Cementless implantation

Choose the stem of the same size as the last broach. Use the stem impactor to insert the cementless EcoFit® stem (Fig. 5a and 5b).

Cemented implantation

Please use the stem which is one size smaller than the last broach.

Please consider the table below to choose the cemented stem of the appropriated size.

broach	cemented stem
7,50mm	6,25mm
8,75mm	7,50mm
10,00mm	7,50mm
11,25mm	10,00mm
12,50mm	10,00mm
13,75mm	12,50mm
15,00mm	12,50mm
17,50mm	15,00mm
20,00mm	17,50mm

Clean and dry the intramedullary canal. Insert the bone cement and impact the cemented stem by using the impactor.

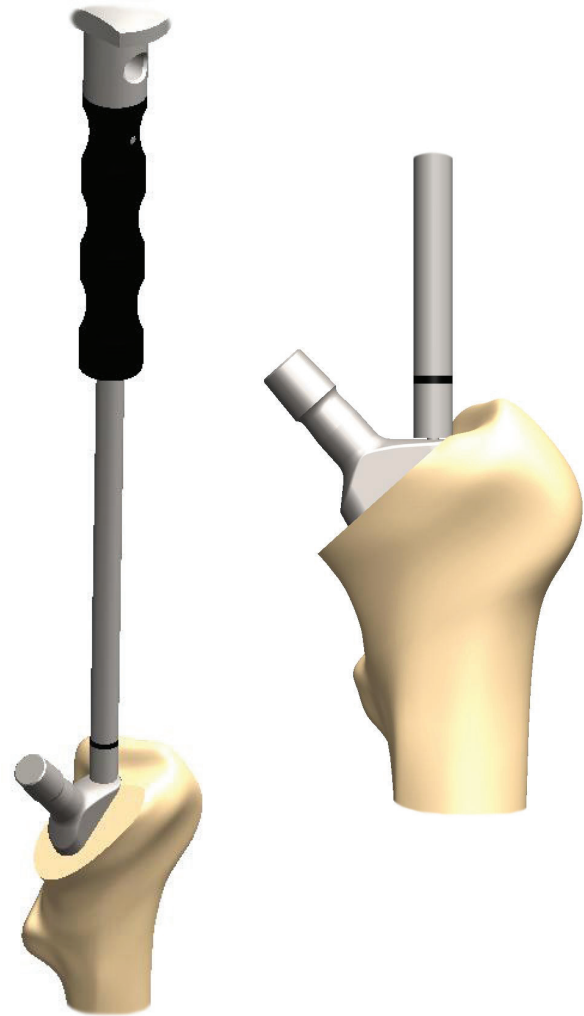

Figure 5a

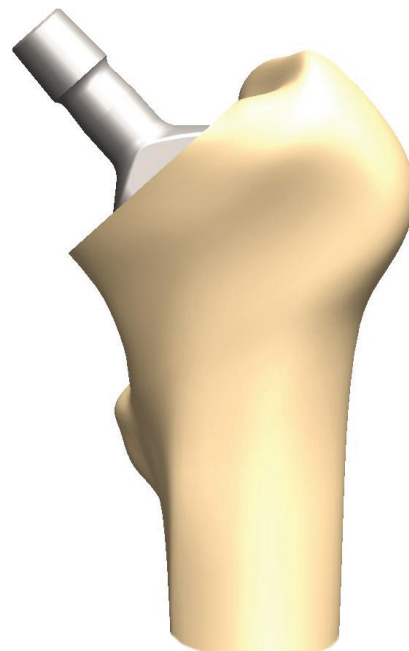

Figure 5b

SURGICAL TECHNIQUE

Impaction of the head

It is optional to perform a final stability and range of motion test (Fig 6). Therefore insert a trial head of the formally used neck length.

Clean and dry the taper (12/14) and add the original head to the tester of the stem.

Use the head implants with a few strokes of a mallet to secure the taper connection (Fig. 7).



Figure 6

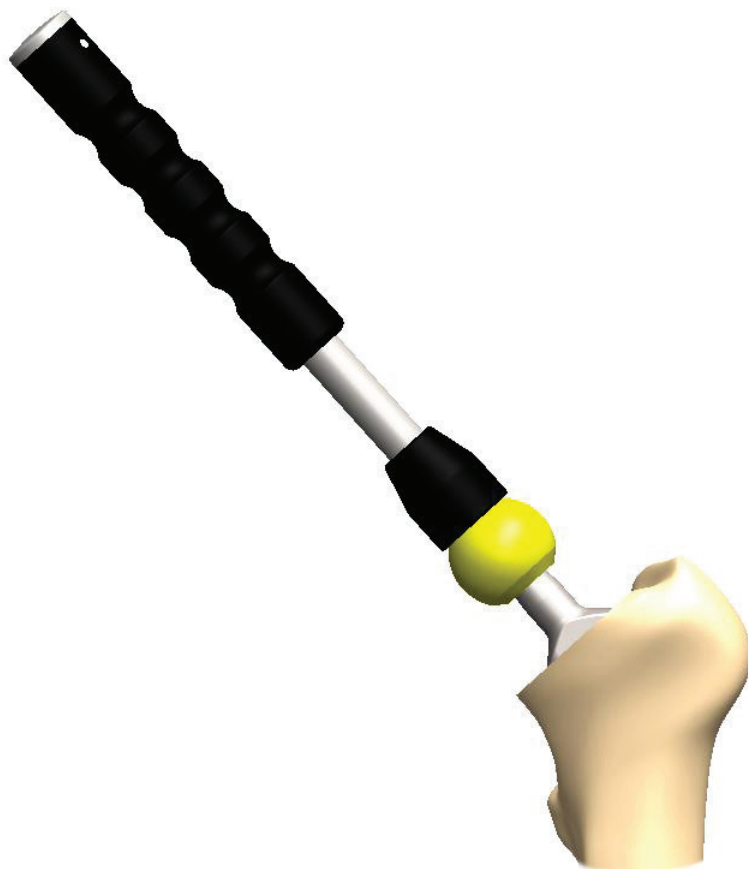
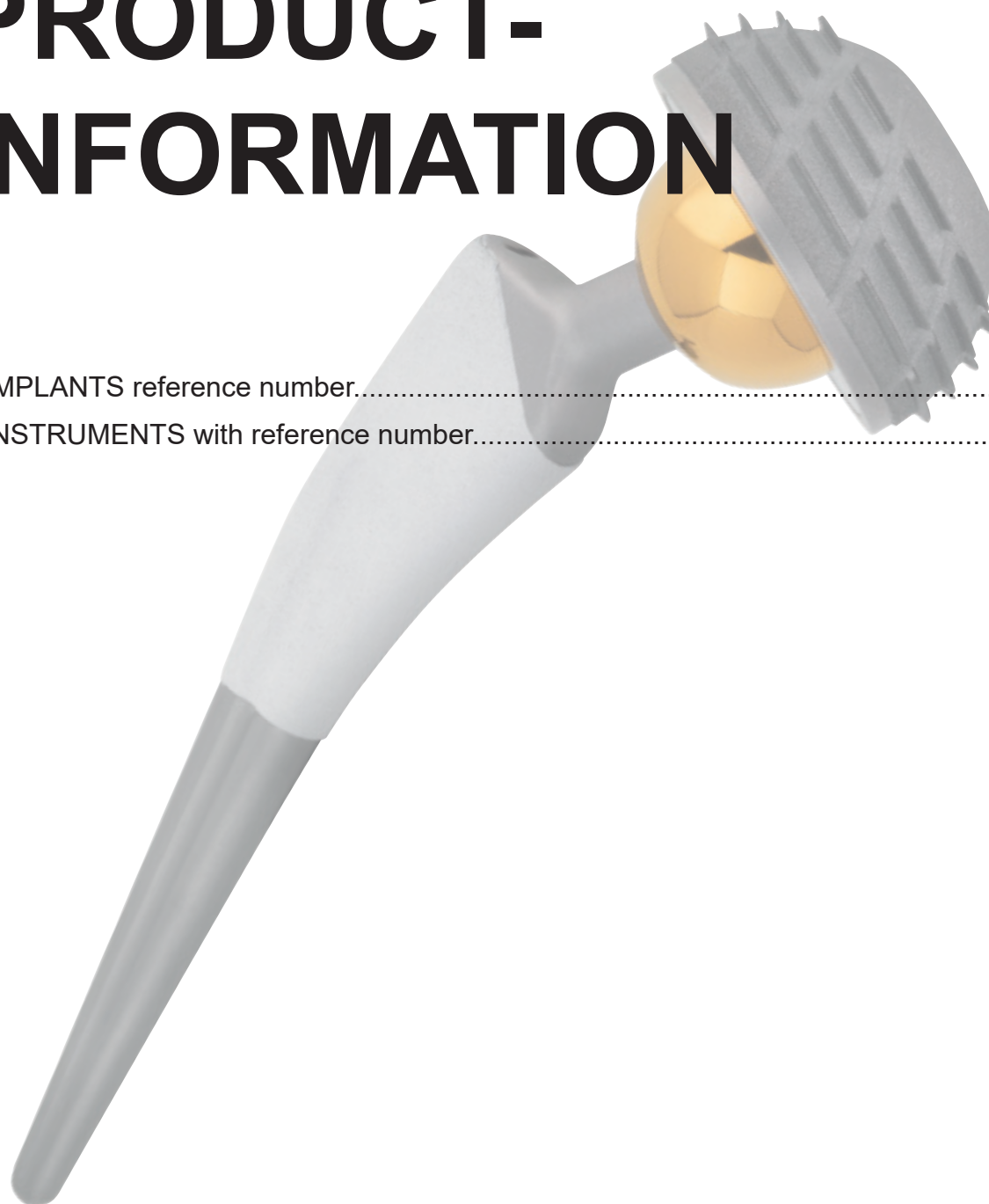

Figure 7

EcoFit®

PRODUCT- INFORMATION

IMPLANTS reference number.....	14
INSTRUMENTS with reference number.....	18



IMPLANTS



**EcoFit® stem, cementless,
implaFix® cpTi-coating**
implatan® TiAl₆V₄ acc. to ISO 5832-3
with implaFix® cpTi-coating

REF standard	size	length	REF lateralised
3039-3062	6,25mm	132,1mm	3039-4062
3039-3075	7,5mm	134,6mm	3039-4075
3039-3087	8,75mm	137,1mm	3039-4087
3039-3100	10mm	139,6mm	3039-4100
3039-3112	11,25mm	142,1mm	3039-4112
3039-3125	12,5mm	144,6mm	3039-4125
3039-3137	13,75mm	147,1mm	3039-4137
3039-3150	15mm	149,6mm	3039-4150
3039-3175	17,5mm	154,6mm	3039-4175
3039-3200	20mm	159,6mm	3039-4200



**EcoFit® stem, cementless,
implaFix® HA-coating**
implatan® TiAl₆V₄ acc. to ISO 5832-3
with implaFix® cpTi-coating and hydroxyapatite coating
acc. to ISO 13779-2

REF standard	size	length	REF lateralised
3038-3062	6,25mm	132,1mm	3038-4062
3038-3075	7,5mm	134,6mm	3038-4075
3038-3087	8,75mm	137,1mm	3038-4087
3038-3100	10mm	139,6mm	3038-4100
3038-3112	11,25mm	142,1mm	3038-4112
3038-3125	12,5mm	144,6mm	3038-4125
3038-3137	13,75mm	147,1mm	3038-4137
3038-3150	15mm	149,6mm	3038-4150
3038-3175	17,5mm	154,6mm	3038-4175
3038-3200	20mm	159,6mm	3038-4200

IMPLANTS

EcoFit® stem, cementless, implaFix® total HA-coating

implatan® TiAl₆V₄ acc. to ISO 5832-3 with cpTi-coating
and hydroxyapatite coating acc. to ISO 13779-2

REF standard	size	length	REF lateralised
3038-6062	6,25mm	132,1mm	3038-7062
3038-6075	7,5mm	134,6mm	3038-7075
3038-6087	8,75mm	137,1mm	3038-7087
3038-6100	10mm	139,6mm	3038-7100
3038-6112	11,25mm	142,1mm	3038-7112
3038-6125	12,5mm	144,6mm	3038-7125
3038-6137	13,75mm	147,1mm	3038-7137
3038-6150	15mm	149,6mm	3038-7150
3038-6175	17,5mm	154,6mm	3038-7175
3038-6200	20mm	159,6mm	3038-7200



IMPLANTS

EcoFit® stem, cemented

implavit® CoCrMo acc. to ISO 5832-4



REF standard	size	length	REF lateralised
3039-6062	6,25mm	132,1mm	3039-8062
3039-6075	7,5mm	134,6mm	3039-8075
3039-6100	10mm	139,6mm	3039-8100
3039-6125	12,5mm	144,6mm	3039-8125
3039-6150	15mm	149,6mm	3039-8150
3039-6175	17,5mm	154,6mm	3039-8175

The EcoFit® stem cemented is available with TiN-coating on request (*N).



EcoFit® stem, cemented, highly polished

implavit® CoCrMo acc. to ISO 5832-4

REF standard	size	length	REF lateralised
3038-0062	6,25mm	132,1mm	3038-1062
3038-0075	7,5mm	134,6mm	3038-1075
3038-0100	10mm	139,6mm	3038-1100
3038-0125	12,5mm	144,6mm	3038-1125
3038-0150	15mm	149,6mm	3038-1150
3038-0175	17,5mm	154,6mm	3038-1175

EcoFit® Subsider

for the use in conjunction with highly polished cemented EcoFit® stems
material: PMMA (polymethylmethacrylate)



REF	size	combinable with stem size
0299-0750	2	6,25mm
0299-1000	3	7,5mm
0299-1250	4	10,0mm
0299-1500	5	12,5mm
0299-1650	6	15mm und 17,5mm

IMPLANTS

BIOLOX® forte
Al₂O₃ acc. to
ISO 6474-1

ic-head

BIOLOX® delta
Al₂O₃ und ZrO₂
acc. to ISO 6474-2

REF	size	REF
2587-2800	28mm, S	2586-2800
2587-2805	28mm, M	2586-2805
2587-2810	28mm, L	2586-2810
2587-3200	32mm, S	2586-3200
2587-3205	32mm, M	2586-3205
2587-3210	32mm, L	2586-3210
-	32mm, XL	2586-3215
2587-3600	36mm, S	2586-3600
2587-3605	36mm, M	2586-3605
2587-3610	36mm, L	2586-3610
-	36mm, XL	2586-3615
-	40mm, S	2586-4000
-	40mm, M	2586-4005
-	40mm, L	2586-4010
-	40mm, XL	2586-4015



CoCrMo
implavit® CoCrMo
acc. to ISO 5832-12

ic-head

Titan
implatan® TiAl₆V₄
acc. to ISO 5832-3
with TiN-coating

REF	size	REF
2387-2800	28mm, S	2787-2800
2387-2805	28mm, M	2787-2805
2387-2810	28mm, L	2787-2810
2387-2815	28mm, XL	2787-2815
2387-2820*	28mm, XXL	2787-2820*
2387-2825*	28mm, XXXL	2787-2825*
2387-3200	32mm, S	2787-3200
2387-3205	32mm, M	2787-3205
2387-3210	32mm, L	2787-3210
2387-3215	32mm, XL	2787-3215
2387-3220*	32mm, XXL	2787-3220*
2387-3225*	32mm, XXXL	2787-3225*
2387-3600	36mm, S	2787-3600
2387-3605	36mm, M	2787-3605
2387-3610	36mm, L	2787-3610
2387-3615	36mm, XL	2787-3615
2387-3620*	36mm, XXL	2787-3620*
2387-3625*	36mm, XXXL	2787-3625*



NOTE: The reference numbers marked with * can be only combined with the EcoFit® stem cementless (cpTi, HA, T-HA coating). Detailed information with regard to the combination possibilities can be removed from the IFU.

INSTRUMENTS

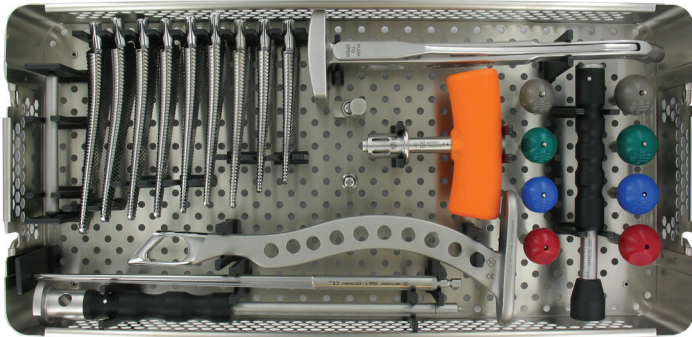

7999-7043
EcoFit® easy lock
Container

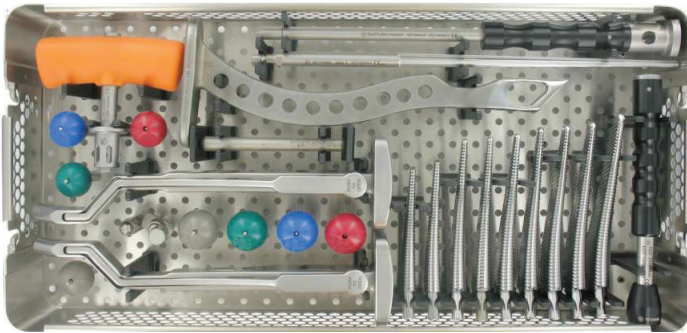

7999-7049
EcoFit® easy lock
GIS® Container

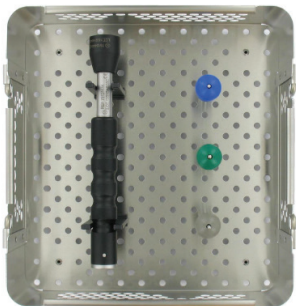

7999-7966
trial head container 22mm S-L

INSTRUMENTS

7999-7074
EcoFit® Container II

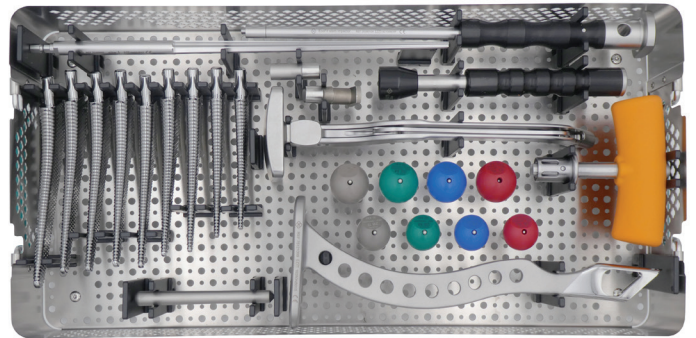

7999-7075
EcoFit® Container III
Note: to combine with the
broach handle containers

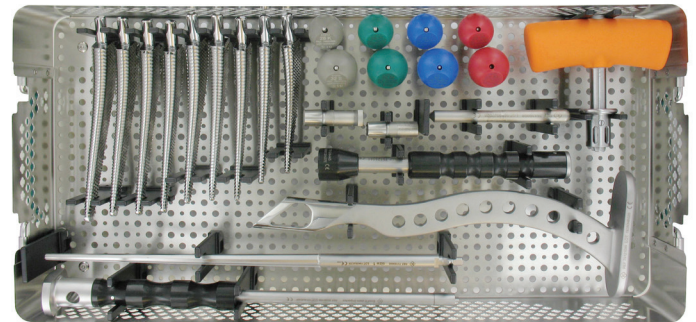

7999-7076
EcoFit® broach handle GIS®
left/right container

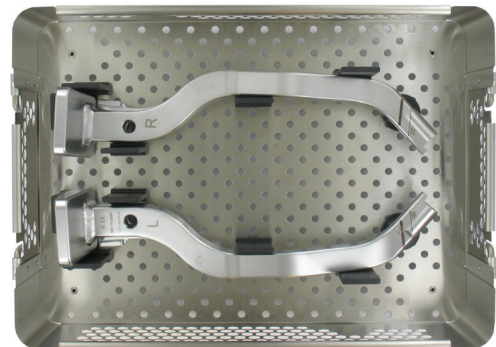

0220-1201
EcoFit® broach handle with double
offset left/right container

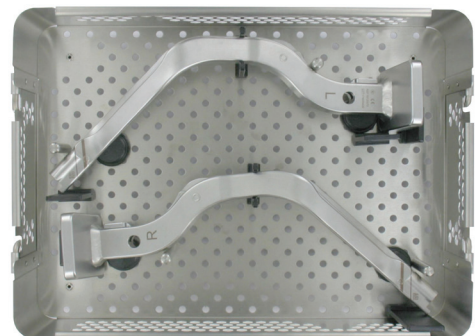

INSTRUMENTS

CONTAINER 7999-7043 / 7999-7049 / 7999-7075 / 7999-7074



cross bar tapered 10mm

7513-9999

7513-9998 alternatively



ic T-handle Zimmer-Jakobs

4223-0023



femoral reamer straight size 1

7516-0005



box chisel

7512-1099



EcoFit® trial neck

7039-1214 standard

7040-1214 lateralized



EcoFit® stem impactor

3039-0109

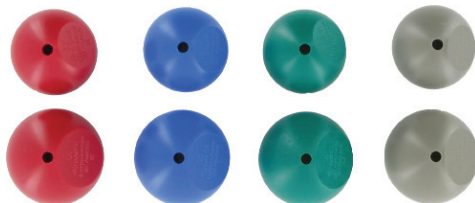

trial head snap taper 12/14mm

7962-2800 / 7965-2800 Ø 28mm short

7962-2805 / 7965-2805 Ø 28mm medium

7962-2810 / 7965-2810 Ø 28mm long

7962-2815 / 7965-2815 Ø 28mm extra long

7962-3200 / 7965-3200 Ø 32mm short

7962-3205 / 7965-3205 Ø 32mm medium

7962-3210 / 7965-3210 Ø 32mm long

7962-3215 / 7965-3215 Ø 32mm extra long



head impactor

7512-4444

INSTRUMENTS

EcoFit® broach

7039-3062	6,25mm
7039-3075	7,50mm
7039-3087	8,75mm
7039-3100	10,00mm
7039-3112	11,25mm
7039-3125	12,50mm
7039-3137	13,75mm
7039-3150	15,00mm
7039-3175	17,50mm

(The EcoFit® broach 20mm (REF 7039-3200)
is only available on request)

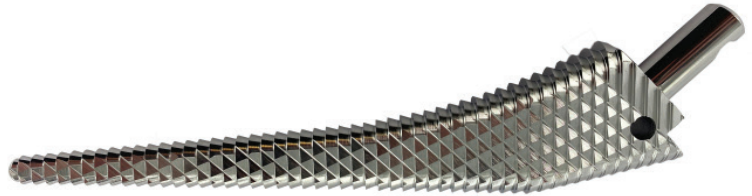

EcoFit® broach handle easy lock

(only in container 7999-7043)

7512-0040

alternative: 7512-0076 incl. screw



EcoFit® broach handle easy lock GIS®

(only in container 7999-7049)

7512-0048 right

7512-0049 left

alternative: 7512-0077 left incl. screw

7512-0078 right incl. screw

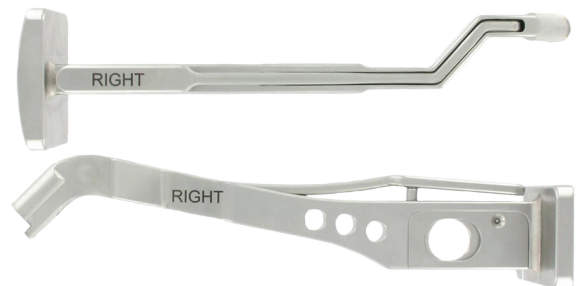

EcoFit® broach handle

(only in Container 7999-7074)

7512-0112



INSTRUMENTS

CONTAINER 7999-7076



EcoFit® broach handle GIS®

REF 7512-0067 left

REF 7512-0068 right

CONTAINER 0220-1201



EcoFit® broach handle with double offset

REF 7512-0073 left

REF 7512-0074 right

CONTAINER 7999-7966



head impactor

7512-4444



trial head snap taper 12/14mm

7962-2200 / 7965-2200 Ø 22mm short

7962-2205 / 7965-2205 Ø 22mm medium

7962-2210 / 7965-2210 Ø 22mm long

SEPARATE INSTRUMENTS



trial head snap taper 12/14mm

7962-2820 / 7965-2820 Ø 28mm XX long

7962-2825 / 7965-2825 Ø 28mm XXX long

7962-3220 / 7965-3220 Ø 32mm XX long

7962-3225 / 7965-3225 Ø 32mm XXX long

7962-3620 / 7965-3620 Ø 36mm XX long

7962-3625 / 7965-3625 Ø 36mm XXX long



implantcast

implantcast GmbH
Lüneburger Schanze 26
21614 Buxtehude
Germany
phone: +49 4161 744-0
fax: +49 4161 744-200
e-mail: info@implantcast.de
internet: www.implantcast.de



Your Local Distributor:

ECOSTOPE-120620

